

# Comprehensive Coordination Chemistry II

**FROM BIOLOGY TO NANOTECHNOLOGY**

**EDITORS-IN-CHIEF**

**Jon A McCleverty  
Thomas J Meyer**

**Edited by  
A.B.P. Lever**

**Volume 1  
Fundamentals: Ligands, Complexes,  
Synthesis, Purification, and Structure**

EDITORS-IN-CHIEF

**Jon A McCleverty**

*University of Bristol, UK*

**Thomas J Meyer**

*Los Alamos National Laboratory, New Mexico, USA*

# Volume Editors

Volume 1: Fundamentals: Ligands, Complexes, Synthesis, Purification,  
and Structure

**A B P Lever**

*York University, Toronto, Ontario, Canada*

Volume 2: Fundamentals: Physical Methods, Theoretical Analysis,  
and Case Studies

**A B P Lever**

*York University, Toronto, Ontario, Canada*

Volume 3: Coordination Chemistry of the s, p, and f Metals

**G F R Parkin**

*Columbia University, New York, USA*

Volume 4: Transition Metal Groups 3–6

**A G Wedd**

*University of Melbourne, Australia*

Volume 5: Transition Metal Groups 7 and 8

**E C Constable**

*University of Basel, Switzerland*

**J R Dilworth**

*University of Oxford, UK*

Volume 6: Transition Metal Groups 9–12

**D E Fenton**

*The University of Sheffield, UK*

Volume 7: From the Molecular to the Nanoscale: Synthesis, Structure,  
and Properties

**M Fujita**

*Nagoya University, Japan*

**A Powell**

*Karlsruhe University, Germany*

**C Creutz**

*Brookhaven National Laboratory, Upton, NY, USA*

Volume 8: Bio-coordination Chemistry

**L Que, Jr.**

*University of Minnesota, MN, USA*

**W B Tolman**

*University of Minnesota, MN, USA*

Volume 9: Applications of Coordination Chemistry

**M D Ward**

*University of Bristol, UK*

# International Advisory Board

A. Chakravorty

*Indian Association for the Cultivation of Science, Calcutta, India*

F. A. Cotton

*Texas A & M University, Texas, USA*

H. B. Gray

*Caltech, Pasadena, California, USA*

R. H. Holm

*Harvard University, Cambridge, Massachusetts, USA*

E. Kimura

*Hiroshima University, Minami-ku, Hiroshima, Japan*

M. Sargeson

*Australian National University, Canberra, Australia*

J.-P. Sauvage

*Universite Louis Pasteur, Strasbourg, France*

K. Wieghardt

*Max-Planck Institut fur Stahlenchemie, Germany*



# Preface

*Comprehensive Coordination Chemistry* (CCC), published in 1987, was intended to give a contemporary overview of the field. The goal was to provide both a convenient first source of information and a stimulus for further advances in the field.

In *Comprehensive Coordination Chemistry II* (CCC2) we have adopted the same general approach. Developments in coordination chemistry since 1982 are surveyed in an authoritative and critical manner taking into account important new trends in biology, materials science, and other areas.

As in many areas of science, it is impossible to provide a totally comprehensive review – the field has grown enormously in the past 20 years. Consequently, our intention is to provide the readers of the series with the most reliable and informative background information on particular areas of coordination chemistry based on key primary and secondary references. In doing so we recognize that those readers will be researchers at all levels including students, non-experts from other areas of science, and industrial chemists. Our hope is that CCC2 will provide a clear overview, at a state-of-the-art level, of those areas that the Editors-in-Chief and the Volume Editors believe to be especially important and/or of high relevance to future developments.

Before proceeding further, it is necessary to define what we include as “coordination” chemistry to set the terms of reference for what follows. For CCC (1987) this was taken to include the synthesis and properties of the products of association of Brønsted bases with a Lewis acid. This definition excluded most organometallic compounds. This definition is still useful, the arbitrary limitation being retained that any coordination compound in which the number of metal–carbon bonds is at least half the coordination number of the metal is deemed to be “organometallic” and nominally outside the scope of coverage. This includes  $\eta^5$ -hydrocarbon ligands but exceptions have been made for complexes containing CO, CNR, NO, and related  $\pi$ -acid ligands.

The emergence of supramolecular chemistry in the early 1980s led to *Comprehensive Supramolecular Chemistry*, published in 1997, which contains much of interest to coordination chemists. Coverage of this area in CCC2 is restricted to developments since 1990. The growth in both bioinorganic and materials chemistries since 1980 has been remarkable. Coordination chemistry has played a key role in their development. They appear prominently in CCC2 where we have attempted to highlight important developments and document fundamental advances.

CCCII comprises ten volumes, of which the last contains only subject indexes. The first two volumes describe the development of new ligands since the 1980s, which complements Volume 2 in CCC. They also include new techniques of synthesis and characterization, with a special emphasis on the burgeoning physical techniques which are increasingly applied to the study of coordination compounds. Developments in theory, computation methods, simulation, and useful software are reported. The volumes conclude with a series of case studies, which illustrate how synthesis, spectroscopy, and other physical techniques have been successfully applied in unravelling some significant problems in coordination chemistry.

Volumes 3–6 describe developments in the coordination chemistry of the metallic elements since 1982 (*s*, *p*, and *f*-block metals, transition metals of Groups 3–6; 7–8; 9–12). These volumes correspond to Volumes 3, 4, and 5 in CCC. A review of technetium coordination chemistry was unavailable when CCC was published, and a complete account of its development from the earliest discoveries to present-day applications is incorporated in the new work. In these volumes space limitations restrict the material that can be presented. The information that appears has been selected to give a near comprehensive coverage of new discoveries, new interpretations of experiment and theory, and applications, where relevant.

The style of reporting follows that used in CCC (1987). In the element chapters, discussion of element properties of bioinorganic and industrial relevance is deliberately limited in scope. These issues are addressed separately in subsequent volumes and are extensively cross-referenced.

In the nanoscale regime (1–100 nm) materials exhibit size-sensitive properties and offer significant prospects for achieving molecular-level control of catalysis, sensors, molecular circuitry, and other applications. This prospect has led to a surge of interest and increasing research in nanoscience and nanotechnology. These are areas in which coordination chemistry plays a substantial role. With this in mind, the synthesis, structure, and physical properties of coordination-complex-based super- and supramolecules, clusters, and nano-particles are presented in depth in Volume 7. This volume describes species ranging from “traditional” monomeric complexes to ligand-stabilized multimetallic assemblies, metal or semiconductor nanoparticles, dendrimers, other polymer-based assemblies, and mesogenic materials. It also reports on the electron transfer, photochemical and photophysical, optical, and magnetic characteristics of these sometimes-remarkable materials. The emphasis in this volume is experimental with some supporting theoretical discussion.

Volume 8 is devoted to the coordination chemistry of metal ions that are involved in biological processes. Throughout this volume, relevant biochemical issues are discussed, but the focus is primarily on structure, function, and properties of the metal centers in biomolecules. Relevant synthetic models and/or functional mimics are included, but the majority of complexes prepared as potential models are discussed in Volumes 2–6.

Volume 9 is concerned with actual and potential applications of metal coordination complexes. Major developments since the 1980s in the uses of coordination compounds have occurred in catalysis and medicine. There have been important developments of coordination chemistry in the technology of dyes and optical materials, for solar energy harvesting, for hydrometallurgical extraction, and in providing MOCVD precursors for new electronic materials. As mentioned above, the last volume in the series contains the indexes.

There are organizational differences between CCC2 and CCC (1987). One is having editors responsible for individual volumes. Another is a greatly increased emphasis on coordination chemistry in medicine and industry, which is an expected result of a maturing area of science. Only Volume 6 was devoted to this subject in CCC (1987).

We are extremely grateful to our editorial colleagues for their invaluable aid in selecting authors and for their participation in helping to define both the contents and organization of CCC2. The authors for this series were deliberately chosen to reflect the geographically diverse nature of the field and include contributors from academe, national laboratories, and industry. We are extremely grateful to them for their hard work and for the insights they have provided in presenting an extraordinary range of topics.

We would also like to acknowledge the editorial and publishing staff at Elsevier for their professional and comprehensive support of the editors and authors in the production of this substantial series. We particularly mention Angela Greenwell, Sandra Migchielsen, Jerome Michalczyk, and Wendy Tomlinson. Their patience, good humor, and professionalism have been constant in the sometimes difficult moments required to bring this complex project involving many authors from around the world to fruition.

Finally, we, the Editors-in-Chief, hope that the readers of this second work in the *Comprehensive Coordination Chemistry* series will find it as useful and informative as the first. It is our hope that the field of coordination chemistry and those who use and advance it will be major beneficiaries of our efforts and those of our authors.

Jon A. McCleverty  
Bristol, UK  
March 2003

Thomas J. Meyer  
Los Alamos, USA  
March 2003

## COMPREHENSIVE COORDINATION CHEMISTRY MAPPING TABLES

The original chapters of *Comprehensive Coordination Chemistry* (CCC, published in 1987) can be accessed via links from the related chapter(s) in *Comprehensive Coordination Chemistry II* as shown in the attached table (Spreadsheet 1).

Chapter(s) in *Comprehensive Coordination Chemistry II* contain links to related chapters of *Comprehensive Coordination Chemistry* as shown in the attached table (Spreadsheet 2).

## Spreadsheet 1

<i>CCC Chapter</i>	<i>Related CCC2 Chapter/Appendix</i>
1.1 General Historical Survey to 1930	1.47 volume 1 appendix
1.2 Development of Coordination Chemistry since 1930	2.47 Topology: General Theory
2 Coordination Numbers and Geometries	1.47 volume 1 appendix
3 Nomenclature of Coordination Compounds	1.47 volume 1 appendix
4 Clusters and Cages	1.47 volume 1 appendix
5 Isomerism in Coordination Chemistry	2.47 Topology: General Theory
6 Ligand Field Theory	2.24 Electronic Emission Spectroscopy 2.35 Ligand Field Theory
7.1 Substitution Reactions	1.47 volume 1 appendix
7.2 Electron Transfer Reactions	2.23 Stark Spectroscopy
7.3 Photochemical Processes	2.24 Electronic Emission Spectroscopy
7.4 Reactions of Coordinated Ligands	1.29 Ligand Reactivity: General Introduction 1.30 Reactivity and Structure of Complexes of Small Molecules: Carbon Dioxide
7.5 Reactions in the Solid State	1.39 Solid State Methods, Hydrothermal
8.1 Electrochemistry and Coordination Chemistry	1.44 Electrochemical Methods, Electrocrystallization 1.45 Spectroelectrochemistry 2.15 Electrochemistry: General Introduction 2.16 Electrochemistry: Proton Coupled Systems 2.18 Electrochemistry: High Pressure 2.19 Ligand Electrochemical Parameters and Electrochemical–Optical Relationships
8.2 Electrochemical Properties in Aqueous Solutions	1.44 Electrochemical Methods, Electrocrystallization 2.15 Electrochemistry: General Introduction 2.16 Electrochemistry: Proton Coupled Systems 2.18 Electrochemistry: High Pressure 2.19 Ligand Electrochemical Parameters and Electrochemical–Optical Relationships
8.3 Electrochemical Properties in Non-aqueous Solutions	1.44 Electrochemical Methods, Electrocrystallization 2.15 Electrochemistry: General Introduction 2.16 Electrochemistry: Proton Coupled Systems 2.17 Electrochemistry: Mixed Valence Systems 2.18 Electrochemistry: High Pressure 2.19 Ligand Electrochemical Parameters and Electrochemical–Optical Relationships
9 Quantitative Aspects of Solvent Effects	1.26 Solvents and Ionic Liquids 2.27 Solvatochromism 2.46 Solvation
10 Applications in Analysis	2.67 volume 2 appendix
11 Mercury as a Ligand	1.47 volume 1 appendix
12.1 Cypimis and Fulminates	1.47 volume 1 appendix
12.2 Silicon, Germanium, Tin and Lead	9.9 Supported Metal Complexes as Catalysts
13.1 Ammonia and Amines	1.47 volume 1 appendix
13.2 Heterocyclic Nitrogen-donor Ligands	1.1 Bipyridine Ligands 1.2 Phenanthroline Ligands 1.3 Terpyridine, Oligopyridine, and Polypyridine Ligands 1.4 Pyridopyridine Ligands 1.5 Heterocyclic and Open-chain 1,2-Diazine Ligands 1.8 Benzimidazole Ligands 1.9 Polyatomic Bridging Ligands
13.3 Miscellaneous Nitrogen-containing Ligands	1.9 Polyatomic Bridging Ligands 1.31 Reactivity and Structure of Complexes of Small Molecules: Nitric and Nitrous Oxide 4.7 Molybdenum

## Spreadsheet 1 continued

<i>CCC Chapter</i>	<i>Related CCC2 Chapter/Appendix</i>
13.4 Amido and Imido Metal Complexes	1.47 volume 1 appendix
13.5 Sulfurdiimine, Triazenido, Azabutadiene and Triatomic Hetero Anion Ligands	1.47 volume 1 appendix
13.6 Polypyrazolylborates and Related Ligands	1.10 Polypyrazolylborate and Scorpionate Ligands
13.7 Nitriles	1.34 Reactivity of Coordinated Nitriles
13.8 Oximes, Guanidines and Related Species	1.33 Reactivity of Coordinated Oximes
14 Phosphorus, Arsenic, Antimony and Bismuth Ligands	1.11 Higher Denticity Ligands
	1.12 Phosphorus Ligands
	1.13 Phosphorus Tripodal Ligands
	1.16 Acyclic Arsine, Stibine, and Bismuthine Ligands
	1.21 Macrocyclic Phosphine and Arsine Ligands
15.1 Water, Hydroxide and Oxide	1.32 Reactivity and Structure of Complexes of Small Molecules: Dioxygen
15.2 Dioxygen, Superoxide and Peroxide	1.32 Reactivity and Structure of Complexes of Small Molecules: Dioxygen
15.3 Alkoxides and Aryloxides	1.32 Reactivity and Structure of Complexes of Small Molecules: Dioxygen
15.4 Diketones and Related Ligands	1.6 $\beta$ -Diketones and Related Ligands
	1.32 Reactivity and Structure of Complexes of Small Molecules: Dioxygen
15.5 Oxyanions	1.32 Reactivity and Structure of Complexes of Small Molecules: Dioxygen
15.6 Carboxylates, Squarates and Related Species	1.32 Reactivity and Structure of Complexes of Small Molecules: Dioxygen
15.7 Hydroxy Acids	1.32 Reactivity and Structure of Complexes of Small Molecules: Dioxygen
15.8 Sulfoxides, Amides, Amine Oxides and Related Ligands	1.32 Reactivity and Structure of Complexes of Small Molecules: Dioxygen
15.9 Hydroxamates, Cupferron and Related Ligands	1.32 Reactivity and Structure of Complexes of Small Molecules: Dioxygen
16.1 Sulfides	1.47 volume 1 appendix
16.2 Thioethers	1.17 Acyclic Thio-, Seleno-, and Telluroether Ligands
	1.18 Macrocyclic Thio-, Seleno-, and Telluroether Ligands
16.3 Metallothio Anions	8.9 Metallothioneins
16.4 Dithiocarbamates and Related Ligands	1.15 1,1-Dithiolato Ligands
16.5 Dithiolenes and Related Species	9.13 Metal Complexes as Dyes for Optical Data Storage and Electrochromic Materials
16.6 Other Sulfur-containing Ligands	1.14 Dichalcogenoimidodiphosph(in)ate Ligands
17 Selenium and Tellurium Ligands	1.17 Acyclic Thio-, Seleno-, and Telluroether Ligands
18 Halogens as Ligands	1.47 volume 1 appendix
19 Hydrogen and Hydrides as Ligands	1.47 volume 1 appendix
20.1 Schiff Bases as Acyclic Polydentate Ligands	1.11 Higher Denticity Ligands
	1.19 Acyclic and Macrocyclic Schiff Base Ligands
20.2 Amino Acids, Peptides and Proteins	8.10 Dioxygen-binding Proteins
20.3 Complexones	1.47 volume 1 appendix
20.4 Bidentate Ligands	1.1 Bipyridine Ligands
21.1 Porphyrins, Hydroporphyrins, Azaporphyrins, Phthalocyanines, Corroles, Corrins and Related Macrocycles	1.20 N Macrocyclic Ligands
	1.23 Porphyrins
	1.24 Phthalocyanines
	9.13 Metal Complexes as Dyes for Optical Data Storage and Electrochromic Materials

21.2	Other Polyaza Macrocycles	1.20	N Macrocyclic Ligands
21.3	Macropolycyclic Ligands	1.47	volume 1 appendix
22	Naturally Occurring Ligands	1.47	volume 1 appendix
23	Alkali Metals and Group IIA Metals	8.5	Alkali and Alkaline Earth Ion Recognition and Transport
24	Boron	3.8	volume 3 appendix
25.1	Aluminum and Gallium	3.4	Aluminum and Gallium
25.2	Indium and Thallium	3.5	Indium and Thallium
26	Silicon, Germanium, Tin and Lead	3.7	Germanium, Tin, and Lead
28	Arsenic, Antimony and Bismuth	3.6	Arsenic, Antimony, and Bismuth
29	Sulfur, Selenium, Tellurium and Polonium	3.8	volume 3 appendix
30	Halogenium Species and Noble Gases	3.8	volume 3 appendix
31	Titanium	4.2	Titanium
32	Zirconium and Hafnium	4.3	Zirconium and Hafnium
33	Vanadium	4.4	Vanadium
34	Niobium and Tantalum	4.5	Niobium and Tantalum
35	Chromium	2.24	Electronic Emission Spectroscopy
36.1	Molybdenum: The Element and Aqueous Solution Chemistry	4.6	Chromium
36.2	Molybdenum(0), Molybdenum(I) and Molybdenum(II)	4.7	Molybdenum
36.3	Molybdenum Complexes Containing One or More Metal-Metal Bonds	4.7	Molybdenum
36.4	Molybdenum(III), Molybdenum(II) and Molybdenum(V)	4.7	Molybdenum
36.5	Molybdenum(VI)	4.7	Molybdenum
36.6	Molybdenum: Special Topics	4.7	Molybdenum
37	Tungsten	4.8	Tungsten
38	Isopolyanions and Heteropolyanions	4.11	Polyoxometalates: Reactivity
39	The Lanthanides	4.1	Scandium and Yttrium
40	The Actinides	3.3	The Actinides
41	Manganese	5.1	Manganese
43	Rhenium	5.3	Rhenium
44.1	Iron(II) and Lower States	5.4	Iron
44.2	Iron(III) and Higher States	5.4	Iron
45	Ruthenium	5.5	Ruthenium and Osmium: Low Oxidation States
46	Osmium	5.6	Ruthenium and Osmium: High Oxidation States
47	Cobalt	5.5	Ruthenium and Osmium: Low Oxidation States
48	Rhodium	5.6	Ruthenium and Osmium: High Oxidation States
49	Iridium	6.1	Cobalt
50	Nickel	6.10	volume 6 appendix
51	Palladium	6.2	Iridium
51.8	Palladium(II): Sulfur Donor Complexes	6.3	Nickel
51.9	Palladium(II): Phosphorus Donor Complexes	6.4	Palladium
52	Platinum	6.4	Palladium
53	Copper	6.5	Platinum
54	Silver	6.6	Copper
55	Gold	6.7	Silver and Gold
56.1	Zinc and Cadmium	6.7	Silver and Gold
56.2	Mercury	6.8	Zinc
		6.9	Cadmium and Mercury
		6.9	Cadmium and Mercury

---

## Spreadsheet 1 continued

<i>CCC Chapter</i>	<i>Related CCC2 Chapter/Appendix</i>
57 Electrochemical Applications	1.44 Electrochemical Methods, Electrocrystallization
	9.10 Electrochemical Reactions Catalyzed by Transition Metal Complexes
	9.24 volume 9 appendix
58 Dyes and Pigments	1.24 Phthalocyanines
59 Photographic Applications	9.24 volume 9 appendix
60 Compounds Exhibiting Unusual Electrical Properties	9.24 volume 9 appendix
61.1 Stoichiometric Reactions of Coordinated Ligands	1.29 Ligand Reactivity: General Introduction
	1.30 Reactivity and Structure of Complexes of Small Molecules: Carbon Dioxide
61.2 Catalytic Activation of Small Molecules	1.29 Ligand Reactivity: General Introduction
61.3 Metal Complexes in Oxidation	1.32 Reactivity and Structure of Complexes of Small Molecules: Dioxygen
61.4 Lewis Acid Catalysis and the Reactions of Coordinated Ligands	9.8 Metal Complexes as Lewis Acid Catalysts in Organic Synthesis
61.5 Decomposition of Water into its Elements	1.47 volume 1 appendix
62.1 Coordination Compounds in Biology	8.2 Electron Transfer: Cytochromes
	8.3 Electron Transfer: Iron–Sulfur Clusters
	8.4 Electron Transfer: Cupredoxins
	8.6 Siderophores and Transferrins
	8.7 Ferritins
	8.26 Metal–Radical Arrays
	8.30 volume 8 appendix
62.2 Uses in Therapy	9.18 Metal Complexes as Drugs and Chemotherapeutic Agents
	9.22 Metal Complexes for Photodynamic Therapy
63 Application to Extractive Metallurgy	1.39 Solid State Methods, Hydrothermal
64 Geochemical and Prebiotic Systems	9.17 Metal Complexes for Hydrometallurgy and Extraction
65 Applications in the Nuclear Fuel Cycle and Radiopharmacy	5.2 Technetium
66 Other Uses of Coordination Compounds	9.24 volume 9 appendix



## Spreadsheet 2

<i>CCC2 Chapter/Appendix</i>	<i>Related CCC Chapter</i>
1.1 Bipyridine Ligands	13.2 Heterocyclic Nitrogen-donor Ligands
1.2 Phenanthroline Ligands	20.4 Bidentate Ligands
1.3 Terpyridine, Oligopyridine, and Polypyridine Ligands	13.2 Heterocyclic Nitrogen-donor Ligands
1.4 Pyridopyridine Ligands	13.2 Heterocyclic Nitrogen-donor Ligands
1.5 Heterocyclic and Open-chain 1,2-Diazine Ligands	13.2 Heterocyclic Nitrogen-donor Ligands
1.6 $\beta$ -Diketones and Related Ligands	15.4 Diketones and Related Ligands
1.8 Benzimidazole Ligands	13.2 Heterocyclic Nitrogen-donor Ligands
1.9 Polyatomic Bridging Ligands	13.2 Heterocyclic Nitrogen-donor Ligands
	13.3 Miscellaneous Nitrogen-containing Ligands
1.10 Polypyrazolylborate and Scorpionate Ligands	13.6 Polypyrazolylborates and Related Ligands
1.11 Higher Denticity Ligands	14 Phosphorus, Arsenic, Antimony and Bismuth Ligands
	20.1 Schiff Bases as Acyclic Polydentate Ligands
1.12 Phosphorus Ligands	14 Phosphorus, Arsenic, Antimony and Bismuth Ligands
1.13 Phosphorus Tripodal Ligands	14 Phosphorus, Arsenic, Antimony and Bismuth Ligands
1.14 Dichalcogenoimidodiphosph(in)ate Ligands	16.6 Other Sulfur-containing Ligands
1.15 1,1-Dithiolato Ligands	16.4 Dithiocarbamates and Related Ligands
1.16 Acyclic Arsine, Stibine, and Bismuthine Ligands	14 Phosphorus, Arsenic, Antimony and Bismuth Ligands
1.17 Acyclic Thio-, Seleno-, and Telluroether Ligands	16.2 Thioethers
	17 Selenium and Tellurium Ligands
1.18 Macrocyclic Thio-, Seleno-, and Telluroether Ligands	16.2 Thioethers
1.19 Acyclic and Macrocyclic Schiff Base Ligands	20.1 Schiff Bases as Acyclic Polydentate Ligands
1.20 N Macrocyclic Ligands	21.1 Porphyrins, Hydroporphyrins, Azaporphyrins, Phthalocyanines, Corroles, Corrins and Related Macrocycles
	21.2 Other Polyaza Macrocycles
1.21 Macrocyclic Phosphine and Arsine Ligands	14 Phosphorus, Arsenic, Antimony and Bismuth Ligands
1.23 Porphyrins	21.1 Porphyrins, Hydroporphyrins, Azaporphyrins, Phthalocyanines, Corroles, Corrins and Related Macrocycles
1.24 Phthalocyanines	21.1 Porphyrins, Hydroporphyrins, Azaporphyrins, Phthalocyanines, Corroles, Corrins and Related Macrocycles
	58 Dyes and Pigments
1.26 Solvents and Ionic Liquids	9 Quantitative Aspects of Solvent Effects
1.29 Ligand Reactivity: General Introduction	7.4 Reactions of Coordinated Ligands
	61.1 Stoichiometric Reactions of Coordinated Ligands
	61.2 Catalytic Activation of Small Molecules
1.30 Reactivity and Structure of Complexes of Small Molecules: Carbon Dioxide	7.4 Reactions of Coordinated Ligands
	61.1 Stoichiometric Reactions of Coordinated Ligands
1.31 Reactivity and Structure of Complexes of Small Molecules: Nitric and Nitrous Oxide	13.3 Miscellaneous Nitrogen-containing Ligands

## Spreadsheet 2 continued

<i>CCC2 Chapter/Appendix</i>	<i>Related CCC Chapter</i>
1.32 Reactivity and Structure of Complexes of Small Molecules: Dioxygen	15.1 Water, Hydroxide and Oxide 15.2 Dioxygen, Superoxide and Peroxide 15.3 Alkoxides and Aryloxides 15.4 Diketones and Related Ligands 15.5 Oxyanions 15.6 Carboxylates, Squarates and Related Species 15.7 Hydroxy Acids 15.8 Sulfoxides, Amides, Amine Oxides and Related Ligands 15.9 Hydroxamates, Cupferron and Related Ligands
1.33 Reactivity of Coordinated Oximes	61.3 Metal Complexes in Oxidation
1.34 Reactivity of Coordinated Nitriles	13.8 Oximes, Guanidines and Related Species
1.39 Solid State Methods, Hydrothermal	13.7 Nitriles 7.5 Reactions in the Solid State
1.44 Electrochemical Methods, Electrocrystallization	63 Application to Extractive Metallurgy 8.1 Electrochemistry and Coordination Chemistry 8.2 Electrochemical Properties in Aqueous Solutions 8.3 Electrochemical Properties in Non-aqueous Solutions
1.45 Spectroelectrochemistry	57 Electrochemical Applications 8.1 Electrochemistry and Coordination Chemistry
2.15 Electrochemistry: General Introduction	8.1 Electrochemistry and Coordination Chemistry 8.2 Electrochemical Properties in Aqueous Solutions 8.3 Electrochemical Properties in Non-aqueous Solutions
2.16 Electrochemistry: Proton Coupled Systems	8.1 Electrochemistry and Coordination Chemistry 8.2 Electrochemical Properties in Aqueous Solutions 8.3 Electrochemical Properties in Non-aqueous Solutions
2.17 Electrochemistry: Mixed Valence Systems	8.3 Electrochemical Properties in Non-aqueous Solutions
2.18 Electrochemistry: High Pressure	8.1 Electrochemistry and Coordination Chemistry 8.2 Electrochemical Properties in Aqueous Solutions 8.3 Electrochemical Properties in Non-aqueous Solutions
2.19 Ligand Electrochemical Parameters and Electrochemical–Optical Relationships	8.1 Electrochemistry and Coordination Chemistry 8.2 Electrochemical Properties in Aqueous Solutions 8.3 Electrochemical Properties in Non-aqueous Solutions
2.23 Stark Spectroscopy	7.2 Electron Transfer Reactions
2.24 Electronic Emission Spectroscopy	6 Ligand Field Theory 7.3 Photochemical Processes 35 Chromium
2.27 Solvatochromism	9 Quantitative Aspects of Solvent Effects
2.35 Ligand Field Theory	6 Ligand Field Theory
2.46 Solvation	9 Quantitative Aspects of Solvent Effects

2.47	Topology: General Theory	1.2	Development of Coordination Chemistry since 1930
3.3	The Actinides	5	Isomerism in Coordination Chemistry
3.4	Aluminum and Gallium	40	The Actinides
3.5	Indium and Thallium	25.1	Aluminum and Gallium
3.6	Arsenic, Antimony, and Bismuth	25.2	Indium and Thallium
3.7	Germanium, Tin, and Lead	28	Arsenic, Antimony and Bismuth
4.1	Scandium and Yttrium	26	Silicon, Germanium, Tin and Lead
4.2	Titanium	39	The Lanthanides
4.3	Zirconium and Hafnium	31	Titanium
4.4	Vanadium	32	Zirconium and Hafnium
4.5	Niobium and Tantalum	33	Vanadium
4.6	Chromium	34	Niobium and Tantalum
4.7	Molybdenum	35	Chromium
		13.3	Miscellaneous Nitrogen-containing Ligands
		36.1	Molybdenum: The Element and Aqueous Solution Chemistry
		36.2	Molybdenum(0), Molybdenum(I) and Molybdenum(II)
		36.3	Molybdenum Complexes Containing One or More Metal-Metal Bonds
		36.4	Molybdenum(III) , Molybdenum(II) and Molybdenum(V)
		36.5	Molybdenum(VI)
		36.6	Molybdenum: Special Topics
4.8	Tungsten	37	Tungsten
4.11	Polyoxometalates: Reactivity	38	Isopolyanions and Heteropolyanions
5.1	Manganese	41	Manganese
5.2	Technetium	65	Applications in the Nuclear Fuel Cycle and Radiopharmacy
5.3	Rhenium	43	Rhenium
5.4	Iron	44.1	Iron(II) and Lower States
		44.2	Iron(III) and Higher States
5.5	Ruthenium and Osmium: Low Oxidation States	45	Ruthenium
5.6	Ruthenium and Osmium: High Oxidation States	46	Osmium
		45	Ruthenium
6.1	Cobalt	46	Osmium
6.2	Iridium	47	Cobalt
6.3	Nickel	49	Iridium
6.4	Palladium	50	Nickel
		51	Palladium
		51.8	Palladium(II): Sulfur Donor Complexes
		51.9	Palladium(II): Phosphorus Donor Complexes
6.5	Platinum	52	Platinum
6.6	Copper	53	Copper
6.7	Silver and Gold	54	Silver
		55	Gold
6.8	Zinc	56.1	Zinc and Cadmium
6.9	Cadmium and Mercury	56.1	Zinc and Cadmium
		56.2	Mercury
8.2	Electron Transfer: Cytochromes	62.1	Coordination Compounds in Biology
8.3	Electron Transfer: Iron–Sulfur Clusters	62.1	Coordination Compounds in Biology
8.4	Electron Transfer: Cupredoxins	62.1	Coordination Compounds in Biology
8.5	Alkali and Alkaline Earth Ion Recognition and Transport	23	Alkali Metals and Group IIA Metals
8.6	Siderophores and Transferrins	62.1	Coordination Compounds in Biology
8.7	Ferritins	62.1	Coordination Compounds in Biology
8.9	Metallothioneins	16.3	Metallothio Anions
8.10	Dioxygen-binding Proteins	20.2	Amino Acids, Peptides and Proteins

---

## Spreadsheet 2 continued

<i>CCC2 Chapter/Appendix</i>	<i>Related CCC Chapter</i>
8.26 Metal–Radical Arrays	62.1 Coordination Compounds in Biology
9.8 Metal Complexes as Lewis Acid Catalysts in Organic Synthesis	61.4 Lewis Acid Catalysis and the Reactions of Coordinated Ligands
9.9 Supported Metal Complexes as Catalysts	12.2 Silicon, Germanium, Tin and Lead
9.10 Electrochemical Reactions Catalyzed by Transition Metal Complexes	57 Electrochemical Applications
9.13 Metal Complexes as Dyes for Optical Data Storage and Electrochromic Materials	16.5 Dithiolenes and Related Species
	21.1 Porphyrins, Hydroporphyrins, Azaporphyrins, Phthalocyanines, Corroles, Corrins and Related Macrocycles
9.17 Metal Complexes for Hydrometallurgy and Extraction	64 Geochemical and Prebiotic Systems
9.18 Metal Complexes as Drugs and Chemotherapeutic Agents	62.2 Uses in Therapy
9.22 Metal Complexes for Photodynamic Therapy	62.2 Uses in Therapy
1.47 volume 1 appendix	1.1 General Historical Survey to 1930
	2 Coordination Numbers and Geometries
	3 Nomenclature of Coordination Compounds
	4 Clusters and Cages
	7.1 Substitution Reactions
	11 Mercury as a Ligand
	12.1 Cypimis and Fulminates
	13.1 Ammonia and Amines
	13.4 Amido and Imido Metal Complexes
	13.5 Sulfurdiimine, Triazenido, Azabutadiene and Triatomic Hetero Anion Ligands
	16.1 Sulfides
	18 Halogens as Ligands
	19 Hydrogen and Hydrides as Ligands
	20.3 Complexones
	21.3 Macropolycyclic Ligands
	22 Naturally Occurring Ligands
	61.5 Decomposition of Water into its Elements
2.67 volume 2 appendix	10 Applications in Analysis
3.8 volume 3 appendix	24 Boron
	29 Sulfur, Selenium, Tellurium and Polonium
	30 Halogenium Species and Noble Gases
	48 Rhodium
6.10 volume 6 appendix	62.1 Coordination Compounds in Biology
8.30 volume 8 appendix	57 Electrochemical Applications
9.24 volume 9 appendix	59 Photographic Applications
	60 Compounds Exhibiting Unusual Electrical Properties
	66 Other Uses of Coordination Compounds

# Coordination Chemistry: The Past, Present, and Possible Future

## Some thoughts gleaned by the Editors-in-Chief from conversations with the International Advisory Board

In the past 20 years, inorganic chemistry has been greatly enriched by the continuing development of organometallic chemistry and the entry of new thinking from an organic perspective. However, the field continues to evolve and there is a growing emphasis on coordination chemistry and the fundamental principles that guide it. The driving forces for the evolution have come from bioinorganic and biomimetic chemistry, and the growing interest in materials. The interest in new materials has been further fueled by an enhanced understanding of the underlying principles and their extension to smaller and smaller domains, some remarkable advances in synthesis, and a marriage between device and materials physics on the one hand, and basic science on the other. The role of the chemist is growing with the advent of nanoscience and nanotechnology and their promise of materials with properties tailored at the molecular level. There are many new directions in coordination chemistry, in molecular magnetism, supramolecular chemistry, non-silicon-based devices, precursors for vapor phase deposition, and single molecule-based photonic devices and sensors.

Theory is playing a significant role. Density functional theory is enabling a deeper understanding of the electronic structure of simple and complex molecules. Theory is being used to calculate spectroscopic parameters, accurately predict structures, and to understand chemical reactivity.

Among some of the successes of coordination chemistry up to now have been:

- tuning of variable valency via ligand control of reductions potentials;
- tuning of spin states;
- isomer preference of oxidation states and valence/geometry recognition;
- water oxidation by a ruthenium shuttle;
- oxygen atom transfer from water, per-acids, and oxo-metal reagents;
- correlating excited state properties of metal complexes with electronic and molecular structure;
- photo-induced electron and energy transfer in metal complex-based molecular assemblies;
- thioether coordination and activation of homolog-specific transformations;
- recognition of the importance of metal nitrosyl complexes in the “biology” and “physiology” of NO;
- spontaneous polynucleation via oximate and phenolate bridging ligands;
- characterization of vanadate esters of carbohydrates;
- unraveling of modes of actions of some metalloenzymes;
- development of metalacycles and the insertion of unsaturates into metalacycles;
- recognition of “non-innocence” as a significant factor in systems where ligands and metals are both redox active;
- isolation and characterization of radical anion ligand complexes, and recognition of their role in biology;
- custom design of cluster oxo-anions and rationalization of their structural parameters, and creation of super-large cluster ions modeling pieces of oxide surfaces;
- increased understanding of structure–function relationships through structural solutions of metallo-enzymes and other bio-molecules;

- application of density functional theory to the elucidation of electronic and molecular structure;
- providing an understanding of the localized-to-delocalized transition in mixed-valence chemistry.

The above represents a long and impressive list of achievements. But the subject continues to develop and grow rapidly. So what are the current “hot topics”? These may include:

- bio-transformations, particularly hydrogen evolution, conversion of nitrogen into ammonia, multi-electron transfer processes, and methane oxidation – all under ambient conditions; and water oxidation;
- all aspects of materials chemistry where the unique properties of transition metals can be exploited;
- metal complexes in supramolecular assemblies for use in catalysis and in optical and magnetic devices;
- use of metal complexes in aqueous solutions (avoidance of organic solvents in synthesis and catalysis, particularly with respect to industrial processes); it is no exaggeration to say that a large part of life processes are basically pH-controlled in aqueous solution;
- metal complexes in biology – either for (i) medical purposes such as chemotherapy or (ii) the identification of metal complex cores in biological functions such as their role as “acids” in aqueous media;
- development of ligand design to facilitate supramolecular systems and designed self-assembly;
- use of coordination compounds as optical triggers and probes, particularly with respect to long-distance electron tunneling in proteins;
- metal binding by carbohydrates.

Having moved from the past to the present, what then is the likely future of coordination chemistry? Very clearly current fashions and realities indicate a multidisciplinary development, particularly in the life sciences. Nature continually presents chemists with surprises, and coordination chemistry will continue to respond to the challenges of bio-mimicry, and associated developments in catalysis and materials science. It is a fact that only 5% of the bacteria in soil are identified and the roles of metals in bacteria are, in general, not evaluated. This could be of considerable industrial and agricultural significance in the future. Enzymology has been high profile for 30 years already, and is likely to be a major preoccupation for another 300! The roles of metals and their coordination environments will continue to be elucidated and modeled in ways that could contribute to the “green chemistry” revolution.

Coordination chemistry will continue to strengthen its role as a central expertise and discipline for materials science. It is critical to the development of new materials for nanoscience and nanotechnology. In materials science, light-driven processes are of enormous importance and processes based on molecular-level phenomena may provide the basis for photonics and information storage in the future. In catalysis, the use of metals will grow, particularly when control of asymmetric processes is mastered.



# Introduction to Volumes 1 and 2

In this first two volumes of *Comprehensive Coordination Chemistry II* we have endeavored to lay down the fundamentals of coordination chemistry as it is understood in the early part of the twenty-first century. We hope to have provided all the necessary fundamental background information needed to prosecute coordination chemistry in the physical and theoretical laboratory and to appreciate fully the information provided in the remaining volumes of this treatise.

These volumes contain 112 contributions from some 130 outstanding, internationally known, contributors. They are subdivided into nine major sections whose content is described briefly below. The contributors were asked to emphasize developments in the field achieved since 1980 and since the publication of CCC (1987).

1. LIGANDS – a survey of the syntheses, characterization, and properties of many of the more commonly employed ligands.
2. SYNTHESIS, PURIFICATION AND CHARACTERIZATION OF COORDINATION COMPOUNDS – including a detailed survey of aqua metal ions, the use of solvents, chromatographic methods, and crystal growth techniques.
3. REACTIONS OF COORDINATED LIGANDS – dealing with the chemistry of molecules such as oxygen, nitric and nitrous oxide, carbon dioxide, oximes, and nitriles
4. STEREOCHEMISTRY, STRUCTURE, AND CRYSTAL ENGINEERING – structure and stereochemistry involving lone pair effects, outer sphere interactions, and hydrogen bonding.
5. NEW SYNTHETIC METHODS – nine contributions dealing with a wide range of newer methodologies from biphasic synthesis to sol–gel to genetic engineering.
6. PHYSICAL METHODS – a very extensive chapter incorporating 34 contributions detailing the enormous breadth of modern physical methods.
7. THEORETICAL MODELS, COMPUTATIONAL METHODS, AND SIMULATION – 17 contributions illustrating the wealth of information that can be extracted from a range of computational methods from semi-empirical to *ab initio*, and from ligand field theory to metal–metal exchange coupling to topology, etc.
8. SOFTWARE – a brief glimpse of some of the packages which are currently available.
9. CASE STUDIES – putting it all together – eight studies which reveal how the many physical and theoretical techniques presented earlier in the volume can be used to solve specific problems.

The creation of these volumes has been an exciting, challenging, time-consuming, and all-absorbing experience. The Editor hopes that it will also be a rewarding experience to the readership. Finally, the Editor is greatly indebted to Paola Panaro for her untiring assistance in the considerable secretarial work associated with these volumes – without her it would have been impossible. He is also much indebted to his wife Elaine Dodsworth for her emotional support!

A B P Lever  
Toronto, Canada  
March 2003

# Introduction to Volume 3

Volume 3 describes the Coordination Chemistry of the *s*-, *p*-, and *f*-block metals.

Chapter 1 is concerned with the 1*s* and 2*s* metals and describes trends in the development of their chemistry since the mid-1980s, such as the increased use of sterically bulky ligands, recognition of importance of non-ionic interactions, reappraisal of the “spectator” role of *s*-block ions, and the application of computational methods. Biological roles of these elements are discussed in Volume 8.

Chapter 2 is concerned with the chemistry of scandium, yttrium, and the lanthanides and is discussed according to the nature of the ligand in which the donor is from Groups 14–17. Divalent and tetravalent lanthanide chemistry is also described.

Chapter 3 describes the chemistry of the actinides, including the historical development. The chemistry described is subdivided according to whether the actinide is early (thorium to plutonium) or late (transplutonium elements). Within this subdivision, the chemistry is further classified according to the oxidation state of the metal (ranging from +3 to +7), and the type of donor (ranging from elements of Groups 15–17). The chapter also contains information pertaining to element separation and aspects of nuclear technology (which is not discussed in Volume 9 and therefore represents a departure from the format of *Comprehensive Coordination Chemistry*).

Chapter 4 describes the chemistry of aluminum and gallium. In addition to aluminum(III) and gallium(III) coordination complexes, this chapter also focuses on complexes with aluminum–aluminum and gallium–gallium bonds, and also describes cyclogallenes and metalloaromaticity.

Chapter 5 describes the chemistry of indium and thallium, including subvalent compounds of indium(II), thallium(II), and thallium(I). Applications of indium and thallium complexes are also described.

Chapter 6 describes the chemistry of arsenic, antimony, and bismuth, including a discussion of the role that these elements play in the environment and biology and medicine. Applications of these complexes are also discussed.

Chapter 7 describes the chemistry of germanium, tin, and lead according to  $M^{IV}$  and  $M^{II}$  oxidation states. Within this classification, the chemistry is further subdivided according to ligand type, which ranges from elements of Groups 13–17.

G F R Parkin  
New York, USA  
March 2003

# Introduction to Volume 4

In the 20 years since 1982, there has been, of course, an avalanche of activity in the coordination chemistry of the early transition metals, Groups 3–6. This has been driven by further fundamental study but also by strategic work in reactivity and catalysis (including biological chemistry) and in solid state and thin film technologies.

Chapters 1–8 cover mononuclear systems, together with polynuclear species in which inter-metallic bonding is not important or which have particular connections to the mononuclear systems. Highlights include the new area of metallofullerene chemistry (Chapter 1), intensive development of the aqueous chemistry of vanadium (Chapter 4) and the spectacular performance of the Group 6 elements chromium, molybdenum, and tungsten, driven by technological and biological aspects. Group 6 chemistry accounts for nearly half of the present volume, when the polynuclear systems of Chapters 9–12 are included.

Chapter 9 covers binuclear metal–metal bonded systems and acts as a link between the mononuclear species and the cluster chemistries of Chapters 10–12. The rapid evolution of the latter aspects is another highlight of development of the chemistry of Groups 4–6.

A G Wedd  
*Parkville, Australia*  
April 2003

# Introduction to Volume 5

This volume presents a survey of significant developments in the chemistry of Groups 7 and 8 of the transition metals since the publication of *Comprehensive Coordination Chemistry* (CCC) in 1987. The material for each element is organized by oxidation state of the metal and also by the nature of the ligands involved, with additional sections covering special features of the coordination chemistry and applications of the complexes.

## **Manganese, Technetium, and Rhenium**

The coverage for manganese and rhenium is from 1982, whereas for technetium the earlier literature is included, as technetium did not feature in CCC (1987). The biological role of manganese has been a significant driving force for recent studies of its coordination chemistry and this area is treated in some detail, as are the uses of manganese complexes for selective oxidations. For technetium much of the literature is closely linked to the applications of  $^{99\text{m}}\text{Tc}$  complexes in diagnostic nuclear medicine and the development of first- and second-generation agents is placed in the context of the reported coordination chemistry. The potential role of radioactive rhenium complexes for therapy is a comparatively recent theme, and is again placed against the backdrop of a systematic account of the fundamental coordination chemistry of the element.

## **Iron, Ruthenium, and Osmium**

The coverage for iron commences in 1984–1985 and aims to provide a broad-based introduction to important advances in the chemistry of this element over the past 20 years. A comprehensive coverage of the chemistry of iron over this period would be impossible and the authors have done an admirable job in selecting the most important papers in the primary literature and have made extensive reference to the review literature to give as broad an overview as possible. Similar constraints apply to the coverage of ruthenium and osmium in both high and low oxidation states. However, the coverage in these two chapters gives an excellent overview of the primary literature since 1982 and leads the reader naturally to the important review literature for these elements.

It would be invidious to pick any particular area of activity in the chemistry of these elements for particular attention, but very significant advances have been made in many aspects of the coordination chemistry of iron, ruthenium, and osmium. Our understanding of the roles which iron can play in biological systems and the subtle chemical control over iron metabolism has increased enormously since 1987 and they represent beautiful aspects of applied coordination chemistry. Much iron coordination chemistry is designed to further understand biomimetic aspects. In low-oxidation-state ruthenium chemistry, renewed interest in photovoltaic cells is generating a resurgence in  $\{\text{Ru}(\text{bpy})_3\}$  chemistry. In high-oxidation-state ruthenium and osmium chemistry, the utilization of complexes as increasingly selective catalytic or stoichiometric oxidizing agents shows no sign of abating.

Finally, we would like to thank the authors involved with these elements for their fortitude in approaching such a potentially enormous task with good humor and a positive attitude.

E C Constable  
Basel, Switzerland  
April 2003

J R Dilworth  
Oxford, UK  
April 2003

# Introduction to Volume 6

This volume is concerned with fundamental developments in the coordination chemistry of the elements of Groups 9–12 since 1982. The individual chapters cover the coordination chemistry of cobalt, iridium, nickel, palladium, platinum, copper, silver and gold, zinc and cadmium, and mercury. Unfortunately, because of factors beyond the Editors' control, the manuscript for the proposed chapter on rhodium was not available in time for publication.

Each author has selected material in such a way as to give the most effective review of discoveries and new interpretations. The style of coverage mainly uses formal oxidation state (highest to lowest) and the nature of the ligand donor atom (C, Group 5, Group 6, halides, H, mixed donor atoms) to define progression through this chapter. Uni- up to polydentate ligands (cyclic and acyclic) and mono- through oligo- to polynuclear species are covered with an emphasis on compounds for which full structural characterization is available.

Throughout this volume it has been the intention not only to highlight the fundamental developments in this field, but also to indicate the very important connections between these fundamentals, and developments in other related fields, with cross-references to the later volumes. For example, if one regards a metallo-protein, or a metallo-enzyme, as a highly elaborated coordination complex, the metal site of which is comprised of one or more metals and their ligating atoms, then the study of the chemistry of the metal centers in such species can be regarded as bio-coordination chemistry. Furthermore, in order to gain insight into metallobiosites for which the structure is not known, it is possible to consider simulating the immediate coordination environment of that metallobiosite through the use of synthetic analogues derived from small-molecule compounds. Our understanding of the bio-coordination chemistry of cobalt, nickel, copper, and zinc has advanced considerably since 1982 and generic issues relating to this chemistry appear in Volume 8.

Application of coordination compounds in medicine, materials chemistry, and as catalysts are mentioned and are cross-referenced to a fuller discussion in Volume 9. Comment is made on application of complexes in nanotechnology, and on the molecular modeling of complexes. The material cannot be totally comprehensive because of space limitations, but is selected in such a way to give the most effective review of discoveries and new interpretations.

Since 1982 there have been enormous developments in metal-based chemistry, particularly the emergence of supramolecular chemistry – “chemistry beyond the molecule,” molecular architecture, and molecular engineering. *Comprehensive Supramolecular Chemistry* was published in 1996, a survey which contains much of interest to coordination chemists. Consequently in this volume review material relating to supramolecular systems is mainly restricted to developments since 1990.

There has been a considerable expansion of the literature in the period under review. In 1982 CAS abstracted 16,095 publications in the CA inorganic section and this number rose to 21,579 abstracts in 2001 – a total of 401,312 abstracts were published in the period 1982–2001 [Source: CAPLUS database on STN]. Although these numbers refer to inorganic chemistry as a whole they nevertheless give an indication of the probable corresponding increase in papers relating specifically to coordination chemistry and clearly indicate the enormity of the task undertaken by the authors of the chapters in this volume. As the Volume Editor I cannot thank them enough for their dedication and diligence in preparing such detailed and stimulating reviews.

D E Fenton  
Sheffield, UK  
February 2003

# Introduction to Volume 7

In this volume recent progress in synthetic coordination chemistry, which has led to the production of materials displaying nanoscopic structural motifs, is described. The availability of increasingly powerful structure determination methods such as area detection for single-crystal X-ray diffraction and high-energy electron microscopies has been a key aspect to the development of this area. It is now possible to determine the structures of very large clusters, aggregates of metal ions, and coordination polymers to atomic resolution on a routine basis. For example, the field of coordination polymers has been explosively developed thanks to the advances in X-ray diffraction methods. The results of such structure determinations are fed back to the precise design of the structures and properties of coordination materials. For example, unique properties of coordination polymers (gas absorption, magnetism, etc.) have been explored through molecular-level designing.

The first eight chapters of this volume explore the emerging worlds of high nuclearity clusters, coordination polymers, and supramolecular systems. Naturally, some of these areas have points of overlap but it is convenient to consider the underlying structural motifs as defining the area of interest. Since the publication of the first edition of CCC (1987) these areas have become firmly established and the emerging importance of nanoscale structures has led to the development of synthetic strategies for producing materials based on coordination chemistry principles where the molecular entity builds up to a nanostructured material. The main aim of this volume is to illustrate this by considering the synthetic and structural aspects associated with this concept. In addition the aspects of the properties of such systems are discussed. These properties are often inexplicable in terms of simple molecular or macroscopic descriptions demanding considerable efforts in developing theoretical expressions to elucidate the observed behavior. Such unusual behavior points towards applications utilizing quantum effects and this aspect has been a major motivation for the huge synthetic efforts currently being applied to the area.

Active areas in coordination chemistry that are rapidly growing after CCC (1987) rely on the explosive development of nano science and technology in recent years. In contrast to the “top-down approach” from physical structures, the “bottom-up approach” from chemical components (i.e., molecules) has been showing remarkable potential for constructing well-defined, functional nanostructures. Coordination chemistry provides an ideal principle for the bottom-up design of molecules because metals and ligands naturally and spontaneously associate with each other through coordination interaction, giving rise to discrete and infinite structures in the nanoscopic region very efficiently. This approach produces not only nanosized structures but also nanoscopic functions, which is intrinsic to nanosized species due to the versatile properties latent in such transitions. This bottom-up approach to nanomolecules and materials is well documented in most of this volume.

Particularly noteworthy is the fact that the bottom-up approach has created new materials and functions which may open up commercial applications. For example, the gas-absorption property of nanoporous coordination materials, which are spontaneously formed from metals and relatively simple ligands in a very efficient fashion, has been explored only in recent years, and are becoming very promising candidates for hydrogen storage for fuel batteries.

In the first chapter the synthesis and structures of new heteropolyoxoanions and related systems are discussed. Such systems can enclose nanoscopic spaces and can be regarded as “nanoreactors”. Clusters containing fragments of the lattices of semiconducting materials such as CdSe provide a vivid illustration of the transition from molecular-based to extended solid properties and show how the properties in the nanoscale region differ from those at each extreme. These are described in the second chapter. A third physical property for which a bounded system



in the sub- to nanoscale regime can display unusual behavior is that of “molecular-based magnetism” and the synthetic and structural aspects of such open-shell systems are described in the third and fourth chapters on clusters and aggregates with paramagnetic centers.

The following chapters deal with supramolecular chemistry based on coordination chemistry. This area has been rapidly growing during the last decade of the twentieth century, making possible the facile production of nanoscopic materials by exploiting weak metal–ligand interactions. From structural aspects, infinite systems (e.g., coordination polymers) and finite systems (e.g., metallodendrimers) are discussed in Chapters 5 and 6. The infinite coordination systems is the most rapidly expanding area and the major interest in this field is shifting from structure to function. Accordingly, gas adsorption properties of nanoporous coordination networks are well discussed.

Templating and self-assembly, which are two major synthetic strategies of supramolecular coordination compounds, are focused upon in Chapters 7 and 8. Both methods have shown powerful potentials for the construction of well-defined nanoarchitecture with interesting properties. Although these methods were previously employed among organic chemists by using organic interactions (hydrogen bonding, van der Waals interactions, etc.), the coordination approach has recently been recognized to be the most efficient strategy for templating and self-assembly thanks to the variation of metal centers and their wide spectrum of coordination geometries. The dynamic properties of coordination assemblies are the current topic in this field, and switchable systems in which molecular motion and function can be controlled by the redox and photo activation of metal centers are focused upon.

In Chapter 9 two areas where single-crystal X-ray diffraction experiments cannot be used to explore the structures of the materials are reviewed. In effect, these are areas where coordination-based materials are processed to give new materials. Research into liquid crystals has burgeoned since CCC (1987) was published and the area of specific interest to coordination chemists, that of metallomesogens, has been developed in order to build in the advantages of incorporating metal centers into these phases. This is a rapidly expanding field which could lead to all sorts of “smart materials”, some of which might combine the sorts of systems discussed in the earlier chapters of the volume with mesogenic properties. Chapter 10 discusses another route to processing coordination compounds using sol-gel processing. This is another area new to CCCII with the possibility of producing materials with quite unusual features, such as thin films and glasses, which have potential applications in a variety of fields.

Whilst we have tried to present new research areas where molecular-based compounds extend to the nanometer-length scale in their overall structures, we were unfortunately not able to include one aspect of relevance to this idea, that of Biomineralization. This field has enjoyed considerable interest since the availability of powerful electron microscopes made it possible to look at the intricate details of the beautiful macroscopic architectures found in the mineralized structures of a variety of creatures at the nanoscale level. It has become clear through this research that much of the “crystal engineering” which is required to create phase- and function-specific structures, often with amazing control over the precise shape of the resulting biomineral, must utilize coordination chemistry principles with the idea put forward that various ligating species become involved during mineral formation to act as templates or growth inhibitors.

Although the vast majority of biomineral structures are composed of calcium carbonates and phosphates or silicate-based materials and therefore outside the scope of what we define as Coordination Chemistry, there are some very important transition metal-based systems, especially the iron oxides and oxyhydroxides, where the biominerals can provide important insights into the coordination chemistry approaches utilized by biological systems. The specific case of the iron(III) oxyhydroxide mineral utilized by organisms to store iron in ferritins is discussed in detail in Chapter 8.7 of Volume 8 of this series. In ferritin, the iron oxyhydroxide is stored inside a hollow spherical cavity of 7–8 nm diameter surrounded by 24 (or 12 dimeric) protein subunits. In this chapter, the general principles in the operation of controlling iron hydrolysis to create iron biominerals are discussed with reference to the coordinating species which can be involved in directing the phase and function of the mineral. Ferritins are also particularly relevant to the research discussed in our volume, since they consist of encapsulated nanoscopic particles where the “ligands” are still clearly visible (the protein shell of the system).

Although as has been stated above, most biominerals are based on what is readily available to organisms for forming structures, calcium and silicate-based systems, there are some very important lessons to be learned by coordination chemists aiming towards “new materials”. We need only think of the strength of rather light bones, which are some ten times stronger than ordinary concrete. When we consider that it is necessary to reinforce concrete with iron wires to achieve an

equivalent strength, and the disadvantages of this material in terms of weight, durability, and self-repair compared with our bones, we can appreciate that the composite material nature has come up with is far superior to anything we can currently create. The construction of calcium carbonate shells gives further insights into design principles we might wish to employ. As well as the different types of crystal growth to give different shapes, which can variously be described in terms of logarithmic growth, linear growth, concentric growth, and so on, there is also the creation of superstructures with careful layering of the mineral to reinforce a weak shear direction or else a change of phase on traveling from the inside of, say, an oyster shell, which is lined with mother-of-pearl (aragonite as nacre), to the tough outside made up of calcite.

In addition to such structural marvels, biomineral structures are used as sensors with some marine species displaying the structural motifs found in photonic crystals. As well as light sensing, calcium carbonate in the form of nanoparticles is used in the human ear as part of a gravity sensor and helps to keep us upright – it serves a similar purpose along the lateral line of fish. Perhaps most intriguing are the magnetic sensors, usually in the form of aligned and elongated nanocrystals of magnetite, found in the tissues of a variety of creatures including bacteria, bees, fish, and birds, which sense the Earth's magnetic field and help these creatures to orientate themselves.

In Chapter 11, Molecular Electron Transfer, the broad and deep field of electron-transfer reactions of metal complexes is surveyed and analyzed. In Chapter 12, Electron Transfer From the Molecular to the Nanoscale, the new issues arising for electron-transfer processes on the nanoscale are addressed; this chapter is less a review than a “toolbox” for approaching and analyzing new situations. In Chapter 13, Magnetism From the Molecular to the Nanoscale, the mechanisms and consequences of magnetic coupling in zero- and one-dimensional systems comprised of transition-metal complexes is surveyed. Related to the topics covered in this volume are a number addressed in other volumes. The techniques used to make the measurements are covered in Section I of Volume 2. Theoretical models, computational methods, and software are found in Volume 2, Sections II and III, while a number of the case studies presented in Section IV are pertinent to the articles in this chapter. Photochemical applications of metal complexes are considered in Volume 9, Chapters 11–16, 21 and 22.

In addition, subjects such as molecular photochemistry and photophysics and optical properties from the molecular to the nanoscale are closely related. Accordingly, a brief selection of lead-in references in these areas is provided. The organization and selection are strongly influenced by the interests of the author. Where possible review articles are cited rather than primary literature. At present the best consistent medium for review articles on inorganic photochemistry is *Coordination Chemistry Reviews*.

## 1. Molecular Photochemistry and Photophysics: General References

Vogler, A.; Kunkely, H. Luminescent metal complexes: diversity of excited states. In *Transition Metal and Rare Earth Compounds: Excited States, Transition, Interactions I*, Vol. 213; Yersin, H., Ed.; Springer: Berlin, 2001; pp 143–182.

Chen, P. Y.; Meyer, T. J. Medium effects on charge transfer in metal complexes. *Chem. Rev.* **1998**, *98*, 1439–1477.

Roundhill, D. M. *Photochemistry and Photophysics of Metal Complexes*; Plenum: New York, 1994.

Horvath, O.; Stevenson, K. L. *Charge Transfer Photochemistry of Coordination Compounds*; VCH: New York, 1993.

Adamson, A. W. Inorganic photochemistry – then and now. *Coord. Chem. Rev.* **1993**, *125*, 1–12.

Balzani, V.; Scandola, F. *Supramolecular Photochemistry*; Ellis Horwood: New York, 1991.

Ferraudi, G. J. *Elements of Inorganic Photochemistry*; Wiley: Chichester, UK, 1988.

Kutal, C.; Adamson, A. W. In *Comprehensive Coordination Chemistry*; Wilkinson, G., Ed.; Pergamon: Oxford, UK, 1987, Vol. 1, pp 385–414.

Zuckerman, J. J., Ed. *Inorganic Reactions and Methods*; VCH: Deerfield Beach, FL, 1986; Vol. 15.

Geoffroy, G. L.; Wrighton, M. S. *Organometallic Photochemistry*; Academic Press: New York. Adamson, A. W.; Fleischauer, P. D., Eds. *Concepts of Inorganic Photochemistry*; Wiley-Interscience: New York, 1975.

Balzani, V.; Carassiti, V. *Photochemistry of Coordination Compounds*; Academic Press, New York, 1970.

Rate constants for quenching of the excited states of metal complexes are available through the Notre Dame Radiation Laboratory DataBase <http://allen.rad.nd.edu/>

## 2. Metal-to-ligand Charge Transfer Excited States

### 2.1 $Ru(bpy)_3^{2+}$ and Other $d^6$ Metal Centers

Bhasikuttan, A. C.; Suzuki, M.; Nakashima, S.; Okada, T. Ultrafast fluorescence detection in tris(2,2'-bipyridine)ruthenium(II) complex in solution: relaxation dynamics involving higher excited states. *J. Am. Chem. Soc.* **2002**, *124*, 8398–8405.

Kelly, C. A.; Meyer, G. J. Excited state processes at sensitized nanocrystalline thin film semiconductor interfaces. *Coord. Chem. Rev.* **2001**, *211*, 295–315.

Qu, P.; Meyer, G. J. Dye sensitization of electrodes. In *Electron Transfer in Chemistry*; Balzani, V., Ed.; Wiley-VCH: New York, 2001; Vol. 4, Part 2, pp 354–411.

Scandola, F.; Chiorbelli, C.; Indelli, M. T.; Rampi, M. A. Covalently linked systems containing metal complexes. In *Electron Transfer in Chemistry*; Balzani, V., Ed.; Wiley-VCH: New York, 2001; Vol. 3, Part 2, pp 337–408.

Striplin, D. R.; Crosby, G. A. Photophysical investigations of rhenium(I)Cl(CO)<sub>3</sub>(phenanthroline) complexes. *Coord. Chem. Rev.* **2001**, *211*, 163–175.

Stufkens, D. J.; Vlcek, A. Ligand-dependent excited state behaviour of Re(I) and Ru(II) carbonyl–diimine complexes. *Coord. Chem. Rev.* **1998**, *177*, 127–179.

Damrauer, N. H.; McCusker, J. K. Ultrafast dynamics in the metal-to-ligand charge transfer excited-state evolution of Ru(4,4'-diphenyl-2,2'-bipyridine)<sub>3</sub> (2+). *J. Phys. Chem. A* **1999**, *103*, 8440–8446.

Sauvage, J. P.; Collin, J. P.; Chambron, J. C.; Guillerez, S.; Coudret, C.; Balzani, V.; Barigelletti, F.; Decola, L.; Flamigni, L. Ruthenium(II) and osmium(II) bis(terpyridine) complexes in covalently linked multicomponent systems – synthesis, electrochemical behavior, absorption spectra, and photochemical and photophysical properties. *Chem. Rev.* **1994**, *94*, 993–1019.

Schanze, K. S.; Macqueen, D. B.; Perkins, T. A.; Cabana, L. A. Studies of intramolecular electron and energy transfer using the fac-(diimine)ReI(CO)<sub>3</sub> chromophore. *Coord. Chem. Rev.* **1993**, *122*, 63–89.

Kalyanasundaram, K. *Photochemistry of Polypyridine and Porphyrin Complexes*; Academic Press: London, 1992.

Kalyanasundaram, K. Photophysics, photochemistry and solar energy conversion with tris(bipyridyl)ruthenium(II) and its analogues. *Coord. Chem. Rev.* **1982**, *46*, 159–244.

Sutin, N.; Creutz, C. Light-induced electron transfer reactions of metal complexes. *Pure Appl. Chem.* **1980**, *52*, 2717–2738.

### 2.2 Other Metal Centers

Vlcek, A. Mechanistic roles of metal-to-ligand charge-transfer excited states in organometallic photochemistry. *Coord. Chem. Rev.* **1998**, *177*, 219–256.

Vogler, A.; Kunkely, H. Photoreactivity of metal-to-ligand charge transfer excited states. *Coord. Chem. Rev.* **1998**, *177*, 81–96.

Scaltrito, D. V.; Thompson, D. W.; O'Callaghan, J. A.; Meyer, G. J. MLCT excited states of cuprous bis-phenanthroline coordination compounds. *Coord. Chem. Rev.* **2000**, *208*, 243–266.

Vogler, A.; Kunkely, H. A new type of MLCT transition relevant to oxidative additions:  $d \rightarrow \sigma^*$  excitation. *Coord. Chem. Rev.* **1998**, *171*, 399–406.

## 3. Ligand-to-metal Charge-transfer Excited States

Sima, J.; Brezova, V. Photochemistry of iodo iron(III) complexes. *Coord. Chem. Rev.* **2002**, *229*, 27–35.

Manson, J. L.; Buschmann, W. E.; Miller, J. S. Tetracyanomanganate(II) and its salts of divalent first-row transition metal ions. *Inorg. Chem.* **2001**, *40*, 1926–1935.

Stanislas, S.; Beauchamp, A. L.; Reber, C. The lowest-energy ligand-to-metal charge-transfer absorption band of trans-OsO<sub>2</sub>(malonate)<sub>2</sub> (2-). *Inorg. Chem.* **2000**, *39*, 2152–2155.

Villata, L. S.; Wolcan, E.; Feliz, M. R.; Capparelli, A. L. Competition between intraligand triplet excited state and LMCT on the thermal quenching in beta-diketonate complexes of europium(III). *J. Phys. Chem. A* **1999**, *103*, 5661–5666.

Yang, Y. S.; Hsu, W. Y.; Lee, H. F.; Huang, Y. C.; Yeh, C. S.; Hu, C. H. Experimental and theoretical studies of metal cation–pyridine complexes containing Cu and Ag. *J. Phys. Chem. A* **1999**, *103*, 11287–11292.

Kunkely, H.; Vogler, A. Photoreactivity of (HBpyrazolyl)<sub>3</sub>) TiCl<sub>3</sub> and (C<sub>5</sub>H<sub>5</sub>)TiCl<sub>3</sub> initiated by ligand-to-metal charge-transfer excitation. *J. Photochem. Photobiol. A-Chem.* **1998**, *119*, 187–190.

Stufkens, D. J.; Aarnts, M. P.; Rossenaar, B. D.; Vlcek, A. A new series of Re and Ru complexes having a lowest sigma pi\* excited state that varies from reactive to stable and long lived. *Pure Appl. Chem.* **1997**, *69*, 831–835.

Sima, J.; Makanova, J. Photochemistry of iron(III) complexes. *Coord. Chem. Rev.* **1997**, *160*, 161–189.

Kuma, K.; Nakabayashi, S.; Matsunaga, K. Photoreduction of Fe(III) by hydroxycarboxylic acids in seawater. *Water Res.* **1995**, *29*, 1559–1569.

Horvath, O.; Vogler, A. Photoredox chemistry of chloromercurate(II) complexes in acetonitrile. *Inorg. Chem.* **1993**, *32*, 5485–5489.

Kalyanasundaram, K.; Zakeeruddin, S. M.; Nazeeruddin, M. K. Ligand-to-metal charge-transfer transitions in Ru(III) and Os(III) complexes of substituted 2,2'-bipyridines. *Coord. Chem. Rev.* **1994**, *132*, 259–264.

Weit, S. K.; Ferraudi, G.; Grutsch, P. A.; Kutal, C. Charge-transfer spectroscopy and photochemistry of alkylamine cobalt(III) complexes. *Coord. Chem. Rev.* **1993**, *128*, 225–243.

Carlos, R. M.; Frink, M. E.; Tfouni, E.; Ford, P. C. Photochemical and spectral properties of the sulfito rhodium(III) complexes *trans*-Rh(NH<sub>3</sub>)<sub>4</sub>(SO<sub>3</sub>)CN and Na(*trans*-Rh(NH<sub>3</sub>)<sub>4</sub>(SO<sub>3</sub>)<sub>2</sub>). *Inorg. Chim. Acta* **1992**, *193*, 159–165.

Bergkamp, M. A.; Gütllich, P.; Netzel, T. L.; Sutin, N. Lifetimes of the ligand-to-metal charge-transfer excited states of iron(III) and osmium(III) polypyridine complexes. Effects of isotopic substitution and temperature. *J. Phys. Chem.* **1983**, *87*, 3877–3883.

#### 4. Polyoxometallates/ Metal Oxo Complexes

Texier, I.; Delouis, J. F.; Delaire, J. A.; Gionnotti, C.; Plaza, P.; Martin, M. M. Dynamics of the first excited state of the decatungstate anion studied by subpicosecond laser spectroscopy. *Chem. Phys. Lett.* **1999**, *311*, 139–145.

Duncan, D. C.; Fox, M. A. Early events in decatungstate photocatalyzed oxidations: a nanosecond laser transient absorbance reinvestigation. *J. Phys. Chem. A* **1998**, *102*, 4559–4567.

Ermolenko, L. P.; Delaire, J. A.; Giannotti, C. Laser flash photolysis study of the mechanism of photooxidation of alkanes catalyzed by decatungstate anion. *J. Chem. Soc. – Perkin Trans.* **1997**, *2*, 25–30.

Duncan, D. C.; Netzel, T. L.; Hill, C. L. Early-time dynamics and reactivity of polyoxometalate excited states – identification of a short-lived lmct excited-state and a reactive long-lived charge-transfer intermediate following picosecond flash excitation of W<sub>10</sub>O<sub>32</sub> (4-) in acetonitrile. *Inorg. Chem.* **1995**, *34*, 4640–4646.

Yamase, T.; Ohtaka, K. Photochemistry of polyoxovanadates. 1. Formation of the anion-encapsulated polyoxovanadate V<sub>15</sub>O<sub>36</sub>(Co<sub>3</sub>) (7-) and electron-spin polarization of alpha-hydroxyalkyl radicals in the presence of alcohols. *J. Chem. Soc. – Dalton Trans.* **1994**, 2599–2608.

Sattari, D.; Hill, C. Catalytic carbon–halogen bond cleavage chemistry by redox-active polyoxometalates. *J. Am. Chem. Soc.* **1993**, *115*, 4649–4657.

Yamase, T.; Sugeta, M. Charge-transfer photoluminescence of polyoxo-tungstates and polyoxo-molybdates. *J. Chem. Soc. – Dalton Trans.* **1993**, 759–765.

Winkler, J. R.; Gray, H. B. On the interpretation of the electronic spectra of complexes containing the molybdenyl ion. *Comments Inorg. Chem.* **1981**, *1*, 257–263.

#### 5. Metal-centered Excited States

##### 5.1 Ligand Field Excited States

Kirk, A. D. Photochemistry and photophysics of chromium(III) complexes. *Chem. Rev.* **1999**, *99*, 1607–1640.

Lees, A. J. Quantitative photochemistry of organometallic complexes: insight to their photo-physical and photoreactivity mechanisms. *Coord. Chem. Rev.* **2001**, *211*, 255–278.

Irwin, G.; Kirk, A. D. Intermediates in chromium(III) photochemistry. *Coord. Chem. Rev.* **2001**, *211*, 25–43.

##### 5.2 Excited States of $d^{10}$ and $s^2$ Systems

Vogler, A.; Kunkely, H. Photoreactivity of gold complexes. *Coord. Chem. Rev.* **2001**, *219*, 489–507.

Vitale, M.; Ford, P. C. Luminescent mixed ligand copper(I) clusters (CuI)(n)(L)(m) (L = pyridine, piperidine): thermodynamic control of molecular and supramolecular species. *Coord. Chem. Rev.* **2001**, *219*, 3–16.

Yam, V. W. W.; Chan, C. L.; Li, C. K.; Wong, K. M. C. Molecular design of luminescent dinuclear gold(I) thiolate complexes: from fundamentals to chemosensing. *Coord. Chem. Rev.* **2001**, *216*, 173–194.

Yam, V. W. W.; Lo, K. K. W. Luminescent polynuclear d(10) metal complexes. *Chem. Soc. Rev.* **1999**, *28*, 323–334.

Ford, P. C.; Cariati, E.; Bourassa, J. Photoluminescence properties of multinuclear copper(I) compounds. *Chem. Rev.* **1999**, *99*, 3625–3648.

Forward, J. M.; Bohmann, D.; J. P. Fackler, J.; Staples, R. J. Luminescence studies of gold(I) thiolate complexes. *Inorg. Chem.* **1995**, *34*, 6330–6336.

Ford, P. C.; Vogler, A. Photochemical and photophysical properties of tetranuclear and hexanuclear clusters of metals with  $d^{10}$  and  $s^2$  electronic configurations. *Acc. Chem. Res.* **1993**, *26*, 220–226.

Dossing, A.; Ryu, C. K.; Kudo, S.; Ford, P. C. Competitive bimolecular electron-transfer and energy-transfer quenching of the excited state(S) of the tetranuclear copper(I) cluster  $Cu_4i_4py_4$  – evidence for large reorganization energies in an excited-state electron-transfer. *J. Am. Chem. Soc.* **1993**, *115*, 5132–5137.

Stacey, E. M.; McMillin, D. R. Inorganic exciplexes revealed by temperature-dependent quenching studies. *Inorg. Chem.* **1990**, *29*, 393–396.

### 5.3 Excited States of $d^2 M \equiv N$ and MO Systems

Bailey, S. E.; Eikay, R. A.; Abu-Omar, M. M.; Zink, J. I. Excited-state distortions determined from structured luminescence of nitridorhenium(V) complexes. *Inorg. Chem.* **2002**, *41*, 1755–1760 and references therein.

Yam, V. W. W.; Pui, Y. L.; Wong, K. M. C.; Cheung, K. K. Synthesis, structural characterisation, photophysics, photochemistry and electrochemistry of nitrido- and *trans*- dioxorhenium(V) complexes with substituted dppe ligands (dppe=bis(diphenylphosphino)ethane). *Inorg. Chim. Acta* **2000**, *300*, 721–732.

Cheng, J. Y. K.; Cheung, K. K.; Che, C. M.; Lau, T. C. Photocatalytic and aerobic oxidation of saturated alkanes by a neutral luminescent *trans*-dioxoosmium(VI) complex  $OsO_2(CN)_2(dpphen)$ . *Chem. Commun.* **1997**, 1443–1444.

Kelly, C.; Szalda, D. J.; Creutz, C.; Schwarz, H. A.; Sutin, N. Electron transfer barriers for ground- and excited-state redox couples: *trans*-dioxo(1,4,8,11-tetramethyl-1,4,8,11-tetraazacyclotetradecane) osmium(VI)/osmium(V). *Inorg. Chim. Acta* **1996**, *243*, 39–45.

Yam, V. W. W.; Tam, K. K.; Lai, T. F. Syntheses, spectroscopy and electrochemistry of nitridorhenium(V) organometallics – X-ray crystal structure of  $ReVnme_2(Pph_3)_2$ . *J. Chem. Soc. – Dalton Trans.* **1993**, 651–652.

Schindler, S.; Castner, E. W., Jr.; Creutz, C.; Sutin, N. Reductive quenching of the emission of *trans*-dioxo(1,4,8,11-tetramethyl-1,4,8,11-tetraazacyclotetradecane)osmium(VI) in water. *Inorg. Chem.* **1993**, *32*, 4200–4208.

### 5.4 $s^2$ Metal Complexes

Vogler, A.; Nikol, H. The structures of  $s^2$  metal complexes in the ground and sp excited states. *Comments. Inorg. Chem.* **1993**, *14*, 245–261.

Vogler, A.; Nikol, H. Photochemistry and photophysics of the main group metals. *Pure Appl. Chem.* **1992**, *64*, 1311–1317.

### 5.5 $f^n$ Metal Complexes

Sabbatini, N.; Guardigli, M.; Lehn, J.-M. Luminescent lanthanide complexes as photochemical supramolecular devices. *Coord. Chem. Rev.* **1993**, *123*, 201–228.

## 6. Ligand-centered Excited States

Wang, X. Y.; Del Guerzo, A.; Schmehl, R. H. Preferential solvation of an ILCT excited state in bis(terpyridine-phenylene-vinylene) Zn(II) complexes. *Chem. Commun.* **2002**, 2344–2345.

Vlcek, A. Highlights of the spectroscopy, photochemistry and electrochemistry of  $M(CO)_4$ - ( $\alpha$ -diimine) complexes,  $M = Cr, Mo, W$ . *Coord. Chem. Rev.* **2002**, *230*, 225–242.

Del Guerzo, A.; Leroy, S.; Fages, F.; Schmehl, R. H. Photophysics of Re(I) and Ru(II) diimine complexes covalently linked to pyrene: contributions from intra-ligand charge transfer states. *Inorg. Chem.* **2002**, *41*, 359–366.

Michalec, J. F.; Bejune, S. A.; Cuttell, D. G.; Summerton, G. C.; Gertenbach, J. A.; Field, J. S.; Haines, R. J.; McMillin, D. R. Long-lived emissions from 4'-substituted  $Pt(trpy)Cl^+$  complexes bearing aryl groups. Influence of orbital parentage. *Inorg. Chem.* **2001**, *40*, 2193–2200.

Yersin, H.; Donges, D.; Nagle, J. K.; Sitters, R.; Glasbeek, M. Intraligand charge transfer in the Pd(II) oxinate complex Pd(qol)(2). Site-selective emission, excitation, and optically detected magnetic resonance. *Inorg. Chem.* **2000**, *39*, 770–777.

van Slageren, J.; Hartl, F.; Stufkens, D. J.; Martino, D. M.; van Willigen, H. Changes in excited-state character of M(L-1)(L-2)(CO)(2)(alpha-diimine) (M = Ru, Os) induced by variation of L-1 and L-2. *Coord. Chem. Rev.* **2000**, *208*, 309–320.

Baba, A. I.; Shaw, J. R.; Simon, J. A.; Thummel, R. P.; Schmehl, R. H. The photophysical behavior of d<sup>6</sup> complexes having nearly isoenergetic MLCT and ligand localized excited states. *Coord. Chem. Rev.* **1998**, *171*, 43–59.

Kimachi, S.; Ikeda, S.; Miki, H.; Azumi, T.; Crosby, G. A. Spectroscopic and magnetic studies of complexes of d<sup>10</sup> closed-shell ions. *Coord. Chem. Rev.* **1994**, *132*, 43–50.

Watts, R. J.; Van Houten; J. The effect of energy gaps on multiple emissions in heterotrisc-helated rhodium(III) complexes. *J. Am. Chem. Soc.* **1978**, *100*(6), 1718–1721.

## 7. Outer-sphere Charge Transfer in Ion Pairs

Electrostatic attraction between charged coordination compounds and oppositely charged counter ions in solution leads to ion pairing. The spectroscopic and photochemical properties of the ion pairs may markedly differ from those of the individual components. In some cases ion pair charge-transfer (IPCT) optical transitions may be observed and ion pairs may undergo energy transfer and photoinduced electron transfer.

Vogler, A.; Kunkely, H. Outer-sphere charge transfer in ion pairs with hydridic, carbanionic, sulfidic and peroxidic anions as electron donors – spectroscopy and photochemistry. *Coord. Chem. Rev.* **2002**, *229*, 147–152.

Billing, R. Optical and photoinduced electron transfer in ion pairs of coordination compounds. *Coord. Chem. Rev.* **1997**, *159*, 257–270.

Kunkely, H.; Vogler, A. Photoredox reaction of [Hg(cyclam)]<sup>2+</sup>[Co(CO)<sub>4</sub>]<sup>-</sup> induced by outer-sphere charge transfer excitation. *Z. Naturforsch.* **1993**, *48b*, 397–398.

## 8. Metal–Metal Bonded Species

Wong, K. M. C.; Hui, C. K.; Yu, K. L.; Yam, V. W. W. Luminescence studies of dinuclear platinum(II) alkynyl complexes and their mixed-metal platinum(II)–copper(I) and –silver(I) complexes. *Coord. Chem. Rev.* **2002**, *229*, 123–132.

Stufkens, D. J.; Aarnts, M. P.; Nijhoff, J.; Rossenaar, B. D.; Vlcek, A. Excited states of metal–metal bonded diimine complexes vary from extremely long lived to very reactive with formation of radicals or zwitterions. *Coord. Chem. Rev.* **1998**, *171*, 93–105.

Roundhill, D. M.; Gray, H. B.; Che, C.-M. Pyrophosphito-bridged diplatinum chemistry. *Acc. Chem. Res.* **1989**, *22*, 55–61.

## 9. Spectroscopy of Semiconductor Particles

Buhro, W. E.; Colvin, V. L. Semiconductor nanocrystals: shape matters. *Nature Mater.* **2003**, *2*, 138–139.

Khoudiakov, M.; Parise, A. R.; Brunshwig, B. S. Interfacial electron transfer in FeII(CN)<sub>6</sub><sup>4-</sup>-sensitized TiO<sub>2</sub> nanoparticles: a study of direct charge injection by electroabsorption spectroscopy. *J. Am. Chem. Soc.* **2003**, *125*, 4637–4642.

Brus, L. Model for carrier dynamics and photoluminescence quenching in wet and dry porous silicon thin films. *Phys. Rev. B* **1996**, *53*, 4649–4656.

Liu, H. J.; Hupp, J. T.; Ratner, M. A. Electronic structure and spectroscopy of cadmium thiolate clusters. *J. Phys. Chem.* **1996**, *100*, 12204–12213.

Turk, T.; Vogler, A.; Fox, M. A. Molecular models for semiconductor particles – luminescence studies of several inorganic anionic clusters. *Adv. Chem. Ser.* **1993**, 233–241.

Bawendi, M. G.; Steigerwald, M. L.; Brus, L. E. The quantum mechanics of larger semiconductor clusters (“quantum dots”). *Ann. Rev. Phys. Chem.* **1990**, *41*, 477–496.

Steigerwald, M. L.; Brus, L. E. Semiconductor crystallites: a class of large molecules. *Acc. Chem. Res.* **1990**, *23*, 183–188.

Brus, L. Electronic wave functions in semiconductor clusters: experiment and theory. *J. Phys. Chem.* **1986**, *90*, 2555–2560.

Brus, L. E. Electron–electron and electron–hole interactions in small semiconductor crystallites: the size dependence of the lowest excited electronic state. *J. Chem. Phys.* **1984**, *80*, 4403–4409.



## 10. Spectroscopy of Metal Particles

Kelly, K. L.; Coronado, E.; Zhao, L. L.; Schatz, G. C. The optical properties of metal nanoparticles: The influence of size, shape, and dielectric environment. *J. Phys. Chem. B* **2003**, *107*, 668–677.

Hu, M.; Hartland, G. V. Heat dissipation for Au particles in aqueous solution: relaxation time versus size. *J. Phys. Chem. B* **2002**, *106*, 7029–7033.

Link, S.; El-Sayed, M. A.; Schaaff, T. G.; Whetten, R. L. Transition from nanoparticle to molecular behavior: a femtosecond transient absorption study of a size-selected 28-atom gold cluster. *Chem. Phys. Lett.* **2002**, *356*, 240–246.

Link, S.; Beeby, A.; FitzGerald, S.; El-Sayed, M. A.; Schaaff, T. G.; Whetten, R. L. Visible to infrared luminescence from a 28-atom gold cluster. *J. Phys. Chem. B* **2002**, *106*, 3410–3415.

Hartland, G. V.; Hu, M.; Wilson, O.; Mulvaney, P.; Sader, J. E. Coherent excitation of vibrational modes in gold nanorods. *J. Phys. Chem. B* **2002**, *106*, 743–747.

El-Sayed, M. A. Some interesting properties of metals confined in time and nanometer space of different shapes. *Acc. Chem. Res.* **2001**, *34*, 257–264.

Link, S.; El-Sayed, M. A. Spectroscopic determination of the melting energy of a gold nanorod. *J. Chem. Phys.* **2001**, *114*, 2362–2368.

Mulvaney, P. Surface plasmon spectroscopy of nanosized metal particles. *Langmuir* **1996**, *12*, 788–800 and references therein.

Creighton, J. A.; Eadon, D. G. Ultraviolet-visible absorption spectra of the colloidal metallic elements. *J. Chem. Soc. Faraday Trans.* **1991**, *87*, 3881–3891.

M Fujita  
Nagoya, Japan  
July 2003

A Powell  
Karlsruhe, Germany  
July 2003

C Creutz  
Upton, USA  
May 2003

# Introduction to Volume 8

Since the publication of CCC (1987), bioinorganic chemistry has blossomed and matured as an interdisciplinary field, which is surveyed in this volume from the perspective of coordination chemistry. Fully comprehensive coverage of biological inorganic chemistry is not possible, so a subset of topics is presented that captures the excitement of the field and reflects the scope and diversity of the systems and research approaches used. As an introduction, a summary of structural motifs that pervade bioinorganic systems is presented (Chapter 1). Subsequent chapters focus on the nature of the metal sites in proteins that participate in electron transfer (Chapters 2–4) and on the transport and storage of metal ions within the biological milieu (Chapters 5–9). The diverse and biologically important array of metalloproteins that bind and activate dioxygen and perform oxidation reactions are then discussed (Chapters 10–18). To complete the presentation of metal–dioxygen chemistry, superoxide processing systems and photosynthetic oxygen evolution are portrayed (Chapters 19–20). The following sections focus on the activation of other small molecules ( $\text{H}_2$ , Chapter 21;  $\text{N}_2$ , Chapter 22), mono- and dinuclear metal sites that perform hydrolysis reactions (Chapters 23–24), and the burgeoning bio-organometallic area (Chapter 25). Proteins with synergistic metal–radical sites are discussed in Chapter 26. Iron–sulfur clusters are revisited in Chapter 27, which presents those that are involved in enzyme catalysis rather than simple electron transfer. The role of metal ions in the environmentally significant process of denitrification is the focus of Chapter 28. Finally, the binding of metal ions to DNA and RNA are emphasized in Chapter 29. Together, the array of topics presented in this volume illustrates the importance of coordination chemistry in the biological realm and the breadth of current bioinorganic chemistry research.

L Que, Jr.  
*Minnesota, USA*  
*March 2003*

W B Tolman  
*Minnesota, USA*  
*March 2003*

# Introduction to Volume 9

This volume aims to give as complete a coverage of the real and possible applications of coordination complexes as is possible in a single volume. It is far more wide-ranging in its coverage than the related volume on ‘applications’ in the first edition of CCC (1987).

The chapters cover the following areas: (i) use of coordination complexes in all types of catalysis (Chapters 1–11); (ii) applications related to the optical properties of coordination complexes, which covers fields as diverse as solar cells, nonlinear optics, display devices, pigments and dyes, and optical data storage (Chapters 12–16); (iii) hydrometallurgical extraction (Chapter 17); (iv) medicinal and biomedical applications of coordination complexes, including both imaging and therapy (Chapters 18–22); and (v) use of coordination complexes as precursors to semiconductor films and nanoparticles (Chapter 23). As such, the material in this volume ranges from solid-state physics to biochemistry.

There are a few points to make about the extent and depth of the coverage of material in this volume. First, the sheer quantity of material involved necessarily limits the depth of the coverage. To take a single example, the use of metal complexes as catalysts for carbonylation reactions is a subject worth a large book in its own right, and covering it in a few tens of pages means that the focus is on recent examples which illustrate the scope of the subject rather than covering encyclopedically all of the many thousands of references on the subject which have appeared since CCC (1987) was published. Accordingly the general emphasis of this volume is on breadth rather than depth, with all major areas in which coordination complexes have practical applications being touched on, and extensive citations to more detailed and larger reviews, monographs, and books where appropriate.

Secondly, many of the chapters contain material which – if a strict definition is applied – is not coordination chemistry, but whose inclusion is necessary to allow a proper picture of the field to be given. A great deal of license has been taken with the division between “coordination” and “organometallic” complexes; the formal distinction for the purposes of this series is that if more than 50% of the bonds are metal–carbon bonds then the compound is organometallic. However, during a catalytic cycle the numbers of metal–carbon and metal–(other ligand) bonds changes from step to step, and it often happens that a catalyst precursor is a “coordination complex” (e.g., palladium(II) phosphine halides, to take a simple example) even when the important steps in the catalytic cycle involve formation and cleavage of M–C bonds. Likewise, many of the volatile molecules described in Chapter 23 as volatile precursors for MOCVD are organometallic metal alkyls; but they can be purified via formation of adducts with ligands such as bipyridine or diphosphines, and it would be artificial to exclude them and cover only “proper” coordination complexes such as diketonates and dithiocarbamates. In other fields, Chapter 15, which describes the use of phosphors in display devices, includes a substantial amount of solid-state chemistry (of doped mixed-metal oxides, sulfides, and the like) as well as coordination chemistry; Chapter 13 describes how a CD-R optical disk functions as a prelude to describing the metal complexes used as dyes for recording the information. So, some of the material in the volume is peripheral to coordination chemistry; but all of it is material that will be of interest to coordination chemists.

Thirdly, some obvious applications of coordination chemistry are omitted from this volume if they are better treated elsewhere. This is the case when a specific application is heavily associated with one particular element or group of elements, to the extent that the application is more appropriately discussed in the section on that element. Essentially all of the coordination chemistry of technetium, for example, relates to its use in radioimmunoimaging; inclusion of this in Chapter 20 of this volume would have left the chapter on technetium in Volume 5 almost empty. For the same reason, the applications of actinide coordination complexes to purification, recovery,

and extraction processes involving nuclear fuel are covered in Volume 2, as this constitutes a major part of the coordination chemistry of the actinides.

In conclusion, it is hoped that this volume will be a stimulating and valuable resource for readers who are interested to see just how wide is the range of applications to which coordination chemistry can be put. If nothing else it will help to provide an answer to the eternally irritating question which academics get asked at parties when they reveal what they do for a living: “But what’s it *for*?”

M D Ward  
*Bristol, UK*  
*February 2003*

## **PERMISSION ACKNOWLEDGMENTS**

Material has been reproduced in this reference work with kind permission of Nature Publishing Group

<http://www.nature.com/nature>

Full citations are given at the relevant places in the text

Material has been reproduced in this reference work with kind permission of the American Association for the Advancement of Science

<http://www.sciencemag.org>

Full citations are given at the relevant places in the text

Material has been reproduced in this reference work with kind permission of Taylor & Francis Ltd.

<http://www.tandf.co.uk/journals>

Full citations are given at the relevant places in the text



ELSEVIER



## COMPREHENSIVE COORDINATION CHEMISTRY II

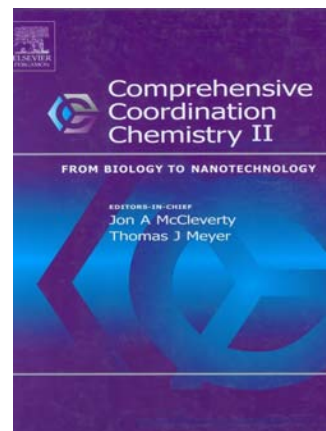
From Biology to Nanotechnology

Second Edition

Edited by

J.A. McCleverty, University of Bristol, UK

T.J. Meyer, Los Alamos National Laboratory, Los Alamos, USA



### Description

This is the sequel of what has become a classic in the field, Comprehensive Coordination Chemistry. The first edition, CCC-I, appeared in 1987 under the editorship of Sir Geoffrey Wilkinson (Editor-in-Chief), Robert D. Gillard and Jon A. McCleverty (Executive Editors). It was intended to give a contemporary overview of the field, providing both a convenient first source of information and a vehicle to stimulate further advances in the field. The second edition, CCC-II, builds on the first and will survey developments since 1980 authoritatively and critically with a greater emphasis on current trends in biology, materials science and other areas of contemporary scientific interest. Since the 1980s, an astonishing growth and specialisation of knowledge within coordination chemistry, including the rapid development of interdisciplinary fields has made it impossible to provide a totally comprehensive review. CCC-II provides its readers with reliable and informative background information in particular areas based on key primary and secondary references. It gives a clear overview of the state-of-the-art research findings in those areas that the International Advisory Board, the Volume Editors, and the Editors-in-Chief believed to be especially important to the field. CCC-II will provide researchers at all levels of sophistication, from academia, industry and national labs, with an unparalleled depth of coverage.

### Bibliographic Information

10-Volume Set - Comprehensive Coordination Chemistry II

Hardbound, ISBN: 0-08-043748-6, 9500 pages

Imprint: ELSEVIER

Price:

USD 5,975

EUR 6,274 Books and electronic products are priced in US dollars (USD) and euro (EUR). USD prices apply world-wide except in Europe and Japan. EUR prices apply in Europe and Japan. See also information about conditions of sale & ordering procedures -<http://www.elsevier.com/wps/find/bookconditionsofsale>.

[cws\\_home/622954/conditionsofsale](http://www.elsevier.com/wps/find/cws_home/622954/conditionsofsale), and links to our regional sales offices [http://www.elsevier.com/wps/find/contact.cws\\_home/regional](http://www.elsevier.com/wps/find/contact.cws_home/regional)

GBP 4,182.50

030/301

Last update: 10 Sep 2005

## Volumes

Volume 1: Fundamentals: Ligands, Complexes, Synthesis, Purification, and Structure

Volume 2: Fundamentals: Physical Methods, Theoretical Analysis, and Case Studies

Volume 3: Coordination Chemistry of the s, p, and f Metals

Volume 4: Transition Metal Groups 3 - 6

Volume 5: Transition Metal Groups 7 and 8

Volume 6: Transition Metal Groups 9 - 12

Volume 7: From the Molecular to the Nanoscale: Synthesis, Structure, and Properties

Volume 8: Bio-coordination Chemistry

Volume 9: Applications of Coordination Chemistry

Volume 10: Cumulative Subject Index

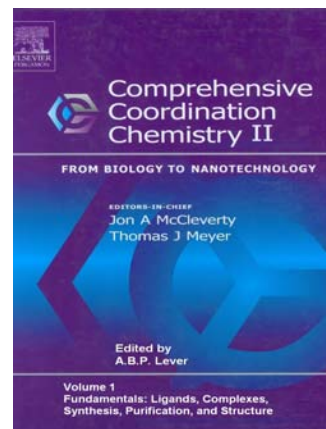
10-Volume Set: Comprehensive Coordination Chemistry II



## COMPREHENSIVE COORDINATION CHEMISTRY II

### Volume 1: Fundamentals: Ligands, Complexes, Synthesis, Purification, and Structure

Edited by  
**A.B.P. Lever**



#### Contents

##### Section 1 - Ligands

- Bipyridine Ligands (C.L. Fraser, A.P. Smith).
- Phenanthroline Ligands (P. Castellano, C.R. Luman).
- Terpyridine, Oligopyridine and Polypyridine Ligands (R.P. Thummel).
- Pyridopyridine Ligands (M.A. Ciriano, L.A.Oro).
- Heterocyclic and Open Chain 1, 2-Diazine Ligands (L.K. Thompson, Z. Higiang Xu).
- O'-Diketones and Related Ligands (C. Pettinari et al).
- Phenylcyanamide Ligands (R.J. Crutchley).
- Benzimidazole Ligands (Masa-aki Haga).
- Polyatomic Bridging Ligands (K.J. Brewer, S. Swavey).
- Polypyrazolylborate and Scorpionate Ligands (C. Pettinari, C. Santini).
- Higher Denticity Ligands (C. Pettinari et al.).
- Phosphorus Ligands (M. Smith, J. H. Downing).
- Phosphorus Tripodal Ligands (G. Huttner et al.).
- Dichalcogenoimidodiphosph(in)ate Ligands (I. Haiduc).
- 1,1 and 1,3 Dithiolato Ligands (I. Haiduc).
- Acyclic Arsine, Stibine and Bismuthine Ligands (W. Levason, G. Reid).
- Acyclic Thio-, Seleno- and Telluro-ether Ligands (W. Levason, G. Reid).
- Macrocyclic Thio-, Seleno- and Telluro-ether Ligands (W. Levason, G. Reid).
- Acyclic and Macrocyclic Schiff Base Ligands ((R.H. Molina, A. Mederos).
- N and mixed NX Macrocyclic Ligands (N.F. Curtis).
- Macrocyclic Phosphine and Arsine Ligands (W. Levason, G. Reid).
- Calixarenes (M. Roundhill).
- Porphyrins (K.M. Smith).
- Phthalocyanines (N.B. McKeown).



## Section II - Synthesis, Purification and Characterization of Coordination Compounds

Metal Aqua Ions (G. Sykes et al.).  
Solvents and Ionic Liquids (P.J. Dyson).  
Chromatographic Methods (R. Shepherd).  
Crystal Growth Methods (W. Clegg).

## Section III - Reactions of Coordinated Ligands

Ligand Reactivity - General Introduction (A.J.L. Pombeiro, Vadim Yu Kukushkin).  
Reactivity and Structure of Complexes of Small Molecules: Carbon Dioxide (D.H. Gibson).  
Reactivity and Structure of Complexes of Small Molecules: Nitric and Nitrous Oxide (J.A. Olabe, L.D. Slep).  
Reactivity and Structure of Complexes of Small Molecules: Dioxygen (R. Berry).  
Reactivity of Coordinated Oximes (A.J.L. Pombeiro, Vadim Yu Kukushkin).  
Reactivity of Coordinated Nitriles (A.J.L. Pombeiro, Vadim Yu Kukushkin).

## Section IV - Stereochemistry, Structure and Crystal Engineering

Lone Pair Effects on Stereochemistry (M. Atanasov, D. Reinen).  
Outer Sphere Coordination Chemistry  
Solid State, Crystal Engineering and Hydrogen Bonds

## Section V - New Synthetic Methods

Biphasic Synthesis (P.J. Dyson).  
Solid State Methods, Hydrothermal (J.A. Zubieta).  
Sol Gel (J. Crayston).  
Sonochemistry (K. Sislick).  
Microwave Heating (A. Harrison, G. Whittaker).  
Assemblies and Self-assembly (G.F. Swiegers).  
Electrochemical Methods, Electrocrystallization (L. Valade, P. Cassoux & Paul-Louis Fabre).  
Spectroelectrochemistry (J. Crayston).  
Applications of Genetic Engineering (D. Barrick).

### *Reviews*

*(The University of Western Australia, Australia)*

*Volume 1 covers the development of new ligands since the publication of CCC.*

*This volume is a must for all advanced students, university and industrial researchers, who are involved in inorganic chemistry. It is a timely update of many areas in this field.*

*Researchers who thought they are skilled in modern aspects of inorganic chemistry should look closely at this compendium.*

# 1.1

## Bipyridine Ligands

A. P. SMITH and C. L. FRASER  
*University of Virginia, Charlottesville, VA, USA*

---

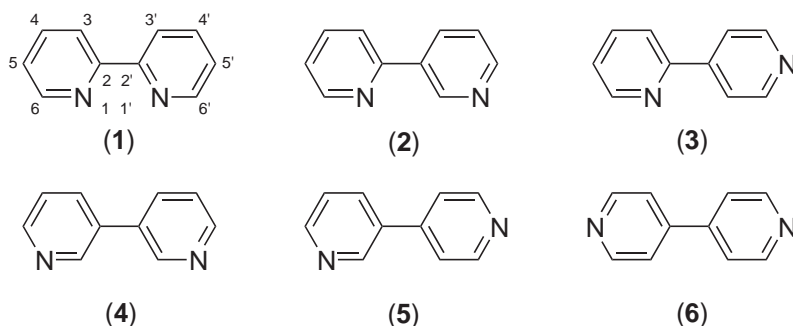
1.1.1	INTRODUCTION	1
1.1.2	SYNTHESIS OF THE BIPYRIDINE RING SYSTEM	2
1.1.2.1	Traditional Methods	2
1.1.2.2	Metal-catalyzed Coupling Reactions	2
1.1.2.2.1	<i>Homocoupling of halopyridines</i>	2
1.1.2.2.2	<i>Cross-coupling of halopyridines with pyridyl organometallics</i>	3
1.1.2.3	Preparation from Acyclic Precursors	4
1.1.2.3.1	<i>Krohnke method</i>	4
1.1.2.3.2	<i>Cycloaddition methods</i>	4
1.1.2.4	Other Synthetic Methods	5
1.1.3	REACTIONS OF THE BASIC BIPYRIDINE RING SYSTEM	6
1.1.3.1	Oxidation and Reduction	6
1.1.3.2	Substitution	6
1.1.4	FUNCTIONALIZED BIPYRIDINES: SYNTHESIS AND USES OF COMMON BUILDING BLOCKS	6
1.1.4.1	Hydrocarbons	8
1.1.4.2	Halomethyl Derivatives	10
1.1.4.3	Acid Derivatives	10
1.1.5	UNSYMMETRICAL DERIVATIVES	11
1.1.6	CHIRAL BIPYRIDINES	12
1.1.6.1	Synthesis	12
1.1.6.2	Asymmetric Catalysis	13
1.1.7	MACROCYCLES	13
1.1.7.1	Bipyridines with Pendant Macrocycles	13
1.1.7.2	Bipyridines in the Macrocycle	14
1.1.8	MULTIDENTATE CHELATES	14
1.1.9	POLYMERS	15
1.1.9.1	Macroligands	15
1.1.9.2	Bipyridines in the Main Chain	15
1.1.9.3	Polymers with Bipyridine Side Chains	16
1.1.10	BIPYRIDINES AND BIOLOGICAL MOLECULES	16
1.1.10.1	Peptides	16
1.1.10.2	Carbohydrates	16
1.1.10.3	Nucleic Acids	17
1.1.11	BIPYRIDINE ANALOGUES	17
1.1.11.1	Biquinolines	17
1.1.11.2	Biisoquinolines	17
1.1.11.3	Other Analogues	18
1.1.12	REFERENCES	18

---

### 1.1.1 INTRODUCTION

Bipyridines (IUPAC), also known as bipyridyls, dipyridyls, and dipyridines, are aromatic nitrogen heterocycles that form complexes with most transition metals.<sup>1-5</sup> This class of compounds contains six possible regioisomers—2,2' (**1**), 2,3' (**2**), 2,4' (**3**), 3,3' (**4**), 3,4' (**5**), and 4,4' (**6**)—most common of which is the bidentate chelate, (**1**), (bpy = 2,2'-bipyridine). Bipyridine ligands interact

with metals via both  $\sigma$ -donating nitrogen atoms and  $\pi$ -accepting molecular orbitals.<sup>6</sup> Bipyridines figure prominently in studies of electron and energy transfer,<sup>7–10</sup> supramolecular and materials chemistry, and catalysis. Previous excellent reviews have discussed bipyridine syntheses<sup>11,12</sup> and coordination chemistry.<sup>13</sup> This chapter highlights synthetic routes to bitys, both useful building blocks and new derivatives.



## 1.1.2 SYNTHESIS OF THE BIPYRIDINE RING SYSTEM

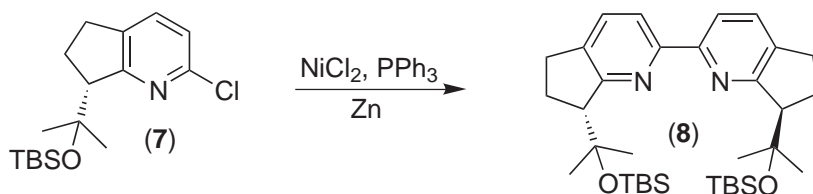
### 1.1.2.1 Traditional Methods

Bpy<sup>14</sup> and symmetrically substituted derivatives<sup>15,16</sup> have traditionally been synthesized by a number of different routes, including the Ullmann reaction, which involves homocoupling of a halopyridine in the presence of  $M^0$  where  $M$  = copper or nickel. The process most often used for large-scale industrial manufacturing of bpy is Raney nickel coupling of simple pyridine.<sup>17,18</sup> While this  $Ni^0$  catalyst can also be used with methyl pyridines (picolines) to form dimethyl-substituted bipyridines, the process is limited to simple, symmetric derivatives. More complex unsymmetrical derivatives have been generated by reaction of pyridinium salts with  $\alpha,\beta$ -unsaturated ketones followed by treatment with ammonium acetate to effect cyclization of the second ring.<sup>19</sup> This preparation, known as the Kröhnke method, is still commonly used to prepare bipyridine derivatives, and recent advances will be discussed in Section 1.1.2.3.1. More recent synthetic methods involve cross-coupling of halopyridines with organometallic pyridines and transition metal-mediated homocoupling of halopyridines. These methods allow the construction of bipyridine ligands in higher yields and permit the incorporation of a number of functional groups.

### 1.1.2.2 Metal-catalyzed Coupling Reactions

#### 1.1.2.2.1 Homocoupling of halopyridines

The most useful transition metal-mediated halopyridine homocouplings make use of a  $Ni^0$  catalyst,<sup>20</sup> most often generated *in situ* through reduction of a  $Ni^{II}$  complex. This method provides product in much higher yield than the classic Ullmann reaction and is compatible with many functional groups. For example, the chiral bipyridine (**8**) was generated in 91% yield via  $Ni$ -catalyzed homocoupling of the pyridyl chloride, (**7**) (Scheme 1).<sup>21</sup> Reactions that employ



Scheme 1

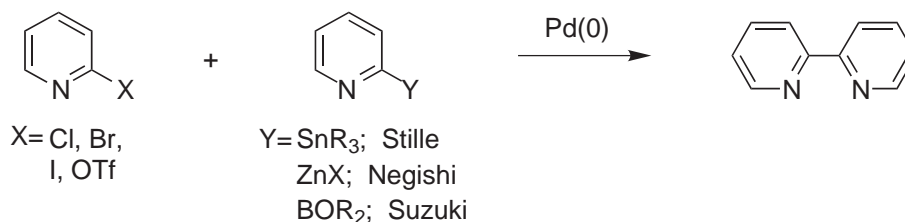
other catalyst systems for halopyridine homocouplings such as Pd/C<sup>22</sup> and Cu<sup>II</sup><sup>23</sup> typically afford product in lower yields.

This methodology has also been used to generate 3,3'-bipyridine, (**4**), (72%)<sup>24</sup> and methyl-substituted 3,3'-bipyridines (84%).<sup>25</sup> The 3,4,3',4'-tetramethoxy-substituted bipyridine, which is a precursor to the natural tetrahydroxy bipyridine, Orelline, was similarly afforded in 80% yield through homocoupling of a dimethoxy-substituted iodopyridine.<sup>26</sup>

Because bipyridines substituted at the 3 and 3' positions exhibit a large steric repulsion between substituents while in the *cis* configuration,<sup>27</sup> they bind metals more weakly and form strained, nonplanar structures.<sup>28</sup> However, a series of 3,3'-disubstituted bipyridines were coordinated to ruthenium, and it was demonstrated that molecular distortions could be used to advantage in modulating physical properties of the resulting complexes.<sup>29</sup>

#### 1.1.2.2.2 Cross-coupling of halopyridines with pyridyl organometallics

In order to synthesize unsymmetric as well as symmetric bipyridines, methods involving cross-coupling of a halopyridine with an organometallic pyridine have been developed. Typically, halopyridines are coupled with either pyridylstannanes (Stille), pyridylborates (Suzuki), or pyridylzinc reagents (Negishi), where the two pyridines may or may not have the same structure to give symmetric and unsymmetrical products, respectively (Scheme 2).



Scheme 2

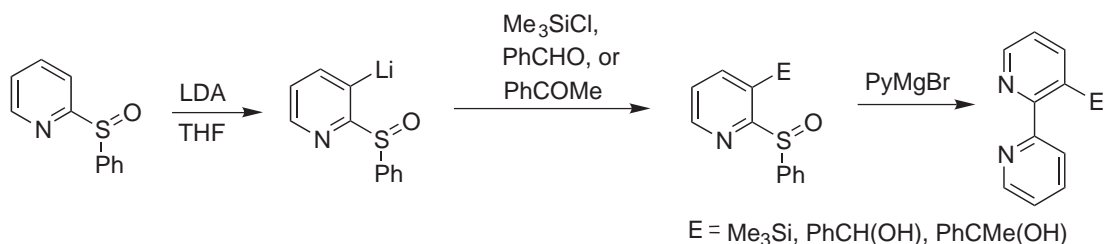
For example, 5,5'-dimethyl bipyridine has been prepared in 86% yield by coupling 2-bromo-5-methylpyridine and the analogous tributylstannane.<sup>30</sup> Many functionalities are stable toward Stille reaction conditions, including ester,<sup>31</sup> carboxylate, cyano, and nitro groups. Pyridine *N*-oxides have also been used as coupling partners in Stille reactions to produce unsubstituted<sup>32</sup> and bromo- and nitro-substituted bipyridine 1-oxides without occurrence of side reactions.<sup>33</sup> An analogue of bipyridine, 2-pyridin-2-yl quinoline, was synthesized via coupling of a pyridyl stannane with a pyridyl triflate<sup>34</sup> in place of the halopyridine.<sup>35</sup>

Halopyridines also serve as viable coupling partners with organozinc reagents in Negishi coupling reactions to give functionalized bipyridines such as 4-bromo-4'-methoxy bipyridine.<sup>36</sup> A pyridyl triflate has been used in place of the halopyridine to generate some products in higher yields. For example, 4-, 5-, and 6-methyl bipyridine were obtained in 93–98% yield using the appropriate pyridyl triflate.<sup>37,38</sup> Negishi strategies have also been used to synthesize 2,4'-bipyridine,<sup>39</sup> and bipyridine ligands with the solubilizing 4-methoxy-2,6-dimethylphenyl, or “manisyl” group.<sup>40</sup>

Boron-substituted pyridine reagents can be used to construct the bipyridine ring system by coupling them with halopyridines in the presence of a Pd<sup>0</sup> catalyst and a base (Suzuki method). Various ligands have been made in this manner in moderate to high yields, including 2,3-bipyridine (85%)<sup>41</sup> and 3,5-dimethyl bipyridine (60%).<sup>42</sup> One valuable feature of the Suzuki method is that it is compatible with stannanes. A pyridyl diethylborane has been coupled to a tributyl tin-functionalized pyridyl bromide.<sup>43</sup> This compatibility is useful for polypyridine syntheses because subsequent Stille coupling of the bipyridyl stannane is possible.

Another synthetic strategy that produces substituted bipyridines in moderate to high yields involves coupling of pyridyl sulfoxides with pyridyl Grignard reagents (Scheme 3).<sup>44,45</sup>

The coupling of a bromopyridine and an aryl bromide with hexamethylditin in the presence of a palladium catalyst has generated various diarenes in one pot.<sup>46</sup> 2,3'-Bipyridine, (**2**), was synthesized in 59% yield by a modification of this method that used hexamethylditin to couple pyridyl triflates with aryl bromides.<sup>47</sup>

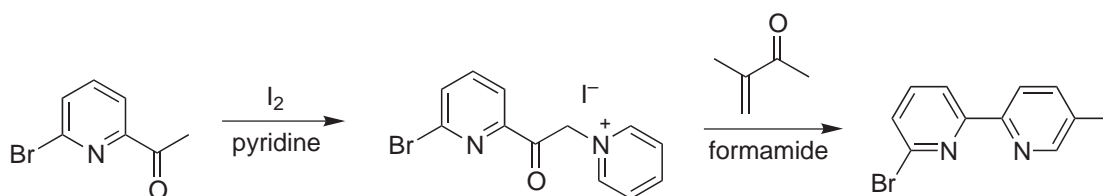


Scheme 3

### 1.1.2.3 Preparation from Acyclic Precursors

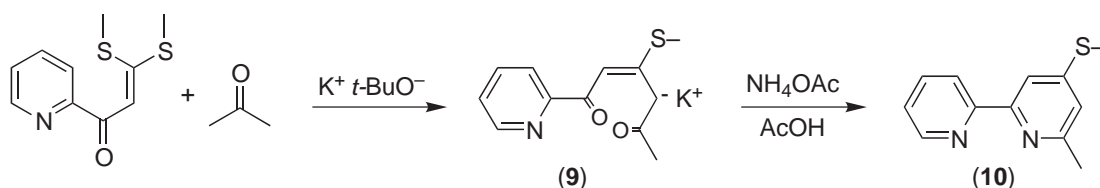
#### 1.1.2.3.1 Krohnke method

Aside from coupling of two pyridyl reagents, bipyridines can also be constructed from acyclic precursors. As mentioned above, the most common of these cyclization reactions is the Kröhnke method.<sup>19</sup> Recent uses of this methodology include the synthesis of bromo-functionalized methyl bipyridines by reaction of an acetylpyridinium iodide salt with methacrolein in formamide (Scheme 4).<sup>48</sup>



Scheme 4

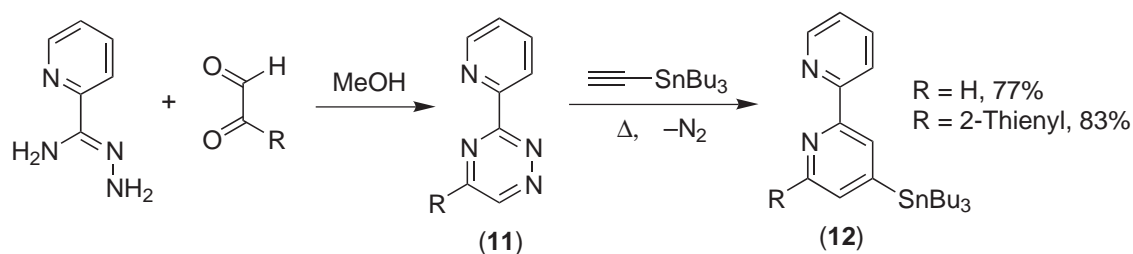
A variation by Potts utilizes  $\alpha$ -oxoketene dithioacetals in a condensation–cyclization bipyridine synthesis.<sup>49,50</sup> For example, reaction of the  $\alpha$ -oxoketene dithioacetal 3,3-bis(methylthio)-1-(2-pyridinyl)-2-propen-1-one with acetone and potassium *t*-butoxide, followed by treatment of the intermediate 1,5-enedione potassium salt, (**9**), with ammonium acetate produced the unsymmetric 6-methyl-4-(methylthio)-bpy, (**10**) (Scheme 5). Desulfurization with nickel boride afforded 6-methyl bipyridine in 72% yield. Various substituted bitys with alkyl and alkylsulfonyl groups were similarly produced in yields ranging from 37% to 94%.



Scheme 5

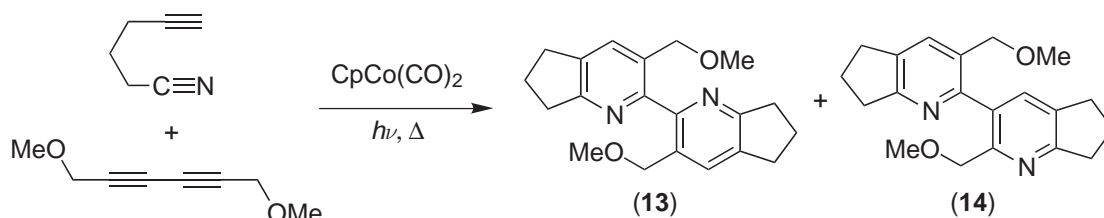
#### 1.1.2.3.2 Cycloaddition methods

Bipyridines have also been synthesized by a number of cycloaddition methods. For example, stannylated bipyridines, (**12**), which can serve as Stille coupling partners for the synthesis of terpyridines and higher oligopyridines, have been generated in 77% and 83% yield by a thermally induced [4 + 2], regioselective cycloaddition between 1,2,4-triazines (**11**) and tributyl(ethynyl)tin derivatives (Scheme 6).<sup>51</sup> Because of the steric interaction of the bulky tributyl tin group with the pyridine ring, less than 5% of the final product was the 3-substituted isomer.



Scheme 6

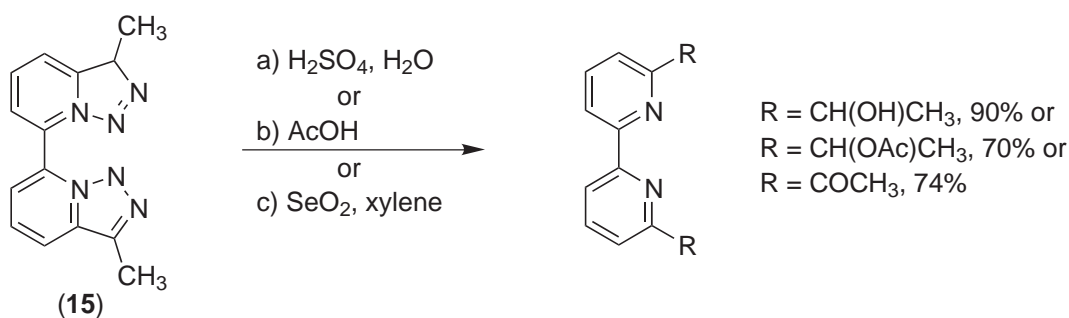
Annelated, 3-substituted bipyridines have been prepared from alkyne nitriles and alkynyl substituted pyridines using a  $\text{Co}^I$ -catalyzed  $[2+2+2]$  cycloaddition strategy.<sup>52</sup> Moreover, 3,3'-disubstituted bipyridines ((13) and (14)) have been generated from acyclic 5-hexynenitrile and 1,3'-diynes in a single step (Scheme 7).<sup>53</sup> While the isolated yields are moderate ( $<50\%$ ), this intriguing one-step preparation exhibits very high regioselectivity with respect to formation of the first pyridine ring.



Scheme 7

#### 1.1.2.4 Other Synthetic Methods

The ring opening of bitriazolopyridines, (15), with the addition of various reagents leads to the formation of 6,6'-disubstituted bips.<sup>54,55</sup> Bipyridines substituted with a secondary alcohol, an ester linkage, and a ketone were synthesized using sulfuric acid, acetic acid, and selenium dioxide, respectively (Scheme 8).<sup>54</sup>



Scheme 8

A library of 500 bipyridines was synthesized using a solid state “combinatorial” approach using five beta-ketoesters, 10 aldehydes, and 10 enamines through sequential Knoevenagel/Hantzsch condensation reactions.<sup>56</sup>

### 1.1.3 REACTIONS OF THE BASIC BIPYRIDINE RING SYSTEM

#### 1.1.3.1 Oxidation and Reduction

Bipyridines may be oxidized to picolinic acid with hot permanganate<sup>57,58</sup> and reduced to 2,2'-bipiperidine with sodium metal in refluxing alcohols<sup>59</sup> or via hydrogenation.<sup>60</sup> Reaction of bipyridine ligands with peroxides or peracids has generated either 1- or 1,1'-*N*-oxides (or a mixture of the two). These ylides serve as valuable intermediates in many synthetic schemes because one or more of the nitrogen atoms is "protected." Removal of the oxide is effected by reagents such as phosphorus trichloride or hydrogen iodide.<sup>58,61</sup>

#### 1.1.3.2 Substitution

Electrophilic substitution reactions primarily occur meta to the nitrogen atoms, while more common nucleophilic substitutions typically take place at positions *ortho* and *para* to nitrogen. For example, methyl lithium and phenyl lithium were reacted with 4,4'-diBu<sup>t</sup> bipyridine to generate 6,6'-dimethyl-4,4'-diBu<sup>t</sup> bipyridine and 6,6'-diphenyl-4,4'-diBu<sup>t</sup> bipyridine, respectively, in high yield.<sup>62</sup>

Bipyridines with halogen substituents are useful coupling agents in oligopyridine<sup>63</sup> syntheses, as well as starting points for numerous other derivatizations. Many halobipyridine derivatives are known, and have been made by a number of different methods. While some procedures are general to a given halogen and ring position, often, specific halogen-substituted isomers require unique preparations. Chlorination of bipyridine *N*-oxide generates a mixture of the 4- and 6-substituted monochloro bipyridines, which can be resolved with NiCl<sub>2</sub> to afford the 6-chloro product in 40% yield.<sup>64</sup> Other chlorinated bipyridines have also been synthesized, including 4,4'-dichloro (33%)<sup>65</sup> and 5,5'-dichloro (40%).<sup>66</sup> The 4,4'-dibromo bipyridine ligand has been prepared in three steps from bipyridine in 24% yield by modifications<sup>67,68</sup> of the classical method of Case,<sup>61</sup> while the 5-bromo- and 5,5'-dibromo derivatives were synthesized in moderate yield using direct bromination of bipyridine hydrobromide salts.<sup>69</sup> The 6,6'-dibromo bipyridine ligand was generated in 72% yield by homocoupling of 2,6-dibromopyridine in the presence of Bu<sup>n</sup>Li, CuCl<sub>2</sub>, and O<sub>2</sub>.<sup>70</sup> The 5,5'-substituted bisiodo bipyridine has been formed (70%) by conversion of 5,5'-diamino bipyridine to the diazonium intermediate, followed by reaction with potassium iodide.<sup>71</sup> Other bisiodo bipyridine isomers may be formed using similar transformations involving the diazonium ion or by halogen exchange with a sodium iodide/acetyl chloride mixture.<sup>72</sup>

Halobipyridines have also been generated by coupling halopyridyl precursors. For example, 6-bromo bipyridine<sup>73</sup> and 6,6'-dichloro bipyridine<sup>74</sup> were synthesized in 80% and 66% yield by coupling 2,6-dibromopyridine and 2-chloro-6-bromopyridine, respectively, with the appropriate 2-pyridyl sulfoxide. The 6,6'-dichloro bipyridine ligand has also been produced in 53% yield by Stille cross-coupling of 2-chloro-6-bromopyridine and 2-chloro-6-stannyl pyridine.<sup>75</sup>

The 6-substituted cyano bipyridine has been generated in 95% yield from bipyridine *N*-oxide by reaction with trimethylsilyl cyanide and dimethylcarbonylchloride.<sup>76</sup> This is an improvement on an earlier method that generated 6-cyano bipyridine from the *N*-oxide in 62% yield using potassium cyanide and benzoyl chloride.<sup>77</sup> This ligand has been used in electrochemical studies of rhenium complexes with sterically hindered bipyridine derivatives, as well as a precursor in the synthesis of 6-carbothioamide-bpy, which showed antitumor activity against P-388 lymphocytic leukemia in mice.<sup>77</sup>

The 6,6'-diamino substituted bipyridine was generated in 52% from the dibromo bipyridine precursor in three steps: (1) H<sub>2</sub>NNH<sub>2</sub>; (2) NaNO<sub>2</sub>, HCl/H<sub>2</sub>O; (3) NaBH<sub>4</sub>, phase transfer reagent.<sup>78</sup> The 5,5'-diamino isomer was synthesized in 60% by Ni-catalyzed homocoupling of 5-amino-2-chloropyridine.<sup>79</sup>

#### 1.1.4 FUNCTIONALIZED BIPYRIDINES: SYNTHESIS AND USES OF COMMON BUILDING BLOCKS

Substituted bipyridine derivatives (Table 1) serve as important building blocks for many supra-molecular and higher order structures. While most of these bipyridine ligands with nucleophilic and/or electrophilic groups have been known for some time, recent synthetic improvements have made their preparation easier and more efficient.

**Table 1** Some common bipyridine ligands.

<i>Substituent</i>	<i>Structure</i>	<i>Position on ring</i>	<i>References</i>
Amino	-NH <sub>2</sub>	4,4'	136
		5,5'	79,137
		6,6'	78
Aminocarbonyl	-CONH <sub>2</sub>	4,4'	138
Aminomethyl	-CH <sub>2</sub> NH <sub>2</sub>	6,6'	139
		6-Me-6'	140,141
Bromo	-Br	4,4'	67,68
		5; 5,5'	69
		6	73
		6,6'	70
Bromobutyl	-CH <sub>2</sub> (CH <sub>2</sub> ) <sub>3</sub> Br	4,4'	142
Bromomethyl	-CH <sub>2</sub> Br	4; 5,6	94
		4,4'	83,143
		4-Me-4'	144
		5-Me-5'	30,145
		6,6'	22,146,147
		6-Me-6'	22,146,148,149
1,3-Butadiynyl	-C≡CC≡CH	4,4'; 6,6'	150
Butyl	-CH <sub>2</sub> (CH <sub>2</sub> ) <sub>2</sub> Me	4,4'	151
		6,6'	152
Bu <sup>t</sup>	-C(Me) <sub>3</sub>	6,6'-Me-4,4'; 6,6'-diphenyl-4,4'	62
		6,6'	62,153,154
Carbamoyl	-CONR	4,4'	155
		5,5'	156
		4,4'; 5,5'; 6,6'	101-104,157
Carboxy	-CO <sub>2</sub> H	4; 6	64
Chloro	-Cl	4,4'	65
		5,5'	66
		6,6'	74,75
		4-CO <sub>2</sub> H-4'	109,110
		158	
Chloromethyl	-CH <sub>2</sub> Cl	4,5,6	94
		4,4'	83
		5,5'	159
		6,6'; 6-Me-6'	93
		6	76
		4,4'	160
Cyano	-CN	5,5'	161
		6,6'	160,162
		6,6'	146
		6; 6-CH <sub>2</sub> Cl-6'	93
		4-Me-4'	163,164
		5,5'	165
		6,6'	112
Ethyl	-Et	4,4'	151
		5,5'	166
		6,6'	152
		4,4'	89,167
Ethynyl	-C≡CH	5,5'	168
		6,6'	89,167,169
		4	108
Formyl	-CHO	4,4'	107,170
		4-CO <sub>2</sub> H-4'	171
		5,5'	172
		6,6'	173-175



Table 1 continued

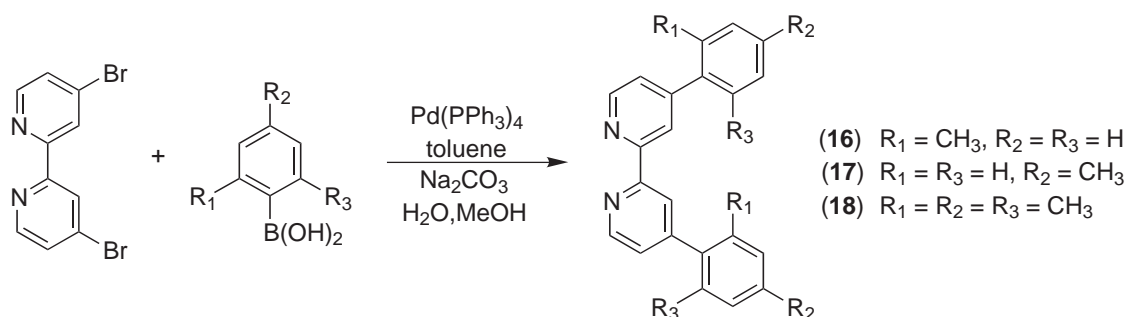
Substituent	Structure	Position on ring	References
Heptadecyl	$-\text{CH}_2(\text{CH}_2)_{15}\text{Me}$	4-Me-4'	80
Heptyl	$-\text{CH}_2(\text{CH}_2)_5\text{Me}$	4,4'	176
Hexadecyl	$-\text{CH}_2(\text{CH}_2)_{14}\text{Me}$	4-Me-4'	80,163
Hydroxy	$-\text{OH}$	4,4'; 6,6'	177,178
1-Hydroxyethyl	$-\text{CH}(\text{OH})\text{Me}$	6,6'	54,179
Hydroxymethyl	$-\text{CH}_2\text{OH}$	4; 4,4'	113
		4-Me-4'	117,144
		6-Me-6'	180
		4-BrMe-4'	143
		5,5'	115
		6,6'	92
Iodo	$-\text{I}$	5,5'	71
Isobutyl	$-\text{CH}_2\text{CH}(\text{Me})_2$	4,4'	181
		4-Me-4'	80
Isopropyl	$-\text{CH}(\text{Me})_2$	4,4'	151
Methoxycarbonyl	$-\text{COOMe}$	4,4';	58,101
		5,5'	172
		6,6'	182
Methyl	$-\text{Me}$	4; 5,6	37,38
		4,4'; 3,5; 4,4',5,5'	42,183
		5,5'; 6,6'	184
Methylamino	$-\text{NHMe}$	4,4'	185
2-Methylphenyl	$-\text{C}_6\text{H}_4(2\text{-Me})$	4,4'	84
4-Methylphenyl	$-\text{C}_6\text{H}_4(4\text{-Me})$	4,4'	84,142
		6-phenyl-4	186
Neopentyl	$-\text{CH}_2\text{C}(\text{Me})_3$	4-Me-4'; 4,4'	82
Nitro	$-\text{NO}_2$	4,4'	65
		5,5'	187
Nonyl	$-\text{CH}_2(\text{CH}_2)_7\text{Me}$	4,4'	188
		4-Me-4'	189
5-Nonyl	$-\text{CH}[(\text{CH}_2)_3\text{Me}]_2$	4,4'	190
Octyl	$-\text{CH}_2(\text{CH}_2)_6\text{Me}$	4,4'; 4-Me-4'	163
Pentyl	$-\text{CH}_2(\text{CH}_2)_3\text{Me}$	4,4'	151
Pent-1-ynyl	$-\text{C}\equiv\text{CCH}_2\text{Et}$	6,6'	191
Phenyl	$-\text{C}_6\text{H}_5$	6,6'	192,193
		5	194
Propyl	$-\text{CH}_2\text{Et}$	6,6'	152
Sulfoxy	$-\text{SO}_3\text{H}$	5	195
Thiomethyl	$-\text{CH}_2\text{SH}$	6,6'	196
Tridecyl	$-\text{CH}_2(\text{CH}_2)_{11}\text{Me}$	4,4'; 4-Me-4'	83,164,197
Trifluoromethyl	$-\text{CF}_3$	4,4'; 5,5'	100
		6,6'	198
		3,3'	97,105
		6-Me-6'	92,199
		6-BrMe-6'	116,200
Trimethylphenyl	$-\text{C}_6\text{H}_2(2,4,6\text{-Me})$	6,6'	201
Trimethylsilyl	$-\text{Si}(\text{Me})_3$	5,5'	202
Undecyl	$-\text{CH}_2(\text{CH}_2)_9\text{Me}$	4-Me-4'	164
Vinyl	$-\text{CH}_2\text{CH}=\text{CH}_2$	4,4'	203
		6,6'	204
		4-Me-4'	87,88,205,206

#### 1.1.4.1 Hydrocarbons

Many functionalized bipyridine ligands can be synthesized from the appropriate alkyl precursors, which are most efficiently constructed using one of the coupling strategies mentioned in Section 1.1.2.2. Countless derivatives have been generated simply by joining appropriately functionalized pyridine halves via cross-coupling methods. A common alternative method to some alkyl bipyridines, such as those with isobutyl,<sup>80</sup> neopentyl,<sup>81,82</sup> and *n*-hexadecyl<sup>80</sup> groups, involves nucleophilic substitution via reaction of dimethyl bipyridine with LDA followed by quenching with the

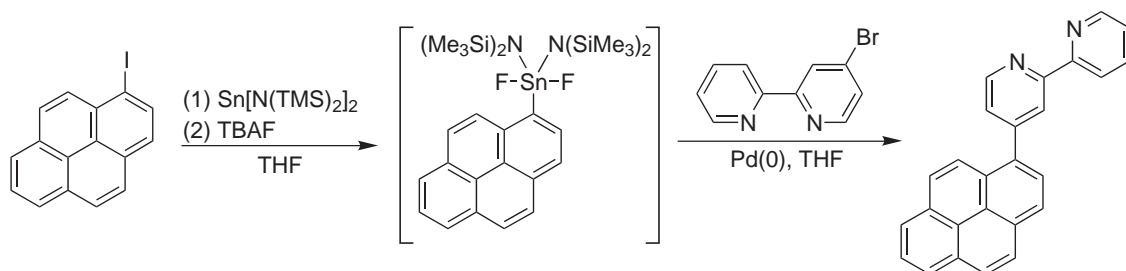
appropriate alkyl bromide. This method of lithiating either one or both of the methyl groups of 4,4'-, 5,5'-, or 6,6'-dimethyl-bpy and then quenching the anionic species with an electrophile has been exploited in the synthesis of many substituted symmetric and unsymmetric bipyridine derivatives. A recent modification of this approach utilizes bipyridine-CH<sub>2</sub>Si(Me)<sub>3</sub> derivatives, which may be activated for reaction with electrophiles after cleavage of the silyl group with cesium fluoride.<sup>83</sup>

Bipyridines with aryl substituents have been prepared in high yield by Suzuki coupling methods. For example, 4,4'-di-*o*-tolyl- (**16**), 4,4'-di-*p*-tolyl- (**17**), and 4,4'-dimesityl-bpy (**18**) were generated by coupling the appropriate boronic acid with 4,4'-dibromo bipyridine (Scheme 9).<sup>84</sup>



Scheme 9

Intramolecular charge transfer has been observed in bipyridine ligands bearing electron-donating groups (the bipyridine rings serve as the electron acceptor) such as pyrenyl. This ligand was synthesized in 61% yield by a modified tin coupling of 4-bromo bipyridine with a pentacoordinated monoorganotin, which was generated *in situ* by combining 1-iodopyrene with bis[*N,N*-bis(trimethylsilyl)amino]tin<sup>II</sup> (Scheme 10).<sup>85</sup> These conditions may prove valuable for bipyridine syntheses in general because they are more mild than those for typical Stille couplings, and avoid product contamination with organotin reagents.



Scheme 10

The vinyl derivative 4-methyl-4'-vinyl-bpy is valuable for chemical electrode modification because its ruthenium and osmium complexes can be polymerized to generate electroactive films with variable properties.<sup>86</sup> This unsymmetric ligand was prepared in 35% overall yield from 4,4'-dimethyl bipyridine by first lithiating one methyl group and quenching the anion with (chloromethyl)methyl ether, then reacting with potassium *t*-butoxide to effect elimination.<sup>87,88</sup>

Bipyridines with alkynyl substituents are useful starting materials for the generation of higher order alkynyl-conjugated polypyridines through oxidative homocoupling. The ligands, 6-ethynyl-5,5'-dimethyl (51%), 6,6'-diethynyl (85%), and 4,4'-diethynyl bipyridine (69%), were synthesized from the corresponding bipyridine bromide or chloride by Pd<sup>II</sup>-catalyzed cross-coupling with (trimethylsilyl)acetylene in the presence of CuI, Pr<sup>i</sup><sub>2</sub>NH, and THF, followed by removal of the TMS group with K<sub>2</sub>CO<sub>3</sub>.<sup>89</sup> Ethynyl derivatives substituted at the 5 position have been prepared by a different method<sup>90</sup> because this position of the bipyridine ring system often has markedly different reactivity relative to the 4 and 6 positions.

### 1.1.4.2 Halomethyl Derivatives

Halomethyl bipyridines are another important class of reagents that can be derivatized for use in many different contexts. Classical preparations include reaction of dimethyl bipyridine with *N*-bromosuccinimide<sup>91</sup> or *N*-chlorosuccinimide<sup>92</sup> to generate bromomethyl and chloromethyl bipyridines, respectively. NCS has also been used to generate 6-dichloromethyl bipyridine in 25% yield from 6-methyl bipyridine.<sup>93</sup> Halomethyl bipyridines have alternately been prepared by first lithiating methyl bipyridines, followed by coupling of the resulting reactive carbanion with various electrophiles. Conversion of the carbanion to a trimethylsilyl group prior to the addition of an electrophile has proven useful in some cases for high-yield transformation of methyl to halomethyl bipyridines (Table 2).<sup>30,37,83,94,95</sup>

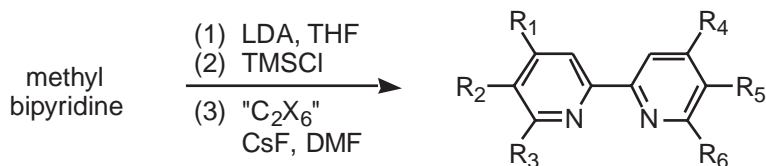
Bipyridines have been functionalized with perfluoroalkylated side chains to generate fluoruous biphasic oxidation media.<sup>96</sup> These two-phase reaction systems are valuable because they enable the recycling of catalytic perfluoroalkylated metal complexes, which are soluble in perfluorinated solvents, while the reagents are soluble in the organic phase.<sup>97</sup> Fluorinated bipyridines have also been used as cocatalysts for atom transfer radical polymerizations (ATRP) in supercritical CO<sub>2</sub> media.<sup>98</sup> These perfluoroalkylated bipyridines have been generated by numerous methods, including coupling of an alcohol end-functionalized perfluoroalkyl chain with a bipyridine diacyl chloride.<sup>99</sup>

Trifluoromethyl bipyridine derivatives substituted in the 4,4', 5,5', and 4,4', 5,5' positions have been synthesized in moderate yields by Ni-catalyzed homocoupling of appropriately substituted pyridyl chlorides.<sup>100</sup> These electron-withdrawing groups have been used for photophysical and photochemical measurements of different metal–bipyridine complexes.

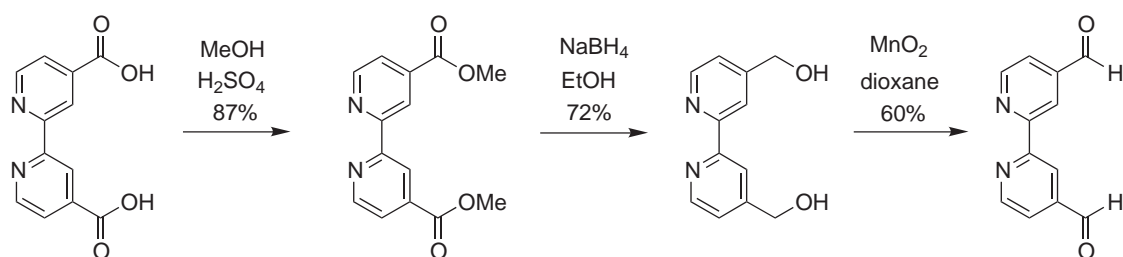
### 1.1.4.3 Acid Derivatives

The most common method for generating bipyridines with carboxylic acid groups is to oxidize methyl precursors. For example 4,4'-dimethyl-bpy can be oxidized with K<sub>2</sub>CrO<sub>7</sub>(CrO<sub>3</sub>)<sup>101</sup>/H<sub>2</sub>SO<sub>4</sub><sup>102</sup> or KMnO<sub>4</sub><sup>103,104</sup> to form the 4,4'-diacid. The ligand 1,10-phenanthroline has been oxidized to generate the 3,3'-diacid.<sup>105,106</sup> Esterification, reduction to the dialcohol, and partial oxidation or Swern oxidation to the aldehyde are all possible (Scheme 11). Both 4-formyl and 4,4'-bis(formyl) bipyridines have alternately been synthesized in high yield from methyl precursors via enamination using Bredereck's reagent followed by subsequent oxidative cleavage with sodium periodate.<sup>107</sup> Another method for synthesizing aldehydes is by reacting 4-aminomethyl-4'-methyl bipyridine with DCC/1-hydroxybenzotriazole in a DMF/CH<sub>2</sub>Cl<sub>2</sub> solvent mixture, followed by deprotection of the 1,3-dioxolane group.<sup>108</sup> Aldehyde-functionalized bipyridines have been bound to silica surfaces to form Fe<sup>II</sup> recognition sites.<sup>108</sup>

**Table 2** Synthesis of halomethyl bips.



Bipyridine	"C <sub>2</sub> X <sub>6</sub> "	R <sub>1</sub>	R <sub>2</sub>	R <sub>3</sub>	R <sub>4</sub>	R <sub>5</sub>	R <sub>6</sub>	Yield (%)
(19); 4-ClCH <sub>2</sub> bpy	(Cl <sub>3</sub> C) <sub>2</sub>	ClCH <sub>2</sub>	H	H	H	H	H	94
(20); 4-ClCH <sub>2</sub> bpy	(Cl <sub>3</sub> C) <sub>2</sub>	H	ClCH <sub>2</sub>	H	H	H	H	98
(21); 4-ClCH <sub>2</sub> bpy	(Cl <sub>3</sub> C) <sub>2</sub>	H	H	ClCH <sub>2</sub>	H	H	H	95
(22); 4,4'-bis(ClCH <sub>2</sub> ) bpy	(Cl <sub>3</sub> C) <sub>2</sub>	ClCH <sub>2</sub>	H	H	ClCH <sub>2</sub>	H	H	94
(23); 4-BrCH <sub>2</sub> bpy	(BrF <sub>2</sub> C) <sub>2</sub>	BrCH <sub>2</sub>	H	H	H	H	H	92
(24); 4-BrCH <sub>2</sub> bpy	(BrF <sub>2</sub> C) <sub>2</sub>	H	BrCH <sub>2</sub>	H	H	H	H	98
(25); 4-BrCH <sub>2</sub> bpy	(BrF <sub>2</sub> C) <sub>2</sub>	H	H	BrCH <sub>2</sub>	H	H	H	99
(26); 4,4'-bis(BrCH <sub>2</sub> ) bpy	(BrF <sub>2</sub> C) <sub>2</sub>	BrCH <sub>2</sub>	H	H	BrCH <sub>2</sub>	H	H	97
(27); 5-BrCH <sub>2</sub> -5'-Me bpy	(BrF <sub>2</sub> C) <sub>2</sub>	H	BrCH <sub>2</sub>	H	H	Me	H	98
(28); 6,6'-bis(BrCH <sub>2</sub> ) bpy	(BrF <sub>2</sub> C) <sub>2</sub>	H	H	BrCH <sub>2</sub>	H	H	BrCH <sub>2</sub>	70



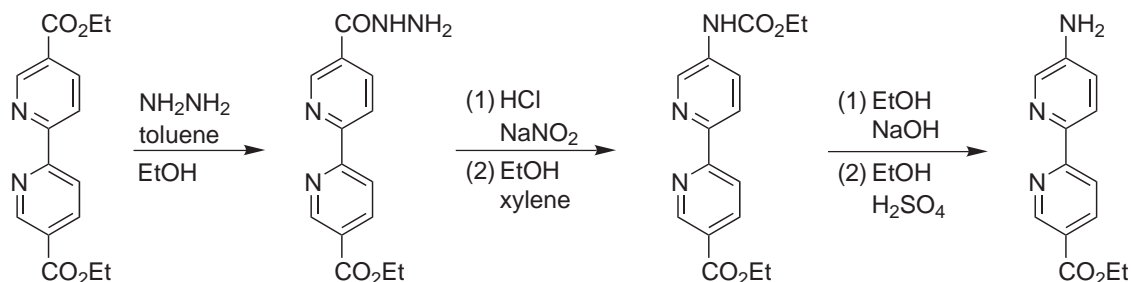
Scheme 11

Often, the carboxylic acid groups are converted to acyl chlorides with  $\text{SOCl}_2$ <sup>109,110</sup> prior to esterification with various alcohols and reaction with other nucleophiles.<sup>111</sup> Both mono- and difunctional ester-substituted bipyridines have been generated in moderate yield by palladium(0)-catalyzed carboalkoxylation of halo- or triflate-substituted precursors in the presence of CO, an alcohol, and a tertiary amine.<sup>112</sup>

Reduction of ester functionalities with  $\text{NaBH}_4$  has furnished the corresponding alcohols. The 4- and 4'-substituted hydroxymethyl bipyridines have also been synthesized from halomethyl precursors, (**23**) and (**26**), respectively, by reaction with  $\text{NaOAc}$  followed by acetate hydrolysis.<sup>113</sup> The 5,5'-dihydroxymethyl bipyridine ligand has been prepared (55%) by converting 5,5'-dimethyl bipyridine to the bis *N*-oxide with hydrogen peroxide, followed by reaction with acetic anhydride in acetic acid,<sup>114</sup> then hydrolysis with  $\text{KCN}$  in ethanol.<sup>115</sup>

### 1.1.5 UNSYMMETRICAL DERIVATIVES

The preparation of unsymmetrical derivatives is often challenging in bipyridine syntheses. The most successful methods involve cross-coupling approaches; however, it is also possible to generate unsymmetric bipyridine derivatives by monofunctionalizing symmetric precursors. For example, certain analogues were formed through monolithiation of 6,6'-bis(hydroxymethyl)-bpy<sup>116</sup> or 4,4'- $\text{Me}_2$ bpy followed by reaction with  $\text{RX}$ , where R contained an acetal group and X is a halogen.<sup>117</sup> Standard organic functional group conversions on the pendant chain, R, to proceed to an aldehyde, an acid, an alcohol, a halogen, and an amine were all compatible with the bipyridine ring system. Some methods for achieving unsymmetric compounds take advantage of the solubility differences between starting materials and products, which allow for the separation of monofunctionalized species from any difunctional by-products that may have formed. For example, reaction of 4,4'-bis(chloromethyl) bipyridine with  $\text{CaCO}_3$  in refluxing dioxane/water has afforded the hetero-difunctional 4-hydroxymethyl-4'-chloromethyl bipyridine ligand.<sup>118</sup> The 5,5'-disubstituted ethyl ester can be converted to the monocarbohydrazide by stirring with hydrazine. By manipulating the solvent conditions, the unsymmetric product precipitates out of solution before the second ester group can react (Scheme 12).<sup>119</sup>



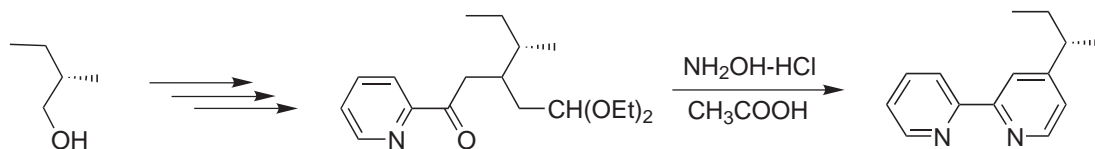
Scheme 12

### 1.1.6 CHIRAL BIPYRIDINES

#### 1.1.6.1 Synthesis

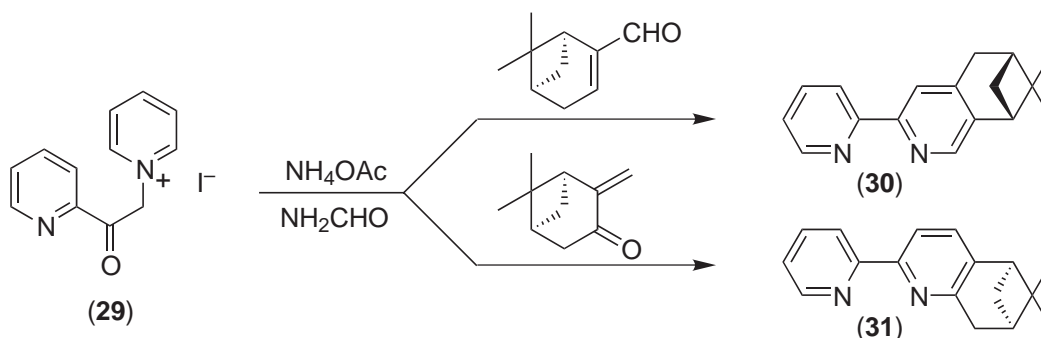
Chiral bipyridines<sup>120</sup> and their metal complexes<sup>121</sup> are finding increasing use in asymmetric catalysis, in part because they tend to be more stable toward oxidation than many common chiral phosphines. Recent advances in resolution with enantiomeric HPLC columns, in addition to their well-known capacity to bind a number of different metal ions, also contribute to the growing interest in chiral bipyridines.

A resolved 4-*sec*-butyl bipyridine exhibiting central chirality was prepared by aza-annulation of a chiral ketone (Scheme 13) and was the first reported nonracemic chiral bipyridine.<sup>122</sup> The 3-,<sup>123</sup> 5-,<sup>123</sup> and 6-Bu<sup>s122</sup> derivatives were also synthesized using various cyclization methods from optically active (*S*)-2-methylbutanol.



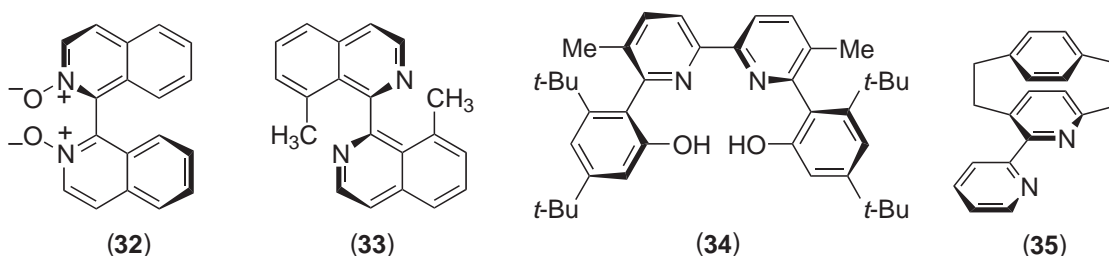
Scheme 13

Chiral bipyridines, (30) and (31), were prepared by the Kröhnke method through reaction of the pyridinium iodide salt, (29), with (–)-myrtenal and (+)-pinocarvone, respectively (Scheme 14).<sup>124</sup> The Kröhnke cyclization has proven useful to the construction of optically active fused-ring bipyridines.<sup>125–127</sup>



Scheme 14

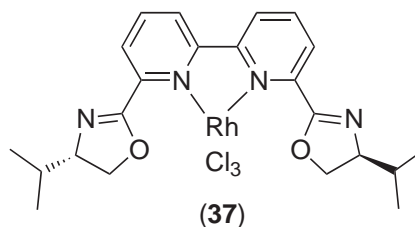
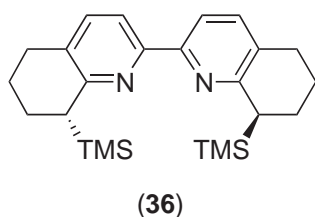
Bipyridines without a chiral center have axial chirality if they exist as enantiomers due to the inability to rotate about a single bond (e.g., the 2,2' bond). These molecules are typically *N*-oxides (32),<sup>128,129</sup> exist in the *trans* conformation (33),<sup>130,131</sup> or have extremely bulky substituents at the 6 and 6' or 3 and 3' positions (34)<sup>132</sup> and have limited utility as transition metal ligands.



Compound (35) is an example of a bipyridine ligand with planar chirality. This ligand was synthesized by reacting a cyano-substituted [2.2]paracyclophane pyridyl derivative with acetylene and cyclopentadienylcycloocta-1,5-dienecobalt in toluene by the Bönemann reaction.<sup>133</sup>

### 1.1.6.2 Asymmetric Catalysis

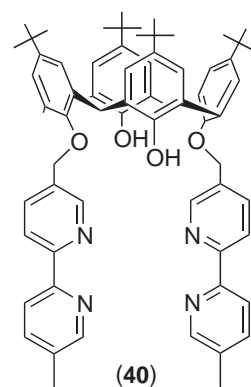
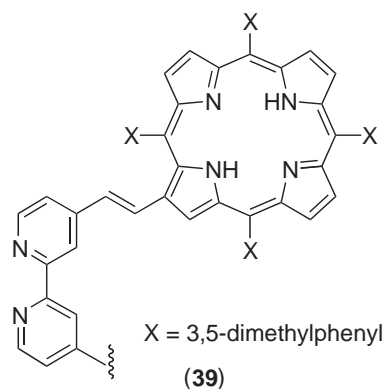
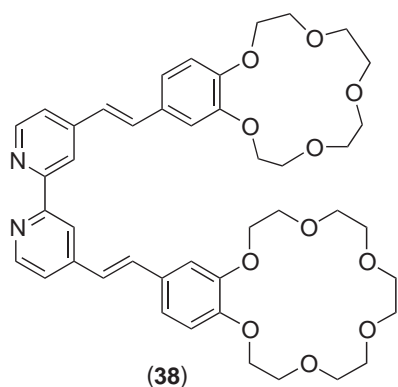
Chiral bipyridines have been employed as asymmetric catalysts for a number of different reactions. Examples of catalysts giving products in a high enantiomeric excess (ee) include the cyclopropanation of styrene with  $\text{Bu}^t$  diazoacetate in the presence of (36) to provide the cis-cyclopropyl product in 98% ee.<sup>134</sup> The  $\text{Rh}^{\text{III}}$ -bipyridine complex, (37), promoted asymmetric hydrosilylation of acetophenone with diphenylsilane at 90% ee.<sup>135</sup> The ligand was synthesized by coupling (*S*)-valinol with the acid chloride of 6,6'-bis(carboxy)-bpy and is two-coordinate, even though the heteroatoms from the oxazoline rings have Lewis-basic character. An iridium complex with ligand (35) was successfully employed as an asymmetric catalyst for the transfer hydrogenation of methyl phenyl ketone to produce *S*-(-)-1-phenylethanol in a more modest 31% ee.<sup>133</sup>



### 1.1.7 MACROCYCLES

#### 1.1.7.1 Bipyridines with Pendant Macrocycles

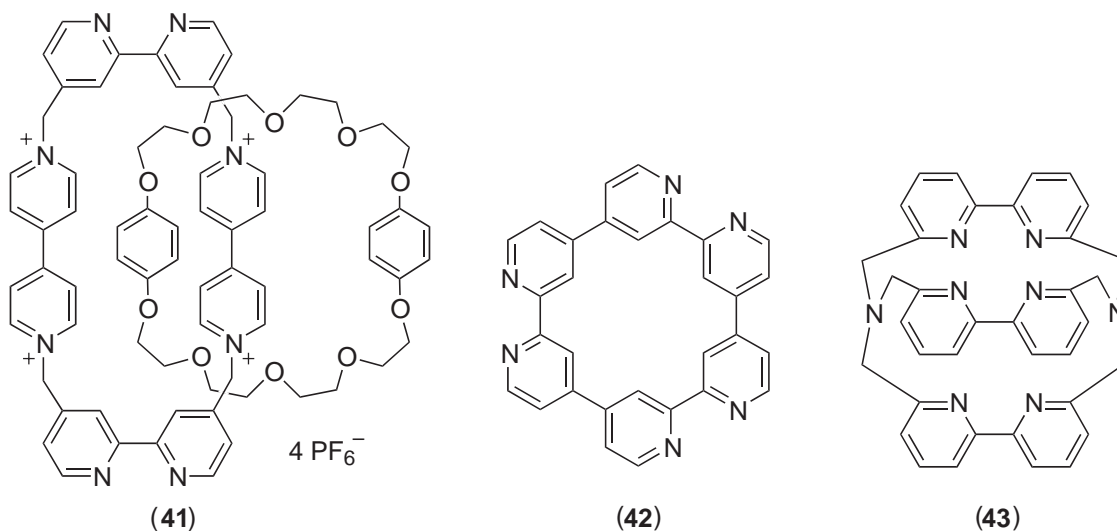
Bipyridines have been functionalized with a variety of macrocycles<sup>207,208</sup> including crown ethers (38)<sup>209,210</sup> porphyrins (39),<sup>211–213</sup> calixarenes (40),<sup>214,215</sup> and cyclodextrin groups, as well as many others.



Conjugated crown ethers analogous to (38) have been prepared by coupling an aldehyde-functionalized crown ether with the lithium dimethyl bipyridine dianion, followed by dehydration. Recognition of group Ia and IIa metals was determined by measuring the electronic absorption and fluorescence-emission of  $[\text{Ru}(\mathbf{38})(\text{bpy})_2]^{2+}$  complexes.<sup>216</sup> The porphyrin substituents of (39) were incorporated through Wittig reaction of 4,4'-diformyl bipyridine with a porphyrin-functionalized phosphonium salt.<sup>212</sup> Calix[4]arenes with bpy *N*-oxide<sup>217</sup> and methyl-substituted bipyridine<sup>199</sup> substituents have been coordinated to lanthanide and copper metals, respectively. The resulting metal complexes exhibited high molar absorptivities and high luminescence quantum yields. Cyclodextrin groups have been bound to bipyridine derivatives via condensation of monohydroxypermethylated  $\beta$ -cyclodextrin with a bromomethyl bipyridine.<sup>218</sup> These, and other modified bipyridine-CD ligands,<sup>219</sup> have been subsequently bound to various transition metals. A bipyridine-linked cyclodextrin dimer has also been generated by coupling 5,5'-dithienyl bipyridine with mono-6-iodo- $\beta$ -cyclodextrin and has been utilized as a template to anchor substrates in close proximity to metal ions bound at the bipyridine site for ester hydrolysis.<sup>220</sup>

### 1.1.7.2 Bipyridines in the Macrocyclic

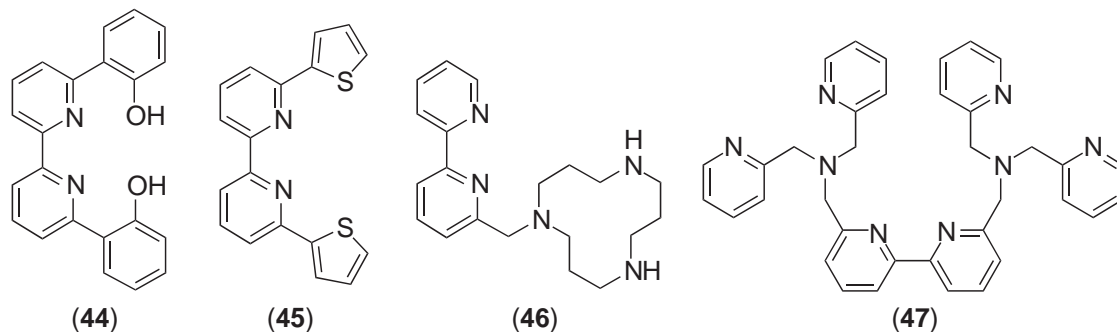
There are other examples where bipyridine units are integral to the macrocyclic ring. These structures may have additional bipyridine groups<sup>221</sup> or other heteroatomic donors. They may be bound either at two positions on one bipyridine ring,<sup>207</sup> or contain two connected bipyridine ligands<sup>222</sup> and are capable of binding one or two or more metals.<sup>223–225</sup> Bipyridines were linked to crown ethers at the 3 and 3' positions by condensing 3,3'-bipyridyl diacid with a polyethylene glycol di-*p*-toluenesulfonate.<sup>226</sup> Bipyridines have also been incorporated into cyclophanes.<sup>227</sup> One example of these macrocycles is comprised of two 4,4'-pyridinium units bound to two 2,2'-bipyridyl units. When synthesized in the presence of macrocyclic polyethers, "intertwined" catenanes are formed (**41**).<sup>143</sup> Mono- and binuclear Re<sup>I</sup>, Ru<sup>II</sup>, Ag<sup>I</sup>,<sup>228</sup> and Cu<sup>I</sup> complexes of (**41**) were prepared by utilizing the free 2,2'-bipyridyl sites on the catenane ligands. The 4,4'-pyridinium construction has also been utilized to tether bowl-shaped cavitands,<sup>229</sup> other cyclophanes, and supramolecular building blocks, as well as for the formation of linear coordination polymers with metal ions (see Section 1.1.9.2).



Cyclo-sexipyridines are another class of macrocycle and have been prepared with the nitrogen atoms directed either outward (extra-sexipyridine, (**42**))<sup>67</sup> or to the center of the molecule (endo-sexipyridine).<sup>174,230</sup> Cryptates can also be comprised of bipyridine ligands (**43**).<sup>231,232</sup> These systems act as sequestering agents wherein the bipyridine ligands compete for chelation of one metal center. Some nonmacrocyclic multidentate bipyridine derivatives are described in Section 1.1.8.

### 1.1.8 MULTIDENTATE CHELATES

Bipyridines have been functionalized with additional coordinating groups to form numerous multidentate structures. Among these systems are bipyridines with additional pyridyl or bipyridyl<sup>221</sup> groups (namely terpyridine and higher order oligopyridines), oxygen chelates (**44**),<sup>233</sup> sulfur groups (**45**),<sup>234,235</sup> as well as cyclic (**46**) and other higher order (**47**) amines.<sup>236</sup>

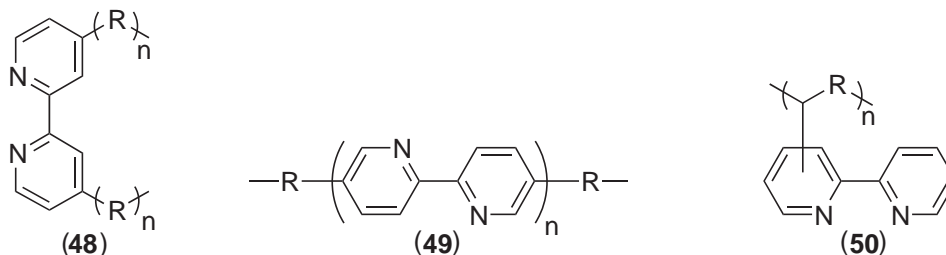




The ligands 6,6'-bis(2-hydroxyphenyl)-bpy, (**44**), and 6,6'-bis(2''-thienyl)-bpy, (**45**), each have two additional groups that may chelate. Ligand (**44**) has been shown to be tetradentate in some copper complexes, and was prepared from 6,6'-diacetyl bipyridine in 90% yield.<sup>237</sup> The mono-substituted phenolic bipyridine is also known.<sup>238</sup> The dithienyl substituted bipyridine was synthesized via Negishi coupling of 6,6'-dibromo bipyridine and 2-thienylzinc chloride.<sup>235</sup>

### 1.1.9 POLYMERS

Bipyridines have been incorporated into polymer chains in three basic ways (**48–50**). Macroligands, (**48**), possess a single bipyridine ligand with polymer chains as substituents. Polymers with bipyridines in the backbone (**49**) or as side chains (**50**) are also common.



#### 1.1.9.1 Macroligands

Polymers with a single bipyridine binding site covalently bound at the center or end of the chain have been chelated to both discrete metal ions,<sup>239–241</sup> and metal clusters.<sup>242</sup> Variants of poly(oxazoline), polystyrene, poly(methyl methacrylate), poly(ethylene glycol), poly(lactic acid), and poly(caprolactone) are known. These macroligands have been synthesized by polymerizing from bipyridine ligands with initiator functionalities<sup>239</sup> or by coupling reactive bipyridines with end groups of linear polymer chains.<sup>243</sup> Similar macromolecular bipyridine ligands with large dendritic wedges in the 4 and 4' positions have been bound to Ru<sup>II</sup> centers to generate dendrimers with a photoactive Ru(bpy)<sub>3</sub><sup>2+</sup> core.<sup>244</sup>

Buckminsterfullerene units have also been incorporated into bipyridine systems by coupling an acyl chloride-functionalized C<sub>60</sub> molecule with a hydroxy-functionalized bipyridine. Two of these ligands were reacted with Cu(MeCN)<sub>4</sub>(PF<sub>6</sub>) to generate a metal-centered dimer.<sup>245</sup>

#### 1.1.9.2 Bipyridines in the Main Chain

Various bis halo-functionalized bipyridine ligands have been polymerized through iterative coupling steps to generate polypyridyl structures. Monomers such as 5,5'-dibromo-3,3'-dinitro-bpy<sup>246</sup> and 5,5'-diiodo-bpy<sup>247</sup> as well as many of their alkyl-substituted derivatives<sup>248</sup> are competent for either cross-coupling with stannanes and borates or for Ni<sup>0</sup>-catalyzed homocouplings. The Heck coupling reaction has been employed in the generation of bipyridyl-containing conjugated copolymers.<sup>249</sup>

Polycondensation of bipyridine diacid or bipyridine dicarbonyl dichloride ligands with the hydrochlorides of 2,5-diamino-1,4-benzenediol; 4,6-diamino-1,3-benzenediol; 2,5-diamino-1,4-benzenedithiol; and 2,3,5,6-tetraaminopyridine in poly(phosphoric acid) have generated rigid-rod poly(benzobisoxazole)-, poly(benzobisthiazole)-, and poly(benzobisimidazole)-bpy copolymers, respectively.<sup>250,251</sup> These polymers have high oxidative and thermal stability and exhibit interesting nonlinear optical, conductivity, and luminescence properties.<sup>252,253</sup> Various polyamides and polyesters have also been produced through condensation methods using bipyridine diacid/diamine<sup>254</sup> and bipyridine diacid chloride/alcohol<sup>255</sup> pairs. Other condensation reactions have generated bpy-phenylene-vinylene type polymers that can be switched from partially to fully conjugated by reaction with metal ions.<sup>256</sup>

The 4,4'-bipyridine ligand has been utilized in the synthesis of linear coordination polymers as well as grids and networks through reaction with transition metal ions. These inorganic–organic polymers and frameworks are potential candidates for use in catalysis, molecular recognition, and nonlinear optics.<sup>257–262</sup>



The dithienyl substituted ligand, (45), can be electrothermally polymerized in MeCN to generate stable *n*-doped materials with high bandgaps.<sup>235</sup> Metallorotaxanes have also been formed using the bpy-thienyl copolymers by coordinating open bipyridine sites with a suitable ruthenium complex.<sup>263</sup> Ruthenium complexes of the form  $[\text{RuL}_3]^{2+}$  and  $[\text{RuL}(\text{bpy})_2]^{2+}$  ( $\text{L} = 4,4'$ - $(4\text{-anilino vinyl})\text{-bpy}$ ) undergo electrochemical polymerization to form a conducting and an insulating film, respectively. The ligand was generated by coupling the dimethyl bipyridine dianion with *p*-aminobenzaldehyde.<sup>264</sup> Analogous ligands with 3-methoxystyryl- derivatives at either the 4 or 4 and 4' positions of the bipyridine ring were similarly synthesized by coupling *m*-methoxybenzaldehyde with the dimethyl dianion, and their  $\text{Ru}^{\text{II}}$  complexes were also polymerized to generate electroactive films.<sup>265</sup> Numerous other polymer chains with bipyridine units in the backbone have been prepared.<sup>266,267</sup>

### 1.1.9.3 Polymers with Bipyridine Side Chains

Bipyridine may be incorporated into polymers as side chains. These macromolecules are typically generated by functionalizing a standard monomer with a bipyridine ligand prior to polymerization. For example, a bromomethyl group substituted at the 3 position of a thiophene ring was coupled with various bipyridine anions formed from lithiation of methyl precursors to generate a bipyridine-functionalized thiophene monomer.<sup>268</sup> Pendant vinyl groups have been polymerized to generate polyethylene macromolecules with attached bipyridine ligands.<sup>269</sup> In other cases, the bipyridine ligand has been introduced after polymerization through subsequent derivatization reactions, such as coupling of a carboxy-functionalized bipyridine with amino groups in the backbone of poly(*N*-acetylethyleneimine).<sup>270,271</sup>

## 1.1.10 BIPYRIDINES AND BIOLOGICAL MOLECULES

### 1.1.10.1 Peptides

As with the three polymeric examples, bipyridine ligands have been incorporated into polypeptides at the chain end, in the backbone, and as attached substituents. Specifically, a bipyridine has been coupled to either the amino or acid terminus of polypeptides to afford biological macro-ligands. For example, the 4,4'-dicarboxylic acid bipyridine was coupled to two 14-unit  $\alpha$ -helices in order to analyze the conformation of the parallel structures.<sup>272</sup> A triple-helical synthetic metallo-protein was formed through metal-templated self-assembly of a bipyridine unit with a 15-residue peptide substituent in the presence of metal ions.<sup>273</sup>

Synthetic bipyridine amino acids have been used to construct polypeptides with bipyridine in the backbone. A bipyridine ligand with both an amino and an acid functionality, 4'-aminomethyl-2,2'-bipyridyl-4-carboxylic acid, was incorporated into a hexapeptide and used to coordinate and encapsulate a  $\text{Ru}^{\text{II}}$  ion. Because the bipyridine group is in the main chain, it can constrain the peptide backbone and influence its secondary structure.<sup>171</sup>

Examples of amino acids with bipyridine units on the peptide side chain are also known.<sup>274</sup> The 6-bromomethyl bipyridine has been used in the stereoselective synthesis and incorporation of an amino acid with a bipyridine binding site into short peptide chains.<sup>275</sup> The ligand (*S*)-2-amino-3-(2,2'-bipyridin-*n*-yl)propanoic acid, where  $n = 4-6$ ,<sup>276</sup> has been prepared in 98% ee.<sup>277</sup>

### 1.1.10.2 Carbohydrates

The established interaction between boronic acids and saccharides has been used to selectively generate  $\Delta$  and  $\Lambda$ - $[\text{Co}(\text{bpy})_3]^{3+}$  in as high as 79% ee with +D-glucose.<sup>278</sup> The 2,2'-bipyridyl-4,4'-diboronic acid ligand precursor was generated from the 4,4'-dibromide in 80% yield. After reaction with different sugars,  $[\text{Co}^{\text{II}}(\text{bpy})_3]$ -saccharide complexes were furnished.<sup>279</sup> Oxidation to the  $\text{Co}^{\text{III}}$  complex generated a more inert, substitution-inactive complex, and locked in the stereochemistry. Reaction with  $\text{AgNO}_3$  removed the sugar and afforded the product  $[\text{Co}(\text{bpy})_3]^{3+}$  complexes.<sup>278</sup> Hexavalent glycoconjugates based on  $\text{Fe}(\text{bpy})_3^{2+}$  displayed high diastereoselectivity and a strong affinity to lectin when the bipyridine ligand was substituted at the 4 and 4' positions with a glucosylated amide with a flexible 3-carbon spacer. The  $\alpha$ - and  $\beta$ -glucosylated bipyridine

ligand preferentially formed the  $\Lambda$ - and  $\Delta$ -Fe(bpy)<sub>3</sub><sup>2+</sup> complexes, respectively.<sup>280</sup> A metal template approach to the preparation of carbohydrate clusters has been reported. In this case, a galactose-functionalized bipyridine ligand formed a tridentate cluster in the presence of Fe<sup>II</sup> that could be recognized by a Tn-specific ligand, where Tn is a simple mucin-type carbohydrate antigen that contains 2-acetamide-2-deoxy- $\alpha$ -D-galactopyranosyl serine or threonine residues. Tn is a marker of malignant transformation in several epithelial tissues.<sup>281</sup>

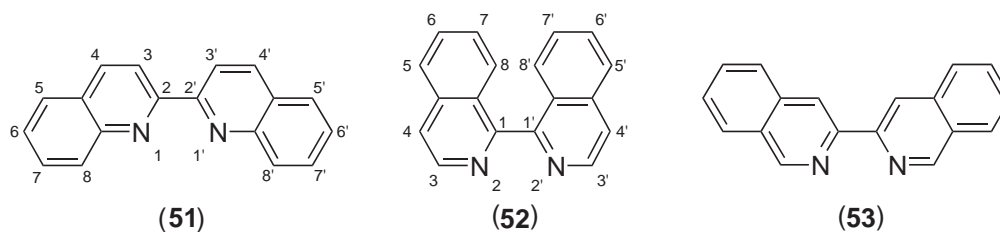
### 1.1.10.3 Nucleic Acids

A bipyridine nucleoside mimic has enabled the incorporation of a copper complex inside the double helix of DNA.<sup>282</sup> The insertion of this *ligandosome* in the DNA sequence permitted “tunable cross-linking” of the DNA duplex, since metal coordination is usually stronger than the natural hydrogen bonding. A Ru(bpy)<sub>3</sub><sup>2+</sup> phosphoramidite was incorporated into DNA using an automated solid-phase synthesizer.<sup>283</sup> Bipyridines have been included in other oligonucleosides through DNA synthesis of ligands functionalized with dimethoxytrityl protected phosphoramidites.<sup>284</sup> The interactions of transition metal complexes of bipyridine (e.g., M = Pd<sup>2+</sup>, Pt<sup>2+</sup>, Ru<sup>2+</sup>, Co<sup>3+</sup>, etc.) and analogous polypyridyl derivatives with DNA have been reviewed.<sup>285–290</sup>

## 1.1.11 BIPYRIDINE ANALOGUES

### 1.1.11.1 Biquinolines

Among the most common bipyridine analogues are biquinolines. As with bipyridine, six regioisomers of biquinoline exist. The 2,2'- isomer, (**51**), is most commonly used as a ligand. Due to the position of the fused rings and thus, the hydrogen atoms at the 8 and 8' positions, biquinoline is a more sterically demanding ligand than bipyridine.<sup>291,292</sup> 2,2'-Biquinoline, as well as the other two symmetric isomers, 3,3'- and 4,4'-biquinoline, have been synthesized in 84%, 61%, and 77% yield by a Ni<sup>0</sup>-catalyzed homocoupling of 2-chloro-, 3-bromo-, and 4-chloro-quinoline, respectively.<sup>293</sup> The 3,3' isomer (as well as 2,2'-dimethyl-3,3'-biquinoline) has also been prepared in 72% yield by a slight modification of this coupling method.<sup>294</sup> The unsymmetrical ligand, 2-(pyridin-2-yl)quinoline, was accessed via Stille coupling.<sup>34</sup>



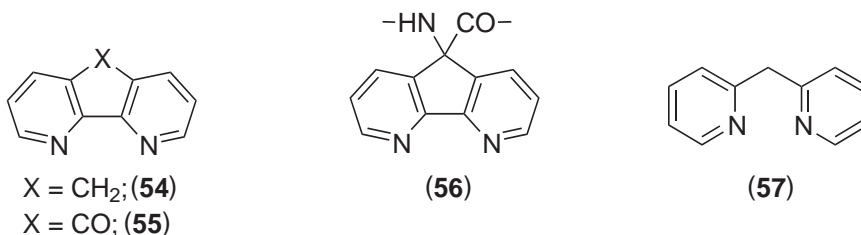
### 1.1.11.2 Biisoquinolines

Biisoquinolines differ from biquinolines in the position of the nitrogen atom relative to the adjacent fused benzene ring. Again, there are six possible biisoquinoline isomers; however, the two symmetric molecules, 1,1'-(**52**) and 3,3'-(**53**), are most commonly employed as transition metal ligands.

Like biquinolines, biisoquinolines are typically prepared by Ni<sup>0</sup>-catalyzed homocoupling of isoquinolyl halides.<sup>293</sup> The 1,1' isomer has also been prepared in moderate yield from simple isoquinoline by reacting it with LDA in hexamethylphosphoramide and ether.<sup>295</sup> This isomer is nonplanar when bound to metal ions due to the steric repulsion between protons at the 8 and 8' positions and thus, is chiral. The interconversion of the conformational isomers (known as *atropisomers*) of this ligand when bound to ruthenium has been reported.<sup>296</sup> The 3,3' isomer has also been studied as a transition metal ligand and more recently as a ligand for lanthanide metals.<sup>297</sup> Luminescence studies on ruthenium complexes<sup>298</sup> of (**53**) and the ligand itself<sup>299</sup> have been reported.

### 1.1.11.3 Other Analogues

Bipyridine ligands have been synthesized in which the 3 and 3' positions are bound by various linkers.<sup>300–302</sup> Ligands with only one atom bridging the 3 and 3' positions ((**54**) and (**55**)) have a more rigid ring structure and a larger bite angle when coordinated to metals relative to bpy. In fact, palladium complexes have been isolated where one (**54**) ligand preferentially bound two palladium centers (one through each nitrogen).<sup>303</sup> Ligand (**56**) has been incorporated into amino acid chains in order to functionalize peptides with transition metal binding sites.<sup>304</sup>



Bis(pyridine-2-yl)methane, (**57**), is another ligand that behaves similar to bipyridine, although because of the carbon linker between pyridine rings, a six-membered metallocelate ring is generated upon coordination to a metal, rather than the five-membered ring obtained in M-bpy complexes. This ligand and the analogue, (2,2'-dipyridyl)propylamine, have been complexed to platinum to generate cisplatin derivatives.<sup>305</sup> Ligand (**57**) has traditionally been synthesized by the method of Leete *et al.*<sup>306</sup>

### 1.1.12 REFERENCES

- Meyer, T. J. *Pure Appl. Chem.* **1986**, *58*, 1193–1206.
- Juris, A.; Balzani, V.; Barigelletti, F.; Campagna, S.; Belser, P.; von Zelewsky, A. *Coord. Chem. Rev.* **1988**, *84*, 85–277.
- Yersin, H.; Vogler, A., Eds. *Photochemistry and Photophysics of Coordination Compounds*; Springer-Verlag: Berlin, 1987.
- Constable, E. C. *Adv. Inorg. Chem.* **1989**, *34*, 1–63.
- Meyer, T. *Acc. Chem. Res.* **1989**, *22*, 165–170.
- Lindoy, L. F.; Livingstone, S. E. *Coord. Chem. Rev.* **1967**, *2*, 173–193.
- Balzani, V.; Juris, A. *Coord. Chem. Rev.* **2001**, *211*, 97–115.
- Hui, J. W. S.; Wong, W. T. *Coord. Chem. Rev.* **1998**, *172*, 389–436.
- Sun, L. C.; Hammarstrom, L. Akermark, B.; Styring, S. *Chem. Soc. Rev.* **2001**, *30*, 36–49.
- Dürr, H.; Bossmann, S. *Acc. Chem. Res.* **2001**, *34*, 905–917.
- Summers, L. A. *Adv. Heterocycl. Chem.* **1984**, *35*, 281–374.
- Steel, P. J. *Adv. Heterocycl. Chem.* **1996**, *67*, 1–117.
- Reedijk, J. Heterocyclic Nitrogen-donor Ligands. In *Comprehensive Coordination Chemistry: The Synthesis, Reactions, Properties and Applications of Coordination Compounds*; Wilkinson, G., Gillard, R. D., McCleverty, J. A. Eds.; Pergamon Press: Oxford, 1987; Vol. 2, Chapter 13.2.
- Burstall, F. H. *J. Chem. Soc.* **1938**, 1662–1672.
- Case, F. H.; Kasper, T. J. *J. Am. Chem. Soc.* **1956**, *78*, 5842–5844.
- MacBride, J. A. H.; Wright, P. M.; Wakefield, B. J. *Tetrahedron Lett.* **1981**, *22*, 4545–4548.
- Sasse, W. H. F. *Org. Synth.* **1966**, *46*, 5–10.
- Badger, G. M.; Sasse, W. H. F. *Adv. Heterocycl. Chem.* **1963**, *2*, 179–202.
- Kröhnke, F. *Synthesis* **1976**, 1–24.
- Undheim, K.; Benneche, T. *Adv. Heterocycl. Chem.* **1995**, *62*, 305–418.
- Ito, K.; Yoshitake, M.; Katsuki, T. *Tetrahedron* **1996**, *52*, 3905–3920.
- Wang, Z.; Reibenspies, J.; Motekaitis, R. J.; Martell, A. E. *J. Chem. Soc., Dalton Trans.* **1995**, 1511–1518.
- Neuman, U.; Vögtle, F. *Chem. Ber.* **1989**, *122*, 589–591.
- Constable, E. C.; Morris, D.; Carr, S. *New J. Chem.* **1998**, 287–294.
- Attias, A.-J.; Cavalli, C.; Bloch, B.; Guillou, N.; Noël, C. *Chem. Mater.* **1999**, *11*, 2057–2068.
- Trécourt, F.; Mallet, M.; Mongin, O.; Gervais, B.; Quéguiner, G. *Tetrahedron* **1993**, *49*, 8373–8380.
- Onggo, D.; Goodwin, H. A. *Aust. J. Chem.* **1991**, *44*, 1539–1551.
- Yoo, J.; Kim, J.-H.; Sohn, Y. S.; Do, Y. *Inorg. Chim. Acta* **1997**, *263*, 53–60.
- Shan, B.-Z.; Zhao, Z.; Goswami, N.; Eichhorn, D. M.; Rillema, D. P. *Coord. Chem. Rev.* **2001**, *211*, 117–144.
- Schubert, U. S.; Eschbaumer, C.; Hochwimmer, G. *Tetrahedron Lett.* **1998**, *39*, 8643–8644.
- Ulrich, G.; Bedel, S.; Picard, C.; Tisnès, P. *Tetrahedron Lett.* **2001**, *42*, 6113–6115.
- Yamamoto, Y.; Tanaka, T.; Yagi, M.; Inamoto, M. *Heterocycles* **1996**, *42*, 189–194.
- Fallahpour, R.-A.; Neuburger, M. *Eur. J. Org. Chem.* **2001**, 1853–1856.
- Echavarren, A. M.; Stille, J. K. *J. Am. Chem. Soc.* **1987**, *109*, 5478–5486.
- Godard, A.; Rovera, J.-C.; Marsais, F.; Plé, N.; Quéguiner, G. *Tetrahedron* **1992**, *48*, 4123–4134.

36. Nshimyumukiza, P.; Cahard, D.; Rouden, J.; Lasne, M.-C.; Plaquevent, J.-C. *Tetrahedron Lett.* **2001**, *42*, 7787–7790.
37. Savage, S. A.; Smith, A. P.; Fraser, C. L. *J. Org. Chem.* **1998**, *63*, 10048–10051.
38. Smith, A. P.; Savage, S. A.; Love, J. C.; Fraser, C. L. *Org. Synth.* **2001**, *78*, 51–62.
39. Wang, Z.; Xiong, R.-G.; Naggar, E.; Foxman, B. M.; Lin, W. *Inorg. Chim. Acta* **1999**, *288*, 215–219.
40. Siegel, J. S.; Loren, J. C. *Angew. Chem., Int. Ed. Engl.* **2001**, *40*, 754–757.
41. Ishikura, M.; Kamada, M.; Terashima, M. *Synthesis* **1984**, 936–938.
42. Fernando, S. R. L.; Maharroof, U. S. M.; Deshayes, K. D.; Kinstle, T. H.; Ogawa, M. Y. *J. Am. Chem. Soc.* **1996**, *118*, 5783–5790.
43. Cruskie, M. P.; Zoltewicz, J. A.; Abboud, K. A. *J. Org. Chem.* **1995**, *60*, 7491–7495.
44. Furukawa, N.; Shibutani, T.; Fujihara, H. *Tetrahedron Lett.* **1989**, *30*, 7091–7094.
45. Uenishi, J.; Ueno, T.; Hata, S.; Nishiwaki, K.; Tanaka, T.; Wakabayashi, S.; Yonemitsu, O.; Oae, S. *Heterocycles* **1999**, *50*, 341–351.
46. Zhang, N.; Thomas, L.; Wu, B. *J. Org. Chem.* **2001**, *66*, 1500–1502.
47. Hitchcock, S. A.; Mayhugh, D. R.; Gregory, G. S. *Tetrahedron Lett.* **1995**, *36*, 9085–9088.
48. Charbonnière, L. J.; Weibel, N.; Ziessel, R. F. *Tetrahedron Lett.* **2001**, *42*, 659–662.
49. Potts, K. T.; Winslow, P. A. *J. Org. Chem.* **1985**, *50*, 5405–5409.
50. Potts, K. T.; Gheysen Raiford, K. A.; Keshavarz, M. K. *J. Am. Chem. Soc.* **1993**, *115*, 2793–2807.
51. Sauer, J.; Heldmann, D. K.; Pabst, G. R. *Eur. J. Org. Chem.* **1999**, 313–321.
52. Varela, J. A.; Castedo, L.; Saá, C. *J. Org. Chem.* **1997**, *62*, 4189–4192.
53. Varela, J. A.; Castedo, L.; Saá, C. *J. Am. Chem. Soc.* **1998**, *120*, 12147–12148.
54. Jones, G.; Pitman, M. A.; Lunt, E.; Lythgoe, D. J.; Abarca, B.; Ballesteros, R.; Elmasnaouy, M. *Tetrahedron* **1997**, *53*, 8257–8268.
55. Abarca, B.; Ballesteros, R.; Elmasnaouy, M. *Tetrahedron* **1998**, *54*, 15287–15292.
56. Tadesse, S.; Bhandari, A.; Gallop, M. A. *J. Comb. Chem.* **1999**, *1*, 184–187.
57. Blau, F. *Monatsh. Chem.* **1889**, *10*, 375.
58. Haginiwa, J. *Jpn. J. Pharmacol.* **1955**, *75*, 731–733.
59. Krumholz, P. *J. Am. Chem. Soc.* **1953**, *75*, 2163–2166.
60. Khandelwal, G. D.; Swan, G. A.; Roy, R. B. *J. Chem. Soc. Perkin Trans. 1* **1974**, 891–896.
61. Maerker, G.; Case, F. H. *J. Am. Chem. Soc.* **1958**, *80*, 2745–2748.
62. Hadda, T. B.; Zidane, I.; Moya, S. A.; Le Bozec, H. *Polyhedron* **1996**, *15*, 1571–1573.
63. Zoltewicz, J. A.; Cruskie, M. P., Jr. *Tetrahedron* **1995**, *51*, 11401–11410.
64. Downard, A. J.; Honey, G. E.; Steel, P. J. *Inorg. Chem.* **1991**, *30*, 3733–3737.
65. Wenkert, D.; Woodward, R. B. *J. Org. Chem.* **1983**, *48*, 283–289.
66. Oae, S.; Kawai, T.; Furukawa, N. *Phosphorus Sulfur* **1987**, *34*, 123–132.
67. Kelly, T. R.; Lee, Y.-J.; Mears, R. J. *J. Org. Chem.* **1997**, *62*, 2774–2781.
68. Nakashima, K.; Shinkai, S. *Chem. Lett.* **1994**, 1267–1270.
69. Romero, F. M.; Ziessel, R. *Tetrahedron Lett.* **1995**, *36*, 6471–6474.
70. Garber, T.; Rillema, D. P. *Synth. Commun.* **1990**, *20*, 1223–1239.
71. Penicaud, V.; Odobel, F.; Bujoli, B. *Tetrahedron Lett.* **1998**, *39*, 3689–3692.
72. Corcoran, R. C.; Bang, S. H. *Tetrahedron Lett.* **1990**, *31*, 6757–6758.
73. Uenishi, J.; Tanaka, T.; Nishiwaki, K.; Wakabayashi, S.; Oae, S.; Tsukube, H. *J. Org. Chem.* **1993**, *58*, 4382–4388.
74. Uenishi, J.; Tanaka, T.; Wakabayashi, S.; Oae, S. *Tetrahedron Lett.* **1990**, *31*, 4625–4628.
75. Choppin, S.; Gros, P.; Fort, Y. *Org. Lett.* **2000**, *2*, 803–805.
76. Masood, M. A.; Sullivan, B. P.; Hodgson, D. *J. Inorg. Chem.* **1999**, *38*, 5425–5430.
77. Antonini, I.; Claudi, F.; Cristalli, G.; Franchetti, P.; Grifantini, M.; Martelli, S. *J. Med. Chem.* **1981**, *24*, 1181–1184.
78. Schneider, J. P.; Topgi, R. S.; Kelly, J. W. *Synth. Commun.* **1992**, *22*, 1033–1037.
79. Janiak, C.; Deblon, S.; Wu, H.-P.; Kolm, M. J.; Klüfers, P.; Piotrowski, H.; Mayer, P. *Eur. J. Inorg. Chem.* **1999**, 1507–1521.
80. Ellison, D. K.; Iwamoto, R. T. *Tetrahedron Lett.* **1983**, *24*, 31–32.
81. Kitamura, N.; Rajagopal, S.; Tazuke, S. *J. Phys. Chem.* **1987**, *91*, 3767–3771.
82. Rutherford, T. J.; Reitsma, D. A.; Keene, F. R. *J. Chem. Soc., Dalton Trans.* **1994**, 3659–3666.
83. Fraser, C. L.; Anastasi, N. R.; Lamba, J. J. S. *J. Org. Chem.* **1997**, *62*, 9314–9317.
84. Damrauer, N. H.; Boussie, T. R.; Devenney, M.; McCusker, J. K. *J. Am. Chem. Soc.* **1997**, *119*, 8253–8268.
85. Rodriguez, A. L.; Peron, G.; Duprat, C.; Vallier, M.; Fouquet, E.; Fages, F. *Tetrahedron Lett.* **1998**, *39*, 1179–1182.
86. Bommarito, S. L.; Lowery-Bretz, S. P.; Abruña, H. D. *Inorg. Chem.* **1992**, *31*, 502–507.
87. Abruña, H. D.; Breiks, A. I.; Collum, D. B. *Inorg. Chem.* **1985**, *24*, 988–989.
88. Williams, C. E.; Lowry, R. B.; Braven, J.; Belt, S. T. *Inorg. Chim. Acta* **2001**, *315*, 112–119.
89. Ziessel, R.; Suffert, J.; Youinou, M.-T. *J. Org. Chem.* **1996**, *61*, 6535–6546.
90. Polin, J.; Schmohel, E.; Balzani, V. *Synthesis* **1998**, 321–324.
91. Gould, S.; Strouse, G. F.; Meyer, T. J.; Sullivan, B. P. *Inorg. Chem.* **1991**, *30*, 2942–2949.
92. Newkome, G. R.; Puckett, W. E.; Kiefer, G. E.; Gupta, V. K.; Xia, Y.; Coreil, M.; Hackney, M. A. *J. Org. Chem.* **1982**, *47*, 4116–4120.
93. Newkome, G. R.; Kiefer, G. E.; Xia, Y.-J.; Gupta, V. K. *Synthesis* **1984**, 676–679.
94. Smith, A. P.; Lamba, J. J. S.; Fraser, C. L. *Org. Synth.* **2001**, *78*, 82–90.
95. Schubert, U. S.; Nuyken, O.; Hochwimmer, G. *Polym. Mater. Sci. Eng.* **1998**, *79*, 11–12.
96. Quici, S.; Cavazzini, M.; Ceragioli, S.; Montanari, F.; Pozzi, G. *Tetrahedron Lett.* **1999**, *40*, 3647–3650.
97. Betzemeier, B.; Cavazzini, M.; Quici, S.; Knochel, P. *Tetrahedron Lett.* **2000**, *41*, 4343–4346.
98. Xia, J.; Johnson, T.; Gaynor, S. G.; Matyjaszewski, K.; DeSimone, J. *Macromolecules* **1999**, *32*, 4802–4805.
99. Garelli, N.; Vierling, P. *J. Org. Chem.* **1992**, *57*, 3046–3051.
100. Furue, M.; Maruyama, K.; Oguni, T.; Naiki, M.; Kamachi, M. *Inorg. Chem.* **1992**, *31*, 3792–3795.
101. Kocian, O.; Mortimer, R. J.; Beer, P. D. *Tetrahedron Lett.* **1990**, *31*, 5069–5072.
102. Oki, A. R.; Morgan, R. J. *Synth. Commun.* **1995**, *25*, 4093–4098.
103. Crooker, J. C.; Murray, R. W. *Anal. Chem.* **2000**, *72*, 3245–3252.

104. Veriot, G.; Dutasta, J.-P.; Matouzenko, G.; Collet, A. *Tetrahedron* **1995**, *51*, 389–400.
105. Dholakia, S.; Gillard, R. D.; Wimmer, F. L. *Polyhedron* **1985**, *4*, 791–795.
106. Hadda, T. B.; Sam, N.; Le Bozec, H.; Dixneuf, P. H. *Inorg. Chem. Commun.* **1999**, *2*, 460–462.
107. Dupau, P.; Renouard, T.; Le Bozec, H. *Tetrahedron Lett.* **1996**, *37*, 7503–7506.
108. Hwang, K.-O.; Sasaki, T. *J. Mater. Chem.* **1998**, *8*, 2153–2156.
109. Hirao, T.; Koichiro, I. *Chem. Commun.* **2001**, 431–432.
110. Mines, G. A.; Bjerrum, M. J.; Hill, M. G.; Casimiro, D. R.; Chang, I.-J.; Winkler, J. R.; Gray, H. B. *J. Am. Chem. Soc.* **1996**, *118*, 1961–1965.
111. Rowe, K. E.; Bruce, D. W. *J. Mater. Chem.* **1998**, *8*, 331–341.
112. El-ghayoury, A.; Ziessel, R. *J. Org. Chem.* **2000**, *65*, 7757–7763.
113. Smith, A. P.; Corbin, P. S.; Fraser, C. L. *Tetrahedron Lett.* **2000**, *41*, 2787–2789.
114. Harding, M. M.; Koert, U.; Lehn, J. M.; Marquis-Rigault, A.; Piguet, C.; Siegel, J. *Helv. Chim. Acta* **1991**, *74*, 594–610.
115. Lee, J.-K.; Yoo, D.; Rubner, M. F. *Chem. Mater.* **1997**, *9*, 1710–1712.
116. Eisenbach, C. D.; Schubert, U. S.; Baker, G. R.; Newkome, G. R. *J. Chem. Soc., Chem. Commun.* **1995**, 69–70.
117. Della Ciana, L.; Hamachi, I.; Meyer, T. J. *J. Org. Chem.* **1989**, *54*, 1731–1735.
118. Smith, A. P.; Fraser, C. L. *Macromolecules* **2002**, *35*, 594–596.
119. Newkome, G. R.; Gross, J.; Patri, A. K. *J. Org. Chem.* **1997**, *62*, 3013–3014.
120. Hassan, J.; Sévignon, M.; Gozzi, C.; Schulz, E.; Lemaire, M. *Chem. Rev.* **2002**, *102*, 1359–1469.
121. von Zelewsky, A. *Coord. Chem. Rev.* **1999**, *190*, 811–825.
122. Bottheghi, C.; Caccia, G.; Chelucci, G.; Soccolini, F. *J. Org. Chem.* **1984**, *49*, 4290–4293.
123. Chelucci, G.; Soccolini, F.; Bottheghi, C. *Synth. Commun.* **1985**, *15*, 807–818.
124. Hayoz, P.; von Zelewsky, A. *Tetrahedron Lett.* **1992**, *33*, 5165–5168.
125. Lötscher, D.; Rupprecht, S.; Stoekli-Evans, E.; von Zelewsky, A. *Tetrahedron: Asymmetry* **2000**, *11*, 4341–4357.
126. Chen, C.; Tagami, K.; Kishi, Y. *J. Org. Chem.* **1995**, *60*, 5386–5387.
127. Malkov, A. V.; Baxandale, I. R.; Bella, M.; Langer, V.; Fawcett, J.; Russell, D. R.; Mansfield, D. J.; Valko, M.; Kocovsky, P. *Organometallics* **2001**, *20*, 673–690.
128. Tichy, M.; Závada, J.; Podlaha, J.; Vojtisek, P. *Tetrahedron: Asymmetry* **1995**, *6*, 1279–1282.
129. Nakajima, M.; Sakaki, Y.; Shiro, M.; Hashimoto, S. *Tetrahedron: Asymmetry* **1997**, *8*, 341–344.
130. Chelucci, G.; Cabras, M. A.; Saba, A.; Sechi, A. *Tetrahedron: Asymmetry* **1996**, *7*, 1027–1032.
131. Hirao, K.; Tsuchiya, R.; Yano, Y.; Tsue, H. *Heterocycles* **1996**, *42*, 415–423.
132. Wong, H. L.; Tian, Y.; Chan, K. S. *Tetrahedron Lett.* **2000**, *41*, 7723–7726.
133. Wörsdörfer, U.; Vögtle, F.; Nieger, M.; Waletzke, M.; Grimme, S.; Glorius, F.; Pfaltz, A. *Synthesis* **1999**, 597–602.
134. Ito, K.; Tabuchi, S.; Katsuki, T. *Synlett* **1992**, 575–576.
135. Nishiyama, H.; Yamaguchi, S.; Park, S. B.; Itoh, K. *Tetrahedron: Asymmetry* **1993**, *4*, 143–150.
136. Araki, K.; Mutai, T.; Shigemitsu, Y.; Yamada, M.; Nakajima, T.; Kuroda, S.; Shimao, I. *J. Chem. Soc. Perkin Trans. 2* **1996**, 613–617.
137. Asselin, C. M.; Fraser, G. C.; Hall, H. K. Jr.; Lindsell, W. E.; Padias, A. B.; Preston, P. N. *J. Chem. Soc., Dalton Trans.* **1997**, 3765–3772.
138. Baxter, P. N. W.; Connor, J. A. *J. Organomet. Chem.* **1988**, *355*, 193–196.
139. Alpha, B.; Anklam, E.; Deschenaux, R.; Lehn, J.-M.; Pietraskiewicz, M. *Helv. Chim. Acta* **1988**, *71*, 1042–1052.
140. Stillner, R.; Lehn, J.-M. *Eur. J. Inorg. Chem.* **1998**, 977–982.
141. Hodacová, J.; Stibor, I. *Collect. Czech. Chem. Commun.* **2000**, *65*, 83–98.
142. Chambron, J.-C.; Sauvage, J.-P. *Tetrahedron* **1987**, *43*, 895–904.
143. Ashton, P. R.; Balzani, V.; Credi, A.; Kocian, O.; Pasini, D.; Prodi, L.; Spencer, N.; Stoddart, J. F.; Tolley, M. S.; Venturi, M.; White, A. J. P.; Williams, D. J. *Chem. Eur. J.* **1998**, *4*, 590–607.
144. Berg, K. E.; Tran, A.; Raymond, M. K.; Abrahamsson, M.; Wolny, J.; Redon, S.; Andersson, M.; Sun, L.; Styring, S.; Hammarstroem, L.; Toftlund, H.; Akermark, B. *Eur. J. Inorg. Chem.* **2001**, 1019–1030.
145. Ziessel, R.; Hissler, M.; Ulrich, G. *Synthesis* **1998**, 1339–1346.
146. Rodriguez-Ubis, J.-C.; Alpha, B.; Plancherel, D.; Lehn, J.-M. *Helv. Chim. Acta* **1984**, *67*, 2264–2269.
147. Schubert, U. S.; Newkome, G. R.; Goedel, A.; Pemp, A.; Kersten, J. L.; Eisenbach, C. D. *Heterocycles* **1998**, *48*, 2141–2148.
148. Canevet, C.; Libman, J.; Shanzer, A. *Angew. Chem. Int. Ed. Engl.* **1996**, *108*, 2842–2845.
149. Shu, M.-H.; Sun, W.-Y.; Duan, C.-Y.; Fu, Y.-J.; Zhang, W.-J.; Tang, W.-X. *J. Chem. Soc., Dalton Trans.* **1999**, 729–734.
150. Ziessel, R.; Suffert, J. *Tetrahedron Lett.* **1996**, *37*, 2011–2014.
151. Rosevear, P. E.; Sasse, W. H. F. *J. Heterocycl. Chem.* **1971**, *8*, 483–485.
152. Pijper, P. J.; van der Goot, H.; Timmerman, H.; Nauta, W. T. *Eur. J. Med. Chem. Chim. Ther.* **1984**, *19*, 399–404.
153. Belsler, P.; von Zelewsky, A. *Helv. Chim. Acta* **1980**, *63*, 1675–1702.
154. Scalzi, F. V.; Golob, N. F. *J. Org. Chem.* **1971**, *36*, 2541–2542.
155. Beer, P. D.; Szemes, F. *J. Chem. Soc. Chem. Commun.* **1995**, *21*, 2245–2248.
156. Beer, P. D.; Fletcher, N. C.; Drew, M. G. B.; Wear, T. J. *Polyhedron* **1997**, *16*, 815–823.
157. Buenzli, J.-C. G.; Charbonniere, L. J.; Ziessel, R. F. *J. Chem. Soc., Dalton Trans.* **2000**, *12*, 1917–1924.
158. Lieberman, M.; Tabet, M.; Sasaki, T. *J. Am. Chem. Soc.* **1994**, *116*, 5035–5044.
159. Lindner, E.; Veigel, R.; Ortner, K.; Nachtigal, C.; Steimann, M. *Eur. J. Inorg. Chem.* **2000**, 959–970.
160. Stanek, J.; Caravatti, G.; Capraro, H.-G.; Furet, P.; Mett, H.; Schneider, P.; Regenass, U. *J. Med. Chem.* **1993**, *36*, 46–54.
161. Pichot, F.; Beck, J. H.; Elliott, C. M. *J. Phys. Chem. A* **1999**, *103*, 6263–6267.
162. Rosevear, P. N. W.; Connor, J. A.; Schweizer, W. B.; Wallis, J. D. *J. Chem. Soc., Dalton Trans.* **1992**, *20*, 3015–3020.
163. Johansen, O.; Kowala, C.; Mau, A. W.-H.; Sasse, W. H. F. *Aust. J. Chem.* **1979**, *32*, 1453–1470.
164. Griggs, C. G.; Smith, D. J. H. *J. Chem. Soc. Perkin Trans. 1* **1982**, *12*, 3041–3044.
165. Hales, N. J.; Beattie, J. F. *J. Med. Chem.* **1993**, *36*, 3853–3858.
166. Kutney, J. P.; Kaczmarek, L.; Mostowicz, D.; Worth, B. R. *Can. J. Chem.* **1982**, *60*, 323–326.

167. Suffert, J.; Ziessel, R. *Tetrahedron Lett.* **1991**, *32*, 757–760.
168. Grosshenny, V.; Romero, F. M.; Ziessel, R. *J. Org. Chem.* **1997**, *62*, 1491–1500.
169. Butler, I.; Soucy-Breau, C. *Can. J. Chem.* **1991**, *69*, 1117–1123.
170. Beer, P. D.; Kocian, O.; Mortimer, R. J.; Spencer, P. *J. Chem. Soc. Chem. Commun.* **1992**, *8*, 602–604.
171. Bishop, B. M.; McCafferty, D. G.; Erickson, B. W. *Tetrahedron* **2000**, *56*, 4629–4638.
172. Tanji, S.; Shibata, T.; Sato, I.; Soai, K. *J. Chem. Soc. Perkin Trans. 1* **2001**, 217–218.
173. Falk, H.; Suste, A. *Monatsh. Chem.* **1993**, *124*, 881–892.
174. Newkome, G. R.; Lee, H.-W. *J. Am. Chem. Soc.* **1983**, *105*, 5956–5957.
175. Funeriu, D.-P.; He, Y.-B.; Bister, H.-J.; Lehn, J.-M. *Bull. Soc. Chim. Fr.* **1996**, *133*, 673–678.
176. Leduc, M. R.; Hawker, C. J.; Dao, J.; Frechet, J. M. J. *J. Am. Chem. Soc.* **1996**, *118*, 11111–11118.
177. Umemoto, T.; Nagayoshi, M.; Adachi, K.; Tomizawa, G. *J. Org. Chem.* **1998**, *63*, 3379–3385.
178. Dehmlow, E. V.; Slegers, A. *Liebigs Ann. Chem.* **1992**, *9*, 953–960.
179. Bolm, C.; Ewald, M.; Felder, M.; Schlingloff, G. *Chem. Ber.* **1992**, *125*, 1169–1190.
180. König, B. *Chem. Ber.* **1995**, *128*, 1141–1144.
181. Bos, K. D.; Kraaijkamp, J. G.; Noltes, J. G. *Synth. Commun.* **1979**, *9*, 497–500.
182. Heirtzler, F. R. *Syn. Lett.* **1999**, *8*, 1203–1206.
183. Baxter, P. N. W.; Connor, J. A.; Wallis, J. D.; Povey, D. C. *J. Organomet. Chem.* **1992**, *426*, 187–194.
184. Schubert, U. S.; Eschbaumer, C.; Heller, M. *Org. Lett.* **2000**, *2*, 3373–3376.
185. Nazeeruddin, M. K.; Zakeeruddin, S. M.; Kalyanasundaram, K. *J. Phys. Chem.* **1993**, *97*, 9607–9612.
186. Neve, F.; Crispini, A.; Campagna, S.; Serroni, S. *Inorg. Chem.* **1999**, *38*, 2250–2258.
187. Hassan, J.; Penalva, V.; Lavenot, L.; Gozzi, C.; Lemaire, M. *Tetrahedron* **1998**, *54*, 13793–13804.
188. Percec, V.; Barboiu, B.; Kim, H.-J. *J. Am. Chem. Soc.* **1998**, *120*, 305–316.
189. Bourgault, M.; Renouard, T.; Lognone, B.; Mountassir, C.; Le Bozec, H. *Can. J. Chem.* **1997**, *75*, 318–325.
190. Matyjaszewski, K.; Patten, T. E.; Xia, J. *J. Am. Chem. Soc.* **1997**, *119*, 674–680.
191. Koevari, E.; Kraemer, R. *Z. Naturforsch. B* **1994**, *49*, 1324–1328.
192. Uchida, Y.; Kajita, R.; Kawasaki, Y.; Oae, S. *Tetrahedron Lett.* **1995**, *36*, 4077–4080.
193. Leadbeater, N. E.; Resouly, S. M. *Tetrahedron Lett.* **1999**, *40*, 4243–4246.
194. Kelly-Basetti, B. M.; Cundy, D. J.; Pereira, S. M.; Sasse, W. H. F.; Savage, G. P.; Simpson, G. W. *Bioorg. Med. Chem. Lett.* **1995**, *5*, 2989–2992.
195. Herrmann, W. A.; Thiel, W. R.; Kuchler, J. G. *Chem. Ber.* **1990**, *123*, 1953–1961.
196. Newkome, G. R.; Kohli, D. K. *Heterocycles* **1981**, *15*, 739–742.
197. el Torki, F. M.; Schmehl, R. H.; Reed, W. F. *J. Chem. Soc. Faraday Trans. 1* **1989**, *85*, 349–362.
198. Chan, K. S.; Tse, A. K.-S. *Synth. Commun.* **1993**, *23*, 1929–1934.
199. de Vains, J.-B. R.; Lamartine, R. *Helv. Chim. Acta* **1994**, *77*, 1817–1825.
200. Newkome, G. R.; Kiefer, G. E.; Kohli, D. K.; Xia, Y.-J.; Fronczek, F. R.; Baker, G. R. *J. Org. Chem.* **1989**, *54*, 5105–5110.
201. Schmittl, M.; Ganz, A.; Schenk, W. A.; Hagel, M. *Z. Naturforsch. B* **1999**, *54*, 559–564.
202. Stange, A. F.; Tokura, S.; Kira, M. *J. Organomet. Chem.* **2000**, *612*, 117–124.
203. Della Ciana, L.; Dressick, W. J.; von Zelewsky, A. *J. Heterocycl. Chem.* **1990**, *27*, 163–165.
204. Newkome, G. R.; Kiefer, G. E.; Matsumura, N.; Puckett, W. E. *J. Org. Chem.* **1985**, *50*, 3807–3810.
205. Furue, M.; Yoshidzumi, T.; Kinoshita, S.; Kushida, T.; Nozakura, S.; Kamachi, M. *Bull. Chem. Soc. Jpn.* **1991**, *64*, 1632–1640.
206. Zhao, W.; Marfurt, J.; Walder, L. *Helv. Chim. Acta* **1994**, *77*, 351–371.
207. Barrett, A. G. M.; Hamprecht, D.; James, R. A.; Ohkubo, M.; Procopiou, P. A.; Toledo, M. A.; White, A. J. P.; Williams, D. J. *J. Org. Chem.* **2001**, *66*, 2187–2196.
208. Kaes, C.; Hosseini, M. W.; Rickard, C. E. F.; Skelton, B. W.; White, A. H. *Angew. Chem. Int. Ed. Engl.* **1998**, *37*, 920–922.
209. Beer, P. D.; Gale, P. A. *Angew. Chem., Int. Ed. Engl.* **2001**, *40*, 486–516.
210. Kocian, O.; Mortimer, R. J.; Beer, P. D. *J. Chem. Soc. Perkin Trans. 1* **1990**, 3203–3205.
211. Chambron, J.-C.; Heitz, V.; Sauvage, J.-P.; Pierre, J.-L.; Zurita, D. *Tetrahedron Lett.* **1995**, *36*, 9321–9324.
212. Allwood, J. L.; Burrell, A. K.; Officer, D. L.; Scott, S. M.; Wild, K. Y.; Gordon, K. C. *Chem. Commun.* **2000**, 747–748.
213. DiMugno, S. G.; Lin, V. S.-Y.; Therien, M. J. *J. Org. Chem.* **1993**, *58*, 5983–5993.
214. Beer, P. D. *J. Chem. Soc., Chem. Commun.* **1996**, 689–696.
215. Gutsche, C. D. Calixarenes. In *Monographs in Supramolecular Chemistry*. Stoddart, J. F., Ed., The Royal Society of Chemistry: Cambridge, 1989.
216. Beer, P. D.; Kocian, O.; Mortimer, R. J.; Ridgway, C. *J. Chem. Soc., Dalton Trans.* **1993**, 2629–2638.
217. Prodi, L.; Pivari, S.; Bolletta, F.; Hissler, M.; Ziessel, R. *Eur. J. Inorg. Chem.* **1998**, 1959–1965.
218. Deschenaux, R.; Harding, M. M.; Ruch, T. *J. Chem. Soc. Perkin Trans. 2* **1993**, 1251–1258.
219. Venema, F.; Nelissen, H. F. M.; Berthault, P.; Birlirakis, N.; Rowan, A. E.; Feiters, M. C.; Nolte, R. J. M. *Chem. Eur. J.* **1998**, *4*, 2237–2250.
220. Zhang, B.; Breslow, R. *J. Am. Chem. Soc.* **1997**, *119*, 1676–1681.
221. Kaes, C.; Katz, A.; Hosseini, M. W. *Chem. Rev.* **2000**, *100*, 3553–3590.
222. Dürr, H.; Kilburg, H.; Bossmann, S. *Synthesis* **1990**, 773–778.
223. Kaes, C.; Hosseini, M. W.; De Cian, A.; Fischer, J. *Tetrahedron Lett.* **1997**, *38*, 3901–3904.
224. Kaes, C.; Hosseini, M. W.; De Cian, A.; Fischer, J. *Tetrahedron Lett.* **1997**, *38*, 4389–4392.
225. Wang, Z.; Reibenspies, J.; Martell, A. E. *Inorg. Chem.* **1997**, *36*, 629–636.
226. Yoo, J.; Sohn, Y. S.; Do, Y. *J. Inorg. Biochem.* **1999**, *73*, 187–193.
227. Houk, K. N.; Menzer, S.; Newton, S. P.; Raymo, F. M.; Stoddart, J. F.; Williams, D. J. *J. Am. Chem. Soc.* **1999**, *121*, 1479–1487.
228. Hamers, C.; Kocian, O.; Raymo, F. M.; Stoddart, J. F. *Adv. Mater.* **1998**, *10*, 1366–1369.
229. Peinador, C.; Román, E.; Abboud, K.; Kaifer, A. E. *Chem. Commun.* **1999**, 1887–1888.
230. Toner, J. L. *Tetrahedron Lett.* **1983**, *24*, 2707–2710.

231. Sabbatini, N.; Guardigli, M.; Lehn, J.-M. *Coord. Chem. Rev.* **1993**, *123*, 201–228.
232. Lehn, J.-M.; Roth, C. O. *Helv. Chim. Acta* **1991**, *74*, 572–578.
233. Albrecht, M.; Riether, C. *Synlett* **1995**, 309–312.
234. Nocentini, G.; Barzi, A. *Gen. Pharmacol.* **1997**, *29*, 701–706.
235. Jenkins, I. H.; Rees, N. G.; Pickup, P. G. *Chem. Mater.* **1997**, *9*, 1213–1216.
236. Alcock, N. W.; McLaren, F.; Moore, P.; Pike, G. A.; Roe, S. M. *J. Chem. Soc. Chem. Commun.* **1989**, 629–632.
237. Couchman, S. M.; Jeffery, J. C.; Ward, M. D. *Polyhedron* **1999**, *18*, 2633–2640.
238. Holligan, B. M.; Jeffery, J. C.; Norgett, M. K.; Schatz, E.; Ward, M. D. *J. Chem. Soc., Dalton Trans.* **1992**, 3345–3351.
239. Fraser, C. L.; Smith, A. P. *J. Polym. Sci., Part A: Polym. Chem.* **2000**, *38*, 4704–4716.
240. Schubert, U. S.; Nuyken, O.; Hochwimmer, G. *J. Macromol. Sci. Pure* **2000**, *37*, 645–658.
241. Williams, M. E.; Masui, H.; Long, J. W.; Malik, J.; Murray, R. W. *J. Am. Chem. Soc.* **1997**, *119*, 1997–2005.
242. Naka, K.; Yaguchi, M.; Chujo, Y. *Chem. Mater.* **1999**, *11*, 849–851.
243. Chujo, Y.; Naka, A.; Krämer, M.; Sada, K.; Saegusa, T. *J. Macromol. Sci. Pure* **1995**, *32*, 1213–1223.
244. Vögtle, F.; Plevvoets, M.; Nieger, M.; Azzellini, G. C.; Credi, A.; De Cola, L.; De Marchis, V.; Venturi, M.; Balzani, V. *J. Am. Chem. Soc.* **1999**, *121*, 6290–6298.
245. Schubert, U. S.; Weidl, C. H.; Rapta, P.; Harth, E.; Müllen, K. *Chem. Lett.* **1999**, 949–950.
246. Choi, B.-K.; Takahashi, H.; Kanbara, T.; Yamamoto, T. *Polym. J.* **2000**, *32*, 991–994.
247. Bouachrine, M.; Lère-Porte, J.-P.; Moreau, J. J. E.; Serein-Spirau, F.; Torreilles, C. *J. Mater. Chem.* **2000**, *10*, 263–268.
248. Yamamoto, T.; Maruyama, T.; Zhou, Z.-H.; Ito, T.; Fukuda, T.; Yoneda, Y.; Begum, F.; Ikeda, T.; Sasaki, S.; Takezoe, H.; Fukuda, A.; Kubota, K. *J. Am. Chem. Soc.* **1994**, *116*, 4832–4845.
249. Wang, Q.; Yu, L. *J. Am. Chem. Soc.* **2000**, *122*, 11806–11811.
250. Yu, S. C.; Gong, X.; Chan, W. K. *Macromolecules* **1998**, *31*, 5639–5646.
251. Tan, L.-S.; Burkett, J. L.; Simko, S. R.; Alexander, M. D., Jr. *Macromol. Rapid Commun.* **1999**, *20*, 16–20.
252. Osaheni, J. A.; Jenekhe, S. A. *J. Am. Chem. Soc.* **1995**, *117*, 7389–7398.
253. Tan, L.-S.; Srinivasan, K. R.; Bai, S. J. *J. Polym. Sci. Polym. Chem.* **1997**, *35*, 1909–1924.
254. Yagi, K.; De Loudres Rivera-Castro, M. *Inorg. Chim. Acta* **1987**, *131*, 273–275.
255. Yu, S. C.; Hou, S.; Chan, W. K. *Macromolecules* **2000**, *33*, 3259–3273.
256. Wang, B.; Wasielewski, M. R. *J. Am. Chem. Soc.* **1997**, *119*, 12–21.
257. Park, H. W.; Sung, S. M.; Min, K. S.; Bang, H.; Suh, M. P. *Eur. J. Inorg. Chem.* **2001**, 2857–2863.
258. Lu, J.; Yu, C.; Niu, T.; Paliwala, T.; Crisci, G.; Somosa, F.; Jacobson, A. J. *Inorg. Chem.* **1998**, *37*, 4637–4640.
259. Lu, J.; Paliwala, T.; Lim, S. C.; Yu, C.; Niu, T.; Jacobson, A. J. *Inorg. Chem.* **1997**, *36*, 923–929.
260. Lu, J. Y.; Cabrera, B. R.; Wang, R. J.; Li, J. *Inorg. Chem.* **1999**, *38*, 4608–4611.
261. Carlucci, L.; Ciani, G.; Proserpio, D. M.; Sironi, A. *J. Am. Chem. Soc.* **1995**, *117*, 4562–4569.
262. Keller, S. W. *Angew. Chem., Int. Ed. Engl.* **1997**, *36*, 247–248.
263. Zhu, S. S.; Swager, T. M. *J. Am. Chem. Soc.* **1997**, *119*, 12568–12577.
264. Storrier, G. D.; Colbran, S. B. *Polyhedron* **1997**, *16*, 2705–2710.
265. Aranyos, V.; Hjelm, J.; Hagfeldt, A.; Grennberg, H. *J. Chem. Soc., Dalton Trans.* **2001**, 1319–1325.
266. Walters, K. A.; Trouillet, L.; Guillerez, S.; Schanze, K. S. *Inorg. Chem.* **2000**, *39*, 5496–5509.
267. Wang, L.-H.; Kang, E.-T.; Huang, W. *Polymer* **2001**, *42*, 3949–3952.
268. Wang, J.; Pappalardo, M.; Keene, F. R. *Aust. J. Chem.* **1995**, *48*, 1425–1436.
269. Lewis, A. L.; Miller, J. D. *J. Mater. Chem.* **1993**, *3*, 897–902.
270. Chujo, Y.; Sada, K.; Saegusa, T. *Polym. J.* **1993**, *25*, 599–608.
271. Chujo, Y.; Sada, K.; Saegusa, T. *Macromolecules* **1993**, *26*, 6320–6323.
272. Mihara, H.; Tanaka, Y.; Fujimoto, T.; Nishino, N. *J. Chem. Soc., Perkin Trans. 2* **1995**, 1133–1140.
273. Ghadiri, M. R.; Soares, C.; Choi, C. *J. Am. Chem. Soc.* **1992**, *114*, 825–831.
274. Schneider, J. P.; Kelly, J. W. *J. Am. Chem. Soc.* **1995**, *117*, 2533–2546.
275. Imperiali, B.; Fisher, S. L. *J. Org. Chem.* **1992**, *57*, 757–759.
276. Cheng, R. P.; Fisher, S. L.; Imperiali, B. *J. Am. Chem. Soc.* **1996**, *118*, 11349–11356.
277. Imperiali, B.; Prins, T. J.; Fisher, S. L. *J. Org. Chem.* **1993**, *58*, 1613–1616.
278. Mizuno, T.; Takeuchi, M.; Hamachi, I.; Nakashima, K.; Shinkai, S. *J. Chem. Soc., Perkin Trans. 2* **1998**, 2281–2288.
279. Mizuno, T.; Takeuchi, M.; Hamachi, I.; Nakashima, K.; Shinkai, S. *Chem. Commun.* **1997**, 1793–1794.
280. Hasegawa, T.; Matsuura, K.; Kobayashi, K. *Chem. Lett.* **2000**, 466–467.
281. Sakai, S.; Sasaki, T. *J. Am. Chem. Soc.* **1994**, *116*, 1587–1588.
282. Weizman, H.; Tor, Y. *J. Am. Chem. Soc.* **2001**, *123*, 3375–3376.
283. Khan, S. I.; Beilstein, A. E.; Sykora, M.; Smith, G. D.; Hu, X.; Grinstaff, M. W. *Inorg. Chem.* **1999**, *38*, 3922–3925.
284. Wiederholt, K.; McLaughlin, L. W. *Nucleic Acids Res.* **1999**, *27*, 2487–2493.
285. Sigel, H. *Coord. Chem. Rev.* **1995**, *144*, 287–319.
286. Toma, H. E.; Araki, K. *Coord. Chem. Rev.* **2000**, *196*, 307–329.
287. Ji, L.-N.; Zou, X.-H.; Liu, J.-G. *Coord. Chem. Rev.* **2001**, *216*, 513–536.
288. Cusumano, M.; Di Pietro, M. L.; Giannetto, A.; Messina, M. A.; Romano, F. *J. Am. Chem. Soc.* **2001**, *123*, 1914–1919.
289. Yamauchi, O.; Odani, A.; Hirota, S. *Bull. Chem. Soc. Jpn.* **2001**, *74*, 1525–1545.
290. Williams, K. M.; Cerasino, L.; Intini, F. P.; Natile, G.; Marzilli, L. G. *Inorg. Chem.* **1998**, *37*, 5260–5268.
291. Bessel, C. A.; Margarucci, J. A.; Acquaye, J. H.; Rubino, R. S.; Crandall, J.; Jircitano, A. J.; Takeuchi, K. *J. Inorg. Chem.* **1993**, *32*, 5779–5784.
292. Constable, E. C.; Steel, P. J. *Coord. Chem. Rev.* **1989**, *93*, 205–223.
293. Iyoda, M.; Otsuka, H.; Sato, K.; Nisato, N.; Oda, M. *Bull. Chem. Soc. Jpn.* **1990**, *63*, 80–87.
294. Fort, Y.; Becker, S.; Caubère, P. *Tetrahedron* **1994**, *50*, 11893–11902.
295. Ashby, M. T.; Govindan, G. N.; Grafton, A. K. *J. Am. Chem. Soc.* **1994**, *116*, 4801–4809.
296. Ashby, M. T. *J. Am. Chem. Soc.* **1995**, *117*, 2000–2007.
297. Mikkala, V. M.; Sund, C.; Kwiatkowski, M.; Pasanen, P.; Hogberg, M.; Kankare, J.; Takalo, H. *Helv. Chim. Acta* **1992**, *75*, 1621–1632.

298. Barigelletti, F.; Juris, A.; Balzani, V.; Belser, P.; von Zelewsky, A. *Inorg. Chem.* **1987**, *26*, 4115–4119.
299. Riesen, H.; Krausz, E. *Chem. Phys. Lett.* **1990**, *172*, 5–9.
300. Mazaleyrat, J.-P.; Wakselman, M.; Formaggio, F.; Crisma, M.; Toniolo, C. *Tetrahedron Lett.* **1999**, *40*, 6245–6248.
301. Elsevier, C. J. *Coord. Chem. Rev.* **1999**, *185–186*, 809–822.
302. Klein, R. A.; van Belzen, R.; Vrieze, K.; Elsevier, C. J.; Thummel, R. P.; Fraanje, J.; Goubitz, K. *Collect. Czech. Chem. Commun.* **1997**, *62*, 238–256.
303. Groen, J. H.; Elsevier, C. J.; Vrieze, K.; Smeets, W. J. J.; Spek, A. L. *Organometallics* **1996**, *15*, 3445–3455.
304. Mazaleyrat, J.-P.; Wright, K.; Wakselman, M.; Formaggio, F.; Crisma, M.; Toniolo, C. *Eur. J. Org. Chem.* **2001**, 1821–1829.
305. Mock, C.; Puscasu, I.; Rauterkus, M. J.; Tallen, G.; Wolff, J. E. A.; Krebs, B. *Inorg. Chim. Acta* **2001**, *319*, 109–116.
306. Leete, E.; Marion, L. *Can. J. Chem.* **1952**, *30*, 563–570.



# 1.2

## Phenanthroline Ligands

C. R. LUMAN and F. N. CASTELLANO  
*Bowling Green State University, Ohio, USA*

---

1.2.1	INTRODUCTION	25
1.2.2	INTRODUCTION AND BASIC TRANSFORMATIONS	25
1.2.2.1	Halogenation	26
1.2.2.2	Oxidative Substitutions	27
1.2.2.3	Alkylation and Catalyzed Cross-coupling	27
1.2.3	RESEARCH TRENDS AMONG PHENANTHROLINE COMPLEXES	28
1.2.3.1	Bioconjugates	28
1.2.3.2	Chiral Phenanthrolines	28
1.2.3.3	Molecular Recognition and Phenanthroline-based Ionophores	28
1.2.3.4	Chromophore-containing Phenanthrolines	29
1.2.3.5	Electroactive Ligands	31
1.2.3.6	Oligophenanthrolines	31
1.2.3.7	Polymer Supports for Phenanthrolines	34
1.2.3.8	Phenanthroline-based Dendrimers	35
1.2.4	REFERENCES	36

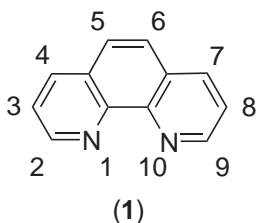
---

### 1.2.1 INTRODUCTION

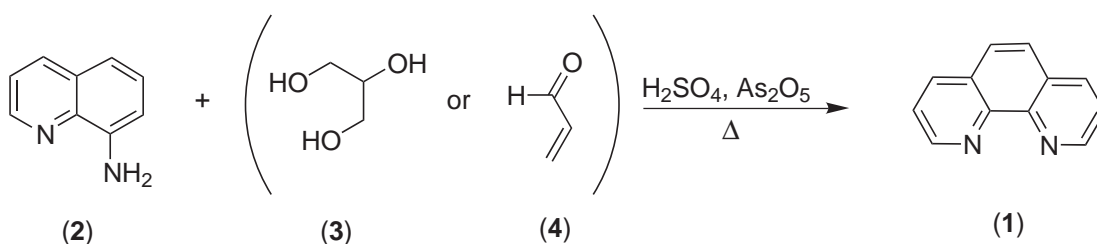
This chapter discusses the preparation of ligands based upon 1,10-phenanthroline and their role in the chemistry of coordination compounds. Our intent is to provide a cumulative description of research involving the synthesis of this particular class of ligands, with emphasis on application-based research. A brief narrative on the origins of 1,10-phenanthroline is presented, including seminal contributions in the preparation of this ligand. A compendium of commonly encountered synthetic routes toward ring-substituted 1,10-phenanthrolines follows. The remainder of the chapter highlights recent developments in the preparation of multifunctional, phenanthroline-based ligands.

### 1.2.2 INTRODUCTION AND BASIC TRANSFORMATIONS

The discovery and coordination chemistry of phenanthrolines closely followed that of the bipyridines throughout the early twentieth century, much as it does today. F. Blau<sup>1</sup> and Gerdiessen<sup>2</sup> are credited with the earliest published syntheses of 1,10-phenanthrolines (phen, **(I)**) in the late nineteenth century. While the colored metal complexes of these compounds had been reported, their utility as colorimetric indicators was not discussed until 1931.<sup>3</sup> For the next several decades, phenanthroline derivatives served primarily as colorimetric indicators for many transition metals. Throughout this period, the contributions of G. F. Smith,<sup>4-7</sup> F. H. Case,<sup>8-10</sup> A. A. Schilt,<sup>11</sup> and others toward the chemistry of these complexes resulted in a wealth of synthetic routes for derivatives of **(I)**. The flourishing studies of polypyridyl-coordinated metal complexes provided inspiration for preparing unique phenanthrolines with a wealth of pendant photo- and electro-active molecules.<sup>12-16</sup>

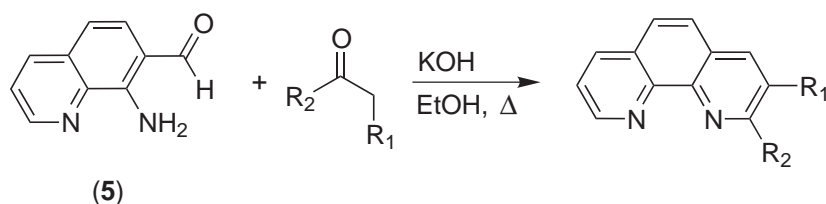


While many phenanthrolines are available from commercial suppliers, the synthesis of this ligand from its various precursors is often necessary in the preparation of more elaborate structures. The earliest syntheses of (1) proceeded by dual Skraup condensation about *o*-phenylenediamine, in a single-pot reaction.<sup>1,2</sup> The low reported yields of this reaction, along with failed subsequent attempts to improve upon it,<sup>17</sup> led to the use of sequential Skraup or Döbner–Miller condensations, with isolation of the intermediate 8-aminoquinoline (2). Reaction of (2) with glycerol (3) or acrolein (4) in the presence of sulfuric or phosphoric acid and arsenic pentoxide produces (1) directly, [Scheme 1](#).<sup>4,8–10,17,18</sup>



Scheme 1

Additionally, phenanthrolines may be prepared from quinolines through Friedländer condensation.<sup>19</sup> Beginning with 8-amino-7-quinolinecarbaldehyde (5), the second pyridine ring is closed by coupling with an enolizable ketone, with concomitant loss of water, according to [Scheme 2](#).<sup>20</sup> This route benefits from higher synthetic yields and the elimination of arsenic pentoxide as an oxidizing agent. Preparation of the starting quinoline (5) is often the most difficult step.<sup>21</sup> The efforts of Thummel and co-workers have resulted in several derivatives, including 5,6-dihydro-[1]<sup>19,22</sup> and fused aryl-[1].<sup>23,24</sup>



Scheme 2

Many of the ring-substituted derivatives of (1) have been prepared by the aforementioned coupling reactions, using appropriately substituted precursors.<sup>4,8–10,25</sup> Regiospecific aromatic substitution reactions have improved the yields of substituted phenanthrolines, and reduced the dependence on the toxic arsenic compounds employed in the Skraup synthesis. These reactions typically give mixtures of mono- and symmetrically di-substituted phenanthrolines, which must be separated through careful workup.

### 1.2.2.1 Halogenation

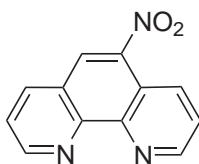
Halogenated derivatives of (1) are the most common starting reagents for the synthesis of more elaborate structures. Brominated phenanthrolines are convenient substrates for palladium-catalyzed

alkynyl and aryl coupling reactions. In bromobenzene<sup>26</sup> or nitrobenzene<sup>27</sup> solutions, bromine adds to (**1**) at the 3- and 8-positions with similar yields (25%) for both the mono- and di-brominated product. Bromination at the 5- and 6-positions is accomplished in fuming sulfuric acid.<sup>28</sup> Treatment of [1]-4,7-dione with POBr<sub>3</sub> gives 4,7-dibromo-[1].<sup>29</sup> Bromination proceeds with very high yields in oleum at elevated temperatures, producing 5-bromo-[1] exclusively.<sup>28</sup>

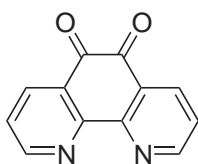
The reaction of (**1**) with hypochlorous acid leads to chlorination at the 5- and 6-positions.<sup>30</sup> Oxidative chlorination with phosphorus pentachloride gives the 2,9-dichloro-[1], as well as the 2,3,8,9-tetrachloro-[1].<sup>31</sup> Chlorinated-[1] may be converted sequentially through the thiol-[1] to the sulfonato-[1].<sup>32</sup> Several trihalomethyl derivatives, particularly fluorinated phenanthrolines, have also been prepared.<sup>33-37</sup>

### 1.2.2.2 Oxidative Substitutions

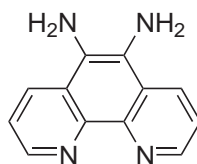
Treatment of (**1**) with oleum and nitric acids gives 5-nitro-[1] (**6**) with yields from 70 to 90%, depending on reaction temperature.<sup>5</sup> A side product of this reaction is the [1]-5,6-dione (**7**), whose colorless iron(II) complex was of little interest at the time of its discovery. A versatile precursor to many other phenanthrolines, (**7**) is readily prepared by treatment of (**1**) with sulfuric and nitric acids in the presence of bromide.<sup>38-40</sup> Through a dioxime intermediate, 5,6-diamino-[1] (**8**) is obtained.<sup>41</sup> 5-Amino-[1] (**9**) may be prepared directly from (**6**) with Sn-HCl reduction.<sup>39</sup> Alternatively, amino-[1] may be formed by conversion of the corresponding chloro-[1] with ammonia.<sup>42</sup>



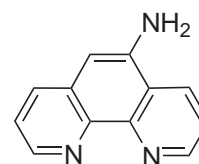
(6)



(7)

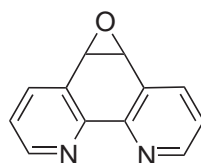


(8)



(9)

Oxidation of (**1**) with commercial bleach (hypochlorite) in the presence of a phase transfer catalyst<sup>43,44</sup> gives the [1]-5,6-epoxide (**10**), which is quite versatile in the preparation of a variety of 5-substituted-phenanthrolines, including cyano-, hydroxy-, dimethylamino-, aza-18-crown-6-, and methoxy-[1].<sup>45</sup> Under acidic conditions, this reaction permits the direct conversion of (**1**) to **7**.<sup>44,46</sup>



(10)

Methylated phenanthroline is commonly oxidized to the aldehyde by selenium dioxide in dioxane, and then to the carboxylic acid by treatment with nitric acid.<sup>37,47</sup> A selenium-free route to the aldehyde has been reported using iodine in DMSO.<sup>48</sup>

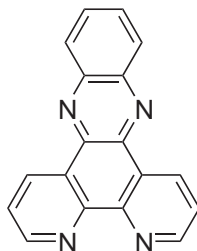
### 1.2.2.3 Alkylation and Catalyzed Cross-coupling

The addition of alkyl<sup>49</sup> and aryl<sup>50-52</sup> groups to the 2- and 9-positions of (**1**) proceeds most commonly by using organolithium reagents. Alkyl extension of methylated-[1] is also achieved by lithiation.<sup>53</sup> Ziessel and co-workers were instrumental in the application of palladium(0)-catalyzed coupling reactions to bromo- and chloro-substituted phenanthrolines, bipyridines, and terpyridines.<sup>54,55</sup> In all cases, conditions have been established to promote the coupling of various alkynyl moieties to these ligands, making it possible to generate new materials such as rod-like organometallic structures and polymers.<sup>26,56-63</sup> Aryl coupling using a phenylboronic ester following the coupling reaction of Suzuki<sup>64</sup> has been accomplished as well.<sup>62</sup>

### 1.2.3 RESEARCH TRENDS AMONG PHENANTHROLINE COMPLEXES

#### 1.2.3.1 Bioconjugates

The interaction between metal complexes and biological macromolecules has been widely studied as a method of nonradioactive labeling, using the same chemistry as their dye counterparts. A convenient method to associate a coordination complex with a biomolecule is through hydrophobic intercalators, such as dipyrrophenazine (dppz, **(11)**). The condensation of **(7)** with *o*-phenylenediamine gives **(11)**, a common intercalating ligand, whose ruthenium(II) complex shows “light switch”-type luminescence enhancement upon intercalation with double-helical DNA.<sup>40,65–68</sup> The same condensation strategy has been applied to substituted phenylenediamines, generating an entire series of new phenazine structures.<sup>40,69–71</sup>



(11)

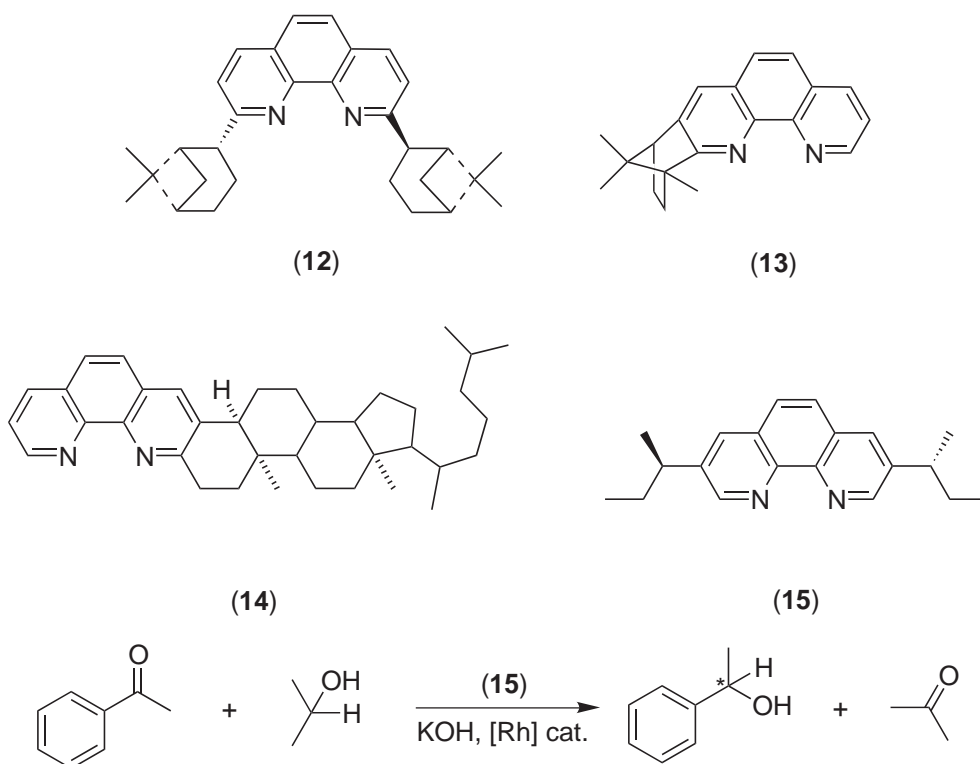
When covalent attachments are desired, free amino groups on proteins can be selectively targeted using metal complexes containing 5-isothiocyanato-**[1]**. This amino-reactive species is prepared from a metal complex containing 5-amino-**[1]** (**(9)**) and thiophosgene.<sup>72,73</sup> More specific substitution is possible if the biological macromolecule contains sulfhydryl groups, provided by free cysteine residues or reduced disulfide bonds. In these cases, metal complexes can be made sulfhydryl reactive by introducing chloro- or iodoacetamide functionalities into **(1)**. Reacting **(9)** with chloroacetyl chloride or iodoacetic anhydride generates both of these sulfhydryl-reactive species, respectively.<sup>74–76</sup> Oligonucleotides have also been covalently tethered to highly luminescent bathophenanthroline (4,7-diphenyl-**[1]**)-containing ruthenium(II) complexes through amide linkages.<sup>77–79</sup>

#### 1.2.3.2 Chiral Phenanthrolines

Chiral domains grafted onto coordination complexes may impart stereoselective control to catalytic and molecular recognition processes. The effectiveness of such modifications requires that the asymmetric moiety be positioned close enough to the catalytic domain to interact with the substrate, without interfering with the process. The need for proximity usually requires that the auxiliary be attached at the 2- or 3-position. Bulky norpinanyl, **(12)**<sup>22,80,81</sup> camphor, **(13)**<sup>82–84</sup> and steroidal **(14)**<sup>83</sup> domains, as well as simpler alkyl<sup>85</sup> domains **(15)**, have been prepared and characterized. In a series of papers addressing the enantioselective hydrogenation of acetophenone with rhodium catalysts (Scheme 3), Gladiali *et al.* examined several ligand-supported chiral motifs.<sup>18,22,86</sup> In a comparison of similarly substituted phenanthrolines and bipyridines, the phenanthrolines typically showed a tenfold increase in enantioselectivity. Additionally, the less bulky **(15)** showed greater enantioselectivity than complexes with larger domains, illustrative of the dichotomy between proximity and size. A novel method communicated by O'Neill and Helquist details a simple procedure for coupling asymmetric ketones with **(1)** using samarium diiodide.<sup>87</sup> This route is demonstrated for a number of linear and cyclic alkyl substituents, with yields ranging between 40 and 90%.

#### 1.2.3.3 Molecular Recognition and Phenanthroline-based Ionophores

Consistent with much of the early work regarding **(1)** and its derivatives as colorimetric indicators for transition-metal ions, various phenanthrolines have recently been developed as ion-selective



Scheme 3

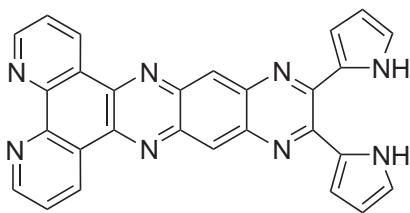
electrochemical sensors, as fluorometric sensors, and as agents for selective ion transport, particularly useful in the detection and transport of  $\text{Li}^+$ .<sup>88–92</sup> The recognition event occurs by complexation with either the diimine moiety of (1),<sup>88</sup> or with a crown ether-substituted (1).<sup>89,91,92</sup>

Some of the most successful sensing applications of (1) and its derivatives are realized when they are chelated to ruthenium(II) centers. The visible-absorbing metal-to-ligand charge transfer (MLCT) excited states associated with these complexes possess long-lifetime, high quantum yield photoluminescence.<sup>12–14</sup> The long lifetimes associated with these chromophores make them susceptible to collisional quenching reactions, such as electron and energy transfer. In terms of sensing, the orange-to-red MLCT-based emission provides a stable and accurate response (in intensity and lifetime) to dioxygen. Demas and co-workers have thoroughly developed this idea using a variety of ligands, metal centers, and solid support materials.<sup>93–97</sup> The charge transfer photoluminescence in ruthenium(II) diimine complexes is also temperature dependent, providing a luminescence response that can accurately determine temperature in a variety of environments.<sup>98–101</sup> In addition to these simple analytes, many other  $d^6$ -metal-chelated (1) systems have been developed for response to a variety of specific analytes such as pH,<sup>102,103</sup> heavy metals,<sup>45,92</sup> and various metal ions.<sup>98</sup>

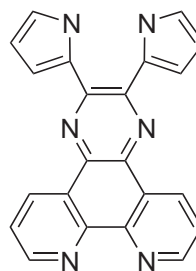
Developments in the world of anion sensing have generated two new phenanthroline-based structures. Sessler and co-workers have prepared a colorimetric and electrochemical-based fluoride ion sensor from ruthenium(II) and cobalt(III) coordination compounds, each containing (1) derivatized with a dipyrrolylquinoxaline (DPQ) (16) receptor.<sup>104</sup> This ligand was prepared through condensation of (7) with the appropriate 1,2-diamino-[DPQ] precursor. At approximately the same time the authors' group, in collaboration with Anzenbacher's group at BGSU, developed a related ligand structure (17) and its corresponding ruthenium(II) (bis)heteroleptic complex to serve as a luminescence lifetime-based sensor for cyanide and related anions.<sup>105</sup> Here, we took advantage of the aforementioned dipyrrophenazine condensation chemistry,<sup>40,68–71</sup> using reversed nucleophilicity.<sup>41,105</sup>

#### 1.2.3.4 Chromophore-containing Phenanthrolines

Although there are many examples of diimine ligands tethered to organic chromophores, most compounds are based upon 2,2'-bipyridine and 2,2',2''-terpyridine structures, the subject of other reviews in this series. Historically, (1) and its derivatives have been largely unexplored for

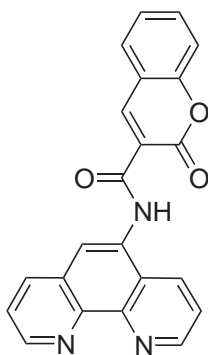


(16)

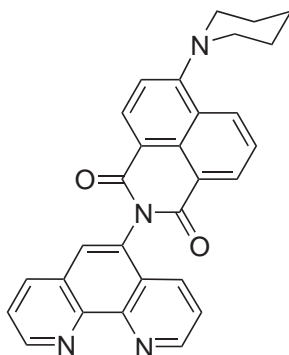


(17)

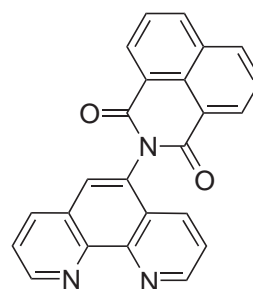
chromophore attachment, since there are a limited number of reactive structures available for synthetic elaboration. Our group has made use of nucleophilic (**9**) in the preparation of coumarin and naphthalimide-containing ligands, (**18**), (**19**), and (**20**).<sup>106–109</sup> The introduction of these organic chromophores into ruthenium(II) complexes has led to MLCT compounds possessing large absorption cross-sections and markedly extended room-temperature, excited-state lifetimes. Rodgers and co-workers have also made use of (**9**) as a nucleophile in the preparation of an amide-linked pyrene derivative of 1,10-phenanthroline, (**21**).<sup>110</sup>  $[\text{Ru}(\text{bpy})_2(\mathbf{21})]^{2+}$  served as the basis for future studies of excited triplet-state equilibria in ruthenium(II) MLCT chromophores.



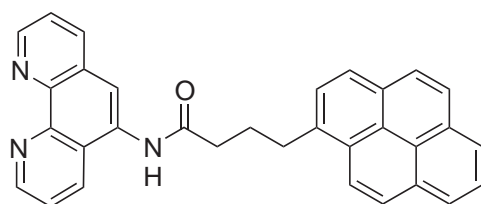
(18)



(19)



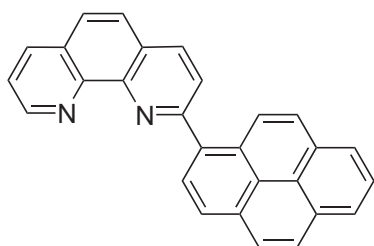
(20)



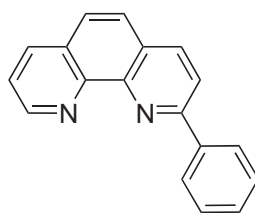
(21)

Concerned about the role of intraligand states in the deactivation of MLCT chromophores, Schmehl, Thummel, *et al.* prepared related structures where pyrene was covalently linked to (**1**) through a single C—C bond in the 2-position (**22**).<sup>111,112</sup> Several other chromophoric 2-aryl-1,10-phenanthrolines were also prepared (aryl = phenyl (**23**), 2-naphthyl (**24**), 1-anthracenyl (**25**)), using the same condensation strategy.<sup>20</sup> Thummel's group has recently developed more elaborate structures designed to elucidate the effects governing the cyclometalation process in complexes of  $\text{Ru}^{\text{II}}$ .<sup>113</sup> Our group has employed Suzuki coupling to generate 5-pyrenyl-[**1**] (**26**) from 5-bromo-[**1**] and 3-pyreneboronic acid.<sup>114,115</sup> We note that the reactivity of the 2- and 9-positions in 5-bromo-[**1**] to strong organic bases such as *n*-BuLi prohibits the formation of 1,10-phenanthroline-5-boronic

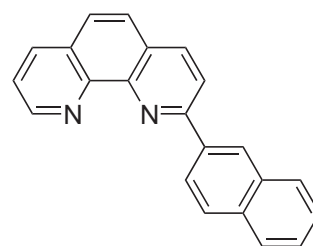
acid using standard reaction conditions. However, this limitation can likely be circumvented using boronic esters under milder conditions, as described by Sauvage *et al.*<sup>62</sup>



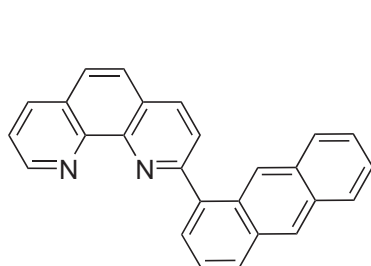
(22)



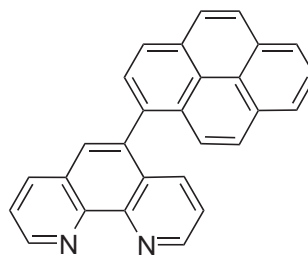
(23)



(24)



(25)



(26)

In the 1990s and early 2000s there has been a significant amount of activity in the synthesis of porphyrins substituted with one or more 1,10-phenanthroline units. The most actively studied systems are typically composed of two porphyrins tethered to (1) at the 2,9-positions. This ligand is useful simply as a rigid spacer between the porphyrins<sup>116–118</sup>, or as a template upon complexation with copper(I) to form catenane and rotaxane structures.<sup>119–125</sup> In several cases, aldehyde derivatives of 1,10-phenanthroline were treated with pyrrole and other arylaldehydes under acid-catalyzed conditions, producing the tetra-[1] porphyrin in reasonable yields.<sup>126</sup> In other cases, porphyrins containing peripheral reactive group(s) were tethered to substituted 1,10-phenanthrolines, generating a variety of linkages.<sup>127</sup>

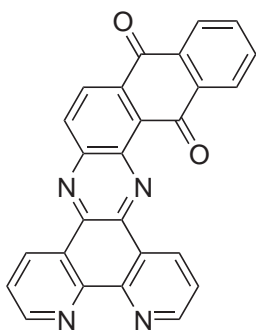
### 1.2.3.5 Electroactive Ligands

The rich coordination chemistry of 1,10-phenanthroline has encouraged the synthesis of new structures that serve as electron acceptors when chelated to appropriate metal complexes. Schanze and Sauer prepared a variety of proline-bridged *p*-benzoquinone derivatives of  $[\text{Ru}(\text{bpy})_2(\mathbf{9})]^{2+}$ , connected to the metal center through an amide bond utilizing the carboxy terminus of L-proline.<sup>128</sup> In all cases, the amide linkage to L-proline was generated from the phen-NH<sub>2</sub> group resident on the metal complex. Other ligands exist in which the quinone is conjugated with the phenanthroline rings (27), (28).<sup>46,129</sup>

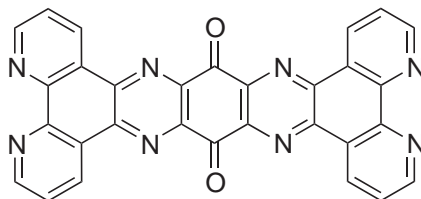
The Hupp group utilized electrochemical oxidation of  $[\text{Ru}(\text{phen})_3]^{2+}$  in the presence of *tert*-butyl-4-pyridine, 4-phenylpyridine, or 4,4'-bipyridine to prepare the pyridinium derivatives, (29), (30), and (31), respectively.<sup>130</sup> It is believed that activation of coordinated (1) is facilitated by oxidation of ruthenium(II) to ruthenium(III). Subsequent elimination of an H atom from (1) by the substituted pyridines is likely accomplished by spontaneous reduction of ruthenium(III) to ruthenium(II), producing the pyridinium salt.

### 1.2.3.6 Oligophenanthrolines

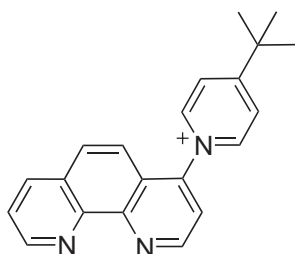
The geometry of coordination complexes provides a convenient starting point for the controlled orientation of ligands. Octahedral, tetrahedral, and square planar phenanthroline complexes impart specific directionality to their substituents. This effect is amplified when larger and



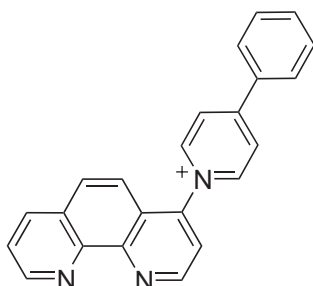
(27)



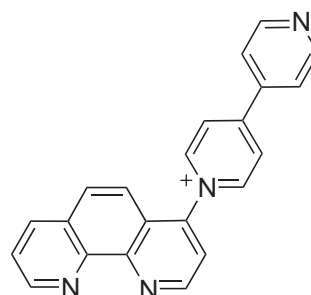
(28)



(29)



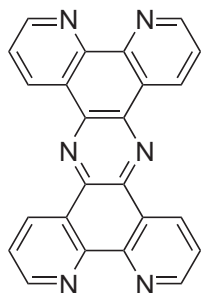
(30)



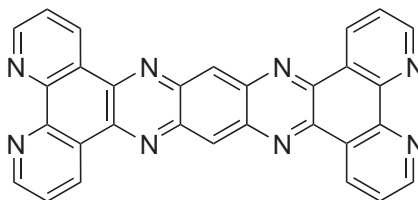
(31)

more complex ligands are employed. In many instances, this allows specific positioning of electronically interactive species. Complex directional structures, formed through the coordination of polychelating ligands, are the topic of this section. Most notably absent are the phenanthroline-based ringed and knotted structures prepared by Sauvage *et al.* which are thoroughly reviewed elsewhere.<sup>131</sup>

From the outset, we consider several basic motifs in the preparation of poly(phenanthroline) ligands. Several approaches exist for coupling (**1**) with itself. Fused-ring oligophenanthrolines exhibit strong electronic coupling. Tetrapyridophenazine (tpphz, (**32**)),<sup>132,133</sup> tetraazatetrapyridopentacene (tatpp, (**33**)),<sup>134</sup> and bisdipyridoquinoxalinepyrene (bqpy, (**34**))<sup>135</sup> are planar bitopic ligands prepared by condensation analogous to dppz (**11**). These often serve as bridging ligands in more complex structures. Eliatin, (**35**), a ligand of biological origin, has been shown to induce dimerization of its (bis)heteroleptic ruthenium(II) complexes.<sup>136</sup> The tritopic ligand hexaazatriphenylene (hat, (**36**)) allows the formation of polynuclear complexes in three directions.<sup>137,138</sup>

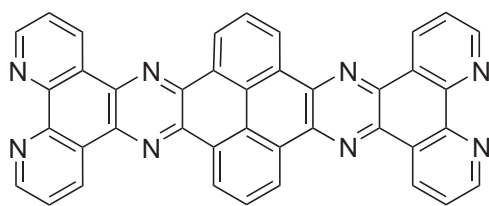


(32)

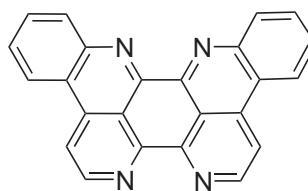


(33)

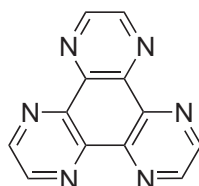




(34)

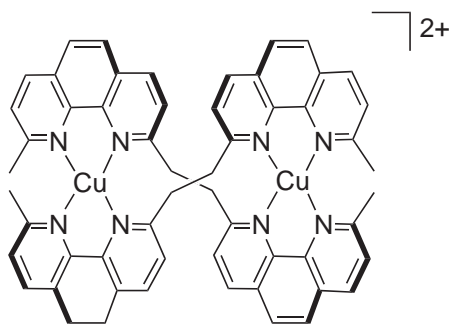


(35)

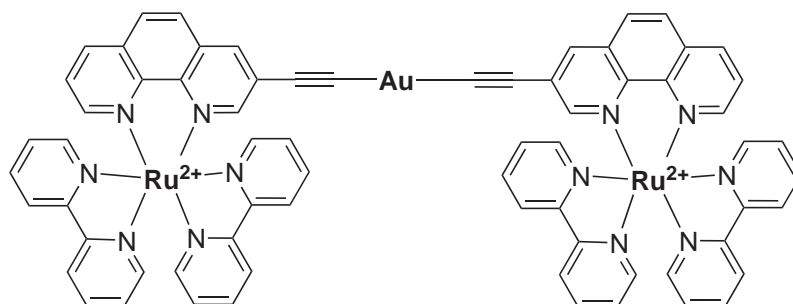


(36)

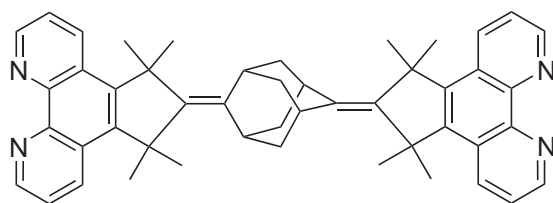
Bis-phenanthrolines connected by a single bond may behave like mono- or di-topic ligands.<sup>21,139</sup> Cyclic bis(phenanthrolines) have been prepared through amino-, aza-, and thiol bridges at the 2,9-positions.<sup>140,141</sup> These ligands possess a coordination environment similar to porphyrins, and form stable complexes with several metals. Ethylene-bridged bis(phenanthrolines) produce helicate dimetallic complexes (37).<sup>142,143</sup> Vinyl, alkynyl, and aryl-tethered phenanthrolines have a more rigid structure, yielding spatially well-defined polynuclear complexes. Extended  $\pi$ -conjugation between coordination sites facilitates electronic communication.<sup>20,57</sup> A recent communication by Shiotsuka *et al.* uses linear acetylide-gold(I) bonds as a conjugated connection between phenanthrolines (38).<sup>63</sup> A combination of endo- and exo-topic bisphenanthrolines form the walls of a tetranuclear “nanobox.”<sup>144,145</sup> Balzani *et al.* have created a rod-like bis-phenanthroline using an adamantyl linkage (39), which interrupts electronic coupling between the two coordination sites.<sup>146</sup>



(37)



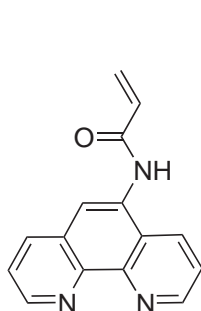
(38)



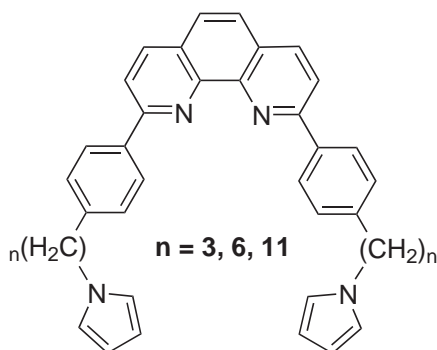
(39)

### 1.2.3.7 Polymer Supports for Phenanthrolines

The inclusion of coordination compounds into polymer matrices creates a stable and malleable environment in which the photophysical and electronic properties of these complexes may be studied. The electroactivity of thin-film-modified electrodes shows promise for new photovoltaics, electrochromics, electrocatalysts, and electroanalytical applications. One approach to these systems is to condense a modified ligand onto an existing polymer chain. This route has been successful in modifying polymers with phenanthrolines through ester<sup>147</sup> and sulfonamide<sup>148,149</sup> linkages via nucleophilic substitution. Another method uses a ligand co-monomer, such as an acrylimide-substituted phenanthroline (**40**). Masked photopolymerization of a thin film of (**40**) on a conductive glass electrode resulted in an electrochemically modulated film, which acted as a polarization grating.<sup>150</sup> A more elementary route to ligand-functionalized polymers is by electropolymerization of the ligand at the electrode surface. This has been demonstrated with coordinated complexes of 5-chloro-[1],<sup>151,152</sup> 5-amino-[1] (**9**),<sup>153</sup> and pyrrole-substituted phenanthrolines (**41**).<sup>154</sup>

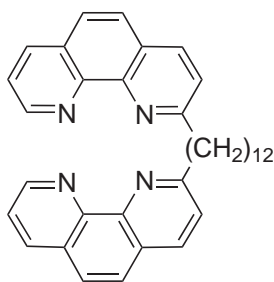


(40)



(41)

Coordination polymers consist of long-chain polytopic ligands which are interconnected by metal–ligand bonds. Bernhard *et al.* reported the synthesis of a copper(I) coordination polymer using *n*-decane-linked bis-phenanthrolines (**42**), whose morphology changes reversibly

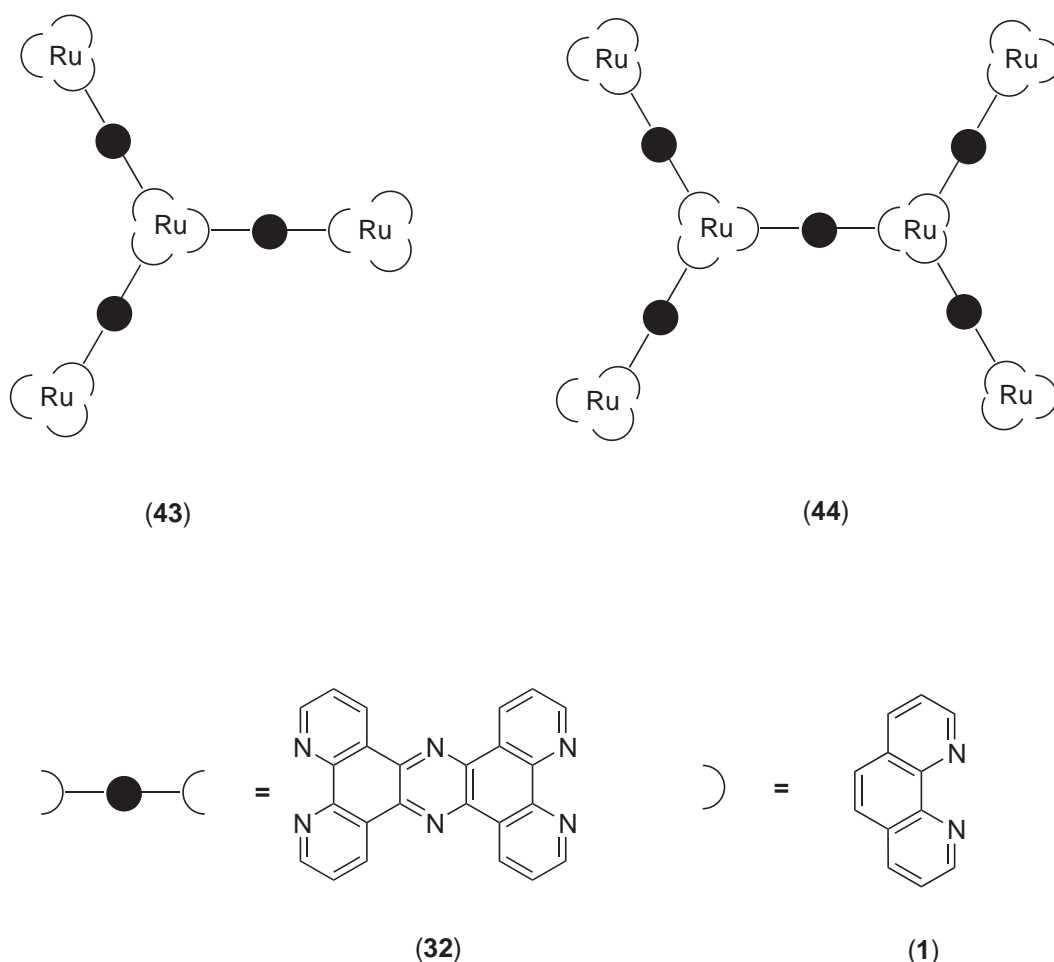


(42)

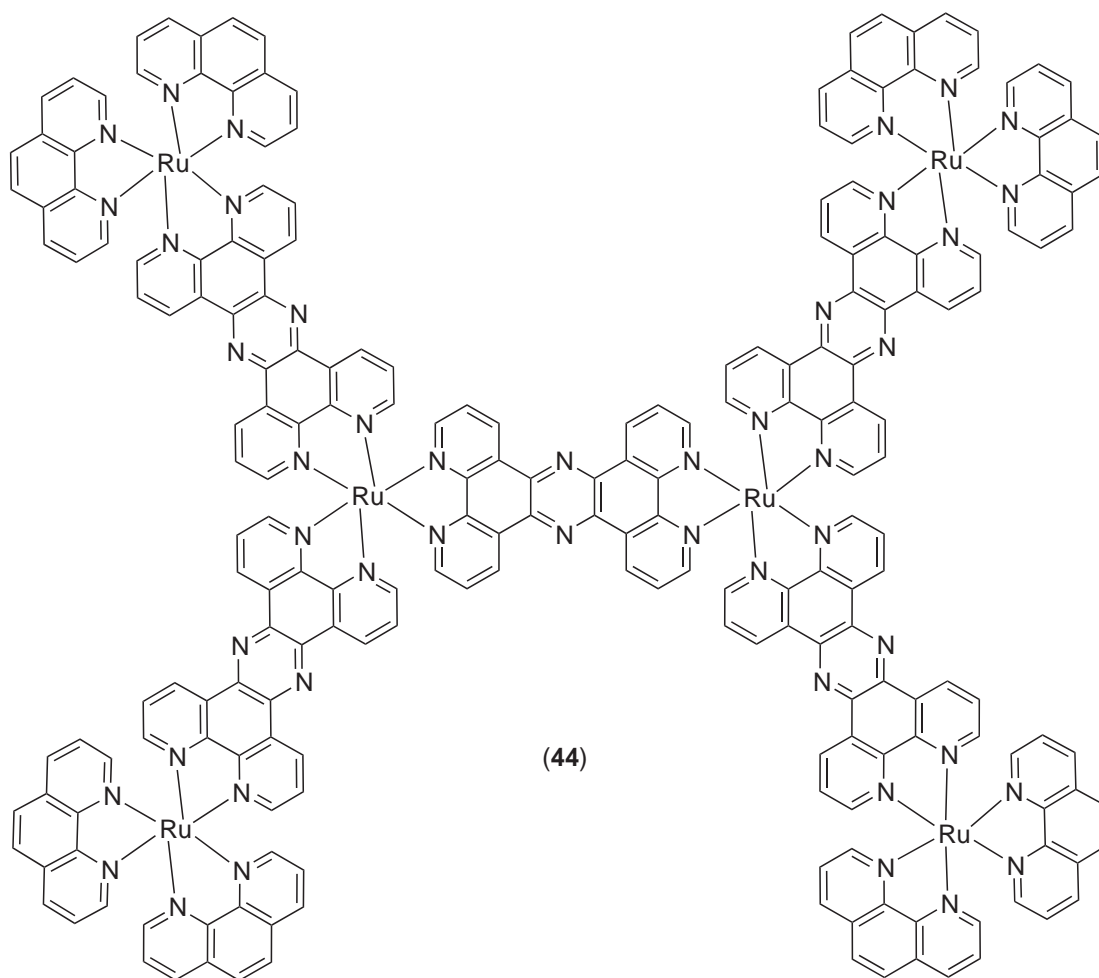
upon electrooxidation.<sup>155</sup> Similarly connected ligands have been prepared with aryl<sup>156</sup> and thiophene<sup>157</sup> spacers. Another preparation of coordination polymers uses the bis-chelate tpphz ligand (**32**).<sup>158–160</sup> MacDonnell and co-workers have used this ligand to prepare linear oligomers as well as large (*ca.* 5 nm) chiral molecular hexagons with mixed metal composition.<sup>161</sup>

### 1.2.3.8 Phenanthroline-based Dendrimers

Like polymers, dendrimers offer a convenient framework for connecting coordination complexes in supramolecular arrays. In conditions where the size, composition, and stereochemistry of the array are critical, dendrimers provide increased synthetic control of these parameters.<sup>162,163</sup> The geometry of the coordination sphere provides sufficient directional control for the growth of branches, while choice of ligand determines the extent of branching. Several first- and second-generation dendrimers have been prepared using tpphz (**32**) to connect ruthenium(II) centers in tetramers (**43**) and hexamers (**44**), as shown in Figure 1<sup>164–166</sup> Condensation of enantiopure  $\Delta$ - or  $\Lambda$ -complexes imparts global chirality to the assembled dendrimer.<sup>167,168</sup> This, combined with the rigidity of the bridging ligands, exemplifies the extensive topological control available from dendritic architectures.



**Figure 1** Representative metallodendrimers prepared by MacDonnell and co-workers.<sup>161–163</sup>



## 1.2.4 REFERENCES

1. Blau, F. *Ber.* **1888**, *21*, 1077–1078.
2. Gerdeissen, *Ber.* **1889**, *22*, 244–254.
3. Walden, Jr., G. H.; Hammett, L. P.; Chapman, R. P. *J. Am. Chem. Soc.* **1931**, *53*, 3908.
4. Richter, F.; Smith, G. F. *J. Am. Chem. Soc.* **1944**, *66*, 396–398.
5. Smith, G. F.; Cagle, F. W., Jr. *J. Am. Chem. Soc.* **1947**, *69*, 781–784.
6. Smith, G. F.; Richter, F. P. *Phenanthroline and Substituted Phenanthroline Indicators, their Preparation, Properties, and Applications to Analysis*; G. F. Smith Chemical Co, Columbus, OH, 1944.
7. Diehl, H.; Smith, G. F. *The Copper Reagents: Cuproine, Neocuproine, Bathocuproine*; G. F. Smith Chemical Co, Columbus, OH, 1958.
8. Case, F. H. *J. Org. Chem.* **1951**, *16*, 941–945.
9. Case, F. H.; Sasin, R. *J. Org. Chem.* **1955**, *20*, 1330–1336.
10. Case, F. H.; Catino, S.; Scholnick, F. *J. Org. Chem.* **1953**, *19*, 31–36.
11. Schilt, A. A. *Analytical Applications of 1,10-Phenanthroline and Related Compounds*; Pergamon Press, New York, 1969.
12. Juris, A.; Balzani, V.; Barigelletti, F.; Campagna, S.; Belsler, P.; Von Zelewsky, A. *Coord. Chem. Rev.* **1988**, *84*, 85–277.
13. Kalyanasundaram, K. *Photochemistry of Polypyridine and Porphyrin Complexes*; Academic Press: New York, 1992.
14. Buckingham, D. A.; Dwyer, F. P.; Goodwin, H. A.; Sargeson, A. M. *Aust. J. Chem.* **1964**, *17*, 325–336.
15. Lindoy, L. F.; Livingstone, S. E. *Coord. Chem. Rev.* **1967**, *2*, 173–193.
16. Armaroli, N. *Chem. Soc. Rev.* **2001**, *30*, 113–124.
17. Smith, C. R. *J. Am. Chem. Soc.* **1930**, *52*, 397–403.
18. Gladiali, S.; Pinna, L.; Delogu, G.; De Martin, S.; Zassinovich, G.; Mestroni, G. *Tetrahedron: Asymmetry* **1990**, *1*, 635–648.
19. Thummel, R. P. *Synlett* **1992**, 1–12.
20. Riesgo, E. C.; Jin, X.; Thummel, R. P. *J. Org. Chem.* **1996**, *61*, 3017–3022.
21. Hung, C.-Y.; Wang, T.-L.; Shi, Z.; Thummel, R. P. *Tetrahedron* **1994**, *50*, 10685–10692.
22. Gladiali, S.; Chelucci, G.; Socolini, F.; Delogu, G.; Chessa, G. *J. Organomet. Chem.* **1989**, *370*, 285–294.

23. Wu, F.; Thummel, R. P. *Inorg. Chim. Acta* **2002**, *327*, 26–30.
24. Thummel, R. P. *Tetrahedron* **1991**, *47*, 6851–6886.
25. Snyder, H. R.; Freier, H. E. *J. Am. Chem. Soc.* **1946**, *68*, 1320–1322.
26. Connors, P. J., Jr.; Tzalis, D.; Dunnick, A. L.; Tor, Y. *Inorg. Chem.* **1998**, *37*, 1121–1123.
27. Tzalis, D.; Tor, Y.; Failla, S.; Siegel, J. S. *Tetrahedron Lett.* **1995**, *36*, 3489–3490.
28. Hissler, M.; Connick, W. B.; Geiger, D. K.; McGarragh, J. E.; Lipa, D.; Lachicotte, R. J.; Eisenberg, R. *Inorg. Chem.* **2000**, *39*, 447–457.
29. Schmittel, M.; Ammon, H. *Synlett* **1997**, 1096–1098.
30. Antkowiak, R.; Antkowiak, W. *Heterocycles* **1998**, *47*, 893–909.
31. Yamada, M.; Nakamura, Y.; Hasegawa, T.; Itoh, A.; Kuroda, S.; Shimao, I. *Bull. Chem. Soc. Jpn.* **1992**, *65*, 2007–2009.
32. Mathis, J. M.; Pallenberg, A. J. *Synth. Comm.* **1997**, *27*, 2943–2951.
33. Okada, E.; Tsukushi, N. *Synthesis* **2000**, 499–501.
34. Beer, R. H.; Jimenez, J.; Drago, R. S. *J. Org. Chem.* **1993**, *58*, 1746–1747.
35. Miller, M. T.; Gantzel, P. K.; Karpishin, T. B. *Angew. Chem. Int. Ed.* **1998**, *37*, 1556–1558.
36. Newkome, G. R.; Theriot, K. J.; Gupta, V. K.; Fronczek, F. R.; Baker, G. R. *J. Org. Chem.* **1989**, *54*, 1766–1769.
37. Chandler, C. J.; Deady, L. W.; Reiss, J. A. *J. Heterocycl. Chem.* **1981**, *18*, 599–601.
38. Torres, A. S.; Maloney, D. J.; Tate, D.; Saad, Y.; MacDonnell, F. M. *Inorg. Chim. Acta* **1999**, *293*, 37–43.
39. Gillard, R. D.; Hill, R. E. *J. Chem. Soc., Dalton Trans.* **1974**, 1217–1236.
40. Yamada, M.; Tanaka, Y.; Yoshimoto, Y.; Kuroda, S.; Shimao, I. *Bull. Chem. Soc. Jpn.* **1992**, *65*, 1006–1011.
41. Bodige, S.; MacDonnell, F. M. *Tetrahedron Lett.* **1997**, *38*, 8159–8160.
42. De Zwart, M. A. H.; Bastiaans, H. M. M.; Van der Goot, H.; Timmerman, H. *J. Med. Chem.* **1991**, *34*, 1193–1201.
43. Krishnan, S.; Kuhn, D. G.; Hamilton, G. A. *J. Am. Chem. Soc.* **1977**, *99*, 8121–8123.
44. Moody, C. J.; Rees, C. W.; Thomas, R. *Tetrahedron* **1992**, *48*, 3589–3602.
45. Shen, Y.; Sullivan, B. P. *Inorg. Chem.* **1995**, *34*, 6235–6236.
46. López, R. B.; Loeb, B. L.; Boussie, T.; Meyer, T. J. *Tetrahedron Lett.* **1996**, *37*, 5437–5440.
47. Yanagida, M.; Singh, L. P.; Sayama, K.; Hara, K.; Katoh, R.; Islam, A.; Sugihara, H.; Arakawa, H.; Nazeeruddin, M. K.; Grätzel, M. *J. Chem. Soc., Dalton Trans.* **2000**, 2817–2822.
48. Angeloff, A.; Daran, J.-C.; Bernadou, J.; Meunier, B. *Eur. J. Inorg. Chem.* **2000**, 1985–1996.
49. Pallenberg, A. J.; Koenig, K. S.; Barnhart, D. M. *Inorg. Chem.* **1995**, *34*, 2833–2840.
50. Dietrich-Buchecker, C. O.; Marnot, P. A.; Sauvage, J. P. *Tetrahedron Lett.* **1982**, *23*, 5291–5294.
51. Masood, M. A.; Zacharias, P. S. *J. Chem. Soc., Dalton Trans.* **1991**, 111–114.
52. Alonso-Vante, N.; Nierengarten, J.-F.; Sauvage, J.-P. *J. Chem. Soc., Dalton Trans.* **1994**, 1649–1654.
53. Katritzky, A. R.; Long, Q. H.; Malhotra, N.; Ramanarayanan, T. A.; Vedage, H. *Synthesis* **1992**, 911–913.
54. Ziessel, R.; Suffert, J.; Youinou, M.-T. *J. Org. Chem.* **1996**, *61*, 6535–6546.
55. Suffert, J.; Ziessel, R. *Tetrahedron Lett.* **1991**, *32*, 757–760.
56. Harriman, A.; Ziessel, R. *Chem. Commun.* **1996**, 1707–1716.
57. Tzalis, D.; Tor, Y. *Chem. Commun.* **1996**, 1043–1044.
58. Tzalis, D.; Tor, Y. *J. Am. Chem. Soc.* **1997**, *119*, 852–853.
59. Guo, W.; Galoppini, E.; Rydja, G.; Pardi, G. *Tetrahedron Lett.* **2000**, *41*, 7419–7421.
60. Schmittel, M.; Michel, C.; Wiegrefe, A.; Kalsani, V. *Synthesis* **2001**, 1561–1567.
61. Liu, S.-X.; Michel, C.; Schmittel, M. *Org. Lett.* **2000**, *2*, 3959–3962.
62. Dietrich-Buchecker, C.; Jimenez, M. C.; Sauvage, J.-P. *Tetrahedron Lett.* **1999**, *40*, 3395–3396.
63. Shiotsuki, M.; Yamamoto, Y.; Okuno, S.; Kitou, M.; Nozaki, K.; Onaka, S. *Chem. Commun.* **2002**, 590–591.
64. Miyaura, N.; Suzuki, A. *Chem. Rev.* **1995**, *95*, 2457–2483.
65. Chambron, J.-C.; Sauvage, J.-P.; Amouyal, E.; Koffi, P. *New J. Chem.* **1985**, *9*, 527–529.
66. Amouyal, E.; Homsy, A.; Chambron, J.-C.; Sauvage, J.-P. *J. Chem. Soc., Dalton Trans.* **1990**, 1841–1845.
67. Jenkins, Y.; Barton, J. K. *J. Am. Chem. Soc.* **1992**, *114*, 8763–8738.
68. Yam, V. W.-W.; Lo, K. K.-W.; Cheung, K.-K.; Kong, R. Y.-C. *J. Chem. Soc., Chem. Commun.* **1995**, 1191–1193.
69. Hartshorn, R. M.; Barton, J. K. *J. Am. Chem. Soc.* **1992**, *114*, 5919–5925.
70. Pabst, G. R.; Pfüller, O. C.; Sauer, J. *Tetrahedron Lett.* **1998**, *39*, 8825–8828.
71. Black, K. J.; Huang, H.; High, S.; Starks, L.; Olson, M.; McGuire, M. E. *Inorg. Chem.* **1993**, *32*, 5591–5596.
72. Ryan, E. M.; O’Kennedy, R.; Feeney, M. M.; Kelly, J. M.; Vos, J. G. *Bioconjugate Chem.* **1992**, *3*, 285–290.
73. Youn, H. J.; Terpetschnig, E.; Szmajnski, H.; Lakowicz, J. R. *Anal. Biochem.* **1995**, *232*, 24–30.
74. Dattelbaum, J. D.; Abugo, O. O.; Lakowicz, J. R. *Bioconjugate Chem.* **2000**, *11*, 533–536.
75. Castellano, F. N.; Dattelbaum, J. D.; Lakowicz, J. R. *Anal. Biochem.* **1998**, *255*, 165–170.
76. Sigman, D. S.; Kuwabara, M. D.; Chen, C. H. B.; Bruce, T. W. *Methods Enzymol.* **1991**, *208*, 414–433.
77. Bannwarth, W. *Anal. Biochem.* **1989**, *181*, 216–219.
78. Bannwarth, W.; Schmidt, D. *Tetrahedron Lett.* **1989**, *30*, 1513–1516.
79. Bannwarth, W.; Schmidt, D.; Stallard, R. L.; Hornung, C.; Knorr, R.; Müller, F. *Helv. Chim. Acta* **1988**, *71*, 2085–2099.
80. Riesgo, E. C.; Credi, A.; De Cola, L.; Thummel, R. P. *Inorg. Chem.* **1998**, *37*, 2145–2149.
81. Chelucci, G.; Falorni, M.; Giacomelli, G. *Tetrahedron* **1992**, *48*, 3653–3658.
82. Kandzia, C.; Steckhan, E.; Knoch, F. *Tetrahedron: Asymmetry* **1993**, *4*, 39–42.
83. Gladiali, S.; Chelucci, G.; Mudadu, M. S.; Gastaut, M.-A.; Thummel, R. P. *J. Org. Chem.* **2001**, *66*, 400–405.
84. Chelucci, G.; Thummel, R. P. *Synth. Comm.* **1999**, *29*, 1665–1669.
85. Weijnen, J. G. J.; Koudijs, A.; Engbersen, J. F. J. *J. Org. Chem.* **1992**, *57*, 7258–7265.
86. Gladiali, S.; Chelucci, G.; Chessa, G.; Delogu, G.; Socolini, F. *J. Organomet. Chem.* **1987**, *327*, C15–C17.
87. O’Neill, D. J.; Helquist, P. *Org. Lett.* **1999**, *1*, 1659–1662.
88. Beer, P. D.; Danks, J. P.; Drew, M. G. B.; McAleer, J. F. *J. Organomet. Chem.* **1994**, *476*, 63–72.
89. Sugihara, H.; Hiratani, K. *Coord. Chem. Rev.* **1996**, *148*, 285–299.
90. Obare, S. O.; Murphy, C. J. *Inorg. Chem.* **2001**, *40*, 6080–6082.
91. Yam, V. W.-W.; Lee, V. W.-M.; Ke, F.; Siu, K.-W. *Inorg. Chem.* **1997**, *36*, 2124–2129.

92. Shen, Y.; Sullivan, B. P. *J. Chem. Educ.* **1997**, *74*, 685–689.
93. Bacon, J. R.; Demas, J. N. *Anal. Chem.* **1987**, *59*, 2780–2785.
94. Demas, J. N.; Harris, E. W.; McBride, R. P. *J. Am. Chem. Soc.* **1977**, *99*, 3547–3551.
95. Xu, W.; Kneas, K. A.; Demas, J. N.; DeGraff, B. A. *Anal. Chem.* **1996**, *68*, 2605–2609.
96. Xu, W.; McDonough, I.; Clayton, R.; Langsdorf, B.; Demas, J. N.; DeGraff, B. A. *Anal. Chem.* **1994**, *66*, 4133–4141.
97. Carraway, E. R.; Demas, J. N.; DeGraff, B. A.; Bacon, J. R. *Anal. Chem.* **1991**, *63*, 337–342.
98. Demas, J. N.; DeGraff, B. A. *Coord. Chem. Rev.* **2001**, *211*, 317–351.
99. Zipp, A. P.; Sacksteder, L.; Streich, J.; Cook, A.; Demas, J. N.; DeGraff, B. A. *Inorg. Chem.* **1993**, *32*, 5629–5632.
100. Carraway, E. R.; Demas, J. N.; DeGraff, B. A. *Anal. Chem.* **1991**, *63*, 332–336.
101. Jain, A.; Xu, W.; Demas, J. N.; DeGraff, B. A. *Inorg. Chem.* **1998**, *37*, 1876–1879.
102. Price, J. M.; Xu, W.; Demas, J. N.; DeGraff, B. A. *Anal. Chem.* **1998**, *70*, 265–270.
103. Giordano, P. J.; Bock, C. R.; Wrighton, M. S. *J. Am. Chem. Soc.* **1978**, *100*, 6960–6965.
104. Mizuno, T.; Wei, W.-H.; Eller, L. R.; Sessler, J. L. *J. Am. Chem. Soc.* **2002**, *124*, 1134–1135.
105. Anzenbacher, P. Jr.; Tyson, D. S.; Jurisková, K.; Castellano, F. N. *J. Am. Chem. Soc.* **2002**, *124*, 6232–6233.
106. Tyson, D. S.; Luman, C. R.; Zhou, X.; Castellano, F. N. *Inorg. Chem.* **2001**, *40*, 4063–4071.
107. Tyson, D. S.; Castellano, F. N. *Inorg. Chem.* **1999**, *38*, 4382–4383.
108. Tyson, D. S.; Gryczynski, I.; Castellano, F. N. *J. Phys. Chem. A* **2000**, *104*, 2919–2924.
109. Tyson, D. S.; Castellano, F. N., unpublished results.
110. Ford, W. E.; Rodgers, M. A. J. *J. Phys. Chem.* **1992**, *96*, 2917–2920.
111. Simon, J. A.; Curry, S. L.; Schmehl, R. H.; Schatz, T. R.; Piotrowiak, P.; Jin, X.; Thummel, R. P. *J. Am. Chem. Soc.* **1997**, *119*, 11012–11022.
112. Bonnefous, C.; Bellec, N.; Thummel, R. P. *Chem. Commun.* **1999**, 1243–1244.
113. Bonnefous, C.; Chouai, A.; Thummel, R. P. *Inorg. Chem.* **2001**, *40*, 5851–5859.
114. Tyson, D. S.; Bialecki, J.; Castellano, F. N. *Chem. Commun.* **2000**, 2355–2356.
115. Tyson, D. S.; Henbest, K. B.; Bialecki, J.; Castellano, F. N. *J. Phys. Chem. A* **2001**, *105*, 8154–8161.
116. Chambron, J.-C.; Heitz, V.; Sauvage, J.-P.; Pierre, J.-L.; Zurita, D. *Tetrahedron Lett.* **1995**, *36*, 9321–9324.
117. Chardon-Noblat, S.; Sauvage, J. P. *Tetrahedron* **1991**, *47*, 5123–5132.
118. Noblat, S.; Dietrich-Buchecker, C. O.; Sauvage, J.-P. *Tetrahedron Lett.* **1987**, *28*, 5829–5832.
119. Blanco, M.-J.; Chambron, J.-C.; Heitz, V.; Sauvage, J.-P. *Org. Lett.* **2000**, *2*, 3051–3054.
120. Amabilino, D. B.; Sauvage, J.-P. *New J. Chem.* **1998**, *22*, 395–409.
121. Solladié, N.; Chambron, J.-C.; Dietrich-Buchecker, C. O.; Sauvage, J.-P. *Angew. Chem., Int. Ed. Engl.* **1996**, *35*, 906–909.
122. Chambron, J.-C.; Dietrich-Buchecker, C. O.; Heitz, V.; Nierengarten, J.-F.; Sauvage, J.-P.; Pascard, C.; Guilhem, J. *Pure Appl. Chem.* **1995**, *67*, 233–240.
123. Chambron, J.-C.; Harriman, A.; Heitz, V.; Sauvage, J.-P. *J. Am. Chem. Soc.* **1993**, *115*, 7419–7425.
124. Chambron, J. C.; Harriman, A.; Heitz, V.; Sauvage, J.-P. *J. Am. Chem. Soc.* **1993**, *115*, 6109–6114.
125. Brun, A. M.; Atherton, S. J.; Harriman, A.; Heitz, V.; Sauvage, J.-P. *J. Am. Chem. Soc.* **1992**, *114*, 4632–4639.
126. Kus, P.; Knerr, G.; Czuchajowski, L. *J. Heterocycl. Chem.* **1990**, *27*, 1161–1166.
127. Kus, P.; Knerr, G.; Czuchajowski, L. *J. Heterocycl. Chem.* **1991**, *28*, 7–11.
128. Schanze, K. S.; Sauer, K. *J. Am. Chem. Soc.* **1988**, *110*, 1180–1186.
129. Kim, M.-J.; Konduri, R.; Ye, H.; MacDonnell, F. M.; Puntoriero, F.; Serroni, S.; Campagna, S.; Holder, T.; Kinsel, G.; Rajeshwar, K. *Inorg. Chem.* **2002**, *41*, 2471–2476.
130. Berg-Brennan, C.; Subramanian, P.; Absi, M.; Stern, C.; Hupp, J. T. *Inorg. Chem.* **1996**, *35*, 3719–3722.
131. Chambron, J. C.; Dietrich-Buchecker, C. O.; Sauvage, J.-P. Transition metals as assembling; templating species: Synthesis of catenanes; molecular knots. In *Comprehensive Supramolecular Chemistry, Vol. 9: Templating, Self-assembly, and Self-organization*; J.-P. Sauvage, M. W. Hosseini, Eds.; Pergamon: New York, 1996; pp 43–83.
132. Chiorboli, C.; Bignozzi, C. A.; Scandola, F.; Ishow, E.; Gourdon, A.; Launay, J.-P. *Inorg. Chem.* **1999**, *38*, 2402–2410.
133. Bolger, J.; Gourdon, A.; Ishow, E.; Launay, J.-P. *Inorg. Chem.* **1996**, *35*, 2937–2944.
134. Wärnmark, K.; Thomas, J. A.; Heyke, O.; Lehn, J.-M. *Chem. Commun.* **1996**, 701–702.
135. Ishow, E.; Gourdon, A.; Launay, J.-P.; Chiorboli, C.; Scandola, F. *Inorg. Chem.* **1999**, *38*, 1504–1510.
136. Gut, D.; Rudi, A.; Kopilov, J.; Goldberg, I.; Kol, M. *J. Am. Chem. Soc.* **2002**, *124*, 5449–5456.
137. Rogers, D. Z. *J. Org. Chem.* **1986**, *51*, 3904–3905.
138. Nasielski-Hinkens, R.; Benedek-Vamos, M.; Maetens, D.; Nasielski, J. *J. Organomet. Chem.* **1981**, *217*, 179–182.
139. Rice, C. R.; Anderson, K. M. *Polyhedron* **2000**, *19*, 495–498.
140. Hirai, M.; Shinozuka, K.; Sawai, H.; Ogawa, S. *Chem. Lett.* **1992**, 2023–2026.
141. Wang, W.-J.; Chuang, K.-S.; Luo, C.-F.; Liu, H.-Y. *Tetrahedron Lett.* **2000**, *41*, 8565–8568.
142. Yao, Y.; Perkovic, M. W.; Rillema, D. P.; Woods, C. *Inorg. Chem.* **1992**, *31*, 3956–3962.
143. Youinou, M.-T.; Ziessel, R.; Lehn, J.-M. *Inorg. Chem.* **1991**, *30*, 2144–2148.
144. Schmittel, M.; Ammon, H. *Synlett* **1999**, 750–752.
145. Schmittel, M.; Ganz, A. *Synlett* **1997**, 710–712.
146. Balzani, V.; Barigelletti, F.; Belser, P.; Bernhard, S.; De Cola, L.; Flamigni, L. *J. Phys. Chem.* **1996**, *100*, 16786–16788.
147. Panunzi, B.; Roviello, A.; Ruffo, F.; Vivo, A. *Inorg. Chim. Acta* **1998**, *281*, 141–147.
148. Surridge, N. A.; McClanahan, S. F.; Hupp, J. T.; Danielson, E.; Gould, S.; Meyer, T. J. *J. Phys. Chem.* **1989**, *93*, 294–304.
149. Surridge, N. A.; Hupp, J. T.; McClanahan, S. F.; Gould, S.; Meyer, T. J. *J. Phys. Chem.* **1989**, *93*, 304–313.
150. Bergstedt, T. S.; Hauser, B. T.; Schanze, K. S. *J. Am. Chem. Soc.* **1994**, *116*, 8380–8381.
151. Fussa-Rydel, O.; Zhang, H.-T.; Hupp, J. T.; Leidner, C. R. *Inorg. Chem.* **1989**, *28*, 1533–1537.
152. Zhang, H.-T.; Yan, S. G.; Subramanian, P.; Skeen-Jones, L. M.; Stern, C.; Hupp, J. T. *J. Electroanal. Chem.* **1996**, *414*, 23–29.
153. Williams, M. E.; Stevenson, K. J.; Massari, A. M.; Hupp, J. T. *Anal. Chem.* **2000**, *72*, 3122–3128.
154. Bidan, G.; Divisia-Blohorn, B.; Lapkowski, M.; Kern, J.-M.; Sauvage, J.-P. *J. Am. Chem. Soc.* **1992**, *114*, 5986–5994.

155. Bernhard, S.; Takada, K.; Jenkins, D.; Abruña, H. D. *Inorg. Chem.* **2002**, *41*, 765–772.
156. Velten, U.; Rehahn, M. *Chem. Commun.* **1996**, 2639–2640.
157. Vidal, P.-L.; Divisia-Blohorn, B.; Bidan, G.; Hazemann, J.-L.; Kern, J. M.; Sauvage, J.-P. *Chem. Eur. J.* **2000**, *6*, 1663–1673.
158. Kelch, S.; Rehahn, M. *Macromolecules* **1997**, *30*, 6185–6193.
159. Kelch, S.; Rehahn, M. *Macromolecules* **1998**, *31*, 4102–4106.
160. Chen, J.; MacDonnell, F. M. *Chem. Commun.* **1999**, 2529–2530.
161. Ali, M. M.; MacDonnell, F. M. *J. Am. Chem. Soc.* **2000**, *122*, 11527–11528.
162. Newkome, G. R.; He, E.; Moorefield, C. N. *Chem. Rev.* **1999**, *99*, 1689–1746.
163. Keene, F. R. *Coord. Chem. Rev.* **1997**, *166*, 121–159.
164. MacDonnell, F. M.; Bodige, S. *Inorg. Chem.* **1996**, *35*, 5758–5759.
165. Bodige, S.; Torres, A. S.; Maloney, D. J.; Tate, D.; Kinsel, G. R.; Walker, A. K.; MacDonnell, F. M. *J. Am. Chem. Soc.* **1997**, *119*, 10364–10369.
166. MacDonnell, F. M.; Kim, M.-J.; Bodige, S. *Coord. Chem. Rev.* **1999**, *185–186*, 535–549.
167. Kim, M.-J.; MacDonnell, F. M.; Gimon-Kinsel, M. E.; Du Bois, T.; Asgharian, N.; Griener, J. C. *Angew. Chem. Int. Ed.* **2000**, *39*, 615–619.
168. Knof, U.; Von Zelewsky, A. *Angew. Chem. Int. Ed.* **1999**, *38*, 302–322.

# 1.3

## Terpyridine, Oligopyridine, and Polypyridine Ligands

R. P. THUMMEL

*University of Houston, TX, USA*

---

1.3.1	INTRODUCTION AND SCOPE	41
1.3.2	PARENT SYSTEM AND <i>N</i> -OXIDES	42
1.3.3	MONOSUBSTITUTED TERPYRIDINES	42
1.3.3.1	4'-Substituted	42
1.3.3.2	4-Substituted	44
1.3.3.3	6-Substituted	44
1.3.4	DISUBSTITUTED TERPYRIDINES	46
1.3.4.1	3,3''-Disubstituted	46
1.3.4.2	4,4'-Disubstituted	46
1.3.4.3	5,5'-Disubstituted	47
1.3.4.4	6,6'-Disubstituted	47
1.3.4.5	3',4'-Disubstituted	48
1.3.5	TRISUBSTITUTED TERPYRIDINES	48
1.3.6	TETRASUBSTITUTED TERPYRIDINES	49
1.3.7	FUSED (ANNELATED) TERPYRIDINES	49
1.3.7.1	Benzo-fused	49
1.3.7.2	Other Fused	49
1.3.8	OLIGOPYRIDINES	51
1.3.9	REFERENCES	52

---

### 1.3.1 INTRODUCTION AND SCOPE

This review will cover recent literature concerning the synthesis of 2,2';6',2'' terpyridine (tpy) and its substituted derivatives. Substituents will also include fused aromatic or aliphatic rings. Also included will be higher homologs of tpy in which additional pyridine rings are attached to one another at their *ortho*-positions. The review will not include tpy analogs which involve other heterocyclic rings as part of the chelating unit, or systems in which the pyridine subunits are not interconnected through their 2,6-positions. As a measure of the increasing importance of this interesting family of ligands, the previous edition of this series devoted only one brief paragraph to tpy ligands.<sup>1</sup>

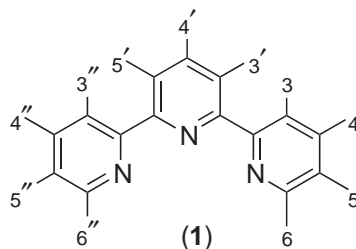
The tpy derivatives will be discussed in order of their increasing degree of substitution on the parent tpy nucleus, and the numbering scheme for such substituents is illustrated in structure (1).

Several basic synthetic approaches will be considered. Coupling reactions have been used to connect preformed pyridines, often with the desired substituents already in place. The tremendous recent emphasis on such bi-aryl coupling methodology, especially mediated by palladium-based reagents, has made this one of the most popular synthetic approaches. Other, more classical methods are based on reactions in which one or more of the pyridine rings are built up by condensations such as the Kröhnke, Chichibabin, or Friedländer condensations. Finally, groups on the tpy ring may be interchanged, leading to substituted derivatives.

An extensive and well-organized overview of the synthesis of tpy ligands by Thompson appeared in 1997.<sup>2</sup> It reviewed the synthetic methodologies, as well as various substitution

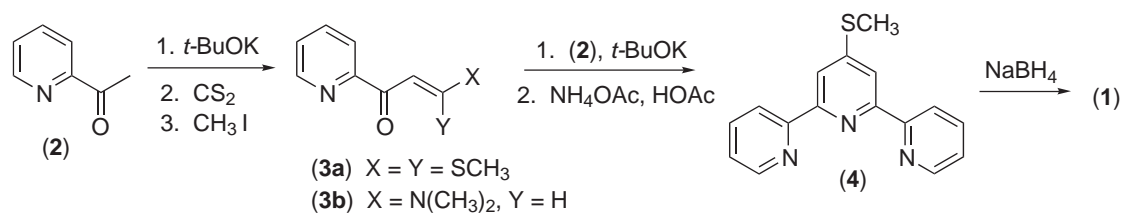


patterns, and the reader is strongly encouraged to consult this review, especially for references to the earlier literature. Another review on chiral derivatives of tpy discusses the synthesis of the ligands, as well as their application to asymmetric catalysis.<sup>3</sup>



### 1.3.2 PARENT SYSTEM AND N-OXIDES

Potts and co-workers have developed a three-step preparation of tpy which involves first the synthesis of the bisthiomethylpropenone intermediate (**3a**) from 2-acetylpyridine (**2**) (Scheme 1). This enone is then cyclized to the 4'-thiomethyltpy (**4**), which is finally reduced to the parent compound.<sup>4</sup> An improved two-step method has been reported, which proceeds through the analogous enamine intermediate (**3b**) and produces the desired tpy in 47% overall yield.<sup>5</sup>



Scheme 1

Alternatively, the enamine (**3b**) may be treated with the morpholine enamine of 2-acetylpyridine. The resulting Michael addition product would be a dipyridyl 1,5-diketone, which is not isolated but rather cyclized directly with ammonium acetate to provide tpy in 82% yield.<sup>6</sup>

Stille coupling has been used to prepare tpy using two complementary routes which work with equal efficiency. Either 2-trimethylstannylpyridine may be coupled with 2,6-dibromopyridine, or 2,6-di-(trimethylstannyl)pyridine may be coupled with 2-bromopyridine, to afford tpy in yields of 74% and 72%, respectively.<sup>7</sup> If an efficient method could be developed for the direct oxidative coupling of pyridine to form tpy, this ligand might become more available and its subsequent coordination chemistry would benefit commensurably.

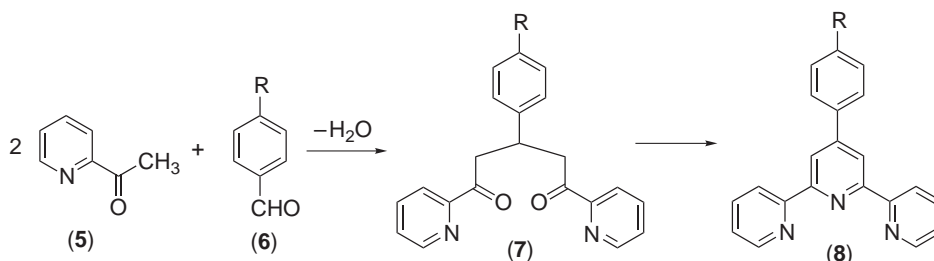
A perdeutero-analog of tpy has been prepared by the Pd<sup>0</sup>-promoted exchange of tpy with D<sub>2</sub>O at 200 °C. The reaction is simple, but requires about one week. Three subsequent enrichments raise the level of deuterium incorporation to about 98%. The use of tpy-*d*<sub>11</sub> as an auxiliary ligand in the preparation of heteroleptic complexes greatly simplifies their NMR analysis.<sup>8</sup> The mono-, di-, and tri-*N*-oxide of tpy have been prepared by the controlled oxidation of tpy.<sup>9</sup> These *N*-oxides should serve as interesting ligands, but relatively few reports of their complexation have appeared.<sup>10</sup>

### 1.3.3 MONOSUBSTITUTED TERPYRIDINES

#### 1.3.3.1 4'-Substituted

Substitution at the 4'-position of tpy is unique in that it provides a ligand which still retains the C<sub>2</sub> symmetry of the parent molecule. No such monosubstituted analog exists for 2,2'-bipyridine (bpy), and thus these 4'-substituted derivatives of tpy have been particularly useful in the construction of well-organized assemblies.

Several complementary reactions, such as the Hantzsch, the Kröhnke, and the Chichibabin, lead to tpy in which the central pyridine ring is built up in a condensation process.<sup>2</sup> These reactions lend themselves well to the formation of 4'-substituted derivatives. The basic ingredient is acetylpyridine, which provides the two distal rings of tpy, as well as C2', C3', C5', and C6' of the central ring. C4' originates from an aldehyde which is generally aromatic. In the example in Scheme 2, an intermediate 1,5-diketone condenses with a nitrogen source, often ammonium acetate, to provide the final tpy. Table 1 summarizes some tpy derivatives which have been prepared by similar condensation approaches.



Scheme 2

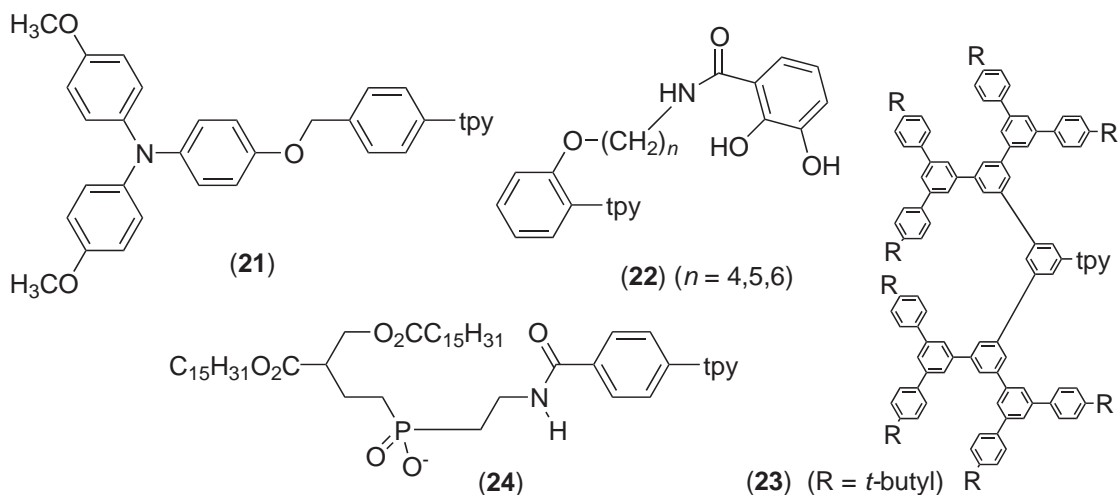
Convenient access to substituted 4'-phenyl tpy derivatives allows for the synthesis of more complex derivatives by elaboration of the substituent. Starting from (9f), the 4-(*N,N*-di-*p*-anisylaminoxy) group may be tethered to tpy to afford (21), whose role in the sensitization of mesoporous oxide films has been examined.<sup>20</sup> Starting from (20), the hydroxy group may be elaborated in four steps to provide ligand (22) with varying lengths of the polymethylene linker.<sup>22</sup> Complexation with Co<sup>III</sup> involves both the tpy and the pendent catechol moieties. The dendrimeric ligand (23) may be prepared from (18), and the rigid branches of the ligand in the 2:1 Ru<sup>II</sup> complex are found to affect the electrochemical properties of the redox-active core.<sup>21</sup> The tpy-functionalized phospholipid (24) has been prepared and incorporated into lecithin vesicles to allow the study of Fe<sup>II</sup>-directed aggregation processes.<sup>23</sup>

A variety of 4'-substituted tpy's have been prepared, either by condensation to form the central ring or by Stille coupling of the pyridine components. The former approach, starting with ethyl 2-pyridinecarboxylate and acetone, leads to (25a) in three steps with an overall yield of 40%.<sup>25</sup> This chloro-derivative can, in turn, be converted to a variety of other 4'-substituted tpy's, such as (26a–g).<sup>26</sup> The nucleosides 2'-deoxyadenosine and 2''-*o*-methyladenosine were similarly coupled with (25a) to afford the tpy's (27), whose Cu<sup>II</sup> complexes effected efficient site-specific cleavage of RNA.<sup>27</sup>

The Stille coupling of 2-tri-*n*-butylstannane with 2,6-dibromo-4-nitropyridine gives (25b), which may be reduced to the amino derivative (25c). Reaction of this species with a 2,4,6-triphe-

Table 1 4'-Aryl-substituted tpy derivatives.

	Ref			
	(9a) R = CH <sub>3</sub> (9b) OCH <sub>3</sub> (9c) OH (9d) Cl (9e) Br (9f) CH <sub>2</sub> Br (9g) NO <sub>2</sub> (9h) NH <sub>2</sub>	11, 12, 13, 16 13, 19 13, 16, 19 13 13, 14 13, 20 24 24	(10) <sup>15,16</sup>	(11) <sup>19</sup>
			(13) <sup>17</sup>	(14) <sup>18</sup>
(15) <sup>18</sup>			(16) <sup>19</sup>	(17) <sup>19</sup>
			(18) <sup>21</sup>	(19) <sup>22</sup>
				(20) <sup>22</sup>



nylpyrylium salt gives the triphenylpyridinium derivative (**28a**).<sup>24</sup> The condensation of *p*-nitrobenzaldehyde with 2-acetylpyridine gives 4'-*p*-anilino-*tpy* (**9h**), which undergoes a similar reaction to give the phenyl-bridged analog (**28b**).<sup>24</sup> Both species have found utility as building blocks for photosensitized supramolecular architectures.

The phosphonated derivative (**25g**) was prepared in 72% yield from the bromo-derivative (**25b**), using diethylphosphite in the presence of tetrakis(triphenylphosphine)palladium(0) and triethylamine.<sup>28</sup> The 4'-thiomethyl derivative (**4**) reacts with the Grignard reagent derived from the *t*-butyl ether of 3-bromopropanol in the presence of  $\text{Ni}^{\text{II}}\text{Cl}_2(\text{dppp})$  ( $\text{dppp} = 1,3\text{-bis}(\text{diphenylphosphino})\text{propane}$ ) to provide (**29a**) in 41% yield.<sup>29</sup> The 4'-thiomethyl derivative (**4**) may also be converted in three steps to the 4-triflate derivative (**25f**) which can, in turn, be treated with vinyl tri-*n*-butylstannane to give the 4'-vinyl derivative (**25h**).<sup>30</sup> The homo- and copolymerization of this species and its transition-metal complexes finds use in the production of chemically modified electrodes. An appropriately protected dialkoxy dialkynyl benzene species may be coupled with (**25f**) and then deprotected to afford (**30**), as well as higher homologs with alkylnylbenzene repeating units.<sup>31,32</sup> The 4'-methyl derivative (**25i**) can be prepared in 14% yield by an unusual [3 + 3] annulation of a 2-azaallyl anion.<sup>33</sup>

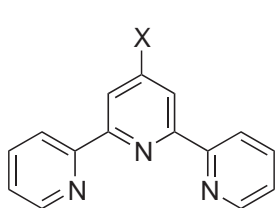
Several interesting derivatives of *tpy* have been prepared in which a ferrocene is linked to the 4'-position. The condensation of ferrocene carbaldehyde with 2-acetylpyridine leads to the parent system (**31a**).<sup>34</sup> Alternatively, 1,5-bis(2-pyridyl)-3-(ferrocenyl)pentane-1,5-dione may be easily prepared in 77% yield, and subsequent treatment with ammonium acetate provides a 78% yield of (**31a**).<sup>35</sup> If ferrocene 1,1'-dicarbaldehyde is used in the first procedure, the bisterpyridyl ferrocene can be synthesized.<sup>36</sup> Addition of the anion derived from (**25i**) to ferrocene carbaldehyde affords the alcohol (**31b**), which can be dehydrated to the ethylene derivative (**31c**).<sup>37</sup> Coupling of alkylnyl ferrocene with the bromo-derivative (**25e**) leads to a *tpy* linked to ferrocene by a phenylacetylene bridge (**31d**).<sup>38</sup>

### 1.3.3.2 4-Substituted

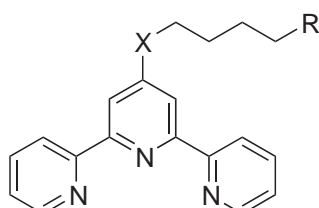
A clever approach to 4-substituted *tpy* involves the cycloaddition of tri-*n*-butyl(ethynyl)tin to the *bpy* 1,2,4-triazine derivative (**32**), followed by thermal loss of dinitrogen (Scheme 3). The triazine is prepared in a straightforward fashion from the analogous 2-cyanobpy.<sup>39</sup> The corresponding 4'- $\text{SnBu}_3$ *tpy* may be prepared in a similar manner.

### 1.3.3.3 6-Substituted

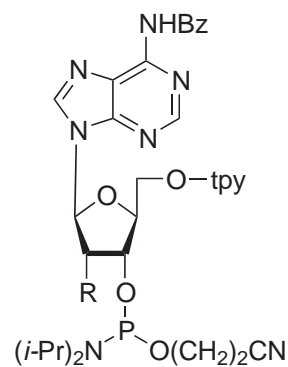
Substitutions at the 6- and 6'-positions of *tpy* are of considerable importance, since these positions are closest to the tridentate coordination site and thus can interact strongly with a bound metal. The 6-*tpy* substituted amidrazone (**35**) reacts with 1,10-phenanthroline-5,6-dione



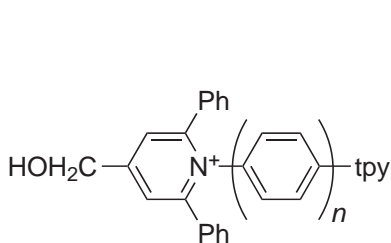
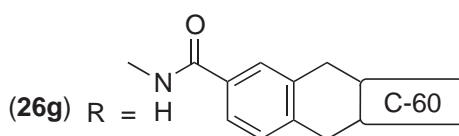
- (25a) X = Cl  
 (25b) X = Br  
 (25c) X = NO<sub>2</sub>  
 (25d) X = NH<sub>2</sub>  
 (25e) X = OH  
 (25f) X = OTf  
 (25g) X = PO<sub>3</sub>Et<sub>2</sub>  
 (25h) X = CH=CH<sub>2</sub>  
 (25i) X = CH<sub>3</sub>



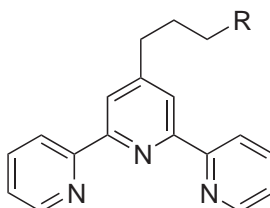
- (26a) X = O, R = CH<sub>2</sub>COOH  
 (26b) X = O, R = CH<sub>2</sub>NH<sub>2</sub>  
 (26c) X = O, R = CH<sub>2</sub>OH  
 (26d) X = O, R = O-*t*-butyl  
 (26e) X = O, R = OH  
 (26f) X = S, R = CH<sub>2</sub>SH



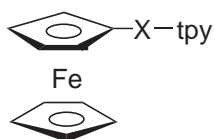
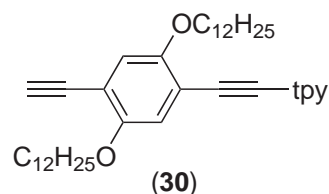
- (27a) R = H  
 (27b) R = OCH<sub>3</sub>



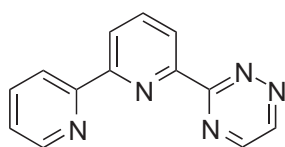
- (28a) n = 0  
 (28b) n = 1



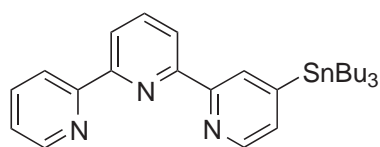
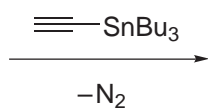
- (29a) R = O-*t*-butyl  
 (29b) R = OH  
 (29c) R = SAc  
 (29d) R = S-S-(2-pyridyl)



- (31a) X = bond  
 (31b) X = CH<sub>2</sub>CH(OH)  
 (31c) X = CH=CH  
 (31d) X = 4'-alkynylphenyl



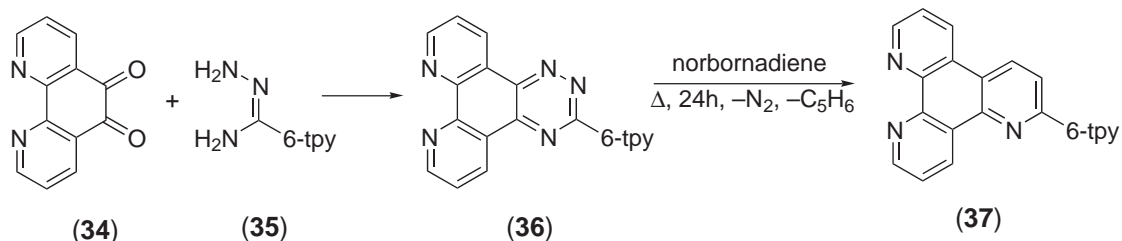
(32)



(33)

Scheme 3

(34) to provide the 1,2,4,8,9-pentaazatriphenylene (36), which then cycloadds to norbornadiene followed by [4 + 2] cycloreversion, extruding nitrogen and cyclopentadiene to give the interesting quaterpyridyl derivative (37) (Scheme 4).<sup>40</sup>



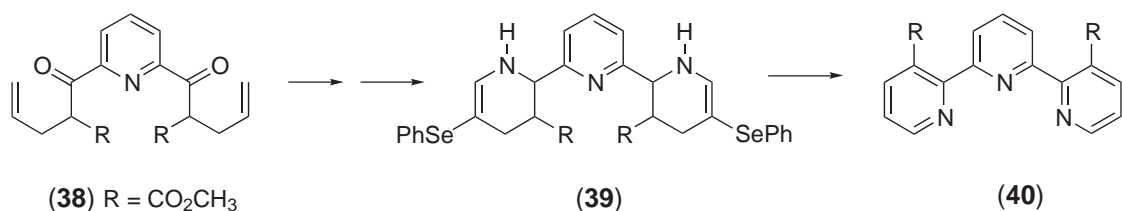
Scheme 4

Treatment of mono-lithiated 1-((dimethylamino)methyl)ferrocene with tpy resulted in the formation of 6-ferrocenyltpy in unspecified yield.<sup>41</sup>

### 1.3.4 DISUBSTITUTED TERPYRIDINES

#### 1.3.4.1 3,3''-Disubstituted

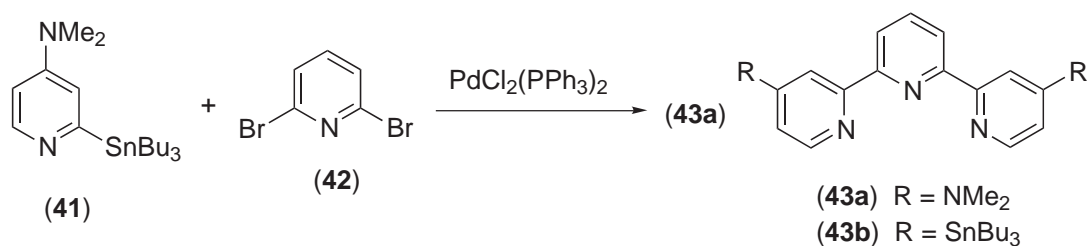
The azidophenylselenation reaction of (38) provides a species which can be subsequently cyclized to give the tetrahydropyridine derivative (39) as a mixture of stereoisomers (Scheme 5). After purification, this species undergoes oxidation to the dicarbomethoxytpy (40) in 60% yield.<sup>42</sup>



Scheme 5

#### 1.3.4.2 4,4'-Disubstituted

Treatment of 4-dimethylaminopyridine with BuLi-Me<sub>2</sub>NCH<sub>2</sub>CH<sub>2</sub>-OLi affords  $\alpha$ -lithiation in good yield. Various electrophiles can then be introduced, including tri-*n*-butylstannane to provide (41). Stille coupling with (42) affords the disubstituted tpy (43) in 50% yield (Scheme 6).<sup>43</sup>

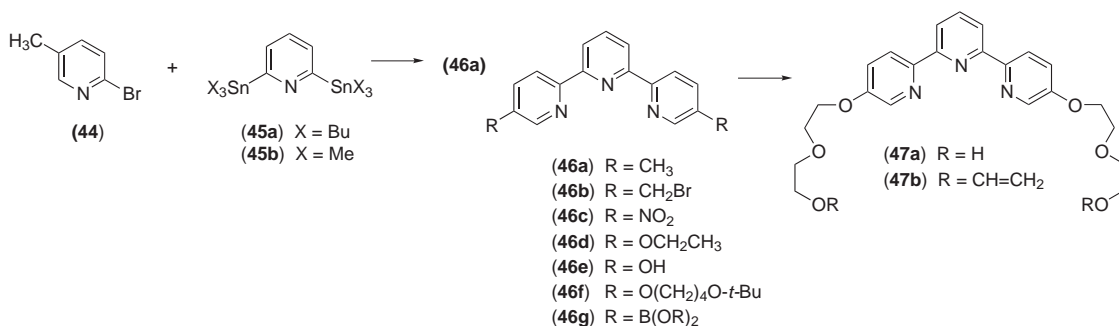


Scheme 6

Analogous to the preparation of (33), the cycloaddition of two equivalents of tri-*n*-butyl (ethynyl)tin to 2,6-bistriazinylpyridine affords the 4,4''-di-(tri-*n*-butyl)stannane (43b) after dinitrogen extrusion.<sup>39</sup>

### 1.3.4.3 5,5'-Disubstituted

Double Stille couplings which employ 2,6-di-(tri-*n*-butylstannyl)pyridine (**45**) and two equivalents of a 5-substituted-2-bromopyridine lead efficiently to 5,5'-disubstituted tpy's. Thus 5-methyl-2-bromopyridine (**44**) reacts with (**45**) to provide (**46a**) (Scheme 7).<sup>44</sup>

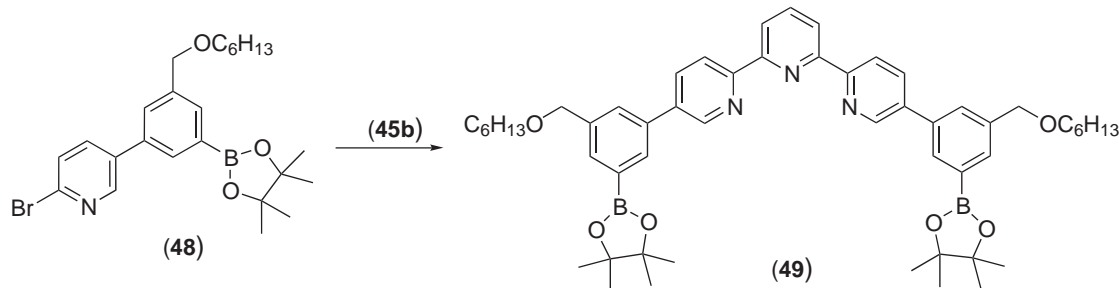


Scheme 7

The reaction also works well when the bromo- and stannyl groups are reversed.<sup>45,46</sup> Treatment of (**46a**) with NBS provides the bisbromomethyl derivative (**46b**) in 24% yield.<sup>45</sup> In a similar fashion, the 5,5'-bis(hydroxytetramethyleneoxymethyl) tpy (**46f**) has also been prepared.<sup>47</sup>

Starting with the dinitro derivative (**46c**), Sauvage and co-workers have prepared the diol (**46e**), which then afforded the vinyl ether (**47b**). This species did not metathesize to the expected simple macrocycle, but instead dimerized to give a larger bisterpyridyl macrocycle.<sup>48</sup>

Suzuki coupling has been used in tandem with Stille coupling. The boronic ester analog of (**44**) has been coupled to provide (**46g**).<sup>49</sup> Similarly, the boronic ester (**48**) was coupled with (**45b**) to afford (**49**), which then was coupled with an analogous diiodo-derivative to give a shape-persistent bis-tpy macrocycle (Scheme 8).<sup>50</sup>

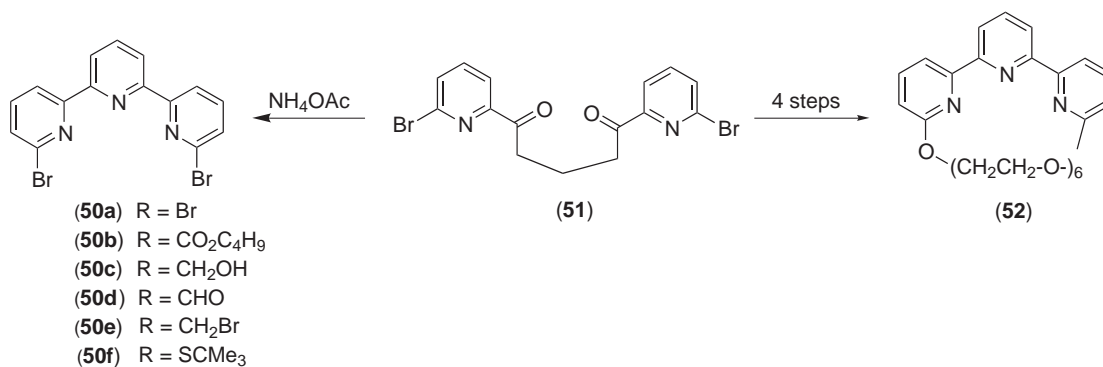


Scheme 8

### 1.3.4.4 6,6'-Disubstituted

A simple method for the introduction of phenyl groups at the *ortho*-positions of tpy involves treatment with phenyllithium at 25 °C to give a bis-adduct, which can then be hydrolyzed and rearomatized with manganese dioxide to provide a 21% yield of 6,6'-diphenyltpy.<sup>51</sup> A 53% yield of 6,6'-dibromotpy can be obtained by lithiation of 4 molar amounts of (**42**) with *n*-BuLi, followed by treatment with PCl<sub>3</sub> in diethyl ether.<sup>52</sup> An alternative approach, giving this dibromotpy in 27% yield, involves a Kröhnke synthesis.<sup>53</sup> Alternatively, the diketo-intermediate (**51**) will provide a 64% yield of the same molecule. If (**51**) is first protected as its bisketal, macrocyclization with disodium hexaethylene glycolate, followed by deprotection and central pyridine formation, affords the intriguing crown ether (**52**) (Scheme 9).<sup>53</sup> The dibromotpy (**50a**) can be converted through its diester (**50b**) and diol (**50c**) to the corresponding dialdehyde (**50d**).<sup>54</sup>

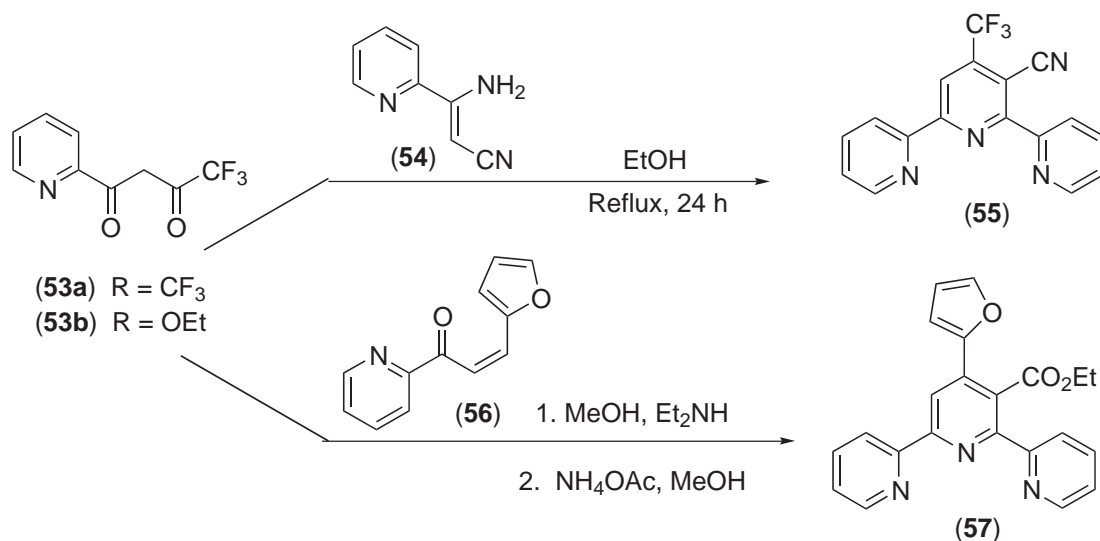
The bisbromomethyl derivative (**50e**) has also been used as a precursor in a macrocyclization, however the authors do not specify the source of this material.<sup>55</sup> A minute amount of (**50f**) was obtained from the Ni<sup>0</sup>-promoted coupling of 2-bromo-6-*t*-butylpyridine.<sup>56</sup>



Scheme 9

### 1.3.4.5 3',4'-Disubstituted

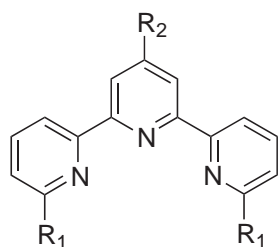
An interesting condensation has been reported in which a 2-pyridyl-1,3-butanedione (**53a**) reacts with  $\beta$ -aminoacrylonitrile (**54**) to provide 3-cyano-4-(trifluoromethyl)tpy (**55**) in 30% yield (Scheme 10).<sup>57</sup> The reaction has been used employing a wide variety of partners besides those involving 2-pyridyl. The Hantzsch approach has been used in the reaction of keto-ester (**53b**) with enone (**56**) to provide (**57**), where the 2-furfuryl group may be oxidized under mild conditions to provide the 3',4'-tpy dicarboxylic acid.<sup>58</sup>



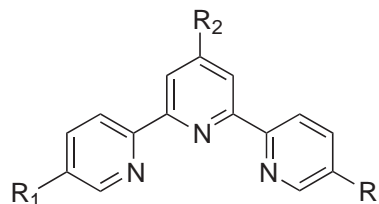
Scheme 10

### 1.3.5 TRISUBSTITUTED TERPYRIDINES

Stille coupling of the 4'-carbomethoxy derivative of (**42**) with 2-tributylstannyl-6-methylpyridine provides the 6,4',6''-trisubstituted derivative (**58a**) which may be converted with NBS to the bromomethyl species (**58b**).<sup>59</sup> The dibromo-*p*-tolyl tpy (**58c**) has been prepared and converted into its di-butylester (**58d**).<sup>54</sup> The reaction of lithium diphenylphosphide with 4'-phenyltpy provides an 84% yield of the bisdiphenylphosphino species (**58e**).<sup>60</sup> An analogous tpy with two *N*-methylhydrazinyl substituents (**58f**) has also been reported.<sup>61</sup> Treatment of 4'-nitro-5,5''-dimethyltpy (**59a**) with sodium azide in DMF provides the analogous 4'-azido derivative (**59b**).<sup>62</sup> Similar monomethyl, disubstituted tpy's have also been prepared.



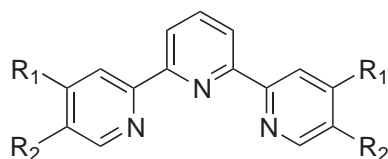
- (58a) R<sub>1</sub> = CH<sub>3</sub>, R<sub>2</sub> = CO<sub>2</sub>Et  
 (58b) R<sub>1</sub> = CH<sub>2</sub>Br, R<sub>2</sub> = CO<sub>2</sub>Et  
 (58c) R<sub>1</sub> = Br, R<sub>2</sub> = *p*-tolyl  
 (58d) R<sub>1</sub> = CO<sub>2</sub>C<sub>4</sub>H<sub>9</sub>, R<sub>2</sub> = *p*-tolyl  
 (58e) R<sub>1</sub> = PPh<sub>2</sub>, R<sub>2</sub> = Ph  
 (58f) R<sub>1</sub> = N(Me)NH<sub>2</sub>, R<sub>2</sub> = Ph



- (59a) R<sub>1</sub> = CH<sub>3</sub>, R<sub>2</sub> = NO<sub>2</sub>  
 (59b) R<sub>1</sub> = CH<sub>3</sub>, R<sub>2</sub> = N<sub>3</sub>

### 1.3.6 TETRASUBSTITUTED TERPYRIDINES

The Kröhnke synthesis applied to 2,6-diacetylpyridine affords a variety of 4,4',5,5''-tetrasubstituted tpy's which can then be transformed in good yields to (60a–f).<sup>63</sup>

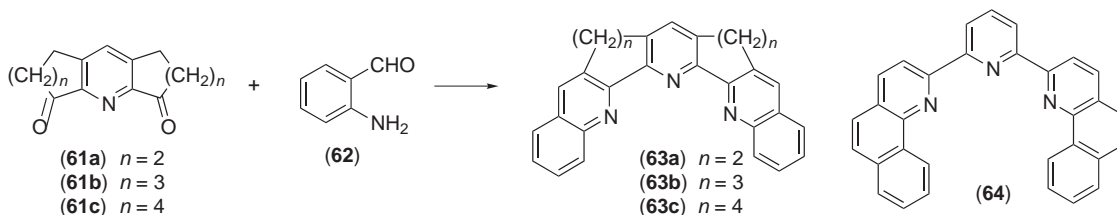


- (60a) R<sub>1</sub> = CH<sub>3</sub>, R<sub>2</sub> = CH<sub>3</sub>  
 (60b) R<sub>1</sub> = C<sub>6</sub>H<sub>5</sub>, R<sub>2</sub> = CH<sub>3</sub>  
 (60c) R<sub>1</sub> = CHO, R<sub>2</sub> = CH<sub>3</sub>  
 (60d) R<sub>1</sub> = CH=CHN(CH<sub>3</sub>)<sub>2</sub>, R<sub>2</sub> = CH<sub>3</sub>  
 (60e) R<sub>1</sub> = CH<sub>2</sub>OH, R<sub>2</sub> = CH<sub>3</sub>  
 (60f) R<sub>1</sub> = CO<sub>2</sub>CH<sub>3</sub>, R<sub>2</sub> = CH<sub>3</sub>

### 1.3.7 FUSED (ANNELATED) TERPYRIDINES

#### 1.3.7.1 Benzo-fused

The Friedländer condensation of 2-aminobenzaldehyde (**62**) with 2,6-diacetylpyridines provides diquinolinylpyridines, which are dibenzo-fused analogues of tpy. The diketones (**61a–c**) are derived from dicycloalkenopyridines in two steps and condensed with (**62**) to afford (**63a–c**) (Scheme 11).<sup>64</sup> If 1-amino-2-naphthalenecarbaldehyde is substituted for (**62**), the dinaphtho-fused system (**64**) results.<sup>65</sup> A bisdimethylene-bridged analogue of (**64**) has been prepared from (**61a**). If one uses 2-aminobenzophenone in place of (**62**), the 2-(4-phenylquinolinyl) derivatives may be prepared, and a series of 2-aminobenzophenones bearing methyl, nitro, cyano, and bromo substituents have provided a series of substituted derivatives.<sup>66</sup>



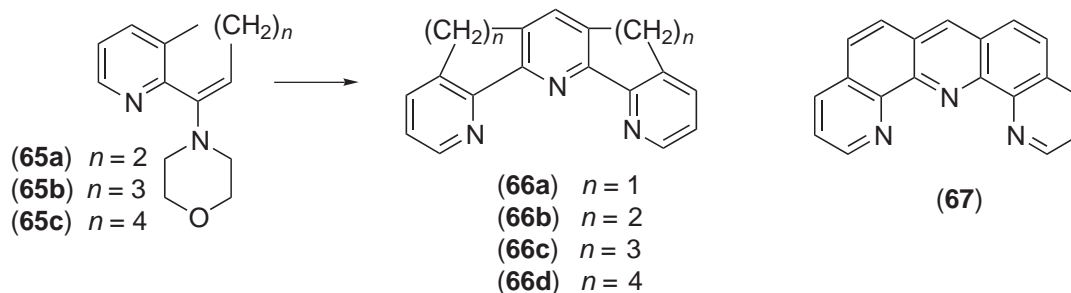
Scheme 11

#### 1.3.7.2 Other Fused

The condensation of  $\beta$ -aminoacrolein with (**61a,c**) leads to the corresponding polymethylene-bridged tpy's (**66b,d**) in low yields. The same systems may be prepared more effectively by the condensation of enamines (**65a–c**) with formaldehyde and subsequent azacyclization of the intermediate 1,5-diketone (Scheme 12).<sup>64</sup> A Hantzsch approach to (**66b**) has also been reported.<sup>67</sup> Benzaldehyde, 4-substituted benzaldehydes, and various other aryl aldehydes can be treated with (**65a**) to afford 4'-aryl derivatives of (**66b**) in moderate yields.<sup>69</sup> A 48% yield of the monomethylene-bridged (**66a**) has been

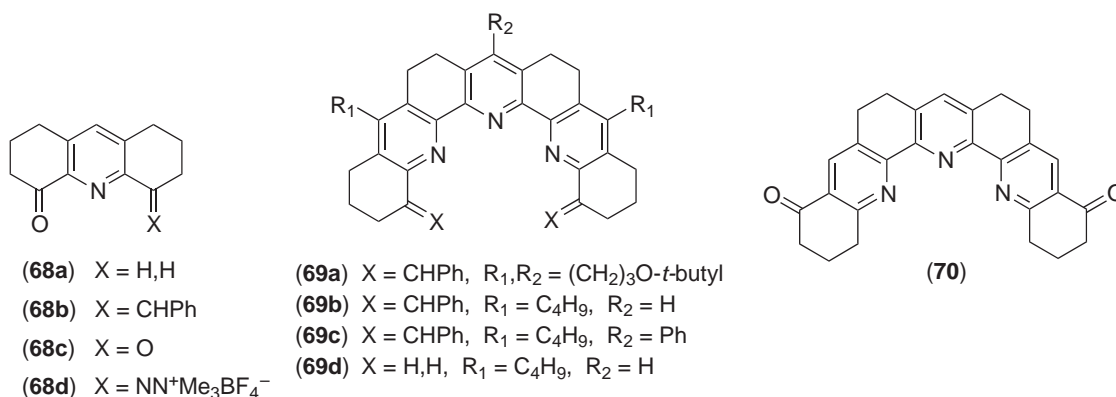


obtained in one step from 1-azaindanone.<sup>70</sup> The molecule (**67**), a completely unsaturated analog of (**66b**), has been prepared and represents a hybrid between tpy and 1,10-phenanthroline.<sup>71</sup>



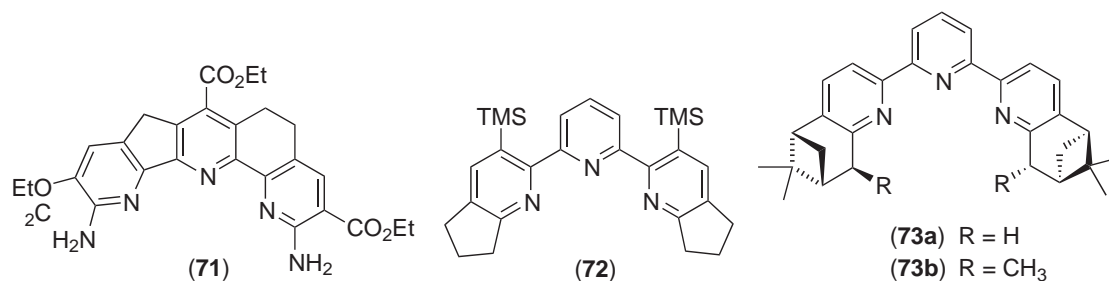
Scheme 12

Octahydroacridone (**68a**) and its benzylidene and keto- analogs have been used as precursors in assembling hexagonal lattice-type derivatives of tpy. Various substituents,  $R_1$  and  $R_2$ , have been introduced to improve the solubility of the relatively planar molecules. Balavoine and co-workers have constructed (**69a**) from ether-substituted derivatives of (**68a**) and (**68b**).<sup>72</sup> Bell and his group have constructed (**69b,c**) in a similar fashion.<sup>73,74</sup> These same workers have employed an interesting reaction discovered by Newkome<sup>75</sup> wherein pyrolysis at 210 °C of the 4- $n$ -butyl derivative of (**68d**) directly provides (**69d**) in 23% yield from the precursor ketone.<sup>76</sup> The diketone (**70**) has been prepared by a Mannich procedure starting from diketone (**68c**).<sup>77</sup>



An enamine approach has been used by Anslyn to prepare the unsymmetrically bridged tpy (**71**) as a potential phosphodiester complexing agent.<sup>78</sup>

Tpys exist where the annelating ring is not bridging. The most important of these have rings fused at the 5,6- (and 5'',6''-) positions which would be most proximate to the coordination site.

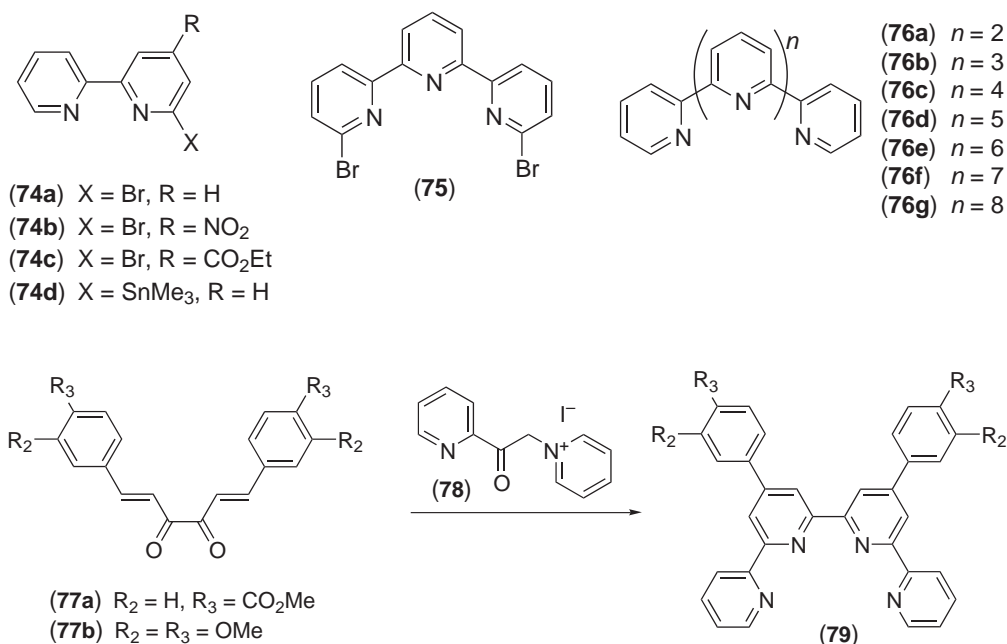


A [2 + 2 + 2] cobalt(I) cycloaddition between 2,6-di-(trimethylsilylethynyl)-pyridine and 5-hexynenitrile builds up the two distal pyridines to provide (**72**).<sup>79</sup> The chiral tpy (**73a**) was built up using Kröhnke methodology and then stereospecifically alkylated with lithium diisopropylamide and different alkyl iodides to provide derivatives such as (**73b**).<sup>80</sup>

### 1.3.8 OLIGOPYRIDINES

The same coupling and condensation methodologies which have been used to construct tpy's have been employed in the synthesis of higher oligomers. Using Stille conditions and appropriate combinations of 2,6-dibromopyridine (**42**), (**74a**), (**74d**), and (**75**), Sauvage and Cárdenas have prepared (**76a**) (46%), (**76b**) (67%), and (**76d**) (82%), as well as the 5,5'''-dimethyl derivative of (**76b**) (68%).<sup>81</sup> The Ni<sup>0</sup> coupling of 6-bromotpy, prepared under Kröhnke conditions, affords a quantitative yield of sexipyridine (**76c**) after demetallation with cyanide.<sup>82</sup> Coupling of (**74b**) with (**74d**) provides 4'-nitro-quaterpyridine which has been converted to the azide.<sup>83</sup> The Ni<sup>0</sup> coupling of (**74c**) affords a 58% yield of 4',4''-dicarboethoxy-quaterpyridine.<sup>84</sup>

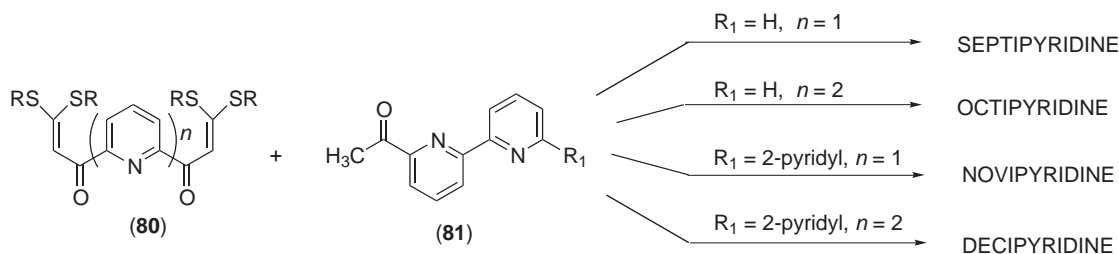
Double Kröhnke reactions have been employed in the preparation of quaterpyridines and sexipyridines. Thus, the chalcone dimer (**77a,b**) reacts with the pyridinium salt (**78**) to provide (**79a,b**) (Scheme 13).<sup>84</sup> An alternative approach involves a bischalcone species based on bpy that can be elaborated to (**76c**), as well as several 4',4''-disubstituted derivatives.<sup>85</sup> A dimeric analogue of (**78**), having a central bpy moiety, undergoes condensation with a Kröhnke-type salt to provide the parent sexipyridine (**76c**).<sup>86</sup>



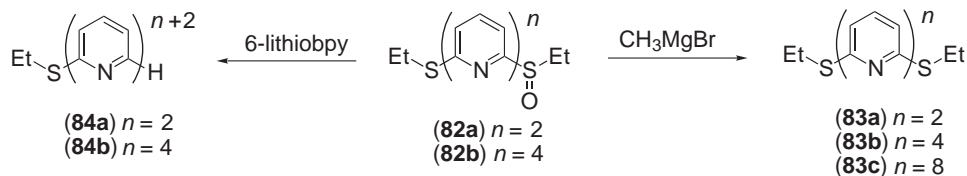
Scheme 13

Synthetic sequences for the preparation of higher oligopyridines (**76d–g**) have been developed by Potts and co-workers.<sup>87</sup> These sequences utilize  $\alpha$ -oxoketene dithioacetals (**80**) reacting with 6-acetyltpy or tpy (**81**), analogous to the preparation of (**4**) from (**3a**) (Scheme 14).

The bis(ethylthio) species (**83a,b**) may be mono-oxidized with MMPP or *m*-CPBA to afford the thiones (**82a,b**). If these species are treated with methylmagnesium bromide, a ring-coupling reaction occurs to provide (**83b,c**) in yields of 56 and 3%, respectively (Scheme 15). Alternatively (**82a,b**) may be treated with 6-lithio-2,2'-bipyridine to provide the oligomers (**84a,b**).<sup>88</sup> A similar reaction has been used to prepare a chiral quaterpyridine derivative employing the mono-sulfone of (**84a**).<sup>89</sup>



Scheme 14



Scheme 15

The cycloaddition–retrocycloaddition chemistry used to prepare (37) can be employed to prepare (76a–c) in quite respectable yields of 79%, 60%, and 78%, respectively.<sup>90</sup>

### 1.3.9 REFERENCES

1. Wilkinson, G. (Ed.) *Comprehensive Coordination Chemistry*; Pergamon: Oxford, UK, 1987, Vol. 2, p 91.
2. Thompson, A. M. W. C. *Coord. Chem. Rev.* **1997**, *160*, 1–52.
3. Chelucci, G.; Thumel, R. P. *Chem. Rev.* **2002**, *102*, 3129–3170.
4. Potts, K. T.; Ralli, P.; Theodoridis, G.; Winslow, P. *Org. Synth.* **1986**, *64*, 189–195.
5. Jameson, D. L.; Guise, L. E. *Tetrahedron Lett.* **1991**, *32*, 1999–2002.
6. Park, J. G.; Jahng, Y. *Bull. Korean Chem. Soc.* **1998**, *19*, 436–439.
7. Yamamoto, Y.; Tanaka, T.; Yagi, M.; Inamoto, M. *Heterocycles* **1996**, *42*, 189–194.
8. Chirayil, S.; Hegde, V.; Jahng, Y.; Thummel, R. P. *Inorg. Chem.* **1991**, *30*, 2821–2823.
9. Thummel, R.; Jahng, Y. *J. Org. Chem.* **1985**, *50*, 3635–3638.
10. Ito, K.; Nagata, T.; Tanaka, K. *Inorg. Chem.* **2001**, *40*, 6331–6333.
11. Collin, J.-P.; Guillerez, S.; Sauvage, J.-P. Barigelletti, F.; Cola, L. D.; Flamigni, L.; Balzani, V. *Inorg. Chem.* **1991**, *30*, 4230–4238.
12. Chamchoumis, C.; Potvin, P. G. *J. Chem. Res., Synop.* **1998**, *4*, 180–181, 870–875.
13. Spahni, W.; Calzaferri, G. *Helv. Chim. Acta* **1984**, *67*, 450–454.
14. Korall, P.; Böerje, A.; Norrby, P.-O.; Åkermark, B. *Acta Chem. Scand.* **1997**, *51*, 760–766.
15. Sun, S.-S.; Lees, A. J. *Inorg. Chem.* **2001**, 3154–3160.
16. Licini, M.; Williams, J. A. G. *Chem. Commun.* **1999**, 1943–1944.
17. Whittle, B.; Everest, N. S.; Howard, C.; Ward, M. D. *Inorg. Chem.* **1995**, *34*, 2095–2032.
18. Grosche, P.; Hölzel, A.; Walk, T. B.; Trautwein, A. W.; Jung, G. *Synthesis* **1999**, *11*, 1961–1970.
19. Kalyanam, N.; Likhate, M. A.; Manjunatha, S. G. *Indian J. Chem., Sect. B.* **1992**, *31B*, 555–556.
20. Bonhôte, P.; Moser, J.-E.; Humphry-Baker, R.; Vlachopoulos, N.; Zakeeruddin, S. M.; Walder, L.; Grätzel, M. *J. Am. Chem. Soc.* **1999**, *121*, 1324–1336.
21. Kimura, M.; Shiba, T.; Muto, T.; Hanabusa, K.; Shirai, H. *Chem. Commun.* **2000**, 11–12.
22. Nagata, T.; Tanaka, K. *Inorg. Chem.* **2000**, *39*, 3915–3521.
23. Constable, E. C.; Meier, W.; Nardin, C.; Mundwiler, S. *Chem. Commun.* **1999**, 1483–1484.
24. Lainé, P.; Bedioui, F.; Ochsenbein, P.; Marvaud, V.; Bonin, M.; Amouya, E. *J. Am. Chem. Soc.* **2002**, *124*, 1364–1377.
25. Constable, E. C.; Ward, M. D. *J. Chem. Soc. Dalton Trans.* **1990**, *4*, 1405–1409.
26. Schubert, U. S.; Eschbaumer, C.; Hien, O.; Andres, P. R. *Tetrahedron Lett.* **2001**, *42*, 4705–4707.
27. Inoue, H.; Furukawa, T.; Shimizu, M.; Tamura, T.; Matsui, M.; Ohtsuka, E. *Chem. Commun. (Cambridge)* **1999**, *1*, 45–46.
28. Zakeeruddin, S. M.; Nazeeruddin, M. K.; Pechy, P.; Rotzinger, F. P.; Humphry-Baker, R.; Kalyanasundaram, K.; Grätzel, M.; Shklover, V.; Haibach, T. *Inorg. Chem.* **1997**, *36*, 5937–5946.
29. Cuenbert, B.; Schepartz, A. *Tetrahedron Lett.* **1991**, *32*, 3325–3328.
30. Potts, K. T.; Konwar, D. *J. Org. Chem.* **1991**, *56*, 4815–4816.
31. Khatyr, A.; Ziessel, R. *J. Org. Chem.* **2000**, *65*, 3126–3134.
32. Khatyr, A.; Ziessel, R. *Tetrahedron Lett.* **1999**, *40*, 5515–5518.
33. Bell, T. W.; Hu, L. Y. *Tetrahedron Lett.* **1988**, *29*, 4819–4822.
34. Constable, E. C.; Edwards, A. J.; Martínez-Mañez, R.; Raithby, P. R.; Thompson, A. M. W. C. *J. Chem. Soc. Dalton Trans.* **1994**, *5*, 645–650.
35. Butler, I. R.; McDonald, S. J.; Hursthouse, M. B.; Malik, K. M. A. *Polyhedron* **1995**, *14*, 529–539.

36. Constable, E. C.; Edwards, A. J.; Marcos, M. D.; Raitby, P. R.; Martínez-Máñez, R.; Tendero, M. J. L. *Inorg. Chim. Acta* **1994**, *224*, 11–14.
37. Padilla-Tosta, M. E.; Martínez-Máñez, R.; Soto, J.; Lloris, J. M. *Tetrahedron* **1998**, *54*, 12039–12046.
38. Siemeling, U.; Vorfeld, U.; Neumann, B.; Stammler, H.-G.; Zanello, P.; Fabrizi De Biani, F. *Eur. J. Inorg. Chem.* **1999**, *1*, 1–5.
39. Sauer, J.; Heldmann, D. K.; Pabst, G. R. *Eur. J. Org. Chem.* **1999**, *1*, 313–321.
40. Pabst, G. R.; Pfüller, O. C.; Sauer, J. *Tetrahedron Lett.* **1998**, *39*, 8825–8828.
41. Butler, I. R. *Organometallics*. **1992**, *11*, 74–83.
42. Tingoli, M.; Tiecco, M.; Testaferri, L.; Andrenacci, R.; Balducci, R. *J. Org. Chem.* **1993**, *58*, 6097–6102.
43. Cuperly, D.; Gros, P.; Fort, Y. *J. Org. Chem.* **2002**, *67*, 238–241.
44. Schubert, U. S.; Eschbaumer, C. *Org. Lett.* **1999**, *1*, 1027–1029.
45. Schubert, U. S.; Eschbaumer, C.; Hochwimmer, G. *Synthesis* **1999**, *5*, 779–782.
46. Fallahpour, R.-A. *Synthesis* **2000**, *8*, 1138–1142.
47. Schubert, U. S.; Eschbaumer, C.; Weidl, C. H. *Synlett* **1999**, *3*, 342–344.
48. Belfrekht, N.; Dietrich-Buchecker, C.; Sauvage, J.-P. *Inorg. Chem.* **2000**, *39*, 5169–5172.
49. Lehmann, U.; Henze, O.; Schlüter, A. D. *Chem. Eur. J.* **1999**, *5*, 854–859.
50. Lehmann, U.; Schlüter, A. D. *Eur. J. Org. Chem.* **2000**, *20*, 3483–3487.
51. Dietrich-Buchecker, C. O.; Marnot, P. A.; Sauvage, J. P. *Tetrahedron Lett.* **1982**, *23*, 5291–5294.
52. Uchida, Y.; Okabe, M.; Kobayashi, H.; Oae, S. *Synthesis* **1995**, *8*, 939–940.
53. Newkome, G. R.; Hager, D. C.; Kiefer, G. E. *J. Org. Chem.* **1986**, *51*, 850–853.
54. El-ghayoury, A.; Ziessel, R. *J. Org. Chem.* **2000**, *65*, 7757–7763.
55. Galaup, C.; Couchet, J. M.; Picard, C.; Tisnès, P. *Tetrahedron Lett.* **2001**, *42*, 6275–6278.
56. Tiecco, M.; Tingoli, M.; Testaferri, L.; Bartoli, D.; Chianelli, D. *Tetrahedron* **1989**, *45*, 2857–2868.
57. Yamaguchi, Y.; Katsuyama, I.; Funabiki, K.; Matsui, M.; Shibata, K. *J. Heterocycl. Chem.* **1998**, *35*, 805–810.
58. Raboin, J.-C.; Kirsch, G.; Beley, M. *J. Heterocyclic Chem.* **2000**, *37*, 1077–1080.
59. Ulrich, G.; Bedel, S.; Picard, C.; Tisnès, P. *Tetrahedron Lett.* **2001**, *42*, 6113–6115.
60. Ziessel, R. *Tetrahedron Lett.* **1989**, *30*, 463–466.
61. Constable, E. C.; Khan, F. K.; Lewis, J.; Liptrot, M. C.; Raithby, P. R. *J. Chem. Soc. Dalton Trans.* **1985**, *2*, 333–335.
62. Fallahpour, R.-A.; Neuburger, M.; Zehnder, M. *Synthesis* **1999**, *6*, 1051–1055.
63. Sasaki, I.; Daran, J. C.; Balavoine, G. G. A. *Synthesis* **1999**, *5*, 815–820.
64. Thummel, R. P.; Jahng, Y. *J. Org. Chem.* **1985**, *50*, 2407–2412.
65. Riesgo, E. C.; Jin, X.; Thummel, R. P. *J. Org. Chem.* **1996**, *61*, 3017–3022.
66. Mamo, A. *J. Heterocyclic Chem.* **2000**, *37*, 1225–1231.
67. Ransohoff, J. E. B.; Staab, H. A. *Tetrahedron Lett.* **1985**, *26*, 6179–6182.
68. Hegde, V.; Jahng, Y.; Thummel, R. P. *Tetrahedron Lett.* **1987**, *28*, 4023–4026.
69. Westerwelle, U.; Risch, N. *Tetrahedron Lett.* **1993**, *34*, 1775–1778.
70. Westerwelle, U.; Esser, A.; Risch, N. *Chem. Ber.* **1991**, *124*, 571–576.
71. Hung, C.-Y.; Wang, T.-L.; Jang, Y.; Kim, W. Y.; Schmehl, R. H.; Thummel, R. P. *Inorg. Chem.* **1996**, *35*, 5953–5956.
72. Bejan, E.; Fontenas, C.; Ait-Haddou, H.; Daran, J.-C.; Balavoine, G. G. A. *Eur. J. Org. Chem.* **1999**, *10*, 2485–2490.
73. Bell, T. W.; Firestone, A. *J. Am. Chem. Soc.* **1986**, *108*, 8109–8111.
74. Bell, T. W.; Heiss, A. M.; Ludwig, R. T.; Xiang, C. *Synlett* **1996**, *1*, 79–81.
75. Newkome, G. R.; Fishel, D. L. *J. Org. Chem.* **1972**, *37*, 1329–1336.
76. Bell, T. W.; Firestone, A. *J. Org. Chem.* **1986**, *51*, 764–765.
77. Sielemann, D.; Keuper, R.; Risch, N. *Eur. J. Org. Chem.* **2000**, *3*, 543–548.
78. Chu, F.; Flatt, L. S.; Anslyn, E. V. *J. Am. Chem. Soc.* **1994**, *116*, 4194–4204.
79. Varela, J. A.; Castedo, L.; Saá, C. *J. Org. Chem.* **1997**, *62*, 4189–4192.
80. Kwong, H.-L.; Wong, W.-L.; Lee, W.-S.; Cheng, L.-S.; Wong, W.-T. *Tetrahedron: Asymmetry* **2001**, *12*, 2683–2694.
81. Cárdenas, D. J.; Sauvage, J. P. *Synlett* **1996**, *9*, 916–918.
82. Constable, E. C.; Chotalia, R. *J. Chem. Soc. Chem. Commun.* **1992**, *1*, 64–66.
83. Fallahpour, R.-A. *Helv. Chim. Acta*. **2000**, *83*, 384–393.
84. Renouard, T.; Fallahpour, R.-A.; Nazeeruddin, M. K.; Humphry-Baker, R.; Gorelsky, S. I.; Lever, A. B. P.; Grätzel, M. *Inorg. Chem.* **2002**, *41*, 367–378.
85. Chotalia, R.; Constable, E. C.; Neuburger, M.; Smith, D. R.; Zehner, M. *J. Chem. Soc. Dalton Trans.* **1996**, *22*, 4207–4216.
86. Constabel, E. C.; Ward, M. D.; Tocher, D. A. *J. Am. Chem. Soc.* **1990**, *112*, 1256–1258.
87. Potts, K. T.; Raiford, K. A. G.; Keshavarz-K, M. *J. Am. Chem. Soc.* **1993**, *115*, 2793–2807.
88. Uenishi, J.; Ueno, T.; Hata, S.; Nishiwaki, K.; Tanaka, T.; Wakabayashi, S.; Yonemitsu, O.; Oae, S. *Heterocycles* **1999**, *50*, 341–351.
89. Uenishi, J.; Nishiwaki, K.; Hata, S.; Nakamura, K. *Tetrahedron Lett.* **1994**, *35*, 7973–7976.
90. Pabst, G. R.; Sauer, J. *Tetrahedron Lett.* **1998**, *39*, 6687–6690.

# 1.4

## Pyridopyridine Ligands

M. A. CIRIANO and L. A. ORO

*Universidad de Zaragoza-C.S.I.C., Spain*

---

1.4.1	INTRODUCTION	55
1.4.2	COMPLEXES WITH THE 1,8-NAPHTHYRIDINE LIGAND	55
1.4.3	COMPLEXES WITH FUNCTIONALIZED DERIVATIVES OF THE 1,8-NAPHTHYRIDINE RING	56
1.4.4	OTHER MULTIDENTATE LIGANDS DERIVED FROM THE 1,8-NAPHTHYRIDINE RING	59
1.4.5	REFERENCES	60

---

### 1.4.1 INTRODUCTION

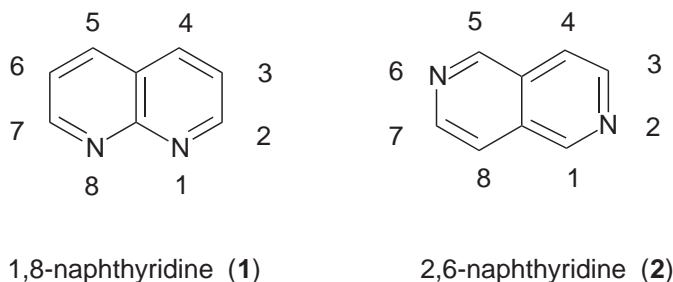
The pyridopyridines, also called benzodiazines, and more commonly naphthyridines, consist of a group of diazanaphthalenes with one nitrogen in each ring and none at the bridgehead position. From the six possible isomers, one example of each of the series 1-X and 2-X, and the numbering scheme, are represented in (1) and (2).

The naphthyridines and their derivatives exhibit various types of biological activity, and the organic chemistry has been frequently reviewed.<sup>1-6</sup> The preparation of the ligands can be found in the references to their metal complexes.

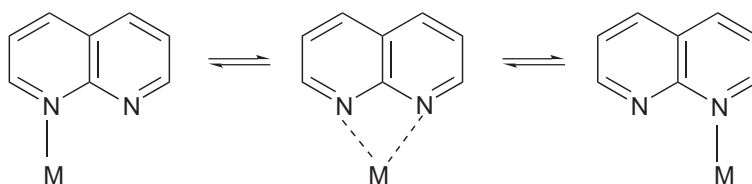
Very few metal complexes of naphthyridines other than 1,8-naphthyridine have been described.<sup>7</sup> Transition-metal complexes of 1,5-naphthyridine (1,5-napy) seem to form one-dimensional coordination polymers, with the ligand acting as bidentate in a “stepped” bridging fashion.<sup>8-9</sup> Monodentate and bridging modes have been observed in the complexes W(1,5-napy)(CO)<sub>5</sub> and W<sub>2</sub>(1,5-napy)(CO)<sub>10</sub>, respectively.<sup>10</sup> The three known complexes of Co<sup>II</sup>, Zn<sup>II</sup>, and Cd<sup>II</sup> with 2,2'-bi-1,6-naphthyridine are isostructural, and form bidimensional planar (4,4) nets made of squares with four metal centres at the corners and four bridging ligands on the edges.<sup>11</sup>

### 1.4.2 COMPLEXES WITH THE 1,8-NAPHTHYRIDINE LIGAND

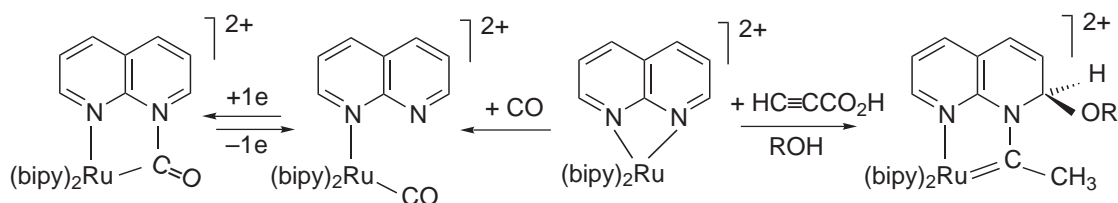
1,8-naphthyridine (napy) and its simplest 2-methyl and 2,7-dimethyl derivatives may act as monodentate and bidentate ligands, resembling the behavior of the carboxylate ligands. As a consequence of the small “bite” of 2.2 Å—defined as the distance between the N atoms—and the formation of four-membered chelate rings, abnormally high coordination numbers are claimed to be reached in the napy complexes of transition metals and lanthanides.<sup>12,13</sup> They have been authenticated in some cases by X-ray diffraction studies.<sup>14,15</sup> However, the parallel orientation of the lone pairs, unfavourable for chelation, and the strain of the four-membered chelate ring lead to a lability toward the opening of the chelate ring and to site-opening and -closing functions.<sup>16</sup> These characteristics provide an easy route for the 1,3-metallotropic shift, which is observed as a low-energy fluxional process for *d*<sup>8</sup>-metal and carbonyl complexes with monodentate 1,8-naphthyridines (Scheme 1).<sup>17-19</sup>



Special interest was focused on the photochemistry and redox properties of mononuclear ruthenium complexes.<sup>20</sup> Examples show the nucleophilic attack of one of the N atoms of 1,8-naphthyridine on the coordinated CO in  $[\text{Ru}(\text{bipy})_2(\text{napy})(\text{CO})]^{2+}$  upon  $1e$  reduction of the napy moiety (Scheme 2). Such a type of metallacyclization enables the reduction of the CO group, derived from the electrochemical reduction of  $\text{CO}_2$  catalyzed by  $[\text{Ru}(\text{bipy})(\text{napy})_2(\text{CO})_2](\text{PF}_6)_2$ , to produce acetone in the presence of  $\text{Me}_4\text{NBF}_4$ .<sup>21,22</sup> An unusual result is the simultaneous formation of a carbene ligand and the addition of the methoxy group to the naphthyridine ring upon reaction of  $[\text{Ru}(\text{bipy})_2(\text{napy})]^{2+}$  with propiolic acid in methanol (Scheme 2).<sup>23</sup>



Scheme 1



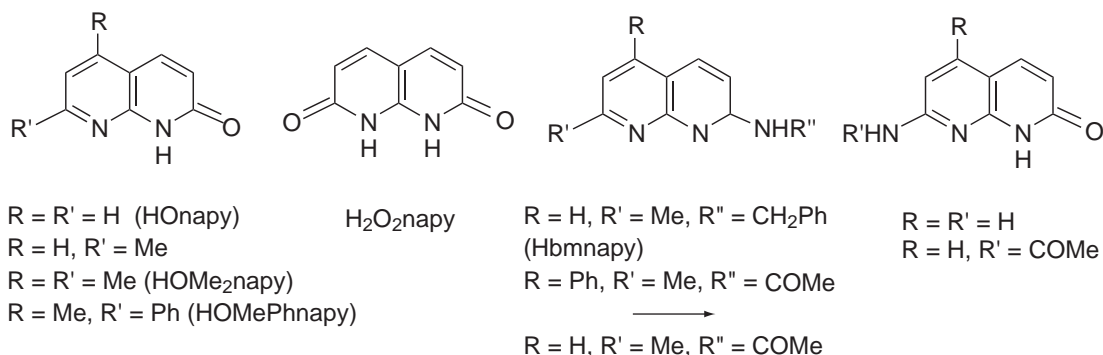
Scheme 2

Finally, the structural characteristics of the 1,8-naphthyridines favour their behavior as bidentate and dinucleating ligands, thus leading to short metal–metal separations in late transition-metal complexes,<sup>24–26</sup> and to the stabilization of mixed-valence complexes.<sup>27,28</sup> The dinuclear ruthenium complex  $[\{\text{Ru}(\text{napy})(\text{H}_2\text{O})_2\}(\mu\text{-Cl})(\mu\text{-OH})](\text{ClO}_4)_2$  is a stable and active catalyst for the oxidation of alcohols and the epoxidation of alkenes, while its mononuclear precursor is much less active.<sup>29</sup>

#### 1.4.3 COMPLEXES WITH FUNCTIONALIZED DERIVATIVES OF THE 1,8-NAPHTHYRIDINE RING

The functionalized derivatives of napy at positions 2 and 7 with, at least, a donor atom or group X (X = O, N, P) provide such ligands with an ambidentate character, while still keeping active all the coordination characteristics of the parent ligand. The new donor atom external to the napy ring (X = O, N, P) introduces multiple coordination possibilities, and the ability to act as polynucleating ligands gathering several metal centres. Many of them have been characterized

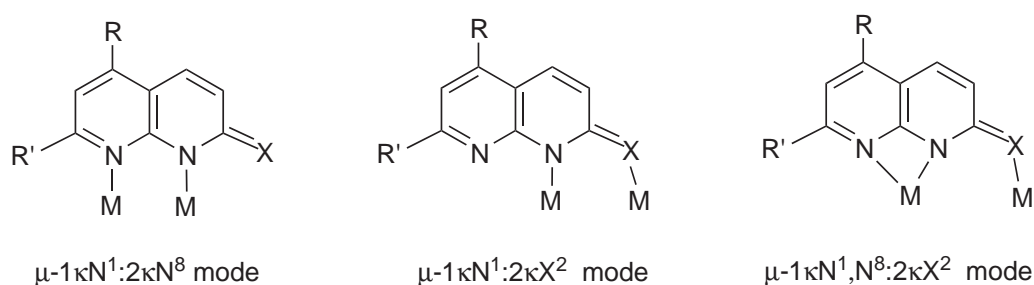
by X-ray diffraction methods. The compounds X-napy and X<sub>2</sub>-napy (X = O, N), shown in Scheme 3, exist mainly as the naphthyridone form in tautomeric equilibria.



Scheme 3

Although the NH proton is weakly acidic, they can be deprotonated by strong bases, and the mono- or dianionic ligands are found in a variety of di- and trinuclear Mo, W, Ru, Rh, Ir, Pd, and Pt complexes.<sup>30–40</sup> Few of them are mononuclear,<sup>36,37,40</sup> and in such cases the two napy nitrogen atoms form the chelate ring. However, the mononuclear and a dinuclear complex of identical composition may be in equilibrium in solution, and they can even be crystallized independently as two polymorphs,<sup>37</sup> as shown by [Rh(OMe<sub>2</sub>napy)(cod)]<sub>n=1,2</sub>.

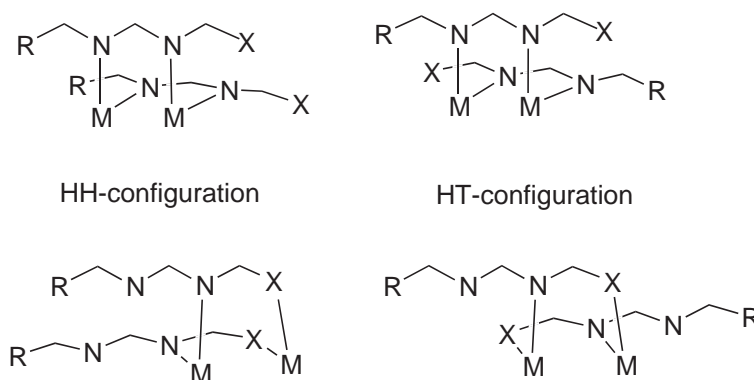
Generally, only two anionic X-napy or X<sub>2</sub>-napy ligands (X = N, O) are present in dinuclear complexes, which adopt mutually *cis* positions. They bridge the metals through two contiguous donor atoms, either those of the naphthyridine ring ( $\mu$ -1 $\kappa$ N<sup>1</sup>:2 $\kappa$ N<sup>8</sup> mode) or through one nitrogen of the ring and the exocyclic donor atom ( $\mu$ -1 $\kappa$ N<sup>1</sup>:2 $\kappa$ X<sup>2</sup> mode) (Scheme 4). The latter mode is observed exclusively by Mo and W complexes,<sup>33,36</sup> while both modes can be exhibited by the complexes of electron-rich metals (Ru, Rh, Ir, Pd, Pt).



Scheme 4

Although it has been argued that the  $\mu$ -1 $\kappa$ N<sup>1</sup>:2 $\kappa$ N<sup>8</sup> coordination mode is electronically favoured for M<sub>2</sub><sup>4+</sup> cores with occupied antibonding orbitals, factors such as the presence of bulky substituents on the napy ring, or bulky ancillary ligands, lead to the more flexible framework derived from the  $\mu$ -1 $\kappa$ N<sup>1</sup>:2 $\kappa$ X<sup>2</sup> coordination mode. Thus, in [{Rh( $\mu$ -Onapy)(CO)<sub>2</sub>]<sub>2</sub>] the ligands are  $\mu$ -N,N-coordinated,<sup>30</sup> while they are  $\mu$ -N,O-coordinated in [{Rh( $\mu$ -OMePhnapy)(CO)<sub>2</sub>]<sub>2</sub>] and [{Rh( $\mu$ -OMe<sub>2</sub>napy)(cod)]<sub>2</sub>.<sup>37,38</sup> Moreover, although the above overview refers to solid-state structures, species showing both coordination modes within a complex have been detected in equilibrium with the symmetrical species in solutions of the Rh<sup>I</sup> and Ir<sup>I</sup> complexes [M<sub>2</sub>( $\mu$ -OMe<sub>2</sub>napy)<sub>2</sub>(CO)<sub>2</sub>(cod)].<sup>37</sup> In a third coordination mode ( $\mu$ -1 $\kappa$ N<sup>1</sup>,N<sup>8</sup>:2 $\kappa$ X<sup>2</sup>), found in [{Ru( $\mu$ -bm-napy)CO<sub>2</sub>]<sub>2</sub>], the X-napy ligands bridge two metals and chelate one of them.<sup>34</sup> The *trans* disposition of the X-napy ligands is unusual and can be found in some diruthenium complexes with tetra-bridged metal–metal bonds.<sup>35</sup>

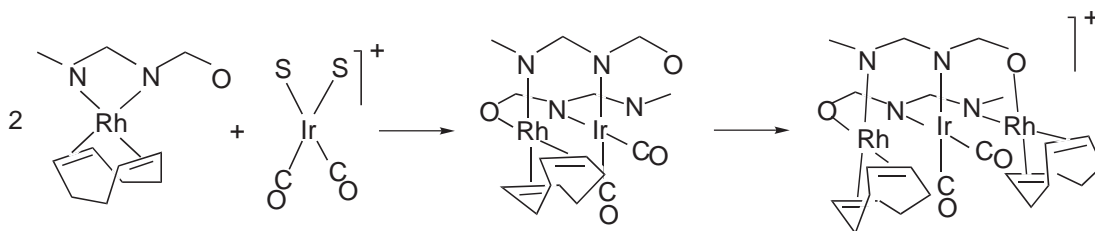




**Figure 1** Possible configurations in dinuclear complexes with X-napy bridges.

A stereochemical consequence of the unsymmetrical nature of the X-napy ligands is the occurrence of head-to-tail (HT) and head-to-head (HH) configurations (Figure 1), relative to the bridging ligands, in any of the above-mentioned coordination modes. The difference in energy between them seems to be small and the HT configuration is commonly observed, unless electronic or steric effects—such as a metal–metal bond, or bulky ancillary ligands—are present in the complexes.

One interesting feature of the anionic X-napy and X<sub>2</sub>-napy (X = N, O) ligands is their behavior as trinucleating  $\mu\text{-}1\kappa\text{N}^1:2\kappa\text{N}^8:3\kappa\text{X}^2$  ligands. In the trinuclear complexes of Ru,<sup>34</sup> Rh,<sup>31,32</sup> Ir,<sup>37</sup> Pd, and Pt,<sup>39,40</sup> the metals adopt almost linear arrangements and are held in close proximity, determined by the structural characteristics of the ligands and the bridging framework. A rationalization of the mechanism of formation for the Rh and Ir trinuclear complexes showed the presence of dinuclear complexes acting as metallaligands, which incorporate the third metal fragment (Scheme 5).<sup>37</sup> However, the metal fragments readily interchange their positions on the donor atoms of the ligands during the process of synthesis, to produce the HT configurations with the less bulky metal fragment occupying the inner position. In the compounds of Pt and Pd where there are no different environments of the metals, both HH and HT configurations were detected.

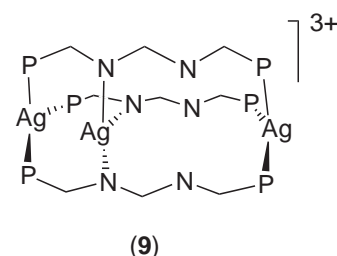
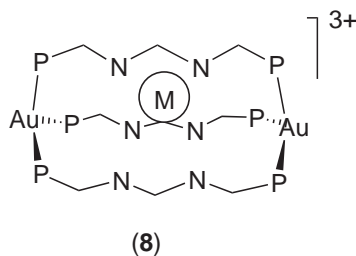
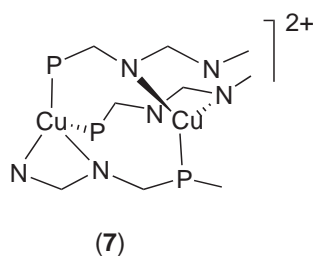
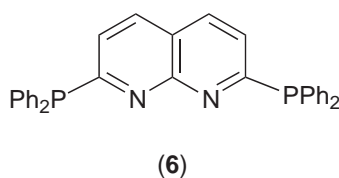
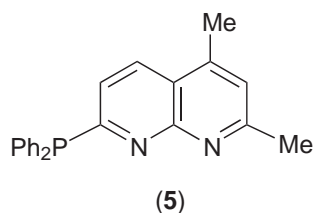
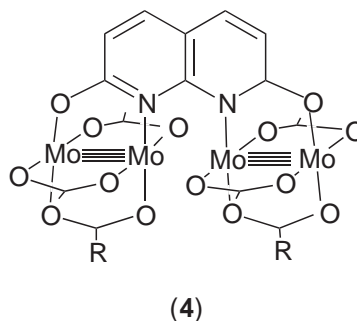
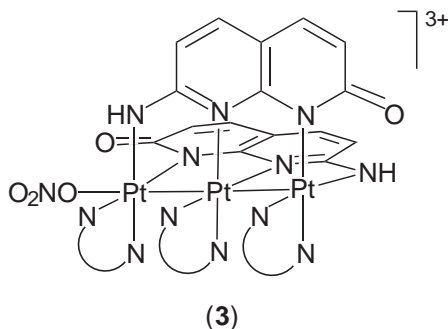


**Scheme 5**

Oxidation of trinuclear Rh, Ir, and Pt complexes of the type  $[\text{M}_3(\mu\text{-Onapy})_2\text{L}_2\text{L}_4]^+$ ,  $[\text{M}_2\text{M}'(\mu\text{-OMe}_2\text{napy})_2\text{L}_2\text{L}_4]^+$  (M = Rh, Ir, M' = Ir, Rh), and  $[\text{Pt}_3(\mu\text{-(NH)Onapy})_2(\text{bipy})_3]^{2+}$  produce mixed-valence compounds of the cores  $[\text{Rh}_3]^{4+}$ ,  $[\text{Rh}_2\text{Ir}]^{4+}$ ,  $[\text{Ir}_2\text{Rh}]^{4+}$ ,  $[\text{Ir}_3]^{4+}$ , and  $[\text{Pt}_3]^{8+}$  with metal–metal bonds of fractional bond order.<sup>32,37,39</sup> The Rh and Rh–Ir complexes are paramagnetic, with an averaged oxidation state of 1.33, while the platinum compound  $[\text{Pt}_3(\mu\text{-(NH)Onapy})_2(\text{NO}_3)(\text{bipy})_3]^{3+}$  (**3**) is diamagnetic, and the averaged oxidation state of the metals is 2.66. The structures of the oxidized and parent compounds are identical, except for a noticeable decrease of the metal–metal and metal–X–napy distances upon oxidation. A tetradentate mode of 1,8-naphthyridine-2,7-dionate, bridging four metal atoms with multiple metal–metal bonds, occurs in the Mo and W complexes  $[\text{M}_2(\mu\text{-O}_2\text{napy})(\mu\text{-O}_2\text{CBu}^t)_3]$  (**4**), which show an electronic communication.<sup>41</sup>



The X-napy ligand (X = PPh<sub>2</sub>) 2,4-dimethyl-7-(diphenylphosphino)-1,8-naphthyridine (**5**) typically uses the phosphorus atom to coordinate metals in mononuclear complexes, and both the phosphorus and the distant N atom of the napy ring ( $\mu$ -1 $\kappa$ N<sup>1</sup>:2 $\kappa$ P<sup>7</sup> coordination mode) in dinuclear Rh, Ir, Pd, and Pt complexes.<sup>42–44</sup> Three different coordination modes of this ligand are displayed in the dinuclear Cu complex [Cu<sub>2</sub>( $\mu$ -Pnapy)<sub>3</sub>]<sup>2+</sup> (**7**),<sup>45</sup> and its behavior as a trinucleating ligand has been found only in the complex HH-[Cu<sub>3</sub>( $\mu$ -Pnapy)<sub>3</sub>(NCMe)]<sup>3+</sup>.<sup>45</sup>

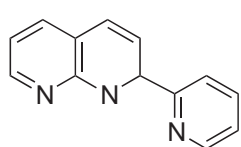


Few complexes of the X<sub>2</sub>-napy ligand 2,7-bis(diphenylphosphino)-1,8-naphthyridine (**6**) have been reported. Coordination of the ligand through the phosphorus atoms in the dinuclear gold complex [Au<sub>2</sub>( $\mu$ -P<sub>2</sub>napy)<sub>3</sub>]<sup>2+</sup> produces a cavity formed by the dimetallacycles that encapsulate alkali ions (**8**).<sup>46,47</sup> The trinuclear complex [Ag<sub>3</sub>( $\mu$ -P<sub>2</sub>-napy)<sub>3</sub>]<sup>3+</sup> (**9**) could be viewed with this perspective as a metallacryptate.<sup>47</sup> Only a single complex of Mo displaying the  $\mu$ -1 $\kappa$ N<sup>1</sup>:2 $\kappa$ N<sup>8</sup> coordination mode has been reported.<sup>48</sup>

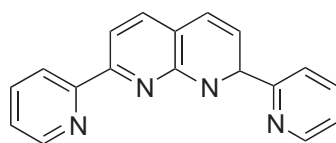
#### 1.4.4 OTHER MULTIDENTATE LIGANDS DERIVED FROM THE 1,8-NAPHTHYRIDINE RING

Coordinating substituents on positions 2 and 7 of the napy ring, such as (**10–12**), give rise to polydentate, cavity-shaped molecules able to coordinate two metal centers in the cavity. Thus, 2,7-bis(2'-pyridyl)-1,8-naphthyridine (**11**), bpnapy and 1,8-naphthyridine-2,7-dicarboxylate<sup>49</sup> (**12**) are croissant-shaped, tetradentate ligands that bridge metal–metal bonds in complexes of the type [M<sub>2</sub>( $\mu$ -bpnapy)( $\mu$ -O<sub>2</sub>CMe)<sub>3</sub>]<sup>+</sup> (M = Rh, Ru) (**13**),<sup>50,51</sup> and occupy the axial positions *trans* to the metal–metal bond. However, this ligand may bridge two nonmetal–metal bonded copper atoms through the naphthyridine nitrogen atoms with a similar crescent-shaped coordination mode in [Cu<sub>2</sub>( $\mu$ -bpnapy)( $\mu$ -OH)( $\mu$ -Cl)Cl<sub>2</sub>], or can act as a simple chelating ligand in [Cu(bpnapy)(PPh<sub>3</sub>)<sub>2</sub>]<sup>+</sup>.<sup>52</sup> The smaller denticity of 2(2'-pyridyl)-1,8-naphthyridine (**10**), pynapy might allow the presence of up to three bridging ligands in the dimetallic Rh complex

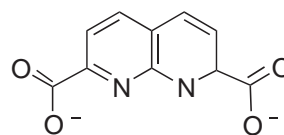
$[\text{Rh}_2(\mu\text{-pynapy})_3\text{Cl}_2]^{2+}$ .<sup>53</sup> The related Rh, Ru, and Mo complexes  $[\text{M}_2(\mu\text{-pynapy})_2(\mu\text{-O}_2\text{CMe})_2]^{2+}$  (**14**) are redox active, showing up to four, one-electron, reversible reductions.<sup>54</sup> The complex with the related ligand 2,7-bis(phenylazo)-1,8-naphthyridine  $[\text{Ru}_2(\text{danapy})\text{Cl}_6]$  is an efficient catalyst for the oxidation of alcohols and the epoxidation of *trans*-stilbene.<sup>55</sup>



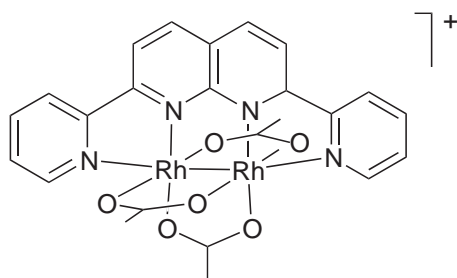
(10)



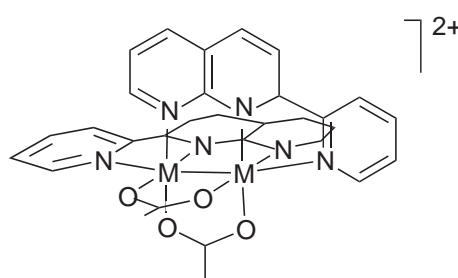
(11)



(12)

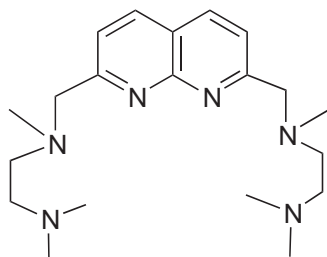


(13)

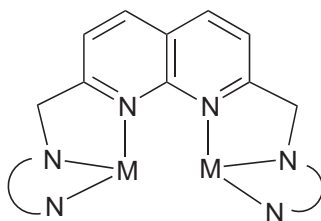


(14)

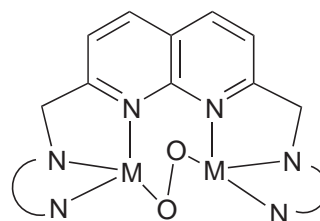
Novel multidentate dinucleating ligands based on 1,8-naphthyridine (**15**) have been prepared with the aim of mimicking the coordination environment of dinuclear metalloenzymes and diiron-containing, redox-active proteins.<sup>56</sup>



(15)



(16)



(17)

These types of ligand (**15**) are the nitrogen analogues of the carboxylate ligands, which bridge the catalytic centres in metallohydrolases that perform the hydrolysis of biologically important substrates such as DNA, RNA, and peptides by the cooperation between two metal centers. Dinuclear complexes of Zn,<sup>57</sup> Cu,<sup>58,59</sup> and Fe<sup>60</sup> with the basic structure shown in (**16**) have been studied as models of the active sites of metalloenzymes. In particular, the copper and iron complexes form bridging peroxo and hydroperoxo complexes (**17**) on treatment with oxygen and hydrogen peroxide, respectively.<sup>61,62</sup>

#### 1.4.5 REFERENCES

1. Paudler, W. W.; Kress, T. J. *Adv. Heterocycl. Chem.* **1970**, *11*, 123–175.
2. Van der Plas, H. C.; Wozniak, M.; Van den Haak, H. J. W. *Adv. Heterocycl. Chem.* **1983**, *33*, 96–146.
3. Paudler, W. W.; Sheets, R. M. *Adv. Heterocycl. Chem.* **1983**, *33*, 147–184.
4. Lowe, P. A. *Naphthyridines, Pyridoquinolines, Anthryridines and Similar Compounds*. In *Comprehensive Heterocyclic Chemistry*; Katritzky, A. R., Rees, C. W. Eds.; Pergamon: Oxford, UK, 1984; Vol. 2, pp 582–628.
5. Stanforth, S. P. *Bicyclic 6-6 Systems: Two heteroatoms 1:1*. In *Comprehensive Heterocyclic Chemistry II*; Katritzky, A. R., Rees, C. W., Scriven, E. F. V. Eds.; Elsevier: Oxford, UK, 1996, Vol. 7, pp 527–555.

6. Litvinov, V. P.; Roman, S. V.; Dyachenko, V. D. *Russ. Chem. Rev.* **2000**, *69*, 201–220; *ibid.* **2001**, *70*, 299–320.
7. Reedijk, J. In *Comprehensive Coordination Chemistry*; Wilkinson, G., Gillard, R. D., McCleverty, J. A., Eds.; Pergamon: Oxford, UK, 1987, Vol. 2, p 92.
8. Stotz, R. W.; Walmsley, J. A.; Walmsley, F. *Inorg. Chem.* **1969**, *8*, 807–810.
9. Kaim, W.; Kohlmann, S. *Inorg. Chem.* **1990**, *29*, 1898–1902.
10. Bessenbacher, C.; Kaim, W. *J. Organomet. Chem.* **1989**, *369*, 83–103.
11. Wu, H.-P.; Janiak, C.; Uehlin, L.; Klüfers, P.; Mayer, P. *Chem. Commun.* **1998**, 2637–2638.
12. Hendricker, D. G.; Foster, R. J. *Inorg. Chem.* **1973**, *12*, 349–352.
13. Foster, R. J.; Hendricker, D. G. *Inorg. Chim. Acta* **1972**, *6*, 371–375.
14. Singh, P.; Clearfiel, A.; Bernal, I. *J. Coord. Chem* **1971**, *1*, 29–37.
15. Epstein, J. M.; Dewan, J. C.; Kepert, D. L.; White, A. H. *J. Chem. Soc., Dalton Trans.* **1974**, 1949–1954.
16. Nakajima, H.; Nagao, H.; Tanaka, K. *J. Chem. Soc., Dalton Trans.* **1996**, 1405–1409.
17. Schmidbaur, H.; Dash, K. C. *J. Am. Chem. Soc.* **1973**, *95*, 4855–4860.
18. Kang, S.-K.; Albright, T. A.; Mealli, C. *Inorg. Chem.* **1987**, *26*, 3158–3166.
19. Bermejo, M. J.; Ruiz, J. I.; Solans, X.; Vinaixa, J. *J. Organomet. Chem.* **1993**, *463*, 143–150.
20. Staniewicz, R. J.; Hendricker, D. G. *J. Am. Chem. Soc.* **1977**, *99*, 6581–6588.
21. Nakajima, H.; Tanaka, K. *Chem. Lett.* **1995**, 891–892.
22. Mizukawa, T.; Tsuge, K.; Nakajima, H.; Tanaka, K. *Angew. Chem. Int. Ed.* **1999**, *38*, 362–363.
23. Tomon, T.; Ooyama, D.; Wada, T.; Shireu, K.; Tanaka, K. *Chem. Commun.* **2001**, 1100–1101.
24. Tiripicchio, A.; Tiripicchio-Camellini, M.; Usón, R.; Oro, L. A.; Ciriano, M. A.; Viguri, F. *J. Chem. Soc., Dalton Trans.* **1984**, 125–131.
25. Ara, I.; Casas, J. M.; Forniés, J.; Rueda, A. *Inorg. Chem.* **1996**, *35*, 7345–7349.
26. Maekawa, M.; Munakata, M.; Kitagawa, S.; Kuroda-Sowa, T.; Suenaga, Y.; Yamamoto, M. *Inorg. Chim. Acta* **1998**, *271*, 129–136.
27. Sacconi, L.; Mealli, C.; Gatteschi, D. *Inorg. Chem.* **1974**, *13*, 1985–1991.
28. Gatteschi, D.; Mealli, C.; Sacconi, L. *Inorg. Chem.* **1976**, *15*, 2774–2778.
29. Boelrijk, A. E. M.; van Velzen, M. M.; Neenan, T. X.; Reedijk, J.; Kooijman, H.; Spek, A. L. *J. Chem. Soc., Chem. Commun.* **1995**, 2465–2467.
30. Manotti-Lanfredi, A. M.; Tiripicchio, A.; Usón, R.; Oro, L. A.; Ciriano, M. A.; Villarroja, B. E. *Inorg. Chim. Acta* **1984**, *88*, L9–L10.
31. Tiripicchio, A.; Lahoz, F. J.; Oro, L. A.; Ciriano, M. A.; Villarroja, B. E. *Inorg. Chim. Acta* **1986**, *111*, L1–L3.
32. Connelly, N. G.; Loyns, A. C.; Ciriano, M. A.; Fernández, M. J.; Oro, L. A.; Villarroja, B. E. *J. Chem. Soc., Dalton Trans.* **1989**, 689–691.
33. Sheldrick, W. S.; Mintert, M. *Inorg. Chim. Acta* **1994**, *219*, 23–29.
34. Mintert, M.; Sheldrick, W. S. *J. Chem. Soc., Dalton Trans.* **1995**, 2663–2669.
35. Mintert, M.; Sheldrick, W. S. *Inorg. Chim. Acta* **1995**, *236*, 13–20.
36. Mintert, M.; Sheldrick, W. S. *Chem. Ber.* **1996**, *129*, 683–689.
37. Villarroja, B. E.; Oro, L. A.; Lahoz, F. J.; Edwards, A. J.; Ciriano, M. A.; Alonso, P. J.; Tiripicchio, A.; Tiripicchio-Camellini, M. *Inorg. Chim. Acta* **1996**, *250*, 241–264.
38. Mintert, M.; Sheldrick, W. S. *Inorg. Chim. Acta* **1997**, *254*, 93–98.
39. Oskui, B.; Sheldrick, W. S. *Eur. J. Inorg. Chem.* **1999**, 1325–1333.
40. Oskui, B.; Mintert, N.; Sheldrick, W. S. *Inorg. Chim. Acta* **1999**, *287*, 72–81.
41. Cayton, R. H.; Chisholm, M. H.; Huffman, J. C.; Lobkovsky, E. B. *J. Am. Chem. Soc.* **1991**, *113*, 8709–8724.
42. Grassi, M.; De Munno, G.; Nicolò, F.; Lo Schiavo, S. *J. Chem. Soc., Dalton Trans.* **1992**, 2367–2374.
43. Lo Schiavo, S.; Sinicropi, M. S. F.; Tresoldi, G.; Arena, C. G.; Piraino, P. *J. Chem. Soc., Dalton Trans.* **1994**, 1517–1522.
44. Lo Schiavo, S.; De Munno, G.; Nicolò, F.; Tresoldi, G. *J. Chem. Soc., Dalton Trans.* **1994**, 3135–3141.
45. Chan, W.-H.; Cheung, Peng, S.-M.; Che, C.-H. *J. Chem. Soc., Dalton Trans.* **1998**, 2867–2871.
46. Uang, R.-H.; Chan, C.-K.; Peng, S.-M.; Che, C.-M. *J. Chem. Soc., Chem. Commun.* **1994**, 2561–2562.
47. Catalano, V. J.; Kar, H. M.; Bennett, B. L. *Inorg. Chem.* **2000**, *39*, 121–127.
48. Tanase, T.; Igoshi, T.; Kobayashi, K.; Yamamoto, Y. *J. Chem. Res. (S)* **1998**, 538–539.
49. Collin, J. P.; Jouaiti, A.; Sauvage, J. P.; Kaska, W. C.; McLoughlin, M. A.; Keder, N. L.; Harrison, W. T. A.; Stucky, G. D. *Inorg. Chem.* **1990**, *29*, 2238–2241.
50. Tikkanen, W. R.; Binamira-Soriaga, E.; Kaska, W. C.; Ford, P. C. *Inorg. Chem.* **1984**, *23*, 141–146.
51. Binamira-Soriaga, E.; Keder, N. L.; Kaska, W. C. *Inorg. Chem.* **1990**, *29*, 3167–3171.
52. Tikkanen, W. R.; Krüger, C.; Bomben, K. D.; Jolly, W. L.; Kaska, W. C.; Ford, P. C. *Inorg. Chem.* **1984**, *23*, 3633–3638.
53. Baker, A. T.; Tikkanen, W. R.; Kaska, W. C.; Ford, P. C. *Inorg. Chem.* **1984**, *23*, 3254–3256.
54. Campos-Fernández, C. S.; Ouyang, X.; Dunbar, K. R. *Inorg. Chem.* **2000**, *39*, 2432–2433.
55. Boelrijk, A. E.; Neenan, T. X.; Reedijk, J. *J. Chem. Soc., Dalton Trans.* **1997**, 4561–4570.
56. He, C.; Lippard, S. J. *Tetrahedron* **2000**, *56*, 8245–8252.
57. Kaminskaia, N. V.; He, C.; Lippard, S. J. *Inorg. Chem.* **2000**, *39*, 3365–3373.
58. He, C.; Lippard, S. J. *Inorg. Chem.* **2000**, *39*, 5225–5231.
59. He, C.; Lippard, S. J. *J. Am. Chem. Soc.* **2000**, *122*, 184–185.
60. He, C.; Lippard, S. J. *Inorg. Chem.* **2001**, *40*, 1414–1420.
61. He, C.; DuBois, J. L.; Hedman, B.; Hodgson, K. O.; Lippard, S. J. *Angew. Chem. Int. Ed.* **2001**, *40*, 1484–1487.
62. He, C.; Barrios, A. M.; Lee, D.; Kuzelka, J.; Davydof, R. M.; Lippard, S. J. *J. Am. Chem. Soc.* **2000**, *122*, 12683–12690.

# 1.5

## Heterocyclic and Open-chain 1,2-Diazine Ligands

Z. XU and L. K. THOMPSON

*Memorial University, St. John's, Newfoundland, Canada*

---

1.5.1 INTRODUCTION AND SCOPE	63
1.5.2 PYRIDAZINE- AND PHTHALAZINE-DERIVED LIGANDS	64
1.5.2.1 Overview	64
1.5.2.2 Ligand Preparations	65
1.5.2.2.1 Pyridazine-derived ligands	65
1.5.2.2.2 Phthalazine-derived ligands	70
1.5.2.3 Coordination Chemistry	74
1.5.3 OPEN-CHAIN DIAZINE LIGANDS	76
1.5.3.1 Overview	76
1.5.3.2 Preparation	78
1.5.3.2.1 Preparation of precursors: imidates, amide hydrazones, and hydrazides	78
1.5.3.2.2 Amide hydrazones (amidrazones) and hydrazides	79
1.5.3.3 Ligand Preparations	79
1.5.3.3.1 Type 8; mixed diazine ( <i>N-N</i> ) ligands	88
1.5.3.4 Coordination Chemistry	88
1.5.4 CONCLUDING REMARKS	90
1.5.5 REFERENCES	93

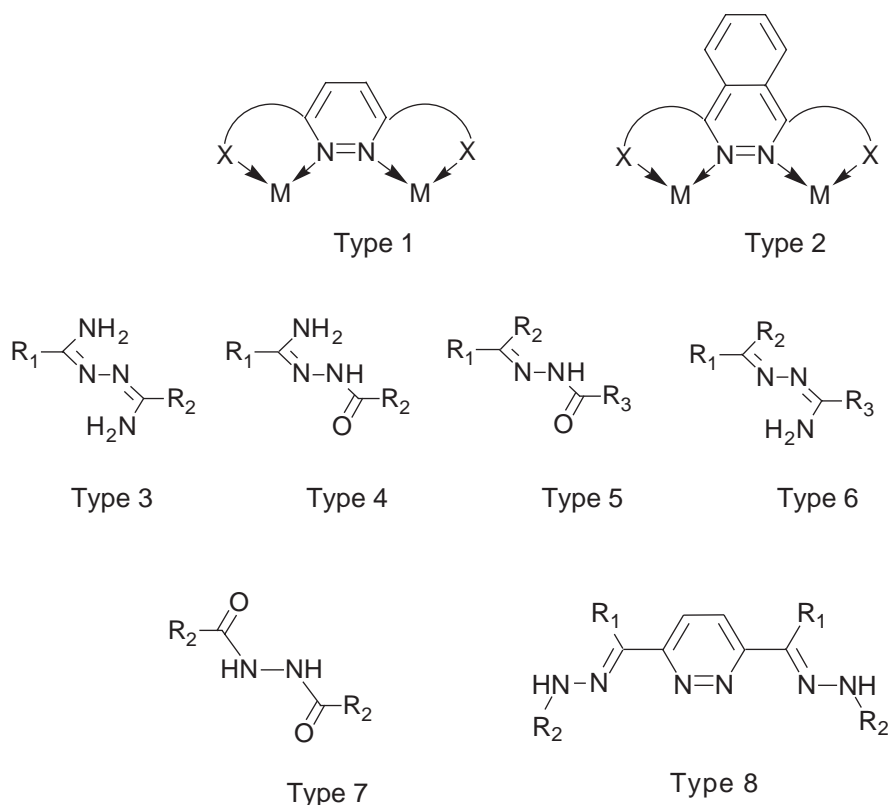
---

### 1.5.1 INTRODUCTION AND SCOPE

A rich coordination chemistry of aromatic diazine (*N-N*), especially pyridazine and phthalazine related ligands has emerged over the last three decades,<sup>1-72</sup> and recently open-chain diazine (*N-N*) coordination chemistry has been well developed, especially by Thompson and others.<sup>62-113</sup> Many types of aromatic heterocyclic compounds contain a 1,2-diazine (*N-N*) moiety, e.g., pyridazine and its 3,6-disubstituted derivatives (Scheme 1, Type 1), phthalazine, condensed phthalazines and their substituted derivatives (Scheme 1, Type 2), and other compounds such as pyrazole, triazole, thiadiazole, tetrazole, indazole, 1,2,4-triazine, 1,2,4,5-tetrazine, and thiadiazepines. Alternatively, the 1,2-diazine (*N-N*) moiety also exists as an open-chain entity in some related compounds, e.g., *N*-substituted-amide hydrazonimidates (Scheme 1, Type 3), *N*-substituted-amide hydrazonidates (Scheme 1, Type 4), *N*-substituted hydrazides (Scheme 1, Type 5), *N*-substituted amidrazones (Scheme 1, Type 6), and *N*-substituted hydrazidates (Scheme 1, Type 7).

The coordination chemistry of free pyridazine and phthalazine or their analogues will not be covered in this chapter. We will only deal with synthetic and coordination chemistry of ligands of Type 1 and Type 2 (Scheme 1) in which the arm group X provides some coordination sites (i.e., one to four sites), Type 3 to Type 7 (Scheme 1) in which the substituted groups ( $R_1$ - $R_3$ ) contain some coordination sites, and a mixed type (Type 8) containing both aromatic and open-chain diazines. The synthesis of some related key precursors to these ligands will also be covered.

Type 1 and Type 2-related chemistry can be found in Section 1.5.2 and the rest will be treated in Section 1.5.3.



Scheme 1

## 1.5.2 PYRIDAZINE- AND PHTHALAZINE-DERIVED LIGANDS

### 1.5.2.1 Overview

Diazine (*N-N*) bridge-containing ligands are of fundamental interest. From the magnetochemistry point of view, diazine (*N-N*) bridges in some conjugated aromatic heterocyclic ligands can bring two metal, e.g., copper(II) centers, into close proximity to form dinuclear complexes, and generate intramolecular magnetic exchange between the metal centers via the  $\pi$  system of the heterocyclic ligand. This varies with the nature of the diazine ligands. Extensive studies have revealed that in the dinuclear copper(II) complexes involving pyrazine, pyrimidine, and other related bridges, where the heterocyclic nitrogen donor centers are arranged at the 1,4 or 1,3 ring positions, weak intramolecular antiferromagnetic interactions are usually observed. However, for some heterocyclic diazine ligands with a 1,2-heterocyclic nitrogen arrangement, moderate to strong antiferromagnetic coupling is observed depending on the identity of the ligand.<sup>1,17-62</sup> Several types of 1,2-aromatic diazine-derived ligands have been investigated and their ability to propagate magnetic coupling highlighted. Among them, pyridazine and phthalazine ligands provide the best platform for magnetic interactions, which are normally antiferromagnetic, e.g., for copper(II) (but not always). Due to the unique features for providing effective electronic superexchange pathways, a substantial number of pyridazine- and phthalazine-derived ligands have been developed since the 1970s. In this section, the synthetic chemistry of pyridazine and phthalazine ligands will mainly be discussed, and a brief coordination chemistry of these ligands will also be covered.

### 1.5.2.2 Ligand Preparations

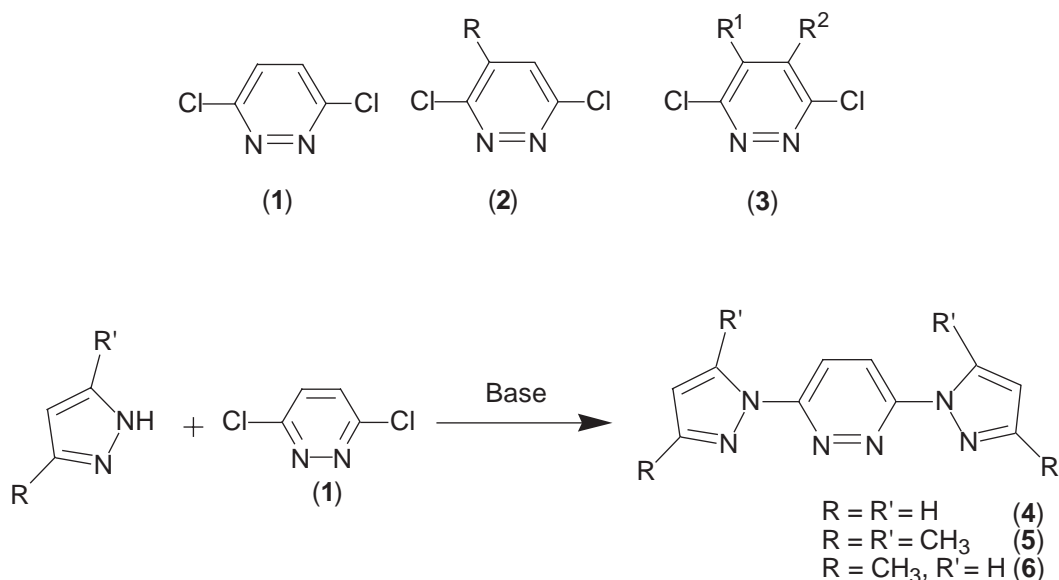
#### 1.5.2.2.1 Pyridazine-derived ligands

##### (i) From halopyridazines

Halo groups on the 3-, 4-, 5-, or 6-positions are strongly activated by one of the ring nitrogen atoms, as in the cases of *o*- or *p*-chloronitrobenzene. Due to their convenient reactivities, halopyridazines, especially 3,6-disubstituted derivatives, have been used extensively as intermediates for making pyridazine-containing ligands. Since there is little difference in reactivities among corresponding fluoro-, chloro-, bromo-, or iodopyridazines, the easily available chloro derivatives are used normally, and 3,6-dichloro-4 and/or 5-substituted pyridazines are the most useful from the ligand building point of view. 3,6-Dichloropyridazine is commercially available, and the preparation methods for others, e.g., (2) and (3), can be found in a well-documented collection book on pyridazines.<sup>114</sup>

Many ligands or useful intermediates have been made from 3,6-dichloropyridazine or 3,6-dichloro-4 and/or 5-substituted pyridazines, e.g., 3,6-dicyanopyridazine, can be made from the reaction of 3,6-diiodopyridazine with cuprous cyanide in pyridine.<sup>115–118</sup>

(a) *Reaction with an active NH group (e.g., pyrazoles)*. (4) and (5) were originally made by Addison *et al.*<sup>119</sup> and Elguero *et al.*<sup>120</sup> respectively. Thompson *et al.*<sup>55</sup> made both of these compounds and also a new member in this family of ligands (6) in a much more practical way, which improved the yield significantly (Scheme 2).



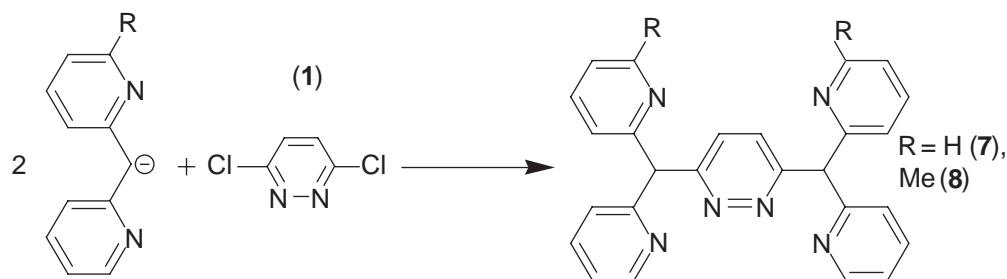
Scheme 2

(b) *Reaction with an active CH group*. (7) and (8) were made by addition of 3,6-dichloropyridazine dissolved in diethyl ether to a solution of (6-methyl-2-pyridyl)(2-pyridyl)-methyl lithium, followed by work-up with water, in fairly good yield (Scheme 3).<sup>69,70</sup> (9) was prepared by the reaction of 3,6-dichloropyridazine with the appropriate Grignard reagent (Scheme 4).<sup>121</sup>

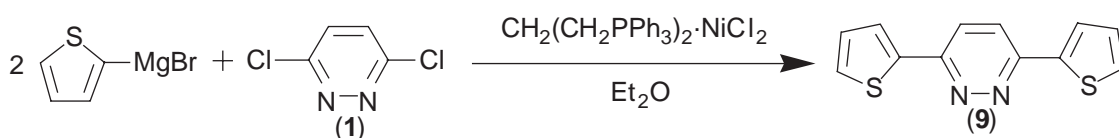
(c) *Reaction with an active SH group*. Several heterocyclic mercaptans, e.g., 2-thiopyridine, 2-thiobenzimidazole, and its homologues, have been reacted with 3,6-dichloropyridazine to give corresponding thioether ligands, e.g., (10)–(12)<sup>31</sup> and (13)–(15) (Scheme 5).<sup>35</sup> (16) was made in a similar way using 3-chloro-6-thiopyridazine without any base, but with a trace amount of HCl.<sup>122</sup>

(17) was prepared by the reaction of 3,6-dichloropyridazine with 2-aminoethanethiol in the presence of base, which has been further converted into (18).<sup>52</sup> The macrocyclic ligands (19)–(21) formed through the reaction of (17) with the corresponding dialdehyde in highly diluted reactions.<sup>52–54</sup>

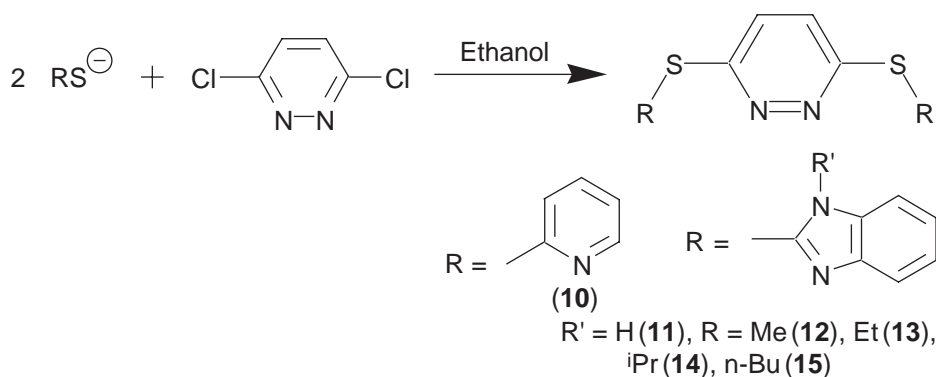
Another macrocyclic family (**22**)–(**26**) was made by reacting 3,6-dichloropyridazine with the corresponding potassium dithiolate salt in ethanol under highly diluted conditions.<sup>51,52</sup>



Scheme 3



Scheme 4

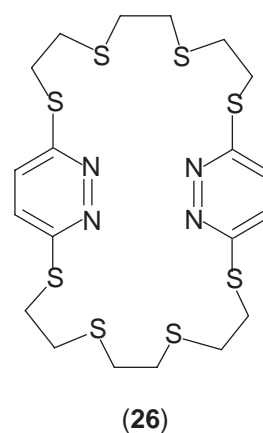
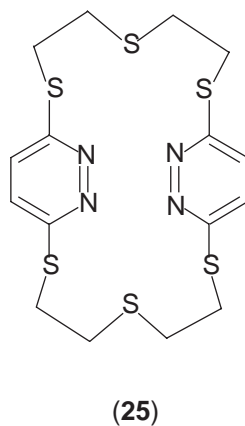
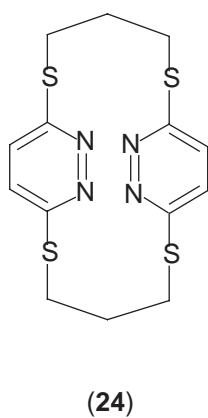
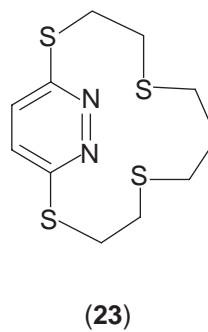
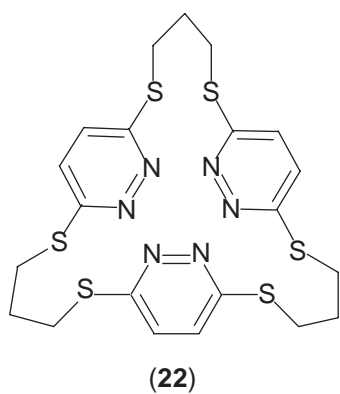
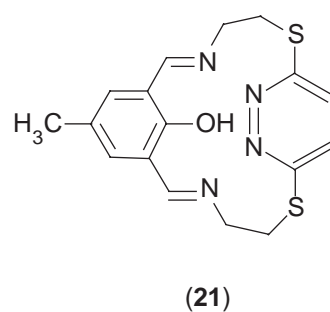
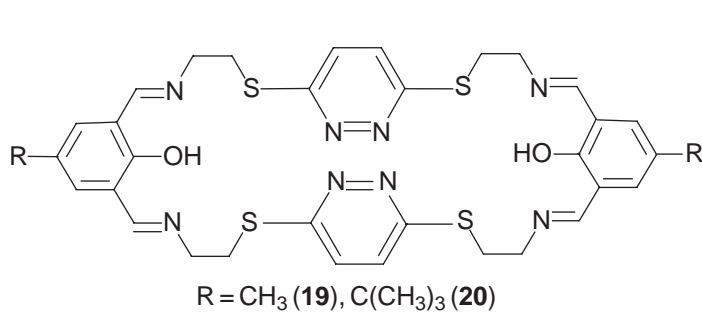
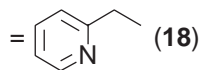
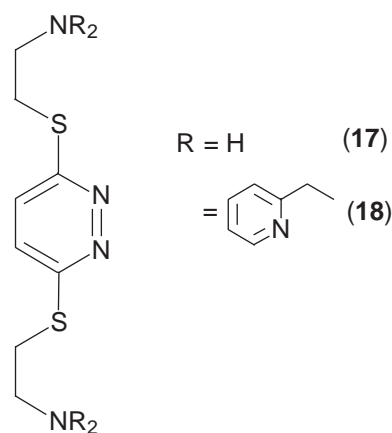
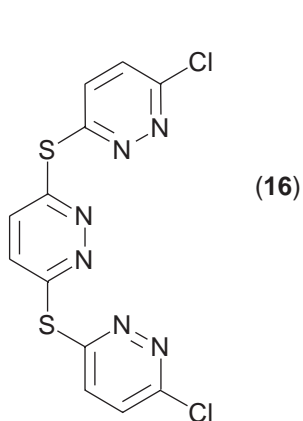


Scheme 5

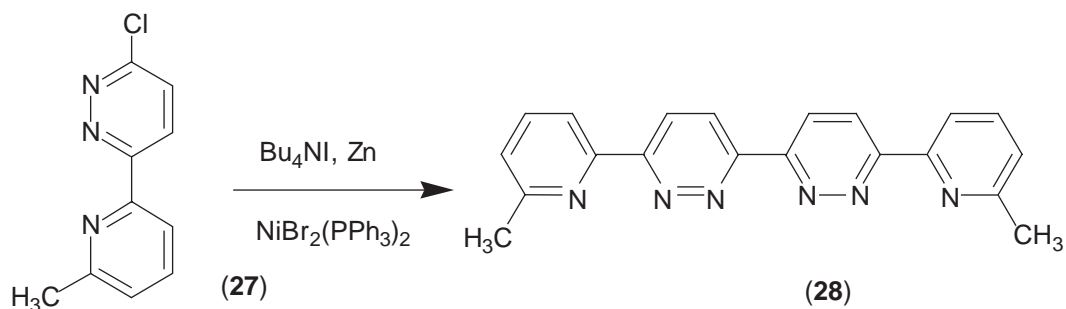
(d) *Displacement reactions.* Lehn and co-workers made (**28**) (Scheme 6) from 3-chloro-6-(6-methylpyridin-2-yl)pyridazine (**27**) in dry DMF catalyzed by a Ni<sup>II</sup> complex in very high yield (80%).<sup>123</sup> More recently, adopting the same method, an extended analogue (**30**) was also synthesized from (**29**) by the same group.<sup>124</sup> The intermediate (**29**) was made from 3-chloro-6-methoxypyridazine via four steps (Scheme 7).

(ii) *From pyridazine-carbaldehydes and pyridazine-ketones*

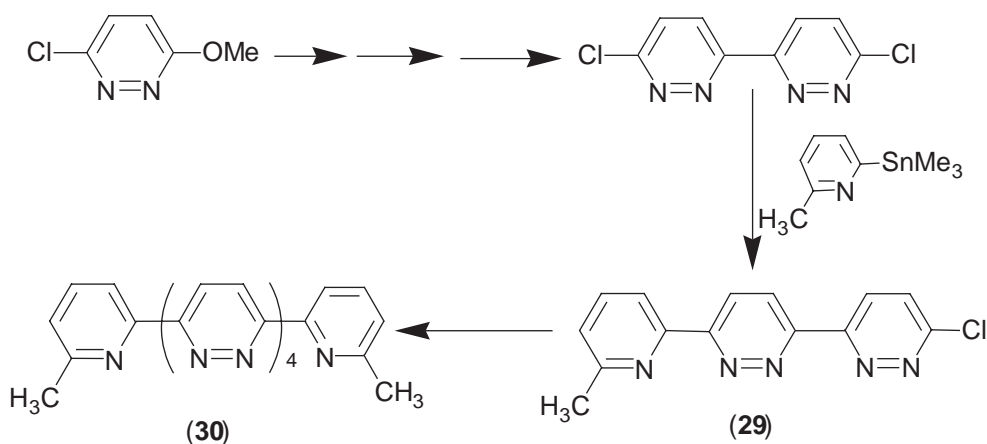
Pyridazinecarbaldehydes have been synthesized in many ways, which normally include oxidation of alkylpyridazines, indirect oxidation of a bromomethylpyridazine, oxidation of hydroxymethylpyridazines, and direct C–C formation. Alternatively, pyridazine ketones have also been made by oxidation of alkylpyridazines and secondary hydroxyalkylpyridazines, from pyridazinecarboxylic esters with carbanions, from pyridazinecarbonyl chloride by Friedel–Crafts reactions, and from pyridazinecarbonitriles with a lithium or Grignard reagent, etc.<sup>125</sup> Many ligands can be derived from pyridazinecarbaldehydes and pyridazine ketones. The dioxime ligands (**31**) and (**32**) were reported by Abraham *et al.* from the corresponding aldehyde and ketone.<sup>65</sup>



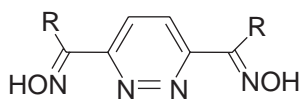




Scheme 6



Scheme 7



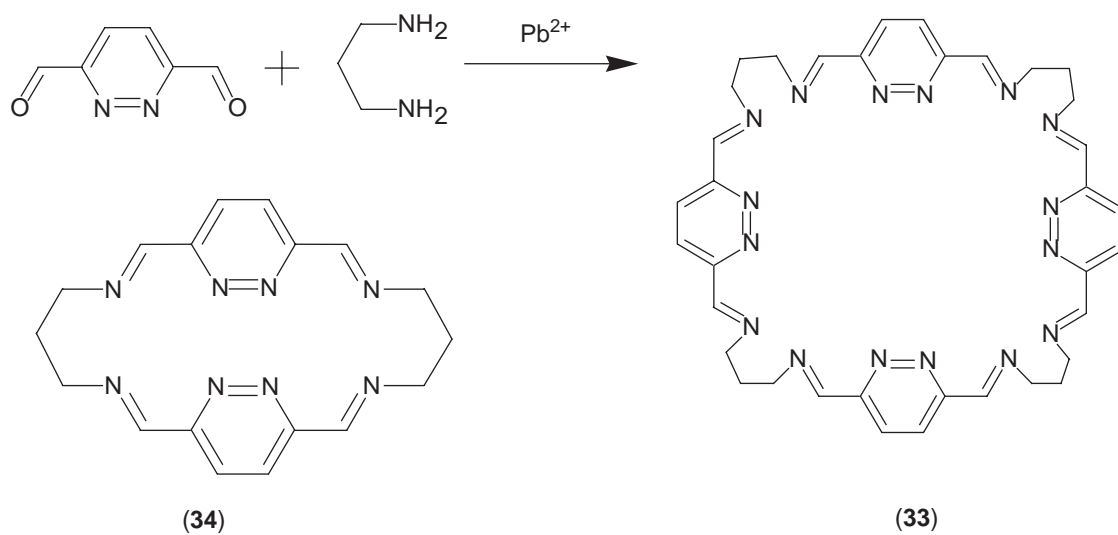
$\text{R} = \text{H}$  (31),  $\text{C}_6\text{H}_5$  (32)

The macrocyclic ligands (33) and (34) were made by Brooker and co-workers using metal ions as template reagents (Scheme 8).<sup>66–68</sup>

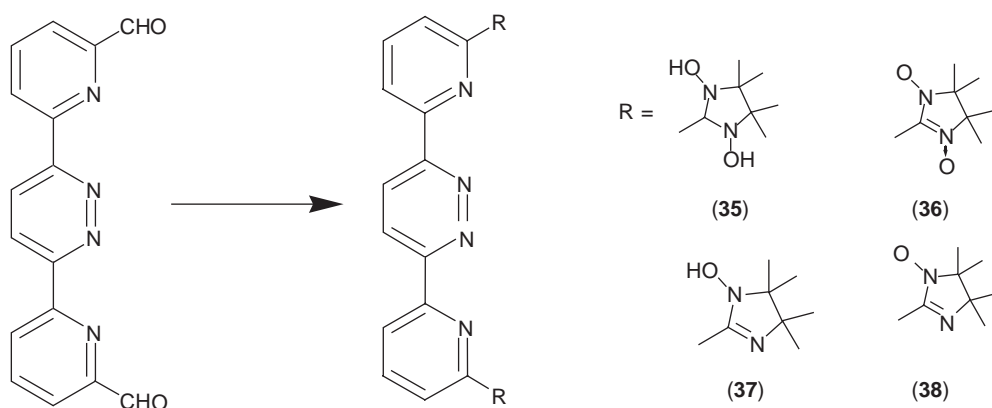
Aiming at the so-called metal–radical approach for molecular magnets, a large number of nitronyl and imino nitroxides have been prepared. A typical nitronyl nitroxide (36) has been made by an oxidation reaction of (35) with  $\text{NaIO}_3$  or  $\text{Ag}_2\text{O}$  under phase-transfer conditions in 94% yield (Scheme 9). The precursor (35) was made by reacting 3,6-bis(6-formylpyridin-2-yl)pyridazine with 2,4-bishydroxyamino-2,4-dimethylbutane in good yield.<sup>126</sup> Similarly the imino nitroxide (38) and its precursor (37) have also been reported by the same group.<sup>127</sup>

### (iii) From 1,2,4,5-tetrazines

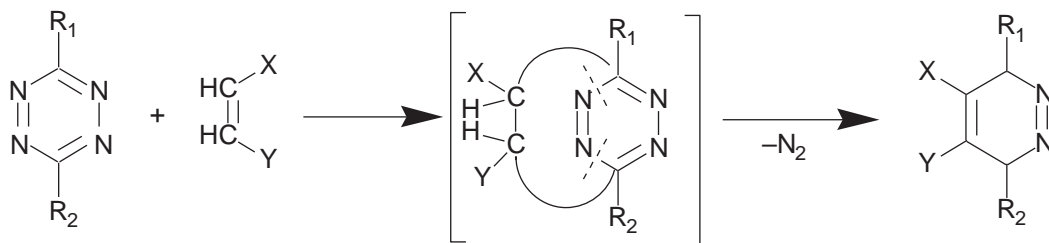
1,2,4,5-Tetrazine derivatives have been used widely in making pyridazines by “inverse electron-demand Diels–Alder reactions” with dienophiles (see Scheme 10), followed by loss of nitrogen from the usually unstable intermediate; if the dienophile has a triple bond or potential triple bond properties, the final pyridazines will be aromatic. From the coordination chemistry point of view 3,6-dipyridin-2'-yl-1,2,4,5-tetrazine and dimethyl 1,2,4,5-tetrazinedicarboxylate and their analogs are probably the most useful starting compounds for making relevant ligands.



Scheme 8



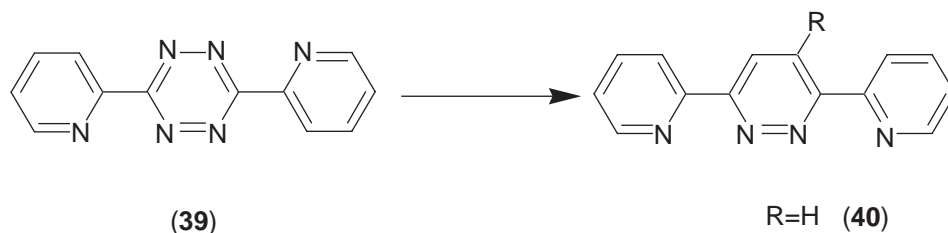
Scheme 9



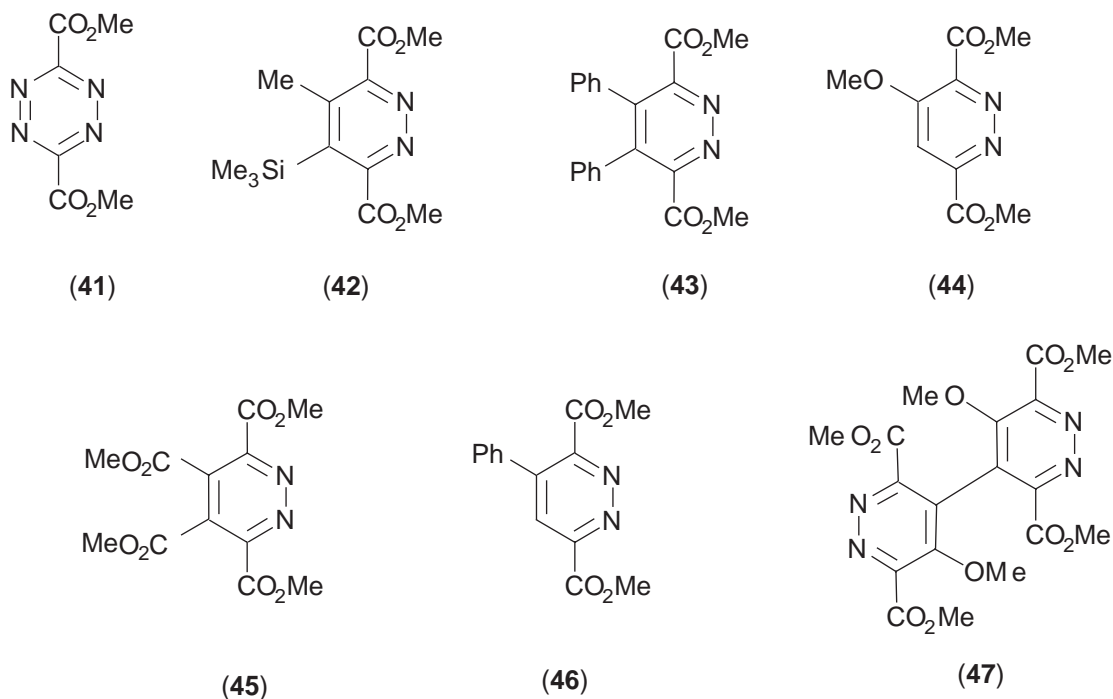
Scheme 10

A large number of homologous ligands ((40), Scheme 11) have been prepared from a tetrazine (39)<sup>4-9</sup> through so-called “inverse electron-demand Diels–Alder reactions”.

Many 4/5-substituted pyridazinedicarboxylic diesters have been made by the same method. Typical examples are as follows (Scheme 12).



Scheme 11



Scheme 12

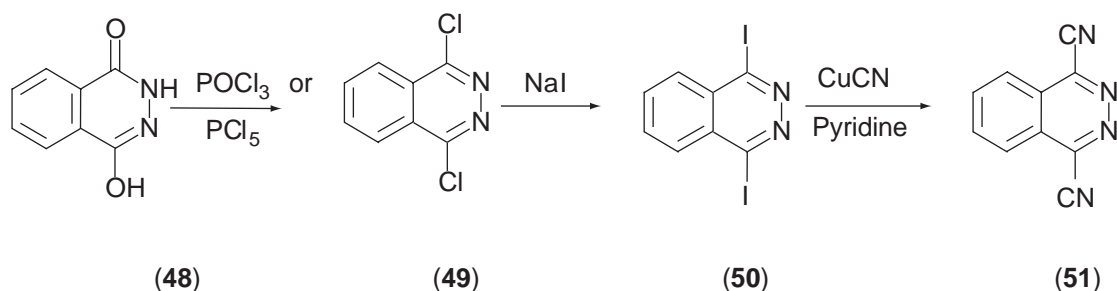
The reaction of 1-trimethylsilylprop-1-yne with **(41)** gives **(42)** in 69% yield,<sup>128,129</sup> and its homologues<sup>130,131</sup> have also been reported. Diphenylacetylene reacting with **(41)** gives **(43)** (xylene, reflux, 30 h, 75%).<sup>132</sup> Ketene dimethylacetal reacting with **(41)** produces **(44)** with loss of methanol and N<sub>2</sub> (in dioxane, yield: 65%) and also analogues.<sup>133</sup> The reaction of dimethyl acetylenedicarboxylate and **(41)** gives **(45)** (*o*-xylene, reflux, 24 h 60%, xylene, reflux 15 h, 53%).<sup>134</sup> The reaction of  $\alpha$ -trimethylsiloxystyrene and **(41)** gives **(46)** with the loss of HOSiMe<sub>3</sub> and N<sub>2</sub> (in dioxane, yield: 95%).<sup>135</sup> The reaction of  $\alpha,\alpha,\delta,\delta$ -tetramethoxybutadiene with two equivalents of **(41)** gives **(47)** (yield 56% and 65% depending on the conditions).<sup>136</sup> These diesters are extremely important precursors for building related pyridazine-containing ligands, such as pyridazine dicarboxylic acids and homologues, and Type 8 ligands containing both pyridazine moieties and open-chain diazines (see Section 1.5.3).

#### 1.5.2.2.2 Phthalazine-derived ligands

(i) *Preparation of precursors: 1,4-dihalophthalazines, 1,4-dicyanophthalazine, and 1,4-dihydrazinophthalazine*

(a) *Preparation of 1,4-dihalophthalazines.* 1,4-dichlorophthalazines have been made by heating 4-hydroxy-1-(2H)phthalazinone (**48**) with phosphorus oxychloride or phosphorus pentachloride.

Hirsch and Orphanos successfully carried out the reaction with phosphorus pentachloride by stirring the reaction mixture in a pressure bottle at 140–145°C for 4 h to give (49) in 96% yield (Scheme 13).<sup>115,116</sup>

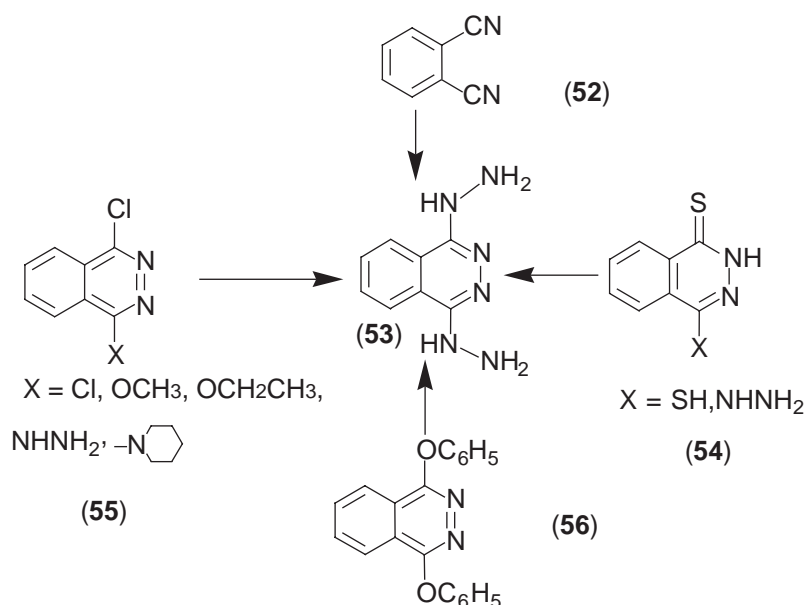


Scheme 13

6-Phenyl- and 6-trifluoromethyl-1,4-dichlorophthalazine have also been prepared in good yield (43% and 84%, respectively) from the corresponding 6-substituted, 4-hydroxy-1-(2H)phthalazinones.<sup>117,118</sup> Similarly, 1,4-dibromophthalazine was prepared by heating 4-hydroxy-1-(2H)phthalazinone with phosphorus pentabromide in 78–97% yield.<sup>115,116</sup> However, treating 4-hydroxy-1-(2H)phthalazinone (48) with phosphorus oxybromide gives 1-bromophthalazine only (88% yield).<sup>115,116</sup> 1,4-Dichlorophthalazine or 1,4-dibromophthalazine can be easily converted into 1,4-diiodophthalazine by the reaction with sodium iodide (NaI) in acetone containing 50% aqueous hydriodic acid (HI) (Scheme 13).<sup>115,116</sup>

(b) *1,4-Dicyanophthalazine*. 1,4-Diiodophthalazine reacts with copper cyanide in pyridine to give 1,4-dicyanophthalazine (51) in 35% yield (Scheme 13).<sup>115,116</sup>

(c) *1,4-dihydrazinophthalazine*. 1,4-Dihydrazinophthalazine (53) can be prepared by two types of reactions (Scheme 14), a nucleophilic substitution reaction, and a condensation reaction. 1,4-Dihydrazinophthalazine was first made by Druey and Ringier<sup>137</sup> by refluxing 1,4-dichlorophthalazine with hydrazine hydrate in ethanol. It has been found that 1-chloro-4-hydrazinophthalazine or 1-chloro-4-alkoxyphthalazines or 1,4-diphenoxyphthalazine can also be converted into 1,4-dihydrazinophthalazine with hydrazine hydrate in ethanol or methanol in ~60–90% yield depending on the starting materials used. A condensation reaction of phthalonitrile with



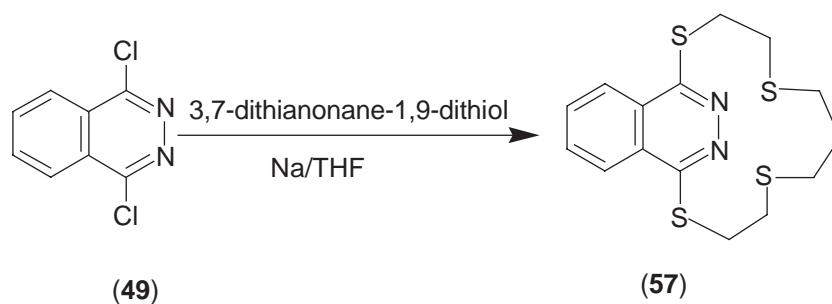
Scheme 14

hydrazine catalyzed by glacial acetic acid in dioxane gives **(53)** with the best yield (Robichaud and Thompson<sup>24</sup> and references therein).

Another reaction, which involves 4-hydrazino-1-(2H)phthalazinethione or 4-thio-1-(2H)phthalazinethione and hydrazine hydrate in refluxing ethanol, will also produce 1,4-dihydrazinophthalazine in 65–85% yield.<sup>138</sup>

(ii) From 1,4-dihalophthalazines

1,4-Dihalophthalazines or their derivatives are very similar in reactivity to the corresponding 3,6-dihalopyridazines, i.e., they can react with active H atoms either on N, S, or C atoms. **(57)**–**(60)** (Scheme 15) were made from the reaction of 1,4-dichlorophthalazine with the corresponding dithiol salts adopting the same method as employed for making related pyridazine macrocycles.<sup>48–50,54</sup>



Scheme 15

**(61)** was made from 1,4-dichlorophthalazine and 2-mercatopyridine,<sup>31</sup> and **(62)** was prepared using the method for making **(4)**.<sup>26</sup> The reaction of 1,4-dichlorophthalazine with the lithium salt of methylimidazole gave **(63)**.<sup>23</sup> **(64)** was made from bi(2-pyridyl)methyl lithium by the same method as that for producing the corresponding pyridazine-derived ligands (**(7)** and **(8)**).<sup>63,64</sup>

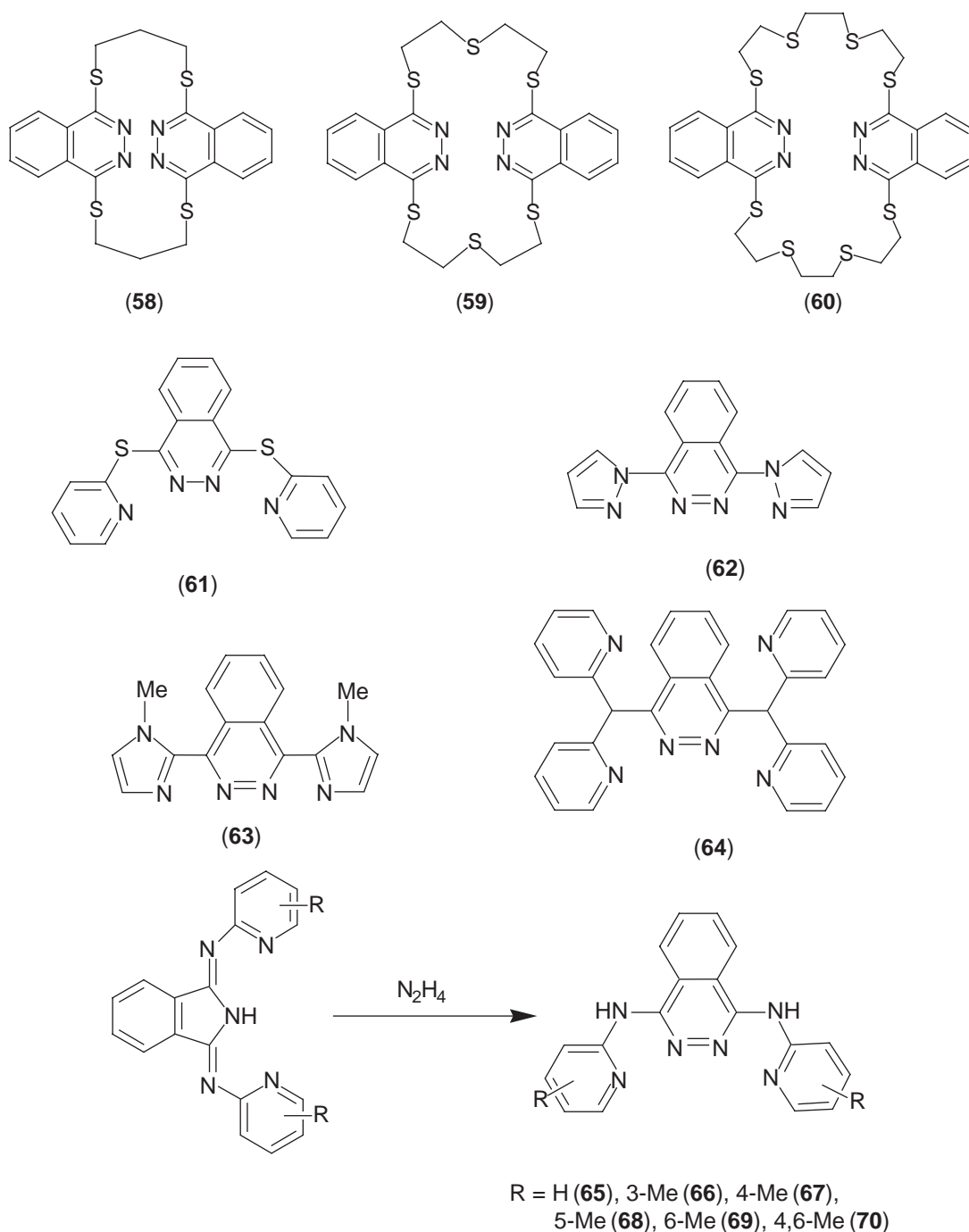
(iii) From 1,3-(substituted-pyridylimino)isoindolines

A large number of binucleating ligands in this family have been developed from the corresponding 1,3-(substituted-pyridylimino)isoindolines compounds in Thompson's group since the late 1960s. Typical examples, **(65)**–**(70)**<sup>1,18–20</sup> are shown in (Scheme 16). 1,3-(Substituted-pyridylimino)isoindolines are easily made by fusing dinitriles (e.g., phthalonitrile) with related amino compounds (e.g., 2-aminopyridine) on heating. The reaction of 1,3-(substituted-pyridylimino)isoindolines with hydrazine hydrate in methanol leads to the final ligands.

By starting with some polyphthalonitrile precursors (e.g., **(71)** or 4,4'-oxybis(1,2-dicyanobenzene), some extended ligands (e.g., **(73)** and **(74)**) (Scheme 17) can also be made successfully by the same route.<sup>58,59,139</sup>

(iv) From 1,4-dihydrazinophthalazine

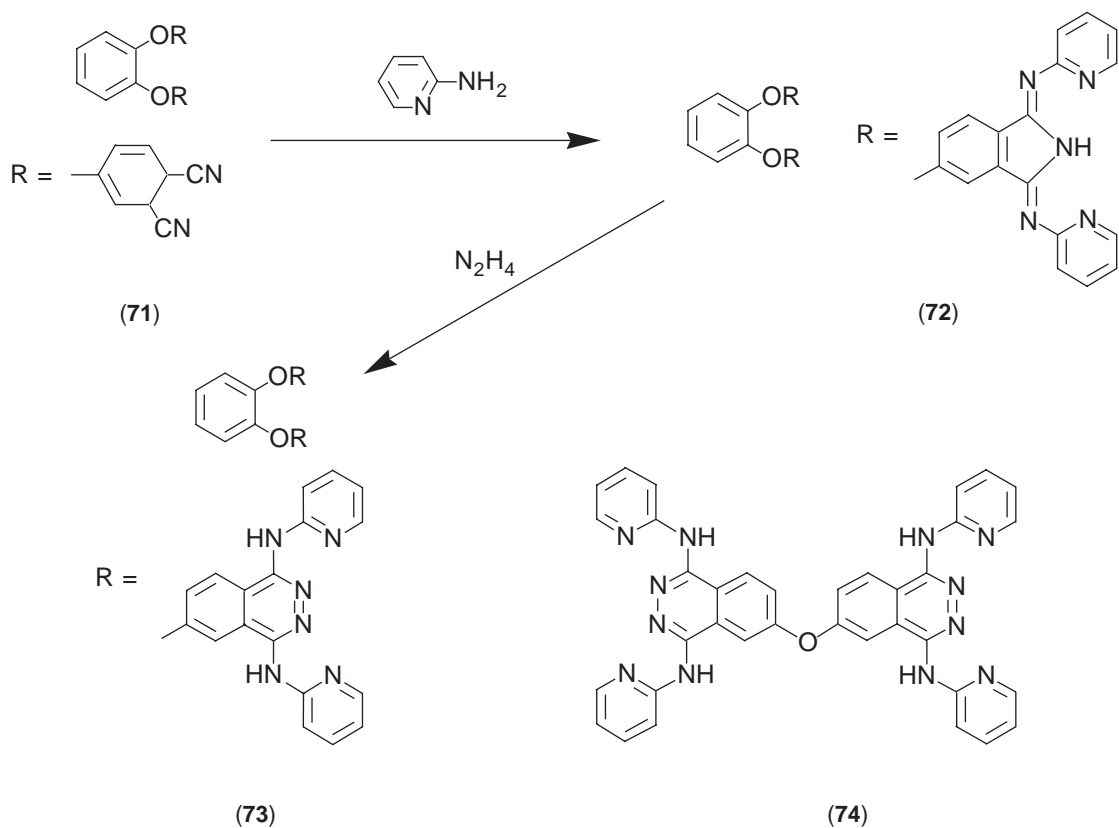
1,4-Dihydrazinophthalazine (DHPH) is a very useful starting compound from which a huge number of binucleating ligands have been generated by various types of reaction. **(75)** and its homologues are made from the reaction of 1,4-dihydrazinophthalazine with diacetonitrile in dry ether followed by alkylation.<sup>140</sup> In the same way, reaction of 1,4-dihydrazinophthalazine with ethyl acetoacetate gives **(76)** (Scheme 18).<sup>141</sup> However, no coordination chemistry of these ligands has been studied to our knowledge. Ligands **(77)**–**(83)**<sup>24,27,32,40</sup> were made by Thompson *et al.* starting with various aldehydes or ketones. The solvents employed are normally methanol or ethanol (Scheme 19). The macrocyclic ligand **(84)** (Scheme 20) was made by a metal ion templating reaction starting with **(53)** and acetone.<sup>71,72</sup>



Scheme 16

*(v) Condensed phthalazine-derived ligands*

Several condensed phthalazine-derived ligands have been made in Thompson's group to investigate the effect of extended  $\pi$  conjugation pathways on magnetic exchange interactions. **(85)** (Scheme 21) was made through an isoindoline analogue intermediate which was prepared from 2,3-naphthalenedicarbonitrile.<sup>56</sup> A series of fused bisphthalazine ligands (**(87)**–**(90)**) (Scheme 22)<sup>42,43</sup> was produced from **(86)**, which was made from 1,2,4,5-tetracyanobenzene.<sup>142</sup>

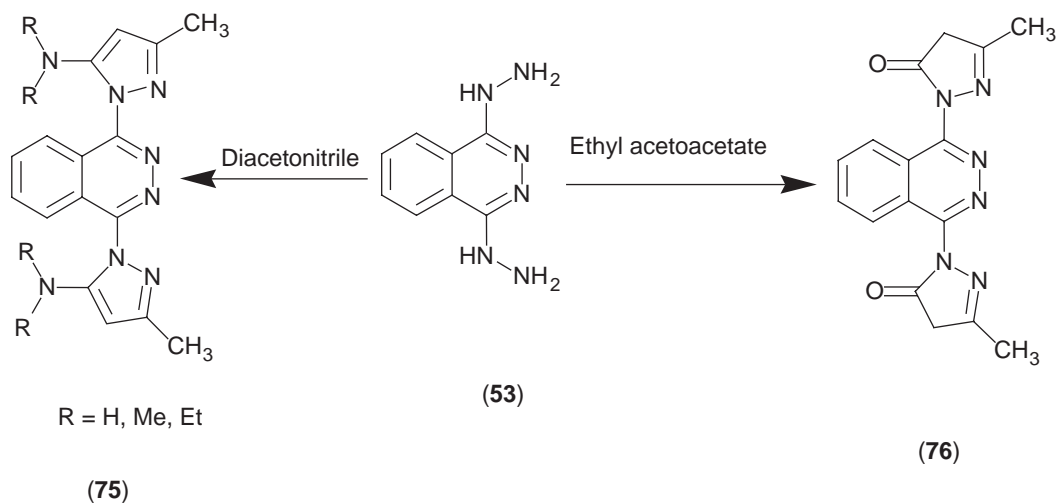


Scheme 17

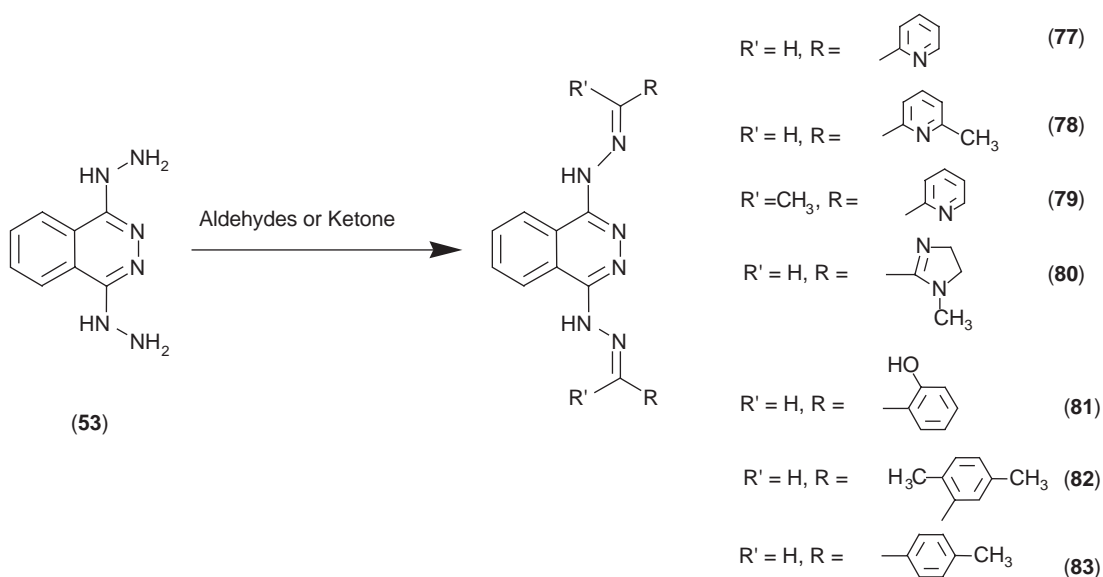
A number of the other condensed phthalazine, e.g., benzo[f]phthalazine precursor compounds such as the (91) family<sup>143</sup> and (92)<sup>144</sup> have been reported, but so far we are not aware of any final ligands derived from these precursors.

### 1.5.2.3 Coordination Chemistry

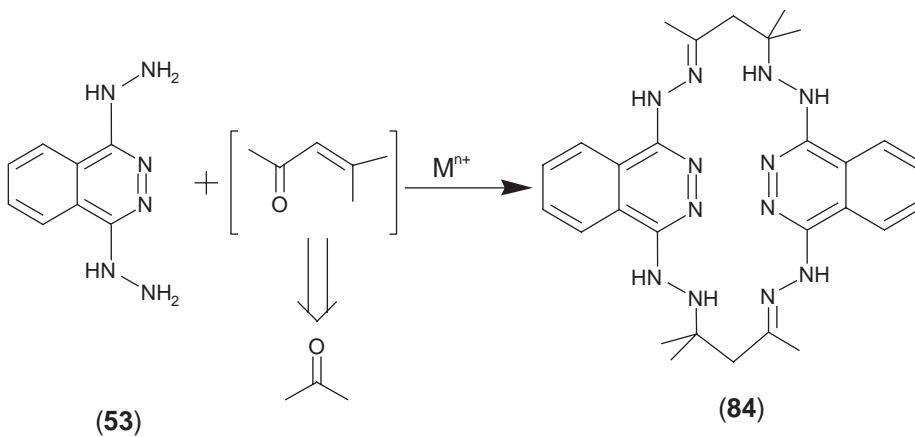
The coordination chemistry of diazine (*N-N*), especially pyridazine- and phthalazine-derived ligands, has been well developed over the last three decades and some of it has been reviewed.<sup>1,60,100</sup> A further detailed review is beyond the scope of this report. Some brief points are however included.



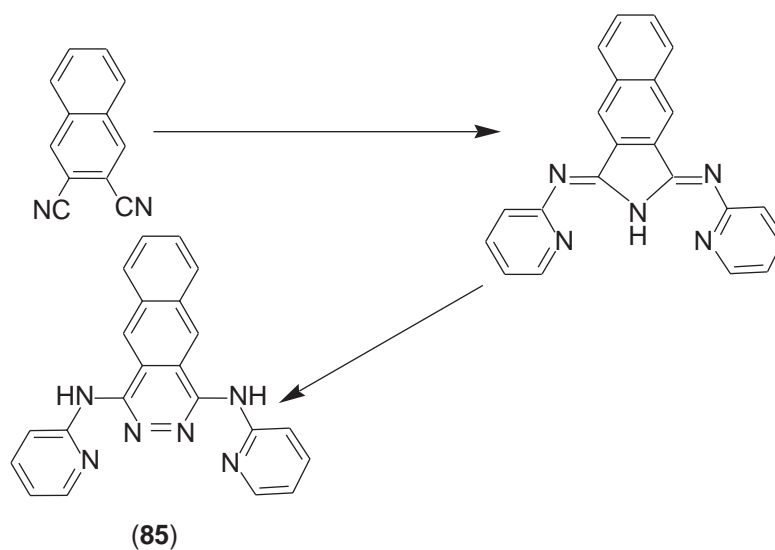
Scheme 18



Scheme 19

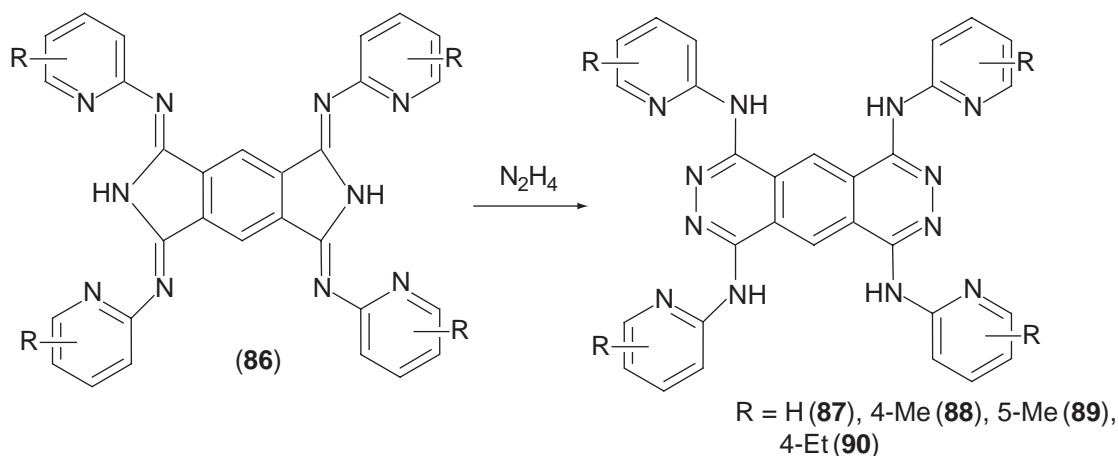


Scheme 20

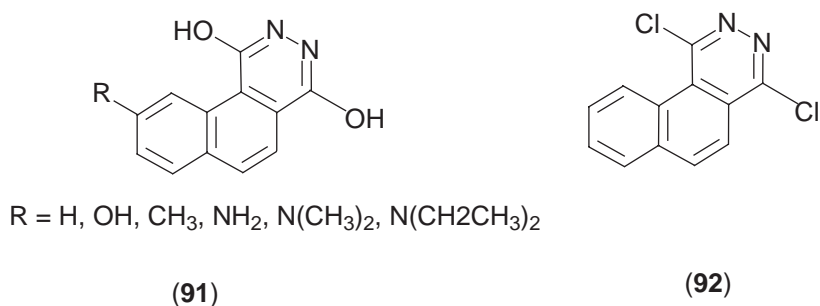


Scheme 21





Scheme 22



- Both pyridazine- and phthalazine-derived ligands show a very similar coordinating behavior to metal ions. It has been observed that in most of their metal complexes the diazine (*N-N*) group bridges two metal in a  $\mu_{1,2}$  fashion (mode 1), but in some cases the diazine (*N-N*) behaves as a mono-dentate ligand (mode 2) (Figure 1).
- When the diazine (*N-N*) in the ligands adopts mode 1, two general kinds of dinuclear complexes have been achieved: one for which the bridges between the metallic ions may be two diazine ligands ( $\text{M}:\text{diazine} = 2:2$ , Figure 2a)<sup>15,28,44</sup> or one in which the metal centers are bridged by one diazine and another bridge(s) (Y) ( $\text{M}:\text{diazine} = 2:1$ , Figure 2b).<sup>46,56,58</sup>
- Higher nuclearity complexes may be obtained by using multi-diazine (*N-N*) containing ligands, e.g., (**87**).<sup>42,43</sup> (Figure 3) shows two copper(II) centers bridged by  $\mu_2$ -(*N-N*) and  $\mu_2$ -(*OH*) groups on each side of the fused aromatic diazine framework.

### 1.5.3 OPEN-CHAIN DIAZINE LIGANDS

#### 1.5.3.1 Overview

Aromatic heterocyclic ligands containing 1,2-diazine backbones usually fix two metal centers in close proximity. However, open-chain ligands involving diazine linkages are much more flexible and provide a

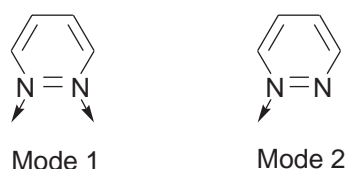
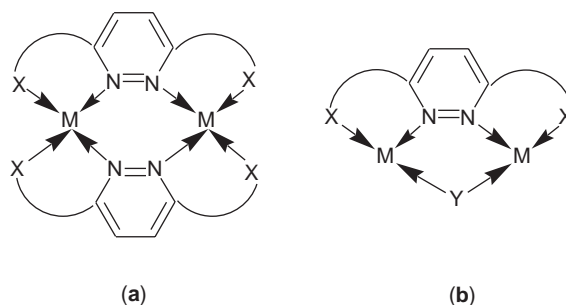
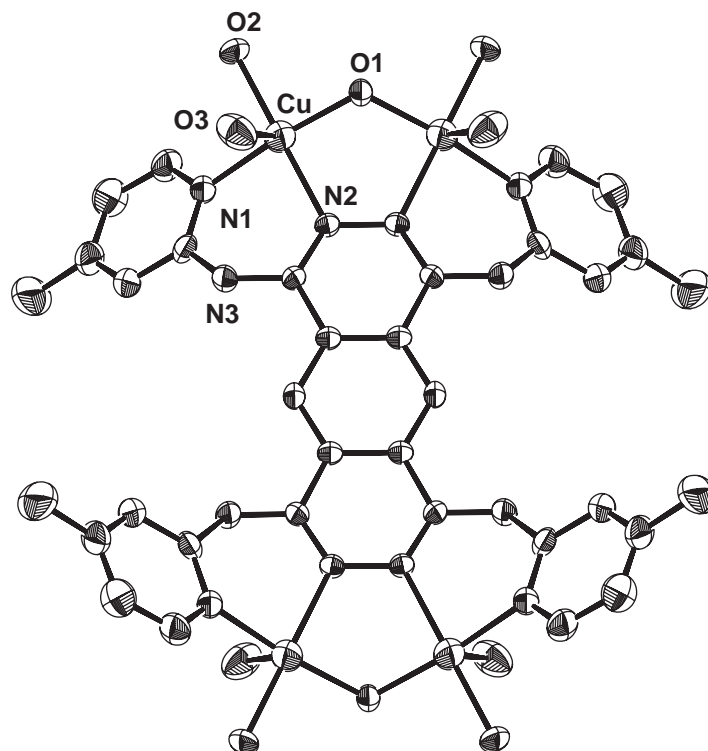


Figure 1 Representation of coordination modes.



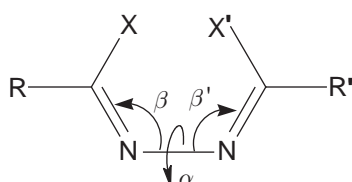
**Figure 2** Schematic structures of  $\mu_{1,2}$  ( $N-N$ ) bridged complexes.



**Figure 3** Structural representation of a tetranuclear  $\text{Cu}^{\text{II}}$  complex of the multi-diazine ( $N-N$ ) containing ligand (87).

very interesting topological variation (Figure 4). Depending on R, R', X, X', and the metal ions, coordination modes will vary with the changes in two types of angles, namely the torsion angle ( $\alpha$ ) about the  $N-N$  linkage, and the bending angle around the two nitrogen atoms ( $\beta$  or  $\beta'$ ).<sup>74</sup>

Those ligands in which both X and X' are H or alkyl or aryl groups are, from the coordination chemistry point of view, comparatively less important, but from the synthetic point of view they are more easily prepared. Basically, they can be derived from the condensation of an aldehyde or ketone and hydrazine.<sup>73</sup> This type of ligand will not be discussed.



**Figure 4** Conformational flexibility of open-chain diazine ( $N-N$ ) systems.

We will focus on the systems where R or R' contain coordinating donors, e.g., pyridine, pyrazine, etc. and X or X' also have the potential to provide additional coordination sites.

Due to the difference of the R, R', X, and X' groups, open-chain diazines may be classified into five types as mentioned earlier (Scheme 1), namely Type 3 to Type 7.

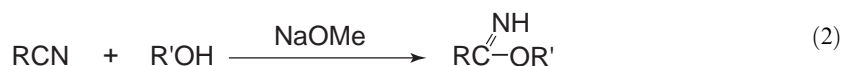
The mixed type (Type 8) containing aromatic and open-chain diazines will be also covered in this section.

### 1.5.3.2 Preparation

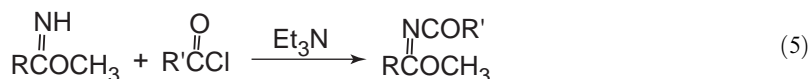
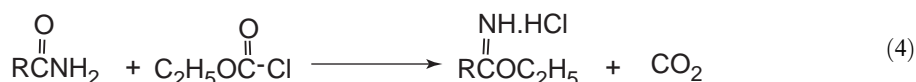
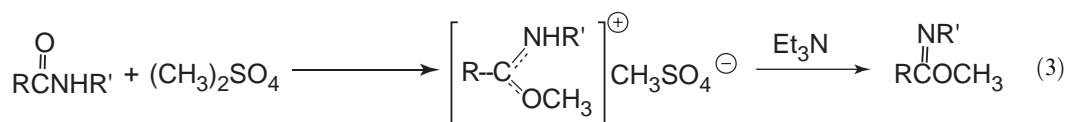
#### 1.5.3.2.1 Preparation of precursors: imidates, amide hydrazones, and hydrazides

Imidate hydrochlorides were first reported in 1877 by Pinner,<sup>145</sup> who reacted the appropriate alcohol and nitrile catalyzed by dried hydrogen chloride gas. The free imidate can be obtained by treatment of the imidate hydrochloride salt with an aqueous potassium carbonate solution and then by extraction using ether.

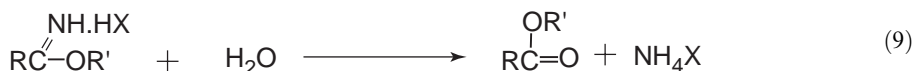
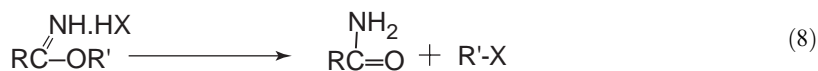
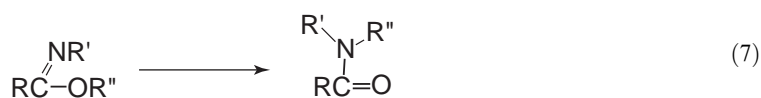
This original Pinner method shown in Equation (1) is still widely used. Solvents such as ether, dioxane, dichloromethane, chloroform, benzene, and nitrobenzene are often used as diluents and as an aid to crystallization of the imidate salt. Methanol and ethanol are the most widely used alcohols in the Pinner reaction, but other alcohols have also been employed and have given satisfactory results. However, the use of substituted nitriles in the Pinner synthesis has some limitations, and some nitriles cannot be converted into corresponding imidates but form amides instead. Fortunately, it has been found that those nitriles which give poor yields under the acidic conditions of the Pinner synthesis give good yields under base-catalyzed conditions (Equation (2)) reported first by Nef, etc.<sup>146,147</sup> The base-catalyzed and acid-catalyzed processes therefore complement each other.



In addition to these two basic methods, some other important methods are shown in Equations (3)–(6).<sup>148</sup>



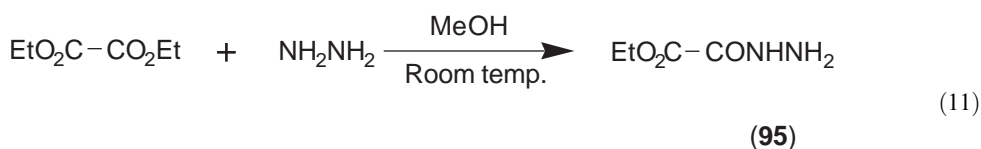
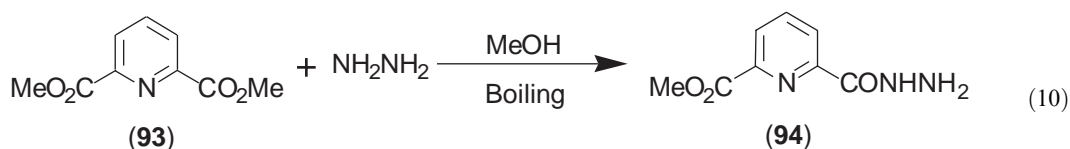
It should be noted that heating the free imidate causes the so-called Chapman rearrangement (Equation (7)),<sup>149</sup> while heating the imidate salts causes decomposition to the corresponding alkyl halide and amide (Equation (8)), and in water, imidates (imidate salts) hydrolyze to corresponding esters and ammonium salts (Equation (9)).



### 1.5.3.2.2 Amide hydrazones (amidrazones) and hydrazides

The preparation of amide hydrazones is quite simple, by mixing corresponding nitriles (or dinitriles) and hydrazine (1:1.5 molar ratio) in ethanol at room temperature and then allowing the mixture to stand overnight. This is called the direct method. The yield by this method is normally good (>90%). If this method does not work, the so-called indirect method can be used, in which a nitrile, e.g., malononitrile, is converted into its imidate then reacted with hydrazine. In early references (e.g., Case, 1965<sup>150</sup>), anhydrous or 95% hydrazine was employed. We have found that 85% hydrazine hydrate still works without any difference in yield. Common recrystallization solvents are benzene or toluene. The amide hydrazones are stable to moisture, and so some amide hydrazones can be recrystallized from water, but they are sensitive to light and heat. As an example, we observed that picolinamide hydrazone (white crystals) partially turns into an orange compound, which has been identified as 3,6-picolin-(2H)-tetrazine.

Hydrazides are normally made by the reaction of acid derivatives, such as esters, acid chlorides, or amides with hydrazine. The interaction of esters and hydrazine hydrate is very straight-forward and gives good yields. If the esters are liquid, simple addition of hydrazine hydrate to the diethyl ether solution of the esters will cause the precipitation of the hydrazide. If the esters are solid or insoluble, solvents such as methanol or ethanol are required. Normally, such reactions take place very rapidly. Diesters normally form dihydrazides if an excess of hydrazine is used. However, we have been able to convert some diesters into monoester-monohydrazide derivatives (e.g., (94) and (95)) by controlling the molar ratio in a highly diluted reaction (for typical examples see Scheme 23).<sup>96</sup>



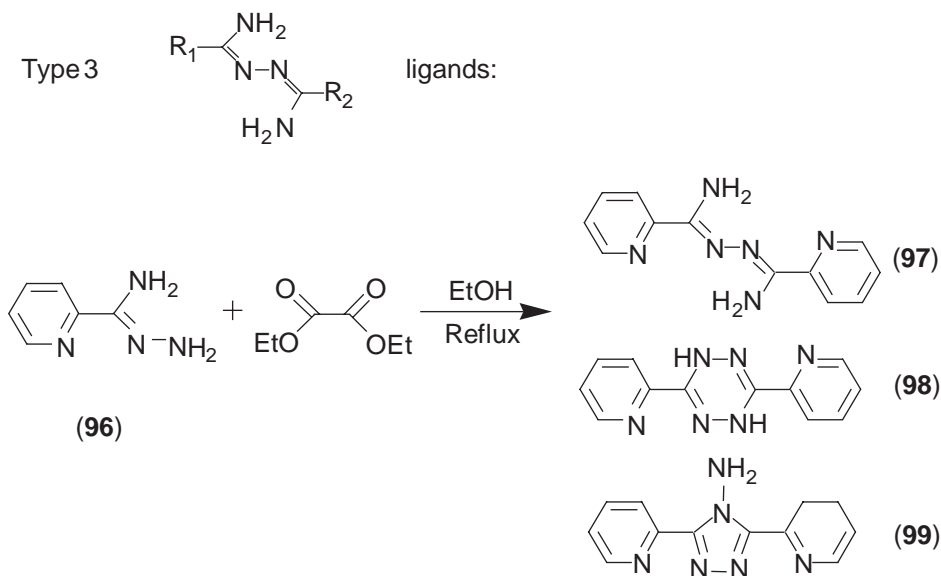
Scheme 23

Once the appropriate imidates, amide hydrazones, or hydrazides are made successfully, the preparations of the target open-chain diazine (*N-N*) ligands is usually fairly straight-forward.

### 1.5.3.3 Ligand Preparations

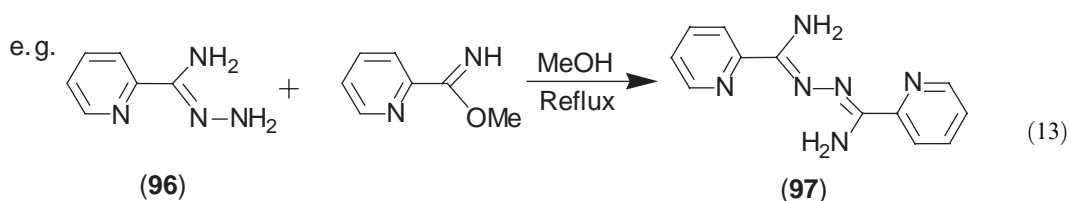
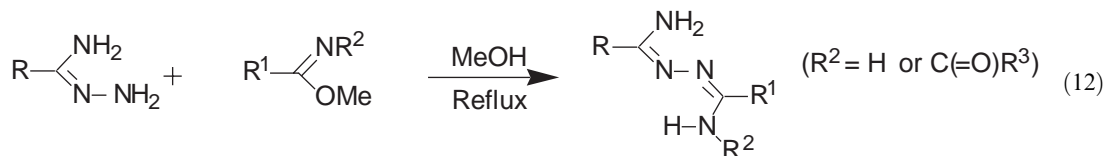
In 1970, Case<sup>151</sup> reacted picolinamide hydrazone (96) with some esters and obtained (97). However, the reaction occurs in low yield, and the mechanism for the reaction was not proposed.

We have repeated the reaction using diethyl oxalate ester and separated three major compounds ((97)–(99)) with a very low yield (~5–10%) for (97) as shown in (Scheme 24).



Scheme 24

We have used a very simple but very effective general synthetic route for ligands of Type 3 by reaction of imidates (normally generated *in situ*) or *N*-substituted imidates with amide hydrazones as shown in Equation (12) (Scheme 25).

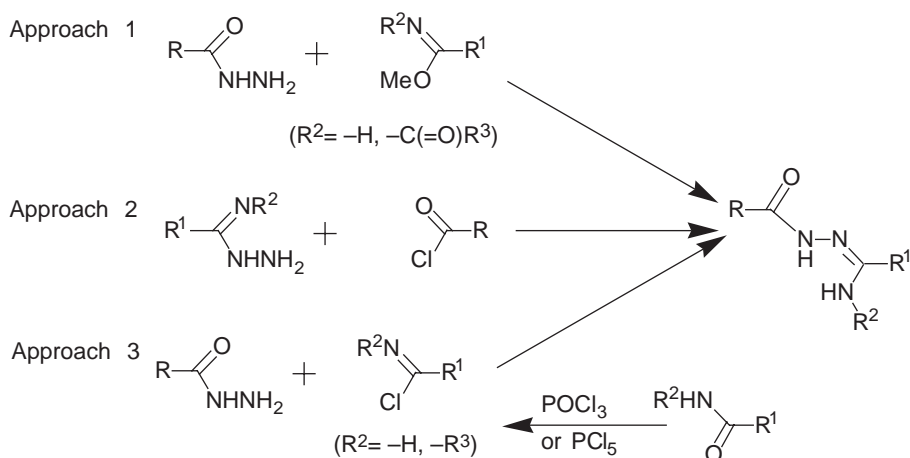
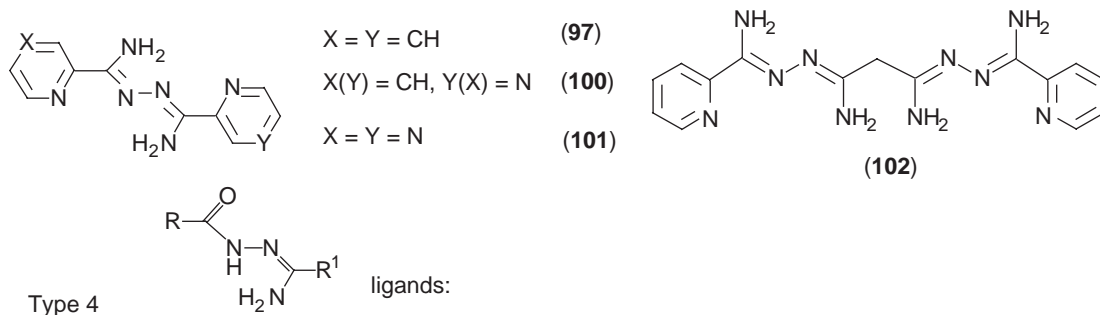


Scheme 25

Typical example for preparation of (97):<sup>75</sup> 2-cyanopyridine (25.2 g, 0.220 mol) was reacted with a solution of sodium methoxide, generated by addition of sodium metal (0.46 g, 0.020 mol) to dry methanol (200 mL), at room temperature for 12 h to form methyl picolinimidate. Picolinamide hydrazone (27.6 g, 0.200 mol) was added to the solution of methyl picolinimidate. Glacial acetic acid (0.5 mL) was added to the resulting clear solution to remove the catalytic amount of base. A yellow crystalline compound formed immediately, and the mixture was refluxed for an additional 1 h. Cooling to room temperature, followed by filtration provided (97) in very high yield (>90% referred to picolinamide hydrazone).

This method has been applied very successfully in making a large number of Type 3 ligands by using varieties of amidrazones and corresponding imidates. The limiting factor is often the stability, solubility, and ease of making the amidrazones. Therefore, ligands (97) and (101) have been made by the reactions of picolinamide (or pyrazinamide) hydrazone with the

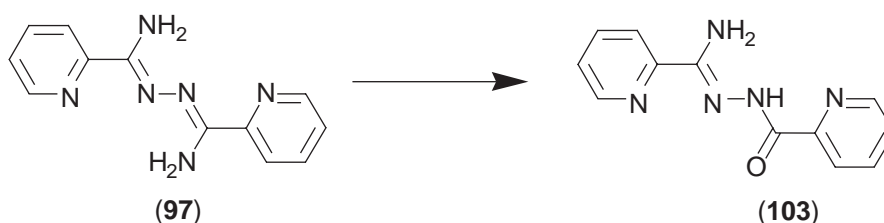
corresponding imidate, and ligand (**100**) was made by the reaction of picolinamide hydrazone with pyridazine imidate, not by the reaction of pyrazinamide hydrazone with methyl picolinimidate due to the low yield and poor stability of pyrazinamide hydrazone. The compound (**102**), containing two Type 3 subunits, was made by reaction of picolinamide hydrazone with ethyl malonicdiimide hydrochloride, which was generated by the classic Pinner reaction as mentioned before.<sup>96</sup>



Scheme 26

There are three basic approaches (Scheme 26) to make Type 4 ligands.

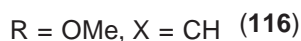
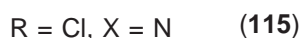
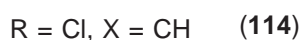
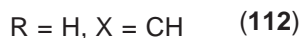
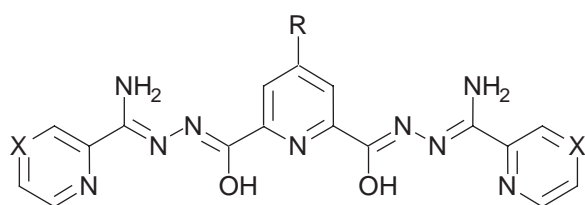
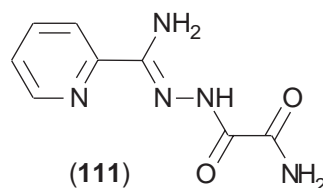
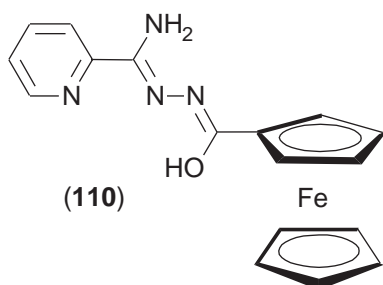
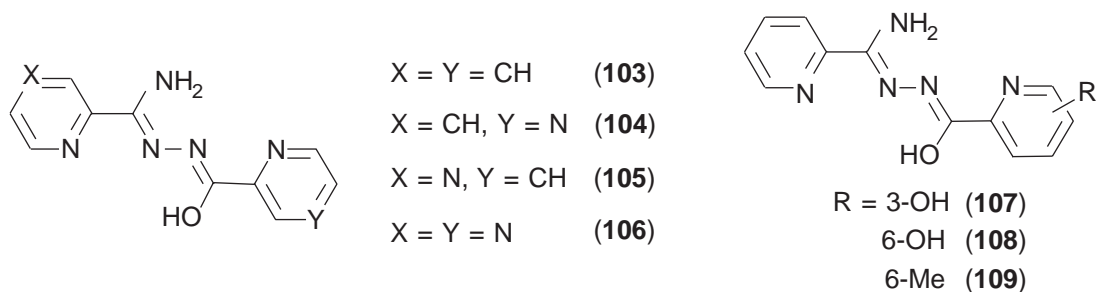
We have employed Approach 1 shown in (Scheme 26) in making many Type 4 ligands very successfully. However, the others are also practically useful. We have found a very unpredictable, hence less important, metal ion catalyzed hydrolysis approach to (**103**) starting with (**97**) (Scheme 27).<sup>77,82</sup> It should be pointed out that amidhydrazones reacting with esters usually do not provide significant amounts of Type 4 ligands. The imidates can be used in their free form or



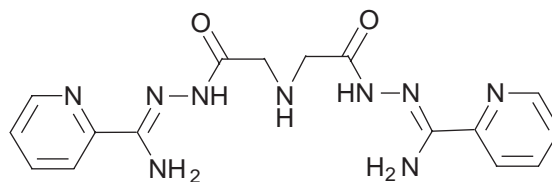
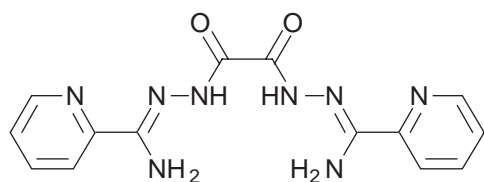
Scheme 27

as their HCl salts, since weakly acidic conditions are favorable to the formation of this type of ligand. Therefore, when a hydrazide is added to the methanolic solution of the free imidate, which is generated instantly by a base-catalyzed process, a small amount of acetic acid is needed to remove the catalytic amount of base (e.g., NaOMe) in order to keep the solution acidic.

The synthesis of ligands which only contain single ((103)–(111)) or multi but symmetrical –C(OH)=N–N=C(NH<sub>2</sub>)– ((112)–(118)) groups are straight-forward, i.e., just by the reactions of hydrazides or dihydrazides with the corresponding imidates. These include (103)–(108),<sup>82,90,94,95</sup> (109),<sup>104</sup> (110),<sup>101</sup> (111),<sup>152</sup> and (112)–(118).<sup>81,83,90,96,100,102</sup>

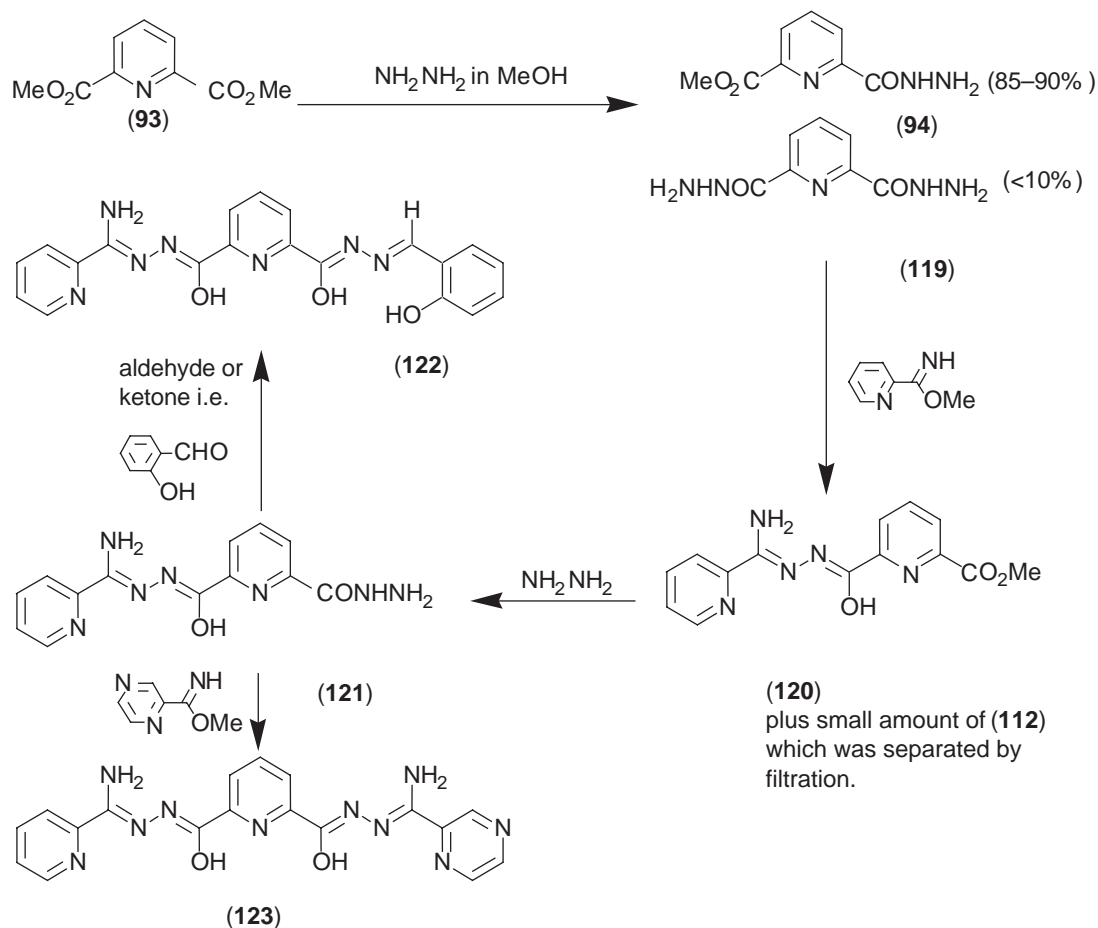


(1)

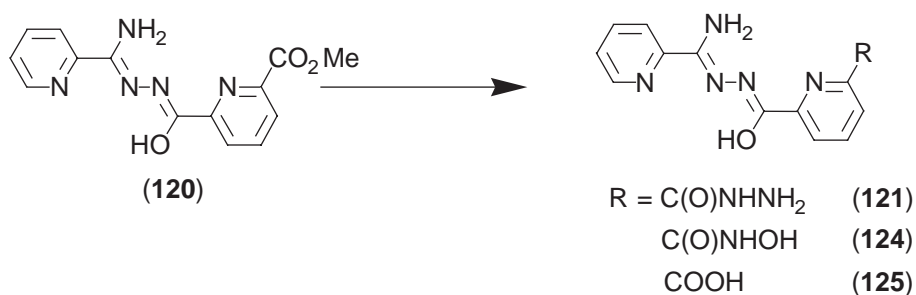


The unsymmetrical ligands (122)<sup>96</sup> and (123)<sup>104</sup> were synthesized from (121) which was derived from monoester monohydrazide (94) (see Equation (10)) through ligand (120) shown in (Scheme 28).

The ligands (**121**) and (**124**) were obtained by the reaction of (**120**) with hydrazine (shown in Scheme 29) and hydroxylamine, respectively. (**125**) was formed by a simple hydrolysis process of (**120**) in aqueous NaOH solution.<sup>99</sup>



Scheme 28



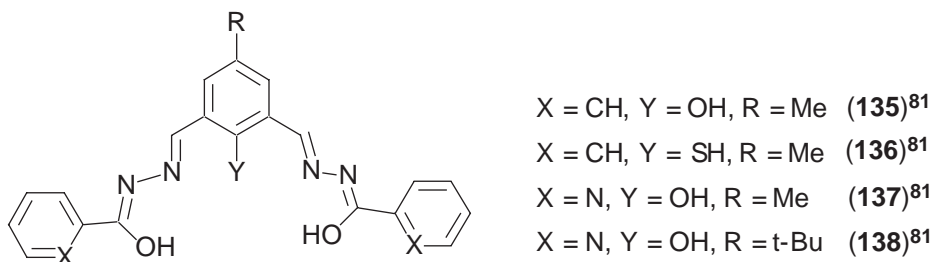
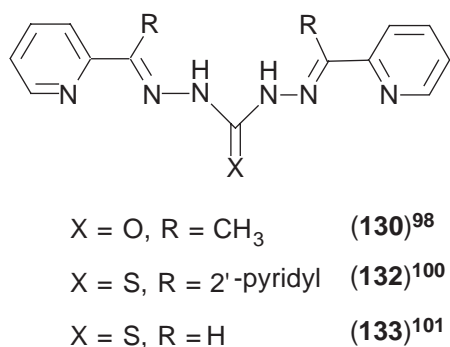
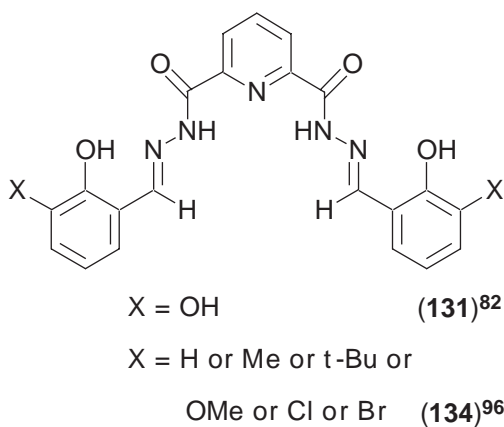
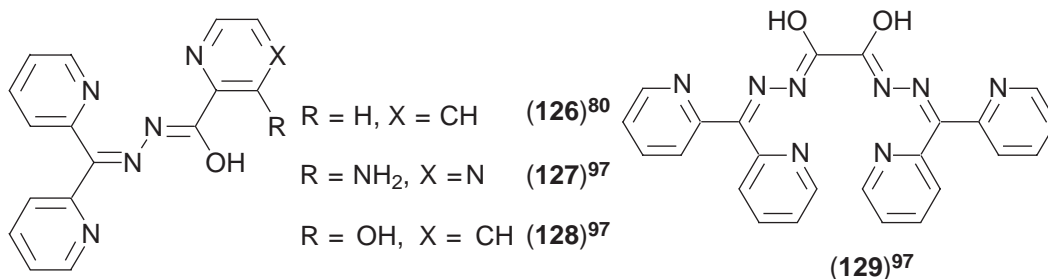
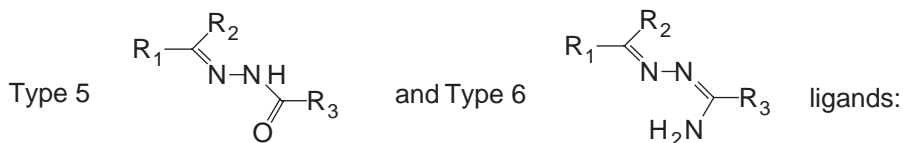
Scheme 29

Typical reaction for making a Type 4 ligand using (**114**) as an example: The procedures are essentially the same as those for making Type 3 ligands, e.g., (**97**) by using a hydrazide (or dihydrazide) instead of using an amide hydrazone. A solution of methyl picolinimidate was prepared *in situ* as mentioned earlier, by reaction of 2-cyanopyridine (6.3 g, 60 mmol) in dry methanol (50 mL) in the presence of a catalytic amount of NaOMe made from 0.14 g sodium with methanol. 4-Chloro-2,6-pyridine dicarboxylic acid dihydrazide (4.6 g, 20 mmol), prepared by reacting 4-chloro-2,6-dimethyl-pyridine dicarboxylate with hydrazine in methanol at room temperature was added to the above solution, followed by a few drops of glacial acetic acid.

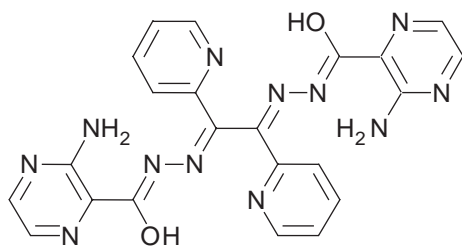
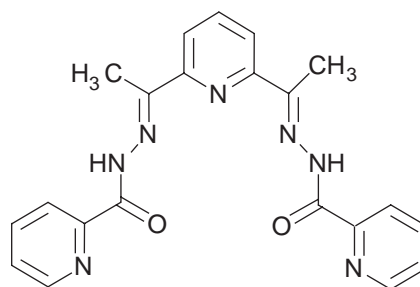
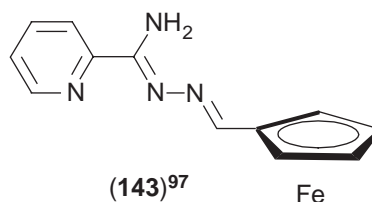
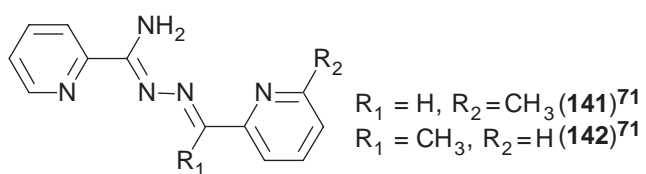


The mixture was stirred and refluxed for 1 h. A yellow powder was obtained, which was filtered off, washed with water, methanol, and then diethyl ether, and dried under vacuum (yield: 8.5 g).<sup>102</sup> Adopting this method improves the yield for (**112**) (85% reported in Zhao *et al.*<sup>84</sup>).

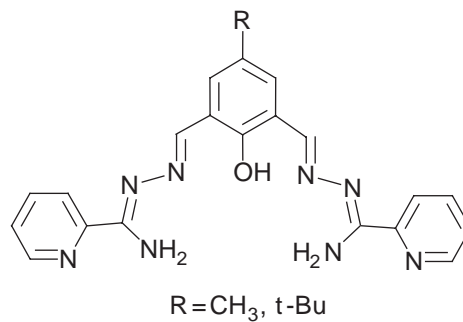
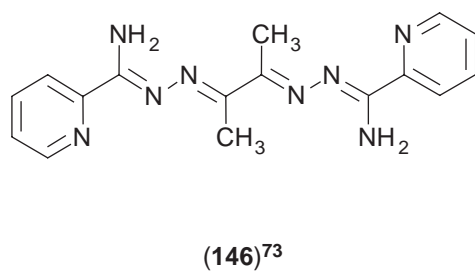
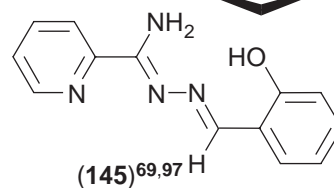
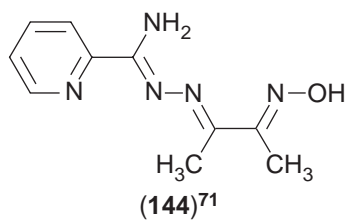
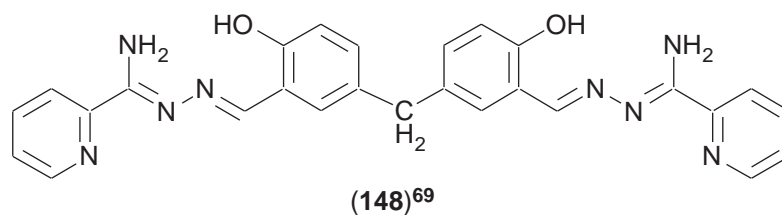
Both *N*-substituted hydrazides (Type 5) and *N*-substituted amidrazones (Type 6) are very easy to make, typically by the reaction of hydrazides or dihydrazide (for Type 5) or amidrazones or diamidrazones (for Type 6) with carbonyl compounds. The solvents for those reactions are normally methanol or ethanol. A typical procedure for making Type 5 and Type 6 ligands can be represented by (**129**).<sup>104</sup>

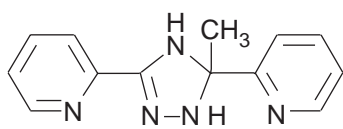


Oxalic dihydrazide (1.18 g, 10.0 mmol) was added to di-2-pyridyl ketone (3.68 g, 20.0 mmol) in methanol (100 mL), and then the mixture was refluxed for 10 h. A pale yellow solid was obtained, which was filtered off, washed with methanol, and dried under vacuum (yield: 3.38 g, 75%). The details for making other ligands of Type 5 and Type 6 can be found in the related references.

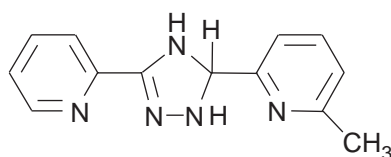
(139)<sup>90</sup>(140)<sup>98,99</sup>

Fe

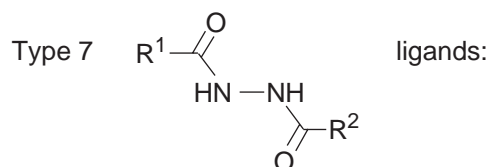
(147)<sup>69</sup>



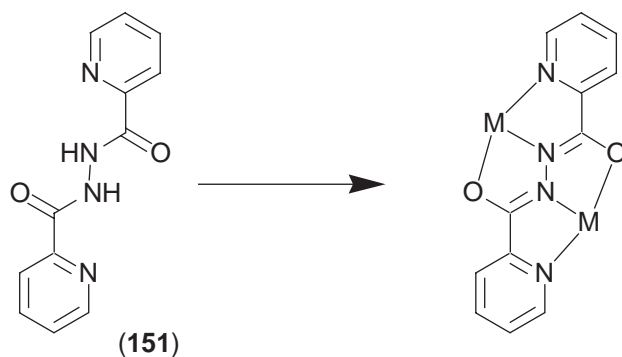
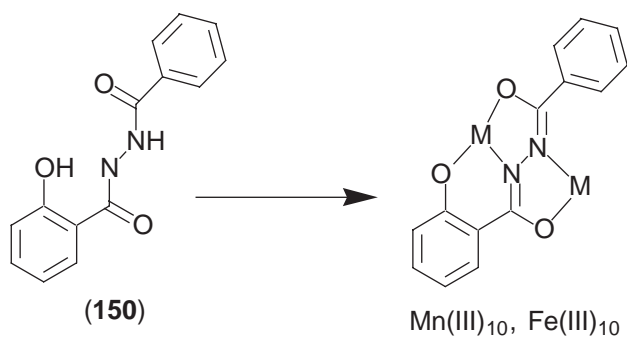
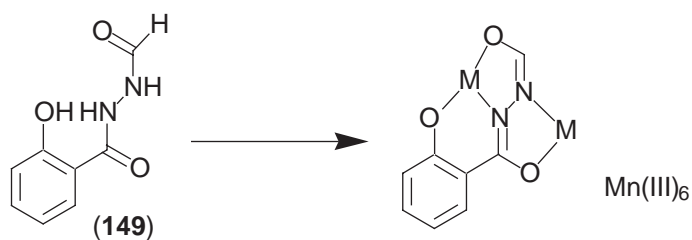
(141)



(142)



Two points should be mentioned for *N*-alkylated amidrazone ligands (Type 6). Firstly, the reaction of *N*-alkylated hydrazones ( $R^1R^2C=N-NH_2$ ) with corresponding imidates ( $R^3C(=NH)OMe$ ) may also be a practical synthetic method. Secondly, an earlier literature reference (Case, 1965<sup>150</sup>) suggested that such compounds are triazoline species as shown below.



Scheme 30

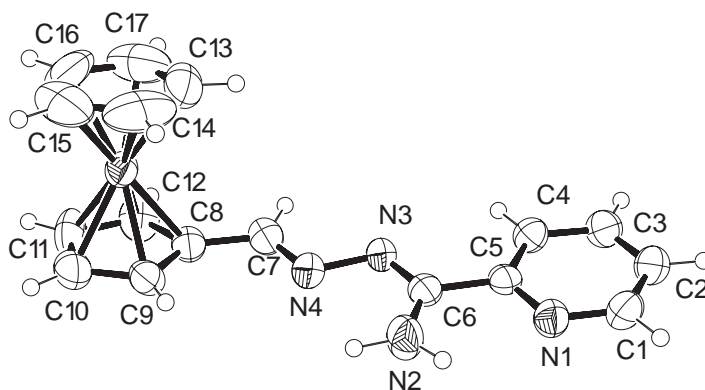


Figure 5 Ortep drawing of (143).

However, our X-ray structural analysis for some complexes of this type of ligand showed that the ligands adopt open-chain structures and are not cyclized. We are confident that the free ligands also adopt open-chain structures, simply because there are two typical C=N stretching bands in their IR spectra, which has been ultimately confirmed in one case by an X-ray analysis of (143) (Figure 5).<sup>104</sup>

This type of ligand can be synthesized simply by the reaction of a hydrazide with the corresponding carboxylic acid chloride. However, among all the open-chain diazine (*N-N*) ligands, Type 7 have not received much attention from the coordination chemistry point of view. Scheme 30 shows three of ligands of this type, along with their coordination modes to metal ions. (Figure 6) shows a metallacrown compound of (150), in which two adjacent Mn<sup>III</sup> centers are bridged by one open-chain diazine (*N-N*) unit in a *trans* conformation.<sup>112</sup>

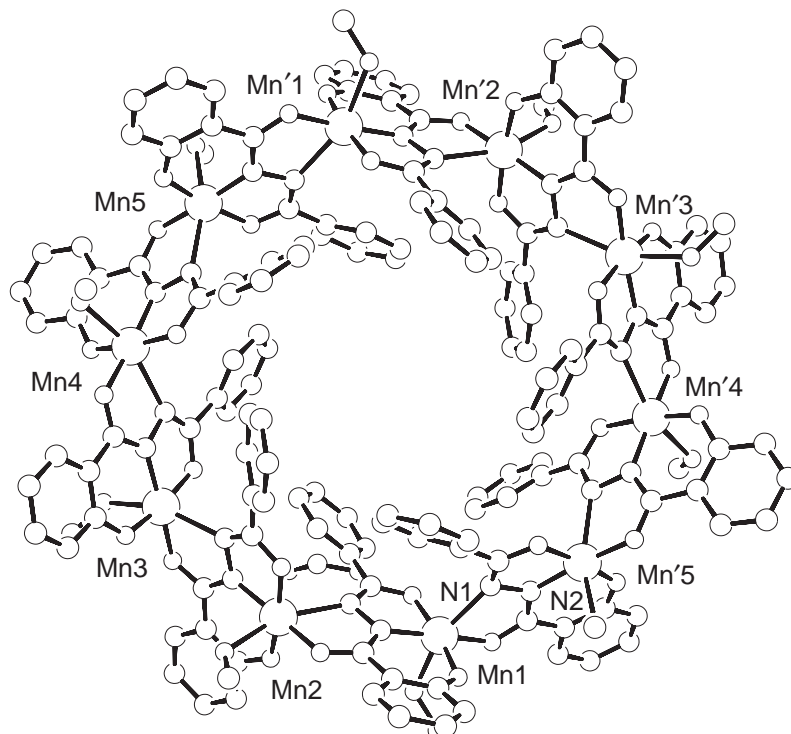


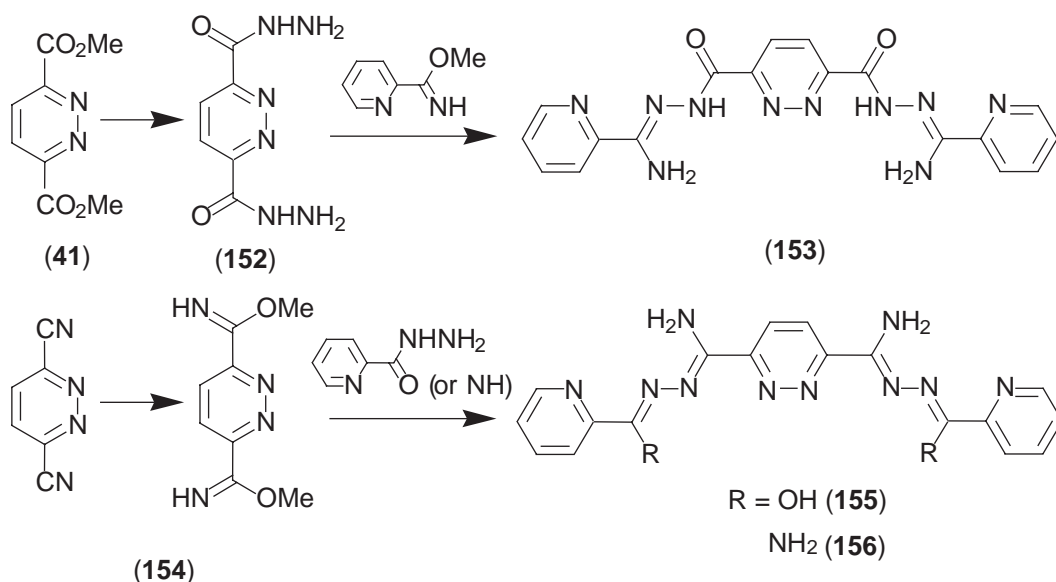
Figure 6 Structural representation of [Mn<sup>III</sup>(150)-(MeOH)]<sub>10</sub>.

### 1.5.3.3.1 Type 8; mixed diazine (N–N) ligands

A new diazine (N–N) ligand family (Type 8), which contains both pyridazine and open-chain diazine (N–N) moieties as defined earlier, can be constructed easily from pyridazinedicarboxylic diesters and pyridazinedinitriles. A practical synthetic method for making pyridazinedicarboxylic diesters has already been mentioned in Section 1.5.2.2.1(iii). Some other alternative ways can be found in relevant books, e.g., Brown, 2000.<sup>125</sup> The synthesis of 3,6-pyridazine dinitrile has been described earlier (see Section 1.5.2.2.1(i)). Typical Type 8 ligands such as (153) (Scheme 31), which contains two open-chain diazine (N–N) subunits (Type 4), and one pyridazine diazine unit (Type 1), has been successfully made by Thompson *et al.*<sup>93</sup> (153) produces a novel incompletely metallated trinuclear Ni<sup>II</sup> complex with a helical structure. (Figure 7) shows the structural representation of the trinuclear cation in the complex. Some similar ligands, e.g., (155) and (156), have also been synthesized from the corresponding 3,6-dimethyl-pyridazinediimide (154) (see Scheme 31).<sup>104</sup>

### 1.5.3.4 Coordination Chemistry

Due to their high coordination flexibility, originating from the rotation around the N–N bond, and the presence of possible additional donors either on R/R' (e.g., pyridine, pyrazine, etc.) or X/X' (e.g., NH<sub>2</sub>, OH, SH, etc.), these open-chain diazine (N–N) ligands are extremely



Scheme 31

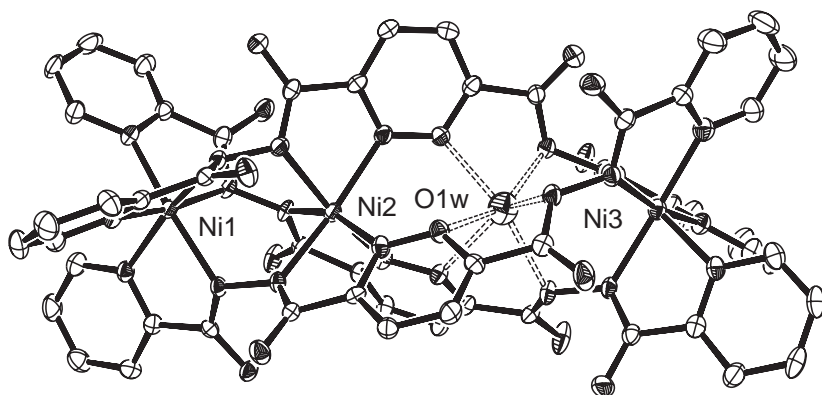
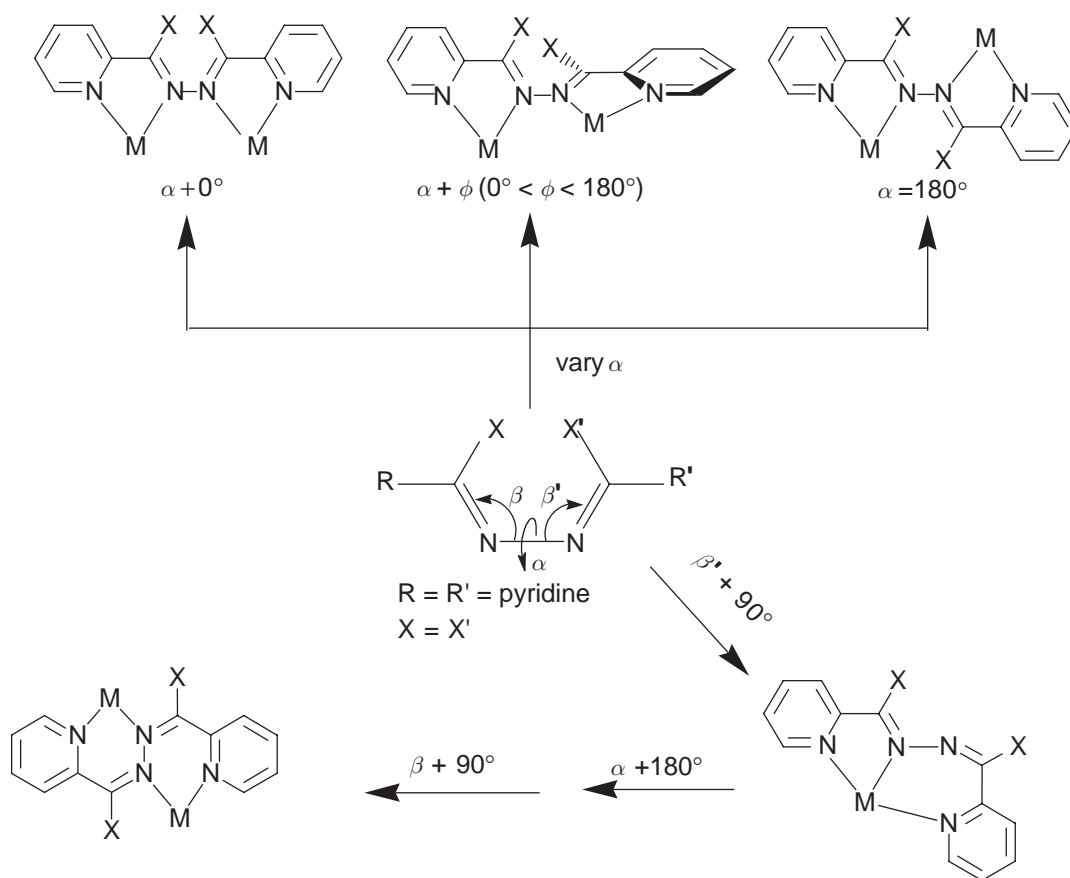


Figure 7 Structural representation of the trinuclear cation in [Ni<sub>3</sub>(153-H)<sub>3</sub>(H<sub>2</sub>O)](NO<sub>3</sub>)<sub>3</sub>·2H<sub>2</sub>O.



Scheme 32

interesting, presenting a very unusual arrangement of potential donor sites, and have generated a huge number of transition metal clusters with nuclearity from two to 10 with variable geometries.<sup>76,78,81,83,84,90,94,97,100,102</sup>

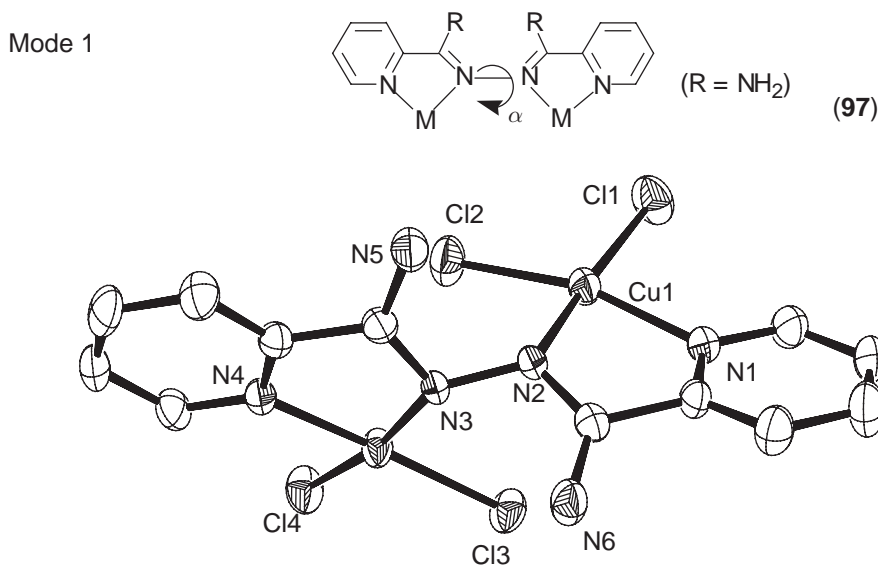
Assuming that both X and X' do not provide coordination sites, we can propose at least five possible coordination modes for this type of ligand, through a series of topological operations (Scheme 32). However, the real coordination modes are closely connected to the nature of the metal ions and the identity of the ligand, the anions, organic co-ligands, the presence of hydrogen bonding or stacking interactions and solvent, etc. For the ligands themselves, when X and/or X' contains some available coordination sites, more complicated coordination modes might occur. Based on X-ray structural analysis of a large number of complexes derived from open-chain-diazine ligands, some rough conclusions about their coordination modes can be made.

For Type 3 ligands, e.g., (97), two coordination modes have been found. Almost all the complexes adopt a *N*–*N* single bond bridging, bisbidentate mode (mode 1, Figure 8),<sup>75–82</sup> with one exception in a vanadyl ( $\text{VO}_2^+$ ) complex of (97) in which the ligand adopts a nonbridging mode (mode 2, Figure 9).<sup>74</sup>

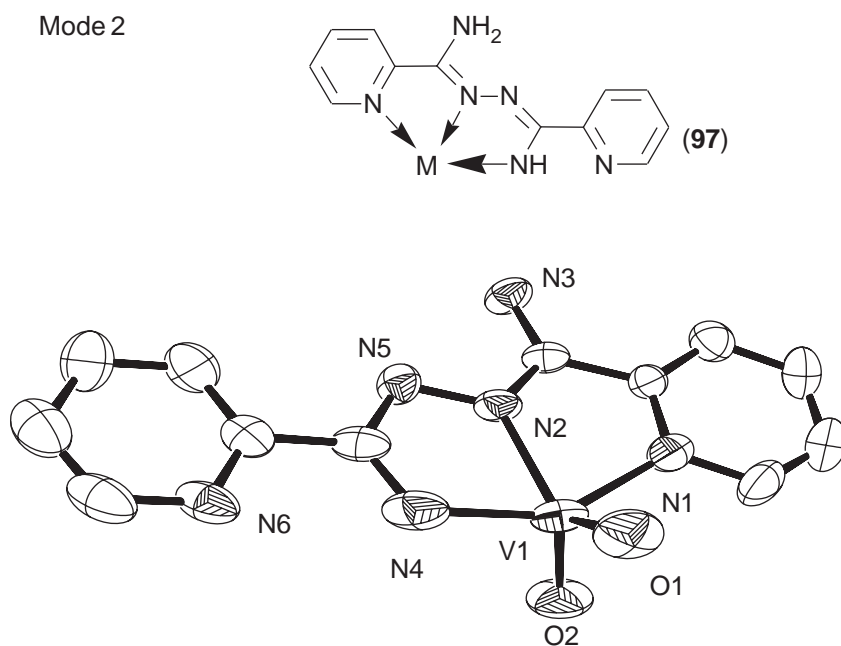
Type 4 ligands have two dominant modes (e.g., represented by (103) and (112)), an alkoxide bridging (mode 3) and a *trans* *N*–*N* single bond bridging (mode 4), and one minor mode, e.g., a nonbridging mode 5, as shown in (Figures 10–12), respectively. These modes are typically demonstrated by a number of tetranuclear, pentanuclear, octanuclear, and nonanuclear complexes<sup>76–85,87,88,95</sup> for mode 3, a dinuclear copper(II) complex<sup>74</sup> for mode 4, and a mononuclear  $\text{Fe}^{\text{III}}$  complex<sup>77</sup> for mode 5.

Type 5 ligands have very similar coordination modes to those for Type 4 ligands in their metal complexes, with metal centers bridged through alkoxide (mode 3) in a *cis* form or *N*–*N* single bond in a *trans* form (mode 4).

In their complexes, Type 6 ligands normally adopt a *trans* *N*–*N* single bond bridging mode (mode 4) or a twisted *N*–*N* single bond bridging mode (mode 1)<sup>80</sup> and a nonbridging mode mode 6 (Figure 13).<sup>76</sup>



**Figure 8** Structural representation of mode 1 in a dinuclear copper(II) complex containing ligand (97).



**Figure 9** Structural representation of mode 2 in a mononuclear complex containing ligand (97).

In their polynuclear metal complexes, Type 7 ligands mainly bind metals through the *N–N* single bonds in a *trans* form (mode 4) as shown in (Scheme 30).

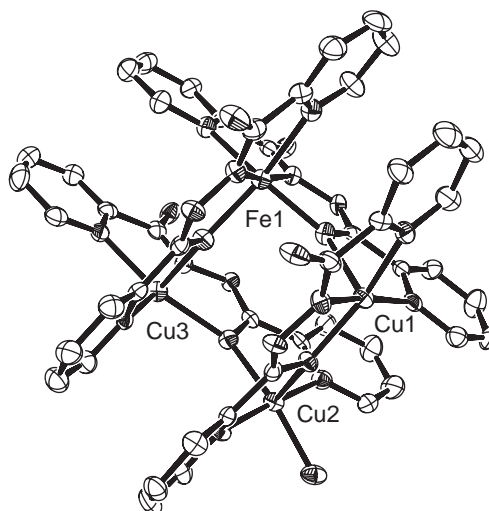
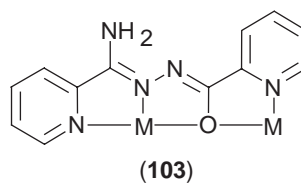
For the mixed Type 8 ligands, very little coordination chemistry has been done. Therefore, it is too early to draw any conclusions regarding their coordination modes.

#### 1.5.4 CONCLUDING REMARKS

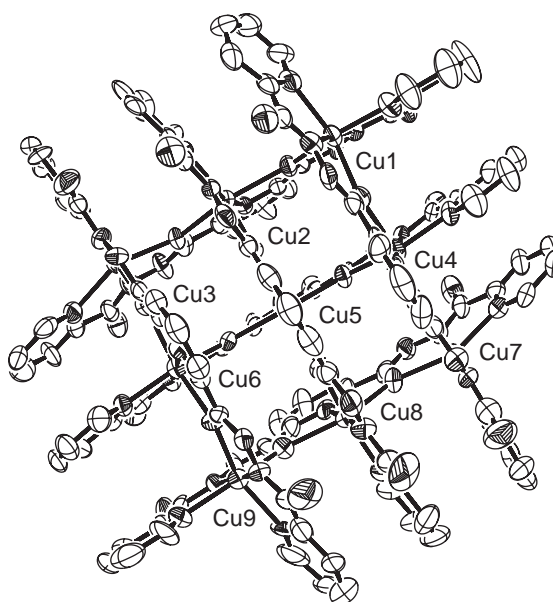
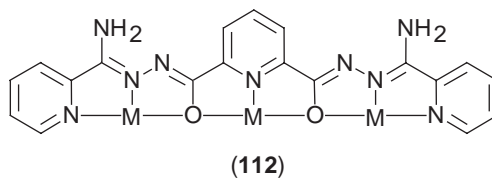
This report gives an overview of some pyridazine, phthalazine, and open-chain diazine (*N–N*)-derived ligands, including their synthesis and some coordination properties. The pyridazine- and

Mode 3

Example 1 of mode 3

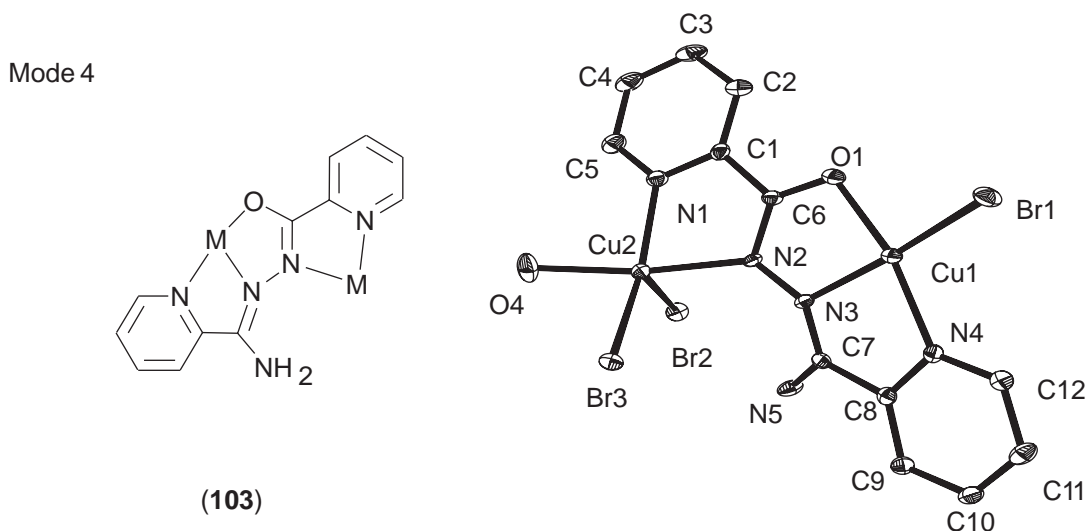


Example 2 of mode 3

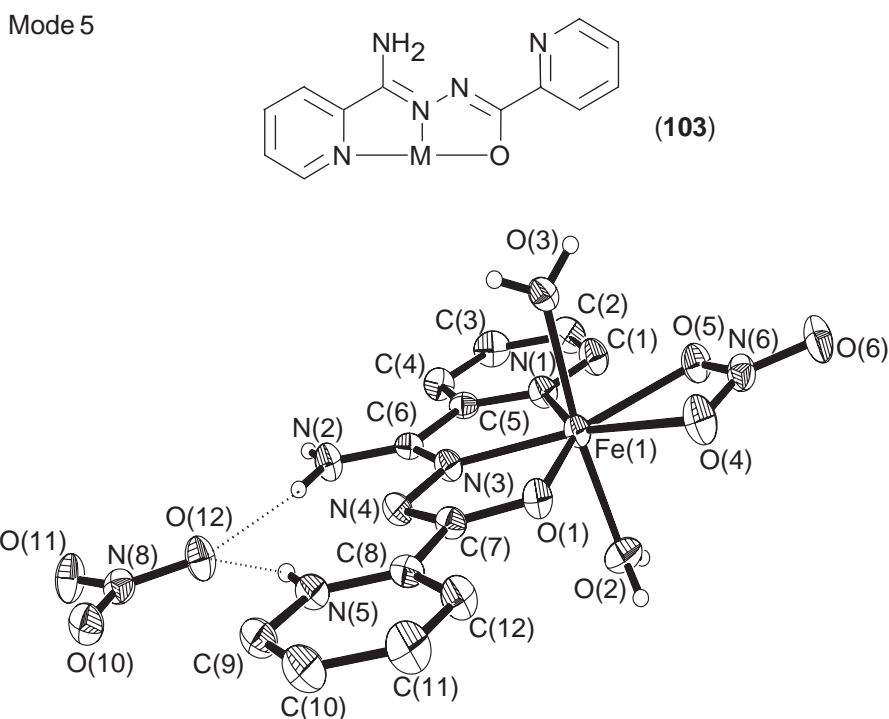


**Figure 10** Structural representation of mode 3 examples. Top:  $\text{FeCu}_3$  tetranuclear complex of (103); bottom:  $\text{Cu}_9$  grid complex of (112).





**Figure 11** Structural representation of mode 4 in a dinuclear copper(II) complex containing ligand (103).



**Figure 12** Structural representation of mode 5 in a mononuclear Fe<sup>III</sup> complex containing ligand (103).

phthalazine-derived ligands and their coordination chemistry have been studied extensively over the last 30 years or so but still continue to attract interest.

Even though open-chain diazine (*N-N*) ligands and their coordination chemistry have been studied since the 1950s, the very recent developments of this class of ligands and their complexes has opened a large new area in coordination chemistry related to their unique structures and physical properties, such as the magnetic properties<sup>81-84</sup> and electrochemical properties<sup>94,102</sup> of the complexes. With the prospect of applying diazine (*N-N*)-derived polynuclear cluster and grid complexes in high-technology areas, e.g., information storage,<sup>153</sup> we can anticipate that more complex extended diazine (*N-N*) ligands, with open-chain and heterocyclic rings, and their complexes will be designed and synthesized in the future.

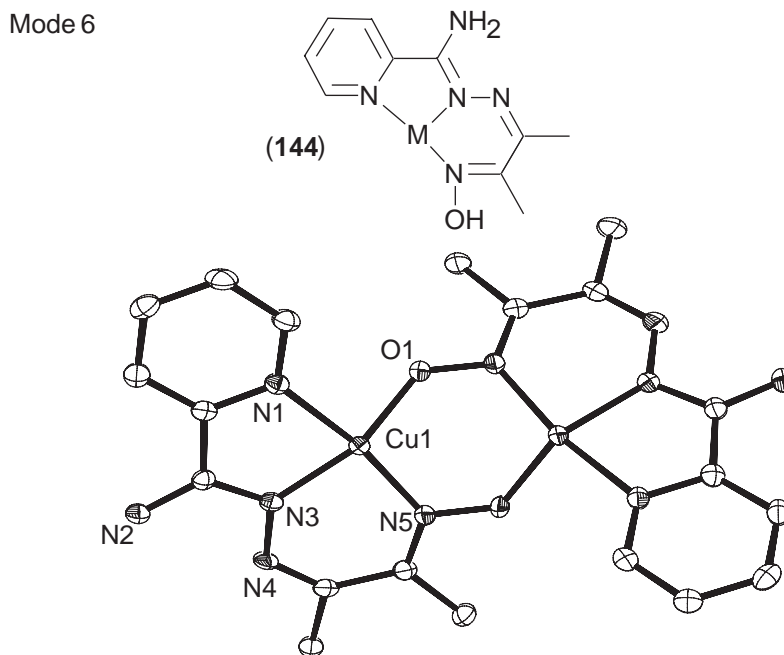


Figure 13 Structural representation of mode 6 in a dinuclear copper(II) complex containing ligand (144).

### 1.5.5 REFERENCES

1. Steel, P. J. *Coord. Chem. Rev.* **1990**, *106*, 227–265.
2. Thompson, L. K.; Chacko, V. T.; Elvidge, J. A.; Lever, A. B. P.; Parish, R. V. *Can. J. Chem.* **1969**, *47*, 4141–4152.
3. Youinou, M.-T.; Rahmouni, N.; Fischer, J.; Osborn, J. A. *Angew. Chem., Int. Ed. Engl.* **1992**, *6*, 733–735.
4. Ghedini, M.; De Munno, G.; Denti, G.; Manotti-Lanfredi, A. M.; Tiripicchio, A. *Inorg. Chim. Acta* **1982**, *57*, 87–93.
5. Dapporto, P.; De Munno, G.; Bruno, G.; Romeo, M. *Acta Crystallogr.* **1983**, *C39*, 718–720.
6. De Munno, G.; Denti, G.; Dapporto, P. *Inorg. Chim. Acta* **1983**, *74*, 199–203.
7. De Munno, G.; Denti, G. *Acta Crystallogr.* **1984**, *C40*, 616–618.
8. De Munno, G.; Bruno, G. *Acta Crystallogr.* **1984**, *C40*, 2022–2024.
9. Dapporto, P.; De Munno, G.; Sega, A.; Meali, C. *Inorg. Chim. Acta* **1984**, *83*, 171–176.
10. Attanasio, D.; Fares, V.; Imperatori, P. *J. Chem. Soc., Chem. Commun.* **1986**, 1476–1477.
11. Tiripicchio, A.; Manotti-Lanfredi, A. M.; Ghedini, M.; Neve, F. *J. Chem. Soc., Chem. Commun.* **1983**, 97–98.
12. Andrew, J. E.; Blake, A. B. *J. Chem. Soc., A* **1969**, 1408–1414.
13. Ball, P. W.; Blake, A. B. *J. Chem. Soc., A* **1969**, 1415–1422.
14. Ball, P. W.; Blake, A. B. *J. Chem. Soc., Dalton Trans.* **1974**, 852–859.
15. Escuer, A.; Vicente, R.; Mernari, B.; Gueddi, A. E.; Pierrot, M. *Inorg. Chem.* **1997**, *36*, 2511–2516, and references therein.
16. Sueur, S.; Lagrenée, M.; Abraham, F.; Bremard, C. *J. Heterocycl. Chem.* **1987**, *24*, 1285–1289.
17. Lever, A. B. P.; Thompson, L. K.; Reiff, W. M. *Inorg. Chem.* **1972**, *11*, 104–109.
18. Bautista, D. V.; Bullock, G.; Hartstock, F. W.; Thompson, L. K. *J. Heterocyclic Chem.* **1983**, *20*, 345–347.
19. Bullock, G.; Hartstock, F. W.; Thompson, L. K. *Can. J. Chem.* **1983**, *61*, 57–62.
20. Bautista, D. V.; Dewan, J. C.; Thompson, L. K. *Can. J. Chem.* **1982**, *60*, 2583–2593.
21. Thompson, L. K. *Can. J. Chem.* **1983**, *61*, 579–583.
22. Thompson, L. K.; Hanson, A. W.; Ramaswamy, B. S. *Inorg. Chem.* **1984**, *23*, 2459–2465.
23. Thompson, L. K.; Hartstock, F. W.; Robichaud, P.; Hanson, A. W. *Can. J. Chem.* **1984**, *62*, 2755–2762.
24. Robichaud, P.; Thompson, L. K. *Inorg. Chim. Acta* **1984**, *85*, 137–142.
25. Mandal, S. K.; Thompson, L. K.; Hanson, A. W. *J. Chem. Soc., Chem. Commun.* **1985**, 1709–1711.
26. Thompson, L. K.; Woon, T. C.; Murphy, D. B.; Gabe, E. J.; Lee, F. L.; LePage, Y. *Inorg. Chem.* **1985**, *24*, 4719–4725.
27. Thompson, L. K.; Mandal, S. K.; Gabe, E. J.; Charland, J.-P. *J. Chem. Soc., Chem. Commun.* **1986**, 1537–1539.
28. Rosenberg, L.; Thompson, L. K.; Gabe, E. J.; Lee, F. L. *J. Chem. Soc., Dalton Trans.* **1986**, 625–631.
29. Mandal, S. K.; Thompson, L. K.; Newlands, M. J.; Lee, F. L.; LePage, Y.; Charland, J.-P.; Gabe, E. J. *Inorg. Chim. Acta* **1986**, *122*, 199–205.
30. Mandal, S. K.; Woon, T. C.; Thompson, L. K.; Newlands, M. J.; Gabe, E. J. *Aust. J. Chem.* **1986**, *39*, 1007–1021.
31. Woon, T. C.; McDonald, R.; Mandal, S. K.; Thompson, L. K. *J. Chem. Soc., Dalton Trans.* **1986**, 2381–2386.
32. Thompson, L. K.; Woon, T. C. *Inorg. Chim. Acta* **1986**, *111*, 45–50.
33. Thompson, L. K.; Mandal, S. K.; Gabe, E. J.; Lee, F. L.; Addison, A. W. *Inorg. Chem.* **1987**, *26*, 657–664.
34. Mandal, S. K.; Thompson, L. K.; Gabe, E. J.; Lee, F. L.; Charland, J.-P. *Inorg. Chem.* **1987**, *26*, 2384–2389.
35. Thompson, L. K.; Mandal, S. K.; Rosenberg, L.; Lee, F. L.; Gabe, E. J. *Inorg. Chim. Acta* **1987**, *133*, 81–91.
36. Thompson, L. K.; Lee, F. L.; Gabe, E. J. *Inorg. Chem.* **1988**, *27*, 39–46.
37. Mandal, S. K.; Thompson, L. K.; Gabe, E. J.; Charland, J.-P.; Lee, F. L. *Inorg. Chem.* **1988**, *27*, 855–859.
38. Thompson, L. K.; Mandal, S. K.; Charland, J.-P.; Gabe, E. J. *Can. J. Chem.* **1988**, *66*, 348–354.

39. Wen, T.; Thompson, L. K.; Lee, F. L.; Gabe, E. J. *Inorg. Chem.* **1988**, *27*, 4190–4196.
40. Mandal, S. K.; Thompson, L. K.; Newlands, M. J.; Charland, J.-P.; Gabe, E. J. *Inorg. Chim. Acta* **1990**, *178*, 169–178.
41. Lacroix, P.; Kahn, O.; Valade, L.; Cassoux, P.; Thompson, L. K. *Synth. Met.* **1990**, *39*, 81–90.
42. Tandon, S. S.; Mandal, S. K.; Thompson, L. K.; Hynes, R. C. *Inorg. Chem.* **1992**, *31*, 2215–2222.
43. Tandon, S. S.; Mandal, S. K.; Thompson, L. K.; Hynes, R. C. *J. Chem. Soc., Chem. Commun.* **1991**, 1572–1753.
44. Tandon, S. S.; Thompson, L. K.; Hynes, R. C. *Inorg. Chem.* **1992**, *31*, 2210–2214.
45. Chen, L. Ph.D. Thesis, Memorial University of Newfoundland, 1993.
46. Chen, L.; Thompson, L. K.; Bridson, J. N. *Inorg. Chem.* **1993**, *32*, 2938–2943, and references therein.
47. Chen, L.; Thompson, L. K.; Bridson, J. N. *Inorg. Chim. Acta* **1993**, *214*, 67–76.
48. Chen, L.; Thompson, L. K.; Bridson, J. N. *Can. J. Chem.* **1992**, *70*, 1886–1896.
49. Chen, L.; Thompson, L. K.; Bridson, J. N. *Can. J. Chem.* **1992**, *70*, 2709–2716.
50. Chen, L.; Thompson, L. K.; Bridson, J. N. *Can. J. Chem.* **1993**, *71*, 1086–1093.
51. Chen, L.; Thompson, L. K.; Tandon, S. S.; Bridson, J. N. *Inorg. Chem.* **1993**, *32*, 4063–4068.
52. Tandon, S.; Chen, L.; Thompson, L. K.; Connors, S. P.; Bridson, J. N. *Inorg. Chim. Acta* **1993**, *213*, 289–300.
53. Tandon, S. S.; Thompson, L. K.; Bridson, J. N. *Inorg. Chem.* **1993**, *32*, 32–39.
54. Tandon, S. S.; Thompson, L. K.; Bridson, J. N.; Bubenik, M. *Inorg. Chem.* **1993**, *32*, 4621–4631.
55. Tandon, S. S.; Thompson, L. K.; Manuel, M. E.; Bridson, J. N. *Inorg. Chem.* **1994**, *33*, 5555–5570.
56. Thompson, L. K.; Tandon, S. S.; Manuel, M. E. *Inorg. Chem.* **1995**, *34*, 2356–2366.
57. Tandon, S. S.; Thompson, L. K.; Miller, D. O. *J. Chem. Soc., Chem. Commun.* **1995**, 1907–1908.
58. Zhang, Y.; Thompson, L. K.; Bridson, J. N.; Bubenik, M. *Inorg. Chem.* **1995**, *34*, 5870–5877.
59. Zhang, Y.; Thompson, L. K.; Bridson, J. N.; Bubenik, M. *J. Chem. Soc., Chem. Commun.* **1993**, 1375–1376.
60. Manzur, L. K.; Tandon, S. S. *Comments Inorg. Chem.* **1996**, *18*, 125–144.
61. Sheppard, C. L.; Tandon, S. S.; Thompson, L. K.; Bridson, J. N.; Miller, D. O.; Handa, M.; Lloret, F. *Inorg. Chim. Acta* **1996**, *250*, 227–239.
62. Chen, L.; Thompson, L. K.; Bridson, J. N. *Inorg. Chim. Acta* **1996**, *244*, 87–93.
63. Barrios, A. M.; Lippard, S. J. *J. Am. Chem. Soc.* **1999**, *121*, 11751–11757.
64. Barrios, A. M.; Lippard, S. J. *Inorg. Chem.* **2001**, *40*, 1060–1064.
65. Abraham, F.; Lagrenée, M.; Sœur, S.; Mernari, B.; Bremard, C. *J. Chem. Soc., Dalton Trans.* **1991**, 1443–1447.
66. Brooker, S.; Kelly, R. J.; Sheldrick, G. M. *J. Chem. Soc., Chem. Commun.* **1994**, 487–488.
67. Brooker, S.; Plieger, P. G.; Moubaraki, B.; Murray, K. S. *Angew. Chem. Int. Ed. Engl.* **1999**, *38*, 408–410.
68. Brooker, S.; Kelly, R. J. *J. Chem. Soc., Dalton Trans.* **1996**, 2117–2122.
69. Spodine, E.; Atria, A. M.; Manzur, J.; Garcia, A. M.; Garland, M. T.; Hocquet, A.; Sanhueza, E.; Baggio, R.; Peña, O.; Saillard, J.-Y. *J. Chem. Soc., Dalton Trans.* **1997**, 3683–3690.
70. Manzur, J.; Garcia, A. M.; Letelier, R.; Spodine, E.; Peña, O.; Grandjean, D.; Olmstead, M. M.; Noll, B. C. *J. Chem. Soc., Dalton Trans.* **1993**, 905–912.
71. Rosen, W. *Inorg. Chem.* **1971**, *10*, 1832–1835.
72. Yeager, E. *Electrochim. Acta* **1984**, *29*, 1527–1537.
73. Woon, T. C.; Robichaud, P.; Thompson, L. K. *Inorg. Chim. Acta* **1984**, *90*, 201–208, and references therein.
74. Xu, Z. Ph.D. Thesis, Memorial University of Newfoundland, 1998.
75. Xu, Z.; Thompson, L. K.; Miller, D. O. *Inorg. Chem.* **1997**, *36*, 3985–3995.
76. Thompson, L. K.; Xu, Z.; Goeta, A. E.; Howard, J. A. K.; Clase, H. J.; Miller, D. O. *Inorg. Chem.* **1998**, *37*, 3217–3229.
77. Xu, Z.; Thompson, L. K.; Miller, D. O.; Clase, H. J.; Howard, J. A. K.; Goeta, A. E. *Inorg. Chem.* **1998**, *37*, 3620–3627.
78. Xu, Z.; Thompson, L. K.; Matthews, C. J.; Miller, D. O.; Goeta, A. E.; Wilson, C.; Howard, J. A. K.; Ohba, M.; Okawa, H. *J. Chem. Soc., Dalton Trans.* **2000**, 69–77.
79. Xu, Z.; White, S.; Thompson, L. K.; Miller, D. O.; Ohba, M.; Okawa, H.; Wilson, C.; Howard, J. A. K. *J. Chem. Soc., Dalton Trans.* **2000**, 1751–1757.
80. Xu, Z.; Thompson, L. K.; Black, D. A.; Ralph, C.; Miller, D. O.; Leech, M. A.; Howard, J. A. K. *J. Chem. Soc., Dalton Trans.* **2001**, 2042–2048.
81. Xu, Z.; Thompson, L. K.; Miller, D. O. *J. Chem. Soc., Chem. Commun.* **2001**, 1170–1171.
82. Xu, Z.; Thompson, L. K.; Matthews, C. J.; Miller, D. O.; Goeta, A. E.; Howard, J. A. K. *Inorg. Chem.* **2001**, *40*, 2446–2449.
83. Zhao, L.; Matthews, C. J.; Thompson, L. K.; Heath, S. L. *J. Chem. Soc., Chem. Commun.* **2000**, 265–266.
84. Zhao, L.; Xu, Z.; Thompson, L. K.; Heath, S. L.; Miller, D. O.; Ohba, M. *Angew. Chem. Int. Ed. Engl.* **2000**, *39*, 3114–3117.
85. Zhao, L.; Xu, Z.; Thompson, L. K.; Miller, D. O. *Polyhedron* **2001**, *20*, 1359–1364.
86. Okawa, H.; Kaikawa, M.; Kida, S.; Luneau, D.; Oshio, H. *J. Chem. Soc., Dalton Trans.* **1990**, 469–475.
87. Iliopoulos, P.; Murray, K. S.; Robson, R.; Wilson, J.; Williams, G. A. *J. Chem. Soc., Dalton Trans.* **1987**, 1585–1592.
88. Cheng, P.; Liao, D.; Yan, S.; Jiang, Z.; Wang, G.; Yao, L.; Wang, H. *Inorg. Chim. Acta* **1996**, *248*, 135–137.
89. Zhao, L.; Thompson, L. K.; Xu, Z.; Miller, D. O.; Stirling, D. R. *J. Chem. Soc., Dalton Trans.* **2001**, 1706–1710.
90. Xu, Z.; Thompson, L. K.; Miller, D. O. Unpublished results.
91. Matthews, C. J.; Avery, K.; Xu, Z.; Thompson, L. K.; Zhao, L.; Miller, D. O.; Biradha, K.; Poirier, K.; Zaworotko, M. J.; Wilson, C.; Goeta, A. E.; Howard, J. A. K. *Inorg. Chem.* **1999**, *38*, 5266–5276.
92. Thompson, L. K.; Matthews, C. J.; Zhao, L.; Xu, Z.; Miller, D. O.; Wilson, C.; Leech, M. A.; Howard, J. A. K.; Heath, S. L.; Whittaker, A. G.; Winpenny, R. E. P. *J. Solid State Chem.* **2001**, *159*, 308–320.
93. Thompson, L. K.; Matthews, C. J.; Zhao, L.; Wilson, C.; Leech, M. A.; Howard, J. A. K. *J. Chem. Soc., Dalton Trans.* **2001**, 2258–2262.
94. Matthews, C. J.; Xu, Z.; Mandal, S. K.; Thompson, L. K.; Biradha, K.; Poirier, K.; Zaworotko, M. J. *J. Chem. Soc., Chem. Commun.* **1999**, 347–348.
95. Matthews, C. J.; Thompson, L. K.; Parsons, S. R.; Xu, Z.; Miller, D. O.; Heath, S. L. *Inorg. Chem.* **2001**, *40*, 4448–4454.
96. Milway, V. A.; Zhao, L.; Abedin, T. A. M.; Thompson, L. K.; Xu, Z. *Polyhedron* **2003**, *22*, 1271–1279.

97. Xu, Z.; Thompson, L. K.; Miller, D. O. Unpublished results.
98. Xu, Z.; Thompson, L. K.; Milway, V. A.; Zhao, L.; Kelly, T.; Miller, D. O. *Inorg. Chem.* **2003**, *42*, 2950–2959.
99. Xu, Z.; Thompson, L. K.; Miller, D. O. *J. Chem. Soc., Dalton Trans.* **2002**, 2462–2466.
100. Thompson, L. K. *Coord. Chem. Rev.* **2002**, *233–234*, 193–206.
101. DeGrace, S. A.; Thompson, L. K. unpublished results.
102. Thompson, L. K.; Zhao, Z.; Xu, Z.; Miller, D. O.; Reiff, W. M. *Inorg. Chem.* **2003**, *42*, 128–139.
103. Chen, X.; Zhan, S.; Hu, C.; Meng, Q.; Liu, Y. *J. Chem. Soc., Dalton Trans.* **1997**, 245–250.
104. Thompson, L.K.; Xu, Z. Unpublished results.
105. Bonardi, A.; Ianelli, S.; Pelizzi, C.; Pelizzi, G. *Inorg. Chim. Acta* **1991**, *187*, 167–174.
106. Mangia, A.; Pelizzi, C.; Pelizzi, G. *Acta Crystallogr.* **1974**, *B30*, 2146–2149.
107. Bacchi, A.; Bonini, A.; Carcelli, M.; Ferraro, F.; Leporati, E.; Pelizzi, C.; Pelizzi, G. *J. Chem. Soc., Dalton Trans.* **1996**, 2699–2704.
108. Duan, C.-Y.; Liu, Z.-H.; You, L.-Z.; Xue, F.; Mak, T. C. *J. Chem. Soc., Chem. Commun.* **1997**, 381–382.
109. Moubaraki, B.; Murray, K. S.; Ranford, J. D.; Wang, L.; Xu, Y. *J. Chem. Soc., Chem. Commun.* **1998**, 353–354.
110. Xu, Z.; Thompson, L. K.; Miller, D. O.; Ruiz, E.; Alvaez, S. *Inorg. Chem.* **2003**, *42*, 1107–1111.
111. Kwak, B.; Rhee, H.; Park, S.; Lah, M. S. *Inorg. Chem.* **1998**, *37*, 3599–3602.
112. Liu, S.-L.; Lin, S.; Lin, B. Z.; Lin, C.-C.; Huang, J. Q. *Angew. Chem. Int. Ed. Engl.* **2001**, *40*, 1084–1087.
113. Lagrenée, M.; Sœur, S.; Wignacourt, J. P. *Acta Crystallogr.* **1991**, *C47*, 1158–1160.
114. Castle, R. N. (ed.). *Pyridazines*, Wiley, 1973.
115. Hirsch, A.; Orphanos, D. *Can. J. Chem.* **1965**, *43*, 2708–2712.
116. Hirsch, A.; Orphanos, D. *Can. J. Chem.* **1965**, *43*, 1551–1555.
117. Cavalleri, B.; Bellasio, E.; Sardi, A. *J. Med. Chem.* **1970**, *18*, 148–152.
118. Vigevani, B.; Cavalleri, B.; Gallo, G. G. *J. Heterocycl. Chem.* **1970**, *7*, 677–679.
119. Addison, A. W.; Burke, P. J. *J. Heterocycl. Chem.* **1981**, *18*, 803–805.
120. Elguero, J.; Jacquier, R.; Mondon, S. *Bull. Soc. Chim. Fr.* **1970**, 1346–1349.
121. Monthéard, J.-P.; Dubois, J.-C. *J. Heterocycl. Chem.* **1985**, *22*, 719–720.
122. Philips, R. B.; Wamser, C. C. *J. Org. Chem.* **1978**, *43*, 1190–1192.
123. Baxter, P. N. W.; Lehn, J.-M.; Fischer, J.; Youinou, M.-T. *Angew. Chem. Int. Ed. Engl.* **1994**, *33*, 2284–2286.
124. Baxter, P. N. W.; Lehn, J.-M.; Baun, G.; Fenske, D. *Chem. Eur. J.* **2000**, *6*, 4510–4517.
125. Brown, D. J. (ed.). *The Pyridazines Supplement I*, Wiley, 2000.
126. Ulrich, G.; Ziessel, R.; Luneau, D.; Rey, P. *Tetrahedron Lett.* **1994**, *35*, 1211–1214.
127. Ulrich, G.; Ziessel, R. *Tetrahedron Lett.* **1994**, *35*, 1215–1218.
128. Russell, R. A.; Marsden, D. E.; Sterns, M.; Warren, R. N. *Aust. J. Chem.* **1981**, *34*, 1223–1234.
129. Asselin, C. M.; Fraser, G. C.; Hall, H. K., Jr.; Lindsell, W. E.; Padias, A. B.; Preston, P. N. *J. Chem. Soc., Dalton Trans.* **1997**, 3765–3772.
130. Birkofer, L.; Hänsel, E. *Chem. Ber.* **1981**, *114*, 3154–3160.
131. Birkofer, L.; Stilke, R. *J. Organometal. Chem.* **1974**, *74*, C1–C3.
132. Neunhoeffer, H.; Werner, G. *Liebigs Ann. Chem.* **1973**, 1955–1962.
133. Boger, D. L.; Coleman, R. S.; Panek, J. S.; Yohannes, D. *J. Org. Chem.* **1984**, *49*, 4405–4409.
134. Neunhoeffer, H.; Werner, G. *Liebigs Ann. Chem.* **1973**, 437–442.
135. Boger, D. L.; Panek, J. S.; Patel, M. *Org. Synth.* **1991**, *70*, 79–92.
136. Boger, D. L.; Baldino, C. M. *J. Am. Chem. Soc.* **1993**, *115*, 11418–11425.
137. Druicy, J.; Ringier, J. *Helv. Chim. Acta* **1951**, *34*, 195–199.
138. Fujii, T.; Sato, H. *Chem. Abstr.* **1957**, *51*, 6650.
139. Siegl, W. O. *J. Heterocycl. Chem.* **1981**, *18*, 1613–1618.
140. Ruggieri, R. *Chem. Abstr.* **1964**, *61*, 4344.
141. Sullivan, D. A.; Palenik, G. J. *Inorg. Chem.* **1977**, *16*, 1127–1133.
142. Gagné, R. R.; Marritt, W. A.; Marks, D. N.; Siegel, W. O. *Inorg. Chem.* **1981**, *20*, 3260–3267.
143. Gundermann, K. D.; Horstmann, W.; Bergmann, G. *Ann. Chem.* **1965**, *684*, 127.
144. Kobe, J.; Krbavacic, A.; Stanovic, B.; Tisler, M. *Croat. Chem. Acta* **1969**, *41*, 245.
145. Pinner, A.; Klein, F. *Chem. Ber.* **1877**, *10*, 1889–1892.
146. Reynaud, P.; Moreau, R. C. *Bull. Soc. Chim. France* **1964**, *67*, 1017–1021.
147. Nef, J. U. *Ann. Chem.* **1896**, *287*, 265–272.
148. Karo, S. (ed.). *Organic Functional Group Preparations III*; Academic Press: New York, 1972.
149. Chapman, W. *J. Chem. Soc.* **1925**, *127*, 1992–1998.
150. Case, F. H. *J. Org. Chem.* **1965**, *30*, 931–933.
151. Case, F. H. *J. Heterocycl. Chem.* **1970**, *7*, 1001–1005.
152. van Koningsbruggen, P. J.; Muller, E.; Haasnoot, J. G.; Reedijk, J. *Inorg. Chim. Acta* **1993**, *208*, 37–42.
153. Ruben, M.; Breuning, E.; Gisselbrecht, J.-P.; Lehn, J.-M. *Angew. Chem. Int. Ed. Engl.* **2000**, *39*, 4139–4141, and references therein.

# 1.6

## $\beta$ -Diketones and Related Ligands

C. PETTINARI and F. MARCHETTI  
*Università degli Studi, Camerino, Italy*

and

A. DROZDOV  
*Moscow State University, Russia*

---

1.6.1	INTRODUCTION	97
1.6.2	MAIN FIELDS OF RESEARCH ON TECHNOLOGICAL APPLICATIONS OF METAL $\beta$ -DIKETONATES	98
1.6.3	STRUCTURE AND TAUTOMERISM OF $\beta$ -DIKETONES	98
1.6.4	SYNTHESIS OF $\beta$ -DIKETONES	99
1.6.5	COORDINATION MODES OF $\beta$ -DIKETONES	101
1.6.5.1	Neutral $\beta$ -diketones	102
1.6.5.2	Monoanionic $\beta$ -diketonates	102
1.6.5.3	Dianionic $\beta$ -diketonates	103
1.6.6	SYNTHESES OF METAL DIKETONATES	103
1.6.6.1	Synthesis from Metals	103
1.6.6.2	Synthesis from Metal Halides	104
1.6.6.3	Synthesis from Organometallic Halides	104
1.6.6.4	Synthesis from Metal Acetates, Nitrates, Sulfates, or Carbonates	104
1.6.6.5	Synthesis from Metal or Organometallic Oxides	105
1.6.6.6	Synthesis from Metal or Organometallic Alkoxides	105
1.6.6.7	Synthesis from Metal Carbonyl	105
1.6.6.8	Synthesis from Metal Alkyls or Aryls	105
1.6.7	TRI-, TETRA-, AND POLYKETONES	106
1.6.7.1	Diketones with Substituents Containing Additional Donor Atoms	107
1.6.7.2	Diketones with Substituents Containing Metallic or Metalloid Atoms	109
1.6.8	ACYLPYRAZOLONES AND ANALOGUE $\beta$ -DIKETONES WITH A HETEROCYCLE FUSED TO THE CHELATING RING	109
1.6.9	REFERENCES	112

---

### 1.6.1 INTRODUCTION

In spite of the fact that  $\beta$ -diketones represent one of the oldest classes of chelating ligands, their coordination chemistry continues to attract much interest, due to recent industrial applications of several of their metal derivatives. An exhaustive review of  $\beta$ -diketones, dealing mainly with structural chemistry and reactivity of most of the metal  $\beta$ -diketonates reported up to 1982, was included in the first edition of *Comprehensive Coordination Chemistry CCC* (1987).<sup>1</sup> Since that time a large number of papers have appeared on new functionalized  $\beta$ -diketone ligands, and on the potential applications of their metal derivatives in new fields of technology. However, well-known  $\beta$ -diketones—such as acacH (acacH = 2,4-pentanedione); bzacH (bzacH = 1-phenyl-1,3-butanedione); dbzmH (dbzmH = 1,3-diphenyl-1,3-propanedione); tmhdH (tmhdH = 2,2,6,6-tetramethyl-3,5-heptanedione); tfacH (tfacH = 1,1,1-trifloro-2,4-pentanedione); and hfacH

(hfacH = 1,1,1,5,5,5-hexafluoro-2,4-pentanedione)—also continue to play a key role as ligands of choice in the stabilization of otherwise unstable metallic or organometallic derivatives, or in the modulation of particular structural and/or physico-chemical properties of their metal complexes. In this review we provide essential information to allow the reader to probe more deeply into the main aspects of the coordination chemistry of these fascinating and apparently simple donor ligands.

### 1.6.2 MAIN FIELDS OF RESEARCH ON TECHNOLOGICAL APPLICATIONS OF METAL $\beta$ -DIKETONATES

Several research groups recognized the potential of  $\beta$ -diketones as extracting and complexing agents for the spectrophotometric determination of metal ions in dilute solutions, and for chromatographic separations. Lanthanide  $\beta$ -diketonates were also found to be useful as NMR shift-reagents.<sup>2</sup>

Since the early 1980s a large number of studies have appeared on the synthesis of new diketonate-containing metal derivatives, with appropriate volatility and thermal stability sufficient to employ them as molecular precursors in chemical vapor deposition (CVD) techniques.<sup>3–5</sup>  $\text{Cu}^{\text{I}}$  and  $\text{Cu}^{\text{II}}$   $\beta$ -diketonate adducts with ancillary Lewis bases are promising precursors for microelectronic devices<sup>6</sup> and, in conjunction with alkaline-earth metal  $\beta$ -diketonates,<sup>7–9</sup> for the generation of new, high-temperature superconducting mixed metal oxides. Many metal  $\beta$ -diketonates have been investigated as molecular precursors for the supercritical fluid transport (SFT) CVD technique.<sup>10</sup>

After the serendipitous discovery of the antitumor properties of *cisplatin* (*cis*-diaminedichloroplatinum), much effort has been devoted to finding other anticancer metal agents, and several Sn, Ti, Zr, and Hf  $\beta$ -diketonates have been proven to possess interesting biological activity. For example, budotitane ((EtO)<sub>2</sub>Ti(bzac)<sub>2</sub>) was the first non-Pt metal complex to reach clinical trials as a potential anticancer agent.<sup>11–15</sup>

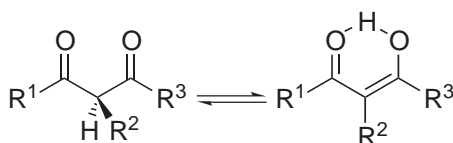
Progress has been made in the search for new lanthanide  $\beta$ -diketonates as sources of luminescence, with application in the fabrication of polymer light-emitting diodes for low-cost, full-color, flat-panel displays.<sup>16,17</sup> Moreover, some complexes seem promising as chiral NMR reagents for the determination of enantiomeric purity<sup>18,19</sup> and prospective catalysts in many organic syntheses.<sup>20</sup>

Another primary field of interest is the potential application of metal  $\beta$ -diketonates as liquid crystal phases; because of their special magnetic and electronic properties, these metal-containing materials are generally known as “metallomesogens.” Most literature in this field is devoted to the  $\beta$ -diketonates of  $\text{Rh}^{\text{I}}$ ,  $\text{Ir}^{\text{I}}$ ,  $\text{Ni}^{\text{II}}$ ,  $\text{Pd}^{\text{II}}$ ,  $\text{Pt}^{\text{II}}$ , and  $\text{Cu}^{\text{II}}$ , which have a linear or planar geometry and therefore mimic conventional organic calamitic or discotic liquid crystals.<sup>21–26</sup> Recently some lanthanide  $\beta$ -diketonate adducts containing particular Lewis bases, such as 1-*N*-alkyl-4-alkyloxy-2-hydroxy-benzaldimines, were also proven to exhibit interesting mesomorphic properties.<sup>27</sup> Transition- and lanthanide-metal derivatives also display interesting catalytic features, where the  $\beta$ -diketonates are important spectator donors for metal-intermediate species involved in several important organic reactions.<sup>28–36</sup>

In the field of nanoscale materials,  $\beta$ -diketonate ligands play an important role as assembly agents in the preparation of high-spin molecules. For example,  $\text{Fe}^{3+}$  and  $\text{Mn}^{3+}$  clusters containing  $\beta$ -diketonate donors have shown interesting magnetic anisotropic behavior, also being able to entrap alkaline ions.<sup>37,38</sup>

### 1.6.3 STRUCTURE AND TAUTOMERISM OF $\beta$ -DIKETONES

$\beta$ -Diketones exist as an equilibrium mixture of keto and enol tautomeric forms (see scheme below). Generally the enol tautomer is more stable than the keto tautomer, due to intramolecular H-bonding and simultaneous conjugation<sup>39,40</sup> (Scheme 1).

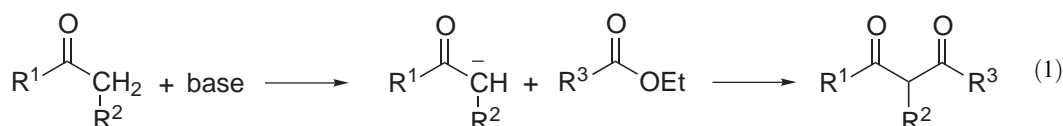


Scheme 1

Replacement of electron-withdrawing groups in  $R^1$ ,  $R^2$ , and/or  $R^3$  shifts the equilibrium in favor of the enolic form. The reverse happens with electron-releasing substituents. The enolic form is favored in nonpolar solvents.

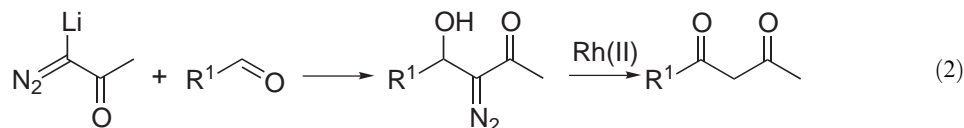
#### 1.6.4 SYNTHESIS OF $\beta$ -DIKETONES

Classical  $\beta$ -diketones can be obtained from the acylation of ketones by esters (Claisen condensation), in the presence of alkali-metal hydroxides, ethoxides, hydrides, or amides as condensing agents, to enhance the relatively low reactivity of the ester carbonyl group (Equation (1)).<sup>41-45</sup> Other general synthetic methods have been described by Mehrotra.<sup>2</sup>

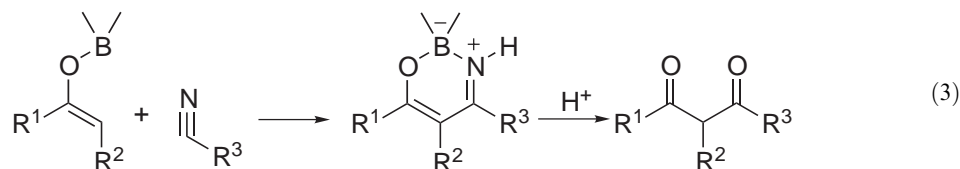


In order to avoid the difficulties which could be encountered with Claisen condensations, such as formation of regioisomers, competing O-acylation, proton exchange between the enolate and the product diketone, and generally poor yields, new synthetic approaches to modified and functionalized  $\beta$ -diketones in  $R^1$ ,  $R^2$ , and/or  $R^3$  positions have been developed.

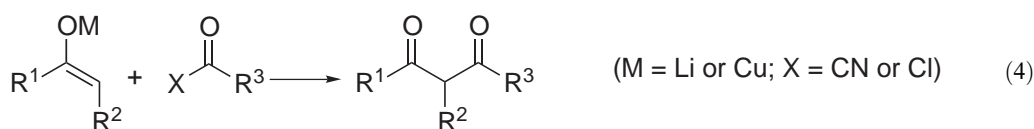
One of the most important improvements has been the successful reaction of 1-diazo-1-lithioacetone with aldehydes, followed by acid-induced transformation of the  $\alpha$ -diazo- $\beta$ -hydroxyketone thus formed into the corresponding  $\beta$ -diketone with a number of  $R^1$  groups, in the presence of  $\text{Rh}^{\text{II}}$  acetate as catalyst (Equation (2)).<sup>46</sup>



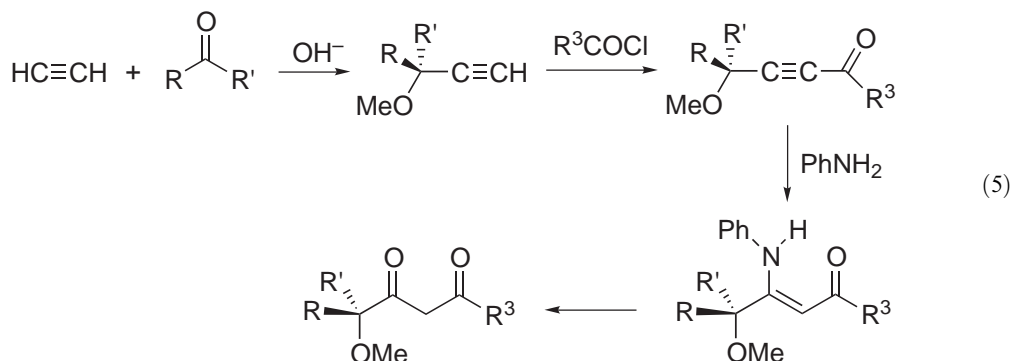
A regiospecific synthesis of unsymmetrical  $\beta$ -diketones is achieved by cycloaddition of nitriles to enol boranes, giving the corresponding boroxazines that readily hydrolyze in acid conditions to  $\beta$ -diketones (Equation (3)).<sup>47</sup>



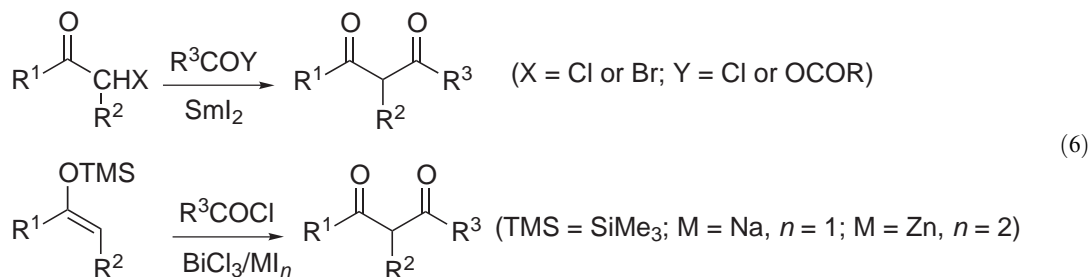
Other versatile syntheses are based on C-acylation of metal (Li or Cu) enolates by acyl cyanides or chlorides (Equation (4)).<sup>48,49</sup>



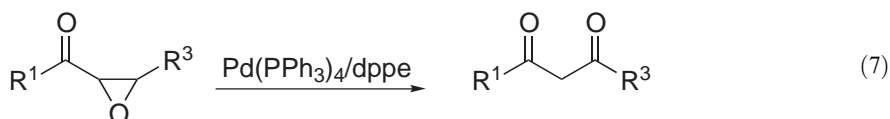
A very useful method leading to highly sterically hindered  $\beta$ -diketones with  $R^1 = \text{CRR}(\text{OMe})$ , employed for the synthesis of alkaline-earth metal-containing molecular precursors for CVD, is based on the condensation of ketones with alkynes, followed by the reaction of the product with acyl chlorides to give  $\alpha$ -acetylinic ketones. Finally the  $\alpha$ -acetylinic ketones react with amines yielding aminovinylketones and, after hydrolysis, the resulting  $\beta$ -diketones (Equation (5)).<sup>50</sup>



New syntheses, based on the condensation of  $\alpha$ -haloketones with acid chlorides or anhydrides catalyzed by  $\text{SmI}_2$ ,<sup>51</sup> or C-acylation of enoxysilanes catalyzed by a mixture of  $\text{BiCl}_3/\text{NaI}$  or  $\text{BiCl}_3/\text{ZnI}_2$ , have been proposed (Equation (6)).<sup>52</sup>

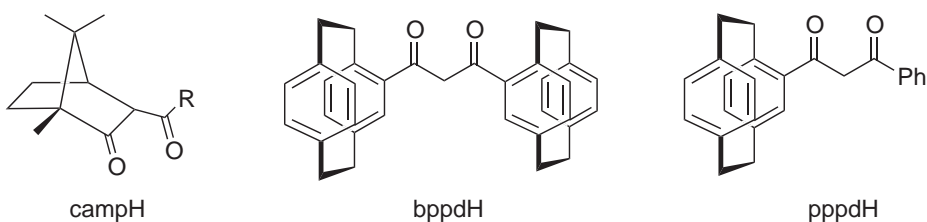


Another route to  $\beta$ -diketones is to heat  $\alpha,\beta$ -epoxyketones in the presence of tetrakis(triphenylphosphine)palladium(0) as catalyst and bis(diphenylphosphino)ethane (dppe) (Equation (7)).<sup>53</sup>

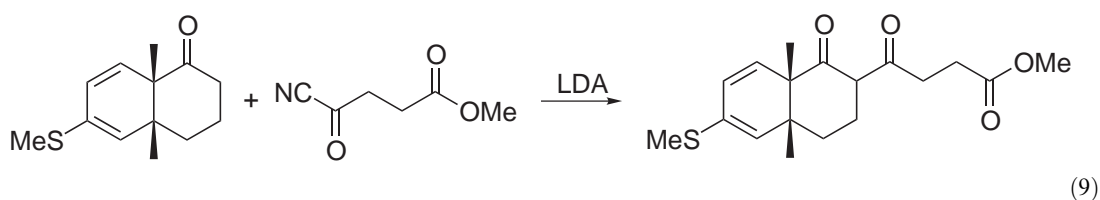
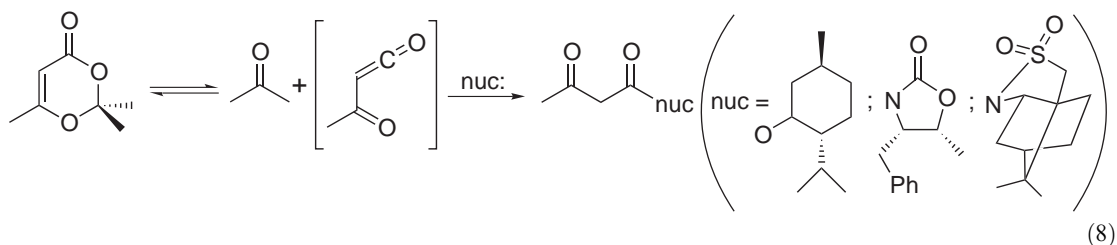


Chiral  $\beta$ -diketones, such as 3-acylcampfor (campH) or 1,3-bis[(S)-(4-[2.2]paracyclophanyl)]propane-1,3-dione (bppdH) or [1-(S)-(4-[2.2]paracyclophanyl)-3-phenyl]propane-1,3-dione (pppdH) (Scheme 2), can be obtained with Claisen condensation;<sup>54,55</sup> a new method for the synthesis of some  $\beta$ -diketones with a chiral substituent in  $R^1$  is based on the reaction of 2,2,6-trimethyl-4*H*-1,3-dioxin-4-one (diketene acetone adduct) with appropriate nucleophiles as (*d*)-menthol, (4*S*)-benzyloxazolidin-2-one or (2*R*)-bornane-10,2-sultam (Equation (8)).<sup>56,57</sup> A particular chiral  $\beta$ -diketone has been synthesized from decalone and carbomethoxypropionyl cyanide in the presence of lithium diisopropylamide (LDA) (Equation (9)).<sup>58</sup>



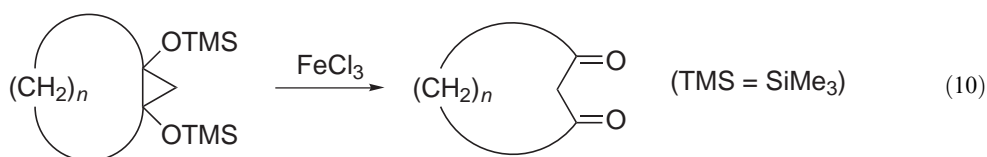


Scheme 2



A wide range of synthetic approaches has been reported to modify  $R^2$  fragments in the diketone molecule by reactions of metal diketonates with carbon and oxygen electrophiles; the field is reviewed by Moreno-Manas *et al.*<sup>59</sup>

The synthesis of cycloalkane-1,3-diones starts from bis(trimethylsilyloxy) bicyclo[n.1.0]alkanes and  $FeCl_3$ , followed by treatment with  $NaO_2CCH_3$  in MeOH (Equation (10)):<sup>60</sup>

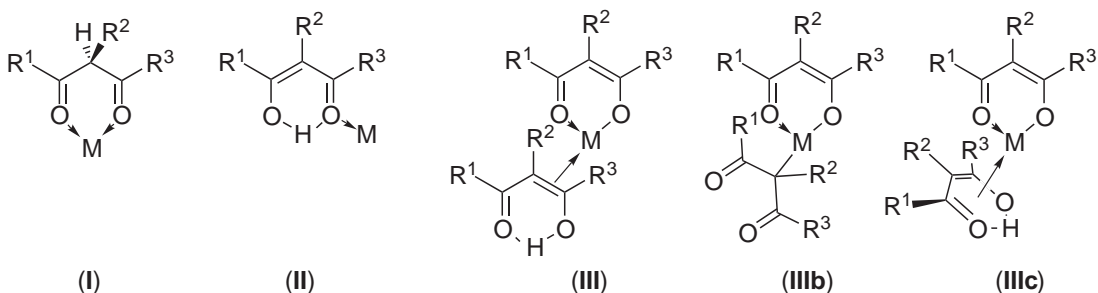


### 1.6.5 COORDINATION MODES OF $\beta$ -DIKETONES

A wide variety of metal  $\beta$ -diketonates have been crystallographically authenticated, and several reviews in the second half of the twentieth century have been devoted to furnishing a more comprehensive picture of the possible coordination modes of  $\beta$ -diketones.<sup>1-8,39,40,61</sup> These modes can be classified into three principal classes, including diketones in the neutral form and diketonates in the mono- and dianionic forms.

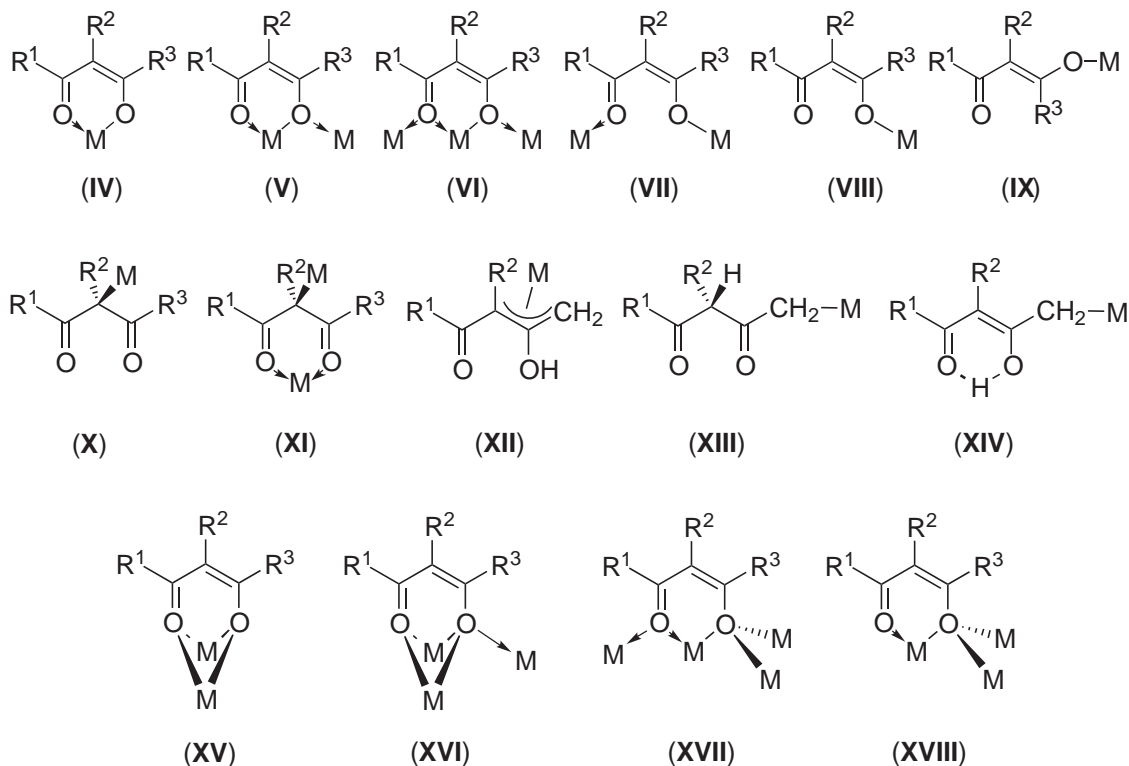
### 1.6.5.1 Neutral $\beta$ -diketones

This type includes the common examples of the O,O-bidentate keto form (I) and less common O-monodentate enol form (II) and  $\eta^2$ -C<sub>2</sub>-bonded enol form (III). In the absence of definitive X-ray data, the latter was carefully investigated by IR and NMR techniques because of the possibility of the additional two structures (IIIb) and (IIIc).



### 1.6.5.2 Monoanionic $\beta$ -diketonates

Apart from the well-known classical O,O-bidentate chelates (IV), there are examples where one (V) or both oxygen atoms (VI) coordinate to other metal centers through a second lone pair. A diketonate ligand can bridge two metal atoms in the O,O-bidentate form (VII), or coordinate in a O-monodentate *cis*- (VIII) or *trans*-mode (IX). Other known binding modes of monoanionic diketonates are those involving a carbon atom bonded to a "soft" metal, as in the C-monodentate keto form (X), in bridging C,O,O-tridentate keto form (XI), the  $\eta^3$ -C<sub>3</sub>-allylic fashion (XII), the terminal C-monodentate keto form (XIII), and corresponding enol form (XIV). More recently, in the case of the heavier alkaline-earth metal derivatives, four additional coordination modes of monoanionic diketonates have been formally identified.<sup>7,8</sup> Among them the most common is  $\eta^2$ - $\eta^2$ -O,O-bis-chelate/ $\mu_2$ - $\mu_2$ -bridging form (XV), but also the  $\eta^2$ - $\eta^2$ -O,O-bis-chelate/ $\mu_2$ - $\mu_3$ -bridging



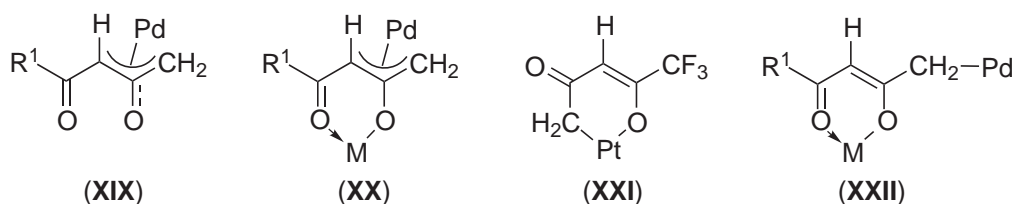
form (XVI), the  $\eta^2$ -O,O-monochelating/ $\mu_2$ - $\mu_3$ -triple-bridging form (XVII), and finally the  $\eta^2$ -O, O-monochelating/ $\mu_3$ -triple-bridging form (XVIII) have been observed.

However, these modes serve only to represent geometrical dispositions of diketonate ligands in the crystal lattice of Sr and Ba complexes, where M—O character is considered almost completely ionic. This explains the large coordination numbers of metal, the marked deviations from planarity of the chelating ring, and the wide variation in M—O distances.

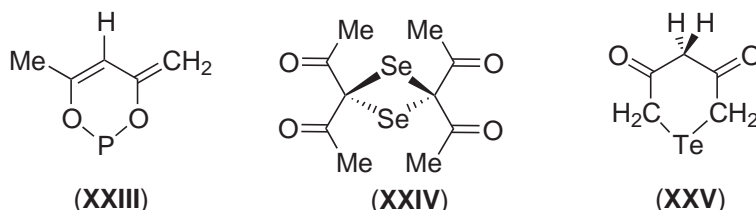
To clarify the controversial nature of the  $\beta$ -diketonates as O,O-chelating symmetrical or not-symmetrical donor ligands in solution, the NMR method of isotopic perturbation of equilibrium has been used.<sup>62</sup> A study successfully applied to the simplest dicarbonyl compounds, malonaldehyde and 2-phenylmalonaldehyde, showed the intrinsic asymmetric nature of several metal complexes containing these donor ligands even though, on the basis of NMR evidence, they appear to be symmetric chelates.<sup>63</sup>

### 1.6.5.3 Dianionic $\beta$ -diketonates

Interesting coordination modes have been discovered in derivatives containing Pd and Pt metal ions or nonmetallic elements, where extra negative charge of the (diketonate)<sup>2-</sup> arises from removal of one of the methyl protons. In (XIX) the (diketonate)<sup>2-</sup> is  $\eta^3$ -C<sub>3</sub>-tridentate to Pd through C<sub>1</sub>, C<sub>2</sub>, and C<sub>3</sub>, in an allylic fashion, whereas in (XX) the donor is additionally O,O-bidentate chelating toward another metal. In (XXI) the (diketonate)<sup>2-</sup> is C,O-bonded to Pt, and in (XXII) is O,O-bonded to a metal and C-bonded to another metal via a terminal —CH<sub>2</sub>.



Other specific coordination modes of dianionic diketonates have been found in derivatives with phosphorus (XXIII), selenium (XXIV), and tellurium (XXV) as central atoms.

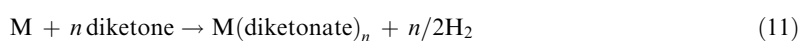


## 1.6.6 SYNTHESSES OF METAL DIKETONATES

Although the synthesis of a metal  $\beta$ -diketonate and its stoichiometry depend largely on the reaction conditions, such as choice of solvent, temperature, and pH of the solution, as well as on the mode of isolation of the pure complex, some general conditions can be outlined.<sup>1,2,7,8,61</sup>

### 1.6.6.1 Synthesis from Metals

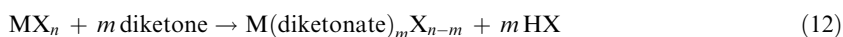
This method is useful only for electropositive elements such as alkali metals, alkaline earths, and aluminum. Diketones react with these metals, in anhydrous aromatic solvents, with evolution of molecular hydrogen and formation of the metal diketonate (Equation (11)):



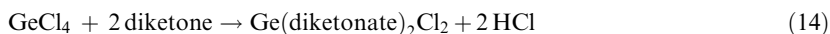
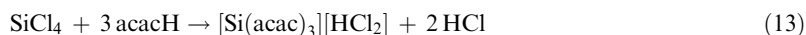
The reaction is facilitated on freshly cut surfaces or with the metal as cathode in the electric cell. More acidic fluorinated ligands, such as fodH, are also able to react with Sc, V, Cr, Mn, Fe, Co, Cu, In, Ga, and Pb, under a nitrogen atmosphere and with traces of nitric acid as catalyst.

### 1.6.6.2 Synthesis from Metal Halides

This reaction affords either a pure metal diketonate or a mixed halide-diketonate complex, mainly depending on the nature of the metal halide (Equation (12)):



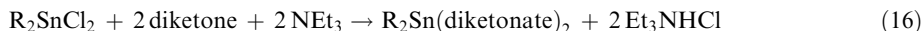
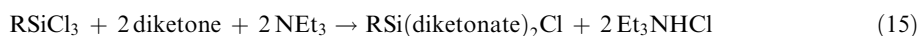
This method is applicable to the preparation of a wide variety of metal derivatives. Mixed metal halide diketonates are generally obtained with the less electropositive elements like B, Si, Ge, Sn, Ti, P, Sb, Nb, Ta, due to steric constraints in the coordination environment, sometimes with formation of ionic species (Equation (13)) or with excess of starting metal halide (Equation (14)):



Actinide complexes of the type  $M(\text{diketonate})_4$  ( $M = \text{Th, U, Np, Pu, or Pa}$ ) have been synthesized in water.

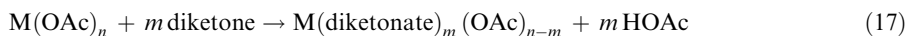
### 1.6.6.3 Synthesis from Organometallic Halides

Organometallic or mixed halide–organometallic diketonates of Si, Ge, Sn, Pb, Ti, Zr, Sb can be synthesized in the presence of base (sodium methoxide, pyridine, triethylamine, ammonia) (Equations (15) and (16)):



### 1.6.6.4 Synthesis from Metal Acetates, Nitrates, Sulfates, or Carbonates

The reaction affords metal diketonates and free acid (Equation (17)); however, an equilibrium mixture occurs, apart from when the metal diketonate precipitates from the reaction medium.

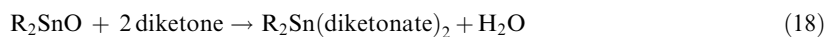


To avoid this problem, it is often necessary to check pH. The reaction is generally conducted in alcohol or water–alcohol mixtures. Diketonates of Cu, Ni, Co, Cr, Fe lanthanides and actinides were synthesized in this way. Nitrates and sulfates of Zr, Th, Fe, Cu, Rh, Al, V, and lanthanides have been employed, in the presence of a base such as ammonia, to prepare the corresponding metal diketonates.

Carbonates of Be, Ca, Sr, Ba, Zn, Co, and Tl react with diketones in refluxing alcohol or water–alcohol mixtures, producing the metal derivatives and  $\text{CO}_2$ .

**1.6.6.5 Synthesis from Metal or Organometallic Oxides**

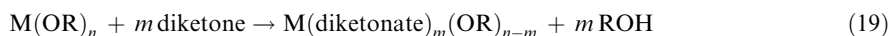
This reaction is generally carried out in refluxing aromatic solvents (Equation (18)), and unreacted insoluble metal oxide (M = Sn, Ge, Mo) can be easily separated by filtration from soluble metal diketonate.



Metal hydroxides like Ce(OH)<sub>4</sub> or Me<sub>2</sub>AuOH react in water with acacH, affording the corresponding Ce(acac)<sub>4</sub> and Me<sub>2</sub>Au(acac).

**1.6.6.6 Synthesis from Metal or Organometallic Alkoxides**

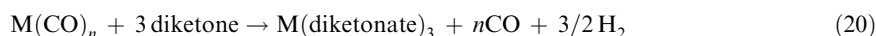
The reaction of β-diketones with metal alkoxides is generally carried out in anhydrous aromatic solvents, affording the desired metal diketonate and delivering alcohol (Equation (19)) that can be removed from the mixture reaction by fractional distillation of the alcohol–benzene azeotrope,



where the alkoxide is generally ethoxide or isopropoxide. This is a good method for the preparation of mixed derivatives by employing stoichiometric amounts of the reactants. The anhydrous lanthanide tris-diketonates can be synthesized by the same procedure. Pure diketonates and mixed alkoxide-diketonates of Al, Ga, Sn, and Ti can be conveniently prepared in this way. Zr, Sb, Nb, Ta, and U species yielded only mixed alkoxide–diketonates.

**1.6.6.7 Synthesis from Metal Carbonyl**

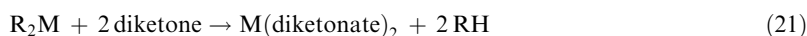
M(CO)<sub>n</sub> (M = Cr, Mn, Fe, Mo, and Co) react with diketones in refluxing anhydrous ethers under nitrogen, or under UV irradiation, affording the corresponding metal diketonate (Equation (20)):



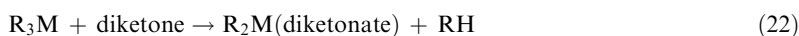
Sometimes mixed carbonyl-diketonates can be obtained.

**1.6.6.8 Synthesis from Metal Alkyls or Aryls**

The general reaction takes place with formation of the desired metal diketonate and loss of the hydrocarbon corresponding to the organic fragment of the starting alkyl or aryl metal compound (Equation (21)). This happens, for example, with divalent organotin and organozinc.

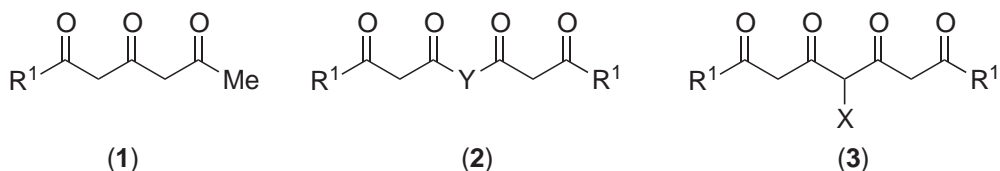


Complete substitution cannot be performed in the case of B, Al, Ga, or Tl (Equation (22)):



## 1.6.7 TRI-, TETRA-, AND POLYKETONES

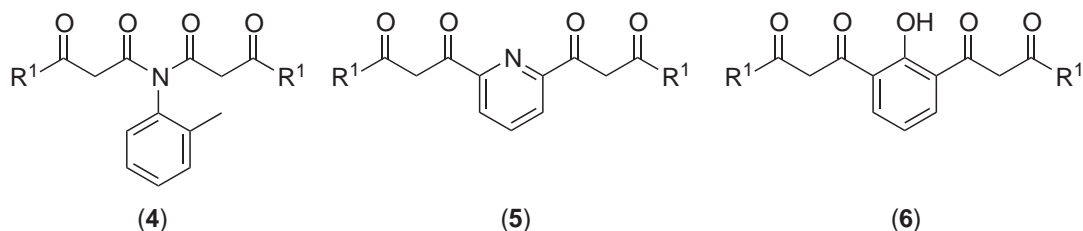
Since 1950 several groups have synthesized  $\beta$ -diketone ligands with additional functionalized fragments, in order to obtain bi- and polymetallic systems of increasing complexity. The structural aspects of the coordination chemistry of triketones (**1**) have been exhaustively surveyed in the previous edition of *CCC*.<sup>1</sup> These ligands are able to coordinate two atoms of the same metal ( $\text{Be}^{2+}$ ,  $\text{Co}^{2+}$ ,  $\text{Ni}^{2+}$ ,  $\text{Pd}^{2+}$ ,  $\text{Fe}^{2+}$ ,  $\text{UO}_2^{2+}$ , or  $\text{Cu}^{2+}$ ) or of different metals simultaneously ( $\text{UO}_2^{2+}$  and  $\text{Mn}^{2+}$ ,  $\text{Co}^{2+}$ ,  $\text{Ni}^{2+}$ ,  $\text{Cu}^{2+}$  or  $\text{Zn}^{2+}$ ), in a planar array.<sup>1</sup> The heptane-2,4,6-trione and 1,5-diphenyl-1,3,5-trione ligands were shown to react with  $\text{Pt}^{2+}$  acceptors, affording platinumacyclobutanones, via a structurally characterized dienediolate intermediate.<sup>64</sup>



Bis( $\beta$ -diketones),  $\text{O}_4$ -tetradentate ligands with two chelating fragments linked to each other through different bridging groups, have been prepared and employed in the coordination of several metal ions. The first papers in this field reported the syntheses of (**2**) (where  $\text{Y} = (\text{CH}_2)_4$ ,  $(\text{CH}_2)_5$ ,  $(\text{CH}_2)_6$ ,  $(\text{CH}_2)_7$ , 1,3- $\text{C}_6\text{H}_4$ , 1,4- $\text{C}_6\text{H}_4$ , and 4,4'- $\text{C}_6\text{H}_4$ - $\text{C}_6\text{H}_4$ )<sup>65</sup> by condensation of bis(acyl chloride) with the sodium salt of a ketone and the remainder by Claisen condensation; and of (**3**) (where  $\text{X} = (\text{CH}_2)_5\text{CH}_3$ , 2- $\text{ClC}_6\text{H}_4$ , 2- $\text{CH}_3\text{OC}_6\text{H}_4$ , 4- $\text{CH}_3\text{OC}_6\text{H}_4$ , 4- $(\text{CH}_3)_2\text{NC}_6\text{H}_4$ , 3,4- $(\text{CH}_2\text{O})_2\text{C}_6\text{H}_3$ , 2- $\text{C}_5\text{H}_4\text{N}$ , 3- $\text{C}_5\text{H}_4\text{N}$ , 4- $\text{C}_5\text{H}_4\text{N}$ ,  $\text{C}_6\text{H}_5$ , 4- $\text{HOC}_6\text{H}_4$ )<sup>66</sup> by condensation of the  $\beta$ -diketone with the appropriate aldehyde in a 2:1 molar ratio. The preparation of bimetallic chelates  $[\text{M}_2(\text{dbaa})_2(\text{H}_2\text{O})_n]$  ( $\text{M} = \text{Cu}^{\text{II}}$ ,  $\text{Ni}^{\text{II}}$ , or  $\text{Co}^{\text{II}}$ ;  $\text{dbbaH}_2 = 1,7$ -diphenyl-1,3,5,7-heptane-tetraone;  $n = 3, 4$ , or  $6$ )<sup>67</sup> a series of heterotrimeric complexes  $(\text{UO}_2)_2\text{M}^{\text{II}}(\text{dbba})_2(\text{py})_4$  (where  $\text{M}^{\text{II}} = \text{Zn}$ ,  $\text{Cu}$ ,  $\text{Ni}$ ,  $\text{Co}$ ,  $\text{Fe}$ , and  $\text{Mn}$ )<sup>68</sup> most of them also structurally characterized,<sup>69</sup> and a cobalt complex which undergoes oxidation of 4-carbon with formation of  $[\text{Co}_2(\text{O}=\text{dbba})_2(\text{py})_4]$ , were subsequently reported.<sup>70</sup> Bis- $\beta$ -diketones with other bridging  $-\text{CHX}-$  groups (**3**) ( $\text{X} = \text{H}$ ,  $\text{Ph}$ , 4- $\text{NMe}_2\text{Ph}$ , 4- $\text{MeOPh}$ , 4- $\text{MePh}$ ) have been reported to form dinuclear metal derivatives with several transition elements.<sup>71-75</sup>

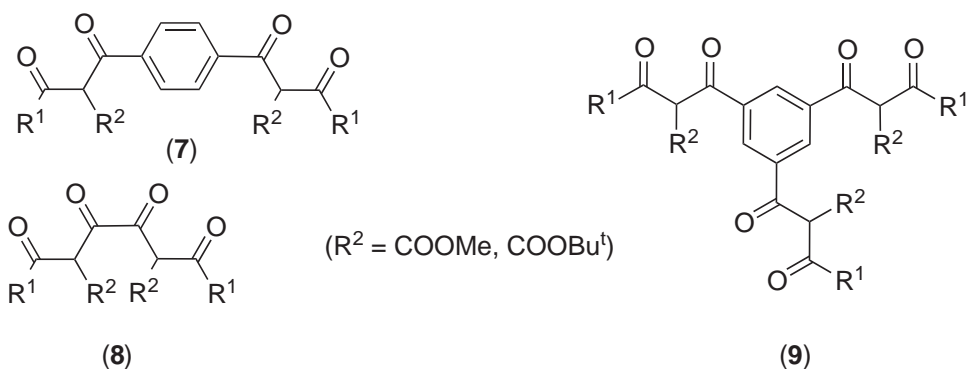
Bis- $\beta$ -diketones (**2**) with a *m*-phenylene, a *p*-phenylene, a *m*-xylylene, or a *p*-xylylene bridging group  $\text{Y}$ , were synthesized and used to form dinuclear complexes with several metal ions.<sup>76-78</sup> A tetraketone ligand ( $\text{nbaH}_2$ ) with a larger 2,7-naphthalenediylbis(methylene) bridge, was shown to form  $[\text{Cu}_2(\text{nba})_2]$  complexes with a cavity suitable to guest Lewis bases such as 1,4-diazabicyclo-[2.2.2]octane (= dabco), affording the structurally identified adduct  $[\text{Cu}_2(\text{nba})_2(\text{dabco})]$ .<sup>79</sup> The bis- $\beta$ -diketone with a *m*-phenylene bridge affords dinuclear metal complexes with  $\text{V}^{3+}$ ,  $\text{Ti}^{3+}$ ,  $\text{Mn}^{3+}$ , and  $\text{Fe}^{3+}$  having a triple-helical structure.<sup>80</sup>

Other bis- $\beta$ -diketones with different and more complex bridging fragments, like 1,4-piperazine,<sup>76</sup> *N*-(*o*-tolyl) (**4**), 2,6-pyridyl (**5**), 4- $\text{CH}_3\text{O}_2\text{C}$ -*m*-xylylene, and 1,3,4,5-tetrachloro-*m*-xylylene, have been reported and their coordinating ability tested toward several transition-metal ions.<sup>81</sup> The bis- $\beta$ -diketone with a 2,6-pyridyl bridge affords a dinuclear iron complex able to encapsulate  $\text{K}$ ,  $\text{Sr}$ , or lanthanide metal ions, giving  $\{2\}$ -metallacryptates.<sup>82</sup> A pentadentate bis- $\beta$ -diketone (**6**) has been employed in its dianionic form, yielding dinuclear complexes with  $\text{Cu}^{\text{II}}$ <sup>83</sup> and a trinuclear complex with  $\text{Mn}^{\text{III}}$ .<sup>84</sup>

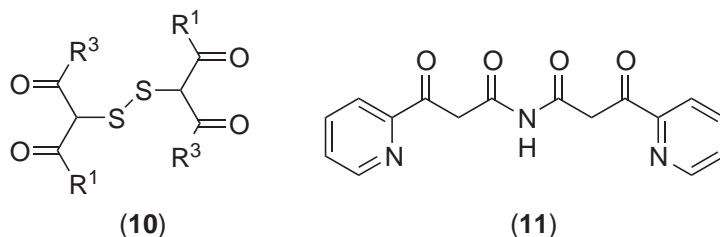


Novel bis- $\beta$ -diketones of formula (**2**), where  $\text{Y}$  is  $\text{CH}_2\text{OCH}_2\text{CH}_2\text{OCH}_2$  or  $\text{CH}_2\text{O}$ -1,2- $\text{C}_6\text{H}_4$ - $\text{OCH}_2$ , have recently been reported as convenient  $\beta$ -agents for the template-mediated self-assembly of

hybrid metallocoronates.<sup>85</sup> Other interesting donors built up from two  $\beta$ -diketone units—each having a  $\text{CO}_2\text{CH}_3$  substituent as  $\text{R}^2$ , linked through a *p*-phenylene group, (7), or directly, (8)—have been reported to afford tetranuclear adamantanoid chelates with alkaline and transition metals.<sup>86,87</sup> Particularly intriguing was a tetranuclear mixed-valence  $\text{Fe}^{\text{II}}\text{--Fe}^{\text{III}}$  complex, suitable to behave as endoreceptor of cations such as  $\text{NH}_4^+$  to compensate charge.<sup>88</sup> Also Mg and Co derivatives, ligands (7) and (8), show the ability to include ammonium ions, affording “tetrahemispheraplexes” compounds.<sup>89</sup> A trigonal tris-bidentate chelator with a central 1,3,5-phenylene fragment (9) produces tetranuclear tetrahedral and hexanuclear trigonal antiprismatic iron clusters.<sup>90</sup>



A bis- $\beta$ -diketone with a disulfide bridge (10) was shown to form dinuclear derivatives with  $\text{VO}_2^{2+}$  ions,<sup>91</sup> but reacts with  $[\text{Ru}(\text{acac})_2(\text{MeCN})_2]$  yielding two products, a mononuclear complex containing the O,S-coordinated 3-S-2,4-pentanedionate fragment, and a dinuclear complex with the bridged O,O,S-coordinated 3-S-2,4-pentanedionate fragment.<sup>92</sup>

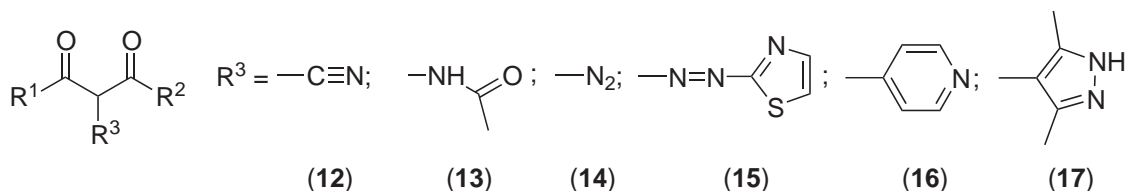


A  $\beta$ -diketone containing a nitrogen atom in the place of  $\text{C}_2$ , and also 2-pyridyl fragments in  $\text{R}^1$  and  $\text{R}^3$  (bpcaH) (11), has been employed in the synthesis of heterotrimetallic derivatives  $[\text{M}(\text{bpca})_2\{\text{M}'(\text{hfac})_2\}_2]$  ( $\text{M}, \text{M}' = \text{Ni}^{2+}, \text{Mn}^{2+}, \text{Cu}^{2+}, \text{Mn}^{2+}; \text{Fe}^{2+}, \text{Mn}^{2+}, \text{Ni}^{2+}, \text{Fe}^{2+}; \text{Fe}^{2+}, \text{Fe}^{2+}$ )<sup>93</sup> and mixed-valence iron clusters with unusual metal assembly.<sup>94</sup>

### 1.6.7.1 Diketones with Substituents Containing Additional Donor Atoms

Ligand design is a critical step in synthesizing new and extended inorganic or organometallic structures. Many efforts were made in the last decades of the twentieth century to modify the electronic and steric properties of  $\beta$ -diketones by inserting different  $\text{R}^1$ ,  $\text{R}^2$ , and  $\text{R}^3$  substituents, which can also contain additional donor atoms, in order to prepare polyfunctional coordinating ligands as “biomimetic” agents with higher complexity and functionality.

The 2-cyano-1,3-diketones (12) have been shown to form simple  $\text{Co}^{\text{II}}$  and  $\text{Cu}^{\text{II}}$  chelates stabilized by intermolecular contacts through the  $-\text{CN}$  group<sup>95,96</sup> and, in the presence of dipyridylamine, a mixed-ligand binuclear  $\text{Cu}^{\text{II}}$  complex with different coordination numbers and conformation in the two copper environments.<sup>97</sup> A new advantageous synthesis of these ligands from bis(benzotriazol-1-yl)methylimine as cyanating agent is also reported.<sup>98</sup>

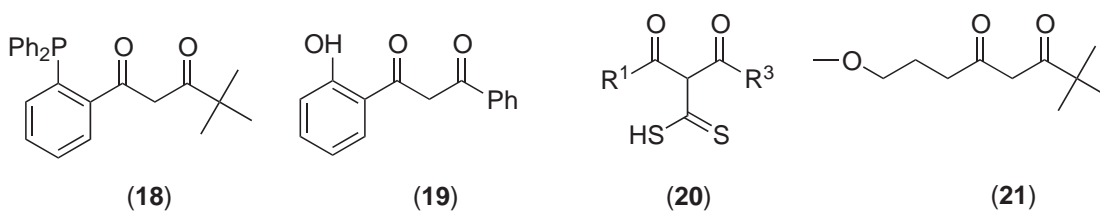


The 3-acetyl-amido-pentane-2,4-dione (amacH) (13) is a highly enolized and acidic substance which is very soluble in water. It was first reported to form a  $Cu^{II}$  complex  $[Cu(amac)_2]$  by Cotton,<sup>99</sup> and has been used to study the kinetics of the mono complex  $M(amac)^+$  formation ( $M = Co, Ni,$  and  $Cu$ ) in aqueous solution.<sup>100</sup> The chemistry of the analogous 3-(hydroxyimino)-pentane-2,4-dione has also been explored.<sup>101</sup>

The 2-diazo-1,3-diketones (14) react with titanocene precursors affording 1-titana-2,*n*-diheterocyclic complexes.<sup>102</sup> 2-(2-thiazolylazo)-1,3-diketones (15) and their corresponding metal derivatives have also been synthesized.<sup>103</sup>

The 3-(4-pyridyl)pentane-2,4-dione (3-pyacacH) (16) interacts with  $Cu^{2+}$  affording  $[Cu(3-pyacac)_2] \cdot 2.5H_2O \cdot 0.5thf$ , where the pyridyl fragment, aligned approximately perpendicularly to the rest of the derivative, binds a second  $Cu$  atom of another molecular unit, thus producing antiferromagnetic interactions at low temperature.<sup>104</sup> A donor with a pyrazolyl moiety as the  $R^2$  substituent (3-pzacac) (17) produced a  $[Be(3-pzacac)_2]$  complex with a supramolecular extended helical array.<sup>105</sup>

Diketones containing a *o*- $Ph_2P-C_6H_4-$  fragment in  $R^1$  and a  $Bu^t$  in  $R^3$  (acacPH = *o*-(diphenylphosphino)benzoyl-pinacolone) (18) have shown interesting properties as P,O,O-tridentate coordinating agents that afford dinuclear homo- (with  $Cu^+$  and with  $Ag^+$ ) and heterobimetallic compounds ( $Cu^{2+}$  together with  $Ir^+, Pt^{2+},$  or  $Ru^{3+}$ ).<sup>106-109</sup> The dinuclear complex  $[Cu(acacP)]_2$  reacts with dibenzoylperoxide or 3-chloroperoxybenzoic acid yielding the mixed-valence  $Cu^I-Cu^{II}$  complexes  $[Cu_2(acacP)_2(m-X-PhCOO)]$  ( $X = H$  or  $Cl$ ).<sup>107</sup> Moreover, oxygenation of  $[Cu(acacP)]_2$  in  $H_2O$  or  $MeOH$  gives rise to dinuclear  $[Cu(acacPO)(OY)]_2$  ( $Y = H$  or  $Me$ ), where the phosphorus of acacP is oxidized and remains uncoordinated.<sup>109</sup>



A  $\beta$ -diketone with a 1-(2-hydroxy)-phenyl fragment as  $R^1$  and a phenyl as  $R^3$  substituent (bzbzOH<sub>2</sub>) (19) behaves as a dianionic tridentate O,O,O-donor affording  $[M_2(bzbzO)_2]$  complexes ( $M = Ni, Cu,$  and  $Zn$ ).<sup>110</sup>

A new  $\beta$ -diketone (acacS<sub>2</sub>H) with a thiolate group in  $R^2$  (20) has been reported able to coordinate through either O<sub>2</sub><sup>-</sup> and S<sub>2</sub>-chelating moieties, and to form mono-, di-, tri-, and tetranuclear complexes with several metal ions (Pt, Pd, Ag, Au, Cu, Ni, Cd, and Hg).<sup>111</sup> In particular, acacS<sub>2</sub>H forms  $[M(Ph_3P)_2(acacS_2)]$  ( $M = Pd$  or  $Pt$ ), which reacts with  $AgClO_4$  and  $PPh_3$  yielding heterodinuclear  $[\{M(Ph_3P)_2\}(acacS_2)\{Ag(PPh_3)\}]ClO_4$  or trinuclear  $[\{M(Ph_3P)_2\}(acacS_2)-\{Ag(PPh_3)\}_2](ClO_4)_2$  complexes, whereas, in the absence of  $PPh_3$ , tetranuclear  $[\{M(Ph_3P)_2\}_2(acacS_2)_2Ag_2](ClO_4)_2$  derivatives are formed, containing two unbound diketonate fragments.<sup>111</sup> The Pt complex reacts with  $MCl_2$  ( $M = Cd, Cu,$  or  $Ni$ ), releasing  $AgCl$  and affording the neutral trinuclear  $[\{Pt(Ph_3P)_2\}_2(acacS_2)_2M'(ClO_4)_2]$  ( $M = Cd$  or  $Cu$ ) or ionic trinuclear  $[\{Pt(Ph_3P)_2\}_2(acacS_2)_2Ni](ClO_4)_2$ .<sup>111</sup>

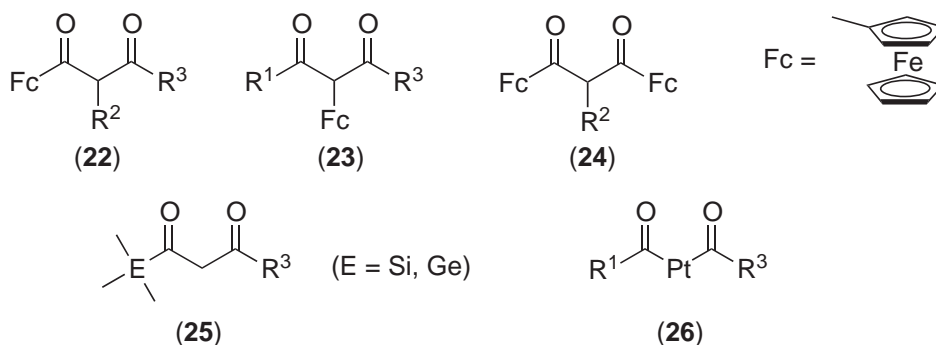
The alkoxyalkyl-substituted  $\beta$ -diketone  $Bu^tCOCH_2CO(CH_2)_3OMe$  (21), with an ethereal "scorpion tail," has been synthesized in order to avoid polymerization by saturating all the possible coordination sites of transition-metal and heavier alkaline earth-metal ions.<sup>112</sup> The crystallographically studied  $Cu^{2+}$  compound shows a five-coordinate metal environment, where the ethereal tail is bonded to the copper atom of another molecular unit through a weak intermolecular interaction. A new liquid monomeric Ba derivative has been successfully prepared; this is a potential molecular precursor in CVD for HTSC mixed metal oxides.<sup>112</sup> The



first heptafluoroacetylacetonate metal derivative has been reported only in 2002, due to difficulty in the preparation of the ligand having  $R^1 = R^3 = CF_3$  and  $R^2 = F$ .<sup>113</sup>

### 1.6.7.2 Diketones with Substituents Containing Metallic or Metalloid Atoms

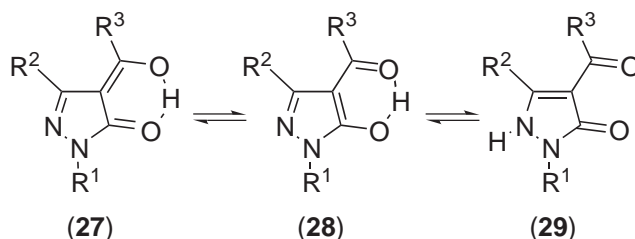
The most famous metal-containing dicarbonyl ligands are ferrocenyl diketones, where the ferrocenyl fragment can be present not only in one of  $R^1$  or  $R^2$  positions (**22**) or (**23**), but also in both  $R^1$  and  $R^3$  (**24**). They were first synthesized by Hauser from Claisen condensation of acetylferrocene and the appropriate ester in the presence of strong bases (metal amides or alkoxides) to overcome the lower acidity of the methyl hydrogen atoms of acetylferrocene, caused by the electron-releasing nature of the ferrocenyl group.<sup>114,115</sup> Metal derivatives of these ligands show a rich chemistry, with very interesting electronic<sup>116–124</sup> and catalytic properties.<sup>33,125</sup>



1-M-2,4-diketones (M = Si, Ge)<sup>126,127</sup> (**25**) have been synthesized and successfully coordinated to  $Cu^{2+}$ , whereas 3-Pt-2,4-diketones<sup>128</sup> (**26**) seem not able to behave as complexing agents, probably because of the presence of a Pt atom between the carbonyl groups.

### 1.6.8 ACYLPYRAZOLONES AND ANALOGUE $\beta$ -DIKETONES WITH A HETEROCYCLE FUSED TO THE CHELATING RING

Another exotic class of diketones, first synthesized at the turn of the nineteenth century,<sup>129</sup> is represented by 4-acyl-5-pyrazolones (here indicated QH), which possess a pyrazole fused to the chelating ring. The pyrazole ring, having electronegativity similar to that of trifluoromethyl anion, greatly influences the properties of these ligands and of their corresponding metal complexes. The delocalization of  $\pi$ -electrons in the pyrazole ring results in many possible tautomeric structural isomers of 4-acyl-5-pyrazolones, some of them also being crystallographically authenticated—(**27**), (**28**), and (**29**)—<sup>130–133</sup> and with enhanced acidity with respect to other diketones, which makes QH more effective in metal-ion extraction in acid media. These ligands have been used as pigments in dyes<sup>133</sup> and as chelating agents in metal extraction,<sup>134–138</sup> in spectrophotometric determinations of trace elements,<sup>139–142</sup> and in liquid membrane separations.<sup>143,144</sup> Some metal acylpyrazolonates have been found to display interesting biological activity as insecticidal and anticancer agents.<sup>145–149</sup> Some lanthanide acylpyrazolonates show enhanced luminescence with respect to classical lanthanide  $\beta$ -diketonates.<sup>150–154</sup>

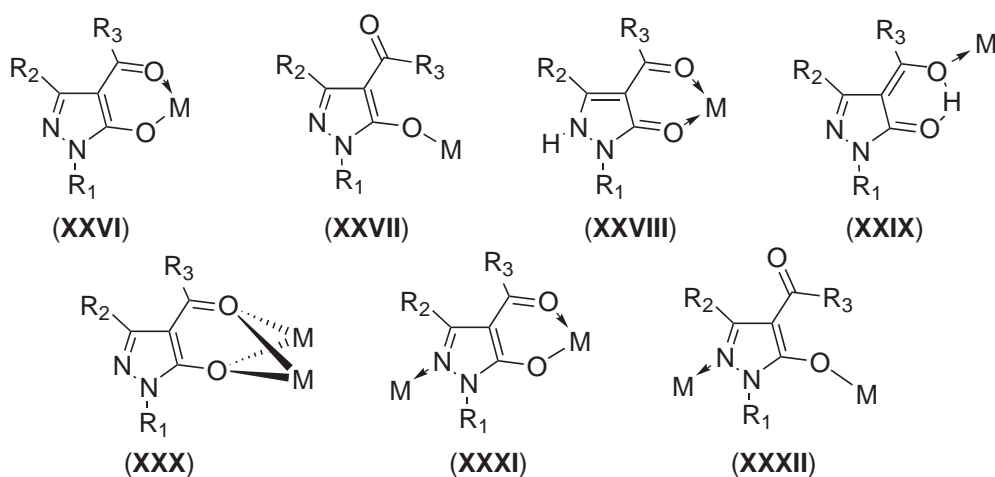


A convenient method of synthesis of acylpyrazolones, reported by Jensen,<sup>155–157</sup> is the acylation in the 4-position of *N*-substituted-5-pyrazolones in basic dioxane with subsequent acidification.

Okafor synthesized fluorinated acylpyrazolones by interaction of *N*-substituted-5-pyrazolones and fluorinated anhydrides in pyridine.<sup>158,159</sup> Another modified procedure starts from 4-acyl-1,2-oxazolin-5-ones, which react with substituted hydrazine affording 4-acyl-5-pyrazolones.<sup>160</sup>

The archetype of these molecules contains  $R^1 = R^3 = \text{Ph}$  and  $R^2 = \text{Me}$ , and modifications generally involved the  $R^3$  fragment. Variations in  $R^1$  and  $R^3$  have also been reported.<sup>161–165</sup> The substituents can greatly influence not only the physico-chemical properties of corresponding metal derivatives, such as solubility in water of bis(acylpyrazolonate)diorganotin(IV) when  $R^1 = \text{Me}$ ,<sup>163</sup> but also their crystal structures: when  $R^1 = 4\text{-CF}_3\text{-Ph}$  *trans*-octahedral bis(acylpyrazolonate)diorganotin(IV) can be isolated in either *syn* or *anti* isomeric forms.<sup>164,165</sup>

Several coordination modes have been identified for acylpyrazolones during the 1990s and early 2000s. Mode (XXVI) with anionic bidentate  $(Q)^-$  is the most diffuse, the two M—O bond distances being similar<sup>166–169</sup> or very different,<sup>170–176</sup> depending on the coordinated metal. Mode (XXVII) has been found in the structure of some trialkyltin(IV) derivatives,<sup>177,178</sup> (XXVIII) has been found in  $[\text{Ba}(Q)_2(QH)_2(\text{H}_2\text{O})]$ ,<sup>179</sup> whereas mode (XXIX) has been detected by  $^1\text{H}$  NMR in organotin(IV) adducts.<sup>180</sup>  $(Q)^-$  donors can also bind two metal centers in a bridging  $\eta^4\text{-O}$ , O-fashion (XXX), as in dinuclear  $[\text{Ba}(Q)_2(L)_2]_2$  ( $L = \text{H}_2\text{O}$  or imH).<sup>181</sup>



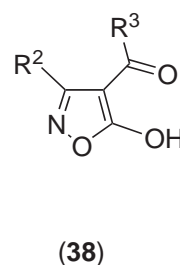
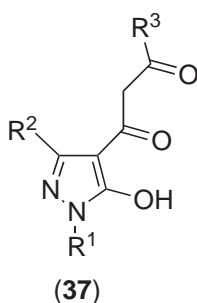
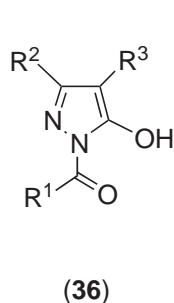
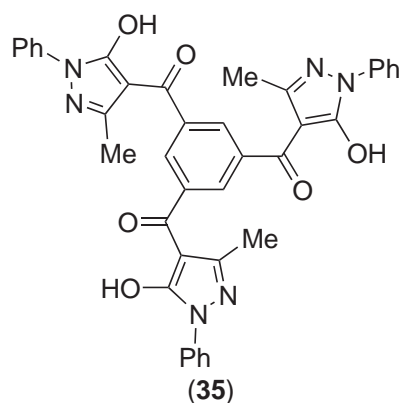
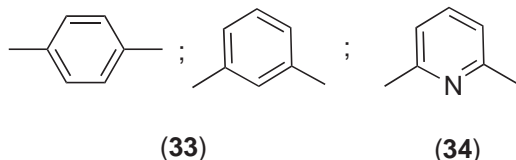
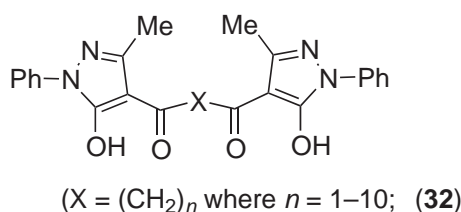
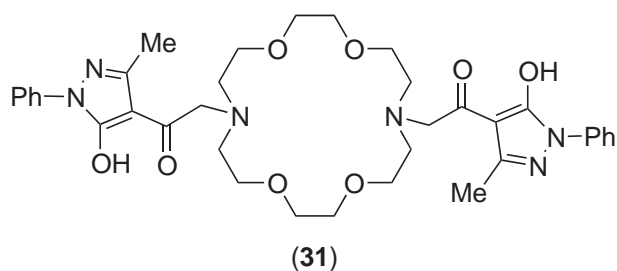
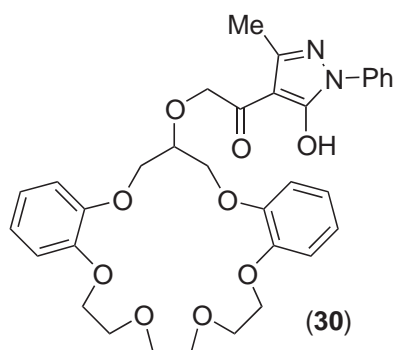
The pyrazole moiety strongly influences the physico-chemical and structural features of the corresponding metal derivatives. They are generally more air- and moisture-stable with respect to analogue metal derivatives of classical  $\beta$ -diketonates,<sup>174</sup> probably because of higher protection of the metallic site offered by the sterically crowded periphery of the ligands in the complexes. In many cases stabilization arises from an extensive intermolecular H-bonding network, involving H atoms from protic molecules (like  $\text{H}_2\text{O}$ , ROH, NH-heterocycles) coordinated to metal and the pyridinic N atom in the pyrazole of the Q donor. This H-bonding affords different and interesting supramolecular assemblies, as in  $[\text{Ba}(Q)_2(L)_2]_2$ ,  $[\text{M}(Q)_2(L)_2]$  ( $M = \text{Zn}$ , Cd, or Ca;  $L = \text{H}_2\text{O}$  or ROH)<sup>182,183</sup> or  $[\text{Cu}(Q)_2(\text{H}_2\text{O})]$ .<sup>184</sup>

The N(2) nitrogen atom of the pyrazole ring has been shown to be responsible for the main differences in coordination modes to metal ions, with respect to analogous metal derivatives of classical  $\beta$ -diketonates.  $[\text{Pb}(Q)_2]$  complexes exist as aggregates involving four primary Pb—O intramolecular and two secondary long Pb—N (XXXI) intermolecular interactions.<sup>170</sup>  $[\text{Ag}(Q)(R_3P)]_2$  dinuclear compounds contain bridging N,O,O-exotridentate Q ligands (XXXI).<sup>185,186</sup> In the polynuclear  $[\text{Ag}(Q)(\text{trimen})]_n$  ( $Q$ )<sup>-</sup> acts as a bridging N,O-exobidentate donor (XXXII).<sup>186</sup> The heterocyclic ring was also responsible in forcing the formation of an O,O-bonded T-shaped organomercury complex, in contrast to classical mercury diketonates which always show the diketonate donors coordinated through the central  $\text{COC}_\alpha\text{CO}$  fragment.<sup>187</sup>

Unusual reactivity has been observed in tin<sup>188–190</sup> and molybdenum<sup>191</sup> derivatives of 4-trichloroacetyl-5-pyrazolone ( $R^3 = \text{CCl}_3$ ). In fact, the acyl  $\text{Cl}_3\text{C}(\text{C}=\text{O})$  fragment undergoes cleavage of the C— $\text{CCl}_3$  bond in alcoholic ROH media in the presence of alkali and tin acceptors,<sup>188–190</sup> affording the tin derivatives of the corresponding keto-ester with the new fragment C—OR. In the presence of  $\text{MoO}_2^{2+}$ , the intermediate of the above alcoholysis has been isolated and crystallographically authenticated.<sup>191</sup>

Crown-ether functionalized acylpyrazolones (30) and (31) have been synthesized and found effective as metal-ion-selective extraction agents.<sup>192</sup> Two chelating acylpyrazolone moieties were linked to each other by aliphatic chains (32) or aromatic moieties (33) and shown to be able to

form monomeric, dimeric, and oligomeric complexes with several main group,<sup>193–196</sup> transition,<sup>140,197–199</sup> and lanthanide metals.<sup>200–204</sup> The crystal structure of a copper derivative, containing two pyrazolone fragments linked by a polymethylene chain, shows association into dimers through oxygen atoms.<sup>199</sup> A potentially NO<sub>4</sub>-pentadentate ligand (**34**), with a pyridine between two chelating moieties, has been reported to simultaneously coordinate Rh and Sn through both chelating moieties,<sup>205</sup> but the donating ability of the nitrogen atom in the central pyridinic fragment is as yet (in 2002) completely unexplored. A recently reported hexadentate ligand, with three acylpyrazolone units bonded to a central phenyl ring (**35**), is able to form cyclic hexanuclear or octanuclear cluster structures with Ga<sup>206</sup> and Eu,<sup>207</sup> the latter being pictorially called “lord of the rings” by the authors.<sup>208</sup> The synthesis procedure for these polydentate donors strictly resembles that of simple acylpyrazolones, using the corresponding di- or tri-acylchlorides.<sup>140,206</sup> 1-Acyl-5-pyrazolones (**36**) have been reported to react with Sn, Tl, Hg, and Sb;<sup>177,187,208</sup> however, they seem to be less of a donor than acylpyrazolones, most likely because of the presence of a nitrogen atom between the carbonyl groups.  $\beta$ -Tricarbonyl donors (**37**) were synthesized some years ago, but no metal derivatives have yet been reported.<sup>209</sup> 4-Acyl-5-isoxazolone donors (**38**), built on five-membered isoxazole, have been used as chelating agents in the liquid–liquid extraction of transition-metal ions,<sup>210–214</sup> and crystal structures of Eu<sup>215</sup> and Cu<sup>216</sup> have been reported. In the latter, the oxygen atom of the isoxazole ring is involved in a secondary intermolecular interaction with the metal atom of another molecular unit.<sup>216</sup>



**1.6.9 REFERENCES**

- Siedle, A. R. *Diketones and Related Ligands*. In *Comprehensive Coordination Chemistry*; Wilkinson, G., Gillard, R. D., McCleverty, J. A., Eds.; Pergamon: Oxford, UK, 1987; pp 365–412.
- Mehrotra, R. C.; Bohra, R.; Gaur, D. P. *Metal β-diketones and Allied Derivatives*; Academic Press: New York, 1978.
- Hierso, J.-C.; Feurer, R.; Kalck, P. *Coord. Chem. Rev.* **1998**, *178–180*, 1811–1834.
- Doppelt, P. *Coord. Chem. Rev.* **1998**, *178–180*, 1785–1809.
- Kodas, T. T.; Hampden-Smith, M. J., Eds., *The Chemistry of Metal CVD*; VCH: Weinheim, Germany, 1994.
- Hampden-Smith, M. J.; Kodas, T. T. *Polyhedron* **1995**, *14*, 699–732.
- Drozdzov, A.; Troyanov, S. I. *Main Group Met. Chem.* **1996**, *19*, 547–569.
- Otway, D. J.; Rees, Jr., W. S. *Coord. Chem. Rev.* **2000**, *210*, 279–328.
- Gleizes, A. N. *Chem. Vap. Deposition* **2000**, *6*, 155–173.
- Darr, J. A.; Poliakoff, M. *Chem. Rev.* **1999**, *99*, 495–541.
- Köpf-Maier, P.; Köpf, H. *Chem. Rev.* **1987**, *87*, 1137–1152.
- Keppeler, B. K.; Friesen, C.; Vongerichten, H.; Vogel, E.; Keppeler, B. K., Ed., *Metal Complexes in Cancer Chemotherapy* **1993**, VCH, Weinheim, Germany.
- Sava, G.; Zorzet, S.; Perissin, L.; Mestroni, G.; Zassinovich, G.; Bontempi, A. *Inorg. Chim. Acta* **1987**, 69–71.
- Searle, D.; Smith, P. J.; Bell, N. A.; March, L. A.; Nowell, I. W.; Donaldson, J. D. *Inorg. Chim. Acta* **1989**, *162*, 143–149.
- Gielen, M., Ed., *Tin Based Antitumor Drugs* **1990**, NATO ASI Series, Springer Verlag, Berlin.
- De Sà, G. F.; Malta, O. L.; De Mello Donegà, C.; Simas, A. M.; Longo, R. L.; Santa-Cruz, P. A.; Da Silva, Jr., E. F. *Coord. Chem. Rev.* **2000**, *196*, 165–195.
- Vicentini, G.; Zinner, L. B.; Zukerman-Schpector, J.; Zinner, K. *Coord. Chem. Rev.* **2000**, *196*, 353–382.
- Raber, D. J. *Lanthanide Shift Reagents in Stereochemical Analysis*; Morril, T. C., Ed.; VCH: New York, 1986.
- Parker, D. *Chem. Rev.* **1991**, *91*, 1441–1457.
- Imamoto, T., Ed. *Lanthanides in Organic Synthesis*; Academic Press, London, 1994.
- Giroud-Godquin, A. M.; Maitlis, P. M. *Angew. Chem., Int. Ed. Engl.* **1991**, *30*, 375–402.
- Espinete, P.; Esteruelas, M. A.; Oro, L. A.; Serrano, J. L.; Sola, E. *Coord. Chem. Rev.* **1992**, *117*, 215–274.
- Hudson, S. A.; Maitlis, P. M. *Chem. Rev.* **1993**, *93*, 861–885.
- Giroud-Godquin, A. M. *Coord. Chem. Rev.* **1998**, *178–180*, 1485–1499.
- Zheng, H.; Xu, B.; Swager, T. M. *Chem. Mater.* **1996**, *8*, 907–911 and references therein.
- Barbera, J.; Elduque, A.; Gimenez, R.; Lahoz, F. J.; Lopez, J. A.; Oro, L. A.; Serrano, J. L.; Villacampa, B.; Villalba, J. *Inorg. Chem.* **1999**, *38*, 3085–3092 and references therein.
- Binnemans, K.; Lodewyckx, K. *Angew. Chem., Int. Ed. Engl.* **2001**, *40*, 242–244.
- Bednarski, M.; Maring, C.; Danishefsky, S. *Tetrahedron Lett.* **1983**, *24*, 3451–3454.
- Bednarski, M.; Danishefsky, S. *J. Am. Chem. Soc.* **1983**, *105*, 3716–3717.
- Matlin, S. A.; Lough, W. J.; Chan, L.; Abram, D. M. H.; Zhou, Z. *J. Chem. Soc. Chem. Commun.* **1984**, 1038–1040.
- Cullen, W. R.; Wickenheiser, J. *Organomet. Chem.* **1989**, *370*, 141–154.
- Blaser, H-U. *Chem. Rev.* **1992**, *92*, 935–952.
- Esteruelas, M. A.; Lahoz, F. J.; Onate, E.; Oro, L. A.; Rodriguez, L. *Organometallics* **1995**, *14*, 263–268 and references therein.
- Esteruelas, M. A.; Lahoz, F. J.; Onate, E.; Oro, L. A.; Rodriguez, L. *Organometallics* **1996**, *15*, 823–834 and references therein.
- Chavez, F. A.; Briones, J. A.; Olmstead, M. M.; Mascharak, P. K. *Inorg. Chem.* **1999**, *38*, 1603–1608 and references therein.
- Esteruelas, M. A.; Martin, M.; Oro, L. A. *Organometallics* **1999**, *18*, 2267–2270 and references therein.
- Abbati, G. L.; Cornia, A.; Fabretti, A. C.; Caneschi, A.; Gatteschi, D. *Inorg. Chem.* **1998**, *37*, 1430–1431 and references therein.
- Abbati, G. L.; Brunel, L.-C.; Casalta, H.; Cornia, A.; Fabretti, A. C.; Gatteschi, D.; Hassan, A. K.; Jansen, A. G. M.; Maniero, A. L.; Pardi, L.; Paulsen, C.; Segre, U. *Chem. Eur. J.* **2001**, *7*, 1796–1807 and references therein.
- Kawaguchi, S. *Coord. Chem. Rev.* **1986**, *70*, 51–84.
- Kawaguchi, S. In *Variety in Coordination of Ligands in Metal Complexes: Inorganic Concepts*; Kawaguchi, S., Ed.; Springer Verlag, Berlin, 1988, Vol. 11, pp 75–119.
- Levine, R.; Conroy, J. A.; Adams, J. T.; House, Ch. R. *J. Am. Chem. Soc.* **1945**, *67*, 1510–1512.
- Martin, D. F.; Shamma, M.; Ferriellius, W. E. *J. Am. Chem. Soc.* **1958**, *80*, 4891–4895.
- Martin, D. F.; Shamma, M.; Ferriellius, W. E. *J. Am. Chem. Soc.* **1958**, *80*, 5851–5856.
- Bloomfield, J. J. *J. Org. Chem.* **1962**, *27*, 2742–2746.
- Vogel, A. I. *Practical Organic Chemistry*, 5th ed.; Longman Scientific & Technical: London, 1989; pp 632–635.
- Pellicciari, R.; Fringuelli, R.; Sisani, E. *J. Chem. Soc. Perkin I* **1981**, 2566–1569.
- Hooz, J.; Oudenes, J. *Synt. Commun.* **1982**, *12*, 189–194.
- Howard, A. S.; Meerholz, C. A.; Michael, J. P. *Tetrahedron Lett.* **1979**, *15*, 1339–1340.
- Taylor, R. J. K. *Synthesis* **1985**, 364–392.
- Igumenov, I. K.; Semyannikov, P. P.; Belaya, S. V.; Zanina, A. S.; Shergina, S. I.; Sokolov, I. E. *Polyhedron* **1996**, *15*, 4521–4530 and references therein.
- Ying, T.; Bao, W.; Zhang, Y.; Xu, W. *Tetrahedron Lett.* **1996**, *37*, 3885–3886.
- Le Roux, C.; Mandrou, S.; Dubac, J. *J. Org. Chem.* **1996**, *61*, 3885–3887.
- Sukuzi, M.; Watanabe, A.; Noyori, R. *J. Am. Chem. Soc.* **1980**, *102*, 2095–2096.
- Togni, A. *Organometallics* **1990**, *9*, 3106–3113.
- Rozenberg, V. I.; Dubrovina, N. V.; Vorontsov, E. V.; Sergeeva, E. V.; Belokon, *Tetrahedron Asymmetry* **1999**, *10*, 511–517.
- Galvez, N.; Moreno-Manas, M.; Padros, I.; Sebastian, R. M.; Serra, N.; Vallribera, A. *Polyhedron* **1995**, *14*, 1397–1399.
- Clemens, R. J.; Hyatt, J. A. *J. Org. Chem.* **1985**, *50*, 2431–2435.

58. Tang, Q.; Sen, S. E. *Tetrahedron Lett.* **1998**, *39*, 2249–2252.
59. Moreno-Manas, M.; Marquest, J.; Vallribera, A. *Tetrahedron* **1996**, *52*, 3377–3401 and references therein.
60. Ito, Y.; Fujii, S.; Saegusa, T. *J. Org. Chem.* **1976**, *41*, 2073–2074.
61. Garnovskii, A. D.; Sadimenko, A. P.; Sadimenko, M. I.; Garnovskii, D. A. *Coord. Chem. Rev.* **1998**, *173*, 31–77.
62. Perrin, C. L.; Kim, Y.-J. *J. Am. Chem. Soc.* **1998**, *120*, 12641–12645.
63. Perrin, C. L.; Kim, Y.-J. *Inorg. Chem.* **2000**, *39*, 3902–3910.
64. Imran, A.; Kemmitt, R. D. W.; Markwick, A. J. W.; McKenna, P.; Russell, D. R.; Sherry, L. J. *J. Chem. Soc. Dalton Trans.* **1985**, 549–554.
65. Martin, D.; Shamma, M.; Fernelius, W. C. *J. Am. Chem. Soc.* **1958**, *80*, 4891–4895.
66. Martin, D.; Shamma, M.; Fernelius, W. C. *J. Am. Chem. Soc.* **1958**, *80*, 5851–5856.
67. Andrelczyk, B.; Lintvedt, R. L. *J. Am. Chem. Soc.* **1972**, *94*, 8633–8634.
68. Lintvedt, R. L.; Schoenfelner, B. A.; Ceccarelli, C.; Glick, M. D. *Inorg. Chem.* **1982**, *21*, 2113–2114.
69. Lintvedt, R. L.; Schoenfelner, B. A.; Ceccarelli, C.; Glick, M. D. *Inorg. Chem.* **1984**, *23*, 2867–2874.
70. Lintvedt, R. L.; Ranger, G.; Ceccarelli, C. *Inorg. Chem.* **1985**, *24*, 456–459.
71. Maverich, A. W.; Martone, D. P.; Bradbury, J. R.; Nelson, J. E. *Polyhedron* **1989**, *8*, 1549–1556.
72. Muthusamy, G.; Jayakumar, N.; Manonmani, B.; Shantha, R.; Natarajan, K. *Synth. React. Inorg. Met.-Org. Chem.* **1992**, *22*, 171–183.
73. Chinnusamy, V.; Natarajan, K. *Synth. React. Inorg. Met.-Org. Chem.* **1994**, *24*, 533–544.
74. Bonitatebus, Jr., P. J.; Mandal, S. K.; Armstrong, W. H. *J. Chem. Soc. Chem. Commun.* **1998**, 939–940.
75. Karvembu, R.; Natarajan, K. *Polyhedron* **2002**, *21*, 219–223 and references therein.
76. Fenton, D. E.; Regan, C. M.; Casellato, U.; Vigato, P. A.; Vidali, M. *Inorg. Chim. Acta* **1982**, *58*, 83–88.
77. Maverick, A. W.; Klavetter, F. E. *Inorg. Chem.* **1984**, *23*, 4129–4130.
78. Whitmore, B. C.; Eisenberg, R. *Inorg. Chem.* **1984**, *23*, 1697–1703.
79. Maverick, A. W.; Buckingham, S. C.; Yao, Q.; Bradbury, J. R.; Stanley, G. G. *J. Am. Chem. Soc.* **1986**, *108*, 7430–7431.
80. Grillo, V. A.; Seddon, E. J.; Grant, C. M.; Aromi, G.; Bollinger, J. C.; Folting, K.; Christou, G. *J. Chem. Soc. Chem. Commun.* **1997**, 1561–1562.
81. Fenton, D. E.; Tate, J. R.; Casellato, U.; Tambrini, S.; Vigato, P. A.; Vidali, M. *Inorg. Chim. Acta* **1984**, *83*, 23–31.
82. Saalfrank, R. W.; Seitz, V.; Caulder, D. L.; Raymond, K. N.; Teichert, M.; Stalke, D. *Eur. J. Inorg. Chem.* **1998**, 1313–1317.
83. Bailey, N. A.; Fenton, D. E.; Lay, J.; Roberts, P. B.; Latour, J.-M.; Limosin, D. *J. Chem. Soc., Dalton Trans.* **1986**, 2681–2689.
84. Aromi, G.; Berzal, P. C.; Gamez, P.; Roubeau, O.; Kooijman, H.; Spek, A. L.; Driessen, W. L.; Reedijk, J. *Angew. Chem., Int. Ed. Engl.* **2001**, *40*, 3444–3446.
85. Saalfrank, R. W.; Maid, H.; Mooren, N.; Hampel, F. *Angew. Chem., Int. Ed. Engl.* **2002**, *41*, 304–307.
86. Saalfrank, R. W.; Stark, A.; Bremer, M.; Hummel, H.-U. *Angew. Chem., Int. Ed. Engl.* **1990**, *29*, 311–314.
87. Saalfrank, R. W.; Hörner, B.; Stalke, D.; Salbeck, J. *Angew. Chem., Int. Ed. Engl.* **1993**, *32*, 1179–1182.
88. Saalfrank, R. W.; Burak, R.; Breit, A.; Stalke, D.; Herbst-Irmer, R.; Daub, J.; Porsch, M.; Bill, E.; Mütter, M.; Trautwein, A. X. *Angew. Chem., Int. Ed. Engl.* **1994**, *33*, 1621–1623.
89. Saalfrank, R. W.; Burak, R.; Reihls, S.; Löw, N.; Hampel, F.; Stachel, H.-D.; Lentmaier, J.; Peters, K.; Peters, E.-M.; von Schnering, H. G. *Angew. Chem., Int. Ed. Engl.* **1995**, *34*, 993–995.
90. Saalfrank, R. W.; Glaser, H.; Demleitner, B.; Hampel, F.; Chowdhry, M. M.; Scünemann, V.; Trautwein, A. X.; Vaughan, G. B. M.; Yeh, R.; Davis, A. V.; Raymond, K. N. *Chem. Eur. J.* **2002**, *8*, 493–497.
91. Grybos, R.; Paw, W. *Polyhedron* **1990**, *9*, 1397–1400.
92. Hashimoto, T.; Endo, A.; Nagao, N.; Sato, G. P.; Natarajan, K.; Shimizu, K. *Inorg. Chem.* **1998**, *37*, 5211–5220.
93. Kamiyama, A.; Noguchi, T.; Kajiwara, T.; Ito, T. *Inorg. Chem.* **2002**, *41*, 507–512.
94. Kamiyama, A.; Ito, T. *Angew. Chem., Int. Ed. Engl.* **2000**, *39*, 230–233.
95. Angelova, O.; Macicek, J.; Atanasov, M.; Petrov, G. *Inorg. Chem.* **1991**, *30*, 1943–1949.
96. Silvernail, C. M.; Yap, G.; Sommer, R. D.; Rheingold, A. L.; Day, V. W.; Belot, J. A. *Polyhedron* **2001**, *20*, 3113–3117.
97. Tsiamis, C.; Tzavellas, L. C.; Stergiou, A.; Anesti, V. *Inorg. Chem.* **1996**, *35*, 4984–4988.
98. Thambidurai, S.; Jayasubramanian, K.; Ramalingam, S. K. *Polyhedron* **1996**, *15*, 4011–4014.
99. Fackler, J. P., Jr.; Cotton, F. A. *Inorg. Chem.* **1963**, *2*, 102–106.
100. Hirsch, J.; Paulus, H.; Elias, H. *Inorg. Chem.* **1996**, *35*, 2343–2351.
101. Elias, H.; Wiegand, D.; Wannowius, K. *J. Inorg. Chim. Acta* **1992**, *197*, 21–24.
102. Nieuwenhuyzen, M.; Schobert, R.; Hampel, F.; Hoops, S. *Inorg. Chim. Acta* **2000**, *304*, 118–121.
103. Krishnankutty, K.; Babu, D. K. *J. Indian Chem. Soc.* **1996**, *73*, 379–384.
104. Turner, S. S.; Collison, D.; Mabbs, F. E.; Halliwell, M. *J. Chem. Soc. Dalton Trans.* **1997**, 1117–1118 and references therein.
105. Boldog, I.; Rusanov, E. B.; Chernega, A. N.; Sieler, J.; Domasevitch, K. V. *Angew. Chem., Int. Ed. Engl.* **2001**, *40*, 3435–3438.
106. Rauchfuss, T. B.; Wilson, S. R.; Wroblewski, D. A. *J. Am. Chem. Soc.* **1981**, *103*, 6769–6770.
107. Wroblewski, D. A.; Wilson, S. R.; Rauchfuss, T. B. *Inorg. Chem.* **1982**, *21*, 2114–2115.
108. Wroblewski, D. A.; Rauchfuss, T. B. *J. Am. Chem. Soc.* **1982**, *104*, 2314–2316.
109. Wroblewski, D. A.; Rauchfuss, T. B.; Rheingold, A. L.; Lewis, K. A. *Inorg. Chem.* **1984**, *23*, 3124–3129.
110. Venugopalan, P.; Krishnankutty, K. *J. Indian Chem. Soc.* **1997**, *74*, 564–565.
111. Vicente, J.; Chicote, M. T.; Huertas, S.; Jones, P. G.; Fischer, A. K. *Inorg. Chem.* **2001**, *40*, 6193–6200.
112. Rees, Jr., W. S.; Caballero, C. R. *Angew. Chem., Int. Ed. Engl.* **1992**, *31*, 735–736.
113. Petrov, V. A.; Marshall, W. J.; Grushin, V. V. *J. Chem. Soc. Chem. Commun.* **2002**, 520–521.
114. Hauser, C. R.; Cain, C. E. *J. Org. Chem.* **1958**, *23*, 1142–1146.
115. Cain, C. E.; Nashburn, T. A.; Hauser, C. R. *J. Org. Chem.* **1961**, *26*, 1030–1034.
116. Woisetschläger, O. E.; Geisbauer, A.; Polborn, K.; Beck, W. *J. Organomet. Chem.* **2001**, *599*, 238–246.
117. (Ina) Du Plessi, W. C.; Davis, W. L.; Cronje, S. J.; Swarts, J. C. *Inorg. Chim. Acta* **2001**, *314*, 97–104.

118. (Ina) Du Plessi, W. C.; Erasmus, J. J. C.; Lamprecht, G. J.; Conradie, J.; Cameron, T. S.; Equino, M. A. S.; Swarts, J. C. *Can. J. Chem.* **1999**, *77*, 378–386.
119. Woisetschläger, O. E.; Geisbauer, A.; Polborn, K.; Beck, W. Z. *Anorg. Allg. Chem.* **2000**, *626*, 766–774.
120. Woisetschläger, O. E.; Geisbauer, A.; Polborn, K.; Sünkel, K.; Beck, W. Z. *Anorg. Allg. Chem.* **1999**, *625*, 2164–2168.
121. (Ina) Du Plessi, W. C.; Vosloo, T. G.; Swarts, J. C. *J. Chem. Soc., Dalton Trans.* **1998**, 2507–2514.
122. Zakaria, C. M.; Morrison, C. A.; McAndrew, D.; Bell, W.; Glidewell, C. *J. Organomet. Chem.* **1995**, *485*, 201–207.
123. Zanello, P.; de Biani, F. F.; Glidewell, C.; Koenig, J.; Marsh, S. J. *Polyhedron* **1998**, *17*, 1795–1801.
124. Kasahara, Y.; Hoshino, Y.; Kajitani, M.; Shimizu, K.; Sato, G. P. *Organometallics* **1992**, *11*, 1968–1971.
125. Abiko, A.; Wang, G.-Q. *J. Org. Chem.* **1996**, *61*, 2264–2265.
126. Banger, K. K.; Birringer, C.; Claessen, R. U.; Lim, P.; Toscano, P. J.; Welch, J. T. *Organometallics* **2001**, *20*, 4745–4748.
127. Banger, K. K.; Kornilov, A.; Claessen, R. U.; Eisenbraun, E. T.; Kaloyeros, A. E.; Toscano, P. J.; Welch, J. T. *Inorg. Chem. Commun.* **2001**, *4*, 496–500.
128. Heinemann, F. W.; Bruhn, C.; Scholz, J.; Steinborn, D. *Organometallics* **1999**, *18*, 564–572.
129. Stoltz, F. *J. Prakt. Chem.* **1897**, *55*, 145–148.
130. O'Connell, M. J.; Ramsay, C. G.; Steel, P. J. *Aust. J. Chem.* **1985**, *38*, 401–409.
131. Guard, J. A. M.; Steel, P. J. *Aust. J. Chem.* **1994**, *47*, 1453–1459.
132. Holzer, W.; Mereiter, K.; Plagens, B. *Heterocycles*, **1999**, *50*, 799–818.
133. Venkataraman, K. In *The chemistry of dyes*; Academic Press: New York, 1952.
134. Zolotov, Y. A.; Gavrilova, L. G. *J. Inorg. Nucl. Chem.* **1969**, *31*, 3613–3621.
135. Zolotov, Y. A.; Kuzmin, N. M. In *The Extraction of Metals by Acylpyrazolones*; Nauka, Moscow, 1977.
136. Mirza, M. Y.; Nwabue, F. K. *Radiochim. Acta* **1980**, *27*, 47–50.
137. Umetani, S.; Kihara, S.; Matsui, M. *Anal. Chim. Acta* **1990**, *232*, 293–299.
138. Mickler, W.; Reich, A.; Uhlemann, E. *Sep. Sci. Technol.* **1998**, *33*, 425–435.
139. Mirza, M. Y.; Nwabue, F. I. *Talanta* **1981**, *28*, 49–53.
140. Miyazaki, S.; Mukai, H.; Umetani, S.; Kihara, S.; Matsui, M. *Inorg. Chem.* **1989**, *28*, 3014–3017.
141. Menzel, E. R.; Lorenz, D. R.; Wasson, J. R.; Radigan, K. R.; McCormick, B. J. *J. Inorg. Nucl. Chem.* **1976**, *38*, 993–996.
142. Okafor, E. C. *Spectrochim. Acta* **1981**, *37A*, 945–955.
143. Mickler, W.; Reich, A.; Uhlemann, E.; Bart, H. J. *J. Membr. Sci.* **1996**, *119*, 91–97.
144. Kuemmel, R.; Schroeder, M.; Uhlemann, E.; Mickler, W. *Chem. Tech.* **1996**, *48*, 197–202.
145. Saxena, S.; Saxena, P. N.; Rai, A. K.; Saxena, S. C. *Toxicology* **1985**, *35*, 241–244.
146. Saxena, P. N.; Saxena, S. *Appl. Organomet. Chem.* **1989**, *3*, 279–281.
147. Omotowa, A.; Mesubi, M. A. *Appl. Organomet. Chem.* **1997**, *11*, 1–10.
148. Prasad, K. M.; Rao, N. R.; Ganorkar, M. C.; Chary, C. M. *J. Organomet. Chem.* **1989**, *376*, 53–59.
149. Caruso, F.; Rossi, M.; Tanski, J.; Sartori, R.; Sariego, R.; Moya, S.; Diez, S.; Navarrete, E.; Cingolani, A.; Marchetti, F.; Pettinari, C. *J. Med. Chem.* **2000**, *43*, 3665–3670.
150. Qian, D.-J.; Yang, K.-Z.; Nakahara, H.; Fukuda, K. *Langmuir* **1997**, *13*, 5925–59932.
151. Huang, C.; Wang, K.; Xu, G.; Zhao, X.; Xie, X.; Xu, Y.; Liu, Y.; Xu, L.; Li, T. *J. Phys. Chem.* **1995**, *99*, 14397–14402.
152. Ying, L.; Yu, A.; Zhao, X.; Li, Q.; Zhou, D.; Huang, C.; Umetani, S.; Matsui, M. *J. Phys. Chem.* **1996**, *100*, 18387–18391.
153. Zhou, D.; Li, Q.; Huang, C.; Yao, G.; Umetani, S.; Matsui, M.; Ying, L.; Yu, A.; Zhao, X. *Polyhedron*, **1997**, *16*, 1381–1389.
154. Pettinari, C.; Marchetti, F.; Pettinari, R.; Drozdov, A.; Troyanov, S. I.; Voloshin, A. I.; Shavaleev, N. M. *J. Chem. Soc., Dalton Trans.* **2002**, 1409–1415.
155. Jensen, B. S. *Acta Chem. Scand.* **1959**, *13*, 1347–1357.
156. Jensen, B. S. *Acta Chem. Scand.* **1959**, *13*, 1668–1670.
157. Jensen, B. S. *Acta Chem. Scand.* **1959**, *13*, 1890–1896.
158. Okafor, E. C. *Spectrochim. Acta* **1981**, *37A*, 939–944.
159. Okafor, E. C. *Talanta* **1982**, *29*, 275–278.
160. Wamhoff, H.; Schiramm, D.; Korte, F. *Synthesis* **1971**, 216–217.
161. Marchetti, F.; Pettinari, C.; Cingolani, A.; Brocanelli, L.; Rossi, M.; Caruso, F. *J. Organomet. Chem.* **1999**, *580*, 344–353.
162. Marchetti, F.; Pettinari, C.; Cingolani, A.; Pettinari, R.; Rossi, M.; Caruso, F. *J. Organomet. Chem.* **2002**, *645*, 134–145.
163. Pettinari, C.; Marchetti, F.; Cingolani, A.; Leonesi, D.; Mundorff, E.; Rossi, M.; Caruso, F. *J. Organomet. Chem.* **1998**, *557*, 187–205.
164. Caruso, F.; Rossi, M.; Marchetti, F.; Pettinari, C. *Organometallics* **1999**, *18*, 2398–2400.
165. Pettinari, C.; Marchetti, F.; Cingolani, A.; Gindulyte, A.; Massa, L.; Rossi, M.; Caruso, F. *Eur. J. Inorg. Chem.* **2001**, 2171–2180.
166. Marchetti, F.; Pettinari, C.; Cingolani, A.; Leonesi, D.; Camalli, M.; Pifferi, A. *Polyhedron* **1996**, 3835–3849.
167. Pettinari, C.; Accorroni, F.; Cingolani, A.; Marchetti, F.; Cassetta, A.; Barba, L. *J. Organomet. Chem.* **1998**, *566*, 187–201.
168. Marchetti, F.; Pettinari, C.; Pettinari, R.; Cingolani, A.; Camalli, M.; Spagna, R. *Inorg. Chim. Acta* **2000**, *299*, 65–79.
169. Zhou, D.; Li, Q.; Huang, C.; Yao, G.; Umetani, S.; Matsui, M.; Ying, L.; Yu, A.; Zhao, X. *Polyhedron* **1997**, *16*, 1381–1389.
170. Okafor, E. C.; Uzuokuwu, A. B.; Hitchcock, P. B.; Smith, J. D. *Inorg. Chim. Acta* **1990**, *172*, 97–103.
171. Saxena, S.; Bohra, R.; Rai, A. K. *Inorg. Chim. Acta* **1990**, *173*, 191–194.
172. Ryan, R. R.; Jarvinen, G. D. *Acta Cryst.* **1987**, *C43*, 1295–1298.
173. Pettinari, C.; Marchetti, F.; Cingolani, A.; Marciantie, C.; Spagna, R.; Colapietro, M. *Polyhedron* **1994**, *13*, 939–950.
174. Pettinari, C.; Marchetti, F.; Leonesi, D.; Rossi, M.; Caruso, F. *J. Organomet. Chem.* **1994**, 123–137.

175. Caruso, F.; Leonesi, D.; Marchetti, F.; Rivarola, E.; Rossi, M.; Tomov, V.; Pettinari, C. *J. Organomet. Chem.* **1996**, 29–44.
176. Mickler, W.; Reich, A.; Sawusch, S.; Schiude, U.; Uhlemann, E. *Acta Cryst.* **1998**, C54, 776–779.
177. Mahon, M. F.; Moloy, K. C.; Omotowa, B. A.; Mesubi, M. A. *J. Organomet. Chem.* **1996**, 511, 227–237.
178. Marchetti, F.; Pettinari, C.; Cingolani, A.; Gioia Lobbia, G.; Cassetta, A.; Barba, L. *J. Organomet. Chem.* **1996**, 517, 141–154.
179. Uhlemann, E.; Schiude, U.; Weller, F. *Z. Naturforsch.* **1994**, 50b, 31–36.
180. Pettinari, C.; Bonati, F.; Cingolani, A.; Gioia Lobbia, G.; Marchetti, F. *Gazz. Chim. Ital.* **1992**, 122, 261–267.
181. Pettinari, C.; Marchetti, F.; Cingolani, A.; Leonesi, D.; Troyanov, S. I.; Drozdov, A. *J. Chem. Soc., Dalton Trans.* **1999**, 1555–1562.
182. Pettinari, C.; Marchetti, F.; Pettinari, R.; Cingolani, A.; Troyanov, S. I.; Drozdov, A. *J. Chem. Soc., Dalton Trans.* **2000**, 831–836.
183. Marchetti, F.; Pettinari, C.; Pettinari, R.; Arriva, D.; Troyanov, S. I.; Drozdov, A. *Inorg. Chim. Acta* **2000**, 307, 97–105.
184. Marchetti, F.; Pettinari, C.; Cingolani, A.; Leonesi, D.; Drozdov, A.; Troyanov, S. I. *J. Chem. Soc., Dalton Trans.* **1998**, 3325–3333.
185. Cingolani, A.; Effendy, Marchetti, F.; Pettinari, C.; Pettinari, R.; Skelton, B. W.; White, A. H. *Inorg. Chim. Acta* **2002**, 329, 100–112.
186. Cingolani, A.; Effendy, Marchetti, F.; Pettinari, C.; Pettinari, R.; Skelton, B. W.; White, A. H. *Inorg. Chim. Acta* **2002**, 41, 1151–1161.
187. Mahon, M. F.; Molloy, K. C.; Omotowa, B. A.; Mesubi, M. A. *J. Organomet. Chem.* **1996**, 525, 239–246 and references therein.
188. Pettinari, C.; Marchetti, F.; Gregori, A.; Cingolani, A.; Tanski, J.; Rossi, M.; Caruso, F. *Inorg. Chim. Acta* **1997**, 257, 37–48.
189. Pettinari, C.; Marchetti, F.; Cingolani, A.; Lorenzotti, A.; Mundorff, E.; Rossi, M.; Caruso, F. *Inorg. Chim. Acta* **1997**, 262, 33–46.
190. Marchetti, F.; Pettinari, C.; Rossi, M.; Caruso, F. *Main Group Met. Chem.* **1998**, 21, 255–259.
191. Uzoukwu, B. A.; Gloe, K.; Rademacher, O. *Z. Anorg. Allg. Chem.* **2001**, 627, 108–113.
192. Yamazaki, S.; Hanada, M.; Yanase, Y.; Fukumori, C.; Ogura, K.; Saeki, T.; Umetani, S. *I. Chem. Soc. Perkin Trans. I* **1999**, 693–696.
193. Pettinari, C.; Marchetti, F.; Cingolani, A.; Leonesi, D.; Gioia Lobbia, G.; Lorenzotti, A. *J. Organomet. Chem.* **1993**, 454, 59–66.
194. Pettinari, C.; Marchetti, F.; Gioia Lobbia, G.; Cingolani, A. *Gazz. Chim. Ital.* **1994**, 285–294.
195. Pettinari, C.; Marchetti, F.; Pettinari, R.; Cingolani, A.; Drozdov, A.; Troyanov, S. I. *J. Chem. Soc., Dalton Trans.* **2002**, 188–194.
196. Okafor, E. C.; Uzoukwu, B. A. *Synth. React. Inorg. Met.-Org. Chem.* **1991**, 21, 825–844.
197. Tayeb, A.; Louati, A.; Kuncaka, A.; Gross, M.; Hauptmann, C.; Bernard, M. Andr e, J. J.; Brunette, J. P. *J. Organomet. Chem.* **1995**, 486, 95–104.
198. Yang, L.; Jin, W.; Lin, J. *Polyhedron* **2000**, 19, 93–98 and references therein.
199. Goetz-Grandmont, G. J.; Tayeb, A.; Matt, D.; Brunette, J.-P.; Toupet, L. *Acta Cryst.* **1995**, C51, 53–57.
200. Li, X. J.; Wanyan, H.; Dong, W. J.; Yang, R. D. *Polyhedron* **1990**, 9, 2285–2291.
201. Li, X. J.; Yang, R. D. *Polyhedron* **1992**, 11, 1545–1550.
202. Yang, L. Q.; Yang, R. D. *J. Coord. Chem.* **1994**, 33, 303–310.
203. Yang, L. Q.; Yang, R. D. *Polyhedron* **1995**, 14, 507–510.
204. Yang, L. Q.; Yang, R. D. *J. Mol. Struct.* **1996**, 380, 75–84.
205. Pettinari, C.; Marchetti, F.; Drozdov, A.; Vertlib, V.; Troyanov, S. I. *Inorg. Chem. Commun.* **2001**, 4, 290–293.
206. Xu, J.; Raymond, K. N. *Angew. Chem., Int. Ed. Engl.* **2000**, 39, 2745–2747.
207. Johnson, D. W.; Xu, J.; Saalfrank, R. W.; Raymond, K. N. *Angew. Chem., Int. Ed. Engl.* **1999**, 38, 2882–2885.
208. Mahon, M. F.; Moloy, K. C.; Omotowa, B. A.; Mesubi, M. A. *J. Organomet. Chem.* **1998**, 560, 95–101.
209. Gelin, S.; Chantegrel, B.; Nadi, A. I. *J. Org. Chem.* **1983**, 48, 4078–4082.
210. Maquestiau, A.; Van Haverbeke, Y.; Muller, R. N. *J. Heterocyclic Chem.* **1975**, 12, 85–90.
211. Bangroo, P. N.; Arora, H. C.; Rao, G. N.; Jagga, C. R. *Indian J. Chem.* **1991**, 30A, 816–818.
212. Le, Q. T. H.; Umetani, S.; Takahara, H.; Matsui, M. *Anal. Chim. Acta* **1993**, 272, 293–299.
213. Uhlemann, E.; Friedrich, A.; Hinsche, G.; Mickler, W.; Schiude, U. *Z. Naturforsch.* **1995**, 50b, 37–42.
214. Reddy, M. L. P.; Varma, R. L.; Ramamohan, T. R.; Rao, T. P.; Iyer, C. S. P.; Damodaran, A. D.; Murali, J. N.; Iyer, R. H. *Radiochim. Acta* **1995**, 69, 55–60.
215. Gan, L. B.; Xu, L. B.; Luo, C. P.; Huang, C. H.; Umetani, S.; Matsui, M. *Polyhedron* **1994**, 13, 3167–3169.
216. Kraudelt, H.; Hinsche, G.; Schiude, U.; Uhlemann, E. *Z. Naturforsch.* **1995**, 50b, 1597–1600.

# 1.7

## Phenylcyanamide Ligands

R. J. CRUTCHLEY

*Carleton University, Ottawa, ON, Canada*

---

1.7.1	INTRODUCTION	117
1.7.2	SYNTHESIS OF PHENYLCYANAMIDE DERIVATIVES	117
1.7.2.1	Neutral Phenylcyanamides (pcydH)	117
1.7.2.2	Anionic Phenylcyanamides (pcyd <sup>-</sup> )	118
1.7.3	PHYSICAL PROPERTIES OF PHENYLCYANAMIDES	118
1.7.4	COORDINATION CHEMISTRY OF PHENYLCYANAMIDES	119
1.7.4.1	Coordination Geometry	119
1.7.4.2	Complex Synthesis	120
1.7.4.3	Ruthenium Complexes	120
1.7.4.4	Cobalt Complexes	121
1.7.4.5	Nickel, Palladium, and Platinum Complexes	122
1.7.4.6	Copper, Silver, and Gold Complexes	122
1.7.5	SUMMARY	123
1.7.6	REFERENCES	124

---

### 1.7.1 INTRODUCTION

The coordination chemistry of phenylcyanamide and its substituted derivatives began with a study by Hollebne<sup>1-3</sup> in 1971 but remained largely unexplored until the late 1980s. This is surprising as the coordination chemistry of phenylcyanamides should be as rich as that of other pseudohalides such as azide<sup>4</sup> and thiocyanate.<sup>5,6</sup> Indeed, the attachment of a phenyl ring to the cyanamide group adds an extra dimension not present in azide or thiocyanate ligands. An extensive  $\pi$  conjugation between the cyanamide group and the phenyl ring provides an energetically favorable means by which a metal ion can couple into a conjugated organic  $\pi$  system. This is demonstrated by the extraordinary ability of 1,4-dicyanamidobenzene to mediate metal-metal coupling, the magnitude of which is dramatically dependent upon the nature of both inner and outer coordination spheres.<sup>7</sup> The development of novel hybrid materials that combine coordination and organic chemistry provides further impetus to explore the coordination chemistry of phenylcyanamide ligands.

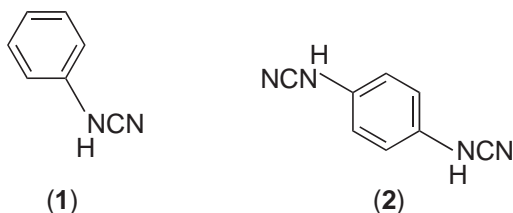
### 1.7.2 SYNTHESIS OF PHENYLCYANAMIDE DERIVATIVES

#### 1.7.2.1 Neutral Phenylcyanamides (pcydH)

Phenylcyanamide (**1**) and its derivatives can be readily prepared in high yields from the corresponding anilines by desulfurization of the thiourea derivative.<sup>1-3,9,10</sup> This reaction does not appear to be particularly limited by the number and type of substituents as polychloro, -fluoro, -methyl and -methoxy substituted phenylcyanamides have been successfully synthesized. The *ortho* substituted

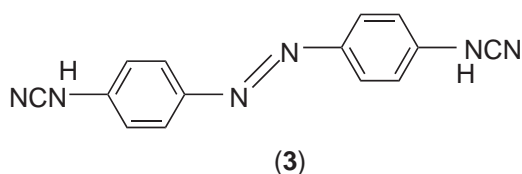


polyhalides were particularly subject to a dimerization reaction, forming *N*-phenyl-*N'*-cyano-*N'*-phenyl-guanidine derivatives.<sup>8</sup> The presence of the dimer can be recognized by infrared spectroscopy as its strong  $\nu(\text{C}=\text{N})$  band at *ca.*  $1670\text{ cm}^{-1}$  is absent in the monomer.



The following 1,4-dicyanamidebenzenes (dicydH<sub>2</sub>) have been synthesized from phenylenediamines: 2,3,5,6-tetrachloro-, 2,5-dichloro-, 2-chloro-, 2-methyl-, 2-methoxy-, 2,5-dimethyl-, 2,3,5,6-tetramethyl- and unsubstituted 1,4-dicyanamidebenzene (2).<sup>9-11</sup>

The thiourea method was also used to prepare 4,4'-dicyanamidebiphenyl<sup>12</sup> and 4,4'-azodi (phenylcyanamide) adpcH<sub>2</sub> (3).<sup>13</sup>



Other researchers have synthesized phenylcyanamides by the reaction of phenylisocyanide dihalides with ammonia,<sup>14</sup> or by the reaction of anilines with cyanogen bromide.<sup>15</sup> A recently prepared cyanating agent, *N'*-cyanoimidazole, when reacted with aniline yielded phenylcyanamide in high yields under moderate conditions.<sup>16</sup> The latter reaction may provide a route to more sensitive cyanamide derivatives.

### 1.7.2.2 Anionic Phenylcyanamides (pcyd<sup>-</sup>)

Thallium salts of anionic phenylcyanamides can be prepared from either the monomer or dimer phenylcyanamide derivatives in acetone/water, in the presence of triethylamine (TEA).<sup>7</sup> The lithium salt of phenylcyanamide was prepared by deprotonation of 5-(phenylamino)-1,2,3,4-thiazotriazole with various lithium bases.<sup>17</sup>

The 1,4-dicyanamidebenzene dianion (dicyd<sup>2-</sup>) and its substituted derivatives can also be precipitated from acetone solution as yellow thallium salts.<sup>18</sup> Tetraphenylarsonium salts have greater solubility in non-aqueous solvents than the Tl<sup>I</sup> salts and have been used to grow X-ray-quality crystals.<sup>19</sup>

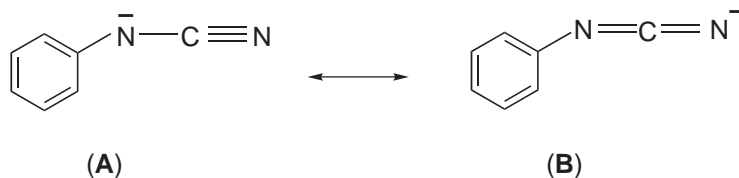
## 1.7.3 PHYSICAL PROPERTIES OF PHENYLCYANAMIDES

The cyanamide group is a three-atom  $\pi$  system in which the amine non-bonding electrons can delocalize into the nitrile  $\pi$  bonds. Accordingly, the cyanamide group is expected to be a poorer  $\pi$  acceptor but better donor than analogous nitrile ligands.<sup>20</sup> For this reason, cyanamides are expected to be less sensitive to base hydrolysis. <sup>13</sup>C NMR, and IR spectroscopic studies and melting points for fourteen phenylcyanamide derivatives have been determined.<sup>21</sup> A <sup>15</sup>N NMR study has also been performed.<sup>22</sup>

The amine proton of phenylcyanamide is relatively acidic compared to other secondary amines and this is because of a resonance stabilization of the negative charge (Scheme 1).

For example, the  $pK_a$  of 2,6-dichlorophenylcyanamide was measured at  $4.90 \pm 0.05$ .<sup>8</sup> Deprotonation of the cyanamide group shifts  $\nu(\text{NCN})$  to lower frequencies (*ca.*  $2120\text{ cm}^{-1}$ ) similar to that of organic carbodiimides (for  $\text{R}-\text{N}=\text{C}=\text{N}-\text{R}$ ,  $\nu(\text{NCN})$  ranges from  $2100$  to  $2150\text{ cm}^{-1}$ ).<sup>23</sup> This suggests that resonance form **B** makes the dominant contribution to the cyanamide anion group as resonance form **A** should have a nitrile stretching frequency similar to neutral cyanamide.

Crystal structures of 2,3,4,5-tetrachloro- ( $\text{Cl}_4\text{dicyd}^{2-}$ ),<sup>24</sup> 2,5-dichloro- ( $\text{Cl}_2\text{dicyd}^{2-}$ ),<sup>19</sup> 2,5-dimethyl- ( $\text{Me}_2\text{dicyd}^{2-}$ ),<sup>19</sup> 2,3,5,6-tetramethyl- ( $\text{Me}_4\text{dicyd}^{2-}$ ),<sup>25</sup> 1,4-dicyanamidebenzene dianion



Scheme 1

(dicyd<sup>2-</sup>)<sup>19</sup> and 4,4'-dicyanamidebiphenyl dianion<sup>12</sup> have been published. Except for the tetramethyl derivative, all of the dianion ligands are approximately planar with cyanamide groups in an *anti* conformation. The anionic cyanamide groups of dicyd<sup>2-</sup> are approximately linear with the NCN angle of 174.1(6)<sup>o</sup>.<sup>19</sup> The terminal nitrogen to carbon bond length is 1.172(10) Å, showing significant triple bond character, and the carbon to amide nitrogen bond length is 1.299(10) Å, showing significant double bond character. This indicates that the bond lengths of the cyanamide group are not simply the average of resonance forms **A** and **B** and suggest that carbon in cyanamide possesses hypervalent character.

1,4-Dicyanamidobenzene, dicyd<sup>2-</sup>, and 4,4'-azodi(phenylcyanamido), adpc<sup>2-</sup> ligands have been examined by *ab initio* methods in order to gain some understanding of their remarkable ability to mediate metal–metal coupling in dinuclear ruthenium complexes.<sup>13</sup>

Anionic phenylcyanamides do not have well-behaved cyclic voltammetry and generally give an irreversible oxidation wave.<sup>7</sup> However, 1,4-dicyanamidebenzene dianion ligands do give reversible oxidation waves with electrochemistry analogous to that of the quinone/hydroquinone system.<sup>26</sup> An extensive investigation of the fully oxidized form, *N,N'*-dicyanoquinonediimine, and its derivatives has been reported.<sup>27</sup> The dianion is very unstable and readily oxidizes to the blue radical anion in the presence of oxygen.<sup>28</sup> *N,N'*-dicyanoquinonediimine derivatives have been used to make conducting organic and organo-metallic charge transfer salts.<sup>29,30</sup>

## 1.7.4 COORDINATION CHEMISTRY OF PHENYLCYANAMIDES

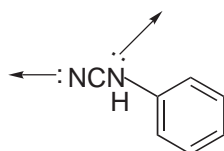
### 1.7.4.1 Coordination Geometry

The phenylcyanamides are ambidentate ligands whether neutral or in anionic form and so the possibility of linkage isomerism must be recognized. As shown in Scheme 2, neutral phenylcyanamides can coordinate to a metal ion through either the nitrile or amine nitrogen. However, at this point in time, there are no crystal structures of neutral phenylcyanamides coordinated to metal ions. The amine nitrogen is sterically crowded by the phenyl ring and so terminal coordination to the cyano nitrogen is expected, particularly for electron-rich metal centers. Metal ions that behave as  $\pi$  acceptors are expected to favor the anionic phenylcyanamide ligand in order to take advantage of the ligand's  $\pi$ -donor properties. Side-on coordination of the cyanamide group has not been observed for phenylcyanamide ligands but has been observed in tungsten complexes of dialkylcyanamides.<sup>31</sup>

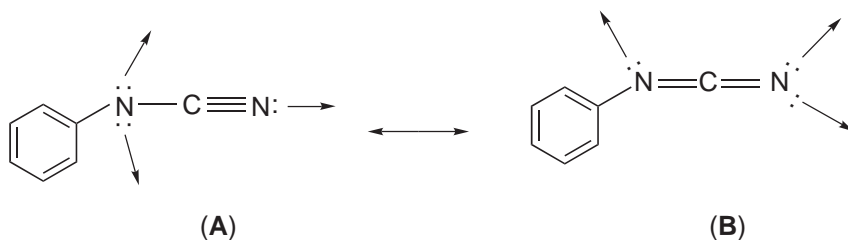
Anionic phenylcyanamides have three non-bonding pairs of electrons that can be involved in coordination chemistry, as shown in Scheme 3.

There are many crystal structures of monodentate phenylcyanamide ligands showing coordination through the cyano nitrogen but there are no examples of amide–nitrogen coordination. Both neutral or anionic phenylcyanamides can function as bridging ligands although this has only been observed for the anionic cyanamide (Scheme 4).

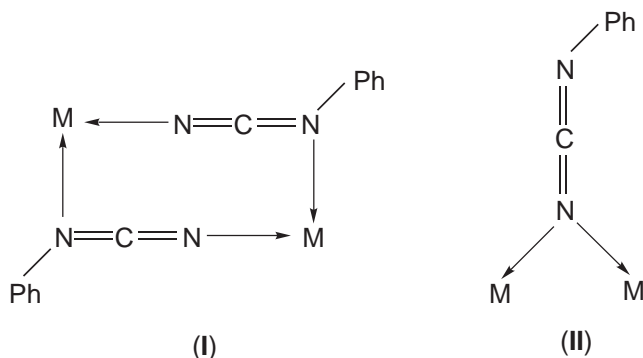
Both bridging modes I and II have been observed in copper(II) complexes (see Section 1.7.4.6).



Scheme 2



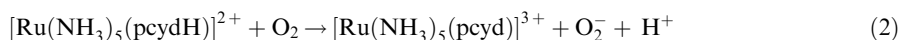
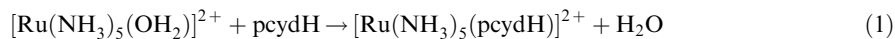
Scheme 3



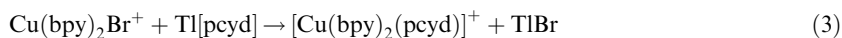
Scheme 4

#### 1.7.4.2 Complex Synthesis

Ruthenium(II) ammine complexes can be readily prepared under mild conditions by reacting the aquo complex with neutral ligand followed by air oxidation:



Cation exchange chromatography is almost always required to ensure complex purity.<sup>9–11,28–36</sup> It is also possible to use thallium(I) salts of phenylcyanamide ligands and react them with complex halides in a metathesis reaction.<sup>1–3,37</sup>

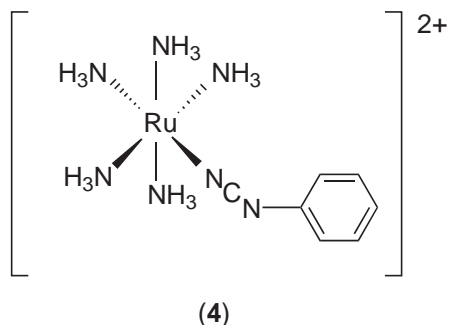


$\text{Cu}^{\text{I}}$  complexes of phenylcyanamide ligands have been prepared by the deprotonation of phenylcyanamide with sodium ethoxide in acetone/ethanol and the addition of this solution to a solution of a  $\text{Cu}^{\text{I}}$  reagent complex.<sup>38</sup>

#### 1.7.4.3 Ruthenium Complexes

Only one  $\text{Ru}^{\text{II}}$  complex,  $[\text{Ru}(\text{NH}_3)_5(2,6\text{-Cl}_2\text{pcydH})][\text{PF}_6]_2$ , has been synthesized and characterized.<sup>8</sup> The  $\text{Ru}^{\text{III}}$  complex,  $[\text{Ru}(\text{NH}_3)_5(2,3\text{-Cl}_2\text{pcydH})][\text{ClO}_4]_3$ , was also prepared but this orange perchlorate salt was found to be explosive and so extreme caution is advised.<sup>7</sup>

There are many examples  $\text{Ru}^{\text{III}}$  and  $\text{Ru}^{\text{II}}$  phenylcyanamido complexes with the pentaammine-ruthenium(III) family comprising the largest number of complexes.  $[\text{Ru}(\text{NH}_3)_5\text{L}]^{2+}$  complexes, where  $\text{L} = 2,4,6\text{-Me}_3\text{pcyd}^-$ ,  $3,5\text{-Me}_2\text{pcyd}^-$ ,  $4\text{-Mepcyd}^-$ ,  $3,4,5\text{-MeO}_3\text{pcyd}^-$ ,  $3,5\text{-MeO}_2\text{pcyd}^-$ ,  $\text{pcyd}^-$  (**4**),  $3\text{-Clpcyd}^-$ ,  $2\text{-Clpcyd}^-$ ,  $4\text{-Clpcyd}^-$ ,  $2,3\text{-Cl}_2\text{pcyd}^-$ ,  $2,4\text{-Cl}_2\text{pcyd}^-$ ,  $2,6\text{-Cl}_2\text{pcyd}^-$ ,  $2,4,5\text{-Cl}_3\text{pcyd}^-$ ,  $2,4,6\text{-Cl}_3\text{pcyd}^-$ ,  $2,3,4,5\text{-Cl}_4\text{pcyd}^-$ ,  $2,3,5,6\text{-Cl}_4\text{pcyd}^-$ , and  $\text{Cl}_5\text{pcyd}^-$ , were characterized by IR and UV-vis spectroscopy, cyclic voltammetry, and X-ray crystallography.<sup>7,32</sup>



There is a characteristic strongly absorbing ligand-to-metal charge transfer band in the visible region of these complexes' electronic absorption spectra that has been assigned to the cyanamido- $\text{Ru}^{\text{III}}$  chromophore. The effect of conjugation on the electronic properties of the cyanamido- $\text{Ru}^{\text{III}}$  chromophore was explored by the synthesis and characterization of  $[\text{Ru}(\text{NH}_3)_5(\text{NCNR})]^{2+}$ , where NCNR is cyanamido, phenylcyanamido, 4-cyanamidobiphenyl, 1-cyanamidonaphthalene, 2-cyanamidonaphthalene, 2-cyanamidophenanthroline and 1-cyanamidopyrene.<sup>39</sup>

Mononuclear complexes,  $[\text{Ru}(\text{NH}_3)_5(\text{LH})]^{2+}$ , where  $\text{LH} = \text{Me}_2\text{dicydH}^-$ ,  $\text{dicydH}^-$  and  $\text{Cl}_2\text{dicydH}^-$ , have been prepared and characterized by electronic absorption spectroscopy and cyclic voltammetry.<sup>40</sup> When deprotonated, the complexes oxidize to the  $\text{Ru}^{\text{IV}}$  oxidation state and this allowed a spectroscopic analysis the  $\text{Ru}^{\text{IV}}$ -cyanamide chromophore. Only  $[\text{Ru}(\text{NH}_3)_5(\text{Me}_2\text{dicyd})]^{2+}$  could be isolated with sufficient purity to permit NMR studies, which suggested the metal ion was diamagnetic  $\text{Ru}^{\text{IV}}$ .

Substituting ammine ligands with pyridine moieties stabilizes the  $\text{Ru}^{\text{II}}$  oxidation state and has allowed the isolation of the following  $\text{Ru}^{\text{II}}$  complexes, *cis*- $[\text{Ru}(\text{bpy})_2\text{L}_2]$ ,<sup>41</sup> *trans*- $[\text{Ru}(\text{py})_4\text{L}_2]$ ,<sup>42</sup>  $\text{Na}[\text{Ru}(\text{bmipy})(\text{dcbpy})\text{L}]$ ,<sup>43,44</sup> and  $[\text{Ru}(\text{trpy})(\text{bpy})\text{L}]$ ,<sup>45,46</sup> ( $\text{py} = \text{pyridine}$ ,  $\text{bpy} = 2,2'$ -bipyridine,  $\text{trpy} = \text{terpyridine}$ ,  $\text{bmipy} = 2,6\text{-bis}(1\text{-methylbenzimidazol-2-yl})\text{pyridine}$ , and  $\text{dcbpy} = 4,4'$ -dicarboxylbipyridine) where  $\text{L}$  is a phenylcyanamide anion derivative. Crystal structures of *cis*- $[\text{Ru}(\text{bpy})_2(4\text{-NO}_2\text{pcyd})_2]$ ,<sup>47</sup> *trans*- $[\text{Ru}(\text{py})_4(2\text{-Clpcyd})_2]$ ,<sup>42</sup> and  $[\text{Ru}(\text{trpy})(\text{bpy})(2,4\text{-Clpcyd})]^{+}$ ,<sup>45,46</sup> all showed monodentate phenylcyanamido derivatives coordinated to  $\text{Ru}^{\text{II}}$  through their cyano nitrogen. These three complex families have been characterized by cyclic voltammetry and spectroelectrochemistry to explore the effect of inner sphere perturbations on the  $\text{Ru}^{\text{III}}$ -cyanamide chromophore. An  $^1\text{H}$  NMR study of the  $\text{Na}[\text{Ru}(\text{bmipy})(\text{dcbpy})\text{L}]$  complexes showed evidence of linkage isomerism.<sup>43,44</sup>

The following families of  $\text{Ru}^{\text{III}}$  dinuclear complexes have been prepared,  $[\{(\text{NH}_3)_5\text{Ru}\}_2(\mu\text{-L})]^{4+}$ ,<sup>9,10</sup> where  $\text{L}$  is  $\text{Cl}_4\text{dicyd}^{2-}$ ,  $\text{Cl}_2\text{dicyd}^{2-}$ ,  $\text{dicyd}^{2-}$ ,  $\text{Me}_2\text{dicyd}^{2-}$ , *trans*-, *trans*- $[\{(\text{NH}_3)_4\text{Ru}(\text{py})\}_2(\mu\text{-L})]^{4+}$ ,<sup>33,34</sup> where  $\text{L}$  is  $\text{Cl}_4\text{dicyd}^{2-}$ ,  $\text{Cl}_2\text{dicyd}^{2-}$ ,  $\text{dicyd}^{2-}$ ,  $\text{Me}_2\text{dicyd}^{2-}$ , *mer*-, *mer*- $[\{(\text{NH}_3)_3\text{Ru}(\text{bpy})\}_2(\mu\text{-dicyd})]^{4+}$ ,<sup>35,36</sup> where  $\text{L}$  is  $\text{Cl}_2\text{dicyd}^{2-}$ ,  $\text{dicyd}^{2-}$ ,  $\text{Me}_2\text{dicyd}^{2-}$ , and  $[\{(\text{NH}_3)_5\text{Ru}\}_2(\mu\text{-bp})]^{3+}$  where  $\text{bp} = 4,4'$ -dicyanamidobiphenyl. Two  $\text{Ru}^{\text{II}}$  dinuclear complexes have been prepared and studied,  $[\{\text{Ru}(\text{bpy})(\text{trpy})\}_2(\mu\text{-dicyd})]^{2+}$ ,<sup>28</sup> and  $[\{\text{Ru}(\text{bpy})(\text{trpy})\}_2(\mu\text{-adpc})]^{2+}$ .<sup>13</sup> UV-vis NIR and IR spectroelectrochemical studies of these complexes gave a comprehensive understanding of mixed-valence properties.<sup>48,49</sup> Intramolecular antiferromagnetic exchange in the  $\text{Ru}^{\text{III}}$  dinuclear complexes was also studied by solid state magnetic susceptibility measurements and solution NMR spectroscopy.<sup>12,50</sup> The mixed-valent complex  $[\{\text{Ru}_2(\text{O}_2\text{CCH}_3)_2(\text{mhp})_2(\mu\text{-Me}_2\text{dicyd})\}]$ , where  $\text{mhp}$  is 2-oxy-6-methylpyridinate, has also been prepared.<sup>51</sup>

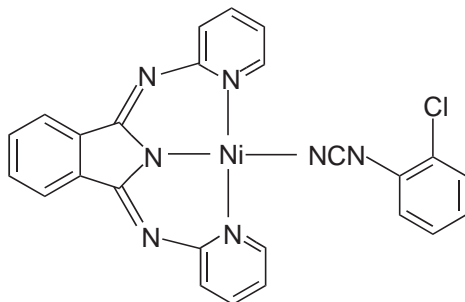
#### 1.7.4.4 Cobalt Complexes

The complexes,  $[\text{Ph}_4\text{As}]_2[\text{CoL}_4]$ , where  $\text{L} = \text{pcyd}^-$ ,  $3,5\text{-Cl}_2\text{pcyd}^-$ ,  $2,4\text{-F}_2\text{pcyd}^-$ ,  $2,4,6\text{-Cl}_3\text{pcyd}^-$ ,  $2\text{-Clpcyd}^-$ , and  $2,4,6\text{-Me}_3\text{pcyd}^-$ , were synthesized.<sup>1-3</sup>  $[\text{Ph}_4\text{As}]_2[\text{Co}(2,4,6\text{-Me}_3\text{pcyd})_4]$  proved unstable as a solid and did not give acceptable elemental analysis. Absorption and magnetic

circular dichroism spectra were measured and the data suggests that spectrochemical, nephelauxetic, and electronegativity can all be related by a simple model.

#### 1.7.4.5 Nickel, Palladium, and Platinum Complexes

Salts of  $[\text{NiL}_4]^{2-}$  where  $\text{L} = 2\text{-Clpcyd}^{2-}$  and  $2,4,6\text{-Cl}_3\text{pcyd}^-$ , were prepared in order to compare the ligand field properties of phenylcyanamide ligands to other pseudo-halogens.<sup>1-3</sup> The complex family  $[\text{Ni}(\text{imd})\text{L}]$  where  $\text{imd} = 1,3\text{-bis}(2\text{-pyridylimino})\text{-isoindolinato}$  and  $\text{L} = 2\text{-Clpcyd}^-$  (**5**),  $4\text{-Clpcyd}^-$ ,  $2,3\text{-Cl}_2\text{pcyd}^-$ ,  $2,6\text{-Cl}_2\text{pcyd}^-$ ,  $2,4,5\text{-Cl}_3\text{pcyd}^-$ ,  $2,3,5,6\text{-Cl}_4\text{pcyd}^-$ , were characterized by X-ray crystallography, IR,  $^1\text{H}$  NMR, and UV-vis spectroscopy.<sup>52</sup>



(5)

Palladium<sup>53,54</sup> and platinum<sup>55</sup> complexes,  $[\text{M}(\text{trpy})\text{L}][\text{PF}_6]$ ,  $\text{M} = \text{Pd}^{\text{II}}$  and  $\text{Pt}^{\text{II}}$  and  $\text{L} = \text{pcyd}^-$ ,  $2\text{-Clpcyd}^-$ ,  $2,3\text{-Cl}_2\text{pcyd}^-$ ,  $2,6\text{-Cl}_2\text{pcyd}^-$ ,  $2,4,6\text{-Cl}_3\text{pcyd}^-$ ,  $2,3,4,5\text{-Cl}_4\text{pcyd}^-$  and  $\text{Cl}_5\text{pcyd}^-$  were synthesized and characterized by X-ray crystallography,  $^1\text{H}$  NMR, and electronic absorption spectroscopy and cyclic voltammetry. Dinuclear  $\text{Pt}^{\text{II}}$  complexes,  $[\{\text{Pt}(\text{trpy})\}_2(\mu\text{-L})][\text{PF}_6]_2$ ,  $\text{L} = \text{dicyd}^{2-}$ ,  $\text{Cl}_2\text{dicyd}^{2-}$  and  $\text{Me}_2\text{dicyd}^{2-}$ , have also been synthesized.<sup>55</sup> Iodine doping of  $[\{\text{Pt}(\text{trpy})\}_2(\mu\text{-Me}_2\text{dicyd})][\text{PF}_6]_2$  gave powder conductivity consistent with semiconductor properties.<sup>56</sup>

#### 1.7.4.6 Copper, Silver, and Gold Complexes

Copper(II) complexes<sup>57</sup> possessing the formula  $[\text{Cu}(\text{bpy})\text{L}_2]$ ,  $\text{L} = 4\text{-Clpcyd}^-$ ,  $3\text{-Clpcyd}^-$ ,  $2\text{-Clpcyd}^-$ ,  $4\text{-Brpcyd}^-$ ,  $4\text{-Fpcyd}^-$ ,  $4\text{-Mepcyd}^-$ ,  $2\text{-Mepcyd}^-$ ,  $4\text{-MeOpcyd}^-$ , and the analogous phenanthroline complexes,  $[\text{Cu}(\text{phen})\text{L}_2]$ , were synthesized. A crystal structure of the phenylcyanamide(bipyridine)Cu complex showed it was dimeric in the solid state with one of the phenylcyanamide ligands adopting bridging mode I.<sup>57,58</sup> The complexes  $[\text{Cu}(\text{pip})_2\text{L}_2]$ , where  $\text{pip} = \text{piperidine}$ ,  $\text{L} = \text{pcyd}^-$ ,  $4\text{-Clpcyd}^-$ , and  $4\text{-Brpcyd}^-$ ,  $[\text{Cu}(\text{py})_4\text{L}_2]$ , where  $\text{L} = \text{pcyd}^-$ ,  $4\text{-Clpcyd}^-$ ,  $3\text{-Clpcyd}^-$ ,  $4\text{-Brpcyd}^-$ , and  $4\text{-Fpcyd}^-$ ,  $[\{\text{Cu}(\text{bpy})(2\text{-Mepcyd})(\text{CH}_3\text{CO}_2)\}_2]$ , and  $[\{\text{Cu}(\text{phen})(\text{L})(\text{CH}_3\text{CO}_2)\}_2]$ , where  $\text{L} = 3\text{-Clpcyd}^-$  and  $3\text{-MeOpcyd}^-$  were also synthesized.<sup>57</sup> The crystal structure of  $[\{\text{Cu}(\text{phen})(\text{CH}_3\text{CO}_2)\}_2(\mu\text{-}3\text{-Clpcyd})_2]$  gave the first example of a phenylcyanamide ligand adopting bridging mode II.<sup>57</sup>

The  $[\text{Cu}(\text{bpy})_2\text{L}][\text{PF}_6]$  complexes, where  $\text{L} = 2\text{-Clpcyd}^-$ ,  $4\text{-Clpcyd}^-$ ,  $2,3\text{-Cl}_2\text{pcyd}^-$ ,  $2,6\text{-Cl}_2\text{pcyd}^-$ ,  $2,4,5\text{-Cl}_3\text{pcyd}^-$ , and  $2,3,5,6\text{-Cl}_4\text{pcyd}^-$ , were synthesized by reacting the thallium phenylcyanamide salt with  $[\text{Cu}(\text{bpy})_2\text{Br}][\text{PF}_6]$  in acetonitrile.<sup>37</sup>  $\text{Cu}^{\text{I}}$  complexes possessing the formulae  $[\text{Cu}_2(\text{dppe})_3\text{L}_2] \cdot 2\text{-acetone}$ , ( $\text{dppe} = 1,2\text{-bis}(\text{diphenylphosphino})\text{-ethane}$ ,  $\text{L} = \text{pcyd}^-$ ,  $4\text{-Clpcyd}^-$ ,  $3\text{-Clpcyd}^-$ ,  $4\text{-Brpcyd}^-$ , and  $4\text{-Fpcyd}^-$ ) and  $[\{\text{Cu}(\text{PPh}_3)_2\text{L}\}_2]$ , ( $\text{L} = \text{pcyd}^-$ ,  $4\text{-Clpcyd}^-$ ,  $3\text{-Clpcyd}^-$ ,  $4\text{-Brpcyd}^-$ ,  $4\text{-Fpcyd}^-$ ,  $4\text{-Mepcyd}^-$ ,  $4\text{-MeOpcyd}^-$ ,  $4\text{-NO}_2\text{pcyd}^-$  and  $4\text{-Me}_2\text{Npcyd}^-$ ) were characterized by IR and  $^{31}\text{P}$  NMR spectroscopy and crystallography.<sup>38,59</sup>

Solid state  $^{31}\text{P}$  cross polarization magic angle spinning NMR data have been obtained on three solid  $\text{Cu}^{\text{I}}$  complexes  $[\{\text{Cu}(\text{PPh}_3)_2\}_2(\mu\text{-L})]$ , where  $\text{L} = \text{pcyd}^-$ ,  $4\text{-Mepcyd}^-$  and  $4\text{-Clpcyd}^-$ .<sup>60,61</sup> It is also possible to form the mononuclear copper complexes  $[\text{Cu}(\text{PPh}_3)_3\text{L}]$  ( $\text{L} = 4\text{-NO}_2\text{pcyd}^-$  and  $4\text{-Me}_2\text{Npcyd}^-$ ).<sup>59</sup> Salts of  $[\text{CuL}_4]^{2-}$  where  $\text{L} = 2\text{-Clpcyd}^-$  and  $2,4,6\text{-Cl}_3\text{pcyd}^-$ , have been prepared and their ligand field spectra and magnetic moments were consistent with tetrahedral geometry.<sup>1-3</sup> A series of dinuclear  $\text{Cu}^{\text{II}}$  complexes with the formulae  $[\{\text{Cu}(\text{dien})\}_2(\mu\text{-L})][\text{CF}_3\text{SO}_3]_2$ , where

dien = diethylenetriamine, and  $[\{\text{Cu}(\text{imd})\}_2(\mu\text{-L})]$ , where  $\text{L} = \text{dicyd}^{2-}$ ,  $\text{Cl}_2\text{dicyd}^{2-}$ , and  $\text{Me}_2\text{dicyd}^{2-}$ , was prepared and characterized by IR, UV-vis, and EPR spectroscopy and magnetic studies.<sup>62</sup>

Triphenylphosphinephenylcyanamid silver(I) complexes,  $[\{\text{Ag}(\text{PPh}_3)_2\}_2(\mu\text{-4-Me}_2\text{Npcyd})_2]$  and  $[\text{Ag}(\text{PPh}_3)_3\text{L}]$ , where  $\text{L} = \text{pcyd}^-$ ,  $2\text{-Clpcyd}^-$ ,  $4\text{-Brpcyd}^-$ ,  $4\text{-MeOpcyd}^-$ ,  $4\text{-NO}_2\text{pcyd}^-$  or  $4\text{-Me}_2\text{Npcyd}^-$ , were prepared and characterized by X-ray crystallography, mpt., conductivity and IR spectroscopy and compared to their  $\text{Cu}^{\text{II}}$  analogs.<sup>59</sup>

A single  $\text{Au}^{\text{I}}$  complex,  $[\text{AuL}(\text{PPh}_3)]$ , where  $\text{L} = 2\text{-cyanamidofluoren-9-one}$ , has been synthesized and characterized by crystallography.<sup>63</sup>

### 1.7.5 SUMMARY

Table 1 provides a comprehensive list of all the aromatic cyanamide ligands that have been described in the literature. In addition to references to the syntheses of these ligands and crystallographic data, mpt and infrared data are included.

**Table 1** IR<sup>a</sup> Spectroscopic data and melting points,<sup>b</sup> and references for the synthesis and crystallography of substituted phenyl (pcydH), biphenyl (bpcydH), naphthalene (nacydH), phenanthrene (phcydH), pyrene (pycydH) and fluoren-9-one (flcydH) cyanamides, substituted 1,4-dicyanamidebenzene (dicydH<sub>2</sub>) derivatives, 4,4'-biphenyldicyanamide (bpdcydH<sub>2</sub>) and azo(diphenyl) mono- (apcH) and di-cyanamides (adpcH<sub>2</sub>).

Ligands	IR $\nu(\text{NCN})$	Mpt (°C)	Synthesis References	Crystallography References <sup>d</sup>
2,4,6-Me <sub>3</sub> pcydH	2225	102	32	
3,5-Me <sub>2</sub> pcydH	2239	124	32	
2-MepcydH	2235		57	
4-MepcydH	2227	62	32	
3,4,5-MeO <sub>3</sub> pcydH	2220	113	32	
3,5-MeO <sub>2</sub> pcydH	2229	150	32	
4-MeOpcydH	2225	74–77	57	59
pcydH	2227	34	32	57,58
4-Me <sub>2</sub> NpcydH			59	59
4-NO <sub>2</sub> pcydH		>165 dec	22	47
4-FpcydH	2241	116–8	57	
2,4-F <sub>2</sub> pcydH		94–5	3	
4-BrpcydH	2239	107–9	57	59
2-ClpcydH	2243	109	32	42
3-ClpcydH	2237	101	32	57
4-ClpcydH	2232	106	32	
3,5-Cl <sub>2</sub> pcydH		160–2	3	
2,3-Cl <sub>2</sub> pcydH	2235	156	32	32,37
2,4-Cl <sub>2</sub> pcydH	2235	170	32	45,46
2,6-Cl <sub>2</sub> pcydH	2249	120 <sup>c</sup>	32	53,54
2,4,5-Cl <sub>3</sub> pcydH	2245	170	32	
2,4,6-Cl <sub>3</sub> pcydH			3	
2,3,4,5-Cl <sub>4</sub> pcydH	2243	168 <sup>c</sup>	32	
4-bpdcydH	2221	141	39	
1-nacydH	2232	141	39	
2-nacydH	2232	112	39	
2-phcydH	2231	>166 dec	39	
1-pycydH	2241	>190 dec	39	
2-flcydH	2232	227	63	63
4,4'-bpdcydH <sub>2</sub>	2224	>200 dec	12	12
DicydH <sub>2</sub>	2220		15,9	9,10,19,33–36
2,5-Me <sub>2</sub> dicydH <sub>2</sub>	2240		15,9	19
2,3,5,6-Me <sub>4</sub> dicydH <sub>2</sub>			25	25
2,5-Cl <sub>2</sub> dicydH <sub>2</sub>	2235		15,9	19
2,3,5,6-Cl <sub>4</sub> dicydH <sub>2</sub>			24	19
4,4'-adpcH <sub>2</sub>	2225	>200 dec	13	13
4-apcH	2222	154–157	13	

<sup>a</sup> Very strong bands, in  $\text{cm}^{-1}$ . <sup>b</sup> Cyanamides polymerize when heated slowly, forming solids that do not melt at temperatures < 250°C. <sup>c</sup> Initial melting was followed by solidification. <sup>d</sup> Crystal structures are of the anion ligands isolated as tetraphenylarsonium salts or complexed.

## 1.7.6 REFERENCES

- Hollebone, B. R.; Nyholm, R. S. *J. Chem. Soc. (A)* **1971**, 332–337.
- Hollebone, B. R. *J. Chem. Soc. (A)* **1971**, 481–486.
- Hollebone, B. R.; Stillman, M. J. *Inorg. Chim. Acta* **1980**, *42*, 169–178.
- Golub, A. M.; Köhler, H.; Skopenko, V. V. *Chemistry of the Pseudohalides*; Elsevier: New York, 1986.
- Kabešová, M.; Boca, R.; Melnick, M.; Valigura, D.; Dunaj-Jurco, M. *Coord. Chem. Rev.* **1995**, *140*, 115–135.
- Bailey, R. A.; Kozak, S. L.; Michelsen, T. W.; Mills, W. N. *Coord. Chem. Rev.* **1971**, *6*, 407–445.
- Crutchley, R. J.; Naklicki, M. L. *Inorg. Chem.* **1989**, *28*, 1955–1958.
- Naklicki, M. L.; Crutchley, R. J. *Inorg. Chem.* **1989**, *28*, 4226–4229.
- Aquino, M. A. S. Ph.D. Thesis, Carleton University, 1991.
- Aquino, M. A. S.; Lee, F. L.; Gabe, E. J.; Bensimon, C.; Greedan, J. E.; Crutchley, R. J. *J. Am. Chem. Soc.* **1992**, *114*, 5130–5140.
- Naklicki, M. L. Ph.D. Thesis, Carleton University, 1995.
- Aquino, M. A. S.; White, C. A.; Bensimon, C.; Greedan, J. E.; Crutchley, R. J. *Can. J. Chem.* **1996**, *74*, 2201–2208.
- Mosher, P. J.; Yap, G. P. A.; Crutchley, R. J. *Inorg. Chem.* **2001**, *40*, 1189–1195.
- Kühle, E. *Angew. Chem., Int. Ed. Engl.* **1969**, *8*, 20–34.
- Aumüller, A.; Hünig, S. *Liebigs Ann. Chem.* **1986**, 142–164.
- Wu, Y.; Limburg, D. C.; Wilkinson, D. E.; Hamilton, G. S. *Org. Lett.* **2000**, *2*, 795–797.
- Armstrong, D. R.; Banbury, F. A.; Cragg-Hine, I.; Davidson, M. G.; Mair, F. S.; Pohl, E.; Raithby, P. R.; Snaith, R. *Angew. Chem., Int. Ed. Engl.* **1993**, *32*, 1769–1771.
- Crutchley, R. J. unpublished results.
- Aquino, M. A. S.; Crutchley, R. J.; Lee, F. L.; Gabe, E. J.; Bensimon, C. *Acta Crystallogr.* **1993**, *C39*, 1543–1547.
- Schadler, H. D.; Reimer, M.; Schroth, W. *Z. Chem.* **1984**, *24*, 407–409.
- Crutchley, R. J. *Coord. Chem. Rev.* **2001**, *219–221*, 125–155.
- Buchanan, G. W.; Crutchley, R. J. *Magn. Resonance Chem.* **1994**, *32*, 552–553.
- King, S. T.; Strobe, J. H. *J. Chem. Phys.* **1971**, *54*, 1289–1295.
- Aquino, M. A. S.; Bostock, A. E.; Crutchley, R. J. *Inorg. Chem.* **1990**, *29*, 3641.
- Aquino, M. A. S.; Lee, F. L.; Gabe, E. J.; Greedan, J. E.; Crutchley, R. J. *Inorg. Chem.* **1991**, *30*, 3234–3644.
- Mann, C. K.; Barnes, K. K. *Electrochemical Reactions in Nonaqueous Systems*; Dekker: New York, 1970.
- Aumüller, A.; Hünig, S. *Liebigs Ann. Chem.* **1986**, 165–176.
- Rezvani, A. R.; Evans, C. E. B.; Crutchley, R. J. *Inorg. Chem.* **1995**, *34*, 4600–4604.
- Kato, R.; Kobayashi, H.; Kobayashi, A. *J. Am. Chem. Soc.* **1989**, *111*, 5224–5232 and references therein.
- Aumüller, A.; Erk, P.; Klebe, G.; Hünig, S.; Von Schutz, U.; Werner, H.-P. *Angew. Chem., Int. Ed. Engl.* **1986**, *25*, 740–741.
- Chisholm, M. H.; Folting, K.; Huffman, J. C.; Marchant, N. S. *Polyhedron* **1984**, *3*, 1033–1035.
- Crutchley, R. J.; McCaw, K.; Lee, F. L.; Gabe, E. J. *Inorg. Chem.* **1990**, *29*, 2576–2581.
- Rezvani, A. R.; Bensimon, C.; Crompt, B.; Reber, C.; Greedan, J. E.; Kondratiev, V. V.; Crutchley, R. J. *Inorg. Chem.* **1997**, *36*, 3322–3329.
- Rezvani, A. R. Ph.D. Thesis, Carleton University, 1995.
- Evans, C. E. B.; Yap, G. P. A.; Crutchley, R. J. *Inorg. Chem.* **1998**, *37*, 6161–6167.
- Evans, C. E. B. Ph.D. Thesis, Carleton University, 1997.
- Crutchley, R. J.; Hynes, R.; Gabe, E. J. *Inorg. Chem.* **1990**, *29*, 4921–4928.
- Ainscough, E. W.; Baker, E. N.; Brader, M. L.; Brodie, A. M.; Ingham, S. L.; Waters, J. M.; Hanna, J. V.; Healy, P. C. *J. Chem. Soc. Dalton Trans.* **1991**, 1243–1249.
- Evans, C. E. B.; Ducharme, D.; Naklicki, M. L.; Crutchley, R. J. *Inorg. Chem.* **1995**, *34*, 1350–1354.
- Naklicki, M. L.; White, C. A.; Kondratiev, V. V.; Crutchley, R. J. *Inorg. Chim. Acta* **1996**, *242*, 63–69.
- Rezvani, A. R.; Crutchley, R. J. *Inorg. Chem.* **1994**, *33*, 170–174.
- Desjardins, P.; Yap, G. P. A.; Crutchley, R. J. *Inorg. Chem.* **1999**, *38*, 5901–5905.
- Ruile, S.; Kohle, O.; Pechy, P.; Gratzel, M. *Inorg. Chim. Acta* **1997**, *261*, 129–140.
- Ruile, S.; Kohle, O.; Pettersson, H.; Gratzel, M. *New J. Chem.* **1998**, *22*, 25–31.
- Mosher, P. J.; Yap, G. P. A.; Crutchley, R. J. *Inorg. Chem.* **2001**, *40*, 550–553.
- Sondaz, E.; Gourdon, A.; Launay, J.-P.; Bonvoisin, J. *Inorg. Chim. Acta* **2001**, *316*, 79–88.
- Desjardins, P. M. Sc. Thesis, Carleton University, 1998.
- Evans, C. E. B.; Naklicki, M. L.; Rezvani, A. R.; White, C. A.; Kondratiev, V. V.; Crutchley, R. J. *J. Am. Chem. Soc.* **1998**, *120*, 13096–13103.
- DeRosa, M. C.; White, C. A.; Evans, C. E. B.; Crutchley, R. J. *J. Am. Chem. Soc.* **2001**, *123*, 1396–1402.
- Naklicki, M. L.; White, C. A.; Plante, L. L.; Evans, C. E. B.; Crutchley, R. J. *Inorg. Chem.* **1998**, *37*, 1880–1885.
- Miyasaka, H.; Clérac, R.; Campos-Fernández, C. S.; Dunbar, K. R. *Inorg. Chem.* **2001**, *40*, 1663–1671.
- Letcher, R. J.; Zhang, W.; Bensimon, C.; Crutchley, R. J. *Inorg. Chim. Acta* **1993**, *210*, 183–191.
- Zhang, W.; Bensimon, C.; Crutchley, R. J. *Inorg. Chem.* **1993**, *32*, 5808–5812.
- Zhang, W. M. Sc. Thesis, Carleton University, 1993.
- Al-Mutlaq, F. M. Sc. Thesis, Carleton University, 1999.
- DeRosa, M. C.; Al-Mutlaq, F.; Crutchley, R. J. *Inorg. Chem.* **2001**, *40*, 1406–1407.
- Brader, M. L.; Ainscough, E. W.; Baker, E. N.; Brodie, A. M.; Ingham, S. L. *J. Chem. Soc. Dalton Trans.* **1990**, 2785–2792.
- Brader, M. L.; Ainscough, E. W.; Baker, E. N.; Brodie, A. M. *Polyhedron* **1989**, *8*, 2219–2220.
- Ainscough, E. W.; Brodie, A. M.; Cresswell, R. J.; Turnbull, J. C.; Waters, J. M. *Croat. Chem. Acta* **1999**, *72*, 377–394.
- Hanna, J. V.; Smith, M. E.; Stuart, S. N.; Healy, P. C. *J. Phys. Chem.* **1992**, *96*, 7560–7567.
- Ainscough, E. W.; Brodie, A. M.; Healy, P. C.; Waters, J. M. *Aust. J. Chem.* **2000**, *53*, 971–973.
- Cheruyot, L. L.; Thompson, L. K.; Greedan, J. E.; Liu, G.; Crutchley, R. J. *Can. J. Chem.* **1995**, *73*, 573–580.
- Adams, C. J. *J. Chem. Soc., Dalton Trans.* **1999**, 2059–2064.



# 1.8

## Benzimidazole Ligands

M. HAGA

*Chuo University, Tokyo, Japan*

---

1.8.1	INTRODUCTION	125
1.8.2	SYNTHETIC METHODS FOR BENZIMIDAZOLE DERIVATIVES	125
1.8.3	DESIGN OF IMIDAZOLE/BENZIMIDAZOLE LIGANDS	127
1.8.3.1	Modular Approach	127
1.8.3.2	Chelate Ligands Composed of a Combination of Bidentate Ligands	128
1.8.3.3	Chelate Ligands Composed of a Combination of Tridentate Ligands	129
1.8.3.4	Chelate Ligands Composed of Miscellaneous Combinations	130
1.8.4	CHEMICAL FUNCTIONS OF COORDINATION COMPOUNDS WITH IMIDAZOLE/BENZIMIDAZOLE LIGANDS	131
1.8.5	REFERENCES	133

---

### 1.8.1 INTRODUCTION

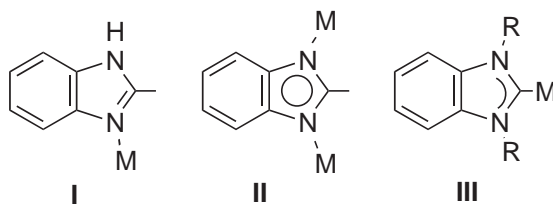
Benzimidazole and imidazole both act as good ligands to transition metal ions<sup>1</sup> and they exhibit several coordination modes as shown in [Scheme 1](#). Compared to imidazole ring systems, benzimidazole derivatives are very stable towards heat and oxidizing agents. Two lone pair electrons are contributed to the aromatic sextet by an imino group, the other nitrogen is therefore pyridine-like, its lone pair being nondelocalized and hence able to impart basic properties. The basicity of benzimidazole is decreased and the acidity very slightly increased relative to imidazole itself. Pyridine-, pyrazine-, and pyrimidine-containing ligands have relatively low-lying  $\pi$ -orbitals, and therefore they act as good acceptors. In contrast, the imidazole-containing ligands such as bisimidazole are poorer  $\pi$ -acceptors and better  $\pi$ -donors. The typical benzimidazole ligands are shown in [Scheme 2](#). Good reviews of earlier research appear in *Comprehensive Coordination Chemistry* (CCC, 1987).<sup>2</sup> Therefore, the simple bidentate and tridentate benzimidazole ligands are omitted in this chapter except for some new chemistry of these ligand systems. Ligand abbreviations are dealt with using code numbers such as **L1** or **L10**. As in CCC (1987),<sup>2</sup> ligands bearing an acidic hydrogen that may be dissociated usually start with a capital H together with the number of hydrogen atoms, such as in **H<sub>2</sub>L9**, and after proton dissociation from this ligand we refer to this anionic deprotonated ligand as **HL9<sup>-</sup>** or **L9<sup>2-</sup>**.

### 1.8.2 SYNTHETIC METHODS FOR BENZIMIDAZOLE DERIVATIVES

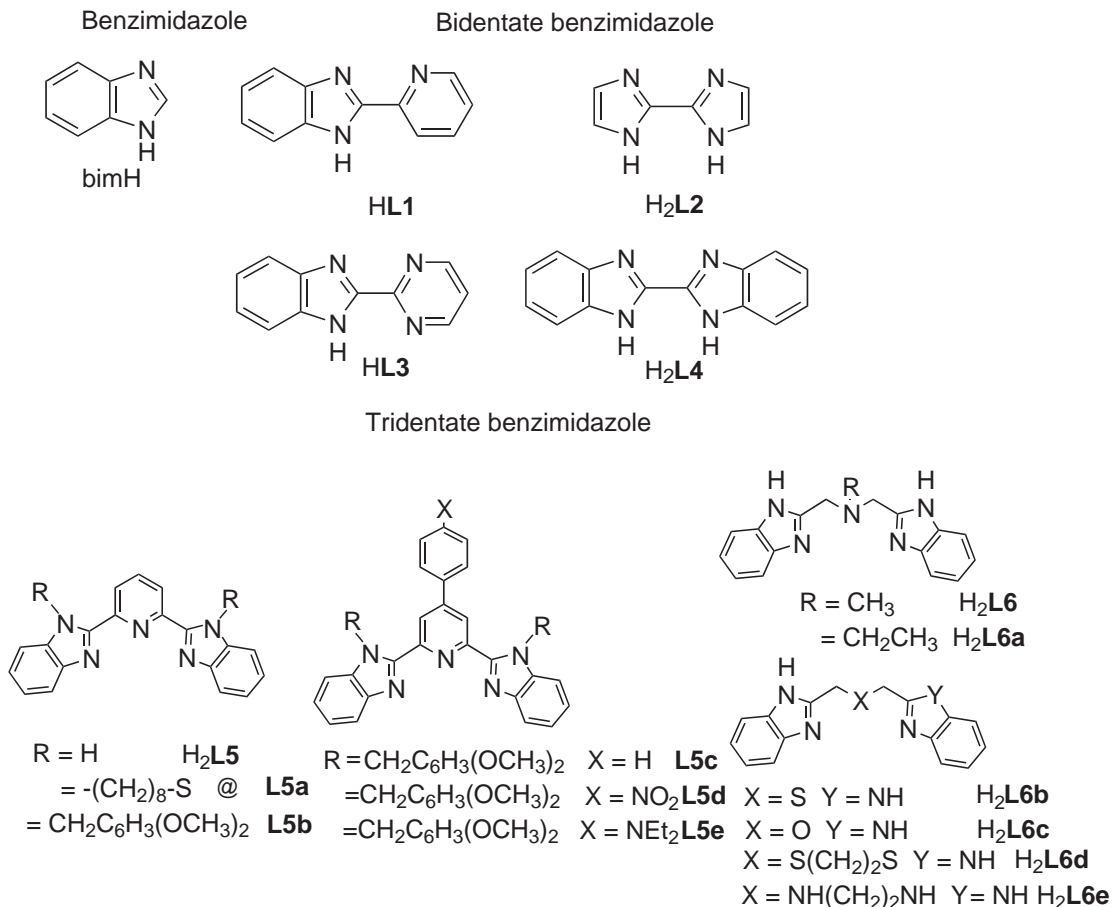
Most 2-substituted benzimidazoles have been obtained by the Phillips condensation reaction of *o*-phenylenediamine with aliphatic or aryl acids either in aqueous mineral acid or in polyphosphoric acid as a condensing agent.<sup>3</sup> Several efficient synthetic routes to substituted benzimidazoles have been reported and are shown in [Scheme 3](#).

- (i) [Scheme 3\(1\)](#). Condensation reactions of *o*-phenylenediamine with aliphatic or aryl acids can afford the benzimidazole derivatives. This synthetic method was applied for the ligand systems **H<sub>2</sub>L5**,<sup>4,5</sup> **H<sub>2</sub>L6**,<sup>6</sup> **H<sub>2</sub>L6b,c**,<sup>5,7</sup> **H<sub>2</sub>L7**,<sup>8</sup> **H<sub>2</sub>L9**,<sup>9</sup> **L10a-c**,<sup>10</sup> **H<sub>4</sub>L14**,<sup>11</sup> **L18a**,<sup>12</sup>





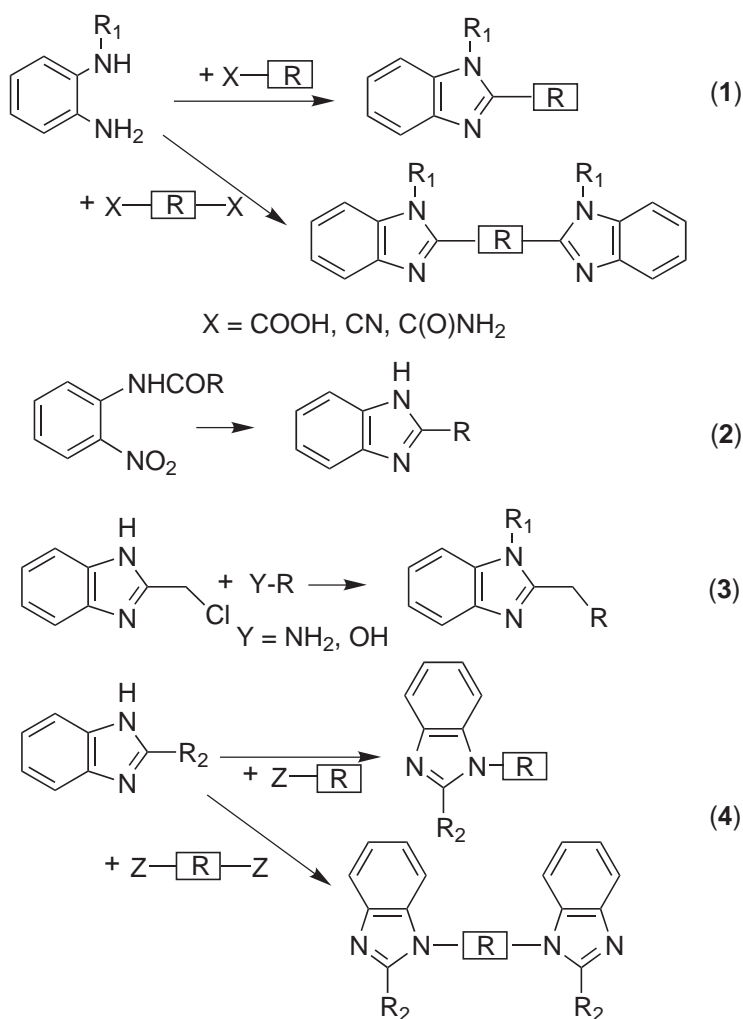
Scheme 1



Scheme 2

**L22**,<sup>13</sup> and **L24**.<sup>12,14</sup> Many carboxylic acid derivatives such as esters, amides, and chlorides or anhydrides may also be used. The same reaction conditions can be applied to the condensation reaction of aromatic nitriles with *o*-phenylenediamine for the synthesis of **H<sub>2</sub>L8**,<sup>15</sup> **H<sub>2</sub>L13**, and **L13a**.<sup>16,17</sup>

- (ii) *Scheme 3(2)*. The formation of the benzimidazole ring system can be achieved simultaneously by the reduction of acylated 2-nitroanilines, using either catalytic or chemical methods such as tin, iron, and hydrochloric acid. The ligands **L10b,c**<sup>18,19</sup> have been synthesized using this method.<sup>20</sup>
- (iii) *Scheme 3(3)*. The condensation reaction between 2-(chloromethyl)benzimidazole with organic groups such as amines, alcohols, and thiols in the presence of a base can produce new polydentate benzimidazole ligands **H<sub>2</sub>L6e**<sup>21</sup> and **L19**.<sup>22</sup>



Scheme 3

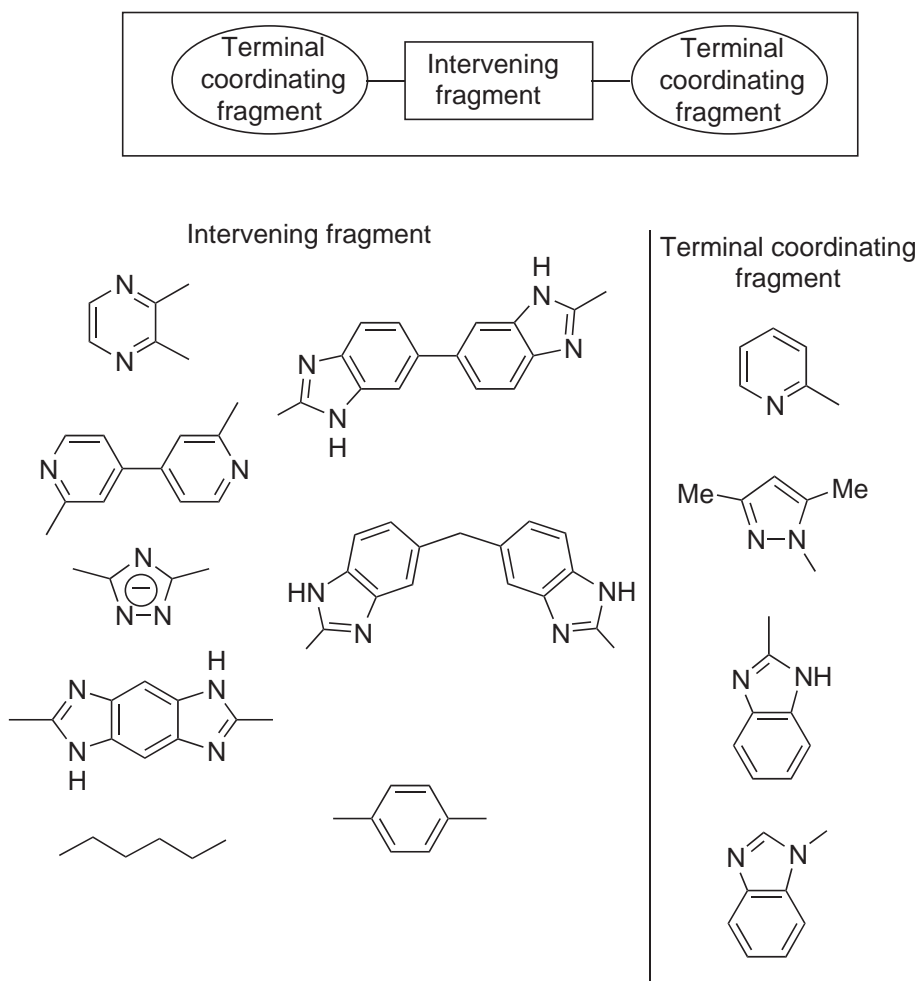
(iv) *Scheme 3(4)*. The substitution of the imino N—H group in benzimidazole can afford a variety of substituted benzimidazole derivatives such as **L20**,<sup>23</sup> **L21**,<sup>23</sup> and **L25a,b**.<sup>24</sup>

The new substituted tridentate ligands **L5c–e** are synthesized in six steps using a Krohnke reaction for the construction of the 4-substituted central pyridine ring.<sup>25</sup> Novel polymeric benzimidazole ligands as an extended system of **H<sub>2</sub>L7** and **H<sub>2</sub>L11b** are also available.<sup>26,27</sup>

### 1.8.3 DESIGN OF IMIDAZOLE/BENZIMIDAZOLE LIGANDS

#### 1.8.3.1 Modular Approach

Imidazole and benzimidazole ligands were used for synthesizing model complexes of metallo-enzymes such as hemocyanin, superoxide dismutase, and plastocyanin for Cu and haemerythrin, methane monooxygenase, and ribonucleotide reductase for Fe<sup>6,28</sup> in the 1980s and the 1990s. New benzimidazole derivatives have been designed to organize metal ions into self-assemblies or into supramolecular architectures with chemical functions. For the purpose of designing a new ligand, the modular approach is generally applied. The combination of molecular fragments can make a new ligand system. When one wants to synthesize a dinuclear complex with a new bridging ligand, the selection of the intervening and terminal coordinating fragments in the bridging ligand is



Scheme 4

necessary. The  $\pi$ -donor– $\pi$ -acceptor properties of the bridging ligand and/or the metal–metal distance can be controlled by choosing the appropriate combination of fragments shown in Scheme 4.

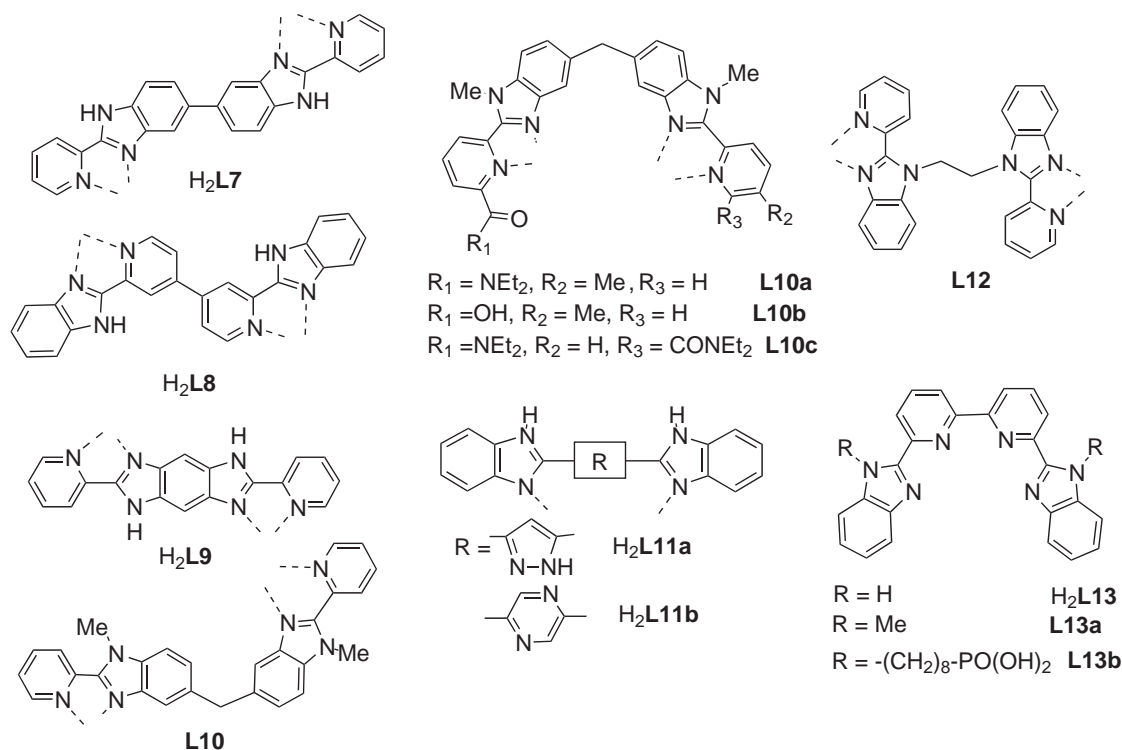
For example, bis(pyridyl)benzimidazole ( $H_2L7$ ), in which the pyridyl group works as a terminal coordinating fragment and the benzimidazole group acts as an intervening group, can bind two  $Ru(bpy)_2$  fragments to form a dinuclear complex.<sup>8,29</sup>

Polydentate ligands can assemble several metal ions into well-defined supramolecular architectures.<sup>30</sup> Segmental bidentate–tridentate and tridentate–tridentate ligands containing benzimidazole groups were synthesized. In the following section, we categorize the benzimidazole ligands into three types in terms of the combination of modular fragments: (i) bidentate + bidentate ligands, (ii) tridentate + tridentate ligands, and (iii) combination of bidentate and/or tridentate ligands and others.

### 1.8.3.2 Chelate Ligands Composed of a Combination of Bidentate Ligands

The development of the synthesis of mixed-valent metal complexes owes much to the molecular design of bridging ligands since the early 1990s. A variety of chelate ligands composed of the bis bidentate ligands containing benzimidazole groups have been synthesized, as shown in Scheme 5.

Depending upon the position of the benzimidazole groups, two types of chelate ligands have been synthesized, i.e., one type where benzimidazole groups are located in terminal coordination sites ( $H_2L8$ ,  $H_2L11$ , or  $L12$ ),<sup>15,24,31,32</sup> and the other where benzimidazole groups are in intervening



Scheme 5

sites (**H<sub>2</sub>L7**, **H<sub>2</sub>L9**, or **H<sub>2</sub>L10**).<sup>9,19</sup> The characteristic of benzimidazole groups as bridging ligands is that the metal–metal communications can be controlled by the protonation/deprotonation of N–H moieties on the benzimidazole groups. The deprotonation of intervening groups in the Ru dinuclear complexes leads to an increase of the Ru–Ru interaction for the mixed-valence Ru<sup>II</sup>–Ru<sup>III</sup> state. Therefore, the protonation/deprotonation of the imidazole or benzimidazole derivatives induces a large change of molecular orbital energies, particularly HOMO and LUMO.

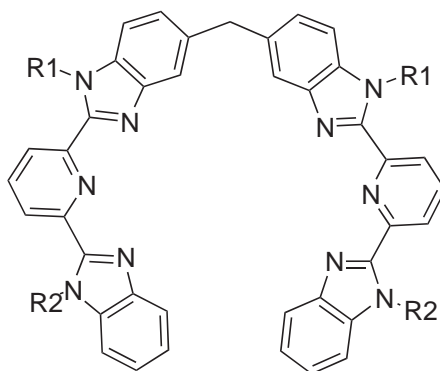
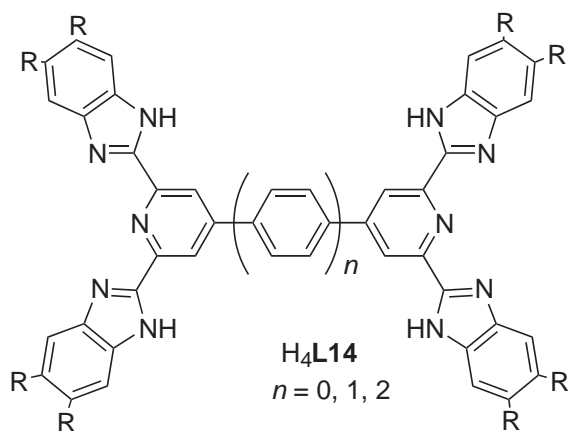
In some cases the combination of two bidentate ligands leads to the tetradentate ligand system. Bis(benzimidazo-2-yl)-bipyridine (**H<sub>2</sub>L13**) acts as a tetradentate ligand for Ru complexes.<sup>16,17,33</sup> The reaction of **H<sub>2</sub>L13** with Pt<sup>II</sup> yields a double-stranded dinuclear helicate [Pt<sub>2</sub>(**H<sub>2</sub>L13**)<sub>2</sub>]<sup>4+</sup>. The Pt centers show a distorted square-planar geometry with each platinum binding to a bipyridine and a benzimidazole of the one ligand and one benzimidazole of the other.<sup>34</sup>

### 1.8.3.3 Chelate Ligands Composed of a Combination of Tridentate Ligands

When six coordination sites around octahedral metal ion are occupied by only bidentate ligands, stereoisomers around the metal ion are formed. However, the coordination of symmetric tridentate ligands to a six-coordinate metal ion leads to only one isomer. Furthermore, tridentate bridging ligands connect metals in a linear fashion, resulting in the formation of stereochemically well-defined supramolecular systems. The rigid structure of these systems is suitable for studies of electron or energy transfer events between the donor–acceptor dyads.

As in the dinucleating “back-to-back” 2,2′:6′,2′′-terpyridine ligands such as 6′,6′′-bis(2-pyridyl)-2,2′:4′,4′′:2′′,2′′-quaterpyridine and 1,4-bis(2,2′:6′,2′′-terpyridin-4-yl)benzene, a series of 2,6-bis(benzimidazol-2-yl)-polypyridine derivatives (**H<sub>4</sub>L14**) have been synthesized (Scheme 6).<sup>11</sup> The increase of the number of phenyl groups in the intervening part leads to a decrease in solubility with common organic solvents. The solubility of the ligands is always a problem for the synthesis of metal complexes; however, the use of microwave-assisted preparative methods solves this problem to some degree.

The bis tridentate ligand **L15** can assemble two lanthanide ions to give dinuclear 2:3 complexes, in which three helically wrapped bis tridentate ligands **L15** are bonded to nine-coordinate tricapped trigonal prismatic lanthanide(III) ions at a metal–metal distance of 8.9 Å.<sup>19,35</sup>

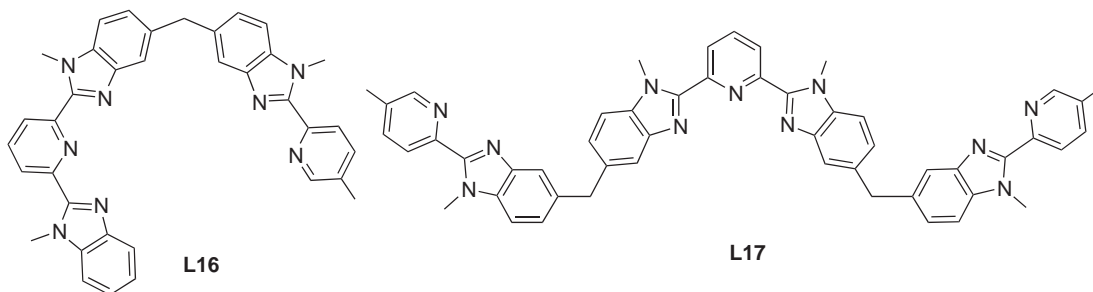


L15

Scheme 6

#### 1.8.3.4 Chelate Ligands Composed of Miscellaneous Combinations

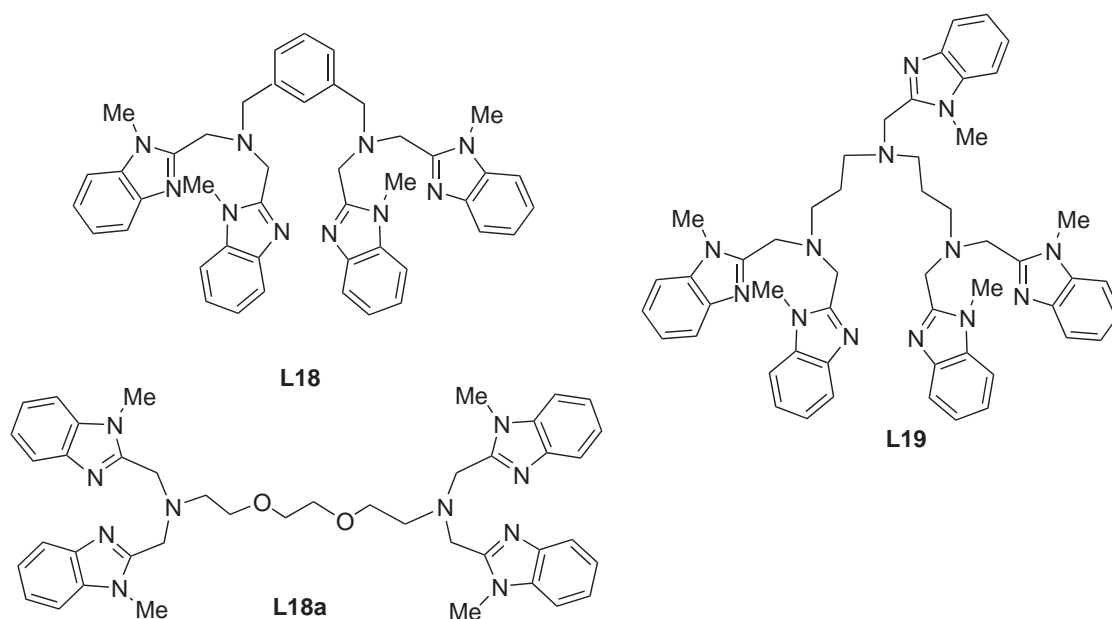
The combination of bidentate and tridentate ligands with a flexible spacer provides versatile binding modes. The ligand **L16** connected by a methylene spacer prevents the simultaneous coordination to the same metal ion and induces a helical twist structure (Scheme 7).<sup>36,37</sup> Segmental bidentate–tridentate–bidentate ligands designed for the self-assembly of heteropolynuclear helical complexes with various metal ions have been synthesized.<sup>38</sup> The introduction of different binding units can introduce selectivity on the basis of coordination number preference; i.e., bis bidentate coordination mode prefers a tetrahedral geometry and the bis tridentate one prefers an octahedral geometry. As a result, strict self-assembly of heteronuclear complexes is observed for the reaction of **L17** with  $Fe^{II}$  and  $Ag^I$ . Therefore, the judicious design of segmental ligands leads to the formation of programmed, organized architectures such as helicates, grids and racks, boxes, catenates, etc.



Scheme 7

### 1.8.4 CHEMICAL FUNCTIONS OF COORDINATION COMPOUNDS WITH IMIDAZOLE/BENZIMIDAZOLE LIGANDS

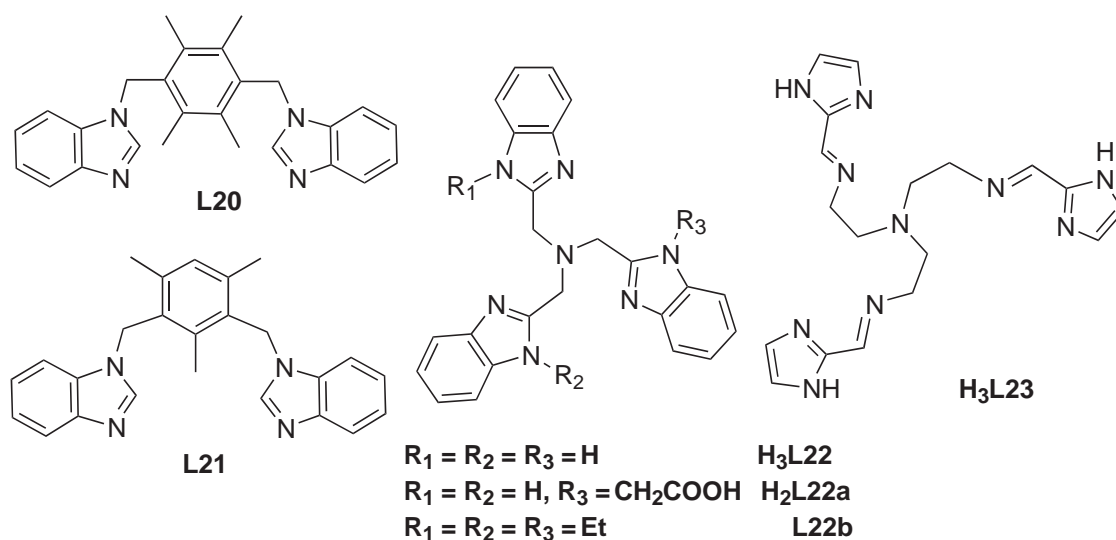
Assembly and integration of molecular components exhibiting specific functions has been a research topic of great interest. The efficacy of coordination complexes with special functions, such as molecular recognition, photochemical activity, or redox activity, can be modified significantly by the use of suitable ligand systems. The benzimidazole ligands relevant for mimicking the active sites of metalloproteins in the field of bioinorganic chemistry have been reviewed in *CCC* (1987). Several new ligand systems have been synthesized as shown in **Scheme 8**. The dicopper(II) complex with ligand **L18** or **L19** has been examined with regard to biomimic activity for catechol oxidase and phenol monooxygenase.<sup>22</sup>



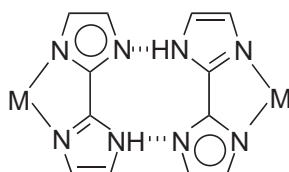
**Scheme 8**

The inclusion of guest molecules into host structures has received much attention due to its potential importance in molecular recognition, separation, and transportation. Discrete molecular architectures with well-defined shape and size containing inner cavities for inclusion have been constructed. The ligands 1,4-bis(benzimidazol-1-ylmethyl)-2,3,5,6-tetramethylbenzene (**L20**) and 1,3-bis(benzimidazol-1-yl-methyl)-2,4,6-trimethylbenzene (**L21**) have been reacted with  $\text{Ag}(\text{CF}_3\text{SO}_3)$  or  $\text{Cu}(\text{ClO}_4)_2$  to form  $\text{M}_2\text{L}_3$  and  $\text{M}_2\text{L}_4$  boxlike complexes, in which anionic molecular guests are accommodated (**Scheme 9**).<sup>23</sup> Similarly, a nanoporous structure, which can be constructed by the hydrogen bonding networks of hexameric metallomacrocycles, was prepared from the reaction of the sodium salt of ligand **H<sub>2</sub>L22a** with  $\text{Cu}(\text{ClO}_4)_2$ . Very large octahedral voids with estimated dimensions of  $11 \times 11 \times 14 \text{ \AA}$  are formed, in which another six NH groups provide a hydrophilic environment to accommodate the guest molecules such as water molecules and perchlorate anions. Also, C3-symmetric tripodal ligands **H<sub>3</sub>L22** and **L22b** react with  $\text{Ag}^+$  salts to afford mono-, di-, tri-, and tetranuclear complexes with different coordination geometries and crystal packings, depending on the counteranions and *N*-substituted alkyl groups.<sup>39</sup>

An important feature of imidazole/benzimidazole ligands is the hydrogen bonding interactions. In crystal engineering, the control of crystal packing and topological networks has a fundamental significance.  $\text{Co}^{\text{III}}$  complexes with achiral tripod-type ligands **H<sub>3</sub>L23** have been synthesized, in which a chiral molecule generated from achiral components gives a homochiral two-dimensional layer via self-organization and intermolecular homochiral interaction; the resulting two-dimensional layers with the same chirality are stacked, resulting in the spontaneous resolution.<sup>40</sup> Similarly, metal complexes of 2,2'-biimidazolate monoanion,  $[\text{M}(\text{HL2})_3]^-$ , form several self-organizing superstructures, such as a one-dimensional linear chain or stacked honeycomb sheet,



Scheme 9



Scheme 10

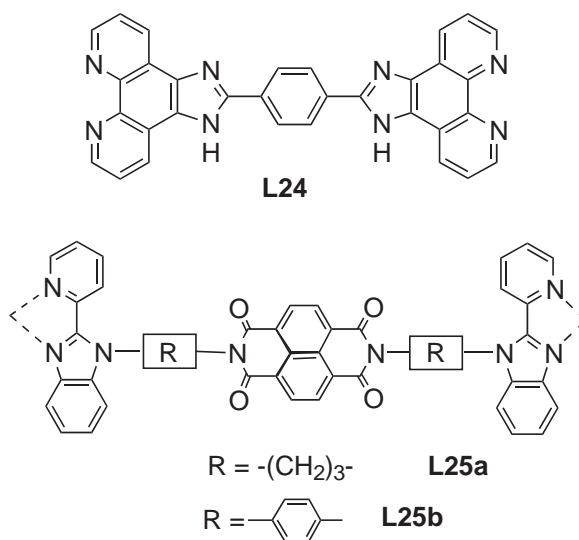
in which intermolecular complementary hydrogen bonding with two sets of NH-donors and N-acceptors plays pivotal roles (Scheme 10).<sup>41,42</sup> Various guest molecules can be included in the cavities of molecular aggregates in the crystals.

Another feature of benzimidazole-containing ligands is the ability to tune the redox potential by remote site deprotonation.<sup>15,43</sup> The oxidation potential of the Ru complex  $[Ru(H_2L5)_2]^{2+}$  is sensitive to solution pH.<sup>44</sup> This change arises from the proton-coupled electron transfer reaction at the remote N—H site on the benzimidazole groups. An octahedral Fe complex containing four imidazole/benzimidazole groups also shows a similar shift of reduction potential, and each deprotonation results in a redox potential shift of approximately 0.3 V per proton.<sup>45</sup> Proton-induced tuning of reduction potential has also been reported in  $[Co(H_3L22)(NCS)]$  complexes.<sup>46</sup>

Benzimidazole derivatives with anchoring groups such as disulfide (L5a) or phosphonate (L13b) have been synthesized and used for the formation of self-assembly monolayers on solid surfaces or gold nanoparticles.<sup>47,48</sup> The syntheses of amphiphilic benzimidazole ligands L5b or L13b have been reported.<sup>49–51</sup> At an air–water interface, amphiphilic Ru and Pt complexes containing L5b or L13b formed a stable Langmuir–Blodgett (LB) monolayer, which can be transferred on a solid substrates as LB films.<sup>52,53</sup>

Nonlinear optical (NLO) materials based on metal complexes have been investigated, particularly from the viewpoint of structure–property relationships for guiding of molecular design. Mono-, di-, and tetranuclear Ru complexes containing 2,2′-*p*-phenylene-bis(imidazo[4,5-*f*]phenanthroline) (L24) have been synthesized and examined with regard to NLO properties (Scheme 11).<sup>54</sup> It has been reported that the magnitude of the hyperpolarizability of the tetranuclear Ru complex is approximately four times larger than that of the mononuclear complex.

Photoinduced intramolecular electron transfer reactions in triad assemblies have been extensively examined with regard to mimicking the photosynthetic center. Novel bridging ligands L25a and L25b were prepared, in which the naphthalene bis(dicarboximide) unit is linked by two bidentate (2-pyridyl)benzimidazole (L1).<sup>55</sup> Under photoirradiation, photoinduced electron transfer from the  $Ru(bpy)_2$  moiety to the diimide site takes place.



Scheme 11

## 1.8.5 REFERENCES

- Sundberg, R. J.; Martin, R. B. *Chem. Rev.* **1974**, *74*, 517.
- Reedijk, J. In *Comprehensive Coordination Chemistry*; Wilkinson, G., Ed.; Pergamon: Oxford, U.K., 1987; Vol. 2, Chap. 13.
- Phillips, M. A. *J. Chem. Soc.* **1928**, 172–177.
- Addison, A. W.; Burke, P. J. *J. Heterocycl. Chem.* **1981**, *18*, 803–805.
- Ruttimann, S.; Piguët, C.; Bernardinelli, G.; Bocquet, B.; Williams, A. F. *J. Am. Chem. Soc.* **1992**, *114*, 4230–4237.
- Adams, H.; Bailey, N. A.; Crane, J. D.; Fenton, D. E.; Latour, J.-M.; Williams, J. M. *J. Chem. Soc., Dalton Trans.* **1990**, 1727–1735.
- Matthews, C. J.; Leese, T. A.; Clegg, W.; Elsegood, M. R. J.; Horsburgh, L.; Lockhart, J. C. *Inorg. Chem.*, **1996**, *35*, 7563–7571.
- Haga, M.; Ano, T.; Kano, K.; Yamabe, S. *Inorg. Chem.* **1991**, *30*, 3843–3849.
- Ohno, T.; Nozaki, K.; Haga, M. *Inorg. Chem.* **1992**, *31*, 4256–4261.
- Piguët, C.; Bernardinelli, G.; Bocquet, B.; Quattropiani, A.; Williams, A. F. *J. Am. Chem. Soc.* **1992**, *114*, 7440–7451.
- Hossain, M. D.; Ueno, R.; Haga, M. *Inorg. Chem. Commun.* **2000**, *3*, 35–38.
- van Rijn, J.; Reedijk, J.; Dartmann, M.; Krebs, B. *J. Chem. Soc., Dalton Trans.* **1987**, 2579–2593.
- Thompson, L. K.; Ramasway, B. S.; Seymour, E. A. *Can. J. Chem.* **1977**, *55*, 878–888.
- Sivagnanam, U.; Pandiyan, T.; Palaniandavar, M. *Indian J. Chem. Sect. B* **1993**, *32B*, 572–576.
- Haga, M.; Ali, M. M.; Koseki, S.; Fujimoto, K.; Yoshimura, A.; Nozaki, K.; Ohno, T.; Nakajima, K.; Stufkens, D. J. *Inorg. Chem.* **1996**, *35*, 3335–3347.
- Mizushima, K.; Nakaura, M.; Park, S.-B.; Nishiyama, H.; Monjushiro, H.; Harada, K.; Haga, M. *Inorg. Chim. Acta* **1997**, *261*, 175–180.
- Renouard, T.; Fallahpour, R.-A.; Nazeeruddin, M. K.; Humphry-Baker, R.; Gorelsky, S. I.; Lever, A. B. P.; Gratzel, M. *Inorg. Chem.* **2002**, *41*, 367–378.
- Edder, C.; Piguët, C.; Bernardinelli, G.; Mareda, J.; Bochet, C. G.; Bunzli, J.-C. G.; Hopfgartner, G. *Inorg. Chem.* **2000**, *39*, 5059–5073.
- Piguët, C.; Bunzli, J.-C. G.; Bernardinelli, G.; Hopfgartner, G.; Petoud, S.; Schaad, O. *J. Am. Chem. Soc.* **1996**, *118*, 6681–6697.
- Iglesias, C. P.; Elhabiri, M.; Hollenstein, M.; Bunzli, J.-C. G.; Piguët, C. *J. Chem. Soc., Dalton Trans.* **2000**, 2031–2043.
- Pandiyan, T.; Palaniandavar, M.; Lakshminarayanan, M.; Manohar, H. *J. Chem. Soc., Dalton Trans.* **1992**, 3377–3384.
- Monzani, E.; Quinti, L.; Perotti, A.; Casella, L.; Gullotti, M.; Randaccio, L.; Geremia, S.; Nardin, G.; Faleschini, P.; Tabbi, G. *Inorg. Chem.* **1998**, *37*, 553–562.
- Su, C.-Y.; Cai, Y.-P.; Chen, C.-L.; Zhang, H.-X.; Kang, B.-S. *J. Chem. Soc., Dalton Trans.* **2001**, 359–361.
- Lions, F.; Martin, K. V. *J. Am. Chem. Soc.* **1958**, *80*, 3858–3865.
- Bochet, C. G.; Piguët, C.; Williams, A. F. *Helv. Chim. Acta* **1993**, *76*, 372–384.
- Cameron, C. G.; Pickup, P. G. *J. Am. Chem. Soc.* **1999**, *121*, 7710–7711.
- Cameron, C. G.; Pickup, P. G. *Chem. Commun.* **1997**, 303–304.
- Crane, J. D.; Fenton, D. E. *J. Chem. Soc., Dalton Trans.* **1990**, 3647–3653.
- Haga, M.; Ano, T.; Ishizaki, T.; Kano, K.; Nozaki, K.; Ohno, T. *J. Chem. Soc., Dalton Trans.* **1994**, 263–272.
- Williams, A. F. *Pure Appl. Chem.* **1996**, *68*, 1285–1289.
- Baitalik, S.; Florke, U.; Nag, K. *Inorg. Chem.* **1999**, *38*, 3296–3308.
- Ohno, T.; Nozaki, K.; Haga, M. *Inorg. Chem.* **1992**, *31*, 548–555.



33. Monjushiro, H.; Harada, K.; Nakaura, M.; Kato, N.; Haga, M.; Ryan, M. F.; Lever, A. B. P. *Mol. Cryst. Liq. Cryst.* **1997**, *294*, 15–18.
34. Haga, M.; Hiratsuka, K.; Kato, M.; Kurosaki, H.; Goto, M.; Arakawa, R.; Yano, S. *Chem. Lett.* **1995**, 1143–1144.
35. Piguet, C.; Bunzli, J.-C. G.; Bernardinelli, G.; Hopfgartner, G.; Williams, A. F. *J. Am. Chem. Soc.* **1993**, *115*, 8197–8206.
36. Piguet, C.; Edder, C.; Rigault, S.; Bernardinelli, G.; Bunzli, J.-C. G.; Hopfgartner, G. *J. Chem. Soc., Dalton Trans.* **2000**, 3999–4006.
37. Albrecht, M. *Chem. Rev.* **2001**, *101*, 3457–3497.
38. Piguet, C.; Hopfgartner, G.; Bocquet, B.; Schaad, O.; Williams, A. F. *J. Am. Chem. Soc.* **1994**, *116*, 9092–9102.
39. Su, C.-Y.; Kang, B.-S.; Du, C.-X.; Yang, Q.-C.; Mak, T. C. W. *Inorg. Chem.* **2000**, *39*, 4843–4849.
40. Katsuki, I.; Motoda, Y.; Sunatsuki, Y.; Matsumoto, N.; Nakashima, T.; Kojima, M. *J. Am. Chem. Soc.* **2002**, *124*, 629–640.
41. Tadokoro, M.; Kanno, H.; Kitajima, T.; Shimada-Umemoto, H.; Nakanishi, N.; Isobe, K.; Nakasuji, K. *Proc. Natl. Acad. Sci. USA* **2002**, *99*, 4950–4955.
42. Tadokoro, M.; Isobe, K.; Uekusa, H.; Ohashi, Y.; Toyoda, J.; Tashiro, K.; Nakasuji, K. *Angew. Chem. Int. Ed. Engl.* **1999**, *38*, 95–98.
43. Haga, M.; Ali, M. M.; Arakawa, R. *Angew. Chem. Int. Ed. Engl.* **1996**, *35*, 76–78.
44. Xiaoming, X.; Haga, M.; Matsumura-Inoue, T.; Ru, Y.; Addison, A. W.; Kano, K. *J. Chem. Soc., Dalton Trans.* **1993**, 2477–2484.
45. Carina, R. F.; Verzeognassi, L.; Bernardinelli, G.; Williams, A. F. *Chem. Commun.* **1998**, 2681–2682.
46. Hammes, B. S.; Kieber-Emmons, M. T.; Sommer, R.; Rheingold, A. L. *Inorg. Chem.* **2002**, *41*, 1351–1353.
47. Haga, M.; Hong, H.-G.; Shiozawa, Y.; Kawata, Y.; Monjushiro, H.; Fukuo, T.; Arakawa, R. *Inorg. Chem.* **2000**, *39*, 4566–4573.
48. Teranishi, T.; Haga, M.; Shiozawa, Y.; Miyake, M. *J. Am. Chem. Soc.* **2000**, *122*, 4237–4238.
49. Nazeeruddin, M. K.; Muller, E.; Humphry-Baker, R.; Vlachopoulos, N.; Gratzel, M. *J. Chem. Soc., Dalton Trans.* **1997**, 4571–4578.
50. Haga, M.; Kato, N.; Monjushiro, H.; Wang, K.; Hossain, M. D. *Supramol. Sci.* **1998**, *5*, 337–342.
51. Ryan, M. F.; Metcalfe, R. A.; Lever, A. B. P.; Haga, M. *J. Chem. Soc., Dalton Trans.* **2000**, 2357–2365.
52. Wang, K.; Haga, M.; Monjushiro, H.; Akiba, M.; Sasaki, Y. *Inorg. Chem.* **2000**, *39*, 4022–4028.
53. Wang, K.; Haga, M.; Hossain, M. D.; Shindo, H.; Hasebe, K.; Monjushiro, H. *Langmuir* **2002**, *18*, 3528–3536.
54. Chao, H.; Li, R.-H.; Jiang, C.-W.; Li, H.; Ji, L.-N.; Li, X.-Y. *J. Chem. Soc., Dalton Trans.* **2001**, 1920–1926.
55. Hossain, M. D.; Haga, M.; Gholamkhash, B.; Nozaki, K.; Tsushima, M.; Ikeda, N.; Ohno, T. *Collect. Czech. Chem. Commun.* **2001**, *66*, 307–337.

# 1.9

## Polyatomic Bridging Ligands

S. SWAVEY and K. J. BREWER  
*Virginia Tech, Blacksburg, VA, USA*

---

1.9.1	SCOPE AND LIMITATIONS	135
1.9.2	INTRODUCTION TO BRIDGING LIGANDS	136
1.9.3	MONODENTATE BRIDGING LIGANDS	137
1.9.3.1	Introduction	137
1.9.3.2	Cyanide	137
1.9.3.3	Diazines and Polyazines	137
1.9.3.4	Fused Pyrazine Ring Systems	138
1.9.3.5	Linked Pyridines	138
1.9.4	BIDENTATE BRIDGING LIGANDS	140
1.9.4.1	Introduction	140
1.9.4.2	Bridging Ligands with Donor Atoms Outside the Ring	140
1.9.4.3	Bridging Ligands with Multiple Donor Atoms in a Ring	141
1.9.4.4	Bridging Ligands with Pyridine Subunits	142
1.9.4.4.1	<i>Conjugated spacers</i>	143
1.9.4.4.2	<i>Nonconjugated spacers</i>	144
1.9.4.5	Bridging Ligands with Phenanthroline Subunits	144
1.9.4.5.1	<i>Fused ring systems</i>	145
1.9.4.5.2	<i>Linked phenanthrolines</i>	146
1.9.5	TRIDENTATE BRIDGING LIGANDS	147
1.9.5.1	Introduction	147
1.9.5.2	Pyridine-based Bridging Ligands	147
1.9.5.3	Phenanthroline-based Bridging Ligands	148
1.9.6	OTHER BRIDGING LIGANDS	148
1.9.6.1	Mixed-denticity Ligands	149
1.9.6.2	Linked Bridging Ligands	149
1.9.6.3	Orthometallated and Interlocked Bridging Ligands	150
1.9.6.4	Porphyrim-containing Bridging Ligands	150
1.9.6.5	Cavity Bridging Ligands	151
1.9.7	REFERENCES	153

---

### 1.9.1 SCOPE AND LIMITATIONS

This chapter deals with heterocyclic ligands possessing  $\pi$ -systems, with primarily nitrogen-donor atoms, known to coordinate to multiple metal centers thereby functioning as a connection or bridge that holds these metal centers together. The bridging ligands will be separated by their denticity, indicating those providing substantial electronic coupling of attached metal centers and those that result in largely electronically uncoupled metals. Where appropriate, synthetic and purification methods for the ligands will be presented. Enormous growth in the field of bridging ligand chemistry has occurred in an effort to extend the field of coordination chemistry to polymetallic systems. Many excellent reviews have been published.<sup>1-10</sup> This section highlights major developments in the field.

The reader is referred to other chapters for (i) aromatic nitrogen-donor nonbridging ligands: bipyridines (Chapter 1.1), terpyridines (Chapter 1.3), phenanthrolines (Chapter 1.2), porphyrins

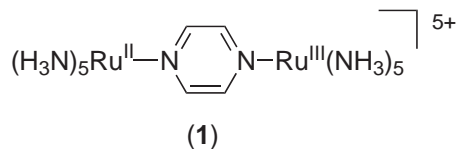
(Chapter 1.23), and phthalocyanines (Chapter 1.24); (ii) nonaromatic bridging ligands: phosphines (Chapter 1.12), macrocycles (Chapter 1.21), amines (Chapter 1.16), and carboxylates (Chapter 1.17).

## 1.9.2 INTRODUCTION TO BRIDGING LIGANDS

Bridging ligands have received much interest recently due to their ability to couple metal centers in a covalent manner resulting in polymetallic complexes that often possess new and interesting properties. Bridging ligands of the type discussed herein bind to each metal through one or more donor atoms forming a coordinate covalent  $\sigma$ -bond. Due to the presence of  $\pi$ -systems on the ligands, commonly  $\pi$ -backbonding or less commonly  $\pi$ -bonding, can lead to enhanced stability of the metal–ligand bonds.

The denticity of a ligand is commonly used to describe its bonding. Herein, monodentate bridging ligands will include the class of ligands that bind to each metal center through only one donor atom. These monodentate bridging ligands are historically significant, thus some of their chemistry is included herein. Bidentate bridging ligands will encompass the broad and rapidly expanding field of ligands which bind to each metal center through two donor atoms. Such bidentate ligands have encompassed much of the recent research in this field and lead to the study of a wide assortment of supramolecular complexes using these ligands as the connectors. Tridentate bridging ligands will include bridging ligands that bind to multiple metal centers using three donor atoms per metal center. The less studied area of ligands of mixed denticity is also presented.

The nature of the bridging ligand used to construct a polymetallic system dictates the spatial orientation and the degree of electronic coupling of the bridged metal center. The shape of the bridging ligand, its rigidity and the coordination geometry to the metals dictates the spatial orientation of the bridged metal systems. A classic example of a monodentate bridging ligand complex is the Creutz–Taube ion (**1**),  $[(\text{NH}_3)_5\text{Ru}^{\text{II}}(\text{pz})\text{Ru}^{\text{III}}(\text{NH}_3)_5]^{5+}$ , where  $\text{pz}$  = pyrazine.<sup>11</sup> This complex illustrates a typical mode of binding for a monodentate bridging ligand, pyrazine, coordinated here to two ruthenium metal centers. Bridging ligands can serve to spatially orient the metal centers that they bridge, most often, the bridging ligand will lie spatially between the bridged metal centers as shown in (**1**). Depending on the aromatic conjugation of the ligand and between the ligand and the metal centers, bridging can promote electronic coupling. This changes, often substantially, the electronic properties of the bridged systems compared to the individual single metal systems. Unconjugated bridged systems can serve to bring the metals into close proximity but typically lead to systems that are electronically uncoupled. This results in bridged polymetallic complexes that often display a simple sum of the properties of the individual metal complexes from which the system is composed. In some cases the bridging ligand orients itself such that it does not lie between the metals it bridges. This often removes contributions from the bridging ligand on electronic coupling but in certain cases allows metal–metal interactions. Typically bridges that do not lie between the metal centers lead to electronically uncoupled systems but some interesting exceptions exist.



Bridging ligands of the type discussed herein not only serve to bridge multiple metal centers but often, by virtue of their  $\pi$ -systems, are redox and spectroscopically active. Very often, the bridging ligands possess quite low-lying empty  $\pi^*$ -orbitals and high-energy filled  $\pi$ -orbitals that serve to mediate electron and energy transfer between bridged metals. The nature of the bridging ligand dictates the energy and occupation of these  $\pi$ - and  $\pi^*$ -orbitals. Bridging ligands with extended aromatic systems typically display lower energy  $\pi^*$ -orbitals and these often function as the site of localization of the lowest unoccupied molecular orbital (LUMO) in metal complexes constructed using these ligands. This makes the nature of the bridging ligand key to redox, spectroscopic, and photochemical properties of these multimetallic complexes.

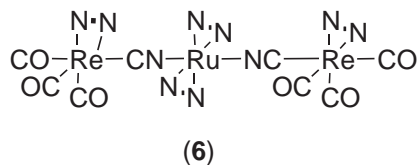
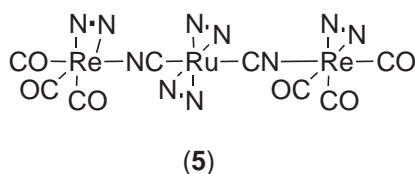
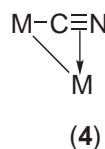
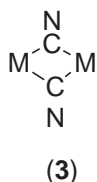
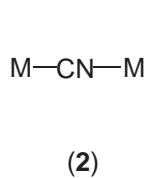
### 1.9.3 MONODENTATE BRIDGING LIGANDS

#### 1.9.3.1 Introduction

This section will discuss monodentate bridging ligands containing primarily nitrogen-donor atoms. Nonbridging nitrogen-donor ligands have been extensively studied in Chapter 13, Volume 2 of *CCC* (1987) and are highlighted in other sections of this volume. There are a number of recent reviews covering the synthesis, characterization and bridging ability of N-donor monodentate and polydentate ligands.<sup>2,3,6,12,13</sup>

#### 1.9.3.2 Cyanide

Although cyanide, as a bridging ligand, has been covered in Chapter 12, Volume 2 of *CCC* (1987), its importance as a bridging ligand bears some mention. Historically, the cyanide ion has been used as a nonbridging monodentate ligand preferentially coordinating to metal centers through the carbon-donor atom. When cyanide is used as a bridging ligand, for example, in the mixed-valence, complex Prussian blue ( $\text{Fe}_4[\text{Fe}(\text{CN})_6]_3$ ), it coordinates in a linear fashion through the carbon and nitrogen ( $\text{Fe}^{\text{II}}\text{CNFe}^{\text{III}}$ ) (2). The importance of cyanide as a bridging ligand for intramolecular energy transfer in polynuclear complexes has been reviewed.<sup>14</sup> Cyanide has also been shown to bridge through the carbon atom (3)<sup>15</sup> and through the carbon and  $\pi$ -system (4)<sup>16</sup>. The versatility of cyanide as a bridging ligand is demonstrated by the trimetallic structural isomers below, where ruthenium is coordinated to carbon in complex (5) and to nitrogen in complex (6) where  $\text{NN} = 2,2'$ -bipyridine.<sup>17</sup> Cyanide has been used effectively as a bridging ligand in the construction of an array of donor-acceptor complexes which show strong vibronic coupling via the cyanide bridge<sup>18,19</sup> and for multielectron photoinduced charge transfer processes.<sup>20</sup>



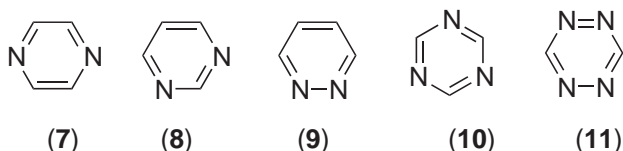
#### 1.9.3.3 Diazines and Polyazines

Diazines are heterocyclic dinitrogen aromatic rings. They are better  $\pi$ -acceptor ligands than pyridine, function as bridging ligands, and lead to  $\pi$ -mediated metal-metal interactions.<sup>21</sup> Pyrazine (7) is one of the more widely studied monodentate bridging ligands and has been used to bridge a variety of transition metals<sup>22</sup> including Pt,<sup>23</sup> Mo,<sup>24</sup> and Ru<sup>25</sup>. Typically, the two metals bridged by pyrazine will be coplanar with the pyrazine ring, providing significant electronic coupling.<sup>16,26,27</sup> Pyrimidine (8) and pyridazine (9) are also used as bridging ligands. Diazines function to bring two metal centers into close proximity providing coupling through a conjugated ring system.

Although not as strong a  $\pi$ -acceptor as the other two diazines pyrimidine (8) is still stronger than pyridine<sup>28</sup> and has been used to bridge Ru<sup>21</sup> and Pt<sup>29</sup>. Stable bridged complexes of pyridazine (9) are rare.<sup>30-32</sup>

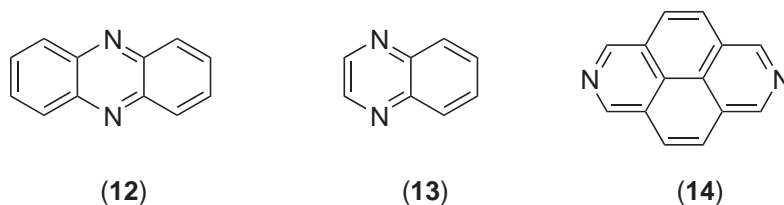
Polyazines like triazine (10) and tetrazine (11) have not been as thoroughly studied as the diazines, however, they make up an important part of the azine literature.<sup>1</sup> Triazine has been used to bridge three platinum(II) metals and the X-ray structure of this triplatinum complex has been

described.<sup>29</sup> In this complex it was determined that coordination at one nitrogen does not significantly affect the donor capacity of the other two nitrogen atoms. The tetrazine ligand by itself is unstable but has been successfully used to bridge ruthenium(II) and iron(II) phthalocyanines.<sup>33</sup>



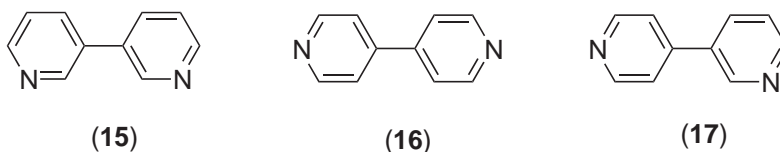
### 1.9.3.4 Fused Pyrazine Ring Systems

Fused pyrazine derivatives like phenazine (**12**) and quinoxaline (**13**) are typically used to bridge low-valent late-transition metals such as copper(I) and silver(I).<sup>34–36</sup> Addition of the fused rings has been shown to add steric demands to the bridged complexes resulting in unique properties for composite materials.<sup>34</sup> These fused ring systems maintain coplanarity while coupling the metal centers through the conjugated  $\pi$ -system as in 2,7-diazapyrene (**14**).<sup>37</sup>



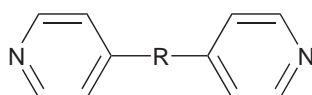
### 1.9.3.5 Linked Pyridines

Bipyridines with the nitrogens located at various positions on the rings, as in 3,3'-bipyridine (**15**), 4,4'-bipyridine (**16**) and 3,4'-bipyridine (**17**) have been studied as bridging ligands. 4,4'-bipyridine can be synthesized in 78% yield from 4-bromopyridine using NaH, Ni(O<sub>2</sub>CHCH<sub>3</sub>)<sub>2</sub>, NaOC(CH<sub>3</sub>)<sub>3</sub>, and PPh<sub>3</sub> in (CH<sub>3</sub>OCH<sub>2</sub>)<sub>2</sub> at 45 °C. Purification is accomplished by chromatography on silica gel using a 50/50 mixture of petroleum ether/diethyl ether as eluent.<sup>38</sup> 3,3'-Bipyridine (**15**) has been used to bridge diindium,<sup>39</sup> diruthenium,<sup>40</sup> and heterobimetallic ruthenium–cobalt<sup>40</sup> complexes. 4,4'-Bipyridine has been used to increase the distance between metal centers in the bridged complex. X-ray crystal studies of a homobimetallic copper complex using (**16**) as a bridging ligand show the complex to exist in a coplanar form, resulting in electronic interactions of the metals through the overlapping  $\pi$ -orbitals of the ligand with a 11.12 Å metal–metal distance.<sup>41</sup> Less electronic overlap is observed in a homobimetallic mixed-valence ruthenium complex due to noncoplanarity of (**16**).<sup>42</sup> Magnetic studies of dinuclear molybdenum complexes using 3,4'-bipyridine (**17**) as the bridging ligand show that the conformation is substantially twisted compared to analogous 3,3'-bipyridine and 4,4'-bipyridine complexes.<sup>43</sup>

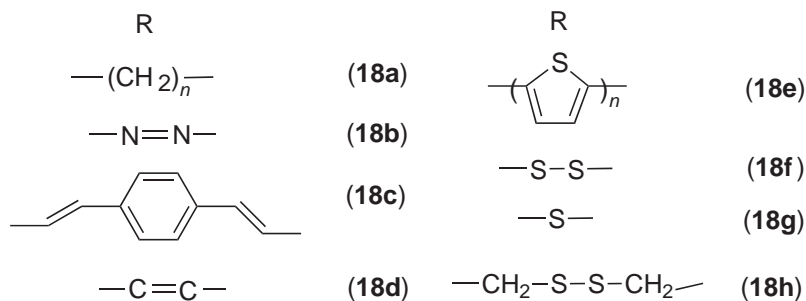


Greater separation between bridged metals has also been achieved by the use of spacers between the pyridine rings, (**18**). Reaction of 4-methylpyridine and 1,2-dibromoethane gives (**18a**) ( $n = 1$ ) in 57% yield.<sup>44</sup> Separation of the 4,4'-bipyridyl rings by an alkyl chain (**18a**) has been used in homobimetallic ruthenium,<sup>45</sup> tungsten,<sup>46</sup> rhenium,<sup>47</sup> osmium,<sup>48</sup> and heterobimetallic ruthenium–rhenium<sup>49</sup> complexes. Coupling of two rhenium metal centers has been achieved with (**18b**) and (**18c**),<sup>50</sup> while homobimetallic ruthenium<sup>45</sup> and tungsten<sup>46</sup> complexes have been synthesized using (**18d**). The bis(pyridine) bridged ligands containing oligothieryl spacers (**18e**) have been used to make dimolybdenum complexes.<sup>51</sup> The use of sulfur linkages has resulted in very

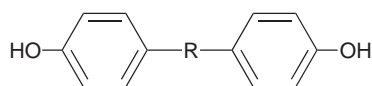
interesting properties of metal complexes of the ligands (**18f–h**).<sup>52</sup> In the mixed-valence bimetallic complex,  $\text{Na}_5[(\text{CN})_5\text{Fe}^{\text{II}}(\mathbf{18f})\text{Fe}^{\text{III}}(\text{CN})_5]$ , no evidence of quadrupole splitting in the Mössbauer spectrum is observed. This suggests that this bridging ligand, (**18f**), leads to a completely delocalized mixed-valence species, showing efficient electronic delocalization facilitated by the —S—S— bridging unit. Use of the bridging ligand with added methylene units, (**18h**), breaks the conjugation of the —S—S— unit with the pyridine rings, and results in largely valence localized mixed-valence species. Interestingly, the bridging ligand with a single S atom also leads to systems with quite weak metal–metal interactions through the bridge. Attachment of  $(\text{NH}_3)_5\text{Ru}$  moieties to these sulfur-containing bridging ligands has also been studied in homobimetallic Ru,Ru and heterobimetallic Ru,Fe systems. The homobimetallic mixed-valence complexes of ligand (**18f**) show intense metal-to-metal charge transfer (MMCT) bands in the near infrared consistent with the strong metal–metal coupling provided by this interesting bridging ligand, giving energetic barriers for this MMCT band similar to that observed for the pyrazine bridge in the Creutz–Taube ion, (**1**).



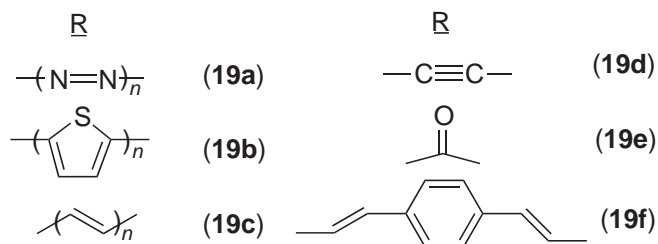
(18)



Bridging ligands analogous to the pyridine ligands (**18**), using phenolate oxygens to coordinate, (**19**), have been used to bridge homobimetallic molybdenum(V) metals.<sup>53</sup> These systems have been used to compare and contrast the effects of the spacer units on the electronic and magnetic interactions of the metal centers, to evaluate their potential as electrochromic dyes, and probe the metal-centered vs. ligand-centered redox activity. The electrochemical, spectroscopic, spectroelectrochemical, and magnetic properties of these dimolybdenum complexes of these noninnocent bridging ligands have been studied. Noninnocent bridging ligands are described as a ligand which, in combination with a particular metal, leads to complexes in which the ligand is redox active displaying redox orbitals of similar energy to the metal-based frontier orbitals. This leads to significant interaction between ligand and metal-based frontier orbitals and makes assignment of the redox processes to individual metals or ligand components difficult. This leads to complexes with interesting and exciting properties. The dimolybdenum complexes of (**19a–f**) show two well-separated reversible one-electron oxidations attributed to



(19)



the Mo<sup>VI/V</sup> redox couple, indicating electronic interaction between the metal centers. One redox wave in the cathodic direction is attributed to the overlapping two-electron reduction of the Mo<sup>V</sup> centers to Mo<sup>IV</sup>. The observation that the oxidations are separated while the reductions of the metal centers are overlapping is attributed to the fact that the HOMO on the oxidizable bridging ligand is close in energy to the metal  $d\pi$  redox orbital. This leads to an effective overlap or delocalization between the oxidized metal in the mixed valence state via hole transfer, leading to significant coupling. The X-ray crystal structure of the dimolybdenum complex using the bridging ligand (**19a**), with  $n=1$ , revealed a planar bridging ligand and a Mo—Mo distance of 14.61 Å.

## 1.9.4 BIDENTATE BRIDGING LIGANDS

### 1.9.4.1 Introduction

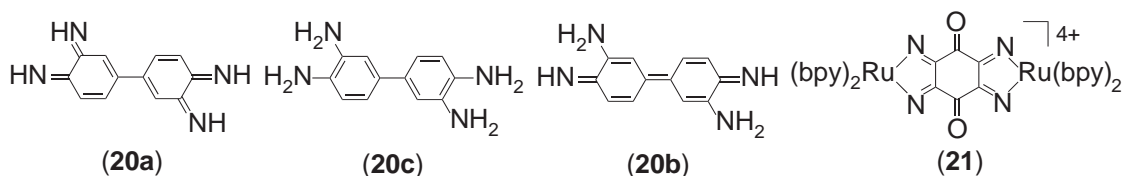
Bidentate bridging ligands bind to each metal by two donor atoms. This gives added stability through the chelating effect. Often, such ligands use diimines that form stable five-membered rings including the metal center. In addition to stability, bidentate bridging ligands often yield very interesting electronic and structural properties. A vast literature of the synthesis of bidentate bridging ligands and their metal complexes as well as their physical properties exists. Many of these complexes and their use as photosynthetic mimics, molecular devices, and electrocatalysts have been reviewed.<sup>1–10</sup> This section will cover bidentate bridging ligands with: donor atoms outside of the ring (Section 1.9.4.2); multiple donor atoms in a ring (Section 1.9.4.3); pyridine subunits (Section 1.9.4.4); and phenanthroline subunits (Section 1.9.4.5) with distinctions made between conjugated and nonconjugated systems.

### 1.9.4.2 Bridging Ligands with Donor Atoms Outside the Ring

The ligand 3,3',4,4'-tetraaminobiphenyl has the ability to coordinate through imine nitrogens and represents another noninnocent bridging ligand. This ligand (**20a**) has been used to couple two Ru<sup>II</sup> moieties.<sup>54,55,58</sup> This ligand can exist in five different oxidation states. Beginning with the fully oxidized diruthenium complex of (**20a**), reduction by one electron gives a quinone/semiquinone, which is stable indefinitely. Addition of another electron gives a semiquinone/semiquinone, (**20b**), bridging ligand which slowly decomposes. Continued reduction gives a semiquinone/catechol bridging ligand complex and finally the fully reduced catechol/catechol, (**20c**), complex. There is some evidence that the twist angle of the biphenyl groups changes with the oxidation state of the ligand. In the semiquinone/semiquinone state, (**20b**), it is possible for pairing of the free radicals constraining the ligand to be planar by forming a double bond between the aromatic rings. In the fully oxidized or fully reduced state, (**20a**) and (**20c**) respectively, there is no double bond between the rings and they are free to rotate. Strong metal–ligand interactions of ligands (**20a–c**) and related ligands indicate that these complexes may be useful in the synthesis of molecular electronic devices.<sup>56–59</sup> A binuclear ruthenium bis(bipyridine) complex has been prepared via *in situ* aerial oxidation of the 1,2,4,5-tetraaminobenzene-bridged binuclear complex followed by hydroxide attack at the 3- and 5-carbons to form the complex (**21**).<sup>60</sup> The bridging ligand 1,2,4,5-tetraimino-3,6-diketocyclohexane can exist in three different oxidation states, and characterization of the complex in its 4+, 3+, and 2+ oxidation states was utilized to determine the delocalization of the ruthenium  $d\pi$  manifold through this bridge as a function of oxidation state. ZINDO and spectroelectrochemical studies of the three oxidation states indicate very strong coupling across the bridging ligand. Mixing of the ruthenium  $d\pi$  orbitals and bridging ligand orbitals increases as the bridging ligand is reduced.

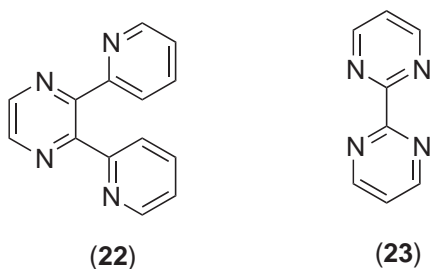
The oxygen-donor atom analog of ligand (**20**) provides a ligand with two dioxolene units linked back to back.<sup>59</sup> This ligand also possesses four redox processes associated with the conversion of each unit between the catechol, semiquinone, and quinone states. The bis-semiquinone state of the diruthenium complex is diamagnetic with a double bond between the phenyl rings. This leads to a significant red shift in the very intense Ru → bridging ligand charge transfer band. This redox-modulated shift of the energy and intensity of charge transfer bands has led to interest in these complexes as molecular electrooptic switches.<sup>59</sup>



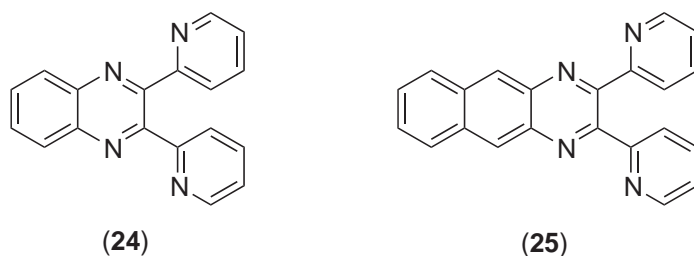


### 1.9.4.3 Bridging Ligands with Multiple Donor Atoms in a Ring

Polyazine bridging ligands such as 2,3-bis(2-pyridyl)pyrazine (dpp) (**22**)<sup>2,3,61</sup> and 2,2'-bipyrimidine (bpm) (**23**)<sup>2,3,62</sup> have been widely studied in the construction of polymetallic complexes and provide electronically coupled polymetallic complexes in which the bridged metals are located in close proximity. Goodwin and Lions reported the synthesis of dpp in the early 1950s.<sup>63</sup> The reaction involves forming the dihydropyrazine ring by a condensation reaction between ethylenediamine and 2,2'-pyridyl followed by dehydrogenation to dpp using a palladium/charcoal catalyst. The dpp ligand binds to two metal centers through a pyridyl and a pyrazine nitrogen acting as an AB chelate and has been used to form homobimetallic complexes of Cu,<sup>64</sup> Ru,<sup>65,66</sup> Re,<sup>67</sup> and Os<sup>68</sup> and heterobimetallic complexes of Ir/Ru,<sup>69</sup> Ru/Rh,<sup>70</sup> Ru/Pd,<sup>71</sup> Ru/Os,<sup>72</sup> and Ru/Pt.<sup>73,1-10</sup> A number of interesting supramolecular polymetallic complexes have also been studied with systems as large as 22 metals.<sup>74,75</sup> X-ray crystallography of a dicopper(II) complex of ligand (**22**) shows noncoplanarity and a Cu—Cu distance of 6.913 Å.<sup>76</sup> The less-studied bpm (**23**) ligand binds to each metal center through two equivalent nitrogens, eliminating the stereoisomers that result from an asymmetric chelate. Bpm has been used to form homobimetallic Ru complexes<sup>77</sup> and heterobimetallic Ru/Rh,<sup>78</sup> Ru/Re,<sup>79</sup> Ru/Ir,<sup>80</sup> and Ru/Pt<sup>73</sup> complexes. A Co—Co distance of 5.782 Å is observed for a dicobalt(II) complex using ligand (**23**) with torsion angles nearly equal to zero.<sup>81</sup>

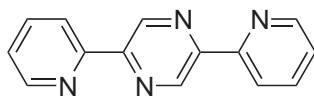


Extension of the aromatic  $\pi$ -system of dpp, (**24**) and (**25**), leads to increased conjugation, stabilized  $\pi^*$ -orbitals, leading to interesting modulation of the spectroscopic and electrochemical properties. The X-ray crystal structure of a dicopper complex of ligand (**24**) shows very little difference between its dpp analog with a Cu—Cu distance of 6.908 Å and torsion angles of approximately 30°.<sup>82</sup> The redox properties of these ligands show that extension of the aromatic system leads to a 270 mV stabilization of the  $\pi^*$ -orbital for (**24**) and 420 mV for (**25**) relative to the pyrazine derivative (**22**).<sup>80</sup> 2,3-Bis(2-pyridyl)quinoxaline, dpq (**24**), has been extensively studied as a bridging ligand<sup>2,3</sup> in homobimetallic complexes with Cu,<sup>64</sup> Ru<sup>83</sup> and heterobimetallic Ru/Re<sup>79</sup> and Re/Os<sup>66</sup> complexes. 2,3-Bis(2-pyridyl)benzoquinoxaline, dpb (**25**), has been used to bridge Ru/Ru,<sup>84</sup> Os/Os,<sup>85</sup> Ru/Rh,<sup>86</sup> Ru/Ir,<sup>87</sup> Ru/Pt,<sup>88</sup> and Cu/Cu<sup>64</sup> atoms.

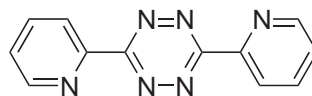




Interesting systems have been prepared that allow for a more linear bridging ligand, (26) and (27). Ligand (26), a 2,5 analog of dpp, has been used to bridge Ru/Ru,<sup>89</sup> Ru/Os,<sup>90</sup> and Os/Os<sup>91</sup> systems, while (27) has been used to form homobimetallic Ru complexes.<sup>2,3,92</sup> Ligand (26) is similar to the bridging ligand 2,2'-bipyrimidine in its coordination abilities, offering a low-lying  $\pi^*$ -orbital localized on the bridging ligand and high symmetry when bridging two metal centers. Nickel(II) and Copper(II) homobimetallic complexes of ligand (26) show nearly coplanar geometry with torsion angles of 4° for the Ni<sup>II</sup> complex and 8° for the Cu<sup>II</sup> complex. The Ni—Ni distance is 6.888 Å and the Cu—Cu distance is 6.760 Å.<sup>93</sup> The bridging ligand (27) has extremely low-lying  $\pi^*$ -orbitals which are further stabilized by metal coordination and is a rather weak  $\sigma$ -donor.

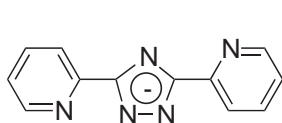


(26)

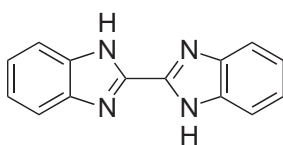


(27)

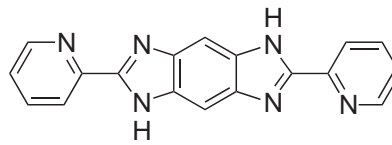
A triazole ligand, (28), leads to asymmetric coordination modes, giving inequivalent metal centers in homobimetallic complexes.<sup>94</sup> Complexes of Ru,Os exhibit efficient energy transfer mediated by the triazole ring. Benzimidazole-based bridging ligands like 2,2'-bibenzimidazolate (29),<sup>95</sup> 2,6-bis(2-pyridyl)benzodiazole (30),<sup>96</sup> 2,2'-bis(2-pyridyl)bibenzimidazole (31),<sup>97</sup> and 1,2-bis(2-pyridyl)benzimidazolyl ethane (32)<sup>97</sup> have been used to bridge Ru/Ru and Os/Os centers. The bis-imidazole ligand, (29), must be deprotonated prior to functioning as a bridge. Ligands (30) and (31) function as bridges without deprotonation and display interesting proton-induced modulation of bridging ligand energetics. This has applications to proton switching of electron transfer pathways in molecular electronics.



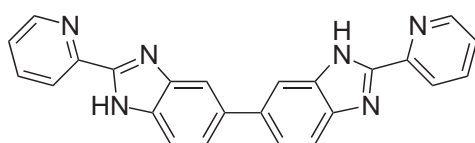
(28)



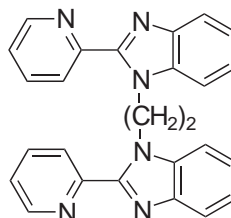
(29)



(30)



(31)



(32)

The metal–metal interactions of the complexes formed with (31) and (32) have been shown to be very weak, in contrast to efficient coupling in (29) and in (30).<sup>95,96</sup>

#### 1.9.4.4 Bridging Ligands with Pyridine Subunits

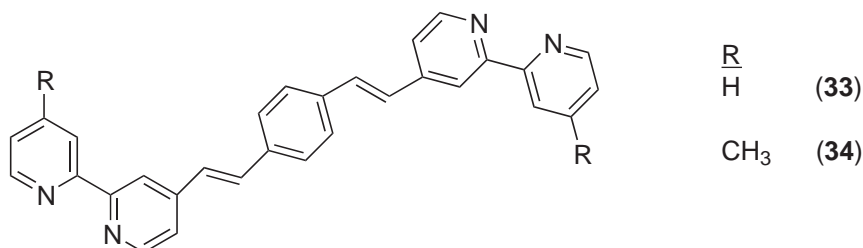
In the systems just described, with the exception of (31) and (32), the bridging ligand works to bring the metal centers into close proximity and provide coupling through conjugated  $\pi$ -systems. These systems are designed to increase the electronic coupling between the metal centers with the goal of increasing the efficiency of electron/energy transfer. Increasing the distance between metal centers while maintaining conjugation has led to a series of interesting bridging ligands allowing the study of long-range energy and electron transfer.<sup>7</sup>

Bipyridine is the most widely recognized and used mononuclear bidentate ligand. The reader is referred to Chapter 1.1 for a review of bipyridine ligands. This section will cover bipyridine ligands linked by a spacer to form polypyridyl bridging ligands. The bridging ligands will be divided into those

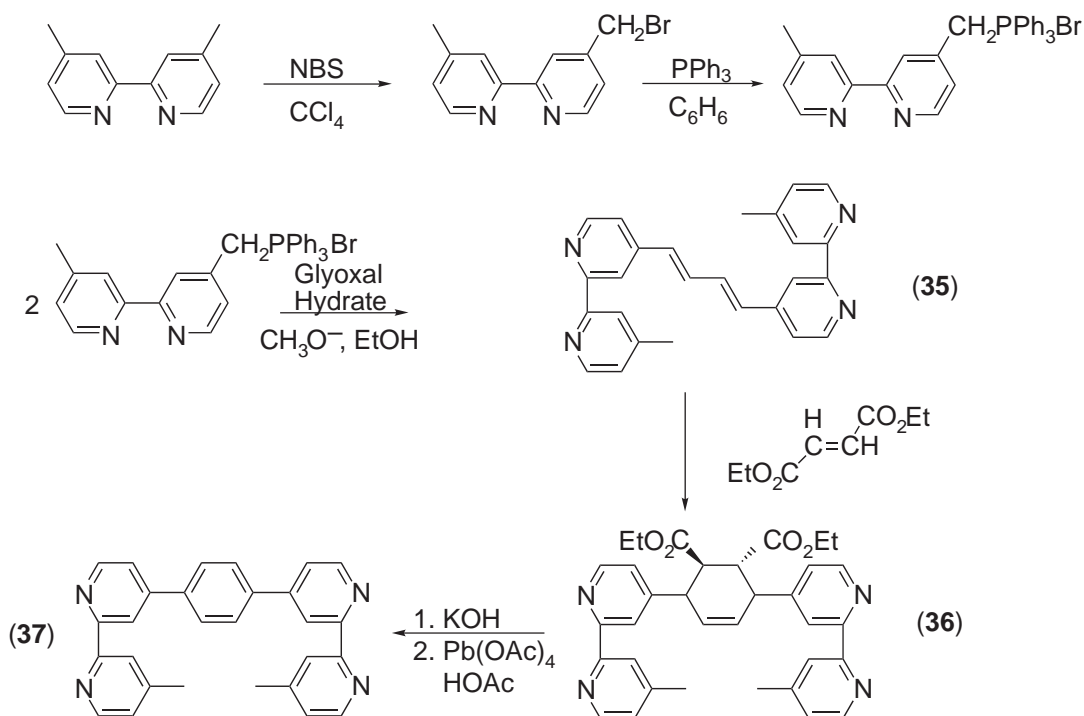
with spacers that maintain conjugation and those with spacers that do not maintain conjugation. A recent review highlights many of these systems including polymeric derivatives not discussed herein.<sup>13</sup>

#### 1.9.4.4.1 Conjugated spacers

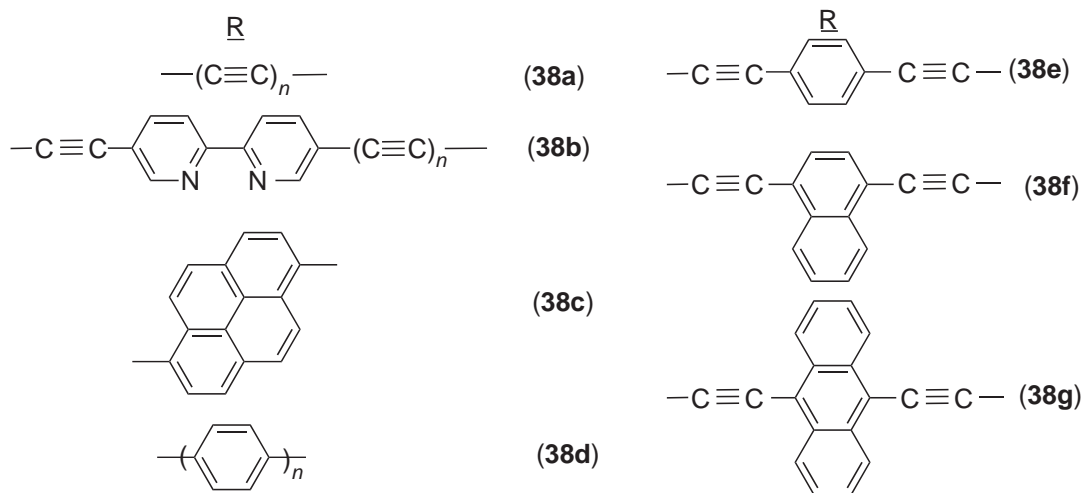
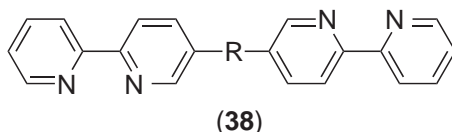
Homobimetallic Re/Re<sup>98</sup> and heterobimetallic Ru/Re<sup>99</sup> complexes based on the bridging ligand (33) and its derivative (34), respectively, have been synthesized and their photophysical properties studied.



These complexes have been shown to phosphoresce from an intraligand excited state. Other conjugated polypyridyl bridging ligands have been synthesized, (35)–(37), and used to complex Ru. The synthetic scheme for these three ligands is illustrated below.<sup>100</sup> Purification of the ligands is accomplished by flash chromatography on silica gel using CHCl<sub>3</sub>:EtO<sub>2</sub>CCH<sub>3</sub>:Et<sub>3</sub>N (4:4:1) as eluent.

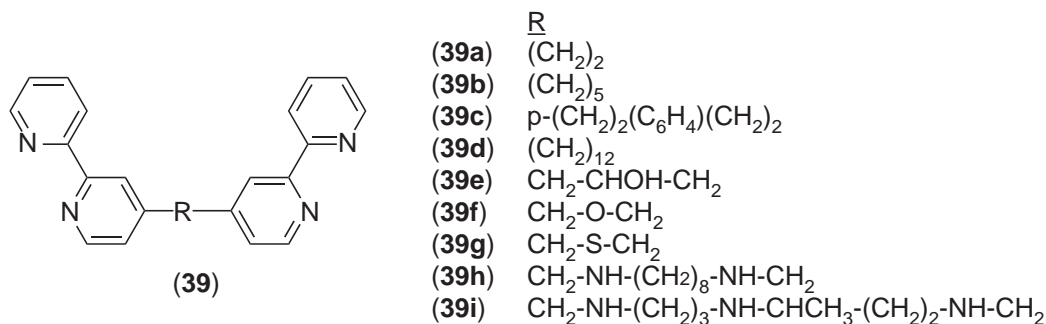


Rigid rod-like polypyridyl ligands, (38a) and (38b), have been used to couple two Ru centers as well as Ru/Os as precursors to molecular-scale wires.<sup>101</sup> Homobimetallic Ru<sup>II</sup> and monometallic Re<sup>I</sup> complexes using ligand (38c)<sup>102</sup> were synthesized to investigate intramolecular energy migration between metal-to-ligand charge transfer (MLCT) states localized on the metal complexes and pyrene-localized <sup>3</sup>(π-π\*) states. The spectroscopic and electrochemical data indicate that the lowest-energy excited state is not a MLCT state but rather a triplet state localized on either the pyrene (<sup>3</sup>IL) or a pyrene (π) to bipyridine (π\*) charge transfer state (<sup>3</sup>ILCT). The photophysical properties of Ru<sup>II</sup> and Os<sup>II</sup> complexes using ligands (38e–g) have been studied and show the ability of these ligands to promote energy transfer over long distances, up to 42 Å.<sup>103,104</sup> Synthesis of (38d) is accomplished by reacting the boronic acid derivatives of the oligophenylenes, (HO)<sub>2</sub>B-(ph)<sub>n</sub>-B(OH)<sub>2</sub> (n = 1, 3, 5), with 4'-Br-phenyl-bipyridine.<sup>104</sup>



#### 1.9.4.4.2 Nonconjugated spacers

One approach to achieving charge separation in photochemical systems has been to vary the spacer length between the pyridyl coordination sites and vary the linking units. The photophysical properties of polynuclear Ru<sub>3</sub>/Fe complexes using the ligands (39a–d) have been investigated, and show that only partial quenching of the ruthenium emission via energy transfer occurs and communication between the ruthenium and iron charge transfer states depends on the length of the covalent linkage between the two centers.<sup>105</sup> Energy transfer of a heterobimetallic Ru<sup>II</sup>/Re<sup>I</sup> complex using (39a) have also been studied.<sup>106</sup> In this complex, excitation of the rhenium center led to energy transfer to the ruthenium center with greater than 80% efficiency. This ligand, (39a), has also been used to couple Fe/Ru,<sup>107</sup> Co/Ru,<sup>108</sup> Ru/Ru,<sup>105</sup> Ru/Os,<sup>109</sup> Ru/Pt,<sup>110</sup> Re/Re,<sup>111</sup> and Ru/Rh<sup>112</sup>. The ligand (39b) has been used to bridge Fe/Ru,<sup>107</sup> Ru/Os,<sup>109</sup> and Fe/Ru<sub>3</sub><sup>105</sup> while (39c) has been used to bridge Ru/Ru,<sup>113</sup> Fe/Ru<sub>3</sub>,<sup>105</sup> and Ru<sub>4</sub><sup>114</sup>. Heterobimetallic complexes of Fe/Ru have been synthesized using (39f–g).<sup>106</sup> The ligand (39e) has been extensively used to complex Ru/Ru,<sup>115</sup> Ru/Rh,<sup>116</sup> Ru/Re,<sup>117</sup> and Ru/Os<sup>109</sup>. Homobimetallic Ru complexes using (39h–i) have also been synthesized.<sup>118</sup>



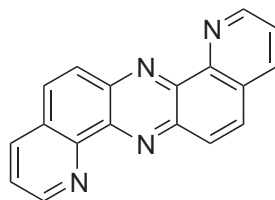
#### 1.9.4.5 Bridging Ligands with Phenanthroline Subunits

Phenanthroline is a bidentate ligand capable of coordination to metal centers through the nitrogen atoms. Unlike bipyridine, phenanthroline is a rigid ligand in which the pyridyl groups are linked together through an aromatic system. This section will discuss phenanthrolines linked

together to form bridging ligands. Distinctions will be made between fused ring systems and linked phenanthrolines.

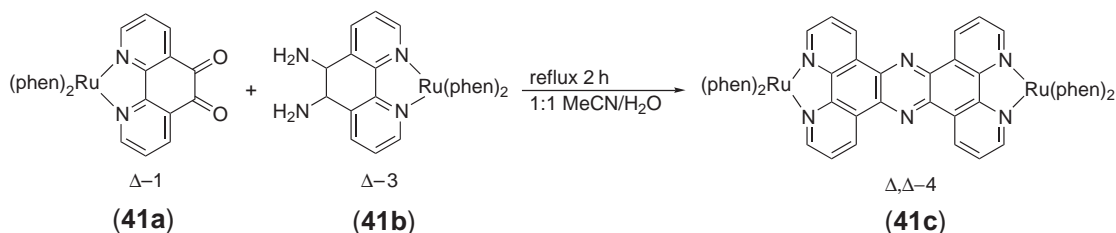
#### 1.9.4.5.1 Fused ring systems

The highly conjugated bridging ligand dipyrido(2,3-a;2',3'-h)phenazine (dpop) (**40**) has been studied for its ability to bind metal centers and enhance photo-induced energy transfer. This ligand possesses a low-lying  $\pi^*$ -orbital leading to complexes with red-shifted absorbances due to the extensive conjugation. Homobimetallic  $\text{Re}^{\text{I}}$ ,<sup>119</sup>  $\text{Ru}^{\text{II}}$ ,<sup>120</sup>  $\text{Os}^{\text{II}}$ ,<sup>121</sup> and  $\text{Mo}^0$ <sup>122</sup> have been synthesized and studied.

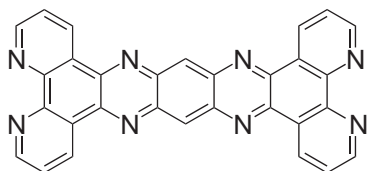


(40)

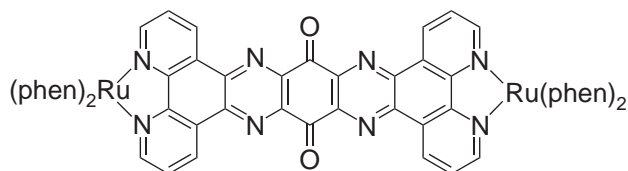
To circumvent the complicated mixtures of enantiomers and diastereomers resulting from complexation of metal centers using tetra-pyrido[3,2-a:2',3'-c:3'',2''-h,3''-j]phenazine (tpphz) (**41c**) a method of synthesis has been developed in which the bridge is formed after the precursors are bound to chiral monometallic synthons.<sup>123</sup>



This procedure has also been expanded to form polynuclear dendrimer complexes.<sup>124,125</sup> Tpphz (**41c**) has been used to bridge  $\text{Os}^{\text{II}}/\text{Os}^{\text{II}}$ ,<sup>128</sup>  $\text{Ru}^{\text{II}}/\text{Ru}^{\text{II}}$ ,<sup>126</sup> and  $\text{Os}^{\text{II}}/\text{Ru}^{\text{II}}$ .<sup>127,128</sup> Related bridging ligands have been prepared using this condensation method.<sup>129-133</sup> Extension of the aromatic system has been accomplished with the synthesis of tatpp, (**42**), which when metallated gives the homobimetallic  $\text{Ru}^{\text{II}}$  complex and following oxidation with ammonium peroxydisulfate leads to the tatpq ruthenium complex (**43**).<sup>134</sup> Electrochemical studies of the homobimetallic ruthenium complex of ligand (**42**) show two reversible one-electron reductions resulting in the formation of the dianion of (**42**).<sup>134</sup> Complex (**43**) undergoes a reversible one-electron reduction creating the semi-quinone bridging ligand.<sup>133</sup> Further reduction to the hydroquinone dianion is quasi-reversible.



(42)

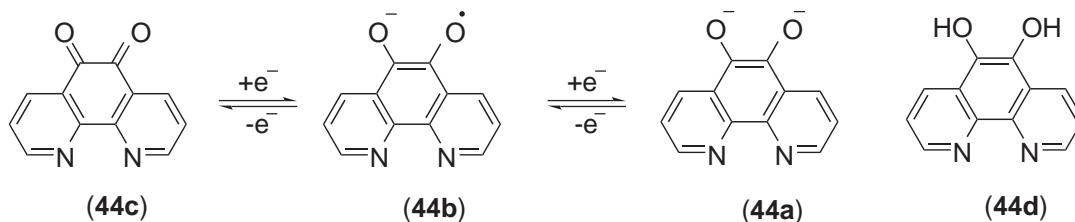


(43)

An interesting redox-active bridging ligand that binds to one metal through two N-donor atoms and the other through two O-donor atoms is 1,10-phenanthroline-5,6-diolate, (**44**).<sup>135</sup>

Metal complexes of this ligand often display similar quinone and metal  $d\pi$  orbital energies. Ancillary ligand variation has been used to modulate the ordering of these orbitals and their

redox processes in mixed-metal Ru/Pt systems.<sup>136</sup> Interesting synthetic methods to form metal complexes of **(44a)** have been developed using the reduced form of the ligand, **(44d)**, reacting with Pt<sup>II</sup> to yield systems with exclusively catecholate coordination.<sup>137</sup> This method allows for stepwise formation of polymeric complexes containing this ligand.

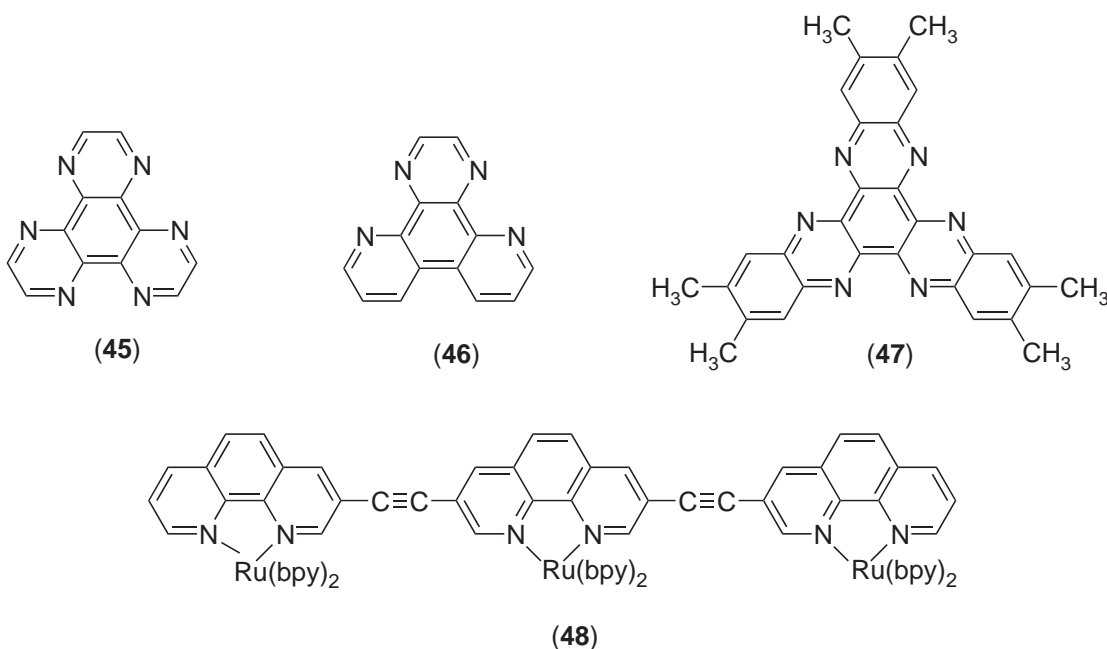


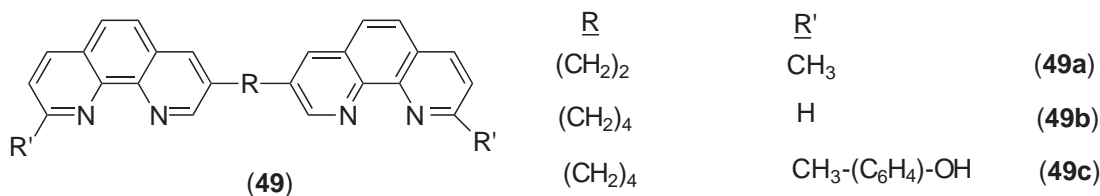
One widely studied phenanthroline-linked bridging ligand is the tris-bidentate ligand 1,4,5,8,9,12-hexaazatriphenylene (HAT) **(45)**. The first report of the synthesis of HAT required a number of steps and was inefficient.<sup>138</sup> The synthesis has been considerably improved with effective synthetic routes to the hexa-aminobenzene precursor, which is subsequently condensed with glyoxal to give HAT.<sup>139</sup> This ligand has been used to form homobimetallic Ru<sup>II</sup>,<sup>140</sup> Rh<sup>III</sup><sup>141</sup> and homotrimetallic Ru<sup>II</sup><sup>142</sup> complexes. Mixed RuRe<sub>2</sub><sup>79</sup> complexes have also been synthesized and studied. Derivatives of HAT have been used to couple Ru<sup>II</sup><sup>143</sup> and Re<sup>I</sup><sup>144</sup> **(46)** and Pd<sup>II</sup>/Re<sup>I</sup> **(47)**.<sup>145</sup> A trinuclear Cu<sup>II</sup> complex using the hexa-cyano derivative of **(45)** has been synthesized showing equivalent Cu—Cu distances of 6.8 Å with a coplanar geometry.<sup>146</sup>

#### 1.9.4.5.2 Linked phenanthrolines

Palladium-mediated cross-coupling reactions between ethynyl and bromo-functionalized octahedral Ru<sup>II</sup> complexes has led to di and tri, **(48)**, nuclear complexes.<sup>147</sup> This represents another example of formation of the monometallic synthons prior to formation of the polymeric complex.

Saturated alkyl chain spacers have been used to separate the phenanthroline subunits in the bridging ligands **(49a)**<sup>148</sup> and **(49b)**.<sup>149</sup>





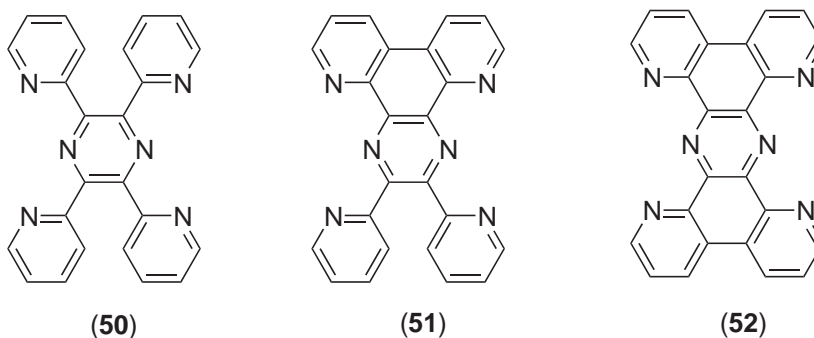
## 1.9.5 TRIDENTATE BRIDGING LIGANDS

### 1.9.5.1 Introduction

Tridentate bridging ligands bind two or more metal centers through three donor atoms per metal center. Fewer tridentate bridging ligands have been explored relative to the bidentate ligands. This results in part from the nonideal bite angle of tpy.<sup>150</sup> This leads to thermally accessible ligand field states in many charge transfer complexes leading to significantly shortened excited state lifetimes.<sup>151</sup> One advantage of using tpy as a ligand is that it occupies three coordination sites, which results in some stereochemical control of supramolecular complexes eliminating the  $\Delta$  and  $\Lambda$  isomeric mixtures in tris-bidentate systems. Many systems have been devised that have stabilized charge transfer states localized on the bridging ligand, allowing for limited population of the ligand field states and giving rise to extended excited state lifetimes.<sup>151</sup> The reader is referred to Chapter 1.3 for a review of nonbridging tpy ligands. This section will cover ligands with terpyridine subunits that are bridging in nature. Reviews of tridentate bridging ligands have been presented.<sup>1,2,151,152</sup>

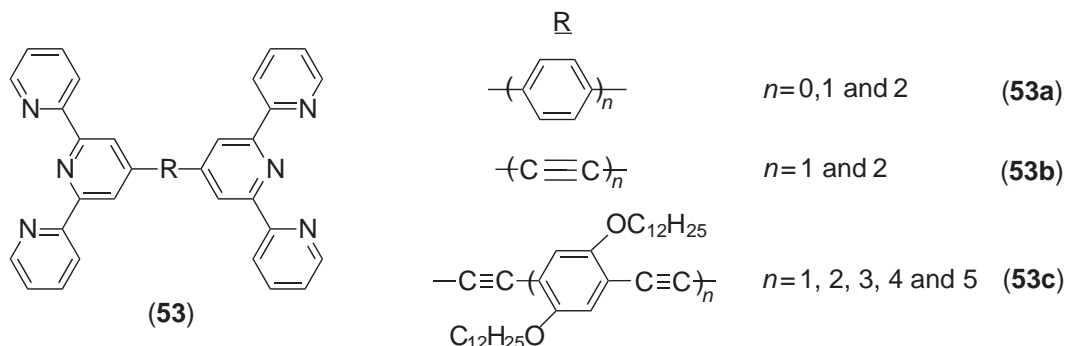
### 1.9.5.2 Pyridine-based Bridging Ligands

A polyazine tridentate ligand that forms polymetallic Ru<sup>II</sup> complexes is 2,3,5,6-(2-pyridyl)pyrazine (tpp) (**50**) prepared by heating together 2,2'-pyridoin and ammonium acetate.<sup>62</sup> When tpp functions as a bridging ligand it produces stereochemically defined complexes with interesting electrochemical and photophysical properties<sup>1,2,151,152</sup> and has been shown to bridge homobimetallic Ru<sup>II</sup>,<sup>153</sup> Cu<sup>II</sup>,<sup>154</sup> Rh<sup>III</sup><sup>155</sup> centers and heterobimetallic Ru<sup>II</sup>/Ir<sup>III</sup><sup>156</sup> Ru<sup>II</sup>/Rh<sup>III</sup>,<sup>157</sup> centers. Homobimetallic complexes of Cu<sup>II</sup> and Ni<sup>II</sup> using ligand (**50**) have been synthesized. Both complexes show antiferromagnetic coupling of the metal centers with metal-metal distances of approximately 6.6 Å. The crystal structures indicate some twisting of the central pyrazine ring.<sup>158</sup> Heterobimetallic complexes of Ru<sup>II</sup> and Os<sup>II</sup> have also been synthesized.<sup>159</sup> This tpp ligand provides efficient electronic coupling mediated by the central pyrazine. The much less studied and closely related ligands (**51**)<sup>160</sup> and (**52**)<sup>161</sup> have been known for some time and have been used in homobimetallic complexes bridging Ru<sup>II</sup> centers.<sup>162-164</sup>

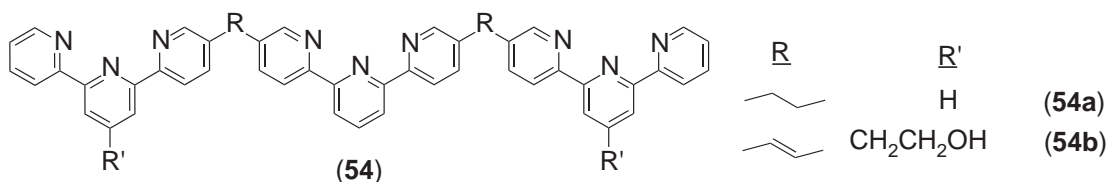


A series of tridentate bridging ligands consisting of two coordinating tpy “ends” held back to back by a spacer at the 4' position have been synthesized. The spacer affects the metal-to-metal distance and the extent of electronic coupling through the ligand. The ligand (**53a**) has been used to bridge Ru<sup>II</sup><sup>165</sup> and Ru<sup>II</sup>/Os<sup>II</sup><sup>166</sup> centers. Electrochemistry of the homobimetallic complexes of (**53a**) show a split in the metal oxidations indicating metal-metal communication. Ligand (**53b**)

has also been used to bridge  $\text{Ru}^{\text{II}}$ <sup>101</sup> and  $\text{Ru}^{\text{II}}/\text{Os}^{\text{II}}$ <sup>167</sup> centers. Studies of the mixed-metal  $\text{Ru}^{\text{II}}/\text{Os}^{\text{II}}$  complex using ligand (**53b**) indicate that there is efficient energy transfer over a distance of 250 Å. The ligand system (**53c**) has been used to bridge homobimetallic  $\text{Ru}^{\text{II}}$  and heterobimetallic  $\text{Ru}^{\text{II}}/\text{Os}^{\text{II}}$  metal centers and the effects of spacer distance on triplet energy transfer has been investigated showing an inverse relationship between the rate of intramolecular electron transfer and the spacer distance.<sup>168</sup>



Ligands with three linked tpy units have been prepared, (**54a,b**), with rigid and flexible spacers to explore electronic coupling of  $\text{Ru}^{\text{II}}$  chromophores.<sup>169</sup> The  $\text{Ru}^{\text{II}}$  complex of ligand (**54a**) was found to behave almost identically to  $[\text{Ru}(\text{tpy})_2]^{2+}$  with no emission at room temperature while the  $\text{Ru}^{\text{II}}$  complex of (**54b**) displayed an emission at room temperature which was attributed to a stabilized  $\pi^*$ -orbital on the bridging ligand.<sup>169</sup>



The trinucleating ligand (**55**) formed in 35% yield from the reaction of 2-acetylpyridine, 1,3,5-benzenetricarboxaldehyde and 1-picolinoylmethylpyridinium iodide acts to bridge three metals in a tridentate fashion and leads to weak metal–metal interaction based on electrochemical experiments.<sup>170</sup>

Luminescent molecular rods have been synthesized using bridging ligand (**56**).<sup>171</sup> Multimetallic  $\text{Ru}^{\text{II}}$  and  $\text{Os}^{\text{II}}$  complexes have been synthesized. The X-ray structure of the homobimetallic  $\text{Ru}^{\text{II}}$  complex of ligand (**56**) is nearly coplanar with torsion angles between the tpy and thienyl moieties between  $5.30^\circ$  and  $6.07^\circ$ , and a metal–metal distance of 14.40 Å. Electrochemical analysis of the bimetallic complexes show two overlapping reversible redox processes in the anodic region attributed to oxidation of the metal centers and ligand-based reductions in the cathodic region.

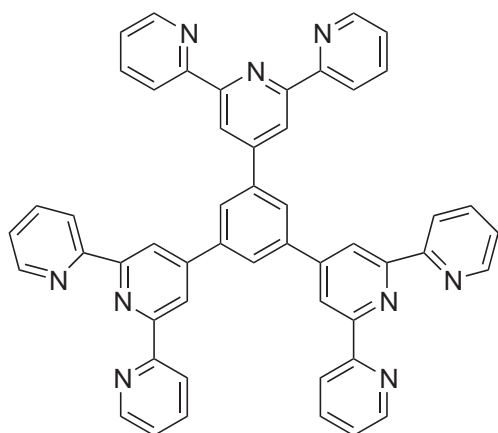
### 1.9.5.3 Phenanthroline-based Bridging Ligands

Tridentate bridging ligands containing phenanthroline subunits such as (**57**)–(**59**) have been used to bridge  $\text{Ru}^{\text{II}}$  metal centers.<sup>172</sup> Reaction of 2-cyanophenanthroline with hydrazine results in the dihydrotetrazine, which is oxidized and further reacted with acetylene under dinitrogen to yield (**57**) in 47% yield. Both ligands (**58**) and (**59**) were obtained by condensation of the appropriate diacetyldiazine precursor and 2 equivalents of 8-amino-7-quinolinecarbaldehyde. Reaction of this product with 4,6-diacetylpyrimidine yields (**58**) in 50% yield, while reaction with diacetylpyrazine yields (**59**) in 41% yield. All three ligands were characterized by  $^1\text{H}$  NMR.

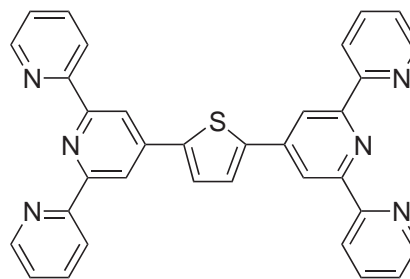
### 1.9.6 OTHER BRIDGING LIGANDS

A wide assortment of bridging ligands do not easily fit into the previous sections. A sampling of these ligands is presented here. This section will include mixed-denticity ligands, linked bridging

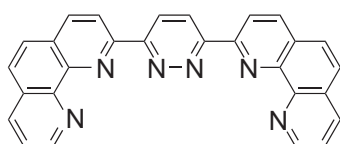




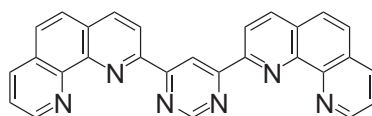
(55)



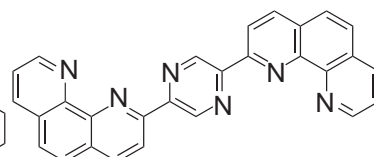
(56)



(57)



(58)



(59)

ligands, orthometallated bridges, knotted ligands, porphyrins which serve as bridging ligands, and cavity ligands often used to model protein active sites.

### 1.9.6.1 Mixed-denticity Ligands

Mixed-denticity ligands have become more important as the complexity of metal complexes using bridging ligands has expanded. The ligand 2,4,6-tris(2-pyridyl)-1,3,5-triazine (**60**) has been extensively used as an analytical reagent for various metals.<sup>173,174</sup> In monometallic complexes (**60**) acts primarily as a tridentate ligand similar to 2,2':6',2''-terpyridine.<sup>175–177</sup> Deactivation of the triazine ring along with steric interactions limits formation of bimetallic complexes of (**60**) but interesting examples exist. (**60**) has been used to form a homobimetallic Ru<sup>II</sup> complex with bis-bidentate chelation.<sup>178</sup>

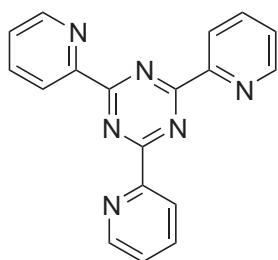
The mixed-denticity ligand (**60**) has also been used to simultaneously coordinate as a tridentate and bidentate ligand in dicobalt<sup>175</sup> and dimercury<sup>179</sup> complexes. The mixed-denticity ligand (**61**)<sup>180</sup> is one example of a series of such ligands being used to construct interesting supramolecular complexes.<sup>101</sup> Trinuclear Ru<sub>2</sub>Fe, Os<sub>2</sub>Fe, and Re<sub>2</sub>Fe complexes have been synthesized. The lowest energy absorption band in these complexes is attributed to an iron-to-ligand charge transfer transition. All of these complexes exhibit luminescence when excited in their MLCT absorption bands, indicative of inefficient energy transfer from the terminal Ru, Os, and Re light absorbers to the central Fe site.

### 1.9.6.2 Linked Bridging Ligands

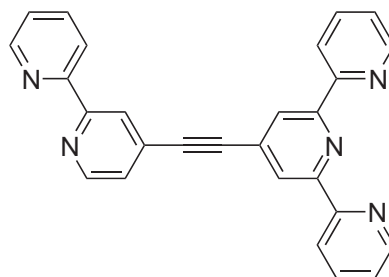
Bridging ligands capable of binding more than two metal centers are less studied. Some examples were highlighted earlier. Polymetallic ruthenium complexes have been synthesized using the tetra-bidentate ligands (**62**) and (**63**) as multi-electron transfer agents.<sup>181,182</sup>

Electrochemical studies of the tetranuclear ruthenium complex of ligand (**62**) indicate two reversible two-electron redox waves in the anodic region attributed to oxidation of the Ru<sup>II</sup> metal centers. This complex is said to act as two binuclear subunits with little or no electronic interaction between subunits. The first two-electron oxidation process results in a mixed valence complex with each subunit having a Ru<sup>II</sup> and Ru<sup>III</sup> metal center.

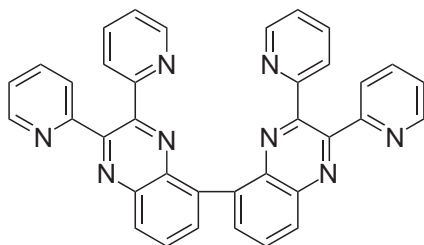




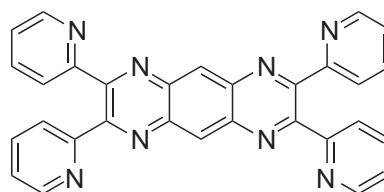
(60)



(61)



(62)



(63)

### 1.9.6.3 Orthometallated and Interlocked Bridging Ligands

A series of bridging ligands have been studied that use an orthometallating benzene ring in place of the central pyridyl ring of tpy and is bridged through the four position of the benzene, (64).<sup>183–186</sup> Homobimetallic Ru<sup>II</sup> and Os<sup>II</sup> and heterobimetallic Ru<sup>II</sup>/Os<sup>II</sup> complexes using ligand (64) were synthesized and characterized, where  $n = 0, 1, 2$ . Electrochemistry of the homobimetallic systems of (64) show that the metal oxidations are split, indicating a large degree of metal–metal communication. Efficient energy transfer is seen in the heterobimetallic Ru/Os systems.

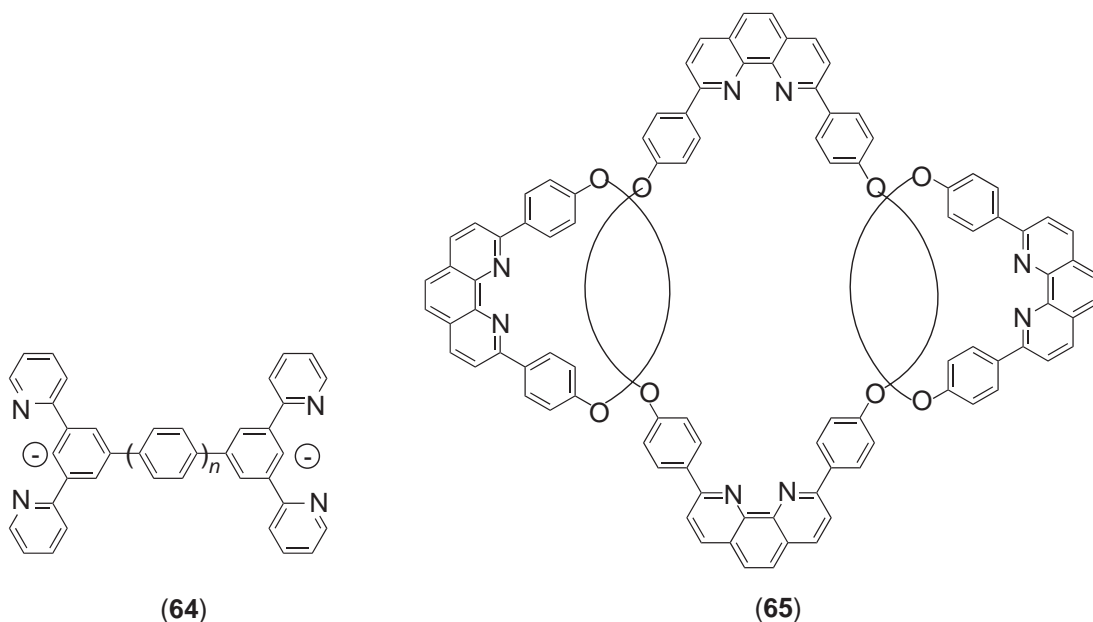
Interlocked macrocycles containing coordinating ligands—catenands—have been widely studied.<sup>187</sup> When these ligands are used to complex metal atoms the photophysical and photochemical properties are affected by the coordinating metal.<sup>188</sup> Ligand (65) contains four 2,9-diphenyl-1,10-phenanthroline chelating units, providing two tetrahedral coordinating sites.<sup>189</sup> This ligand has been used to make homobimetallic Cu<sup>I</sup> and Ag<sup>I</sup> and heterobimetallic Cu<sup>I</sup>/Ag<sup>I</sup>, Cu<sup>I</sup>/Zn<sup>II</sup>, and Cu<sup>I</sup>/Co<sup>II</sup> complexes.

The free ligand (65) exhibits intense  $\pi-\pi^*$  transitions in the UV region, which decrease in intensity upon metal coordination. In these complexes, two or more subunits can be identified each with its own excited-state properties. In the Cu/Zn and Cu/Ag complex the <sup>3</sup>LC state is quenched by the copper and by cobalt in the Cu/Co complex. Many related systems have been synthesized and their electrochemical and excited-state properties explored.<sup>190,191</sup>

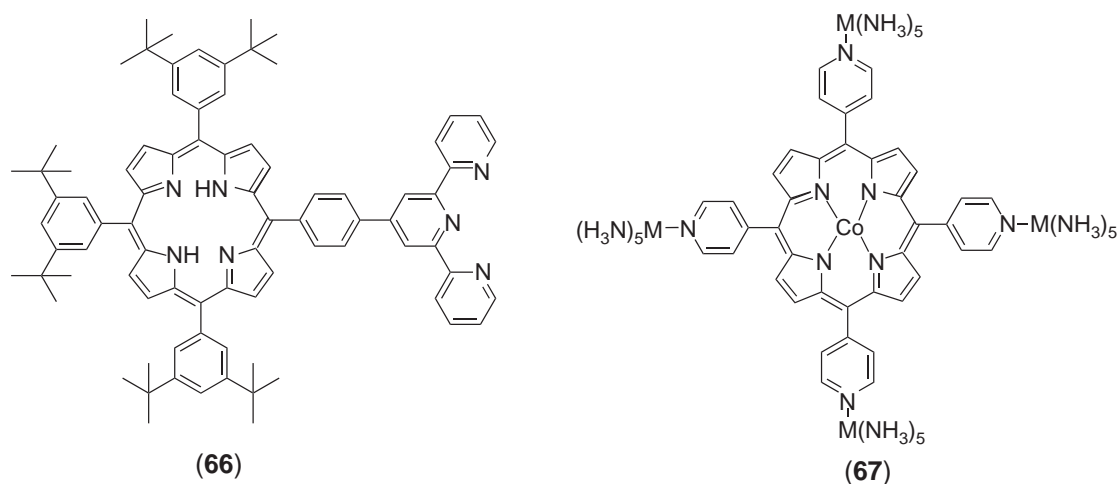
### 1.9.6.4 Porphyrin-containing Bridging Ligands

Many bridging ligands have been constructed that contain porphyrin subunits. Two examples are given to show the versatility of this structural motif. Porphyrins have been used for many years as models for the reactive site in the photosynthetic reaction center because of the resemblance to the natural components and the ability to vary the spectroscopic and redox properties of these chromophores by the use of bulky substituents and by their coordination to different transition metals.<sup>192</sup> Molecular dyads of Zn<sup>II</sup>/Ir<sup>III</sup> and Au<sup>III</sup>/Ir<sup>III</sup> and triads of Zn<sup>II</sup>/Ir<sup>III</sup>/Au<sup>III</sup> have been synthesized using the porphyrin bridging ligand (66).<sup>193–195</sup>

The dyads and triads of ligand (66) were used to study charge-separated species as models for the photosynthetic reaction center. It was observed that charge separation depends on the thermodynamic parameters as well as the solvent system. The Zn/Ir/Au triad was shown to yield a fully charge separated species in toluene when excited in the visible region with a lifetime of 450 ns.



Porphyrins have also been of interest in fuel cells as potential electrocatalysts for conversion of chemical energy into electricity. Complex (67), where  $M = \text{Ru}^{\text{II}}$  or  $\text{Os}^{\text{II}}$ , has been adsorbed onto graphite electrodes and used to catalyze the reduction of molecular oxygen to water in acidic media.<sup>196,197</sup> It is believed that the purpose of the peripheral  $\text{Ru}^{\text{II}}$  and  $\text{Os}^{\text{II}}$  moieties is to add electron density to the  $\text{Co}^{\text{II}}$  metal center through  $\pi$ -backbonding, strengthening the  $\text{Co}^{\text{II}}-\text{O}_2$  interaction and allowing for the required four-electron reduction from the electrode to give water.

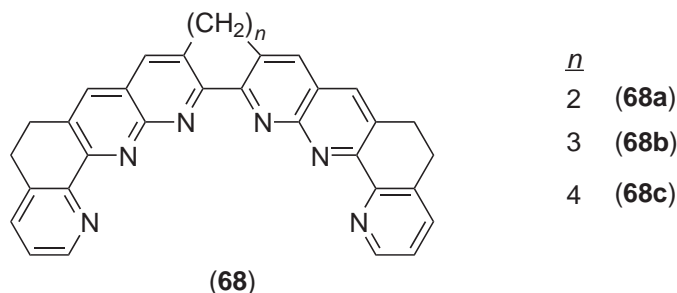


### 1.9.6.5 Cavity Bridging Ligands

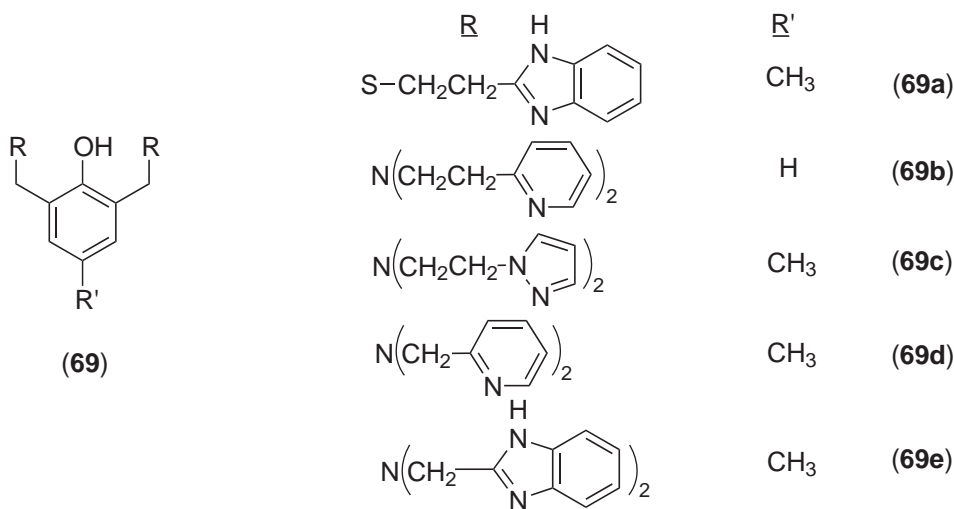
Interesting bridging ligands that bind two metals in close proximity using internal cavities have been studied extensively. A few brief examples are included to highlight their ability to serve as interesting cavity bridging ligands. The search to understand the structure/function relationship of the active site of various transition metal proteins has resulted in a vast database of very interesting ligands designed to model these active sites.<sup>198–202</sup> Many of these ligands bridge the transition metals in such a way as to bring them into close proximity, allowing them to activate small molecules, thereby mimicking the protein active site. This has given researchers the opportunity to probe the kinetics and reactivity of many large metalloenzymes. Spatial limitations prevent more than a brief look at a few such ligands. Two different types of bridging ligand will be discussed, ligands which directly bridge the two metal centers and ligands which function to

hold the metal centers in close proximity allowing them to form peroxy or oxo bridges when reacted with hydrogen peroxide or molecular oxygen.

Interesting polyaza cavity shaped bridging ligands have been prepared by the condensation of cyclic 1,2-diketones with 2-amino-5,6-dihydro-1,10-phenanthroline-3-carboxaldehyde.<sup>203</sup> Variation of the cyclic diketone ring size modulates the bridged metal's orientation by controlling the length of the central polymethylene bridge. The diruthenium complex of (**68c**) has been characterized by X-ray crystallography and shows a helical type shape to the bridging ligand made possible by the eight-membered ring linking the central pyridines, leading to a dihedral angle of 74° about the C—C bond.

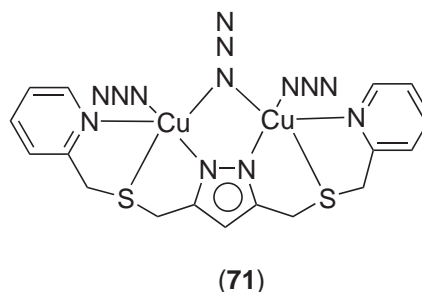
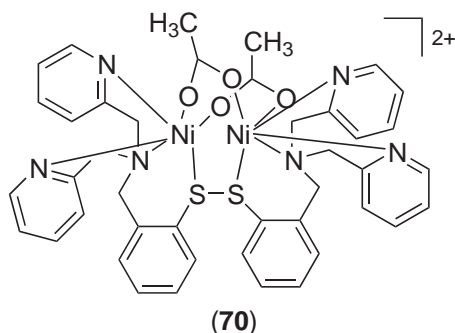


Phenoxy bridging ligands, (**69**), have been synthesized and used to form binuclear copper complexes as models for certain copper-containing enzymes (e.g., hemocyanin and tyrosinase).<sup>202,205</sup>

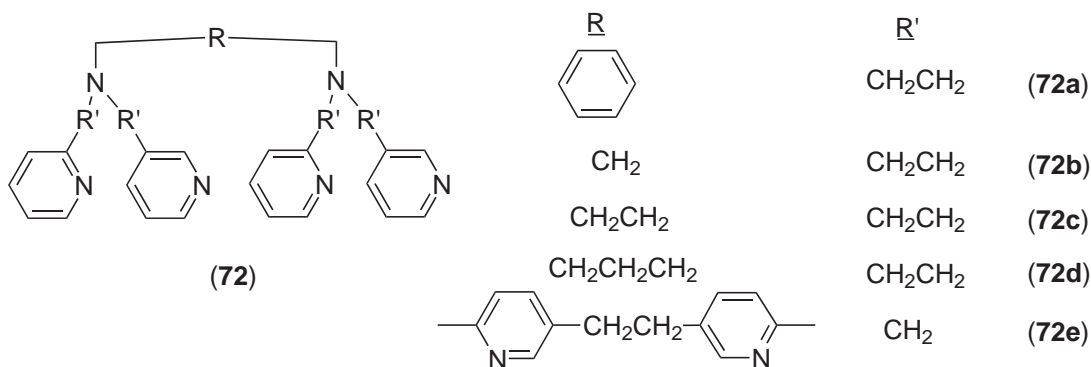


A series of bimetallic  $Cu^{II}$  complexes have been synthesized and studied using ligand (**69a**).<sup>204</sup> The X-ray structure of the  $\mu$ -1,1-azide bridged complex reveals that the copper centers are also bridged endogenously by the phenoxy oxygen and each copper center is in a square-pyramidal environment.<sup>202</sup> The base of the square pyramid consists of the phenoxy oxygen, a sulfur, a nitrogen from the benzimidazol group, and the azide nitrogen. The copper centers are antiferromagnetically coupled. Similar coordination environments are observed for bimetallic  $Cu^{II}$  complexes of (**69b**)<sup>205</sup> and (**69e**),<sup>206</sup> while (**69c**)<sup>207</sup> has one Cu center in a square-pyramidal geometry and the other Cu center in a distorted trigonal bipyramidal geometry. The dicopper complex of (**69d**) has both Cu centers in a trigonal bipyramidal geometry with a Cu—Cu distance of 2.989 Å.<sup>208</sup>

Bimetallic  $Ni^{II}$ <sup>209</sup> and  $Cu^{II}$ <sup>210</sup> complexes, (**70**) and (**71**) respectively, have been reported. Both  $Ni^{II}$  centers of complex (**70**) are in an octahedral geometry with a Ni—Ni distance of 4.243 Å. The Cu—Cu distance in complex (**71**) is 3.486 Å and both copper atoms are in a distorted square pyramid with the pyridyl group in the axial position. This complex exhibits high-energy ligand-based transitions in the electronic absorption spectrum and low-energy LMCT transitions in the visible region of the spectrum, with the lowest energy transition assigned to a  $N_3^-$  to Cu charge transfer.<sup>210</sup>



Dioxygen activation by transition metal complexes has led to the study of additional bridging ligands.<sup>211</sup> Mononuclear complexes, which form dimeric bridged complexes when reacted with hydrogen peroxide at low temperatures, represent a large portion of this literature.<sup>201</sup> Bridging ligands have been designed that are capable of coordinating to two metal centers to form oxo- or peroxy-bridged complexes when reacted with hydrogen peroxide or molecular oxygen. Ligand (72) is a hexadentate ligand which coordinates to two metal centers through the pyridyl and amine nitrogens.



Reactions of the bimetallic Cu<sup>I</sup> complex of (72a) with molecular oxygen results in a ( $\mu$ - $\eta^2$ : $\eta^2$ -peroxy)(Cu<sup>II</sup>)<sub>2</sub> complex which hydroxylates the aromatic ligand in quantitative yields.<sup>212,213</sup> It has been shown that dinickel(II) complexes of ligands (72a-d) form  $\mu$ -oxo bridged dinickel(III) complexes when reacted with hydrogen peroxide, which then undergo aliphatic ligand hydroxylation but not aromatic hydroxylation in contrast to their dicopper analog.<sup>214</sup> The dicopper(II) complex of ligand (72e) has been used for specific strand scission of DNA in the presence of a reductant and molecular oxygen, indicating that the intermediate responsible for DNA cleavage is produced by the activation of molecular oxygen by a copper(I) form of the dinuclear complex.<sup>215</sup>

## 1.9.7 REFERENCES

1. Steele, P. J. *Coord. Chem. Rev.* **1990**, *106*, 227–265.
2. Kalyanasundaram, K.; Nazeeruddin, K. *Inorg. Chim. Acta* **1994**, *226*, 213–230.
3. Balzani, V.; Juris, A.; Venturi, M.; Campagna, S.; Serroni, S. *Chem. Rev.* **1996**, *96*, 759–833.
4. McCleverty, J. A.; Ward, M. D. *Acc. Chem. Res.* **1998**, *31*, 842–851.
5. Collin, J.-P.; Gavina, P.; Heitz, V.; Sauvage, J.-P. *Eur. J. Inorg. Chem.* **1998**, 1–14.
6. Keene, F. R. *Coord. Chem. Rev.* **1997**, *166*, 121–159.
7. Cola, L. D.; Belser, P. *Coord. Chem. Rev.* **1998**, *177*, 301–346.
8. Sauvage, J.-P.; Collin, J.-P.; Chambron, J.-C.; Guillerez, S.; Coudret, C.; Balzani, V.; Barigelletti, F.; Cola, L. D.; Flamigni, L. *Chem. Rev.* **1994**, 993–1019.
9. Balzani, V.; Ceroni, P.; Juris, A.; Venturi, M.; Campagna, S.; Puntoriero, F.; Seroni, S. *Coord. Chem. Rev.* **2001**, *219–221*, 545–572.
10. Balzani, V.; Juris, A. *Coord. Chem. Rev.* **2001**, *211*, 97–115.
11. Cruetz, C.; Taube, H. *J. Am. Chem. Soc.* **1969**, *91*, 3988–3989.
12. Cabeza, J. A.; Fernandez-Colinas, J. M. *Coord. Chem. Rev.* **1993**, *126*, 319–336.

13. Kaes, C.; Katz, A.; Hosseini, M. W. *Chem. Rev.* **2000**, *100*, 3553–3590.
14. Scandola, F.; Bignozzi, C. A.; Chiorboli, C.; Indelli, M. T.; Rampi, M. A. *Coord. Chem. Rev.* **1990**, *97*, 299–312.
15. Rehder, D. *J. Organomet. Chem.* **1972**, *37*, 303–312.
16. Curtis, M. D.; Han, K. R.; Butler, W. M. *Inorg. Chem.* **1980**, *19*, 2096–2101.
17. Matsui, K.; Nazeeruddin, M. K.; Humphrey-Baker, R.; Graetzel, M.; Kalyanasundaram, K. *J. Phys. Chem.* **1992**, *96*, 10587–10590.
18. Endicott, J. F.; McNamara, P. G.; Buranda, T.; Macatangay, A. V. *Coord. Chem. Rev.* **2000**, *208*, 61–75.
19. Endicott, J. F.; Watzky, M. A.; Song, X.; Buranda, T. *Coord. Chem. Rev.* **1997**, *159*, 295–323.
20. Chang, C. C.; Pfenning, B.; Bocarsly, A. B. *Coord. Chem. Rev.* **2000**, *208*, 33–45.
21. Richardson, D. E.; Taube, H. *J. Am. Chem. Soc.* **1983**, *105*, 40–51.
22. Kaim, W. *Angew. Chem.* **1983**, *95*, 201–221.
23. Siedle, A. R.; Filipovich, G.; Toren, P. E.; Palensky, F. J.; Newmark, A. R.; Duerst, R. W.; Stebbings, W. L.; Mishmash, H. E.; Melancon, K.; Bohling, D. A. *Inorg. Chem.* **1985**, *24*, 2216–2223.
24. Appel, M.; Sacher, W.; Beck, W. *J. Organomet. Chem.* **1987**, *333*, 237–244.
25. Toerien, J. G.; Van Rooyan, P. H. *J. Chem. Soc., Dalton Trans.* **1991**, 2693–2702.
26. Steed, J. W.; Tocher, D. A. *Polyhedron* **1992**, *11*, 2729–2737.
27. Barrado, G.; Miguel, D.; Riera, V.; Garcia-Granda, S. *J. Organomet. Chem.* **1995**, *489*, 129–135.
28. Johnston, C. R.; Shepherd, R. E. *Inorg. Chem.* **1983**, *22*, 2439–2444.
29. Kaufmann, W.; Venanzi, L. M.; Albinati, A. *Inorg. Chem.* **1988**, *27*, 1178–1187.
30. Cotton, F. A.; Hanson, B. E.; Jamerson, J. D. *J. Am. Chem. Soc.* **1977**, *99*, 6588–6594.
31. Foulds, G. A.; Johnson, B. F. G.; Lewis, J. *J. Organomet. Chem.* **1985**, *294*, 123–129.
32. Oro, L. A.; Carmona, D.; Lahoz, F.; Puebla, P. M.; Esteban, M.; Foces-Foces, C.; Cano, F. H. *J. Chem. Soc., Dalton Trans.* **1986**, 2113–2117.
33. Keppler, U.; Deger, S.; Lange, A.; Hanack, M. *Angew. Chem., Int. Ed. Engl.* **1987**, *26*, 344–345.
34. Chesnut, D. J.; Plewak, D.; Zubieta, J. *J. Chem. Soc., Dalton Trans.* **2001**, 2567–2580.
35. Graham, P. M.; Pike, R. D.; Sabat, M.; Bailey, R. D.; Pennington, W. T. *Inorg. Chem.* **2000**, *39*, 5121–5132.
36. Megumu, M.; Susumu, K.; Naohiko, U.; Masaki, N.; Masahiko, M.; Hajime, M. *Inorg. Chem.* **1993**, *32*, 826–832.
37. Lee, G.-H.; Ciana, L. D.; Haim, A. *J. Am. Chem. Soc.* **1989**, *111*, 2535–2541.
38. Vanderesse, R.; Lourak, M.; Fort, Y.; Caubere, P. *Tet. Letters* **1986**, *27*, 5483–5486.
39. Foster, D. F.; Rushworth, S. A.; Cole-Hamilton, D. J.; Cafferty, R.; Harrison, J.; Parkes, P. *J. Chem. Soc., Dalton Trans.* **1988**, 7–11.
40. Rieder, K.; Taube, H. *J. Am. Chem. Soc.* **1977**, *99*, 7891–7894.
41. Julve, M.; Verdaguer, M.; Fans, J.; Tinti, F.; Moratal, J.; Monge, A.; Gutierrez-Puebla, E. *Inorg. Chem.* **1987**, *26*, 3520–3527.
42. Oh, D. H.; Sano, M.; Boxer, S. G. *J. Am. Chem. Soc.* **1991**, *113*, 6880–6890.
43. Cargill Thompson, A. M. W.; Gatteschi, D.; McCleverty, J. A.; Navas, J. A.; Reutschler, E.; Ward, M. D. *Inorg. Chem.* **1996**, *35*, 2701–2703.
44. Ito, T.; Kobayashi, K.; Saegusa, T. *J. Organomet. Chem.* **1986**, *303*, 301–308.
45. Curtis, J. C.; Bernstein, J. S.; Meyer, T. J. *Inorg. Chem.* **1985**, *24*, 385–397.
46. Zulu, M. M.; Lees, A. J. *Inorg. Chem.* **1988**, *27*, 3325–3331.
47. Tapolsky, G.; Duesing, R.; Meyer, T. J. *Inorg. Chem.* **1990**, *29*, 2285–2297.
48. Schanze, K. S.; Meyer, T. J. *Inorg. Chem.* **1985**, *24*, 2121–2123.
49. Lin, R.; Guarr, T. F. *Inorg. Chim. Acta* **1994**, *226*, 79–90.
50. Yam, V. W.-W.; Lau, V. C.-Y.; Cheung, K.-K. *J. Am. Chem. Soc. Chem. Commun.* **1995**, 259–261.
51. Hock, J.; Cargill Thompson, A. M. W.; McCleverty, J. A.; Navas, J. A.; Ward, M. D. *J. Chem. Soc., Dalton Trans.* **1996**, 4257–4263.
52. de Sousa Moreira, I.; de Lima, J. B.; Franco, D. W. *Coord. Chem. Rev.* **2000**, *196*, 197–217.
53. Bayly, S. R.; Humphrey, E. R.; de Chair, H.; Paredes, C. G.; Bell, Z. R.; Jeffery, J. C.; McCleverty, J. C.; Ward, M. D.; Totti, F.; Gatteschi, D.; Courric, S.; Steele, B. R.; Screttas, C. G. *J. Chem. Soc., Dalton Trans.* **2001**, *9*, 1401–1414.
54. Auburn, P. R.; Lever, A. B. P. *Inorg. Chem.* **1990**, *29*, 2551–2553.
55. Hartl, F.; Snoeck, T. L.; Stufkens, D. J.; Lever, A. B. P. *Inorg. Chem.* **1995**, *34*, 3887–3894.
56. Ward, M. D. *Inorg. Chem.* **1996**, *35*, 1712–1714.
57. Dei, A.; Gatteschi, D.; Pardi, L. *Inorg. Chim. Acta* **1991**, *189*, 125–128.
58. Metcalfe, R. A.; Vasconcellos, L. C. G.; Mirza, H.; Franco, D. W.; Lever, A. B. P. *J. Chem. Soc., Dalton Trans.* **1999**, 2653–2667.
59. Joulie, L. F.; Schatz, E.; Ward, M. D.; Weber, F.; Yellowlees, L. J. *J. Chem. Soc. Dalton Trans.* **1994**, 799–804.
60. Masui, H.; Freda, A. L.; Zerner, M. C.; Lever, A. B. P. *Inorg. Chem.* **2000**, *39*, 141–152.
61. Braunstein, C. H.; Baker, A. D.; Streckas, T. C.; Gafney, H. D. *Inorg. Chem.* **1984**, *23*, 857–864.
62. Hunziker, M.; Ludi, A. *J. Am. Chem. Soc.* **1977**, *99*, 7370–7371.
63. Goodwin, H. A.; Lions, F. *J. Am. Chem. Soc.* **1959**, *81*, 6415–6422.
64. Yam, V. W.-W.; Lo, K. K.-W. *J. Chem. Soc., Dalton Trans.* **1995**, 499–500.
65. Wallace, A. W.; Murphy, W. R.; Petersen, J. D. *Inorg. Chim. Acta* **1989**, *166*, 47–54.
66. Kalyanasundaram, K.; Nazeeruddin, M. K. *Inorg. Chem.* **1990**, *29*, 1888–1897.
67. Kalyanasundaram, K. *J. Indian Chem. Soc.* **1993**, *70*, 433–453.
68. Richter, M. M.; Brewer, K. J. *Inorg. Chem.* **1993**, *32*, 2827–2834.
69. Petersen, J. D. In *Supramolecular Photochemistry*; Balzani, V. Ed.; Reidel: Dordrecht, The Netherlands, 1987; p 135.
70. Kalyanasundaram, K.; Graetzel, M.; Nazeeruddin, M. K. *J. Phys. Chem.* **1992**, *96*, 5865–5872.
71. Yam, V. W.-W.; Lee, V. W.-M.; Cheung, K.-K. *J. Chem. Soc. Chem. Commun.* **1994**, 2075–2076.
72. Kalyanasundaram, K.; Nazeeruddin, M. K. *Chem. Phys. Lett.* **1989**, *158*, 45–50.
73. Swavey, S.; Fang, Z.; Brewer, K. J. *Inorg. Chem.* **2002**, *41*, 2598–2607.
74. Denti, G.; Serroni, S.; Campagna, S.; Juris, A.; Balzani, V. *Mol. Cryst. Sci. Technol. Sect. A* **1993**, *234*, 79–88.
75. Serroni, S.; Campagna, S.; Puntoriero, F.; Pietro, C. D.; McClenaghan, N. D.; Loiseau, F. *Chem. Soc. Rev.* **2001**, *30*, 367–375.

76. Sletten, J.; Bjorsvik, O. *Acta Chem. Scand.* **1998**, *52*, 770–777.
77. Dose, E. V.; Wilson, L. J. *Inorg. Chem.* **1978**, *17*, 2660–2666.
78. MacQueen, D. B.; Petersen, J. D. *Inorg. Chem.* **1990**, *29*, 2313–2320.
79. Sahai, R.; Rillema, D. P.; Shaver, R.; Van Wallendael, S.; Jackman, D.; Boldaji, M. *Inorg. Chem.* **1989**, *28*, 1022–1028.
80. Bridgewater, J. S.; Vogler, L. M.; Molnar, S. M.; Brewer, K. J. *Inorg. Chim. Acta* **1993**, *208*, 179–188.
81. DeMunno, G.; Julve, M.; Lloret, F.; Faus, J.; Caneschi, A. *J. Chem. Soc., Dalton Trans.* **1994**, 1175–1183.
82. Gordon, K. C.; Al-Obaidi, A. H. R.; Jayaweera, P. M.; McGarvey, J. J.; Malone, J. F.; Bell, S. E. *J. Chem. Soc., Dalton Trans.* **1996**, 1591–1596.
83. Rillema, D. P.; Mack, K. B. *Inorg. Chem.* **1982**, *21*, 3849–3854.
84. Treadway, J. A.; Strouse, G. F.; Ruminski, R. R.; Meyer, T. J. *Inorg. Chem.* **2001**, *40*, 4508–4509.
85. Richter, M. M.; Brewer, K. J. *Inorg. Chem.* **1992**, *31*, 1594–1598.
86. Molnar, S. M.; Jensen, G. E.; Vogler, L. M.; Jones, S. W.; Laverman, L.; Bridgewater, J. S.; Richter, M. M.; Brewer, K. J. *J. Photochem. Photobiol., A* **1994**, *80*, 315–322.
87. Molnar, S. M.; Nallas, G.; Bridgewater, J. S.; Brewer, K. J. *J. Am. Chem. Soc.* **1994**, *116*, 5206–5210.
88. Milkevitch, M.; Brauns, E.; Brewer, K. J. *Inorg. Chem.* **1996**, *35*, 1737–1739.
89. Ernst, S. D.; Kaim, W. *Inorg. Chem.* **1989**, *28*, 1520–1528.
90. Juris, A.; Balzani, V.; Campagna, S.; Denti, G.; Serroni, S.; Frei, G.; Gudel, H. U. *Inorg. Chem.* **1994**, *33*, 1491–1496.
91. Denti, G.; Serroni, S.; Sabatino, L.; Ciano, M.; Ricevuto, V.; Campagna, S. *Gazz. Chim. Ital.* **1991**, *121*, 37–43.
92. Jaradat, Q.; Barqaw, K.; Akasheh, T. S. *Inorg. Chim. Acta* **1986**, *116*, 63–73.
93. Neels, A.; Neels, B. M.; Stoeckli-Evans, H.; Clearfield, A.; Poojary, D. M. *Inorg. Chem.* **1997**, *36*, 3402–3409.
94. Fanni, S.; Keyes, T. E.; O'Connor, C. M.; Hughes, H.; Wang, R.; Vos, J. G. *Coord. Chem. Rev.* **2000**, *208*, 77–86.
95. Haga, M.; Matsumura-Inoue, T.; Yamabe, S. *Inorg. Chem.* **1987**, *26*, 4148–4154.
96. Rillema, D. P.; Sahai, R.; Matthews, P.; Edwards, A. K.; Shaver, R. J.; Morgan, L. *Inorg. Chem.* **1990**, *29*, 167–175.
97. Ohno, T.; Nozaki, K.; Haga, M. *Inorg. Chem.* **1992**, *31*, 548–555.
98. Shaw, J. R.; Schmehl, R. H. *J. Am. Chem. Soc.* **1991**, *113*, 389–394.
99. Encinas, S.; Barthram, A. M.; Ward, M. D.; Barigelletti, F.; Campagna, S. *Chem. Commun.* **2001**, 277–278.
100. Baba, A. I.; Ensley, H. E.; Schmehl, R. H. *Inorg. Chem.* **1995**, *34*, 1198–1207.
101. Harriman, A.; Ziessel, R. *Chem. Commun.* **1996**, 1707–1716.
102. Guerzo, A. D.; Leroy, S.; Fages, F.; Schmehl, R. H. *Inorg. Chem.* **2002**, *41*, 359–366.
103. El-ghayoury, A.; Harriman, A.; Khatyr, A.; Ziessel, R. *J. Phys. Chem. A* **2000**, *104*, 1512–1523.
104. Schlicke, B.; Belsler, P.; De Cola, L.; Sabbioni, E.; Balzani, V. *J. Am. Chem. Soc.* **1999**, *121*, 4207–4214.
105. Schmehl, R. H.; Auerbach, R. A.; Wacholtz, W. F.; Elliott, C. M.; Freitag, R. A.; Merkert, J. W. *Inorg. Chem.* **1986**, *25*, 2440–2445.
106. Van Wallendael, S.; Perkovic, M. W.; Rillema, D. P. *Inorg. Chim. Acta* **1993**, *213*, 253–260.
107. Larson, S. L.; Hendrickson, S. M.; Ferrere, S.; Derr, D. L.; Elliott, C. M. *J. Am. Chem. Soc.* **1995**, *117*, 5881–5882.
108. Song, X.; Lei, Y.; Van Wallendael, S.; Perkovic, M. W.; Jackman, D. C.; Endicott, J. F.; Rillema, D. P. *J. Phys. Chem.* **1993**, *97*, 3225–3236.
109. Furue, M.; Yoshidzumi, T.; Kinoshita, S.; Kushida, T.; Nozakura, S.; Kamachi, M. *Bull. Chem. Soc. Jpn.* **1991**, *64*, 1632–1640.
110. Sahai, R.; Baucom, D. A.; Rillema, P. D. *Inorg. Chem.* **1986**, *25*, 3843–3845.
111. Van Wallendael, S.; Shaver, R. J.; Rillema, R. D. *Inorg. Chem.* **1990**, *29*, 1761–1767.
112. Indelli, M. T.; Bignozzi, C.; Harriman, A.; Schoonover, J. R.; Scandola, F. *J. Am. Chem. Soc.* **1994**, *116*, 3768–3779.
113. Schmehl, R. H.; Auerbach, R. A.; Wacholtz, W. F. *J. Phys. Chem.* **1988**, *92*, 6202–6206.
114. Wacholtz, W. F.; Auerbach, R. A.; Schmehl, R. H. *Inorg. Chem.* **1987**, *26*, 2989–2994.
115. Furue, M.; Kuroda, N.; Sano, S. *J. Macromol. Sci. Chem.* **1988**, *A25*, 1263–1274.
116. Furue, M.; Hirata, M.; Kinoshita, S.; Kushida, T.; Kamachi, M. *Chem. Lett.* **1990**, 2065–2068.
117. Furue, M.; Naiki, M.; Kanematsu, Y.; Kushida, T.; Kamachi, M. *Coord. Chem. Rev.* **1991**, *111*, 221–226.
118. Sasaki, I.; Imberdis, M.; Gaudemer, A.; Drahi, B.; Azhari, D.; Amouval, E. *New J. Chem.* **1994**, *18*, 759–764.
119. Ruminski, R. R.; Lehmpuhl, D. *Inorg. Chim. Acta* **1993**, *204*, 45–51.
120. Ruminski, R. R.; Freiheit, D.; Serveiss, D.; Snyder, B.; Johnson, J. E. B. *Inorg. Chim. Acta* **1994**, *224*, 27–34.
121. Ruminski, R. R.; Serveiss, D.; Jaquez, M. *Inorg. Chem.* **1995**, *34*, 3358–3362.
122. Ruminski, R. R.; DeGross, C.; Smith, S. J. *Inorg. Chem.* **1992**, *31*, 3325–3328.
123. MacDonnell, F. M.; Bodige, S. *Inorg. Chem.* **1996**, *35*, 5758–5759.
124. Kim, M. J.; MacDonnell, F. M.; Gimon-Kinsel, M. E.; DuBois, T.; Asgharian, N.; Griener, J. C. *Angew. Chem. Int. Ed.* **2000**, *39*, 615–619.
125. Campagna, S.; Serroni, S.; Bodige, S.; MacDonnell, F. M. *Inorg. Chem.* **1999**, *38*, 692–701.
126. Ishow, E.; Gourdon, A.; Launay, J.-P.; Chiorboli, C.; Scandola, F. *Inorg. Chem.* **1999**, *38*, 1504–1510.
127. Bolger, J.; Gourdon, A.; Ishow, E.; Launay, J.-P. *Inorg. Chem.* **1996**, *35*, 2937–2944.
128. Chiorboli, C.; Bignozzi, C. A.; Scandola, F.; Ishow, E.; Gourdon, A.; Launay, J.-P. *Inorg. Chem.* **1999**, *38*, 2402–2410.
129. Bolger, J.; Gourdon, A.; Ishow, E.; Launay, J.-P. *J. Chem. Soc. Chem. Commun.* **1995**, 1799–1800.
130. Warnmark, K.; Thomas, J. A.; Heyke, O.; Lehn, J.-M. *Chem. Commun.* **1996**, 2603–2604.
131. Hiort, C.; Lincoln, P.; Norden, B. *J. Am. Chem. Soc.* **1993**, *115*, 3448–3454.
132. Hartshorn, R. M.; Barton, J. K. *J. Am. Chem. Soc.* **1992**, *114*, 5919–5925.
133. Crossley, M. J.; Burn, P. L.; Langford, S. J.; Prashar, J. K. *J. Chem. Soc., Chem. Commun.* **1995**, 1921–1923.
134. Kim, M.-J.; Rama, K.; Hongwei, Y.; MacDonnell, F. M.; Puntoriero, F.; Serroni, S.; Campagna, S.; Holder, T.; Kinsel, G.; Rajeshwar, K. *Inorg. Chem.* **2002**, *41*, 2471–2476.
135. Fox, G. A.; Bhattacharya, S.; Pierpont, C. G. *Inorg. Chem.* **1991**, *30*, 2895–2899.
136. Hill, P. L.; Lee, L. Y.; Younkin, T. R.; Orth, S. D.; McElwee-White, L. *Inorg. Chem.* **1997**, *36*, 5655–5657.
137. Paw, L.; Eisenberg, R. *Inorg. Chem.* **1997**, *36*, 2287–2293.
138. Nasielski-Hinkens, R.; Benedek-Vamos, M.; Maetens, D.; Nasielski, J. *J. Organometal. Chem.* **1981**, *217*, 179–182.

139. Nasielski, J.; Verhoeven, C.; Nasielski-Hinkens, R.; Praefcke, K.; Kohne, B.; Kohlshreiber, Th.; Korinth, F. *Chimia* **1987**, *43*, 343–348.
140. Kirsch-De Mesmaeker, A.; Jacquet, L.; Masschelein, A.; Vanhecke, F.; Heremans, K. *Inorg. Chem.* **1989**, *28*, 2465–2470.
141. Didier, P.; Jacquet, L.; Kirsch-De Mesmaeker, A.; Hueber, R.; Van Dorselaer, A. *Inorg. Chem.* **1992**, *31*, 4803–4809.
142. Masschelein, A.; Jacquet, L.; Kirsch-De Mesmaeker, A.; Nasielski, J. *Inorg. Chem.* **1990**, *29*, 855–860.
143. Fuchs, Y.; Lofters, S.; Dieter, T.; Shi, W.; Morgan, R.; Streckas, T. C.; Gafney, H. D.; Baker, A. D. *J. Am. Chem. Soc.* **1987**, *109*, 2691–2697.
144. Yoblinski, B. J.; Stathis, M.; Guarr, T. F. *Inorg. Chem.* **1992**, *31*, 5–10.
145. Catalano, V. J.; Larson, W. E.; Olmstead, M. M.; Gray, H. B. *Inorg. Chem.* **1994**, *33*, 4502–4509.
146. Okubo, T.; Kitagawa, S.; Kondo, M.; Matsuzaka, H.; Ishii, T. *Angew. Chem. Int. Ed.* **1999**, *38*, 931–933.
147. Tzalis, D.; Tor, Y. *J. Am. Chem. Soc.* **1997**, *119*, 852–853.
148. Youinou, M. T.; Ziessel, R.; Lehn, J. M. *Inorg. Chem.* **1991**, *30*, 2144–2148.
149. Yao, Y.; Perkovic, M. W.; Rillema, P. D.; Woods, C. *Inorg. Chem.* **1992**, *31*, 3956–3962.
150. Kirchoff, J. R.; McMillin, D. R.; Marnot, P. A.; Sauvage, J.-P. *J. Am. Chem. Soc.* **1985**, *107*, 1138–1141.
151. Brewer, K. J. *Comments Inorg. Chem.* **1999**, *21*, 201–224.
152. Jones, S. W.; Jordan, M. R.; Brewer, K. J. *Molecular and Supramolecular Photochemistry*, Ed.; Marcel Dekker, 1999, pp 151–183.
153. Thummel, R. P.; Chirayil, S. *Inorg. Chim. Acta* **1988**, *154*, 77–81.
154. Escuer, A.; Comas, T.; Ribas, J.; Vicente, R.; Solans, X.; Zanchini, C.; Gatteschi, D. *Inorg. Chim. Acta* **1989**, *162*, 97–103.
155. Ruminski, R. R.; Letner, C. *Inorg. Chim. Acta* **1989**, *162*, 175–177.
156. Vogler, L. M.; Scott, B.; Brewer, K. J. *Inorg. Chem.* **1993**, *32*, 898–903.
157. Lee, J.-D.; Vrana, L. M.; Bullock, E. R.; Brewer, K. J. *Inorg. Chem.* **1998**, *37*, 3575–3580.
158. Graf, M.; Stoeckli-Evans, H.; Escuer, A.; Vicente, R. *Inorg. Chim. Acta* **1997**, *257*, 89–97.
159. Arana, C. R.; Abruna, H. D. *Inorg. Chem.* **1993**, *32*, 194–203.
160. Pfeiffer, F. R.; Case, F. H. *J. Org. Chem.* **1966**, *31*, 3384–3390.
161. Case, F. H. *J. Heterocycl. Chem.* **1967**, *4*, 157–159.
162. Bonhote, P.; Lecas, A.; Amouyal, E. *Chem. Commun.* **1998**, 885–886.
163. Gourdon, A.; Launay, J.-P. *Inorg. Chem.* **1998**, *37*, 5336–5341.
164. Lerner, D. A.; Sbai, M.; Tarrago, G.; Marzin, C. *Proc. SPIE-int. Soc. Opt. Eng.* **1993**, 1885, 317–322.
165. Indelli, M. T.; Scandola, F.; Collin, J.-P.; Sauvage, J.-P.; Sour, A. *Inorg. Chem.* **1996**, *35*, 303–312.
166. Barigelletti, F.; Flamigni, L.; Balzani, V.; Collin, J.-P.; Sauvage, J.-P.; Sour, A.; Constable, E. C.; Cargill Thompson, A. M. W. *J. Am. Chem. Soc.* **1994**, *116*, 7692–7699.
167. Grosshenny, V.; Harriman, A.; Ziessel, R. *Angew. Chem. Int. Ed., Engl.* **1995**, *34*, 1100–1102.
168. Harriman, A.; Khatyr, A.; Ziessel, R.; Benniston, A. C. *Angew. Chem. Int. Ed.* **2000**, *39*, 4287–4290.
169. Hasenkopf, B.; Hall, J.; Lehn, J.-M.; Balzani, V.; Credi, A.; Campagna, S. *New J. Chem.* **1996**, *20*, 725–730.
170. Constable, E. C.; Cargill Thompson, A. M. W.; Tocher, D. A. *Supramolecular Chemistry*, Kluwer Academic: The Netherlands, 1992, pp 219–233.
171. Encinas, S.; Flamigni, L.; Barigelletti, F.; Constable, E. C.; Housecroft, C. E.; Schofield, E. R.; Figgemeier, E.; Fenske, D.; Neuburger, M.; Vos, J. G.; Zehnder, M. *J. Eur. Chem.* **2002**, *8*, 137–150.
172. Brown, D.; Muranjan, S.; Jang, Y.; Thummel, R. *Org. Lett.* **2002**, *4*, 1253–1256.
173. Embry, W. A.; Ayres, G. H. *Anal. Chem.* **1968**, *40*, 1499–1501.
174. Janmohamed, M. J.; Ayres, G. H. *Anal. Chem.* **1972**, *44*, 2263–2268.
175. Vagg, R. S.; Warren, R. N.; Watton, E. C. *Aust. J. Chem.* **1969**, *22*, 141–152.
176. Pagenkopf, G. K.; Margerum, D. W. *Inorg. Chem.* **1968**, *7*, 2514–2519.
177. Collins, P.; Diehl, H.; Smith, G. F. *Anal. Chem.* **1959**, *31*, 1862–1867.
178. Thomas, N. C.; Foley, B. L.; Rheingold, A. L. *Inorg. Chem.* **1988**, *27*, 3426–3429.
179. Halfpenny, J.; Small, R. W. H. *Acta Crystallogr., Sect. B: Struct. Crystallogr. Cryst. Chem.* **1982**, *B38*, 939–942.
180. Hissler, M.; Ziessel, R. *New J. Chem.* **1995**, *19*, 751–759.
181. Rillema, D. P.; Mack, K. B. *Inorg. Chem.* **1982**, *21*, 3849–3854.
182. Rillema, D. P.; Callahan, R. W.; Mack, K. B. *Inorg. Chem.* **1982**, *21*, 2589–2596.
183. Chodorowski-Kimmes, S.; Beley, M.; Collin, J.-P.; Sauvage, J.-P. *Tetrahedron Lett.* **1996**, *37*, 2963–2966.
184. Beley, M.; Chodorowski, S.; Collin, J.-P.; Sauvage, J.-P.; Flamigni, L.; Barigelletti, F. *Inorg. Chem.* **1994**, *33*, 2543–2547.
185. Beley, M.; Collin, J.-P.; Sauvage, J.-P. *Inorg. Chem.* **1993**, *32*, 4539–4543.
186. Barigelletti, F.; Flamigni, L.; Guardigli, M.; Juris, A.; Beley, M.; Chodorowski-Kimmes, S.; Collin, J.-P.; Sauvage, J.-P. *Inorg. Chem.* **1996**, *35*, 136–142.
187. Dietrich-Buchecker, C. O.; Sauvage, J.-P. *Chem. Rev.* **1987**, *87*, 795–810.
188. Amaroli, N.; De Cola, L.; Balzani, V.; Sauvage, J.-P.; Dietrich-Buchecker, C. O.; Kern, J.-M.; Bailal, A. *J. Chem. Soc., Dalton Trans.* **1993**, 3241–3247.
189. Amaroli, N.; Balzani, V.; Barigelletti, F.; De Cola, L.; Flamigni, L.; Sauvage, J.-P.; Hemmert, C. *J. Am. Chem. Soc.* **1994**, *116*, 5211–5217.
190. Dietrich-Buchecker, C. O.; Nierengarten, J.-F.; Sauvage, J.-P.; Amaroli, N.; Balzani, V.; De Cola, L. *J. Am. Chem. Soc.* **1993**, *115*, 11237–11244.
191. Dietrich-Buchecker, C. O.; Hemmert, C.; Sauvage, J.-P. *New J. Chem.* **1990**, *14*, 603–605.
192. Kadish, K. M.; Smith, K. M.; Guillard, R. Eds, *The Porphyrin Handbook*; Academic Press, 2000.
193. Dixon, I. M.; Collin, J.-P.; Sauvage, J.-P.; Flamigni, L. *Inorg. Chem.* **2001**, *40*, 5507–5517.
194. Dixon, I. M.; Collin, J.-P.; Sauvage, J.-P.; Barigelletti, F.; Flamigni, L. *Angew. Chem. Int. Ed.* **2000**, *39*, 1292–1295.
195. Flamigni, L.; Dixon, I. M.; Collin, J.-P.; Sauvage, J.-P. *J. Chem. Soc. Chem. Commun.* **2000**, 2479–2480.
196. Shi, C.; Anson, F. C. *J. Am. Chem. Soc.* **1991**, *113*, 9564–9570.
197. Shi, C.; Anson, F. C. *Inorg. Chem.* **1996**, *35*, 7928–7931.
198. Mani, F. *Coord. Chem. Rev.* **1992**, *120*, 325–359.

199. Du Bois, J.; Mizoguchi, T. J.; Lippard, S. J. *Coord. Chem. Rev.* **2000**, 200–202, 443–485.
200. Krebs, B.; Buldt-Karentzoulos, K.; Eicken, C.; Rompel, A.; Witzel, H.; Feldmann, A.; Kruth, R.; Reim, J.; Steinforth, N.; Teipel, S.; Zippel, F.; Schindler, S.; Wiesermann, F. *Bioinorg. Chem.* **1997**, 616–631.
201. Kopf, M.-A.; Karlin, K. D. *Biomimetic Oxidations Catalyzed by Transition Metal Complexes*, Meunier, B., Ed., Imperial College Press: London, UK, 2000, pp 309–362.
202. Karlin, K. D.; Kaderli, S.; Zuberbuhler, A. D. *Acc. Chem. Res.* **1997**, 30, 139–147.
203. Thummel, R. P.; Williamson, D.; Hery, C. *Inorg. Chem.* **1993**, 32, 1587–1596.
204. Benzekri, A.; Dubourdeaux, P.; Latour, J. M.; Rey, P.; Laugier, J. *J. Chem. Soc., Dalton Trans.* **1991**, 3359–3365.
205. Karlin, K. D.; Hayes, J. C.; Gultneh, Y.; Cruse, R. W.; McKown, J. W.; Hutchinson, J. P.; Zubieta, J. *J. Am. Chem. Soc.* **1984**, 106, 2121–2128.
206. Berends, H. P.; Stephan, D. W. *Inorg. Chim. Acta* **1985**, 99, L53–L56.
207. Sorrell, T. N.; Jameson, D. L.; O'Connor, C. J. *Inorg. Chem.* **1984**, 23, 190–195.
208. Maloney, J. J.; Glogowski, M.; Rohrbach, D. F.; Urbach, F. L. *Inorg. Chim. Acta* **1987**, 127, L33–L35.
209. Belle, C.; Bougault, C.; Aberbuch, M.-T.; Darif, A.; Pierre, J.-L.; Latour, J.-M.; Pape, L. L. *J. Am. Chem. Soc.* **2001**, 123, 8053–8066.
210. Chou, J.-L.; Chyn, J.-P.; Urbach, F. L.; Gervasio, D. F. *Polyhedron* **2000**, 19, 2215–2223.
211. Que, Jr., L.; True, A. E. *Prog. Inorg. Chem.* **1990**, 38, 97–200.
212. Karlin, K. D.; Dahlstrom, P. L.; Cozzette, S. N.; Scensny, P. M.; Zubieta, J. *J. Chem. Soc., Chem. Commun.* **1981**, 881–882.
213. Pidcock, E.; Obias, H. V.; Abe, M.; Liang, H.-C.; Karlin, K. D.; Solomon, E. I. *J. Am. Chem. Soc.* **1999**, 121, 1299–1308.
214. Itoh, S.; Bandoh, H.; Nakagawa, M.; Nagatomo, S.; Kitagawa, T.; Karlin, K. D.; Fukuzumi, S. *J. Am. Chem. Soc.* **2001**, 123, 11168–11178.
215. Humphreys, K. J.; Karlin, K. D.; Rokita, S. E. *J. Am. Chem. Soc.* **2002**, 124, 6009–6019.



# 1.10

## Polypyrazolylborate and Scorpionate Ligands

C. PETTINARI and C. SANTINI

*Università di Camerino, Camerino, Macerata, Italy*

---

1.10.1	INTRODUCTION	159
1.10.2	POLYPYRAZOLYLBORATE OR SCORPIONATE LIGANDS	161
1.10.2.1	Abbreviation System	161
1.10.2.2	Preparation of Poly(pyrazolyl)borates	161
1.10.2.3	Bp <sup>x</sup> Ligands	163
1.10.2.3.1	<i>Specific Bp<sup>x</sup> Ligands</i>	163
1.10.2.4	Tp <sup>x</sup> Ligands	181
1.10.2.4.1	<i>Regiochemistry in ligand synthesis</i>	181
1.10.2.4.2	<i>Steric effects</i>	182
1.10.2.4.3	<i>Electronic effects</i>	183
1.10.2.5	Coordination Modes	183
1.10.3	SOFT S-DONOR SCORPIONATES	184
1.10.3.1	Hydrobis(mercaptoimidazolyl)Borates (Bm <sup>x</sup> )	185
1.10.3.2	Hydrotris(mercaptoimidazolyl)Borates (Tm)	186
1.10.3.3	Other S <sub>3</sub> -donor Scorpionates	187
1.10.4	POLY(IMIDAZOLYL)BORATES	187
1.10.4.1	Poly-(triazolyl)- (H <sub>n</sub> B(tz) <sub>4-n</sub> ), -(tetrazolyl)-borates (H <sub>n</sub> B(tet) <sub>4-n</sub> )	188
1.10.4.2	Poly(benzotriazolyl)Borates (H <sub>n</sub> B(Btz) <sub>4-n</sub> )	189
1.10.5	POLY(PYRAZOLYL)ALKANES	190
1.10.5.1	Bis(pyrazolyl)Alkanes	190
1.10.5.1.1	<i>Coordination modes of bis(pyrazolyl)alkanes</i>	190
1.10.5.1.2	<i>Synthesis of symmetrical bis(pyrazolyl)alkanes</i>	192
1.10.5.1.3	<i>Synthesis of unsymmetrical bis(pyrazolyl)alkanes</i>	193
1.10.5.2	Tris(pyrazolyl)Alkanes	194
1.10.5.2.1	<i>Synthesis of tris(pyrazolyl)methanes</i>	195
1.10.5.2.2	<i>Unsymmetrical tris(pyrazolyl)methane</i>	197
1.10.5.2.3	<i>C-alkylated tris(pyrazolyl)methane</i>	198
1.10.6	POLY(PYRAZOLYL)SILANES	199
1.10.7	TRIS(PYRAZOLYL)METHANESULFONATO	200
1.10.8	HETEROSCORPIONATES	201
1.10.9	POLY(AZOLYL)-PHOSPHINE, -PHOSPHINATE, PHOSPHAZENE AND PHOSPHINE-OXIDE	202
1.10.9.1	Bis(azolyl)-metallates	203
1.10.10	REFERENCES	204

---

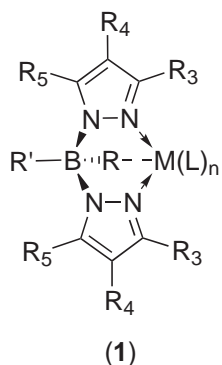
### 1.10.1 INTRODUCTION

Since the first report of Trofimenko,<sup>1</sup> many papers have appeared describing the synthesis and the application of poly(pyrazolyl)borates, or Trofimenko ligands, in an extraordinarily wide range of chemistry, from modeling the active site of metallo-enzymes, through analytical chemistry and organic synthesis, to catalysis and material science.

After the early reviews in 1971<sup>2</sup> and 1972<sup>3</sup> on poly(pyrazolyl)borate chemistry and pyrazole-derived ligands, and the boron–pyrazole compounds chemistry described in 1986,<sup>4</sup> Trofimenko reported in 1986<sup>5</sup> and in 1993<sup>6</sup> a summary on the coordination chemistry of poly(pyrazolyl)borates. In 1999 Trofimenko described the coordination chemistry of scorpionate ligands in a book.<sup>7</sup>

Apart from Trofimenko's reviews, a number of reviews and chapters were devoted to this subject: Shaver<sup>8</sup> wrote a chapter on poly(pyrazolyl)borate and related ligands; in 1983 McCleverty reviewed his work on chemistry of Tp\* with Mo and W;<sup>9</sup> in 1988 Niedenzu reviewed the pyrazaboles;<sup>10</sup> in 1992 Canty wrote about the simple tris(pyrazolyl)borate chemistry of Pd and Pt.<sup>11</sup> In 1995 Santos and Marques discussed coordination chemistry of tris(pyrazolyl)borate ligands in lanthanides and actinides complexes,<sup>12</sup> in the same year Parkin reported metal hydroxides, hydrides and organometallics derived from hindered poly(pyrazolyl)borate ligands,<sup>13</sup> while Kitajima and Tolman reviewed the organometallic and bioinorganic chemistry of hindered Tp<sup>x</sup> ligands.<sup>14</sup> In 1996 Etienne devoted a review to the coordination chemistry of Tp ligands with V, Nb, and Ta<sup>15</sup> and in 1997 and 1998 Janiak summarized the coordination chemistry of Tp<sup>x</sup> toward Ti.<sup>16,17</sup> In 1998 McCleverty and Ward described the use of scorpionate ligands to form a variety of bridged polynuclear complexes of Mo;<sup>18</sup> the same authors reviewed their work on coordination and supramolecular chemistry of Tp<sup>Py</sup>-based ligand in 2001.<sup>19</sup> Vahrenkamp recently reported the zinc pyrazolylborate chemistry related to zinc enzymes.<sup>20</sup> In 2001 Slugovc and Carmona described C–H activation and coordination chemistry of rhodium- and iridium-tris(pyrazolyl)borate complexes.<sup>21</sup>

The fundamental feature in all poly(pyrazolyl)borate complexes is the six-membered ring within a more general structure  $RR'B(\mu\text{-pz})_2M(L)_n$ , (1).



Because of the bond angles and distances involved, the  $B(\mu\text{-pz})_2M$  ring has nearly a boat conformation. In Structure (1) R and R' are different: the pseudoaxial R' is pointing away from the metal roughly along the B–M axis, but the pseudoaxial R is directed towards the metal, and may bond to it, interact with it, or simply screen it from other ligands. R may be H, alkyl, aryl, OR, SR, NMe<sub>2</sub>, or another pyrazolyl group with unspecified substituents (pz<sup>x</sup>). It was this feature that prompted Trofimenko to coin the term “scorpionates” for poly(pyrazolyl)borates, as the coordination behavior of the  $RR'B(\mu\text{-pz})_2$  ligands closely resembles the hunting habits of a scorpion: this creature grabs its prey with two identical claws (coordination of M through the two 2-N atoms of the  $B(\mu\text{-pz})_2$  groups), and then may, or may not, proceed to sting it with its overarching tail (the R' group).

Two families of scorpionate ligand may be distinguished. The first is *homoscorpionates*, where the pseudoaxial R group is another pyrazolyl group (pz<sup>x</sup>) identical to the two bridging pz<sup>x</sup> groups. In this case the ligand is tridentate and has local C<sub>3v</sub> symmetry. Homoscorpionates typically coordinate to the metal in a tridentate fashion, a feature that prompted a comparison of the Tp ligands system with the cyclopentadienyls Cp or Cp<sup>x</sup>. The second family are the *heteroscorpionates*, where the coordinating pseudoaxial R group is anything but pz<sup>x</sup>. Heteroscorpionates also include ligands where R is another pyrazolyl group (pz<sup>y</sup>) different from pz<sup>x</sup>. Heteroscorpionate ligands may coordinate in a tridentate fashion, not only in the case where R is pz<sup>y</sup> or a heteroatom, but even in cases where R is a hydrogen or an alkyl group (agostic bonding).

## 1.10.2 POLYPYRAZOLYLBORATE OR SCORPIONATE LIGANDS

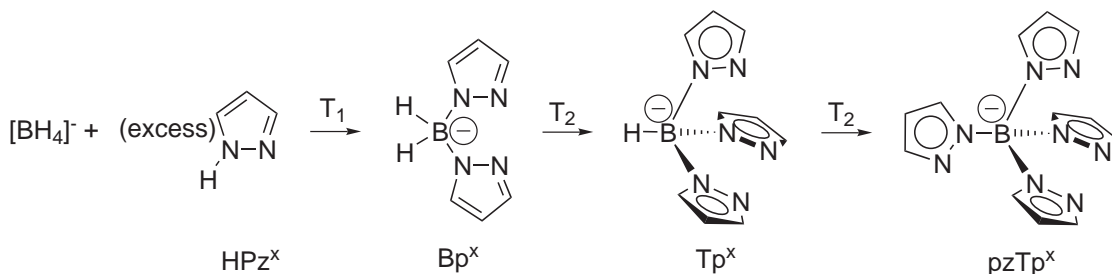
### 1.10.2.1 Abbreviation System

The systematic method to represent tris(pyrazolyl)borate ligands, proposed by Curtis,<sup>22,23</sup> is to use the abbreviation **Tp** for the hydrotris(pyrazol-1-yl)borate (also indicated as HB(pz)<sub>3</sub>) and **Tp\*** for hydrotris(3,5-dimethylpyrazol-1-yl)borate (also indicated as HB(3,5-Me<sub>2</sub>pz)<sub>3</sub>). For the sake of convenience we adopt here the Tp nomenclature. The tetrakis(pyrazol-1-yl)borate ligand will be represented by **pzTp** and the dihydrobis(pyrazol-1-yl)borate ligand by **Bp**. As proposed by Trofimenko<sup>6</sup> other poly(pyrazolyl)borate ligands are identified on the basis on the Tp abbreviation and using the following rules:

- The basic HB(pz)<sub>3</sub> structure is denoted by **Tp**, and a non-hydrogen substituent in the 3-position is denoted by a superscript. Thus, hydrotris(3-methylpyrazol-1-yl)borate is denoted as **Tp<sup>Me</sup>** and hydrotris(3-phenylpyrazol-1-yl)borate **Tp<sup>Ph</sup>**, and so forth. This is because in the reaction of KBH<sub>4</sub> with 3(5)-monosubstituted pyrazoles the asymmetric R-substituent ends up in the 3-position of the ligand. When there are four identical pyrazolyl groups bound to boron, as in tetrakis(3-methylpyrazol-1-yl)borate, the ligand will be denoted as pzTp<sup>R</sup>. Boron substituents are written preceding “**Tp**”: for instance, butylhydrotris(pyrazol-1-yl)borate is **BuTp**.
- The 5-substituent follows the 3-substituent as a superscript, separated by a comma. For instance, hydrotris(3-isopropyl-5-methylpyrazol-1-yl)borate is denoted as **Tp<sup>iPr,Me</sup>**. When both 3 and the 5 substituents are identical, the superscript R-substituent is followed by a 2: for instance hydrotris(3,5-diisopropylpyrazol-1-yl)borate is **Tp<sup>iPr2</sup>**. In the case of the most commonly used ligand, hydrotris(3,5-dimethylpyrazol-1-yl)borate the systematic abbreviation would be **Tp<sup>Me2</sup>** although, considering the long historical use of **Tp\***, this abbreviation will be adhered to in this review.
- A substituent in the 4-position is denoted as a 4R superscript. Thus, hydrotris(3-methyl-4-bromopyrazol-1-yl)borate is Tp<sup>Me,4Br</sup> and hydrotris(4-chloropyrazol-1-yl)borate is Tp<sup>4Cl</sup>. Since Tp\* defines uniquely the position of the two methyl substituents, a substituent in the 4-position follows the asterisk: for instance, the hydrotris(3,4,5-trimethylpylpyrazol-1-yl)borate ligand is **Tp\*<sup>Me</sup>**.
- Poly(indazolyl)borates ligands will be represented as benzopyrazolylborates, **Tp<sup>Bo</sup>**, with the mode of fusion of the benzo ring to pz indicated by the superscript of 3 or 4 preceding “Bo” to indicate a 3,4- or 4-5 fusion of the benzo ring, and with the position numbering following the indazole numbering system.
- A general homoscorpionate ligand with unspecified substituents will be denoted as **Tp<sup>x</sup>**, and a general pyrazolyl group will be pz<sup>x</sup>.
- Heteroscorpionate ligands will be abbreviated as “**Bp**”, with the C-substituents denoted as defined above for Tp, and with the non-hydrogen substituents on the boron written before the abbreviation. For instance, diethylbis(pyrazol-1-yl)borate will be denoted as **Et<sub>2</sub>Bp**, and dihydrobis(3-tertbutylpyrazol-1-yl)borate as **Bp<sup>tBu</sup>**.

### 1.10.2.2 Preparation of Poly(pyrazolyl)borates

Poly(pyrazolyl)borate ligands are prepared, through a more general reaction, by heating tetrahydroborate ion in molten pyrazole (Scheme 1):



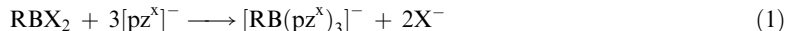
Scheme 1

This reaction can be stopped, through careful temperature control, to yield bis-, tris-, and in the case of 5-unsubstituted pyrazoles, tetrakis(pyrazolyl)borates. Syntheses of the parent ligands Bp, Tp, and pzTp have been described in detail.<sup>24</sup> A large variety of 1-H pyrazoles may be employed to synthesize poly(pyrazolyl)borate by this route, with the exception of those containing functionalities incompatible with the borohydride ion.

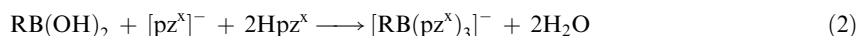
A substituent in the 3-position of a Tp ligand has the most telling effect on the coordination chemistry of the resulting Tp<sup>x</sup> ligand. This is because the 3-substituent is closest to the coordinated metal ion, and it defines the size of the cavity harboring the metal, as expressed by cone and wedge angles, or by some other means. The effect of a 3-substituent is dominant, and any additional substitution at the 4- or 5-positions, while at times of some significance is of secondary importance. The 4-substituent on the pyrazolyl ring is remote from both coordinated metal and boron atom, being thus of little steric consequence. However, the 4-substituents may influence the electron density of the ligand through electron donation or withdrawal. Two types of 3,4-disubstituted Tp<sup>x</sup> ligands are known: the first is derived from a 3-substituted pyrazole, which was additionally substituted in the 4-position either by halogenation, which is very facile with pyrazoles, or by the introduction of an alkyl group which is more difficult; the second contains a fused benzo-, or naphtho-ring at the 3,4-positions of the pyrazole, that is, the Tp<sup>x</sup> ligands are hydrotris(indazol-2-yl)borates. The examples known are limited to ligands derived from indazoles that contain either a 7-alkyl substituent, or a 6,7-fused benzo ring. There are a variety of known 3,4,5-trisubstituted Tp<sup>x</sup> ligands. The most common trisubstituted ligands are derived from Tp\*, where a halogen or an alkyl group was introduced into the 4-position. In general, substituents in the 4-position do not introduce major deviations from the coordination chemistry of the Tp\* ligands.

Tetrakis(pyrazolyl)borate ligands, pzTp<sup>x</sup>, which are limited to 5-unsubstituted pyrazoles, are prepared by the reaction of Hpz<sup>x</sup> with KBH<sub>4</sub> in a 5–6:1 mol ratio. After completion of the reaction, excess Hpz<sup>x</sup> is either distilled off, or sublimed *in vacuo*, and the residue can be directly used for the synthesis of complexes or it can be converted to the TI salt.

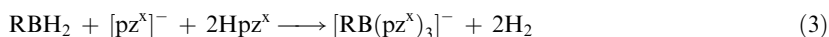
The boron-substituted ligands, RTp<sup>x</sup>, where R is alkyl or aryl, are generally prepared from the reaction of RBX<sub>2</sub> or ArBX<sub>2</sub><sup>25,26</sup> (X = halogen or a leaving group such as tosylate) with the pyrazolate ion and excess pyrazole (Equation (1)):



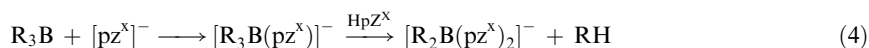
Alternatively, the [RB(pz<sup>x</sup>)<sub>3</sub>]<sup>−</sup> ligands may be prepared from the reaction of alkyl or arylboronic acids,<sup>25,27</sup> or RB(OR)<sub>2</sub> ester,<sup>28,29,30</sup> with the pyrazolate ion and excess pyrazole (Equation (2)):



A different route employs organoborohydrides RBH<sub>2</sub> or LiRBH<sub>3</sub>,<sup>31</sup> obtained from the reaction of the corresponding boronic acids RB(OH)<sub>2</sub> with LiAlH<sub>4</sub>,<sup>32</sup> in the reaction with pyrazolate ion and excess pyrazole (Equation (3)).<sup>33</sup>



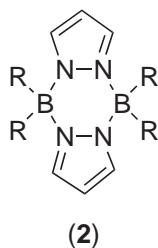
R<sub>2</sub>Bp<sup>x</sup> type ligands are prepared from trialkylboranes, triarylboranes, or tetraphenylborate ion. A typical reaction of an R<sub>3</sub>B or Ar<sub>3</sub>B species with pyrazole is preceded by the formation of an anionic species [R<sub>3</sub>Bpz<sup>x</sup>]<sup>−</sup>, through the reaction of R<sub>3</sub>B with a pyrazolate ion, [pz<sup>x</sup>]<sup>−</sup>. The R group in [R<sub>3</sub>Bpz<sup>x</sup>]<sup>−</sup> can be replaced by a pz<sup>x</sup> group upon reaction with excess pyrazole (Equation (4)).



The presence of sufficient pyrazolate ion (pz)<sup>−</sup> is necessary to convert the R<sub>2</sub>B(pz<sup>x</sup>) species quickly to the [R<sub>2</sub>B(pz<sup>x</sup>)<sub>2</sub>]<sup>−</sup>, otherwise the R<sub>2</sub>B(pz<sup>x</sup>) species will dimerize to the stable pyrazobole R<sub>2</sub>B(μ-pz<sup>x</sup>)<sub>2</sub>BR<sub>2</sub> (2), which are not readily convertible to scorpionate ligands.<sup>34,35</sup>

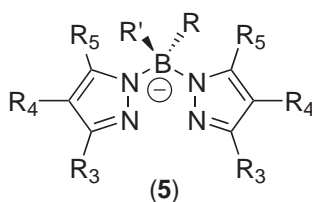
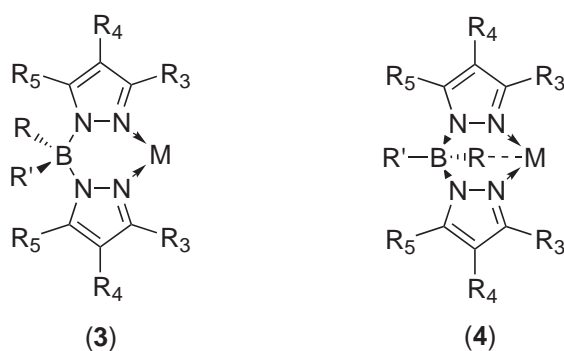
The reaction (4) generally stops at the disubstitution stage. With high boiling substituted pyrazoles, it can be driven one step further to obtain the [RB(pz<sup>x</sup>)<sub>3</sub>]<sup>−</sup> species. As with the KBH<sub>4</sub> reaction, the pyrazole 3(5)-substituent ends up in the 3-position.

Procedures for synthesizing specific, differently substituted scorpionates, are given in the references in Tables 1–11.



### 1.10.2.3 Bp<sup>x</sup> Ligands

Heteroscorpionate ligands can exist in two general structures: The difference between these two structures is that in (3) there is no interaction of the pseudoaxial R group with the coordinated metal ion, while in (4) there is such an interaction, which can range from a regular bond, through a long-distance bond, to an agostic interaction. All of this depends, of course, on the nature of R, and the depth of the boat in the B( $\mu$ -pz<sup>x</sup>)<sub>2</sub>M ring.



The known types of heteroscorpionate ligands are:

- (1) H<sub>2</sub>B(pz<sup>x</sup>)<sub>2</sub> (or Bp<sup>x</sup>), including R<sub>2</sub>B(pz<sup>x</sup>)<sub>2</sub> (or R<sub>2</sub>Bp<sup>x</sup>), (5), where R = alkyl, aryl, or halogen.
- (2) R(R'Z)B(pz<sup>x</sup>)<sub>2</sub> (= R(R'Z)Bp<sup>x</sup>), where R = H, alkyl, aryl, and Z is a heteroatom (O, S, NR').
- (3) H<sub>2</sub>B(pz<sup>x</sup>)(pz<sup>y</sup>) where pz<sup>x</sup> and pz<sup>y</sup> are different pyrazolyl groups.

In general, the H<sub>2</sub>B(pz<sup>x</sup>)<sub>2</sub> ligands are prepared from reaction, in refluxing anhydrous DMF, of substituted pyrazole and MBH<sub>4</sub> (M = Li, Na or K) in a 2.3:1.0 mole ratio. When the reaction is complete, DMF is distilled out at reduced pressure. The residue is boiled with toluene, which should dissolve most of the un-reacted pyrazole, and the mixture is filtered. The crude M[H<sub>2</sub>B(pz<sup>x</sup>)<sub>2</sub>] is contaminated by only small amounts of Hpz<sup>x</sup> and is usually suitable for complex formation. Additional purification can be achieved by converting the crude K salt to the Tl salt which shows no tendency to retain Hpz<sup>x</sup>. Specific procedures for synthesizing diversely substituted scorpionates are given in the references in Table 1.

#### 1.10.2.3.1 Specific Bp<sup>x</sup> Ligands

Bp<sup>x</sup> ligands are characterized by the presence of the BH<sub>2</sub> group which, although it renders the Bp<sup>x</sup> ligands more hydrolytically labile than their Tp<sup>x</sup> counterparts, permits elaboration of the Bp<sup>x</sup> ligand

**Table 1** Bp<sup>x</sup> ligands and references to their synthesis.

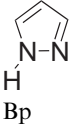
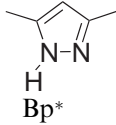
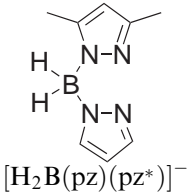
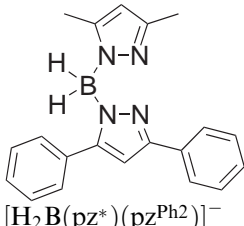
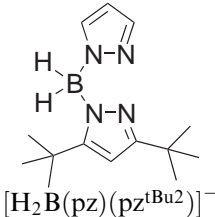
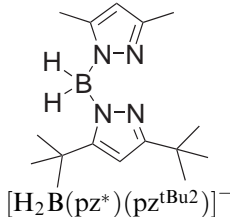
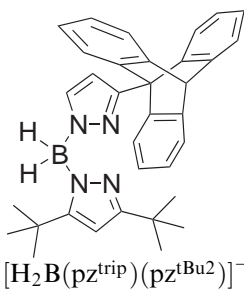
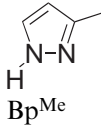
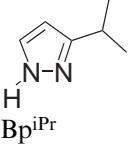
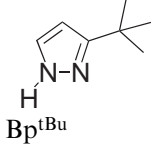
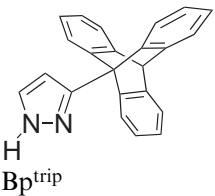
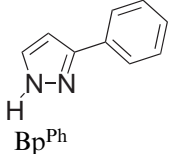
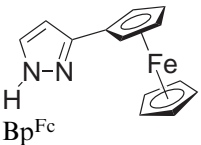
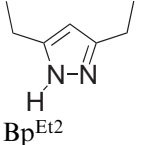
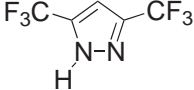
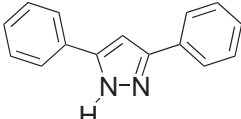
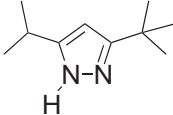
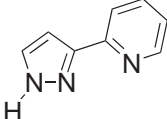
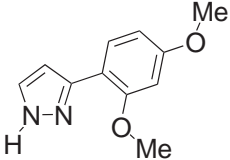
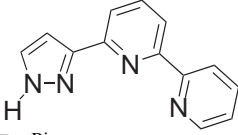
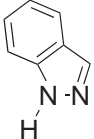
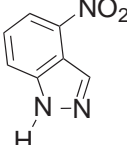
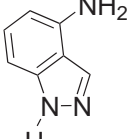
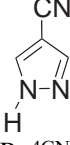
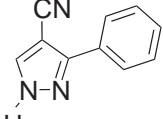
Pyrazole or ligand drawing {Ligand}	References	Pyrazole or ligand drawing {Ligand}	References
 Bp	172	 Bp*	25
 [H <sub>2</sub> B(pz)(pz*)] <sup>-</sup>	61	 [H <sub>2</sub> B(pz*)(pz <sup>Ph2</sup> )] <sup>-</sup>	61
 [H <sub>2</sub> B(pz)(pz <sup>tBu2</sup> )] <sup>-</sup>	63	 [H <sub>2</sub> B(pz*)(pz <sup>tBu2</sup> )] <sup>-</sup>	63
 [H <sub>2</sub> B(pz <sup>trip</sup> )(pz <sup>tBu2</sup> )] <sup>-</sup>	63	 Bp <sup>Me</sup>	64
 Bp <sup>iPr</sup>	66	 Bp <sup>tBu</sup>	65
 Bp <sup>trip</sup>	285	 Bp <sup>Ph</sup>	65
 Bp <sup>Fc</sup>	287	 Bp <sup>E12</sup>	36

Table 1 continued

Pyrazole or ligand drawing {Ligand}	References	Pyrazole or ligand drawing {Ligand}	References
 Bp(CF <sub>3</sub> ) <sub>2</sub>	73	 Bp <sup>Ph</sup> <sub>2</sub>	36
 Bp <sup>tBu,iPr</sup>	70	 Bp <sup>Py</sup>	76
 Bp[ <sub>2,4</sub> (Ome) <sub>2</sub> Ph]	141	 Bp <sup>Bipy</sup>	80
 Bp <sup>4Bo</sup>	288	 Bp <sup>4Bo,5NO<sub>2</sub></sup>	289
 Bp <sup>4Bo,5NH<sub>2</sub></sup>	290	 Bp <sup>4CN</sup>	291
 Bp <sup>Ph,4CN</sup>	292		

through the addition of various unsaturated systems to the B—H bond. Moreover the Bp<sup>x</sup> ligands are able to establish an agostic B—H—M bond with many metals. Finally, the residual reducing power of the BH<sub>2</sub> group makes the Bp<sup>x</sup> complexes of easily reducible cations, such as silver(I) and palladium(II), unstable, and they can be used in some instances for organic reductions.

The Bp ligand is the simplest of all heteroscorpionate ligands, and it is basically bidentate, forming the typical boat-shaped H<sub>2</sub>B(μ-pz)<sub>2</sub>M ring, in which the pseudoaxial B—H may sometimes form an agostic bond with the metal.<sup>36,37</sup> Bp<sub>2</sub>M complexes of first-row transition metals are usually square planar or tetrahedral,<sup>24,38</sup> although some octahedral anionic [Bp<sub>3</sub>M]<sup>−</sup> species of low stability can be isolated.<sup>39,40</sup> Five-coordinate anionic species [Bp<sub>2</sub>MX]<sup>−</sup> (M = Cr, Mn; X = halides or pseudoalides) have also been prepared and characterized.<sup>41,42</sup> Stable η<sup>2</sup>-iminoacyl-carbonyl derivatives, BpMo(η<sup>2</sup>-RN=C Bu<sup>t</sup>)(CO)<sub>2</sub>(PMe<sub>3</sub>),<sup>43,44</sup> are reported and a brief

**Table 2** RTp<sup>x</sup> ligands and references to their synthesis.

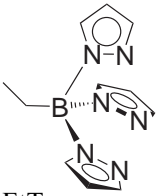
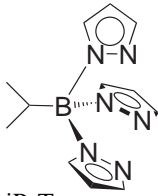
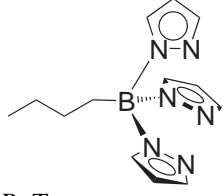
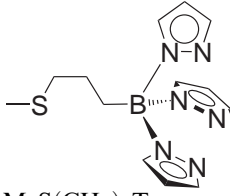
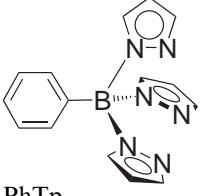
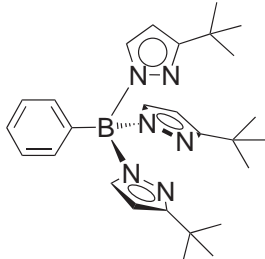
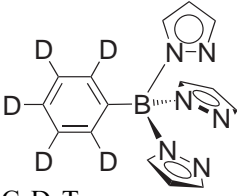
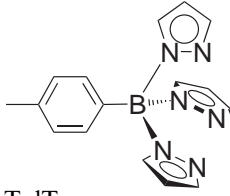
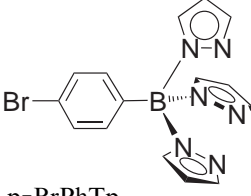
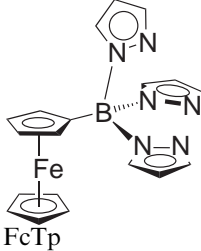
Pyrazole or ligand drawing {Ligand}	References	Pyrazole or ligand drawing {Ligand}	References
	293		27
	25		33
	25		294
	295		296
	297		298



Table 2 continued

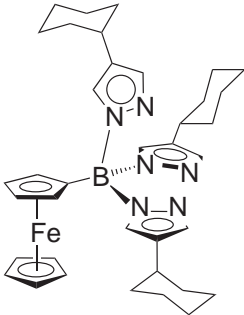
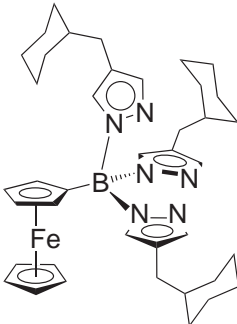
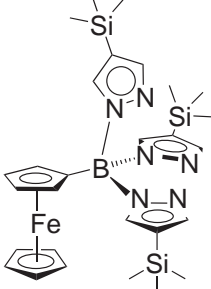
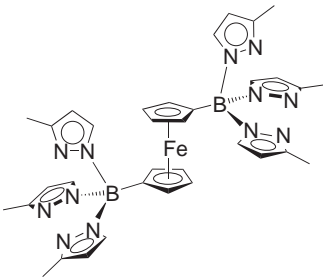
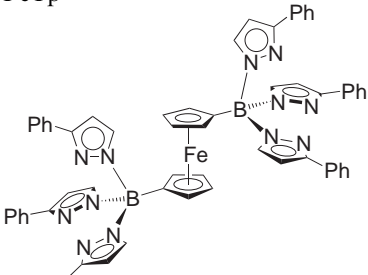
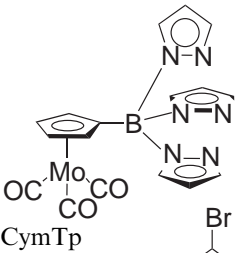
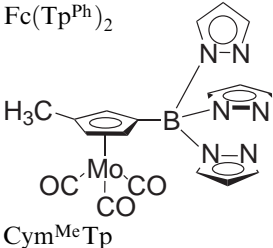
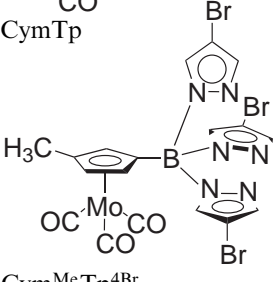
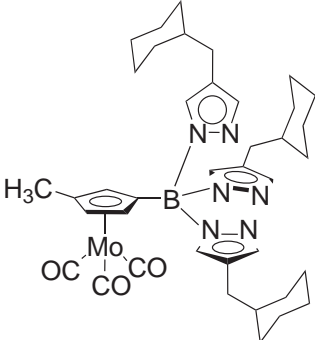
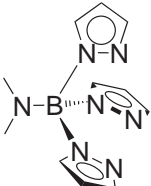
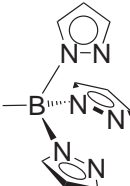
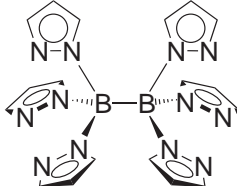
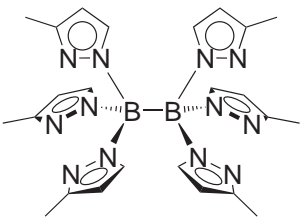
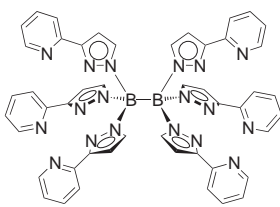
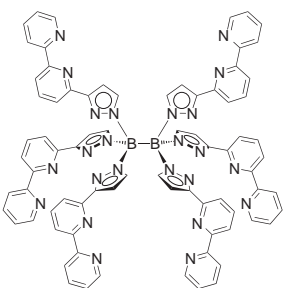
Pyrazole or ligand drawing {Ligand}	References	Pyrazole or ligand drawing {Ligand}	References
 <p>FcTp<sup>4</sup>Cy</p>	300	 <p>FcTp<sup>4</sup>(CH<sub>2</sub>)Cy</p>	300
 <p>FcTp<sup>4</sup>SiMe<sub>3</sub></p>	300	 <p>Fc(Tp<sup>Me</sup>)<sub>2</sub></p>	299
 <p>Fc(Tp<sup>Ph</sup>)<sub>2</sub></p>	299	 <p>CymTp</p>	301
 <p>Cym<sup>Me</sup>Tp</p>	301	 <p>Cym<sup>Me</sup>Tp<sup>4</sup>Br</p>	301
 <p>Cym<sup>Me</sup>Tp<sup>4</sup>(CH<sub>2</sub>)Cy</p>	301	 <p>Me<sub>2</sub>NTp</p>	302,303

Table 2 continued

Pyrazole or ligand drawing {Ligand}	References	Pyrazole or ligand drawing {Ligand}	References
 MeTp	28	 Tp-Tp	304
 Tp <sup>Me</sup> -Tp <sup>Me</sup>	305	 Tp <sup>Py</sup> -Tp <sup>Py</sup>	305
 Tp <sup>bipy</sup> -Tp <sup>bipy</sup>	305		

review on the structural and reactivity aspects of molybdenum acyl complexes derived from the Bp and Bp\* was published.<sup>45</sup> A large number of octahedral complexes of the BpRu moiety have been prepared; they included BpRu(R)(CO)(PPh<sub>3</sub>)<sub>2</sub> and BpRu(R)(CS)(PPh<sub>3</sub>)<sub>2</sub> (R = H, Ph and vinylic).<sup>46</sup> Acetyl complexes of Fe and Ru, such as BpM(PMe<sub>3</sub>)<sub>2</sub>(CO)(COMe), were also reported.<sup>47</sup> Syntheses of numerous palladium complexes, BpPd(PMe<sub>3</sub>)<sub>2</sub>(R), have been reported, (R = CH<sub>2</sub>CMe<sub>2</sub>Ph, CH<sub>2</sub>SiMe<sub>3</sub>).<sup>48</sup> BpCu was synthesized and converted to derivatives of general structure BpCuL (L = bipy, dppe, (py)<sub>2</sub>, (PPh<sub>3</sub>)<sub>2</sub> and PCy<sub>3</sub>). BpCu is able to catalyze the cyclopropanation of olefins with diazoacetic ester in homogeneous and heterogeneous systems.<sup>49</sup> Gallium and indium complexes of Bp were reported including Bp<sub>2</sub>GaCl, Bp<sub>3</sub>Ga, Bp<sub>2</sub>GaMe, BpGaMe<sub>2</sub><sup>50</sup> and Bp<sub>3</sub>In.<sup>51</sup> A number of other related indium(III) complexes (BpInMeCl and BpInMe<sub>2</sub>) were also reported.<sup>52</sup> Bp<sub>2</sub>Sn and (BpSnCl)<sub>2</sub> have been synthesized, and the structure of the latter showed a long-range halide interaction between the two tin ions, which were in a pyramidal environment.<sup>53,54</sup> Several tin(IV) complexes BpSnClR<sub>2</sub> and Bp<sub>2</sub>SnR<sub>2</sub> (R = Me, Bu, Ph) have been described<sup>52</sup> showing that halogenation of BH<sub>2</sub> moiety occurs without ligand degradation. Five- and six-coordinate organotin(IV) complexes, BpSnClMe<sub>2</sub><sup>55</sup> and BpSnClR<sub>2</sub><sup>56</sup> R:CH<sub>3</sub>OCH<sub>2</sub>CH<sub>2</sub> respectively, were also described.

Various Bp\*<sub>2</sub>M (M = first-row transition metal) were synthesized and found to resemble their Bp<sub>2</sub>M counterparts, with the exception of Bp\*<sub>2</sub>Mn and Bp\*<sub>2</sub>Fe these complexes are no longer air-sensitive, presumably due to the screening effect of the 3-Me groups.<sup>8</sup> In recent years a variety of

**Table 3** Tp<sup>x</sup> ligands derived from 3-monosubstituted pyrazole rings and references to their synthesis.






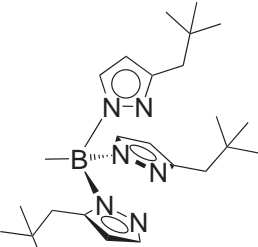

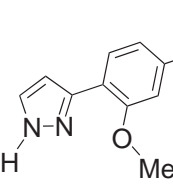


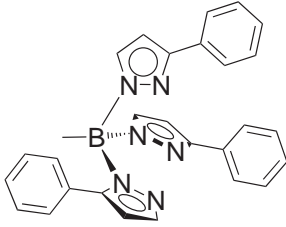



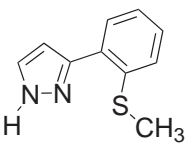
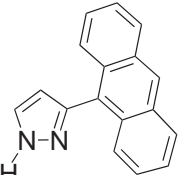
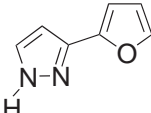
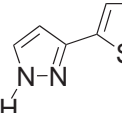
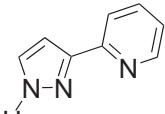
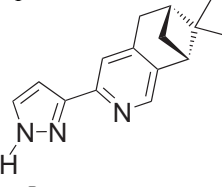
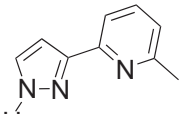
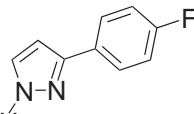
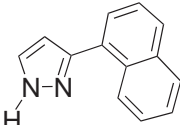
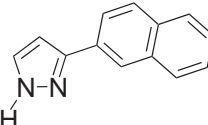
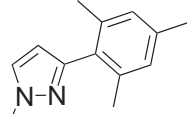
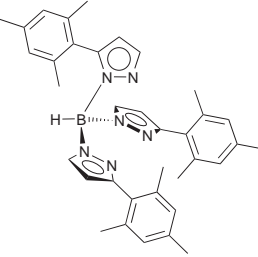
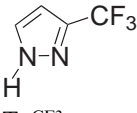
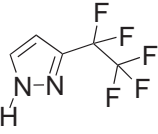
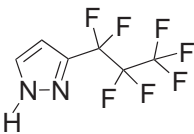
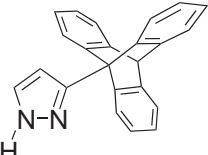
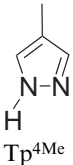
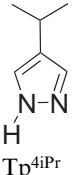
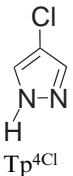
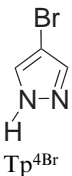
Pyrazole or ligand drawing {Ligand}	References	Pyrazole or ligand drawing {Ligand}	References
 Tp	172,24	 Tp <sup>Me</sup>	82
 Tp <sup>iPr</sup>	66	 Tp <sup>tBu</sup>	65
 Tp <sup>Np</sup>	89	 Tp <sup>Np*</sup>	89
 Tp <sup>CPr</sup>	100	 Tp <sup>(2,4(OMe)2Ph)</sup>	141
 Tp <sup>Cy</sup>	306	 Tp <sup>Ph</sup>	65
 Tp <sup>Ph*</sup>	93	 Tp <sup>pTol</sup>	105,359
 Tp <sup>pAn</sup>	105	 Tp <sup>oAn</sup>	140,307

Table 3 continued

Pyrazole or ligand drawing {Ligand}	References	Pyrazole or ligand drawing {Ligand}	References
 Tp <sup>Ph(oSMe)</sup>	308	 Tp <sup>Ant</sup>	90
 Tp <sup>Fn</sup>	309	 Tp <sup>Tn</sup>	97
 Tp <sup>2Py</sup>	310	 Tp <sup>Py*</sup>	311
 Tp <sup>2Py6Me</sup>	312	 Tp <sup>4FPh</sup>	309
 Tp <sup>αNt</sup>	313,310	 Tp <sup>βNt</sup>	313,310
 Tp <sup>Ms</sup>	88	 Tp <sup>Ms*</sup>	88
 Tp <sup>CF3</sup>	314,315	 Tp <sup>C2F5</sup>	316
 Tp <sup>C3F7</sup>	316	 Tp <sup>Trip</sup>	285

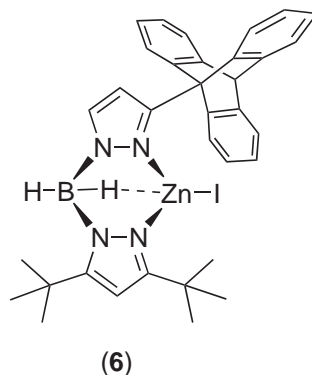
**Table 4** Tp<sup>x</sup> ligands derived from 4-monosubstituted pyrazole rings and references to their synthesis.

Pyrazole or ligand drawing {Ligand}	References	Pyrazole or ligand drawing {Ligand}	References
 Tp <sup>4Me</sup>	317	 Tp <sup>4iPr</sup>	25
 Tp <sup>4Cl</sup>	25	 Tp <sup>4Br</sup>	318

Bp\*Pd(PMe<sub>3</sub>)(R) complexes has been reported, and the structure of Bp\*Pd(PMe<sub>3</sub>)(CH<sub>2</sub>SiMe<sub>3</sub>) was determined by X-ray crystallography.<sup>48</sup> Several gallium(III) and indium(III) complexes of Bp\*, including Bp\*M(Me)Cl and Bp\*M(Me)<sub>2</sub> have also been described.<sup>57</sup> Bp\* complexes of lanthanides and actinides were synthesized, and structures of the isomorphous Bp\*<sub>3</sub>U and Bp\*<sub>3</sub>Sm determined by X-ray crystallography.<sup>58</sup> The same structural typology was found in Bp\*<sub>3</sub>Y.<sup>59</sup> In these complexes the Bp\* ligand is tridentate, by way of a B—H—M agostic bond, so that the metal ions were in a formally nine-coordinate environment, and the six nitrogen atoms were arranged in a trigonal prismatic geometry.

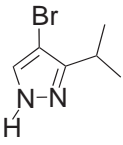
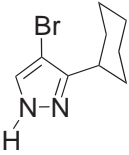
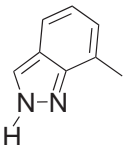
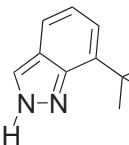
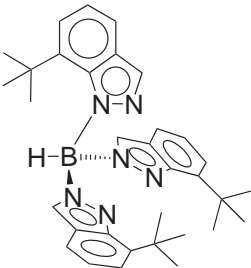
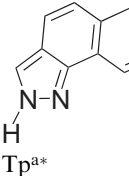
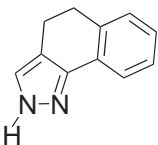
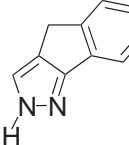
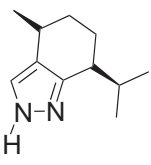
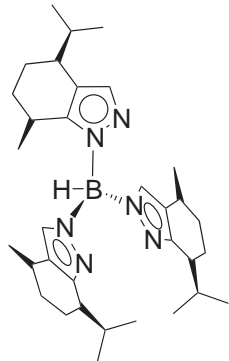
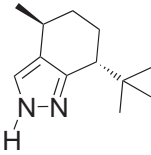
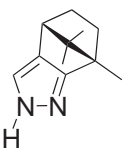
In 1982 the first Bp<sup>x</sup> ligand containing two different pyrazolyl groups, [H<sub>2</sub>B(pz)(pz\*)]<sup>-</sup>, was synthesized<sup>60</sup>; this was converted in the sodium salt [H<sub>2</sub>B(pz\*)(pz<sup>x</sup>)]Na.<sup>61</sup> The nickel complex [H<sub>2</sub>B(pz)(pz\*)]<sub>2</sub>Ni was synthesized and the structure determined by X-ray crystallography showing a square planar structure containing the (pz) and (pz\*) rings in a *trans* arrangement.<sup>62</sup>

The asymmetric ligands, [H<sub>2</sub>B(pz)(pz<sup>tBu2</sup>)]<sup>-</sup>, [H<sub>2</sub>B(pz\*)(pz<sup>tBu2</sup>)]<sup>-</sup> and [H<sub>2</sub>B(pz<sup>trip</sup>)(pz<sup>tBu2</sup>)]<sup>-</sup>, were obtained by reaction of LiBH<sub>4</sub> with a 1:1 mixture of two different pyrazoles and their thallium complexes [H<sub>2</sub>B(pz)(pz<sup>tBu2</sup>)]Tl, containing an agostic B—H—Tl bond, were structurally characterized together with the zinc derivatives ([H<sub>2</sub>B(pz)(pz<sup>tBu2</sup>)]ZnI(Hpz<sup>tBu,iPr</sup>), [H<sub>2</sub>B(pz\*)(pz<sup>tBu2</sup>)]ZnI and [H<sub>2</sub>B(pz<sup>trip</sup>)(pz<sup>tBu2</sup>)]ZnI (6).<sup>63</sup> In the latter case the zinc ion was in a tetrahedral environment, due to the presence of an agostic B—H—Zn bond.



The Bp<sup>Me</sup> ligand was synthesized in 1975<sup>64</sup> and converted to a variety of first-row transition metal complexes<sup>62</sup> and tin(II) complexes.<sup>54</sup> In a similar way the Bp<sup>Ph</sup> ligand was isolated as a thallium(I) salt, and was converted to first-row transition metal complexes (Bp<sup>Ph</sup>)<sub>2</sub>M, as well as to Bp<sup>Ph</sup>MO(CO)<sub>2</sub>(η<sup>3</sup>-CH<sub>2</sub>CRCH<sub>2</sub>) (R = H, Me).<sup>65</sup>

**Table 5** Tp<sup>x</sup> ligands derived from 3,4-disubstituted pyrazole rings and references to their synthesis.

Pyrazole or ligand drawing {Ligand}	References	Pyrazole or ligand drawing {Ligand}	References
 Tp <sup>iPr,4Br</sup>	66	 Tp <sup>Cy,4Br</sup>	319
 Tp <sup>3Bo,7Me</sup>	320	 Tp <sup>3Bo,7tBu</sup>	321
 Tp <sup>(3Bo,7tBu)*</sup>	320,321	 Tp <sup>a*</sup>	320,99
 Tp <sup>a</sup>	98	 Tp <sup>b</sup>	98
 Tp <sup>Menth</sup>	94	 Tp <sup>Menth*</sup>	94
 Tp <sup>Mementh</sup>	94	 Tp <sup>Camph</sup>	321

**Table 6** Tp<sup>x</sup> ligands derived from 3,5-disubstituted pyrazole rings and references to their synthesis.

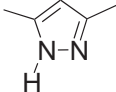
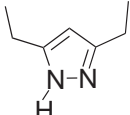
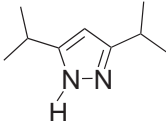
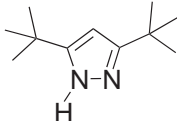
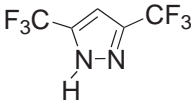
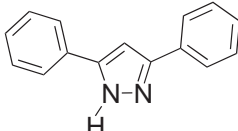
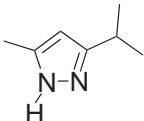
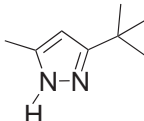
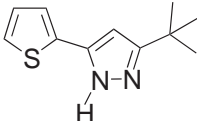
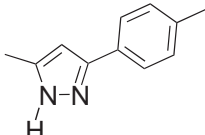
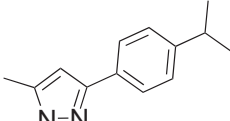
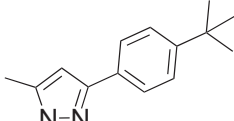
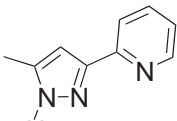
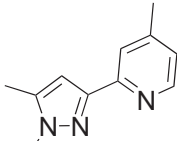
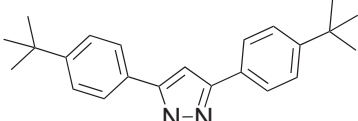
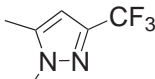
Pyrazole or ligand drawing {Ligand}	References	Pyrazole or ligand drawing {Ligand}	References
 Tp*	25	 Tp <sup>Et2</sup>	25
 Tp <sup>iPr2</sup>	322	 Tp <sup>tBu2</sup>	323
 Tp <sup>(CF<sub>3</sub>)2</sup>	71,72	 Tp <sup>Ph2</sup>	322
 Tp <sup>iPr,Me</sup>	128	 Tp <sup>tBu,Me</sup>	105
 Tp <sup>tBu,Tn</sup>	309	 Tp <sup>Tol,Me</sup>	98
 Tp <sup>Cum,Me</sup>	324	 Tp <sup>p-tBuPh,Me</sup>	325
 Tp <sup>3Py,Me</sup>	326,327	 Tp <sup>3Pic,Me</sup>	328
 Tp <sup>(p-tBuPh)2</sup>	328	 Tp <sup>CF<sub>3</sub>,Me</sup>	329

Table 6 continued

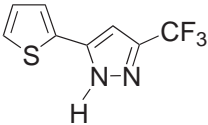
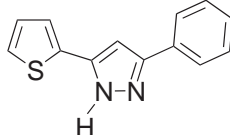
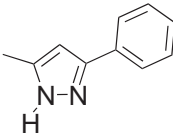
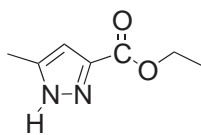
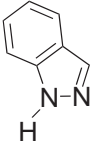
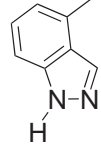
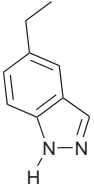
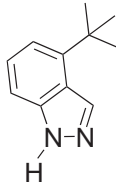
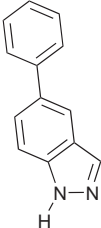
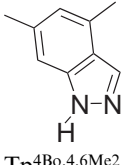
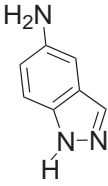
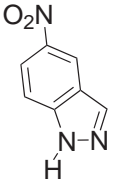
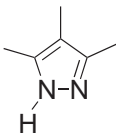
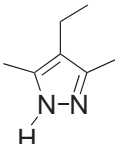
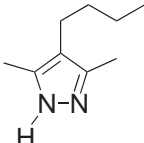
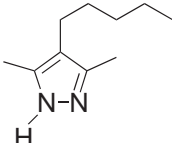
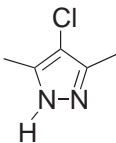
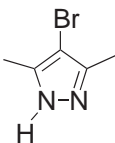
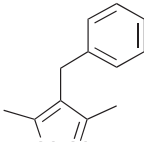
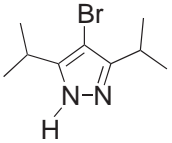
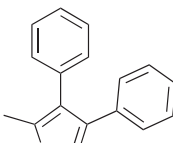
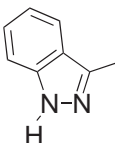
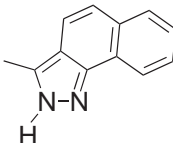
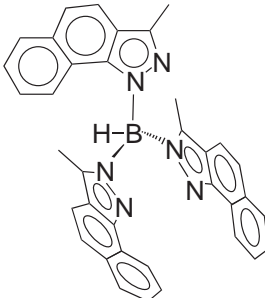
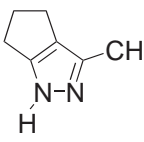
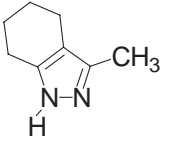
Pyrazole or ligand drawing {Ligand}	References	Pyrazole or ligand drawing {Ligand}	References
	131		86
$\text{Tp}^{\text{CF}_3, \text{Tn}}$		$\text{Tp}^{\text{Ph}, \text{Tn}}$	
	330		285
$\text{Tp}^{\text{Ph}, \text{Me}}$		$\text{Tp}^{\text{CO}_2\text{Et}, \text{Me}}$	

Table 7  $\text{Tp}^x$  ligands derived from 4,5-disubstituted pyrazole rings and references to their synthesis.

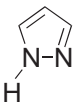
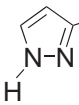
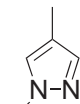
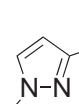
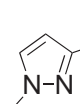
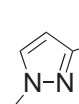
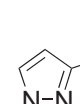
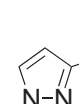
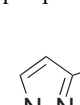
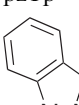
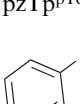

Pyrazole or ligand drawing {Ligand}	References	Pyrazole or ligand drawing {Ligand}	References
	319,331		319
$\text{Tp}^{4\text{Bo}}$		$\text{Tp}^{4\text{Bo}, 5\text{Me}}$	
	319		319
$\text{Tp}^{4\text{Bo}, 5\text{Et}}$		$\text{Tp}^{4\text{Bo}, 5\text{tBu}}$	
	319		319
$\text{Tp}^{4\text{Bo}, 5\text{Ph}}$		$\text{Tp}^{4\text{Bo}, 4, 6\text{Me}_2}$	
	289		332,333
$\text{Tp}^{4\text{Bo}, 5\text{NH}_2}$		$\text{Tp}^{4\text{Bo}, 5\text{NO}_2}$	



**Table 8** Tp<sup>x</sup> ligands derived from trisubstituted pyrazole rings and references to their synthesis.

Pyrazole or ligand drawing {Ligand}	References	Pyrazole or ligand drawing {Ligand}	References
 Tp*Me	25	 Tp*Et	334
 Tp*Bu	334	 Tp*Am	334
 Tp*Cl	131,335	 Tp*Br	95
 Tp*Bn	336	 Tp <i>iPr</i> <sub>2</sub> ,Br	337
 Tp <sup>Ph,Me,Ph</sup>	338	 Tp <sup>4Bo,3Me</sup>	319
 Tp <sup>(a*,3Me)</sup>	319	 Tp <sup>(a*,3Me)*</sup>	319
 Tp <sup>Me,mt3</sup>	339	 Tp <sup>Me,mt4</sup>	339

**Table 9** pzTp<sup>x</sup> ligands and references to their synthesis.

Pyrazole or ligand drawing {Ligand}	References	Pyrazole or ligand drawing {Ligand}	References
 pzTp	172,24	 pzTp <sup>Me</sup>	82
 pzTp <sup>4Me</sup>	316	 pzTp <sup>iPr</sup>	66
 pzTp <sup>tBu</sup>	65	 pzTp <sup>Cpr</sup>	340
 pzTp <sup>Cy</sup>	318,341	 pzTp <sup>pAn</sup>	341
 pzTp <sup>pTol</sup>	358	 pzTp <sup>4Bo</sup>	342
 pzTp <sup>4Bo,5NO2</sup>	332,333	 pzTp <sup>Camph</sup>	321

The more sterically hindered Bp<sup>iPr</sup> and Bp<sup>tBu</sup> ligands were synthesized and characterized respectively as potassium<sup>66</sup> and thallium<sup>65</sup> salts. Several three-coordinate monoalkylzinc derivatives Bp<sup>tBu</sup>ZnR (R = Me, Et, Bu<sup>t</sup>) were prepared,<sup>67</sup> as well as a number of nickel complexes Bp<sup>tBu</sup>Ni(Ar)(PMe<sub>3</sub>)<sub>2</sub> (Ar = Ph, Tol, An, Ph-*p*-NMe<sub>2</sub>), containing a very rare example of a monodentate Bp<sup>tBu</sup> ligand.<sup>68</sup> The Bp<sup>tBu,iPr</sup> ligand was synthesized. Its cobalt complex [Bp<sup>tBu,iPr</sup>]<sub>2</sub>Co, is in an octahedral environment, due to the presence of an agostic B—H—Co bond.<sup>69</sup> The organozinc complex of this ligand, [Bp<sup>tBu,iPr</sup>]ZnMe, was converted by treatment with paraformaldehyde to [(MeO)Bp<sup>tBu,iPr</sup>]ZnMe, which involved insertion of CH<sub>2</sub>O into the pseudoaxial B—H bond.<sup>70</sup>

The K salt of the fluorinated Bp<sup>(CF<sub>3</sub>)<sub>2</sub></sup> was synthesized,<sup>71,72</sup> and the structure determined by X-ray crystallography as was the square planar [Bp<sup>(CF<sub>3</sub>)<sub>2</sub>]<sub>2</sub>Cu complex, and the tetrahedral [Bp<sup>(CF<sub>3</sub>)<sub>2</sub>]<sub>2</sub>Zn.<sup>73</sup> The copper(I) complex [Bp<sup>(CF<sub>3</sub>)<sub>2</sub>]Cu(CNBU<sup>t</sup>)<sub>2</sub>, showing an agostic B—H—Cu bond, was also characterized.<sup>74</sup> An analogous agostic interaction was present in the ruthenium complex [Bp<sup>(CF<sub>3</sub>)<sub>2</sub>]RuH(COD), which was converted to [Bp<sup>(CF<sub>3</sub>)<sub>2</sub>]RuH(PR<sub>3</sub>)<sub>3</sub> and</sup></sup></sup></sup></sup>

**Table 10** R<sub>2</sub>Bp<sup>x</sup> ligands and references to their synthesis.

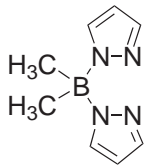
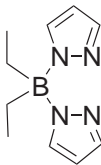
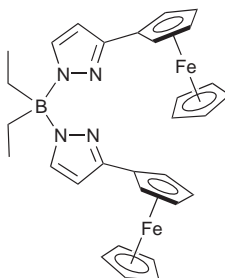
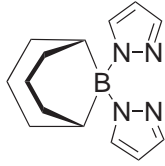
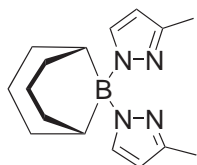
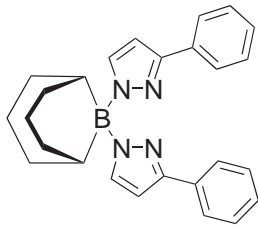
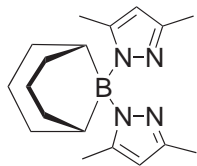
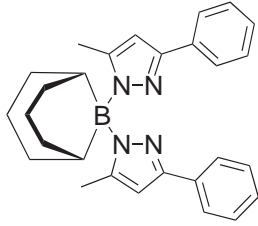
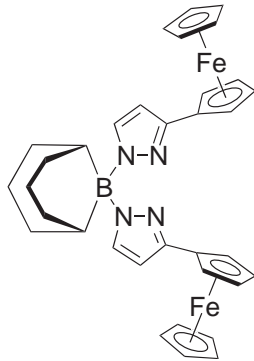
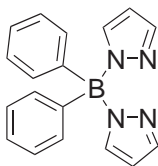
Pyrazole or ligand drawing {Ligand}	References	Pyrazole or ligand drawing {Ligand}	References
 Me <sub>2</sub> Bp	343	 Et <sub>2</sub> Bp	25
 Et <sub>2</sub> Bp <sup>Fc</sup>	286	 (BBN)Bp	344
 (BBN)Bp <sup>Me</sup>	345	 (BBN)Bp <sup>Ph</sup>	346
 (BBN)Bp <sup>*</sup>	346	 (BBN)Bp <sup>Ph.Me</sup>	346
 (BBN)Bp <sup>Fc</sup>	286	 Ph <sub>2</sub> Bp	25

Table 10 continued

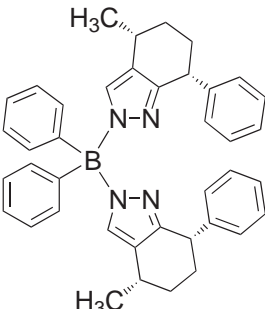
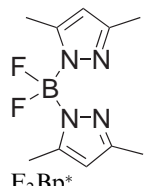
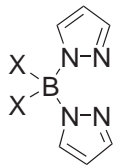
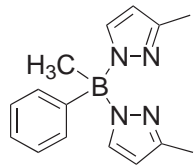
Pyrazole or ligand drawing {Ligand}	References	Pyrazole or ligand drawing {Ligand}	References
 Ph <sub>2</sub> Bp <sup>pm</sup>	347	 F <sub>2</sub> Bp*	25
 X <sub>2</sub> Bp, (X = Cl, Br, I)	52	 Ph(Me)Bp <sup>Me</sup>	28

Table 11 R(Z)Bp ligands and references to their synthesis.

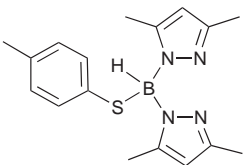
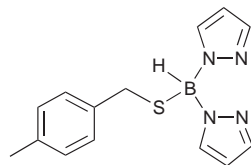
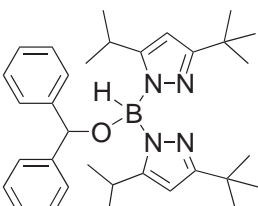
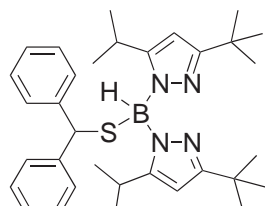
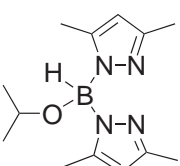
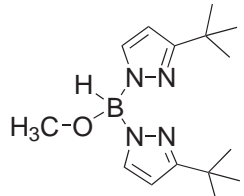
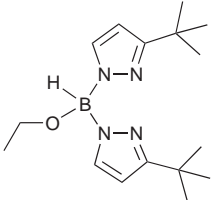
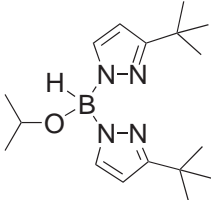
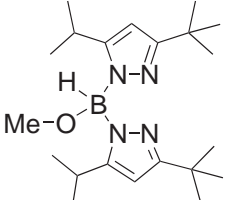
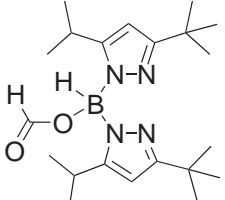
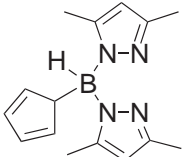
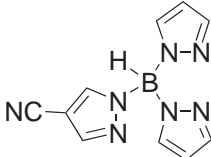
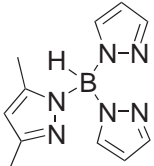
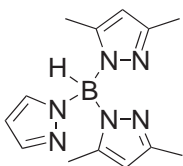
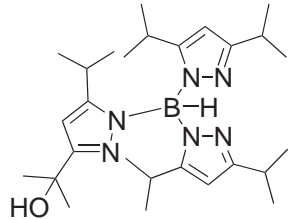
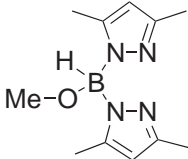
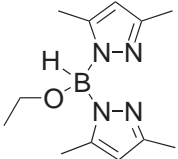
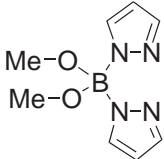
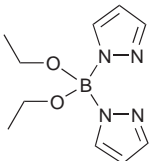
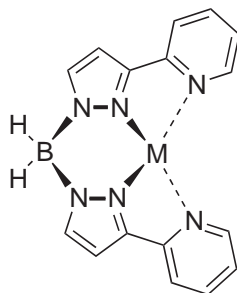
Pyrazole or ligand drawing {Ligand}	References	Pyrazole or ligand drawing {Ligand}	References
 ( <i>p</i> -TolS)Bp*	348	 (MeBnS)Bp*	349
 (Ph <sub>2</sub> CHO)Bp <sup>tBu,iPr</sup>	350	 (Ph <sub>2</sub> CHS)Bp <sup>tBu,iPr</sup>	350
 (Pr <sup>i</sup> O)Bp*	351	 (MeO)Bp <sup>tBu</sup>	351

Table 11 continued

Pyrazole or ligand drawing {Ligand}	References	Pyrazole or ligand drawing {Ligand}	References
	67		67
(EtO)Bp <sup>tBu</sup>		(Pr <sup>i</sup> O)Bp <sup>tBu</sup>	
	352		353
(MeO)Bp <sup>tBu,iPr</sup>		(HCOO)Bp <sup>tBu,iPr</sup>	
	354		2
CpBp <sup>*</sup>		(pz <sup>4CN</sup> )Bp	
	355		355
(pz <sup>*</sup> )Bp		(pz)Bp <sup>*</sup>	
	356		357
[3-(CMe <sub>2</sub> OH)-5-iPrpz]Bp <sup>iPr2</sup>		(MeO)Bp <sup>*</sup>	
	357		357
(EtO)Bp <sup>*</sup>		(MeO) <sub>2</sub> Bp	
	357		
(EtO) <sub>2</sub> Bp			

$[\text{Bp}^{(\text{CF}_3)_2}]_2\text{RuH}(\text{C}_6\text{H}_6)$ , in which no agostic  $\text{B}-\text{H}-\text{Ru}$  bond is present, and to  $[\text{Bp}^{(\text{CF}_3)_2}]\text{RuH}(\text{H}_2)(\text{PCy}_3)_2$  where  $[\text{Bp}^{(\text{CF}_3)_2}]$  is coordinated in the rare monodentate mode.<sup>75</sup>

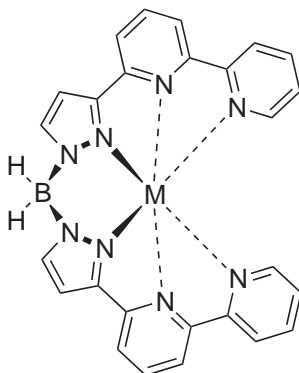
The potentially tetradentate bis(pyrazolyl)borate ligand  $\text{Bp}^{\text{Py}}$  with two bidentate arms (7), was prepared from reaction of 3-(2-pyridyl)pyrazole (Hpzpy) with  $\text{KBH}_4$  in a melt.<sup>76</sup>



(7)

The coordination properties of the ligand  $\text{Bp}^{\text{Py}}$  can be split into two categories: i) all donor atoms coordinate to the same metal ion, to give in this case a tetradentate chelate; ii) the two bidentate arms attach to different metal ions, in which case more elaborate polynuclear complexes may assemble. The simple mononucleating coordination mode of  $\text{Bp}^{\text{Py}}$  is exemplified by the structures of  $\text{Tl}(\text{Bp}^{\text{Py}})$  and  $\text{Ln}(\text{Bp}^{\text{Py}})_2(\text{NO}_3)$ . In  $\text{Tl}(\text{Bp}^{\text{Py}})$  the  $\text{Tl}(\text{I})$  ion has two short strong interactions with the pyrazolyl  $N$  donors (between 2.61 Å and 2.69 Å), and two much more tenuous ones with the pyridyl  $N$  donors (between 2.96 Å and 3.17 Å).<sup>77</sup> In  $\text{Ln}(\text{Bp}^{\text{Py}})_2(\text{NO}_3)$  the two  $\text{Bp}^{\text{Py}}$  ligands are coordinated as conventional tetradentate chelates, with the lanthanide ion being ten-coordinate from two such ligands and a bidentate nitrate.<sup>78</sup> Reaction of  $\text{Bp}^{\text{Py}}$  with  $\text{Co}^{\text{II}}$  salts, followed by precipitation with hexafluorophosphate as the anion, afforded a material whose electrospray mass spectrum contains a peak corresponding to the fragment  $[\text{Co}_8(\text{Bp}^{\text{Py}})_{12}(\text{PF}_6)]^{3+}$  at  $m/z$  1,410.<sup>79</sup> The crystal structure of the perchlorate salt shows the eight metal ions and twelve bridging ligands form a closed ring, with the perchlorate ion bound in the centre of the cavity. Each ligand  $\text{Bp}^{\text{Py}}$  acts as a bridge between two adjacent metal ions, with an alternating pattern of one and two bridging ligands between each adjacent pair of metals. Each metal is therefore six-coordinate (pseudo-octahedral) by three bidentate chelating fragments, each from a different ligand.  $\text{Bp}^{\text{Py}}\text{Tl}$  and  $\text{Bp}^{\text{Py}}_2\text{Pb}$  were also reported. The  $\text{Bp}^{\text{Py}}\text{Tl}$  structure revealed molecular stacking, with two long bonds from the pyridyl nitrogen atoms to Tl, while in  $\text{Bp}^{\text{Py}}_2\text{Pb}$  all eight nitrogen atoms were directed at the metal ion, with variable degrees of interaction.<sup>77</sup>

The potentially hexadentate ligand,  $\text{Bp}^{\text{Bipy}}$  (8) was synthesized and the structure of its K salt was determined by X-ray crystallography.<sup>80</sup>



(8)

The first-row ions yielded dinuclear cationic complexes  $[(\text{Bp}^{\text{Bipy}})_2\text{M}]_2[\text{BF}_4]$ . The structure of the complex  $[(\text{Bp}^{\text{Bipy}})_2\text{Cu}]_2[\text{BF}_4]_2$  revealed a double helical ligand array, which also included stacking between ligands, while  $[\text{Bp}^{\text{Bipy}}]\text{Gd}(\text{NO}_3)_2$  showed a hexadentate  $\text{Bp}^{\text{Bipy}}$  ligand with two  $\kappa^2$  nitrate ions. In  $\text{Bp}^{\text{Bipy}}\text{Tl}$  the metal is three-coordinate.<sup>81</sup>

### 1.10.2.4 $\text{Tp}^x$ Ligands

In general, the procedure for the synthesis of  $\text{Tp}^x$  ligands involves thermolysis of a mixture of a suitable pyrazole and a borohydride salt,  $\text{MBH}_4$  ( $M = \text{K}$  or  $\text{Na}$ ), in a 4:1 ratio, either in a melt or in a high-boiling solvent. The reaction was monitored by hydrogen evolution. When the pyrazole is a liquid or a low-melting solid, the excess pyrazole is distilled out keeping the temperature as low as possible, in order to prevent the formation of the tetrasubstituted  $\text{pzTp}^x$  ligand. The residual  $\text{M}[\text{Tp}^x]$  salt can be converted to the  $\text{Tl}(\text{I})$  salt and purified by recrystallization.

If the pyrazole is 3-substituted and high-melting, the best method is to reflux a mixture in 3.5:1  $\text{pz}^x$  to  $\text{MBH}_4$  ratio in a high-boiling solvent such as toluene, anisole, methylanisole or kerosene. As with pyrazole itself, the reactions affording  $\text{Tp}^x$  ligands proceed via the dihydrobis(pyrazolyl)borate anion, which in some instances was isolated.<sup>65</sup> If the temperature is too high the  $\text{pzTp}^x$  anion can also be isolated.<sup>24</sup> When large R groups are in the 3-position the formation of the more highly boron-substituted product is relatively disfavored, facilitating the preparation of the desired  $\text{Tp}^x$  in most cases. If it precipitates, the mixture is filtered hot, and the solid is washed with a small amount of hot solvent itself. After drying, a very pure  $\text{MTp}^x$  salt is usually obtained. If the theoretical amount of hydrogen evolves and the solution remains clear, then the solvent is distilled out under vacuum and the residue is converted to the thallium salt by treatment with aqueous  $\text{TlNO}_3$  or methanolic  $\text{TlOAc}$ . In order to obtain the ligands in a pure form the thallium salt is extracted with methylene chloride, and the extracts are filtered, stripped and stirred with methanol in which  $\text{Hpz}^x$ , but not  $\text{TlTp}^x$ , is usually soluble.

With 3,5-disubstituted pyrazole the melt method is preferred, since tetrasubstitution does not take place, and high temperatures can be employed. It would be better to use a large excess of  $\text{Hpz}^x$  ( $\text{Hpz}^x:\text{MBH}_4$  in 6:1 molar ratio) to prevent the precipitation of the less soluble potassium or sodium salt and decomposition. After completion of the reaction, the excess of  $\text{Hpz}^x$  is sublimed out and the residue is converted to the  $\text{Tl}^{\text{I}}$  salt in the usual way.

#### 1.10.2.4.1 Regiochemistry in ligand synthesis

A critical issue in the synthesis of polypyrazolylborate ligand obtained from pyrazoles whose anions are not of  $\text{C}_{2v}$  symmetry, is the regiochemistry of B–N bond formation. Usually, the larger substituents end up in the pyrazolyl ring 3-position, relatively distant from the B–N bond. This tendency is most pronounced when the steric differences between R(3) and R(5) are large. This regioselectivity was first demonstrated in the reaction of 3(5)-methylpyrazole, leading to  $\text{Bp}^{\text{Me}}$ <sup>64</sup> and to  $\text{Tp}^{\text{Me}}$ <sup>82</sup> as well as in the regiospecific synthesis of  $\text{Tp}^{\text{Ph}}$ <sup>83</sup> and  $\text{Tp}^{\text{tBu}}$ .<sup>65</sup> A mixture of  $\text{Tp}^{\text{R}}$  and  $\text{Tp}^{\text{5R}}$  isomers is often formed when the steric differences between the pyrazolyl rings substituent in the 3-position and in the 5-position are less substantial. For example, reaction of 3-isopropyl-5-methylpyrazole with  $\text{KBH}_4$  resulted in the formation of an approximate 4:1 ratio of  $\text{Tp}^{\text{iPr,Me}}$  and its isomer  $[\text{HB}(3\text{-isopropyl-5-methylpyrazolyl})_2(3\text{-methyl-5-isopropylpyrazolyl})]^-$  ( $= \text{Tp}^{\text{(iPr,Me)*}}$ ; the asterisk indicates the isomeric species).<sup>84</sup>

The probable reason for this regioselectivity is that boron–nitrogen bond formation, involving a concerted loss of hydrogen, proceeds through a less sterically encumbered transition state, when bonding occurs to the less hindered N(1) rather than to N(2). The only exception is benzopyrazole (indazole) and its derivatives containing alkyl or aryl substituents in the 3-, 4-, 5-, or 6-positions, which produces scorpionate ligands where boron is bonded to the more hindered nitrogen. This happens, presumably, because electronic effects outweigh steric ones. This tendency is most clearly manifested in  $\text{Tp}^{\text{CF}_3, \text{Me}}$ <sup>85</sup> and  $\text{Tp}^{\text{CF}_3, \text{Tn}}$ <sup>86</sup> in which electronically quite different substituents are present. The syntheses of these ligands are highly regioselective, with the larger  $\text{CF}_3$  group residing exclusively in the 3-position. The preference of an electron-withdrawing group for the 3-position in  $\text{Tp}^x$  ligands can be explained to consider that the inductive electron-withdrawing effect of the  $\text{CF}_3$  group makes the distal nitrogen more basic, favoring the tautomer with the  $\text{CF}_3$  group in the 3 position,  $\text{Hpz}^{\text{3CF}_3}$ .<sup>87</sup> The relative influence of steric and electronic effects on the course of ligand synthesis is evident from the preparation of  $\text{Tp}^{\text{Ms}}$ <sup>88</sup> ( $\text{Hpz}^{\text{Ms}} = 3\text{-mesitylpyrazole}$ ) in which the asymmetric isomer  $[\text{HB}(3\text{-Rpz})_2(5\text{-Rpz})]^-$  ( $= \text{Tp}^{\text{Ms*}}$ )<sup>4</sup> was the major product. A similar situation occurs, for instance, in the synthesis of  $\text{Tp}^{\text{Np}}$  ( $\text{Hpz}^{\text{Np}} = 3\text{-neopentylpyrazole}$ )<sup>89</sup> and  $\text{Tp}^{\text{Ant}}$  ( $\text{Ant} = 3(9\text{-anthryl})\text{pyrazole}$ ).<sup>90</sup>

Sometimes a regiochemically pure ligand  $\text{Tp}^{\text{R}}$  undergoes rearrangement to  $\text{Tp}^{\text{R*}}$  during the course of complex formation. For example, the 3-isopropyl substituent, in  $\text{Tp}^{\text{iPr}}$  and  $\text{Tp}^{\text{iPr,4Br}}$ , is large enough to prevent  $\text{Tp}_2\text{M}$  formation, although octahedral cobalt(II) complexes will form if a

borotropic migration occurs in the original ligands to yield  $\text{Tp}^{\text{iPr}*}$  and  $\text{Tp}^{(\text{iPr},4\text{Br})*}$  respectively.<sup>66</sup> Octahedral  $(\text{Tp}^{\text{Np}})_2\text{Ni}$  and  $(\text{Tp}^{\text{Np}})_2\text{Co}$  complexes have been isolated and crystallographically characterized. They are thermodynamically unstable and were converted upon heating to  $(\text{Tp}^{\text{Np}*})_2\text{Ni}$  and  $(\text{Tp}^{\text{Np}*})_2\text{Co}$  via a 1,2-borotropic shift.<sup>89</sup> Similar rearrangements were also found in the conversion from  $\text{Tp}^{\text{tBu}}\text{AlR}_2$  to  $\text{Tp}^{\text{tBu}*}\text{AlR}_2$ ,<sup>91,92</sup> from  $[(\text{Tp}^{\text{Ph}})_2\text{Al}]^+$  to  $[(\text{Tp}^{\text{Ph}*})_2\text{Al}]^{+93}$  and from  $\text{Tp}^{\text{Menth}}\text{TiCl}_3$  to  $\text{Tp}^{\text{Menth}*}\text{TiCl}_3$ .<sup>94</sup>  $\text{Tp}^{\text{Me}}\text{Ir}(\text{COD})$  was found to rearrange in solution first to  $\text{Tp}^{\text{Me}*}\text{Ir}(\text{COD})$  and then, on heating, to  $[\text{HB}(5\text{-Mepz})_2(3\text{-Mepz})]\text{Ir}(\text{COD})$ .<sup>95</sup>

#### 1.10.2.4.2 Steric effects

In a  $\text{M}[\text{Tp}^x]$  fragment the  $x$  substituents protrude in space past the metal, enveloping it, and forming a protective pocket of varying size and shape. Then, evaluation of the size of the variously substituted  $\text{Tp}^x$  ligands is more important to develop an understanding of the influence of the pyrazolyl ring substituents on the chemistry of their metal complexes. Ligand size can be evaluated by the concept of *cone angle* ( $\theta$ ). Refinements to the original method of cone angle determination, which was originally introduced for phosphine ligands,<sup>96</sup> which attempt to take into account steric demand changes accompanying orientational variations have been introduced. The smaller the cone angle, and the larger the wedge angle, the easier it is for other ligands to coordinate to the metal. Because of this feature, the proper choice of 3-R substituents does adjust the steric accessibility of the coordinated metal, in this fashion controlling the coordination chemistry of the  $\text{Tp}^x\text{M}$  species. Trofimenko and co-workers calculated cone angles for several  $\text{Tp}^x$  ligands using the dimensions established by X-ray crystallography for selected complexes,<sup>6,97–99</sup> connecting the center of the metal atom to the outermost point of the R-group and taking into account its van der Waals radii for all hydrogen atoms.<sup>100</sup>

All of the  $\text{Tp}$  ligands have a cone angle ( $\theta$ ) larger than  $180^\circ$ , and the trends in the values of these angles were consistent with the trends in the coordination chemistry of the  $\text{Tp}^x$  ligands. Indeed, the ligands of small cone angle ( $\text{Tp}$ ,  $\text{Tp}^{\text{Me}}$ ,  $\text{Tp}^{\text{cpr}}$ ,  $\text{Tp}^{\text{Tn}}$ ) are characterized by a strong tendency to form  $\text{Tp}^x_2\text{M}$  complexes with divalent first-row transition metals, and an inability to form stable  $\text{Tp}^x\text{MX}$  species.<sup>6,12,13,15–18,101,102</sup>

Ligands having an intermediate cone angle ( $\text{Tp}^{\text{iPr}}$ ,  $\text{Tp}^{\text{iPr}2}$ ,  $\text{Tp}^{\text{iPr},4\text{Br}}$ ,  $\text{Tp}^{\text{iPr},\text{Me}}$ ,  $\text{Tp}^{\text{Menth}}$ ,  $\text{Tp}^{\text{Np}}$ ,  $\text{Tp}^{\text{Ph}}$  and  $\text{Tp}^{\text{Ar}}$ , where Ar is a number of various substituted phenyl groups) are able to form both,  $\text{Tp}^x_2\text{M}$  and  $\text{Tp}^x\text{MX}$  species. Indeed, coordination of a solvent (sol) molecule or stronger binding of an additional  $\text{TpM}$  unit to form five-coordinate  $\text{TpMX}(\text{sol})$  or  $\text{TpM}(\mu\text{-L})_n\text{MTp}$  dimers, respectively, are possible. Representative examples of these motifs are the structures of  $\text{Tp}^{\text{iPr}2}\text{CuCl}(\text{dmf})$ , ( $\text{dmf} = N,N$ -dimethylformamide),<sup>103</sup>  $[(\text{Tp}^{\text{iPr}2}\text{Cu})_2(\mu\text{-OH})(\mu\text{-N}_3)]$ <sup>104</sup> and  $[(\text{Tp}^{\text{iPr},4\text{Br}}\text{Ni})_2(\mu\text{-NCS})_2]$ .<sup>105</sup>

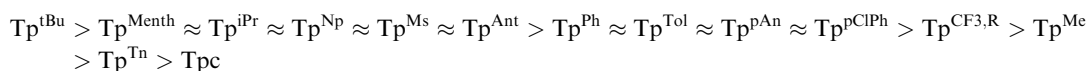
The most sterically demanding ligands (i.e.,  $\text{Tp}^{\text{tBu}}$ ,  $\text{Tp}^{\text{tBu},\text{Me}}$ ,  $\text{Tp}^{\text{tBu},\text{Tn}}$ ,  $\text{Tp}^{\text{tBu},\text{iPr}}$ ,  $\text{Tp}^{\text{Ms}}$ ,  $\text{Tp}^{\text{Ant}}$  and  $\text{Tp}^{\text{Triip}}$ ) inhibit formation of  $\text{Tp}_2\text{M}$  and  $\text{TpM}(\mu\text{-L})\text{MTp}$  ( $\text{L} =$  bridging group) complexes and heavily favor four-coordinate compounds  $\text{Tp}^x\text{MX}$  with  $\text{C}_{3v}$ -distorted tetrahedral geometries. A wide range of structurally characterized complexes of divalent metal halides and pseudohalides exemplifies these characteristic features. Representative cases are:  $\text{Tp}^{\text{tBu},\text{Me}}\text{Ni}(\text{NCS})$ ,<sup>105</sup>  $\text{Tp}^{\text{tBu}}\text{-CuCl}$ .<sup>101</sup> However, some exceptions to the “tetrahedral rule” are possible. In fact, small co-ligands such as  $\text{O}_2^-$ ,<sup>106</sup>  $\text{NO}_2^-$ ,<sup>107</sup> and  $\text{NO}_3^-$ ,<sup>101</sup> are able to bind the metal ions in a bidentate fashion to afford essentially five-coordinate complexes, as well as monodentate binding of two or three co-ligands to yield five- or six-coordinate complexes, respectively, of second-row transition metals and lanthanides.<sup>24,108</sup>

The cone angles depend not only on the ligand itself, but also on the length of the N—M bond. The choice of thallium complexes  $\text{Tp}^x\text{Tl}$ , the structures of which have been established by X-ray crystallography,<sup>90,98,103,109,110</sup> as “standard” systems for calculating the cone angles seemed to be the best choice. These specifications can be used to establish a relative steric hierarchy for the various  $\text{Tp}^x$  ligands.<sup>16</sup>

Comparisons of structures, physical properties, and reactivity of sets of similar compounds with homologous ligands provide additional insight into the steric demands of the variously substituted  $\text{Tp}^x$  ligands. For example, it is interesting to compare the X-ray crystal structures of the dimers  $[\text{Tp}^{\text{tBu}}\text{Cu}]_2$ ,<sup>111</sup>  $[\text{Tp}^{\text{tBu},\text{Me}}\text{Cu}]_2$ ,<sup>112</sup>  $[\text{Tp}^{\text{Ph}2}\text{Cu}]_2$ ,<sup>111</sup>  $[\text{Tp}^{\text{Me}2}\text{Cu}]_2$ ,<sup>113</sup>  $[\text{TpCu}]_2$ ,<sup>113</sup> that are useful starting materials for bioinorganic modeling studies.<sup>14,114–119</sup> Coordination numbers, geometries, and Cu—N distances within the set vary smoothly with the size of the ligand substituents. Combined results from experimental studies in which structures, spectroscopic properties, and



reactivity of a number of metal complexes were examined,<sup>14</sup> can be summarized by the following series in accordance with the effective steric bulk at a complexed metal center:

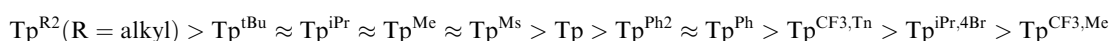


Ligands with identical R(3) groups but different R(4) or R(5) substituents should probably be placed in the same category as their analogs with R(4) = R(5) = H, although some structural and spectroscopic data suggest that their effective size is slightly larger.

### 1.10.2.4.3 Electronic effects

Comparison of the structure, physical and spectroscopic properties of similar compounds with homologous ligands provide insight into the relative electron-donating or -withdrawing capabilities of  $\text{Tp}^x$  ligands. Much of these experimental data were collected during efforts to compare Tp and  $\text{Tp}^*$  ligands with their formally iso-electronic analogs Cp and  $\text{Cp}^*$ . A useful set of molecules to contemplate are the  $\text{Cp}^x\text{M}(\text{CO})_3$  and  $\text{Tp}^x\text{M}(\text{CO})_3$  radicals and anions, where M is Cr, Mo and W.<sup>120–122</sup> Stereoelectronic effect differences have been inferred from IR  $\nu(\text{CO})$  values and oxidation potentials for the carbonyl anions.<sup>123</sup> The lower oxidation potentials ( $>0.1$  V) and the 15–20  $\text{cm}^{-1}$  lower energy of the *E* symmetry  $\nu(\text{CO})$  bands for the Tp versus the Cp complexes suggest that the Tp ligand is the stronger electron donor. Substitution of  $\text{Tp}^*$  for Tp results in shifts of oxidation potentials and of  $\nu(\text{CO})$  bands of the anions to lower values. These data, combined with redox potential measurements acquired for other complexes, including  $\text{CpRuTp}$  and  $\text{CpRuTp}^*$ <sup>124</sup> and the set  $\text{Cp}_2\text{Fe}$ ,  $\text{Cp}^*\text{Fe}$ , and  $\text{Tp}_2\text{Fe}$ ,<sup>125</sup> support the following trend in ligand electron-releasing capability:  $\text{Tp}^* > \text{Tp} \approx \text{Cp}^* > \text{Cp}$ .

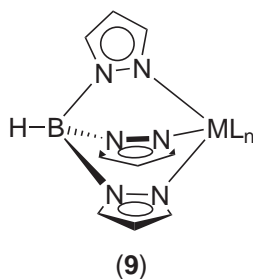
As recently reported by Kitajima and Tolman,<sup>14</sup> the relative electron-donating or electron-releasing properties of the more hindered  $\text{Tp}^x$  ligands can be gained by comparing  $\nu(\text{CO})$  data for sets of like metal carbonyl complexes that differ only in their pyrazolyl ring substituents; for example:  $\text{Tp}^x\text{Cu}(\text{CO})$ ,<sup>113,117,126,127</sup>  $\eta^2\text{-Tp}^x\text{Rh}(\text{CO})_2$ ,<sup>98</sup>  $\eta^3\text{-Tp}^x\text{Rh}(\text{CO})_2$ ,<sup>88,98</sup>  $[\text{NEt}_4][\text{TpW}(\text{CO})_3]$ ,<sup>108,123</sup> and  $\text{Tp}^x\text{Mo}(\text{CO})_2(\text{NO})$ .<sup>65,66,128,129</sup> Higher values for the carbonyl stretching frequencies reflect lower electron density at the metal center and decreased electron donation by the  $\text{Tp}^x$  ligand for compounds within each set. Experimental data support the following trend of electron-donating ability of  $\text{Tp}^x$  ligands:



The order is generally that expected on the basis of the extensive knowledge of electronic effects of substituents in organic chemistry; in fact, the electron donation increases with the number of pyrazolyl alkyl substituents.

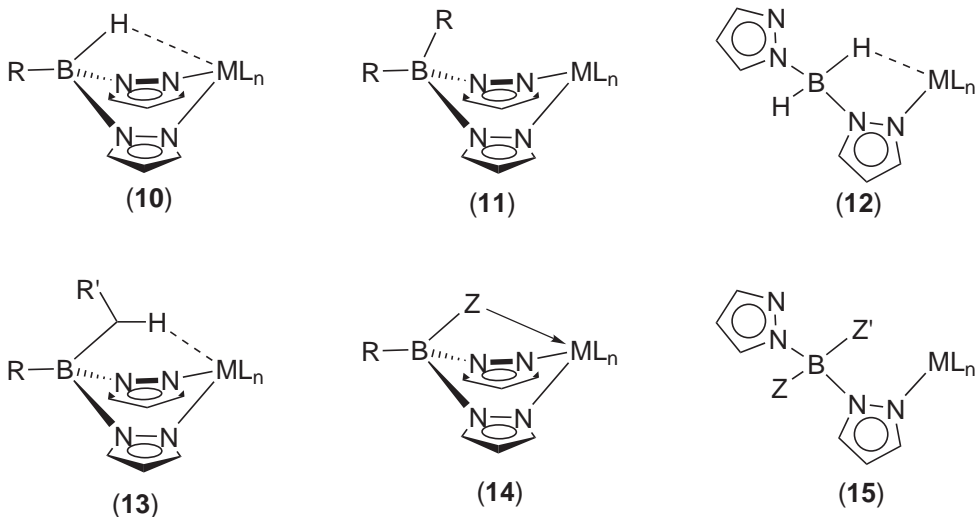
### 1.10.2.5 Coordination Modes

Poly(pyrazolyl)borate ligands are so popular due to their reliability and accountability as spectator ligands, which normally do not interfere with the reaction scenarios occurring at the metal centers. Tris(pyrazolyl)borates,  $\text{Tp}^x$ , generally coordinate as tridentate ligands through three nitrogen atoms of the pyrazole rings  $\kappa^3\text{-N}, \text{N}', \text{N}''$ , (9) thereby providing effective steric shielding of the metal center.<sup>2,6,13,14,23,121</sup>



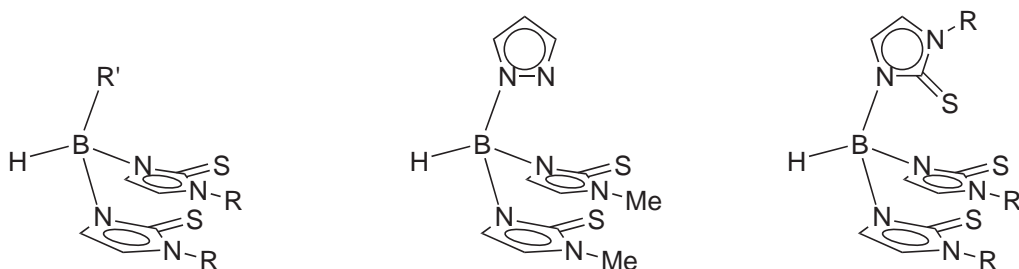
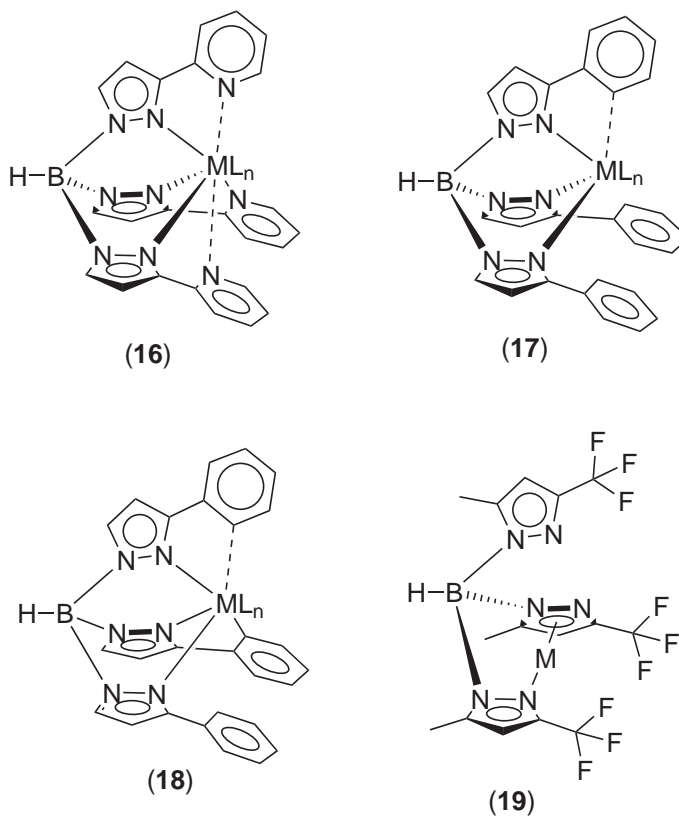
By introducing suitable substituents (e.g., Me, CF<sub>3</sub>, *t*Bu, Ph) in the 3-position of the pyrazolyl rings this effect can be tuned to a large extent. Cone angles much larger than 180° can be achieved with the use of such sterically demanding scorpionate ligands, which, for example, have been utilized to realize unusual bonding.

Besides the very common  $\kappa^3$ -*N,N',N''* coordination mode, the tridentate  $\kappa^3$ -*N,N',B-H* type (**10**)<sup>110</sup>, the bidentate  $\kappa^2$ -*N,N'* (**11**)<sup>130–132</sup> and  $\kappa^2$ -*N,B-H* coordination (**12**)<sup>133–135</sup> are also known. In contrast to the relatively easy formation of agostic B—H—M bonds with Bp<sup>x</sup> ligands, the formation of agostic B—C—H—M (**13**) bonds does not occur very frequently. In addition these bonds can easily be broken by donor ligands. At the same time, the R groups may shield effectively the coordinated metal from other ligands. On the other hand, no agostic interaction was found with the Ph<sub>2</sub>Bp ligand. Ligands of type R(Z)Bp<sup>x</sup> are generally tridentate, due to the presence of a heteroatom Z which can, and does, coordinate to the metal (**14**). The [R(Z)Bp<sup>x</sup>]<sup>−</sup> ligands will also include those where Z is a pyrazolyl group, provided it is different from pz<sup>x</sup>, and is not its regioisomer. It will not include Tp<sup>x\*</sup> ligands, arising from a rearrangement of a Tp<sup>x</sup> ligand. Lower denticity, such as  $\kappa^1$ -*N*, has also been reported (**15**).<sup>68,136,131,134</sup> Recently, Carmona *et al.* were able to prove a denticity change in a rhodium pyrazolylborate system and thereby isolate the first ionic complex containing a  $\kappa^0$ -Tp\* ligand (Tp\* serves exclusively as an uncoordinated counter ion).<sup>137</sup> It was possible to interconvert Tp\*– $\kappa^3$ N,  $\kappa^2$ N,  $\kappa^1$ N, and  $\kappa^0$  complexes. The stepwise change in the denticity of pyrazolylborate ligands from  $\kappa^3$  to  $\kappa^0$  may have important implications in catalytic uses of Tp<sup>x</sup> metal complexes. Expansion of Tp<sup>x</sup> denticity beyond  $\kappa^3$  can occur by way of the 3-R substituent containing donor atoms, as in the demonstrably hexadentate Tp<sup>Py</sup> (**16**),<sup>138,139</sup> or in the potentially hexadentate ligands Tp<sup>oAn</sup><sup>140</sup> or Tp<sup>2,4(OMe)2Ph</sup>.<sup>141</sup> On the other hand, tetradenticity was reported in Tp<sup>x</sup> ligands where R doesn't contain donor atoms, either by way of agostic bonding,<sup>142</sup> or through cyclometalation taking place at one of the aliphatic R groups per ligand (**17**).<sup>143</sup> Recently an example was reported of an unusual  $\kappa^5$  coordination demonstrated by hydrotris(3-phenylpyrazolyl)borate ligands (Tp<sup>Ph</sup>) (**18**).<sup>144</sup> Yet another entirely new aspect of scorpionate coordination chemistry is the  $\eta^5$  coordination of a pyrazole ring. Despite the formal similarities with the cyclopentadienyl ligands a  $\pi$ -interaction between a pyrazolylborate ligand and a metal center was recently reported only in a blue complex of composition [(KTp<sup>CF<sub>3</sub>,Me</sup>)<sub>2</sub>(CuCO<sub>3</sub>)<sub>2</sub>] (**19**).<sup>145</sup> Of special interest is the coordination environment around the potassium center. One of the coordination hemispheres of the potassium ion is occupied by two carbonate oxygen atoms, one N atom of the Tp<sup>CF<sub>3</sub>,Me</sup> ligand, and three fluorine atoms. On the opposite side the potassium ion is located directly above the center of a pyrazole ring, thus allowing a comparison with the  $\eta^5$ -cyclopentadienyl coordination in polymeric KCp.<sup>146</sup>



### 1.10.3 SOFT S-DONOR SCORPIONATES

For the nomenclature of these ligands (Scheme 2) we adopt a scheme derived from that of the tris(pyrazolyl)borate ligands. We call the bis(thioimidazolyl)hydroborate RBm<sup>x</sup> and the tris(thioimidazolyl)hydroborate RTm<sup>x</sup> with x naming the substituent at the 1-positions of the imidazole rings and R the substituent at boron atom.



$Bm^{Me}$ :  $R = Me, R' = H$

$Bm^{Mes}$ :  $R = \text{mesityl}, R' = H$

$MeBm^{Me}$ :  $R = Me, R' = Me$

$PhBm^{Me}$ :  $R = Me, R' = Ph$

$pzBm^{Me}$

$Tm^{Me}$ :  $R = Me$

$Tm^{Ph}$ :  $R = Ph$

$Tm^{t-Bu}$ :  $R = t-Bu$

$Tm^{Mes}$ :  $R = \text{mesityl}$

$Tm^{Cum}$ :  $R = \text{cumenyl}$

$Tm^{Bz}$ :  $R = \text{benzyl}$

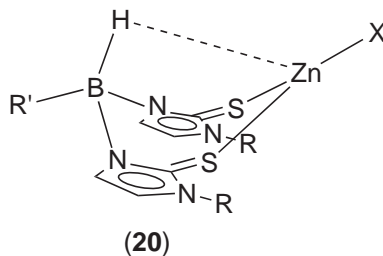
$Tm^{p-Tol}$ :  $R = p\text{-tolyl}$

Scheme 2

### 1.10.3.1 Hydrobis(mercaptoimidazolyl)Borates ( $Bm^x$ )

The bidentate  $S_2$ -donor bis(mercaptoimidazolyl) ligands  $Bm^{Me}$  and  $Bm^{Mes}$  were obtained by Parkin by reaction of  $LiBH_4$  with two equivalents of 2-mercapto-1-R-imidazole in toluene at  $50^\circ C$ .<sup>29</sup> Since thallium derivatives have proven to be useful reagents for transferring bis- and

tris(pyrazolyl)borate ligands, the thallium complex  $[\text{Bm}^{\text{Me}}]\text{Tl}$  was prepared by reaction of  $[(\text{Bm}^{\text{Me}})\text{Li}]$  with  $\text{Tl}(\text{O}_2\text{CCMe})$ .<sup>147</sup> Subsequent treatment of  $(\text{Bm}^{\text{Me}})$  and  $(\text{Bm}^{\text{Mes}})$  with  $\text{ZnX}_2$  ( $\text{X} = \text{Me}, \text{I}, \text{NO}_3$ ) yields a series of  $[(\text{Bm})\text{ZnX}]$  complexes each of which possesses 3-center-2-electron  $[\text{Zn} \cdots \text{H}-\text{B}]$  interactions (**20**).



The homoleptic complex  $[(\text{Bm})_2\text{Zn}]$  may be obtained by a redistribution reaction of  $[(\text{Bm})\text{ZnMe}]$  in  $\text{CHCl}_3$ , and possesses a tetrahedral zinc center which is devoid of a 3-center-2-electron  $[\text{Zn} \cdots \text{H}-\text{B}]$  interaction.<sup>147</sup> The zinc complexes  $[(\text{Bm})\text{ZnX}]$  are monomeric in the solid state whereas the Li and Tl species are oligonuclear with the metal centers being bridged by sulfur atoms of the mercaptoimidazolyl group. The isolation of the 1:1  $[(\text{Bm})\text{ZnX}]$  species provides a contrast with the homoleptic  $\text{L}_2\text{Zn}$  derivatives that have been previously obtained using related  $\text{S}_2$ -donor ligands.

The ligands  $\text{RBm}^{\text{Me}}$  ( $\text{R} = \text{Me}^{\text{31}}$  and  $\text{Ph}^{\text{148}}$ ) have been described by Santos who also reported their coordination chemistry towards  $\text{U}^{\text{III}}$  and  $\text{Re}^{\text{I}}$  salts.

Kimblin and Parkin also reported the synthesis and use of  $\text{pzBm}^{\text{Me}}$  to provide  $[\text{SSN}]$  coordination environments suitable for modeling aspects of the bioinorganic chemistry of zinc enzymes.<sup>29,149</sup> Complexes  $[(\text{pzBm}^{\text{Me}})_2\text{M}]$  ( $\text{M} = \text{Zn}, \text{Co}$  or  $\text{Cd}$ ), despite their similar composition, adopt a different structure: 1) the zinc complex exhibits a tetrahedral  $\text{Zn}[\text{S}_4]$  core in which only the sulfur donors coordinated to metal; 2) the cobalt complex a trigonal-bipyramidal  $\text{Co}[\text{S}_3\text{NH}]$  structure in which one of the pyrazolyl groups and one of the BH coordinates to metal; 3) the cadmium complex exhibits a six-coordinate  $\text{Cd}[\text{S}_4\text{H}_2]$  structure in which both BH interact with the metal. In addition Parkin demonstrated that the mixed bis(thioimidazolyl)(pyrazolyl)hydroborates open the way to tetrahedral  $(\text{N},\text{S},\text{S})\text{Zn}-\text{X}$  complexes. It became obvious too, however, that such complexes have a tendency for dismutation, resulting in neutral bis(ligand) complexes with  $\text{ZnS}_4$  coordination.

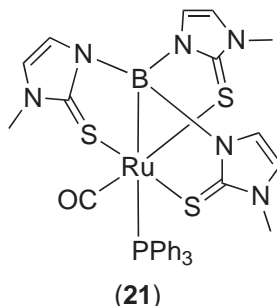
### 1.10.3.2 Hydrotris(mercaptoimidazolyl)Borates (Tm)

Reglinski and co-workers have recently reported the synthesis of the tripodal  $\text{S}_3$ -donor  $\text{Tm}^{\text{Me}}$  by reaction of  $[\text{BH}_4]^-$  with 2-mercapto(imidazolyl)borato ligands in the melt, a procedure similar to that used in the preparation of tris(pyrazolyl)borato derivatives.<sup>150</sup> Treatment of zinc bromide with excess ligand leads to the preferential formation of the 1:1 complex  $[(\text{Tm}^{\text{Me}})\text{ZnBr}]$  (**20**).<sup>150</sup> In some cases  $\text{Tm}^{\text{Me}}$  offers a slightly different metal binding geometry to that found in  $\text{Tp}$ , as demonstrated by the comparison of the  $[(\text{Tp})\text{ZnBr}]$  with  $[(\text{Tm})\text{ZnBr}]$ . The ligand  $\text{Tm}^{\text{Me}}$  is the first example of a soft, singly charged, tridentate trigonal six-electron donor analog of  $\text{Tp}$ .  $\text{Tm}^{\text{Me}}$ , along with the mixed pyrazole/methimazole donor ligand  $\text{pzBm}^{\text{Me}}$ , has great potential for tuning the electron density at the metal center and hence the redox properties, a factor which is of great importance when exploiting the coordination chemistry of organometallic compounds in catalysis and material science. This novel ligand system maintains the tripodal geometry around the boron while allowing the replacement of the three nitrogen donor atoms by three sulfur thione donor atoms, thus providing a complementary soft, tridentate face capping ligand system.<sup>151</sup> The compound  $(\text{Tm}^{\text{Me}})\text{Na}$  is essentially salt like with discrete anions and hydrated sodium cations.<sup>151</sup>

Reglinski ( $\text{Tm}^{\text{Me}}$ ),<sup>150,151</sup> Parkin ( $\text{Tm}^{\text{Ph}}$  and  $\text{Tm}^{\text{Mes}}$ ),<sup>152</sup> Vahrenkamp ( $\text{Tm}^{\text{t-Bu}}$  and  $\text{Tm}^{\text{Cum}}$ ),<sup>153</sup> and Rheingold ( $\text{Tm}^{\text{Bz}}$  and  $\text{Tm}^{\text{p-Tol}}$ )<sup>154</sup> showed that this family of ligands is indeed suitable for a biomimetic zinc complex chemistry.

In their initial attempts to prepare classical chelate complexes containing  $\text{Tm}^{\text{Me}}$ , Hill and co-workers<sup>155</sup> have encountered an unprecedented class of reaction for tris(azolyl)borate, namely the intramolecular activation of the bridgehead B—H bond which provides the first example of a metallaboratrane. The reaction of  $\text{Tm}^{\text{Me}}$  with  $[\text{Ru}(\text{R})\text{Cl}(\text{COPPh}_3)]$  ( $\text{CH}=\text{CHCPh}_2\text{OH}$ ) likely yield

the complex  $[\text{Ru}(\text{R})(\text{CO})(\text{PPh}_3)(\text{Tm}^{\text{Me}})]$ . In contrast to the rigid chelation of Tp ligands, the more expansive chelation of  $(\text{Tm}^{\text{Me}})$  might be expected to be more flexible and labile. Dissociation of one  $(\text{Tm}^{\text{Me}})$  arm followed by agostic BH coordination and ultimate oxidative addition of the BH bond could provide a cis-hydrido-vinyl complex that undergoes alkene reductive elimination with formation of the complex (**21**). The remarkable facility with which the ruthenaboratrane forms may presumably be traced to both the lability of  $(\text{Tm}^{\text{Me}})$  chelation and the increased ring size of the chelates, which allows the scorpion sting to more closely approach the metal center.



The tris(mercaptophenylimidazolyl)borate iron and cobalt complexes  $[(\text{Tm}^{\text{Ph}})_2\text{M}]$  ( $\text{M} = \text{Fe}, \text{Co}$ ) have been synthesized by reaction of  $(\text{Tm}^{\text{Ph}})\text{Ti}$  with  $\text{MI}_2$ .<sup>156</sup> Structural characterization by X-ray diffraction demonstrates that the potentially tridentate  $\text{Tm}^{\text{Ph}}$  binds through only two sulfur donors in these sandwich complexes and that the tetrahedral metal centers supplement the bonding by interactions with two BH groups. Comparison of the structures of  $[(\text{Tm}^{\text{Ph}})_2\text{M}]$  with those of related tris(pyrazolyl)borate counterparts indicates that the Tm favors lower primary coordination number in divalent metal complexes.

The molecular structure of  $(\text{Tm}^{\text{Ph}})_2\text{Pb}$ , synthesized by Parkin,<sup>157</sup> was determined by X-ray diffraction, revealing that it possesses an unusual structure with an inverted  $\eta^4$ -coordination mode for the  $\text{Tm}^{\text{Ph}}$  ligand which includes a  $\text{Pb}\cdots\text{H}-\text{B}$  interaction. Whereas an inverted  $\eta^3$ -coordination mode for the  $\text{Tm}^{\text{Me}}$  ligand was found in a silver(I) phosphino compound.<sup>158</sup> In absence of phosphine  $\text{Tm}^{\text{Me}}$  reacts with silver yielding a dinuclear complex in which the  $\text{S}_3$ -donor acts in tetradentate bridging fashion.<sup>159</sup> The same ligand reacts with triorganotin(IV) moieties acting in an unprecedented monodentate S-donor coordination mode.<sup>160</sup>

Molybdenum and tungsten complexes containing  $\text{Tm}^{\text{Me}}$  are reported as the first examples of transition-metal organometallic complexes of this family of ligands, serving as general entry points for a wide range of Group 6 organometallic complexes. The crystal structures have been determined, and comparison is made with the homologous pyrazolylborate (Tp) and cyclopentadienyl (Cp) complexes, leading to predictions regarding their reactions.<sup>161</sup>

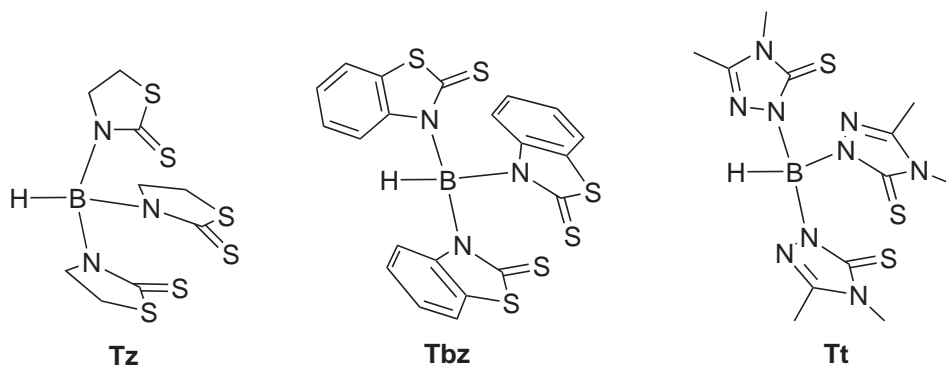
### 1.10.3.3 Other $\text{S}_3$ -donor Scorpionates

The synthesis of new soft tripodal anions, hydrotris-(mercaptothiazolyl)borates (Tz) and (mercaptobenzothiazolyl)borates (Tbz) (Scheme 3) was reported by Ojo using the protocol of Trofimenko (Scheme 1). Ojo indicated that analysis of the respective thione melting points and  $\text{p}K_a$  values enables the prediction of which thiazolylborate anions can be produced using borohydride melts. The X-ray crystal structure of  $[\text{Ti}(\text{Tbz})_\infty]$  is also reported.<sup>162</sup>

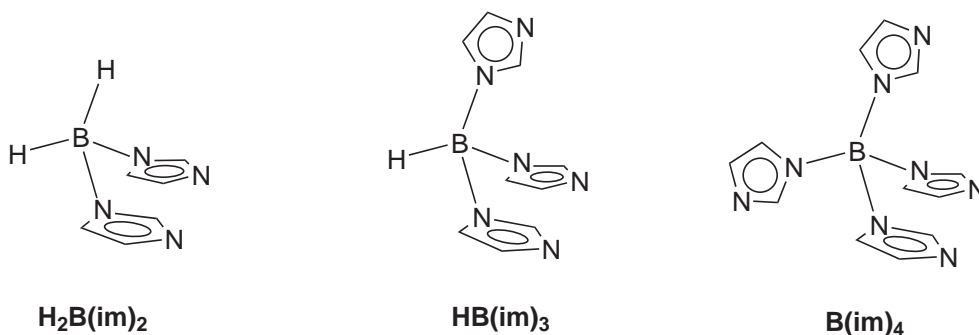
Treatment of 5-thioxo-4,5-dihydro-3,4-dimethyl-1,2,4-triazole with sodium tetrahydroborate at  $210^\circ\text{C}$  provides the new  $\text{N}_3\text{S}_3$ -donor tripod ligand Tt as its sodium complex salt  $[\text{Na}(\text{H}_2\text{O})_6][\text{Na}(\text{Tt})_2]$ . Bailey also describes some Tt bismuth(III), tin(IV) and manganese complexes, which illustrated the flexible Tt offering a combination of the properties of the Tp and Tm ligands.<sup>163</sup>

### 1.10.4 POLY(IMIDAZOLYL)BORATES

Poly(imidazolyl)borates  $\text{H}_n\text{B}(\text{im})_{4-n}$  (Scheme 4) can be prepared by analogy with that reported for poly(pyrazolyl)borates.<sup>164</sup>  $\text{H}_n\text{B}(\text{im})_{4-n}$  can be used to model the histidine imidazole coordination in metalloproteins.  $\text{H}_n\text{B}(\text{im})_{4-n}$  complexes have been widely described,<sup>165</sup> but only few metal derivatives are structurally authenticated: i.e., the ionic lithium salt of tetrakis(imidazolyl)borate,<sup>166</sup>



Scheme 3



Scheme 4

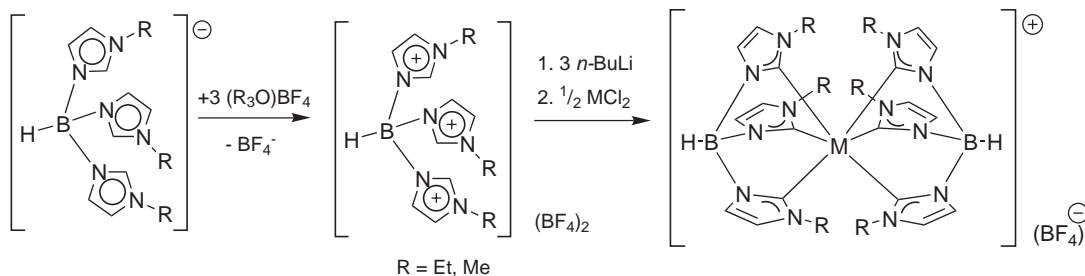
a hydrotris(imidazolyl)borato thallium(I), in which each imidazolyl ring coordinates a different thallium ion to form a one-dimensional twisted ladder-like strand<sup>167</sup> and two silver(I) compounds in which the metal atoms are bridged by H<sub>2</sub>B(im)<sub>2</sub> and B(im)<sub>4</sub> ligands.<sup>168</sup> Unlike poly(pyrazolyl)borates, the isomeric H<sub>n</sub>B(im)<sub>4-n</sub> ligands cannot chelate a metal center but have to bridge between metal ions.

A modified *in situ* preparation of the chelating monoanionic dicarbene<sup>169</sup> and tricarbene ligands<sup>170</sup> along with the syntheses of the hexacarbene metal complexes reported by Fehlhammer and co-workers is shown in Scheme 5.

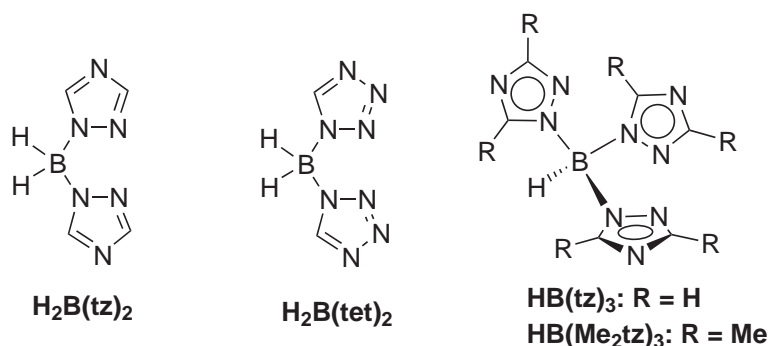
Lanthanide complexes with dihydrobis(benzimidazolyl)borate for which a seven-coordinate polymeric structure was proposed have been described by Khan and co-workers.<sup>171</sup>

#### 1.10.4.1 Poly-(triazolyl)- (H<sub>n</sub>B(tz)<sub>4-n</sub>), -(tetrazolyl)-borates (H<sub>n</sub>B(tet)<sub>4-n</sub>)

Although a cobalt complex of hydrotris(1,2,4-triazolyl)borate was reported by Trofimenko in 1967,<sup>172</sup> the chemistry of triazolylborate ligands has remained undeveloped for many decades. A convenient



Scheme 5

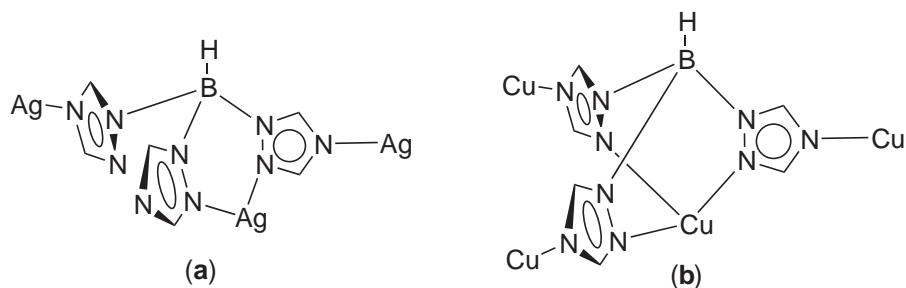


Scheme 6

preparation of potassium salt of  $(\text{HB}(\text{tz})_3)$  was reported by Gioia Lobbia,<sup>173</sup> whereas the synthesis of the corresponding salt of  $(\text{H}_2\text{B}(\text{tz})_2)$  was reported by Janiak.<sup>174</sup>

Two features of  $\text{H}_n\text{B}(\text{tz})_{4-n}$  (Scheme 6) make them attractive candidates for further examination: a) they should be electron-withdrawing relative to their pyrazolyl-based counterparts; b) the exo ring-nitrogen atoms of the triazolyl-based ligands can bridge between metal centers, thereby creating coordination polymers with interesting solid-state structures and optical properties, as shown by Janiak.<sup>174</sup> An unprecedented coordination mode was found in a silver compound where  $\text{HB}(\text{tz})_3$  bis-chelates the metal center with two endodontate nitrogen atoms and also bridges to two other silver atoms through two of the three exodontate nitrogen atoms (Scheme 7a).<sup>175</sup> In a copper(II) complex  $\text{HB}(\text{tz})_3$  utilizes all six nitrogen atoms in metal coordination, thereby bridging four copper centers and yielding a three-dimensional coordination polymer (Scheme 7b).<sup>176</sup> The X-ray crystal structures of the iron and cobalt complexes of  $\text{HB}(\text{tz})_3$  show the formation of a two-dimensional liquid water phase in the crystal lattice. Transition metal complexes of  $\text{H}_2\text{B}(\text{tz})_2$  are one-dimensional coordination polymers separated by one-dimensional arrays of water molecules in the form of edge-sharing six-membered rings.<sup>174</sup> A dioxomolybdenum compound containing the methyl substituted  $\text{HB}(\text{Me}_2\text{tz})_3$  was reported by Xiao.<sup>177</sup>

The synthesis and structure of the first tetrazolylborate  $\text{H}_2\text{B}(\text{tet})_2$  was reported by Janiak<sup>178</sup> which also employed  $\text{H}_2\text{B}(\text{tet})_2$  in the construction of infinite two-dimensional metal–ligand frameworks and one-dimensional water substructures.<sup>179</sup>

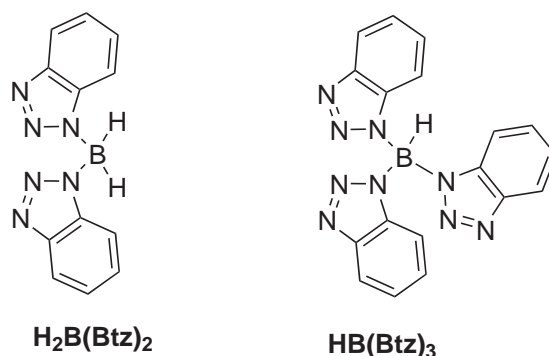


Scheme 7

#### 1.10.4.2 Poly(benzotriazolyl)Borates ( $\text{H}_n\text{B}(\text{Btz})_{4-n}$ )

In 1988 Lalor reported the synthesis and spectroscopic characterization of some new poly(benzotriazolyl)borate salts (Scheme 8).<sup>180</sup> The regioselectivity of the synthesis of  $\text{H}_n\text{B}(\text{Btz})_{4-n}$  differs from that of pyrazole/ $\text{BH}_4^-$  reaction in that B–N bond formation takes place in a manner that maximizes steric crowding at boron (i.e., at the triazole N(1) atoms). In 1989 Shiu describes some new metal carbonyls of  $\text{HB}(\text{Btz})_3$ .<sup>181</sup> The synthesis and spectroscopic characterization of some first-row transition metal complexes was reported by Cecchi,<sup>182</sup> whereas Hill described some new Rh<sup>183</sup> and Ru<sup>184</sup> carbonyl and isonitrile complexes. The formation of isonitrile derivatives was proposed to proceed through an associative mechanism involving an intermediate complex





Scheme 8

containing a  $\text{K}^+$ -unidentate  $\text{H}_2\text{B}(\text{Btz})_2$ .<sup>185</sup> Two different coordination modes for this family of ligands have been recently structurally authenticated in a series of copper(I) complexes.<sup>186</sup>

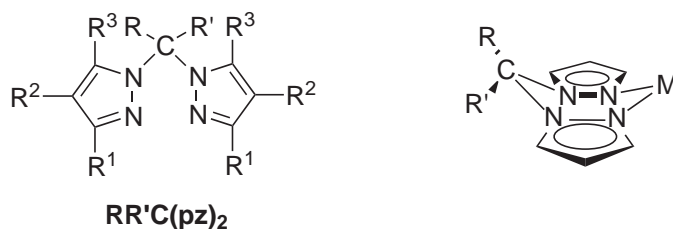
### 1.10.5 POLY(PYRAZOLYL)ALKANES

Poly(pyrazolyl)alkanes constitute a family of stable and flexible polydentate ligands isoelectronic and isosteric with poly(pyrazolyl)borate. These donors can be prepared readily and various substituents may replace each hydrogen atom, so that electronic and steric effects can be varied nearly at will. These molecules contain azole rings which are generally very stable towards chemical attack, for example against both oxidizing and reducing agents. In contrast to poly(pyrazolyl)borates, the synthesis and reactivity of their neutral and isosteric carbon-centered analogs, the poly(pyrazolyl)methanes, is considerably less developed, perhaps due to the relatively small number of such ligands currently available. However, recent developments in bis(pyrazolyl)methane chemistry, including the synthesis of potential platinum anticancer agents,<sup>187</sup> and the preparation of asymmetric allylic alkylation,<sup>188</sup> olefin hydrogenation,<sup>189</sup> and alkyne hydroamination catalysts have been reported.<sup>190</sup>

#### 1.10.5.1 Bis(pyrazolyl)Alkanes

##### 1.10.5.1.1 Coordination modes of bis(pyrazolyl)alkanes

Bis(pyrazolyl)alkanes, e.g.,  $(\text{RR}'\text{C}(\text{pz})_2)$  in Scheme 9, are bidentate ligands which have been shown to afford several types of stable metal complexes. In the growing number of metal derivatives of this family of ligands some were also characterized through X-ray crystal structures (Sn,<sup>191</sup> Nb,<sup>192</sup>



$\text{R}, \text{R}' = \text{H}, \text{Me}$  or Ph

$\text{R}^1, \text{R}^2 = \text{H}, \text{Me}, t\text{-Bu}, i\text{-Pr}, \text{Ph}$

$\text{R}^3 = \text{Me}, \text{Cl}, \text{Br}, \text{NO}_2$

Scheme 9



Pd<sup>193</sup>, Mo<sup>194</sup>). These showed that RC(pz)<sub>2</sub> are mainly chelating and fit into several coordination arrangements.

While 2,2'-bipyridine or phenanthroline adducts are likely to contain an approximately planar, five-membered –M-N-C-C-N moiety, upon coordination of a RR'<sub>2</sub>C(pz)<sub>2</sub> a six-membered cycle is formed for which a boat conformation is predicted. Nevertheless, both the internal and external angles of the formally related M-(N-N)<sub>2</sub>-E moieties (where E is not carbon), are known to be able to undergo wide variations. Indeed, X-ray studies carried out on several μ-pyrazolato-*N,N'*-derivatives showed that the six-membered ring is not always in the boat conformation. This may undergo a severe folding as in bis(3,5-dimethylpyrazolyl)borato-*N,N'*[(η<sup>3</sup>-cycloheptatrienyl)(dicarbonyl)molybdenum,<sup>195</sup> or may even approximate a chair, or at least, a distorted chair as in dimeric bis(cyclopentadienyltitanium)(μ-pyrazolato-*N,N'*) (Scheme 10a).<sup>196</sup>

The reaction of Me<sub>2</sub>C(pz)<sub>2</sub> with Pt<sup>II</sup> derivatives was investigated. Cleavage of a C(sp<sup>3</sup>)–N bond in Me<sub>2</sub>C(pz)<sub>2</sub> is promoted by Pt<sup>II</sup>.<sup>197</sup> In the compound [(Me<sub>2</sub>C(pz)<sub>2</sub>)PdCl<sub>2</sub>] a Pd···H–C agostic interaction was found.<sup>198</sup>

Thermolysis of [PhHC(Me<sub>2</sub>pz)<sub>2</sub>Mo(CO)<sub>4</sub>] in DME gives [PhHC(Me<sub>2</sub>pz)<sub>2</sub>Mo(CO)<sub>3</sub>]. Comparison of the structural details of these two compounds and the reactivity of the latter compound show that it is the first example containing an intramolecularly coordinated η<sup>2</sup>-arene ligand (Scheme 10b).<sup>199</sup>

The reaction between Pd<sup>II</sup> acetate and (H<sub>2</sub>C(aryl)pz)<sub>2</sub> in refluxing acetic acid affords metallacycles with two different five- and six-membered palladacycles, one containing an aromatic carbon–metal bond and the other a pyrazole carbon–metal bond (Scheme 10c).<sup>200</sup>

Some neutral and cationic palladium(II) (RR'<sub>2</sub>C(pz)<sub>2</sub>) complexes have been reported by Tsuji and co-workers.<sup>201</sup> The cation [(Me<sub>2</sub>C(pz)<sub>2</sub>)Pd(CH<sub>2</sub>=CH<sub>2</sub>)]<sup>+</sup> undergoes ethylene insertion at –10 °C and oligomerizes ethylene (1 atm) to predominantly linear internal C<sub>8</sub> to C<sub>24</sub> olefins (*ca.* 0.1 branches per 2 carbons) at 23 °C.

The bidentate ligands (RR'<sub>2</sub>C(pz)<sub>2</sub>) react with R''<sub>2</sub>BX compounds, where X is a leaving group, to form boronium cations [(RR'<sub>2</sub>C(pz)<sub>2</sub>)BR''<sub>2</sub>]<sup>+</sup> isosteric with pyrazaboles and isolable as PF<sub>6</sub><sup>–</sup> salts.<sup>202</sup>

Some Li(BH<sub>4</sub>) complexes containing (RR'<sub>2</sub>C(pz)<sub>2</sub>) ligands have been prepared for use as potential new hydrogen sources.<sup>203</sup>

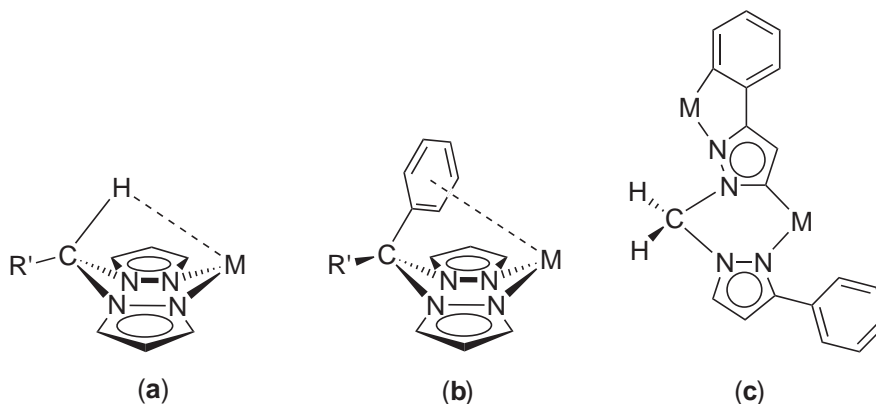
Gem-(R<sub>2</sub>C(pz)<sub>2</sub>) can be lithiated at the inter ring carbon atom to give carbanions which react with a variety of electrophyles.<sup>204</sup> Lithiation can also be directed to the 5-position of the ring.

C-organostannyl and organosilyl derivatives of (Me<sub>2</sub>C(pz)<sub>2</sub>) and (H<sub>2</sub>C(pz)<sub>2</sub>) have been reported and characterized spectroscopically by Molloy and co-workers.<sup>205</sup> Lithiation and subsequent substitution by R<sub>3</sub>M takes place at the 5,5'-positions for both bis-heterocycles.

Synthesis and physicochemical studies of 1,2-bis(azolyl)ethanes are widely reported by Claramunt and co-workers<sup>206</sup> whereas the coordination properties have been investigated by Pettinari<sup>207</sup> and Elguero.<sup>208</sup>

Bis(pyrazolyl)propanes were proposed by Ward.<sup>209</sup> The 3-(2-pyridyl)-substituted ligand acts as tetradentate chelate to a single metal ion, forming a variety of mononuclear complexes.

The <sup>1</sup>H and <sup>13</sup>C NMR of selected (RR'<sub>2</sub>C(pz)<sub>2</sub>) have been reported by Elguero *et al.*<sup>210</sup> whereas X-ray crystal structures for the free ligands are reported by Bonati<sup>211</sup> and Pettinari.<sup>191</sup>



Scheme 10

### 1.10.5.1.2 Synthesis of symmetrical bis(pyrazolyl)alkanes

*N,N*-polyazolylmethanes can be prepared by reaction of azoles with methylene chloride in an autoclave at 150 °C (Scheme 11).<sup>202</sup> At 200 °C this reaction leads to 4,4'-dipyrazolylmethane, which upon reaction with boranes gives a pyrazaboles polymer. Some derivatives have been prepared from the reaction of potassium salts of the azole and methylene iodide. The ligand (tetrakis-(1-pyrazolyl)methane was prepared analogously. In selected cases a basic medium was employed.<sup>212</sup>



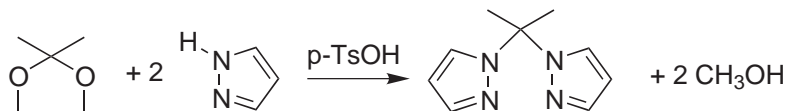
Scheme 11

Methylene chloride is often used in phase transfer catalysis as an inert solvent, and in some cases as a double alkylating agent. Juliá *et al.* demonstrate that phase transfer catalysis is an excellent method to obtain *N,N*-diazolylmethanes both by solid–liquid or liquid–liquid procedure.<sup>213</sup> Some general procedures are as follows: (a) a mixture of the azole (29 moles), 10 ml of 40% aqueous sodium hydroxide, tetrabutylammonium bromide (1.4 mmoles) and 1,2-dibromoethane in 25 ml toluene is heated (external temperature, 60–80 °C) for 24–72 h. After cooling, the aqueous phase is extracted with 3 × 40 ml of dichloromethane and the extract combined with the organic phase and the crude product obtained is purified by distillation, crystallization, column chromatography on silica gel with dichloromethane or sublimation. (b) A suspension of azole, anhydrous potassium carbonate (29 mmoles), powdered potassium hydroxide (29 mmoles), tetrabutylammonium bromide (1.4 mmoles) and 1,2-dibromoethane (14.5 mmoles) in 50 ml of toluene or xylene, is heated (external temperature 120 °C) for 48 hours. The hot reaction mixture is filtered and the residue washed twice with 30 ml of warm toluene or xylene. The solution is dried over anhydrous sodium sulfate and then treated as in (a).

The reaction of azoles and benzazoles with dihalomethane and dihaloethanes for the synthesis of bis(azolyl)methanes and ethanes was also performed in the absence of solvent by solid–liquid phase transfer catalysis. No solvent was used during the reaction and, when possible, during the work-up. Comparison with classical P.T.C. methods indicates the usefulness of Phase Transfer Catalysis without solvent in the synthesis of bis(azolyl)methanes. The advantages are higher yields and milder conditions by this method. Moreover, P.T.C. in the absence of solvent is a general procedure for the preparation of bis(azolyl)methanes while classical solid–liquid or liquid–liquid P.T.C. methods are used depending on the azole and this fact could be not rationalized. Finally, the absence of solvent permits the use of dibromomethane with the less reactive azoles because the alkylation agent is used in an equimolar amount and not in a large excess (as a solvent). Nevertheless, the regioselectivity obtained by this method is similar to that described by classical methods.<sup>214</sup>

When pyrazole rings are bridged by larger alkyl group (isopropylidene) the ligands were better prepared by acid-catalyzed reaction of pyrazole or C-substituted pyrazole with acetals or ketals (Scheme 12).<sup>215</sup>

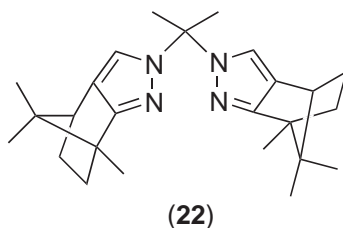
This method, conducted under equilibrating conditions when an unsymmetrically substituted



Scheme 12

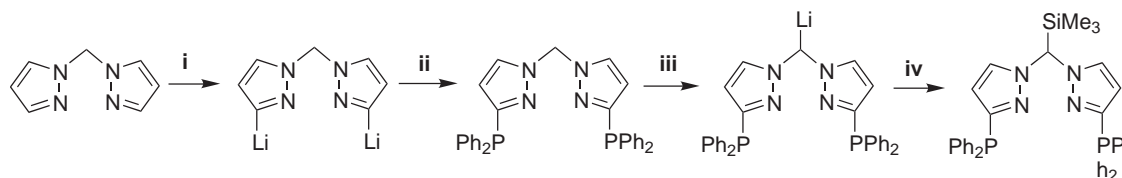
pyrazole was employed, gives rise to the isomer in which steric interaction between the pyrazole is minimized. The same procedure was applied to the synthesis of chiral bis(pyrazolyl)methane such as (22).<sup>109</sup>

The metal-catalyzed reaction of 1,1'-carbonyldipyrazoles with aldehydes or ketones to give 1,1'-alkylidenedipyrazoles and carbon dioxide, the latter being derived from the amide carbonyl



group, as shown by labeling experiments, is sensitive to electronic and steric substituent effects. Under comparable reaction conditions, 1,1'-carbonyldiimidazole, *N*-acetylpyrazole, and 1-pyrazole-*N,N*-diethylcarbonamide do not react with acetone while pyrazole-1-carbo(*N*-phenylhydrazide) yields an anilino isocyanate dimer. These results are interpreted in terms of a mechanism that involves coordination of the metal ion at the 2,2'-nitrogen atoms of the pyrazole rings and heterolytic cleavage of an amide bond, followed by formation of a carbamate intermediate, decarboxylation and metal ion exchange.<sup>216</sup>

The multistep syntheses of the novel polyfunctional ligands  $\text{H}_2\text{C}(3\text{-Ph}_2\text{Ppz})_2$  and  $(\text{Me}_3\text{SiCH}(3\text{-Ph}_2\text{Ppz})_2)$  have been reported by Otero (Scheme 13).<sup>217</sup> The coordinating ability of these ligands towards a variety of early and late metal ions was studied.



i) 2  $\text{Bu}^n\text{Li}$ , thf,  $-70^\circ\text{C}$ , 30min; ii) 2  $\text{Ph}_2\text{P-Cl}$ , thf, r.t., 12h; iii) 2  $\text{Bu}^n\text{Li}$ , thf,  $-70^\circ\text{C}$ , 1h; iv)  $\text{Me}_3\text{Si-Cl}$ , thf, r.t., 12h

Scheme 13

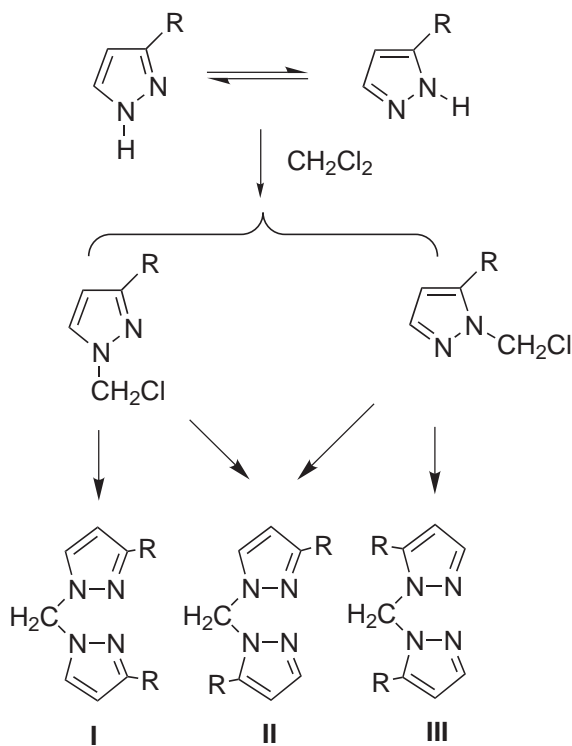
Since an asymmetric pyrazole such as 3(5)-Mepz can exist in two tautomeric structures in solution the reaction of asymmetric pyrazole with alkylation agents under P.T.C. conditions yields the three isomers I, II, and III shown in Scheme 14. Generally, the relative amounts of isomeric  $\text{RR}'\text{C}(\text{pz})_2$  (I:II:III) correspond to  $(a+b)^2$ . Reaction of 3-(2-pyridyl)pyrazole with  $\text{CH}_2\text{Br}_2$  affords only two isomers I and II,<sup>218</sup> whereas 3-(tertbutyl)pyrazole under analogous conditions gives only isomer I.<sup>219</sup>

The ligand  $(1,2\text{-(CH}_2)_2(3\text{-Fopz})_2)$  was prepared by reaction of 3-formylpyrazole with 1,2-ditosylate-ethane and  $\text{KO}t\text{-Bu}$  at  $-40^\circ\text{C}$  in thf. It converts, in the presence of copper(II), to the new ligand  $(1,2\text{-(CH}_2)_2(3\text{-Acetalpz})_2)$  which forms polymeric copper(II) complexes with the oxygen atoms from the acetal fragments semicoordinated to the metal ion, adjusting the coordination sphere to a very distorted octahedron (Scheme 15). This particular coordination is considered to be the driving force for the transformation of the aldehyde groups of the initial fragments into the acetal fragments.<sup>220</sup>

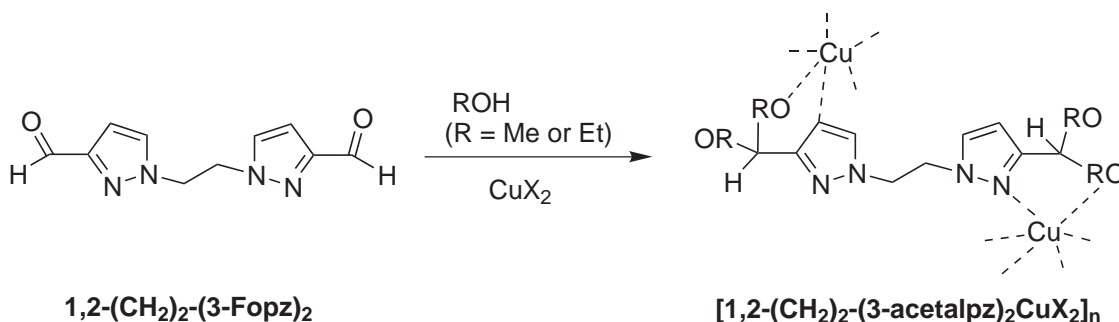
The modification of  $(\text{H}_2\text{C}(\text{Me}_3\text{pz})_2)$  by substitution of organotin(IV) groups on the central carbon atom was carried out by reaction of  $[\text{HLiC}(\text{Me}_3\text{pz})_2]$  with a triaryltin(IV) chloride. This new ligand shows an unprecedented  $\kappa^3[\text{N,C,N}]$  coordination mode.<sup>221</sup>

### 1.10.5.1.3 Synthesis of unsymmetrical bis(pyrazolyl)alkanes

Unsymmetrical bis(pyrazolyl)methanes can be obtained according to a general procedure published by Elguero in 1986.<sup>222</sup> The pyrazole was transformed into its 1-hydroxymethyl derivative by the action of formaldehyde. The 1-hydroxymethyl derivative then reacted with thionyl chloride to produce the 1-chloromethyl derivative which was isolated as its hygroscopic hydrochloride salt. Then under solid-liquid phase transfer conditions the 1-chloromethylpyrazole reacts with one equivalent of 3,4,5-trimethylpyrazole to selectively produce the unsymmetrical bis(pyrazolyl)-methane.



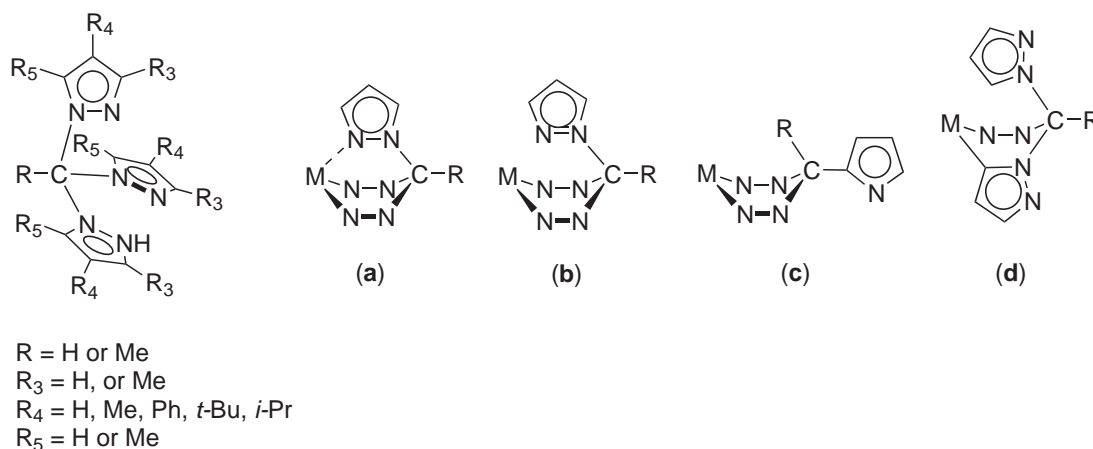
Scheme 14



Scheme 15

### 1.10.5.2 Tris(pyrazolyl)Alkanes

Metal complexes of the tris(pyrazolyl)borate ligand system are one of the most widely investigated classes of coordination compounds. On the other hand the tris(pyrazolyl)alkane ligands  $RC(pz)_3$  (Scheme 16) have received much less attention.  $RC(pz)_3$  are suitable for exploring the tendency of metal ions such as  $Rh^I$  and  $Ir^I$ ,<sup>223</sup> which characteristically form square-planar complexes, to extend their coordination environment to square-pyramidal or octahedral via axial interactions. The behavior of the tris(pyrazolyl)methane complex should mirror the behavior of the corresponding tris(pyrazolyl)borate, the major difference being in the charge between the methane and the borate counterpart. However, large differences appear in some cases: for example the  $RC(pz)_3$  ligands react with Group 6 metal hexacarbonyls to afford insoluble and involatile species, whereas the neutral species  $[(Tp)M(CO)_3]$  are very soluble and sublime easily.<sup>202</sup> The tripodal ligand  $HC(pz)_3$  produces a relatively strong ligand field, consistent with the rather short metal–nitrogen bond lengths in the complexes. The pyrazole group acts as moderately strong  $\sigma$  donor and a weak out-of-plane  $\pi$  donor, with the  $\pi$  interaction in the plane of the amine ligand probably being close to zero.<sup>224</sup>

**RC(pz)<sub>3</sub>****Scheme 16**

The most common coordination modes include tridentate (a), and bidentate with the third donor group above the metal center, but uncoordinated (b) or directed away from the metal center (c), as illustrated in Scheme 16. For example, interaction of (RC(pz)<sub>3</sub>) with tetrachloropalladate and removal of chloro-ligands yielded [Pd(L<sub>2</sub>)]<sup>++</sup>[X<sup>-</sup>]<sub>2</sub> in which the ligand RC(pz)<sub>3</sub> acts as a bidentate ligand to give a square-planar PdN<sub>4</sub> geometry.<sup>225</sup> Metalation (d) of (HC(pz)<sub>3</sub>) can occur with Me<sub>2</sub>Pt<sup>II</sup><sup>226</sup> and Ir<sup>III</sup> complexes.<sup>227</sup> Trofimenko showed that as with the tris(pyrazolyl)borate analogs these ligands bind both early and late transition metals.<sup>202</sup> Canty and co-workers have developed the chemistry of the heavier metals in Group 10 and 11, showing that (RC(pz)<sub>3</sub>) is able to stabilize high-oxidation-state organopalladium(IV) complexes.<sup>228,229</sup> Enemark has published several molybdenum complexes prepared from (HC(Me)<sub>2</sub>pz)<sub>3</sub><sup>230</sup> whereas the Ru chemistry was investigated by Meyer<sup>231</sup> and Macchioni.<sup>232</sup> Tris(pyrazolyl)methane Ru aquo complexes undergo two pH-dependent, chemically reversible one-electron oxidation corresponding to the associated Ru<sup>IV</sup>/Ru<sup>III</sup> and Ru<sup>III</sup>/Ru<sup>II</sup> couples.<sup>231</sup>

Reger used RC(pz)<sub>3</sub> ligands to prepare cationic complexes of Na,<sup>233</sup> Fe,<sup>234</sup> Cd,<sup>235</sup> Pb,<sup>236</sup> Ag,<sup>237</sup> Cu<sup>237</sup> and Tl<sup>238</sup> isoelectronic with known neutral tris(pyrazolyl)borate complexes. Sn<sup>IV</sup>,<sup>239</sup> Ag<sup>I</sup>,<sup>240</sup> and Cu<sup>II</sup><sup>241</sup> were also reported by Pettinari and co-workers. In the silver<sup>I</sup> compounds the ligand acts in a bridging mode.

Four- and five-coordinated precious metal complexes with tris(pyrazolyl)methane have been described, many of which are stereochemically non-rigid.<sup>225</sup> In particular, the X-ray structure of [Au(Me)<sub>2</sub>(HC(pz)<sub>3</sub>)]NO<sub>3</sub> shows a cis-planar coordination, with one pyrazolyl group involved in a weak axial Au ··· N interaction.<sup>242</sup>

Rhodium and iridium complexes of RC(pz)<sub>3</sub> show interesting structural and dynamic properties that shed new light on the chemistry of other pyrazole ligands, a field already vast and rapidly increasing in importance. Metallotropy was shown to be easier for rhodium than for iridium.<sup>223</sup>

Treatment of THF solutions of [W(=CR)(CO)<sub>2</sub>{HC(pz)<sub>3</sub>}] [BF<sub>4</sub>]<sup>-</sup> with LiBu<sup>n</sup>, followed by BF<sub>3</sub> · Et<sub>2</sub>O, affords the neutral alkylidynetungsten complexes [W(=CR)(CO)<sub>2</sub>{(F<sub>3</sub>B)(pz)<sub>3</sub>}] [BF<sub>4</sub>]<sup>-</sup>.<sup>243</sup>

The applications of these ligands have been limited to the work by Nakazawa *et al.*<sup>244</sup> who found tris(pyrazolyl)methane titanium complexes to be high-activity catalysts for the polymerization of olefins, and the use of tris(pyrazolyl)methane zinc complexes to model zinc-containing enzymes, such as dihydrorootase and carbonic anhydrase.<sup>245</sup> The structure of the free ligand HC(Me)<sub>2</sub>pz)<sub>3</sub> has also been reported.<sup>246</sup>

**1.10.5.2.1 Synthesis of tris(pyrazolyl)methanes**

Tris(pyrazolyl)methanes were first prepared by Huckel by the reaction of sodium pyrazolate with chloroform in benzene in 34% yield.<sup>247</sup> Two related methods using THF as solvent were reported

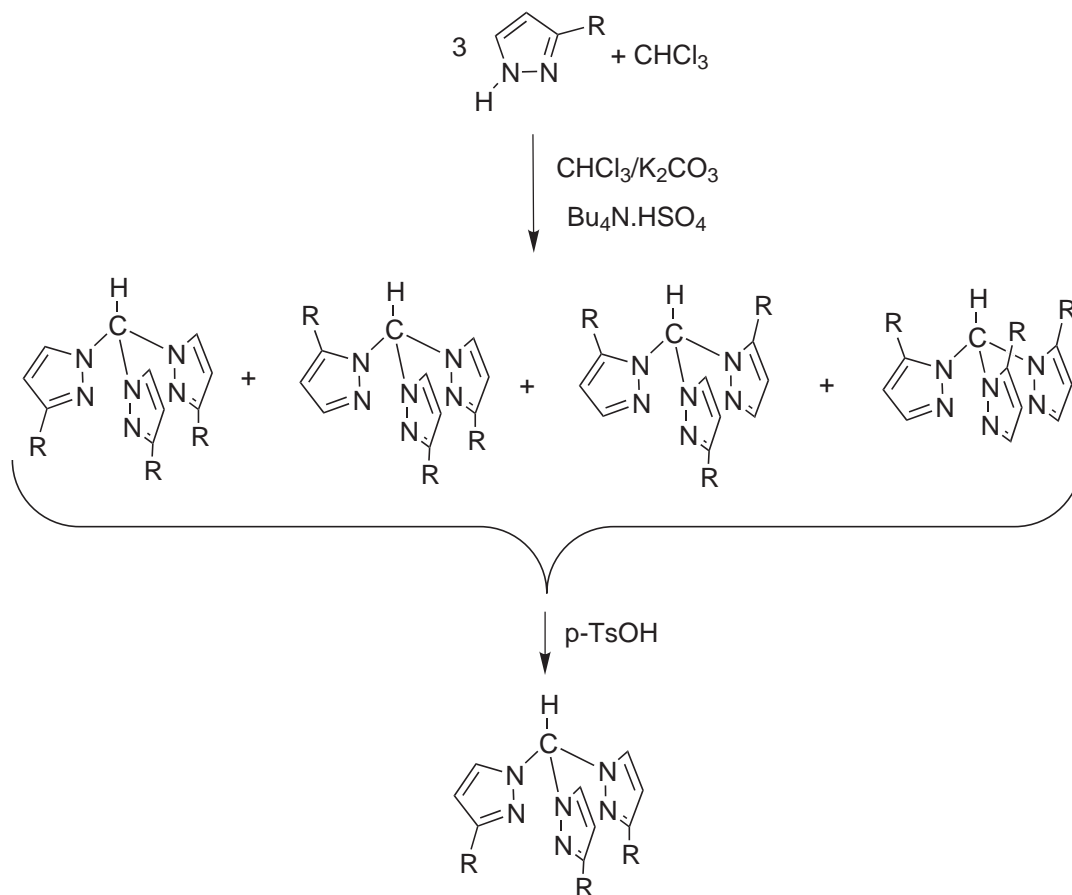
by Trofimenko in 1970<sup>202</sup> and Canty and co-workers in 1990.<sup>193</sup> The main reason for the lack of chemistry with tris(pyrazolyl)methane ligands is that the ligands were hard to prepare and a careful column chromatography step was needed to purify them. Phase transfer methods have also been used to synthesize tris(pyrazolyl)methanes, but again, the yields were still quite low.

Elguero and co-workers reported a solid-liquid phase transfer procedure which involved heating a mixture of the appropriate pyrazole, chloroform, potassium carbonate and tetrabutylammonium hydrogen sulfate at reflux overnight.<sup>248</sup> The earlier procedure used either liquid-liquid (dichloromethane with 50% aqueous NaOH as the base) or solid-liquid (dichloromethane with KOH/K<sub>2</sub>CO<sub>3</sub> as the base) phase transfer conditions. This method was deemed unsuitable for the synthesis of tris(azolyl)methanes due to the generation of dichlorocarbene and its likely reaction to produce ring expansion products. Elguero proposed that the tris(azolyl)methane were obtained via nucleophilic reaction of the azolate anion with chloroform.

Very recently, Reger modified the method of Elguero by heating a mixture of the pyrazole, water, chloroform, tetrabutylammonium bromide and sodium carbonate at reflux for three days.<sup>249</sup>

A modification of Elguero's procedure was developed by Armanasco,<sup>250</sup> which involved stirring a mixture of 3,5-dimethylpyrazole, chloroform, potassium carbonate, and tetrabutyl ammonium bromide at room temperature for a week. During this time the initially colorless reaction mixture became increasingly brown. The separation of the ligands from the respective reaction mixtures was extremely tedious and difficult (chromatography or fractional sublimation when the compounds are volatile).

An approach to tris(pyrazolyl)methane containing unsymmetrically substituted pyrazoles was proposed by Reger (Scheme 17). The conditions of the nucleophilic displacement reaction give rise to a mixture of regioisomers, that when treated under equilibrating conditions (refluxing toluene, catalytic acid) result in the conversion to a single regioisomer in which steric interactions are minimized.<sup>251</sup>



Scheme 17

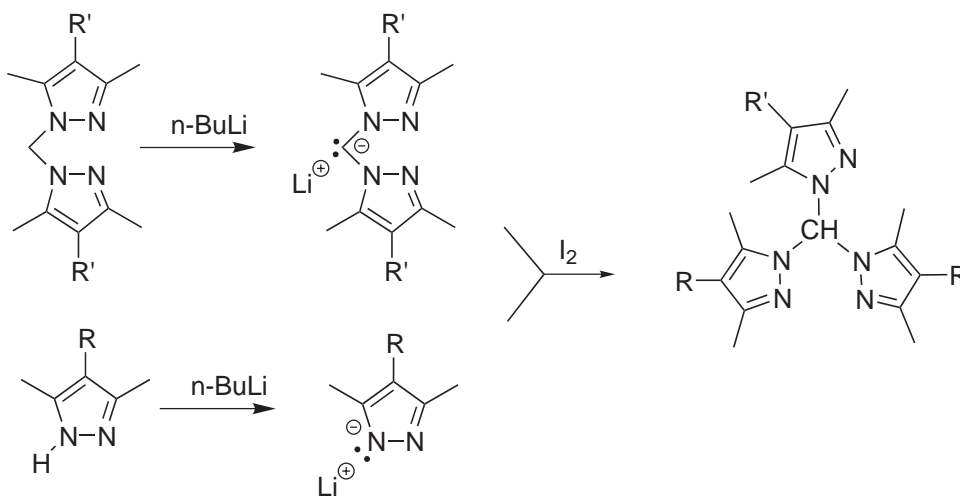
### 1.10.5.2.2 Unsymmetrical tris(pyrazolyl)methane

A new synthesis of unsymmetrical tris(pyrazolyl)methane by an oxidative coupling method was proposed by Armanasco (Scheme 18).<sup>250</sup>

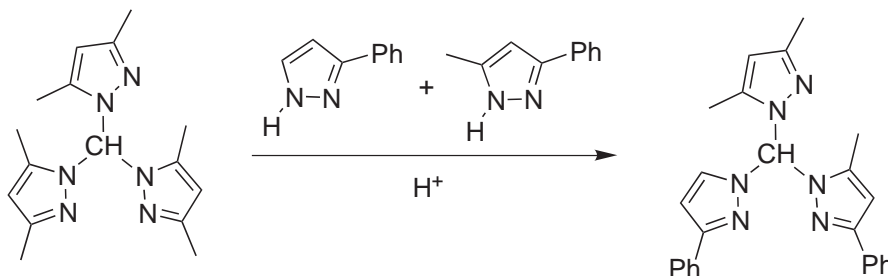
In order to synthesize unsymmetrical tris(pyrazolyl)methanes of the type  $\text{HC}(\text{pz})_2\text{pz}'$  and  $\text{HC}(\text{pz})(\text{pz}')(\text{pz}'')$  while precluding the formation of unwanted compounds the different pyrazoles need to be introduced to the reaction mixture in a stepwise fashion. The first part of the proposed synthesis requires the lithiation of a bis(pyrazolyl)methane. Bis(pyrazolyl)methane can be synthesized in high yield using the method reported by Elguero and co-workers.<sup>213</sup> It is known from the work of Katritzky *et al.*<sup>204</sup> that bis(pyrazolyl)methane can be deprotonated at the methylene group to give the corresponding carbanions. The next part of the proposed synthesis calls for the preparation of a pyrazolate anion, which can easily be generated by the treatment of the appropriate pyrazole with a strong base, or an alkali metal such as potassium. The oxidative coupling step to produce was modeled on the work of Lehn and Ziessel, who showed that various bipyridylethanes could be synthesized by the oxidative coupling of the corresponding monomeric methylene carbanions with bromine, iodine or 1,2-dibromomethane.<sup>252</sup>

The synthesis of unsymmetrical ligands related to  $\text{HC}(\text{pz})_3$  was developed by Canty.<sup>253</sup> The reaction is a metal-catalyzed condensation of  $(\text{pz})_2\text{CO}$  prepared from the reaction of pyrazolate with aldehydes to yield the desired ligand and  $\text{CO}_2$ . An important improvement of the reaction is replacing  $\text{pz}_2\text{CO}$  with  $\text{pz}_2\text{SO}$  derived from thionyl chloride. These ligands have found application in coordination and organometallic chemistry. Their Pd complexes exhibit isomerism and have played a key role in the development of organopalladium chemistry.

Goodman reported that  $\text{HC}(\text{pz})_3$  can be equilibrated with substituted pyrazoles to form new mixed tris(pyrazolyl)methanes (Scheme 19). The product ratio depends on the nature of the starting tris(pyrazolyl)methane, the nature of the substituted pyrazole and the relative amount of these two reagents.<sup>254</sup>



Scheme 18



Scheme 19



### 1.10.5.2.3 C-alkylated tris(pyrazolyl)methane

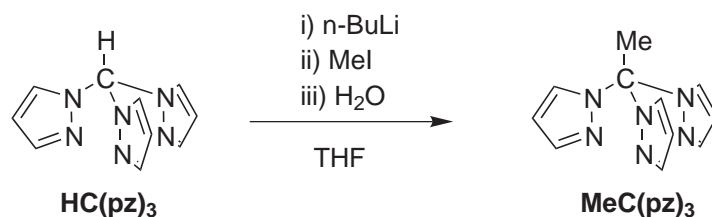
Tris(pyrazolyl)methanes alkylated on the methyne carbon atom have been synthesized.<sup>255,256</sup> Methylation of  $\text{HC}(\text{pz})_3$  was carried out according to Scheme 20. The synthesis of alkylated tris(pyrazolyl)methanes was only successful when the pyrazole rings contained no alkyl substituents on the 5-position (Scheme 20).

The methyne hydrogen of  $\text{HC}(\text{pz})_3$  ligand is acidic and can be removed (Equation 5). Once deprotonated, an alcohol functional group may be introduced using *para*-formaldehyde and water. This new ligand allows for an increase in the hydrophilic nature of the system.

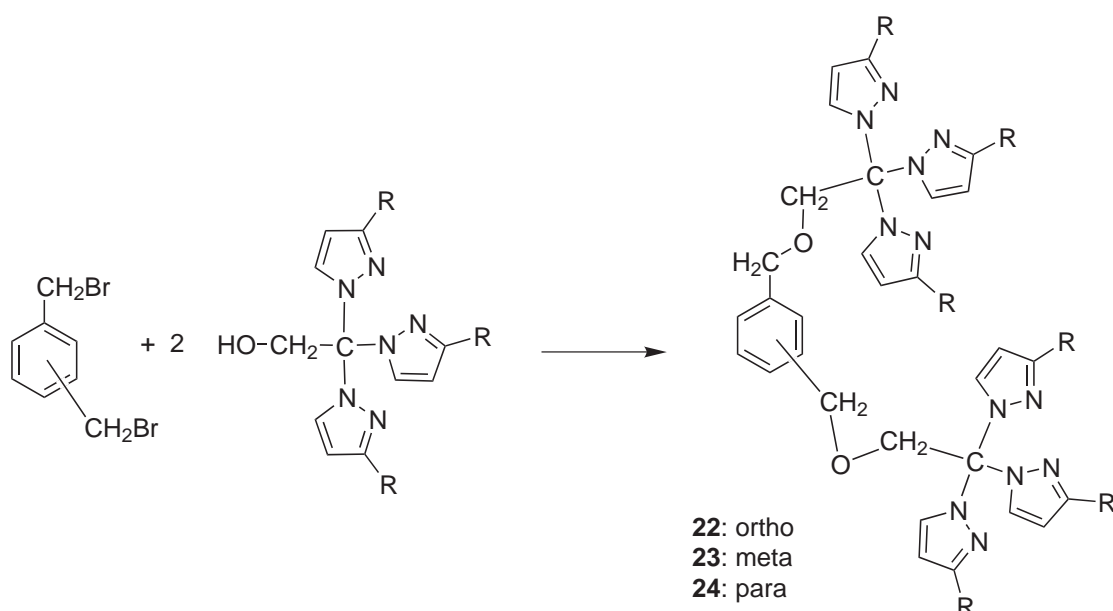


Starting from  $\text{HOCH}_2\text{C}(\text{pz})_3$  the three ligands (**22–24**) (*ortho*, *meta* and *para* substituted) in Scheme 21 can be prepared in a single step. They have special features: 1) the rigid architecture of facial bonding is encoded in each  $\text{HC}(\text{pz})_3$  group; 2) the different positions of the sidearms on the arene ring induce different orientations of the binding groups; 3) the overall length and structure of the xylene-based bridge prevent simultaneous coordination of both sides to one metal center, but do not rule out such coordination for the *ortho* ligand.<sup>257</sup>

The ligand (**25**) (Scheme 22) consists, in the solid state, of discrete molecules without significant intermolecular association. Within each  $\text{HC}(\text{pz})_3$  unit the orientation of the three pyrazolyl ring is a propeller arrangement. This ligand supports the supramolecular architecture of a silver coordination polymer.<sup>258</sup>

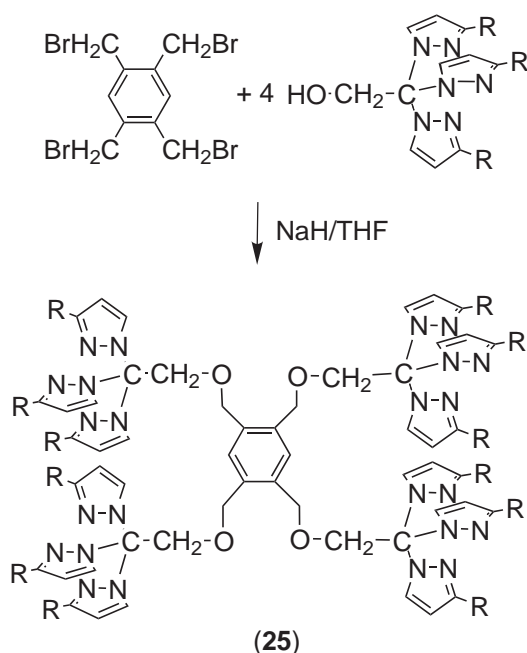


Scheme 20



Scheme 21



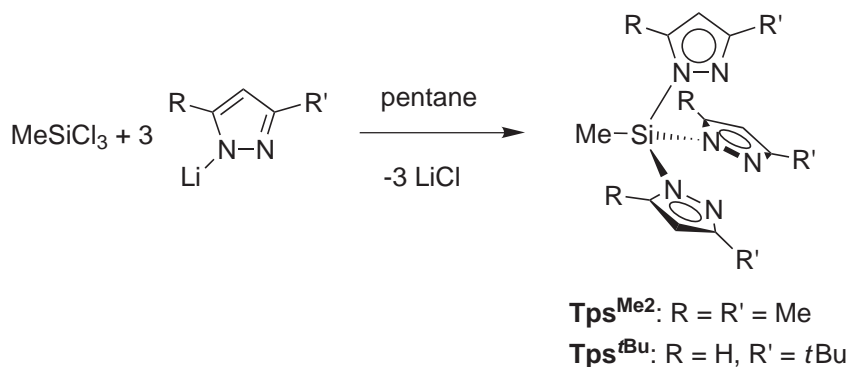


Scheme 22

### 1.10.6 POLY(PYRAZOLYL)SILANES

Although synthesis of pyrazolylsilanes (abbreviated as Bps and Tps) was mentioned in an old review,<sup>3</sup> an efficient synthesis (Scheme 23) of  $\text{Tps}^{\text{Me}_2}$  and  $\text{Tps}^{\text{tBu}}$  was only recently described.<sup>259</sup>

The pure ligands, free from lithium chloride, were isolated as white solids in almost quantitative yield. They are stable in dry air for several months. They are soluble in common organic solvents, including aliphatic and aromatic hydrocarbons, dichloromethane, ethers, THF and acetonitrile, but they slowly decompose in the presence of solvents having acidic protons such as alcohols and water, a significant difference from the related tris(pyrazolyl)methanes. The first transition metal derivatives of these ligands  $[(\text{Tps})\text{Cu}(\text{NCMe})](\text{PF}_6)$  have been prepared and characterized analytically and spectroscopically by Rheingold and co-workers,<sup>259</sup> who also prepared octahedral tricarbonyl complexes from the reaction of labile nitrile adducts  $[\text{M}(\text{CO})_3(\text{NCMe})_3]$  ( $\text{M} = \text{Cr}, \text{Mo}$ ) or  $[\text{W}(\text{CO})_3(\text{NCtEt})_3]$  and Tps in acetonitrile or tetrahydrofuran.<sup>260</sup> X-ray diffraction studies of these carbonyl complexes revealed that the cone angle of the silane ligand is not only moderately larger than that of Tp, but also approaches the value estimated for well-known “tetrahedral enforcer” ligands such as  $\text{Tp}^{\text{tBu}}$ . Last but not the least, X-ray crystallography data

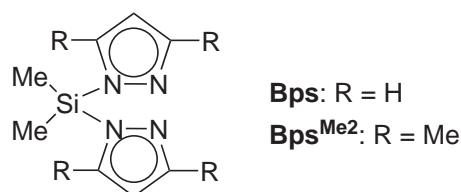


Scheme 23

were used to calculate a value of 1.59 Å for the covalent radius of tungsten(0) in an octahedral environment, a plausible estimate when compared to the reported radii of Cr(0) and Mo(0).

Tps<sup>Me2</sup> can be also prepared by the transilylation reaction of methyltrichlorosilane with three equivalents of (3,5-dimethylpyrazolyl)trimethylsilane. It was characterized unequivocally by single-crystal X-ray diffraction.<sup>261</sup>

The bis(pyrazolyl)silanes Bps (Scheme 24) were readily prepared from the reaction of Me<sub>2</sub>SiCl<sub>2</sub> and two molar equivalents of the corresponding alkali metal pyrazolates.<sup>262</sup> Both Bps and Bps<sup>Me2</sup> ligands were isolated in excellent yield. They are stable in dry air for at least six months and soluble in aliphatic and aromatic hydrocarbons, acetonitrile, dichloromethane and ethers. However, they slowly decompose in acetone or in the presence of solvents with acidic protons such as water and alcohols, an important difference with respect to the analogous poly(pyrazolyl)methane ligands. Both bidentate ligands have been used to prepare zinc(II) derivatives.



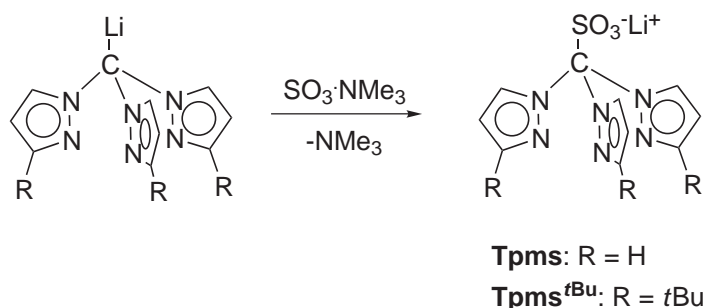
Scheme 24

### 1.10.7 TRIS(PYRAZOLYL)METHANESULFONATO

The methyne proton of tris(pyrazolyl)methane is sufficiently acidic to be removed by *n*BuLi, and the resulting reactive intermediate readily reacts with electrophiles. Kläui prepared two new anionic tripodal nitrogen water-soluble ligands (the lithium salts of tris(pyrazolyl)- and tris(3-tert-butylpyrazol)-methanesulfonic, Tpms and Tmps<sup>tBu</sup> respectively) by addition of lithiated tris(pyrazolyl)methane to a sulfur trioxide–trimethylamine complex (Scheme 25).<sup>146</sup>

A metathesis reaction of this compound with potassium carbonate gave the corresponding potassium salt. Instead of the boron hydride unit of Tp, Tpms has a methanesulfonate unit, which imparts very good stability toward hydrolysis and an increased solubility in polar solvents. In contrast to tris(pyrazolyl)methane Tpms is almost exclusively soluble in water and only moderately soluble in methanol. The ligand Tpms is stable over a wide range of pH values in aqueous solution. Preliminary experiments demonstrate that the ligand Tmps<sup>tBu</sup> forms tetrahedral complexes with transition metals that are C<sub>3v</sub>-symmetric. The Tpms ligand yields a Rh complex [(Tpms)Rh(CO)(PMe<sub>3</sub>)] which is the only known catalyst with a tripodal ligand which is active in the catalytic carbonylation of benzene.<sup>263</sup> The Tpms coordinates Rh<sup>I</sup> in a κ<sup>2</sup> or κ<sup>3</sup> mode.<sup>264</sup>

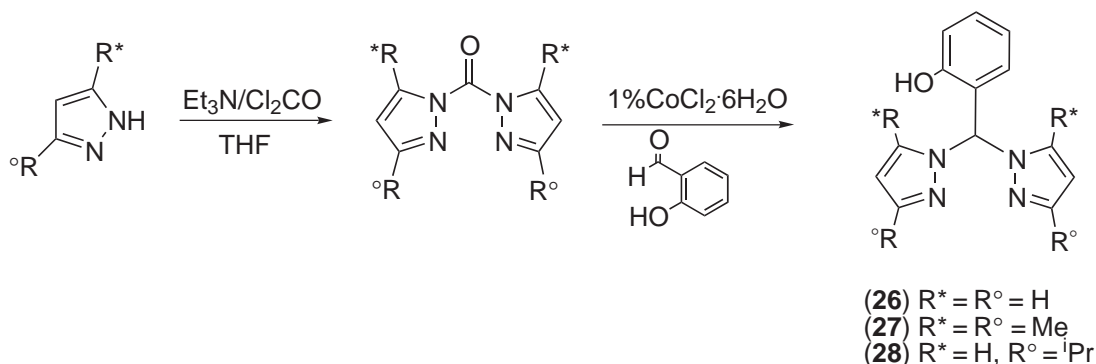
Heterometal cubane-type MFe<sub>3</sub>S<sub>4</sub> clusters, trigonally symmetrized with a Tpms capping ligand, have recently been reported.<sup>265</sup>



Scheme 25

## 1.10.8 HETEROSCORPIONATES

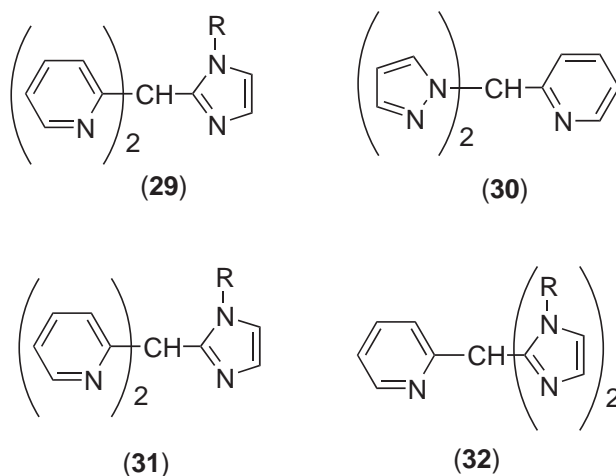
Despite their advantages the poly(pyrazolyl)borate ligands are completely symmetric with all nitrogen donors, and so were unable to mimic many metalloprotein active sites which do not have such mono-functional donor spheres. Thus there was a need for poly(functional) ligands which retain the desirable properties of tris(pyrazolyl)borates, i.e., easily syntheses, tridentate, facially coordinating and monoanionic. Using the synthesis of Peterson *et al.*<sup>216</sup> of bis(pyrazolyl)alkanes, starting from bis(pyrazolyl)ketones and aliphatic or aromatic carbonyl compounds, Carrano<sup>266</sup> developed a synthetic strategy for producing a new class of tripodal biomimetic mixed functionality ligands (Scheme 26).



Scheme 26

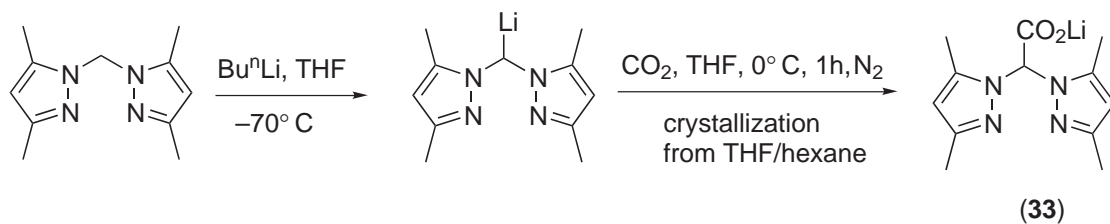
These ligands are related to the tris(pyrazolyl)methane ligand, but with one of the pyrazole groups replaced by a phenol,<sup>266,267</sup> thiophenol,<sup>268</sup> benzenecarboxylic acid or other functionalized phenyl groups. Steric hindrance can easily be incorporated into the ligands via the pyrazolyl rings, giving considerable potential variety with regards to coordination chemistry.

The same scheme was used by Canty *et al.*<sup>269</sup> to synthesize a series of all nitrogen functionality, imidazole/pyrazole, imidazole/pyridine, and pyrazole/pyridine ligands (29–32).

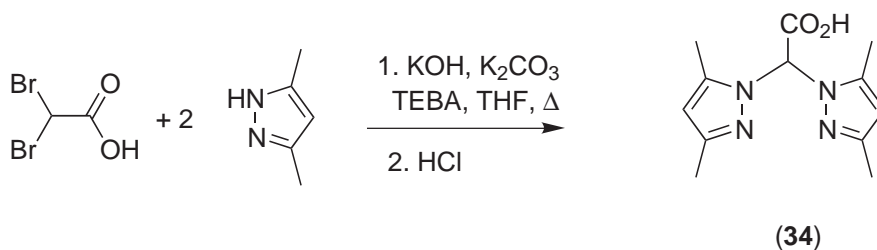


Replacement of one strongly  $\sigma$ -donating pyrazolyl group in Tp by the electronegative  $C(=O)O^-$  groups should reduce the electron-donating properties of the tripodal ligand. In addition to the multistep ligand synthesis reported by Otero<sup>270</sup> for the bis(pyrazolyl)acetate ligand (33), a scorpionate containing a carboxylate and two pyrazolyl groups (Scheme 27), Burzlaff reported a simple one-step synthesis starting from commercially available reagents (Scheme 28).<sup>271</sup>

Some alkynylcarbyne tungsten complexes containing the anion of (34) have been synthesized; these constitute good starting compounds for chain extension and for the synthesis of binuclear complexes with an odd number of bridging carbon atoms. The high thermal stability of the



Scheme 27



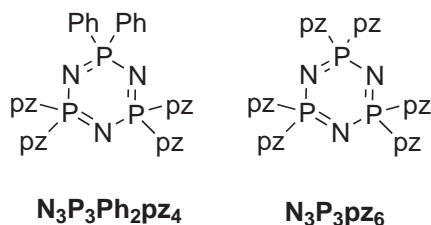
Scheme 28

tungsten alkynyl carbyne complexes should make coupling reactions feasible, which usually requires elevated temperatures.<sup>272</sup>

### 1.10.9 POLY(AZOLYL)-PHOSPHINE, -PHOSPHINATE, PHOSPHAZENE AND PHOSPHINE-OXIDE

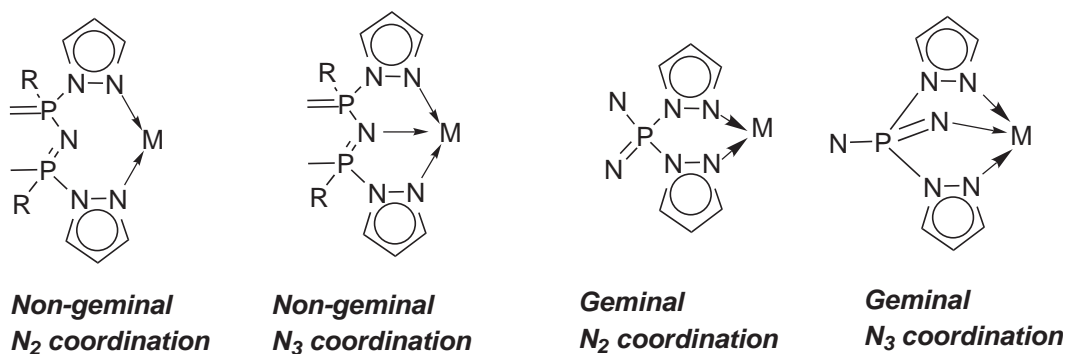
The tripodal sterically hindered tris(imidazolyl)phosphine ligands  $\text{Pim}^{\text{iPr}_2}$  and  $(\text{Pim}^{\text{iPr.tBu}})$  were prepared according to a multistep procedure by reaction of the appropriate imidazole, butyllithium,  $\text{PCl}_3$  and concentrated  $\text{NH}_4\text{OH}$ .<sup>273</sup> They have been employed in the synthesis of charged, structurally analogous, complexes containing Tp ligands.<sup>274</sup> The dioxygen activity of pseudotetrahedral copper complexes of  $\text{Pim}^{\text{iPr.tBu}}$  was also examined.<sup>273</sup>

Pyrazolylcyclophosphazenes such as  $(\text{N}_3\text{P}_3\text{R}_2\text{pz}_4)$  and  $(\text{N}_3\text{P}_3\text{pz}_6)$  were introduced by Paddock<sup>275</sup> and co-workers in 1979 and more recently several novel pyrazolyl-substituted have been examined as ligands for transition metals.<sup>276</sup>



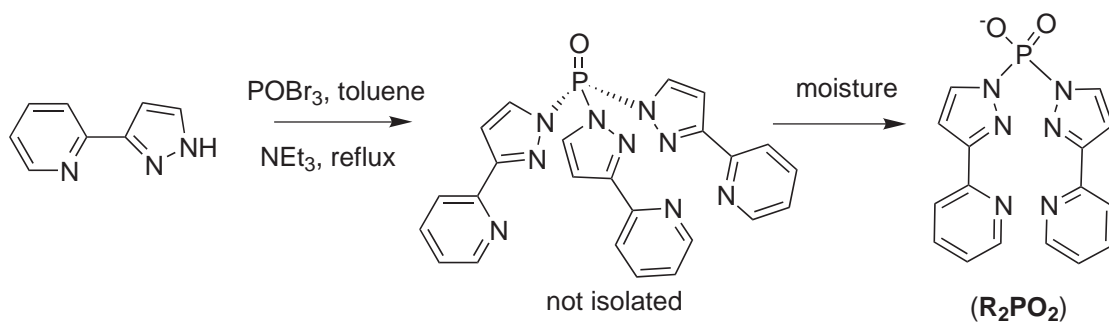
Depending on the nature of the substituents other than pyrazolyl groups and the metals, four different coordination modes shown in Scheme 29 have been observed. They coordinate to the metal through the exocyclic pyrazolyl and the phosphazene skeletal nitrogen atoms. The interaction of the cyclophosphazene skeletal nitrogen with the transition metal is of the  $\sigma$ -type and is generally weak. The basicity of a cyclophosphazene ligand may be affected by changing substituents other than donor groups with electron-rich moieties and/or by modifying the substituents on the exocyclic donor groups.

The tris(pyrazolyl)phosphine oxide ligand  $\text{O}=\text{P}(\text{Me}_2\text{pz})_3$  was prepared by substitution of the chloride of  $\text{OPCl}_3$  by the appropriate pyrazole in the presence of triethylamine in refluxing benzene. Its reaction with Mo- $\pi$ -allyl complexes was investigated. Hydrolysis of one pyrazolyl group was found in the crystal structure of one of the complexes.<sup>277</sup> Partial hydrolysis occurred during the attempted synthesis or work-up of  $\text{O}=\text{PR}_3$  ( $\text{R} = 2$ -pyridylpyrazolyl) to give the bis(pyrazol-1-yl)-



Scheme 29

phosphinate  $[\text{NEt}_3\text{H}][\text{R}_2\text{PO}_2^-]$  (Scheme 30) which was employed in the synthesis of one-dimensional helical chains and discrete mononuclear complexes of  $\text{Ag}^{\text{I}}$ ,  $\text{Tl}^{\text{I}}$ ,  $\text{Pb}^{\text{II}}$  and  $\text{Ba}^{\text{II}}$ .<sup>277</sup>

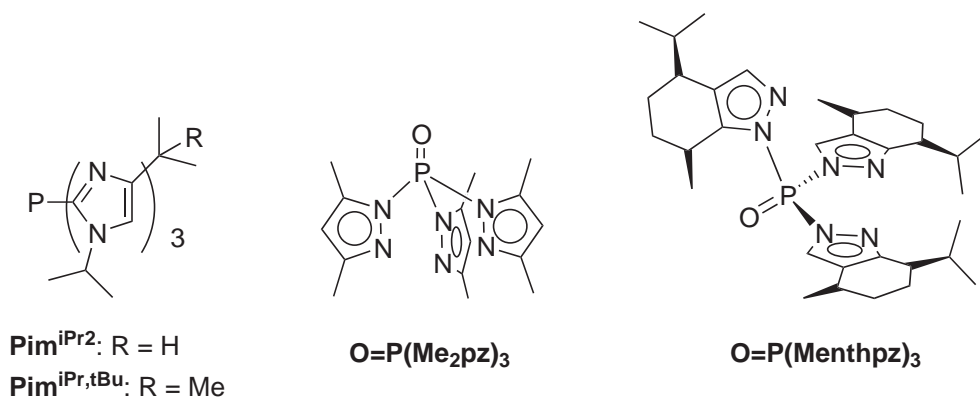


Scheme 30

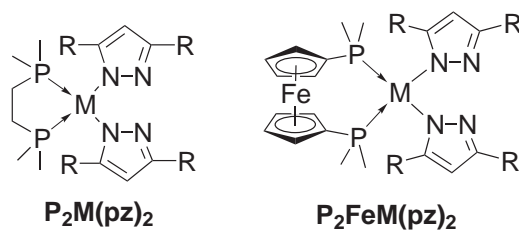
Optically active and  $C_3$ -symmetric tris(pyrazolyl)phosphine oxide ligands such as  $\text{O}=\text{P}(\text{Menthpz})_3$  were prepared by procedures analogous to those reported for achiral variants (Scheme 31).<sup>109</sup>

### 1.10.9.1 Bis(azolyl)-metallates

Several bis(azolyl)-metallates involving platinum(II) and palladium(II) of general formula  $(\text{P}_2\text{M}(\text{pz})_2)$  (Scheme 32) have been described and spectroscopically characterized. They can be



Scheme 31



Scheme 32

considered as potentially bidentate ligands.<sup>279,280</sup> Tetrafluoroboric acid often protonates both pyrazolato groups, affording  $[P_2M(pzH)_2]^{++}$  cations, whose reactivity,<sup>281</sup> e.g., with  $[BH_4]^-$  and spectroscopic properties,<sup>282</sup> were investigated. Heteropolymetallic compounds containing the 1,1'-bis(diphenylphosphino)ferrocene ligand ( $P_2FeM(pz)_2$ ) were recently reported and structurally characterized. These sterically hindered ligands afforded very soluble trinuclear and pentanuclear tetrahedral complexes.<sup>283</sup> Fast atom bombardment mass spectrometry of some of these derivatives have been reported.<sup>284</sup>

### 1.10.10 REFERENCES

1. Trofimenko, S. *J. Am. Chem. Soc.* **1966**, *88*, 1842–1844.
2. Trofimenko, S. *Acc. Chem. Res.* **1971**, *4*, 17–22.
3. F. Klanberg, personal communication, ref. 177 in “The coordination chemistry of pyrazole-derived ligands”, S. Trofimenko, *Chem. Rev.* **1972**, *72*, 497–509.
4. Niedenzu, K.; Trofimenko, S. *Topics in Current Chemistry* **1986**, *131*, 1–37.
5. Trofimenko, S. *Progress Inorg. Chem.* **1986**, *34*, 115–210.
6. Trofimenko, S. *Chem. Revs.* **1993**, *93*, 943–980.
7. Trofimenko, S. *Scorpionates: The Coordination Chemistry of Poly(pyrazolyl)borate Ligands* **1999**, Imperial College Press: London.
8. Shaver, A. *Comprehensive Coordination Chemistry* **1982**, *2*, 245–259.
9. McCleverty, J. A. *Chem. Soc. Rev.* **1983**, *12*, 331–360.
10. Niedenzu, K. *Adv. Boron Boranes, Molecular Struct. Energetics* **1988**, *5*, 357.
11. Byers, P. K.; Canty, A. J.; Honeyman, R. T. *Adv. Organomet. Chem.* **1992**, *34*, 1–65.
12. Santos, S.; Marques, N. *New J. Chem.* **1995**, *19*, 551–571.
13. Parkin, G. *Adv. Inorg. Chem.* **1995**, *42*, 291–393.
14. Kitajima, N.; Tolman, W. B. *Progress Inorg. Chem.* **1995**, *43*, 419–531.
15. Reger, D. L. *Coord. Chem. Rev.* **1996**, *147*, 571–595.
16. Janiak, C. *Coord. Chem. Rev.* **1997**, *163*, 107–216.
17. Janiak, D. *Main Group Met. Chem.* **1998**, *21*, 33–49.
18. McCleverty, J. A.; Ward, M. D. *Acc. Chem. Res.* **1998**, *31*, 842–851.
19. Ward, M. D.; McCleverty, J. A.; Jeffery, J. C. *Coord. Chem. Rev.* **2001**, *222*, 251–272.
20. Vahrenkamp, H. *Acc. Chem. Res.* **1999**, *32*, 589–596.
21. Slugovc, C.; Padilla-Martinez, I.; Siroli, S.; Carmona, E. *Coord. Chem. Rev.* **2001**, *213*, 129–157.
22. Curtis, M. D.; Shiu, K.-B.; Butler, W. M. *Organometallics* **1983**, *2*, 1475–1477.
23. Curtis, M. D.; Shiu, K.-B.; Butler, W. M. *J. Am. Chem. Soc.* **1986**, *108*, 1550–1561.
24. Trofimenko, S. *Inorg. Synth.* **1970**, *12*, 99–205.
25. Trofimenko, S. *J. Am. Chem. Soc.* **1967**, *89*, 6288–6294.
26. Jákle, F.; Polborn, K.; Wagner, M. *Chem. Ber.* **1996**, *129*, 603–606.
27. Reger, D. L.; Tarquini, M. E. *Inorg. Chem.* **1982**, *21*, 840–842.
28. Bucher, U. E.; Fässler, T. F.; Hunzicker, M.; Nesper, R.; Rieggger, H.; Venanzi, L. M. *Gazz. Chim. Ital.* **1995**, *125*, 181–188.
29. Kimblin, C.; Hascall, T.; Parkin, G. *Inorg. Chem.* **1997**, *36*, 5680–5681.
30. Chiou, S.-J.; Ge, P.; Riordan, C. G.; Liable-Sands, L. M.; Rheingold, A. L. *Chem. Commun.* **1999**, 159–160.
31. Garcia, R.; Paulo, A.; Domingos, A.; Santos, I. *J. Organometal. Chem.* **2001**, *632*, 41–48.
32. Singaram, B.; Cole, T. E.; Brown, C. H. *Organometallics* **1984**, *3*, 774–777.
33. Aubagnac, J.-L.; Claramunt, R. M.; Elguero, J.; Gilles, I.; Sanz, D.; Trofimenko, S.; Virgili, A. *Bull. Chem. Soc. Belg.* **1995**, *104*, 473–482.
34. Companion, A. L.; Liu, F.; Niedenzu, K. *Inorg. Chem.* **1985**, *24*, 1738–1740.
35. Schleyer, P. V. R.; Bühl, M. *Angew. Chem. Int. Ed. Engl.* **1990**, *29*, 304–306.
36. Trofimenko, S. *Inorg. Chem.* **1970**, *9*, 2493–2499.
37. Cotton, F. A.; Stanislawski, A. G. *J. Am. Chem. Soc.* **1974**, *96*, 5074–5082.
38. Bernarducci, E.; Schwindinger, W. F.; Hughey IV, J. L.; Krogh-Jespersen, K.; Schugar, H. J. *J. Am. Chem. Soc.* **1981**, *103*, 1686–1691.
39. Liang, Z.; Marshall, A. G.; Marçalo, J.; Marques, N.; Pires de Matos, A.; Santos, I.; Well, D. A. *Organometallics* **1991**, *10*, 2794–2797.
40. Mani, F. *Inorg. Chim. Acta* **1986**, *117*, L1–L2.

41. DiVaira, M.; Mani, F. *J. Chem. Soc., Dalton Trans.* **1990**, 191–194.
42. Bencini, A.; DiVaira, M.; Mani, F. *J. Chem. Soc., Dalton Trans.* **1991**, 41–44.
43. Pizzano, A.; Sanchez, L.; Altmann, M.; Monge, A.; Ruiz, C.; Carmona, E. *J. Am. Chem. Soc.* **1995**, *117*, 1759–1765.
44. Conejo, M.; delMar, P.; Pizzano, A.; Sánchez, L. J.; Carmona, E. *J. Chem. Soc., Dalton Trans.* **1996**, 3687–3691.
45. Contreras, L.; Pizzano, A.; Sánchez, L.; Carmona, E. *J. Organomet. Chem.* **1995**, *500*, 61–67.
46. Hill, A. F.; White, A. J. P.; Williams, D. J.; Wilton-Ely, J. D. E. T. *Organometallics* **1998**, *17*, 4249–4258.
47. Bellachioma, G.; Cardaci, G.; Gramlich, V.; Macchioni, A.; Pieroni, F.; Venanzi, L. M. *J. Chem. Soc., Dalton Trans.* **1998**, 947–951.
48. Gutiérrez, E.; Nicasio, M. C.; Paneque, M.; Ruyiz, C.; Salazar, V. *J. Organomet. Chem.* **1997**, *549*, 167–176.
49. Díaz-Requejo, M. M.; Nicasio, M. C.; Pérez, P. P. *Organometallics* **1998**, *17*, 3051–3057.
50. Reger, D. L.; Knox, S. J.; Lebioda, L. *Organometallics* **1990**, *9*, 2218–2222.
51. Nicholson, B. K.; Thompson, R. A.; Watts, F. D. *Inorg. Chim. Acta* **1988**, *48*, 101–104.
52. Dey, D. K.; Das, M. K.; Bansal, R. K. *J. Organomet. Chem.* **1997**, *535*, 7–15.
53. Reger, D. L.; Knox, S. J.; Huff, M. F.; Rheingold, A. L.; Haggerty, B. S. *Inorg. Chem.* **1991**, *30*, 1754–1759.
54. Hansen, M. N.; Niedenzu, K.; Serwatowska, J.; Serwatowski, J.; Woodrum, K. R. *Inorg. Chem.* **1991**, *30*, 866–868.
55. Lee, S. K.; Nicholson, B. K. *J. Organomet. Chem.* **1986**, *309*, 257–265.
56. Jung, O.-S.; Jeong, J. H.; Sohn, Y. S. *Organometallics* **1991**, *10*, 2217–2221.
57. Reger, D. L.; Pender, M. J.; Caulder, D. L.; Reger, L. B.; Rheingold, A. L.; Liable-Sands, L. M. *J. Organomet. Chem.* **1996**, *512*, 91–96.
58. Carvalho, A.; Domingos, A.; Gaspar, P.; Marques, N.; Pires de Matos, A.; Santos, I. *Polyhedron* **1992**, *12*, 1481–1488.
59. Reger, D. L.; Lindeman, J. A.; Lebioda, L. *Inorg. Chem.* **1988**, *27*, 1890–1896.
60. Frauendorfer, E.; Agrifoglio, G. *Inorg. Chem.* **1982**, *21*, 4122–4125.
61. Agrifoglio, G. *Inorg. Chim. Acta* **1992**, *197*, 159–162.
62. Kokusen, H.; Sohrin, Y.; Matsui, M.; Hata, Y.; Hasegawa, H. *J. Chem. Soc., Dalton Trans.* **1996**, 195–201.
63. Ghosh, P.; Hascall, T.; Dowling, C.; Parkin, G. *J. Chem. Soc., Dalton Trans.* **1998**, 3355–3357.
64. McCurdy, W. H., Jr. *Inorg. Chem.* **1975**, *14*, 2292–2294.
65. Trofimenko, S.; Calabrese, J. C.; Thompson, J. S. *Inorg. Chem.* **1987**, *26*, 1507–1414.
66. Trofimenko, S.; Calabrese, J. C.; Domaille, P. J.; Thompson, J. S. *Inorg. Chem.* **1989**, *28*, 1091–1101.
67. Looney, A.; Han, R.; Gorrell, I. B.; Cornebise, M.; Yoon, K.; Parkin, G.; Rheingold, A. L. *Organometallics* **1995**, *13*, 274–288.
68. Gutiérrez, E.; Hudson, S. A.; Monge, A.; Nicasio, M. C.; Paneque, M.; Ruiz, C. *J. Organomet. Chem.* **1998**, *551*, 215–227.
69. Ghosh, P.; Bonnano, J. B.; Parkin, G. *J. Chem. Soc., Dalton Trans.* **1998**, 2779–2781.
70. Dowling, C.; Parkin, G. *Polyhedron* **1996**, *15*, 2463–2465.
71. Dias, H. V. R.; Lu, H.-L.; Rateliff, R. E.; Bott, S. G. *Inorg. Chem.* **1995**, *34*, 1975–1976.
72. Renn, O.; Venanzi, L. M.; Martelletti, A.; Gramlich, V. *Helv. Chim. Acta* **1995**, *78*, 993–1000.
73. Dias, H. V. R.; Gorden, J. D. *Inorg. Chem.* **1996**, *35*, 318–324.
74. Dias, H. V. R.; Lu, H.-L.; Gorden, J. D.; Jin, W. *Inorg. Chem.* **1996**, *35*, 2149–2151.
75. Rodríguez, V.; Full, J.; Donnadiou, B.; Sabo-Etienne, S.; Chaudret, B. *New. J. Chem.* **1997**, *21*, 847–849.
76. Bardwell, D. A.; Jeffery, J. C.; Jones, P. L.; McCleverty, J. A.; Psillakis, E.; Reeves, Z.; Ward, M. D. *J. Chem. Soc., Dalton Trans.* **1997**, 2079–2086.
77. Bardwell, D. A.; Jeffery, J. C.; McCleverty, J. A.; Ward, M. D. *Inorg. Chim. Acta* **1998**, *267*, 323–328.
78. Armaroli, N.; Accorsi, G.; Barigelletti, F.; Couchman, S. M.; Fleming, J. S.; Harden, N. C.; Jeffery, J. C.; Mann, K. L. V.; McCleverty, J. A.; Rees, L. H.; Starling, S. R.; Ward, M. D. *Inorg. Chem.* **1999**, *38*, 5769–5776.
79. Jones, P. L.; Byrom, K. J.; Jeffery, J. C.; McCleverty, J. A.; Ward, M. D. *Chem. Commun.* **1997**, 1361–1362.
80. Psillakis, E.; Jeffery, J. C.; McCleverty, J. A.; Ward, M. D. *Chem. Commun.* **1997**, 479–480.
81. Fleming, J. S.; Psillakis, E.; Couchman, S. M.; Jeffery, J. C.; McCleverty, J. A.; Ward, M. D. *J. Chem. Soc., Dalton Trans.* **1998**, 537–543.
82. Niedenzu, K.; Niedenzu, P. M.; Warner, K. R. *Inorg. Chem.* **1985**, *24*, 1604–1606.
83. Calabrese, J. C.; Trofimenko, S.; Thompson, J. S. *J. Chem. Soc., Chem. Commun.* **1986**, 1122–1123.
84. Cano, M.; Heras, J. V.; Jones, C. J.; McCleverty, J. A.; Trofimenko, S. *Polyhedron* **1990**, *9*, 619–621.
85. Ghosh, C. K.; Hoyano, J. K.; Krentz, R.; Graham, W. A. G. *J. Am. Chem. Soc.* **1989**, *111*, 5480–5481.
86. Han, R.; Ghosh, P.; Desrosiers, P. J.; Trofimenko, S.; Parkin, G. *J. Chem. Soc., Dalton Trans.* **1997**, 3713–3717.
87. Lopez, C.; Claramount, R. M.; Trofimenko, S.; Elguero, J. *Can. J. Chem.* **1993**, *71*, 678–684.
88. Rheingold, A. L.; White, C. B.; Trofimenko, S. *Inorg. Chem.* **1993**, *32*, 3471–3477.
89. Calabrese, J. C.; Trofimenko, S. *Inorg. Chem.* **1992**, *31*, 4810–4814.
90. Han, R.; Parkin, G.; Trofimenko, S. *Polyhedron* **1995**, *14*, 387–391.
91. Looney, A.; Parkin, G. *Polyhedron* **1990**, *9*, 265–276.
92. Chisholm, M. H.; Eilerts, N. W.; Huffman, J. C. *Inorg. Chem.* **1996**, *35*, 445–450.
93. Darenbourg, D. J.; Maynard, E. L.; Holtcamp, M. W.; Klausmeyer, K. K.; Reibenspies, J. H. *Inorg. Chem.* **1996**, *35*, 2682–2684.
94. LeCloux, D. D.; Keyes, M. C.; Osawa, M.; Reynolds, V.; Tolman, W. B. *Inorg. Chem.* **1994**, *33*, 6361–6368.
95. Albinati, A.; Bovens, M.; Rügger, H.; Venanzi, L. M. *Inorg. Chem.* **1997**, *36*, 5991–5999.
96. Tolman, C. A. *Chem. Rev.* **1977**, *77*, 313–348.
97. Calabrese, J. C.; Domaille, P. J.; Trofimenko, S.; Long, G. J. *Inorg. Chem.* **1991**, *30*, 2795–2801.
98. Rheingold, A. L.; Ostrander, R. L.; Haggerty, B. S.; Trofimenko, S. *Inorg. Chem.* **1994**, *33*, 3666–3676.
99. Rheingold, A. L.; Haggerty, B. S.; Trofimenko, S. *J. Chem. Soc., Chem. Commun.* **1994**, 1973–1974.
100. Rheingold, A. L.; Liable-Sands, L. M.; Trofimenko, S. *Chem. Commun.* **1997**, 1691–1692.
101. Han, R.; Looney, A.; McNeill, K.; Parkin, G.; Rheingold, A. L.; Haggerty, B. S. *J. Inorg. Biochem.* **1993**, *49*, 105–121.
102. Young, C. G.; Wedd, A. G. *Chem. Commun.* **1997**, 1251–1257.
103. Kitajima, N.; Fujisawa, K.; Moro-oka, Y. *J. Am. Chem. Soc.* **1990**, *112*, 3210–3212.

104. Kitajima, N.; Fujisawa, K.; Hikichi, S.; Moro-oka, Y. *J. Am. Chem. Soc.* **1993**, *115*, 7874–7875.
105. Trofimenko, S.; Calabrese, J. C.; Kochi, J. K.; Wolowicz, S.; Hulsbergen, F. B.; Reedijk, J. *Inorg. Chem.* **1992**, *31*, 3943–3950.
106. Egan, J. W., Jr.; Haggerty, B. S.; Rheingold, A. L.; Sendlinger, S. C.; Theopold, K. H. *J. Am. Chem. Soc.* **1990**, *112*, 2445–2446.
107. Tolman, W. B. *Inorg. Chem.* **1991**, *30*, 4877–4880.
108. Caffyn, A. J. M.; Feng, S. G.; Dierdorf, A.; Gamble, A. S.; Eldredge, P. A.; Vossen, M. R.; White, P. S.; Templeton, J. L. *Organometallics* **1991**, *10*, 2842–2848.
109. LeCloux, D. D.; Tokar, C. J.; Osawa, M.; Houser, R. P.; Keyes, M. C.; Tolman, W. B. *Organometallics* **1994**, *13*, 2855–2866.
110. Calabrese, J. C.; Domaille, P. J.; Thompson, J. S.; Trofimenko, S. *Inorg. Chem.* **1990**, *29*, 4429–4437.
111. Carrier, S. M.; Ruggiero, C. E.; Houser, R. P.; Tolman, W. B. *Inorg. Chem.* **1993**, *32*, 4889–4899.
112. Kiani, S.; Long, J. R.; Stavropoulos, P. *Inorg. Chim. Acta* **1997**, *263*, 357–366.
113. Mealli, C.; Arcus, C. S.; Wilkinson, J. L.; Marks, T. J.; Ibers, J. *J. Am. Chem. Soc.* **1976**, *98*, 711–718.
114. Kitajima, N.; Koda, T.; Moro-oka, Y. *Chem. Letters* **1988**, 347–350.
115. Kitajima, N.; Koda, T.; Hashimoto, S.; Kitagawa, T.; Moro-oka, Y. *J. Chem. Soc., Chem. Commun.* **1988**, 151–152.
116. Kitajima, N.; Koda, T.; Iwata, Y.; Moro-oka, Y. *J. Am. Chem. Soc.* **1990**, *112*, 8833–8839.
117. Kitajima, N.; Koda, T.; Hashimoto, S.; Kitagawa, T.; Moro-oka, Y. *J. Am. Chem. Soc.* **1991**, *113*, 5664–5671.
118. Bérces, A. *Inorg. Chem.* **1997**, *36*, 4831–4837.
119. Kitajima, N.; Moro-oka, Y. *Chem. Rev.* **1994**, *94*, 737–757.
120. MacNeil, J. H.; Watkins, W. C.; Baird, M. C.; Preston, K. F. *Organometallics* **1992**, *11*, 2761–2762.
121. Curtis, M. D.; Shiu, K. B.; Butler, W. M.; Huffman, J. C. *J. Am. Chem. Soc.* **1986**, *108*, 3335–3343.
122. Shiu, K. B.; Lee, L.-Y. *J. Organomet. Chem.* **1988**, *348*, 357–360.
123. Skagestad, V.; Tilset, M. *J. Am. Chem. Soc.* **1993**, *115*, 5077–5083.
124. McNair, A. M.; Boyd, D. C.; Mann, K. R. *Organometallics* **1986**, *5*, 303–310.
125. Sharp, P. R.; Bard, A. J. *Inorg. Chem.* **1983**, *22*, 2689–2693.
126. Ruggiero, C. E.; Carrier, S. M.; Antholine, W. E.; Whittaker, J. W.; Cramer, C. J.; Tolman, W. B. *J. Am. Chem. Soc.* **1993**, *115*, 11285–11298.
127. Bruce, M. I.; Ostaszewski, A. P. *J. Chem. Soc., Dalton Trans.* **1973**, 2433–2436.
128. Cano, M.; Heras, J. V.; Trofimenko, S.; Monge, A.; Gutierrez, E.; Jones, C. J.; McCleverty, J. A. *J. Chem. Soc., Dalton Trans.* **1990**, 3577–3582.
129. Reynolds, S. J.; Smith, C. F.; Jones, C. J.; McCleverty, J. A. *Inorg. Synth.* **1985**, *23*, 4–9.
130. Ball, R. G.; Ghosh, C. K.; Hoyano, J. K.; McMaster, A. D.; Graham, W. A. G. *J. Chem. Soc. Chem. Commun.* **1989**, 341–342.
131. Bucher, U. E.; Currao, A.; Nesper, R.; Rügger, H.; Venanzi, L. M.; Younger, E. *Inorg. Chem.* **1995**, *34*, 66–74.
132. Chauby, V.; Serra Le Berre, C.; Kalck, P.; Daran, J.-C.; Commenges, G. *Inorg. Chem.* **1996**, *35*, 6354–6355.
133. Dias, H. V. R.; Lu, H.-L. *Inorg. Chem.* **2000**, *39*, 2246–2248.
134. Malbosc, F.; Kalck, P.; Daran, J.-C.; Etienne, M. *J. Chem. Soc. Dalton Trans.* **1999**, 271–272.
135. Herberhold, M.; Eibl, S.; Milius, W.; Wrackmeyer, B. *Z. Anorg. Allg. Chem.* **2000**, *626*, 552–555.
136. Gutierrez, E.; Hudson, S. A.; Monge, A.; Nicasio, M. C.; Paneque, ; Carmona, E. *J. Chem. Soc. Dalton Trans.* **1992**, 2651–2652.
137. Paneque, M.; Sirol, S.; Trujillo, M.; Gutiérrez-Puebla, E.; Monge, M. A.; Carmona, E. *Angew. Chem. Int. Ed.* **2000**, *39*, 218–221.
138. Amoroso, A. J.; Thompson, A. M. C.; Jeffery, J. C.; Jones, P. L.; McCleverty, J. A.; Ward, M. D. *J. Chem. Soc. Chem. Commun.* **1994**, 2751–2752.
139. Amoroso, A. J.; Jeffery, J. C.; Jones, P. L.; McCleverty, J. A.; Rees, L.; Rheingold, A. L.; Sun, Y.; Takats, J.; Trofimenko, S.; Ward, M. D.; Yap, G. P. A. *J. Chem. Soc. Chem. Commun.* **1995**, 1881–1882.
140. Jones, P. L.; Mann, K. L. V.; Jeffery, J. C.; McCleverty, J. A.; Ward, M. D. *Polyhedron* **1997**, *16*, 2435–2440.
141. Rheingold, A. L.; Haggerty, B. S.; Liable-Sands, L. M.; Trofimenko, S. *Inorg. Chem.* **1999**, *38*, 6306–6308.
142. Keyes, M. C.; Young, V. G., Jr.; Tolman, W. B. *Organometallics* **1996**, *15*, 4133–4140.
143. Takahashi, Y.; Hikichi, S.; Akita, M.; Moro-oka, Y. *Organometallics* **1999**, *18*, 2571–2573.
144. Slugovc, C.; Mereiter, K.; Trofimenko, S.; Carmona, E. *Chem. Commun.* **2000**, 121–122.
145. Hu, Z.; Gorun, S. M. *Inorg. Chem.* **2001**, *40*, 667–671.
146. Kläui, W.; Berghahn, M.; Rheinwald, G.; Lang, H. *Angew. Chem. Int. Ed.* **2000**, *39*, 2464–2466.
147. Kimblin, C.; Bridgewater, B. M.; Hascall, T.; Parkin, G. *J. Chem. Soc., Dalton Trans.* **2000**, 891–897.
148. Maria, L.; Domingos, A.; Santos, I. *Inorg. Chem.* **2001**, *40*, 6863–6864.
149. Kimblin, C.; Bridgewater, B. M.; Churchill, D. G.; Hascall, T.; Parkin, G. *Inorg. Chem.* **2000**, *39*, 4240–4243.
150. Garner, M.; Reglinski, J.; Cassidy, I.; Spicer, M. D.; Kennedy, A. R. *J. Chem. Soc. Chem. Commun.* **1996**, 1975–1976.
151. Reglinski, J.; Garner, M.; Cassidy, I. D.; Slavina, P. A.; Spicer, M. D.; Armstrong, D. R. *J. Chem. Soc. Dalton Trans.* **1999**, 2119–2126.
152. Kimblin, C.; Churchill, B. M.; Bridgewater, D. G.; Parkin, G. *J. Chem. Soc. Chem. Commun.* **1999**, 2301–2302.
153. Tesmer, M.; Shu, M. H.; Vahrenkamp, H. *Inorg. Chem.* **2001**, *40*, 4022–4029.
154. Bakbak, S.; Bhatia, V.; Incarvito, C. D.; Rheingold, A. L.; Rabinovich, D. *Polyhedron* **2001**, *20*, 3343–3348.
155. Hill, A. F.; Owen, G. R.; White, A. J. P.; Williams, D. J. *Angew. Chem. Int. Ed.* **1999**, *38*, 2759–2761.
156. Kimblin, C.; Churchill, D. G.; Bridgewater, B. M.; Girard, J. N.; Quarless, D. A.; Parkin, G. *Polyhedron* **2001**, *20*, 1891–1896.
157. Bridgewater, B. M.; Parkin, G. *Inorg. Chem. Commun.* **2000**, *3*, 534–536.
158. Santini, C.; Pettinari, C.; Gioia Lobbia, G.; Spagna, R.; Pellei, M.; Vallorani, F. *Inorg. Chim. Acta* **1999**, *285*, 81–88.
159. Effendy; Gioia Lobbia, G.; Pettinari, C.; Santini, C.; Skelton, B. W.; White, A. H. *Inorg. Chim. Acta* **2000**, *308*, 65–72.
160. Santini, C.; Pellei, M.; Gioia Lobbia, G.; Pettinari, C.; Drozdov, A.; Troyanov, S. *Inorg. Chim. Acta* **2001**, *325*, 20–28.
161. Garner, M.; Lehmann, M. A.; Reglinski, J.; Spicer, M. D. *Organometallics* **2001**, *20*, 5233–5236.



162. Ojo, J. F.; Slavin, P. A.; Reglinski, J.; Garner, M.; Spicer, M. D.; Kennedy, A. R.; Teat, S. J. *Inorg. Chim. Acta* **2001**, *313*, 15–20.
163. Bailey, P. J.; Lanfranchi, M.; Marchiò, L.; Parsons, S. *Inorg. Chem.* **2001**, *40*, 5030–5035.
164. Zaidi, S. A. A.; Khan, T. A. *Synth. React. Inorg. Met.-Org. Chem.* **1984**, *14*, 717–729.
165. Zaidi, S. A. A.; Khan, T. A.; Zaidi, S. R. A.; Siddiqi, Z. A. *Polyhedron* **1985**, *4*, 1163–1166.
166. Knop, O.; Bakshi, P. K. *Can. J. Chem.* **1995**, *73*, 151–160.
167. Janiak, C.; Temidzemir, S. Röhr, C. Z. *Anorg. Allg. Chem.* **2000**, *626*, 1265–1267.
168. Effendy; Gioia Lobbia, G.; Pellei, M.; Pettinari, C.; Santini, C.; Skelton, B. W.; White, A. H. *J. Chem. Soc. Dalton Trans.* **2001**, 528–534.
169. Fränkel, R.; Kniczek, J.; Ponikwar, W.; Nöth, H.; Polborn, K.; Fehllhammer, W. P. *Inorg. Chim. Acta* **2001**, *312*, 23–39.
170. Fränkel, R.; Kernbach, U.; Bakola-Christianopoulou, M.; Plaia, U.; Suter, M.; Ponikwar, W.; Nöth, H.; Moinet, C.; Fehllhammer, W. P. *J. Organomet. Chem.* **2001**, *617–618*, 530–545.
171. Khan, T. A.; Khan, M. A.; Haq, M. M. *Synth. React. Inorg. Met.-Org. Chem.* **1996**, *26*, 1467–1476.
172. Trofimenko, S. J. *Am. Chem. Soc.* **1967**, *89*, 3170–3177.
173. Gioia Lobbia, G.; Bonati, F.; Cecchi, P. *Synth. React. Inorg. Met.-Org. Chem.* **1991**, *21*, 1141–1151.
174. Janiak, C.; Scharmann, T. G.; Hernling, H.; Lentz, D.; Pickardt, J. *Chem. Ber.* **1995**, *128*, 235–244.
175. Janiak, C.; Scharmann, T. G.; Albrecht, P.; Marlow, F.; Macdonald, R. J. *Am. Chem. Soc.* **1996**, *118*, 6307–6308.
176. Janiak, C.; Scharmann, T. G.; Günther, W.; Hinrichs, W.; Lentz, D. *Chem. Ber.* **1996**, *129*, 991–995.
177. Xiao, Z.; Gable, R. W.; Wedd, A. G.; Young, C. G. *J. Chem. Soc., Chem. Commun.* **1994**, 1295–1296.
178. Janiak, C.; Esser, L. Z. *Naturforsch.* **1993**, *48b*, 394–396.
179. Janiak, C.; Scharmann, T. G.; Brzezinka, K.-W.; Reich, P. *Chem. Ber.* **1995**, *128*, 323–328.
180. Lalor, F. J.; Miller, S. M.; Garvey, N. J. *Organomet. Chem.* **1988**, *356*, C57–C60.
181. Shiu, K.-B.; Shen, F.-M.; Wang, S.-L.; Wei, S.-C. *J. Organomet. Chem.* **1989**, *372*, 251–261.
182. Cecchi, P.; Gioia Lobbia, G.; Leonesi, D.; Pettinari, C.; Sepe, C.; Vinciguerra, V. *Gazz. Chim. Ital.* **1993**, *123*, 569–572.
183. Anderson, S.; Harman, A.; Hill, A. F. *J. Organomet. Chem.* **1995**, *498*, 251–255.
184. Cartwright, J.; Harman, A.; Hill, A. F. *J. Organomet. Chem.* **1990**, *396*, C31–C34.
185. Burns, I. D.; Hill, A. F.; White, A. J. P.; Williams, D. J.; Wilton-Ely, J. D. E. T. *Organometallics* **1998**, *17*, 1552–1557.
186. Gioia Lobbia, G.; Pellei, M.; Pettinari, C.; Santini, C.; Somers, N.; White, A. H. *Inorg. Chim. Acta* **2002**, *333*, 100–108.
187. Broomhead, J. A.; Lynch, M. J. *Inorg. Chim. Acta* **1995**, *240*, 13–17.
188. Bovens, M.; Togni, A.; Venanzi, L. M. *J. Organomet. Chem.* **1993**, *451*, C28–C31.
189. Jalón, F. A.; Otero, A.; RodriguezA.; Perez-Manrique, M. *J. Organomet. Chem.* **1996**, *58*, 69–74.
190. Burling, S.; Field, L. D.; Messerle, B. A. *Organometallics* **2000**, *19*, 87–90.
191. Pettinari, C.; Lorenzotti, A.; Selavi, G.; Cingolani, A.; Rivarola, E.; Colapietro, M.; Cassetta, A. *J. Organomet. Chem.* **1995**, *496*, 69–85.
192. Fernández-Baeza, J.; Jalón, F. A.; Otero, A.; Rodrigo-Blanco, Ma., E. *J. Chem. Soc., Dalton Trans.* **1995**, 1015–1021.
193. Trofimenko, S. J. *Am. Chem. Soc.* **1970**, *92*, 5118–5126.
194. Joshi, V. S.; Nandi, M.; Zhang, H.; Haggerty, B. S.; Sarkar, A. *Inorg. Chem.* **1993**, *32*, 1301–1303.
195. Cotton, F. A.; Jeremic, M. A.; Shaver, A. *Inorg. Chim. Acta.* **1972**, *6*, 543–551.
196. Fieslmann, B. F.; Stucky, G. D. *Inorg. Chem.* **1978**, *17*, 2074–2077.
197. Cinellu, M. A.; Stoccoro, S.; Minghetti, G.; Bandini, A. L.; Banditelli, G.; Bovio, B. *J. Organomet. Chem.* **1989**, *372*, 311–325.
198. Minghetti, G.; Cinellu, M. A.; Bandini, A. L.; Banditelli, G.; DeMartin, F.; Manassero, M. *J. Organomet. Chem.* **1986**, *315*, 387–399.
199. Shiu, K.-B.; Chou, C.-C.; Wang, S.-L.; Wei, S.-C. *Organometallics* **1990**, *9*, 286–288.
200. Alonso, M. T.; Juanes, O.; de Mendoza, J.; Rodriguez-Ubis, J. C. *J. Organomet. Chem.* **1994**, *484*, 19–26.
201. Tsuji, S.; Swenson, D. C.; Jordan, R. F. *Organometallics* **1999**, *18*, 4758–4764.
202. Trofimenko, S. J. *Am. Chem. Soc.* **1970**, *92*, 5118–5126.
203. Stearns, J. E.; Matthews, M. A.; Reger, D. L.; Collins, J. E. *Int. J. Hydrogen Energy* **1998**, *23*, 469–474.
204. Katritzky, A. R.; Abdel-Rahman, A. E.; Leahy, D. E.; Schwarz, O. A. *Tetrahedron* **1983**, *39*, 4133–4142.
205. Hill, M. S.; Mahon, M. F.; McGinley, J. M. G.; Molloy, K. C. *Polyhedron* **2001**, *20*, 1995–2002.
206. Torres, J.; Lavandera, J. L.; Cabildo, P.; Claramunt, R. M.; Elguero, J. *J. Heterocyclic Chem.* **1988**, *25*, 771–782.
207. Pettinari, C.; Marchetti, F.; Lorenzotti, A.; Gioia Lobbia, G.; Leonesi, D.; Cingolani, A. *Gazz. Chim. Ital.* **1994**, *124*, 51–55.
208. Claramunt, R. M.; Domiano, P.; Elguero, J.; Lavandera, J. L. *Bull. Soc. Chim. Fr.* **1989**, *4*, 472–476.
209. Mann, K. L. V.; Jeffery, J. C.; McCleverty, J. A.; Ward, M. D. *J. Chem. Soc., Dalton Trans.* **1998**, 3029–3035.
210. Elguero, J.; Claramunt, R. M.; Garcera, R.; Julia, S.; Avila, L.; del Mazo, J. M.; *Magn. Res. Chem.* **1987**, *25*, 260–268.
211. Bonati, F.; Bovio, B. *J. Crystallogr. Spectr. Res.* **1990**, *20*, 233–244.
212. Singh, H.; Singh, P. *Chem. Ind. (London)* **1978**, 126–127.
213. Juliá, S.; Sala, P.; del Mazo, J.; Sancho, M.; Ochoa, C.; Elguero, J.; Fayet, J.-P.; Vermut, M.-C. *Heterocyclic Chem.* **1982**, *19*, 1141–1145.
214. Díez-Barra, E.; de la Hoz, A.; Sánchez-Migallón, A.; Tejada, J. *Heterocycles* **1992**, *34*, 1365–1373.
215. Jameson, D. L.; Castellano, R. K. *Inorg. Synth.* **1998**, *32*, 51–63.
216. Peterson, L. K.; Kiehlmann, E.; Sanger, A. R.; The, K. I. *Can. J. Chem.* **1974**, *52*, 2367–2374.
217. Antiñolo, A.; Carrillo-Hermosilla, F.; Díez-Barra, E.; Fernández-Baeza, J.; Fernández-López, M.; Lara-Sánchez, A.; Moreno, A.; Otero, A.; Rodríguez, A. M.; Tejada, J. *J. Chem. Soc. Dalton Trans.* **1998**, 3737–3743.
218. Mann, K. L. V.; Jeffery, J. C.; McCleverty, J. A.; Thornton, P.; Ward, M. D. *J. Chem. Soc. Dalton Trans.* **1998**, 89–97.
219. Tang, L.-F.; Wang, Z.-H.; Ja, W.-L.; Xu, Y.-M.; Wang, J.-T. *Polyhedron* **2000**, *19*, 381–387.

220. Koval, I. A.; Schuitema, A. M.; Driessen, W. L.; Reedijk, J. *J. Chem. Soc. Dalton Trans.* **2001**, 3663–3667.
221. Tang, L.-F.; Jia, W.-L.; Song, D.-T.; Wang, Z.-H.; Chai, J.-F.; Wang, J.-T. *Organometallics* **2002**, *21*, 445–447.
222. Julia, S.; Martinez-Martorell, C.; Elguero, J. *Heterocycles* **1986**, *24*, 2233–2237.
223. Esteruelas, M. A.; Oro, L. A.; Apreada, M. C.; Foces-Foces, C.; Cano, F. H.; Claramunt, R. M.; Lopez, C.; Elguero, J.; Begtrup, M. *J. Organomet. Chem.* **1988**, *344*, 93–108.
224. Astley, T.; Gulbis, J. M.; Hitchman, M. A.; Tiekink, E. R. T. *J. Chem. Soc., Dalton Trans.* **1993**, 509–515.
225. Canty, A. J.; Minchin, N. J.; Engelhardt, L. M.; Skelton, B. W.; White, A. H. *J. Chem. Soc., Dalton Trans.* **1986**, 645–650.
226. Canty, A. J.; Minchin, N. J.; Patrick, J. M.; White, A. H. *J. Chem. Soc., Dalton Trans.* **1983**, 1253–1259.
227. Heinekey, D. M.; Oldham, W. J., Jr.; Wiley, J. S. *J. Am. Chem. Soc.* **1996**, *118*, 12842–12843.
228. Brown, D. G.; Byers, P. K.; Canty, A. J. *Organometallics* **1990**, *9*, 1231–1235.
229. Canty, A. J.; Honeyman, R. T.; Skelton, B. W.; White, A. H. *J. Organomet. Chem.* **1992**, *430*, 245–257.
230. Dhawan, I. K.; Bruck, M. A.; Schilling, B.; Grittini, C.; Enemark, J. H. *Inorg. Chem.* **1995**, *34*, 3801–3808.
231. Llobet, A.; Doppelt, P.; Meyer, T. J. *Inorg. Chem.* **1988**, *27*, 514–520.
232. Macchioni, A.; Bellachioma, G.; Cardaci, G.; Cruciani, G.; Foresti, E.; Sabatino, P.; Zuccaccia, C. *Organometallics* **1998**, *17*, 5549–5556.
233. Reger, D. L.; Collins, J. E.; Flomer, W. A.; Rheingold, A. L.; Incarvito, C.; Guzei, L. A. *Polyhedron* **2001**, *20*, 2491–2494.
234. Reger, D. L.; Little, C. A.; Young, V. G., Jr.; Pink, M. *Inorg. Chem.* **2001**, *40*, 2870–2874.
235. Reger, D. L.; Collins, J. E.; Myers, S. M.; Rheingold, A. L.; Liable-Sands, L. M. *Inorg. Chem.* **1996**, *35*, 4904–4909.
236. Reger, D. L.; Wright, T. D.; Little, C. A.; Lamba, J. J. S.; Smith, M. D. *Inorg. Chem.* **2001**, *40*, 3810–3814.
237. Reger, D. L. *Comments Inorg. Chem.* **1999**, *21*, 1–28.
238. Reger, D. L.; Collins, J. E.; Layland, R.; Adams, R. D. *Inorg. Chem.* **1996**, *35*, 1372–1376.
239. Pettinari, C.; Pellei, M.; Cingolani, A.; Martini, D.; Drozdov, A.; Troyanov, S.; Panzeri, W.; Mele, A. *Inorg. Chem.* **1999**, *38*, 5777–5787.
240. Cingolani, A.; Effendy; Martini, D.; Pellei, M.; Pettinari, C.; Skelton, B. W.; White, A. H. *Inorg. Chim. Acta* **2002**, *328*, 87–95.
241. Martini, D.; Pellei, M.; Pettinari, C.; Skelton, B. W.; White, A. H. *Inorg. Chim. Acta* **2002**, *333*, 72–82.
242. Canty, A. J.; Minchin, N. J.; Healy, P. C.; White, A. H. *J. Chem. Soc., Dalton Trans.* **1982**, 1795–1802.
243. Byers, P. K.; Stone, F. G. A. *J. Chem. Soc. Dalton Trans.* **1991**, 93–99.
244. Nakazawa, H.; Ikai, S.; Mitani, N. Japanese Patent 09220476, 1997.
245. Supuran, C. T.; Claramunt, R. M.; Lavandera, J. *Biol. Pharm. Bull.* **1996**, *19*, 1417–1422.
246. DeClercq, J. P.; Van Meerssche, M. *Acta Cryst.* **1984**, *C40*, 1098–1101.
247. Huckel, W.; Bretschneider, H. *Chem. Ber.* **1937**, *70*, 2024–2026.
248. Julia, S.; del Mazo, J. Ma; Avila, L.; Elguero, J. *Org. Prep. Proc. Int.* **1984**, *16*, 299–307.
249. Reger, D. L.; Grattan, T. C.; Brown, K. J.; Little, C. A.; Lamba, J. J. S.; Rheingold, A. L.; Sommer, R. D. *J. Organomet. Chem.* **2000**, *607*, 120–128.
250. Armanasco, N. L. B. Sc., Ph. D. Thesis, Univ. of Western Australia, 2000: *Poly(pyrazolyl)alkanes and Their Coordination Chemistry*.
251. Reger, D. L. *Inorg. Synth.* **1998**, *32*, 63–65.
252. Lehn, J.-M.; Ziessel, R. *Helv. Chim. Acta* **1988**, *71*, 1511.
253. See for example: Canty, A. J.; Honeyman, R. T. *J. Organomet. Chem.* **1990**, *387*, 247–263.
254. Goodman, M. S.; Bateman, M. A. *Tetrahedron Letters* **2001**, *42*, 5–7.
255. Byers, P. K.; Canty, A. J.; Honeyman, R. T.; Claramunt, R. M.; Lopez, C.; Lavandera, J. L.; Elguero, J. *Gazz. Chim. Ital.* **1992**, *122*, 341–344.
256. Esteruelas, M. A.; Oro, L. A.; Claramunt, R. M.; Lopez, C.; Lavandera, J. L.; Elguero, J. *J. Organomet. Chem.* **1989**, *366*, 245–255.
257. Reger, D. L.; Wright, T. D.; Semeniuc, R. F.; Grattan, T. C.; Smith, M. D. *Inorg. Chem.* **2001**, *40*, 6212–6219.
258. Reger, D. L.; Semeniuc, R. F.; Smith, M. D. *Inorg. Chem.* **2001**, *40*, 6545–6546.
259. Pullen, E. E.; Rheingold, A. L.; Rabinovich, D. *Inorg. Chem. Commun.* **1999**, *2*, 194–196.
260. Pullen, E. E.; Rabinovich, D.; Incarvito, C. D.; Concolino, T. E.; Rheingold, A. L. *Inorg. Chem.* **2000**, *39*, 1561–1567.
261. Vepachedu, S.; Stibrany, R. T.; Knapp, S.; Potenza, J. A.; Schugar, H. J. *Acta Crystallogr.* **1995**, *C51*, 423–426.
262. Richburg, L. M.; Farouq, J. A.; Incarvito, C. D.; Rheingold, A. L.; Rabinovich, D. *Polyhedron* **2000**, *19*, 1815–1820.
263. Kläui, W.; Schramm, D.; Peters, W. *Eur. J. Inorg. Chem.* **2001**, 3113–3117.
264. Kläui, W.; Schramm, D.; Peters, W.; Rheinwald, G.; Lang, H. *Eur. J. Inorg. Chem.* **2001**, 1415–1424.
265. Fomitchev, D. V.; McLauchlan, C. C.; Holm, R. H. *Inorg. Chem.* **2002**, *41*, 958–966.
266. Higgs, T. C.; Carrano, C. J. *Inorg. Chem.* **1997**, *36*, 298–306.
267. Higgs, T. C.; Dean, N. S.; Carrano, C. J. *Inorg. Chem.* **1998**, *37*, 1473–1482.
268. Higgs, T. C.; Ji, D.; Czernuszewicz, R. S.; Matzanke, B. F.; Schunemann, V.; Trautwein, A. X.; Helliwell, M.; Ramirez, W.; Carrano, C. J. *Inorg. Chem.* **1998**, *37*, 2383–2392.
269. Byers, P. K.; Canty, A. J.; Honeyman, R. T. *J. Organomet. Chem.* **1990**, *385*, 417–427.
270. Otero, A.; Fernández-Baeza, J.; Tejada, J.; Antiñolo, A.; Carrillo-Hermosilla, F.; Diez-Barra, E.; Lara-Sánchez, A.; Fernández-López, M.; Lanfranchi, M.; Pellinghelli, M. A. *J. Chem. Soc., Dalton Trans.* **1999**, 3537–3539.
271. Beck, A.; Weibert, B.; Burzlaff, N. *Eur. J. Inorg. Chem.* **2001**, 521–527.
272. Schwenzer, B.; Schleu, J.; Burzlaff, N.; Karl, C.; Fischer, H. *J. Organomet. Chem.* **2002**, *641*, 134–141.
273. Sorrell, T. N.; Allen, W. E.; White, P. S. *Inorg. Chem.* **1995**, *34*, 852–960.
274. Kimblin, C.; Murphy, V. J.; Parkin, G. *J. Chem. Soc., Chem. Commun.* **1996**, 235–236.
275. Gallicano, K. D.; Paddock, N. L.; Rettig, S. J.; Trotter, J. *Inorg. Nucl. Chem. Lett.* **1979**, *15*, 417–421.
276. Justin Thomas, K. R.; Chandrasekhar, V.; Pal, P.; Scott, S. R.; Hallford, R.; Cordes, A. W. *Inorg. Chem.* **1993**, *32*, 606–611.
277. Joshi, V. S.; Kale, V. K.; Sathe, K. M.; Sarkar, A.; Tavale, S. S.; Suresh, C. G. *Organometallics* **1991**, *10*, 2898–2902.
278. Psillakis, E.; Jeffery, J. C.; McCleverty, J. A.; Ward, M. D. *J. Chem. Soc., Dalton Trans.* **1997**, 1645–1651.
279. Minghetti, G.; Banditelli, G.; Bonati, F. *Chem. Ind. (London)* **1977**, 123–124.

280. Bandini, A. L.; Banditelli, G.; Minghetti, G.; Bonati, F. *Can. J. Chem.* **1979**, *57*, 3237–3242.
281. Minghetti, G.; Bandini, A. L.; Banditelli, G.; Bonati, F.; Szostak, R.; Strouse, C. E.; Knobler, C. B.; Kaesz, H. D. *Inorg. Chem.* **1983**, *22*, 2324–2331.
282. Bovio, B.; Banditelli, G.; Bandini, L. *Inorg. Chim. Acta* **1985**, *96*, 213–223.
283. Pettinari, C.; Marchetti, F.; Cingolani, A.; Troyanov, S. I.; Drozdov, A. *J. Chem. Soc., Dalton Trans.* **1998**, 3335–3342.
284. Cetini, G.; Operti, L.; Vaglio, G. A.; Bandini, A. L.; Banditelli, G. *Gazz. Chim. Ital.* **1988**, *118*, 545–548.
285. Lillebeen, T.; Hascall, T.; Parkin, G. *Inorg. Chem.* **1997**, *36*, 3787–3790.
286. Hammes, B. S.; Carrano, M. W.; Carrano, C. J. *J. Chem. Soc., Dalton Trans.* **2001**, 1448–1451.
287. Niedenzu, K.; Serwatowski, J.; Trofimenko, S. *Inorg. Chem.* **1991**, *30*, 524–527.
288. Zaidi, S. A. A.; Neyazi, M. A. *Trans. Met. Chem.* **1979**, *4*, 164.
289. Siddiqi, Z. A.; Khan, S.; Zaidi, S. A. A. *Synth. React. Inorg. Met.-Org. Chem.* **1982**, *12*, 433–453.
290. Siddiqi, K. S.; Neyazi, M. A.; Tabassum, S.; Luftullah; Zaidi, S. A. A. *Indian J. Chem.* **1991**, *30A*, 724–726.
291. Rheingold, A. L.; Incarvito, C. D.; Trofimenko, S. *Inorg. Chem.* **2000**, *39*, 5569–5571.
292. Siemer, C. J.; Goswami, N.; Kahol, P. K.; Van Stipdonk, M. J.; Eichhorn, D. M. *Inorg. Chem.* **2001**, *123*, 4081–4084.
293. Trofimenko, S. *J. Am. Chem. Soc.* **1969**, *91*, 5410–5411.
294. Kisko, J. L.; Hascall, T.; Parkin, G. *J. Am. Chem. Soc.* **1998**, *120*, 10561–10562.
295. Domaille, P. J. *J. Am. Chem. Soc.* **1980**, *102*, 5392–5393.
296. Bothner-By, A. A.; Domaille, P. J.; Gayathri, C. *J. Am. Chem. Soc.* **1981**, *103*, 5602–5603.
297. White, D. L.; Faller, J. W. *J. Am. Chem. Soc.* **1982**, *104*, 1548–1552.
298. Fabrizi de Biani, F.; Jákle, F.; Spiegler, M.; Wagner, M.; Zanello, P. *Inorg. Chem.* **1997**, *36*, 2103–2111.
299. Hertweck, E.; Peters, F.; Scherer, W.; Wagner, M. *Polyhedron* **1998**, *17*, 1149–1157.
300. Guo, S. L.; Peters, F.; Fabrizi de Biani, F.; Bats, J. W.; Herdtweck, E.; Zanello, P.; Wagner, M. *Inorg. Chem.* **2001**, *40*, 4928–4936.
301. Guo, S. L.; Bats, J. W.; Bolte, M.; Wagner, M. *J. Chem. Soc., Dalton Trans.* **2001**, 3572–3576.
302. Niedenzu, K.; Seelig, S. S.; Weber, W. Z. *Anorg. Allg. Chem.* **1981**, *483*, 51–62.
303. Niedenzu, K.; Trofimenko, S. *Inorg. Chem.* **1985**, *24*, 4222–4223.
304. Brock, C. P.; Das, M. K.; Minton, R. P.; Niedenzu, K. *J. Am. Chem. Soc.* **1988**, *110*, 817–822.
305. Harden, N. C.; Jeffery, J. C.; McCleverty, J. A.; Rees, L. H.; Ward, M. D. *New J. Chem.* **1998**, 661–663.
306. Rheingold, A. L.; Haggerty, B. S.; Trofimenko, S. *Angew. Chem. Int. Ed. Engl.* **1994**, *33*, 1983–1985.
307. Humphrey, E. R.; Harden, N. C.; Rees, L. H.; Jeffery, J. C.; McCleverty, J. A.; Ward, M. D. *J. Chem. Soc., Dalton Trans.* **1998**, 3353–3354.
308. Humphrey, E. R.; Williams, K. L. V.; Reeves, Z. R.; Behrendt, A.; Jeffery, J. C.; Maher, J. P.; McCleverty, J. A.; Ward, M. D. *New J. Chem.* **1999**, *23*, 417–423.
309. Halcrow, M. A.; McInnes, E. J. L.; Mabbs, F. E.; Scowen, I. J.; McPartlin, M.; Powell, H. R.; Davies, J. E. *J. Chem. Soc., Dalton Trans.* **1997**, 4025–4035.
310. Lopez, C.; Sanz, D.; Caramunt, R. M.; Trofimenko, S.; Elguero, J. *J. Organomet. Chem.* **1995**, *503*, 265–272.
311. Motson, G. R.; Mamula, O.; Jeffery, J. C.; McCleverty, J. A.; Ward, M. D.; Ward, M. D. *J. Chem. Soc., Dalton Trans.* **2001**, 1389–1391.
312. Reeves, Z. R.; Mann, K. L. V.; Jeffery, J. C.; McCleverty, J. A.; Ward, M. D.; Barigelletti, F.; Armaroli, N. *J. Chem. Soc., Dalton Trans.* **1999**, 349–355.
313. Rheingold, A. L.; Liable-Sands, L. M.; Trofimenko, S. *Inorg. Chem.* **2001**, *40*, 6509–6513.
314. Dias, H. V. R.; Jin, W.; Kim, H.-J.; Lu, H.-L. *Inorg. Chem.* **1996**, *35*, 2317–2328.
315. Dias, H. V. R.; Kim, H.-J.; Lu, H.-L.; Rajeshwar, K.; de Tacconi, N. R.; Dereeskei-Kovacs, A.; Marynick, D. S. *Organometallics* **1996**, *15*, 2994–3003.
316. Dias, H. V. R.; Kim, H.-J. *Organometallics* **1996**, *15*, 5374–5379.
317. Gioia Lobbia, G.; Valle, G.; Calogero, S.; Cecchi, P.; Santini, C.; Marchetti, F. *J. Chem. Soc., Dalton Trans.* **1996**, 2475–2483.
318. Gioia Lobbia, G.; Bovio, B.; Santini, C.; Cecchi, P.; Pettinari, C.; Marchetti, F. *Polyhedron* **1998**, *17*, 17–26.
319. Trofimenko, S.; Rheingold, A. L.; Liable-Sands, L. M. *Inorg. Chem.* **2002**, *41*, 1889–1896.
320. Rheingold, A. L.; Haggerty, B. S.; Yap, G. P. A.; Trofimenko, S. *Inorg. Chem.* **1997**, *36*, 5097–5103.
321. Rheingold, A. L.; Liable-Sands, L. M.; Yap, G. P. A.; Trofimenko, S. *Chem. Commun.* **1996**, 1233–1234.
322. Brunner, H.; Singh, U. P.; Boeck, T.; Altmann, S.; Scheck, T.; Wrackmeyer, B. *J. Organomet. Chem.* **1993**, *443*, C16–C18.
323. Kitajima, N.; Fujisawa, K.; Fujimoto, C.; Moro-oka, Y.; Hashimoto, S.; Kitagawa, T.; Toriumi, K.; Tatsumi, K.; Nakamura, A. *J. Am. Chem. Soc.* **1992**, *114*, 1277–1291.
324. Dowling, C. M.; Leslie, D.; Chisbolm, M. H.; Parkin, G. *Main Group Chem.* **1995**, *1*, 29–52.
325. Kläui, W.; Schilde, W.; Schmidt, M. *Inorg. Chem.* **1997**, *36*, 1598–1601.
326. Ruf, M.; Weis, K.; Vahrenkamp, H. *J. Chem. Soc., Chem. Commun.* **1994**, 135–136.
327. Ghosh, P.; Parkin, G. *Inorg. Chem.* **1996**, *35*, 1429–1430.
328. Conry, R. R.; Ji, G.; Tipton, A. A. *Inorg. Chem.* **1999**, *38*, 906–913.
329. Weis, K.; Vahrenkamp, H. *Inorg. Chem.* **1997**, *36*, 5589–5591.
330. Libertini, E.; Yoon, K.; Parkin, G. *Polyhedron* **1993**, *12*, 2539–2542.
331. Ruf, M.; Burth, R.; Weis, K.; Vahrenkamp, H. *Chem. Ber.* **1996**, *129*, 1251–1257.
332. Rheingold, A. L.; Yap, G.; Trofimenko, S. *Inorg. Chem.* **1995**, *34*, 759–760.
333. Siddiqi, K. S.; Khan, S. S.; Zaidi, A. A. *Synth. React. Inorg. Met.-Org. Chem.* **1983**, *13*, 425–447.
334. Siddiqi, Z. A.; Khan, S.; Siddiqi, K. S.; Zaidi, S. A. A. *Synth. React. Inorg. Met.-Org. Chem.* **1984**, *14*, 303–324.
335. Włodarczyk, A.; Richardson, R. M.; Ward, M. D.; McCleverty, J. A.; Hursthouse, M. H. B.; Coles, S. J. *Polyhedron* **1996**, *15*, 27–35.
336. McCleverty, J. A.; Seddon, D.; Bailey, N. A.; Walker, N. W. J. *J. Chem. Soc., Dalton Trans.* **1976**, 898–908.
337. Jeffery, J. C.; Kurek, S. S.; McCleverty, J. A.; Psillakis, E.; Richardson, R. M.; Ward, M. D.; Włodarczyk, A. J. *J. Chem. Soc., Dalton Trans.* **1994**, 2559–2564.
338. Takahashi, Y.; Akita, M.; Hikichi, S.; Moro-oka, Y. *Organometallics* **1998**, *17*, 4884–4888.

339. Huang, J.; Lee, L.; Haggerty, B. S.; Rheingold, A. L.; Walters, M. A. *Inorg. Chem.* **1995**, *34*, 4268–4270.
340. Rheingold, A. L.; Liable-Sands, L. M.; Trofimenko, S. *Inorg. Chem.* **2000**, *39*, 1333–1335.
341. Rheingold, A. L.; Yap, G. P. A.; Liable-Sands, L. M.; Guzei, I. A.; Trofimenko, S. *Inorg. Chem.* **1997**, *36*, 6261–6265.
342. Campo, A.; Cano, M.; Heras, J. V.; Pinilla, E.; Monge, A.; McCleverty, J. A. *J. Chem. Soc., Dalton Trans.* **1998**, 3065–3070.
343. Lalor, F. J.; Miller, S. M.; Garvey, N. *Polyhedron* **1990**, *9*, 63–68.
344. Breakell, K. R.; Patmore, D. J.; Storr, A. *J. Chem. Soc., Dalton Trans.* **1975**, 749–754.
345. Trofimenko, S.; Calabrese, J. C.; Thompson, J. S. *Inorg. Chem.* **1992**, *31*, 974–979.
346. Bortolin, M.; Bucher, U. E.; Rieger, H.; Venanzi, L. M.; Albinati, A.; Lianza, F.; Trofimenko, S. *Organometallics* **1992**, *11*, 2514–2521.
347. Yalpani, M.; Boese, R.; Köster, K. *Chem. Ber.* **1990**, *123*, 1285–1291.
348. Keyes, M. C.; Chamberlain, B. M.; Caltagirone, S. A.; Halfen, J. A.; Tolman, W. B. *Organometallics* **1998**, *17*, 1984–1992.
349. Thompson, J. S.; Zitzman, J. L.; Marks, T. J.; Ibers, J. A. *Inorg. Chim. Acta* **1980**, *46*, L101–L105.
350. Hill, A. F.; Malget, J. M. *J. Chem. Soc. Dalton Trans.* **1997**, 2003–2004.
351. Ghosh, P.; Parkin, G. *Chem. Commun.* **1998**, 413–414.
352. Cano, M.; Heras, J. V.; Santamaria, E.; Pinilla, E.; Monge, A.; Jones, C. J.; McCleverty, J. A. *Polyhedron* **1993**, *12*, 1711–1714.
353. Gorrell, I. B.; Looney, A.; Parkin, G. *J. Am. Chem. Soc.* **1990**, *112*, 4068–4069.
354. Ghosh, P.; Parkin, G. *J. Chem. Soc., Dalton Trans.* **1998**, 2281–2283.
355. Lopes, I.; Lin, G. Y.; Domingos, A.; McDonald, R.; Marques, N.; Takats, J. *J. Am. Chem. Soc.* **1999**, *121*, 8110–8111.
356. Buchen, T.; Gütlich, P. *Inorg. Chim. Acta* **1995**, *231*, 221–223.
357. Osawa, M.; Tanaka, M.; Fujisawa, K.; Kitajima, N.; Moro-oka, Y. *Chem. Lett.* **1996**, 397–398.
358. Paulo, A.; Ascenso, J.; Domingos, A.; Galvão, A.; Santos, I. *J. Chem. Soc., Dalton Trans.* **1999**, 1293–1300.
359. Lalor, F. J.; Desmond, T. J.; Cotter, G. M.; Shanahan, C. A.; Ferguson, G.; Parvez, M.; Ruhl, B. *J. Chem. Soc., Dalton Trans.* **1995**, 1709–1726.

# 1.11

## Higher Denticity Ligands

C. PETTINARI and F. MARCHETTI  
*Università di Camerino, Macerata, Italy*

and

A. DROZDOV  
*Moscow State University, Moscow, Russia*

---

1.11.1	INTRODUCTION	211
1.11.2	AMINES	212
1.11.2.1	Substituted Diamines	212
1.11.2.2	Substituted Piperazines	215
1.11.2.3	Polyamines	215
1.11.2.4	Diamine–Diamide Ligands	218
1.11.2.5	1,3-Diamino-2-propanol Derivatives	219
1.11.3	LIGANDS CONTAINING AROMATIC OR HETEROCYCLIC SPACERS	219
1.11.3.1	2,6-Substituted Pyridines	219
1.11.3.2	Xylyl-based Ligands	220
1.11.3.3	Multidentate Ligands Containing Pyridazine, Phthalazine, Pyrazolyl, Thiazolyl, Oxadiazolyl, Triazine, and Thiophene Bridges	221
1.11.3.4	Multidentate Ligands Containing More than Two Pyridine Rings	223
1.11.4	DITHIA-ALKANE LIGANDS	224
1.11.5	POLYETHYLENEGLYCOLS AND GLYMES	224
1.11.6	TRIPODAL LIGANDS	226
1.11.6.1	Tripodal Ligands with Nitrogen as the Bridgehead Atom	226
1.11.6.2	Tripodal Ligands with Carbon as the Bridgehead Atom	231
1.11.7	MACROCYCLIC LIGANDS	232
1.11.7.1	Crown Ethers	233
1.11.7.2	Cryptands and Polycyclic Compounds	234
1.11.7.3	Other Preorganized Macrocycles	234
1.11.7.4	Switchable and Chromogenic Macrocycles	235
1.11.7.4.1	Photoresponsive macrocycles	235
1.11.7.4.2	pH-responsive macrocycles	236
1.11.7.4.3	Redox-responsive macrocycles	237
1.11.7.4.4	Ion-responsive fluorescent macrocycles	237
1.11.7.4.5	Chromogenic macrocycles	237
1.11.7.5	Siderophore-type Macrocycles	237
1.11.8	DENDRIMERIC LIGANDS	238
1.11.9	POLYCARBOXYLIC ACIDS	240
1.11.10	REFERENCES	246

---

### 1.11.1 INTRODUCTION

Since the first edition of *Comprehensive Coordination Chemistry (CCC, 1987)* was published, the number of known multidentate ligands has increased dramatically. The pursuit of multidentate ligands for applications in catalysis, bioinorganic and material chemistry is a primary concern of

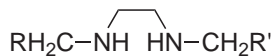
organic and inorganic chemistry alike. Much of the current impetus is provided by the need for cheap, efficient, nontoxic, water-soluble catalysts, for models of metalloenzymes in which bi- and multimetallic centers occur in the active sites, and for efficient chelating agents toward lanthanide and actinide ions used in bioinorganic chemistry and materials science. Complexes containing multidentate ligands have been investigated to understand the role of metal ions in multielectron redox reactions and in the activation of small molecules such as  $O_2$  and  $N_2$ , as well as to control possible cooperative phenomena between the two metal centers. For example, suitably designed multimetallic complexes formed by binucleating ligands possessing four- to six-coordinate sites could provide reactivity patterns distinct from those shown by analogous monometallic species. The design of appropriate ligand cores, providing coordination sites with well-defined metal-metal separations, is highly desirable. Studies on the assembly of double- and triple-helicate complexes are also actually a major area in coordination chemistry. It has been observed that the formation of architecturally complex systems is directed by the interplay between simple parameters such as the stereoelectronic preference of the metal ions and the disposition of the binding sites in the ligand. How a polydentate ligand becomes partitioned into distinct metal-binding sites is a key parameter in the assembly of helicates. Recent progress in the field of crystal engineering based on polymeric coordination has been devoted to the use of novel polydentate ligands. Much study has centered upon the use of supramolecular contacts between suitable molecules to generate multidimensional arrays or networks. The simple strategy of combining metal centers with polyhapto ligands can generate crystalline architecture, with obvious implications for the rational design of new and varied topological types. There are numerous examples of polymeric sheet or network materials involving bifunctional building blocks connected by coordination to metal centres.

This chapter covers the coordination chemistry of ligands with four or more donor atoms (N, O, or S) that are referred to as high-denticity or multidentate. Particular emphasis has been devoted to N- and O-donor ligands, which present several distinct advantages: they are often largely available in pure form and are easy to synthesize; some sulfur donors are also included. A large number of organic molecules with at least four donor atoms have been shown to coordinate metal cations. Many of them contain different substituents (amine, amide, hydroxy, oxo, carboxy, etc.), which makes it impossible to classify them based on the nature of their functional groups. Here we divided them into several classes taking into consideration: (i) the arrangement of the ligand around the metal center; (ii) the nature of donor groups and heteroatoms. The multidentate donors that belong to a separate, well-defined group, such as tetraketones, polypyridines, etc., are discussed in the appropriate chapters. Systematic names are cumbersome, and a variety of trivial names have been used. Both will be avoided in this chapter, and the better-known system of abbreviations, or a code number, will be used.

## 1.11.2 AMINES

### 1.11.2.1 Substituted Diamines

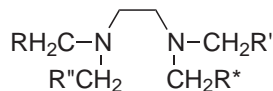
*N,N'*-substituted ethylenediamine and related compounds (1), (2), in which R and R' are groups containing at least one donor atom (N, O, or S), are among the most common N-donor ligands, which usually act as chelates towards a single metal center, while *N,N,N',N'*-substituted ethylenediamines (3) are generally bis-chelating.



(1)



(2)

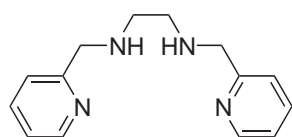


(3)

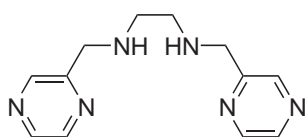
R, R', R'', R\* = N-, O-, or S-donor moiety

The *N*-substituted ethylenediamines and propylenediamines can be prepared, according to Goodwin and Lions,<sup>1</sup> by the reaction of the diamine with the appropriate aldehyde followed by the reduction of enamine by zinc dust,  $MBH_4$  (M = Na, K), or hydrogen with Pt/C catalyst. This method has been employed to obtain pyridyl- and pyrazyl-substituted ligands such as (4)<sup>2</sup> or (5),<sup>3</sup>

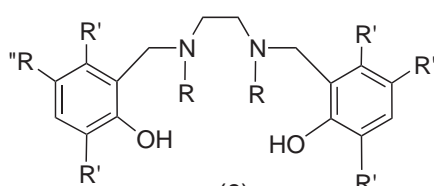
or phenolate-substituted ones such as (6)<sup>4-6</sup> or (7), the latter having two OH groups attached to a nitrogen heterocyclic ring to impart specificity for trivalent metal ions, such as those of Ga<sup>III</sup>, In<sup>III</sup>, and Fe<sup>III</sup>.<sup>7</sup> The reduction of the amide by LiAlH<sub>4</sub> was used in the synthesis of (8), a ligand forming cationic 1:1 Rh<sup>I</sup> and Ir<sup>I</sup> complexes which have been tested in the asymmetric hydrogenation of prochiral olefins, providing enantioselectivities up to 36%.<sup>8</sup> The potentially hexadentate ligand (9) reacts with Ln<sup>III</sup> ions in methanol, in the presence of a base, yielding complexes characterized by different nuclearity and charge depending on the reaction conditions and on the size of the metal.<sup>9</sup> The incompatibility of the denticity of (9) with the coordination requirements on the metal ions was proven to be a useful tool in the construction of multinuclear metal-ion arrays.<sup>9</sup> Compound (10) was prepared by condensation of *o*-phenylenediamine and EDTA.<sup>10</sup>



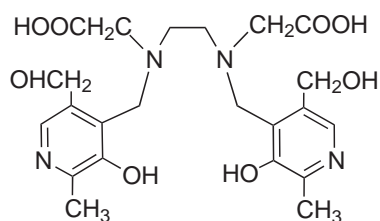
(4)



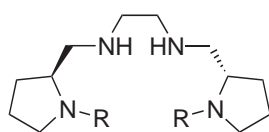
(5)



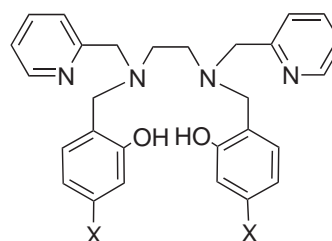
(6)



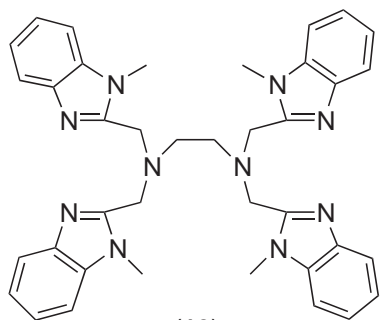
(7)



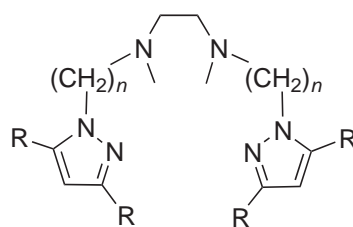
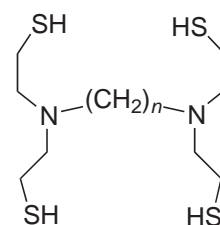
(8)



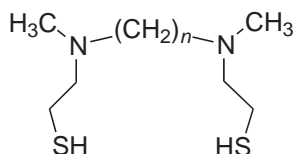
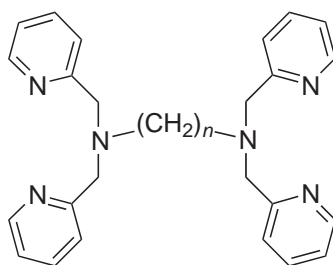
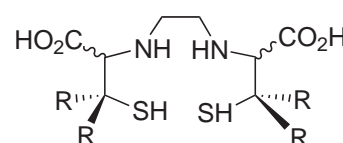
(9)



(10)

(11)  $n = 1, 2$ 

(12)

(13)  $n = 2, 3$ (14)  $n = 2-5$ 

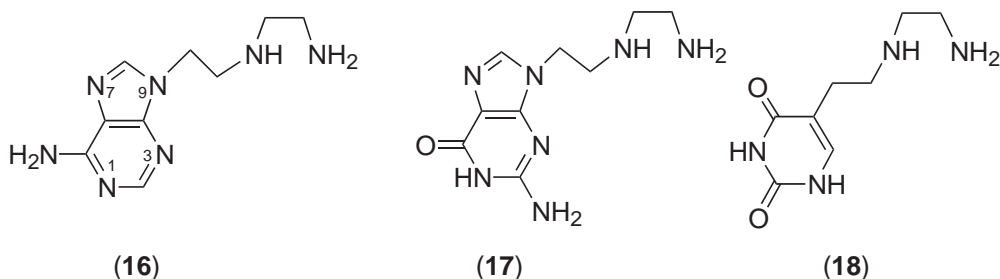
(15)

The nucleophilic substitution at an  $sp^3$ -carbon atom by amines is another synthetic method used to obtain derivatives such as (11),<sup>11</sup> (12),<sup>12</sup> (13),<sup>13</sup> and (14).<sup>14,15</sup> The meso N<sub>2</sub>S<sub>2</sub>-donor ligand

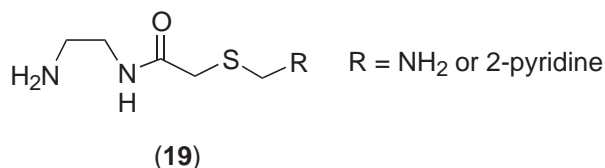
(15), prepared from racemic penicillamine, is able to coordinate metal cations such as  $[\text{Re}^{\text{V}}=\text{O}]^{3+}$ .<sup>16</sup> The coordinating ability of this potentially hexaanionic ligand varies upon increasing the pH.

The length of the carbon chain between the amine nitrogen atoms is an important factor in determining the stoichiometry of the complex formed. The bite angle for the metal is different in five-, six-, or seven-membered chelate rings. Ligands containing sterically hindered groups near to the coordination site can produce deviations or distortions in the microenvironment of the core metal (obstacle effect), but generally don't affect the stoichiometry of the complexes. Metal derivatives of ethylenediamine are generally more strained than those of propylenediamine. The constraints imposed by the five-membered ethylenediamine chelate ring, and the relative instability of the six-membered ring, may be responsible for the difference in reactivity and for the contrasting electrochemical behavior of their metal derivatives. The achiral ligand (7) is shown to adopt a chiral conformation in their metal complexes, which is important for their use in asymmetric catalysis.<sup>7</sup> X-ray structures of titanium derivatives of (7) indicate a different coordination with respect to that of salen ligands toward titanium acceptors.<sup>4-6</sup> Compounds (10) and (14) are binucleating ligands able to form dicopper(I)-dioxygen complexes, relevant as models for biological systems.

Some alkyldiamines containing nucleobases have been synthesized to study the interactions of metal ions with nucleotides, and it has been demonstrated that chelate-tethered nucleobases can form extended molecular assemblies by bridging metal ions. Derivatives (16) and (17) were prepared as hydrochloride salts from the reaction of chloroalkylpurines and ethylenediamine,<sup>17,18</sup> while in the case of thymine derivative the reaction yielded (18).<sup>19</sup> Irrespective of the nucleobase, the diamine function chelates a single metal center. The adenine and guanine derivatives show a tendency for three coordination, using the chelating tether with the N7 atom of the nucleobase.<sup>20</sup> The effect of the chelating tether is often profound, with the result that nucleobase-metal binding occurs at typically unreactive sites such as N3 or C.



The ligands (19) were prepared *in situ* by alkylating *N*-(2-aminoethyl)-2-mercaptoacetamide with the appropriate alkylating agent.<sup>21</sup> They generally act as tetradentate ligands in the anionic form, adopting a *cis-β* coordination geometry about the metal atom in octahedral systems (Figure 1).<sup>21</sup>



The chiral tetradentate  $\text{N}_2\text{O}_2$ -donor ligands (20) were synthesized by reaction of the chiral precursor 1*R*,2*R*-diaminocyclohexane with *R*-styrene oxide or *S*-propylene oxide.<sup>22</sup> Ligands (20)

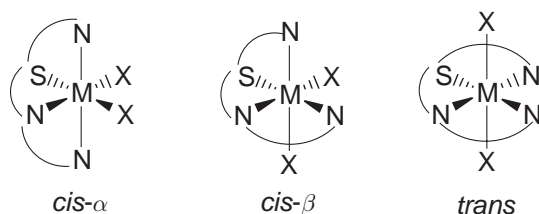
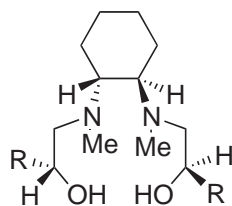


Figure 1



possess  $C_2$ -symmetry (relevant for enantioselective catalysis) and both hard tertiary nitrogen and alcohol(ate) donors compatible with high-oxidation-level metal ions. In addition, the cyclohexane unit enforces rigidity and encourages stereospecific coordination at octahedral centers such as  $Ti^{IV}$ .<sup>22</sup>

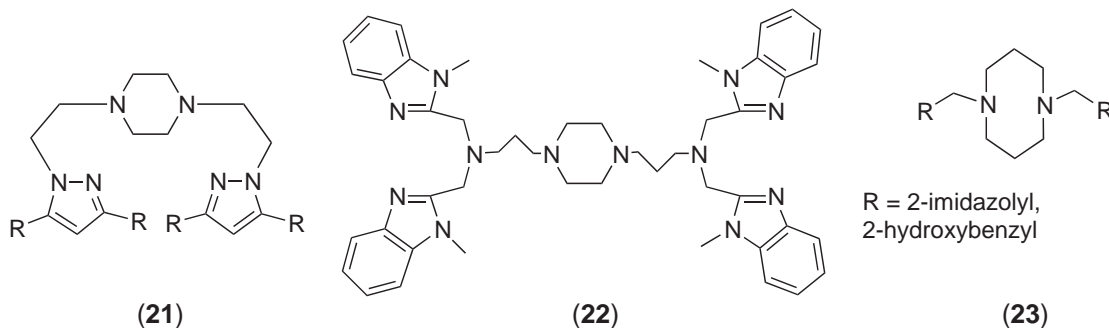


R = Ph or Me

(20)

### 1.11.2.2 Substituted Piperazines

The  $N,N'$ -substituted piperazines (**21**)<sup>23</sup> are similar to ethylenediamine derivatives, both in their preparation modes and coordinating ability. An octadentate tetraammino-tetrabenzimidazole ligand (**22**) has been designed, containing two terminal tridentate binding sites and a central one built with the bidentate piperazine residue able to bind divalent copper, yielding trinuclear complexes  $[Cu_3(\mathbf{22})]^{6+}$ .<sup>24</sup> The piperazine donor can be easily displaced by protonation to form  $[Cu_2(\mathbf{22}-H_2)]^{6+}$ . Complexes containing reduced copper ions have been prepared, in which the piperazine moiety remains uncoordinated.



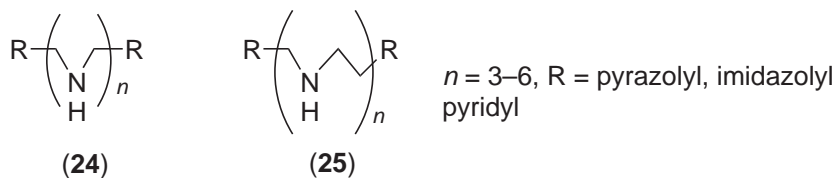
The ligand (**23**) is derived from 1,5-diazacyclooctane functionalized by additional donor groups, such as imidazolyl and hydroxybenzyl.<sup>25</sup> Results obtained with (**23**), showing a boat/chair configuration in transition-metal coordination complexes, indicate that the nature of the pendant arm is a key factor governing the structures and properties of the complexes.<sup>25</sup>

### 1.11.2.3 Polyamines

Polyamines are potential therapeutic agents in biological disorders such as cancer and parasitic diseases. They can also be ion-channel blockers or vectors in gene delivery. A recent (2000) review on polyamines synthesis is available.<sup>26</sup> Karigiannis describes some synthetic protocols for the preparation of polyamines and conjugates: functionalization (selective) of primary and secondary amino groups, Michael addition of amino components to acrylonitrile and crotonitrile, reaction of amino components with alkylating agents, acylation of amines with carboxylic acids followed by reduction, alkylation of sulfonamides.<sup>27</sup>

The unsubstituted linear tri-, tetra-, penta-, and hexamines are known to coordinate nearly all metals. Sometimes they are used as additional neutral donors to saturate the coordination sphere of the central atom.<sup>28</sup> Considerable interest in the design of such ligands is concentrated on the synthesis of new chelating donors able to form kinetically inert or thermodynamically stable complexes of transition and nontransition metals. The coordination ability of the amine can be

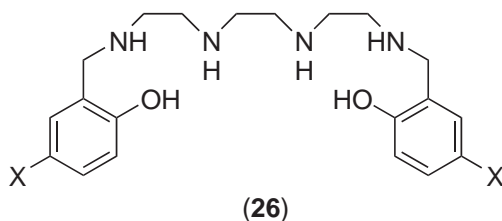
enhanced by the addition of terminal donor groups (e.g., pyridyl, pyrazolyl, imidazolyl, as in **(24)** and **(25)**), with potential  $\pi$ -bonding between  $\pi$ - or  $\pi^*$ -orbitals of the substituent and metal  $d$ -orbitals of appropriate symmetry.<sup>29</sup> Such multidentate ligands are generally prepared by hydrogenation of aldimino groups in parent Schiff bases.<sup>30,31</sup> Reaction of these ligands with  $\text{Cu}^{2+}$ ,  $\text{Ni}^{2+}$ ,  $\text{Zn}^{2+}$ , and  $\text{Co}^{2+}$  exhibits significantly higher entropy changes than those observed for the reaction of unsubstituted polyamines of similar basicity.<sup>29</sup>



The less favorable entropies of the polyamine ligand reactions are attributed to the greater loss of rotational freedom about the C—N bonds of the aliphatic bases upon metal-ion coordination. It was observed that the coordinated polyamine of a cobalt dioxygen complex undergoes oxidative dehydrogenation under anaerobic conditions to form an imine with the double bond conjugated to the heterocyclic ligand.<sup>32</sup>

A simple and efficient method for the small-scale combinatorial synthesis of polyamine derivatives from diverse aminoalcohols and amines has been proposed by Renault and co-workers.<sup>33</sup>

Linear hexadentate tetramine phenols such as **(26)** have been shown to form metal derivatives that are very stable in aqueous solutions.<sup>34</sup> This class of ligands generally binds the metals in a dianionic  $\text{N}_4\text{O}_2$ -donor form, yielding an octahedral environment. The four nitrogen atoms of the tetra-amine backbone form the equatorial plane of the octahedron, whereas the two phenolates are coordinated *trans* to each other.<sup>34</sup>



The design of new linear polyamines is caused mainly by the need of asymmetric synthesis. Chiral transition-metal complexes containing optically active tetramines are a good source of asymmetry in asymmetric synthesis. Methyl substituents in tetramines affect significantly the configurations of metal complexes (Figure 2), among which the  $[\text{CoCl}_2(\text{tetramine})]^+$  core is the most studied.<sup>35,36</sup>

A series of hexa-amines **(27)** has been reported for which the ionization behavior has been determined, together with the microscopic or intrinsic protonation constants for the different chemical environment and ionic strengths.<sup>37</sup> A study carried out on copper(II) complexes of hexa-amines **(27)** has revealed how a preference for bimetallic, bis-tridentate coordination of the hexa-amine ligands in this series may be promoted either by extension of the bridging polymethylene chain (disfavoring chelation), or by *N*-methylation of the terminal amine groups (steric effects).<sup>38</sup>

Carrington and co-workers have recently developed a solid-phase organic synthesis route to target unsymmetrical polyamines and their acridinil and dansyl conjugates **(28)**, **(29)**.<sup>39</sup>

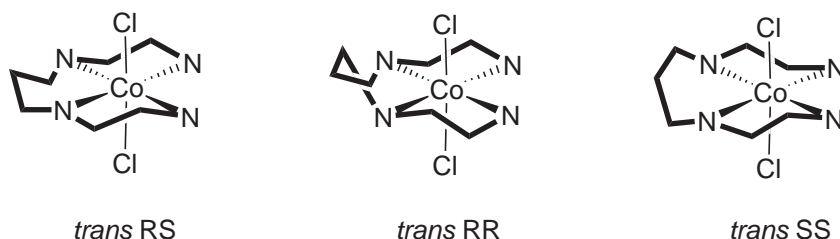
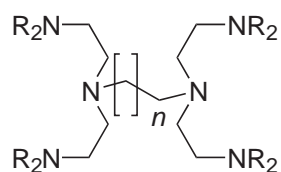
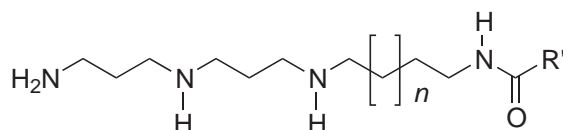


Figure 2



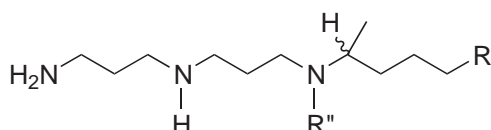
$n = 1-3$ ,  $R = H$  or  $Me$

(27)



$n = 1$  or  $2$ ,  $R' = \text{acridinyl}$

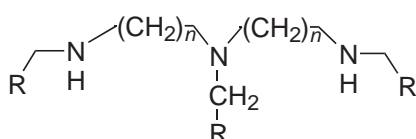
(28)



$R' = \text{acridinyl}$ ,  $R'' = \text{dansyl}$

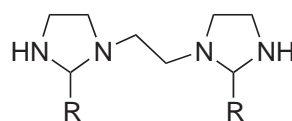
(29)

The synthesis of the ligand (30) has been described by Motekaitis and co-workers. The correlation of the ligand structure with the dioxygen affinity of the cobalt complexes has been also reported.<sup>40</sup> The synthesis of penta-N-protected polyamine containing five different N-protecting groups is described by Goulaouic-Dubois, who also investigated the selective removal of the same groups.<sup>41</sup>



$R = O\text{- or }N\text{-donor group}$

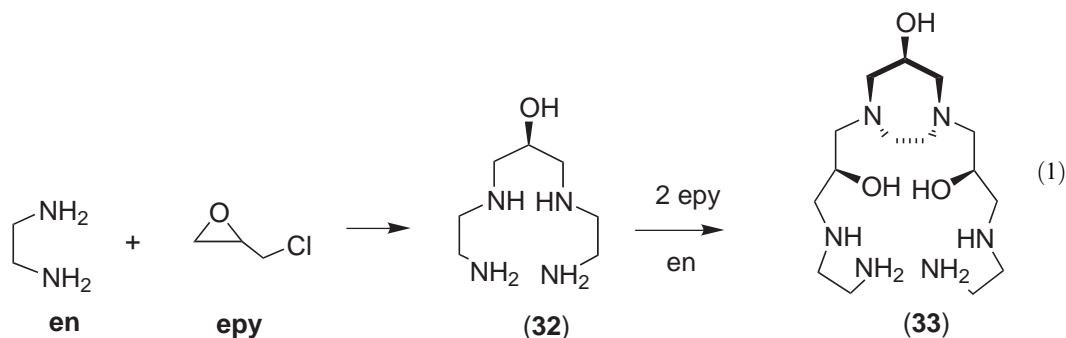
(30)



(31)

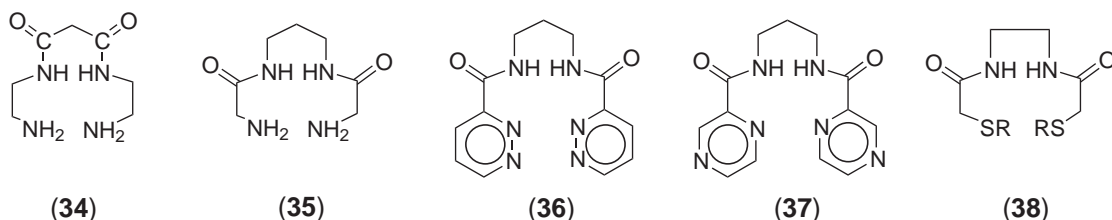
Condensation reactions of aromatic aldehydes with  $\alpha,\omega$ -polyamines lead to Schiff bases, if the polyamine involved contains only primary amino groups; or to imidazolidines, if the polyamine contains a secondary amino group. Condensation of 2-pyridinecarboxaldehyde *N*-oxide with triethylenetetramine yields derivative (31), with two imidazolidine rings, which in the presence of  $\text{Cu}^{\text{II}}$  undergoes a ring-opening reaction due to the formation of a complex.<sup>42</sup>

The new polyaminoalcohol (33), obtained as an oligomeric 3:3 addition product of epichlorohydrin to ethylenediamine, likely involving (32) as an intermediate (Equation (1)) in the doubly deprotonated form yields a trinuclear copper(II) complex showing very little conformational freedom.<sup>43</sup>



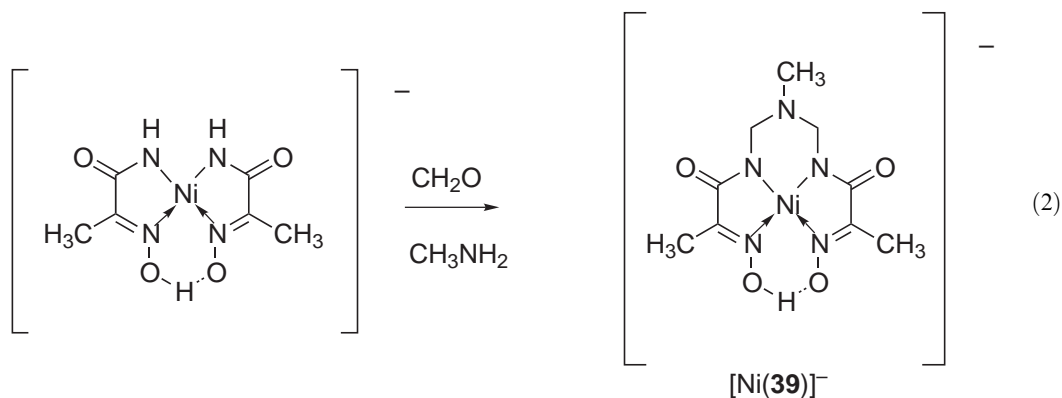
### 1.11.2.4 Diamine–Diamide Ligands

Carboxamides containing alkylamine arms like (34), synthesized from dialkylmalonate and ethylenediamine, act as chelating dianionic  $N_4$ -donors,<sup>44,45</sup> whereas the geometric isomer (35) was prepared from 1,3-diaminopropane and chloroacetyl chloride.<sup>46</sup> The hexadentate bis(pyrazine)-carboxamides (36) and (37) can be obtained by the addition of 1,3-propanediamine to the appropriate carboxylic acid.<sup>47</sup> Compound (36), in the dianionic form, can be used to obtain homo- and hetero-metal bridged complexes, whereas (37) has been shown to yield tetranuclear copper(II) complexes involving opened-up dianionic ligand molecules.<sup>47</sup>

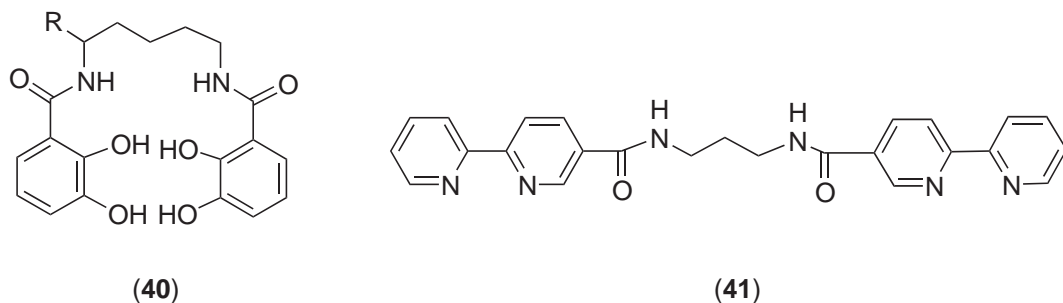


The basicity constants of a series of diaminoamides in aqueous solution were determined potentiometrically.<sup>48</sup> Among the sulfur carboxamide ligands, a series of benzoyl-protected dimercaptodiamides like (38) should be mentioned.<sup>49</sup> This amide thiol ligand in the tetra-anionic form ( $R = H$ ) spans the basal position of an expected square-pyramidal structure, increasing the kinetic stability of the low-spin  $TcO$  core which can be used in diagnostic nuclear medicine procedures.

An interesting example of template synthesis is the amidomethylation of 2-(hydroxyimino)propanamide in its  $Ni^{II}$  complex, which gave the carboxamide chelate  $[Ni(39)]^-$  (Equation (2)).<sup>50</sup> This is the first example of a ring-closure reaction featuring coordinated amide groups.

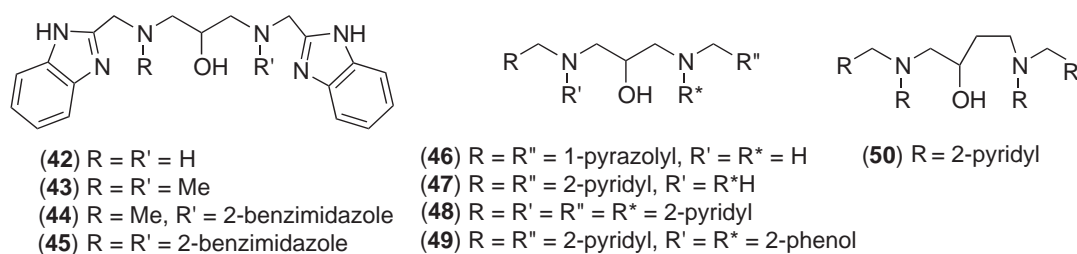


A linear bis(catecholamide), analogue of the naturally occurring siderophore (40), has been synthesized by the azolide method and its complexation with molybdenum investigated.<sup>51</sup> Thermodynamic and kinetic studies on the flexible ligand (41), able to form a homochiral  $Fe_2(41)_3$  dinuclear iron(II) complex, were undertaken for a better understanding of the self-assembling processes.<sup>52</sup>



### 1.11.2.5 1,3-Diamino-2-propanol Derivatives

Multidentate ligands with N- and O-donor atoms derived from *N,N'*-substituted 1,3-diamino-2-propanol (**42**)–(**49**) were mainly designed for modeling coordination-number asymmetry at metal sites in binuclear metalloproteins.<sup>53</sup> This family of ligands acts in monoanionic form, easily yielding bimetallic complexes with appropriate distance between the two metal centers.<sup>54–56</sup> They can be obtained by alkylation of 1,3-diamino-2-propanol<sup>57,58</sup> or by the reduction of Schiff bases.<sup>59,60</sup> Symmetric benzimidazole derivatives such as (**45**) can be efficiently prepared by condensation of 1,2-diaminobenzene with 2-hydroxy-1,2-diaminopropanetetraacetic acid.<sup>61,62</sup> A binuclear copper complex of the asymmetric multidentate ligand (**44**) demonstrates proof-of-concept for inducing coordinative unsaturation at one metal of the binuclear pair, and subsequent reaction with azide shows site-directed reactivity. The hydroxo oxygen of this class of ligands often does not participate in metal coordination. The ligands (**46**)<sup>58</sup> and (**47**)<sup>59</sup> coordinate copper(II) in a mononuclear fashion, with the ligand acting as an N<sub>4</sub>-donor set with an uncomplexed alcohol oxygen. A series of symmetrical and unsymmetrical polypodal proligands derived from 1,*n*-diaminoalcohols and bearing pyridyl and phenolic groups, (**48**)–(**50**), have been synthesized and used to prepare a range of dinuclear transition-metal complexes.<sup>63</sup> A schematic representation of the complex skeletons found is given in Figure 3.



### 1.11.3 LIGANDS CONTAINING AROMATIC OR HETEROCYCLIC SPACERS

#### 1.11.3.1 2,6-Substituted Pyridines

Six-membered aromatic systems with arms containing donor atoms can easily act as chelating ligands towards different metal centers. The simplest one in this family is 2,6-bis(aminomethyl)pyridine, (**51**), for which some metal derivatives are known.<sup>64</sup> Organic molecules containing three pyridine rings linked by amino, ether, or thioether groups also give mononuclear metal derivatives.<sup>65</sup> The ligand (**52**), prepared from pyridine-2,6-dicarboxylic acid and methyl-*o*-phenylenediamine,<sup>66</sup> was shown to act as a chelating N<sub>3</sub>-donor.<sup>67</sup>

Further developments in this field include the preparation of thiolate ligands such as 2,6-bis(2-mercaptophenylamino)dimethylpyridines, (**53**), both acting as anionic pentadentate donors.<sup>68,69</sup>

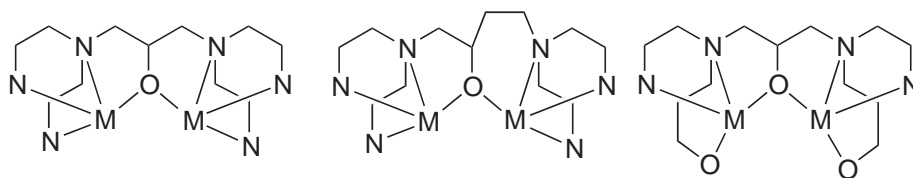
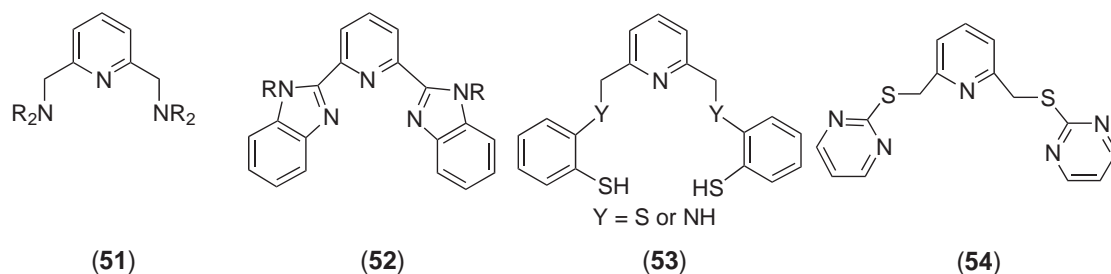


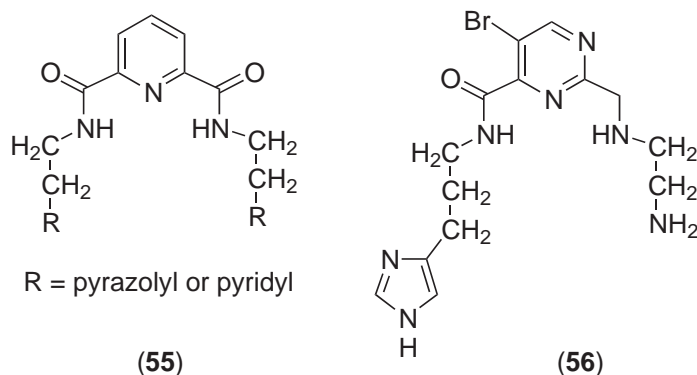
Figure 3



The introduction of steric constraints in these ligands can enforce meridional coordination of the three central donors and *trans*-coordination of the terminal thiolate donors. The use of ligands with pyrimidinyl substituents such as (**54**), a neutral S<sub>2</sub>N<sub>5</sub>-donor obtained *in situ* from 2,6-bis(chloromethyl)pyridine and sodium pyrimidine-2-thiolate in dmf, opens the way for the synthesis of coordination polymers.<sup>70</sup>

Mukherjee has exhaustively investigated the coordination chemistry of chelating ligands containing pyrazolyl and pyridyl groups towards divalent metal ions.<sup>71</sup> Derivatives containing both pyridine (soft) and pyrazole (hard) donors generally exert a relatively weak field around the metal ion. The formation of a joint  $\pi$ -system involving pyrazolyl and pyridine moieties is prevented, owing to the placement of methylene spacers between the rings.

The 2,6-substituted pyridines with one or two amide arms have been extensively studied. Due to the acidic protons of amide groups, they act as anionic ligands. Symmetrical dipeptides such as (**55**) have been prepared in high yield from 2,6-pyridinedicarbonyl dichloride and 2-(2-aminoethyl)pyridine<sup>72</sup> or 1-(2-aminoethyl)pyrazole,<sup>73</sup> respectively. These ligands bind transition-metal centers in N<sub>5</sub>-pentadentate fashion, with two deprotonated carboxamido nitrogens in addition to three nitrogen atoms from the heterocyclic rings.<sup>74,75</sup>



Analogous to 2,6-pyridine-substituted carboxamides is the pentadentate anionic ligand (**56**), containing an imidazolyl-substituted carboxamide and a diamine arm. Compound (**56**) has been extensively studied as a synthetic analogue of bleomycins—a family of glucopeptide antitumor antibiotics that cause DNA damage in the presence of Fe<sup>2+</sup> ions and molecular oxygen.<sup>76</sup>

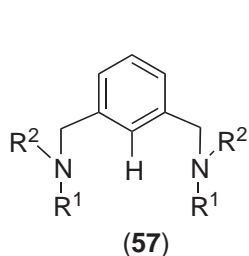
### 1.11.3.2 Xylyl-based Ligands

A family of *m*-xylyl dinucleating ligands with chelating arms containing combinations of methyl, pyrazole, pyridine, imidazole, and benzimidazole moieties, (**57**), was prepared by the amination of 1,3-di(bromomethyl)benzene by the corresponding secondary amine.<sup>77–79</sup> The synthesis of unsymmetrical ligands is more complex and involves three steps.<sup>80</sup> Symmetrical ligands such as (**57**) (where R<sup>1</sup> = R<sup>2</sup> = heterocyclic N-donor) act as neutral hexanuclear bridging donors, providing three nitrogen atoms to each metal ion. Dicopper(I) derivatives of (**57**) were shown to react in dmf or CH<sub>2</sub>Cl<sub>2</sub> solution with molecular oxygen, yielding hydroxylated copper(II). Such transformations closely model copper monooxygenases.<sup>81–83</sup> It was shown that if 1-pyrazolyl or 2-imidazolyl donor groups fully or partially replace the 2-pyridyl substituents, then hydroxylation does not occur.<sup>84</sup>

The dinucleating ligand (**58**) has been prepared by standard methods via the bis-hydroxymethylation of 4R-substituted phenols. It has been observed that modification of the R substituent induces a drastic effect on the catecholase activity of the dicopper(II) complexes containing (**58**) in the deprotonated form.<sup>85</sup> A similar coordination pattern to those found in metal derivatives of (**58**) is realized in bis(triazacyclononane) systems bridged by a *m*-xylyl fragment (**59**)<sup>86</sup> and in (**60**).<sup>87</sup> *p*-Xylyl ligands exhibit different coordination chemistry and reactivity.<sup>85</sup>

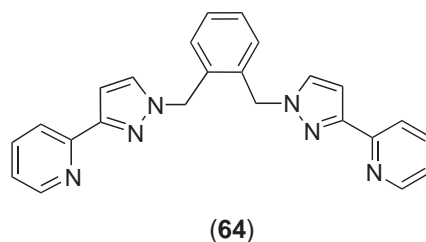
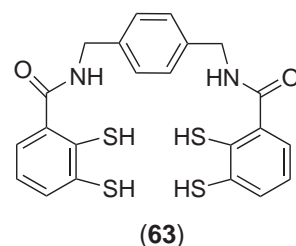
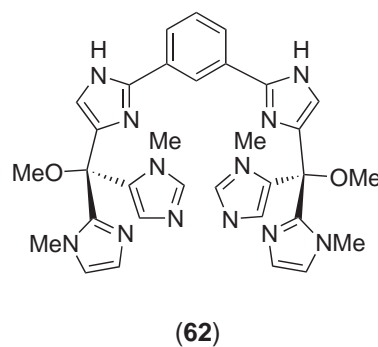
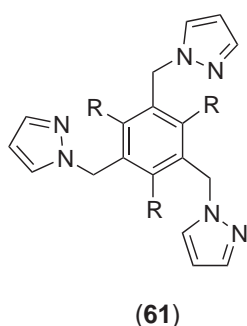
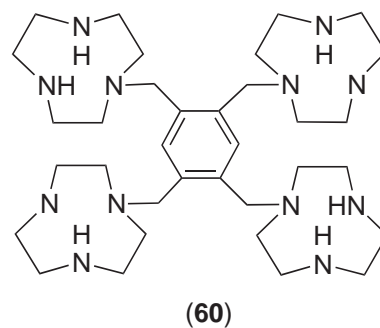
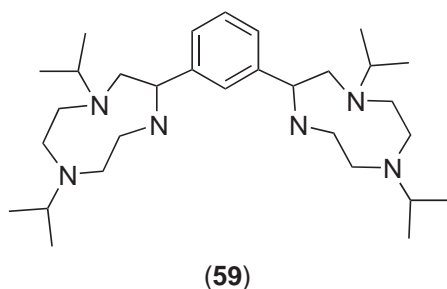
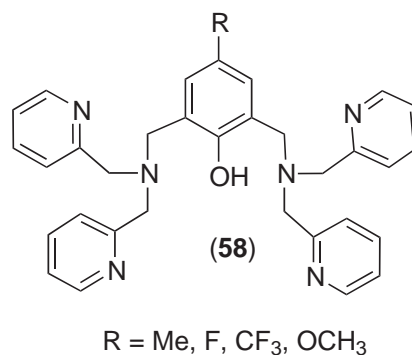
The trifunctional pyrazolyl ligands (**61**) afford a Ru<sup>II</sup> complex, in which the coordinated metal is simultaneously involved in  $\eta^6$ -bonding to the benzene ring and tripodal pyrazole coordination to a suitably placed ligand.<sup>88</sup>

The hexaimidazole ligand (**62**) has been obtained upon dual metalation (potassium diisopropylamide) at C5 of the N-protected imidazoles in a 1,3-bis(2-imidazolyl)benzene, followed by condensation with molecules of bis(1-methylimidazolyl)ketone, methylation of the resulting diol,



R<sup>1</sup> = -CH<sub>2</sub>(2-pyridyl), CH<sub>2</sub>(2-azolyl)

R<sup>2</sup> = H, Me or -CH<sub>2</sub>(2-pyridyl), CH<sub>2</sub>(2-azolyl)



and deprotection.<sup>89</sup> A dicopper(II) methanol inclusion complex containing the dinucleating (62) has been synthesized and structurally characterized.<sup>88</sup>

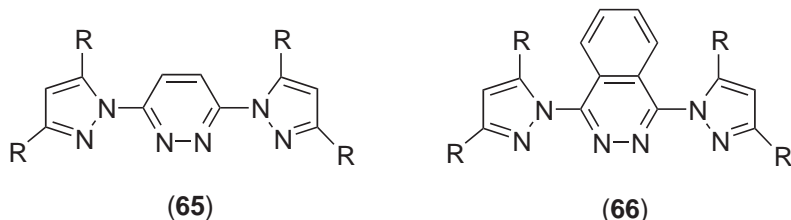
The bis(dithiolate) ligand (63) has been prepared from 2,3-dimercaptobenzoic acid and employed in the preparation of a dinuclear, air-stable titanocene complex.<sup>90</sup> *o*-Xylyl spacers were also employed. Donors such as (64) are capable of acting as either a mononucleating or a bridging ligand, depending on the stereoelectronic coordination preferences of the metal ion in dictating the course of the assembly process.<sup>91</sup>

### 1.11.3.3 Multidentate Ligands Containing Pyridazine, Phthalazine, Pyrazolyl, Thiazolyl, Oxadiazolyl, Triazine, and Thiophene Bridges

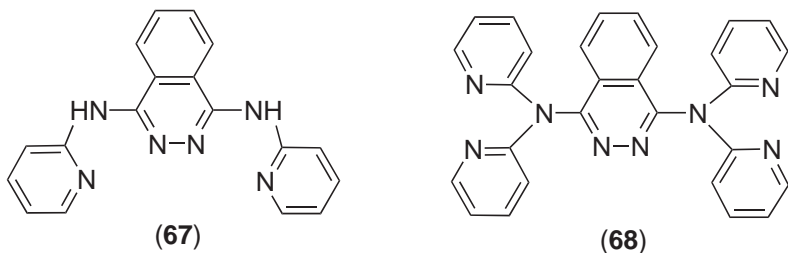
Much attention has been devoted to the synthesis of nitrogen-donor ligands that give complexes containing two metal ions in close proximity, with intermolecular antiferromagnetic interactions

between the metal centers. One of the simplest species is tetradentate 3,6-bis(2'-pyridyl)pyridazine, commercially available.<sup>92</sup> The derivatives **(65)** and **(66)** possess similar coordination patterns.<sup>93</sup>

When these pyrazolyl–diazine systems react with  $M(\text{CO})_6$  species, they act only as monodentate ligands forming mononuclear complexes.<sup>94</sup>

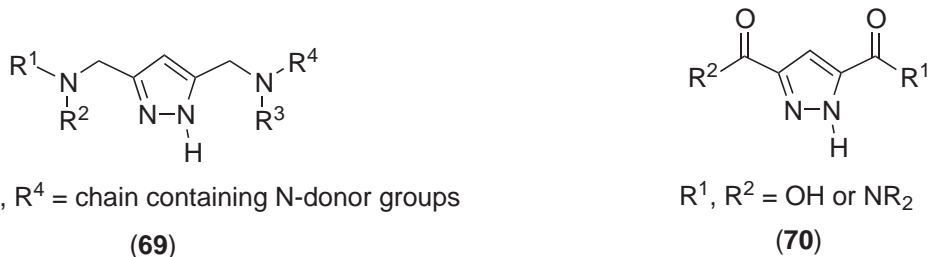


Phthalazine-based ligands such as **(67)**, although not strictly biomimetic, incorporate many properties that are desirable in a ligand suitable to model metalloenzymes. They form stable dinuclear complexes, where the dinuclear metal centers retain additional coordination sites for exogenous ligand binding. In addition, the ligand system is flexible enough to allow a range of metal–metal distances and a variety of exogenous ligands.<sup>95,96</sup> Hydroxo-bridged dinuclear copper(II) complexes of phthalazine- and pyridazine-based ligands have been reported by several researchers, whereas the reactivity of these complexes has been recently explored by Barrios.<sup>97,98</sup> To enhance complex solubility, as well as to improve the yield of ligand synthesis, the derivative **(68)**—formed from the reaction of lithiated 2,2'-dipyridylmethane with 1,4-dichlorophthalazine—has been prepared. With two terminal and two bridging coordination sites available for nucleophile and substrate binding, the ligand **(68)** shows promise for use in metallohydrolase modeling. The phthalazine moiety, although electronically distinct from the carboxylate ligands often encountered in enzymes, serves a similar purpose in bringing two metal ions into proximity.



The ability of the 1,2-diazole ring unit of pyrazolate to bridge two metal ions is well documented.<sup>99</sup> Meyer reported some pyrazolyl-based ligands possessing additional chelating substituents in the 3- and 5-positions.<sup>100,101</sup>

Derivatives **(69)** act as octadentate anionic ligands, setting up a bimetallic coordination pocket with constrained metal–metal separation. It has been found that the  $M-M$  distance is independent of the chain lengths of the substituents of the pyrazolate.



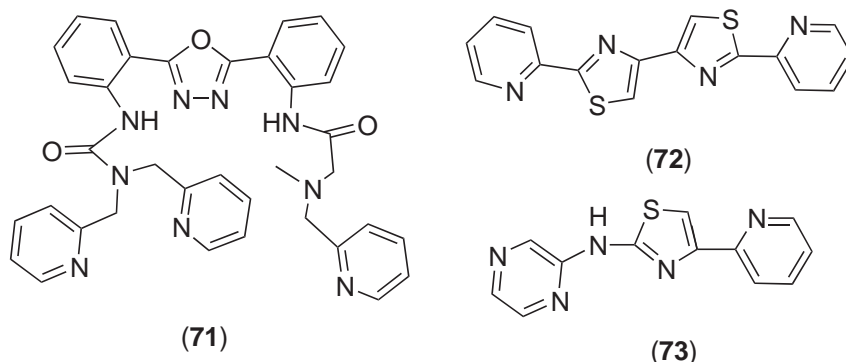
A series of pyrazolato 3,5-dicarboxylato-bridged dinuclear complexes has been synthesized and structurally characterized. Complexes containing the anions of molecules such as **(70)** exhibit the different reactivity patterns of unsymmetrical dinuclear entities towards substrate molecules, e.g., resulting from the cooperative effects of both hard and soft metal centers located in close proximity.<sup>102</sup>

The transition-metal complexes with unsymmetrical binucleating ligands based on substituted azole moieties are of interest as subjects for mechanistic studies of oxidation. A good example is the oxadiazole-based ligand **(71)** that has been reported.<sup>103</sup>

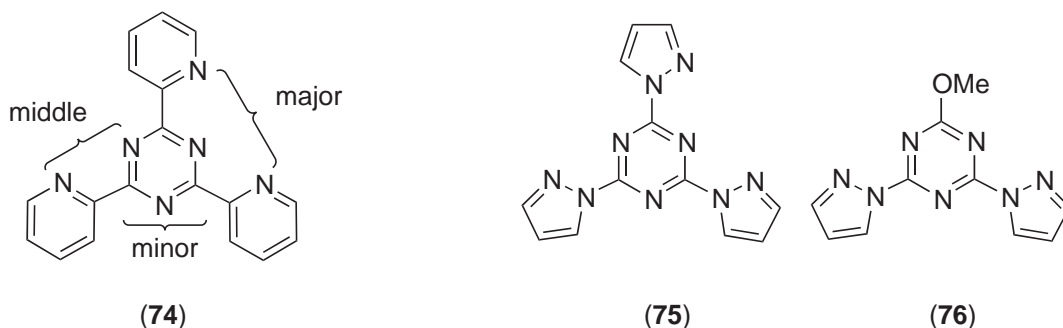


When bound to two metals in the dianionic form, (71) yields complexes in which the metals are in five- and six- coordinate sites after the incorporation of an exogenous bridging ligand.<sup>102</sup>

Rice has proposed a series of polydentate N-donors based on thiazolyl fragments.<sup>104</sup> Ligands such as (72) and (73) may be considered analogues of the well-known poly(pyridines), but with two important exceptions. First, the incorporation of five-membered thiazole units into the chain results in a natural partition of the ligand into separate binding domains. The coordination behavior of these ligands can be controlled according to the position of the thiazole units in the chain. These ligands are exceptionally easy to prepare in high yields using a simple modular approach. The key step is assembly of the thiazole unit from reaction of an  $\alpha$ -bromoacetyl group with a thioamide.



Other aromatic polydentate N-donor ligands, such as (74), have also received attention; especially in complex formation for charge-transfer studies and related properties. This particular ligand has three coordination sites (major, middle, and minor) according to the number of donor nitrogen atoms. Protonated (74) has a high aqueous solubility, particularly in acids, and also the resulting complexes with metal ions predominantly remain in the aqueous phase.<sup>105</sup> The pyrazolyl derivatives (75) and (76) can be prepared from the corresponding pyrazolate anion and 2,4,6-trichloro-1,3,5-triazine or 2,4-dichloro-6-methoxy-1,3,5-triazine.<sup>106</sup>



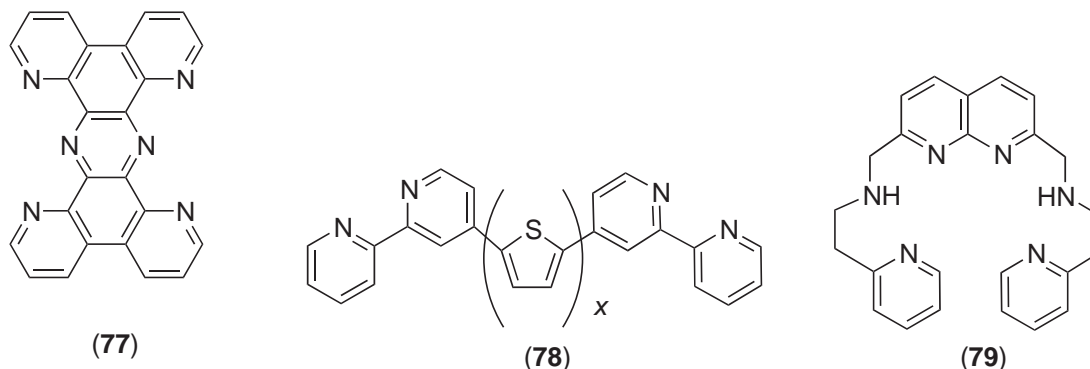
The bridging phenazine ligand (77)<sup>107</sup> has been obtained in moderate yields by condensation of 4,7-phenanthroline-dione in ammonium acetate.

Bis(bipyridine) ligands with oligothiophene bridges (78) and their binuclear ruthenium complexes have been reported.<sup>108</sup> The oligothiophene bridge introduces an attractive method of tuning the redox and electronic properties of the ligand relative to the metal by changing the oligomer length. In addition, thiophene oligomers have been shown to form stable molecules in oxidized states that can also  $\pi$ -stack in solution or in the solid state.<sup>109</sup> Several  $\alpha$ -coupled oligothiophenes, dimers through hexamers, symmetrically substituted at the “inside”- or “outside”-positions with two or four methoxy groups, and with terminal methyl groups, were reported.<sup>110</sup>

#### 1.11.3.4 Multidentate Ligands Containing More than Two Pyridine Rings

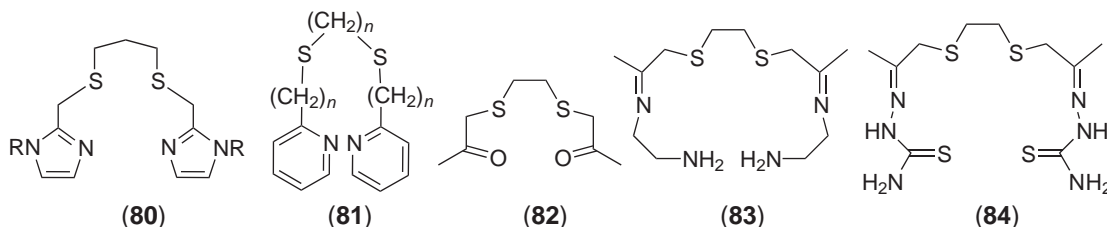
Some 3,3'-substituted 2,2'-bipyridyls have been reported.<sup>111</sup> Among the polydentate substituted naphthyridines, the neutral hexadentate (79) should be mentioned. Derivative (79) was prepared

by condensation of 1,8-naphthyridine-2,7-dicarboxaldehyde with 2-(2-aminoethyl)pyridine, followed by reduction.<sup>112</sup> A stable dinuclear zinc hydroxocomplex containing (79) has been used as a model compound to investigate the reactivity of zinc centers in metallohydrolases.<sup>113</sup>



#### 1.11.4 DITHIA-ALKANE LIGANDS

Analogous to diamine previously discussed, some dithia-alkane ligands have been prepared as model compounds for type I copper proteins. Ligands such as (80) can be obtained from 4-hydroxymethylimidazole and alkane-1,*n*-dithiols in refluxing acetic acid, or by reaction of 3,7-dithianonanedioic acid with 1,2-diaminobenzene.<sup>114</sup> The structure of [CuCl<sub>2</sub>(80)] has been determined and a detailed comparison with related structures has been made.<sup>115</sup> Bis(pyridyl)dithioether open-chain tetradentate ligands (81) were obtained as oils from the reaction of 2-(chloromethyl)pyridine and 1,*n*-alkanedithiols by standard procedures.<sup>116</sup> 4,7-Dithiadecane-2,9-dione (82) serves as a starting point for the synthesis of multidentate nitrogen/sulfur chelating agents. Condensation with ethylenediamine or diethylenetriamine in the presence of nickel salts yields the neutral hexadentate ligands (83) and (84).<sup>117</sup>



#### 1.11.5 POLYETHYLENEGLYCOLS AND GLYMES

Polyethyleneglycols and their ethers represent another significant group of oxygen-donor polydentate ligands. They are colorless, high-boiling, viscous-flow liquids, soluble in water and in most organic solvents including hydrocarbons. Polyethyleneglycols are generally prepared from ethylene oxide and ethylene glycol. The monoalkylation of glycol by alcohol results in monosubstituted methyl ethers of polyethyleneglycols—cellosolves; the latter can be easily converted into the appropriate dimethyl ethers (glymes) using dimethyl sulfate. Polyethyleneglycols, cellosolves, and glymes are generally used by coordination chemists as polydentate, neutral, Lewis bases toward hard metal centers with high coordination numbers, in order to saturate the coordination sphere of the central atom and therefore prevent oligomerization of the molecule.<sup>118–120</sup> Tetraglyme made it possible to stabilize barium diketonates in the form of monomers and hence to increase the volatility.<sup>117</sup> Noncyclic polyethers show a high complexation selectivity, which makes them suitable reagents for the extraction and analysis of lanthanide and alkaline-earth metals.<sup>117</sup>

Triethyleneglycol (85) usually acts as a tetradentate chelator (Figure 4a), as in the heptacoordinate [LnCl<sub>3</sub>(85)] (Ln = Y, Dy) and nonacoordinate [Ln(85)(H<sub>2</sub>O)<sub>5</sub>]<sup>3+</sup> (Ln = Nd, Eu, Gd, Dy) species.<sup>121,122</sup> Some examples of asymmetric<sup>123</sup> (Figure 4b) and symmetric<sup>124</sup> (Figure 4c) tetradentate bridging functions of this ligand have been reported. In the cation [La(85)<sub>3</sub>(H<sub>2</sub>O)]<sub>3</sub><sup>+</sup>, one of three (85) donors was found acting as monodentate (Figure 4d).<sup>125</sup>

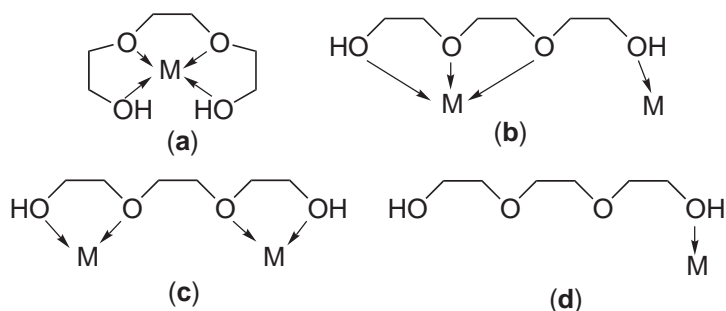
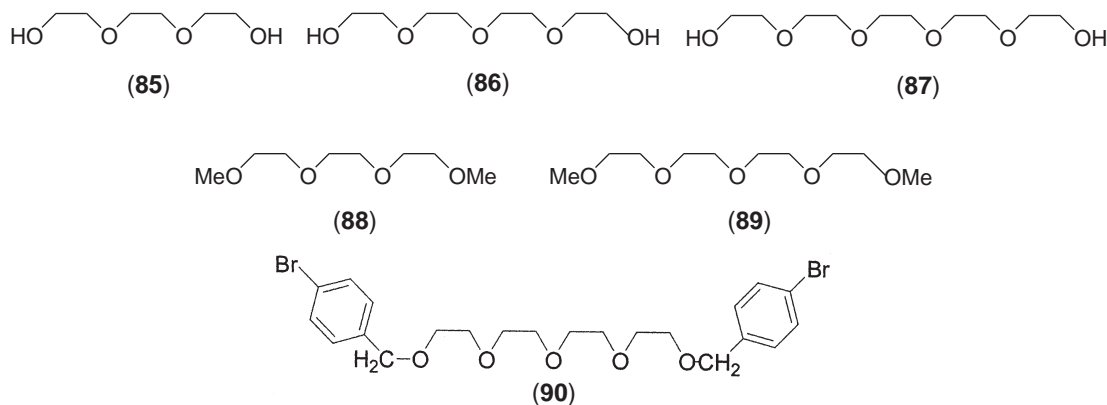


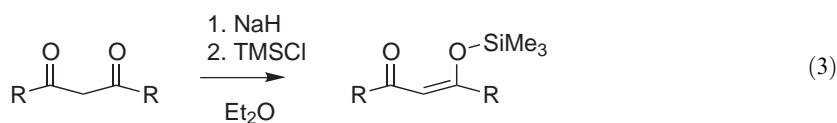
Figure 4

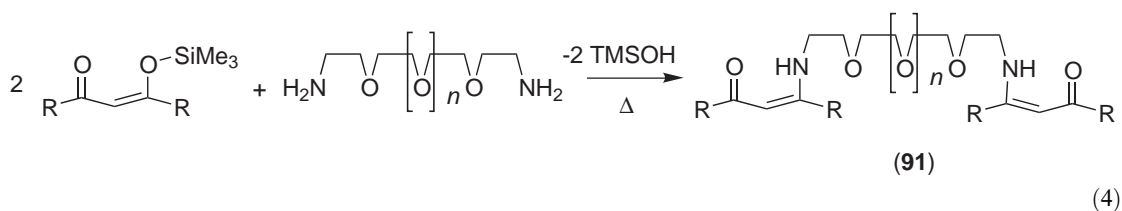
Tetraethyleneglycol (**86**) containing five donor atoms is a typical pentadentate ligand, e.g., in  $[\text{TaCl}_2(\mathbf{86})]^+$ ,<sup>126</sup>  $[\text{VBr}_2(\mathbf{86})]^+$ ,<sup>127</sup> and  $[\text{La}(\text{NO}_3)_3(\mathbf{86})]$ .<sup>128</sup> A tetradentate chelating function of the ligand has been found in  $[\text{HgI}_2(\mathbf{86})]$ .<sup>129</sup> It is interesting that in the very similar  $[\text{HgCl}_2(\mathbf{87})]$  the pentaethyleneglycol (**87**) was found pentadentate, one of the oxygens being found not to be a donor, the CN of the metal being seven, which is not typical for Hg. The ligand (**87**) tends to be pentacoordinate, even toward large-sized metal acceptors such as lanthanides. In this case bis(pentaethyleneglycol) derivatives form, e.g.,  $[\text{Nd}(\mathbf{87})_2]^{3+}$  with CN = 10.<sup>130</sup> In the tris-aqua complexes  $[\text{Ln}(\mathbf{87})(\text{H}_2\text{O})_3]^{3+}$  (Ln = La, Sm), all the donor atoms of the ligand are coordinated to the rare-earth metal.<sup>131</sup>

Among the polydentate glymes, triglyme (**88**) and tetraglyme (**89**) are the most common. They both show a trend to chelate a single metal center, acting as tetra- and pentadentate, respectively.<sup>132,133</sup> Tetradentate<sup>134</sup> and bichelating bridging<sup>135</sup> coordinations of tetraglyme are also known. The pentadentate  $\omega$ -bromobenzyl diether of tetraethyleneglycol (**90**) was found pentadentate, like tetraglyme, even in the mercury derivative.<sup>136</sup> Penta- and hexaglymes usually afford six<sup>137</sup> and seven coordination<sup>129</sup> modes respectively. The structural chemistry of polyethylene glycol complexes of main-group and transition elements has been widely investigated by Rogers and co-workers (as an example see ref. 138)



The design of new, multidonor polyethers is focused on the incorporation of different side-donor arms, like carboxyl,<sup>139</sup> diphenylphosphine,<sup>140</sup> or ketoiminate moieties.<sup>141,142</sup> The use of such ligands opened new trends in the development of volatile, mononuclear metal complexes for chemical vapor deposition. A new class of linked  $\beta$ -ketoiminate-polyether- $\beta$ -ketoiminate ligands (**91**) was synthesized by the routes shown in Equations (3) and (4). The polyglyme bridge is functionalized by first tosylating the terminal hydroxyl functionalities of a commercially available polyglycol. The ditosylate is then subjected to reaction with diethanolamine, yielding a diamine as well as lengthening the polyglyme bridge. The final ligands are then assembled by condensation of the diamine with the requisite  $\beta$ -diketone. These ligands are designed to encapsulate alkaline-earth cations having low charges and large ionic radii.<sup>141,142</sup>



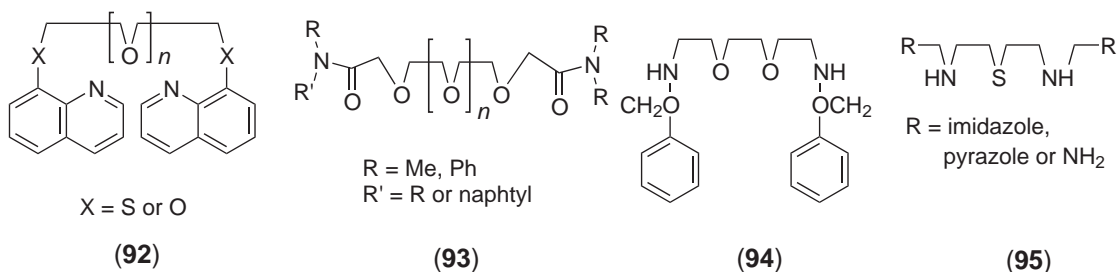


There has been much interest in synthetic acyclic oligoethers (see, for example, ref. 143) because of their unique coordination abilities. Various modifications have been made to the basic polyether structure and a variety of functions attained. Vogtle and Weber reported a series of 8-quinolyloxy-terminated acyclic oligoethers (**92**).<sup>144</sup> These compounds react with alkali metals to form stable complexes in which the ligand tends to wrap around alkali-metal cations in a planar, helical, or spherical arrangement, depending on the number of ethyleneoxy fragments in the backbone of the ligand.<sup>145</sup>

Ligand (**93**) acts as a multidentate ligand, forming a ring-like coordination structure similar to those of crown compounds.<sup>146</sup> They can be generally prepared by reaction of dioxo-alkanedionyl chlorides with appropriate amines in benzene. The reactions between lanthanide ions and these acyclic oligoethers have been exhaustively investigated by Liu and co-workers (see, for example, ref. 147)

The ligand (**94**) can be prepared by the reaction of (benzyloxy)amine and 1,8-bis((*p*-tolylsulfonyl)-oxy)-3,6-dioxaoctane at 95 °C under N<sub>2</sub> in *p*-dioxane.<sup>148</sup>

The synthesis of several thioether pentadentate ligands (**95**) is described.<sup>149</sup> Acid dissociation constants and metal-chelate formation for a series of divalent metals, as well as formation constants for dioxygen adducts of their cobaltous complexes, are also reported.

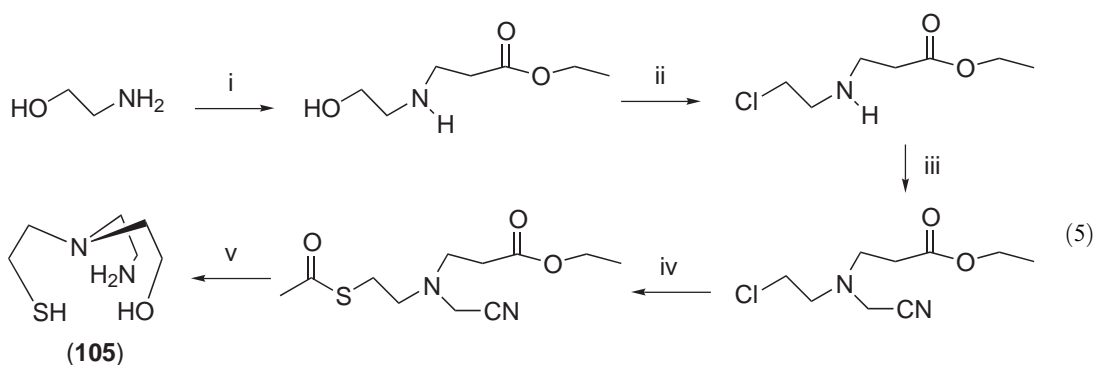
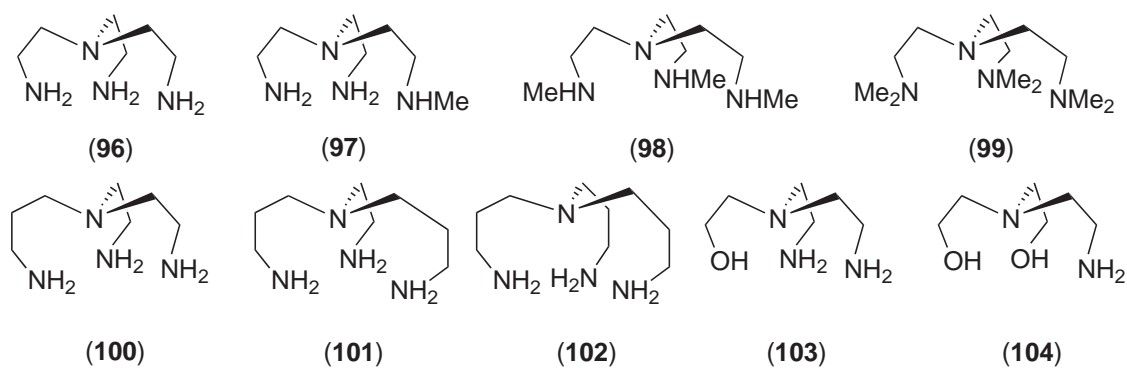


## 1.11.6 TRIPODAL LIGANDS

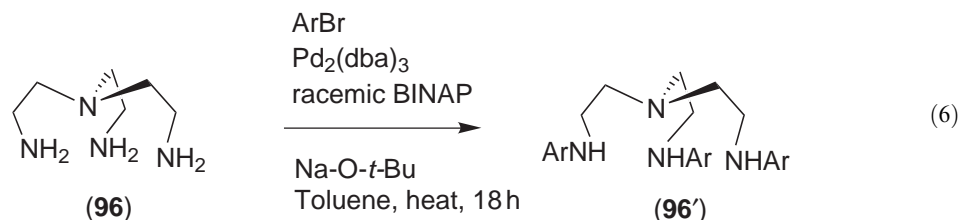
### 1.11.6.1 Tripodal Ligands with Nitrogen as the Bridgehead Atom

The simplest *N*-tripodal ligands, such as (**96**),<sup>150</sup> (**97**),<sup>151</sup> (**98**),<sup>152</sup> and (**99**),<sup>153</sup> are widely known and commercially available, or else can be easily prepared following common procedures: such as Michael addition of acrylamide to ammonia followed by reduction of the triamide.

Some further symmetric and asymmetric aliphatic tetramines, such as (**100**), (**101**), and (**102**), have been prepared.<sup>154,155</sup> Copper complexes have been reported, and it has been found that the geometry adopted by the Cu<sup>2+</sup> complexes of (**96**) and analogous tripodal tetra-amine ligands with different arm lengths vary between trigonal bipyramidal and square pyramidal.<sup>154,155</sup> Two modified derivatives of (**96**), in which one (**103**) or two (**104**) primary amines have been replaced by hydroxyl groups, have been reported.<sup>156</sup> Acidity constants related to deprotonation of the terminal primary amine functions were similar in both mixed ligands and in (**96**), whereas the acidity of the tertiary ammonium N atom is shown to differ in each of these three compounds.<sup>154,155</sup> Finally, a completely unsymmetrical tripodal NNOS<sub>2</sub>-donor ligand (**105**), with three different donor arms, has been prepared (Equation (5)). The synthesis of its nickel complex, carried out in acetone, resulted in the formation of a Schiff-base derivative with the solvent.<sup>157</sup> The arylated triethyltetra-amines (**96'**), with a higher back  $\pi$ -donation, can be obtained by the reaction between aryl bromide and (**101**), catalyzed by Pd<sub>2</sub>(dba)<sub>3</sub> in the presence of racemic BINAP and Na-O-*t*-Bu (Equation (6)).<sup>158</sup> Molybdenum and tungsten complexes containing this ligand in the trianionic, tetradentate form have been reported.<sup>137</sup>



i: ethyl acrylate, 8h, r.t.; ii: 1.  $\text{SOCl}_2$ , toluene,  $80^\circ\text{C}$ . 2.  $\text{K}_2\text{CO}_3$ ; iii: 1.  $\text{Na}_2\text{S}_2\text{O}_7$ , 2.  $\text{CH}_2\text{O}$ , 1h, 3.  $\text{KCN}$ ,  $0^\circ\text{C}$ ; iv:  $\text{KSAC}$ ,  $\text{DMF}$ , 45 min,  $60^\circ\text{C}$ ; v:  $\text{AlH}_3$ ,  $\text{THF}$ .



The ligand (**106**), usually known as semisepulcrate (semisep), was first proposed as an intermediate in the formation of sepulcrate and then synthesized by template reaction from ethylenediamine, ammonia, and formaldehyde.<sup>159</sup>

The chemistry of tris(2-pyridyl) tripod ligands such as (**107**)–(**113**) and their metal derivatives has been recently reviewed.<sup>160</sup> These ligands are neutral donors, coordinating in a facial manner to a single metal center through the pyridyl nitrogens. Tris(2-pyridyl)amine (**107**), which is a pyridine analogue of triphenylamine, and its monosubstituted derivatives can be prepared by sequential condensation of 2-halopyridine with 2-aminopyridine.<sup>160</sup>

The ligand (**108**) was first prepared in 1967 by condensation of 2-pyridylmethylamine with 2-pyridylmethylchloride,<sup>161</sup> tris[(substituted-pyridyl)methyl]amine<sup>162</sup> and unsymmetrical mixed ligands such as *N,N'*-bis((6-methylpyridid-2-yl)methyl)-*N*-2-pyridylmethylamine have been prepared similarly. The values of the protonation constants reported show that for (**108**) the protonation occurs first at the aliphatic nitrogen atom, whereas in (**107**) only the pyridine groups can be protonated. Ligand (**108**) acts as tetradentate, forming metal derivatives that usually display trigonal-bipyramidal geometry with one apical site occupied by an anion or a solvent molecule.<sup>163</sup> In this case the ligand exists in a conformation having a  $C_3$ -axis. Tetradentate (**108**) encompasses the metal ion via a spatial arrangement of the three pyridyl groups, tilting with

respect to the metal–amine axis, which resembles a propeller. The two possible propeller-like stereoisomers are conformational enantiomers. In another conformation the ( $C_\sigma$ ) ligand has a plane of symmetry that is observed in octahedral and square-pyramidal metal–(108) complexes.<sup>164</sup> The  $C_\sigma$ -conformation is expected to be higher in energy (*ca.* 3.5 kcal mol<sup>-1</sup> according to semi-empirical calculations), owing to steric repulsion between the pyridine rings which are constrained to be closer to one another.<sup>165</sup>

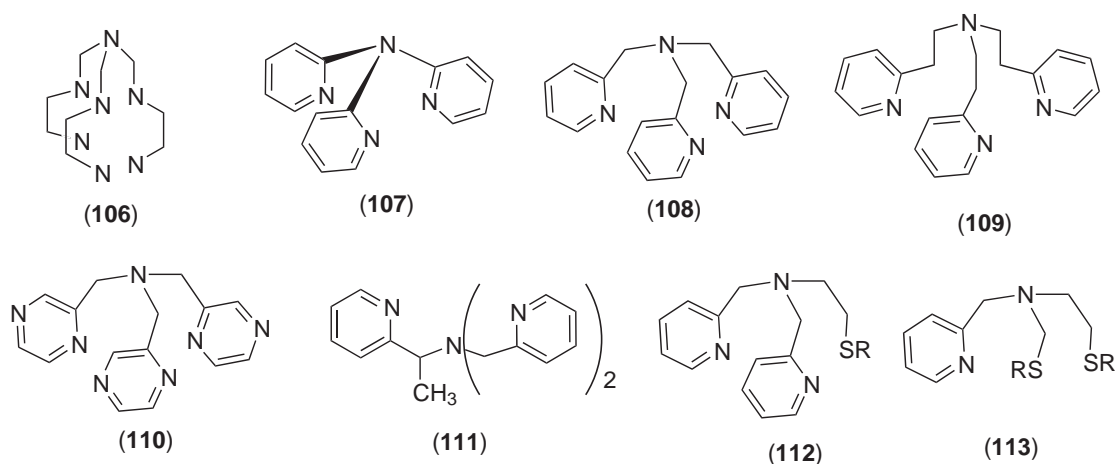
Tris(2-pyridyl)ethylamine (109) seems to reveal the same coordination patterns. The crystal structure of the protonated ligand (109) has been reported. In H(109)ClO<sub>4</sub> the amine nitrogen is the most basic and therefore protonated first, in contrast to protonated (108) where three acidic protons reside on the pyridyl nitrogens, none being located on the amine nitrogen.<sup>166</sup> Mixed (2-pyridyl)ethyl/(2-pyridyl)methyl amines have been also reported.<sup>167</sup>

The tetradentate ligand (110) has been prepared by Wietzke and co-workers.<sup>168</sup> It resembles (108) with three pyridine groups replaced by softer donors (pyrazine groups), in order to study the influence of the electronic configuration of the ligand on the complexation of *f*-elements. The ligand (110) is, unlike (108), a selective complexant of actinides(III).<sup>168</sup> For tris[(2,2'-bipyridin-6-yl)-methyl]amine, see ref. 169.

Upon introduction of substituents into one of three arms of a tripod, chiral  $C_3$ -symmetric (108)-type ligands with one asymmetric center can be prepared.<sup>170</sup> Molecular modeling showed that for  $C_3$  coordination of a chiral ligand such as (111), two binding conformations are possible (Figure 5): the “*anti*,” in which the  $\alpha$ -substituent points away from the pyridyl-groups, and the “*syn*,” with  $\alpha$ -substituent pointing toward one pyridyl group.<sup>171</sup>

The use of  $C_3$ -symmetric tripodal ligands in crystal engineering has been reviewed.<sup>172</sup>

$N_2S_2$ - and  $N_3S$ -donor ligands containing thioether and pyridine moieties, such as (112) and (113), have been developed because of the potential relevance of their metal derivatives as model systems for metal sites in metalloenzymes.<sup>173,174</sup>



A pentadentate  $N_4S$ -donor tripod (114), with thiol-like sulfur and pendant pyrazolyl groups, has been synthesized and investigated in the monoanionic form as a model of mononuclear active sites of blue copper<sup>175,176</sup> and nickel proteins.<sup>177</sup> The interesting feature of this ligand is the

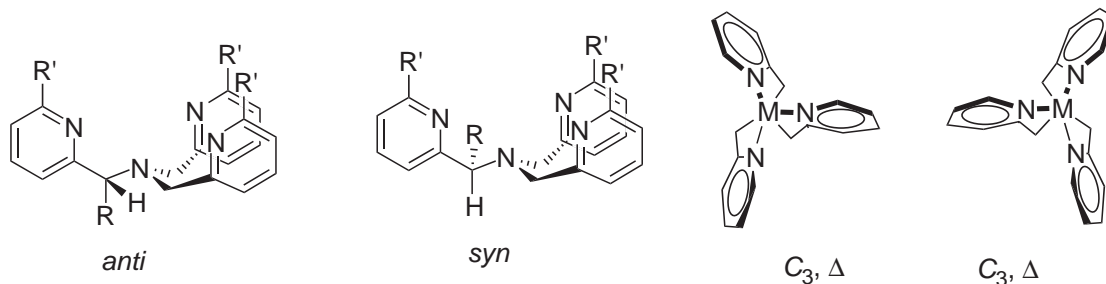
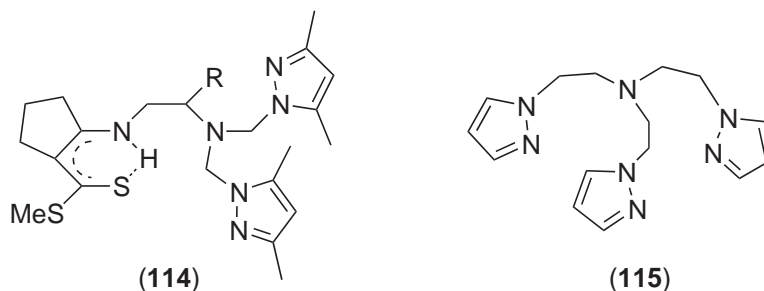


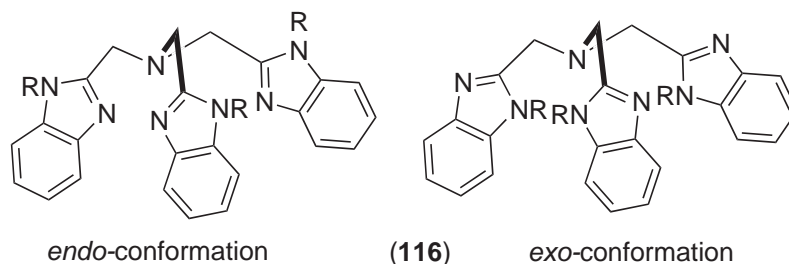
Figure 5

presence of extended electron delocalization, because of which the C—S bond behaves predominantly like a thiolate group.

A series of tripodal ligands with symmetric or asymmetric arms built using azole units is known. The tetradentate ligand (**115**) has been prepared in good yield by the reaction of deprotonated pyrazole with tris(2-chloroethyl)amine hydrochloride.<sup>178,179</sup> Ligands containing substituted pyrazolate units can be prepared similarly. Crystallographic studies of copper(I) and copper(II) complexes containing (**115**) revealed that both trigonal and “plane” geometry of the ligand are possible, leading to trigonal-pyramidal and square-pyramidal complexes, respectively.<sup>178,179</sup>



Tripodal benzimidazoles such as (**116**) and *N*-substituted derivatives, prepared by reaction of the corresponding phenylenediamine with nitrilotriacetic acid in propylene glycol, were used for the construction of various cage-like or box-like complexes as elements of supramolecular assemblies.<sup>180,181</sup> Such ligands were shown to possess cavities suitable for encapsulating metal ions, such as lanthanides, giving complexes with either 1:1 or 1:2 metal ratio. Such two-(2-D) or three-dimensional (3-D) supramolecular networks with encapsulated lanthanide complexes were used in the construction as building blocks.<sup>182</sup> Compounds (**116**) behave as tri- or tetradentate donors, depending on the nature of the cation. The ability of three benzimidazole arms to freely rotate about N<sub>(apical)</sub>—C bonds permits the ligand to adopt either the *endo*- or the *exo*-conformation. In the *exo*-case the tripod ligand may use its pendant arms to embrace a single metal atom, or may act in pairs to form sandwiched oligonuclear clusters. The *exo*-conformation facilitates the construction of large multicomponent structures that may possess an internal cavity.<sup>183</sup>

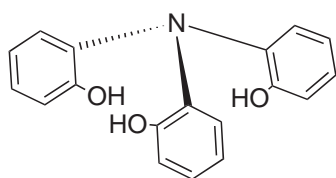


*N*-tripodal chelating arylhydroxides are extremely versatile ligands, since proper ring-substitution patterns allow for substantial modification of steric and electronic properties. Those mostly used are tris(2-hydroxyphenyl)amine (**117**)<sup>184</sup> and tris(2-hydroxybenzylamine) (**118**),<sup>185,186</sup> both acting as tri- or tetradentate donors depending on the nature of the metal ion.<sup>187</sup> Derivative (**118**) can be prepared by the reaction of 2-methoxybenzylbromide with 2-methoxybenzylamine in refluxing CH<sub>3</sub>CN in the presence of K<sub>2</sub>CO<sub>3</sub>, whereas (**119**) has been obtained by the one-step Mannich reaction of 2,4-dimethylphenol with hexamethylenetetramine. The thiol analogue of (**119**) has been also reported.<sup>188</sup>

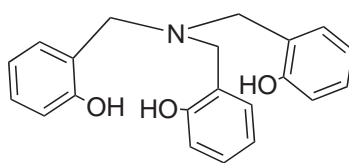
Mixed hydroxyphenyl–pyridine tripods (**120**) are also known.<sup>189</sup> They act as anionic, tetradentate, N<sub>3</sub>O-tripod ligands, ensuring fivefold coordination in their zinc complexes.<sup>189</sup>

Tripodal amine phenols, in which three chelating arms are bridged by a tertiary nitrogen atom (e.g., (**121**)), are potentially heptadentate.<sup>190,191</sup> Their coordination behavior is largely dependent on the size and properties of the bonded metal ion. For large lanthanide ions, the cavity is too small for a ligand to completely enclose the metal center; homonuclear complexes are formed under basic conditions. However, in small, trivalent metal cations (Al<sup>3+</sup>, Ga<sup>3+</sup>), the cavity is too large for all seven donors to coordinate to the metal ion, six- coordination being observed. For these types of ligand, five different coordination modes (encapsulated, capped, bicipped, encapsulated dimer, sandwich dimer) have been identified and structurally characterized.<sup>192</sup>

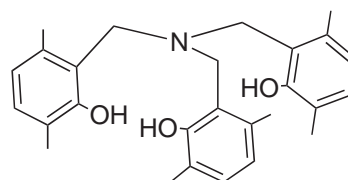




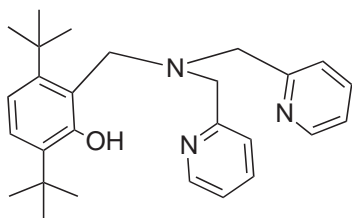
(117)



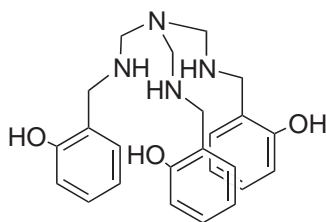
(118)



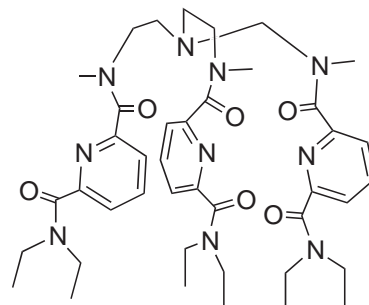
(119)



(120)



(121)



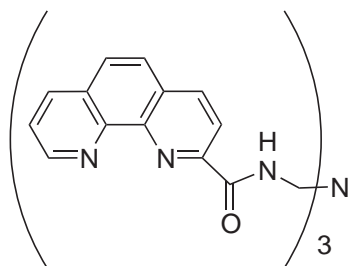
(122)

The family of (96)-based tripodal amides and ureates has been further developed. New ligands have been prepared by condensation of (96) with the appropriate acyl chloride. The attachment of chelating sidearms to (96) via secondary amide groups provides a network of intramolecular  $\text{OC-N-H}\cdots\text{N}$  hydrogen bonds, which severely constrains the covalent tripod.<sup>193</sup> The podand (122), in which three unsymmetrical tridentate pyridine-2,6-dicarboxamide units are connected to a (96) tripod,<sup>194</sup> exists in solution as a statistical mixture of four conformers. In aqueous medium the central nitrogen is protonated and the whole molecule adopts an *endo*-conformation, compatible with the formation of bi- and trifurcated hydrogen bonds with the oxygen atoms of the proximal carboxamide groups. Its high flexibility with the tripod structure allows it to facially organize semirigid, bent, tridentate binding units around nine-coordinate rare-earth ions.

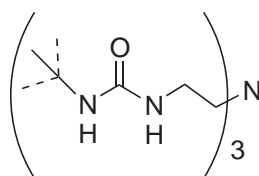
The incorporation of polyaromatic binding units in polydentate podands is of great interest in the design of new photosensitizers. A recently designed nonadentate 3*N*-substituted (96), with three 1,10-phenanthroline-2-carboxamido arms (123), has been structurally characterized.<sup>195</sup> In the presence of lanthanide ion (123) undergoes a rearrangement, yielding three tridentate binding units encapsulating the nine-coordinated lanthanide.

The ligand (124) contains three urea groups appended from the central amine nitrogen via ethylene spacers.<sup>196</sup> Deprotonation of the  $\alpha$ -ureate nitrogens leads to the trianionic species that readily binds a metal ion. This binding creates a protective H-bonding cavity around the metal center that is provided by the three  $\alpha'$ -NHR groups of the ligand. The formation of H-bonds between the cavity  $\alpha'$ -NH groups and the atom coordinated to the metal occurs, owing to the high stability of six-membered rings. The additional deprotonation of one  $\alpha'$ -NH group leads to metal derivatives with an intramolecular base positioned within the cavity.<sup>197</sup>

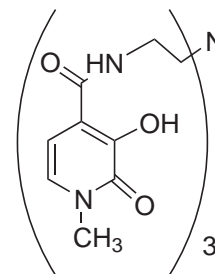
A series of hydroxypyridinone tripods has been used as metal chelators. The derivative (125) has been prepared by carboxylation of 1-methyl-3-hydroxy-2(1H)-pyridinone under



(123)



(124)



(125)



Kolbe–Schmidt conditions, followed by activation and amidation.<sup>198</sup> The ligand (**125**) acts as a versatile, anionic, polydentate chelator, binding an array of metal ions with high affinity. (**125**) is known to exhibit excellent kinetics for iron removal from the serum protein transferrin and it is recommended as a decorporation agent for the medical treatment of iron overload.<sup>199</sup> Its gadolinium(III) derivative has been shown to be a prominent magnetic-resonance-imaging contrast agent with appropriate features, including low toxicity, high stability, and high relaxivity.<sup>200</sup> Several other hydroxypyridinone ligands have been developed.<sup>201,202</sup>

A Mn<sup>II</sup> complex has been formed with the tripodal heptadentate ligand (**126**), which turns out to be the only ligand coordinated to the metal ion and therefore achieves seven coordination.<sup>203</sup>

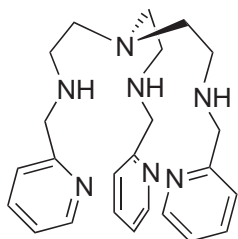
A tripod-type Schiff-base ligand, (**127**), was prepared by a 3:1 condensation reaction of 2-phenyl-4-formylimidazole in methanol.<sup>204</sup> In two nickel(II) complexes, the screw coordination arrangement of the tripod ligand (**127**) around the metal ion induces chirality, resulting in a  $\Delta$  (clockwise) or a  $\Lambda$  (anticlockwise) enantiomer.<sup>204</sup> A multifunctional tripodal ligand possessing two different functionalities, such as pyridine and cyano moieties, (**128**), has been prepared by the reaction of 2-aminomethylpyridine, excess acrylonitrile, and glacial acetic acid.<sup>205</sup>

Tris(2-mercaptobenzyl)amine (**129**) and tris(2-hydroxybenzyl)amine (**130**), S<sub>3</sub>N- and O<sub>3</sub>N-donor, respectively, were prepared as the hydrochloride, according to the literature.<sup>206,207</sup> The protonation and metal binding constants were determined and their similarities and differences with analogous ligands discussed.<sup>208</sup>

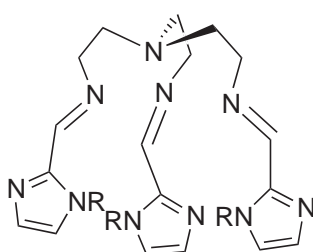
A class of tripodal ligands such as (**131**), synthesized by reaction of 3,5-dimethylaniline and nitrilotriacetic acid with triphenylphosphite, has been reported and its coordination chemistry toward iron nitrosyl acceptors has been investigated. When bonded to a metal ion, they form cavities around vacant coordination sites on metal ions.<sup>210</sup>

#### 1.11.6.2 Tripodal Ligands with Carbon as the Bridgehead Atom

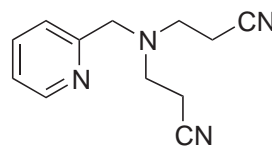
With respect to nitrogen-bridgehead analogues, these ligands are generally less basic and cannot undergo a tertiary N atom “umbrella”-type inversion, being more preorganized. The simplest members of the series, tris(aminomethyl)methane, 1,1,1-tris(aminomethyl)ethane, and tris(2-pyridyl)methane,<sup>211</sup> are tridentate and therefore are outside the scope of this review. The hexadentate ligands (**132**) and (**133**) are prepared by tosylation of 1,1,1-tris(hydroxymethyl) ethane, followed by addition of a large excess of diamine and extraction with pyridine.<sup>212</sup> The racemization of their cobalt(III) complexes was the object of some studies.<sup>213</sup> A family of potentially hexadentate, tribasic, tripodal amine phenols (**134**) has been synthesized by the reduction of appropriate Schiff



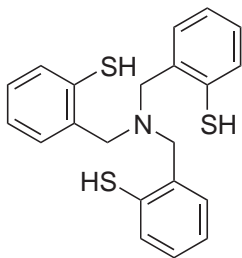
(126)



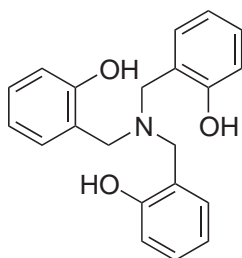
(127)



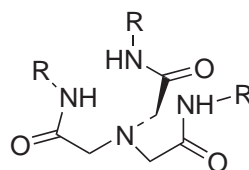
(128)



(129)



(130)

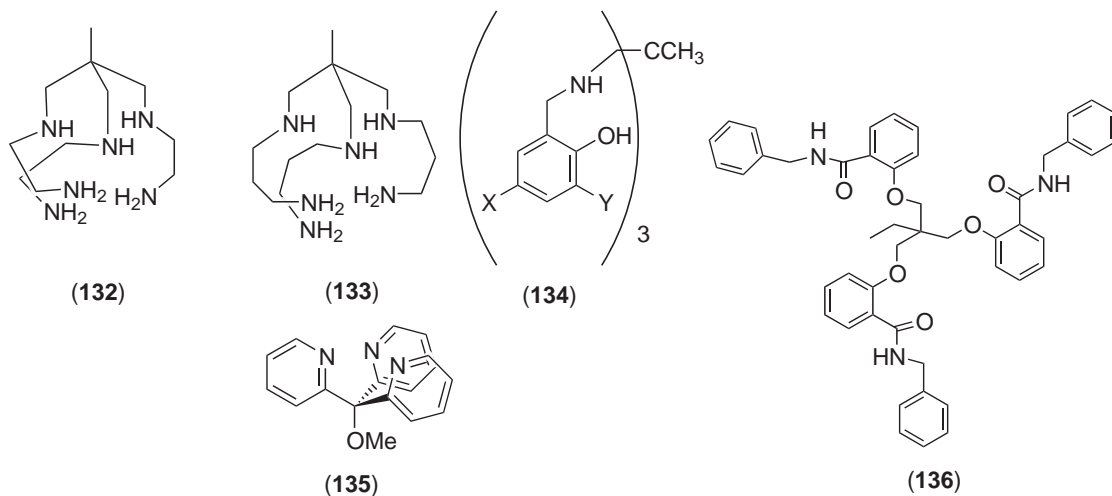


(131)

bases.<sup>214</sup> These ligands are shown to coordinate trivalent metal ions in the trianionic form, giving neutral, six-coordinated complexes.

Among the pyridine-based tripods, only tris(2-pyridyl)methanol ligands such as (135) and bis(2-*N*-methylimidazolyl)(2-pyridyl)methanol are potentially tetradentate,<sup>215,216</sup> but up to the time of writing (2002) they have not been known in such a binding mode.

Some rigid tripodal ligands have been synthesized for the construction of various novel cage- or box-like complexes, and have demonstrated their potential use in supramolecular chemistry. The relatively flexible amide-type ligand (136) was prepared by the replacement reaction of 1,1,1-tris(*p*-tosyloxymethyl)propane and *N*-benzylsalicylamide.<sup>217</sup>



### 1.11.7 MACROCYCLIC LIGANDS

Macrocyclic ligands are an interesting family of molecules, which have spawned the new area of supramolecular chemistry since the first preparation of these compounds by Pedersen.<sup>218</sup> Within two decades, this expanding area resulted in the awarding of the Nobel Prize in Chemistry to three prominent researcher in the field: Pedersen,<sup>219</sup> Cram,<sup>220</sup> and Lehn.<sup>221</sup> The unusual ability of macrocycles to recognize not only cations, but also anions and neutral molecules, in a selective fashion has been summarized in *CCC* (1987).<sup>222</sup> A number of reviews cover all the literature in this field until 1994.<sup>223–227</sup> Several books about the host–guest concept and similarities with biological molecules have appeared since about 1980; some references can be found in the reviews of Izatt and co-workers.<sup>223–227</sup> More recent studies have been directed also toward the development of a new systematic heterosupramolecular chemistry, in order to program a nanocrystal to recognize and selectively bind a molecule, another nanocrystal, or a suitable patterned substrate in solution.<sup>228</sup>

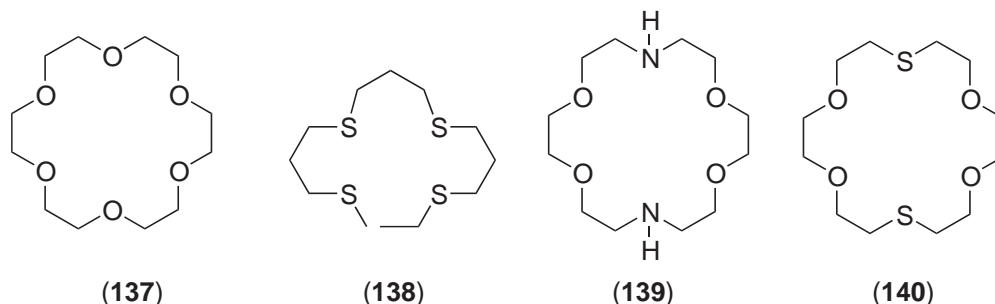
Multidentate macrocyclic ligands are comprised of molecules with an organic backbone interspersed with heteroatoms able to bind a variety of species. Macropolycyclic ligands are a 3-D extension of macrocyclic ligands, in which more than one macrocycle is incorporated into the same molecule. Multidentate macrocyclic and macropolycyclic ligands attract an increasing interest because they can function as receptors for several kinds of substrates, and because, after coordination, the physical and chemical properties of these substrates can be significantly modified.

Although in the early studies a correlation between cavity radius and cation radius was demonstrated in complexes with alkali and alkaline-earth metals, later studies by Hancock *et al.* showed that the concept of size-match selectivity of macrocyclic ligands has limited applicability, that it is in reality a selectivity governed by chelate ring-size considerations, and that enthalpy is the major contributor to the macrocyclic and cryptate effects.<sup>229</sup> More recently, the important role also played by hydrogen-bonding interactions to counter anions and other co-ligands such as water has been recognized, by examining the structural chemistry of first- and second-sphere alkali-metal-cation complexes of several crown ethers.<sup>230</sup> Much effort has been put into designing and preparing macrocycles that would selectively bind specific cations. Ligands were varied by changing the dimensions and rigidity of the macrocycle, or by substituting sulfur and nitrogen atoms for part or all of the crown ether oxygen atoms. Ligands with only neutral

oxygen atoms were found to be excellent donors for alkaline, alkaline-earth, and some post-transition-metal ions, whereas sulfur atoms in the form of sulfide groups showed a high affinity toward soft metal ions such as  $\text{Pd}^{2+}$  and  $\text{Hg}^{2+}$  and some borderline acids such as  $\text{Cu}^{2+}$ .<sup>231,232</sup> In this chapter we follow the classification of Izatt and co-workers in their reviews.<sup>223–227</sup>

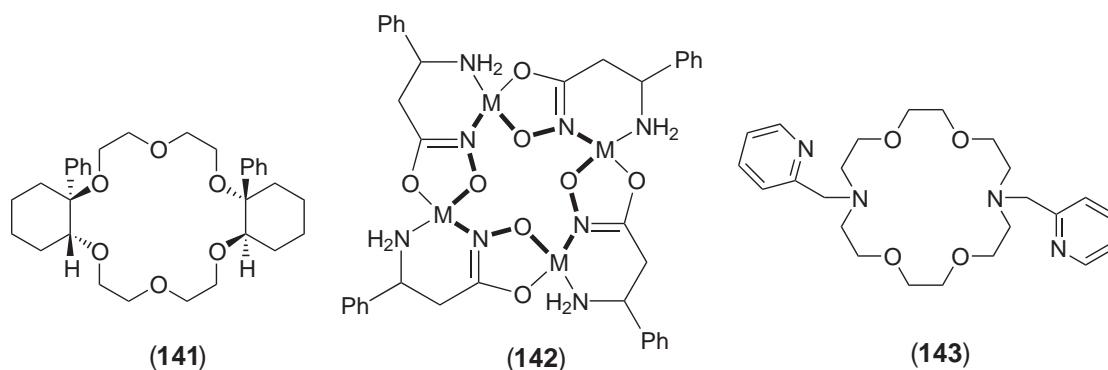
### 1.11.7.1 Crown Ethers

Crown ethers possess oxygen atoms (**137**), sulfur atoms,<sup>233</sup> (138) or different donor atoms as in (139) and (140). Polyaza-macrocycles are treated by other authors. Two or three carbon atoms are generally interposed between each pair of donor atoms; many ligands with aromatic rings fused to the macrocycle have been reported.



Chiral crown ethers containing phenyl-substituted cyclohexane-1,2-diol fragments (**141**) have been shown to be useful for recognizing neutral chiral amines.<sup>234</sup> Izatt published an excellent review on the enantiomeric recognition of amine compounds by chiral macrocyclic receptors in 1997.<sup>235</sup> A new strategy for finding suitable chiral recognition agents is the development of chiral metallacrowns (**142**) which, in the solid state, form cavities that selectively recognize anions.<sup>236</sup> A particular class of macrocycles named “lariat” crown ethers, possessing a chelating fragment in the “lariat arm,” shows a high degree of cation selectivity.<sup>237,238</sup> The “lariat arm” is able to envelop a cation by providing a third dimension of solvation to a ring-bound cation (Figure 6).

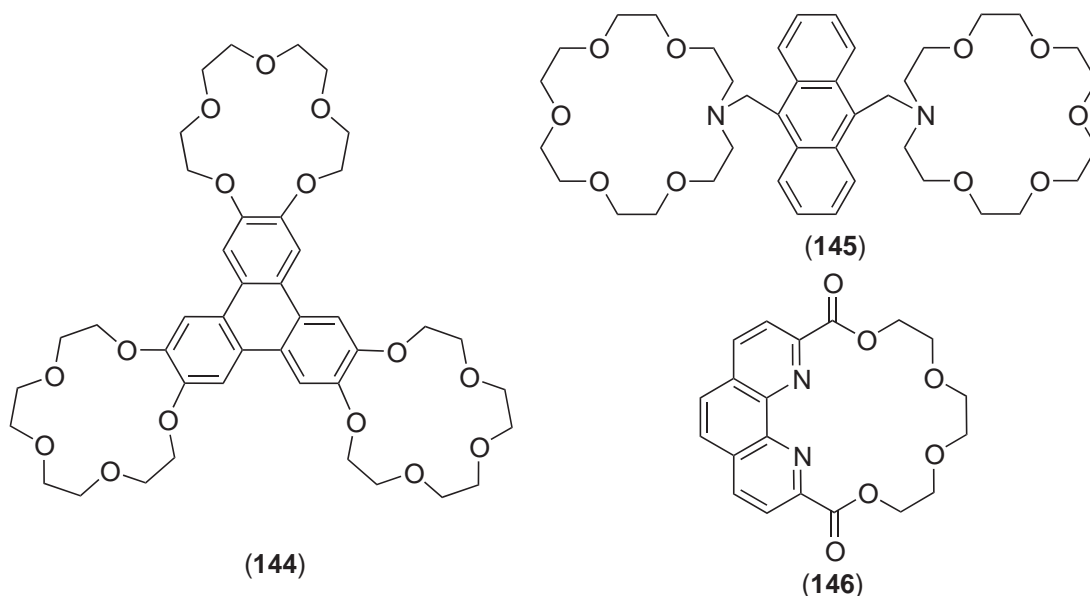
The name “lariat” was suggested by similarities with the use of a “lasso” in Old West America to “rope and tie” an animal.<sup>237–240</sup> A good example is the ligand (**143**), with two pyridyl-containing arms.



Two or more macrocyclic entities can be linked in several different ways, as shown by (**144**) and (**145**).<sup>241</sup> Linked macrocyclic systems can bind simultaneously two or more metal ions, giving rise to complexes with unusual electronic, catalytic, and/or redox properties.<sup>242</sup> Macrocycles incorporating phenanthroline moieties (**146**) are useful sensing agents for ion-selective electrodes and fluorimetry, and suitable carriers for selective ion transport in liquid-membrane systems.<sup>243,244</sup>

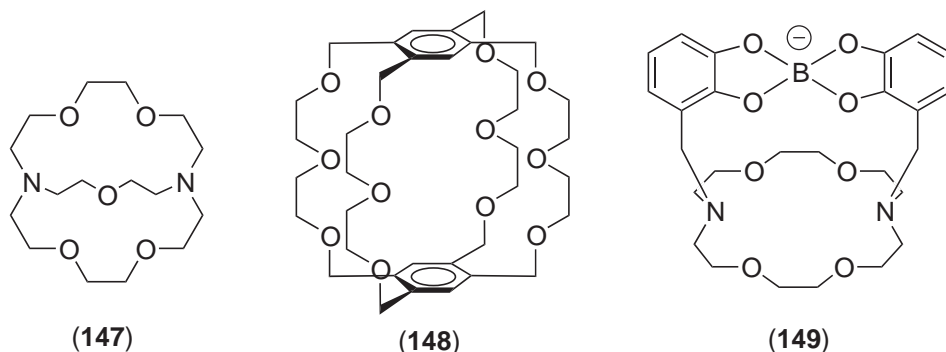


Figure 6



### 1.11.7.2 Cryptands and Polycyclic Compounds

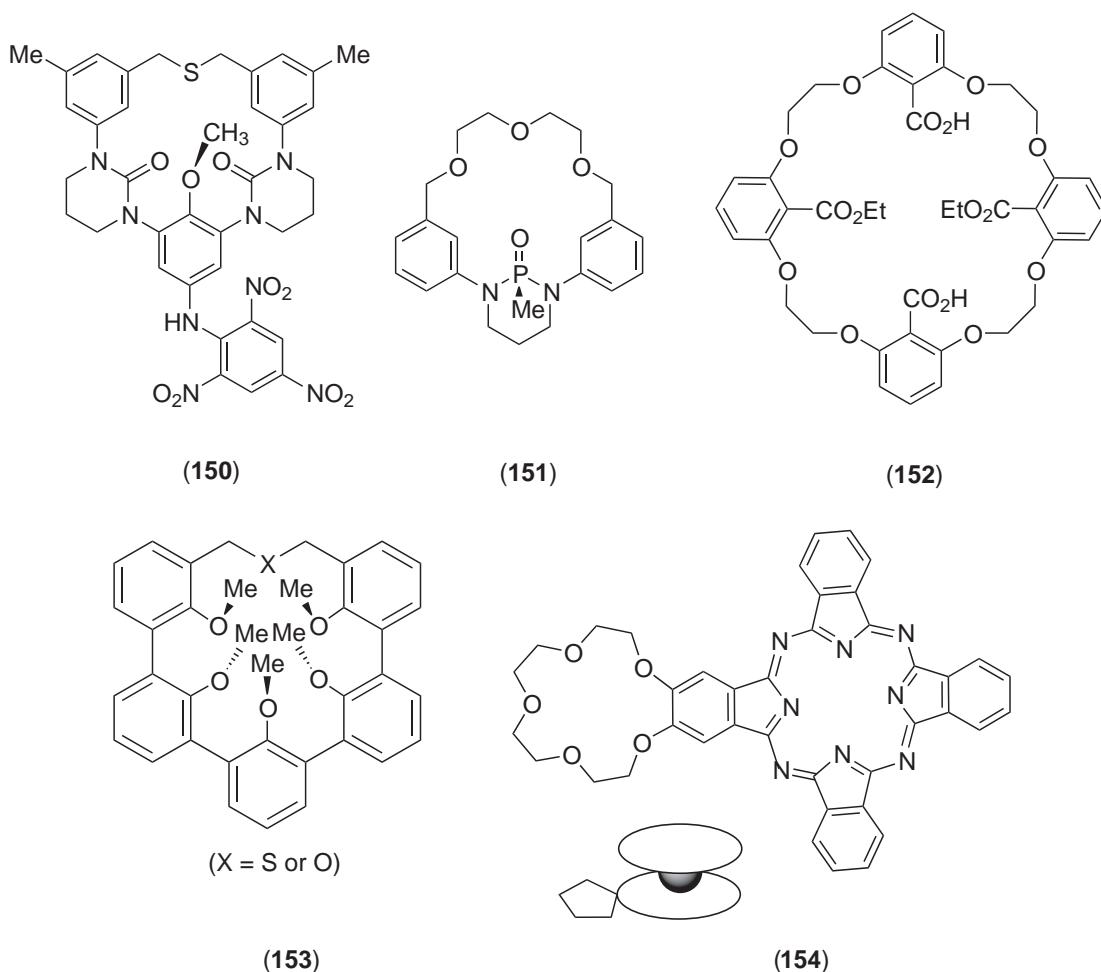
Cryptands are macro-bi- or -poly-cycles able to encapsulate an ion by providing it higher protection because of their cage-like structures, as in (147) and (148). For these ligands the correspondence between cavity size and complex stability is more pronounced than for simple crown ethers. Recent approaches to improve the metal-ion selectivity of cryptands, as for example by replacement of ethylene units between each donor atoms with propylene units, or by insertion of several substituents into the macrocycles, have been reviewed.<sup>245</sup> A new, interesting family of cryptands is constituted by borocryptands (149), which are useful receptors for chiral substrates, where enantiomeric differentiation can be achieved by using NMR spectroscopy.<sup>246</sup>



### 1.11.7.3 Other Preorganized Macrocycles

After identifying the important role of “preorganization” and “complementarity” in determining the stabilities of cation complexes, Cram formulated the *Principle of Preorganization*: “The smaller the changes in organization of host, guest, and solvent required for complexation, the stronger will be the binding.”<sup>247</sup> A recent preorganized macrocycle is the spherand (150), which shows enhanced selectivity for  $\text{Na}^+$  over  $\text{Li}^+$  in chloroform–water extraction. The ligand (151) imposes the inward orientation of the phosphorus moiety into the macrocyclic cavity. The diacid ligand (152) displays a balanced conformational flexibility and preorganization. Examples of spherands are (153), which contain five *meta*-linked anisyl binding sites and demonstrate how preorganization overcomes the poor intrinsic donating ability of aliphatic ethers by incorporation of three adjacent anisyl into the host.

A very recent class of ligands (2002) is based on a lanthanide phthalocyanine moiety which links one or four polyether macrocycles (**154**): they show different aggregate forms under various conditions, i.e., the cation present or the solvent used.<sup>248</sup>



#### 1.11.7.4 Switchable and Chromogenic Macrocycles

Some chemical substances have been used in the past as “switches” to control ion transport. Several new molecular sensory devices, which are responsive crown ethers used for the dynamic control of cation and anion binding induced by changes in pH, redox potential, temperature, light, and magnetic and electrical field, have been developed. These new ligands possess chromophores or fluorophores linked to the macrocycle, and display drastic variations in their photochemical and/or luminescent properties upon cation complexation.

##### 1.11.7.4.1 Photoresponsive macrocycles

Examples of photoresponsive macrocycles are styrene-containing dyes (Figure 7), or the bis-anthracenyl macrotricycles (**155**) and lariat ethers with an anthracenyl arm (**156**).

We note particularly a class of photocleavable cryptands where the release of a cation is light-induced (Figure 8).<sup>249,250</sup>

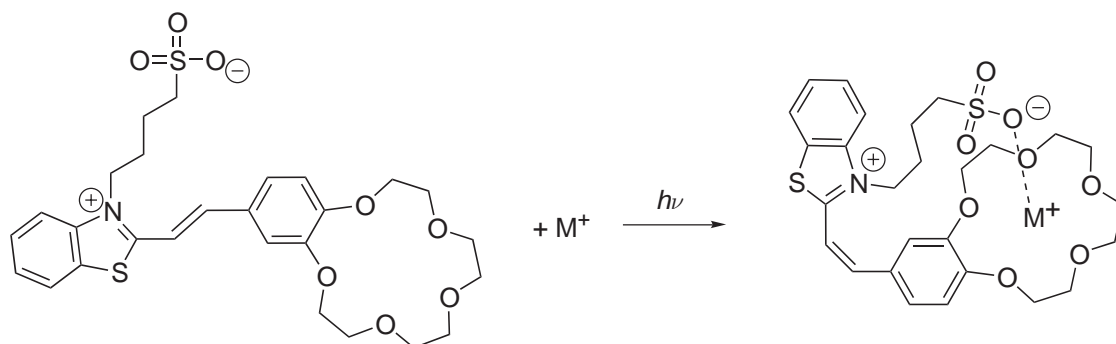


Figure 7

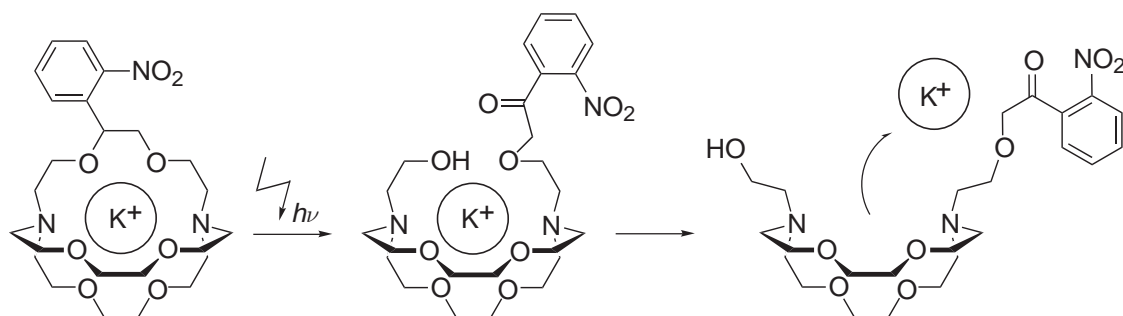
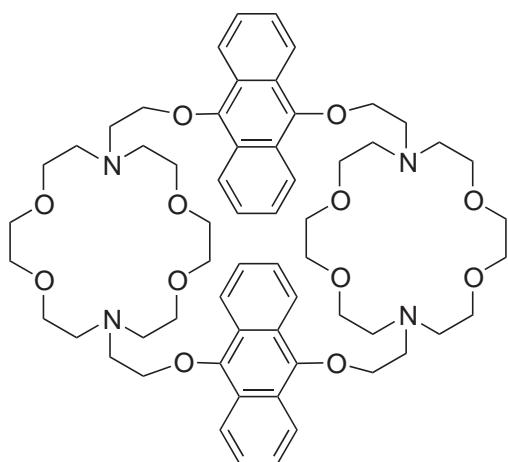
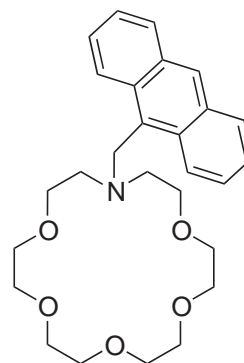


Figure 8



(155)



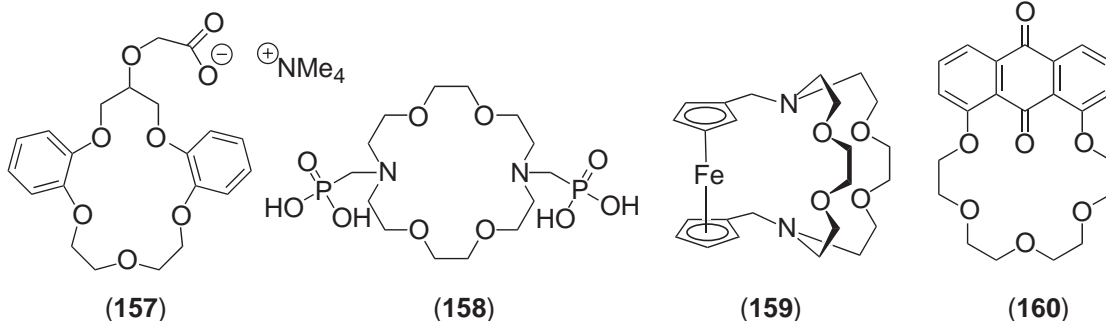
(156)

#### 1.11.7.4.2 pH-responsive macrocycles

These are ionizable macrocyclic carriers which allow, by pH changes, the turning on/off of cation transport through liquid membranes. They possess an ionizable proton in a group exterior to the ring of donor atoms (**157**), or attached to an atom that extends from the macrocycle (i.e., calixarenes) or to one of the ring donor atoms. Ionizable armed crown ethers, such as those containing alkylphosphoric acid fragments (**158**), show some advantages over simple crown ethers. In fact they provide rapid incorporation of cations from the basic aqueous phase into the organic phase and their rapid release to the acidic aqueous phase and, moreover, an enhancement of cation selectivity by formation of a 3-D cavity using the crown ring and the anion site of the pendant arm.<sup>251</sup>

### 1.11.7.4.3 Redox-responsive macrocycles

These contain redox-active centers able to switch on/off cation or anion complexation when treated with redox reagents or electrochemical stimulation. Examples include some ferrocenyl-containing macrocycles, such as **(159)**, or donors with an anthraquinone fragment, as in **(160)**.<sup>252</sup> The functionalization of electroactive polymers by monocyclic polyethers has been used for the building of cation-responsive electrodes.<sup>253</sup>

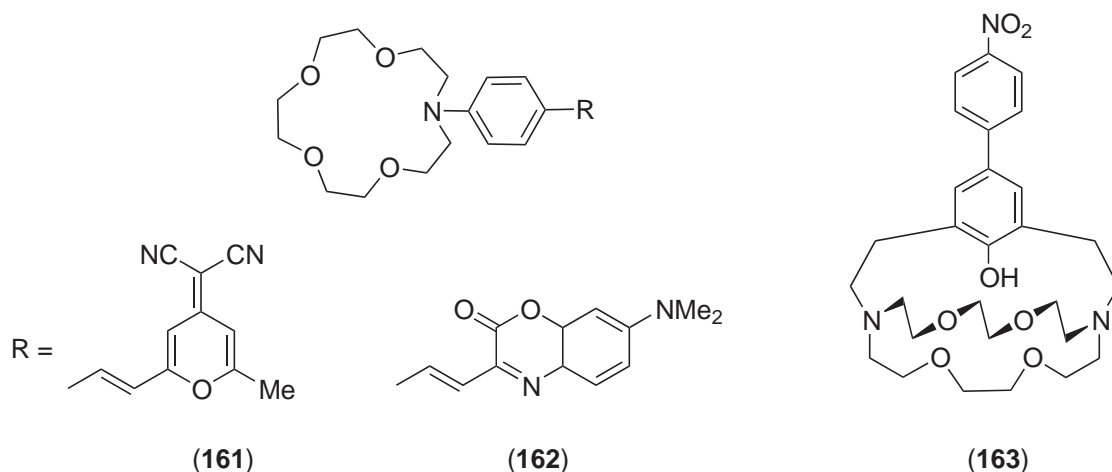


### 1.11.7.4.4 Ion-responsive fluorescent macrocycles

These ligands possess a variety of cation-responsive fluorescence fragments such as merocyanine, **(161)**, and benzoxazinone, **(162)**.<sup>254</sup>

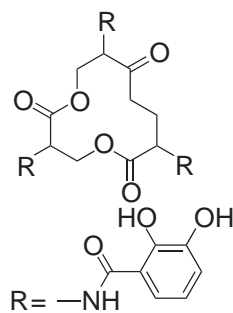
### 1.11.7.4.5 Chromogenic macrocycles

These contain chromophore moieties, as in **(163)**, that give rise to color changes on complexation with metal cations.

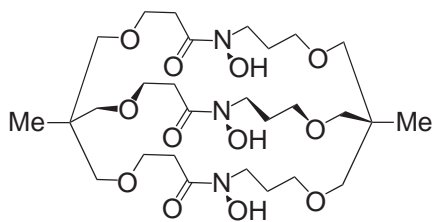


### 1.11.7.5 Siderophore-type Macrocycles

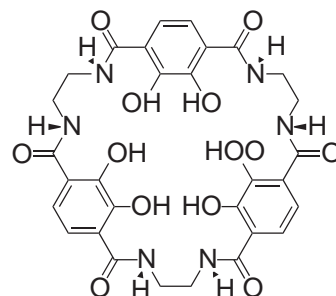
The siderophores are a particular class of macrocycles able to sequester and solubilize  $\text{Fe}^{3+}$  microbially produced in the form of insoluble ferric hydroxide and facilitate its transport into the cell. They strictly resemble the activity of a natural, catechol-based, macrocyclic siderophore known as enterobactin **(164)**, which can be isolated from several enteric bacteria and is able to form a very stable complex with  $\text{Fe}^{3+}$ .<sup>255,256</sup> They are generally subdivided into two main classes: those based on hydroxamate chelating groups **(165)** and those based on catechol groups **(166)**.



(164)



(165)



(166)

### 1.11.8 DENDRIMERIC LIGANDS

Dendrimers (from Greek, *dendron* = tree and *meros* = part) are referred to as tree-like molecules emanating from a core and extending with each subsequent branching unit (Figure 9).<sup>257</sup> Owing to the regular and highly symmetric structure, with internal cavities and a defined number of functional end groups, they offer a wide range of unusual properties. The chemistry of these compounds, known only since the middle of the 1980s, is rapidly developing. Dendrimers with different cores, branching units, and end groups have been synthesized. Here we discuss only the species acting as ligands toward metal donors.

Dendrimer-based metal complexes are now expected to be promising components for the design of new materials. Compared with conventional metal-containing organic polymers based on polyacetylene and polyphenylene units, cascade molecules offer a highly controlled architecture, which can be the basis for dendrimer-supported metal complexes with new properties. If the metal complexation is limited to the terminal groups, all the coordination centers will be readily accessible for stoichiometric or catalytic reactions. The stabilization of reactive centers at the surface of dendrimers could result in regioselectivity as a consequence of the blocking of conformations due to the steric crowding induced by the dendrimer.

Another advantage of dendrimer-based catalysts concerns their easy recovery by stabilization at the surface of a polymer. The principal activities in dendritic catalysis lie in homogeneous catalysis, including Kharash addition of  $\text{CCl}_4$  to methacrylate, palladium-catalyzed allylic alkylation, hydrogenation of olefins, hydroformylation, cyclopropanation, and oxidation.<sup>258</sup> Dendrimers with redox-active cores have been proposed as promising materials for miniaturized information-storage circuits.<sup>259</sup>

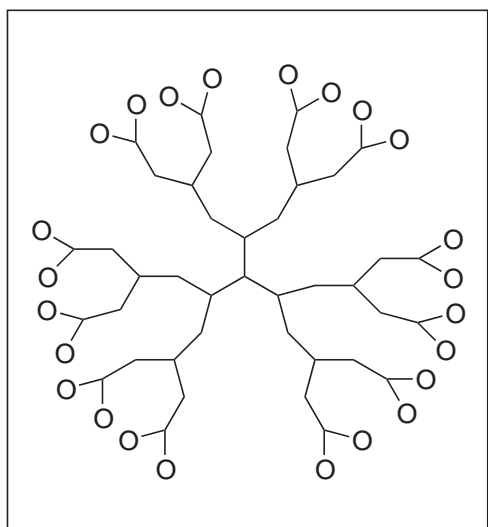


Figure 9



Two methods of construction of dendrimeric molecules have been developed: the divergent (or “inside out”) and convergent (or “outside in”). In the divergent method<sup>260</sup> the tree-like molecule is built step by step starting from the central core, by attaching one branching unit after another. This process affords the first generation of dendrimers. If the peripheral units of the dendrimers contain reactive sites, the process can be iterated, yielding a second-generation dendrimer. In the convergent method<sup>261</sup> the skeleton is constructed stepwise, starting from the terminal groups toward the inside, and it is finally treated with a core molecule.

Metal-containing dendrimers can be divided into two groups. The first consists of small-branch, repeating units with donor groups acting as bridging ligands that are linked by coordination to metal centers. Such dendrimers are built using polynuclear oligopyridyl or pyrazino-pyridyl building blocks,<sup>262</sup> or other polydentate species.<sup>263</sup>

Another group is represented by dendritic polymers with functional groups or moieties acting as huge polydentate ligands toward metal centers. The metal atoms can be incorporated into the center of the dendrimer as in dendrimer-metalloporphyrins,<sup>264</sup> or linked to the terminal donor groups as in polyamine- and polyamide-,<sup>265,266</sup> nucleobase-,<sup>267</sup> or polyphosphine-based<sup>268</sup> dendrimers. A synthetic approach to two- (a) and four-directional (b) dendrimers possessing specifically localized piperazine subunits is shown in Figure 10.

An example of a polyamine dendrimer functionalised by 2-pyridylethyl- substituents is (167).<sup>269</sup> The interaction of (167) with copper(II) acceptors gives metal derivatives containing one metal for each bis[2-(2-pyridyl)ethyl]amine moiety. (167) is found to bind approximately 32 Cu ions. Polyamidoamine species containing Cu ions can be reduced in solution to zerovalent copper nanoclusters, providing a metal nanocomposite.<sup>270</sup> Such copper(0) solutions are stable for several months, owing to the surface properties of the host dendrimer molecules.

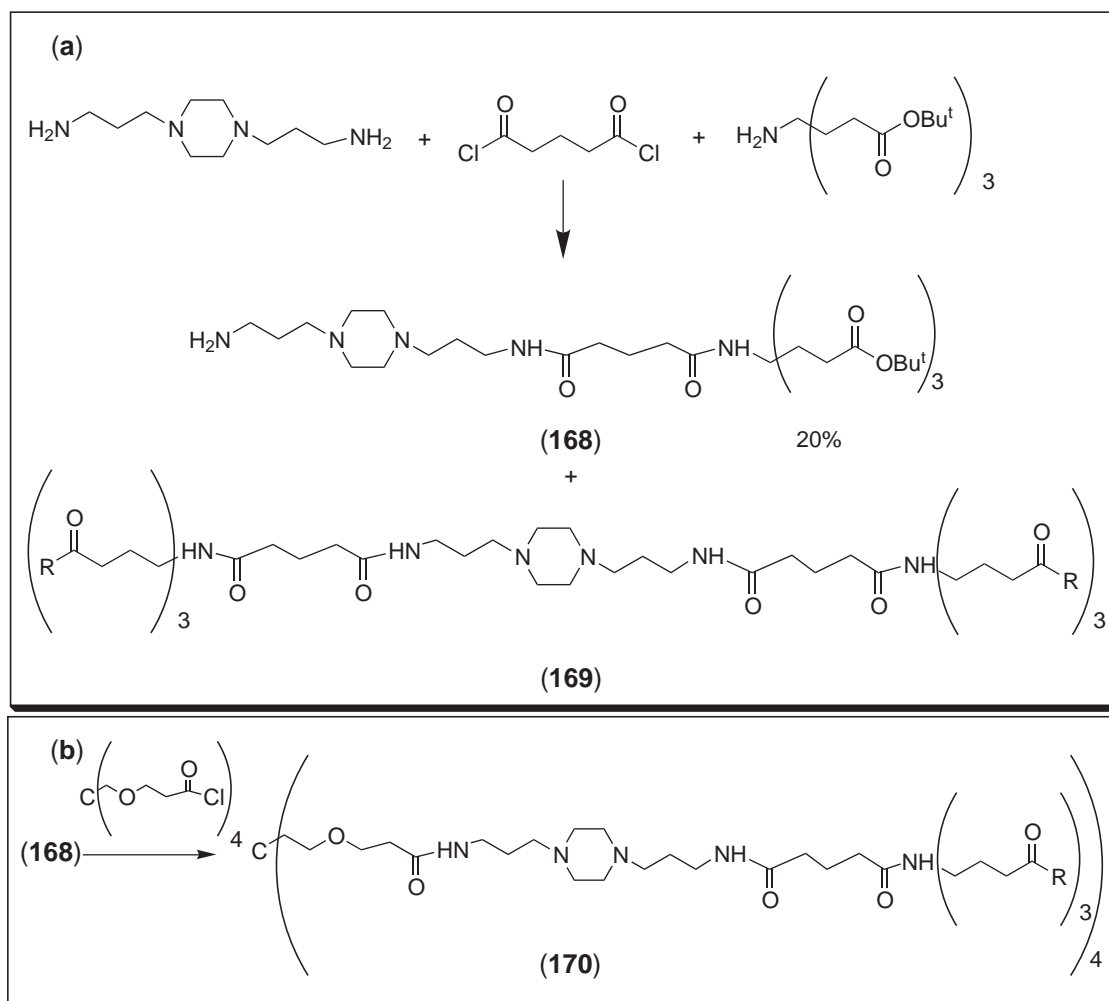
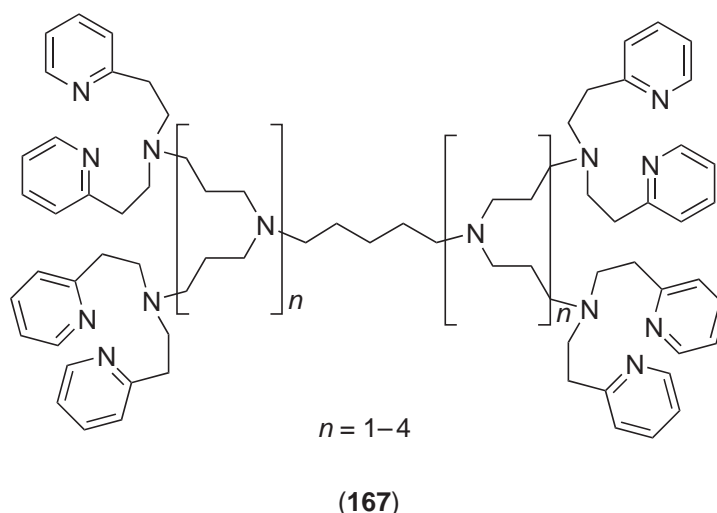


Figure 10

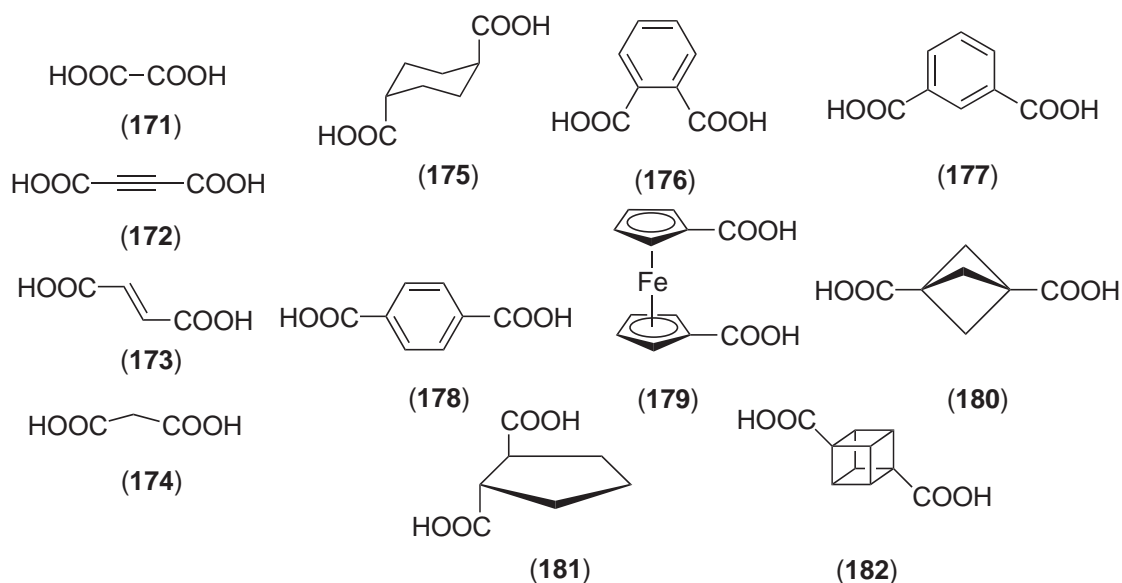


### 1.11.9 POLYCARBOXYLIC ACIDS

Several naturally occurring di- and tricarboxylic acids are involved in important biological processes as donor ligands—see, for example, L-tartaric and citric acid—and their chemical behavior has been the object of many studies. Chemists have realized that polycarboxylic ligands can function as chelating agents useful in several fields of application. For example, ethylenediamine-tetraacetic acid (EDTA) is commonly used as a chelating agent for a number of metal ions in analytical applications. In the last decades studies on polycarboxylate donors have increased enormously. Considerable effort has been devoted to the formation of metal–polycarboxylate assemblies. Polycarboxylate ligands function as connectors in coordination polymers that can offer new network architectures, many of which do not exist in natural solids. They find particular application in the crystal engineering of special geometrical and topological coordination polymers, potentially useful in catalysis, chemical absorption, metal-ion exchange and recognition, magnetism and electrical conductivity.

Polycarboxylic acids can basically be subdivided into three main classes: (i) donors containing only a carbon-based backbone; (ii) donors with carboxylate groups attached to a mono-, di-, or polyamine backbone; and (iii) donors built on aza-macrocycles, crown ethers, or calixarenes. The first class of ligands represents very useful building units for the design of highly porous and robust metal–organic frameworks. Porous solids usually find applications in the areas of ion exchange, separation, and catalysis. Research into the solid-state chemistry for the construction of extended solids from molecular building blocks attracts great interest, because of the advantages it offers for the design of materials. Cotton *et al.* have shown how it is possible to create discrete tetranuclear (pairs or loops), hexanuclear (triangles), octanuclear (squares), and dodecanuclear (cages) species, as well as 1-D, 2-D, or 3-D molecular nanotubes, by employing M–M bonded dimetal entities as building units, instead of single metal ions, and equatorial and axial organic linkers represented by different polycarboxylate polyanions and neutral nitrogen-containing molecules, respectively.<sup>271</sup>

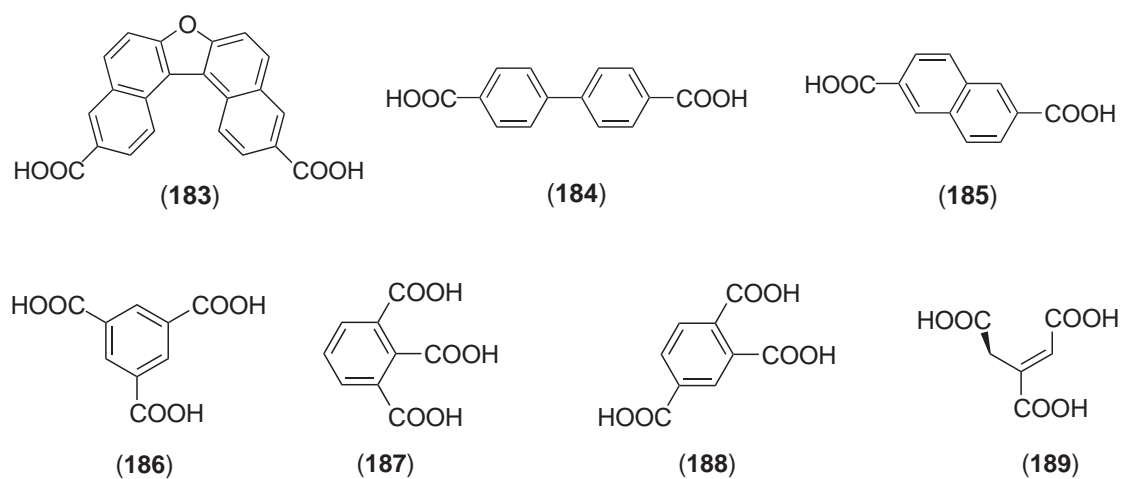
Classical dicarboxylate donors such as oxalate (**171**), acetylene dicarboxylate (**172**), fumarate (**173**), propane-1,3-dicarboxylate (**174**), *trans*-1,4-cyclohexanedicarboxylate (**175**), phthalate (**176**), isophthalate (**177**), terephthalate (**178**), ferrocene-dicarboxylate (**179**), bicyclo[1.1.1]-pentane-1,3-dicarboxylate (**180**), *trans*-cyclopentane-1,2-dicarboxylate (**181**), and 1,4-cubanedicarboxylate (**182**) can be used as secondary building units as a basis for the design of highly porous and robust metal–organic carboxylate frameworks.<sup>272</sup> These supramolecular arrays contain cross-section channel systems that occupy a volume constituting a large percentage of the structures, able to incorporate highly mobile guest molecules.<sup>273–275</sup> The rigid-angular ligand 7-oxa-dibenzofluorene-3,11-dicarboxylate (**183**) has been shown to be useful in the formation of a nanoscopic molecular rectangle for the construction of a 1-D coordination polymer by coordination with Cu<sup>II</sup> and Co<sup>II</sup>.<sup>276</sup> The 4,4'-diphenylcarboxylate (**184**) and 2,6-naphthalenedicarboxylate (**185**) can be



employed in the coordination of  $Zn^{II}$  as infinite secondary building units in the formation of 3-D structures having a framework where catenation is forbidden.<sup>278</sup>

The tri-functionalized 1,3,5-benzenetricarboxylate (trimesic acid) (**186**) is one of the most widely employed triangular building units for the construction of 3-D porous networks characterized by high selectivity for guest binding in a tailored channel. The multidentate functionality of (**186**) imparts rigidity and stability to the resulting porous frameworks, even in the absence of guests, thus allowing examination of their inclusion chemistry.<sup>278-284</sup> This donor can bind in several different modes, as depicted in Figure 11.<sup>285</sup>

Other examples of analogous, benzene-based, tricarboxylate donors are hemimellitic (**187**) and trimellitic acid (**188**), which show an enhanced lanthanide-sensitized luminescence, mainly with  $Tb^{III}$ .<sup>286</sup> The flexible, aliphatic-based *trans*-acotinic acid (**189**) reacts with  $[Co(\eta^5-C_5H_5)_2]^+[OH]^-$  generating a large, honeycomb-type structure, in which the resulting superanion  $[C_3H_3(CO_2H)_2CO_2^-(H)C_3H_3(CO_2H)_2CO_2^-]$  retains four  $-CO_2H$  groups available for “neutral”  $O-H\cdots O$  hydrogen bonding, while the deprotonated  $CO_2^-$  forms a “charge-enhanced”-type hydrogen bond within the superanion.<sup>287</sup>



Tetracarboxylate ligands such as 1,2,3,4-cyclobutanetetracarboxylate (**190**),<sup>287</sup> 1,3,5,7-adamantanetetracarboxylate (**191**),<sup>288</sup> a bis-isophthalate derivative (**192**),<sup>289</sup> (2*R*,4*R*,6*R*,8*R*)-1,9-dihydroxy-3,5,7-trioxanonane-2,4,6,8-tetracarboxylate (**193**),<sup>290</sup> and 1,2,4,5-benzenetetracarboxylate (**194**)<sup>291</sup> have been synthesized and applied as building blocks in open-metal-site porous materials.

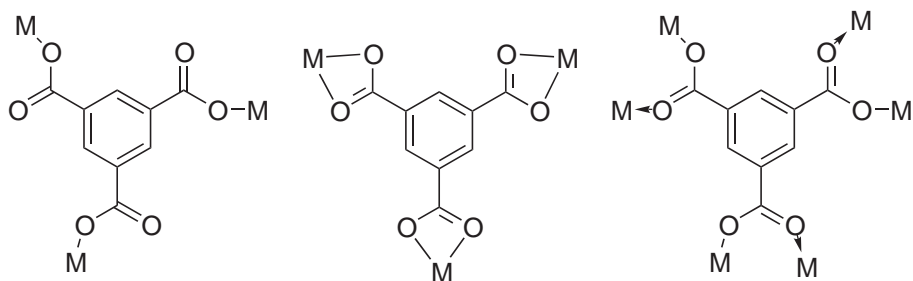
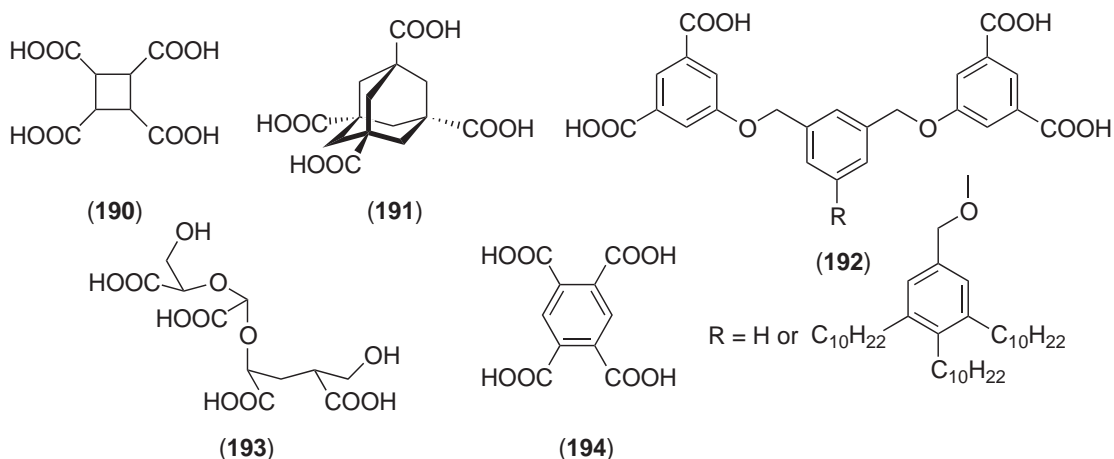


Figure 11



(190) forms supra-anionic organic frameworks held together by  $\text{O}-\text{OH}\cdots\text{O}$  and  $\text{O}-\text{OH}\cdots\text{O}^-$  hydrogen bonds which accommodate the diamagnetic  $[\text{Co}(\eta^5\text{-C}_5\text{H}_5)_2]^+$  and the paramagnetic  $[\text{Cr}(\eta^6\text{-C}_6\text{H}_6)_2]^+$  cations, respectively.<sup>287</sup> Ligand (192) has been used as a building block in the design of self-assembling, solid-state structures with cavities of defined size. The ordered porous materials are based on hydrogen interactions as intermolecular bonds (Figure 12).<sup>289</sup> Ligand (193) is an important lanthanide-sequestrant agent, able to bind also through ethereal oxygen atoms.<sup>290</sup>

Another wide class of polycarboxylate ligands is based on a mono-, di-, or polyamine backbone with three or more pendant carboxylate groups. These find potential applications in the field of radiometal-labeled agents,<sup>292</sup> as therapeutic radiopharmaceuticals,<sup>293</sup> or as MRI contrasting agents used as diagnostic tools in medical bioassays.<sup>294</sup> The coordinating ability of ligands derived from *ortho*- (195), *meta*- (196), or *para*-phenylenediamines (197), which can behave as dinucleating donors, is of special interest because of the intriguing magnetic properties of their transition-metal derivatives.<sup>295</sup>

Several mono- and polyamino-carboxylate ligands have been synthesized, and their coordinating ability with respect to transition- and lanthanide-metal ions has been widely investigated. Van Eldik *et al.* have reported the systematic investigation of  $\text{Fe}^{\text{II}}$  polycarboxylate complexes with respect to their reactivity against nitric oxide and dioxygen in aqueous solution.<sup>296</sup> Their classification of polyamino-carboxylate ligands is very useful. Additional information about each of the following ligands reported here can be found in a series of very recent reviews.<sup>292-295,297-301</sup> Monoamino-dicarboxylates (Figure 13) are usually subdivided into three different subgroups. While in subgroup (a) the hydrogen can be exchanged by another noncoordinating group, in subgroup (b) it is exchanged by a further coordinating function, and in subgroup (c) by a heteroatom. Particular ligands based on heterocyclic rings are (198)<sup>301</sup> and (199),<sup>296</sup> whereas the ligand (200)<sup>296</sup> contains both amine and ethereal functions.

Diamino-polycarboxylates are analogues of EDTA and can have a polymethylene chain of variable length as a spacer between the amine nitrogen atoms, in which branching, ethereal functionalities, or a fifth  $-\text{COO}$  group can also be present (Figure 14).

Another big family of ligands is that derived by replacement of some or all four acetic acid end groups, without affecting the central ethylenediamine component (Figure 15).

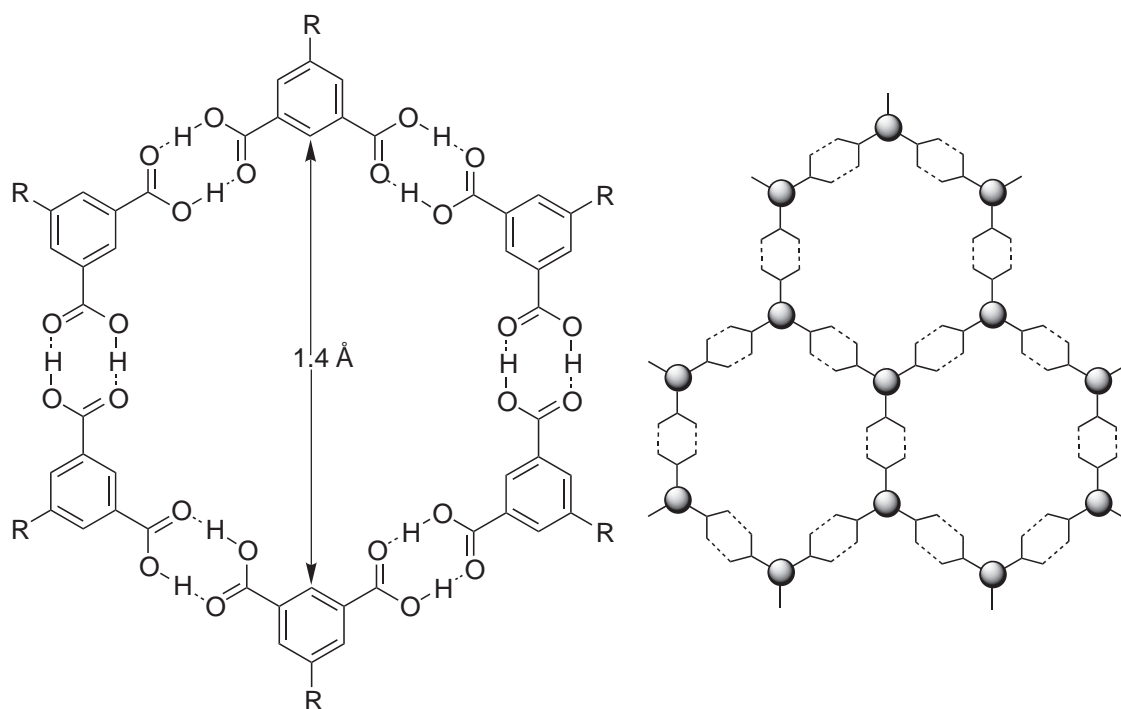
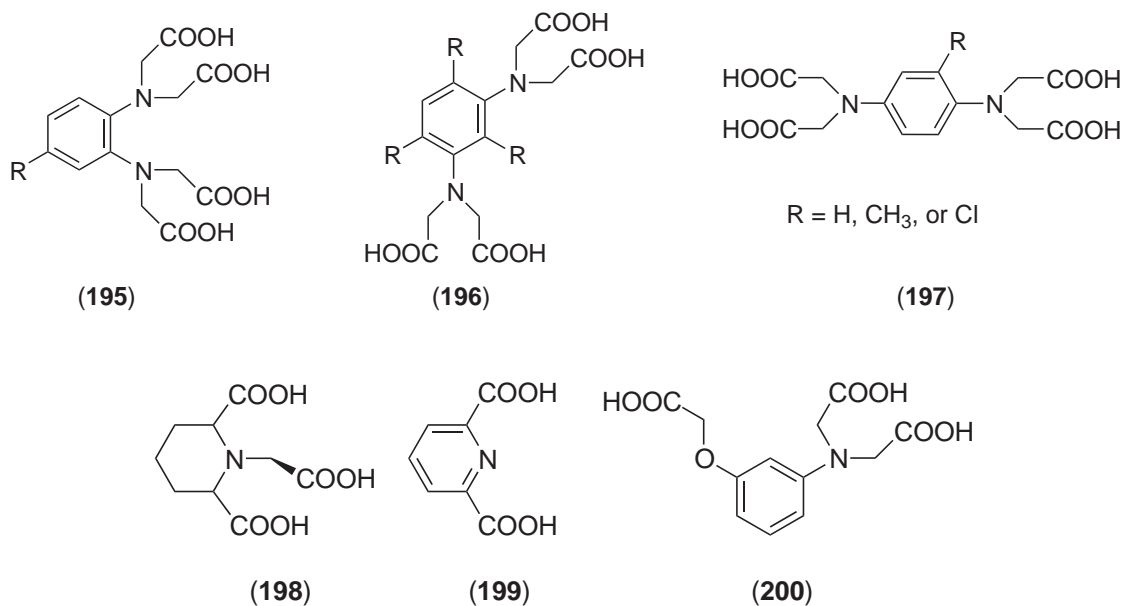


Figure 12



A large number of triamino-polycarboxylates also exist (Figure 16), with different coordinating or noncoordinating substituents bound to the central nitrogen atom.

An additional series of triamino-polycarboxylates with substituents in the terminal COO end groups is shown in Figure 17.

The polydentate donor (201) contains six carboxylic acid groups and forms an anionic 1:1 complex with gadolinium, of formula  $[\text{Gd}(\mathbf{201})]^{3-}$ .<sup>301</sup>

Other interesting donor ligands such as (202) and (203), containing one or more pyridine rings, can react through their terminal  $-\text{NCS}$  or  $-\text{NH}_2$  groups with amino acids and simultaneously chelate transition and lanthanide radio-metal ions.<sup>297</sup>

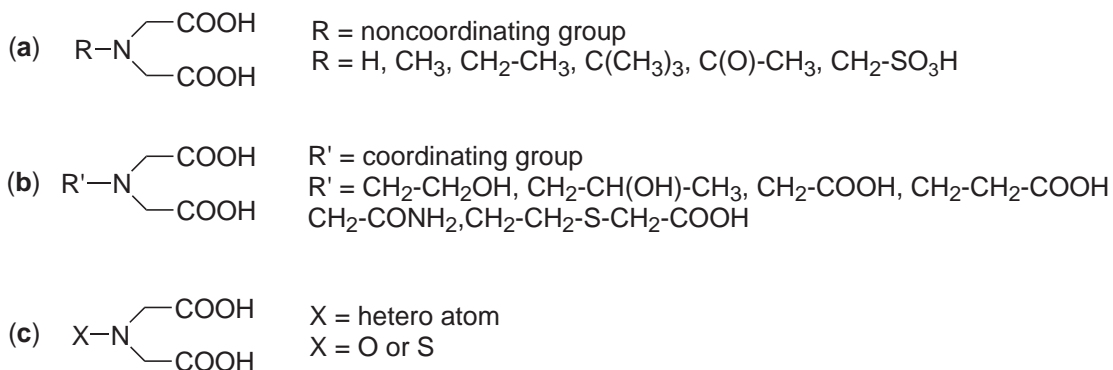


Figure 13

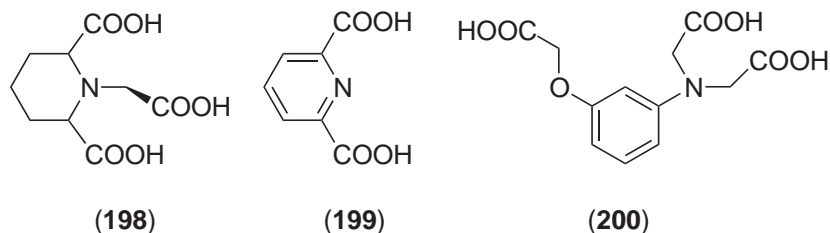


Figure 14

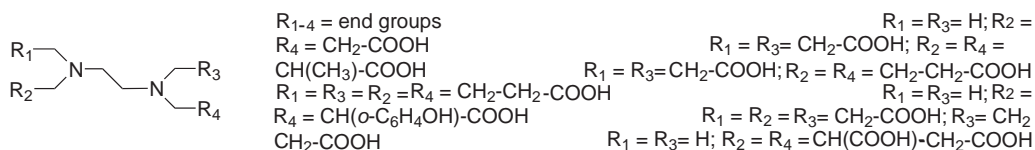


Figure 15

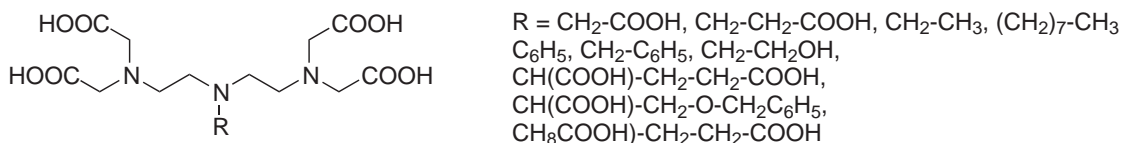


Figure 16

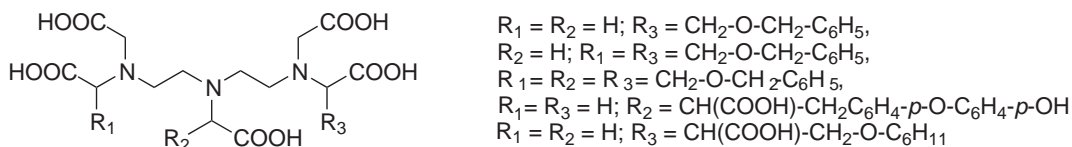
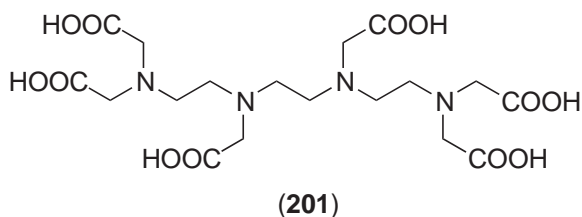
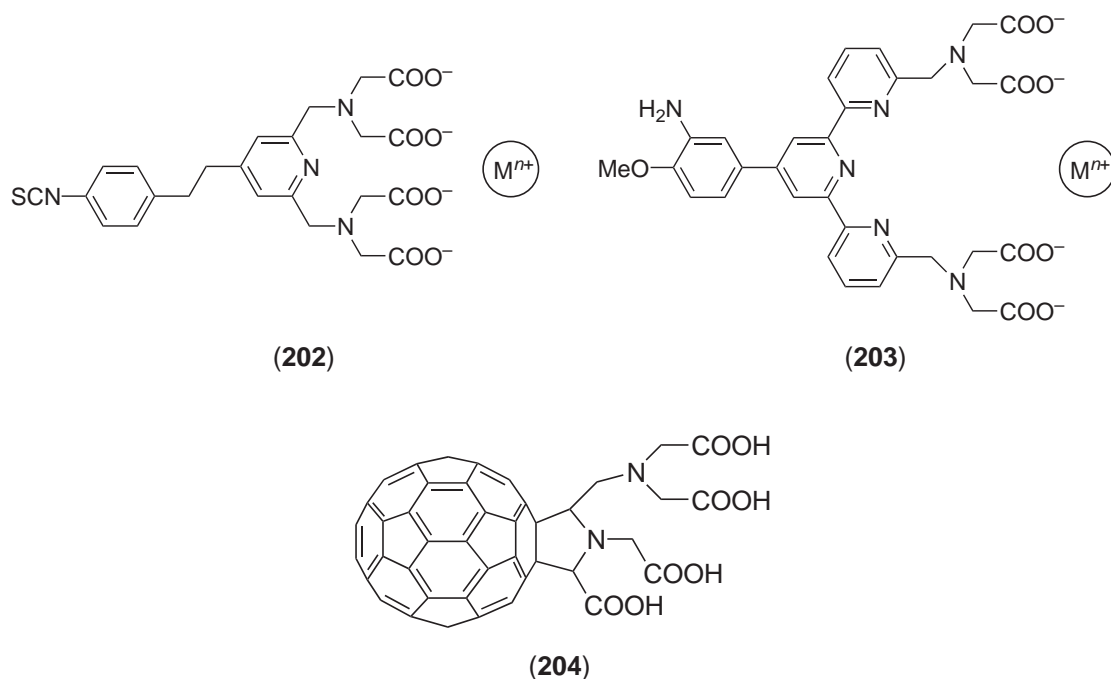


Figure 17





A fullerene-based amine-carboxylate ligand (**204**), able to form monolayer films with particular photoelectric conversion properties, has also been synthesized.<sup>302</sup>

The third class of ligands we mention here is that of polyaza-macrocycles, crown ethers, and calixarenes bearing polycarboxylate arms.<sup>293,294,299–301</sup>

Several polyaza-macrocyclic polycarboxylates with various cycle-size and  $\text{COO}^-$  units linked (Figure 18), useful as MRI contrast agents, have been synthesized.<sup>294</sup>

Polycarboxylate crown ethers such as (**205**) are suitable ligands for potentiometric studies of mixed-metal complexes of  $\text{Al}^{3+}$  and alkali or alkaline-earth cations.<sup>303</sup> A similar (+)-18-crown-6-tetracarboxylic acid, chemically immobilized on a chiral stationary phase (CSP), can selectively recognize both enantiomers of some analytes.<sup>304</sup> Calixarene polycarboxylates such as (**206**) and (**207**) are useful ligands toward alkali-<sup>305,306</sup> and also transition-metal ions,<sup>307,308</sup> with applications in

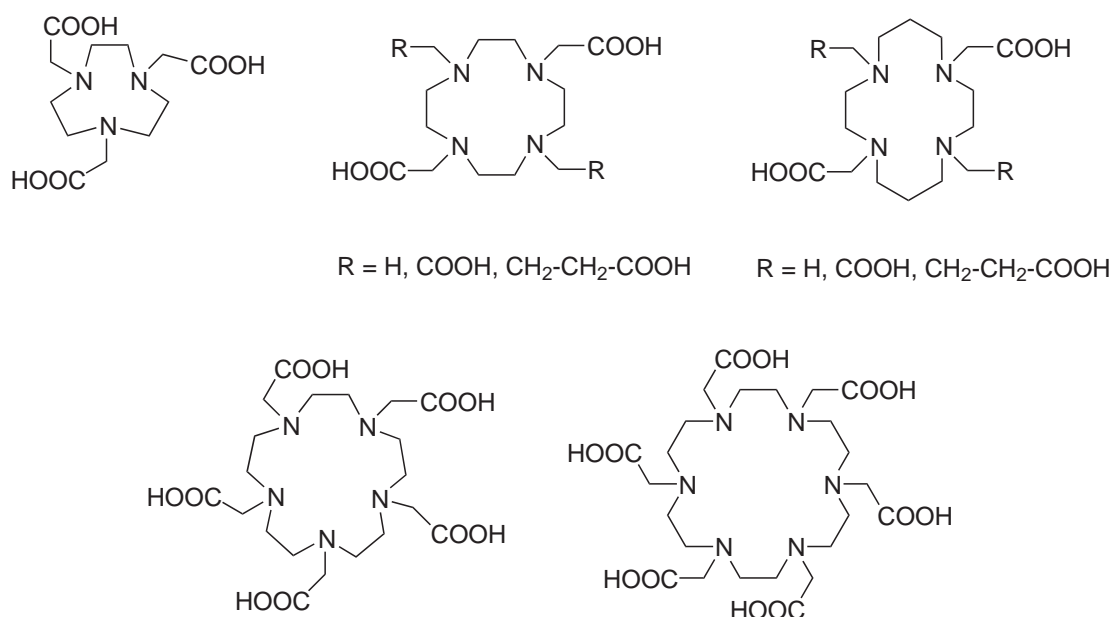
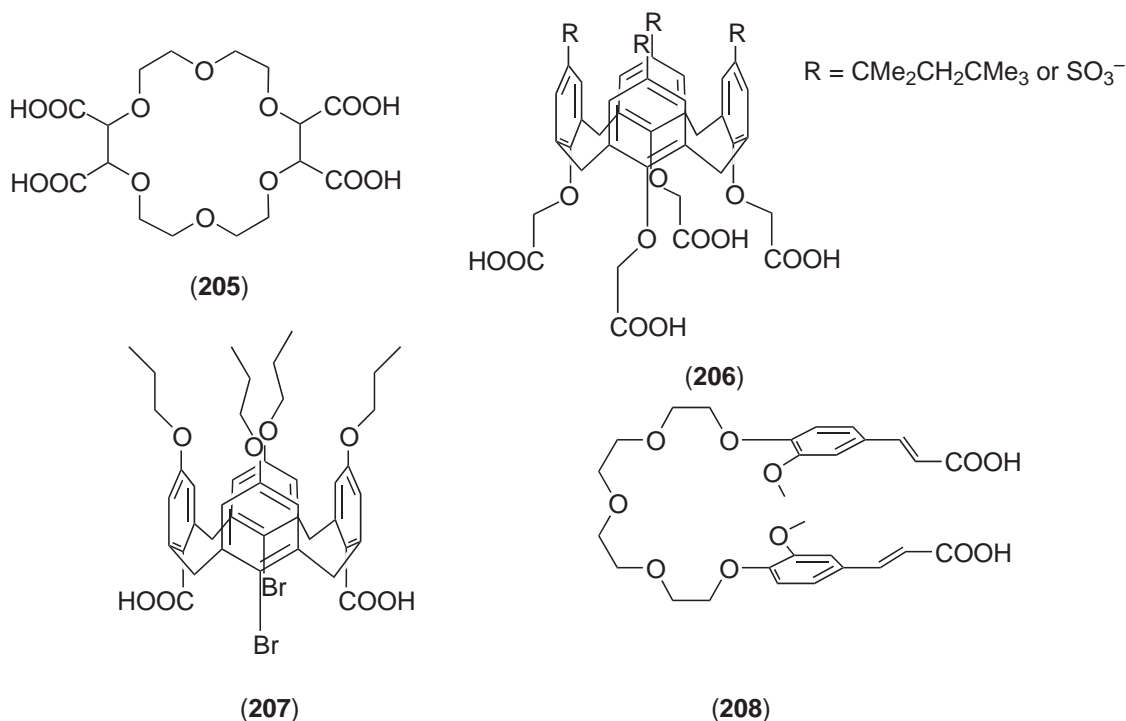


Figure 18



self-coextraction of sodium and in catalysis, respectively. A novel molecular-assembly mode has been shown by ferulic acid derivatives such as (208), which is a ligand able to give three kinds of noncovalent interaction, i.e., metal coordination, hydrogen coordination, and C—H- $\pi$  interaction, and to form stable dinuclear alkali-metal ions.<sup>309</sup>

### 1.11.10 REFERENCES

- Goodwin, H. A.; Lions, F. *J. Am. Chem. Soc.* **1960**, *82*, 5013–5023.
- Newkome, G. R.; Frere, Y. A.; Fronczek, F. R.; Gupta, V. K. *Inorg. Chem.* **1985**, *24*, 1001–1006.
- Goodson, P. A.; Oki, A. R.; Glerup, J.; Hodgson, D. J. *J. Am. Chem. Soc.* **1990**, *112*, 6248–6254.
- Wong, E.; Liu, S.; Rettig, S. J.; Orvig, C. *Inorg. Chem.* **1995**, *34*, 3057–3064.
- Luo, H.; Lo, J.-M.; Fanwick, P. E.; Stowell, J. G.; Green, M. A. *Inorg. Chem.* **1999**, *38*, 2071.
- Balsells, J.; Carroll, P. J.; Walsh, P. J. *Inorg. Chem.* **2001**, *40*, 5568–5574.
- Taliaferro, C. H.; Motekaitis, R. J.; Martell, A. E. *Inorg. Chem.* **1984**, *23*, 1188–1192.
- Alcón, M. J.; Iglesias, M.; Sánchez, F.; Viani, I. *J. Organomet. Chem.* **2000**, *601*, 284–292.
- Setyawati, I. A.; Liu, S.; Rettig, S. J.; Orvig, C. *Inorg. Chem.* **2000**, *39*, 496–507.
- Hendriks, H. M. J.; ten Bokkel Huinink, W. O.; Reedjik, J. *Recl. Trav. Chim. Pays-Bas* **1979**, *98*, 499–500.
- Haanstra, W. G.; Driessen, R. A. G.; Reedjik, J.; Turpeinen, U.; Hämmäläinen, R. *J. Chem. Soc., Dalton Trans.* **1989**, 2309–2314.
- Karlin, K. D.; Lippard, S. J. *J. Am. Chem. Soc.* **1976**, *98*, 6951–6957.
- Pickett, C.; Kumar, S.; Vella, P. A.; Zubieta, J. *Inorg. Chem.* **1982**, *21*, 908–916.
- Gagné, R. R.; Kreh, R. P.; Dodge, J. A.; Marsh, R. E.; McCool, M. *Inorg. Chem.* **1982**, *21*, 254–261.
- Liang, H.-C.; Karlin, K. D.; Dyson, R.; Kaderli, S.; Jung, B.; Zuberbühler, A. D. *Inorg. Chem.* **2000**, *39*, 5884–5894.
- Hansen, L.; Hirota, S.; Xu, X.; Taylor, A. T.; Marzilli, L. G. *Inorg. Chem.* **2000**, *39*, 5731–5740.
- Price, C.; Elsegood, M. R. J.; Clegg, W.; Houlton, A. *J. Chem. Soc., Chem. Commun.* **1995**, 2285–2286.
- Shipman, M. A.; Price, C.; Elsegood, M. R. J.; Clegg, W.; Houlton, A. *Angew. Chem. Int. Ed. Engl.* **2000**, *39*, 2360–2362.
- Price, C.; Rees, N. H.; Elsegood, M. R. J.; Clegg, W.; Houlton, A. *J. Chem. Soc., Dalton Trans.* **1998**, 2001–2006.
- Shipman, M. A.; Price, C.; Gibson, A. E.; Elsegood, M. R. J.; Clegg, W.; Houlton, A. *Chem. Eur. J.* **2000**, *6*, 4371–4378.
- Toscano, P. J.; Marzilli, L. G. *Inorg. Chem.* **1983**, *22*, 3342–3350.
- Cross, R. J.; Farrugia, L. J.; Newman, P. D.; Peacock, R. D.; Stirling, D. *Inorg. Chem.* **1999**, *38*, 1186–1192.
- Casella, L.; Ibers, J. A. *Inorg. Chem.* **1981**, *20*, 2438–2448.
- Monzani, E.; Casella, L.; Zoppellaro, G.; Gullotti, M.; Pagliarin, R.; Bonomo, R. P.; Tabbi, G.; Nardin, G.; Randaccio, L.; *Inorg. Chim. Acta* **1998**, *282*, 180–192.
- Bu, X.-H.; Du, M.; Shang, Z.-L.; Zhang, R.-H.; Liao, D.-Z.; Shionoya, M.; Clifford, T. *Inorg. Chem.* **2000**, *39*, 4190–4199.
- Kuksa, V.; Buchan, R. *Synthesis* **2000**, *9*, 1189–1207 and references therein.



27. Karigiannis, G.; Papaioannou, D. *Eur. J. Org. Chem.* **2000**, *10*, 1841–1863.
28. Otway, D. J.; Rees, W. S., Jr. *Coord. Chem. Rev.* **2000**, *210*, 279–328.
29. Timmons, J. H.; Martell, A. E.; Harris, W. R.; Murase, I. *Inorg. Chem.* **1982**, *21*, 1525–1529.
30. Timmons, J. H.; Harris, W. R.; Murase, I.; Martell, A. E. *Inorg. Chem.* **1978**, *17*, 2192–2197.
31. Kim, S.-D.; Kim, J.-K.; Jung, W.-S. *Polyhedron* **1998**, *17*, 1223–1229.
32. Raleigh, C. J.; Martell, A. E. *Inorg. Chem.* **1985**, *24*, 142–148.
33. Renault, J.; Lebranchu, M.; Lecat, A.; Uriac, P. *Tetrahedron Lett.* **2001**, *42*, 6655–6658.
34. Wong, E.; Caravan, P.; Liu, S.; Rettig, S. J.; Orvig, C. *Inorg. Chem.* **1996**, *35*, 715–724.
35. Ajioka, M.; Yano, S.; Saburi, M.; Yoshikawa, S. *Inorg. Chem.* **1981**, *20*, 884–890.
36. Saburi, M.; Ishii, Y.; Obata, S.; Yamaguchi, M.; Yoshikawa, S. *Inorg. Chem.* **1985**, *24*, 527–533.
37. van Duijvenbode, R. C.; Rajanayagam, A.; Koper, G. J. M.; Borkovec, M.; Paulus, W.; Steuerle, U.; Häußling, L. *Phys. Chem. Chem. Phys.* **1999**, *1*, 5649–5652.
38. Bernhardt, P. V. *Inorg. Chem.* **2001**, *40*, 1086–1092.
39. Carrington, S.; Renault, J.; Tomasi, S.; Corbel, J.-C.; Uriac, P.; Blagbrough, I. S. *J. Chem. Soc., Chem. Commun.* **1999**, 1341–1342.
40. Motekaitis, R. J.; Martell, A. E.; Nelson, D. A. *Inorg. Chem.* **1984**, *23*, 275–283.
41. Goulaouic-Dubois, C.; Guggisberg, A.; Hesse, M. *Tetrahedron* **1995**, *51*, 12573–12582.
42. Boča, M.; Baran, P.; Boča, R.; Fuess, H.; Kickelbick, G.; Linert, W.; Renz, F.; Svoboda, I. *Inorg. Chem.* **2000**, *39*, 3205–3212.
43. Bernhardt, P. V.; Sharpe, P. C. *J. Chem. Soc., Dalton Trans.* **1998**, 1087–1088.
44. Hill, H. A. O.; Raspin, K. A. *J. Chem. Soc. A.* **1968**, 3036–3039.
45. Storvick, J. P.; Pagenkopf, G. K. *Inorg. Chem.* **1985**, *24*, 2523–2525.
46. Hansen, L.; Lampeka, Y. D.; Gavriš, S. P.; Xu, X.; Taylor, A. T.; Marzilli, L. G. *Inorg. Chem.* **2000**, *39*, 5859–5866.
47. Chalitta-Bechara, A.; Chiumia, G. C.; Craig, D. C.; Philips, D. J. *Inorg. Chim. Acta* **1998**, *271*, 210–216.
48. Liu, S.-H.; Chung, C.-S. *Inorg. Chem.* **1984**, *23*, 1803–1806.
49. Davison, A.; Jones, A. G.; Orvig, C.; Sohn, M. *Inorg. Chem.* **1981**, *20*, 1629–1632.
50. Fritsky, I. O. *J. Chem. Soc., Dalton Trans.* **1999**, 825–826.
51. Duhme, A.-K.; Dauter, Z.; Hider, R. C.; Pohl, S. *Inorg. Chem.* **1996**, *35*, 3059–3061.
52. Fatin-Rouge, N.; Blanc, S.; Leize, E.; Van Dorsselaer, A.; Baret, P.; Pierre, J.-L.; Albrecht-Gary, A. M. *Inorg. Chem.* **2000**, *39*, 5771–5778.
53. Boelrijk, A. E. M.; Khangulov, S. V.; Dismukes, G. C. *Inorg. Chem.* **2000**, *39*, 3009–3019.
54. Pessiki, P. J.; Khangulov, S. V.; Ho, D. M.; Dismukes, G. C. *J. Am. Chem. Soc.* **1994**, *116*, 891–897.
55. Satcher, J. H.; Balch, A. L.; Olmstead, M. M.; Droege, M. W. *Inorg. Chem.* **1996**, *35*, 1749–1750.
56. Satcher, J. H.; Droege, M. W.; Olmstead, M. M.; Balch, A. L. *Inorg. Chem.* **2001**, *40*, 1454–1458.
57. Satcher, J. H.; Droege, M. W.; Weakley, T. J. R.; Taylor, R. T. *Inorg. Chem.* **1995**, *34*, 3317–3328.
58. Malachowski, M. R.; Carden, J.; Davidson, M. G.; Driessen, W. L.; Reedijk, J. *Inorg. Chim. Acta* **1997**, *257*, 59–67.
59. Mazurek, W.; Berry, K. J.; Murray, K. S.; O'Connor, M. J.; Snow, M. R.; Wedd, A. G. *Inorg. Chem.* **1982**, *21*, 3071–3080.
60. Mazurek, W.; Kennedy, B. J.; Murray, K. S.; O'Connor, M. J.; Rodgers, J. R.; Snow, M. R.; Wedd, A. G.; Zwack, P. R. *Inorg. Chem.* **1985**, *24*, 3258–3264.
61. McKee, V.; Zvagulis, M.; Dagdigian, J. V.; Patch, M. G.; Reed, C. A. *J. Am. Chem. Soc.* **1984**, *106*, 4765–4772.
62. Mathur, P.; Crowder, M. W.; Dismukes, G. C. *J. Am. Chem. Soc.* **1987**, *109*, 5227–5233.
63. Adams, H.; Bradshaw, D.; Fenton, D. *J. Chem. Soc., Dalton Trans.* **2002**, 925–930 and references therein.
64. Tinner, U.; Marty, W. *Inorg. Chem.* **1981**, *20*, 3750–3756.
65. Newkome, G. R.; Gupta, V. K.; Fronczek, F. R.; Pappalardo, S. *Inorg. Chem.* **1984**, *23*, 2400–2408.
66. Addison, A. W.; Burman, S.; Wahlgren, C. G.; Rajan, O. A.; Rowe, T. M.; Sinn, E. *J. Chem. Soc., Dalton Trans.* **1987**, 2621–2630.
67. Gayathri, V.; Leelamani, E. G.; Gowda, N. M. N.; Reddy, G. K. N. *Polyhedron* **1997**, *16*, 1169–1176.
68. Brand, U.; Burth, R.; Vahrenkamp, H. *Inorg. Chem.* **1996**, *35*, 1083–1086.
69. Sellmann, D.; Utz, J.; Heinemann, F. W. *Inorg. Chem.* **1999**, *38*, 5314–5322.
70. Wang, R.-H.; Hong, M.-C.; Su, W.-P.; Liang, Y.-C.; Cao, R.; Zhao, Y.-J.; Weng, J.-B. *Inorg. Chim. Acta* **2001**, *323*, 139–146.
71. Mukherjee, R. *Coord. Chem. Rev.* **2000**, *203*, 151–218.
72. Chavez, F. A.; Olmstead, M. M.; Mascharak, P. K. *Inorg. Chem.* **1996**, *35*, 1410–1412.
73. Chavez, F. A.; Olmstead, M. M.; Mascharak, P. K. *Inorg. Chim. Acta* **1998**, *269*, 269–273.
74. Chavez, F. A.; Olmstead, M. M.; Mascharak, P. K. *Inorg. Chem.* **1997**, *36*, 6323–6327.
75. Chavez, F. A.; Rowland, J. M.; Olmstead, M. M.; Mascharak, P. K. *J. Am. Chem. Soc.* **1998**, *120*, 9015–9027.
76. Tan, J. D.; Hudson, S. E.; Brown, S. J.; Olmstead, M. M.; Mascharak, P. K. *J. Am. Chem. Soc.* **1992**, *114*, 3841–3853.
77. Sorrell, T. N.; Jameson, D. L.; O'Connor, C. J. *Inorg. Chem.* **1984**, *23*, 190–195.
78. Sorrell, T. N.; Vankai, V. A.; Garrity, M. L. *Inorg. Chem.* **1991**, *30*, 207–210.
79. Ghosh, D.; Mukherjee, R. *Inorg. Chem.* **1998**, *37*, 6597–6605.
80. Murthy, N. N.; Mahroof-Tahir, M.; Karlin, K. D. *Inorg. Chem.* **2001**, *40*, 628–635.
81. Nishida, Y.; Shimo, H.; Maehara, H.; Kida, S. *J. Chem. Soc., Dalton Trans.* **1985**, 1945–1955.
82. Nasir, M. S.; Karlin, K. D.; McGowty, D.; Zubieta, J. *J. Am. Chem. Soc.* **1991**, *113*, 698–700.
83. Torelli, S.; Belle, C.; Gautier-Luneau, I.; Pierre, J. L.; Saint-Aman, E.; Latour, LePape J. M. L.; Luneau, D. *Inorg. Chem.* **2000**, *39*, 3526–3536.
84. Nasir, M. S.; Cohen, B.; I. Karlin, K. D. *J. Am. Chem. Soc.* **1992**, *114*, 2482–2494.
85. Belle, C.; Beguin, C.; Gautier-Luneau, I.; Hamman, S.; Philouze, C.; Pierre, J. L.; Thomas, F.; Torelli, S.; Saint-Aman, E.; Bonin, M. *Inorg. Chem.* **2002**, *41*, 479–491.
86. Mahapatra, S.; Kaderli, S.; Llobet, A.; Neuhold, Y.-M.; Palanché, T.; Halfen, J. A.; Young, V. G.; Kaden, T. A.; Que, L.; Zuberbühler, A. D.; Tolman, W. B. *Inorg. Chem.* **1997**, *36*, 6343–6356.
87. Graham, B.; Grannas, M. J.; Hearn, M. T. W.; Kepert, C. M.; Spiccia, L.; Skelton B. W.; White, A. H. *Inorg. Chem.* **2000**, *39*, 1092–1099.

88. Hartshorn, C. M.; Steel, P. J. *Angew. Chem. Int. Ed. Engl.* **1996**, *35*, 2655–2657 and reference therein.
89. Tolman, W. B.; Rardin, R. L.; Lippard, S. J. *J. Am. Chem. Soc.* **1989**, *111*, 4532–5433.
90. Seidel, W. W.; Hahn, F. E.; Llugger, T. *Inorg. Chem.* **1998**, *37*, 6586–6596.
91. Ward, M. D.; McCleverty, J. A.; Jeffery, J. C. *Coord. Chem. Rev.* **2001**, *222*, 251–272.
92. Dapporto, P.; De Munno, G.; Segal, A.; Mealli, C. *Inorg. Chim. Acta* **1984**, *83*, 171–176.
93. Thompson, L. K.; Woon, T. C.; Murphy, D. B.; Gabe, E. J.; Lee, F. L.; Le Page, Y. *Inorg. Chem.* **1985**, *24*, 4719–4725.
94. Gamasa, M. P.; Gimeno, J.; Lastra, E.; Garcia-Granda, S.; Moreiras, D. *J. Chem. Soc., Dalton Trans.* **1991**, 1557–1562.
95. Bautista, D. V.; Dewan, J. C.; Thompson, L. K. *Can. J. Chem.* **1982**, *60*, 2583–2593.
96. Thompson, L. K.; Hartstock, F. W.; Rosenberg, L.; Woon, T. C. *Inorg. Chim. Acta* **1985**, *97*, 1–7.
97. Barrios, A. M.; Lippard, S. J. *J. Am. Chem. Soc.* **1999**, *121*, 11751–11757.
98. Barrios, A. M.; Lippard, S. J. *Inorg. Chem.* **2001**, *40*, 1060–1064.
99. Sadimenko, A. P.; Basson, S. S. *Coord. Chem. Rev.* **1996**, *147*, 247–297.
100. Konrad, M.; Meyer, F.; Heinze, K.; Zsolnai, L. *J. Chem. Soc., Dalton Trans.* **1998**, 199–205.
101. Meyer, F.; Heinze, K.; Nuber, B.; Zsolnai, L. *J. Chem. Soc., Dalton Trans.* **1998**, 207–213.
102. Meyer, F.; Ruschewitz, U.; Schober, P.; Antelmann, B.; Zsolnai, L. *J. Chem. Soc., Dalton Trans.* **1998**, 1181–1186.
103. Incarvito, C.; Rheingold, A. L.; Gavrilova, A. L.; Jin Qin, C.; Bosnich, B. *Inorg. Chem.* **2001**, *40*, 4101–4108.
104. Rice, C. R.; Wörl, S.; Jeffery, J. C.; Paul, R. L.; Ward, M. D. *J. Chem. Soc. Dalton Trans.* **2001**, 550–559.
105. Byers, P.; Chan, G. Y. S.; Drew, M. G. B.; Hudson, M. J. *Polyhedron* **1996**, *15*, 2845–2849.
106. Gómez-de La Torre, F.; de la Hoz, A.; Jalón, F. A.; Manzano, B. R.; Otero, A.; Rodríguez, A.; Rodríguez-Pérez, M. C. *Inorg. Chem.* **1998**, *37*, 6606–6614.
107. Gourdon, A.; Launay, J.-P. *Inorg. Chem.* **1998**, *37*, 5336–5341.
108. Pappenfus, T. M.; Mann, K. R. *Inorg. Chem.* **2001**, *40*, 6301–6307.
109. Yu, Y.; Gunic, E.; Zinger, B.; Miller, L. L. *J. Am. Chem. Soc.* **1996**, *118*, 1013–1018.
110. Miller, L. L.; Yu, Y. *J. Org. Chem.* **1995**, *60*, 6813–6819.
111. Schenker, S.; Stein, P. C.; Wolny, J. A.; Brady, C.; McGarvey, J. J.; Toftlund, H.; Hauser, A. *Inorg. Chem.* **2001**, *40*, 134–139.
112. Kaminskaia, N. V.; He, C.; Lippard, S. J. *Inorg. Chem.* **2000**, *39*, 3365–3373.
113. He, C.; Lippard, S. J. *J. Am. Chem. Soc.* **2000**, *122*, 184–185.
114. Schilstra, M. J.; Birker, P. J. M. W. L.; Verschoor, G. C.; Reedijk, J. *Inorg. Chem.* **1982**, *21*, 2637–2644.
115. van Rijn, J.; Driessen, W. L.; Reedijk, J.; Lehn, J.-M. *Inorg. Chem.* **1984**, *23*, 3584–3588.
116. Nikles, D. E.; Powers, M. J.; Urbach, F. L. *Inorg. Chem.* **1983**, *22*, 3210–3217.
117. Pavlishchuk, V. V.; Kolotilov, S. V.; Addison, A. W.; Butcher, R. J.; Sinn, E. *J. Chem. Soc., Dalton Trans.* **2000**, 335–341.
118. Timmer, K.; Spee, K. I. M. A.; Mackor, A.; Meinema, H. A. *Inorg. Chim. Acta* **1991**, *190*, 109–117.
119. Gardiner, R.; Brown, D. W.; Kirlin, P. S.; Rheingold, A. L. *Chem. Mater.* **1991**, *3*, 1053–1059.
120. Drake, S. R.; Miller, A. S.; Williams, D. J. *Inorg. Chem.* **1993**, *32*, 3227–3235.
121. Rogers, R. D.; Voss, E. J.; Etzenhouser, R. D. *Inorg. Chem.* **1988**, *27*, 533–542.
122. Rogers, R. D.; Etzenhouser, R. D.; Murdoch, J. S.; Reyes, E. *Inorg. Chem.* **1991**, *30*, 1445–1455.
123. Mindrul, V. F.; Erman, L. Ya.; Gal'perin, E. L.; Kurochkin, V. K.; Petrunin, V. A. *Russ. J. Coord. Chem.* **1991**, *17*, 1290–1295.
124. Rogers, R. D.; Bond, A. H.; Aguinaga, S.; Reyes, E. *Inorg. Chim. Acta* **1993**, *212*, 225–231.
125. Jian-Ming, G.; Lin-Jiang, W.; Cheng, X.; Yun, Y. *Jiegou Huaxue* **1996**, *15*, 239–246.
126. Bulychiev, B. M.; Bel'sky, V. K. *Russ. J. Inorg. Chem.* **1995**, *40*, 1834–1845.
127. Neumann, R.; Assael, I. *J. Am. Chem. Soc.* **1989**, *111*, 8410–8413.
128. Casellato, U.; Tomat, G.; Di Bernardo, P.; Graziani, R. *Inorg. Chim. Acta* **1982**, *61*, 181–187.
129. Rogers, R. D.; Bond, A. H.; Wolff, J. L. *J. Coord. Chem.* **1993**, *29*, 187–207.
130. Rogers, R. D.; Rollins, A. N.; Henry, R. F.; Murdoch, J. S.; Etzenhouser, R. D.; Huggins, S. E.; Nunez, L. *Inorg. Chem.* **1991**, *30*, 4946–4954.
131. Rogers, R. D.; Rollins, A. N.; Etzenhouser, R. D.; Voss, E. J.; Bauer, C. B. *Inorg. Chem.* **1993**, *32*, 3451–3462.
132. Malandrino, G.; Benelli, C.; Castelli, F.; Fragalà, I. L. *Chem. Mater.* **1998**, *10*, 3434–3444.
133. Drozdov, A.; Troyanov, S. *Main Group Metal Chem.* **1996**, *19*, 547–569.
134. Malandrino, G.; Fragalà, I. L.; Aime, S.; Dastur, W.; Gobetto, R.; Benelli, C. *J. Chem. Soc., Dalton Trans.* **1998**, 1509–1512.
135. Iwamoto, R.; Wakano, H. *J. Am. Chem. Soc.* **1976**, *98*, 3764–3768.
136. Weber, G. *Acta Crystallogr. C.* **1980**, *36*, 2779–2781.
137. Bünzli, J.-C. G.; Pfefferle, J.-M.; Ammann, B.; Chapuis, G.; Zuniga, F.-J. *Helv. Chim. Acta* **1984**, *67*, 1121–1127.
138. Rogers, R. D.; Bond, A. H.; Roden, D. M. *Inorg. Chem.* **1996**, *35*, 6964–6973.
139. McCann, S.; McCann, M.; Casey, R. M. T.; Devereux, M.; McKee, V.; McMichael, P.; McCrea, J. G. *Polyhedron* **1997**, *16*, 4247–4252.
140. Powell, J.; Kuksis, A.; May, C. J.; Nyburg, S. C.; Smith, S. J. *J. Am. Chem. Soc.* **1981**, *103*, 5941–5943.
141. Studebaker, D. B.; Neumayer, D. A.; Hinds, B. J.; Stern, C. L.; Marks, T. J. *Inorg. Chem.* **2000**, *39*, 3148–3157.
142. Neumayer, D. A.; Belot, J. A.; Feezel, R. L.; Reedy, C.; Stern, C. L.; Marks, T. J.; Liable-Sands, L. M.; Rheingold, A. L. *Inorg. Chem.* **1998**, *37*, 5625–5633.
143. Newkome, G. R.; Yao, Z. Q.; Baker, G. R.; Gupta, V. K.; Russo, P. S.; Saunders, M. J. *J. Am. Chem. Soc.* **1986**, *108*, 849–850.
144. Tümmler, B.; Maass, G.; Weber, E.; Wehner, W.; Vögtle, F. *J. Am. Chem. Soc.* **1977**, *99*, 4683–4690.
145. Koch, K. R.; Niven, M. L.; Sacht, C. *J. Coord. Chem.* **1992**, *26*, 161–176.
146. Liu, S.-X.; Liu, W.-S.; Tan, M.-Y.; Yu, K.-B. *Polyhedron* **1997**, *16*, 1491–1495.
147. Tang, Y.; Gan, X.; Liu, W.; Tang, N.; Yu, K. *Polyhedron* **1996**, *15*, 2607–2612.
148. Sun, Y.; Martell, A. E.; Motekaitis, R. J. *Inorg. Chem.* **1985**, *24*, 4343–4350.
149. Bedell, S. A.; Timmons, J. H.; Martell, A. E.; Murase, I. *Inorg. Chem.* **1982**, *21*, 874–878.

150. Hahn, F. E.; Tamm, M. *Angew. Chem. Int. Ed. Engl.* **1991**, *30*, 203–205.
151. Buckingham, D. A.; Edwards, J. D.; McLaughlin, G. M. *Inorg. Chem.* **1982**, *21*, 2770–2787.
152. Schmidt, H.; Lensink, C.; Xi, S. K.; Verkade, J. D. *Z. Anorg. Allg. Chem.* **1989**, *578*, 75–80.
153. Ciampolini, M.; Nardi, N. *Inorg. Chem.* **1966**, *5*, 41–44.
154. Dittler-Klingemann, A. M.; Hahn, F. E. *Inorg. Chem.* **1996**, *35*, 1996–1999.
155. Dittler-Klingemann, A. M.; Orvig, C.; Hahn, F. E.; Thaler, F.; Hubbard, C. D.; van Eldik, R.; Schindler, S.; Fábíán, I. *Inorg. Chem.* **1996**, *35*, 7798–7803.
156. Song, B.; Reuber, C.; Ochs, C.; Hahn, F. E.; Lügger, T.; Orvig, C. *Inorg. Chem.* **2001**, *40*, 1527–1535.
157. Ochs, C.; Hahn, F. E.; Fröhlich, R. *Chem. Eur. J.* **2000**, *6*, 2193–2199.
158. Greco, G. E.; Schrock, R. *Inorg. Chem.* **2001**, *40*, 3850–3860.
159. Suh, M. P.; Kim, D. *Inorg. Chem.* **1985**, *24*, 3712–3714.
160. Szczepura, L. F.; Witham, L. M.; Takeuchi, K. J. *Coord. Chem. Rev.* **1998**, *174*, 5–32.
161. Anderegg, G.; Wenk, F. *Helv. Chim. Acta* **1967**, *50*, 2330–2332.
162. Anderegg, G.; Hubmann, E.; Podder, N. G.; Wenk, F. *Helv. Chim. Acta* **1977**, *60*, 123–140.
163. Chuang, C.-L.; Lim, K.; Chen, Q.; Zubieta, J.; Canary, J. W. *Inorg. Chem.* **1995**, *34*, 2562–2568.
164. Kojima, T.; Leising, R. A.; Yan, S.; Que, L. J. *J. Am. Chem. Soc.* **1993**, *115*, 11328–11335.
165. Allen, C. S.; Chuang, C.-L.; Cornebise, M.; Canary, J. W. *Inorg. Chim. Acta* **1995**, *239*, 29–37.
166. Hazell, A.; McGinley, J.; Toftlund, H. *J. Chem. Soc., Dalton Trans.* **1999**, 1271–1276.
167. Schatz, M.; Becker, M.; Thaler, F.; Hampel, F.; Schindler, S.; Jacobson, R. R.; Tyeklár, Z.; Murthy, N. N.; Ghosh, P.; Chen, Q.; Zubieta, J.; Karlin, D. *Inorg. Chem.* **2001**, *40*, 2312–2322.
168. Wietzke, R.; Mazzanti, M.; Latour, J.-M.; Pécaut, J.; Cordier, P.-Y.; Madić, C. *Inorg. Chem.* **1998**, *37*, 6690–6697.
169. Ziessel, R.; Lehn, J.-M. *Helv. Chim. Acta* **1990**, *73*, 1149–1162.
170. Canary, J. W.; Allen, C. S.; Castagnetto, J. M.; Wang, Y. *J. Am. Chem. Soc.* **1995**, *117*, 8484–8485.
171. Canary, J. W.; Allen, C. S.; Castagnetto, J. M.; Chiu, Y.-H.; Toscano, P. J.; Wang, Y. *Inorg. Chem.* **1998**, *37*, 6255–6262.
172. Hammes, B. S.; Ramos-Maldonado, D.; Yap, G. P. A.; Rheingold, A. L.; Young, V. G. Jr.; Borovik, A. S. *Coord. Chem. Rev.* **1998**, *174*, 241–253.
173. Marabella, C. P.; Enemark, J. H.; Miller, K. F.; Bruce, A. E.; Pariyadath, N.; Corbin, J. L.; Stiefel, E. I. *Inorg. Chem.* **1983**, *22*, 3456–3461.
174. Berreau, L. M.; Allred, R. A.; Makowska-Grzyska, M. M.; Arif, A. M. *Chem. Commun.* **2000**, 1423–1424.
175. Driessen, W. L. *Recl. Trav. Chim. Pays-Bas* **1982**, *101*, 441–443.
176. Blattacharyya, S.; Kumar, S. B.; Dutta, S. K.; Tiekink, E. R. T.; Chaudhury, M. *Inorg. Chem.* **1996**, *35*, 1967–1973.
177. Blattacharyya, S.; Weakley, T. J. R.; Chaudhury, M. I. *Inorg. Chem.* **1999**, *38*, 633–638.
178. Di Vaira, M.; Mani, F. *Inorg. Chim. Acta* **1983**, *70*, 99–105.
179. Sorrell, T. N.; Jameson, D. L. *Inorg. Chem.* **1984**, *21*, 1014–1019.
180. Thompson, L. K.; Ramaswamy, B. S.; Seymour, E. A. *Can. J. Chem.* **1977**, *55*, 878–888.
181. Oki, A. R.; Bommarreddy, P. K.; Zhang, H. M.; Hosmane, N. *Inorg. Chim. Acta* **1995**, *231*, 109–114.
182. Su, C.-Y.; Kang, B.-S.; Yang, Q.-C.; Mak, T. C. W. *J. Chem. Soc., Dalton Trans.* **2000**, 1857–1862.
183. Su, C.-Y.; Kang, B.-S.; Du, C.-X.; Yang, Q.-C.; Mak, T. C. W. *Inorg. Chem.* **2000**, *39*, 4843–4849.
184. Frye, C. L.; Vincent, G. A.; Hauschildt, G. L. *J. Am. Chem. Soc.* **1966**, *88*, 2727–2730.
185. Hwang, J.; Govindaswamy, K.; Koch, S. A. *Chem. Commun.* **1998**, 1667–1668.
186. Chandrasekaran, A.; Day, R. O.; Holmes, R. R. *J. Am. Chem. Soc.* **2000**, *122*, 1066–1072.
187. Michalczyk, L.; de Gala, S.; Bruno, J. W. *Organometallics* **2001**, *20*, 5547–5556.
188. Govindaswamy, N.; Quarless, D. A., Jr.; Koch, S. A. *J. Am. Chem. Soc.* **1995**, *117*, 8468–8469.
189. Trösch, A.; Vahrenkamp, H. *Inorg. Chem.* **2001**, *40*, 2305–2311.
190. Liu, S.; Gelmini, L.; Rettig, S. J.; Thompson, R. C.; Orvig, C. *J. Am. Chem. Soc.* **1992**, *114*, 6081–6087.
191. Liu, S.; Rettig, S. J.; Orvig, C. *Inorg. Chem.* **1992**, *31*, 5400–5407.
192. Xu, Z.; Read, P. W.; Hibbs, D. E.; Hursthouse, M. B.; Malik, K. M. A.; Patrick, B. O.; Rettig, S. J.; Seid, M.; Summers, D. A.; Pink, M.; Thompson, R. C.; Orvig, C. *Inorg. Chem.* **2000**, *39*, 508–516.
193. Wainwright, K. P. *Coord. Chem. Rev.* **1997**, *166*, 35–90.
194. Renaud, F.; Pigué, C.; Bernardinelli, G.; Bünzli, J.-C. G.; Hopfgartner, G. *J. Am. Chem. Soc.* **1999**, *121*, 9326–9342.
195. Bretonnière, Y.; Wietzke, R.; Lebrun, C.; Mazzanti, M.; Pécaut, J. *Inorg. Chem.* **2000**, *39*, 3499–3505.
196. Hammes, B. S.; Young, V. G., Jr.; Borovik, A. S. *Angew. Chem. Int. Ed. Engl.* **1999**, *38*, 666–669.
197. MacBeth, C. E.; Hammes, B. S.; Young, V. G. Jr.; Borovik, A. S. *Inorg. Chem.* **2001**, *40*, 4733–4741.
198. Xu, J.; Franklin, S. J.; Whisenhunt, D. W. Jr.; Raymond, K. N. *J. Am. Chem. Soc.* **1995**, *117*, 7245–7246.
199. Cohen, S. M.; O'Sullivan, B.; Raymond, K. N. *Inorg. Chem.* **2000**, *39*, 4339–4346.
200. Aime, S.; Botta, M.; Fasano, M.; Terreno, E. *Acc. Chem. Res.* **1999**, *32*, 941–949.
201. Cohen, S. M.; Xu, J.; Radkov, E.; Raymond, K. N.; Botta, M.; Barge, A.; Aime, S. *Inorg. Chem.* **2000**, *39*, 5747–5756.
202. Sunderland, C. J.; Botta, M.; Aime, S.; Raymond, K. N. *Inorg. Chem.* **2001**, *40*, 6746–6756.
203. Deroche, A.; Morgenstern-Badarau, I.; Cesario, M.; Guilhem, J.; Keita, B.; Nadjo, L.; Houée-Levin, C. *J. Am. Chem. Soc.* **1996**, *118*, 4567–4573.
204. Katsuki, I.; Matsumoto, N.; Kojima, M. *Inorg. Chem.* **2000**, *39*, 3350–3354.
205. Kang, Y.; Lee, S. S.; Park, K.-M.; Lee, S. H.; Kang, S. O.; Ko, J. *Inorg. Chem.* **2001**, *40*, 7027–7031.
206. Govindaswamy, N.; Quarless, D. A.; Koch, S. A. *J. Am. Chem. Soc.* **1995**, *117*, 8468–8469.
207. Hwang, J. W.; Govindaswamy, N.; Koch, S. A. *J. Chem. Soc., Chem. Commun.* **1998**, *16*, 1667–1668.
208. Motekaitis, R. J.; Martell, A. E.; Koch, S. A.; Hwang, J. W.; Quarless, D. A.; Welch, M. J. *Inorg. Chem.* **1998**, *37*, 5902–5911.
209. Ray, M.; Yap, G. P. A.; Rheingold, A.; Borovik, A. S. *J. Chem. Soc., Chem. Commun.* **1995**, 1777–1778.
210. Ray, M.; Golombek, A.; Hendrich, M.; Young, V. G.; Borovik, A. S. *J. Am. Chem. Soc.* **1996**, *118*, 6084.
211. White, D. L.; Faller, J. W. *Inorg. Chem.* **1982**, *21*, 3119–3122.
212. Sakaguchi, U.; Tomioka, K.; Kashihara, T.; Yoneda, H. *Inorg. Chem.* **1985**, *24*, 463–467.
213. Geue, R. J.; Searle, G. H. *Aust. J. Chem.* **1983**, *31*, 927–935.

214. Liu, S.; Wong, E.; Karunaratne, V.; Rettig, S. J.; Orvig, C. *Inorg. Chem.* **1993**, *32*, 1756–1765.
215. Canty, A. J.; Patrick, J. M.; White, A. H. *Inorg. Chem.* **1984**, *23*, 3827–3830.
216. Jonas, R. T.; Stack, T. D. P. *Inorg. Chem.* **1998**, *37*, 6615–6629.
217. Zhang, J.; Tang, Y.; Tang, N.; Tan, M.-Y.; Liu, W.-S.; Yu, K.-B. *J. Chem. Soc., Dalton Trans.* **2002**, 832–833.
218. Pedersen, C. J. *J. Am. Chem. Soc.* **1967**, *89*, 7017–7036.
219. Pedersen, C. J. *Angew. Chem. Int. Ed. Engl.* **1988**, *27*, 1021–1027.
220. Cram, D. J. *Angew. Chem. Int. Ed. Engl.* **1988**, *27*, 1009–1020.
221. Lehn, J.-M. *Angew. Chem. Int. Ed. Engl.* **1988**, *27*, 89–112.
222. Mertes, K. B.; Lehn, J.-M. In *Comprehensive Coordination Chemistry*; Wilkinson, G., Gillard, R. D., McCleverty, J. A., Eds.; Pergamon: Oxford, UK, 1987; pp 915–957.
223. Christensen, J. J.; Eatough, D. J.; Izatt, R. M. *Chem. Rev.* **1974**, *74*, 351–384.
224. Izatt, R. M.; Bradshaw, J. S.; Nielsen, S. A.; Lamb, J. D.; Christensen, J. J.; Sen, D. *Chem. Rev.* **1985**, *85*, 271–339.
225. Izatt, R. M.; Pawlak, K.; Bradshaw, J. S.; Bruening, R. L. *Chem. Rev.* **1991**, *91*, 1721–2085.
226. Izatt, R. M.; Bradshaw, J. S.; Pawlak, K.; Bruening, R. L.; Tarbet, B. J. *Chem. Rev.* **1992**, *92*, 1261–1354.
227. Izatt, R. M.; Pawlak, K.; Bradshaw, J. S.; Bruening, R. L. *Chem. Rev.* **1995**, *95*, 2529–2586.
228. Connolly, S. C.; Rao, S. N.; Rizza, R.; Zaccheroni, N.; Fitzmaurice, D. *Coord. Chem. Rev.* **1999**, *185–186*, 277–295.
229. Hancock, R. D. *J. Chem. Ed.* **1992**, *69*, 615–621.
230. Steed, J. W. *Coord. Chem. Rev.* **2001**, *215*, 171–221.
231. Mori, A.; Kubo, K.; Takeshita, H. *Coord. Chem. Rev.* **1996**, *148*, 71–96.
232. Yordanov, A. T.; Roundhill, D. M. *Coord. Chem. Rev.* **1998**, *170*, 93–124.
233. See for example: Danks, J. P.; Champness, N. R.; Schroder, M. *Coord. Chem. Rev.* **1998**, *174*, 417–468.
234. Naemura, K.; Tobe, Y.; Kaneda, T. *Coord. Chem. Rev.* **1996**, *148*, 199–219.
235. Zhang, X. X.; Bradshaw, J. S.; Izatt, R. M. *Chem. Rev.* **1997**, *97*, 3313–3361.
236. Bodwin, J. J.; Cutland, A. D.; Malsani, R. G.; Pecoraio, V. L. *Coord. Chem. Rev.* **2001**, *216–217*, 489–512.
237. Gokel, G. W. *Chem. Soc. Rev.* **1992**, *21*, 39–47.
238. Bradshaw, J. S.; Izatt, R. M. *Acc. Chem. Res.* **1997**, *30*, 338–345.
239. Tsukube, H. *Coord. Chem. Rev.* **1996**, *148*, 1–17.
240. Hancock, R. D.; Maumela, H.; De Sousa, A. S. *Coord. Chem. Rev.* **1996**, *148*, 315–347.
241. Gokel, G. W.; Barbour, L. J.; De Wall, S. L.; Meadows, E. S. *Coord. Chem. Rev.* **2001**, *222*, 127–154.
242. Lindoy, L. F. *Coord. Chem. Rev.* **1998**, *174*, 327–342.
243. Sugihara, H.; Hiratani, K. *Coord. Chem. Rev.* **1996**, *148*, 285–299.
244. Keefe, M. H.; Benkstein, K. D.; Hupp, J. T. *Coord. Chem. Rev.* **2000**, *205*, 201–228.
245. Zhang, X. X.; Izatt, R. M.; Bradshaw, J. S.; Krakowian, K. E. *Coord. Chem. Rev.* **1998**, *174*, 179–189.
246. Graf, E.; Hosseini, M. W. *Coord. Chem. Rev.* **1998**, *178–180*, 1193–1209.
247. Cram, D. J.; Cram, J. M. In *Selectivity: A Goal for Synthetic Efficiency*; Barman, W., Trost, B. M., Eds.; Verlag Chemie: Weinheim, Germany, 1984; pp 43–64.
248. Ishikawa, N.; Kaizu, Y. *Coord. Chem. Rev.* **2002**, *226*, 93–101.
249. For recent developments see for example: Kimura, K. *Coord. Chem. Rev.* **1996**, *148*, 41–61.
250. Desvergne, J.-P.; Bouas-Laurent, H.; Perez-Inestrosa, E.; Marsau, P.; Cotrait, M. *Coord. Chem. Rev.* **1999**, *185–186*, 357–371.
251. Habata, Y.; Akabori, S. *Coord. Chem. Rev.* **1996**, *148*, 97–113.
252. Beer, P. D.; Gale, P. A.; Chen, G. Z. *Coord. Chem. Rev.* **1999**, *185–186*, 3–36.
253. Fabre, B.; Simonet, J. *Coord. Chem. Rev.* **1998**, *178–180*, 1211–1250.
254. See also: Valeur, B. and Leray I. *Coord. Chem. Rev.* **2000**, *205*, 3–40.
255. Harris, W. R.; Carrano, C. J.; Raymond, K. N. *J. Am. Chem. Soc.* **1979**, *101*, 2213–2214.
256. Harris, W. R.; Carrano, C. J.; Raymond, K. N. *J. Am. Chem. Soc.* **1979**, *101*, 6097–6104.
257. Fischer, M.; Vögtle, F. *Angew. Chem. Int. Ed. Engl.* **1999**, *38*, 884–905.
258. Astruc, D.; Chardac, F. *Chem. Rev.* **2001**, *101*, 2991–3023.
259. Gorman, C. B.; Smith, J. C.; Hager, M. W.; Parkhurst, B. L.; Sierzputowska-Gracz, H.; Haney, C. A. *J. Am. Chem. Soc.* **1999**, *121*, 9958–9966.
260. Tomalia, D. A.; Naylor, A. M.; Goddard, W. A. *Angew. Chem. Int. Ed. Engl.* **1990**, *29*, 138–175.
261. Hawker, C. J.; Fréchet, J. M. J. *J. Am. Chem. Soc.* **1990**, *112*, 7638–7642.
262. Balzani, V.; Campagna, S.; Denti, G.; Juris, A.; Serroni, S.; Venturi, M. *Acc. Chem. Res.* **1998**, *31*, 26–34.
263. Huck, W. T. S.; van Veggel, F. C. J. M.; Kropman, B. L.; Blank, D. H. A.; Keim, E. G.; Smithers, M. M. A.; Reinhoudt, D. N. *J. Am. Chem. Soc.* **1995**, *117*, 8293–8294.
264. Bhyrappa, P.; Young, J. K.; Moore, J. S.; Suslick, K. S. *J. Am. Chem. Soc.* **1996**, *118*, 5708–5711.
265. Newkome, G. R.; Gross, J.; Moorefield, C. N.; Woosley, B. D. *J. Chem. Soc., Chem. Commun.* **1997**, 515–516.
266. Lange, P.; Schier, A.; Schmidbauer, H. *Inorg. Chem.* **1996**, *35*, 637–642.
267. Tominaga, M.; Hosogi, J.; Konishi, K.; Aida, T. *J. Chem. Soc., Chem. Commun.* **2000**, 719–720.
268. Bardaji, M.; Caminade, A.-M.; Majoral, J.-P.; Chaudret, B. *Organometallics* **1997**, *16*, 3489–3497.
269. Klein Gebbink, R. J. M.; Bosman, A. W.; Feiters, M. C.; Meijer, E. W.; Nolte, R. J. M. *Chem. Eur. J.* **1999**, *5*, 65–69.
270. Balogh, L.; Tomalia, D. A. *J. Am. Chem. Soc.* **1998**, *120*, 7355–7356.
271. Cotton, F. A.; Lin, C.; Murillo, C. A. *Acc. Chem. Res.* **2001**, *34*, 759–771 and refs. therein.
272. Eddaoudi, M.; Moler, D. B.; Li, H.; Chen, B.; Reineke, T. M.; O’Keeffe, M.; Yaghi, O. M. *Acc. Chem. Res.* **2001**, *34*, 319–330 and refs. therein.
273. See for example: Decurtins, S.; Gross, M.; Schmalke, H. W.; Ferlay, S. *Inorg. Chem.* **1998**, *37*, 2443–2449.
274. Reineke, T. M.; Eddaoudi, M.; O’Keeffe, M.; Yaghi, O. M. *Angew. Chem. Int. Ed. Engl.* **1999**, *38*, 2590–2594.
275. Barthelet, K.; Marrot, J.; Riou, D.; Ferey, G. *Angew. Chem. Int. Ed. Engl.* **2002**, *41*, 281–284.
276. Cui, Y.; Ngo, H. L.; and Lin, W. *Inorg. Chem.* **2002**, *41*, 1033–1035.
277. Rosi, N. L.; Eddaoudi, M.; Kim, J.; O’Keeffe, M.; Yaghi, O. M. *Angew. Chem. Int. Ed. Engl.* **2002**, *41*, 284–287.
278. Yaghi, O. M.; Li, H.; Groy, T. L. *J. Am. Chem. Soc.* **1996**, *118*, 9096–9101.
279. Yaghi, O. M.; Li, H.; Davis, C.; Richardson, D.; Groy, T. L. *Acc. Chem. Res.* **1998**, *31*, 474–484.
280. Choi, H. J.; Suh, M. P. *J. Am. Chem. Soc.* **1998**, *120*, 10622–10628.

281. Reineke, T. M.; Eddaoudi, M.; Fehr, M.; Kelley, D.; Yaghi, O. M. *J. Am. Chem. Soc.* **1999**, *121*, 1651–1657.
282. Reineke, T. M.; Eddaoudi, M.; Fehr, M.; Kelley, D.; Yaghi, O. M. *J. Am. Chem. Soc.* **1999**, *121*, 1651–1657.
283. Eddaoudi, M.; Li, H. Yaghi O. M. *J. Am. Chem. Soc.* **2000**, *122*, 1391–1397.
284. Plater, M. J.; Foreman, M. R. StJ.; Howie, A.; Skakle, J. M. S.; Coronado, E.; Gomez-Garcia, C. J.; Gelbrich, T.; Hursthouse, M. B. *Inorg. Chim. Acta* **2001**, *319*, 159–175.
285. Yaghi, O. M.; Davis, C. E.; Li, G.; Li, H. *J. Am. Chem. Soc.* **1997**, *119*, 2861–2868.
286. Caro de la Torre, M. A.; Gomez-Hens, A. *Anal. Chim. Acta* **2000**, *407*, 53–60.
287. Braga, D.; Benedi, O.; Maini, L.; Grepioni, F. *J. Chem. Soc., Dalton Trans.* **1999**, 2611–2617.
288. Chem, B.; Eddaoudi, M.; Reineke, T. M.; Kampf, J. W.; O’Keeffe, M.; Yaghi, O. M. *J. Am. Chem. Soc.* **2000**, *122*, 11559–11560.
289. Zafar, A.; Yang, J.; Gelb, S. J.; Hamilton, A. D. *Tetrahedron Lett.* **1996**, *37*, 2327–2330.
290. Arts, S. J. H. F.; Peters, J. A.; Sheldon, R. A. *Inorg. Chem.* **1998**, *37*, 2400–2404.
291. Chu, D.-Q.; Xu, J.-Q.; Duan, L.-M.; Wang, T.-G.; Tang, A.-Q.; Ye, L. *Eur. J. Inorg. Chem.* **2001**, 1135–1137.
292. Anderson, C. J.; Welch, M. J. *Chem. Rev.* **1999**, *99*, 2219–2234.
293. Volkert, W. A.; Hoffman, T. J. *Chem. Rev.* **1999**, *99*, 2269–2292.
294. Caravan, P.; Eleison, J. J.; McMurphy, T. J.; Lauffer, R. B. *Chem. Rev.* **1999**, *99*, 2293–2352.
295. Mederos, A.; Dominguez, S.; Hernandez-Molina, R.; Sanchiz, J.; Brito, F. *Coord. Chem. Rev.* **1999**, *193–195*, 857–911.
296. Schnepfenseper, T.; Finkler, S.; Czap, A.; van Eldik, R.; Heus, M.; Nieuwenhuizen, P.; Wreesmann, C.; Abma, W. *Eur. J. Inorg. Chem.* **2001**, 491–501.
297. Yam, V. W.-W.; Lo, K. K.-W. *Coord. Chem. Rev.* **1998**, *184*, 157–240.
298. Reichert, D. E.; Lewis, J. S.; Anderson, C. J. *Coord. Chem. Rev.* **1999**, *184*, 3–66.
299. Heeg, M. J.; Jurisson, S. S. *Acc. Chem. Res.* **1999**, *32*, 1053–1060.
300. Aime, S.; Botta, M.; Fasano, M.; Terreno, E. *Acc. Chem. Res.* **1999**, *32*, 941–949.
301. Bianchi, A.; Calabi, L.; Corana, F.; Fontana, S.; Losi, P.; Maiocchi, A.; Paleari, L.; Valtancoli, B. *Coord. Chem. Rev.* **2000**, *204*, 309–393.
302. Shi, Y.; Zhang, W.; Gan, L.; Huang, C.; Luo, H.; L, N. *Thin Solid Films* **1999**, *352*, 218–222.
303. Tavakkoli, N.; Shamsipur, M. *Talanta* **1998**, *45*, 1219–1225.
304. Machida, Y.; Nishi, H.; Nakamura, K. *J. Chromatograph.* **1998**, *810*, 33–41.
305. Ohto, K.; Ishibashi, H.; Inoue, K. *Chem. Lett.* **1998**, 631–632.
306. Di Costanzo, L.; Geremia, S.; Randaccio, L.; Purrello, R.; Laceri, R.; Sciotto, D.; Gulino, F. G.; Pavone, V. *Angew. Chem. Int. Ed. Engl.* **2001**, *40*, 4245–4247.
307. Akdas, H.; Graf, E.; Hosseini, M. W.; De Cian, A.; Harrowfield, J. McB. *J. Chem. Soc., Chem. Commun.* **2000**, 2219–2220.
308. Seitz, J.; Maas, G. *J. Chem. Soc., Chem. Commun.* **2002**, 338–339.
309. Miyake, Y.; Hosoda, A.; Takagaki, M.; Nomura, E.; Tanicuchi, H. *J. Chem. Soc., Chem. Commun.* **2002**, 132–133.

# 1.12

## Phosphorus Ligands

J. H. DOWNING and M. B. SMITH  
*Loughborough University, UK*

---

1.12.1	INTRODUCTION	254
1.12.2	SYNTHESIS OF PHOSPHORUS-BASED COMPOUNDS	254
1.12.2.1	Halophosphines	254
1.12.2.1.1	<i>Synthetic routes</i>	254
1.12.2.1.2	<i>Physical properties</i>	256
1.12.2.1.3	<i>Reactions of halophosphines</i>	256
1.12.2.2	Primary Phosphines	256
1.12.2.2.1	<i>By reduction</i>	256
1.12.2.2.2	<i>Using metal phosphides</i>	258
1.12.2.2.3	<i>Miscellaneous methods</i>	258
1.12.2.2.4	<i>Physical properties</i>	259
1.12.2.2.5	<i>Reactions of primary phosphines</i>	259
1.12.2.2.6	<i>Coordination chemistry of primary phosphines</i>	259
1.12.2.3	Secondary Phosphines	259
1.12.2.3.1	<i>By reduction</i>	260
1.12.2.3.2	<i>Using metal phosphides</i>	260
1.12.2.3.3	<i>By P–H addition reaction</i>	261
1.12.2.3.4	<i>Miscellaneous methods</i>	261
1.12.2.3.5	<i>Physical properties</i>	261
1.12.2.3.6	<i>Reactions of secondary phosphines</i>	261
1.12.2.3.7	<i>Coordination chemistry of secondary phosphines</i>	262
1.12.2.3.8	<i>Catalytic applications of metal complexes with secondary phosphines</i>	262
1.12.2.4	Tertiary Phosphines	262
1.12.2.4.1	<i>Using Grignard reagents</i>	263
1.12.2.4.2	<i>Using organolithium reagents</i>	263
1.12.2.4.3	<i>Using other organometallics</i>	263
1.12.2.4.4	<i>Alkali–metal derivatives</i>	264
1.12.2.4.5	<i>Reduction methods</i>	265
1.12.2.4.6	<i>Hydrophosphinations</i>	265
1.12.2.4.7	<i>Metal-catalyzed phosphinations</i>	266
1.12.2.4.8	<i>Miscellaneous methods</i>	266
1.12.2.4.9	<i>Physical properties</i>	267
1.12.2.4.10	<i>Coordination chemistry of tertiary phosphines</i>	267
1.12.2.4.11	<i>Catalytic applications of metal complexes with tertiary phosphines</i>	267
1.12.2.5	Unsymmetrical Tertiary Phosphines	267
1.12.2.5.1	<i>Preparation by classic methods</i>	267
1.12.2.5.2	<i>Miscellaneous methods</i>	268
1.12.2.6	Functionalized Tertiary Phosphines	268
1.12.2.7	Ditertiary Phosphines	270
1.12.2.8	Polydentate Tertiary Phosphines	272
1.12.2.9	Water-soluble Tertiary Phosphines	274
1.12.2.9.1	<i>Synthetic routes to water-soluble tertiary phosphines</i>	274
1.12.2.9.2	<i>Coordination chemistry of water-soluble tertiary phosphines</i>	276
1.12.2.9.3	<i>Catalytic applications of metal complexes with water-soluble tertiary phosphines</i>	276
1.12.2.10	Fluorinated Tertiary Phosphines	276
1.12.2.10.1	<i>Synthetic routes to fluorinated tertiary phosphines</i>	276
1.12.2.10.2	<i>Coordination chemistry of fluorinated tertiary phosphines and catalytic applications</i>	277
1.12.2.11	Tertiary Phosphine Oxides	278
1.12.2.11.1	<i>Synthesis of tertiary phosphine oxides</i>	278

1.12.2.11.2	Properties of tertiary phosphine oxides	279
1.12.2.11.3	Coordination chemistry and catalytic uses	280
1.12.2.12	Chiral Phosphorus-based Ligands	280
1.12.2.12.1	Synthetic routes	280
1.12.2.12.2	Coordination chemistry and catalytic applications of metal complexes with chiral tertiary phosphines	282
1.12.2.13	Phosphinites, Phosphonites, and Phosphites	282
1.12.2.13.1	Synthesis of phosphinites, phosphonites, and phosphites	282
1.12.2.13.2	Coordination chemistry	285
1.12.2.13.3	Catalytic chemistry	286
1.12.2.14	(Phosphino)amines	286
1.12.2.14.1	By aminolysis reactions	286
1.12.2.14.2	From the lithium amide	288
1.12.2.14.3	From silylated compounds	288
1.12.2.14.4	By aminolysis with (dialkylamino)phosphines	288
1.12.2.14.5	Coordination chemistry of (phosphino)amines	288
1.12.2.14.6	Catalytic applications of metal complexes with (phosphino)amines	289
1.12.3	CONCLUSIONS AND OUTLOOK	289
1.12.4	REFERENCES	289

## 1.12.1 INTRODUCTION

The chemistry of phosphorus(III) compounds is centered on the lone pair and its availability for forming new bonds to phosphorus. Phosphorus(III) compounds have a major structural difference from their nitrogen relatives; in both families, the geometry is pyramidal, as would be expected, but whereas pyramidal inversion is rapid in amines at room temperature, it is slow in phosphines, so as to give them fixed pyramidal structures.

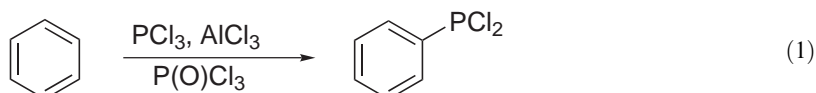
Methods for synthesizing phosphorus-based ligands have been reviewed extensively by McAuliffe,<sup>1</sup> Gilheany and Mitchell,<sup>2</sup> and more recently Quin.<sup>3</sup> With the large number of phosphorus compounds reported each year, the purpose of this chapter is to overview the subject area highlighting, where appropriate, synthetic routes of more recent examples. This work will focus primarily on synthetic methods for the preparation of primary, secondary, and tertiary phosphines (including functionalized and chiral analogues). In later sections common synthetic strategies for trivalent P–O- and P–N-based ligands will also be given. In some sections key references for coordination complexes of selected ligands are included, along with examples where they are utilized in homogeneous catalytic reactions. Where relevant, the reader is directed to previous reference material for more comprehensive discussions and detailed experimental procedures. Topics including electronic and steric properties (including cone angles) of phosphorus(III) ligands,<sup>4,5</sup> ligand bite angle effects,<sup>6</sup> bonding in metal phosphine complexes<sup>7–10</sup> and <sup>31</sup>P{<sup>1</sup>H} nmr spectroscopy<sup>3</sup> have all been discussed in detail elsewhere.

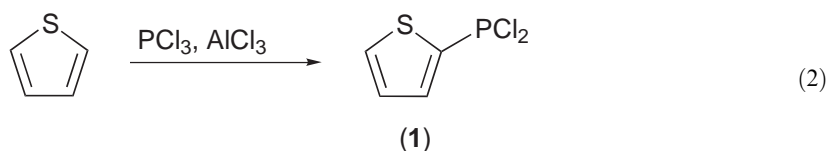
## 1.12.2 SYNTHESIS OF PHOSPHORUS-BASED COMPOUNDS

### 1.12.2.1 Halophosphines

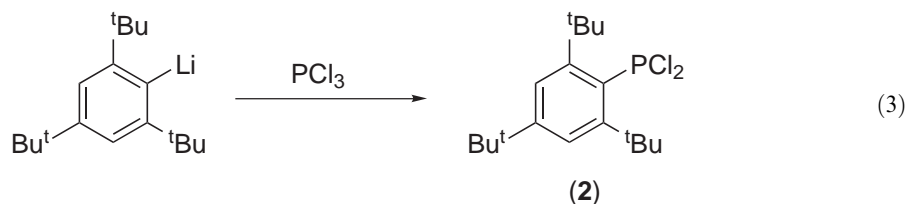
#### 1.12.2.1.1 Synthetic routes

Of the known halophosphines, most is documented about the chloroderivatives and hence preparations frequently use these as starting materials. Bromophosphines also have important properties, but are less frequently used. Phosphorus trichloride is cheap and commercially available and readily prepared from P<sub>4</sub> and Cl<sub>2</sub> using PCl<sub>3</sub> as solvent.<sup>11</sup> It is the starting material for many other organophosphorus compounds and can be used to make PhPCl<sub>2</sub> (Equation (1)) and Ph<sub>2</sub>PCl (by disproportionation of PhPCl<sub>2</sub> at 600 °C).<sup>11</sup> Both procedures are still used today for the manufacture of PhPCl<sub>2</sub> and Ph<sub>2</sub>PCl. The procedure in Equation (2) can also be used to prepare heterocyclic dichlorophosphines (e.g., (I)), whilst no catalyst is required in the case of furan and *N*-methylpyrrole counterparts.<sup>3</sup>



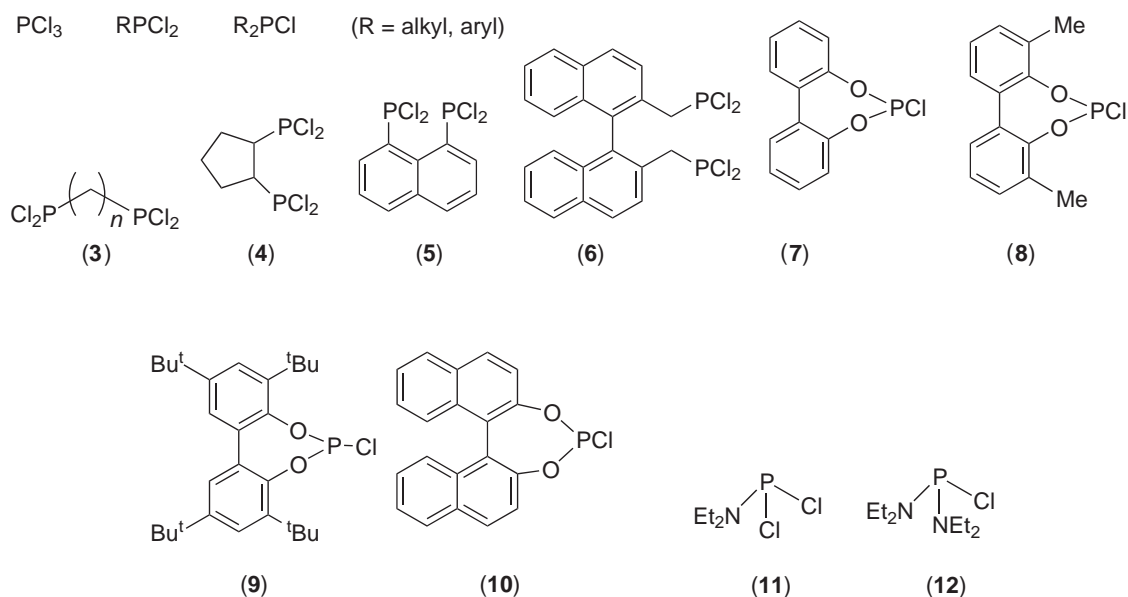


Many alkylphosphinous chlorides can be isolated under appropriate conditions by replacement of one or two Cls of  $\text{PCl}_3$  by reaction with an organometallic Grignard or alkyllithium reagent. This works effectively only if R is a highly branched alkyl group, e.g., Cy,  $^t\text{Pr}$ , or  $^t\text{Bu}$ , thereby retarding overalkylation. A good example is the synthesis of 2,4,6-tri-*t*-butylphenylphosphinous dichloride (2) (Equation (3)). Other reagents may also be used, including  $^n\text{Bu}_2\text{Cd}$ ,  $\text{Et}_4\text{Pb}$ , or  $\text{Bu}_3\text{SnCH}_2\text{CO}_2\text{R}$ .



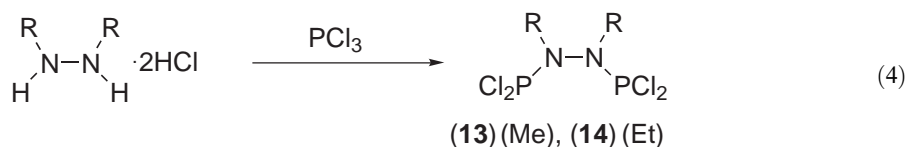
The bis-substituted alkyl backbone chlorophosphines  $\text{Cl}_2\text{P}(\text{CH}_2)_n\text{PCl}_2$  (3) and (4) (Scheme 1), along with the arene compounds (5) and (6), can be synthesized by various routes.<sup>12–17</sup> Hence (3) and (4) can be prepared<sup>12,14</sup> from the alkene,  $\text{P}_4$ , and  $\text{PCl}_3$  (other routes<sup>15,16</sup> are available for (4)); compound (5) ( $\delta(\text{P})$  136 ppm) by P–N bond cleavage of the corresponding diethylamino precursor.<sup>17</sup>

Halophosphines of formula  $\text{ClP}(\text{OR})_2$  ((7)–(10)) (Scheme 1) are easy to prepare from the appropriate alcohol,  $\text{PCl}_3$ , and base (usually  $\text{NEt}_3$ ).<sup>18,19</sup> Another important class of reactants is the dialkylaminochlorophosphines (11) and (12), readily obtained from the reaction of  $\text{R}_2\text{NH}$  (R = Me or Et) and  $\text{PCl}_3$ .<sup>20</sup> They are extremely useful synthetic reagents, since the P–N bonds are easily cleaved by gaseous HCl to give P–Cl bonds (as used in the preparation of (5)). Inorganic analogs of (3),  $\text{Cl}_2\text{P}\{\text{N}(\text{R})\}_2\text{PCl}_2$  (R = Me (13); Et (14)), containing a –N(R)N(R)– backbone, are readily prepared from  $\text{HN}(\text{R})\text{N}(\text{R})\text{H}\cdot 2\text{HCl}$  and  $\text{PCl}_3$  (Equation (4)).<sup>21,22</sup>



Scheme 1





### 1.12.2.1.2 Physical properties

Compounds containing a P—X bond should be regarded as hazardous to handle. Most of the simple chlorophosphines are distillable liquids, e.g., MePCl<sub>2</sub>, b.p. 81 °C; PhPCl<sub>2</sub>, b.p. 222 °C; Me<sub>2</sub>PCL, b.p. 72–75 °C; Ph<sub>2</sub>PCL, b.p. 320 °C. Some of the chlorophosphines (e.g., (2)) are solids at room temperature. The chlorophosphines are very sensitive to hydrolysis (liberating HCl), toxic, and easily oxidized (spontaneously flammable for the lower alkyl derivatives). Hence suitable precautions are necessary to protect them from the atmosphere.

### 1.12.2.1.3 Reactions of halophosphines

By far the most important type of reaction displayed by halophosphines is nucleophilic substitution. This is pivotal to the preparation of many other three-coordinate compounds containing either solely P—C, P—O, P—N bonds, or mixed combinations. These reactions are often exothermic and frequently carried out at low temperatures. For the synthesis of phosphorus(III) compounds containing a P—O or P—N bond it is often necessary to add a base (triethylamine or pyridine are frequently used) to capture the hydrogen halide eliminated from these condensation reactions. In the case of P—C bond formation, a variety of routes are possible using various carbon-derived nucleophiles.

## 1.12.2.2 Primary Phosphines

By far the most common methods known for the preparation of primary phosphines are shown in Figure 1. These will be discussed in turn, with appropriate examples given.

### 1.12.2.2.1 By reduction

Primary phosphines are most conveniently prepared by reduction of the appropriate halophosphine (RPX<sub>2</sub>, RP(S)X<sub>2</sub>, or RP(O)X<sub>2</sub>; X = Cl, typically) with a suitable, anhydrous reducing agent. Of the many reagents used, the most frequently encountered is LiAlH<sub>4</sub>, with reactions preferably carried out at low temperatures. Alternatively the silanes PhSiH<sub>3</sub>, Ph<sub>2</sub>SiH<sub>2</sub>, and HSiCl<sub>3</sub> have been used. Dry and oxygen-free solvents (diethyl ether, tetrahydrofuran, or dioxane) are used to perform these reduction steps. For example, LiAlH<sub>4</sub> reduction of dimethylmethylphosphonate in dioxane yields MePH<sub>2</sub>, a spontaneously inflammable gas.<sup>1</sup> Phenylphosphine is a liquid and is obtained by LiAlH<sub>4</sub> reduction of dichlorophenylphosphine (in 90% yield). The preparation of primary vinylphosphines on the gram scale has been achieved by the chemoselective

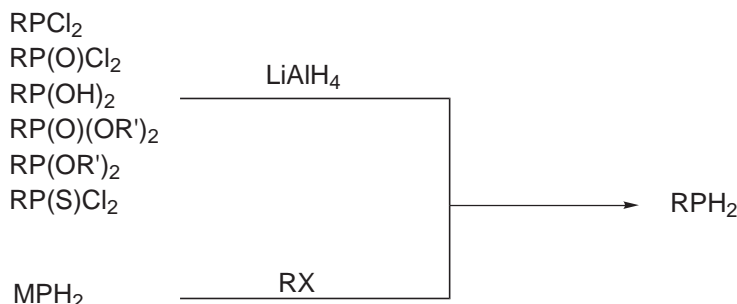
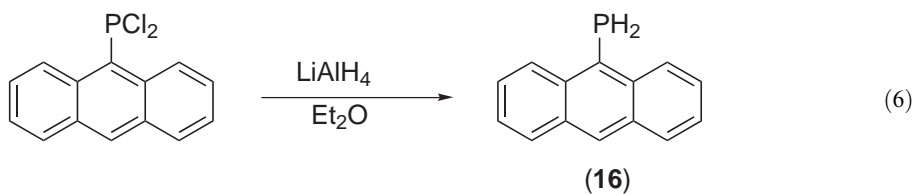
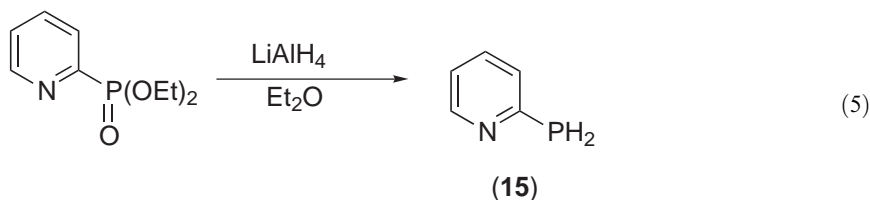


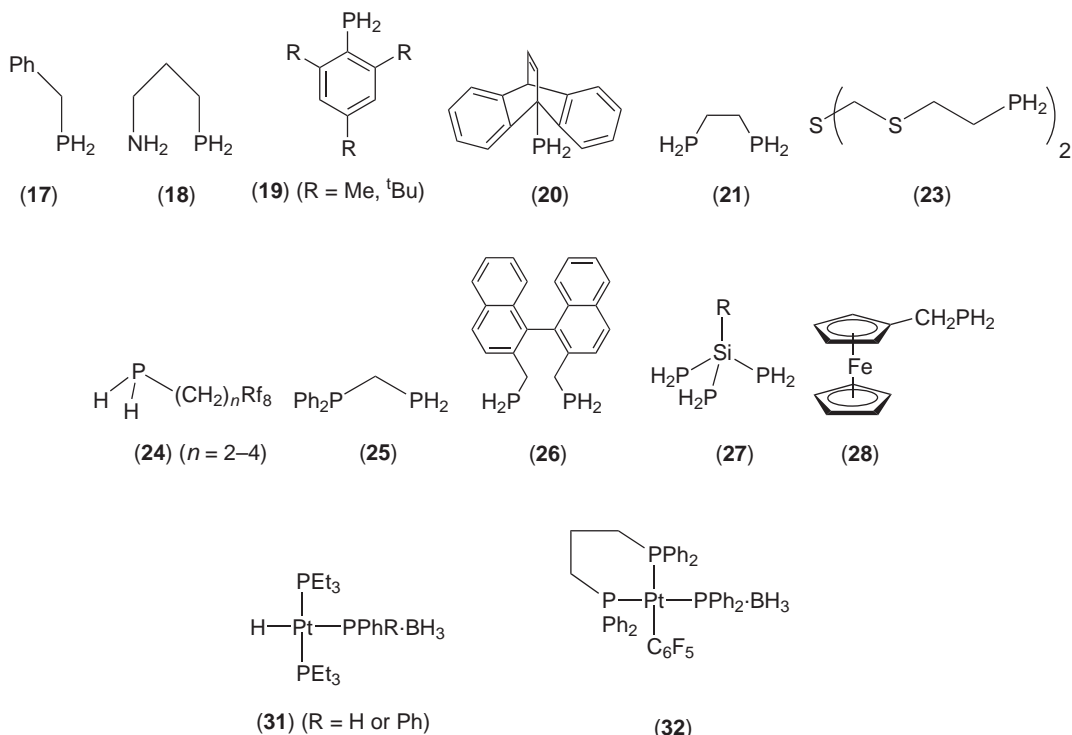
Figure 1 Common synthetic routes to primary phosphines.

reduction of the corresponding vinylphosphonates using dichloroalane in excess.<sup>23</sup> The pyridylphosphine (**15**) ( $\delta(\text{P}) -121$  ppm) can also be prepared by reduction of the corresponding phosphonate using  $\text{LiAlH}_4$  (Equation (5)).<sup>24</sup> Reduction of the dichloroanthrylphosphine at  $-77^\circ\text{C}$  with  $\text{LiAlH}_4$  in ether gave the anthrylphosphine (**16**) as an air sensitive, light yellow solid in 83% yield (Equation (6)).<sup>25</sup> Other examples include the synthesis of  $\text{PhCH}_2\text{PH}_2$  (**17**) (from  $\text{PhCH}_2\text{P}(\text{O})(\text{OEt})_2/\text{LiAlH}_4$  and ultrasonic activation), and  $\text{H}_2\text{N}(\text{CH}_2)_3\text{PH}_2$  (**18**) (from  $\text{N}_3(\text{CH}_2)_3\text{P}(\text{O})(\text{OEt})_2/\text{LiAlH}_4$ ) in 65% yield (Scheme 2).<sup>26</sup> The colorless liquid phosphine (**18**) is nonpyrophoric and moderately stable in air. Various modified primary phosphines can be prepared utilizing this reactive amino group.<sup>26</sup>



Primary phosphines are invariably air-sensitive in both the solid state and solution; however, the use of bulky R groups can improve stability towards aerial oxidation. One of the earliest air-stable phosphines reported was 2,4,6-tri-*t*-butylphenylphosphine (**19**), which is significantly more air

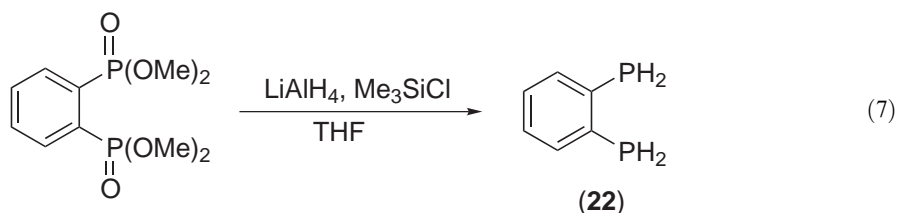
$\text{RPH}_2$  R = alkyl, aryl



Scheme 2

stable than  $\text{PhPH}_2$ .<sup>27</sup> Recent examples where the primary phosphine is relatively air stable include the synthesis of dibenzobarellene phosphine (**20**) (by reaction of the lithiated salt in THF with  $\text{PCl}_3$ , followed by  $\text{LiAlH}_4$  reduction in THF) in 42% yield, and the ferrocenyl phosphine (**28**).<sup>28–30</sup>

Primary phosphines bearing two  $-\text{PH}_2$  functionalities are known, e.g., (**21**), (**22**), and serve as useful starting materials for the preparation of important chiral P-containing ligands such as the  $C_2$ -symmetric 2,5-dialkylsubstituted phospholanes (see Section 1.12.2.12.1).<sup>31</sup> The diprimary phosphine *o*- $\text{C}_6\text{H}_4(\text{PH}_2)_2$  (**22**) is conveniently prepared by the reduction of the precursor bis-phosphonate (Equation (7)).<sup>32</sup> Air-stable, functionalized diprimary phosphines such as  $\text{S}(\text{CH}_2\text{SCH}_2\text{CH}_2\text{PH}_2)_2$  (**23**) have been described.<sup>33</sup>



#### 1.12.2.2.2 Using metal phosphides

Primary fluororous phosphines  $\text{PH}_2(\text{CH}_2)_n\text{Rf}_8$  ( $n=2-4$ ) (**24**) (Scheme 2) were prepared from fluororous primary alkyl iodides and  $\text{LiPH}_2 \cdot \text{dme}$  ( $\text{dme} = \text{dimethoxyethane}$ ), generated from  $\text{PH}_3$  and  ${}^n\text{BuLi}$ , in THF at  $-45^\circ\text{C}$ .<sup>34</sup> The primary phosphines were isolated either as clear liquids or as a low-melting white solid.<sup>34</sup> Subsequent free-radical addition reactions of olefinic fluororous precursors with these primary phosphines afforded unsymmetrical ligands.

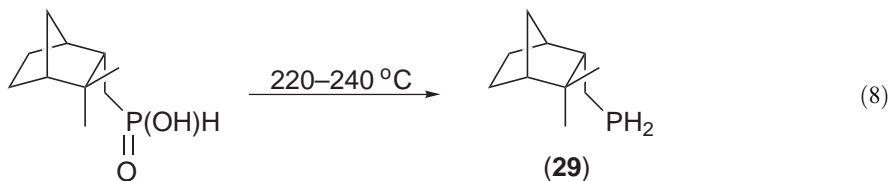
Unsymmetrical ligands, e.g.,  $\text{Ph}_2\text{PCH}_2\text{PH}_2$  (**25**), can be prepared from chloromethyl-diphenylphosphine, phosphine, and potassium hydroxide in a two-phase system (toluene/water) using  ${}^n\text{Bu}_4\text{NCl}$  as a phase-transfer catalyst.<sup>35</sup> This general procedure can be extended to the synthesis of the primary phosphine (**26**) by selective alkylation of phosphine with alkyl halides in the presence of concentrated aqueous potassium hydroxide in DMSO, or in a two-phase system involving a phase-transfer catalyst.<sup>36</sup>

The use of the phosphinoaluminate reagent  $\text{Li}[\text{Al}(\text{PH}_2)_4]$  has found application in the synthesis of a family of organotris(phosphino)silanes (**27**).<sup>37</sup>

#### 1.12.2.2.3 Miscellaneous methods

The air-stable primary phosphine, ferrocenylmethylphosphine, (**28**) (Scheme 2) ( $\delta(\text{P}) -129$  ppm) is a crystalline, sublimable solid, obtained in 52% yield by elimination of formaldehyde from  $[(\text{C}_5\text{H}_5)\text{Fe}\{\text{C}_5\text{H}_4\text{CH}_2\text{P}(\text{CH}_2\text{OH})_2\}]$  with one mole equivalent of  $\text{Na}_2\text{S}_2\text{O}_5$ .<sup>29,30</sup>

An alternative route for the synthesis of primary phosphines involves the disproportionation of phosphinic acids,  $\text{RP}(\text{O})(\text{OH})\text{H}$ , at elevated temperatures. This procedure has been used in the synthesis of endo-8-camphanylphosphine (**29**) from inexpensive camphene by pyrolysis at  $220-240^\circ\text{C}$  (Equation (8)).<sup>38</sup> The phosphine is a colorless, low-melting-point solid that partly crystallizes on standing or, in other preparations, is obtained as an air-sensitive, odorous liquid.



Other routes include using readily prepared (hydrolysis of aluminum phosphide) or commercially available  $\text{PH}_3$  and the appropriate alkene, under either free-radical or metal-catalyzed hydrophosphination conditions (see Section 1.12.2.4.6).<sup>39,40</sup> However, separation problems are often encountered, and hence this reaction has so far received limited attention as a convenient route to primary phosphines compared with other, more traditional methods.

#### 1.12.2.2.4 Physical properties

Primary phosphines are generally air-sensitive liquids with foul odors. They will oxidize very easily in the presence of oxygen, and a number of primary phosphines are pyrophoric. The use of bulky R groups can effectively improve resistance towards oxidation and these compounds can be isolated as solids.<sup>27–30</sup>

#### 1.12.2.2.5 Reactions of primary phosphines

Primary phosphines can add to carbon–carbon (or other unsaturated double bonds) under a variety of conditions to give new phosphorus(III) compounds.<sup>41</sup> Furthermore, another reaction of primary (and secondary) phosphines is their ready conversion into air-stable, crystalline hydroxymethylphosphonium salts by reaction with an excess of formaldehyde and hydrochloric acid.<sup>42</sup> These can subsequently be used in the synthesis of new (hydroxymethyl)phosphines. Alternatively, formylation of primary phosphines with formaldehyde affords functionalized tertiary phosphines, which often display excellent water solubility (e.g.,  $\text{H}_2\text{P}(\text{CH}_2)_2\text{PH}_2$  (**21**) gives  $(\text{HOCH}_2)_2\text{P}(\text{CH}_2)_2\text{P}(\text{CH}_2\text{OH})_2$  (**30**)).<sup>33</sup>

Metalation of primary phosphines can readily be accomplished, thereby generating reactive intermediates for the synthesis of new trivalent phosphorus compounds (see Section 1.12.2.3.2).

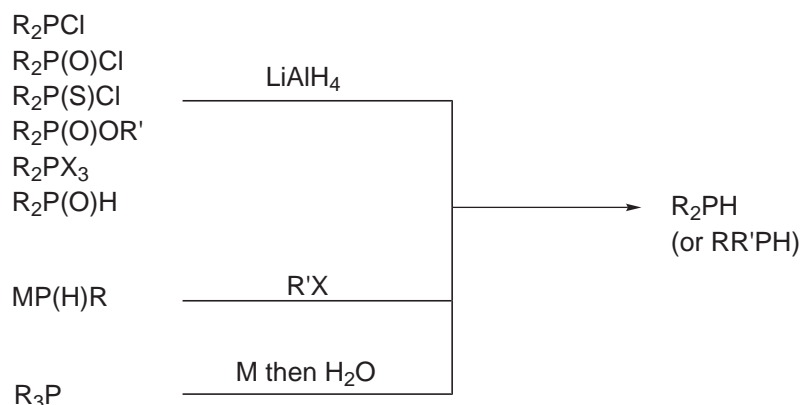
#### 1.12.2.2.6 Coordination chemistry of primary phosphines

A few selected examples highlight the coordination chemistry and reactivity of primary phosphines. Compared with that of tertiary phosphines, the metal chemistry of primary phosphines continues to develop more slowly. They do, however, receive continuing interest as precursors for the preparation of multidentate ligands. One common feature in their chemistry is the ease of oxidative addition, giving rise to bridging or terminal phosphido ligands.<sup>10</sup> However, a few instances are known in which metal-mediated cleavage is not observed.<sup>10</sup> Reaction of the phosphine–borane adduct  $\text{PhP}(\text{R})\text{H}\cdot\text{BH}_3$  ( $\text{R} = \text{H}, \text{Ph}$ ) with the zerovalent complex  $[\text{Pt}(\text{PEt}_3)_3]$  gave *trans*- $[\text{Pt}(\text{H})(\text{PPhR}\cdot\text{BH}_3)(\text{PEt}_3)_2]$  (**31**) (Scheme 2).<sup>43</sup> A similar observation was noted for compound (**32**), which is presumed to be an intermediate in the catalytic cycle for the phosphorylation of aryl iodides with  $\text{Ph}_2\text{PH}\cdot\text{BH}_3$ .<sup>44</sup>

A range of metal complexes (Mo, Ru, Ni, Pd, Cu, Ag, and Au) of mesitylphosphine (**19**) and the ferrocenyl primary phosphine (**28**) have been reported.<sup>29,30,45,46</sup> Pope and Reid described a range of manganese(I) complexes of  $\text{PhPH}_2$  and *o*- $\text{C}_6\text{H}_4(\text{PH}_2)_2$  (**22**).<sup>47</sup>

#### 1.12.2.3 Secondary Phosphines

By far the most common methods known for the preparation of secondary phosphines are shown in Figure 2. These will be discussed in turn, with appropriate examples given.



**Figure 2** Common synthetic routes to secondary phosphines.

### 1.12.2.3.1 By reduction

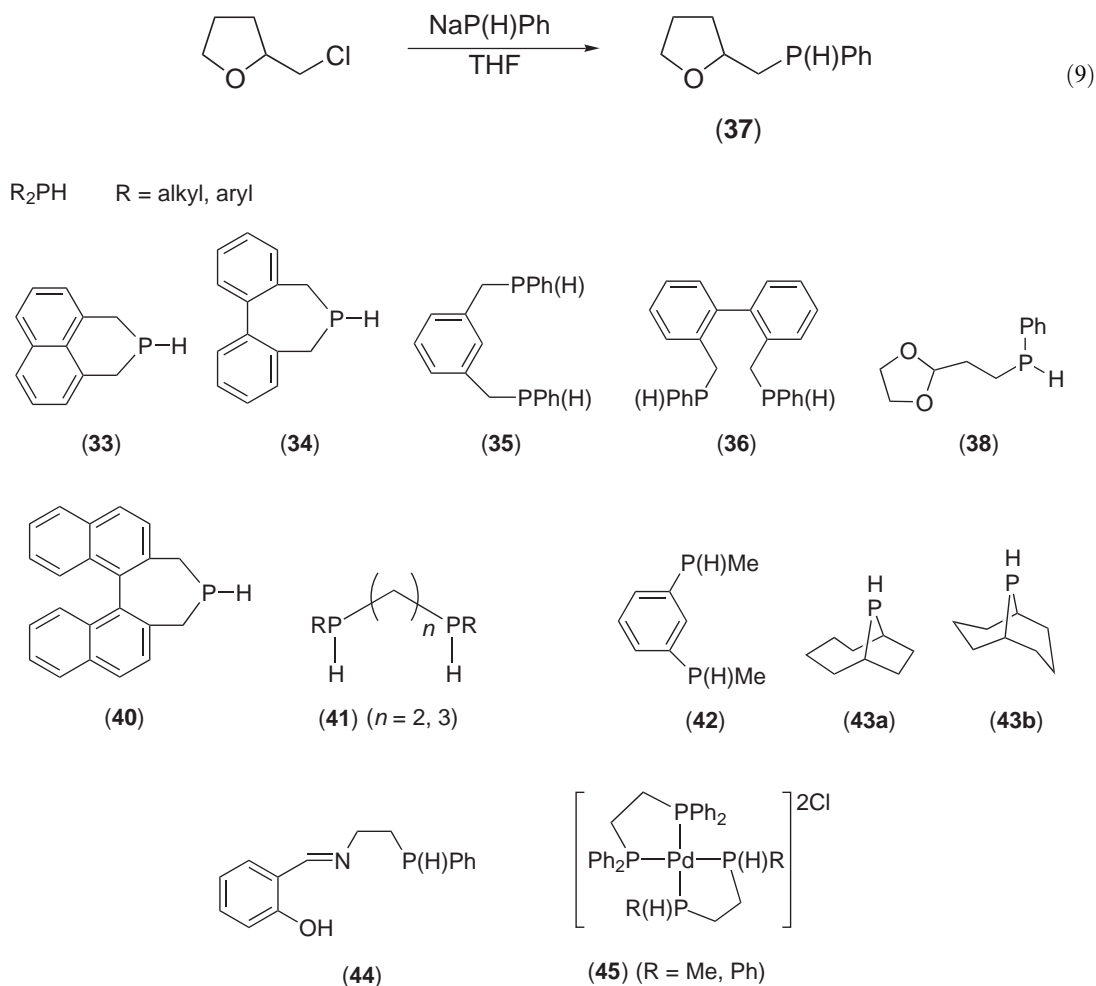
Secondary phosphines,  $R_2PH$ , are readily obtained by  $LiAlH_4$  reductions of  $R_2PX$ ,  $R_2P(S)X$ , or  $R_2P(O)X$ . Reductions are usually carried out using excess  $LiAlH_4$  to avoid byproducts. Often the reaction is refluxed and followed with an aqueous work-up. The inflammable liquid  $Me_2PH$  is best prepared from  $LiAlH_4$  and  $Me_2P(S)P(S)Me_2$  through a sequence of desulfurization, hydrolytic cleavage, and disproportionation steps.<sup>48</sup>

Secondary phosphines can also be cleanly synthesized by reduction of phosphinic acids with silanes (e.g.,  $PhSiH_3$  or  $Ph_2SiH_2$ ) as illustrated by the preparation of (33)–(36) (Scheme 3).<sup>49</sup> As expected, these phosphines are sensitive to oxidation. In most cases, it is preferable to complex them into more stable borane adducts, e.g., by reacting with  $BH_3 \cdot THF$  overnight at room temperature.<sup>49</sup> The reactive P–H group in these adducts can be used to make various ditertiary phosphines (including chiral variants), either as the free ligand or again as the borane-protected adducts.<sup>49</sup>

### 1.12.2.3.2 Using metal phosphides

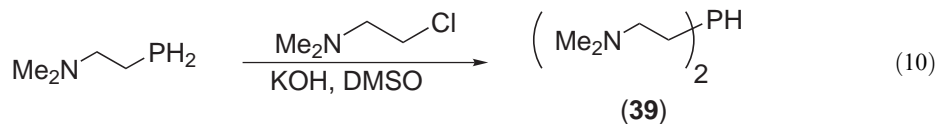
By hydrolysis of the corresponding phosphide  $MPR_2$ ; hence diphenylphosphine is obtained by cleavage of a phenyl group from triphenylphosphine with  $Li/THF$  or  $Na/$ liquid ammonia and subsequent hydrolysis of the resulting phosphide. Diphenylphosphine is also commercially available and widely used as a precursor to new P-containing compounds bearing a  $-PPh_2$  unit.<sup>50</sup>

Mixed secondary phosphines can also be prepared via this method, as illustrated by the synthesis in 2000 (Equation (9)) of the OPN-functionalized ligands (37) ( $\delta(P) -66$  ppm) and (38).<sup>51</sup>



Scheme 3

Stelzer and co-workers have shown<sup>36,52</sup> that phosphide anions may be generated from primary and secondary phosphines under aqueous conditions using conc. aqueous alkali in DMSO (DMSO = dimethylsulfoxide) or other dipolar aprotic solvents. Aminoalkylation of  $\text{H}_2\text{P}(\text{CH}_2)_2\text{NMe}_2$  with  $\text{Me}_2\text{N}(\text{CH}_2)_2\text{Cl}$  in the superbasic medium DMSO/KOH afforded the secondary phosphine  $\{\text{Me}_2\text{N}(\text{CH}_2)_2\}_2\text{PH}$  (**39**) (Equation (10)) in good yield (53%).<sup>52</sup> In a similar synthetic strategy the PH-functionalized phosphine (**40**) with a binaphthyl backbone was prepared from the appropriate dichloride and  $\text{PH}_3$  at 1.1 bar in toluene/DMSO/water and conc. KOH in 75%.<sup>36</sup>



The disecundary phosphines (**41**) and (**42**) (Scheme 3) are readily prepared by double P—Ph bond cleavage of dppe or dppp (for **41**) with lithium under ultrasonic irradiation, followed by aqueous hydrolysis.<sup>53,54</sup> Disecundary phosphines  $\text{PhPH}(\text{CH}_2)_n\text{PPh}$  ( $n = 2, 3$ ) have attracted recent interest for their use as starting materials for the preparation of multidentate and macrocyclic ligands. Thus it has been shown that alkylation of the metal phosphide intermediate affords ditertiary or, in the case of (**42**), optically active tetra(tertiary)phosphines (see Section 1.12.2.12.1).<sup>55,56</sup>

#### 1.12.2.3.3 By P—H addition reaction

Secondary phosphines can also be prepared by addition of P—H bonds across olefinic double bonds.<sup>40</sup> For example, the industrially important bicyclic secondary phosphine “phobane” (**43**) can be synthesized from phosphine gas and cycloocta-1,5-diene, albeit as a mixture of two isomers (**43a**) and (**43b**) (Scheme 3).<sup>57</sup> These isomers have recently been separated by an elegant sequence of hydrophosphination/dehydrophosphination steps, affording pure isomers which have been used in subsequent tertiary and ditertiary phosphine ligand syntheses.<sup>57</sup>

#### 1.12.2.3.4 Miscellaneous methods

A Schiff base condensation reaction (see also Section 1.12.2.6 for further examples) has recently been used in the preparation of the air-sensitive yellow compound (**44**) (Scheme 3) from salicylaldehyde and 2-(phenylphosphino)ethylamine.<sup>58</sup>

#### 1.12.2.3.5 Physical properties

The simple dialkyl and diarylphosphines are liquids with unpleasant odors and are susceptible to oxidation. The products of most secondary phosphine oxides tend invariably to be the phosphinic acid produced by tautomerization and further oxidation.

#### 1.12.2.3.6 Reactions of secondary phosphines

Of the secondary phosphines documented to 2002, diphenylphosphine has served as an excellent starting reagent for other preparations. The free-radical addition (AIBN,  $h\nu$ ) of  $\text{Ph}_2\text{PH}$  on  $2\text{-C}_6\text{H}_4(\text{CHO})(\text{CH}=\text{CH}_2)$  afforded in quantitative yield the functionalized tertiary phosphine  $2\text{-C}_6\text{H}_4(\text{CHO})(\text{CH}_2\text{CH}_2\text{PPh}_2)$ .<sup>59</sup> The addition of secondary phosphines to maleic anhydride and other related activated olefins has been shown to give functionalized tertiary phosphines.<sup>60</sup> Alkylation of  $\text{Ph}_2\text{PH}$  with  $\text{CH}_2\text{Cl}_2$  under phase-transfer conditions provides  $\text{Ph}_2\text{PCH}_2\text{Cl}$  in high yield.<sup>35</sup> The bicyclic secondary phosphine (**43b**) has been used to synthesize symmetrical and unsymmetrical ditertiary phosphines.<sup>57</sup>

The formation of secondary phosphide anions by metallation of secondary phosphines with butyllithium is an extremely efficient practical route for the introduction of the  $-\text{PPh}_2$  group, and numerous examples are cited in the following sections.<sup>50</sup>

### 1.12.2.3.7 Coordination chemistry of secondary phosphines

Diphenylphosphine palladium complexes have recently been prepared by the reaction of  $[\text{PdCl}_2(\text{PhCN})_2]$  with  $\text{Ph}_2\text{PH}$  in toluene.<sup>61</sup> The complex  $[\text{PdCl}_2(\text{Ph}_2\text{PH})_2]$  transforms to the dimeric complex  $\text{trans}-[\text{PdCl}(\mu\text{-PPh}_2)(\text{PPh}_2)]_2$ .<sup>61</sup> This latter feature illustrates one of the main obstacles to isolating primary or secondary phosphine metal complexes, namely the high reactivity of P—H bonds.<sup>10</sup> The secondary phosphine  $\text{PBu}^t_2\text{H}$  reacts rapidly with  $[\text{PdCp}(\text{C}_3\text{H}_5)]$  (Cp = cyclopentadienyl) to give a colorless, air-sensitive solid  $[\text{Pd}(\text{PBu}^t_2\text{H})_3]$ .<sup>62</sup> The zerovalent complex  $[\text{Pd}(\text{PBu}^t_2\text{H})_2]$  undergoes facile oxidative addition of  $\text{CH}_2\text{Cl}_2$  to give  $\text{trans}-[\text{PdCl}(\text{CH}_2\text{Cl})(\text{PBu}^t_2\text{H})_2]$  in 70% yield.

$\text{PhHP}(\text{CH}_2)_n\text{PPh}$  complexes of W and Pd have been documented.<sup>53,63</sup> The complexes  $[\text{Pd}(\text{dppe})\{\text{RPH}(\text{CH}_2)_2\text{PHR}\}]\text{Cl}_2$  (R = Me, Ph) (**45**) (Scheme 3) were prepared from  $[\text{PdCl}_2(\text{dppe})]$  and  $\text{RPH}(\text{CH}_2)_2\text{PHR}$ ; subsequent reaction with  $[\text{PdCl}_2(\text{dppe})]$  and  $\text{Na}_2\text{CO}_3$  gave dimeric palladium compounds with bridging phosphido ligands.<sup>63</sup>

A wide variety of secondary phosphine complexes of either alkali (e.g., Li)<sup>64</sup> or transition metals (e.g., Mo, Mn, Co, Ni, Cu, Au) have been documented.<sup>47,58,65–69</sup>

### 1.12.2.3.8 Catalytic applications of metal complexes with secondary phosphines

The binuclear palladium complex  $[(^t\text{Bu}_2\text{PH})\text{PdP}^t\text{Bu}_2]_2$  with oxygen gave a very efficient catalyst for the hydrogenation of  $\alpha,\beta$ -unsaturated carbonyls.<sup>70</sup> Glueck and co-workers have undertaken studies on aspects of platinum-catalyzed hydrophosphinations of activated olefins.<sup>71,72</sup>

### 1.12.2.4 Tertiary Phosphines

A vast number of tertiary phosphines have been synthesized since the pioneering work of von Hofmann and Michaelis. Whilst conceptually the simplest method for synthesizing phosphines is by direct reaction of elemental phosphorus, or from  $\text{PH}_3$ , the former approach is a very poorly developed practical method in contrast to the latter. However, one disadvantage with the second method is the use of  $\text{PH}_3$  gas (toxicity and handling problems), which necessitates careful Schlenk line manipulations. Phosphine can be generated in the laboratory or purchased from commercial suppliers. The use of a masked form of  $\text{PH}_3$ , namely  $[\text{PH}_4]\text{I}$ ,  $\text{P}(\text{CH}_2\text{OH})_3$  or  $\text{P}(\text{SiMe}_3)_3$ , has been demonstrated in very few cases. The most common methods employed for the preparation of tertiary phosphines are shown in Figure 3 and, with some recent additions, have remained popular synthetic routes ever since. The different methods will be discussed in turn and only a few examples given to illustrate this procedure. In the following sections numerous other examples are given using the basic synthetic routes outlined here.

The number of important methods used in the preparation of new phosphines has not changed significantly from that given by McAuliffe,<sup>1</sup> Gilheany and Mitchell,<sup>2</sup> and Quin.<sup>3</sup> The major

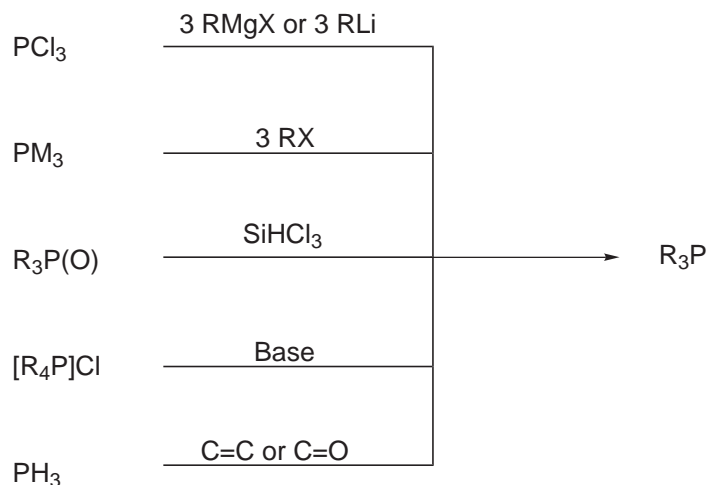


Figure 3 Common synthetic routes to tertiary phosphines.



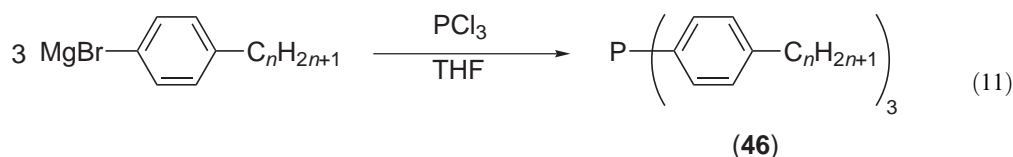
methods used in the formation of P—C bonds are: via organometallic reagents and halophosphines, nucleophilic substitutions using metal phosphides, or reduction of phosphonium salts or tertiary phosphine oxides. This latter method is practical for the synthesis of optically active tertiary phosphines (Section 1.12.2.12.1) since it has been demonstrated that resolution of phosphonium salts, phosphine oxides, or phosphine–borane adducts is considerably easier than with the parent phosphine. More recent strategies that are emerging as excellent methods for preparing new tertiary phosphines (both symmetrical and unsymmetrical derivatives) include hydrophosphinations, metal-catalyzed phosphinations, phosphorus-modified Mannich reactions, and Schiff base condensations.

In general syntheses should always be carried out in well-ventilated fumehoods using distilled, dry, and oxygen-free solvents for the majority of preparations. Many reactions can easily be monitored by  $^{31}\text{P}\{^1\text{H}\}$  NMR spectroscopy, to establish whether the reaction undertaken is complete or to ascertain the purity of the phosphorus(III) compound. It is often necessary to purify the tertiary phosphine, either by recrystallization or by column chromatography. At the end of any experiment it is essential to bleach all glassware (or to use  $\text{Br}_2$  in EtOH), so as to oxidize the phosphine residues to harmless phosphine oxides or acids.

The most useful and versatile of the many methods for synthesis of tertiary phosphines are dealt with in the following sections.

#### 1.12.2.4.1 Using Grignard reagents

This procedure usually works well for alkylphosphines; arylphosphines are usually prepared from aryllithium reagents instead. The general method entails adding the phosphorus halide (usually  $\text{PCl}_3$ , but  $\text{PBr}_3$  has also been used) to the Grignard reagent (usually in slight excess) at or below room temperature, and completing the reaction by refluxing in  $\text{Et}_2\text{O}$  or THF. The products are usually separated by addition of  $[\text{NH}_4]\text{Cl}$  solution followed by distillation of the solvent. Using this procedure a series of tris(aryl)phosphines (**46**) with straight-chain alkyl groups have been prepared (Equation (11)).<sup>73</sup>



This method can be used to prepare commercially the best of all known tertiary phosphines, triphenylphosphine ( $\text{PPh}_3$ ). Its combination of favorable physical properties (air-stable solid, easy to handle) and solubility in organic media has resulted in extensive uses as a ligand in coordination or organometallic chemistry or as a reagent in organic synthesis.

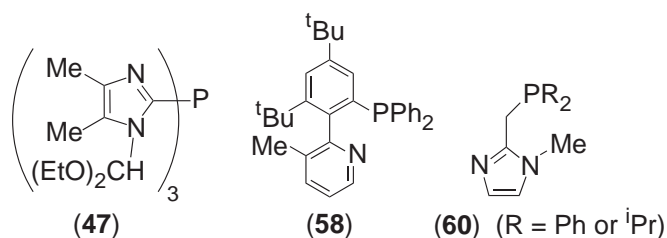
#### 1.12.2.4.2 Using organolithium reagents

Organolithium reagents resemble Grignards in their reactions but are more reactive, by virtue of the C—Li bond being more ionic than the C—Mg bond. For the synthesis of tertiary phosphines the procedure resembles that of Grignard reactions, i.e., it is carried out in a similar manner except that lower temperatures (typically  $-40^\circ\text{C}$  to  $-80^\circ\text{C}$ ) are necessary in the addition of the halophosphine to the organolithium reagent. Frequently the most common method for generating organolithium species is by metallation using butyllithium (sometimes *N,N,N',N'*-tetramethylethylenediamine (TMEDA) is added to stabilize the organolithium intermediate) or lithium diisopropylamide (LDA). This method is generally favored over that of the Grignard route, especially for arylphosphine syntheses. A wide range of tertiary phosphines have been synthesized using this organolithium route; some recent examples include the preparation of compounds (**47**) (Scheme 4) and (**48**) (Equation (12)).<sup>74,75</sup>

#### 1.12.2.4.3 Using other organometallics

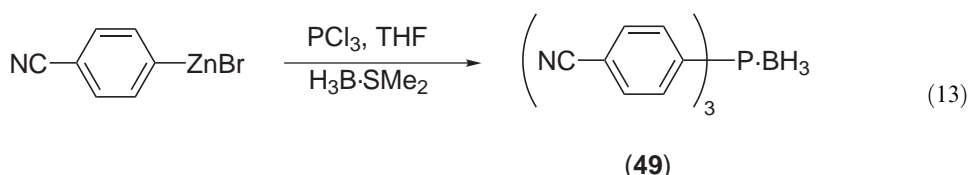
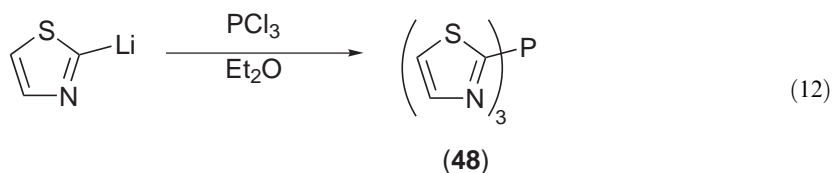
Whilst Grignard and organolithium reagents are most widely employed, they are by no means exclusive. Organo-zirconium, silicon, tin, copper, zinc, cadmium, and mercury compounds have





Scheme 4

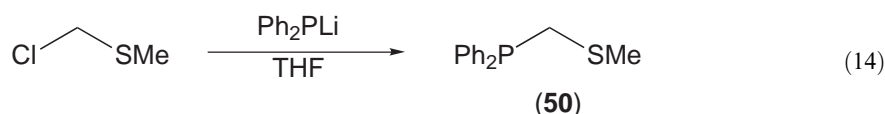
all received some occasional use, despite the popularity of Grignard and organolithium reagents.<sup>76,115</sup> Zinc organometallics (RZnI) have been used for the preparation of tertiary phosphines<sup>76</sup> and obtained in high yields by reaction of 1,2-dibromoethane, Me<sub>3</sub>SiCl, and zinc dust with alkyl iodides in THF (40 °C, 1–3 h). A range of air-stable protected phosphines can be synthesized and purified by flash chromatography using various chlorophosphines [PCl<sub>3</sub>, PhPCl<sub>2</sub>, Cl<sub>2</sub>P(CH<sub>2</sub>)<sub>2</sub>PCl<sub>2</sub>, Ph<sub>2</sub>PCl] as starting materials. An illustrative example is the synthesis of (49) from *p*-CNC<sub>6</sub>H<sub>4</sub>ZnBr (Equation (13)), protected in this case as the borane complex.<sup>76</sup>



#### 1.12.2.4.4 Alkali-metal derivatives

The synthesis and uses of alkali-metal phosphides in the preparation of tertiary phosphines is the opposite of that discussed previously in Sections 1.12.2.4.1–1.12.2.4.3. Alkali-metal diphenylphosphides are readily obtained by cleavage of a phenyl group from PPh<sub>3</sub> by lithium in THF (in some cases accelerated by use of ultrasonic radiation), sodium, or lithium in liquid ammonia, or by potassium in dioxane. The metal-phenyl product can be destroyed by addition of a calculated amount of <sup>t</sup>BuCl or [NH<sub>4</sub>]Cl. Usually MPPH<sub>2</sub> are prepared *in situ*, but they can be isolated, usually as solvates. Alternatively, these compounds can be obtained from Ph<sub>2</sub>PCl and the alkali metal, or from Ph<sub>2</sub>PH and butyllithium. The alkali-metal derivatives are usually colored deep red and are soluble in ether, THF, dioxane, and liquid ammonia. They readily hydrolyze and oxidize, hence all manipulations must be carried out under nitrogen and with freshly distilled solvents. They are strong nucleophiles and react with many functional groups; they also slowly ring-open THF under reflux, which may sometimes be a problem. Tertiary alkyl and cycloalkyl phosphines do not undergo alkali-metal cleavage; however, mixed aryl/alkyl phosphines are cleaved. Dimethylphosphide can be easily obtained in ether (Li salt) or ammonia (Na salt) by alkali-metal cleavage of the P–P bond in Me<sub>2</sub>PPMe<sub>2</sub>, itself available by desulfurization of Me<sub>2</sub>P(S)P(S)Me<sub>2</sub> with tributylphosphine or iron powder.<sup>48</sup>

The reaction of binary metal phosphides (M<sub>3</sub>P) and organohalides is not a popular route and more frequently, the use of phosphorus trihalides (e.g., PCl<sub>3</sub>) is favored instead. However, unsymmetrical tertiary phosphines,<sup>77,78</sup> e.g., (50)<sup>77</sup> (Equation (14)) are regularly prepared by this route (using MPR<sub>2</sub> instead), and numerous other examples are given in the following sections. The leaving groups on the organic precursor are typically halide, tosylate, or mesylate.



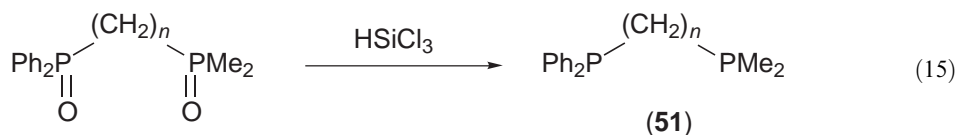
#### 1.12.2.4.5 Reduction methods

This is a very useful route for the preparation of phosphines, especially chiral phosphines. Tertiary phosphine oxides (and sulfides) and phosphonium salts are often precursors of choice in these reduction procedures. The following sections highlight reagents and reaction conditions; in forthcoming sections further examples will be given.

##### (i) Reduction of phosphine oxides

Because of the easy interconversion of phosphine oxides and phosphines, it is possible to regard the oxo group as a protecting group on phosphorus. However, the great strength of the P=O bond means that powerful (often nonselective) reductants such as  $\text{LiAlH}_4$ ,  $\text{HSiCl}_3$ ,  $\text{PhSiH}_3$ , or  $\text{Si}_2\text{Cl}_6$  are necessary for phosphine oxide reduction. Phosphine sulfides are reduced by a similar range of reagents to those successfully used in phosphine oxide reduction. Many other reagents, including  $\text{NaBH}_4$ ,  $\text{P(OPh)}_3$ , alanes, and  $\text{Bu}_3\text{P}$  have been used for the reduction of P=O and P=S bonds.<sup>3</sup>

The most common choices of silanes are  $\text{HSiCl}_3$ ,  $\text{Si}_2\text{Cl}_6$ , or  $\text{PhSiH}_3$ . Trichlorosilane is commercially available and probably the most popular of the reducing agents used. It is frequently used in the presence of a tertiary amine, usually triethylamine or pyridine to mop up any hydrogen chloride. A typical procedure for the reduction would entail mixing the oxide and excess silane in an inert solvent (e.g., benzene, xylenes) under nitrogen. The reactions are usually exothermic and hence may require cooling. To ensure complete reduction it may be necessary to reflux. The phosphine can be obtained by distillation or recrystallization. Silanes work well in the proximity of other functional groups, which are left unaffected. The synthesis of  $\text{Ph}_2\text{P}(\text{CH}_2)_n\text{PMe}_2$  ( $n = 6, 8$ ) (51) (Equation (15)) is an example of such a reduction.<sup>79</sup>



##### (ii) Reduction of phosphonium salts

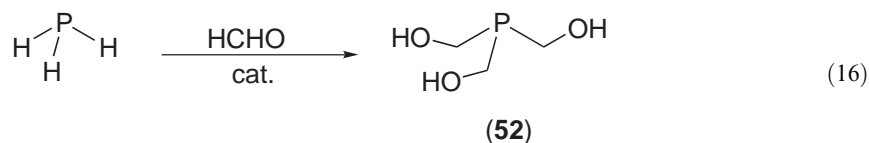
In contrast to phosphine oxides, whereby the phosphoryl group is reduced, the reduction of phosphonium salts involves cleavage of a P—C bond. There are several ways this can be achieved, including base-induced cleavage, thermal decomposition, hydride or electrolytic reduction.<sup>2</sup>

#### 1.12.2.4.6 Hydrophosphinations

One of the many important differences between phosphorus and nitrogen chemistry is the relative strengths of their bonds to hydrogen. The relatively weak P—H bond means that this functionality can be added across a wide variety of unsaturated molecules (alkenes, alkynes, carbonyls) and hence this represents an excellent method for preparing tertiary phosphines. The addition of P—H compounds to C=O and C=N has been described in detail by Gilheany and Mitchell.<sup>2</sup> The reaction can be catalyzed by base (potassium hydroxide, butyllithium), acid (HCl, carboxylic acids, sulfonic acids, boron trifluoride), free radical (uv, organic peroxides, AIBN) or metal (simple metal salts, late transition-metal complexes). In some circumstances no catalyst is required at all for P—H additions to proceed.<sup>60</sup>

The hydrophosphination of formaldehyde with  $\text{PH}_3$  is an excellent example of a metal-catalyzed reaction (Equation (16)) affording the industrially important  $\text{P}(\text{CH}_2\text{OH})_3$  (52).<sup>80–82</sup> This approach works well for tertiary phosphines bearing electron-withdrawing groups such as  $\text{P}(\text{CH}_2\text{CH}_2\text{CN})_3$

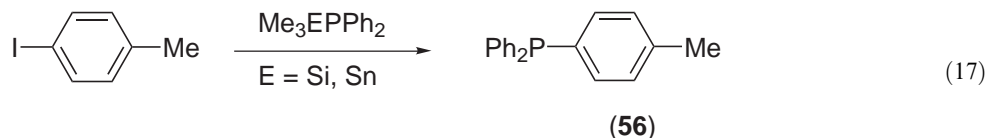
(**53**)<sup>83,84</sup> or  $\text{P}(\text{CH}_2\text{CH}_2\text{CO}_2\text{Et})_3$  (**54**).<sup>85</sup> Glueck and co-workers have studied mechanistic aspects of hydrophosphination reactions in some detail.<sup>71,72</sup> Other examples of hydrophosphinations are described throughout the remaining sections in this chapter.



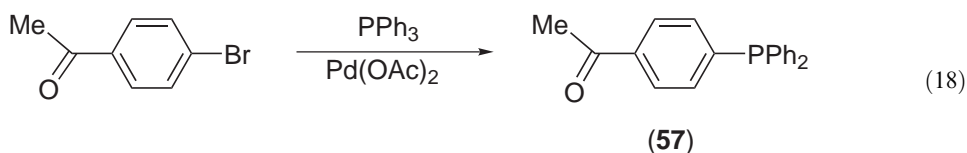
Insertion of the P—H bond of  $\text{R}_2\text{PH}$  ( $\text{R} = \text{Ph}$ , typically) across carbon–oxygen or carbon–carbon unsaturated double bonds is a frequent entry point to unsymmetrical tertiary phosphines. A common example, where no catalyst is required, is the addition of  $\text{Ph}_2\text{PH}$  across  $\text{HCHO}$ , affording  $\text{Ph}_2\text{PCH}_2\text{OH}$  (**55**) which itself is a valuable precursor for other mixed tertiary phosphines.<sup>85,86</sup> Frequently (**55**) is generated *in situ* from  $\text{Ph}_2\text{PH}/(\text{CH}_2\text{O})_n$ , the secondary phosphine serving as both reactant and solvent medium.<sup>87</sup>

#### 1.12.2.4.7 Metal-catalyzed phosphinations

Tunney and Stille<sup>88</sup> described the coupling of diphenyl(trimethylsilyl)phosphine or (trimethylstannyl)diphenylphosphine with various aryl halides, in the presence of a palladium catalyst, to give aryl-diphenylphosphines, e.g., (**56**), according to Equation (17). Unfortunately the reaction conditions are not compatible with functional groups such as  $\text{NO}_2$ ,  $\text{CHO}$ ,  $\text{NH}_2$ , or  $\text{OH}$ .



Palladium-catalyzed phosphination of substituted aryl bromides, using triarylphosphines as the phosphinating agents, has been developed, as illustrated by the synthesis of (**57**) (Equation (18)).<sup>89</sup> This method tolerates various functionalities, e.g., ketone, aldehyde, ester, nitrile, ether, and chloride. Under similar catalytic conditions, various *P,N*-ligands, e.g., (**58**) (Scheme 4), were synthesized using triflate precursors instead.<sup>90,91</sup> Arylphosphines can also be prepared by phosphination with triphenylphosphine catalyzed by palladium on charcoal.<sup>92</sup>



#### 1.12.2.4.8 Miscellaneous methods

##### (i) From elemental phosphorus

A particularly attractive route for the preparation of organophosphorus compounds would be direct from either red or white elemental phosphorus.<sup>93</sup> However, the low reactivity with various reagents has precluded a more widespread use of this substance. Yields from these reactions tend to be rather low, and experimental conditions often necessitate high temperatures/pressures.<sup>2</sup>

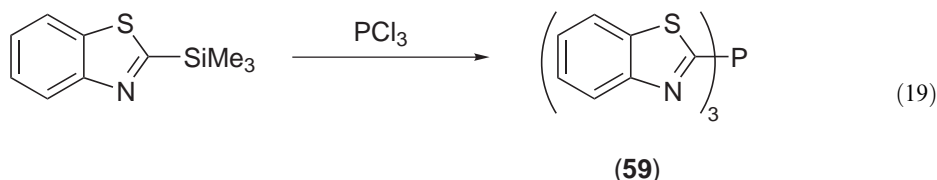
##### (ii) From polyphosphines

The chemistry of diphosphines and polyphosphines centers on the facile cleavage of the P—P bond (by alkali metals, organometallic reagents), affording phosphide anions. From these,

phosphines may be obtained by the methods outlined in Section 1.12.2.4.4. The P—P bond has remarkable thermal stability and many compounds based on this bond type are known.

### (iii) Heteroaryltrimethylsilanes

Readily accessible from the reaction between a heteroaryl organometallic reagent and chlorotrimethylsilane, affording the desired heteroaryl-substituted phosphines when treated with  $\text{PCl}_3$ .<sup>75</sup> An example of this transformation is illustrated in Equation (19) for (59) ( $\delta(\text{P})$  –21 ppm); other ligands (e.g., (60) (Scheme 4)) have been synthesized by this route.<sup>94</sup>



### 1.12.2.4.9 Physical properties

Trialkylphosphines are usually air sensitive, and in cases can react violently when exposed to air. For this reason they must be prepared and stored under an inert atmosphere (usually nitrogen or argon). Trialkylphosphines generally have a strong, unpleasant odor and are assumed to be toxic. Triarylphosphines invariably tend to be solids and display greater resistance towards aerial oxidation. Reaction of either  $\text{MeMgI}$  or  $\text{MeLi}$  with  $\text{PCl}_3$  affords  $\text{PMe}_3$ , and since this is a low-boiling, inflammable liquid it is usually stored as  $\text{AgI}\cdot\text{PMe}_3$ ,  $\text{AgNO}_3\cdot\text{PMe}_3$ , or  $\text{InCl}_3\cdot(\text{PMe}_3)_2$ , from which it is easily liberated.

### 1.12.2.4.10 Coordination chemistry of tertiary phosphines

The coordination chemistry of tertiary phosphines, e.g.,  $\text{PPh}_3$ ,  $\text{PMe}_3$ , etc. is vast and only a token selection of examples based on Mo,<sup>95</sup> Re,<sup>96</sup> Ru,<sup>97</sup> Os,<sup>97</sup> Ni,<sup>98</sup> Pd,<sup>99,100</sup> Pt,<sup>101–103</sup> Cu,<sup>104</sup> Au,<sup>103</sup> and rare-earth elements<sup>105</sup> are reported here. One particular aspect that has attracted interest is the coordination chemistry and reactivity of orthometallated triphenylphosphine complexes<sup>106–108</sup> and their use in catalysis.<sup>109–111</sup>

### 1.12.2.4.11 Catalytic applications of metal complexes with tertiary phosphines

Triphenylphosphine complexes of Ru, Rh, and Pd continue to play a crucial role in homogeneous catalysis for a wide range of transformations. Palladium complexes with  $\text{PPh}_3$  are extremely useful in organic synthesis.<sup>112,113</sup>

## 1.12.2.5 Unsymmetrical Tertiary Phosphines

### 1.12.2.5.1 Preparation by classic methods

Although mixed alkylphosphines have displayed only sparse use as ligands, in contrast alkyl-arylphosphines (aryl = phenyl) have received extensive attention from coordination chemists.<sup>10</sup> Unsymmetrical phosphines may be synthesized by a variety of methods using organometallic reagents, based ostensibly on those shown in Figure 4. Which route is employed often depends on the availability of the starting materials (e.g., halophosphine). The chlorophosphines  $\text{RPCl}_2$  are useful for synthesizing  $\text{RPR}'_2$ , whereas  $\text{R}_2\text{PCl}$  can be used to prepare  $\text{R}_2\text{PR}'$ . Alternatively, a second common approach is nucleophilic attack by  $\text{R}_2\text{P}^-$  ( $\text{R} = \text{Ph}$ , typically) on a suitable organic precursor  $\text{R}'\text{X}$  (see Section 1.12.2.4.4). Examples of the synthesis of unsymmetrical phosphines are given in the following sections.

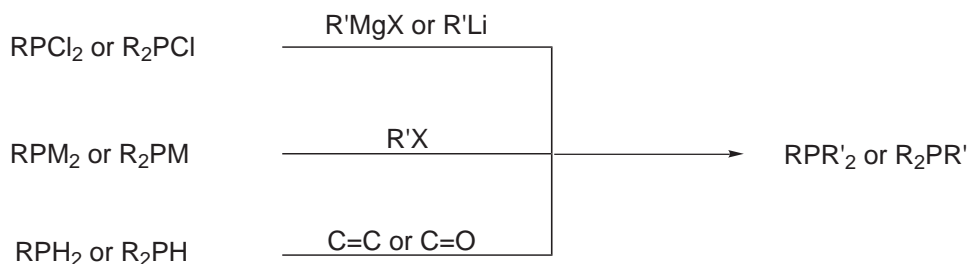


Figure 4 Common synthetic routes to mixed tertiary phosphines.

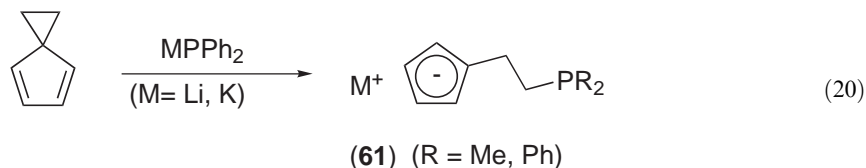
#### 1.12.2.5.2 Miscellaneous methods

A new synthesis of unsymmetrical tertiary phosphines,  $\text{PR}^1\text{R}^2\text{R}^3$ , has been developed by Singh and Nicholas,<sup>114</sup> employing a selective, sequential alkylation of chloroaminophosphines by Grignard and organolithium reagents, respectively. Hence chloroaminophosphines,  $\text{P}(\text{R})\{\text{N}(\text{Me})\text{Ph}\}\text{Cl}$  ( $\text{R} = \text{Ph}$  or  $\text{Et}$ ), prepared by reaction of readily available organodichlorophosphines with  $\text{LiN}(\text{Me})\text{Ph}$  (THF,  $20^\circ\text{C}$ ), undergo a selective reaction with Grignard reagents, producing aminophosphines. Organolithium reagents then readily react giving unsymmetrical tertiary phosphines.

#### 1.12.2.6 Functionalized Tertiary Phosphines

Functionalized tertiary phosphines continue to attract considerable interest for their unusual coordination chemistry and their increasing importance in catalysis. Whilst this subject area is extensive, only a few types of functionalized phosphines will be discussed here, including brief details regarding preparative procedures.

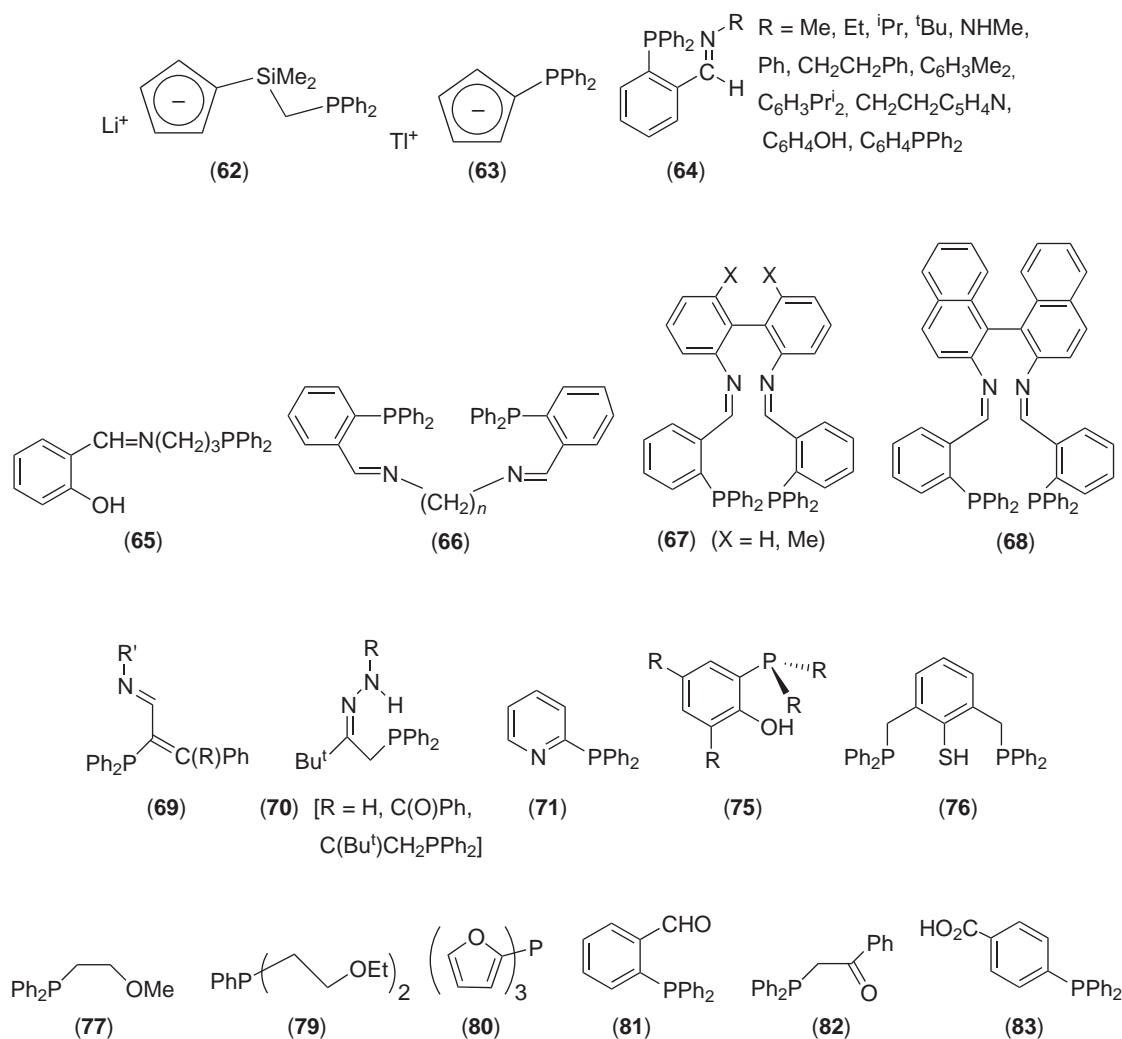
Dialkyl and diarylphosphine cyclopentadienyl-modified ligands, e.g., (61)–(63) are known, and in the case of (61) may be prepared according to Equation (20).<sup>116–119</sup> Phosphine (62) is best prepared by reaction of  $\text{Li}(\text{TMEDA})\text{CH}_2\text{PPh}_2$  with neat  $\text{SiMe}_2\text{Cl}_2$  in THF at  $-78^\circ\text{C}$  to afford  $\text{Ph}_2\text{PCH}_2\text{SiMe}_2\text{Cl}$ , which upon further reaction with  $\text{LiCp}$ , followed by deprotonation with  $\text{BuLi}$ , gave the desired anionic ligand.<sup>119</sup>



The chemistry of substituted cyclopentadienides such as (61)–(63) (Scheme 5) and related ligands with various transition metals<sup>118–121</sup> and lanthanides<sup>117,121</sup> has been the subject of some attention.

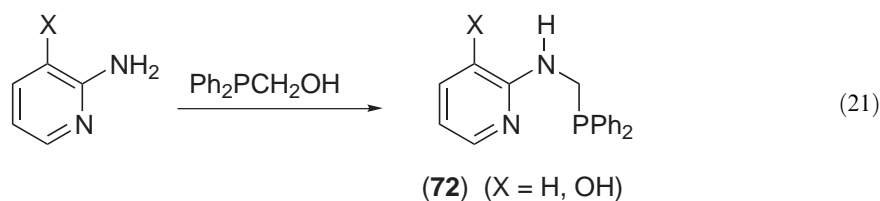
Schiff base condensation reactions have also been widely used in the preparation of new imine-functionalized tertiary phosphines (64)–(68).<sup>122–129</sup> The most frequently used experimental procedure involves the condensation of a carbonyl compound (often  $2\text{-Ph}_2\text{PC}_6\text{H}_4\text{CHO}$ )<sup>176</sup> and the appropriate amine in ethanol, benzene, or THF under refluxing conditions. To ensure complete reaction, a Dean–Stark trap or the addition of molecular sieves is often necessary, to remove water formed during the reaction. Evaporation of the solvent and recrystallization yield the desired ligand in good to excellent yields. This approach can be used to prepare bis-phosphines, e.g., (66)–(68).<sup>127–129</sup> The iminophosphine (69) was prepared by a series of coupling reactions at a palladium template, and was liberated from the metal by treatment with aqueous cyanide.<sup>130</sup>

A variety of transition-metal complexes with Schiff base tertiary phosphines, (64)–(68) (Scheme 5), are known, including those of  $\text{Cr}$ ,<sup>125</sup>  $\text{Mo}$ ,<sup>125,126,131</sup>  $\text{W}$ ,<sup>125</sup>  $\text{Ru}$ ,<sup>132</sup>  $\text{Ni}$ ,<sup>124,127,128</sup>  $\text{Pd}$ ,<sup>122–124,128,133,134</sup>  $\text{Pt}$ ,<sup>123,124,128</sup> and  $\text{Cu}$ .<sup>127</sup> Metal complexes of iminophosphines have been used in various catalytic reactions, such as the coupling of organostannanes with aryl halides,<sup>135</sup> oligomerization of ethene,<sup>122</sup> Heck reactions,<sup>136</sup> and allylic alkylation reactions.<sup>123</sup>



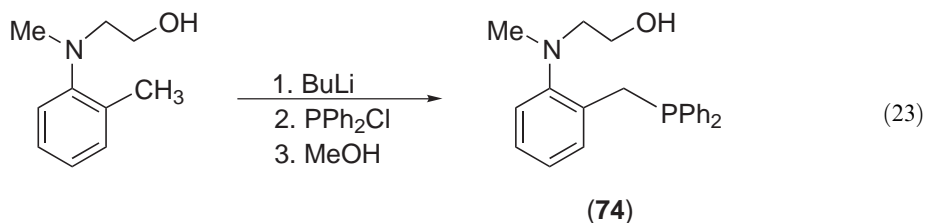
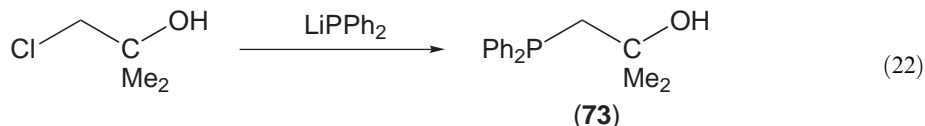
Scheme 5

A somewhat similar strategy can be used to make the *P,N*-donor ligands (70), as described by Shaw and co-workers.<sup>137–139</sup> Another class of compound that has received more attention is pyridylphosphines, the most frequently encountered of which is (71).<sup>140–142</sup> Various synthetic strategies are available for the synthesis of this versatile ligand class,<sup>140</sup> one example being the use of a phosphorus-modified Mannich reaction for the preparation of (72) (Equation (21)).<sup>143,144</sup> Ligands such as (72) possess an additional reactive site (OH or halide) for further functionalization using classic procedures outlined previously.<sup>143</sup> “Hybrid” ligands containing a bipyridine,<sup>145</sup> naphthyridine,<sup>146</sup> or terpyridine<sup>147</sup> group have also been reported.



The chemistry of (71) (and related systems) has been widely exploited, with a variety of different coordination modes observed for this versatile ligand class, as illustrated by reported complexes of Mo,<sup>148</sup> W,<sup>149</sup> Fe,<sup>150</sup> Ru,<sup>143,144,151,152</sup> Os,<sup>153,154</sup> Rh,<sup>143,144</sup> Ir,<sup>143,144</sup> Pd,<sup>155</sup> Pt,<sup>143,144,156</sup> and Au.<sup>157</sup>

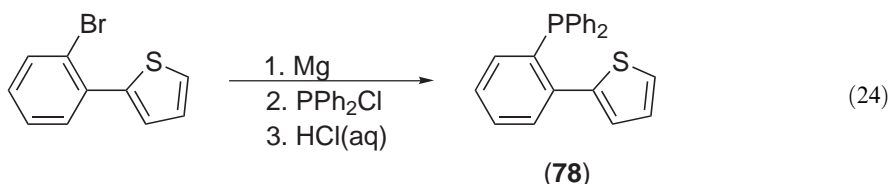
The syntheses of new functionalized ligands bearing an alcohol, ether, or carbonyl functionality have received much interest for the ability to act as hemilabile ligands when *P*-coordinated to a metal. Standard synthetic procedures have been used in the synthesis of hydroxyl-containing phosphines (**73**) and (**74**) (Equations (22) and (23)).<sup>158–160</sup> The general method shown in Figure 4 was also used to synthesize (**75**),<sup>161</sup> whereas Ph<sub>2</sub>PCH<sub>2</sub>OH was prepared by reaction of Ph<sub>2</sub>PH with paraformaldehyde and serves as a useful precursor for other functionalized tertiary phosphines.<sup>143,144</sup>



Metal complexes of (**73**)–(**75**), Ph<sub>2</sub>PCH<sub>2</sub>OH and PhP(CH<sub>2</sub>OH)<sub>2</sub>, are known for Mo,<sup>162</sup> Rh,<sup>159</sup> Ni,<sup>161</sup> Pd,<sup>160,163,164</sup> Pt,<sup>158,165</sup> and Cu,<sup>160</sup> amongst others. The ligand Ph<sub>2</sub>PCH<sub>2</sub>OH can act as a bridging phosphinoalkoxide, as illustrated by the formation of the heterodinuclear complex [TpZr(μ-OCH<sub>2</sub>PPh<sub>2</sub>)<sub>3</sub>Mo(CO)<sub>3</sub>].<sup>166</sup> Several complexes have been shown to act as catalysts for ethene oligomerization,<sup>161</sup> silylation of aryl halides,<sup>167</sup> or hydroformylation.<sup>159</sup>

Thiol-based arenephosphines, such as (**76**) which has recently been synthesized, form complexes in which the ligand can additionally coordinate as a thiolate.<sup>168,169</sup>

Ether, thioether, and thiophene-modified ligands, e.g., (**77**)–(**79**) (Scheme 5) are known and are prepared by standard procedures, as illustrated in Equation (24) for (**78**).<sup>170–174</sup> The tri-2-furylphosphine (**80**) has a rich and varied chemistry and is widely used as a ligand in various metal-catalyzed reactions.<sup>175</sup>

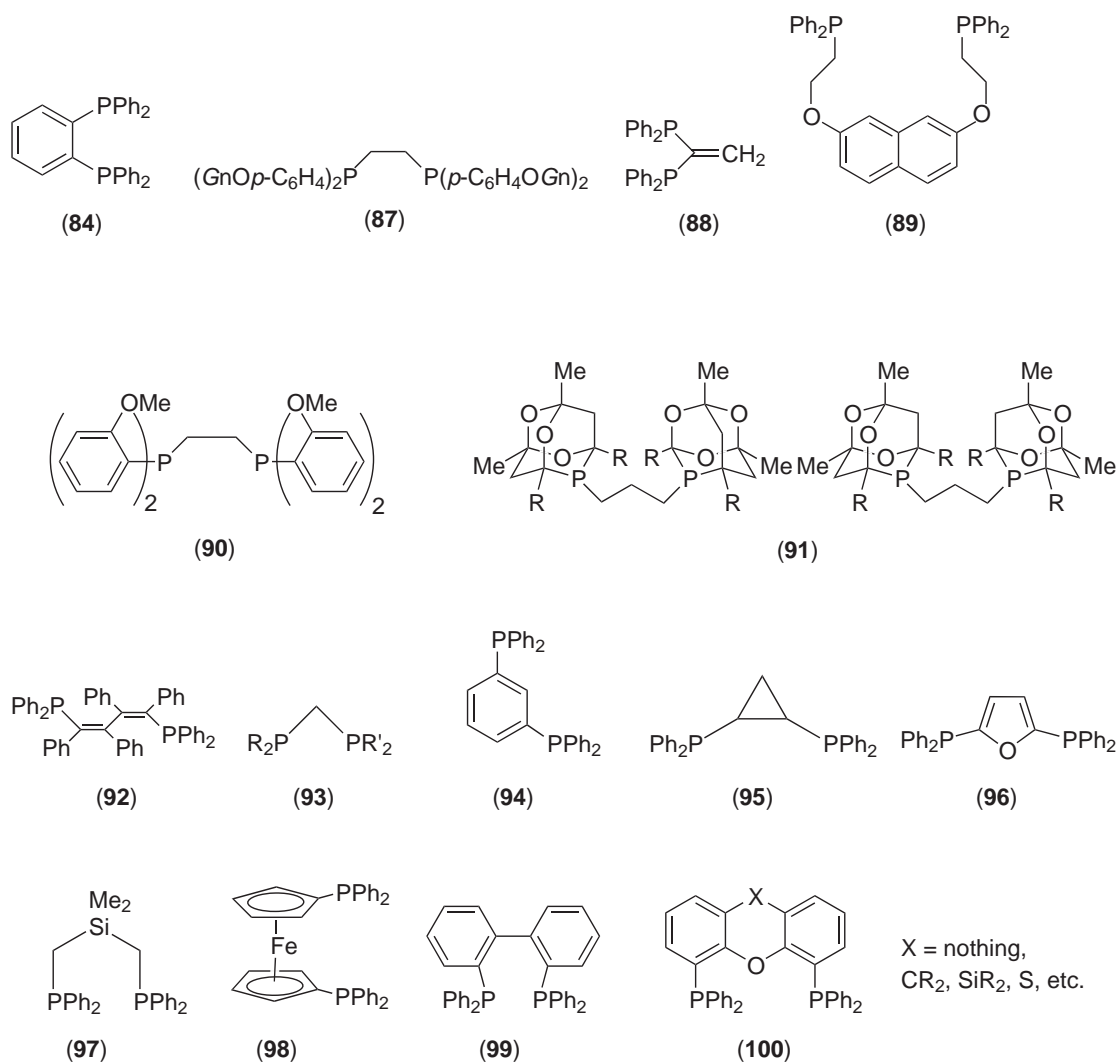


Aldehyde- (e.g., (**81**)),<sup>176</sup> ketone- (e.g., (**82**)),<sup>177–182</sup> and carboxylic acid-functionalized (e.g., (**83**))<sup>183</sup> phosphines are also known and undergo a variety of reactions at metal centers, as well as displaying some catalytic properties.<sup>184,185</sup>

### 1.12.2.7 Ditertiary Phosphines

By far the most common type of ditertiary phosphines is those containing two –PPh<sub>2</sub> groups. Typical ditertiary phosphines include the series (Ph<sub>2</sub>P)<sub>2</sub>(CH<sub>2</sub>)<sub>*n*</sub> (*n* = 1–4, typically) and the chemistry of these and related systems continues to flourish. Various different synthetic routes exist, the method of greatest applicability being the reaction of alkali-metal phosphides with dihaloalkanes, alkenes, etc. Generally this reaction proceeds well and in high yield; excess dihaloalkane should be avoided, as that leads to the production of phosphonium salts which can contaminate the product. The most widely used diphosphine ligands are the bis(diphenylphosphino)alkanes (*n* = 1–3, typically). They are readily obtainable from X(CH<sub>2</sub>)<sub>*n*</sub>X and LiPPh<sub>2</sub> in THF. In the case of dppe (*n* = 2), the ligand is also obtainable by base-catalyzed addition of Ph<sub>2</sub>PH to Ph<sub>2</sub>PCH=CH<sub>2</sub>, although the former method is preferred. The ligands dpmm, dppe, and dppp are air-stable, crystalline solids, the

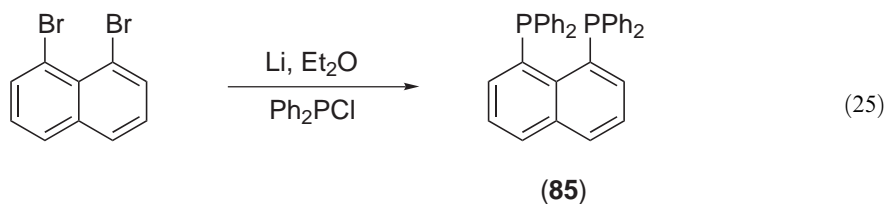




Scheme 6

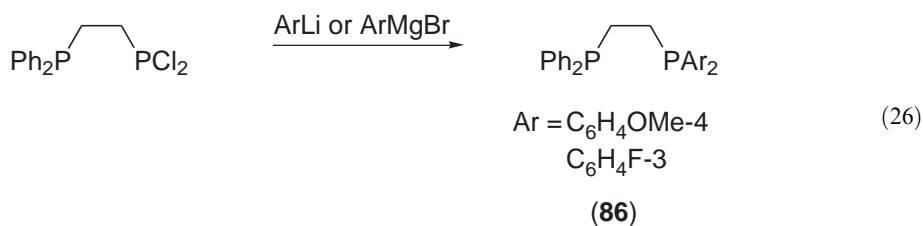
higher analogs being solids or oils. Unsymmetrical ditertiary phosphines (**51**) can be prepared by a succession of quaternization, alkaline hydrolysis, and reduction steps.<sup>79</sup>

An overview of the preparations of some more recent examples of ditertiary phosphines is given below. One popular route still continues to be generation of a reactive organolithium or magnesium reagent and reaction with a suitable chlorophosphine. This procedure can be used to prepare (**84**) (Scheme 6), containing either an arene<sup>88</sup> or naphthalene (**85**) (Equation (25)) backbone.<sup>187</sup>



Unsymmetrical diphosphines, e.g., (**86**) can be prepared by reaction of the *in situ*-generated ArLi (or ArMgBr) with Ph<sub>2</sub>PCH<sub>2</sub>CH<sub>2</sub>PCl<sub>2</sub> (Equation (26)).<sup>188</sup> Dendrimer-functionalized bidentate phosphines (**87**), analogs to dppe, can be prepared by the reaction of a lithiated intermediate with 1,2-bis(dichlorophosphino)ethane.<sup>189</sup>





The ditertiary phosphine 1,2-bis(diphenylphosphinomethyl)ethene (**88**) was conveniently prepared in 68% yield from  $\text{Ph}_2\text{PNa}$  and 3-chloro-2-chloromethylprop-1-ene,<sup>190</sup> whilst (**89**) ( $\delta(\text{P})$  –23 ppm; m.p. 137–138 °C) was synthesized from the bismesylate and  $\text{Ph}_2\text{PLi}$ .<sup>191</sup> The synthesis of the methoxy-functionalized ditertiary phosphine (**90**) has recently been described and involves P–C bond cleavage of  $\text{P}(o\text{-OMeC}_6\text{H}_4)_3$  with sodium in ammonia and quenching with 1,2-dichloroethane.<sup>192</sup>

Very bulky diphosphines, e.g., (**91**) are readily prepared from  $\text{H}_2\text{P}(\text{CH}_2)_3\text{PH}_2$ , acetylacetonone, and HCl as an air-stable solid, present as a mixture of diastereomers. Selective crystallization of the *rac* isomer can be achieved upon addition of MeOH to a  $\text{CH}_2\text{Cl}_2$  solution of a mixture of both ligands.<sup>193</sup>

The diphosphine (**92**) was prepared by transmetalation of a zirconacycle to copper, then quenching with  $\text{Ph}_2\text{PCl}$ .<sup>194</sup> A transmetalation approach, using  $\text{R}_2\text{PCH}_2\text{SbR}'_2$ , was also employed in the preparation of unsymmetrical diphosphines (**93**) bearing a single methylene spacer.<sup>195</sup>

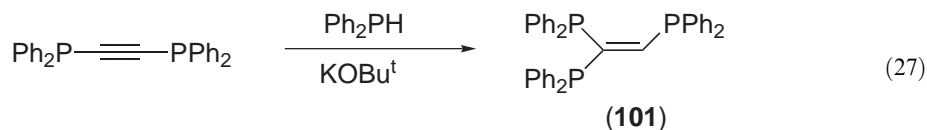
Metal complexes of (**51**), (**84**)–(**93**), and (**94**)–(**98**) with Cr,<sup>190</sup> Mo,<sup>190,197</sup> W,<sup>190</sup> Ru,<sup>194,203</sup> Rh,<sup>188,195</sup> Ir,<sup>199</sup> Ni,<sup>192,202</sup> Pd,<sup>193,194</sup> Pt,<sup>189,191,198</sup> Ag,<sup>199</sup> Au,<sup>193,196</sup> and Cd<sup>201</sup> have been described. Large *trans*-spanning ditertiary phosphines, e.g.,  $\text{Ph}_2\text{P}(\text{CH}_2)_{14}\text{PPh}_2$  have been prepared by olefin metathesis using Grubb's catalyst.<sup>204</sup>

Ditertiary phosphines such as (**86**), (**92**), and (**98**)–(**100**) (Scheme 6) have found important uses as ligands for metal-catalyzed transformations, including e.g., palladium-catalyzed Grignard cross couplings,<sup>194,205</sup> rhodium-catalyzed Michael additions,<sup>205</sup> hydrocyanations,<sup>206</sup> copolymerizations,<sup>207</sup> and palladium-catalyzed aminations.<sup>208</sup> Rhodium complexes of (**86**) are catalysts for the carbonylation of methanol.<sup>188</sup> More recently the ligand bite angle of ditertiary phosphines such as (**100**) has been shown to influence catalytic activity/selectivity in several important catalytic processes.<sup>209–213</sup>

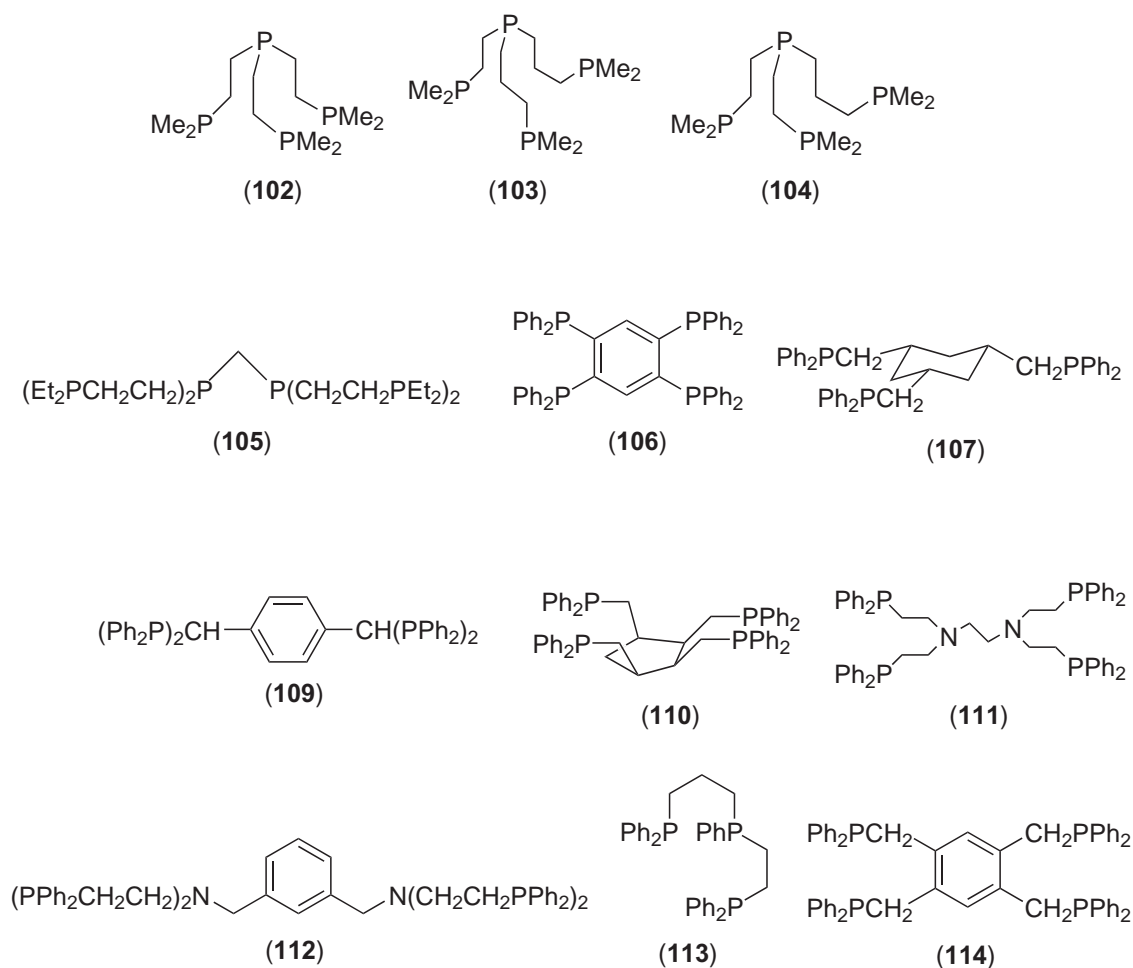
### 1.12.2.8 Polydentate Tertiary Phosphines

Polydentate phosphines continue to attract much interest, especially in the complexes they form, and also in the catalytic applications displayed by some compounds.<sup>214–216</sup> To differentiate this class from that of Section 1.12.2.7 on bidentate tertiary phosphines, polyphosphines are compounds possessing three or more phosphorus donor atoms. Most synthetic routes are similar to those outlined before,<sup>50,216</sup> so only a selection of polydentate phosphines will be given here including a brief summary, where appropriate, of their syntheses and key reactions.

Examples of tridentate phosphines include the synthesis of tris(diphenylphosphino)ethene (**101**) in 51% yield by the base-catalyzed addition of  $\text{Ph}_2\text{PH}$  to the 1,2-disubstituted phosphine  $\text{Ph}_2\text{PCCPPh}_2$  (Equation (27)).<sup>217</sup> This protocol has also been used in the preparation of various polyphosphines using  $(\text{Ph}_2\text{P})_2\text{C}=\text{CH}_2$  and an appropriate P–H source, again with  $\text{KOBU}^t$  as base.<sup>218,219</sup>



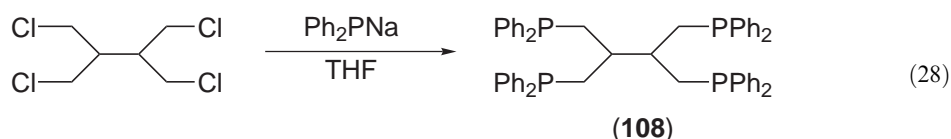
An improved synthesis has been described for (**102**) (Scheme 7), involving the photochemical addition between  $\text{Me}_2\text{PH}$  and trivinylphosphine.<sup>220</sup> The tripodal tetradentate ligand (**102**) was isolated as an air-sensitive, white solid of low melting point (m.p. 45–46 °C). Unsymmetrical analogs (**103**) and (**104**) were prepared by similar strategies.<sup>220</sup> The hexadentate tertiary phosphine (**105**) was prepared by AIBN-catalyzed P–H addition of  $\text{H}_2\text{PCH}_2\text{PH}_2$  (generated *in situ* from  $(\text{Me}_3\text{Si})_2\text{PCH}_2\text{P}(\text{SiMe}_3)_2/\text{MeOH}$ ) to four equivalents of  $\text{H}_2\text{C}=\text{CHPET}_2$ .<sup>221</sup>



Scheme 7

Tris and tetrakis(diphenylphosphino)benzenes (e.g., (106)) can readily be prepared by reaction of the corresponding isomer of  $\text{C}_6\text{H}_{6-n}\text{F}_n$  and  $n$  equivalents of  $\text{Ph}_2\text{PNa}$  in liquid ammonia.<sup>222</sup> However, this route has so far been unsuccessful for preparing more highly substituted (diphenylphosphino)benzene analogs.

The tridentate ligand (107) was prepared in 66% yield by nucleophilic substitution of the tribromomethylcyclohexane precursor.<sup>223</sup> In a similar manner the tetradentate ligand (108) ( $\delta(\text{P}) -22$  ppm, m.p. 91–93 °C) was prepared from the tetrachloro starting material and  $\text{Ph}_2\text{PH}/\text{Na}$  in THF (Equation (28)).<sup>224</sup>



The tetraphosphine  $(\text{Ph}_2\text{P})_2\text{CHC}_6\text{H}_4\text{CH}(\text{PPh}_2)_2$  (109) could readily be prepared by nucleophilic reaction of  $\text{Ph}_2\text{PCH}_2\text{C}_6\text{H}_4\text{CH}_2\text{PPh}_2$  with  $\text{BuLi}$  at  $-40$  °C, followed by quenching of the lithiated intermediate with  $\text{Ph}_2\text{PCl}$ .<sup>225</sup> The same conditions could then be applied to the intermediate triphosphine, affording (109) as an air-sensitive white solid.<sup>225</sup> Alternatively, albeit in lower yield, slow addition of  $\text{LiPPh}_2$  to  $\alpha, \alpha, \alpha', \alpha'$ -tetrabromo-*p*-xylene also gave (109).

The penultimate step in the synthesis of the new tetradentate ligand (110) was reaction of the tetratosylate with  $\text{LiPPh}_2$  (generated *in situ* from  $\text{Li}$  metal and  $\text{ClPPh}_2$ ).<sup>226</sup> Compound

(110) was air-sensitive and hence stored as its tetraborane adduct before work-up. Deprotection of the borane groups was readily accomplished using diethylamine and heating at 55–60 °C for 10 h.

The polydentate phosphines (111) and (112) (Scheme 7) were readily prepared from  $[\text{CH}_2\text{N}(\text{CH}_2\text{CH}_2\text{Cl})_2]_2$  or  $1,3\text{-C}_6\text{H}_4\{\text{CH}_2\text{N}(\text{CH}_2\text{CH}_2\text{Cl})_2\}_2$  and  $\text{KPPH}_2$  in THF.<sup>227</sup>

New unsymmetrical chiral triphosphine ligands can also be prepared via a stepwise sequence. Reaction of *dpe* with  $[\text{Ph}_3\text{P}(\text{CH}_2)_3\text{I}]\text{I}$  gave the mixed salt  $[\text{Ph}_3\text{P}(\text{CH}_2)_3\text{PPh}_2(\text{CH}_2)_2\text{PPh}_2]\text{I}_2$ , which upon treatment with NaOH gave the corresponding dioxide  $\text{Ph}_2\text{P}(\text{O})(\text{CH}_2)_3\text{P}(\text{O})\text{Ph}(\text{CH}_2)_2\text{PPh}_2$ . Reduction with  $\text{HSiCl}_3$  gave the unsymmetrical triphosphine  $\text{Ph}_2\text{P}(\text{CH}_2)_3\text{PPh}(\text{CH}_2)_2\text{PPh}_2$  (113) as an oil.<sup>228</sup> Symmetrical triphosphine ligands have also been documented.<sup>229</sup>

The tetradentate ligand (114) was prepared in high yield (96%) by  $\text{HSiCl}_3$  reduction of the corresponding tetra(tertiary)phosphine oxide.<sup>230</sup>

The coordination chemistry of these and other polydentate tertiary phosphines has been documented with a variety of ligating modes observed for these ligands.<sup>214–216</sup> Aspects of coordination behavior of the above polydentate phosphines with Fe,<sup>220,225,231,232</sup> Ru,<sup>233</sup> Co,<sup>221</sup> Ni,<sup>228,234,235</sup> Pd,<sup>226,228,234,236</sup> Pt,<sup>234</sup> and Cu<sup>227</sup> have been reported.

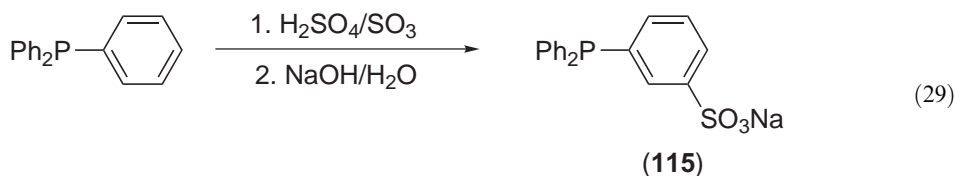
The tetratertiary phosphine (110) has been successfully used in palladium-catalyzed allylic substitution reactions,<sup>226</sup> while dinuclear palladium complexes of (105) catalyze the electrochemical reduction of  $\text{CO}_2$  to CO in acidic DMF solutions.<sup>236</sup>

### 1.12.2.9 Water-soluble Tertiary Phosphines

Interest in water-soluble phosphines has caused extensive coordination and organometallic studies to be undertaken in aqueous media, and also catalytic applications to be developed.<sup>237</sup> Most water-soluble tertiary and ditertiary phosphines contain one (or more) sulfonate functionalities, although other functional groups such as  $\text{CO}_2\text{Na}$ , OH,  $\text{PMe}_3^+$ ,  $\text{NMe}_3^+$ ,  $\text{P}(\text{O})(\text{ONa})_2$ , and polyethers have been documented. By far the most widely studied ligands are those containing polar sulfonate groups.

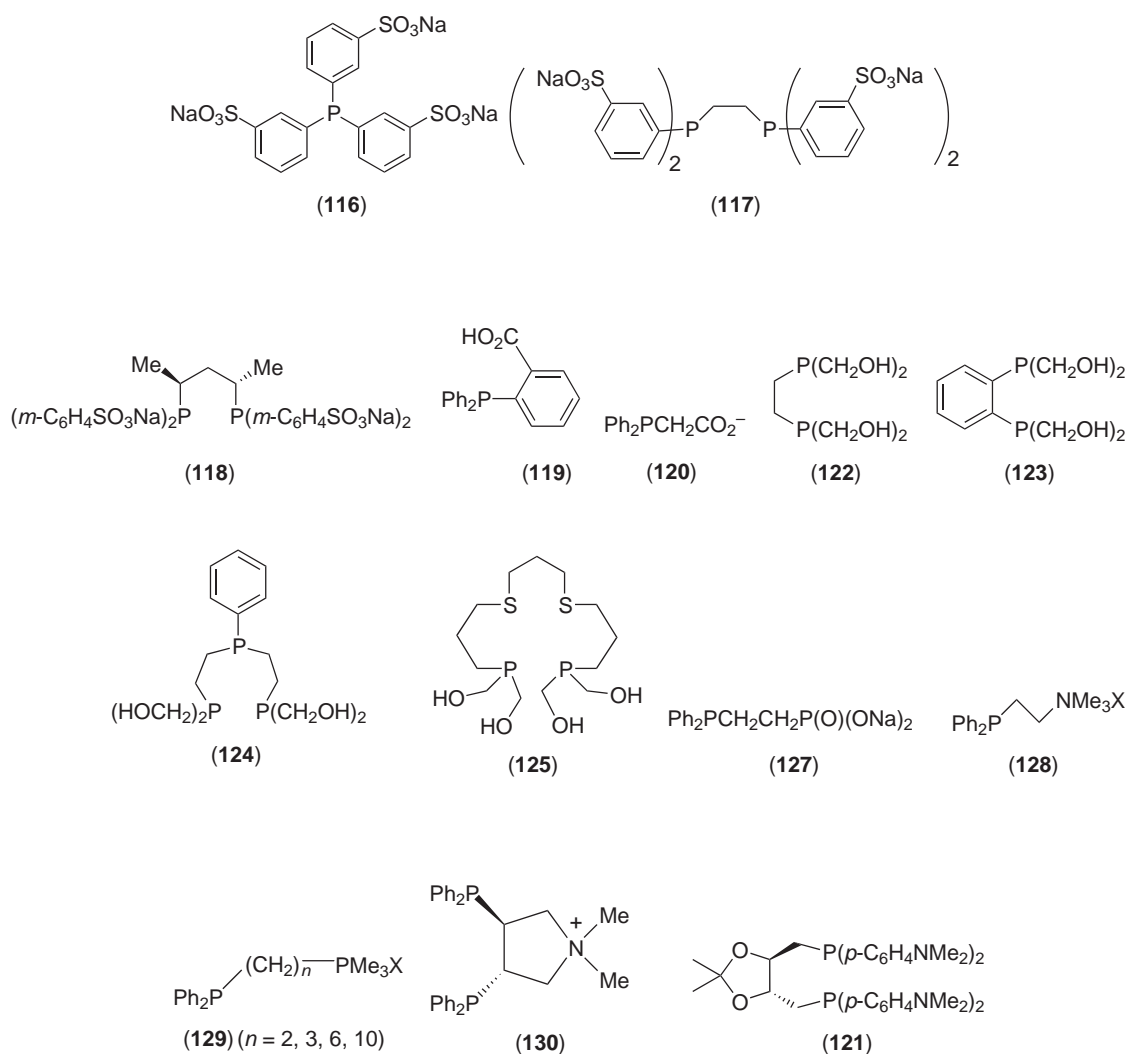
#### 1.12.2.9.1 Synthetic routes to water-soluble tertiary phosphines

Sulfonation of triarylphosphines is a good procedure for preparing aqueous soluble phosphines. The mono-sulfonated triphenylphosphine (115) (frequently abbreviated as TPPMS) ( $\delta(\text{P})$  –4 ppm ( $\text{D}_2\text{O}$ )) is readily prepared from  $\text{PPh}_3$  and fuming sulfuric acid, followed by neutralization with NaOH solution (Equation (29)).<sup>238</sup> The sodium salt has an approximate solubility of  $12\text{ g L}^{-1}$  in water at room temperature and is virtually insoluble in most common organic solvents.

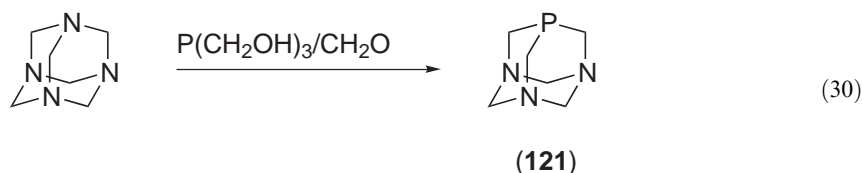


The di-(TPPDS)<sup>239</sup> and tri-sulfonated phosphines (116) (Scheme 8) (TPPTS)<sup>239</sup> are also known, the latter being the most widely used water-solubilizing phosphine ligand, as of 2002. The synthesis of (116) is ostensibly similar to that of (115), although more recently it has been shown that addition of orthoboric acid to the sulfonation mixture reduces the amount of tertiary phosphine oxide side products.<sup>240</sup> This general sulfonation procedure has been used for the preparation of various ditertiary (e.g., (117))<sup>241,242</sup> and chiral sulfonated phosphines (e.g., (118)).<sup>241,243–245</sup> Carboxylic acid- and carboxylate-modified phosphines (e.g., (119) and (120)) are also known.<sup>246,247</sup>

The compound 1,3,5-triaza-7-phosphaadamantane (121) is a neutral, water-soluble compound, by virtue of hydrogen bonding to the tertiary nitrogen atoms, and may be synthesized according to Equation (30).<sup>248</sup> Here  $\text{P}(\text{CH}_2\text{OH})_3$  (52) is used as a convenient source of introducing a phosphorus atom into the adamantane framework.

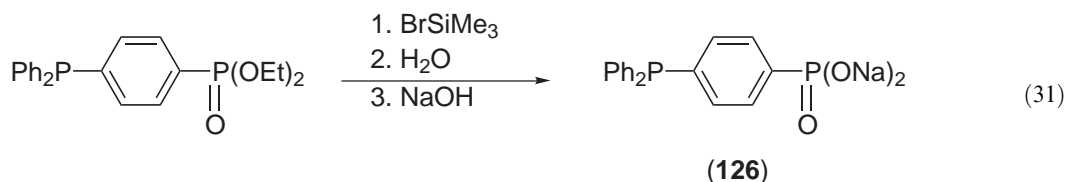


Scheme 8



Hydroxy-functionalized tertiary phosphines also display good water solubility, as demonstrated by the groups of Pringle and Katti. The nonionic alkylphosphine (**52**) has been known since the 1970s and gave the first examples of water-soluble phosphine complexes. Pringle and co-workers found that (**52**) ( $\delta(\text{P}) -24$  ppm) is formed (see Section 1.12.2.4.6) when  $\text{PH}_3$  is bubbled through an aqueous solution of formaldehyde in the presence of various platinum-based catalysts (some of those complexed with (**52**)).<sup>80–82</sup> Katti<sup>33</sup> prepared a wide range of water-soluble ligands, e.g., (**122**)–(**125**), using a formylation approach. Both (**121**) and (**52**) are often regarded as water-soluble analogs of  $\text{PMe}_3$ .

New hybrid phosphine aryl and alkylphosphonate ligands (**126**) (Equation (31)) and (**127**), respectively, were prepared via transesterification with  $\text{XSiMe}_3$  ( $\text{X} = \text{Br}, \text{Cl}$ ) and subsequent hydrolysis under mild conditions.<sup>249,250</sup>



The incorporation of an alkylammonium group can readily be achieved, as for **(128)**, by reduction of the protected tertiary phosphine (as its oxide) with  $\text{HSiCl}_3$ .<sup>251</sup> The analogous phosphonium salt **(129)** is also known.<sup>252</sup> The chiral quaternized phosphine **(130)** has been documented,<sup>253</sup> whilst protonation of the rhodium(I) complex containing **(131)** with aqueous  $\text{HBF}_4$  gave a water-soluble complex.<sup>254</sup> Addition of a weak base ( $\text{NEt}_3$ ) cleanly reversed this reaction.

#### 1.12.2.9.2 Coordination chemistry of water-soluble tertiary phosphines

Various Ru, Rh, and Ir complexes of **(115)**,<sup>238,255,256</sup> Co, Rh, Ni, Pd, Pt, Cu, and Ag complexes of **(116)**,<sup>239,256–260</sup> and complexes with other sulfonated phosphines<sup>242,261</sup> have been reported. The coordination chemistry of **(121)** has also received widespread attention, with complexes known for Re, Ru, Ir, Ni, Pd, and Pt.<sup>262–268</sup>

#### 1.12.2.9.3 Catalytic applications of metal complexes with water-soluble tertiary phosphines

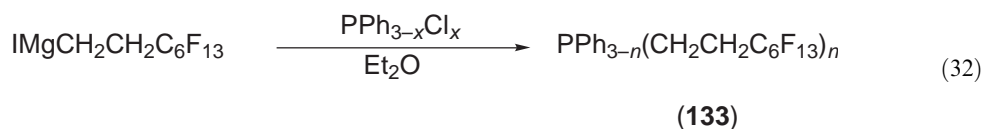
Important applications in homogeneous catalysis are also possible using water as an environmentally benign solvent. The most widely studied tertiary phosphines are those with sulfonate groups since they resemble triphenylphosphine, albeit with water-solubilizing properties. Transition-metal complexes with TPPMS, TPPTS, or other tertiary phosphines bearing sulfonate groups have been used as catalysts for transformations including (asymmetric) hydrogenations,<sup>243,244,268</sup> olefin metathesis,<sup>269</sup> hydrocarboxylation of vinyl arenes and alkenes,<sup>270,273</sup> hydroformylation,<sup>271</sup> hydration of nitriles,<sup>272</sup> and copolymerizations.<sup>274</sup> The Ruhrchemie/Rhône-Poulenc process for production of butyraldehyde uses rhodium(I)-based catalysts containing **(116)**.<sup>237</sup> The trialkylphosphine **(121)** is also a reasonably active catalyst for the selective hydrogenation of unsaturated aldehydes to unsaturated alcohols.<sup>265</sup> Water-soluble complexes of **(52)** are efficient catalysts for the hydrophosphination of formaldehyde, hydrogenation of cinnamaldehyde, and hydroformylation of pent-1-ene.<sup>80–82,275</sup>

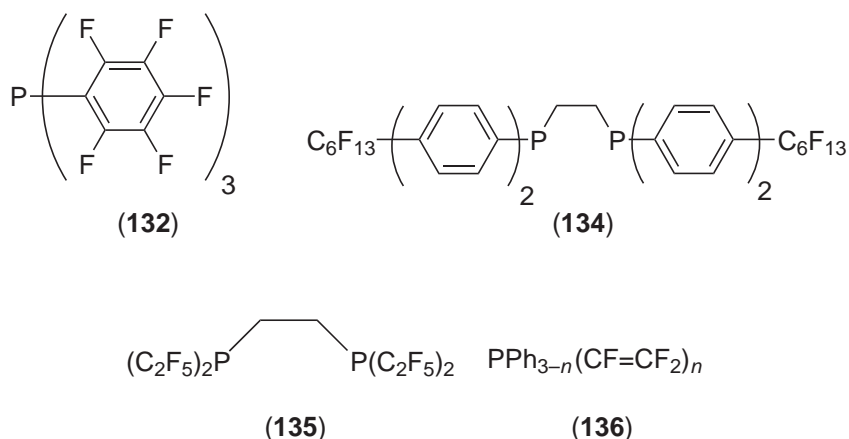
### 1.12.2.10 Fluorinated Tertiary Phosphines

#### 1.12.2.10.1 Synthetic routes to fluorinated tertiary phosphines

The surge in interest, in the early 2000s, in fluorinated derivatives of trivalent phosphorus(III) compounds has stemmed primarily from the ease with which catalysts can be recovered using fluorinated biphasic separation methods. Preparative routes to highly fluorinated-soluble analogs, of those more commonly used in classic organic-based solvents, are based on those general methods illustrated in Sections 1.12.2.4.1 and 1.12.2.4.2.

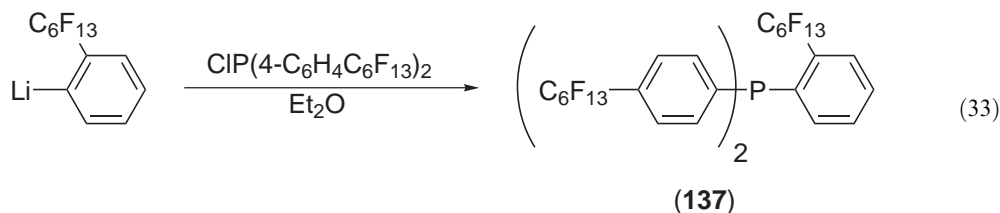
The fluorine-substituted tertiary phosphine  $\text{P}(\text{C}_6\text{F}_5)_3$  **(132)** (Scheme 9) was prepared by the reaction of  $\text{C}_6\text{F}_5\text{MgBr}$  and  $\text{PCl}_3$  in diethyl ether.<sup>276</sup> This procedure was also extended to the preparation of phosphorus(III) ligands with fluorinated ponytails such as  $\text{PPh}_{3-n}(\text{CH}_2\text{CH}_2\text{C}_6\text{F}_{13})_n$  ( $n = 1-3$ , **(133)**) (Equation (32)) and the ditertiary phosphine **(134)**.<sup>277,278</sup>





Scheme 9

By far the most widely used method for the preparation of fluorinated tertiary phosphines is from the organolithium reagent and the appropriate chlorophosphine. The perfluoroethyl (**135**) and perfluorovinyl (**136**) phosphines were prepared by metal–halogen exchange at low temperatures, followed by quenching with either  $\text{PPh}_{3-n}\text{Cl}_n$  ( $n = 1-3$ ) or the tetrachlorophosphine  $\text{Cl}_2\text{P}(\text{CH}_2)_2\text{PCl}_2$ .<sup>279,280</sup> The unsymmetrical triarylphosphine (**137**) was prepared likewise, as shown in Equation (33).<sup>281</sup>

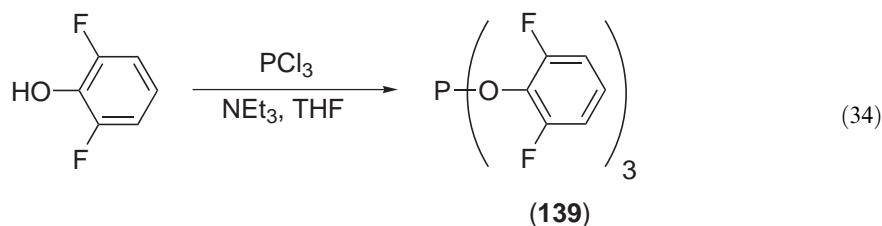


The above strategies have also been used in the preparation of a wide range of other fluorinated tertiary phosphines.<sup>282–288</sup>

It is also interesting to note that hydrophosphination reactions can be used to generate fluorinated trialkylphosphines in high yields. Hence convenient multigram syntheses of the symmetrically substituted fluorinated trialkylphosphines  $\text{P}(\text{CH}_2\text{CH}_2\text{Rf})_3$  (**138**) by free-radical chain reaction of  $\text{PH}_3$  to the corresponding alkenes  $\text{H}_2\text{C}=\text{CH}(\text{CH}_2)_{m-2}\text{Rf}_n$  have been described.<sup>289,290</sup>

Notably, the only other routine method for preparing fluorinated phosphorus(III) ligands involves reduction of the corresponding tertiary phosphine oxide with  $\text{HSiCl}_3/\text{NEt}_3$ .<sup>291,292</sup>

By using methods related to those employed for the synthesis of phosphorus compounds containing P–O bonds (see Section 1.12.2.13.1), a variety of fluorinated phosphinite,<sup>293,294</sup> phosphonite,<sup>294</sup> and phosphites<sup>295–298</sup> have been prepared. An illustrative example (Equation (34)) is given for (**139**) ( $\delta(\text{P})$  132 ppm, septet,  $^4J(\text{PF})$  34 Hz).<sup>295</sup>



#### 1.12.2.10.2 Coordination chemistry of fluorinated tertiary phosphines and catalytic applications

The coordination chemistry of many of these ligands has focused predominantly on those metals which have been shown to display important catalytic properties.<sup>299,300</sup> Fluorinated phosphines

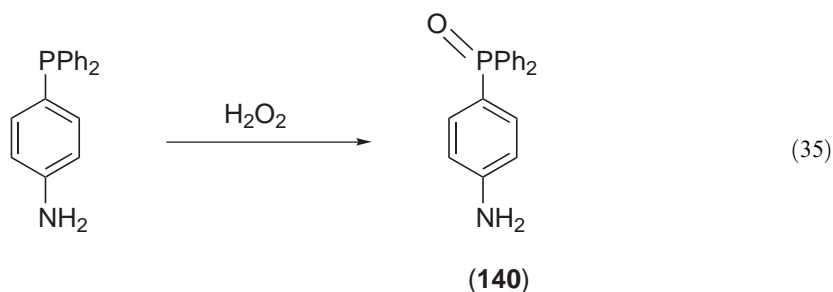
have been used in hydrogenation, hydroformylation, hydroboration, and C—C bond-forming reactions.<sup>281</sup>

### 1.12.2.11 Tertiary Phosphine Oxides

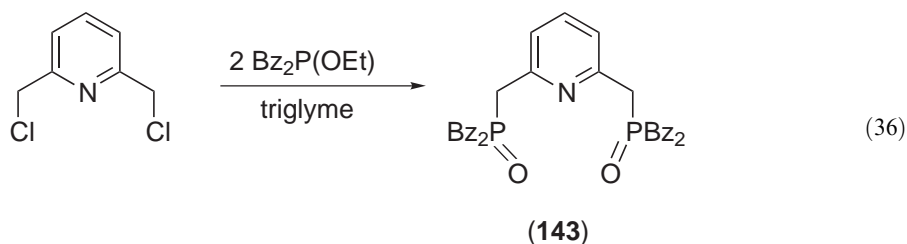
Tertiary phosphine oxides are extremely stable and show contrasting reactivity behavior, reflecting the nature of the oxygen donor atom. The volume of known phosphine oxides is immense, and the purpose of this section is to give some examples to illustrate how they are synthesized, some brief coordination compounds, and applications of the oxides and their complexes. The phosphine oxide group, like other oxygen or nitrogen functional groups, can often render such ligands as hemilabile and this property has been exploited in catalysis.<sup>301</sup> For a more comprehensive overview of this topic the reader should consult ref. 3.

#### 1.12.2.11.1 Synthesis of tertiary phosphine oxides

Various strategies exist for the preparation of alkyl- or aryl-substituted tertiary phosphines. Direct oxidation of alkyl-substituted phosphines by exposure to air is not practical since side products with P—O—C bonds might be formed.<sup>3</sup> A few illustrative examples highlight the different routes that may be used. Arylphosphine oxides (e.g., **(140)**) can be made using aqueous H<sub>2</sub>O<sub>2</sub> in diethylether as solvent (Equation (35)).<sup>302</sup> The same procedure (aq. H<sub>2</sub>O<sub>2</sub>, THF, 0 °C) can be used to prepare **(141)** (Scheme 10) in 49% yield; the dioxide **(142)** can easily be separated from **(141)** by virtue of its poor solubility in THF.<sup>303</sup>

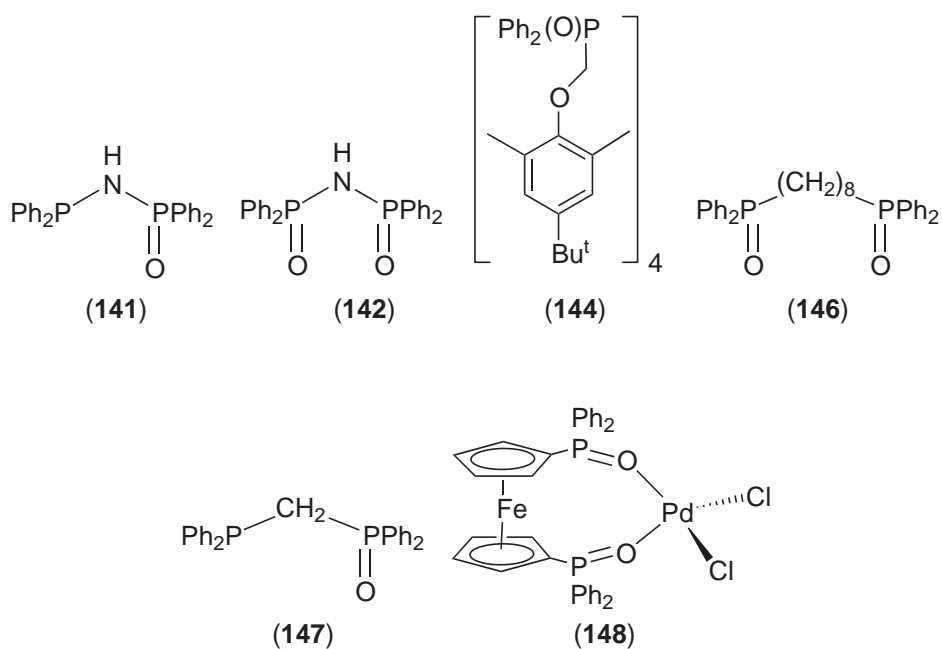


Arbusov and Michaelis–Becker reactions are frequently used to prepare organophosphonates and phosphine oxides. Hence **(143)** (R = Bz) can be prepared in 67% yield by an Arbusov reaction (Equation (36)), whilst other derivatives can be prepared by reaction of the preformed Grignard reagent R<sub>2</sub>P(O)MgBr (R = Et, Pr, Bu, Tol, etc.).<sup>304</sup> Alternatively phosphorus oxychloride can be used to prepare symmetrical phosphine oxides. However, reactions with organometallics can be sluggish and do not always give high yields. The tetrasubstituted calix[4]arene **(144)** can be prepared by initial treatment of *para-tert*-butylcalix[4]arene with NaH, then reaction with the highly reactive tosylated phosphine oxide Ph<sub>2</sub>P(O)CH<sub>2</sub>O<sub>3</sub>SC<sub>6</sub>H<sub>4</sub>Me-*p*.<sup>305</sup>



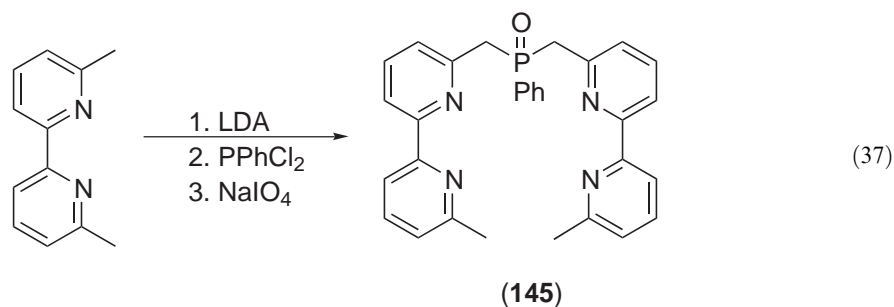
Ligand **(145)** (Equation (37)) can be prepared by lithiation of 6,6'-dimethyl-2,2'-bipyridine with LDA, quenching with ClPPh<sub>2</sub>, and oxidation with NaIO<sub>4</sub> under phase-transfer conditions.<sup>306</sup>

Another way to use tertiary phosphines as precursors for phosphine oxides is to quaternize them with alkyl halides and then decompose the quaternary ion by alkaline hydrolysis (usually



Scheme 10

20–40% NaOH). One of the *P*-substituents is eliminated as the hydrocarbon and the tertiary phosphine oxide is formed. Purification can be achieved by recrystallization or chromatography, as illustrated by the synthesis of (146).<sup>307</sup>



One problem, as shown by the synthesis of (141), is the poor control over double oxidation of both phosphorus centers when preparing mixed phosphine–phosphine oxide ligands. One attractive solution, developed by Grushin, is a catalytic method using simple Pd(II) salts, 1,2-dibromoethane under biphasic conditions. In this manner (147) was prepared in high yield (>70%).<sup>308</sup>

Unsymmetrical phosphorus ligands  $\text{Ph}_2\text{P}(\text{X})\text{CH}_2\text{P}(\text{Y})\text{Ph}_2$  (where X, Y = lone pair, O, S, or Se combinations) have been synthesized.<sup>309</sup>

#### 1.12.2.11.2 Properties of tertiary phosphine oxides

Tertiary phosphine oxides are crystalline, nontoxic solids, and in general easy to handle. Phosphine oxides are highly polar and some display high solubility in water. Tertiary phosphine oxides can be reduced to phosphines using  $\text{Si}_2\text{Cl}_6$  (or  $\text{HSiCl}_3$ ) and this constitutes an important route to these compounds (see Section 1.12.2.4.5(i)). The oxygen atom of phosphine oxides can be exchanged for sulfur using Lawesson's reagent. Alternatively, tertiary phosphine sulfides can be prepared from the tertiary phosphine and elemental sulfur.



### 1.12.2.11.3 Coordination chemistry and catalytic uses

The coordination properties of phosphine oxides has been explored with late transition-metal (Ru, Co, Rh, Ir, Pd, Pt, Cu, and Au),<sup>301,303,305,306,310-316</sup> early transition-metal,<sup>317</sup> lanthanide,<sup>304,318,319</sup> and actinide<sup>307,320</sup> ions. One interesting complex is the palladium(II) complex (**148**) (Scheme 10) which is an extremely rare example of a  $d^8$  metal center with a tetrahedral geometry.<sup>313</sup> Phosphine oxides have found uses in the extraction of alkali, alkaline earth, and actinide metals;<sup>321</sup> in catalysis (hydroformylation of alkenes<sup>322,323</sup> and epoxides,<sup>314</sup> carbonylation of methanol<sup>324</sup>); and as a useful crystallization aid ( $\text{Ph}_3\text{PO}$ ).<sup>325</sup>

### 1.12.2.12 Chiral Phosphorus-based Ligands

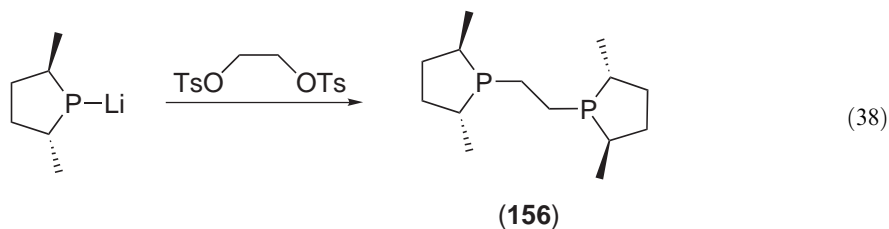
#### 1.12.2.12.1 Synthetic routes

Optically active phosphines are of great interest, primarily for their use as ligands in metal coordination chemistry and catalysts for various asymmetric syntheses. Chiral phosphines may derive their chirality by virtue of having either a chiral center at phosphorus or at another atom, usually carbon. A range of different synthetic routes have been used to synthesize optically active phosphines, many of which have their chirality not located at phosphorus. Prior to 1980 chiral diphosphines described in the literature included, e.g., skewphos, norphos, chiraphos, diop, and others. Since then there has been a significant surge in the number of chiral ligands, only a selection of which are described briefly here. Many of the synthetic routes are ostensibly similar to those outlined before and illustrative examples only will be given.

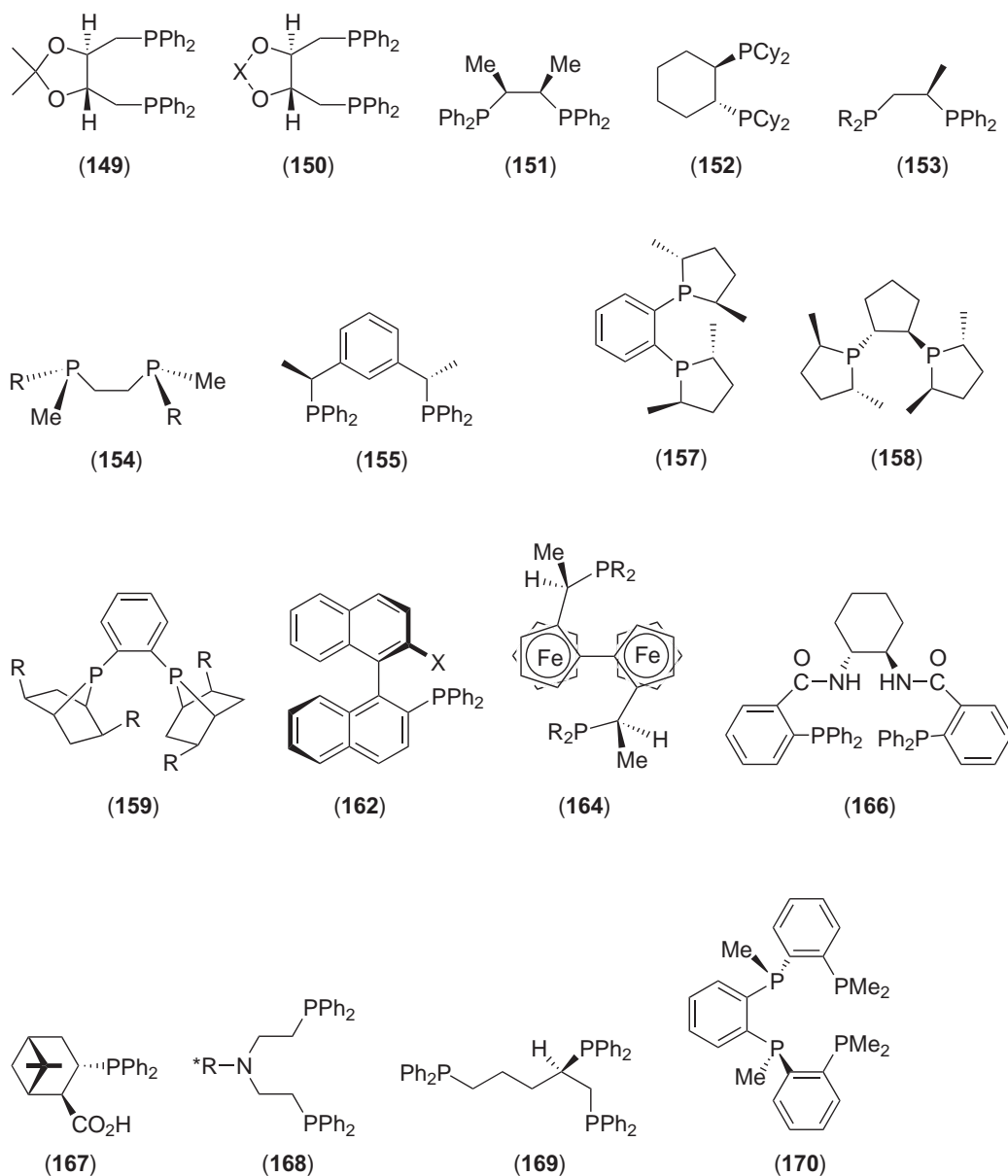
A new synthesis of Diop (**149**) (Scheme 11) has recently been reported and found to give a yield of 56%.<sup>326</sup> Various derivatives of Diop (e.g., (**150**)) have been prepared by reaction of the corresponding diol with  $\text{Cl}_2\text{X}$  (X = BPh, P(O-naphthyl), P(O)NMe<sub>2</sub>).<sup>327,328</sup> New routes to Chiraphos (**151**) have been described<sup>329,330</sup> and, in one procedure, involve reaction of the methanesulfonate  $\text{CH}_3\text{CH}(\text{OSO}_2\text{CH}_3)\text{CH}(\text{OSO}_2\text{CH}_3)\text{CH}_3$  with  $\text{KPPh}_2$  in THF, complexation to  $\text{Ni}(\text{NCS})_2$  in EtOH, and decomplexation with NaCN in EtOH/H<sub>2</sub>O to give pure *S,S*-chiraphos.<sup>330</sup>

A range of new chiral diphosphines with an alkyl backbone have been described in the literature. Various routes have been employed, including the reduction of a phosphine oxide with  $\text{HSiCl}_3$  (autoclave, 14 h, toluene) for (**152**);<sup>331</sup> ring opening of a cyclic sulfate with  $\text{R}'_2\text{PLi}$  then addition of a second nucleophile  $\text{R}''_2\text{PLi}$  for (**153**);<sup>332</sup> and the oxidative coupling of  $\text{P}(\text{BH}_3)\text{RMe}_2$ <sup>333</sup> or alkylation of  $\text{LiP}(\text{BH}_3)\text{PPh}_2$ <sup>334</sup> to afford (**154**) or (**155**), respectively. Other ligands prepared by this last route have also been reported.<sup>335,336</sup>

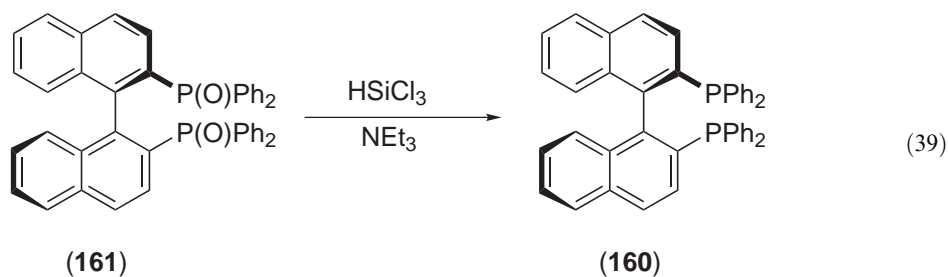
An important class of chiral ligands includes the chiral didentate 2,5-disubstituted phospholanes (e.g., (**156**), (**157**)).<sup>337</sup> Reaction of the lithium phosphide with the ditosylate of ethylene glycol in THF gave (**156**) (Equation (38)).<sup>337</sup> Various other examples of bisphospholanes (e.g., (**158**))<sup>338-344</sup> (including functionalized<sup>339,340</sup> and those with chirality in the acyclic backbone<sup>341</sup>) and other bulkier, more rigid ligands, e.g., (**159**),<sup>345</sup> have been prepared by standard synthetic procedures.



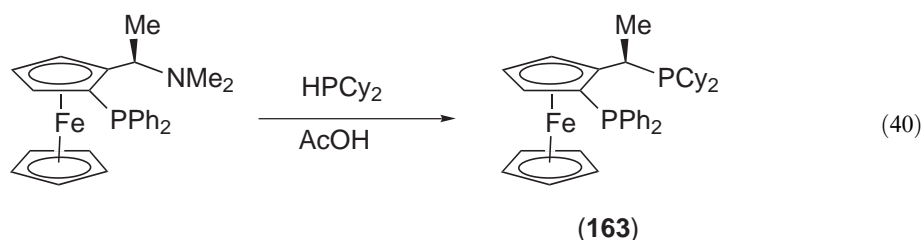
One of the most successful chiral ligands used extensively in asymmetric catalysis is BINAP (**160**). This has been obtained in optically pure form by resolution of racemic BINAPO (**161**) with camphorsulfonic acid or 2,3-di-*o*-benzoyltartaric acid. The final step involves reduction of the resolved BINAPO with  $\text{SiHCl}_3$  and  $\text{NEt}_3$  in xylenes (Equation (39)).<sup>346,347</sup> Alternatively (**160**) has been prepared in 75% yield via a novel, nickel-catalyzed coupling reaction using a chiral ditriflate of binaphthol,  $\text{PPh}_2\text{H}$ , and  $\text{NiCl}_2(\text{dppe})$  as catalyst.<sup>348</sup> Partially hydrogenated analogs of (**160**) have been prepared,<sup>349</sup> along with numerous examples of optically active monophosphine compounds with various functional groups, e.g., (**162**).<sup>350-357</sup>



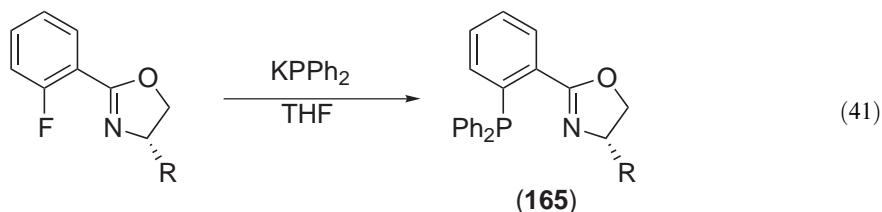
Scheme 11



The synthesis and application of chiral ferrocene derivatives has attracted much interest.<sup>358</sup> Hence the ferrocenyldiphosphine (163) (Josiphos) can be prepared by direct HPR<sub>2</sub> substitution of the dimethylamino group (Equation (40)).<sup>359</sup> Various other ferrocene-based chiral ligands are known (e.g., the TRAP ligands (164)).<sup>360–364</sup>



Another important type of chiral phosphine ligand that continues to attract much interest is the phosphinoxazolines.<sup>365</sup> Numerous strategies exist for the introduction of an oxazoline group; one example is shown in Equation (41) for the preparation of (165). The versatile oxazoline group has also been used for the synthesis of, amongst others, ferrocenylphosphine,<sup>369–371</sup> binaphthylphosphine,<sup>372,373</sup> phosphinite-<sup>374</sup> and phosphonite-based<sup>375</sup> chiral ligands.



Other chiral ligands to highlight include those prepared by Trost (e.g., (166)),<sup>376</sup> chiral  $\beta$ -phosphinocarboxylic acids (167),<sup>377</sup> the aminodiphosphine (168),<sup>378</sup> and the poly(tertiary) phosphines (169)<sup>379</sup> and (170) (Scheme 11).<sup>380</sup> Although far from exhaustive, this section summarizes just some of the chiral ligands reported to date.

#### 1.12.2.12.2 Coordination chemistry and catalytic applications of metal complexes with chiral tertiary phosphines

The coordination chemistry of many chiral ligands is directed towards preparing complexes with catalytically useful metals, most notably late transition metals. Some Rh, Pd, Pt, and Ag complexes of Diop (149) (and also (150)) have been described,<sup>327,328,381,382</sup> along with the use of palladium Diop complexes in asymmetric palladium catalysed cross-couplings<sup>383</sup> and alkene hydrocyanation reactions.

The Duphos ligand (157) has been used to prepare organometallic complexes of palladium.<sup>385</sup> Rhodium complexes of ligands (156), (157), or (159) are efficient catalysts for enantioselective hydrogenations<sup>337–341,343,345,386–388</sup> and furthermore, in the case of platinum complexes with (157), as catalysts for the asymmetric hydrophosphination of activated olefins.<sup>71</sup>

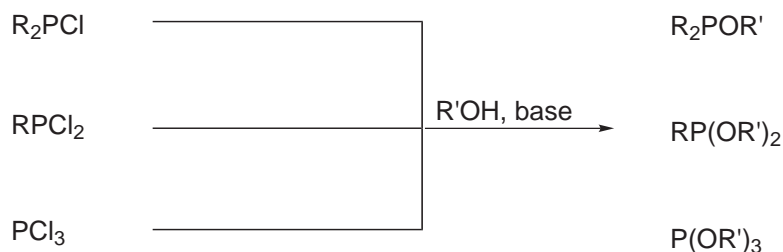
BINAP complexes have been used extensively in asymmetric synthesis, for example in hydrogenations,<sup>389,390</sup> olefin isomerizations,<sup>390</sup> arylation of olefins,<sup>391</sup> and enantioselective allylation of aldehydes.<sup>392</sup> Palladium or platinum complexes of (165) find important applications in enantioselective C—C bond formation,<sup>393–396</sup> whilst iridium complexes are catalysts for the hydrogenation of nonfunctionalized tri- and tetrasubstituted olefins.<sup>397</sup>

#### 1.12.2.13 Phosphinites, Phosphonites, and Phosphites

##### 1.12.2.13.1 Synthesis of phosphinites, phosphonites, and phosphites

By far the most common methods known for the preparation of phosphinites, phosphonites, and phosphites are shown in Figure 5. These will be discussed with appropriate examples given.

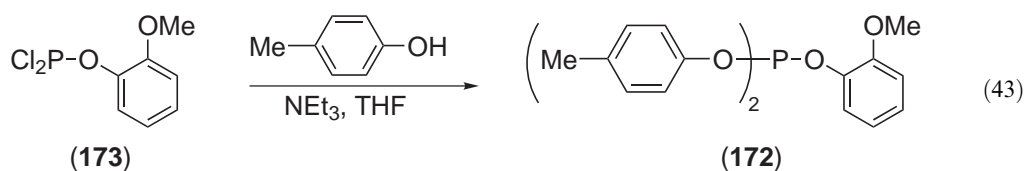
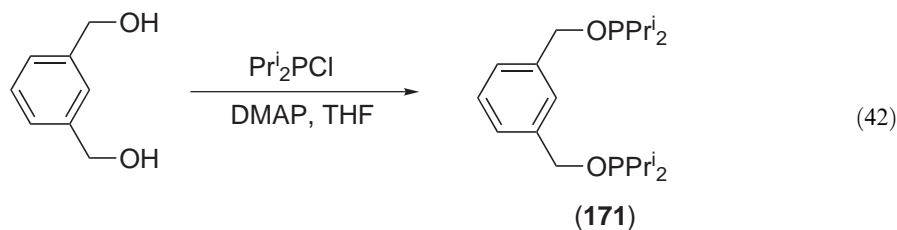
In general, the standard method for P—O bond formation involves reaction of a suitable alcohol precursor and a halogenophosphine (usually a chloro derivative such as  $R_2\text{PCl}$ ,  $\text{RPCl}_2$ , or  $\text{PCl}_3$ ) in the presence of a base (typically  $\text{NEt}_3$  or pyridine) in  $\text{CH}_2\text{Cl}_2$ , toluene,



**Figure 5** Common synthetic routes to phosphonites, phosphinites, and phosphites.

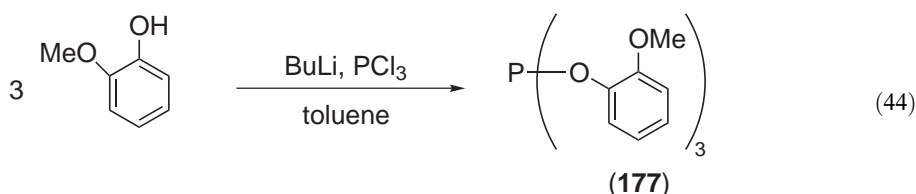
or THF. Reactions are normally complete within hours at room temperature; the ammonium salt byproduct is removed by filtration (usually performed under an inert atmosphere) and the crude material isolated from the filtrate. Recrystallization or chromatography may be required in some cases. Slight variations in experimental procedures have been used and include the use of DMAP (DMAP = 4-dimethylaminopyridine). Yields can often be quantitative.

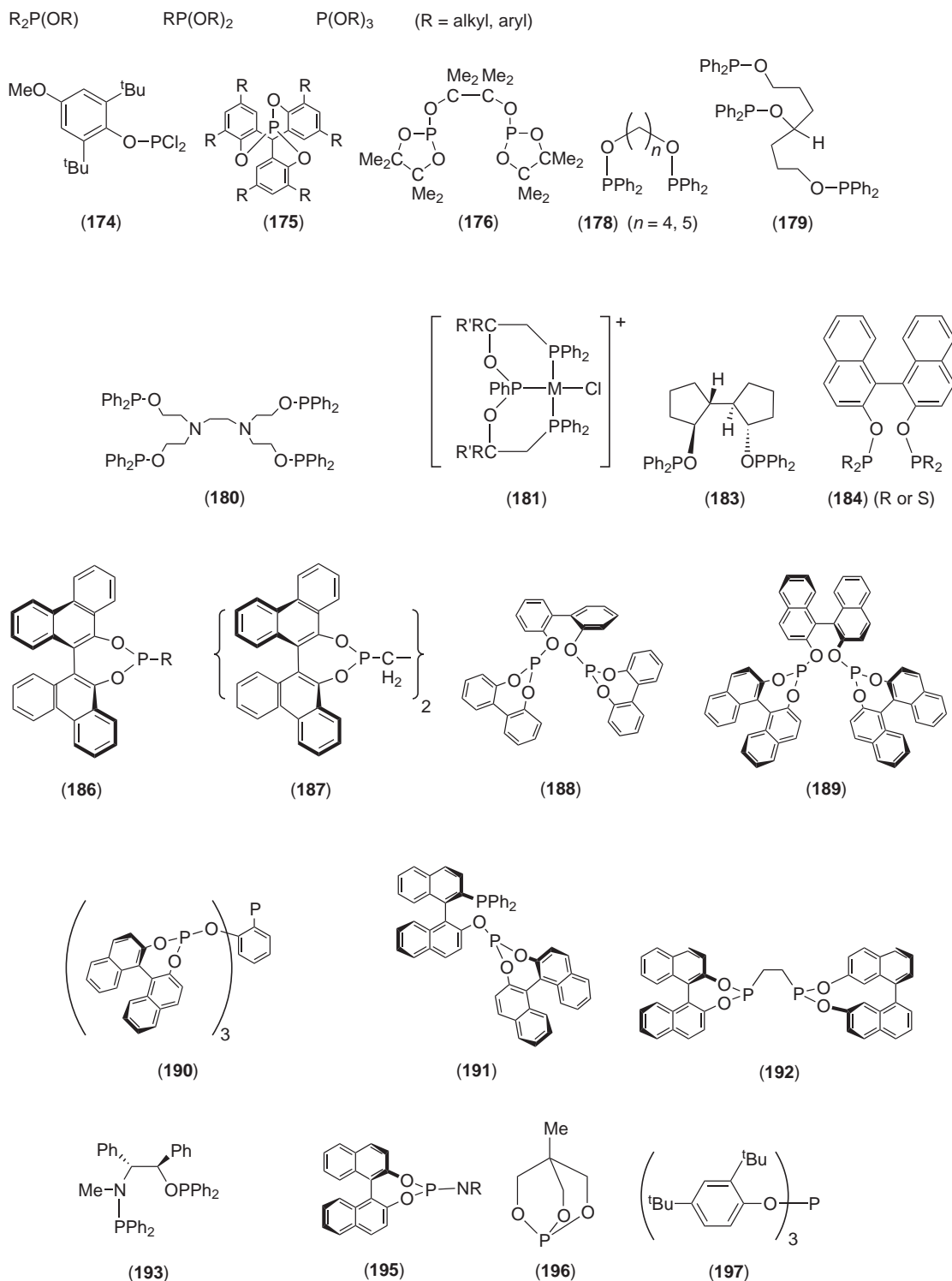
The 1,3-disubstituted phosphinite (**171**) ( $\delta(\text{P}) - 149$  ppm) can be prepared by reaction of the precursor diol with two equivalents of  $\text{Pr}^i_2\text{PCI}$  in THF with DMAP (Equation (42)).<sup>398</sup> The unsymmetrical tertiary phosphite (**172**) was synthesized by reaction of two equivalents of phenol with the dichloroprecursor (**173**) (Equation (43)).<sup>399</sup> Similar to (**173**) is (**174**) (Scheme 12), prepared by stoichiometric reaction of the trisubstituted phenol and  $\text{PCl}_3$ .<sup>400</sup> This general approach was also employed in the preparation of the  $\text{C}_3$ -symmetric phosphite (**175**).<sup>401</sup> The cyclic phosphite (**175**) is remarkably stable with respect to oxidation. Even after reflux in toluene or acetone/water in the presence of air for 24 h, no decomposition was observed, strongly contrasting with the behavior of  $\text{P}(\text{OPh})_3$ . Phosphite (**175**) displays very good stability to hydrolysis.



The chelating bis(phosphite) (**176**) was synthesized by condensation of  $\text{PCl}_3$  with  $\text{HO}(\text{CMe}_2)_2\text{OH}$  in diethyl ether in the presence of *N,N*-dimethylaniline.<sup>402</sup> Sterically congested bis(phosphites) have also been described.<sup>403</sup>

Functionalized phosphates, e.g., (**177**) can be prepared in 89% yield, initially by making the lithio salt of 2-methoxy phenol with  $\text{BuLi}$  in toluene, followed by addition of phosphorus trichloride in toluene (Equation (44)).<sup>399</sup>

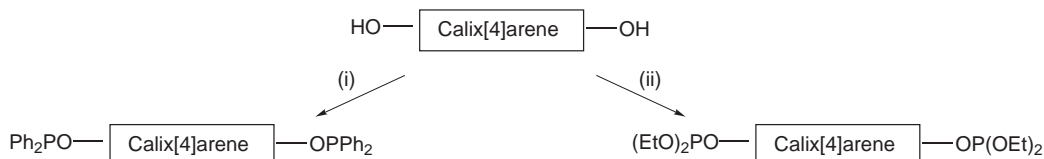




Scheme 12

A series of calix[4]arene-derived mono- and diphosphinites, and also diphosphites (Figure 6), have been prepared by reacting the dihydroxy precursors with BuLi, then addition of  $\text{Ph}_2\text{PCl}$  or  $(\text{EtO})_2\text{PCl}$  in THF.<sup>400,404,405</sup>

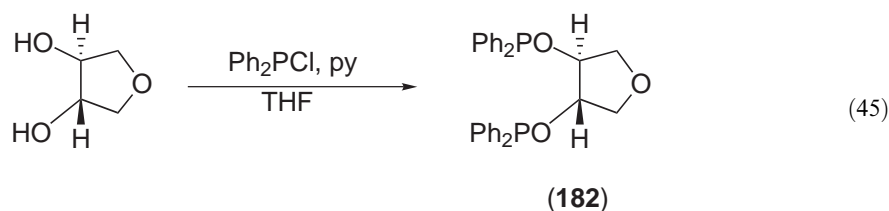
Schwartz reagent  $[\text{Cp}_2\text{ZrHCl}]_n$  has been used for the preparation of a series of di- (178), tri- (179), and tetraphosphinites (180) via mild cleavage of various lactones and anhydrides.<sup>406</sup> This reagent



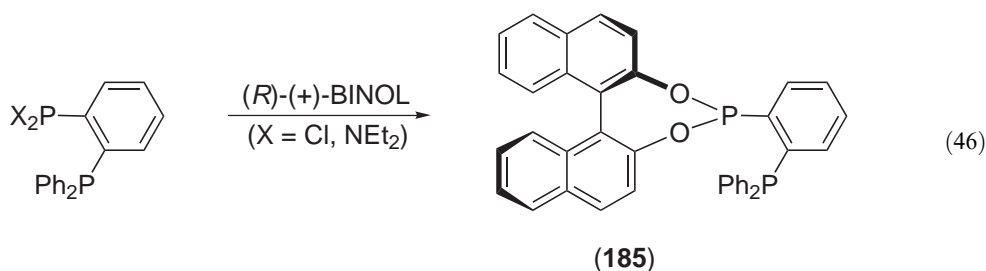
**Figure 6** (i) BuLi, Ph<sub>2</sub>PCL, THF; (ii) BuLi, (EtO)<sub>2</sub>PCL, THF.

has also been used for the synthesis of other phosphorus(III) compounds.<sup>407</sup> Finally a metal-temple synthesis has been used in the synthesis of diphosphine-phosphonite PhP(OCR'R'/CH<sub>2</sub>PPh<sub>2</sub>)<sub>2</sub> (R, R' = H, Me) ligands coordinated at Pt, Pd, or Ni metal centers (**181**).<sup>408</sup>

A significant development that has received widespread attention is the synthesis of new mono- and bis-substituted chiral phosphinite, phosphonite, and phosphite ligands. The standard protocol for their syntheses is based on that illustrated in Figure 5. For example, the synthesis of the chiral diphosphinite (**182**)<sup>409</sup> is shown in Equation (45), this basic procedure working extremely well for other chiral diphosphinites such as (**183**) and (**184**).<sup>410,411</sup>

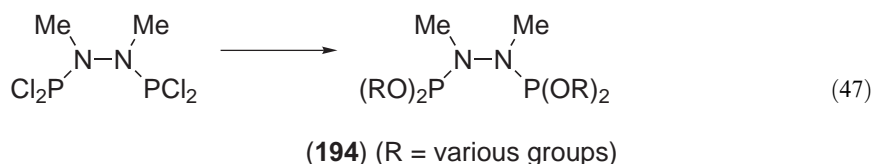


This procedure has also been extended to the synthesis of phosphine-phosphonites (e.g., (**185**),<sup>412,413</sup> Equation (46)), and very recently (2000) an elegant series of monodentate biarylphosphonites (**186**) and (**187**).<sup>414</sup>



Chiral chelating phosphites such as (**188**)–(**191**)<sup>415–419</sup> (and others<sup>420,421</sup>) are readily accessible from the appropriate alcohol and chloro precursors using NEt<sub>3</sub> as base in ether or THF. Alternatively treatment of (Et<sub>2</sub>N)<sub>2</sub>PCH<sub>2</sub>CH<sub>2</sub>P(NEt<sub>2</sub>)<sub>2</sub> with (*R*)-(+)-BINOL in THF gave (**192**) in good yield.<sup>422</sup>

Achiral and chiral compounds containing mixed P–O/P–N combinations (e.g., (**193**)–(**195**)) are known and their syntheses are ostensibly identical to those described previously (Equation (47) for (**194**)).<sup>21,423,424</sup>



### 1.12.2.13.2 Coordination chemistry

The coordination chemistry of phosphorus(III) ligands bearing P–O connectivities has been studied, although significantly less than that of tertiary phosphines. Recently the tied-back phosphite (**196**) (Scheme 12) was shown to form various Mn(I) and Re(I) metal carbonyl complexes.<sup>425</sup> Various Mo, Ru, Co, Rh, Ni, Pd, Pt, and Ag complexes containing phosphinite,

phosphonite, or phosphite ligands have been documented.<sup>398,399,401,402,405,408,426</sup> One aspect of coordinated tertiary phosphites that has received some attention is their ability to undergo aromatic C—H activation.<sup>427–431</sup> Hence phosphites such as P(OPh)<sub>3</sub> and **(197)** undergo cyclometallation at Ru, Ir, or Pd metal centers to form orthometallated compounds, the latter being efficient catalysts for C—C coupling reactions.

### 1.12.2.13.3 Catalytic chemistry

Compounds with P—O bonds, primarily tertiary and ditertiary phosphites, have found widespread applications in areas of catalysis (including asymmetric), such as hydrogenation,<sup>410,413,414,422,432–437</sup> hydroformylation,<sup>400,404,419,420,438–440</sup> hydrocyanation,<sup>409,415,416</sup> enantioselective conjugate additions,<sup>417,424</sup> Heck<sup>398</sup> and biaryl couplings,<sup>431</sup> hydrosilylation of ketones<sup>441</sup> and allylic alkylations.<sup>442</sup> Simple trialkyl or triarylphosphite palladium(II) complexes [PdCl<sub>2</sub>L<sub>2</sub>] (L = P(OEt)<sub>3</sub> or P(OPh)<sub>3</sub>) efficiently carbonylate aryl halides in supercritical carbon dioxide.<sup>443</sup>

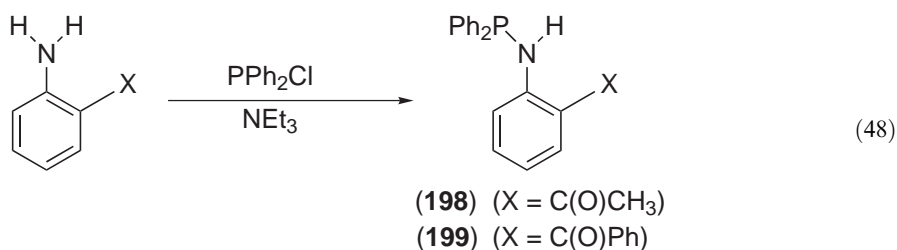
### 1.12.2.14 (Phosphino)amines

(Phosphino)amines, ligands containing one, two or three P—N bonds, have attracted much interest due to their ease of preparation, their diverse coordination chemistry, and their catalytic applications. There are several synthetic routes now available, as highlighted below.

#### 1.12.2.14.1 By aminolysis reactions

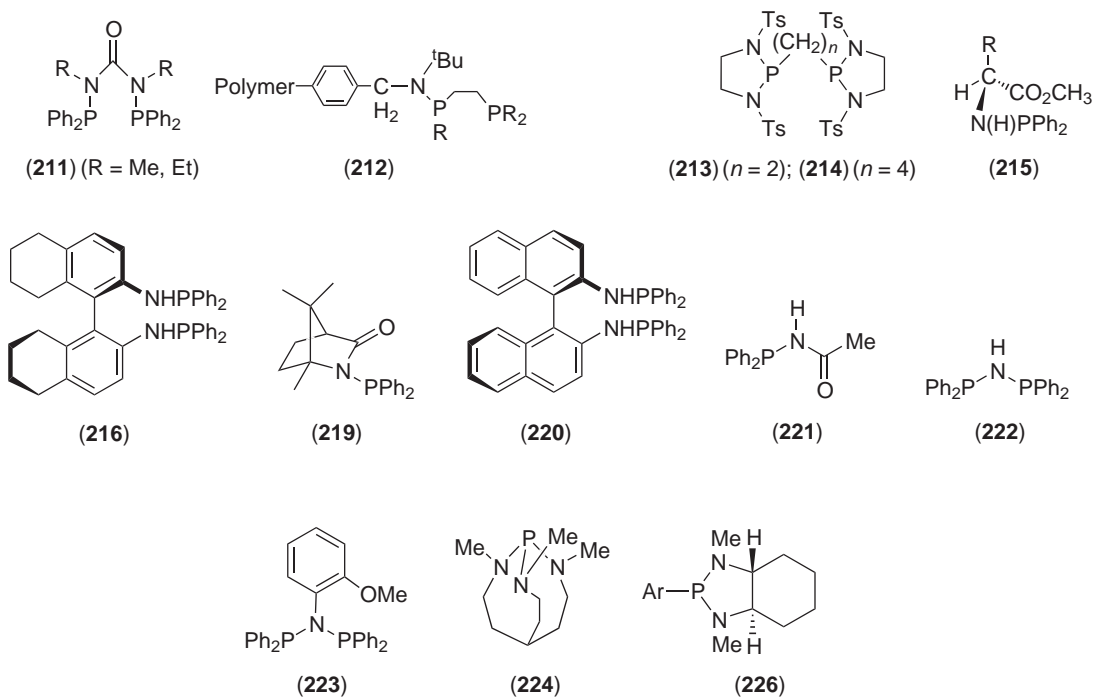
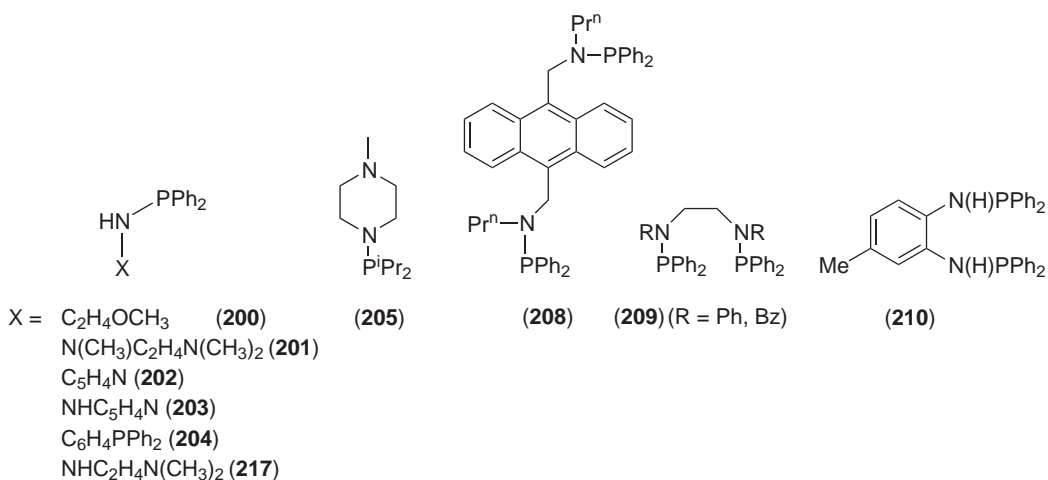
A common synthetic strategy involves reaction of an appropriate chlorophosphine and the amine (primary, secondary, aliphatic, aromatic) in the presence of base (usually triethylamine, pyridine, or DBU (1,8-diazabicyclo[5.4.0]undec-7-ene)). Care is often required during these syntheses to exclude water, thereby preventing the formation of Ph<sub>2</sub>PP(O)Ph<sub>2</sub>. Work-up procedures are similar to those for the preparation of phosphites, phosphonites, etc. and yields are often high. In some cases this strategy may yield mixtures of (phosphino)amines in which both full and partial aminolysis has resulted.

The (phosphino)amines **(198)** and **(199)**, closely related to Ph<sub>2</sub>PN(H)C<sub>6</sub>H<sub>5</sub>, were readily synthesized (Equation (48)) from Ph<sub>2</sub>PCL and *o*-H<sub>2</sub>NC<sub>6</sub>H<sub>4</sub>X (X = C(O)CH<sub>3</sub> or C(O)Ph) in ca. 70% yields (δ(P) ca. 26 ppm).<sup>444</sup> In a similar manner ether- **(200)**,<sup>445</sup> amine- **(201)**,<sup>446</sup> pyridine- **(202)**,<sup>447</sup> hydrazinopyridine- **(203)**,<sup>448</sup> or tertiary phosphine-functionalized **(204)**<sup>449</sup> aminophosphines have also been reported (Scheme 13). Alternatively, dialkylchlorophosphines have been used to prepare bulky electron-rich phosphino(amines) such as **(205)**.<sup>450</sup>

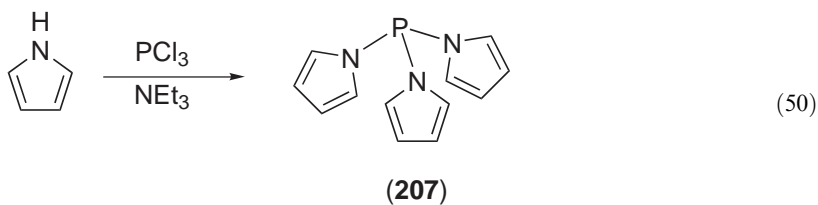
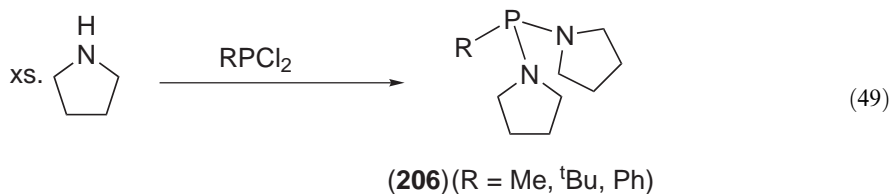


Mono-, bis-, and tris-substituted *N*-pyrrolyl or *N*-pyrrolidine phosphines have recently been described and prepared in excellent yields from pyrrole (or pyrrolidine), a phosphorus halide and base (NEt<sub>3</sub>, pyrrolidine, or DBU), as illustrated by the syntheses of **(206)** (Equation (49)) and **(207)** (Equation (50)).<sup>451–453</sup>

Bis(phosphino)amines **(208)–(211)** were readily prepared by condensation of Ph<sub>2</sub>PCL and the appropriate secondary amine in diethyl ether, tetrahydrofuran, dichloromethane, or benzene, with triethylamine as base.<sup>454–457</sup> Polymer-supported phosphine-phosphino(amines) **(212)** have also been reported.<sup>458</sup> Hersh and co-workers have described a novel series of bis(*p*-toluenesulfonylamino) phosphines **(213)** and **(214)** from bis(dichlorophosphino) starting materials and *N,N'*-(ditoluenesulfonyl)-1,2-diaminoethane.<sup>459</sup>



Scheme 13





Chiral phosphino(amines) based on amino-acid (**215**)<sup>460–462</sup> or partially hydrogenated binaphthyl (**216**)<sup>463</sup> units have been prepared from Ph<sub>2</sub>PCL, the amine precursor (in the case of (**215**) from readily available amino ester hydrochlorides) and triethylamine as base. These compounds can be isolated as (off) white solids or oils in yields of up to 90%.

#### 1.12.2.14.2 From the lithium amide

Simple (phosphino)amines bearing alkyl, aryl, or functional containing groups can readily be prepared using this route. Lithium amides LiN(H)R react readily with chlorophosphines to give new aminophosphines. Deprotonation of the amine at low temperature with BuLi (or other suitable base) and then treatment with Ph<sub>2</sub>PCL has been used as a successful alternative strategy. This procedure works well for the synthesis of Ph<sub>2</sub>PN(H)CH<sub>2</sub>CH<sub>2</sub>NMe<sub>2</sub> (**217**), with none of the bis-substituted product observed.<sup>446</sup>

The bulky aminophosphine (**218**) was obtained from LiN(H)Ph (generated at low temperature) and PMes<sub>2</sub>Cl (Mes = 2,4,6-Me<sub>3</sub>C<sub>6</sub>H<sub>2</sub>) in 80% yield (Equation (51)).<sup>464</sup>



The chiral phosphines (**219**) and (**220**), based on camphor lactam or binaphthyl backbones, were obtained by treatment of the precursor amine with BuLi or NaH, followed by quenching with Ph<sub>2</sub>PCL.<sup>465,466</sup>

#### 1.12.2.14.3 From silylated compounds

An alternative route to condensation with HCl elimination is the use of precursor silyl compounds (here eliminating Me<sub>3</sub>SiCl). Hence reaction of Me<sub>3</sub>SiN(H)COMe with ClPPh<sub>2</sub> in toluene at 60 °C gave Ph<sub>2</sub>PN(H)COMe (**221**) (Scheme 13) in 84% yield.<sup>467</sup>

Probably the most widely studied (phosphino)amine is Ph<sub>2</sub>PN(H)PPh<sub>2</sub> (**222**), which is readily prepared by heating a toluene solution of Me<sub>3</sub>SiN(H)SiMe<sub>3</sub> and Ph<sub>2</sub>PCL.<sup>468</sup> In contrast, bis(phosphino)amines such as (**223**) are accessible via experimental conditions outlined in Section 1.12.2.14.1.<sup>469</sup> Compound (**222**) is a versatile starting material for many other phosphorus(III) and phosphorus(V) compounds and has an extensive coordination chemistry.

#### 1.12.2.14.4 By aminolysis with (dialkylamino)phosphines

The cage compound (**224**) (Scheme 13) was prepared as its chloride cation (**225**) by reaction of {Me(H)NCH<sub>2</sub>CH<sub>2</sub>}<sub>3</sub>N and ClP(NMe<sub>2</sub>)<sub>2</sub> in CH<sub>2</sub>Cl<sub>2</sub> with NEt<sub>3</sub> as base.<sup>470</sup> Heating (**225**) with a large excess of anhydrous NaOH above 200 °C under vacuum gave (**224**) after extraction.

The synthesis of new diazaphospholidines (**226**) by condensation of a diamine with a bis-(dimethylamino)arylphosphine has been described by Wills and co-workers.<sup>471,472</sup>

#### 1.12.2.14.5 Coordination chemistry of (phosphino)amines

The coordination chemistry of (phosphino)amines has received widespread attention, with emphasis on complexes with late transition-metal centers (especially those of Ru, Rh, Pd, Pt, Ag, and Au) but also with Cr, Ni, Cu, Mo, and W. Recently the homoleptic complex [Ni{Ph<sub>2</sub>PN(H)Ph}<sub>4</sub>] was described and prepared by the reaction of NiCl<sub>2</sub>·6H<sub>2</sub>O with Ph<sub>2</sub>PN(H)Ph in the presence of zinc dust.<sup>473</sup> Of particular interest is Ph<sub>2</sub>PN(H)PPh<sub>2</sub> (**222**), which has been extensively studied.<sup>474–477</sup>

One particularly interesting reaction of coordinated (phosphino)amines is their ability to undergo orthometallation, as observed for ligands (**198**) and (**199**) at platinum(II) and rhodium(III) metal centers.<sup>444</sup> These constitute the first examples of CH activation of a (phosphino)amine, in

contrast to numerous examples known for tertiary phosphines, and to a lesser extent, tertiary phosphites.

#### 1.12.2.14.6 Catalytic applications of metal complexes with (phosphino)amines

(Phosphino)amines and their complexes have been shown to be efficient catalysts for the palladium-catalyzed Suzuki coupling reaction of chloroarenes,<sup>449</sup> rhodium-catalyzed hydroformylations<sup>458</sup> and asymmetric hydrogenations,<sup>463,466</sup> allylic substitution reactions,<sup>471,472</sup> conversion of isocyanates to isocyanurates,<sup>478</sup> and as ethylene polymerization catalysts.<sup>479</sup>

### 1.12.3 CONCLUSIONS AND OUTLOOK

The synthesis and characterization of phosphorus-based ligands continues to receive considerable attention on account of their diverse coordination chemistry, reactivities, and applications, principally in the field of homogeneous catalysis. Such spectacular interest in this fascinating class of ligand stems from the ease with which important properties of the ligand can be finely manipulated, as reflected by many of the examples cited here. Without doubt, phosphorus chemistry will continue to develop in the foreseeable future, with many diverse and interesting compounds yet to be discovered.

### 1.12.4 REFERENCES

1. McAuliffe, C. A. In *Comprehensive Coordination Chemistry*; Wilkinson, G., Gillard, R. D., McCleverty, J. A., Eds; Pergamon Press, Oxford, UK, 1987; Vol. 2, pp 989–1066.
2. Gilheany, D. G.; Mitchell, C. M., In *The Chemistry of Organophosphorus Compounds*; Hartley, F. R., Ed.; Wiley: New York, 1990; Vol. 1, pp 150–190 and references therein.
3. Quin, L. D. *A Guide to Organophosphorus Chemistry*; Wiley: New York, 2000.
4. Sowa, J. R. Jr.; Angelici, R. J. *Inorg. Chem.* **1991**, *30*, 3534–3537.
5. Tolman, C. A. *Chem. Rev.* **1977**, *77*, 313–348.
6. van Leeuwen, P. W. N. M.; Kamer, P. C. J.; Reek, J. N. H.; Dierkes, P. *Chem. Rev.* **2000**, *100*, 2741–2769.
7. Dias, P. B.; Minas de Piedade, M. E.; Martinho Simoes, J. A. *Coord. Chem. Rev.* **1994**, *135/136*, 737–807.
8. Pacchioni, G.; Bagus, P. S. *Inorg. Chem.* **1992**, *31*, 4391–4398.
9. Orpen, A. G.; Connelly, N. G. *J. Chem. Soc., Chem. Commun.* **1985**, 1310–1311.
10. Levason, W. In *The Chemistry of Organophosphorus Compounds*; Hartley, F. R., Ed.; Wiley: New York, 1990; Vol. 1, 567–641.
11. Greenwood, N. N.; Earnshaw, A., Eds. *Chemistry of the Elements*, 2nd ed.; Butterworth: Heinemann, 1997; p 496.
12. Henderson, R. A.; Hussain, W.; Leigh, G. J.; Normanton, F. B. *Inorg. Synth.* **1985**, *23*, 141–143.
13. Diemert, K.; Kuchen, W.; Kutter, J. *Phosphorus Sulfur* **1983**, *15*, 155.
14. Allen, D. L.; Gibson, V. C.; Green, M. L. H.; Skinner, J. F.; Bashkin, J.; Grebenik, P. D. *J. Chem. Soc., Chem. Commun.* **1983**, 895–896.
15. Dahlenburg, L.; Kaunert, A. *Eur. J. Inorg. Chem.* **1998**, 885–887.
16. Brunner, H.; Stefaniak, S.; Zabel, M. *Synthesis* **1999**, 1776–1784.
17. Karacar, A.; Thönnessen, H.; Jones, P. G.; Bartsch, R.; Schmutzler, R. *Chem. Ber.* **1997**, *130*, 1485–1489.
18. Caruso, A. J.; Lee, J. L. *J. Org. Chem.* **1997**, *62*, 1058–1063.
19. Buisman, G. J. H.; Kamer, P. C. J.; van Leeuwen, P. W. N. M. *Tetrahedron: Asymmetry* **1993**, *4*, 1625–1634.
20. Butters, T.; Winter, W. *Chem. Ber.* **1984**, *117*, 990–1002.
21. Reddy, V. S.; Katti, K. V. *Inorg. Synth.* **1998**, *32*, 132–136.
22. Slawin, A. M. Z.; Wainwright, M.; Woollins, J. D. *J. Chem. Soc., Dalton Trans.* **2002**, 513–519.
23. Shay, R. H.; Diel, B. N.; Schubert, D. M.; Norman, A. D. *Inorg. Chem.* **1988**, *27*, 2378–2382.
24. Spiegel, G. U.; Stelzer, O. *Chem. Ber.* **1990**, *123*, 989–993.
25. Yang, F.; Fanwick, P. E.; Kubiak, C. P. *Organometallics* **1999**, *18*, 4222–4225.
26. Prabhu, K. R.; Pillarsetty, N.; Gali, H.; Katti, K. V. *J. Am. Chem. Soc.* **2000**, *122*, 1554–1555.
27. Issleib, V. K.; Schmidt, H.; Wirkner, C. Z. *Anorg. Allg. Chem.* **1982**, *488*, 75–79.
28. Brynda, M.; Geoffroy, M.; Bernardinelli, G. *Chem. Commun.* **1999**, 961–962.
29. Goodwin, N. J.; Henderson, W.; Nicholson, B. K. *Chem. Commun.* **1997**, 31–32.
30. Goodwin, N. J.; Henderson, W.; Nicholson, B. K.; Fawcett, J.; Russell, D. R. *J. Chem. Soc., Dalton Trans.* **1999**, 1785–1793.
31. Burk, M. J. *J. Am. Chem. Soc.* **1991**, *113*, 8518–8519.
32. Kyba, E. P.; Liu, S.-T.; Harris, R. L. *Organometallics* **1983**, *2*, 1877–1879.
33. Katti, K. V.; Gali, H.; Smith, C. J.; Berning, D. E. *Acc. Chem. Res.* **1999**, *32*, 9–17 and references therein.
34. Alvey, L. J.; Rutherford, D.; Juliette, J. J.; Gladysz, J. A. *J. Org. Chem.* **1998**, *63*, 6302–6308.
35. Langhans, K.-P.; Stelzer, O.; Weferling, N. *Chem. Ber.* **1990**, *123*, 995–999.
36. Bitterer, F.; Herd, O.; Kühnel, M.; Stelzer, O.; Weferling, N.; Sheldrick, W. S.; Hahn, J.; Nagel, S.; Rösch, N. *Inorg. Chem.* **1998**, *37*, 6408–6417.

37. Baudler, M.; Scholz, G.; Oehlert, W. Z. *Naturforsch* **1989**, *44b*, 627–631.
38. Berrigan, R. A.; Russell, D. K.; Henderson, W.; Leach, M. T.; Nicholson, B. K.; Woodward, G.; Harris, C. *New J. Chem.* **2001**, *25*, 322–328.
39. Albouy, D.; Etemad-Moghadam, G.; Koenig, M. *Eur. J. Org. Chem.* **1999**, 861–868.
40. Costa, E.; Pringle, P. G.; Worboys, K. *Chem. Commun.* **1998**, 49–50.
41. Dahlenburg, L.; Kurth, V. *J. Organomet. Chem.* **1999**, *585*, 315–325.
42. Fawcett, J.; Hoye, P. A. T.; Kemmitt, R. D. W.; Law, D. J.; Russell, D. R. *J. Chem. Soc., Dalton Trans.* **1993**, 2563–2568.
43. Dorn, H.; Jaska, C. A.; Singh, R. A.; Lough, A. J.; Manners, I. *Chem. Commun.* **2000**, 1041–1042.
44. Gaumont, A.-C.; Hursthouse, M. B.; Coles, S. J.; Brown, J. M. *Chem. Commun.* **1999**, 63–64.
45. Schmidbauer, H.; Weidenhiller, G.; Steigelmann, O.; Müller, G. *Chem. Ber.* **1990**, *123*, 285–287.
46. Kourkine, I. V.; Maslennikov, S. V.; Ditchfield, R.; Glueck, D. S.; Yap, G. P. A.; Liable-Sands, L. M.; Rheingold, A. L. *Inorg. Chem.* **1996**, *35*, 6708–6716.
47. Pope, S. J. A.; Reid, G. *J. Chem. Soc., Dalton Trans.* **1999**, 1615–1621.
48. Trenkle, A.; Vahrenkamp, H. *Inorg. Synth.* **1982**, *21*, 180–181.
49. Soulier, E.; Clément, J.-C.; Yaouanc, J.-J.; des Abbayes, H. *Tetrahedron Lett.* **1998**, *39*, 4291–4294.
50. Laurenti, D.; Santelli, M. *Org. Preparations Procedures* **1999**, *31*, 247–294.
51. Green, M. J.; Cavell, K. J.; Edwards, P. G. *J. Chem. Soc., Dalton Trans.* **2000**, 853–858.
52. Bitterer, F.; Kucken, S.; Stelzer, O. *Chem. Ber.* **1995**, *128*, 275–279.
53. Dickson, R. S.; Elmes, P. S.; Jackson, W. R. *Organometallics* **1999**, *18*, 2912–2914.
54. Airey, A. L.; Swiegers, G. F.; Willis, A. C.; Wild, S. B. *Inorg. Chem.* **1997**, *36*, 1588–1596.
55. Chou, T.-S.; Tsao, C.-H.; Hung, S. C. *J. Org. Chem.* **1985**, *50*, 4329–4332.
56. Chatterjee, S.; Moore, F. K. E.; Salem, G.; Waring, P.; Willis, A. C. *J. Chem. Soc., Dalton Trans.* **2000**, 4487–4489.
57. Downing, J. H.; Gee, V.; Pringle, P. G. *Chem. Commun.* **1997**, 1527–1528.
58. Scherhag, G.; Spicer, M. D. *J. Chem. Soc., Dalton Trans.* **2000**, 1237–1238.
59. Therrien, B.; Ward, T. R.; Pilkington, M.; Hoffmann, C.; Gilardoni, F.; Weber, J. *Organometallics* **1998**, *17*, 330–337.
60. van Doorn, J. A.; Frijns, J. H. G.; Meijboom, N. *J. Chem. Soc., Perkin Trans.* **1990**, *2*, 479–485.
61. Giannandrea, R.; Mastroilli, P.; Nobile, C. F. *Inorg. Chim. Acta* **1999**, *284*, 116–118.
62. Leoni, P. *Organometallics* **1993**, *12*, 2432–2434.
63. Mizuta, T.; Aoki, S.; Nakayama, K.; Miyoshi, K. *Inorg. Chem.* **1999**, *38*, 4361–4364.
64. Bartlett, R. A.; Olmstead, M. M.; Power, P. P.; Sigel, G. A. *Inorg. Chem.* **1987**, *26*, 1941–1946.
65. Kyba, E. P.; Kerby, M. C.; Kashyap, R. P.; Mountzouris, J. A.; Davis, R. E. *J. Am. Chem. Soc.* **1990**, *112*, 905–907.
66. Carriedo, G. A.; Riera, V.; Rodriguez, M. L.; Sainz-Velicia, J. J. *Polyhedron* **1987**, *6*, 1879–1884.
67. Black, J. R.; Levason, W.; Spicer, M. D.; Webster, M. J. *J. Chem. Soc., Dalton Trans.* **1993**, 3129–3136.
68. Dyson, D. B.; Parish, R. V.; McAuliffe, C. A.; Pritchard, R. G.; Fields, R.; Beagley, B. *J. Chem. Soc., Dalton Trans.* **1989**, 907–914.
69. Blanco, M. C.; Fernández, E. J.; Jones, P. G.; Laguna, A.; López-de-Luzuriaga, J. M.; Olmos, M. E. *Angew. Chem., Int. Ed. Engl.* **1998**, *37*, 3042–3043.
70. Sommovigo, M.; Alper, H. *Tetrahedron Lett.* **1993**, *34*, 59–62.
71. I. Kovacic, I.; Wicht, D. K.; Grewal, N. S.; Glueck, D. S.; Incarvito, C. D.; Guzei, L. A.; Rheingold, A. L. *Organometallics* **2000**, *19*, 950–953.
72. Wicht, D. K.; Kourkine, I. V.; Kovacic, I.; Glueck, D. S.; Concolino, T. E.; Yap, G. P. A.; Incarvito, C. D.; Rheingold, A. L. *Organometallics* **1999**, *18*, 5381–5394.
73. Franks, S.; Hartley, F. R. *J. Chem. Soc., Perkin Trans. I* **1980**, 2233–2237.
74. Curtis, N. J.; Brown, R. S. *J. Org. Chem.* **1980**, *45*, 4038–4040.
75. Moore, S. S.; Whitesides, G. M. *J. Org. Chem.* **1982**, *47*, 1489–1493.
76. Langer, F.; Püntener, K.; Stürmer, R.; Knochel, P. *Tetrahedron: Asymmetry* **1997**, *8*, 715–738.
77. Anderson, G. K.; Kumar, R. *Inorg. Chim. Acta* **1985**, *97*, L21–L23.
78. Sanger, A. R. *Can. J. Chem.* **1982**, *61*, 2214–2219.
79. Hill, W. E.; Islam, M. Q.; Webb, T. R.; McAuliffe, C. A. *Inorg. Chim. Acta* **1989**, *157*, 215–222.
80. Harrison, K. N.; Hoye, P. A. T.; Orpen, A. G.; Pringle, P. G.; Smith, M. B. *J. Chem. Soc., Chem. Commun.* **1989**, 1096–1097.
81. Ellis, J. W.; Harrison, K. N.; Hoye, P. A. T.; Orpen, A. G.; Pringle, P. G.; Smith, M. B. *Inorg. Chem.* **1992**, *31*, 3026–3033.
82. Hoye, P. A. T.; Pringle, P. G.; Smith, M. B.; Worboys, K. *J. Chem. Soc., Dalton Trans.* **1993**, 269–274.
83. Pringle, P. G.; Smith, M. B. *J. Chem. Soc., Chem. Commun.* **1990**, 1701–1702.
84. Costa, E.; Pringle, P. G.; Smith, M. B.; Worboys, K. *J. Chem. Soc., Dalton Trans.* **1997**, 4277–4282.
85. Durran, S. E.; Smith, M. B.; Slawin, A. M. Z.; Gelbrich, T.; Hursthouse, M. B.; Light, M. E. *Can. J. Chem.* **2001**, *79*, 780–791.
86. Smith, M. B.; Elsegood, M. R. *J. Tetrahedron Lett.* **2002**, *43*, 1299–1301.
87. Hope, H.; Viggiano, M.; Moezzi, B.; Power, P. P. *Inorg. Chem.* **1985**, *23*, 2550–2552.
88. Tunney, S. E.; Stille, J. K. *J. Org. Chem.* **1987**, *52*, 748–753.
89. Kwong, F. Y.; Chan, K. S. *Chem. Commun.* **2000**, 1069–1070.
90. Kwong, F. Y.; Chan, K. S. *Organometallics* **2000**, *19*, 2058–2060.
91. Kwong, F. Y.; Chan, K. S. *Organometallics* **2001**, *20*, 2570–2578.
92. Lai, C. W.; Kwong, F. Y.; Wang, Y.; Chan, K. S. *Tetrahedron Lett.* **2001**, *42*, 4883–4885.
93. Schull, T. L.; Brandow, S. L.; Dressick, W. J. *Tetrahedron Lett.* **2001**, *42*, 5373–5376.
94. Jalil, M. A.; Fujinami, S.; Senda, H.; Nishikawa, H. *J. Chem. Soc., Dalton Trans.* **1999**, 1655–1661.
95. Fettinger, J. C.; Kraatz, H.-B.; Poli, R.; Quadrelli, E. A. *J. Chem. Soc. Dalton Trans.* **1999**, 497–507.
96. Fortin, S.; Beauchamp, A. L. *Inorg. Chem.* **2001**, *40*, 105–112.
97. Harlo, K. J.; Hill, A. F.; Wilton-Ely, J. D. E. *J. Chem. Soc., Dalton Trans.* **1999**, 285–291.
98. Klein, H.-F.; Dal, A.; Jung, T.; Flörke, U.; Haupt, H.-J. *Eur. J. Inorg. Chem.* **1998**, 2027–2032.
99. Tarlton, S. V.; Choi, N.; McPartlin, M.; Mingos, D. M. P.; Vilar, R. *J. Chem. Soc., Dalton Trans.* **1999**, 653–654.

100. Durà-Vilà, V.; Mingos, D. M. P.; Vilar, R.; White, A. J. P.; Williams, D. J. *Chem. Commun.* **2000**, 1525–1526.
101. Kayser, B.; Missing, C.; Knizek, J.; Nöth, H.; Beck, W. *Eur. J. Inorg. Chem.* **1998**, 375–379.
102. Wong, W.-Y.; Choi, K.-H.; Cheah, K.-W. *J. Chem. Soc., Dalton Trans.* **2000**, 113–115.
103. Khan, M. N. I.; King, C.; Fackler, J. P. Jr.; Winpenny, R. E. P. *Inorg. Chem.* **1993**, 32, 2502–2505.
104. Ainscough, E. W.; Brodie, A. M.; Burrell, A. K.; Hanna, J. V.; Healy, P. C.; Waters, J. M. *Inorg. Chem.* **1999**, 38, 201–203.
105. Arndt, S.; Voth, P.; Spaniol, T. P.; Okuda, J. *Organometallics* **2000**, 19, 4690–4700.
106. Bennett, M. A.; Contel, M.; Hockless, D. C. R.; Welling, L. L.; Willis, A. C. *Inorg. Chem.* **2002**, 41, 844–855.
107. Bennett, M. A.; Bhargava, S. K.; Ke, M.; Willis, A. C. *J. Chem. Soc., Dalton Trans.* **2000**, 3537–3545.
108. Bennett, M. A.; Hockless, D. C. R.; Rae, A. D.; Welling, L. L.; Willis, A. C. *Organometallics* **2001**, 20, 79–87.
109. Nowotny, M.; Maschmeyer, T.; Johnson, B. F. G.; Lahuerta, P.; Thomas, J. M.; Davies, J. E. *Angew. Chem., Int. Ed. Engl.* **2001**, 40, 955–958.
110. Barberis, M.; Lahuerta, P.; Pérez-Prieto, J.; Sanaú, M. *Chem. Commun.* **2001**, 439–440.
111. Estevan, F.; Herbst, K.; Lahuerta, P.; Barberis, M.; Pérez-Prieto, J. *Organometallics* **2001**, 20, 950–957.
112. Tsuji, J. *Palladium Reagents and Catalysts* 1999, Wiley, Chichester, UK.
113. Grigg, R.; Savic, V. *Chem. Commun.* **2000**, 873–874.
114. Singh, S.; Nicholas, K. M. *Chem. Commun.* **1998**, 149–150.
115. Meyer, C.; Grützmacher, H.; Pritzkow, H. *Angew. Chem., Int. Ed. Engl.* **1997**, 36, 2471–2473.
116. Karsch, H. H.; Graf, V. W.; Reisky, M. *Chem. Commun.* **1999**, 1695–1696.
117. Karsch, H. H.; Graf, V. W.; Reisky, M.; Witt, E. *Eur. J. Inorg. Chem.* **1998**, 1403–1406.
118. Döhring, A.; Jensen, V. R.; Jolly, P. W.; Thiel, W.; Weber, J. C. *Organometallics* **2001**, 20, 2234–2245.
119. Lefort, L.; Crane, T. W.; Farwell, M. D.; Baruch, D. M.; Kaeuper, J. A.; Lachicette, R. J.; Jones, W. D. *Organometallics* **1998**, 17, 3889–3899.
120. Anderson, G. K.; Lin, M.; Chiang, M. Y. *Organometallics* **1990**, 9, 288–289.
121. Butenschön, H. *Chem. Rev.* **2000**, 100, 1527–1564.
122. van den Beuken, E. K.; Smeets, W. J. J.; Spek, A. L.; Feringa, B. L. *Chem. Commun.* **1998**, 223–224.
123. Rülke, R. E.; Kaasjager, V. E.; Wehman, P.; Elsevier, C. J.; van Leeuwen, P. W. N. M.; Vrieze, K.; Fraanje, J.; Goubitz, K.; Spek, A. L. *Organometallics* **1996**, 15, 3022–3031.
124. Bhattacharyya, P.; Parr, J.; Slawin, A. M. Z. *J. Chem. Soc., Dalton Trans.* **1998**, 3609–3614.
125. Ainscough, E. W.; Brodie, A. M.; Buckley, P. D.; Burrell, A. K.; Kennedy, S. M. F.; Waters, J. M. *J. Chem. Soc., Dalton Trans.* **2000**, 2663–2671.
126. Gray, G. M.; Takada, N.; Jan, M.; Zhang, H.; Atwood, J. L. *J. Organomet. Chem.* **1990**, 381, 53–67.
127. Jeffery, J. C.; Rauchfuss, T. B.; Tucker, P. A. *Inorg. Chem.* **1980**, 19, 3306–3316.
128. Ligtenbarg, A. G. J.; van den Beuken, E. K.; Meetsma, A.; Veldman, N.; Smeets, W. J. J.; Spek, A. L.; Feringa, B. L. *J. Chem. Soc., Dalton Trans.* **1998**, 263–270.
129. Wong, W. K.; Gao, J. X.; Wong, W. T.; Che, C. M. *Polyhedron* **1993**, 12, 2063–2066.
130. Liu, X.; Mok, K. F.; Vittal, J. J.; Leung, P.-H. *Organometallics* **2000**, 19, 3722–3729.
131. Sánchez, G.; Serrano, J. L.; López, C. M.; García, J.; Pérez, J.; López, G. *Inorg. Chim. Acta* **2000**, 306, 168–173.
132. Bhattacharyya, P.; Parr, J.; Slawin, A. M. Z. *J. Chem. Soc., Dalton Trans.* **1999**, 2917–2921.
133. Sánchez, G.; Serrano, J. L.; Moral, M. A.; Pérez, J.; Molins, E.; López, G. *Polyhedron* **1999**, 18, 3057–3064.
134. Wong, W.-K.; Zhang, L.-L.; Chen, Y.; Wong, W.-Y.; Wong, W.-T.; Xue, F.; Mak, T. C. W. *J. Chem. Soc., Dalton Trans.* **2000**, 1397–1398.
135. Shirakawa, E.; Hiyama, T. *J. Organomet. Chem.* **1999**, 576, 169–178.
136. Reddy, K. R.; Surekha, K.; Lee, G.-H.; Peng, S.-M.; Liu, S.-T. *Organometallics* **2000**, 19, 2637–2639.
137. Perera, S. D.; Shaw, B. L. *J. Chem. Soc., Dalton Trans.* **1998**, 2887–2891.
138. Shaw, B. L.; Ike, U. U.; Perera, S. D.; Thornton-Pett, M. *Inorg. Chim. Acta* **1998**, 279, 95–103.
139. Ahmad, M.; Perera, S. D.; Shaw, B. L.; Thornton-Pett, M. *J. Chem. Soc. Dalton Trans.* **1997**, 2607–2612.
140. Newkome, G. R. *Chem. Rev.* **1993**, 93, 2067–2089.
141. Zhang, Z.-Z.; Cheng, H. *Coord. Chem. Rev.* **1996**, 147, 1–39.
142. Espinet, P.; Soulantica, K. *Coord. Chem. Rev.* **1999**, 193–195, 499–556.
143. Durran, S. E.; Smith, B.; Slawin, A. M. Z.; Steed, J. W. *J. Chem. Soc., Dalton Trans.* **2000**, 2771–2778.
144. Coles, S. J.; Durran, S. E.; Hursthouse, M. B.; Slawin, A. M. Z.; Smith, M. B. *New J. Chem.* **2001**, 25, 416–422.
145. Ziessel, R.; Toupet, L.; Chardon-Noblat, S.; Deronzier, A.; Matt, D. *J. Chem. Soc., Dalton Trans.* **2000**, 3777–3784.
146. Chan, W.-H.; Peng, S.-M.; Che, C.-M. *J. Chem. Soc., Dalton Trans.* **1998**, 2867–2871.
147. Pickaert, G.; Cesario, M.; Douce, L.; Ziessel, R. *Chem. Commun.* **2000**, 1125–1126.
148. Casares, J. A.; Espinet, P.; Hernando, R.; Iturbe, G.; Villafañe, F.; Ellis, D. D.; Orpen, A. G. *Inorg. Chem.* **1997**, 36, 44–49.
149. Hirsivaara, L.; Haukka, M.; Pursiainen, J. *Eur. J. Inorg. Chem.* **2001**, 2255–2262.
150. Song, H.-B.; Zhang, Z.-Z.; Mak, T. C. W. *Inorg. Chem.* **2001**, 40, 5928–5933.
151. Deeming, A. J.; Smith, M. B. *J. Chem. Soc., Dalton Trans.* **1993**, 2041–2046.
152. Jones, N. D.; MacFarlane, K. S.; Smith, M. B.; Schutte, R. P.; Rettig, S. J.; James, B. R. *Inorg. Chem.* **1999**, 38, 3956–3966.
153. Deeming, A. J.; Smith, M. B. *J. Chem. Soc., Chem. Commun.* **1993**, 844–846.
154. Deeming, A. J.; Smith, M. B. *J. Chem. Soc., Dalton Trans.* **1993**, 3383–3391.
155. Braunstein, P.; J. Durand, J.; Morise, X.; Tiripicchio, A.; Ugozzoli, F. *Organometallics* **2000**, 19, 444–450.
156. Catalano, V. J.; Bennett, B. L.; Muratidis, S.; Noll, B. C. *J. Am. Chem. Soc.* **2001**, 123, 173–174.
157. Wilton-Ely, J. D. E. T.; Schier, A.; Mitzel, N. W.; Schmidbaur, H. *J. Chem. Soc., Dalton Trans.* **2001**, 1058–1062.
158. Alcock, N. W.; Platt, A. W. G.; Pringle, P. G. *J. Chem. Soc., Dalton Trans.* **1987**, 2273–2280.
159. Kostas, I. D.; Screttas, C. G. *J. Organomet. Chem.* **1999**, 585, 1–6.
160. Andrieu, J.; Steele, B. R.; Screttas, C. G.; Cardin, C. J.; Fornies, J. *Organometallics* **1998**, 17, 839–845.
161. Heinicke, J.; He, M.; Dal, A.; Klein, H.-F.; Hetch, O.; Keim, W.; Flörke, U.; Haupt, H.-J. *Eur. J. Inorg. Chem.* **2000**, 431–440.
162. Kane, J. C.; Yap, G. P. A.; Rheingold, A. L.; Wong, E. H. *Inorg. Chim. Acta* **1999**, 287, 209–211.

163. Sembiring, S. B.; Colbran, S. B.; Craig, D. C.; Scudder, L. J. *Chem. Soc. Dalton Trans.* **1995**, 3731–3741.
164. Platt, A. W. G.; Pringle, P. G. *J. Chem. Soc., Dalton Trans.* **1989**, 1193–1196.
165. Davies, D. L.; Niold, J.; Prouse, L. J. S.; Russell, D. R. *Polyhedron* **1993**, *12*, 2121–2124.
166. Köhl, O.; Blaurock, S.; Sieler, J.; Hey-Hawkins, E. *Polyhedron* **2001**, *20*, 2171–2177.
167. Shirakawa, E.; Kurahashi, T.; Yoshida, H.; Hiyama, T. *Chem. Commun.* **2000**, 1895–1896.
168. Dilworth, J. R.; Zheng, Y.; Griffiths, D. V. *J. Chem. Soc., Dalton Trans.* **1999**, 1877–1881.
169. Pérez-Lourido, P.; Romero, J.; García-Vázquez, J. A.; Sousa, A.; Maresca, K. P.; Zubieta, I. *Inorg. Chem.* **1999**, *38*, 3709–3715.
170. Anderson, G. K.; Kumar, R. *Inorg. Chem.* **1984**, *23*, 4064–4068.
171. Chadwell, S. J.; Coles, S. J.; Edwards, P. G.; Hursthouse, M. B.; Imran, A. *Polyhedron* **1995**, *14*, 1057–1065.
172. Mason, M. R.; Su, Y.; Jacobson, R. A.; Verkade, J. G. *Organometallics* **1991**, *10*, 2335–2344.
173. Valls, E.; Suades, J.; Mathieu, R. *Organometallics* **1999**, *18*, 5475–5483.
174. Clot, O.; Wolf, M. O.; Yap, G. P. A.; Patrick, B. O. *J. Chem. Soc., Dalton Trans.* **2000**, 2729–2737.
175. Andersen, N. G.; Keay, B. A. *Chem. Rev.* **2001**, *101*, 997–1030.
176. Hoots, J. E.; Rauchfuss, T. B.; Wroblewski, D. A. *Inorg. Synth.* **1982**, *21*, 175–178.
177. Klein, H.-F.; Lemke, U.; Lemke, M.; Brand, A. *Organometallics* **1998**, *17*, 4196–4201.
178. Matt, D.; Huhn, M.; Braunstein, P. *Inorg. Synth.* **1997**, *31*, 138–143.
179. Andrieu, J.; Braunstein, P.; Naud, F.; Adams, R. D. *J. Organomet. Chem.* **2000**, *601*, 43–50.
180. Braunstein, P.; Gomes Carneiro, T. M.; Matt, D.; Balegroune, F.; Grandjean, D. *J. Organomet. Chem.* **1989**, *367*, 117–132.
181. Braunstein, P.; Chauvin, Y.; Nähring, J.; Dusausoy, Y.; Bayeul, D.; Tiripicchio, A.; Uguzzoli, F. *J. Chem. Soc., Dalton Trans.* **1995**, 851–862.
182. Braunstein, P.; Matt, D.; Nobel, D.; Balegroune, F.; Bouaoud, S.-E.; Grandjean, D.; Fischer, J. *J. Chem. Soc., Dalton Trans.* **1988**, 353–361.
183. Knight, D. A.; Cole-Hamilton, D. J.; Cupertino, D. C.; Harman, M.; Hursthouse, M. B. *Polyhedron* **1992**, *11*, 1987–1993.
184. Ravindar, V.; Hemling, H.; Schumann, H.; Blum, J. *Synth. Commun.* **1992**, *22*, 841–851.
185. Matt, D.; Huhn, M.; Fischer, J.; De Cian, A.; Kläui, W.; Tkatchenko, I.; Bonnet, M. C. *J. Chem. Soc., Dalton Trans.* **1993**, 1173–1178.
186. Robertson, R. A. M.; Poole, A. D.; Payne, M. J.; Cole-Hamilton, D. J. *Chem. Commun.* **2001**, 47–48.
187. Jackson, R. D.; James, S.; Orpen, A. G.; Pringle, P. G. *J. Organomet. Chem.* **1993**, *458*, C3–C4.
188. Carraz, C.-A.; Ditzel, E. J.; Orpen, A. G.; Ellis, D. D.; Pringle, P. G.; Sunley, G. J. *Chem. Commun.* **2000**, 1277–1278.
189. Balaji, B. S.; Obora, Y.; Ohara, D.; Koide, S.; Tsuji, Y. *Organometallics* **2001**, *20*, 5342–5350.
190. Bookham, J. L.; McFarlane, W. *Polyhedron* **1991**, *10*, 2381–2388.
191. Armstrong, S. K.; Cross, R. J.; Farrugia, L. J.; Nichols, D. A.; Perry, A. *Eur. J. Inorg. Chem.* **2002**, 141–151.
192. Angulo, I. M.; Bouwman, E.; Lutz, M.; Mul, W. P.; Spek, A. L. *Inorg. Chem.* **2001**, *40*, 2073–2082.
193. Gee, V.; Orpen, A. G.; Phetmung, H.; Pringle, P. G.; Pugh, R. I. *Chem. Commun.* **1999**, 901–902.
194. Doherty, S.; Knight, J. G.; Robins, E. G.; Scanlan, T. H.; Champkin, P. A.; Clegg, W. *J. Am. Chem. Soc.* **2001**, *123*, 5110–5111.
195. Wolf, J.; Manger, M.; Schmidt, U.; Fries, G.; Barth, D.; Weberndörfer, B.; Vicic, D. A.; Jones, W. D.; Werner, H. *J. Chem. Soc., Dalton Trans.* **1999**, 1867–1875.
196. Hill, W. E.; Islam, M. Q.; Webb, T. R.; McAuliffe, C. A. *Inorg. Chim. Acta* **1989**, *157*, 215–222.
197. Ueng, C.-H.; Hwang, G.-Y. *J. Chem. Soc., Dalton Trans.* **1991**, 1643–1645.
198. Alcock, N. W.; Judd, L.; Pringle, P. G. *Inorg. Chim. Acta* **1986**, *113*, L13–L15.
199. Brown, J. M.; Lucy, A. R. *J. Organomet. Chem.* **1986**, *314*, 241–26.
200. Brown, J. M.; Canning, L. R. *J. Chem. Soc., Chem. Commun.* **1983**, 460–462.
201. Meehan, P. R.; Ferguson, G.; Shakya, R. P.; Alyea, E. C. *J. Chem. Soc., Dalton Trans.* **1997**, 3487–3491.
202. Angulo, I. M.; Bouwman, E.; Lok, S. M.; Lutz, M.; Mul, W. P.; Spek, A. L. *Eur. J. Inorg. Chem.* **2001**, 1465–1473.
203. Bandoli, G.; Dolmella, A. *Coord. Chem. Rev.* **2000**, *209*, 161–196.
204. Bauer, E. B.; Ruwwe, J.; Martín-Alvarez, J. M.; Peters, T. B.; Bohling, J. C.; Hampel, F. A.; Szafert, S.; Lis, T.; Gladysz, J. A. *Chem. Commun.* **2000**, 2261–2262.
205. Ogasawara, M.; Yoshida, K.; Hayashi, T. *Organometallics* **2000**, *19*, 1567–1571.
206. Kamer, P. C. J.; Van Leeuwen, P. W. N. M.; Reek, J. N. H. *Acc. Chem. Res.* **2001**, *34*, 895–904.
207. Sesto, B.; Consiglio, G. *Chem. Commun.* **2000**, 1011–1012.
208. Hartwig, J. F. *Acc. Chem. Res.* **1998**, *31*, 852–860.
209. Haenel, M. W.; Jakubik, D.; Rothenberger, E.; Schroth, G. *Chem. Ber.* **1991**, *124*, 1705–1710.
210. Dierkes, P.; van Leeuwen, P. W. N. M. *J. Chem. Soc., Dalton Trans.* **1999**, 1519–1529.
211. Kranenburg, M.; Kamer, P. C. J.; van Leeuwen, P. W. N. M. *Eur. J. Inorg. Chem.* **1998**, 155–157.
212. Goertz, W.; Kamer, P. C. J.; van Leeuwen, P. W. N. M.; Vogt, D. *Chem. Commun.* **1997**, 1521–1522.
213. van der Veen, L. A.; Keeven, P. K.; Kamer, P. C. J.; van Leeuwen, P. W. N. M. *J. Chem. Soc., Dalton Trans.* **2000**, 2105–2112.
214. Mayer, H. A.; Kaska, W. C. *Chem. Rev.* **1994**, *94*, 1239–1272.
215. Balch, A. L. *Prog. Inorg. Chem.* **1994**, *41*, 239–329.
216. Cotton, F. A.; Hong, B. *Prog. Inorg. Chem.* **1992**, *40*, 179–289.
217. Bookham, J. L.; McFarlane, W.; Colquhoun, I. J.; Thornton-Pett, M. *J. Organomet. Chem.* **1988**, *354*, 313–323.
218. Bookham, J. L.; McFarlane, W.; Colquhoun, I. J. *J. Chem. Soc., Chem. Commun.* **1986**, 1041–1042.
219. Bookham, J. L.; McFarlane, W.; Thornton-Pett, M. *J. Chem. Soc., Dalton Trans.* **1992**, 2353–2360.
220. Bamos, N.; Field, L. D.; Messerle, B. A.; Smernik, R. *J. Inorg. Chem.* **1993**, *32*, 4084–4088.
221. Askham, F. R.; Stanley, G. G.; Marques, E. C. *J. Am. Chem. Soc.* **1985**, *107*, 7423–7431.
222. McFarlane, H. C. E.; McFarlane, W. *Polyhedron* **1988**, *7*, 1875–1879.
223. Mayer, H. A.; Kaska, W. C. *Chem. Ber.* **1990**, *123*, 1827–1831.
224. Mason, M. R.; Duff, C. M.; Miller, L. L.; Jacobson, R. A.; Verkade, J. G. *Inorg. Chem.* **1992**, *31*, 2746–2755.
225. Barney, A. A.; Fanwick, P. E.; Kubiak, C. P. *Organometallics* **1997**, *16*, 1793–1796.

226. D. Laurenti, D.; Feuerstein, M.; Pepe, G.; Doucet, H.; Santelli, M. *J. Org. Chem.* **2001**, *66*, 1633–1637.
227. Khan, M. M. T.; Paul, P.; Venkatasubramanian, K.; Purohit, S. *J. Chem. Soc., Dalton Trans.* **1991**, 3405–3412.
228. Dyer, G.; Roscoe, J. *Inorg. Chem.* **1996**, *35*, 4098–4102.
229. Green, L. M.; Meek, D. W. *Polyhedron* **1990**, *9*, 35–45.
230. Steenwinkel, P.; Kilmschot, S.; Gossage, R. A.; Dani, P.; Veldman, N.; Spek, A. L.; van Koten, G. *Eur. J. Inorg. Chem.* **1998**, 477–483.
231. Bampos, N.; Field, L. D. *Inorg. Chem.* **1990**, *29*, 587–588.
232. Field, L. D.; Messerle, B. A.; Smernik, R. J. *Inorg. Chem.* **1997**, *36*, 5984–5990.
233. Jia, G.; Lee, I.-M.; Meek, D. W.; Gallucci, J. C. *Inorg. Chim. Acta* **1990**, *177*, 81–88.
234. Saum, S. E.; Laneman, S. A.; Stanley, G. G. *Inorg. Chem.* **1990**, *29*, 5065–5074.
235. Aubry, D. A.; Laneman, S. A.; Fronczek, F. R.; Stanley, G. G. *Inorg. Chem.* **2001**, *40*, 5036–5041.
236. Steffey, B. D.; Curtis, C. J.; DuBois, D. L. *Organometallics* **1995**, *14*, 4937–4943.
237. Herrmann, W. A.; Kohlpaintner, C. W. *Angew. Chem., Int. Ed. Engl.* **1993**, *32*, 1524–1544.
238. Joo, F.; Kovacs, J.; Katho, A.; Benyei, A. C.; Decuir, T.; Darensbourg, D. J. *Inorg. Synth.* **1998**, *32*, 1–8.
239. Herrmann, W. A.; Kohlpaintner, C. W. *Inorg. Synth.* **1998**, *32*, 8–25.
240. Herrmann, W. A.; Albanese, G. P.; Manetsberger, R. B.; Lappe, P.; Bahrmann, H. *Angew. Chem., Int. Ed. Engl.* **1995**, *34*, 811–813.
241. Ding, H.; Bunn, B. B.; Hanson, B. E. *Inorg. Synth.* **1998**, *32*, 29–36.
242. Gulyás, H.; Árva, P.; Bakos, J. *Chem. Commun.* **1997**, 2385–2386.
243. Sinou, D.; Bakos, J. *Inorg. Synth.* **1998**, *32*, 36–39.
244. Ding, H.; Bunn, B. B.; Hanson, B. E. *Angew. Chem., Int. Ed. Engl.* **1995**, *34*, 1645–1647.
245. Wan, K. T.; Davis, M. E. *J. Chem. Soc., Chem. Commun.* **1993**, 1262–1264.
246. Hoots, J. E.; Rauchfuss, T. B.; Wroblewski, D. A. *Inorg. Synth.* **1982**, *21*, 175–179.
247. Peuckert, M.; Keim, W. *Organometallics* **1983**, *2*, 594.
248. Daigle, D. J. *Inorg. Synth.* **1998**, *32*, 40–45.
249. Schull, T. L.; Fettinger, J. C.; Knight, D. A. *Inorg. Chem.* **1996**, *35*, 6717–6723.
250. Ganguly, S.; Mague, J. T.; Roundhill, D. M. *Inorg. Chem.* **1992**, *31*, 3500–3501.
251. Smith, R. T.; Baird, M. C. *Inorg. Chim. Acta* **1982**, *62*, 135–139.
252. Renaud, E.; Russell, R. B.; Fortier, S.; Brown, S. J.; Baird, M. C. *J. Organomet. Chem.* **1991**, *419*, 403.
253. Nagel, U.; Kinzel, E. *Chem. Ber.* **1986**, *119*, 1731.
254. Toth, L.; Hanson, B. E. *Tetrahedron: Asymmetry* **1990**, *1*, 895–912.
255. Roman, P. J.; Paterniti, D. P.; See, R. F.; Churchill, M. R.; Atwood, J. D. *Organometallics* **1997**, *16*, 1484–1490.
256. Paterniti, D. P.; Francisco, L. W.; Atwood, J. D. *Organometallics* **1999**, *18*, 123–127.
257. Papadogianakis, G.; Maat, L.; Sheldon, R. A. *Inorg. Synth.* **1998**, *32*, 25–29.
258. Herrmann, W. A.; Kulpe, J. A.; Kellner, J.; Riepl, H.; Bahrmann, H.; Konkol, W. *Angew. Chem., Int. Ed. Engl.* **1990**, *29*, 391–393.
259. Helfer, D. S.; Atwood, J. D. *Organometallics* **2002**, *21*, 250–252.
260. Tisato, F.; Refosco, F.; Bandoli, G.; Pilloni, G.; Corain, B. *Inorg. Chem.* **2001**, *40*, 1394–1396.
261. Wedgwood, J. L.; Hunter, A. P.; Kresinski, R. A.; Platt, A. W. G.; Stein, B. K. *Inorg. Chim. Acta* **1999**, *290*, 189–106.
262. Darensbourg, D. J.; Decuir, T. J.; Stafford, N. W.; Robertson, J. B.; Draper, J. D.; Reibenspies, J. H.; Katho, A.; Joó, F. *Inorg. Chem.* **1997**, *36*, 4218–4226.
263. Darensbourg, D. J.; Joo, F.; Kannisto, M.; Katho, A.; Reibenspies, J. H.; Daigle, D. J. *Inorg. Chem.* **1994**, *33*, 200–208.
264. Darensbourg, D. J.; Joo, F.; Kannisto, M.; Katho, A.; Reibenspies, J. H. *Organometallics* **1992**, *11*, 1990–1993.
265. Darensbourg, D. J.; Robertson, J. B.; Larkins, D. L.; Reibenspies, J. H. *Inorg. Chem.* **1999**, *38*, 2473–2481.
266. Krogstad, D. A.; Halfen, J. A.; Terry, T. J.; Yound, V. G. Jr. *Inorg. Chem.* **2001**, *40*, 463–471.
267. Schibli, R.; Katti, K. V.; Volkert, W. A.; Barnes, C. L. *Inorg. Chem.* **1998**, *37*, 5306–5312.
268. Pruchnik, F. P.; Smolenski, P.; Galdecka, E.; Galdecki, Z. *Inorg. Chim. Acta* **1999**, *293*, 110–114.
269. Lunn, D. M.; Mohr, B.; Grubbs, R. H.; Henling, L. M.; Day, M. W. *J. Am. Chem. Soc.* **2000**, *122*, 6601–6609.
270. Miquel-Serrano, M. D.; Aghmiz, A.; Dieguez, M.; Masdeu-Bulto, A. M.; Claver, C.; Sinou, D. *Tetrahedron: Asymmetry* **1999**, *10*, 4463–4467.
271. Ding, H.; Hanson, B. E. *J. Chem. Soc., Chem. Commun.* **1994**, 2747–2748.
272. Koffi-Bie Djoman, M. C.; Ajjou, A. N. *Tetrahedron Lett.* **2000**, *41*, 4845–4849.
273. Verspui, G.; Schanssema, F.; Sheldon, R. A. *Angew. Chem., Int. Ed. Engl.* **2000**, *39*, 804–806.
274. Schreuder Goedheijt, M.; Reek, J. N. H.; Kamer, P. C. J.; van Leeuwen, P. W. N. M. *Chem. Commun.* **1998**, 2431–2432.
275. Fukuoka, A.; Kosugi, W.; Morishita, F.; Hirano, M.; McCaffrey, L.; Henderson, W.; Komiya, S. *Chem. Commun.* **1999**, 489–490.
276. Karipides, A.; Miller Cosio, C. *Acta Cryst.* **1989**, *C45*, 1743–1745.
277. Bhattacharyya, P.; Gudmunson, D.; Hope, E. G.; Kemmitt, R. D. W.; Paige, D. R.; Stuart, A. M. *J. Chem. Soc., Perkin Trans. I.* **1997**, 3609–3612.
278. Ernst, M. F.; Roddick, D. M. *Inorg. Chem.* **1989**, *28*, 1624–1627.
279. Banger, K. K.; Banham, R. P.; Brisdon, A. K.; Cross, W. I.; Damant, G.; Parsons, S.; Pritchard, R. G.; Sousa-Pedraes, A. *J. Chem. Soc., Dalton Trans.* **1999**, 427–434.
280. Peters, R. G.; Bennett, B. L.; Schnabel, R. C.; Roddick, D. M. *Inorg. Chem.* **1997**, *36*, 5962–5965.
281. Croxtall, B.; Fawcett, J.; Hope, E. G.; Stuart, A. M. *J. Chem. Soc., Dalton Trans.* **2002**, 491–499 and references cited therein.
282. de Wolf, E.; Richter, B.; Deelman, B.-J.; van Koten, G. *J. Org. Chem.* **2000**, *65*, 5424–5427.
283. Hope, E. G.; Kemmitt, R. D. W.; Paige, D. R.; Stuart, A. M.; Wood, D. R. W. *Polyhedron* **1999**, *18*, 2913–2917.
284. Palo, D. R.; Erkey, C. *Organometallics* **2000**, *19*, 81–86.
285. Kainz, S.; Koch, D.; Baumann, W.; Leitner, W. *Angew. Chem., Int. Ed. Engl.* **1997**, *36*, 1628–1630.
286. Soos, T.; Bennett, B. L.; Rutherford, D.; Barthel-Rosa, L. P.; Gladysz, J. A. *Organometallics* **2001**, *20*, 3079–3086.
287. Smith, D. C. Jr.; Stevens, E. D.; Nolan, S. P. *Inorg. Chem.* **1999**, *38*, 5277–5281.

288. Alvey, L. J.; Rutherford, D.; Juliette, J. J. J.; Gladysz, J. A. *J. Org. Chem.* **1998**, *63*, 6302–6308.
289. Alvey, L. J.; Meier, R.; Soós, T.; Bernatis, P.; Gladysz, J. A. *Eur. J. Inorg. Chem.* **2000**, 1975–1983.
290. Klose, A.; Gladysz, J. A. *Tetrahedron: Asymmetry* **1999**, *10*, 2665–2674.
291. Sinou, D.; Pozzi, G.; Hope, E. G.; Stuart, A. M. *Tetrahedron Lett.* **1999**, *40*, 849–852.
292. Chen, W.; Xiao, J. *Tetrahedron Lett.* **2000**, *41*, 3697–3700.
293. Haar, C. M.; Huang, J.; Nolan, S. P.; Petersen, J. L. *Organometallics* **1998**, *17*, 5018–5024.
294. Atherton, M. J.; Fawcett, J.; Hill, A. P.; Holloway, J. H.; Hope, E. G.; Russell, D. R.; Saunders, G. C.; Stead, R. M. *J. Chem. Soc., Dalton Trans.* **1997**, 1137–1147.
295. Holloway, J. H.; Hope, E. G.; Jones, K.; Saunders, G. C.; Fawcett, J.; Reeves, N.; Russell, D. R.; Atherton, M. J. *Polyhedron* **1993**, *12*, 2681–2685.
296. Mathivet, T.; Monflier, E.; Castanet, Y.; Mortreux, A.; Couturier, J.-L. *Tetrahedron Lett.* **1999**, *40*, 3885–3888.
297. Mathivet, E.; Monflier, Y.; Castanet, Y.; Mortreux, A.; Couturier, J.-L. *Tetrahedron Lett.* **1998**, *39*, 9411–9414.
298. Hope, E. G.; Kemmitt, R. D. W.; Stuart, A. M. *J. Chem. Soc., Dalton Trans.* **1998**, 3765–3770.
299. Horváth, I. T.; Rábai, J. *Science* **1994**, *266*, 72–75.
300. Horváth, I. T. *Acc. Chem. Res.* **1998**, *31*, 641–650.
301. Slone, C. S.; Weinberger, D. A.; Mirkin, C. A. *Prog. Inorg. Chem.* **1999**, *48*, 233–350.
302. Whitaker, C. M.; Kott, K. L.; McMahon, R. J. *J. Org. Chem.* **1995**, *60*, 3499–3508.
303. Bhattacharyya, P.; Slawin, A. M. Z.; Smith, M. B.; Woollins, J. D. *Inorg. Chem.* **1996**, *35*, 3675–3682.
304. Gan, X.-M.; Duesler, E. N.; Paine, R. T. *Inorg. Chem.* **2001**, *40*, 4420–4427.
305. Dieleman, C.; Loeber, C.; Matt, D.; De Cain, A.; Fischer, J. *J. Chem. Soc. Dalton Trans.* **1995**, 3097–3100.
306. Douce, L.; Charbonnière, L.; Cesario, M.; Ziessel, R. *New J. Chem.* **2001**, *25*, 1024–1030.
307. Cristau, H.-J.; Mouchet, P.; Dozol, J.-F.; Rouquette, H. *Heteroatom Chem.* **1995**, *6*, 533–544.
308. Grushin, V. V. *Organometallics* **2001**, *20*, 3950–3961.
309. Grim, S. O.; Walton, E. D. *Inorg. Chem.* **1980**, *19*, 1982–1987.
310. Slawin, A. M. Z.; Smith, M. B.; Woollins, J. D. *J. Chem. Soc., Dalton Trans.* **1996**, 1283–1293.
311. Slawin, A. M. Z.; Smith, M. B.; Woollins, J. D. *J. Chem. Soc., Dalton Trans.* **1996**, 4567–4573.
312. Slawin, A. M. Z.; Smith, M. B.; Woollins, J. D. *J. Chem. Soc., Dalton Trans.* **1996**, 4575–4581.
313. Yeo, J. S. L.; Vittal, J. J.; Hor, T. S. A. *Chem. Commun.* **1999**, 1477–1478.
314. Weber, R.; Englert, U.; Ganter, B.; Keim, W.; Mothrath, M. *Chem. Commun.* **2000**, 1419–1420.
315. Takahashi, Y.; Hikichi, S.; Akita, M.; Moro-oka, Y. *Chem. Commun.* **1999**, 1491–1492.
316. Faller, J. W.; Patel, B. P.; Albrizzio, M. A.; Curtis, M. *Organometallics* **1999**, *18*, 3096–3104.
317. Thorman, J. L.; Young, V. G. Jr.; Boyd, P. D. W.; Guzei, I. A.; Woo, L. K. *Inorg. Chem.* **2001**, *40*, 499–506.
318. Paine, R. T.; Bond, E. M.; Parveen, S.; Donhart, N.; Duesler, E. N.; Smith, K. A.; Nöth, H. *Inorg. Chem.* **2002**, *41*, 444–448.
319. Bond, E. M.; Duesler, E. N.; Paine, R. T.; Nöth, H. *Polyhedron* **2000**, *19*, 2135–2140.
320. Aparna, K.; Krishnamurthy, S. S.; Nethaji, M. *J. Chem. Soc., Dalton Trans.* **1995**, 2991–2997.
321. Le, Q. T. H.; Umetani, S.; Sasaki, T.; Tomita, T.; Matsui, M. *Bull. Chem. Soc. Jpn.* **1995**, *68*, 2867–2873.
322. Le Gall, I.; Laurent, P.; Soulier, E.; Salaün, J.-Y.; des Abbayes, H. *J. Organomet. Chem.* **1998**, *567*, 13–20.
323. Ellis, D. D.; Harrison, G.; Orpen, A. G.; Phetmung, H.; Pringle, P. G.; deVries, J. G.; Oevering, H. *J. Chem. Soc., Dalton Trans.* **2000**, 671–675.
324. Wegman, R. W.; Abatjoglou, A. G.; Harrison, A. M. *J. Chem. Soc., Chem. Commun.* **1987**, 1891–1892.
325. Etter, M. C.; Baures, P. W. *J. Am. Chem. Soc.* **1988**, *110*, 639–640.
326. Zhang, S.-Q.; Zhang, S.-Y.; Feng, R. *Tetrahedron: Asymmetry* **1991**, *2*, 173–174.
327. Börner, A.; Ward, J.; Kortus, K.; Kagan, H. B. *Tetrahedron: Asymmetry* **1993**, *4*, 2219–2228.
328. Börner, A.; Kadyrov, R.; Michalik, M.; Heller, D. *J. Organomet. Chem.* **1994**, *470*, 237–242.
329. Beghetto, V.; Matteoli, U.; Scrivanti, A. *Chem. Commun.* **2000**, 155–156.
330. Bergens, S. H.; Whelan, J.; Bosnich, B. *Inorg. Synth.* **1997**, *31*, 131–138.
331. Demay, S.; Volant, F.; Knochel, P. *Angew. Chem., Int. Ed. Engl.* **2001**, *40*, 1235–1238.
332. Fries, G.; Wolf, J.; Pfeiffer, M.; Stalke, D.; Werner, H. *Angew. Chem., Int. Ed. Engl.* **2000**, *39*, 564–566.
333. Imamoto, T.; Watanabe, J.; Wada, Y.; Masuda, H.; Yamada, H.; Tsuruta, H.; Matsukawa, S.; Yamaguchi, K. *J. Am. Chem. Soc.* **1998**, *120*, 1635–1636.
334. Longmire, J. M.; Zhang, X. *Tetrahedron Lett.* **1997**, *38*, 1725–1728.
335. McKinstry, L.; Livinghouse, T. *Tetrahedron* **1995**, *51*, 7655–7666.
336. Imamoto, T.; Oshiki, T.; Onozawa, T.; Kusumoto, T.; Sato, K. *J. Am. Chem. Soc.* **1990**, *112*, 5244–5252.
337. Burk, M. J.; Feaster, J. E.; Harlow, R. L. *Organometallics* **1990**, *9*, 2653–2655.
338. Fernandez, E.; Gillon, A.; Heslop, K.; Horwood, E.; Hyett, D. J.; Orpen, A. G.; Pringle, P. G. *Chem. Commun.* **2000**, 1663–1664.
339. Li, W.; Zhang, Z.; Xiao, D.; Zhang, X. *Tet. Lett.* **1999**, *40*, 6701–6704.
340. Holz, J.; Quirnbach, M.; Schmidt, U.; Heller, D.; Stürmer, R.; Börner, A. *J. Org. Chem.* **1998**, *63*, 8031–8034.
341. Burk, M. J.; Pizzano, A.; Martin, J. A.; Liable-Sands, L. M.; Rheingold, A. L. *Organometallics* **2000**, *19*, 250–260.
342. Hegedüs, C.; Madarász, J.; Gulyás, H.; Szöllösy, A.; Bakos, J. *Tetrahedron: Asymmetry* **2001**, *12*, 2867–2873.
343. Carmichael, D.; Doucet, H.; Brown, J. M. *Chem. Commun.* **1999**, 261–262.
344. Gladiali, S.; Dore, A.; Fabbri, D.; De Lucchi, O.; Valle, G. *J. Org. Chem.* **1994**, *59*, 6363–6371.
345. Jiang, Q.; Jiang, Y.; Xiao, D.; Cao, P.; Zhang, X. *Angew. Chem., Int. Ed. Engl.* **1998**, *37*, 1100–1103.
346. Takaya, H.; Akutagawa, S.; Noyori, R. *Org. Synth.* **1988**, *67*, 20–32.
347. Takaya, H.; Mashima, K.; Koyano, K.; Yagi, M.; Kumobayashi, H.; Taketomi, T.; Akutagawa, S.; Noyori, R. *J. Org. Chem.* **1986**, *51*, 629–635.
348. Cai, D.; Payack, J. F.; Bender, D. R.; Hughes, D. L.; Verhoeven, T. R.; Reider, P. J. *J. Org. Chem.* **1994**, *59*, 7180–7181.
349. Zhang, X.; Mashima, K.; Koyano, K.; Sayo, N.; Kumobayashi, H.; Akutagawa, S.; Takaya, H. *J. Chem. Soc., Perkin Trans. 1* **1994**, 2309–2322.
350. Sumi, K.; Ikariya, T.; Noyori, R. *Can. J. Chem.* **2000**, *78*, 697–703.
351. McCarthy, M.; Goddard, R.; Guiry, P. J. *Tetrahedron: Asymmetry* **1999**, *10*, 2797–2807.



352. Ding, K.; Wang, Y.; Yun, H.; Liu, J.; Wu, Y.; Terada, M.; Okubo, Y.; Mikami, K. *Chem. Eur. J.* **1999**, *5*, 1734–1737.
353. Hayashi, T. *Acta Chem. Scand.* **1996**, *50*, 259–266.
354. Vyskocil, S.; Smrcina, M.; Hanus, V.; Polasek, M.; Kocovsky, P. *J. Org. Chem.* **1998**, *63*, 7738–7748.
355. Vyskocil, S.; Smrcina, M.; Kocovsky, P. *Tetrahedron Lett.* **1998**, *39*, 9289–9292.
356. Uozumi, Y.; Danjo, H.; Hayashi, T. *Tetrahedron Lett.* **1998**, *39*, 8303–8306.
357. Hayashi, T.; Iwamura, H.; Uozumi, Y.; Matsumoto, Y.; Ozawa, F. *Synthesis* **1994**, 526–532.
358. Richards, C. J.; Locke, A. J. *Tetrahedron: Asymmetry* **1998**, *9*, 2377–2407.
359. Togni, A.; Breutel, C.; Schnyder, A.; Spindler, F.; Landert, H.; Tijani, A. *J. Am. Chem. Soc.* **1994**, *116*, 4062–4066.
360. Kuwano, R.; Sawamura, M.; Okuda, S.; Asai, T.; Ito, Y.; Redon, M.; Krief, A. *Bull. Chem. Soc. Jpn.* **1997**, *70*, 2807–2822.
361. Sawamura, M.; Hamashima, H.; Sugawara, M.; Kuwano, R.; Ito, Y. *Organometallics* **1995**, *14*, 4549–4558.
362. Abbenhuis, H. C. L.; Burekhardt, U.; Gramlich, V.; Köllner, C.; Pregosin, P. S.; Salzmänn, R.; Togni, A. *Organometallics* **1995**, *14*, 759–766.
363. Gambs, C.; Consiglio, G.; Togni, A. *Helvetica Chim. Acta* **2001**, *84*, 3105–3126.
364. Hayashi, T.; Yamamoto, A.; Hojo, M.; Ito, Y. *J. Chem. Soc., Chem. Commun.* **1989**, 495–496.
365. Helmchen, G.; Pfaltz, A. *Acc. Chem. Res.* **2000**, *33*, 336–345.
366. Allen, J. V.; Dawson, G.; Frost, C. G.; Williams, J. M. J.; Coote, S. J. *Tetrahedron* **1994**, *50*, 799–808.
367. Lee, S.; Lee, S. H.; Song, C. E.; Chung, B. Y. *Tetrahedron: Asymmetry* **1999**, *10*, 1795–1802.
368. Gómez, M.; Jansat, S.; Müller, G.; Panyella, D.; van Leeuwen, P. W. N. M.; Kamer, P. C. J.; Goubitz, K.; Fraanje, J. *Organometallics* **1999**, *18*, 4970–4981.
369. Deng, W.-P.; Hou, X.-L.; Dai, L.-X.; Yu, Y.-H.; Xia, W. *Chem. Commun.* **2000**, 285–286.
370. Deng, W.-P.; Hou, X.-L.; Dai, L.-X.; Dong, X.-W. *Chem. Commun.* **2000**, 1483–1484.
371. Patti, A.; Lotz, M.; Knochel, P. *Tetrahedron: Asymmetry* **2001**, *12*, 3375–3380.
372. Selvakumar, K.; Valentini, M.; Wörle, M.; Pregosin, P. S.; Albinati, A. *Organometallics* **1999**, *18*, 1207–1215.
373. Selvakumar, K.; Valentini, M.; Pregosin, P. S.; Albinati, A.; Eisenträger, F. *Organometallics* **2000**, *19*, 1299–1307.
374. Blankenstein, J.; Pfaltz, A. *Angew. Chem., Int. Ed. Engl.* **2001**, *40*, 4445–4447.
375. Braunstein, P.; Naud, F.; Pfaltz, A.; Rettig, S. J. *Organometallics* **2000**, *19*, 2676–2683.
376. Trost, B. M.; Marschner, C. *Bull. Soc. Chim. Fr.* **1997**, *134*, 263–274.
377. Knühl, G.; Sennhenn, P.; Helmchen, G. *J. Chem. Soc., Chem. Commun.* **1995**, 1845–1846.
378. Bianchini, C.; Farnetti, E.; Glendenning, L.; Graziani, M.; Nardin, G.; Peruzzini, M.; Rocchini, E.; Zanobini, F. *Organometallics* **1995**, *14*, 1489–1502.
379. Brunner, H.; Lautenschlager, H.-J. *Synthesis* **1989**, 706–709.
380. Chatterjee, S.; Doyle, R.; Hockless, D.; Salem, G.; Willis, A. C. *J. Chem. Soc., Dalton Trans.* **2000**, 1829–1830.
381. Fulwood, R.; Parker, D.; Ferguson, G.; Kaltner, B. *J. Organomet. Chem.* **1991**, *419*, 269–276.
382. Wu, B.; Zhang, W.-J.; Yu, S.-Y.; Wu, X.-T. *J. Chem. Soc., Dalton Trans.* **1997**, 1795–1796.
383. de Graaf, W.; Boersma, J.; van Koten, G.; Elsevier, C. J. *J. Organomet. Chem.* **1989**, *378*, 115–124.
384. Hodgson, M.; Parker, D.; Taylor, R. J.; Ferguson, G. *Organometallics* **1988**, *7*, 1761–1766.
385. Drago, D.; Pregosin, P. S. *J. Chem. Soc., Dalton Trans.*, **2000**, 3191–3196.
386. Jiang, Q.; Xiao, D.; Zhang, Z.; Cao, P.; Zhang, X. *Angew. Chem., Int. Ed. Engl.* **1999**, *38*, 516–518.
387. Burk, M. J.; Feng, S.; Gross, M. F.; Tumas, W. *J. Am. Chem. Soc.* **1995**, *117*, 8277–8278.
388. Burk, M. J.; Harper, T. G. P.; Kalberg, C. S. *J. Am. Chem. Soc.* **1995**, *117*, 4423–4424.
389. Noyori, R. *Acta Chem. Scand.* **1996**, *50*, 380–390.
390. Noyori, R.; Takaya, H. *Acc. Chem. Res.* **1990**, *23*, 345–350.
391. Hayashi, T.; Kubo, A.; Ozawa, F. *Pure Appl. Chem.* **1992**, *64*, 421–427.
392. Yanagisawa, A.; Nakashima, H.; Ishiba, A.; Yamamoto, H. *J. Am. Chem. Soc.* **1996**, *118*, 4723–4724.
393. Blacker, A. J.; Clarke, M. L.; Loft, M. S.; Mahon, M. F.; Williams, J. M. J. *Organometallics* **1999**, *18*, 2867–2873.
394. Blacker, A. J.; Clark, M. L.; Loft, M. S.; Williams, J. M. J. *Chem. Commun.* **1999**, 913–914.
395. A. J. Blacker, M. L. Clarke, M. S. Loft, M. F. Mahon, M. E. Humphries, ; J. M. J. Williams, *Chem. Eur. J.* **2000**, *6*, 353–360.
396. Loiseleur, O.; Hayashi, M.; Schmees, N.; Pfaltz, A. *Synthesis* **1997**, 1338–1345.
397. Lightfoot, A.; Schnider, P.; Pfaltz, A. *Angew. Chem., Int. Ed. Engl.* **1998**, *37*, 2897–2899.
398. Morales-Morales, D.; Grause, C.; Kasaoka, K.; Redon, R.; Cramer, R. E.; Jensen, C. M. *Inorg. Chim. Acta* **2000**, *300–302*, 958–963.
399. Baker, M. J.; Harrison, K. N.; Orpen, A. G.; Pringle, P. G.; Shaw, G. *J. Chem. Soc., Dalton Trans.* **1992**, 2607–2614.
400. Paciello, R.; Siggel, L.; Röper, M. *Angew. Chem., Int. Ed. Engl.* **1999**, *38*, 1920–1923.
401. Dinger, M. B.; Scott, M. J. *Inorg. Chem.* **2001**, *40*, 856–864.
402. Bleeke, J. R.; Donaldson, A. J.; Peng, W.-J. *Organometallics* **1988**, *7*, 33–37.
403. Pastor, S. D.; Shum, S. P.; DeBellis, A. D.; Burke, L. P.; Rodebaugh, R. K.; Clarke, F. H.; Rihs, G. *Inorg. Chem.* **1996**, *35*, 949–958.
404. Parlevliet, F. J.; Kiener, C.; Fraanje, J.; Goubitz, K.; Lutz, M.; Spek, A. L.; Kamer, P. C. J.; van Leeuwen, P. W. N. M. *J. Chem. Soc., Dalton Trans.* **2000**, 1113–1122.
405. Jeunesse, C.; Dieleman, C.; Steyer, S.; Matt, D. *J. Chem. Soc., Dalton Trans.* **2001**, 881–892.
406. Cénac, N.; Zabolocka, M.; Igau, A.; Majoral, J.-P.; Skowronska, A. *J. Org. Chem.* **1996**, *61*, 796–798.
407. Majoral, J.-P.; Zabolocka, M.; Igau, A.; Cénac, N. *Chem. Ber.* **1996**, *129*, 879–886.
408. Platt, A. W. G.; Pringle, P. G. *Inorg. Chim. Acta* **1989**, *160*, 33–36.
409. Jackson, W. R.; Lovel, C. G. *Aust. J. Chem.* **1982**, *35*, 2069–2075.
410. Zhu, G.; Zhang, X. *J. Org. Chem.* **1998**, *63*, 3133–3136.
411. Clyne, D. S.; Mermet-Bouvier, Y. C.; Nomura, N.; RajanBabu, T. V. *J. Org. Chem.* **1999**, *64*, 7601–7611.
412. Schull, T. L.; Knight, D. A. *Tetrahedron: Asymmetry* **1999**, *10*, 207–211.
413. Reetz, M. T.; Gosberg, A. *Tetrahedron: Asymmetry* **1999**, *10*, 2129–2137.
414. Claver, C.; Fernandez, E.; Gillon, A.; Heslop, K.; Hyett, D. J.; Martorell, A.; Orpen, A. G.; Pringle, P. G. *Chem. Commun.* **2000**, 961–962.
415. Baker, M. J.; Harrison, K. N.; Orpen, A. G.; Pringle, P. G.; Shaw, G. *J. Chem. Soc., Chem. Commun.* **1991**, 803–804.
416. Baker, M. J.; Pringle, P. G. *J. Chem. Soc., Chem. Commun.* **1991**, 1292–1293.



417. Yan, M.; Yang, L.-W.; Wong, K.-Y.; Chan, A. S. C. *Chem. Commun.* **1999**, 11–12.
418. Baker, M. J.; Pringle, P. G. *J. Chem. Soc., Chem. Commun.* **1993**, 314–315.
419. Nozaki, K.; Sakai, N.; Nanno, T.; Higashijima, T.; Mano, S.; Horiuchi, T.; Takaya, H. *J. Am. Chem. Soc.* **1997**, *119*, 4413–4423.
420. Diéguez, M.; Pàmies, O.; Ruiz, A.; Castellón, S.; Claver, C. *Chem. Commun.* **2000**, 1607–1608.
421. Scherer, J.; Huttner, G.; Büchner, M. *Chem. Ber.* **1996**, *129*, 697–713.
422. Reetz, M. T.; Gosberg, A.; Goddard, R.; Kyung, S.-H. *Chem. Commun.* **1998**, 2077–2078.
423. Mi, A.; Lou, R.; Jiang, Y.; Deng, J.; Qin, Y.; Fu, F.; Li, Z.; Hu, W.; Chan, A. S. C. *Synlett* **1998**, 847–848.
424. Feringa, B. L. *Acc. Chem. Res.* **2000**, *33*, 346–353.
425. Fang, X.; Scott, B. L.; John, K. D.; Kubas, G. J. *Organometallics* **2000**, *19*, 4141–4149.
426. Hariharasarma, M.; Watkins, C. L.; Gray, G. M. *Organometallics* **2000**, *19*, 1232–1238.
427. Lewis, L. N. *Inorg. Chem.* **1985**, *24*, 4433–4435.
428. Lewis, L. N. *J. Am. Chem. Soc.* **1986**, *108*, 743–749.
429. Lewis, L. N.; Smith, J. F. *J. Am. Chem. Soc.* **1986**, *108*, 2728–2735.
430. Albisson, D. A.; Bedford, R. B.; Lawrence, S. E.; Scully, P. N. *Chem. Commun.* **1998**, 2095–2096.
431. Bedford, R. B.; Chaloner, P. A.; Hitchcock, P. B. *J. Chem. Soc., Chem. Commun.* **1995**, 2049–2050.
432. Reetz, M. T.; Sell, T. *Tetrahedron Lett.* **2000**, *41*, 6333–6336.
433. Hu, W.; Yan, M.; Lau, C.-P.; Yang, S. M.; Chan, A. S. C.; Jiang, Y.; Mi, A. *Tetrahedron Lett.* **1999**, *40*, 973–976.
434. Chen, Y.; Li, X.; Tong, S.-K.; Choi, M. C. K.; Chan, A. S. C. *Tetrahedron Lett.* **1999**, *40*, 957–960.
435. Reetz, M. T.; Neugebauer, T. *Angew. Chem., Int. Ed. Engl.* **1999**, *38*, 179–181.
436. Pàmies, O.; Dieguez, M.; Net, G.; Ruiz, A.; Claver, C. *Chem. Commun.* **2000**, 2383–2384.
437. Blandin, V.; Carpentier, J.-F.; Mortreux, A. *New J. Chem.* **2000**, *24*, 309–312.
438. Dieleman, C. B.; Kamer, P. C. J.; Reek, J. N. H.; van Leeuwen, P. W. N. M. *Helv. Chim. Acta* **2001**, *84*, 3269–3280.
439. Deerenberg, S.; Kamer, P. C. J.; van Leeuwen, P. W. N. M. *Organometallics* **2000**, *19*, 2065–2072.
440. Selent, D.; Hess, D.; Wiese, K.-D.; Röttger, D.; Kunze, C.; Börner, A. *Angew. Chem., Int. Ed. Engl.* **2001**, *40*, 1696–1698.
441. Haag, D.; Runsink, J.; Scharf, H.-D. *Organometallics* **1998**, *17*, 398–409.
442. Deerenberg, S.; Schrekker, H. S.; van Strijdonck, G. P. F.; Kamer, P. C. J.; van Leeuwen, P. W. N. M.; Fraanje, J.; Goubitz, K. *J. Org. Chem.* **2000**, *65*, 4810–4817.
443. Kayaki, Y.; Noguchi, Y.; Iwasa, S.; Ikariya, T.; Noyori, R. *Chem. Commun.* **1999**, 1235–1236.
444. Gaw, K. G.; Slawin, A. M. Z.; Smith, M. B. *Organometallics* **1999**, *18*, 3255–3257.
445. Burrows, A. D.; Mahon, M. F.; Palmer, M. T. *J. Chem. Soc., Dalton Trans.* **2000**, 1669–1677.
446. Burrows, A. D.; Mahon, M. F.; Palmer, M. T. *J. Chem. Soc., Dalton Trans.* **2000**, 3615–3619.
447. Aucott, S. M.; Slawin, A. M. Z.; Woollins, J. D. *J. Chem. Soc., Dalton Trans.* **2000**, 2559–2575.
448. Clarke, M. L.; Slawin, A. M. Z.; Wheatley, M. V.; Woollins, J. D. *J. Chem. Soc., Dalton Trans.* **2001**, 3421–3429.
449. Aucott, S. M.; Slawin, A. M. Z.; Woollins, J. D. *J. Organomet. Chem.* **1999**, *582*, 83–89.
450. Clarke, M. L.; Cole-Hamilton, D. J.; Woollins, J. D. *J. Chem. Soc., Dalton Trans.* **2001**, 2721–2723.
451. Andrews, C. D.; Burrows, A. D.; Lynam, J. M.; Mahon, M. F.; Palmer, M. T. *New J. Chem.* **2001**, *25*, 824–826.
452. Clarke, M. L.; Cole-Hamilton, D. J.; Slawin, A. M. Z.; Woollins, J. D. *Chem. Commun.* **2000**, 2065–2066.
453. Moloy, K. G.; Petersen, J. L. *J. Am. Chem. Soc.* **1995**, *117*, 7696–7710.
454. Xu, F.-B.; Weng, L.-H.; Sun, L.-J.; Zhang, Z.-Z.; Zhou, Z.-F. *Organometallics* **2000**, *19*, 2658–2660.
455. Balakrishna, M. S.; Abhyankar, R. M.; Mague, J. T. *J. Chem. Soc., Dalton Trans.* **1999**, 1407–1412.
456. Ly, T. Q.; Slawin, A. M. Z.; Woollins, J. D. *J. Chem. Soc., Dalton Trans.* **1997**, 1611–1616.
457. Slawin, A. M. Z.; Wainwright, M.; Woollins, J. D. *J. Chem. Soc., Dalton Trans.* **2001**, 2724–2730.
458. Li, G. Y.; Fagan, P. J.; Watson, P. L. *Angew. Chem., Int. Ed. Engl.* **2001**, *40*, 1106–1109.
459. Magee, M. P.; Luo, W.; Hersh, W. H. *Organometallics* **2002**, *21*, 362–372.
460. Zhang, Q.; Slawin, A. M. Z.; Woollins, J. D. *J. Chem. Soc., Dalton Trans.* **2001**, 3598–3602.
461. Slawin, A. M. Z.; Woollins, J. D.; Zhang, Q. *J. Chem. Soc., Dalton Trans.* **2001**, 621–632.
462. Slawin, A. M. Z.; Woollins, J. D.; Zhang, Q. *Inorg. Chem. Commun.* **1999**, *2*, 386.
463. Zhang, F.-Y.; Kwok, W. H.; Chan, A. S. C. *Tetrahedron: Asymmetry* **2001**, *12*, 2337–2343.
464. Kühn, O.; Blaurock, S.; Sieler, J.; Hey-Hawkins, E. *Polyhedron* **2001**, *20*, 111–117.
465. Hosokawa, T.; Wakabayashi, Y.; Hosokawa, K.; Tsuji, T.; Murahashi, S.-I. *Chem. Commun.* **1996**, 859–860.
466. Zhang, F.-Y.; Pai, C.-C.; Chan, A. S. C. *J. Am. Chem. Soc.* **1998**, *120*, 5808–5809.
467. Braunstein, P.; Frison, C.; Morise, X.; Adams, R. D. *J. Chem. Soc., Dalton Trans.* **2000**, 2205–2214.
468. Wang, F. T.; Najdzionek, J.; Leneker, K. L.; Wasserman, H.; Braitsch, D. M. *Synth. React. Inorg. Met. Org. Chem.* **1978**, *8*, 119–125.
469. Gaw, K. G.; Slawin, A. M. Z.; Smith, M. B. *New J. Chem.* **2000**, *24*, 429–435.
470. Lensink, C.; Xi, S. K.; Daniels, L. M.; Verkade, J. G. *J. Am. Chem. Soc.* **1989**, *111*, 3478–3479.
471. Tye, H.; Smyth, D.; Eldred, C.; Wills, M. *Chem. Commun.* **1997**, 1053–1054.
472. Smyth, D.; Tye, H.; Eldred, C.; Alcock, N. W.; Wills, M. *J. Chem. Soc., Perkin Trans. 1* **2001**, 2840–2849.
473. Kühn, O.; Junk, P. C.; Hey-Hawkins, E. Z. *Anorg. Allg. Chem.* **2000**, *626*, 1591–1594.
474. Bhattacharyya, P.; Slawin, A. M. Z.; Williams, D. J.; Woollins, J. D. *J. Chem. Soc., Dalton Trans.* **1993**, 2393–2400.
475. Balakrishna, M. S.; Reddy, V. S.; Krishnamurthy, S. S.; Nixon, J. F.; Burckett St. Laurent, J. C. T. R. *Coord. Chem. Rev.* **1994**, *129*, 1–90.
476. Bhattacharyya, P.; Woollins, J. D. *Polyhedron* **1995**, *14*, 3367–3388.
477. Ly, T. Q.; Woollins, J. D. *Coord. Chem. Rev.* **1998**, *176*, 451–481.
478. Tang, J.-S.; Verkade, J. G. *Angew. Chem. Int. Ed. Engl.* **1993**, *32*, 896–898.
479. Cooley, N. A.; Green, S. M.; Wass, D. F.; Heslop, K.; Orpen, A. G.; Pringle, P. G. *Organometallics* **2001**, *20*, 4769–4771.

# 1.13

## Phosphorus Tripodal Ligands

G. HUTTNER, J. STRITTMATTER, and S. SANDHÖFNER

*Anorganisch Chemisches Institut der Ruprecht-Karls-Universität  
Heidelberg, Germany*

---

1.13.1	INTRODUCTION	297
1.13.2	TRIPOD LIGANDS WITH A TRIMETHYLENE-METHANE BACKBONE	298
1.13.2.1	Tripod Ligands with Three Equal Phosphane Donors	298
1.13.2.2	Tripod Ligands with Three Different Phosphane Donors	299
1.13.2.3	Tripod Ligands with Chiral Phosphane Donors	301
1.13.2.4	Tripod Ligands Containing Two Potentially Different Phosphane Donors	302
1.13.2.5	Tripod Ligands Containing One Phosphane Donor	304
1.13.2.6	Tripod Ligands Containing <sup>R</sup> Cp Donor Groups	305
1.13.3	TRIPOD LIGANDS BASED ON A CENTRAL CARBON WITH DIFFERENT TYPES OF LINKING GROUPS	307
1.13.3.1	Tripod Ligands with One Oxo Bridging Group	307
1.13.3.2	Tripod Ligands with Different Types of Linker and Donor Groups	307
1.13.3.3	Tripod Ligands with a Phosphane Donor Bonded to the Central Carbon	310
1.13.4	TRIPOD LIGANDS BASED ON A CENTRAL HETEROATOM	312
1.13.4.1	Tripod Ligands with a Neopentane-like Scaffolding	312
1.13.4.2	Tripod Ligands with a Central Silicon	313
1.13.4.3	Tripod Ligands with a Central Nitrogen	313
1.13.4.4	Tripod Ligands with a Central Phosphorus	314
1.13.5	TRIPOD LIGANDS BASED ON MISCELLANEOUS SCAFFOLDINGS	316
1.13.5.1	Tripod Ligands Based on Tartaric Acid	318
1.13.5.2	Tripod Ligands Based on Calixarenes	318
1.13.5.3	Tripod Ligands Based on Sesquisilanes	318
1.13.6	HETEROCYCLES AS TRIPOD LIGANDS	318
1.13.7	SUMMARY	320
1.13.8	REFERENCES	320

---

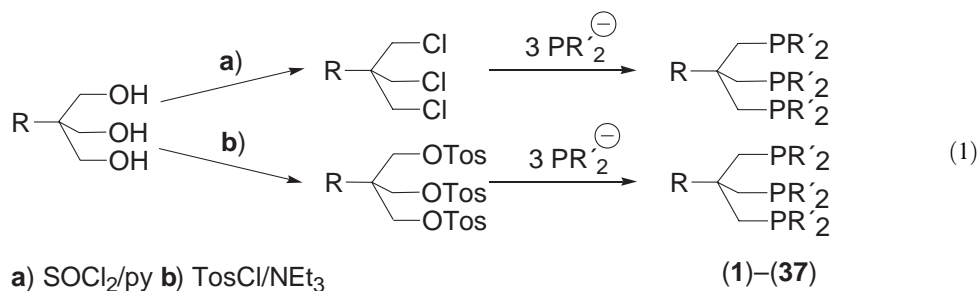
### 1.13.1 INTRODUCTION

Tripod ligands play an essential role in many branches of modern chemistry. This chapter deals with the synthesis of tripod ligands which contain at least one phosphane donor group. Only those ligands are considered for which facial, i.e., tripodal coordination has either been experimentally proved or is feasible on the basis of the stereochemistry of their scaffolding. Tripod ligands in which the donor groups are fixed to a central carbon atom by appropriate linkers are described in [Sections 2](#) and [3](#). [Section 4](#) describes ligands for which the central atom is a heteroatom. [Section 5](#) reports tripod ligands whose scaffolding is based on preorganized multi-atom arrangements such as cyclohexanes and calixarenes. [Section 6](#) collects ligands in which the three donor functions are themselves constituents of a cyclic system. The large group of tridentate phosphane ligands with a linear arrangement of donor functions is excluded since these ligands may allow facial as well as meridional coordination.

## 1.13.2 TRIPOD LIGANDS WITH A TRIMETHYLENE-METHANE BACKBONE

## 1.13.2.1 Tripod Ligands with Three Equal Phosphane Donors

The standard ligand in this series is undoubtedly  $\text{CH}_3\text{C}(\text{CH}_2\text{PPh}_2)_3$  (**3**) which has been used in coordination chemistry for a long time. Many modifications of this type of ligand have been reported. Ligands containing three equal  $\text{PR}_2$  functions or different groups instead of Me at the backbone of the tripod entity (**1**)–(**37**) are shown in Table 1. The standard reaction scheme is given in Equation (1).

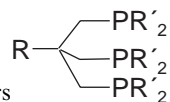


The best standard protocol for this reaction appears to consist in deprotonation of  $\text{Ar}_2\text{PH}$  in DMSO by  $\text{KO}^t\text{Bu}$  to yield  $\text{Ar}_2\text{PK}$ , followed by dropwise addition of the trichloride and keeping the resulting solution above  $100^\circ\text{C}$  for 10 hours.

$\text{Alk}_2\text{P}$ -substituents (**1**) are generally introduced by addition of the trichloride to thf solutions of the alkylphosphide. Ligands (**1**)–(**37**) (Table 1) are accessible by these procedures.

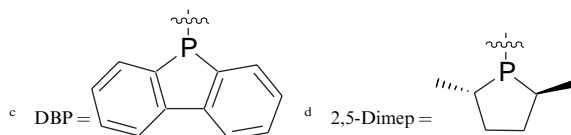
The scaffolding of the ligands shown in Table 1 (and 2–6) is based on the achiral  $\sim\text{C}(\text{CH}_2)_3\sim$  linker. Chiral modification (**38**) is possible by the reaction sequence shown in Equation (2).<sup>19</sup> Intermediate protection of the phosphane function as an oxophosphorane (step iv) is necessary to avoid side reactions during mesylation (step v).

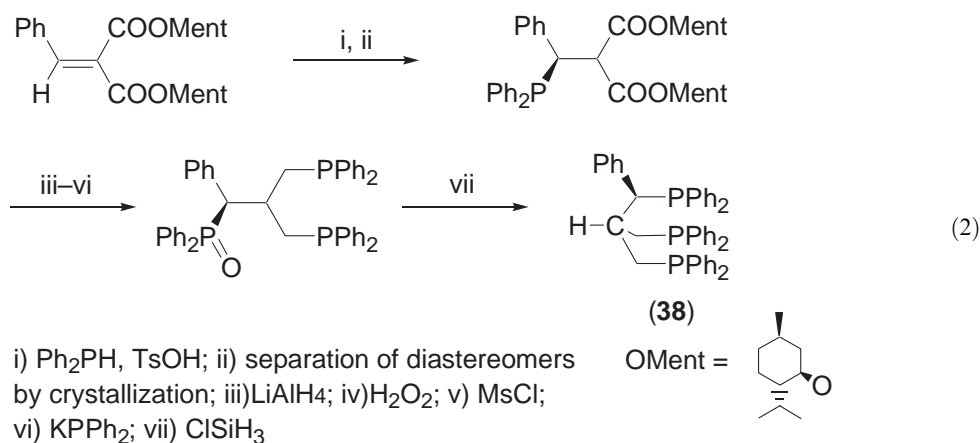
Table 1 Tripod ligands with three equal phosphane donors



Compound/Equation	$\text{PR}'_2$	R	References
(1)/(1)	$\text{PMe}_2$	$\text{CH}_3$	1
(2)/(1)	$\text{PPh}_2$	H	2
(3)/(1)	$\text{PPh}_2$	$\text{CH}_3$	3
(4)–(18)/(1)	$\text{PPh}_2$	$\text{R}''\text{OCH}_2^{\text{a}}$	4–9
(19)–(29)/(1)	$\text{PPh}_2$	$\text{R}'''\text{CH}_2^{\text{b}}$	10–16
(30)/(1)	$\text{P}(3\text{-Tol})_2$	$\text{CH}_3$	17
(31)/(1)	$\text{P}(4\text{-Tol})_2$	$\text{CH}_3$	17
(32)/(1)	$\text{P}(4\text{-}t\text{Bu})_2$	$\text{CH}_3$	17
(33)/(1)	$(1\text{-Naph})_2$	$\text{CH}_3$	17
(34)/(1)	$\text{DBP}^{\text{c}}$	$\text{CH}_3$	17
(35)/(1)	$\text{DBP}^{\text{c}}$	Camphanoyl $\text{CH}_2$	8
(36)/(1)	$\text{DBP}^{\text{c}}$	$\text{PhCH}_2$	8
(37)/(1)	2,5-Dimep <sup>d</sup>	H	18

<sup>a</sup>  $\text{R}''$  in  $\text{R}''\text{OCH}_2^-$ : (4) Me, (5) Et, (6) Mes, (7) Benzyl, (8) Stilbenyl, (9)  $(\text{CH}_2)_6\text{Br}$ , (10)  $(\text{CH}_2)_6\text{CN}$ , (11)  $(\text{CH}_2)_6\text{COOH}$ , (12)  $(\text{CH}_2)_7\text{OH}^{[9]}$ , (13) *p*-Styryl<sup>[4]</sup>; (14)  $\text{NaO}_3\text{SC}_6\text{H}_4^{[5-7]}$ ; (15)  $\text{Me}_3\text{Si}$ , (16)  $\text{C}(\text{S})\text{Me}$ , (17) Camphanyl, (18) Phthalyl<sup>[8]</sup>. <sup>b</sup>  $\text{R}'''$  in  $\text{R}'''\text{CH}_2^-$ : (19)  $\text{Ph}^{[11, 14, 15]}$ ; (20)  $\text{Cl}^{[10]}$ ; (21) 4-HO- $\text{C}_6\text{H}_4$ , (22) 3-Cl-4-HO- $\text{C}_6\text{H}_3$ , (23) 4-MeO- $\text{C}_6\text{H}_4$ , (24) 4-EtO- $\text{C}_6\text{H}_4$ <sup>[16]</sup>; (25) 1-Octenyl, (26) *n*-Butyl<sup>[12]</sup>; (27) *n*-Undecyl, (28) Isobutyl<sup>[14]</sup>; (29)  $\text{PPh}_2$ <sup>[13]</sup>

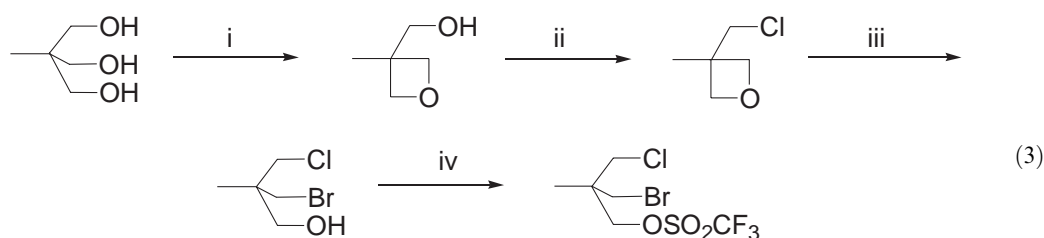




### 1.13.2.2 Tripod Ligands with Three Different Phosphane Donors

Ligands with three different phosphine donors (**39**)–(**47**) (Table 2) are accessible on the routes shown in Scheme 1. The starting materials for routes A and B are generally obtained from the corresponding triol (see Equation (3)).

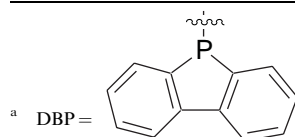
The functionalized oxetane obtained in step i—after activation as a mesylate—gives the starting material for route B. The racemic trifunctionalized compound obtained in step iv is the starting material for route A. The starting material used in route C is easily accessible from  $\text{C}(\text{CH}_2\text{Br})_2(\text{CH}_2\text{OH})_2$ .



i)  $\text{OC}(\text{OEt})_2$ ; ii)  $\text{PPh}_3/\text{CCl}_4$ ; iii)  $\text{HBr}$ ; iv)  $(\text{CF}_3\text{SO}_2)_2\text{O}$ , DMAP

**Table 2** Tripod ligands with three different phosphane donors

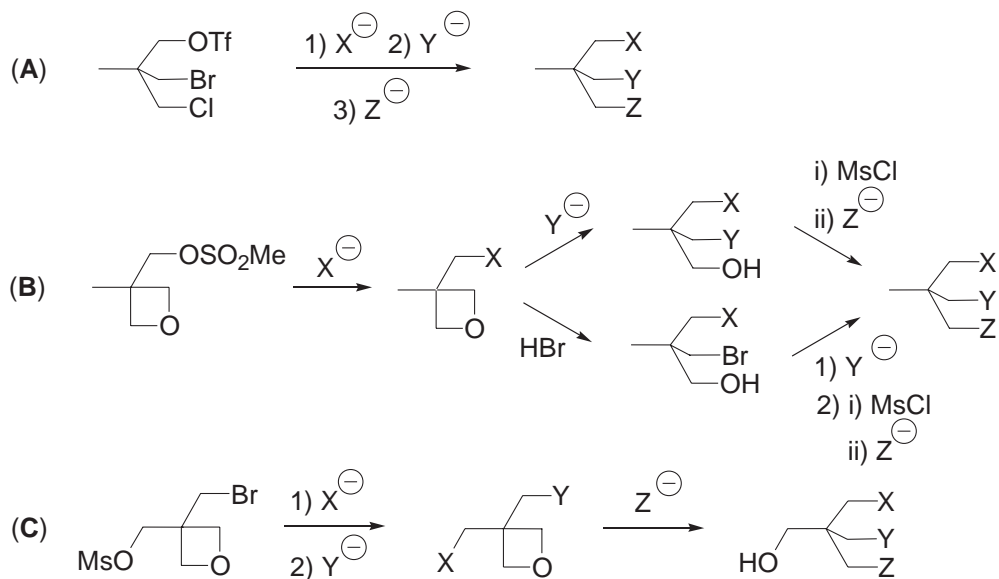
Compound/Equation	$\text{PR}'_2$	$\text{PR}''_2$	R	References
(39)/Scheme 1A	$\text{P}(2\text{-Tol})_2$	$\text{P}(3\text{-Tol})_2$	Me	20
(40)/Scheme 1A	$\text{P}(2\text{-Tol})_2$	$\text{P}(4\text{-Tol})_2$	Me	20,21
(41)/Scheme 1A	$\text{P}(3\text{-Tol})_2$	$\text{P}(4\text{-Tol})_2$	Me	20
(42)/Scheme 1B	$\text{P}(4\text{-Tol})_2$	$\text{P}(3,5\text{-Xyl})_2$	Me	22
(43)/Scheme 1A	$\text{DBP}^a$	$\text{P}(4\text{-Tol})_2$	Me	20,21
(44)/Scheme 1A, 4	$\text{DBP}^a$	$\text{P}(3,5\text{-Xyl})_2$	Me	20,21,23
(45)/Scheme 1C	$\text{DBP}^a$	$\text{P}(3,5\text{-Xyl})_2$	$\text{CH}_2\text{OH}$	24
(46)/Scheme 1C	$\text{DBP}^a$	$\text{P}(1\text{-Naphth})_2$	$\text{CH}_2\text{OH}$	24
(47)/Scheme 1A	$\text{DBP}^a$	$\text{PEt}_2$	Me	21



The starting material used in route A allows for the introduction of three different nucleophiles due to the different nucleofugicity of its three leaving groups.

The mesylate function of the starting material used in route B may be substituted by a nucleophile  $X^-$ . The oxetane cycle may then be opened by a second nucleophile  $Y^-$ . The remaining OH group, after appropriate activation (generally as a mesylate), may be substituted by a third nucleophile  $Z^-$ .

Alternatively, electrophilic ring opening of the oxetane cycle by HBr produces a difunctionalized compound which after activation of its OH group allows for selective substitution of the leaving groups by two different nucleophiles (Scheme 1, route B, lower branch).

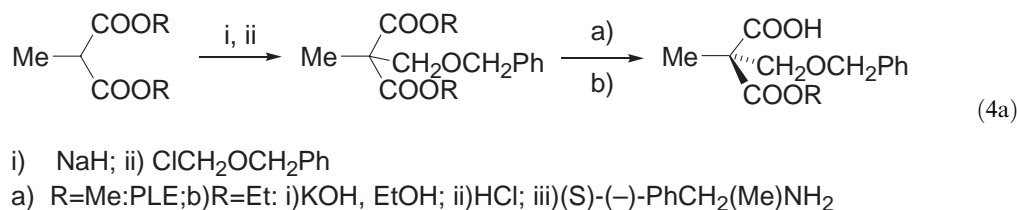


Scheme 1

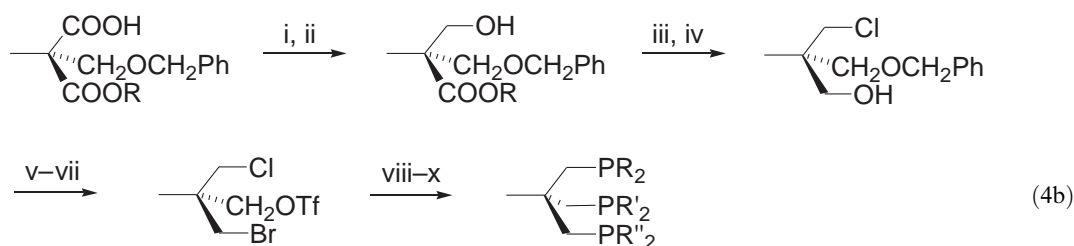
Route C is similar to route B, the difference being that the substituent at the backbone of the tripod ligand is a  $CH_2OH$  group instead of a  $CH_3$  group. With the nucleophiles X/Y/Z being different phosphides, compounds (39)–(47) are obtained.

Compounds (39)–(41), (43), (44), and (47) are obtained on route A. Ligand (42) has been synthesized on route B. Route C leads to compounds (45) and (46) (Table 2).

The ligands prepared by the procedures A–C of Scheme 1 are obtained as racemates. EPC synthesis of enantiomerically pure tripod ligands may be achieved starting from enantiopure malonic ester derivatives which are prepared following Equation (4a).<sup>25</sup>



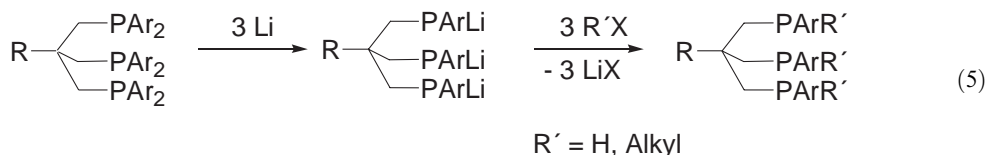
In a series of standard transformations (steps i–vii in Equation (4b)), the enantiomerically pure precursor  $CH_3C(CH_2Cl)(CH_2Br)(CH_2OTf)$  is obtained. Stepwise substitution of the triflate, bromide, and chloride leaving groups (in that order) by phosphide nucleophiles leads to the enantiomerically pure tripod ligand (44) (Table 2, Equation (4b)).



- i) ClCOOEt, NEt<sub>3</sub>; ii) NaBH<sub>4</sub>; iii) PPh<sub>3</sub>/CCl<sub>4</sub>; iv) LiAlH<sub>4</sub>  
 v) Tribromimidazole, Imidazole, PPh<sub>3</sub>; vi) Pd/C/H<sub>2</sub>; vii) (CF<sub>3</sub>SO<sub>2</sub>)<sub>2</sub>O, DMAP  
 viii) LiPR<sub>2</sub>; ix) LiPR'<sub>2</sub>; x) KPR''<sub>2</sub>

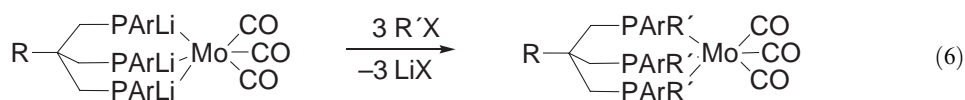
### 1.13.2.3 Tripod Ligands with Chiral Phosphane Donors

Ligands containing three CH<sub>2</sub>PARR' groups are easily obtained from precursors containing three PAR<sub>2</sub> donors (Equation (5)). Lithium substitution in the PARLi groups to produce PARR' groups is straightforward with R' = H, Alkyl. This type of substitution is also possible when the trilitio compounds are coordinated as tripod ligands in their Mo(CO)<sub>3</sub> derivatives (Equation (6)) (ligands (52)–(58), (61), (64), (67)–(69)). These coordination compounds are easily prepared from (CH<sub>3</sub>CN)<sub>3</sub>Mo(CO)<sub>3</sub> and the appropriate ligands. The standard route to the trilitiated coordination compounds is based on deprotonation of the appropriate coordinated ligands. Since the ligands contain three chiral phosphane donors, they are obtained as two diastereomers, each of them consisting of a racemic pair. Due to diastereodiscrimination the ratio of the (RRR)–(SSS)–diastereomer to the (RRS)–(SSR)–diastereomer deviates strongly from the statistic ratio (up to 4:1 instead of 1:3).<sup>28,29</sup>



**Table 3** Tripod ligands with chiral phosphane donors

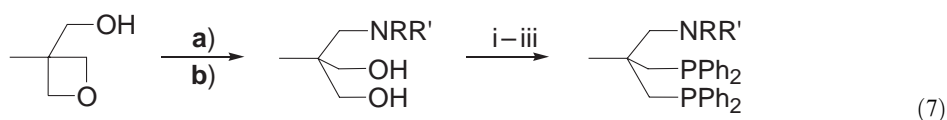
Compound/Equation	R	Ar	R'	References
(48)/(5)	Me	Ph	H	26–28
(49)/(5)	PhCH <sub>2</sub>	Ph	H	28
(50)/(5)	Me	Ph	Li	26–28
(51)/(5)	PhCH <sub>2</sub>	Ph	Li	28
(52)/(6)	Me	Ph	Me	26–28
(53)/(6)	Me	Ph	Et	26–28
(54)/(6)	Me	Ph	<i>i</i> Pr	26–28
(55)/(6)	Me	Ph	CH <sub>2</sub> Ph	26–28
(56)/(6)	PhCH <sub>2</sub>	Ph	CH <sub>2</sub> Ph	28
(57)/(6)	Me	Ph	CH <sub>2</sub> –(2,5-Xyl) <sub>2</sub>	28
(58)/(6)	Me	Ph	CH <sub>2</sub> –(2-Naphth) <sub>2</sub>	28
(59)/(5)	Me	2-Tol	H	28
(60)/(5)	Me	2-Tol	Li	28
(61)/(6)	Me	2-Tol	CH <sub>2</sub> Ph	28
(62)/(5)	Me	4-Tol	H	28
(63)/(5)	Me	4-Tol	Li	28
(64)/(6)	Me	4-Tol	CH <sub>2</sub> Ph	28
(65)/(5)	Me	3,5-Xyl	H	28
(66)/(5)	Me	3,5-Xyl	Li	28
(67)/(6)	Me	3,5-Xyl	Me	28
(68)/(6)	Me	3,5-Xyl	Et	28
(69)/(6)	Me	3,5-Xyl	CH <sub>2</sub> Ph	28



### 1.13.2.4 Tripod Ligands Containing Two Potentially Different Phosphane Donors

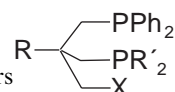
The reaction principles shown in Scheme 1 are also applicable to the synthesis of ligands containing two phosphane donors and a third alternative donor group. The hydroxy functionalized oxetane shown in Equation (3) may be used to introduce an amine functionality by ring opening as the first step (Equation (7)).

Nucleophilic opening of the oxetane cycle by amines calls for rather harsh conditions and works satisfyingly only for a few types of amines (HNMe<sub>2</sub>, H<sub>2</sub>NMe, H<sub>2</sub>NBn) (Equation (7), route a, (71), (72), (74)–(76)). The further transformation to tripod ligands calls for intermediate protection of the NHR groups in the form of their carbobenzoxy derivatives (74), (76).

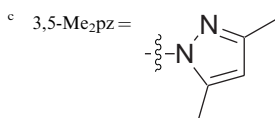
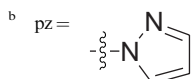
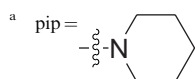


a) HNRR', 30 bar, 160 °C, H<sub>2</sub>O; b) RR'NLi, THF, 0 °C; i) *n*-BuLi; ii) MsCl; iii) LiPPh<sub>2</sub>

**Table 4** Tripod ligands containing two potentially different phosphane donors



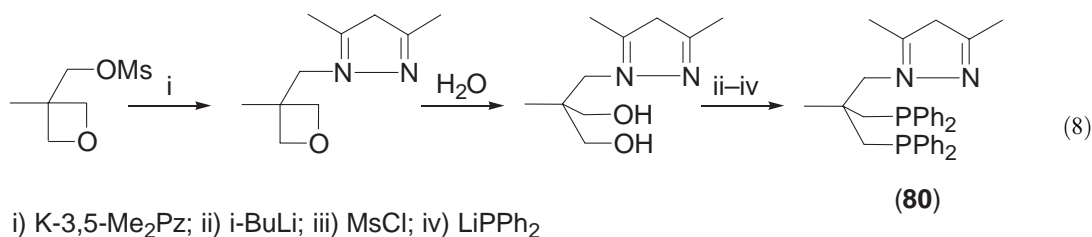
Compound/Equation	R	PR' <sub>2</sub>	X	References
(70)/Scheme 2A	Me	PPh <sub>2</sub>	NH <sub>2</sub>	30
(71)/(7)	Me	PPh <sub>2</sub>	NMeH	31,32
(72)/(7)	Me	PPh <sub>2</sub>	NMe <sub>2</sub>	31,32
(73)/Scheme 2A	Me	PPh <sub>2</sub>	NEt <sub>2</sub>	33
(74)/(7)	Me	PPh <sub>2</sub>	NMeBoc	31
(75)/(7)	Me	PPh <sub>2</sub>	N(H)CH <sub>2</sub> Ph	31
(76)/(7)	Me	PPh <sub>2</sub>	NCH <sub>2</sub> Ph(Boc)	31,34
(77)/(7)	Me	PPh <sub>2</sub>	pip <sup>a</sup>	31
(78)/(9)	CH <sub>2</sub> OH	PPh <sub>2</sub>	pz <sup>b</sup>	32,34
(79)/(9)	CH <sub>2</sub> OH	P(3,5-Xyl) <sub>2</sub>	pz <sup>b</sup>	34
(80)/(8)	Me	PPh <sub>2</sub>	3,5-Me <sub>2</sub> pz <sup>c</sup>	34
(81)/Scheme 1B	Me	PPh <sub>2</sub>	OH <sup>d</sup>	35
(82)/Scheme 2A	Me	PPh <sub>2</sub>	OMe	33,36,37
(83)/Scheme 1B	Me	PPh <sub>2</sub>	OMs <sup>d</sup>	22,38
(84)/(10, 11)	Me	PPh <sub>2</sub>	SH	39
(85)/(10, 11)	Me	PPh <sub>2</sub>	S <sup>-</sup>	40
(86)/(11)	Me	PPh <sub>2</sub>	SCH <sub>2</sub> Ph	39,40
(87)/(10, 11)	Me	P(4-Tol) <sub>2</sub>	SH	39
(88)/(10, 11)	Me	P(3,5-Xyl) <sub>2</sub>	SH	39
(89)/(11)	Me	P(3,5-Xyl) <sub>2</sub>	SCH <sub>2</sub> Ph	39
(90)/Scheme 2A	Me	PPh <sub>2</sub>	SPh	33,36



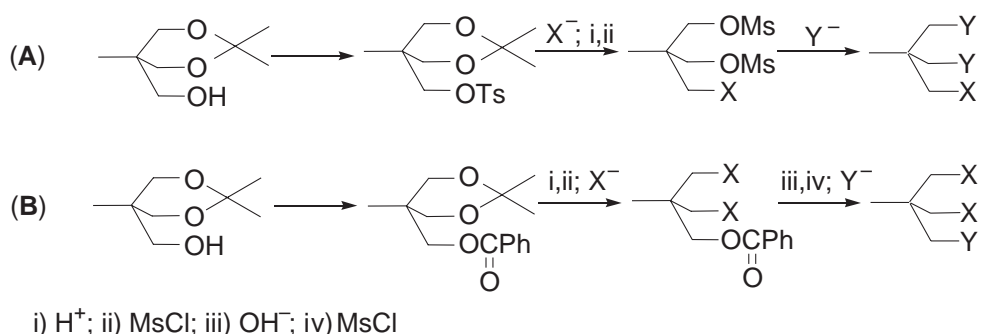
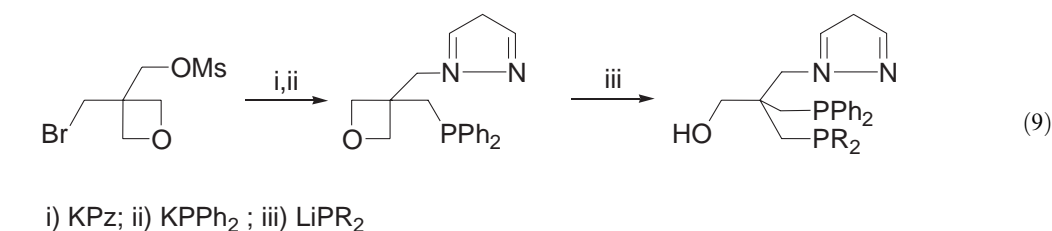
<sup>d</sup> Only one example of OH and OMs substituted tripod ligands is given in the table since these types of compounds are intermediates in the synthesis of tripod ligands (Schemes 1 and 2).

The oxetane cycle may also be nucleophilically attacked by lithium amides, but this reaction has only been reported for Lithiumpiperidyl ( $\text{LiC}_5\text{H}_{10}\text{N}$ ) as the nucleophile (Equation (7), route b, (77)).<sup>31</sup>

The introduction of pyrazol donors is easily achieved on routes B and C (Scheme 1) with pyrazol and its derivatives acting as nucleophiles (see Equation (8) for an example (80)).



The synthesis of hydroxymethyl-substituted tripod ligands ((78), (79)) is shown in Equation (9). In those cases where tripod ligands with a set of two equal donors and a third donor of a different kind are the synthetic goal, the specialized methods given in Scheme 2 are appropriate. These two routes differ by the activation (A) or deactivation (B) of the OH group of the starting material. The starting material itself is obtained from the corresponding triol by acetalization.

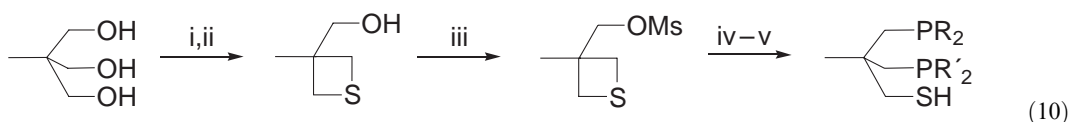


Scheme 2

Nitrogen functions may be introduced following route A (Scheme 2) by using  $\text{N}_3^-$  as the nucleophile  $\text{X}^-$  which is then reduced by  $\text{PPh}_3/\text{H}_2\text{O}$  to give an  $\text{NH}_2$  donor function (70). Procedure (A) (Scheme 2), with appropriate modifications, offers itself to the synthesis of tripod compounds with two phosphorus donors and one oxygen or sulfur donor ((82), (90)).

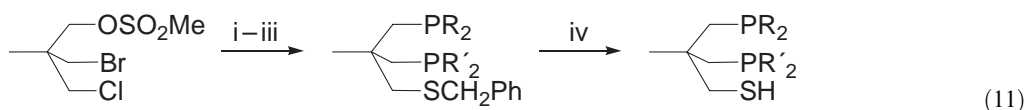
Sulfur donors may also be introduced by the primary transformation of the triol into a functionalized thiethane (Equation (10)). Subsequent addition of two potentially different phosphorus nucleophiles leads to tripod ligands containing two phosphane donors together with an SH function ((84), (85), (87), (88)).





- i)  $(\text{EtO})_2\text{CO}$ ; ii)  $\text{KSCN}$ ,  $180\text{ }^\circ\text{C}$ ; iii)  $\text{MsCl}/\text{NEt}_3$   
 iv)  $\text{LiPR}_2$ ,  $0\text{ }^\circ\text{C}$ ; v)  $\text{LiPR}'_2$ ,  $70\text{ }^\circ\text{C}$

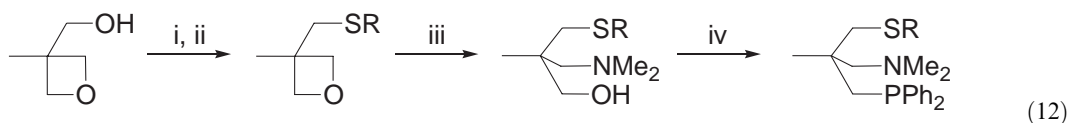
An alternative strategy relies on the starting compound  $\text{CH}_3\text{C}(\text{CH}_2\text{Cl})(\text{CH}_2\text{Br})(\text{CH}_2\text{OMs})$  (synthesis analogous to the procedure given in Equation (3)), which, by consecutive treatment with two phosphides and the *S*-benzyl nucleophile, produces the tripod ligands (**86**) and (**89**). Debenzylation of these ligands is an alternative way to thiol (thiolate) functionalized tripod ligands ((**84**), (**85**), (**87**), and (**88**), Equation (11)).



- i)  $\text{LiPR}_2$ ,  $-50\text{ }^\circ\text{C}$ ; ii)  $\text{LiPR}'_2$ ,  $0\text{ }^\circ\text{C}$ ; iii)  $\text{KSCH}_2\text{Ph}$ ,  $100\text{ }^\circ\text{C}$ ; iv)  $\text{Li}$ ,  $\text{THF}/\text{NH}_3$ ,  $-50\text{ }^\circ\text{C}$

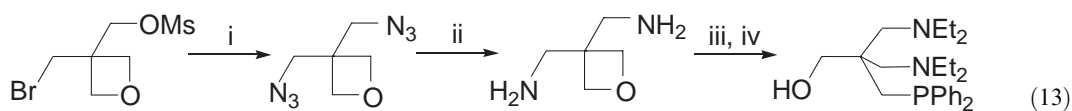
### 1.13.2.5 Tripod Ligands Containing One Phosphane Donor

The introduction of nitrogen donors into this type of ligand may be achieved by nucleophilic opening of an oxetane cycle. This procedure works well with  $\text{HNMe}_2$  as the nucleophile (Equation (12)) (**94**)–(**96**). Instead of *SR* substituents pyrazolylmethyl substituents are also tolerated (**93**). Ligands containing two different nitrogen donors or a nitrogen and a sulfur donor in addition to a phosphorus donor are obtained this way. Introduction of an *SH*-donor function is achieved in an indirect way by hydrogenolysis of an *S*-benzyl entity ((**94**), see Equation (11)).



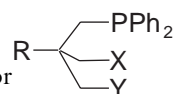
- i)  $\text{MsCl}$ ; ii)  $\text{RSLi}$ ; iii)  $\text{HNMe}_2$ , 30 bar,  $160\text{ }^\circ\text{C}$   $\text{SR} = \text{SiPr}, \text{SBz}, (\text{SH})$   
 iv)  $n\text{-BuLi}$ ,  $\text{MsCl}$ ,  $\text{LiPPh}_2$

Introduction of two equal nitrogen donors is achieved following Scheme 1, pathway C. Two pyrazolyl donors are introduced in the first substitution step leading to an oxetane with two pyrazolylmethyl groups as its geminal substituents in the 3 position. The  $\text{PPh}_2$  group is introduced by nucleophilic opening of the oxetane cycle (**92**).  $\text{NAlk}_2$  functions are obtained by first synthesizing the diazide (Equation (13)), which is then reduced to the diamine. Nucleophilic ring opening serves to introduce the phosphorus donor in the last step (**91**).

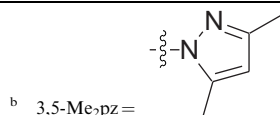
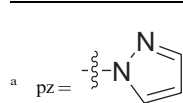


- i)  $\text{NaN}_3$ ,  $\text{DMSO}$ ,  $120\text{ }^\circ\text{C}$ ; ii)  $\text{PPh}_3$ ,  $\text{Et}_2\text{O}$ ,  $\text{H}_2\text{O}$ ; iii)  $\text{EtI}$ ; iv)  $\text{LiPPh}_2$  (**91**)

Two potentially different sulfur donors in addition to one  $\text{PPh}_2$  donor (ligands (**97**), (**98**), (**100**), (**102**), (**103**), (**106**)–(**111**), and (**113**)) may be introduced following the general routes B or C in

**Table 5** Tripod ligands containing one phosphane donor

Compound/Equation	R	X	Y	References
(91)/(13)	CH <sub>2</sub> OH	NEt <sub>2</sub>	NEt <sub>2</sub>	32,34
(92)/Scheme 1C	CH <sub>2</sub> OH	Pz <sup>a</sup>	pz <sup>a</sup>	32,34
(93)/(12)	Me	NMe <sub>2</sub>	3,5-Me <sub>2</sub> pz <sup>b</sup>	32,34
(94)/(12)	Me	NMe <sub>2</sub>	SH	31
(95)/(12)	Me	NMe <sub>2</sub>	SiPr	31
(96)/(12)	Me	NMe <sub>2</sub>	SCH <sub>2</sub> Ph	31
(97)/Scheme 1B	Me	SH	SH	41
(98)/Scheme 1C	CH <sub>2</sub> OMe	SH	SH	41
(99)/Scheme 1B	Me	SEt	OH	42
(100)/Scheme 1B	Me	SEt	SH	41
(101)/Scheme 2B	Me	SPh	SPh	43,44
(102)/Scheme 1B	Me	SEt	SEt	42
(103)/Scheme 1B	Me	SiPr	SH	41
(104)/Scheme 1B	Me	SCH <sub>2</sub> Ph	OH	42
(105)/(10)	Me	SCH <sub>2</sub> Ph	SH	39
(106)/Scheme 1B	Me	SCH <sub>2</sub> Ph	SEt	41,42
(107)/Scheme 1B	Me	SCH <sub>2</sub> Ph	SiPr	41,42
(108)/Scheme 1B	Me	SCH <sub>2</sub> Ph	SCH <sub>2</sub> Ph	41,42
(109)/Scheme 1C	CH <sub>2</sub> OH	SCH <sub>2</sub> Ph	SCH <sub>2</sub> Ph	9
(110)/Scheme 1C	CH <sub>2</sub> OMe	SCH <sub>2</sub> Ph	SCH <sub>2</sub> Ph	9,41
(111)/Scheme 1C	CH <sub>2</sub> OEt	SCH <sub>2</sub> Ph	SCH <sub>2</sub> Ph	9
(112)/Scheme 1B	Me	SPh	OH	42
(112)/Scheme 1B	Me	SPh	SCH <sub>2</sub> Ph	42



**Scheme 1**, where the alternative of choosing one or the other branch of route **B** depends on the kind of donor set. Again, SH functions are obtained by hydrogenolysis of *S*-benzyl functions (ligands **(97)**, **(98)**, **(100)**, **(103)**). Alternatively, SH functions may be generated by the nucleophilic ring opening of a thiethane moiety (see **Equation (10)**) **(105)**.

Ligands **(99)**, **(104)**, and **(112)** are intermediates in the synthesis following **Scheme 1**. If in this type of reaction the phosphorus donor is not introduced in the last substitution step, it has to be protected by BH<sub>3</sub> in order to allow for the activation of the remaining OH group as a mesylate. This precaution has to be taken throughout and is also valid for analogous synthetic steps in the preparation of compounds as shown in **Tables 2** and **4**. The introduction of two equal sulfur donors and one PPh<sub>2</sub> donor into the tripod framework is also possible following the reaction sequence **B** shown in **Scheme 2** with SPh<sup>-</sup> as the nucleophile **(101)**.

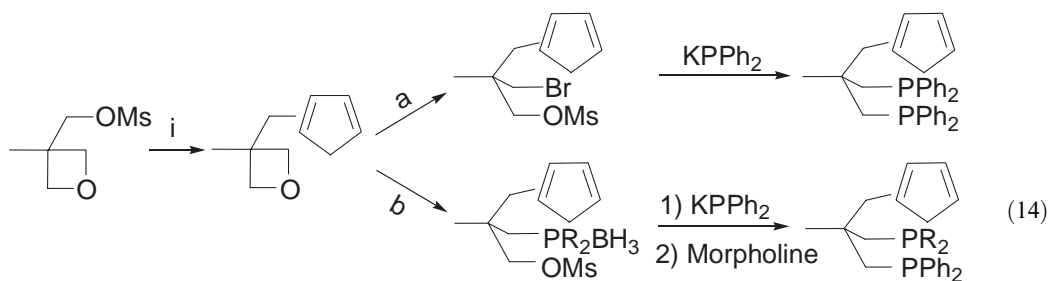
### 1.13.2.6 Tripod Ligands Containing <sup>R</sup>Cp Donor Groups

<sup>R</sup>Cp ligands have an extremely broad application in coordination chemistry. In addition, the chemistry of <sup>R</sup>Cp complexes is often decidedly influenced by additional phosphane ligands. Thus it appears natural to link these two types of donor moieties within one tripodal scaffolding.

Reaction sequences following **Scheme 1B** have been devised for the synthesis of ligands **(117)**, **(118)**, **(121)**, **(123)** containing one Cp and two potentially different phosphine donors (**Equation (14)**). Alternatively, CH<sub>3</sub>C(CH<sub>2</sub>Cl)(CH<sub>2</sub>Br)(CH<sub>2</sub>OTf) with its three different leaving groups (see **Equation (3)**) allows for the substitution of the triflate group by Cp<sup>-</sup> and consequent substitution of the bromide and chloride functions by PPh<sub>2</sub><sup>-</sup> (**(118)**, see **Scheme 1**, route A).

The introduction of indenyl (Ind) or fluorenyl (Flu) groups instead of Cp is not possible along the pathways shown in **Equation (14)**, since spirocyclization between the electrophilically activated CH<sub>2</sub> groups and the deprotonated <sup>R</sup>Cp moiety is the inevitable dead end of these sequences.<sup>38</sup> These <sup>R</sup>Cp functions may be incorporated into tripod ligands following **Equation (15)** (ligands

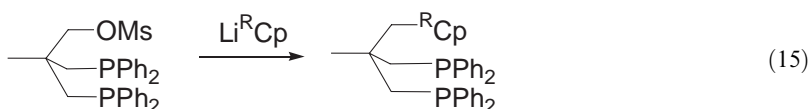
(125)–(127), (130)–(132)) also by routes following Scheme 1C. The sequence of the addition of the nucleophiles is essential for specific  $^R\text{Cp}$  groups (ligands with  $\text{CH}_2\text{OX}$  groups in Table 6).<sup>46,48</sup>



i)  $\text{CpMgCl}$

a): i)  $\text{HBr}$ ; ii)  $\text{NaOH}$ , iii)  $\text{MsCl}$

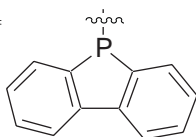
b): i)  $n\text{-BuLi}$ ; ii)  $\text{LiPR}_2$ ; iii)  $\text{BH}_3\text{.THF}$ ; iv)  $\text{MsCl}$



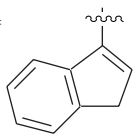
**Table 6** Tripod ligands containing  $^R\text{Cp}$  donor groups

Compound/Equation	$R$	$^R\text{Cp}$	$X$	References
<b><math>\text{PR}'_2 = \text{PPh}_2</math></b>				
(114)/(14)	Me	Cp	OH	45
(115)/(14)	Me	Cp	OMs	45
(116)/Scheme 1C	$\text{CH}_2\text{OH}$	Cp	$\text{SCH}_2\text{Ph}$	46
(117)/(14)	Me	Cp	$\text{PEt}_2$	45,47
(118)/(14), Scheme 1A	Me	Cp	$\text{PPh}_2$	45,47
(119)/Scheme 1C	$\text{CH}_2\text{OH}$	Cp	$\text{PPh}_2$	46
(120)/Scheme 1C	$\text{CH}_2\text{OCOMe}$	Cp	$\text{PPh}_2$	46
(121)/(14)	Me	Cp	$\text{P}(3,5\text{-Xyl})_2$	45,47
(122)/Scheme 1C	$\text{CH}_2\text{OH}$	Cp	$\text{P}(3,5\text{-Xyl})_2$	46
(123)/(14)	Me	Cp	$\text{DBP}^{\text{a}}$	45
(124)/Scheme 1C	$\text{CH}_2\text{OH}$	Cp	$\text{DBP}^{\text{a}}$	46
(125)/(15)	Me	$\text{Ind}^{\text{b}}$	OH	38
(126)/(15)	Me	$\text{Ind}^{\text{b}}$	OMs	38
(127)/(15)	Me	$\text{Ind}^{\text{b}}$	$\text{PPh}_2$	38
(128)/Scheme 1C	$\text{CH}_2\text{OH}$	$\text{Ind}^{\text{b}}$	$\text{PPh}_2$	48
(129)/Scheme 1C	$\text{CH}_2\text{OSiMe}_3$	$\text{Ind}^{\text{b}}$	$\text{PPh}_2$	48
(130)/(15)	Me	$\text{Flu}^{\text{c}}$	OH	38
(131)/(15)	Me	$\text{Flu}^{\text{c}}$	OMs	38
(132)/(15)	Me	$\text{Flu}^{\text{c}}$	$\text{PPh}_2$	38
(133)/Scheme 1C	$\text{CH}_2\text{OH}$	$\text{Flu}^{\text{c}}$	$\text{PPh}_2$	48
(134)/Scheme 1C	$\text{CH}_2\text{OSiMe}_3$	$\text{Flu}^{\text{c}}$	$\text{PPh}_2$	48
<b><math>\text{PR}'_2 = \text{PEt}_2</math></b>				
(135)/(15)	Me	$\text{Ind}^{\text{b}}$	OH	38
(136)/Scheme 1C	$\text{CH}_2\text{OH}$	$\text{Ind}^{\text{b}}$	$\text{PPh}_2$	48
(137)/Scheme 1C	$\text{CH}_2\text{OSiMe}_3$	$\text{Ind}^{\text{b}}$	$\text{PPh}_2$	48

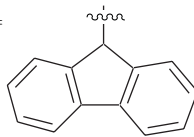
<sup>a</sup> DBP =



<sup>b</sup> Ind =



<sup>c</sup> Flu =



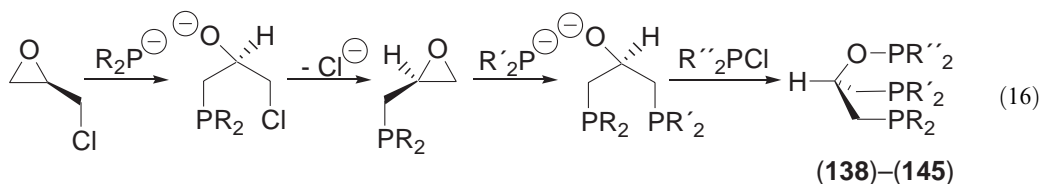
Instead of a phosphide, a thiolate may be used in the first substitution step, such that tripod ligands with one Cp, one phosphorus, and one sulfur donor are available (**116**). Compounds obtained following [Scheme 1C](#) have a CH<sub>2</sub>OH group at the backbone which may be silylated, but could not by now be transformed into an ether function.<sup>48</sup>

### 1.13.3 TRIPOD LIGANDS BASED ON A CENTRAL CARBON WITH DIFFERENT TYPES OF LINKING GROUPS

The tripod ligands described in [Section 2](#) all have the same type of scaffolding in which a central carbon is linked to the donor groups by three CH<sub>2</sub> entities. [Section 3](#) deals with tripod ligands in which the central element is still carbon, but where the linking groups are—at least in part—different from ~CH<sub>2</sub>~.

#### 1.13.3.1 Tripod Ligands with One Oxo Bridging Group

The ligands shown in [Table 7](#) are structurally closely related to those described in [Section 2](#). The difference is, that while two linkers are still CH<sub>2</sub> groups, the third one is an oxygen function. The synthesis of this type of ligand (**138**)–(**145**) is based on epichlorohydrine as the starting material ([Equation \(16\)](#)).



Enantiomerically pure epichlorohydrine produces enantiomerically pure tripod ligands of this type.

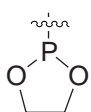
#### 1.13.3.2 Tripod Ligands with Different Types of Linker and Donor Groups

The tripodal ligands shown in [Table 8](#) have in common that their phosphane donor group is linked to a central carbon atom by a spacer group. Most of the ligands in [Table 8](#) have at

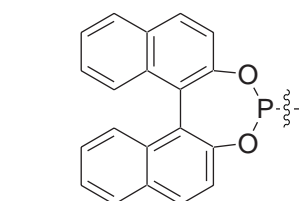
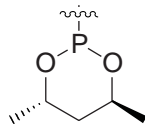
**Table 7** Tripod ligands with one oxo bridging group

Compound/Equation	$PR'_2$	$PR''_2$	References
(138)/(16)	PPh <sub>2</sub>	PCl <sub>2</sub>	49
(139)/(16)	PPh <sub>2</sub>	PPh <sub>2</sub>	15,49
(140)/(16)	PPh <sub>2</sub>	<sup>a</sup>	15,49
(141)/(16)	PPh <sub>2</sub>	<sup>b</sup>	15,50
(142)/(16)	PPh <sub>2</sub>	Pbinol <sup>c</sup>	15,50
(143)/(16)	PPh <sub>2</sub>	PDPO <sup>b</sup>	15,49
(144)/(16)	P(4-Tol) <sub>2</sub>	PDPO <sup>d</sup>	49,51
(145)/(16)	DBP	PDPO <sup>d</sup>	49,51

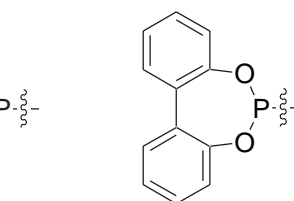
<sup>a</sup>



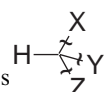
<sup>b</sup>



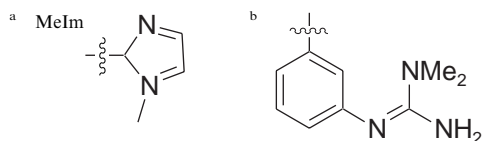
<sup>c</sup> Pbinol=



<sup>d</sup> PDPO=

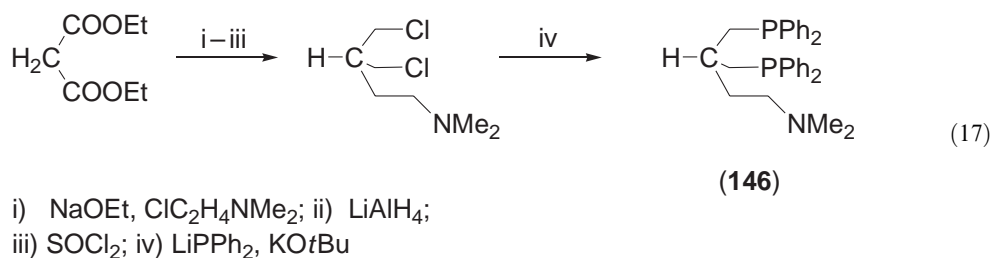
**Table 8** Tripod ligands with different types of linker and donor groups

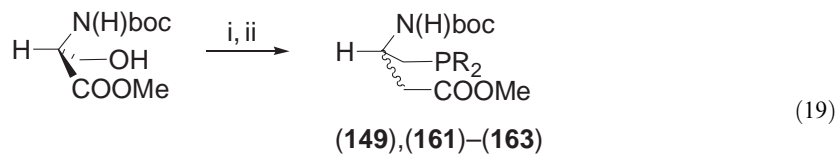
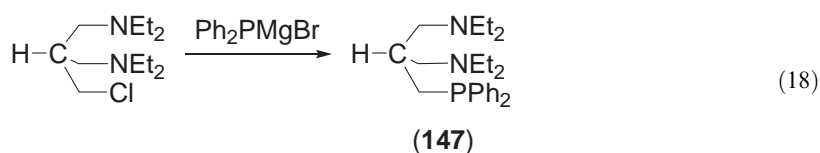
Compound/Equation	X	Y	Z	References
(146)/(17)	CH <sub>2</sub> PPh <sub>2</sub>	CH <sub>2</sub> PPh <sub>2</sub>	C <sub>2</sub> H <sub>4</sub> NMe <sub>2</sub>	52,53
(147)/(18)	CH <sub>2</sub> PPh <sub>2</sub>	CH <sub>2</sub> NEt <sub>2</sub>	NEt <sub>2</sub>	54
(148)/–	CH <sub>2</sub> PPh <sub>2</sub>	MeIm <sup>a</sup>	MeIm <sup>a</sup>	55,56
(149)/(19)	CH <sub>2</sub> PPh <sub>2</sub>	COOMe	NHBoc	57
(150)/(21)	CH <sub>2</sub> PPh <sub>2</sub>	NMe <sub>2</sub>	CH <sub>2</sub> SMe	58
(151)/(21)	CH <sub>2</sub> PPh <sub>2</sub>	NMe <sub>2</sub>	CH <sub>2</sub> SiPr	58
(152)/(21)	CH <sub>2</sub> PPh <sub>2</sub>	NMe <sub>2</sub>	(CH <sub>2</sub> ) <sub>2</sub> SMe	58
(153)/(21)	CH <sub>2</sub> PPh <sub>2</sub>	NMe <sub>2</sub>	C(Me <sub>2</sub> ) <sub>2</sub> SMe	58
(154)/(22)	CH <sub>2</sub> PPh <sub>2</sub>	NMe <sub>2</sub>	(CH <sub>2</sub> ) <sub>2</sub> S(O)Me	59
(155)/(21)	CH <sub>2</sub> PPh <sub>2</sub>	NMe <sub>2</sub>	(CH <sub>2</sub> ) <sub>4</sub> NMe <sub>2</sub>	59
(156)/(21)	CH <sub>2</sub> PPh <sub>2</sub>	NMe <sub>2</sub>	(CH <sub>2</sub> ) <sub>3</sub> SMe	59
(157)/(23)	CH <sub>2</sub> PPh <sub>2</sub>	CH <sub>2</sub> OH	OH	60
(158)/(23)	CH <sub>2</sub> PPhMe	CH <sub>2</sub> OH	OH	60
(159)/(23)	CH <sub>2</sub> PPhH	CH <sub>2</sub> OH	OH	60
(160)/(23)	CH <sub>2</sub> PPhR <sup>b</sup>	CH <sub>2</sub> OH	OH	60
(161)/(19)	CH <sub>2</sub> P(2-Tol) <sub>2</sub>	COOMe	NHBoc	57
(162)/(19)	CH <sub>2</sub> PPh(3,5-Xyl) <sub>2</sub>	COOMe	NHBoc	57
(163)/(19)	CH <sub>2</sub> P(Cy) <sub>2</sub>	COOMe	NHBoc	57
(164)/(20)	OPPh <sub>2</sub>	CH <sub>2</sub> SMe	NMe <sub>2</sub>	61
(165)/(20)	OPPh <sub>2</sub>	C <sub>2</sub> H <sub>4</sub> SMe	NMe <sub>2</sub>	61
(166)/(24)	o-C <sub>6</sub> H <sub>4</sub> PPh <sub>2</sub>	NHCH <sub>2</sub> Ph	P(O)Me <sub>2</sub>	62
(167)/(25)	o-C <sub>6</sub> H <sub>4</sub> PPh <sub>2</sub>	COOH	NH <sub>2</sub>	63
(168)/(25)	o-C <sub>6</sub> H <sub>4</sub> PphMe	COOH	NH <sub>2</sub>	63



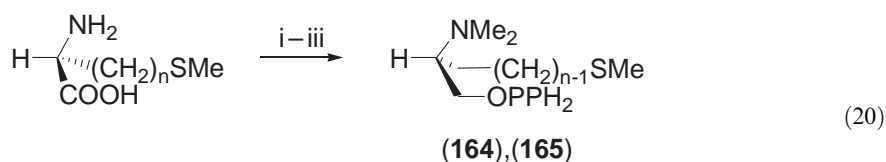
least one CH<sub>2</sub>PR<sub>2</sub> building block which is linked to the central carbon atom (146)–(163). Ligands with a phosphane function directly bonded to the central carbon are described in Section 1.13.3.3.

Ligand (146) containing two CH<sub>2</sub>PPh<sub>2</sub> building blocks is accessible from malonic ester (Equation (17)). Ligand (147) is obtained from an easily accessible precursor by nucleophilic substitution with Ph<sub>2</sub>PMgBr (Equation (18)). Ligand (148) is described in the literature without specific details of its preparation. Ligands (149) and (161)–(163) are prepared from L-serine (Equation (19)). It is observed, however, that the chiral information is lost under the basic reaction conditions. Modifying this synthetic route by replacing the acidic hydrogen by a methyl group is in progress.<sup>57</sup> As a variation of this synthetic scheme L-methionine and L-cysteine (Equation (20)) may be used as chiral precursors (for ligands (164), (165)). In this case the chiral information is not lost. Ligands (150)–(153) are accessible following Equation (21) starting from methionine and cysteine derivatives. Analogous procedures starting from lysine or homocysteine allow the stereoselective synthesis of (155) and (156).

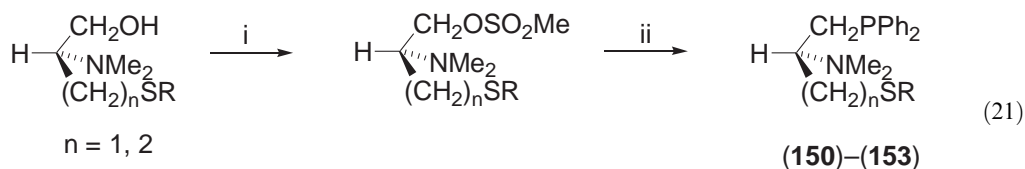




i) a) TsCl; b) NaI; ii)  $\text{K}_2\text{CO}_3$ ,  $\text{R}_2\text{PH}$

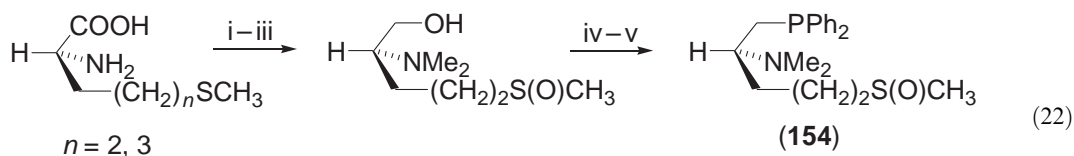


i)  $\text{H}_2\text{CO}$ ,  $\text{H}_2$ , Pd/C; ii)  $\text{LiAlH}_4$ ; iii) a) NaH; b)  $\text{Ph}_2\text{PCl}$

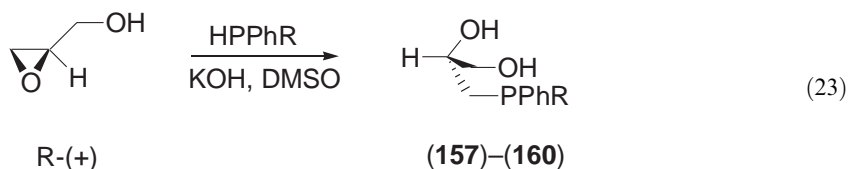


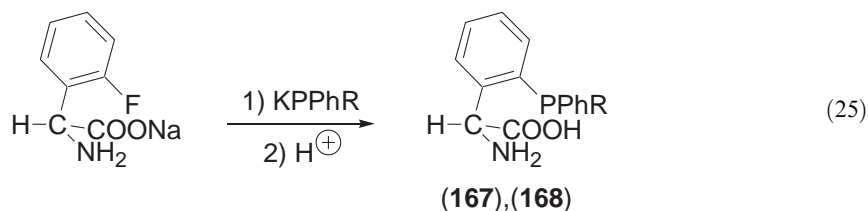
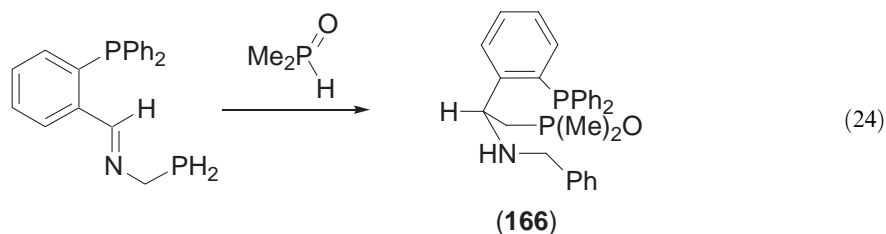
i)  $\text{MeSO}_2\text{Cl}$ , proton sponge; ii)  $\text{HPPH}_2$ ,  $\text{KOtBu}$

Oxidation of the thioether function to a sulfoxide function (Equation (22)) is also completely stereoselective (154). Ligands (157)–(160) are obtained in enantiopure form from the enantiopure functionalized oxirane shown in Equation (23). The starting material shown in Equation (24) is obtained from ortho- $\text{C}_6\text{H}_4\text{FCH}_2\text{NH}_2$  and is easily transformed into ligand (166). The starting material shown in Equation (25) is prepared from ortho- $\text{C}_6\text{H}_4\text{FCHO}$  in a multistep procedure. The fluorine function may be substituted by a phosphorus nucleophile to yield (167) and (168).



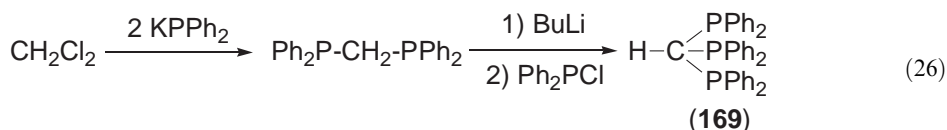
i)  $\text{H}_2\text{O}_2$ ; ii)  $\text{LiAlH}_4$ ; iii)  $\text{HCOOH}$ ,  $\text{CH}_2\text{O}$ ; iv)  $\text{CH}_3\text{SO}_2\text{Cl}$ ,  $\text{NEt}_3$ ; v)  $\text{HPPH}_2$ ,  $\text{KOtBu}$





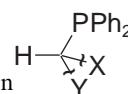
### 1.13.3.3 Tripod Ligands with a Phosphane Donor Bonded to the Central Carbon

Potential tripod ligands containing a phosphane group directly bonded to the bridging carbon atom (Table 9) call for specific synthetic procedures. The potential ligand (169) has been known for a long time, but its coordination chemistry has only recently been explored.<sup>64,65</sup> The synthesis follows Equation (26)

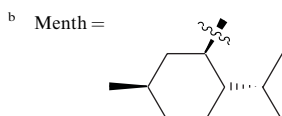
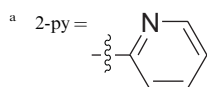


A convenient starting material for the synthesis of compounds (170)–(174) is 1,1-dichloroethene (see Equation (27)). Nucleophilic substitution of the chlorine functions by LiPPh<sub>2</sub> leads to a substituted ethene, which easily adds HP RR'. Adding PhAsH<sub>2</sub> instead in the last step leads to (176).

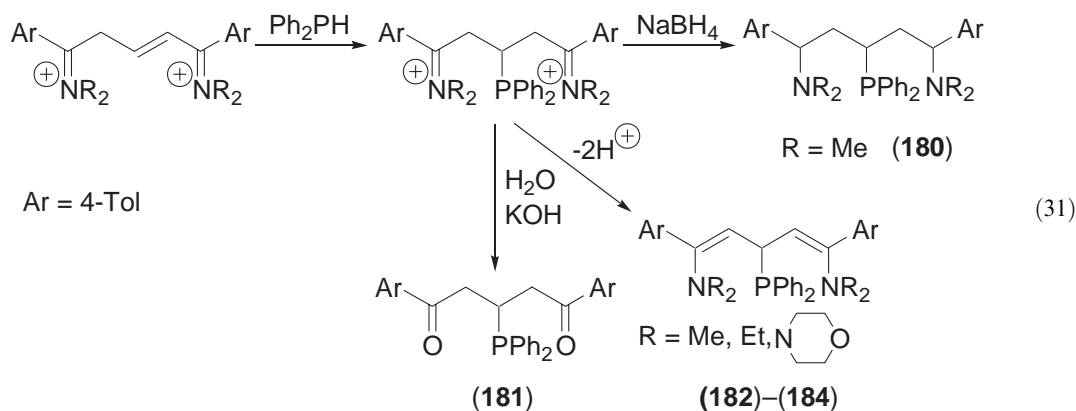
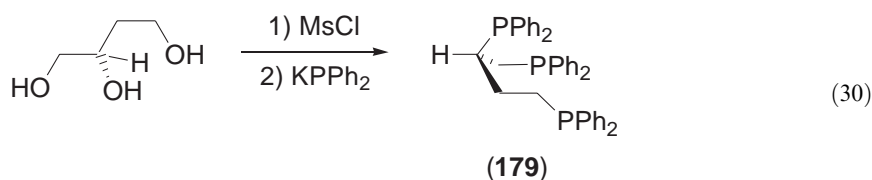
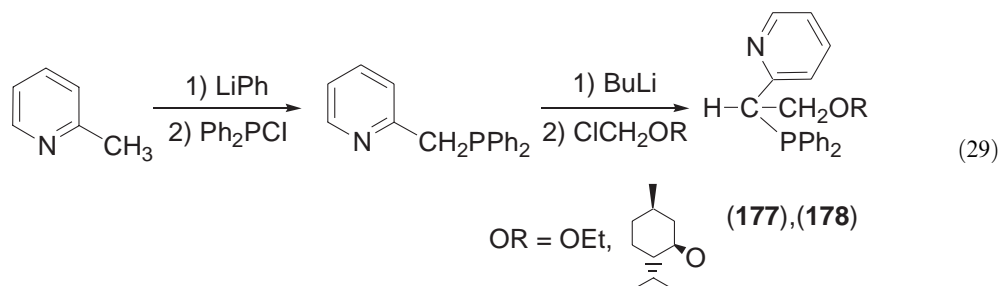
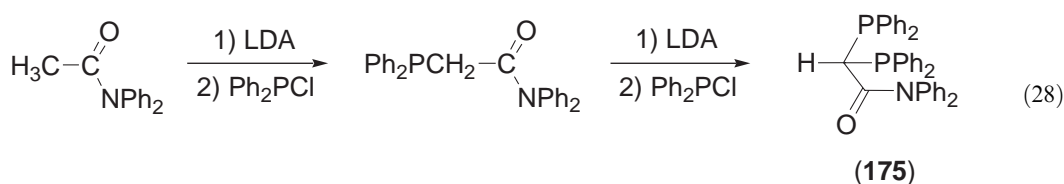
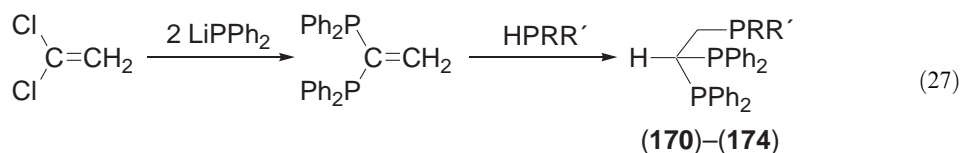
Table 9 Tripod ligands with a phosphane donor bonded to the central carbon



Compound/Equation	X	Y	References
(169)/(26)	PPh <sub>2</sub>	PPh <sub>2</sub>	64,65
(170)/(27)	PPh <sub>2</sub>	CH <sub>2</sub> PPhH	66
(171)/(27)	PPh <sub>2</sub>	CH <sub>2</sub> PPh <sub>2</sub>	66–68
(172)/(27)	PPh <sub>2</sub>	CH <sub>2</sub> PPhR <sup>c</sup>	66
(173)/(27)	PPh <sub>2</sub>	CH <sub>2</sub> PPhR <sup>d</sup>	66
(174)/(27)	PPh <sub>2</sub>	CH <sub>2</sub> PR <sup>d</sup>	66
(175)/(28)	PPh <sub>2</sub>	C(O)NPh <sub>2</sub>	66
(176)/(27)	PPh <sub>2</sub>	AsPhH	66
(177)/(29)	CH <sub>2</sub> OEt	2-py <sup>a</sup>	70–72
(178)/(29)	CH <sub>2</sub> Omenth <sup>b</sup>	2-py <sup>a</sup>	70,71
(179)/(30)	CH <sub>2</sub> Ph <sub>2</sub>	C <sub>2</sub> H <sub>4</sub> PPh <sub>2</sub>	73,74
(180)/(31)	CH <sub>2</sub> CH(4-Tol)NMe <sub>2</sub>	CH <sub>2</sub> CH(4-Tol)NMe <sub>2</sub>	75
(181)/(31)	CH <sub>2</sub> C(O)(4-Tol)	CH <sub>2</sub> C(O)(4-Tol)	75
(182)/(31)	CH=C(4-Tol)NMe <sub>2</sub>	CH=C(4-Tol)NMe <sub>2</sub>	75
(183)/(31)	CH=C(4-Tol)NEt <sub>2</sub>	CH=C(4-Tol)NEt <sub>2</sub>	75
(184)/(31)	Ch=C(4-Tol)Nmorph	CH=C(4-Tol)Nmorph	75



Compound (**175**) results from two consequent deprotonation and substitution steps of *N,N*-diphenylacetamide (see Equation (28)). Two consequent steps of deprotonation and substitution transform  $\alpha$ -picoline into the ligands (**177**) and (**178**) (see Equation (29)). Using the chloromethylether of menthol, the resulting diastereomers can be separated by chromatography. Starting from an enantiopure triol (see Equation (30)), the molecule (**179**) with linker groups of 0, 1, and 2 carbon atoms in the tripod scaffolding is obtained. The starting materials for the synthesis of (**180**)–(**184**) (Equation (31)) are pentamethinium salts obtained from the corresponding polymethines. The intermediate obtained by addition of  $\text{HPPH}_2$  may be reduced to (**180**), hydrolyzed to (**181**), or deprotonated to (**182**)–(**184**).



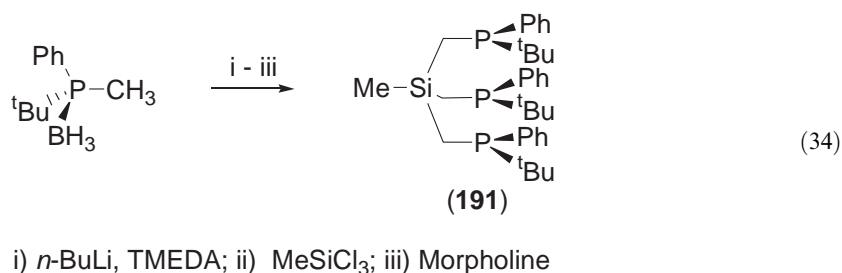
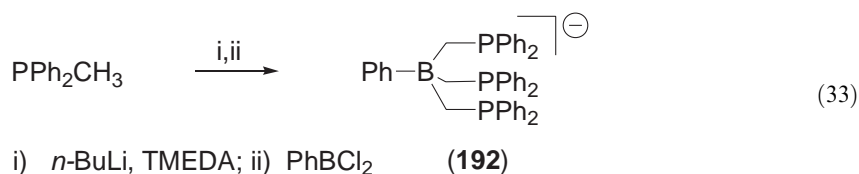
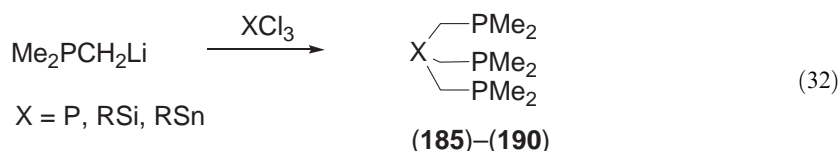


### 1.13.4 TRIPOD LIGANDS BASED ON A CENTRAL HETEROATOM

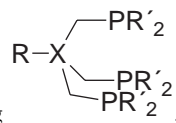
The bridging element in all the compounds described up to now is carbon. Analogs in which the bridging element is a heteroatom are also known.

#### 1.13.4.1 Tripod Ligands with a Neopentane-like Scaffolding

The straightforward synthesis of compounds (185)–(190) is based on the propensity of the methyl group in  $R_2PMe$  to deprotonation.<sup>80</sup> This nucleophile replaces element–halide bonds in starting materials containing silicon, tin, or phosphorus as the central elements (see Equation (32)). With  $PhBCl_2$  as the element–halide compound, the corresponding borate (192) is formed (following Equation (33)). The introduction of enantiomerically pure  $CH_2PtBuPh$  moieties to yield compound (191) is based on the same type of procedure (see Equation (34)). The enantiopure starting material is obtained by chromatographic separation of the borane adduct of racemic  $CH_3PPh_tBu$ .



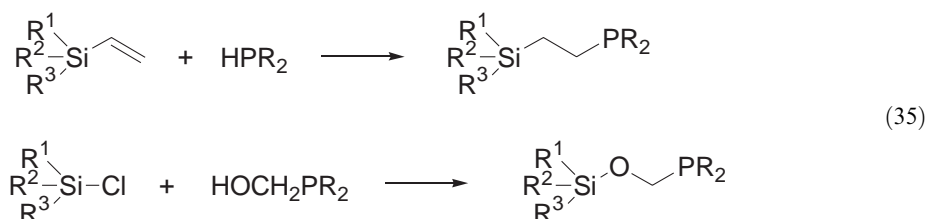
**Table 10** Tripod ligands with a neopentane-like scaffolding



Compound/Equation	$PR'_2$	X	R	References
(185)/(32)	$PMe_2$	Si	Me	76,77
(186)/(32)	$PMe_2$	Si	<i>t</i> Bu	78–80
(187)/(32)	$PMe_2$	Si	$CH_2PMe_2$	77
(188)/(32)	$PMe_2$	Sn	Me	77
(189)/(32)	$PMe_2$	Sn	$CH_2PMe_2$	77
(190)/(32)	$PMe_2$	P		80
(191)/(34)	$P(tBu)Ph$	Si	Me	81
(192)/(33)	$PPh_2$	$B^-$	Ph	82–84

### 1.13.4.2 Tripod Ligands with a Central Silicon

Table 11 collects tripod ligands (193)–(205) containing silicon as the bridging element which are easily accessible by the procedures given in Equation (35). One of the two routes shown is based on the addition of a P–H bond across a vinyl double bond and leads to ligands with an ethylene linker between the central silicon and the phosphorus donor. The other one makes use of  $\text{RPH}_2\text{CH}_2\text{OH}$ , which is available from  $\text{R}_2\text{PH}$  and formaldehyde in a straightforward reaction. The silicon–halide is transformed into the corresponding phosphorus-containing silylether.



### 1.13.4.3 Tripod Ligands with a Central Nitrogen

Tripod ligands containing nitrogen as the bridging atom have been known for a long time. The basic reaction scheme shown in Equation (36) allows the introduction of different donor groups

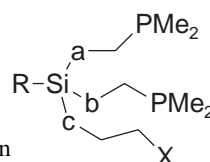


Table 11 Tripod ligands with a central silicon

Compound/Equation	X	a	b	c	R	References
(193)–(198)/(35)	$\text{PMe}_2$	$\text{CH}_2$	$\text{CH}_2$	$\text{CH}_2$	$\text{R}^a$	85,86
(199)/(35)	$\text{PMe}_2$	O	$\text{CH}_2$	$\text{CH}_2$	Me	85,86
(200)/(35)	$\text{PMe}_2$	O	O	$\text{CH}_2$	Me	85,86
(201)/(35)	$\text{P}(\text{CF}_3)_2$	O	O	$\text{CH}_2$	Me	85
(202)/(35)	$\text{NMe}_2$	O	O	$\text{CH}_2$	Me	85
(203)/(35)	$\text{PMe}_2$	O	O	O	Me	85
(204)/(35)	$\text{PMe}_2$	O	O	O	$\text{OCH}_2\text{PMe}_2$	85
(205)/(35)	$\text{PMe}_2$	O	O	O	Me	86

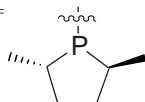
<sup>a</sup> R = Me,  $\text{C}_3\text{H}_5$ ,  $\text{NMe}_2$ ,  $\text{OMe}$ , F, Cl



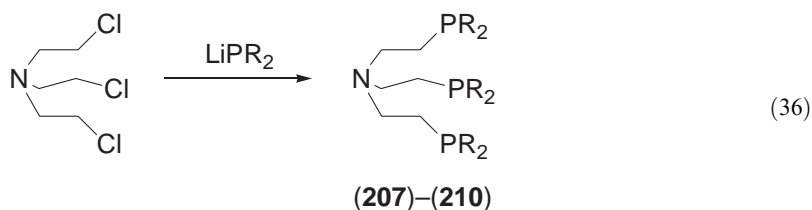
Table 12 Tripod ligands with a central nitrogen

Compound/Equation	X	Y	Z	References
(206)/see text	$\text{CH}_2\text{PPh}_2$	$\text{CH}_2\text{PPh}_2$	$\text{CH}_2\text{PPh}_2$	87
(207)/(36)	$\text{C}_2\text{H}_4\text{PMe}_2$	$\text{C}_2\text{H}_4\text{PMe}_2$	$\text{C}_2\text{H}_4\text{PMe}_2$	88
(208)/(36)	$\text{C}_2\text{H}_4\text{PCy}_2$	$\text{C}_2\text{H}_4\text{PCy}_2$	$\text{C}_2\text{H}_4\text{PCy}_2$	89,90
(209)/(36)	$\text{C}_2\text{H}_4\text{Dimep}^a$	$\text{C}_2\text{H}_4\text{Dimep}^a$	$\text{C}_2\text{H}_4\text{Dimep}^a$	18
(210)/(36)	$\text{C}_2\text{H}_4\text{PPh}_2$	$\text{C}_2\text{H}_4\text{PPh}_2$	$\text{C}_2\text{H}_4\text{PPh}_2$	88
(211)/(37)	$\text{C}_2\text{H}_4\text{PPh}_2$	$\text{C}_2\text{H}_4\text{PPh}_2$	$\text{C}_2\text{H}_4\text{NEt}_2$	91,92
(212)/(37)	$\text{C}_2\text{H}_4\text{PPh}_2$	$\text{C}_2\text{H}_4\text{PPh}_2$	$\text{C}_2\text{H}_4\text{NEt}_2$	91,92
(213)/see text	$\text{C}_2\text{H}_4\text{PPh}_2$	$\text{C}_2\text{H}_4\text{PPh}_2$	$\text{C}(\text{O})t\text{Bu}$	93

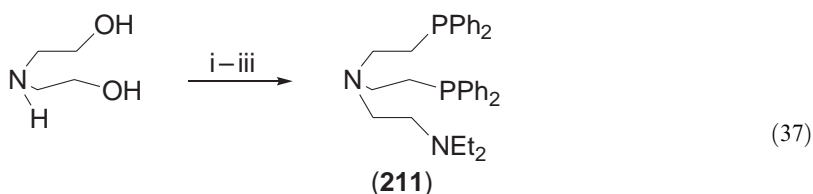
<sup>a</sup> Dimep =



((207)–(210)). The chiral tripod ligand (209) is also obtained by this route by using enantiomerically pure 2,5-dimethylphosphole as the building block.



Introducing different donor groups into tripod ligands of this type is possible by the sequence shown in Equation (37), where one kind of donor is introduced by nucleophilic substitution at an N-bonded  $\text{C}_2\text{H}_4\text{Cl}$  function, while a second donor X is added to the central nitrogen by the appropriate  $\text{ClC}_2\text{H}_4\text{X}$  reagent ((211), (212)). Both of these strategies may in principle also be applied to the synthesis of tripod ligands containing three equal donor groups. Correspondingly, (206), which had already been synthesized from  $\text{Ph}_2\text{PCH}_2\text{OH}$  and  $\text{NH}_3$ , has also been obtained as the product of the reaction of  $\text{N}(\text{CH}_2\text{Cl})_3$  and  $\text{LiPPh}_2$ . The synthesis of (213) follows Equation (37) with pivaloylchloride as the electrophile.



i)  $\text{Et}_2\text{NC}_2\text{H}_4\text{Cl}$ ; ii)  $\text{SOCl}_2$ ; iii)  $\text{KPPh}_2$

#### 1.13.4.4 Tripod Ligands with a Central Phosphorus

Tripod ligands containing phosphorus as the bridging element (Table 13) are generally obtained by 1,2-addition across the double bond of a vinylic group. Ligands (214) and (215) are obtained from trivinylphosphane (see Equation (38)). Ligand (216) results from the addition of a pyridyl-substituted phosphane to diphenylvinylphosphane (see Equation (39)). An analogous procedure leads to (217) (see Equation (40)), which contains a nitrile donor function. (217) may be reduced to (218) with its amine donor group. The potential tripodal ligand (219) is available from the corresponding diphosphane and trivinylphosphane (see Equation (41)). Ligand (214) is selectively

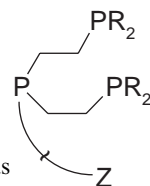
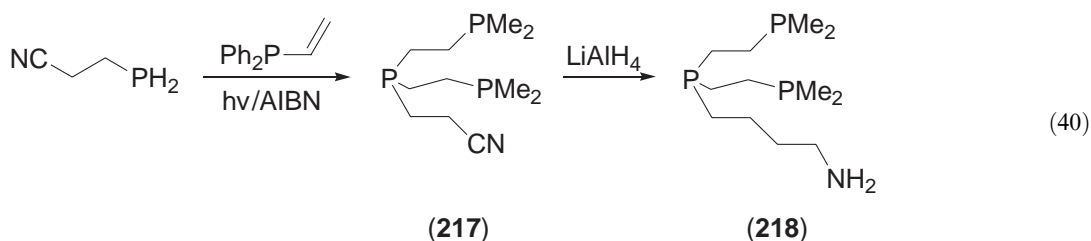
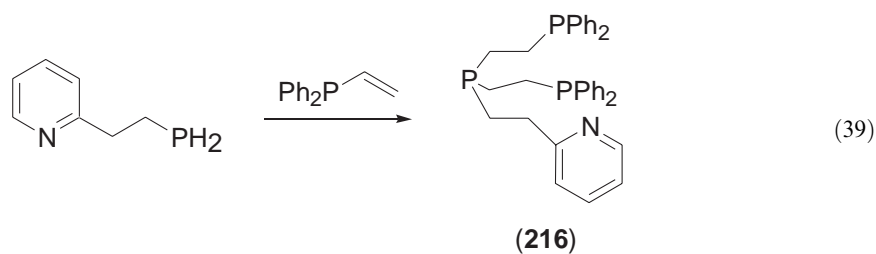
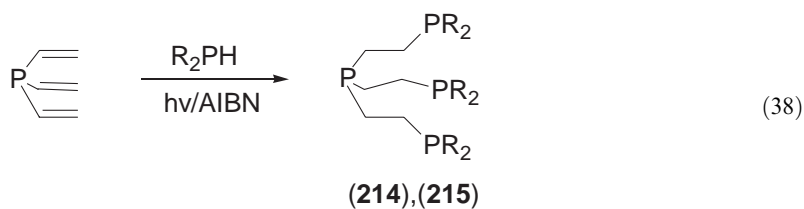


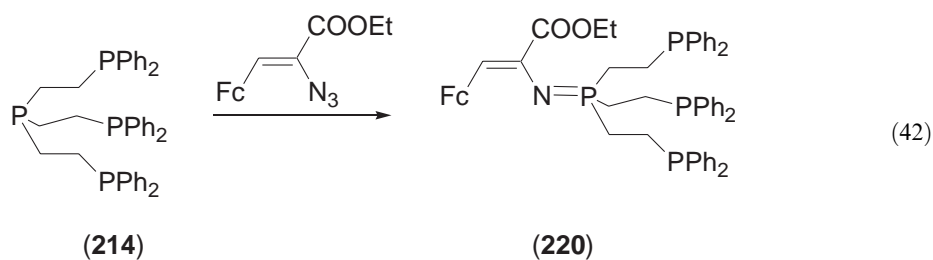
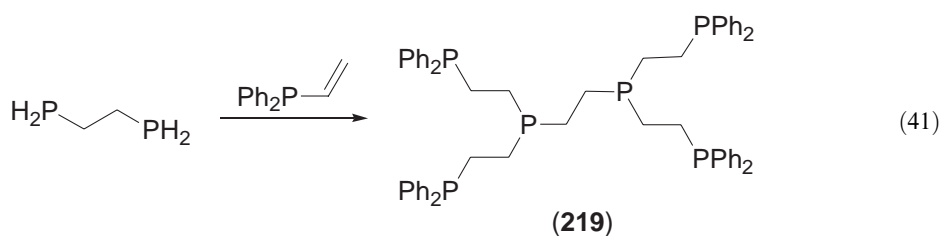
Table 13 Tripod ligands with a central phosphorus

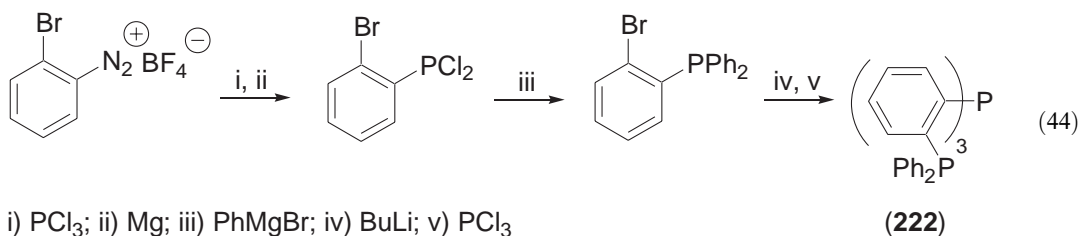
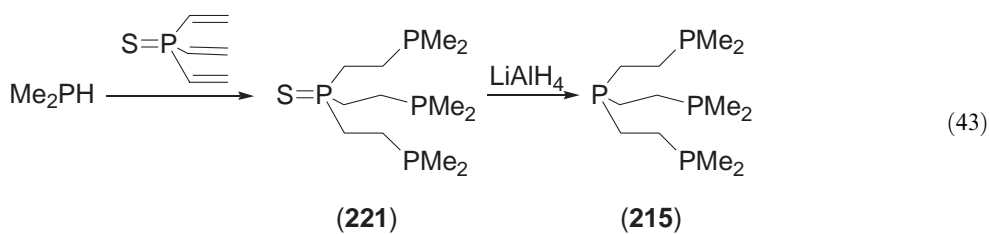
Compound/Equation	$\text{PR}_2$	Z	References
(214)/(38)	$\text{PPh}_2$	$\text{C}_2\text{H}_4\text{PPh}_2$	88,94,95
(215)/(38)	$\text{PMe}_2$	$\text{C}_2\text{H}_4\text{PMe}_2$	96
(216)/(39)	$\text{PPh}_2$	$\text{C}_2\text{H}_4\text{-2-py}^a$	97
(217)/(40)	$\text{PPh}_2$	$(\text{CH}_2)_2\text{CN}$	98
(218)/(40)	$\text{PPh}_2$	$(\text{CH}_2)_3\text{NH}_2$	98,99
(219)/(41)	$\text{PPh}_2$	$(\text{CH}_2)_2\text{P}(\text{C}_2\text{H}_4\text{PPh}_2)_2$	95,100

<sup>a</sup> 2-py =



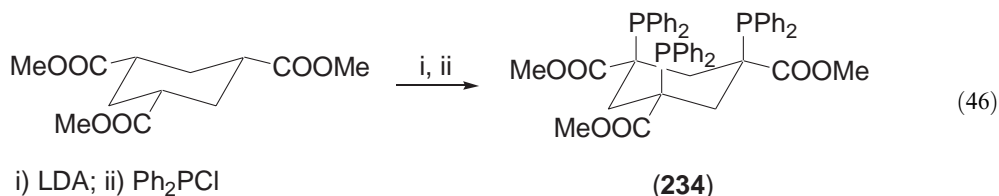
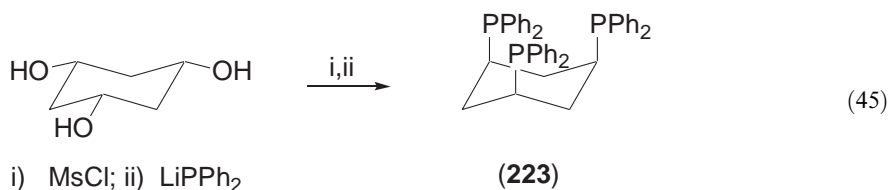
oxidized at the central phosphorus by a specific azide (see Equation (42)) to produce the modified tripod ligand (**220**).<sup>94</sup> The PS function of ligand (**221**) (see Equation (43)) is present in the starting material already. Ligand (**221**) may be reduced to compound (**215**).<sup>101</sup> Ligand (**222**) (see Equation (44)) with its aryl linker groups is synthesized from the corresponding functionalized arylphosphane.<sup>90,102</sup>



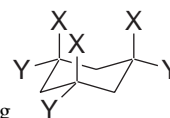


### 1.13.5 TRIPOD LIGANDS BASED ON MISCELLANEOUS SCAFFOLDINGS

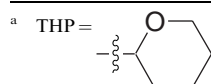
A completely different type of tripod ligand is derived from cyclohexane as the basic scaffolding. The appropriately symmetrically trifunctionalized cyclohexanes, used as starting materials, are available by catalytic hydrogenation of the corresponding benzene derivatives. Ligand (223) is obtained from the corresponding triol (see Equation (45)) by activating the oxo functions as mesylates and substituting the mesylate groups by phosphane groups. The process is completely stereoselective (the figures in Equations (45)–(48) are chosen to represent the conformation with all donor functions being in the axial positions. This conformation is the one which makes the compounds efficient tripod ligands. In the free state the all-equatorial conformation is of course preferred). An umpolung of this reaction scheme is shown in Equation (46), which leads to ligand (234).



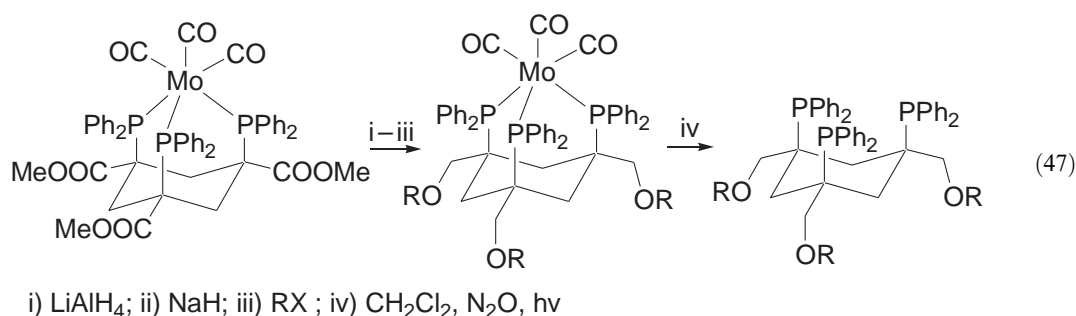
Carbomethoxy substitution makes the adjacent CH group of the cyclohexane moiety acidic enough to be deprotonated such that reaction with Ph<sub>2</sub>PCl allows the introduction of PPh<sub>2</sub> groups. Nitrile groups are also efficient in this respect, such that (235) is obtained from the analogous symmetric trinitrile precursor. (234) is the starting material for the preparation of (224)–(233). The standard reaction sequence starts with transforming (234) into its Mo(CO)<sub>3</sub> compound (see Equation (47)) by standard methods. The coordinated ligand may be transformed into the free acid (233) or into the amide (232). Reduction of the carboxymethyl functions into CH<sub>2</sub>OH groups (see Equation (47)) leads to (224). (224) serves as the starting material for the synthesis of the ether

**Table 14** Tripod ligands based on a cyclohexane scaffolding

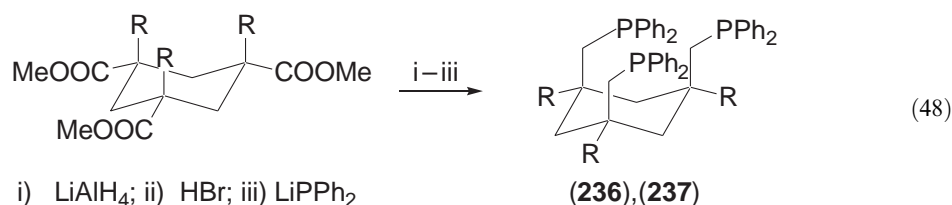
Compound/Equation	X	Y	References
(223)/(45)	PPh <sub>2</sub>	H	103
(224)/(47)	PPh <sub>2</sub>	CH <sub>2</sub> OH	104
(225)/(47)	PPh <sub>2</sub>	CH <sub>2</sub> OMe	104
(226)/(47)	PPh <sub>2</sub>	CH <sub>2</sub> OCH <sub>2</sub> OMe	104
(227)/(47)	PPh <sub>2</sub>	CH <sub>2</sub> OC <sub>2</sub> H <sub>4</sub> OMe	104
(228)/(47)	PPh <sub>2</sub>	CH <sub>2</sub> OCH <sub>2</sub> CHCH <sub>2</sub>	104
(229)/(47)	PPh <sub>2</sub>	CH <sub>2</sub> OCH <sub>2</sub> (THP) <sup>a</sup>	104
(230)/(47)	PPh <sub>2</sub>	CH <sub>2</sub> (OC <sub>2</sub> H <sub>4</sub> ) <sub>n</sub> OH	105
(231)/(47)	PPh <sub>2</sub>	CH <sub>2</sub> (OC <sub>2</sub> H <sub>4</sub> ) <sub>n</sub> OMe	105
(232)/(47) (see text)	PPh <sub>2</sub>	C(O)NHC <sub>2</sub> H <sub>4</sub> NH <sub>2</sub>	104
(233)/(47) (see text)	PPh <sub>2</sub>	COOH	104
(234)/(46)	PPh <sub>2</sub>	COOMe	106,107
(235)/(46) (see text)	PPh <sub>2</sub>	CN	107,108
(236)/(48)	CH <sub>2</sub> PPh <sub>2</sub>	H	109,110
(237)/(48) (see text)	CH <sub>2</sub> PPh <sub>2</sub>	Me	109



derivatives (225)–(231) (see Equation (47)). Solubilizing polyether functions (230) and (231) are introduced by using oxirane, (CH<sub>2</sub>)<sub>2</sub>O, as an equivalent of the RX electrophile (see Equation (47)).

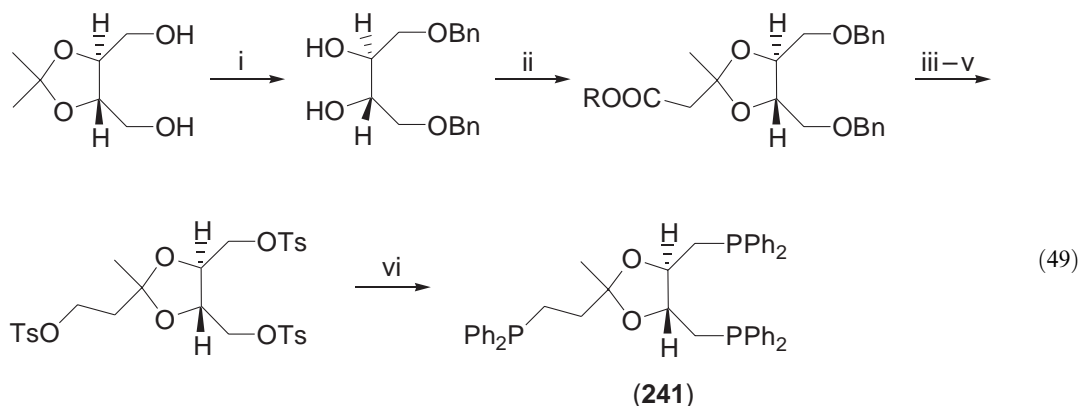


Following Equation (47) all tripod ligands are obtained in the form of their Mo(CO)<sub>3</sub> coordination compounds. The organometallic protection group Mo(CO)<sub>3</sub> may finally be selectively removed by pyridin-N-oxide/hν or N<sub>2</sub>O/hν without accompanying oxidation of the phosphane functions. Compounds (225)–(229), (231), and (233) have been obtained in the free state this way. Ligand (236) is accessible via transformation of the symmetrical triscarbomethoxy-substituted cyclohexane into the trisubstituted cyclohexane by LiPPh<sub>2</sub> gives the final product (236) (see Equation (48)). Its trimethyl derivative (237) is analogously prepared from the corresponding trimethylated starting material (see Equation (48)).



### 1.13.5.1 Tripod Ligands Based on Tartaric Acid

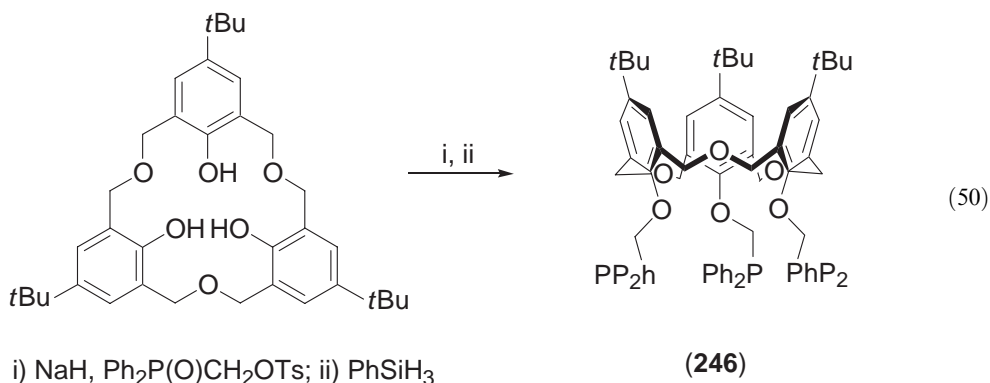
Yet another scaffolding for potential tripod ligands is derived from tartaric acid (see Table 15). The starting material for the synthesis of these compounds (see Equation (49)) is derived from tartaric acid by standard procedures. Its transformation into the potential tripod ligands (238)–(245) follows the scheme shown in Equation (49) for the specific case of (241). The chirality of the starting material is preserved throughout. Depending on the kind of oxo compound used for acetalization, different groups R (see Table 15) and different chain lengths n are easily introduced.



- i)  $\text{BnCl}/\text{NEt}_3$ ; ii)  $\text{CH}_3\text{C}(\text{O})\text{CH}_2\text{COOR}$ ,  $\text{TsOH}$ ; iii)  $\text{LiAlH}_4$ ; iv)  $\text{Pd}/\text{C}$ ,  $\text{H}_2$ ;  
v)  $\text{TsCl}$ ,  $\text{Py}$ ; vi)  $\text{LiPPh}_2$

### 1.13.5.2 Tripod Ligands Based on Calixarenes

Calixarenes may also serve as scaffoldings. The calix[3]arene in Equation (50) has been transformed into the tripod ligand (246).<sup>112</sup>



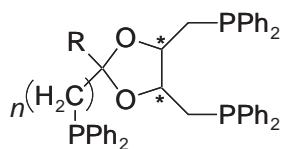
- i)  $\text{NaH}$ ,  $\text{Ph}_2\text{P}(\text{O})\text{CH}_2\text{OTs}$ ; ii)  $\text{PhSiH}_3$

### 1.13.5.3 Tripod Ligands Based on Sesquisilanes

The Sesquisilane shown in Equation (51) may serve as the basis for the potential tripod ligand (247). This inorganic scaffolding is transformed into the corresponding triphosphine (247) by the reaction sequence shown in Equation (51).<sup>113</sup>

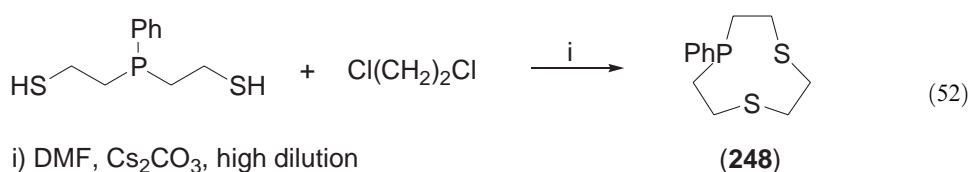
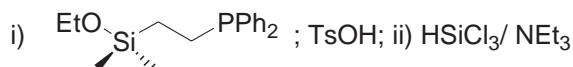
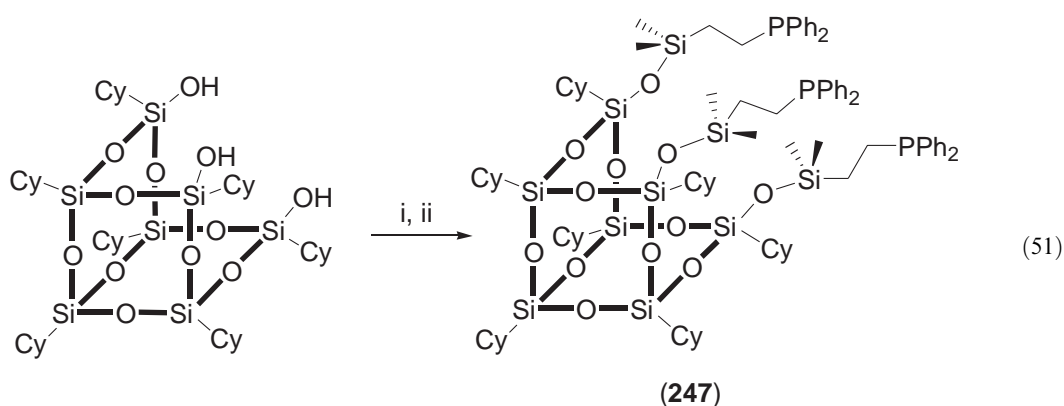
## 1.13.6 HETEROCYCLES AS TRIPOD LIGANDS

Cyclic tripod ligands such as TACN play an important role in the coordination chemistry of nitrogen-based chelate ligands. Few analogs have been reported in phosphorus chemistry.

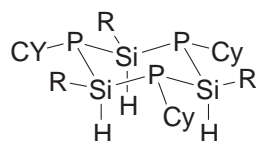
**Table 15** Tripod ligands based on tartaric acid

Compound/Equation	<i>N</i>	<i>R</i>	Configuration	References
(238)/(49)	1	H	R,R	111
(239)/(49)	1	H	R,S	111
(240)/(49)	2	Me	R,S	111
(241)/(49)	2	Me	R,R	111
(242)/(49)	3	Me	R,R	111
(243)/(49)	4	Me	R,R	111
(244)/(49)	5	Me	R,R	111
(245)/(49)	6	Me	R,R	111

The TACN analog (**248**) is accessible from the open chain starting compound by standard high dilution methods.<sup>114</sup> An alternative procedure starting from facially Mo(CO)<sub>3</sub> coordinated PhP(C<sub>2</sub>H<sub>5</sub>S)<sup>2-</sup> has also been reported.<sup>115</sup>



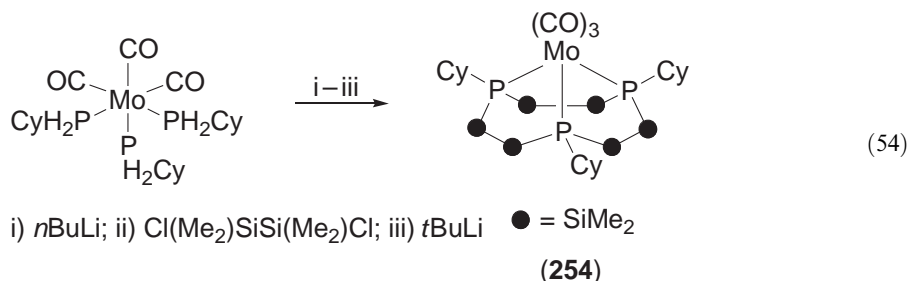
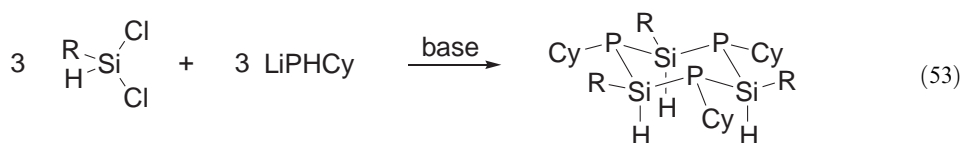
The silane-based ligands (**249**)–(**253**) (see Table 16) are obtained in highly efficient multi-component syntheses (see Equation (53)) by condensation of the corresponding dichlorosilane

**Table 16** Silane-based tripod ligands

Compound/Equation	<i>R</i>	References
(249)/(53)	Ph	116
(250)/(53)	2-CH <sub>3</sub> C <sub>6</sub> H <sub>4</sub>	116
(251)/(53)	2- <i>i</i> PrC <sub>6</sub> H <sub>4</sub>	116
(252)/(53)	2-CF <sub>3</sub> C <sub>6</sub> H <sub>4</sub>	116
(253)/(53)	Mes	116



with LiP(H)Cy. The synthesis of (**254**), a formal analog of TACN, is achieved by a template reaction. Facially coordinated  $(\text{CyPH}_2)_3\text{Mo}(\text{CO})_3$  is deprotonated at the phosphorus center with the coordinated phosphido ligands condensed with the symmetrical dichlorosilane.<sup>117</sup>



### 1.13.7 SUMMARY

Most of the coordination chemistry of tripodal ligands with soft donor groups reported so far makes use of the standard tripod ligand  $\text{CH}_3\text{C}(\text{CH}_2\text{PPh}_2)_3$ . The propensity of this ligand to stabilize a wide variety of unprecedented bonding modes and coligands in low valent coordination compounds has been amply demonstrated by the elegant work of the late L. Sacconi.

Tripod ligands with hard donor groups have exhibited similar astonishing properties in the chemistry of metals in high oxidation states especially in bioinorganic chemistry. From this type of chemistry it is known that modification of the donor groups by appropriate substituents is a prerequisite for success in many cases.

With phosphane-based tripod ligands, the aspect of varying the donor groups by different types of substitution has of course also been known; the appropriate synthetic procedures have, however, only been developed since the early 1990s. The combination of soft and hard donor groups in one and the same tripod ligand also holds much promise. It is well known that coordination compounds containing a combination of hard and soft ligands have very specific properties. Nevertheless, the synthesis of tripod ligands with mixed donor sets has only been developed quite recently. Chiral enantiomerically pure tripod ligands have also only become known since the late 1990s.

The reason for the sluggish development of ligand synthesis in this case lies in the fact that standard transformation sequences of organic chemistry have to be modified substantially whenever phosphane groups are part of an organic precursor. Many methods to overcome these inherent difficulties have been developed and many novel tripod ligands are hence waiting for their use in coordination chemistry.

### 1.13.8 REFERENCES

1. Mealli, C.; Midollini, S.; Moneti, S.; Sacconi, L. *J. Organomet. Chem.* **1981**, *205*, 273.
2. Janssen, B. C.; Asam, A.; Huttner, G.; Sernau, V.; Zsolnai, L. *Chem. Ber.* **1994**, *127*, 501.
3. Hewertson, W.; Watson, H. R. *J. Chem. Soc.* **1962**, 1490.
4. Bianchini, C.; Frediani, M.; Vizza, F. *Chem. Commun. (Cambridge)* **2001**, 479.
5. Bianchini, C.; Frediani, P.; Sernau, V. *Organometallics* **1995**, *14*, 5458.
6. Bianchini, C.; Meli, A.; Oberhauser, W. *N. J. Chem.* **2001**, *25*, 11.
7. Bianchini, C.; Meli, A.; Patinec, V.; Sernau, V.; Vizza, F. *J. Am. Chem. Soc.* **1997**, *119*, 4945.
8. Seitz, T.; Asam, A.; Huttner, G.; Walter, O.; Zsolnai, L. *Z. Naturforsch., B: Chem. Sci.* **1995**, *50*, 1287.
9. Schober, P.; Soltek, R.; Huttner, G.; Zsolnai, L.; Heinze, K. *Eur. J. Inorg. Chem.* **1998**, 1407.
10. Tsvetkov, E. N.; Bondarenko, N. A.; Malakhova, I. G.; Kabachnik, M. I. *Synthesis* **1986**, 198.
11. Asam, A.; Janssen, B.; Huttner, G.; Zsolnai, L.; Walter, O. *Z. Naturforsch., B: Chem. Sci.* **1993**, *48*, 1707.
12. Muth, A.; Asam, A.; Huttner, G.; Barth, A.; Zsolnai, L. *Chem. Ber.* **1994**, *127*, 305.
13. Seitz, T.; Huttner, G.; Buechner, M. *Z. Naturforsch., B: Chem. Sci.* **1994**, *49*, 1813.

14. Janssen, B. C.; Sernau, V.; Huttner, G.; Asam, A.; Walter, O.; Buechner, M.; Zsolnai, L. *Chem. Ber.* **1995**, *128*, 63.
15. Scherer, J.; Huttner, G.; Walter, O.; Janssen, B. C.; Zsolnai, L. *Chem. Ber.* **1996**, *129*, 1603.
16. Schober, P.; Huttner, G.; Zsolnai, L.; Jacobi, A. *J. Organomet. Chem.* **1998**, *571*, 279.
17. Muth, A.; Walter, O.; Huttner, G.; Asam, A.; Zsolnai, L.; Emmerich, C. *J. Organomet. Chem.* **1994**, *468*, 149.
18. Burk, M. J.; Harlow, R. L. *Angew. Chem.* **1990**, *102*, 1511.
19. Yao, Y.; Daley, C. J. A.; McDonald, R.; Bergens, S. H. *Organometallics* **1997**, *16*, 1890.
20. Heidel, H.; Huttner, G.; Helmchen, G. *Z. Naturforsch., B: Chem. Sci.* **1993**, *48*, 1681.
21. Heidel, H.; Scherer, J.; Asam, A.; Huttner, G.; Walter, O.; Zsolnai, L. *Chem. Ber.* **1995**, *128*, 293.
22. Seitz, T.; Muth, A.; Huttner, G. *Chem. Ber.* **1994**, *127*, 1837.
23. Heidel, H.; Huttner, G.; Zsolnai, L. *Z. Naturforsch., B: Chem. Sci.* **1995**, *50*, 729.
24. Seitz, T.; Muth, A.; Huttner, G. *Z. Naturforsch., B: Chem. Sci.* **1995**, *50*, 1045.
25. Heidel, H.; Huttner, G.; Vogel, R.; Helmchen, G. *Chem. Ber.* **1994**, *127*, 271.
26. Walter, O.; Klein, T.; Huttner, G.; Zsolnai, L. *J. Organomet. Chem.* **1993**, *458*, 63.
27. Walter, O.; Buchner, M.; Huttner, G. *J. Organomet. Chem.* **1997**, *529*, 103.
28. Buechner, M.; Huttner, G.; Winterhalter, U.; Frick, A. *Chem. Ber./Recl.* **1997**, *130*, 1379.
29. Beyreuther, S.; Hunger, J.; Cunsakis, S.; Diercks, T.; Frick, A.; Planker, E.; Huttner, G. *Eur. J. Org. Chem.* **1998**, 1641.
30. Liu, S. T.; Liu, C. Y. *J. Org. Chem.* **1992**, *57*, 6079.
31. Jacobi, A.; Huttner, G.; Winterhalter, U. *Chem. Ber./Recl.* **1997**, *130*, 1279.
32. Jacobi, A.; Huttner, G.; Winterhalter, U. *J. Organomet. Chem.* **1998**, *571*, 231.
33. Wang, H.-E.; Cheng, M.-C.; Lee, G.-H.; Peng, S.-M.; Liu, S.-T. *J. Organomet. Chem.* **1993**, *445*, 171.
34. Jacobi, A.; Huttner, G.; Winterhalter, U.; Cunsakis, S. *Eur. J. Org. Chem.* **1998**, 675.
35. Muth, A.; Reinhard, G.; Huttner, G.; Seitz, T.; Klein, T.; Zsolnai, L. *Z. Naturforsch., B: Chem. Sci.* **1994**, *49*, 889.
36. Liu, S. T.; Wang, H. E.; Cheng, M. C.; Peng, S. M. *J. Organomet. Chem.* **1989**, *376*, 333.
37. Liu, S. T.; Yieh, C. H.; Lu, H. J. *Phosphorus, Sulfur Silicon Relat. Elem.* **1989**, *44*, 261.
38. Vogelgesang, J.; Huttner, G.; Kaifer, E.; Kirchner, P.; Rutsch, P.; Cunsakis, S. *Eur. J. Org. Chem.* **1999**, 2187.
39. Reinhard, G.; Soltek, R.; Huttner, G.; Barth, A.; Walter, O.; Zsolnai, L. *Chem. Ber.* **1996**, *129*, 97.
40. Koerner, V.; Huttner, G.; Zsolnai, L.; Buechner, M.; Jacobi, A.; Guenauer, D. *Chem. Ber.* **1996**, *129*, 1587.
41. Soltek, R.; Huttner, G. *Eur. J. Org. Chem.* **1998**, 1417.
42. Soltek, R.; Huttner, G.; Zsolnai, L.; Driess, A. *Inorg. Chim. Acta* **1998**, *269*, 143.
43. Liu, S. T.; Wang, H. E.; Yiin, L. M.; Tsai, S. C.; Liu, K. J.; Wang, Y. M.; Cheng, M. C.; Peng, S. M. *Organometallics* **1993**, *12*, 2277.
44. Liu, S. T.; Liu, K. J. *Inorg. Chem.* **1990**, *29*, 4576.
45. Antelmann, B.; Winterhalter, U.; Huttner, G.; Janssen, B. C.; Vogelgesang, J. *J. Organomet. Chem.* **1997**, *545–546*, 407.
46. Antelmann, G.; Huttner, G.; Winterhalter, U. *J. Organomet. Chem.* **1998**, *553*, 433.
47. Antelmann, B.; Huttner, G.; Vogelgesang, J.; Walter, O.; Winterhalter, U. *J. Organomet. Chem.* **1997**, *549*, 139.
48. Vogelgesang, J.; Frick, A.; Huttner, G.; Kircher, P. *Eur. J. Inorg. Chem.* **2001**, 949.
49. Scherer, J.; Huttner, G.; Buechner, M. *Chem. Ber.* **1996**, *129*, 697.
50. Scherer, J.; Huttner, G.; Buechner, M.; Bakos, J. *J. Organomet. Chem.* **1996**, *520*, 45.
51. Scherer, J.; Huttner, G.; Heidel, H. *J. Organomet. Chem.* **1997**, *539*, 67.
52. Yamagishi, T.; Ikeda, S.; Yatagai, M.; Yamaguchi, M.; Hida, M. *J. Chem. Soc., Perkin Trans. 1* **1988**, 1787.
53. Yamada, I.; Fukui, K.; Aoki, Y.; Ikeda, S.; Yamaguchi, M.; Yamagishi, T. *J. Organomet. Chem.* **1997**, *539*, 115.
54. Gupta, P. K. S.; Houk, L. W.; Van der Helm, D.; Hossain, M. B. *Acta Crystallogr., Sect. B* **1982**, *B38*, 1818.
55. Ruether, T.; Done, M. C.; Cavell, K. J.; Peacock, E. J.; Skelton, B. W.; White, A. H. *Organometallics* **2001**, *20*, 5522.
56. Done, M. C.; Ruther, T.; Cavell, K. J.; Kilner, M.; Peacock, E. J.; Braussaud, N.; Skelton, B. W.; White, A. *J. Organomet. Chem.* **2000**, *607*, 78.
57. Brauer, D. J.; Kottsieper, K. W.; Schenk, S.; Stelzer, O. *Z. Anorg. Allg. Chem.* **2001**, *627*, 1151.
58. Griffin, J. H.; Kellogg, R. M. *J. Org. Chem.* **1985**, *50*, 3261.
59. Cross, G.; Vriesema, B. K.; Boven, G.; Kellogg, R. M.; Van Bolhuis, F. *J. Organomet. Chem.* **1989**, *370*, 357.
60. Brauer, D. J.; Machnitzki, P.; Nickel, T.; Stelzer, O. *Eur. J. Inorg. Chem.* **2000**, 65.
61. Faller, J. W.; Zhang, N.; Chase, K. J.; Musker, W. K.; Amaro, A. R.; Semko, C. M. *J. Organomet. Chem.* **1994**, *468*, 175.
62. Liek, C.; Machnitzki, P.; Nickel, T.; Schenk, S.; Tepper, M.; Stelzer, O. *Z. Naturforsch., B: Chem. Sci.* **1999**, *54*, 1532.
63. Tepper, M.; Stelzer, O.; Haeusler, T.; Sheldrick, W. S. *Tetrahedron Lett.* **1997**, *38*, 2257.
64. El-Amouri, H.; Bahsoun, A. A.; Osborn, J. A. *Polyhedron* **1988**, *7*, 2035.
65. Issleib, K.; Abicht, H. P. *J. Prakt. Chem.* **1970**, *312*, 456.
66. Bookham, J. L.; McFarlane, W.; Colquhoun, I. J. *J. Chem. Soc., Chem. Commun.* **1986**, 1041.
67. Nawar, N.; Smith, A. K. *J. Organomet. Chem.* **1995**, *493*, 239.
68. Dolby, P. A.; Harding, M. M.; Newar, N.; Smith, A. K. *J. Chem. Soc., Dalton Trans.* **1992**, 2939.
69. Andrieu, J.; Braunstein, P.; Tiripicchio, A.; Ugozzoli, F. *Inorg. Chem.* **1996**, *35*, 5975.
70. Yang, H.; Alvarez-Gressier, M.; Lugan, N.; Mathieu, R. *Organometallics* **1997**, *16*, 1401.
71. Yang, H.; Alvarez, M.; Lugan, N.; Mathieu, R. *J. Chem. Soc., Chem. Commun.* **1995**, 1721.
72. Alvarez, M.; Lugan, N.; Mathieu, R. *J. Chem. Soc., Dalton Trans.* **1994**, 2755.
73. Lee, H. M.; Bianchini, C.; Jia, G.; Barbaro, P. *Organometallics* **1999**, *18*, 1961.
74. Lee, H. M.; Yang, C.; Jia, G. *J. Organomet. Chem.* **2000**, *601*, 330.
75. Toro, J.-F.C.; Riviere, F.; Wolf, J.-G.; Sanchez, M.; Romanenko, V. D. *Chem. Commun. (Cambridge)* **1998**, 2183.
76. Boncella, J. M.; Green, M. L. H.; O'Hare, D. *J. Chem. Soc., Chem. Commun.* **1986**, 618.
77. Karsch, H. H.; Appelt, A. *Z. Naturforsch., B: Anorg. Chem., Org. Chem.* **1983**, *38B*, 1399.
78. You, Y.; Wilson, S. R.; Girolami, G. S. *Organometallics* **1994**, *13*, 4655.
79. Gardner, T. G.; Girolami, G. S. *Angew. Chem.* **1988**, *100*, 1755.
80. Karsch, H. H.; Schmidbaur, H. *Z. Naturforsch., B: Anorg. Chem., Org. Chem.* **1977**, *32B*, 762.
81. Ward, T. R.; Venanzi, L. M.; Albinati, A.; Lianza, F.; Gerfin, T.; Gramlich, V.; Ramos Tombo, G. M. *Helv. Chim. Acta* **1991**, *74*, 983.

82. Shapiro, I. M.; Jenkins, D. M.; Thomas, J. C.; Day, M. W.; Peters, J. C. *Chem. Commun. (Cambridge, United Kingdom)* **2001**, 2152.
83. Peters, J. C.; Feldman, J. D.; Tilley, T. D. *J. Am. Chem. Soc.* **1999**, *121*, 9871.
84. Barney, A. A.; Heyduk, A. F.; Nocera, D. G. *Chem. Commun. (Cambridge)* **1999**, 2379.
85. Grobe, J.; Wehmschulte, R. *Z. Anorg. Allg. Chem.* **1993**, *619*, 563.
86. Grobe, J.; Krummen, N. *Z. Naturforsch., B: Anorg. Chem., Org. Chem.* **1986**, *41B*, 1239.
87. Walter, O.; Huttner, G.; Kern, R. *Z. Naturforsch., B: Chem. Sci.* **1996**, *51*, 922.
88. Bianchini, C.; Elsevier, C. J.; Ernsting, J. M.; Peruzzini, M.; Zanolini, F. *Inorg. Chem.* **1995**, *34*, 84.
89. Stoppioni, P.; Morassi, R.; Zanolini, F. *Inorg. Chim. Acta* **1981**, *52*, 101.
90. Mani, F.; Stoppioni, P. *Inorg. Chim. Acta* **1976**, *16*, 177.
91. Sacconi, L.; Morassi, R. *J. Chem. Soc. A* **1969**, 2904.
92. Drefahl, G.; Konig, K. H. *Chem. Ber.* **1954**, *87*, 1632.
93. Kuang, S.-M.; Fanwick, P. E.; Walton, R. A. *Inorg. Chem.* **2002**, *41*, 405.
94. Molina, P.; Arques, A.; Garcia, A.; Ramirez de Arellano, M. C. *Eur. J. Inorg. Chem.* **1998**, 1359.
95. King, R. B.; Kapoor, R. N. *J. Amer. Chem. Soc.* **1969**, *91*, 5191.
96. Bampos, N.; Field, L.; Messerle, B. A.; Smernik, R. J. *Inorg. Chem.* **1993**, *32*, 4084.
97. Hessler, A.; Fischer, J.; Kucken, S.; Stelzer, O. *Chem. Ber.* **1994**, *127*, 481.
98. Uriarte, R.; Mazanec, T. J.; Tau, K. D.; Meek, D. W. *Inorg. Chem.* **1980**, *19*, 79.
99. DuBois, D. L. *Inorg. Chem.* **1984**, *23*, 2047.
100. King, R. B.; Kapoor, P. N. *J. Am. Chem. Soc.* **1971**, *93*, 4153.
101. King, R. B.; Cloyd, J. C., Jr. *J. Am. Chem. Soc.* **1975**, *97*, 53.
102. Hartley, J. G.; Venanzi, L. M.; Goodall, D. C.; *J. Chem. Soc.* **1963**, 3930.
103. Mayer, H. A.; Otto, H.; Kuehbauch, H.; Fawzi, R.; Steimann, M. *J. Organomet. Chem.* **1994**, *472*, 347.
104. Stoessel, P.; Mayer, H. A.; Maichle-Moessmer, C.; Fawzi, R.; Steimann, M. *Inorg. Chem.* **1996**, *35*, 5860.
105. Stoessel, P.; Mayer, H. A.; Auer, F. *Eur. J. Inorg. Chem.* **1998**, 37.
106. Mayer, H. A.; Stoessel, P.; Fawzi, R.; Steimann, M. *J. Organomet. Chem.* **1995**, *492*, C1.
107. Stoessel, P.; Heins, W.; Mayer, H. A.; Fawzi, R.; Steimann, M. *Organometallics* **1996**, *15*, 3393.
108. Mayer, H. A.; Stoessel, P.; Fawzi, R.; Steimann, M. *Chem. Ber.* **1995**, *128*, 719.
109. Mayer, H. A.; Fawzi, R.; Steimann, M. *Chem. Ber.* **1993**, *126*, 1341.
110. Mayer, H. A.; Kaska, W. C. *Chem. Ber.* **1990**, *123*, 1827.
111. Holz, J.; Kless, A.; Boerner, A. *Synlett* **1996**, 267.
112. Dieleman, C. B.; Matt, D.; Neda, I.; Schmutzler, R.; Harriman, A.; Yafitian, R. *Chem. Commun. (Cambridge)* **1999**, 1911.
113. Wada, K.; Izuhara, D.; Shiotsuki, M.; Kondo, T.; Mitsudo, T.-A. *Chem. Lett.* **2001**, 734.
114. Smith, R. J.; Powell, A. K.; Barnard, N.; Dilworth, J. R.; Blower, P. J. *J. Chem. Soc., Chem. Commun.* **1993**, 54.
115. Blower, P. J.; Jeffery, J. C.; Miller, J. R.; Salek, S. N.; Schmaljohann, D.; Smith, R. J.; Went, M. J. *Inorg. Chem.* **1997**, *36*, 1578.
116. Driess, M.; Pritzkow, H.; Reisgys, M. *Chem. Ber.* **1996**, *129*, 247.
117. Driess, M.; Faulhaber, M.; Pritzkow, H. *Angew. Chem., Int. Ed. Engl.* **1997**, *36*, 1892.

# 1.14

## Dichalcogenoimidodiphosph(in)ate Ligands

I. HAIUC

Universitatea "Babes-Bolyai", Cluj-Napoca, Roumania

---

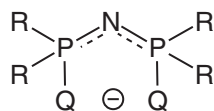
1.14.1	INTRODUCTION	323
1.14.2	SYNTHESIS	324
1.14.2.1	Preparative Reactions	324
1.14.2.1.1	Oxidation of bis(phosphino)amines – method A	324
1.14.2.1.2	Oxidation of bis(phosphino)amines – method B	325
1.14.2.2	Coupling of Phosphoryl or Phosphinyl Amides with Phosphoryl or Phosphinyl Halides	325
1.14.2.2.1	Organolithium reagents	325
1.14.2.2.2	Sodium hydride	325
1.14.2.2.3	Alcoholysis of bis(dichlorophosphoryl)amide (tetrachlorodioxodiphosphazane)	326
1.14.2.3	Other Formation Reactions	327
1.14.2.3.1	Thermal condensation of phosphinyl amides	327
1.14.2.3.2	Hydrolysis of diphosphazene chlorides	327
1.14.2.3.3	Hydrolysis of other functional diphosphazene derivatives	327
1.14.2.3.4	Alcoholysis of trichlorophosphazo derivatives, followed by partial acid splitting of R <sup>1</sup> O groups	328
1.14.2.3.5	Coupling of phosphoryl azides with phosphites, followed by acid splitting of OR <sup>1</sup> groups	328
1.14.2.3.6	Hydrolysis or alcoholysis of N-silylated imidodiphosphoryl derivatives	328
1.14.2.3.7	Splitting of OR <sup>1</sup> groups from phosphate esters with sodium amide	328
1.14.2.3.8	In situ formation of imidodiphosphinato ligands	328
1.14.3	ACIDITY AND PREPARATION OF ALKALI METAL AND OTHER SALTS	329
1.14.4	SPECTROSCOPIC AND STRUCTURAL CHARACTERIZATION	334
1.14.5	COORDINATION PATTERNS	335
1.14.6	METAL COMPLEXES	341
1.14.7	CONCLUSIONS	342
1.14.8	REFERENCES	342

---

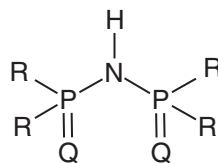
### 1.14.1 INTRODUCTION

The anions of general formula  $[\text{R}^1_2(\text{Q}^1)\text{PNP}(\text{Q}^1)\text{R}^1_2]^-$  (**1**), known under the generic name of dichalcogenoimidodiphosphinates ( $\text{R}^1 = \text{alkyl, aryl}$ ) and dichalcogenoimidodiphosphates ( $\text{R}^1 = \text{alkoxy, aroxy}$ ), are versatile ligands, formally derived from the corresponding bis(phosphinyl)- and bis(phosphoryl)imides,  $\text{R}^1_2(\text{Q}^1)\text{PNHP}(\text{Q}^1)\text{R}^1_2$  (**2**) by deprotonation.

The nomenclature of these compounds is somewhat erratic and various systems are used. The IUPAC names (also used by *Chemical Abstracts*) are cumbersome. Thus, bis(diphenylphosphinyl)-imide,  $\text{Ph}_2(\text{O})\text{PNHP}(\text{O})\text{Ph}_2$  is called *N-(P,P-diphenylphosphinoyl)-P,P-diphenylphosphinimidic acid*. A shorter name is usually preferred, i.e., tetraphenylimidodiphosphinic acid. Referring to these compounds as “acids” is justified by their ready deprotonation (*vide infra*). The use of names such as: iminodiphosphinechalcogenides,<sup>1</sup> bis(thiophosphinoyl)amines,<sup>2</sup> imido-tetraphenyldiphosphinic acid,<sup>3</sup> imidotetraphenyldithiodiphosphinate<sup>4,5</sup> imidobis(diphenylselenophosphinate),<sup>6</sup> bis(diphenylchalcogenophosphoryl)amide,<sup>7,8</sup>  $\mu$ -nitrido-bis(diorganylphosphinate),<sup>9</sup>



(1)



(2)

bis(thiodiphenyl phosphino)amide,<sup>10</sup> tetraphenylimidodiphosphorane,<sup>11</sup> etc., only serve to illustrate the confusion and lack of uniformity in the nomenclature of these compounds.

A great diversity of compounds is possible, by varying the organic groups and the chalcogens, and symmetric and unsymmetrical derivatives (i.e., with differing Q<sup>1</sup> or R<sup>1</sup>) have been reported. The compounds R<sup>1</sup><sub>2</sub>(Q<sup>1</sup>)PNP(Q<sup>2</sup>)R<sup>2</sup><sub>2</sub> and their deprotonated [Q<sup>1</sup>R<sup>1</sup><sub>2</sub>PNP(Q<sup>2</sup>)R<sup>2</sup><sub>2</sub>]<sup>-</sup> anions can be described as combinations of phosphinyl, R<sup>1</sup><sub>2</sub>(Q<sup>1</sup>)P-, phosphoryl, (R<sup>1</sup>O)<sub>2</sub>(Q<sup>1</sup>)P- or (seldom) phosphonyl, R<sup>1</sup>(R<sup>1</sup>O)(Q<sup>1</sup>)P-groups. For simplicity, sometimes all R<sup>1</sup><sub>2</sub>(Q<sup>1</sup>)PNP(Q<sup>2</sup>)R<sup>2</sup><sub>2</sub> compounds are referred to as imidodiphosphinates, and the present OR<sup>1</sup> groups are indicated as alkoxy substituents; thus, Ph<sub>2</sub>(O)PNP(O)(OEt)<sub>2</sub> is designated as diphenyl-diethoxyimidodiphosphinate.

The chemistry of imidodiphosph(in)ato ligands and their metal complexes, or some of its particular aspects, has been reviewed more or less comprehensively, at various stages and covers almost all metallic and semimetallic elements of the periodic table.<sup>12–21</sup>

## 1.14.2 SYNTHESIS

### 1.14.2.1 Preparative Reactions

There are numerous reactions in which the title compounds are formed, but only a few of them have preparative value. This is mainly determined by the availability of the starting materials.

#### 1.14.2.1.1 Oxidation of bis(phosphino)amines – method A

This is the most convenient method for preparing symmetric bis(chalcogenophosphinyl)imides, using the reaction of chlorodiorganophosphines with hexamethyldisilazane, followed by oxidative addition of oxygen, sulfur or selenium:



where

Q<sup>1</sup> = O (oxidation with H<sub>2</sub>O<sub>2</sub>), Ph (85% yield),<sup>22,23</sup> R<sup>1</sup> = Pr<sup>i</sup> (54% yield)<sup>28</sup>

Q<sup>1</sup> = S, R<sup>1</sup> = Pr<sup>i</sup> (58% yield),<sup>24</sup> Ph (74% yield)<sup>22,25,26</sup>

Q<sup>1</sup> = Se, R<sup>1</sup> = Pr<sup>i</sup> (48–65% yield),<sup>27,28</sup> Ph (65% yield with KSeCN,<sup>22</sup> 84% yield with gray Se)<sup>29,30</sup>

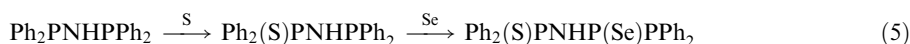
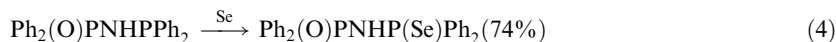
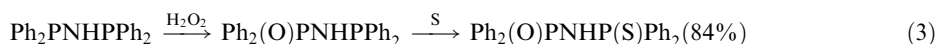
For the preparation of the dioxo derivatives, the oxidation can be carried out with hydrogen peroxide 30% or with concentrated nitric acid,<sup>31</sup> which indicates a remarkable stability of these compounds.

The reaction fails with Me<sub>2</sub>P(S)Br, Bu<sup>t</sup><sub>2</sub>PCl, or Ph<sub>2</sub>P(S)Cl in toluene since these halides do not react with hexamethyldisilazane,<sup>22</sup> but in the absence of solvent, Me<sub>2</sub>P(S)X (X = Cl, Br) gives

$\text{Me}_2\text{P(S)NH-TMS}$ , which can then react with  $\text{Me}_2\text{P(S)Br}$ , at  $60\text{--}70^\circ\text{C}$ , to form  $\text{Me}_2(\text{S})\text{PNHP(S)Me}_2$  in a quantitative yield.<sup>32</sup>

#### 1.14.2.1.2 Oxidation of bis(phosphino)amines – method B

The oxidation can be carried out in two steps, thus affording mixed chalcogen ligands. The first phosphorus atom is oxidized by adding oxygen or sulfur, and in the second step an identical or a different chalcogen is added to the other phosphorus site:<sup>33,34</sup>



The reaction can be carried out *in situ*, without isolation of the  $\text{P}^{\text{III}}\text{--P}^{\text{V}}$  intermediate, e.g., with  $\text{R}^1 = \text{Pr}^i$ , to prepare  $\text{Pr}_2^i(\text{S})\text{PNHP(Q}^1)\text{Pr}_2^i$  ( $\text{Q}^1 = \text{O, Se}$ ); the yields are, however, moderate (37% for  $\text{Q}^1 = \text{Se}$ , 25% for  $\text{Q}^1 = \text{O}$ ).<sup>28</sup>

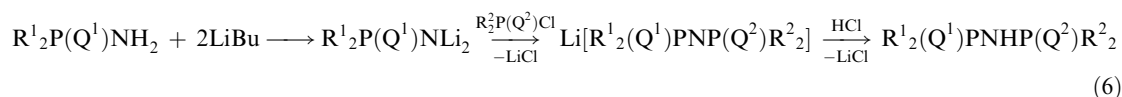
#### 1.14.2.2 Coupling of Phosphoryl or Phosphinyl Amides with Phosphoryl or Phosphinyl Halides

The coupling of phosphoryl or phosphinyl amides with phosphoryl or phosphinyl halides is an excellent method for the preparation of unsymmetrical ligands, and affords the synthesis of compounds with both organic groups and chalcogens differing.

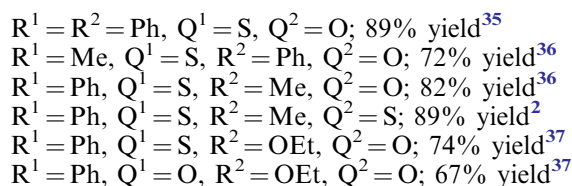
The reactions are carried out in the presence of a base, preferably a metallating reagent for the amine.

##### 1.14.2.2.1 Organolithium reagents

Organolithium reagents can be used successfully, and the reaction is carried out in diethyl ether or THF.



where

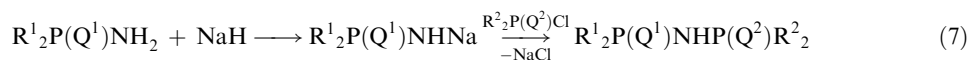


Methylithium was used in the reaction with  $\text{R}^1 = \text{R}^2 = \text{Ph, Q}^1 = \text{Q}^2 = \text{S}$ .<sup>38</sup>

##### 1.14.2.2.2 Sodium hydride

Sodium hydride can be used alternatively as a metallating reagent. The reaction can be carried out in THF or benzene, but in some cases better results are obtained using DMF, which insures

improved solubility of the intermediates.<sup>39</sup> A large number of derivatives have been prepared recently by using this method:

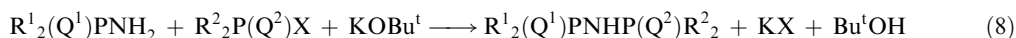


where

- $\text{R}^1 = \text{R}^2 = \text{PhO}$ ,  $\text{Q}^1 = \text{Q}^2 = \text{S}$ ; 61% yield (in benzene)<sup>40</sup>
- $\text{R}^1 = \text{Ph}$ ,  $\text{Q}^1 = \text{S}$ ,  $\text{R}^2 = \text{EtO}$ ,  $\text{Q}^1 = \text{S}$ ; 73% yield (in THF)<sup>41</sup>
- $\text{R}^1 = \text{Et}$ ,  $\text{Q}^1 = \text{O}$ ,  $\text{R}^2 = \text{Ph}$ ,  $\text{Q}^2 = \text{S}$ ; 81% yield (in THF)<sup>41</sup>
- $\text{R}^1 = \text{R}^2 = \text{ArO}$ ,  $\text{Q}^1 = \text{Q}^2 = \text{O}$  or  $\text{S}$  (Ar = Ph, *o*-, *m*- or *p*-tolyl (in benzene)<sup>42</sup>
- $\text{R}^1 = \text{R}^2 = \text{ArO}$ ,  $\text{Q}^1 = \text{O}$ ,  $\text{Q}^2 = \text{S}$  (Ar as above) (in benzene)<sup>42</sup>
- $\text{R}^1 = \text{Ph}$ ,  $\text{Q}^1 = \text{S}$ ,  $\text{R}^2 = \text{EtO}$ ,  $\text{Q}^2 = \text{S}$ ; 78% yield (in THF)<sup>43</sup>
- $\text{R}^1$ ,  $\text{R}^2 = \text{Bu}^n$ ,  $\text{Bu}^i$ ,  $\text{Bu}^s$  in various combinations;  $\text{Q}^1 = \text{Q}^2 = \text{S}$  (in THF)<sup>44</sup>
- $\text{R}^1 = \text{Ph}$ ,  $\text{R}^2 = \text{Et}$ ,  $\text{Pr}^i$ ,  $\text{Q}^1 = \text{Q}^2 = \text{S}$ ; yields 54–67% (in THF)<sup>45</sup>
- $\text{R}^1 = \text{PhO}$ ,  $\text{R}^2 = \text{Et}$ ,  $\text{Pr}^i$ ,  $\text{EtO}$ ,  $\text{Q}^1 = \text{Q}^2 = \text{S}$ , yields 60–83% (in THF)<sup>45</sup>
- $\text{R}^1 = \text{R}^2 = \text{Ph}$ ,  $\text{Q}^1 = \text{S}$ ,  $\text{Q}^2 = \text{Se}$ ; 78% yield (in THF)<sup>46</sup>
- $\text{R}^1 = \text{Ph}$ ,  $\text{R}^2 = \text{PhO}$ ,  $\text{Q}^1 = \text{S}$  or  $\text{Se}$ ,  $\text{Q}^2 = \text{S}$ , yields 13–26% (in THF)<sup>39</sup>
- $\text{R}^1 = \text{OPh}$ ,  $\text{R}^2 = \text{Pr}^i$  or  $\text{Ph}$ ,  $\text{Q}^1 = \text{O}$ ,  $\text{Q}^2 = \text{S}$  or  $\text{Se}$ ; yields 23–34% (in THF)<sup>39</sup>
- $\text{R}^1 = \text{OPh}$ ,  $\text{R}^2 = \text{Pr}^i$  or  $\text{Ph}$ ,  $\text{Q}^1 = \text{S}$ ,  $\text{Q}^2 = \text{O}$  or  $\text{S}$ ; yields 72–82% (in DMF)<sup>39</sup>

The coupling reaction with sodium hydride has been used for the synthesis of ligands chiral at phosphorus, such as  $\text{Ph}_2(\text{S})\text{PNHP}^*(\text{S})\text{Ph}(\text{OPh})$  and  $(\text{PhO})_2(\text{Q}^1)\text{PNHP}^*(\text{S})\text{Ph}(\text{OPh})$  ( $\text{Q}^1 = \text{O}$  or  $\text{S}$ ).<sup>47</sup> These compounds are combined from phosphinyl (or phosphoryl) with phosphonyl fragments and are the only representatives of this type reported.

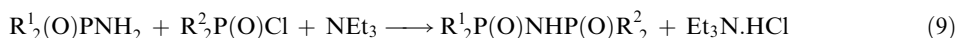
In earlier years the coupling reaction was carried out with potassium *tert*-butoxide,  $\text{KOBU}^t$ :



where

- $\text{R}^1 = \text{R}^2 = \text{Ph}$ ,  $\text{Q}^1 = \text{Q}^2 = \text{S}$ ,  $\text{X} = \text{Cl}$ <sup>38</sup>
- $\text{R}^1 = \text{Me}$  or  $\text{Ph}$ ,  $\text{R}^2 = \text{Me}$  or  $\text{Ph}$ ,  $\text{Q}^1 = \text{Q}^2 = \text{S}$ ,  $\text{X} = \text{Br}$ ; 32–55% yields<sup>48</sup>
- $\text{R}^1 = \text{R}^2 = \text{Me}$ ,  $\text{Q}^1 = \text{Q}^2 = \text{S}$ ,  $\text{X} = \text{Br}$ <sup>49,50</sup>

The coupling of phosphoryl or phosphinyl amides with related chlorides, in the presence of triethylamine, gives only moderate yields of the dioxo ligands:



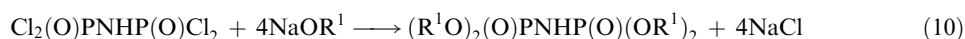
where

- $\text{R}^1 = \text{OEt}$ ,  $\text{R}^2 = \text{Ph}$  (42% yield)<sup>51</sup>
- $\text{R}^1 = \text{Et}$ ,  $\text{R}^2 = \text{OPh}$  (21% yield)<sup>32</sup>
- $\text{R}^1 = \text{R}^2 = \text{C}_3\text{F}_7$  (yield 65%)<sup>52</sup>

Sodium amide was used in the preparation of  $\text{Et}_2(\text{S})\text{PNHP}(\text{S})\text{Et}_2$ ,<sup>53</sup> but attempts to use pyridine in the condensation of  $\text{Ph}_2\text{P}(\text{S})\text{NH}_2$  with  $\text{Ph}_2\text{P}(\text{S})\text{Cl}$  failed to produce the condensation product.<sup>38</sup> The condensation can also be performed with  $\text{KOH}$  in  $\text{DMSO}$ , but the yields are low (18–46%) in the synthesis of  $(\text{R}^1\text{O})_2\text{P}(\text{S})\text{NHP}(\text{S})\text{R}^2_2$  ( $\text{R}^1 = \text{MeO}$ ,  $\text{R}^2 = \text{MeO}$ ,  $\text{Pr}^i\text{O}$ ;  $\text{R}^1 = \text{Pr}^i\text{O}$ ,  $\text{R}^2 = \text{Pr}^i\text{O}$ ,  $\text{Ph}$ ).<sup>54</sup>

#### 1.14.2.2.3 Alcoholysis of bis(dichlorophosphoryl)amide (tetrachlorodioxodiphosphazane)

Alcoholysis of bis(dichlorophosphoryl)amide (tetrachlorodioxodiphosphazane) was used for the synthesis of alkoxy-substituted ligands, although the starting material is not a common reagent:



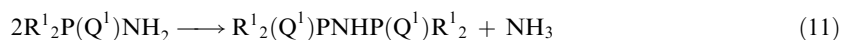
where

$R^1 = \text{Me, Et, Pr, Ph}$  ( $R^1\text{OH}$  instead of  $\text{NaOR}^1$ )<sup>55</sup>  
 $R^1 = \text{Ph}$  (50% yield)<sup>56,57</sup>  
 $R^1 = 4\text{-MeC}_6\text{H}_4$  (39% yield), 3,4- $\text{Me}_2\text{C}_6\text{H}_3$  (42% yield), 3,5- $\text{Me}_2\text{C}_6\text{H}_3$  (52% yield),  
 2,3- $\text{Me}_2\text{C}_6\text{H}_3$  (52% yield)<sup>57-59</sup>

### 1.14.2.3 Other Formation Reactions

A large number of other reactions leading to bis(chalcogenophosphinyl and -phosphoryl)imides have been reported in the literature, but the starting materials are not readily available or the reaction conditions are not practical, and therefore, they cannot be recommended for preparative purposes. These reactions are briefly listed below.

#### 1.14.2.3.1 Thermal condensation of phosphinyl amides

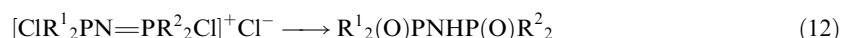


where  $R^1 = \text{Bu}^n$ ,  $Q^1 = \text{O}$ <sup>60</sup>;  $R^1 = \text{Me}$ ,  $Q^1 = \text{S}$ .<sup>48</sup>

The amide  $\text{Ph}_2\text{P(S)NH}_2$  was unchanged after 17 h of refluxing in mesitylene at 160 °C, but underwent condensation to  $\text{Ph}_2(\text{S})\text{PNHP(S)Ph}_2$  (68% yield) at 280 °C, with formation of some secondary products, such as  $[\text{Ph}_2\text{PN}]_3$  (7%) and  $[\text{Ph}_2\text{P(S)NH}]_2$  (17.3%) and elimination of  $\text{H}_2\text{S}$  and benzene.<sup>61,62</sup>

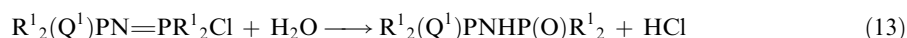
#### 1.14.2.3.2 Hydrolysis of diphosphazene chlorides

Hydrolysis of diphosphazene chlorides, under various conditions, e.g., with  $\text{HCO}_2\text{H}$  (with elimination of  $\text{CO}$ ),  $\text{K}_2\text{CO}_3$  (with formation of the potassium salt, followed by acidification):



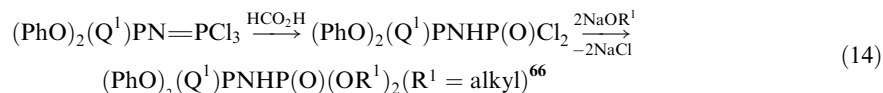
where

$R^1 = \text{Ph}$  (with  $\text{HCO}_2\text{H}$ )<sup>63</sup>  
 $R^1 = R^2 = \text{Me}$  or  $\text{Ph}$  (with  $\text{K}_2\text{CO}_3$ )<sup>48</sup>



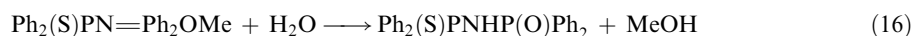
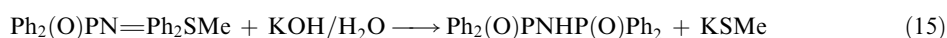
where

$R^1 = \text{Ph}$ ,  $Q^1 = \text{O}$ ;<sup>64</sup>  $R^1 = \text{Ph}$ ,  $Q^1 = \text{S}$ <sup>31</sup>  
 $R^1 = \text{Ph}$ ,  $Q^1 = \text{O}$  (starting from  $\text{Ph}_2\text{PCl}$  and chloramine,  $\text{NH}_2\text{Cl}$ )<sup>65</sup>



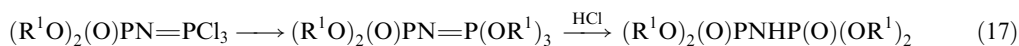
#### 1.14.2.3.3 Hydrolysis of other functional diphosphazene derivatives

Hydrolysis of other functional diphosphazene derivatives, e.g., thiolates and alkoxides:<sup>31</sup>





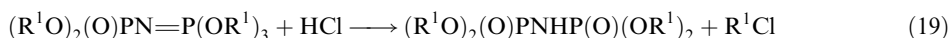
#### 1.14.2.3.4 Alcoholysis of trichlorophosphazo derivatives, followed by partial acid splitting of R<sup>1</sup>O groups



where R<sup>1</sup> = Me, Et, Pr, Bu<sup>n</sup>, Bu<sup>i</sup>, (CH<sub>2</sub>)<sub>2</sub>X (X = F, Cl, OEt), etc.<sup>67</sup>

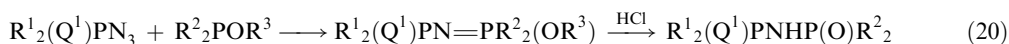


where Q<sup>1</sup> = O or S.<sup>66</sup>

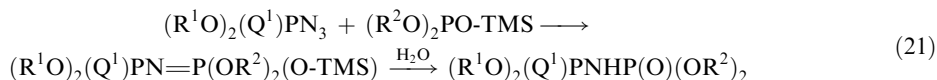


where R<sup>1</sup> = Et.<sup>31</sup>

#### 1.14.2.3.5 Coupling of phosphoryl azides with phosphites, followed by acid splitting of OR<sup>1</sup> groups



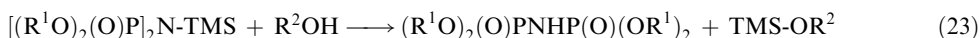
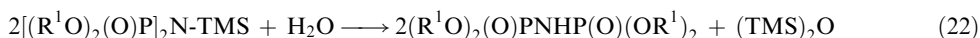
where Q<sup>1</sup> = O;<sup>68,69</sup> Q<sup>1</sup> = S<sup>69</sup>



where Q<sup>1</sup> = O, R<sup>1</sup> = R<sup>2</sup> = Et or Bu ; R<sup>1</sup> = Me, R<sup>2</sup> = Et, etc.<sup>70</sup>

#### 1.14.2.3.6 Hydrolysis or alcoholysis of N-silylated imidodiphosphoryl derivatives

Hydrolysis or alcoholysis of N-silylated imidodiphosphoryl derivatives (said to be useful for the purification of bis(phosphoryl) amides:<sup>71</sup>



where R<sup>1</sup> = Me, Et, Pr.<sup>71</sup>

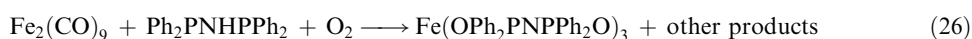
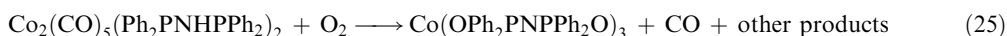
#### 1.14.2.3.7 Splitting of OR<sup>1</sup> groups from phosphate esters with sodium amide



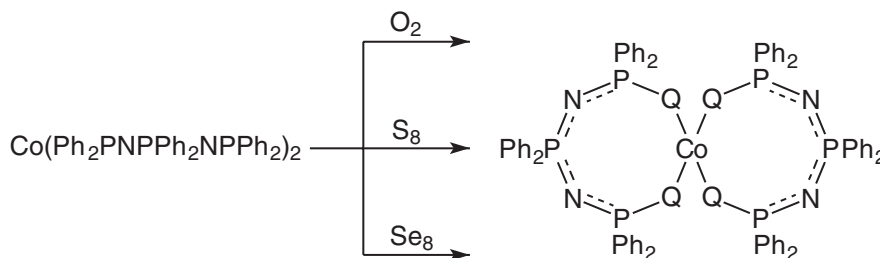
where R<sup>1</sup> = Et, Ph.<sup>72</sup>

#### 1.14.2.3.8 In situ formation of imidodiphosphinato ligands

There are several examples of *in situ* formation of imidodiphosphinato ligands, leading directly to their metal complexes. Thus, air oxidation of iron<sup>73</sup> or cobalt<sup>74</sup> complexes of bis(diphenylphosphanyl)amine, Ph<sub>2</sub>PNHPPH<sub>2</sub>, leads directly to imidodiphosphinato complexes:



This type of reaction affords cobalt complexes of larger imidodiphosphinato ligands, by ring enlargement of Co—P—N metallacycles; such compounds are unavailable by other routes (Scheme 1) ( $Q^1 = O$ , 87% yield;  $Q^1 = S$ , 85% yield;  $Q^1 = Se$ , 90% yield).<sup>75</sup>

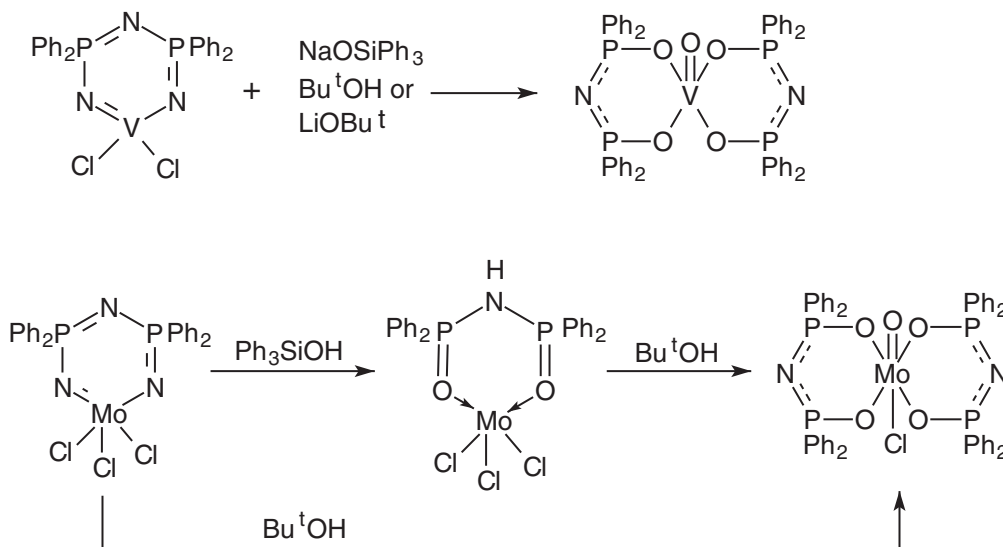


Scheme 1

The number of known complexes containing the  $Ph_2PNHPPH_2$  and related ligands is impressive, thus their oxidative addition reactions deserve further investigation.

Some P—N—P metallacycles, containing vanadium<sup>76</sup> and molybdenum<sup>77</sup> are converted to imidodiphosphinato complexes on attempted replacement of chlorine substituents, in reactions with oxygen-containing reagents (Scheme 2).

The known bis(chalcogenophosphinyl and -phosphoryl)imides, and their alkali metal salts (*vide infra*) are listed in Tables 1–4.



Scheme 2

### 1.14.3 ACIDITY AND PREPARATION OF ALKALI METAL AND OTHER SALTS

Bis(chalcogenophosphinyl and -phosphoryl)imides,  $R^1_2(Q^1)PNHP(Q^1)R^1_2$ , are acidic compounds. A solvent-dependent tautomeric equilibrium between  $R^1_2(O)PNHP(O)R^1_2$  and  $R^1_2(O)PN=P(OH)(O)R^1_2$  was suggested, for  $R^1 = \text{alkoxy}$ <sup>79,101</sup> or  $Ph$ ,<sup>102</sup> and probably the acidic properties are due to the imidol form, with proton dissociation occurring from the  $P(O)OH$  site.

The acidity constants have been determined for a series of derivatives (Table 5).

Deprotonation of bis(chalcogenophosphinyl and -phosphoryl)imides can be readily performed with the aid of various bases. Butyllithium produces lithium salts,  $Li[Q^1R^1_2PNR^1_2Q^2]$ , e.g., with

**Table 1** Bis(phosphinyl and -phosphoryl)imides,  $R^1_2(O)PNHP(O)R^2_2$ .

$R^1$	$R^2$	Yield (%)	MP (°C)	$^{31}P$ NMR	References
Me	Me		130/0.07 mm	43.4	48,78
	K salt		253–254		48
Me	Ph	60	217	44.4/21.3	48
Et	Et	57			9
Et	EtO	75	72.0–72.5		69,79
Et	PhO	21	98	51.9/–8.84	51
Pr <sup>n</sup>	EtO	47	100/10 <sup>–4</sup> mm		69,79
Pr <sup>i</sup>	Pr <sup>i</sup>	54	cryst.	55.5	28
C <sub>3</sub> F <sub>7</sub>	C <sub>3</sub> F <sub>7</sub>	65	130/0.07 mm	25.48	52
Bu <sup>n</sup>	Bu <sup>n</sup>	54	136–137		69,79
			121–122		80
Ph	Ph	100	266.5		63
			267–270		65
			272–273		69
			269–271		64
		85	268–269		22
		47	259–260	–	23
		97	275–277	19.4	81
	Li <sup>+</sup> salt	81	269	19.7	82
	Na <sup>+</sup> salt	70	335–338	11.3	81
	Na <sup>+</sup> salt	80			83
Ph	EtO	67	170	26.1/1.8	37
	K salt	42	114	20.0/0.73	51
		99	190	15.2/4.4	37
MeO	MeO		oil		55
MeO	EtO	72	80–81/10 <sup>–4</sup>		70
MeO	PhO		90		66
EtO	EtO	58	79–80/10 <sup>–3</sup>		68
		71	88–89/10 <sup>–4</sup>		70
EtO	Bu <sup>i</sup> O	81	112/10 <sup>–4</sup>		70
EtO	Bu <sup>n</sup> O	78	118–122/10 <sup>–4</sup> mm		69
EtO	PhO		93		66
Pr <sup>n</sup> O	Pr <sup>n</sup> O		oil		55
Pr <sup>i</sup> O	Pr <sup>i</sup> O	51	oil		69,79
Bu <sup>n</sup> O	Bu <sup>n</sup> O	34	140/10 <sup>–4</sup> mm		67,69,79
		100			70
			oil		84
Bu <sup>i</sup> O	Bu <sup>i</sup>		oil		84
HexO	HexO		oil		84
Oct <sup>n</sup> O	Oct <sup>n</sup> O		oil		84
EtO(CH <sub>2</sub> ) <sub>2</sub> O	EtO(CH <sub>2</sub> ) <sub>2</sub> O		oil		84
F(CH <sub>2</sub> ) <sub>2</sub> O	F(CH <sub>2</sub> ) <sub>2</sub> O		oil		84
Cl(CH <sub>2</sub> ) <sub>2</sub> O	Cl(CH <sub>2</sub> ) <sub>2</sub> O		oil		84
(ClCH <sub>2</sub> ) <sub>2</sub> CHO	(ClCH <sub>2</sub> ) <sub>2</sub> CHO		oil		84
F(CF <sub>2</sub> ) <sub>2</sub> CH <sub>2</sub> O	F(CF <sub>2</sub> ) <sub>2</sub> CH <sub>2</sub> O		oil		84
PhO	PhO		113	–10.7	56,85
		83	112	–9.87	42
		50	113–114		57
	Li salt		177–178		57
	Na salt		176–177		86
	Na salt				87
	(hexameric)				
	[Et <sub>2</sub> NH <sub>2</sub> ] <sup>+</sup> salt		112.5	–11.5	86
PhO	4-tolO	81	102	–9.89/ +5.8	42
2-MeC <sub>6</sub> H <sub>4</sub> O	2-MeC <sub>6</sub> H <sub>4</sub> O	74	85	9.0	42
3-MeC <sub>6</sub> H <sub>4</sub> O	3-MeC <sub>6</sub> H <sub>4</sub> O		Oil		42
4-MeC <sub>6</sub> H <sub>4</sub> O	4-MeC <sub>6</sub> H <sub>4</sub> O	80	128	–10.1	42
		39	125–128		88
	Cs <sup>+</sup> salt		162–164		58,59

Table 1 continued

$R^1$	$R^2$	Yield (%)	MP (°C)	$^{31}\text{P}$ NMR	References
3,4-Me <sub>2</sub> C <sub>6</sub> H <sub>3</sub> O	3,4-Me <sub>2</sub> C <sub>6</sub> H <sub>3</sub> O	42	91–93		88
		42	45–62		57,60
	Rb salt		176–178		60
	Cs salt		164–165		58–60
	K/Rb mixed salt (1:5)		174–175		60
	Rb/Cs mixed salt (1:1)		169–170		60
	Rb/Cs mixed salt (3:1)		172–174		60
	Rb/Cs mixed salt (1:3)		164–165		60
	3,5-Me <sub>2</sub> C <sub>6</sub> H <sub>3</sub> O	3,5-Me <sub>2</sub> C <sub>6</sub> H <sub>3</sub> O	51	134–135	
Cs salt			150–151		60
2,3-Me <sub>2</sub> C <sub>6</sub> H <sub>3</sub> O	2,3-Me <sub>2</sub> C <sub>6</sub> H <sub>3</sub> O	52	160–161		87
	Cs salt		194–195		58,59

$R^1 = \text{Me}$ ,  $Q^1 = \text{O}$ ,  $R^2 = \text{Ph}$ ,  $Q^2 = \text{S}$  (92% yield);  $R^1 = \text{Ph}$ ,  $Q^1 = \text{O}$ ,  $R^2 = \text{Me}$ ,  $Q^2 = \text{S}$  (79% yield),  $Q^2 = \text{O}$  (81% yield).<sup>82</sup> In earlier years, lithium salts were prepared from lithium metal in dioxane or THF, and were obtained as solvates, e.g.,  $\text{Li}[\text{SPh}_2\text{PNPPPh}_2\text{S}] \cdot 3\text{dioxane}$  and  $\text{Li}[\text{SPh}_2\text{PNPPPh}_2\text{S}] \cdot 2\text{THF}$ , respectively.<sup>38</sup>

Sodium salts (as glyme complexes) have been prepared with the aid of NaOH in aqueous methanol in the presence of triglyme and tetraglyme (75% and 82% yields, respectively),<sup>95</sup> with sodium methoxide in methanol ( $Q^1 = \text{O}$ ,  $Q^2 = \text{S}$ ,  $R^1 = \text{Me}$ ,  $R^2 = \text{Ph}$ , quantitative yield),<sup>36,48</sup> sodium ethoxide in ethanol ( $Q^1 = Q^2 = \text{O}$ ),  $R^1 = R^2 = \text{Ph}$ , 80% yield),<sup>83</sup> with sodium hydride in THF ( $Q^1 = \text{O}$ ,  $Q^2 = \text{S}$ ,  $R^1 = R^2 = \text{Ph}$ )<sup>35</sup> or in dry benzene ( $Q^1 = Q^2 = \text{O}$ ,  $R^1 = R^2 = \text{PhO}$ ).<sup>106,107</sup>

By far the most frequently used method is the deprotonation with potassium *tert*-butoxide, which gives the potassium salts in nearly quantitative yields. The method seems to be usable for any bis(chalcogenophosphinyl and -phosphoryl)imide and has been employed for a broad diversity of derivatives, regardless of the nature of the chalcogen.<sup>2,26,30,33,36–38,49,89,91,99</sup> If the salts are needed for further use in reactions with metal halides to form complexes, the potassium salt can be used *in situ*, without isolation, e.g., with zinc(II) chloride or palladium and platinum chloro complexes.<sup>41,43</sup> Potassium metal in THF also forms the salt  $\text{K}[\text{SPh}_2\text{PNPPPh}_2\text{S}]$  in 82% yield,<sup>38</sup> but the method is not practical for preparative purposes. Potassium-crown ether complexes,  $[\text{K}(18\text{-crown-6})][\text{Q}^1\text{Ph}_2\text{PNPPPh}_2\text{Q}^1]$  with  $Q^1 = \text{O}$ ,<sup>92</sup>  $Q^1 = \text{S}$ ,<sup>93</sup> and  $Q^1 = \text{Se}$ ,<sup>98</sup> have been prepared by direct complexation of the potassium salt with the macrocyclic ligand.

Rubidium, caesium, and mixed potassium/rubidium and rubidium/caesium salts were obtained by treating bis(phosphoryl)amides,  $(\text{ArO})_2(\text{O})\text{PNHP}(\text{O})(\text{OAr})_2$ , with the appropriate alkali metal carbonates or their mixtures. The caesium salts can also be obtained with caesium hydroxide.<sup>58–60</sup>

The ammonium salt  $[\text{NH}_4][\text{SPh}_2\text{PNPPPh}_2\text{S}]$  is formed when ammonia gas is passed through solutions of  $\text{Ph}_2(\text{S})\text{PNHP}(\text{S})\text{Ph}_2$ .<sup>26,38</sup> The  $\text{PPN}^+$  salt is obtained by metathesis from the potassium salt and  $[\text{Ph}_3\text{PNPPPh}_3]\text{Cl}$ .<sup>96</sup> The diethylammonium salt  $[\text{Et}_2\text{NH}_2][\text{O}(\text{PhO})_2\text{PNP}(\text{OPh})_2\text{O}]$  has been also prepared with diethylamine.<sup>86</sup> The alkali earth salts have been neglected, but the barium compound  $\text{Ba}[\text{SPh}_2\text{PNPPPh}_2\text{S}]_2$  has been obtained from  $\text{Ph}_2(\text{S})\text{PNHP}(\text{S})\text{Ph}_2$  with barium metal in THF,<sup>97</sup> and calcium and barium salts of  $[\text{O}(\text{PhO})_2\text{PNHP}(\text{OPh})_2\text{O}]^-$  have been described but not characterized structurally.<sup>86</sup>

In the structures of alkali and alkali earth metal salts, the chalcogens are usually coordinated to the metal. There are few salts in which the anion is free in the crystal lattice. In  $[\text{K}(18\text{-crown-6})]^+[\text{SPh}_2\text{PNPPPh}_2\text{S}]^-$  there is no interaction between potassium cation and the sulfur atoms of the anion.<sup>93</sup> In the complex  $[\text{K}(18\text{-crown-6})][\text{SePh}_2\text{PNPPPh}_2\text{Se}]$ , the crown ether coordinated potassium cation is involved only in  $\text{K}^+ \cdots \text{aryl } \pi$ -interactions with phenyl groups of the anion.<sup>98</sup> Another case when the chalcogens are not connected with the alkali metal cation in the solid state is the  $\text{PPN}^+$  salt,  $[\text{Ph}_3\text{PNPPPh}_3]^+[\text{SPh}_2\text{PNPPPh}_2\text{S}]^-$  salt, which also provides the unique example known of linear P–N–P fragment in an imidodiphosphinate structure.<sup>96</sup> In  $[(\text{H}_2\text{N})\text{Ph}_2\text{PNPPPh}_2\text{-(NH}_2)]^+[\text{SPh}_2\text{PNPPPh}_2\text{S}]^-$  the sulfur atoms of the anion are hydrogen bonded to an  $\text{NH}_2$  group of the cation.<sup>108</sup>

**Table 2** Bis(thiophosphinyl and -phosphoryl)imides,  $R^1_2(S)PNHP(S)R^2_2$ .

$R^1$	$R^2$	Yield (%)	MP (°C)	$^{31}P$ NMR	References		
Me	Me	71	177.5		48		
		55	178	59.6	48		
			177–180	60.4	49		
			103–104		48		
		95	112	43.8	48		
		100			48		
Me	Na <sup>+</sup> salt (H <sub>2</sub> O)				50		
					49		
					49		
		96	235–237	44.0	49		
		Me	Ph	32	156–157	64.1/52.5	48
				71	187–189	43.3/37.6	48
Et	Na salt	89	157–159	63.9/51.3			
			251–253		2		
			251–253	13.7/38.0	89		
		34	111–112		54		
		Et	Et				
		Et	Ph	67		84.5/51.2	39
Et	PhO	73		81.3/52.3	45		
Pr <sup>i</sup>	Pr <sup>i</sup>	58	165–166	91.2	24		
Pr <sup>i</sup>	Ph	54	104–105	99.7/52.7	39		
		54		100/51.5	45		
Pr <sup>i</sup>	PhO	72	86–87	94.5/55.7	39		
		60		94.6/51.5	45		
Bu <sup>n</sup>	Bu <sup>n</sup>	64	61	71.0	44		
Bu <sup>i</sup>	Bu <sup>i</sup>	41	66–68	68.3	44		
Bu <sup>s</sup>	Bu <sup>s</sup>	52	93–95	87.2	44		
Bu <sup>n</sup>	Bu <sup>i</sup>	18	low melting	72.3/70.4	44		
Bu <sup>n</sup>	Bu <sup>s</sup>	21	low melting	79.0/84.7	44		
Bu <sup>s</sup>	Bu <sup>i</sup>	5.6	20–30	76.0/82.7	44		
Ph	Ph	68	213		61,62		
		74	212–213		22		
		91	213–214.5		26,38		
		70	212–214		25		
			217–221		38		
			Li salt (dioxane solvate)				
		78	155–163		38,48		
		89	167	39.3	82		
		82	363–366		26,38,91		
		85			92		
		80	209–211		93		
	297–300		94				
75	165		95				
82	156		95				
	NH <sub>4</sub> <sup>+</sup> salt		210–212	26,38			
	PPN <sup>+</sup> salt		234–235	96			
Ph	EtO	78	62	53.3/63.6	43		
		73	84	64.1/19.7	41		
		46	75	60/54	54		
Ph	PhO	26	128–129	55.4/56.0	39		
		64	128–129		39		
MeO	MeO	22	44	68	54		
MeO	Pr <sup>i</sup> O	24	liquid	66/57	54		
EtO	PhO	83		60.4/51.8	45		
Pr <sup>i</sup> O	Pr <sup>i</sup> O	18	liquid	58	54		
PhO	PhO	61	112	50.8	40		
				51.83	42		
PhO	4-TolO	76	106	52.0/52.49	42		
2-MeC <sub>6</sub> H <sub>4</sub> O	2-MeC <sub>6</sub> H <sub>4</sub> O		oil	50.0	42		
3-MeC <sub>6</sub> H <sub>4</sub> O	3-MeC <sub>6</sub> H <sub>4</sub> O		oil	52.0	42		
4-MeC <sub>6</sub> H <sub>4</sub> O	4-MeC <sub>6</sub> H <sub>4</sub> O	61	63–67	51.5	42		

**Table 3** Bis(selenophosphinyl)imides,  $R^1_2(\text{Se})\text{PNHP}(\text{Se})R^2_2$ .

$R^1$	$R^2$	Yield (%)	MP (°C)	$^{31}\text{P}$ NMR	References
Pr <sup>i</sup>	Pr <sup>i</sup>	48	172–173	90.8	27
		65		89.5	28
Ph	Ph	60	208–211	53.1	22
		84		53.2	29,30
	K <sup>+</sup> salt	95	28.5	30	
	K <sup>+</sup> (18-crown-6) salt	82	223–224	29.2	98

**Table 4** Mixed bis(chalcogenophosphinyl and -phosphoryl)imides,  $R^1_2(Q^1)\text{PNHP}(Q^2)R^2_2$ .

$R^1$	$Q^1$	$R^2$	$Q^2$	Yield (%)	MP (°C)	$^{31}\text{P}$ NMR	References		
Me	O	Ph	S	82	223–225	50.8/47.9	36		
		Li salt		92	282–283	31.6/33.5	82		
		Na <sup>+</sup> salt		100	138–140	35.8/37.2	36		
		K <sup>+</sup> salt		100	138–140	31.6/35.8	36		
Pr <sup>i</sup>	O	Pr <sup>i</sup>	S	25		54.8/90.9	28		
Ph	O	Me	S	72	179–181	23.9/63.0	36		
		Li salt		79	256–258	19.1/40.8	82		
		(THF solvate)							
		Li <sup>+</sup> salt					82		
		(2H <sub>2</sub> O)							
		K <sup>+</sup> salt (THF)		98	227–230	21.2/47.8	36		
Ph	O	Ph	S	76	172–174	22.1/54.2	31		
						172–174	23.1/56.1	99	
						96		21.0/57.0	33
						89	172–174		35
				Li salt		83	198–200	20.6/37.3	82
				(THF solvate)					
				Na <sup>+</sup> salt		73	180–182	15.8/35.8	35
				(2THF solvate)					
				K <sup>+</sup> salt		78		13.9/35.3	33
						61–92	295–298	12.4/34	31
				K <sup>+</sup> salt		95	286–288	16.1/37.9	99
				NH <sub>4</sub> <sup>+</sup> salt					31
Ph	O	EtO	S	73	84	19.7/64.1	41		
Ph	O	PhO	S	82	194–197	21.9/56.6	39		
MeO	O	PhO	S	90	115–117		66		
EtO	O	Ph	S	74	180	1.3/53.2	37		
				81	174		41		
				98	119–122	5.3/37.3	37		
		K <sup>+</sup> salt							
		(H <sub>2</sub> O solvate)							
EtO	O	EtO	S	35	78/10 <sup>-4</sup>		69,79		
				70	92.5		70		
EtO	O	PhO	S	81	67–69		66		
BuO	O	EtO	S	78	101–103/0.07		70		
PhO	O	PhO	S	87	100–102		66		
				84	111	–11.06/53.3	42		
				53		–11.1/52.1	100		
				34	162–163	–7.2/53.9	39		
PhO	O	Pri	S	23	129–130	–6.9/91.6	39		
4-ClC <sub>6</sub> H <sub>4</sub> O	O	PhO	S	34	144–146		66		
4-O <sub>2</sub> NC <sub>6</sub> H <sub>4</sub> O	O	PhO	S		174–176		66		
2-TolO	O	2-TolO	S	85	95	–9.9/52.3	42		
3-TolO	O	3-TolO	S	82	106	–11.0/52.3	42		
4-TolO	O	4-TolO	S	78	126	–10.3/53.1	42		

Table 4 continued

$R^1$	$Q^1$	$R^2$	$Q^2$	Yield (%)	MP (°C)	$^{31}\text{P}$ NMR	References
Ph	O	Ph	Se	74		21.0/52.4	33
		$\text{K}^+$ salt		78			33
PhO	O	Ph	Se	27	165	-7.7/48.8	39
PhO	O	$\text{Pr}^i$	Se	34	99–101	-7.1/89.8	39
$\text{Pr}^i$	S	$\text{Pr}^i$	Se	37		92.1/89.2	28
Ph	S	Ph	Se	80		57.1/52.7	34
				78		56.9/52.5	46
PhO	S	$\text{K}^+$ salt		97			34
		Ph		13	130–132	55.3/505	39

Table 5 Acidity constants of  $\text{R}^1_2(\text{Q}^1)\text{PNHP}(\text{Q}^2)\text{R}^2_2$  derivatives.

$Q^1$	$R^1$	$Q^2$	$R^2$	$pK_a$	References
O	Et	O	OEt	7.65 <sup>a</sup>	69
O	OMe	O	OMe	2.6 <sup>b</sup>	55
O	OEt	O	OEt	3.7 <sup>b</sup>	55
O	$\text{OPr}^n$	O	$\text{OPr}^n$	4.3 <sup>b</sup>	55
O	$\text{OBu}^n$	O	$\text{OBu}^n$	5.47 <sup>c</sup>	70
				1.82 <sup>d</sup>	84
O	$\text{OC}_6\text{H}_{13}$	O	$\text{OC}_6\text{H}_{13}$	1.63 <sup>d</sup>	84
O	$\text{OC}_8\text{H}_{17}$	O	$\text{OC}_8\text{H}_{17}$	1.48 <sup>d</sup>	84
O	$\text{O}(\text{CH}_2)_2\text{OEt}$	O	$\text{O}(\text{CH}_2)_2\text{OEt}$	1.28 <sup>d</sup>	84
O	$\text{O}(\text{CH}_2)_2\text{OCl}$	O	$\text{O}(\text{CH}_2)_2\text{OCl}$	1.07 <sup>b</sup>	83
O	OPh	O	OPh	2.26 <sup>e</sup>	103
				4.11 <sup>f</sup>	104
				2.4 <sup>g</sup>	42,105
O	2-TolO	O	2-TolO	2.7 <sup>g</sup>	42,105
O	4-TolO	O	4-TolO	2.8 <sup>g</sup>	42,105
O	PhO	O	4-TolO	2.6 <sup>g</sup>	42
O	PhO	O	3-TolO	2.6 <sup>g</sup>	105
O	PhO	S	PhO	2.8 <sup>g</sup>	105
				3.0 <sup>g</sup>	42
O	2-TolO	S	2-TolO	3.0 <sup>g</sup>	42,105
O	3-TolO	S	3-TolO	3.0 <sup>g</sup>	42,105
S	Me	S	Me	8.7 <sup>h</sup>	53
S	Et	S	Et	9.6 <sup>h</sup>	53
S	PhO	S	PhO	3.2 <sup>g</sup>	42,105
				3.16 <sup>g</sup>	40
S	PhO	S	2-TolO	3.4 <sup>g</sup>	105
S	PhO	S	4-TolO	3.4 <sup>g</sup>	42

#### 1.14.4 SPECTROSCOPIC AND STRUCTURAL CHARACTERIZATION

Probably the most useful spectroscopic technique for the characterization of “imidodiphosphinates” (free and coordinated) is NMR spectroscopy, which was introduced quite early in the study of these compounds.<sup>31,38,109</sup> The  $^{31}\text{P}$  NMR spectra clearly distinguish between various types of  $\text{R}^1_2(\text{Q}^1)\text{P}$ -moieties and can serve for identification and characterization of a compound. Therefore, the  $^{31}\text{P}$  NMR chemical shifts were included in Tables 1–3, for all the compounds listed, when available. A single signal is observed for symmetrical  $\text{Q}^1\text{PNHPQ}^1$  proligands and  $\text{Q}^1\text{PNPQ}^1$  ligands (in metal complexes) and two distinct signals for the unsymmetrical ones. Phosphorus–phosphorus coupling is sometimes observed.

IR spectroscopy, much used in the earlier period, can distinguish between the protonated and unprotonated forms of the ligands in complexes. A strong IR absorption band in the range

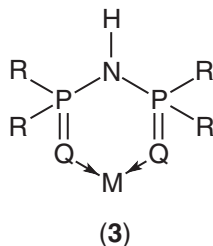
950–900  $\text{cm}^{-1}$  is assigned to  $\nu_{\text{as}}(\text{PNHP})$  and a  $\nu_{\text{as}}(\text{PNP})$  band around 1,250  $\text{cm}^{-1}$  indicates deprotonated PNP groups.<sup>31,38,85,94,110</sup>

Numerous crystal structure determinations of bis(chalcogenophosphinyl and -phosphoryl) imides,  $\text{R}^1_2(\text{Q}^1)\text{PNHP}(\text{Q}^2)\text{R}^2_2$  have been reported though space limitations prevent any detailed discussion here. Practically all are associated through hydrogen bonds, to form either dimers or chain-like arrays. Some essential data are collected in Table 6, and the reader interested in fine structural detail is invited to consult the original publications cited. The  $\text{P}=\text{Q}^1$  bonds in the bis(chalcogenophosphinyl and -phosphoryl) imides,  $\text{R}^1_2(\text{Q}^1)\text{PNHP}(\text{Q}^2)\text{R}^2_2$ , are shorter than in their deprotonated anions  $[\text{Q}^1\text{R}^1_2\text{PNPR}^2_2\text{Q}^2]^-$  and display double bond character; in the anions the  $\text{P}-\text{N}$  bonds are shortened and the  $\text{P}-\text{Q}^1$  bonds are elongated by comparison with the protonated forms, in agreement with structures (1) and (2). Thus, the  $\text{P}-\text{N}$  bonds gain some double bond character, while the  $\text{P}-\text{Q}^1$  bond order decreases.

### 1.14.5 COORDINATION PATTERNS

The bis(chalcogenophosphoryl and -phosphinyl)imides (in protonated form) form chelate complexes (3), with a few elements, but they tend to undergo deprotonation.

Complexes of the protonated ligand, (3), are known with  $\text{R}^1 = \text{Me}$ ,  $\text{M} = \text{Ti}$ ,  $\text{V}$  ( $\text{Q}^1 = \text{S}$ );<sup>113</sup>  $\text{R}^1 = \text{Ph}$ ,  $\text{M} = \text{Al}$  ( $\text{Q}^1 = \text{O}$ ),<sup>9</sup>  $\text{Sn}$  ( $\text{Q}^1 = \text{O}$ ),<sup>83</sup>  $\text{Co}$ ,  $\text{Pd}$ ,  $\text{Cu}$ ,  $\text{Zn}$ ,  $\text{Hg}$  ( $\text{Q}^1 = \text{S}$ ),<sup>110</sup>  $\text{Ag}$  ( $\text{Q}^1 = \text{Se}$ ),<sup>116</sup>  $\text{Au}$ ,<sup>117</sup> and  $\text{Pd}$  ( $\text{Q}^1 = \text{S}$ ).<sup>118</sup> Also, some niobium, tantalum, and antimony complexes with  $\text{R}^1 = \text{PhO}$ ,  $\text{Q}^1 = \text{O}$  have been reported as  $\text{MF}_5 \cdot \text{LH}$  and  $2\text{MF}_5 \cdot \text{LH}$  adducts [ $\text{LH} = (\text{PhO})_2(\text{O})\text{PNHP}(\text{O})(\text{OPh})_2$ ].<sup>119</sup>



There is a great variety of coordination patterns of the derived anionic ligands (dichalcogenoimidodiphosphinates and -phosphates), which can be described as monodentate, bidentate chelating (symmetrical or unsymmetrical) and bridging, or with the aid of metal connectivity terminology.<sup>120,121</sup> Several types can be distinguished (Table 7):

- (a) Coordination patterns involving only the chalcogen atoms (donor sites):
  - $\text{Q}^1$ -monodentate; monometallic  $\text{Q}^1$ -monoconnective, monohapto  $\eta^1$
  - $\text{Q}^1, \text{Q}^2$ -isobidentate chelating; symmetrical monometallic  $\text{Q}^1, \text{Q}^2$ -biconnective
  - $\text{Q}^1, \text{Q}^2$ -anisobidentate chelating; unsymmetrical monometallic  $\text{Q}^1, \text{Q}^2$ -diconnective
  - $\text{Q}^1, \text{Q}^1$ -bidentate bridging (symmetrical); dimetallic  $\text{Q}^1, \text{Q}^2$ -diconnective
  - $\text{Q}^1, \text{Q}^2$ -bidentate bridging (unsymmetrical); dimetallic  $\text{Q}^1, \text{Q}^2$ -diconnective
  - $\text{Q}^1$ -monodentate bridging;  $\text{Q}^1$ -dimetallic diconnective
  - $\text{Q}^1, \text{Q}^2$ -bidentate chelating +  $\text{Q}^2$ -bridging; bimetallic  $\text{Q}^1, \text{Q}^2$ -triconnective
  - $\text{Q}^1, \text{Q}^2$ -bidentate chelating +  $\text{Q}^1, \text{Q}^2$ -bridging; trimetallic  $\text{Q}^1, \text{Q}^2$ -tetraconnective
- (b) Coordination patterns involving chalcogen and nitrogen donor sites:
  - $\text{Q}^1, \text{N}, \text{Q}^2$ -doubly chelating; monometallic  $\text{Q}^1, \text{N}, \text{Q}^2$ -triconnective
  - $\text{Q}^1, \text{N}$ -bidentate bridging; dimetallic  $\text{Q}^1, \text{N}$ -diconnective
  - $\text{Q}^1, \text{N}$ -bidentate chelating +  $\text{Q}^1, \text{Q}^2$ -bridging;  $\text{Q}^1, \text{N}, \text{Q}^2$ -tetrametallic pentaconnective
- (c) Coordination patterns involving only nitrogen donor sites:
  - $\text{N}$ -monodentate bridging;  $\text{N}$ -dimetallic diconnective
- (d) Coordination patterns involving chalcogen chelating supplemented by metal- $\pi$  aryl interactions with aryl substituents at phosphorus sites.
- (e) Coordination patterns involving chalcogen chelating supplemented by dative bonds from donor substituents at phosphorus sites.
- (f) Mixed coordination patterns involving chalcogen chelating supplemented by metal- $\pi$  aryl interactions with aryl substituents and dative bonds from donor substituents at phosphorus sites.
- (g) Coordination patterns involving only the substituents at phosphorus sites (metal- $\pi$  aryl interactions).



**Table 6** X-Ray structural data for  $R^1_2(Q^1)PNHP(Q^2)R^2_2$ .

$R^1/Q^1$	$R^2/Q^2$	Association mode	$P-Q^1; P-Q^2$ (Å)	$P-N$ (Å)	$P-N-P$ (°)	References
Pr <sup>i</sup> /O	Pri/O	Chain	1.486; 1.471	1.671; 1.669	130.0	28
Ph/O	Ph/O	Chain	1.519	1.535	180	111
Ph/O	EtO/O	Chain	1.463; 1.423	1.66; 1.62	126.5	37
PhO/O	PhO/O	Dimer	1.474; 1.448	1.639; 1.653	130.0	112
2-TolO/O	2-TolO/O	Dimer	1.465; 1.453	1.641; 1.645	130.4	42
4-TolO/O	4-TolO/O	Dimer	1.454; 1.459	1.646; 1.642	129.1	88
ArO/O	ArO/O					
Ar = 2,3-Me <sub>2</sub> C <sub>6</sub> H <sub>3</sub>		Dimer	1.447; 1.460	1.640; 1.629	128.9	88
Ar = 3,5-Me <sub>2</sub> C <sub>6</sub> H <sub>3</sub>		Dimer	1.445; 1.462	1.643; 1.631	129.9	88
Ar = 3,4-Me <sub>2</sub> C <sub>6</sub> H <sub>3</sub>		Dimer	1.447; 1.459	1.638; 1.639	128.0	88
Ar = 2,3-Me <sub>2</sub> C <sub>6</sub> H <sub>3</sub>		Dimer	1.447; 1.460	1.640; 1.629	128.9	88
Me/S	Me/S	Chain	1.939; 1.962	1.679; 1.675	133.2	49
Me/S	Ph/S	Chain	1.962; 1.946	1.698; 1.692	126.1	2
Et/S	Ph/S	Dimer	1.936; 1.948	1.684; 1.678	132.1	45
Et/S	Ph/S	Chain	1.888; 1.944	1.660; 1.691	131.5	45
Pr <sup>i</sup> /S	Pr <sup>i</sup> /S	Chain	1.941; 1.949	1.682; 1.682	131.6	24
Pr <sup>i</sup> /S	Ph/S	Chain	1.936; 1.948	1.675; 1.703	129.5	45
Pr <sup>i</sup> /S	PhO/S	Dimer	1.877; 1.943	1.686; 1.636	136.5	39
Pr <sup>i</sup> /S	PhO/S	Dimer	1.880; 1.946	1.655; 1.710	133.0	45
Bu <sup>n</sup> /S	Bu <sup>n</sup> /S	Dimer	1.941; 1.929	1.681; 1.686	132.1	44
Bu <sup>i</sup> /S	Bu <sup>i</sup> /S	Chain	1.948; 1.932	1.706; 1.657	133.0	44
Bu <sup>s</sup> /S	Bu <sup>i</sup> /S	Dimer	1.943; 1.935	1.686; 1.695	133.1	44
Ph/S	Ph/S	Dimer	1.950; 1.936	1.671; 1.684	132.6	111
			1.950; 1.937	1.672; 1.683	132.7	113
			1.917; 1.915	1.700; 1.652	131.7	114
Ph/S	EtO/S	Dimer	1.937; 1.920	1.681; 1.667	129.9	43
Ph/S	PhO/S	Dimer	1.929; 1.915	1.702; 1.640	130.2	39
Ph/S	PhO,Ph/S	Dimer	1.945; 1.914	1.675; 1.655	132.5	47
PhO/S	PhO,Ph/S	Dimer	1.897; 1.935	1.654; 1.664	130.3	47
PhO/S	PhO/S	Dimer	1.911; 1.894	1.662; 1.653	129.3	40
(two independent molecules)			1.912; 1.892	1.650; 1.670	130.4	
Pr <sup>i</sup> /Se	Pr <sup>i</sup> /Se	Chain	2.103; 2.096	1.693; 1.686	131.2	28
Ph/Se	Ph/Se	Dimer	2.101; 2.085	1.678; 1.686	132.3	29
Ph/Se	Ph/Se	Monomer	2.094,2	1.675,7	125.1	115
(THF solvate)						
Ph/Se	Ph/Se	Monomer	2.099; 2.097	1.680; 1.689	132.7	115
(2 THF solvate)						
			P-O; P-S			
Me/O	Ph/S	Chain	1.480; 1.946	1.66; 1.71	123.0	36
Ph/O	Me/S	Chain	1.480; 1.944	1.662; 1.681	126.5	36
(three independent molecules)			1.477; 1.925	1.665; 1.681	128.7	
			1.479; 1.941	1.666; 1.669	127.9	
Ph/O	Ph/S	Chain	1.491; 1.935	1.668; 1.694	131.4	35
(two independent molecules)			1.514; 1.915	1.683; 1.673	132.9	
Ph/O	Ph/S	Chain	1.54; 1.881	1.669; 1.681	133.5	33
Ph/O	EtO/S	Chain	1.476; 1.895	1.673; 1.662	122.6	41
(two independent molecules)			1.484; 1.921	1.653; 1.661	127.2	
EtO/O	Ph/S	Dimer	1.471; 1.940	1.641; 1.697	130.1	37
			1.457; 1.931	1.632; 1.679	130.5	41
PhO/O	Ph, PhO/S	Dimer	1.461; 1.917	1.632; 1.676	128.2	47
PhO/O	PhO/S	Chain	1.458; 1.898	1.640; 1.650	127.4	39
2-TolO/O	2-TolO/S	Dimer	1.465; 1.911	1.653; 1.658	132.0	42
3-TolO/O	3-TolO/S	Dimer	1.457; 1.902	1.643; 1.654	131.4	42
TolO/O	4-TolO/S	Dimer	1.459; 1.902	1.635; 1.654	133.0	42

Table 6 continued

$R^1/Q^1$	$R^2/Q^2$	Association mode	$P-Q^1; P-Q^2$ (Å)	$P-N$ (Å)	$P-N-P$ (°)	References
PhO/O	Ph/Se	Dimer	P-O; P-Se 1.473; 2.089	1.654; 1.671	131.8	39
PhO/O	Pr <sup>i</sup> /Se	Chain	1.456; 2.093	1.620; 1.694	129.3	39
(two independent molecules)			1.462; 2.081	1.621; 1.686	132.4	
Ph/S	Ph/Se	Monomer	P-S; P-Se			46
PhO/S	Ph/Se	Dimer	S/Se disordered 1.915; 2.079	1.627; 1.702	131.3	39

Table 7 Bonding modes and coordination patterns of dichalcogenoimidodiphosph(in)ato ligands. Selected examples.

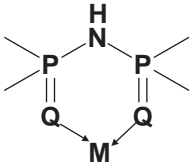
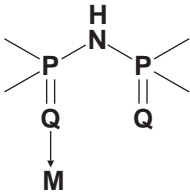
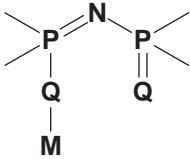
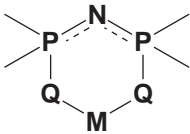
Coordination pattern	Examples	References
	[Ag(SePh <sub>2</sub> PNHPh <sub>2</sub> Q <sup>1</sup> ) <sub>2</sub> ]Br Q <sup>1</sup> = S, Se [Pd(SPr <sup>i</sup> <sub>2</sub> PNHPPr <sup>i</sup> <sub>2</sub> S) (SPr <sup>i</sup> <sub>2</sub> PNPPr <sup>i</sup> <sub>2</sub> S)]Cl	116 118
	[Ag(SePh <sub>2</sub> PNHPPh <sub>2</sub> O) <sub>2</sub> ]Br	116
	[Pd(SePh <sub>2</sub> PNPPh <sub>2</sub> O)(dien)]PF <sub>6</sub> Pd(SPh <sub>2</sub> PNPPh <sub>2</sub> O)(ampy)]H <sub>2</sub> O Pd(en)(SePh <sub>2</sub> PNPPh <sub>2</sub> O) R <sup>1</sup> <sub>3</sub> P.Au(SPh <sub>2</sub> PNPPh <sub>2</sub> O) Co(η <sup>2</sup> -OPh <sub>2</sub> PNPPh <sub>2</sub> O) <sub>2</sub> (η <sup>1</sup> -OPh <sub>2</sub> PNPPh <sub>2</sub> O)	122 122 123 124 125
	Be(OPh <sub>2</sub> PNPPh <sub>2</sub> O) <sub>2</sub> Co(SPh <sub>2</sub> PNPPh <sub>2</sub> S) <sub>2</sub> Ni(SPh <sub>2</sub> PNPPh <sub>2</sub> S) <sub>2</sub> Pd(SPh <sub>2</sub> PNPPh <sub>2</sub> S) <sub>2</sub> Ph <sub>3</sub> P.Cu(Q <sup>1</sup> Ph <sub>2</sub> PNPPh <sub>2</sub> Q <sup>1</sup> ) Q <sup>1</sup> = S, Se Ph <sub>3</sub> P.Ag(SPh <sub>2</sub> PNPPh <sub>2</sub> S) Cl <sub>2</sub> Au(SPh <sub>2</sub> PNPPh <sub>2</sub> S) [(Et <sub>3</sub> P) <sub>2</sub> Pt(SPh <sub>2</sub> PNPPh <sub>2</sub> S)]PF <sub>6</sub> Ph <sub>2</sub> Tl(SPh <sub>2</sub> PNPPh <sub>2</sub> S) Me <sub>2</sub> Sn(SPh <sub>2</sub> PNPPh <sub>2</sub> S) and many more	161 11 126 127 128–130 130 131 132 133 134

Table 7 continued

Coordination pattern	Examples	References
	$\text{Ph}_3\text{P}\cdot\text{Au}(\text{SPh}_2\text{PNPPh}_2\text{S})$ $\text{Te}[\text{SPh}_2\text{PNP}(\text{OPh})_2]_2$ <i>cis</i> $\text{C}_4\text{H}_8\text{Te}(\text{SPh}_2\text{PNPPh}_2\text{S})_2$ $\text{Me}_2\text{Te}(\text{SPh}_2\text{PNPPh}_2\text{S})_2$ $\text{Se}(\text{SPh}_2\text{PNPPh}_2\text{S})_2$ $\text{Bi}(\text{OPh}_2\text{PNPPh}_2\text{O})_3$	130 135 136 137 138 139
	$\text{Ph}_3\text{Te}^+[\text{SPh}_2\text{PNPPh}_2\text{S}]^-$ $\text{Ph}_3\text{Te}^+[\text{OPh}_2\text{PNPPh}_2\text{O}]^-$	140 141
	$[\text{NMe}_4]^+[\text{SPh}_2\text{PNPPh}_2\text{S}]^-$ $[\text{Pt}(\text{R}^1\text{NH})(\text{R}^1\text{NH}_2)]^+$ $[\text{OPh}_2\text{PNPPh}_2\text{Se}]^-$ $\text{R}^1 = \text{Ph}_2\text{PC}_6\text{H}_4$	142 124
	$\text{PPN}^+[\text{SPh}_2\text{PNPPh}_2\text{S}]^-$	96
	$\text{Au}(\text{SePh}_2\text{PNPPh}_2\text{Se})(\text{Ph}_2\text{PCH}_2\text{PPh}_2)$ $[\text{O}(\text{TeC}_4\text{H}_8)_2(\text{OPh}_2\text{PNPPh}_2\text{O})_2]^{2+}$	144 136
	$[\text{PhTeSPh}_2\text{PNPPh}_2\text{S}]_2$ $[\text{Me}_3\text{SnSPh}_2\text{PNPPh}_2\text{S}]_x$	145 146
	$\text{Os}_3\text{H}(\text{CO})_9(\text{SPh}_2\text{PNPPh}_2\text{S})$	147

Table 7 continued

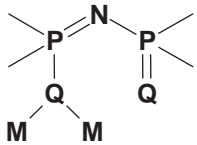
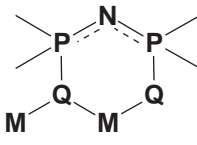
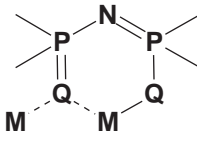
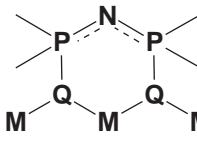
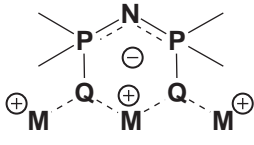
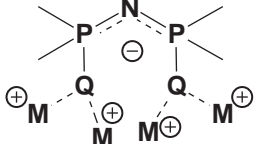
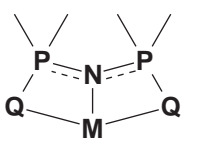
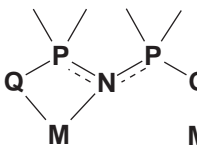
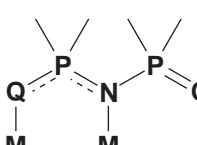
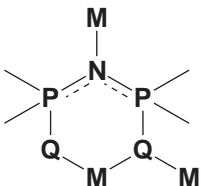
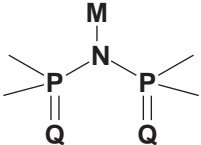
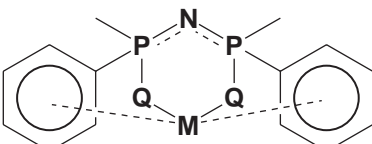
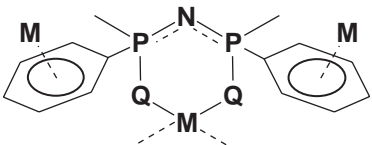
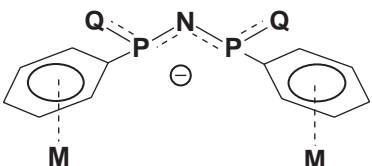
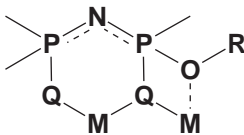
Coordination pattern	Examples	References
	[Mn(OPh <sub>2</sub> PNPPh <sub>2</sub> O) <sub>2</sub> ] <sub>2</sub> [Li(OPh <sub>2</sub> PNPPh <sub>2</sub> S)·2H <sub>2</sub> O] <sub>2</sub> (η <sup>3</sup> -C <sub>3</sub> H <sub>5</sub> )Pd(SePh <sub>2</sub> PNPPh <sub>2</sub> Q <sup>1</sup> ) Q <sup>1</sup> = S, Se	148 82 34
	[(CO) <sub>3</sub> Mn(SMe <sub>2</sub> PNPMe <sub>2</sub> S) <sub>2</sub> ] [Cu(SR <sup>1</sup> <sub>2</sub> PNPR <sup>1</sup> <sub>2</sub> S)] <sub>3</sub> [Cu(SPh <sub>2</sub> PNPPh <sub>2</sub> O)] <sub>3</sub> Cu <sub>5</sub> (SMe <sub>2</sub> PNPMe <sub>2</sub> S) <sub>5</sub> [Na(OPh <sub>2</sub> PNPPh <sub>2</sub> S) <sub>2</sub> THF] <sub>2</sub>	149 150 151 151 35
	Pb(OPh <sub>2</sub> PNPPh <sub>2</sub> S) <sub>2</sub>	152
	[K(SPh <sub>2</sub> PNPPh <sub>2</sub> S)] <sub>x</sub> Cu <sub>5</sub> (SMe <sub>2</sub> PNPMe <sub>2</sub> S) <sub>5</sub> Cu <sub>8</sub> (SMe <sub>2</sub> PNPMe <sub>2</sub> S) <sub>6</sub> Cl <sub>2</sub>	91 151 151
	{Cs[O(ArO) <sub>2</sub> PNP(OAr) <sub>2</sub> O]} <sub>x</sub> [Na{O(PhO) <sub>2</sub> PNP(OPh) <sub>2</sub> O}] <sub>6</sub>	58,59 106,107
	[Na{O(PhO) <sub>2</sub> PNP(OPh) <sub>2</sub> O}] <sub>6</sub>	106,107
	Y(Q <sup>1</sup> Ph <sub>2</sub> PNPPh <sub>2</sub> Q <sup>1</sup> ) <sub>3</sub> Q <sup>1</sup> = S, Se Cp <sub>2</sub> Y(Q <sup>1</sup> Ph <sub>2</sub> PNPPh <sub>2</sub> Q <sup>1</sup> ) Q <sup>1</sup> = S, Se (PhSe)Sm(SePh <sub>2</sub> PNPPh <sub>2</sub> Se) <sub>2</sub> ·THF	153 154,155 7
	Pd[SR <sup>1</sup> <sub>2</sub> PNP(O)(OPh) <sub>2</sub> ] <sub>2</sub> R <sup>1</sup> = Pr <sup>i</sup> , Ph Pd[OR <sup>1</sup> <sub>2</sub> PNP(O)(OPh) <sub>2</sub> ] <sub>2</sub> R <sup>1</sup> = Pr <sup>i</sup> , Ph Pd[O(PhO) <sub>2</sub> PNP(S)(OPh) <sub>2</sub> ] <sub>2</sub>	39 39 156
	[Ag(OPh <sub>2</sub> PNPPh <sub>2</sub> O)] <sub>4</sub> ·2EtOH	157

Table 7 continued

Coordination pattern	Examples	References
	$[\text{Ag}(\text{OPh}_2\text{PNPPh}_2\text{O})]_4 \cdot 2\text{EtOH}$	157
	$\text{PhHgN}[\text{P}(\text{OPh})_2]_2$	100
	$\text{Pb}(\text{SPh}_2\text{PNPPh}_2\text{S})_2$	158
	$[\text{K}(\text{SPh}_2\text{PNPPh}_2\text{S})]_x$	91
	$[\text{K}(18\text{-crown-6})][\text{SePh}_2\text{PNPPh}_2\text{Se}]$	98
	$\text{K}[\text{SPh}_2\text{PNP}(\text{OEt})_2\text{O}] \cdot \text{H}_2\text{O}$	37

## 1.14.6 METAL COMPLEXES

The large number of metal complexes containing dichalcogenoimidodiphosph(in)ato ligands cannot be covered here. In addition to the illustration of the coordination patterns, provided in Table 7, a list of ligands and their metal complexes is given in Tables 8–11.

**Table 8** Imidodiphosphinato and imidodiphosphato complexes,  $M(OR^1_2PNR^2_2O)_n$ .

$R^1$	$R^2$	$M$
Cl	Cl	Ti, Al, Ga, In, Sn <sup>159</sup>
Et	PhO	Hg <sup>51</sup>
Ph	Ph	Be, <sup>160,161</sup> LZr, <sup>162</sup> VO, <sup>76</sup> MoCl <sub>2</sub> , <sup>76</sup> LMo, <sup>77</sup> Mn, <sup>81,148,163</sup> LRe, <sup>164,165</sup> Fe, <sup>73,166</sup> Co, <sup>125,167</sup> Ni, <sup>167</sup> Cu, <sup>168,169</sup> Ag, <sup>157</sup> Zn, <sup>170,171</sup> B, Al, <sup>9</sup> Ga, <sup>139</sup> R <sup>1</sup> <sub>2</sub> Ga, <sup>172</sup> In, <sup>173,174</sup> Si, Ge, <sup>175</sup> Sn, <sup>9,83,175,177</sup> R <sup>1</sup> <sub>n</sub> Sn, <sup>177</sup> F <sub>n</sub> P <sup>3</sup> , R <sup>1</sup> <sub>n</sub> Sb, <sup>178</sup> Bi, <sup>23,139</sup> R <sup>1</sup> <sub>n</sub> Te, <sup>136,141</sup> La, <sup>180</sup> Pr, <sup>181–183</sup> Dy, <sup>183</sup> Eu, <sup>37</sup> Gd, <sup>184</sup> Tb, <sup>74,185</sup> Th, <sup>186</sup> LTh, <sup>187</sup> U <sup>116</sup>
EtO	EtO	La, <sup>188,189</sup> Ce, Pr, Nd, Sm <sup>189</sup>
PhO	PhO	Ca, Ba, <sup>86</sup> Sc, <sup>104,190</sup> Y, <sup>104</sup> Hf, <sup>191</sup> Nb, Ta, <sup>119</sup> F <sub>n</sub> P, <sup>192</sup> Fe, <sup>86</sup> Cu, <sup>86</sup> Hg, PhHg, <sup>56,193</sup> La, Ce, Pr, Nd, Sm, Eu, Gd, Tb, Dy, Ho, Er, Tm, Yb, Lu <sup>104,194–198</sup>

**Table 9** Dithioimidodiphosphinato and -phosphato complexes,  $M(SR^1_2PNR^2_2S)_n$ .

$R^1$	$R^2$	$M$
Me	Me	LMn, <sup>149</sup> Fe, <sup>67,167,199,200</sup> Co, <sup>49,67,94,167</sup> Ni, <sup>67,167,201,202</sup> Pd, <sup>67,167,203</sup> Pt, <sup>67,167</sup> Cu, <sup>204</sup> Zn, <sup>67,167</sup> Bi <sup>205</sup>
Me	Ph	Co, <sup>2</sup> Ni <sup>89</sup>
Et	Ph	Te <sup>206</sup>
Et	PhO	Pd, <sup>45</sup> Te <sup>206</sup>
Pr <sup>i</sup>	Pr <sup>i</sup>	LRu, <sup>207</sup> Os, LOS, <sup>208</sup> Co, <sup>27</sup> Ni, <sup>24</sup> Pd, Pt, <sup>118</sup> Cu, <sup>150,209</sup> Zn, Cd, <sup>24</sup> R <sup>1</sup> <sub>2</sub> Ga, <sup>172</sup> InCl, <sup>210</sup> LTe <sup>206</sup>
Pr <sup>i</sup>	Ph	Pt, <sup>45</sup> Cu, <sup>150</sup> Te <sup>206</sup>
Pr <sup>i</sup>	PhO	Pd, Pt, <sup>45</sup> Cu <sup>150</sup>
Bu <sup>n</sup>	Bu <sup>n</sup>	Zn, Pd, Pt <sup>44</sup>
Bu <sup>i</sup>	Bu <sup>i</sup>	Zn, Pd, Pt <sup>44</sup>
Bu <sup>s</sup>	Bu <sup>s</sup>	Zn, Pd, Pt <sup>44</sup>
Bu <sup>n</sup>	Bu <sup>i</sup>	Zn, Pd <sup>44</sup>
Bu <sup>n</sup>	Bu <sup>s</sup>	Zn, Pd <sup>44</sup>
Bu <sup>s</sup>	Bu <sup>i</sup>	Zn, Pd <sup>44</sup>
Ph	Ph	Ba, <sup>97</sup> Y, <sup>152,153</sup> Cp <sub>2</sub> Y, <sup>155</sup> Mo <sub>3</sub> S <sub>7</sub> , <sup>211</sup> Mo <sub>4</sub> Cu <sub>8</sub> , <sup>212</sup> Mn, <sup>163,213,214</sup> LMn, <sup>215</sup> LTe, <sup>216,217</sup> LRe, <sup>10,164,165,216–218</sup> Fe, <sup>26,67,85,94,167,219</sup> LRu, <sup>34,98,207,220–223</sup> Os, LOS, <sup>147,208,218</sup> Co, <sup>11,26,27,67,85,94,110,167</sup> Cp*Rh, <sup>34,221</sup> Cp*Ir, <sup>224</sup> Ni, <sup>26,29,38,67,89,167,170,171,225</sup> LNi, <sup>68,167</sup> Pd, <sup>29,67,110,127,167,226,227</sup> LPd, <sup>34,221</sup> Pt, <sup>29,67,110,167</sup> LPt, <sup>34,87,132,221,228</sup> Cu, <sup>25,85,94,229,230</sup> LCu, <sup>128,130</sup> Ag, <sup>231</sup> LAg, <sup>130</sup> Au, <sup>231–233</sup> LAu, <sup>130,131,232,234,235</sup> R <sup>1</sup> <sub>2</sub> Au, <sup>50</sup> Zn, <sup>67,110,167,236</sup> Cd, <sup>110,170,171</sup> Hg, <sup>110</sup> In, <sup>173</sup> R <sup>1</sup> <sub>n</sub> Sn, <sup>134,146,237,238</sup> Pb, <sup>26,158</sup> Sb, <sup>239</sup> Bi, <sup>23,240</sup> Se, <sup>138</sup> Te, <sup>127,241</sup> R <sup>1</sup> <sub>n</sub> Te, <sup>4,5,127,136,137,140,145,242,243</sup> Cp <sub>2</sub> Yb, <sup>154</sup> Sm <sup>7</sup>
Ph	EtO	Zn <sup>41</sup>
Ph	PhO	Pd <sup>39</sup>
EtO	PhO	Cu, <sup>150</sup> Te <sup>206</sup>
PhO	PhO	Pd, <sup>40</sup> LPt <sup>87,132</sup>

**Table 10** Diselenoimidodiphosphinato complexes,  $M(\text{SeR}^1_2\text{PNPR}^2_2\text{Se})_n$ .

$R^1$	$R^2$	$M$
$\text{Pr}^i$	$\text{Pr}^i$	$\text{Co},^{27} \text{Pd}, \text{Pt}, \text{Zn}, \text{Cd},^{28} \text{InCl},^{210} \text{Te}^{206}$
Ph	Ph	$\text{Y},^{152} \text{Cp}_2\text{Y},^{155} \text{V}, \text{VO}, \text{Cr},^{244} \text{Mo}_3\text{Se}_7,^{212,245} \text{LRe},^{165,246} \text{LRu},^{98,220,221,223} \text{LOs},^{208} \text{Co},^{27,129} \text{Cp}^*\text{Rh},^{34,90,221,247} \text{LRh},^{30} \text{Cp}^*\text{Ir},^{224,247} \text{Ni},^{29,248} \text{Pd},^{29,226,248} \text{LPd},^{30,34,221} \text{Pt},^{29,248} \text{LPt},^{30,34,221,228} \text{LCu},^{129} \text{LAu},^{144,235} \text{Zn}, \text{Cd}, \text{Hg},^8 \text{R}^1_2\text{Al}, \text{R}^1_2\text{Ga},^1 \text{In},^{174,210} \text{Sn},^{8,249,250} \text{R}^1_n\text{Sn},^6 \text{Pb},^8 \text{Sb}, \text{Bi},^{174} \text{Se},^{251} \text{Te},^{252} \text{R}^1\text{Te},^{136,252} \text{Cp}_2\text{La}, \text{Cp}_2\text{Gd}, \text{Cp}_2\text{Er}, \text{Cp}_2\text{Yb},^{154} \text{Sm}^7$

**Table 11** Metal complexes of mixed dichalcogenoimidodiphosphinates and -phosphates,  $M(\text{Q}^1\text{R}^1_2\text{PNPR}^2_2\text{Q}^2)_n$ .

$R^1/\text{Q}^1$	$R^2/\text{Q}^2$	$M$
Me/O	Ph/S	$\text{Mn},^{148} \text{Ni}^{253}$
$\text{Pr}^i/\text{O}$	$\text{Pr}^i/\text{S}$	$\text{Mo},^{254} \text{Zn}^{28}$
Ph/O	Me/S	$\text{Mn},^{148,184} \text{Ni},^{253} \text{Pd}^{203}$
Ph/O	Ph/S	$\text{Mo},^{254} \text{Mn},^{148,184} \text{Ni},^{94,253} \text{LPd},^{34,122-124,143,255} \text{LPt},^{33,122,124} \text{Cu},^{94,169} \text{Au},^{124} \text{LAu},^{123} \text{In},^{256} \text{R}^1_n\text{Sn},^{99} \text{Pb},^{152} \text{R}^1_n\text{Pb},^{126} \text{R}^1_n\text{Sb},^{178} \text{R}^1_n\text{Te}^{137,141}$
Ph/O	EtO/S	$\text{Pd}, \text{Pt}^{41}$
EtO/O	Ph/S	$\text{Zn}, \text{Pd}, \text{Pt}^{41,43}$
PhO/O	PhO/S	$\text{Pd}^{156}$
PhO/O	Ph/S	$\text{Pd}^{39}$
PhO/O	$\text{Pr}^i/\text{S}$	$\text{Pd}^{39}$
Ph/O	Ph/Se	$\text{Pd},^{33} \text{LPd},^{34,123,143,255} \text{LPt},^{33,124} \text{LAu},^{123,124}$
$\text{Pr}^i/\text{S}$	$\text{Pr}^i/\text{Se}$	$\text{Zn}, \text{Pd}, \text{Pt}^{28}$
Ph/S	Ph/Se	$\text{LRu},^{34} \text{Co},^{46} \text{Cp}^*\text{Rh},^{34} \text{LPd},^{34} \text{Zn},^{46} \text{In},^{256} \text{Sn},^{46} \text{Bi}^{46}$

### 1.14.7 CONCLUSIONS

The dichalcogenoimidodiphosphinato and -phosphato anions, are versatile ligands, whose properties can be finely tuned by varying the chalcogen and the substituents at phosphorus. In addition to the broad variety of coordination patterns, these ligands are attractive due to the flexibility of the  $\text{Q}^1\text{PNPQ}^1$  backbone, which results in various chelate ring conformations (planar, boat, chair, etc.). The resurgence of the interest towards these ligands after 1990 suggests that their large-scale use in the immediate future can be anticipated. They may become successful competitors for the very popular pyrazolylborates (“scorpionates”).<sup>252</sup>

### 1.14.8 REFERENCES

- Munoz-Hernandez, M. A.; Singer, A.; Atwood, D.; Cea-Olivares, R. *J. Organomet. Chem.* **1998**, *571*, 15–20.
- Silvestru, C.; Rösler, R.; Drake, J. E.; Yang, J.; Espinosa-Perez, G.; Haiduc, I. *J. Chem. Soc., Dalton Trans.* **1998**, 73–78.
- Il'in, E. G.; Kovalev, V. V.; Buslaev, Yu. A.; Schmidpeter, A. *Doklady-Physical Chemistry(Engl.)* **1997**, *355*, 201–206 [Doklady Akad.Nauk (Russ.) 1997, 355, 66–71].
- Canseco-Melchor, G.; Garcia-Montalvo, V.; Toscano, R. A.; Cea-Olivares, R. *Z. Anorg. Allg. Chem.* **2001**, *627*, 2391–2396.
- Canseco-Melchor, G.; Garcia-Montalvo, V.; Toscano, R. A.; Cea-Olivares, R. *J. Organomet. Chem.* **2001**, *631*, 99–104.
- Flores-Santos, L.; Cea-Olivares, R.; Hernandez-Ortega, S.; Toscano, R. A.; Garcia-Montalvo, V.; Novosad, J.; Woollins, J. D. *J. Organomet. Chem.* **1997**, *544*, 37–41.
- Geissinger, M.; Magull, J. *Z. Anorg. Allg. Chem.* **1997**, *623*, 755–761.

8. Garcia-Montalvo, V.; Novosad, J.; Kilian, P.; Slawin, A. M. Z.; Gacia y Garcia, P.; Lopez-Cardoso, M.; Espinosa-Perez, G.; Cea-Olivares, R. *J. Chem. Soc., Dalton Trans.* **1997**, 1025–1029.
9. Jirjahn, B.; Hildebrandt, H.; Heller, G. Z. *Naturforsch. B: Chem. Sci.* **1997**, 52, 95–101.
10. Abram, U.; Schultz-Lang, E.; Dilworth, J. R. *Acta Crystallogr. Sect. C* **1997**, 53, 289–292.
11. Aragoni, M. C.; Arca, M.; Garau, A.; Isaia, F.; Lippolis, V.; Abbati, G. L.; Fabretti, A. C. Z. *Anorg. Allg. Chem.* **2000**, 626, 1454–1459.
12. Haiduc, I.; Silaghi-Dumitrescu, I. *Coord. Chem. Rev.* **1986**, 74, 127–270.
13. Roesky, H. W. *Synlett* **1980**, 651–659.
14. Lobana, T. S. *Prog. Inorg. Chem.* **1989**, 37, 495–588.
15. Bhattacharyya, P.; Woollins, J. D. *Polyhedron* **1995**, 14, 3367–3388.
16. Woollins, J. D. *J. Chem. Soc., Dalton Trans.* **1996**, 2893–2901 [96–17].
17. Woollins, J. D. *Main Group Chem. News* **1996**, 4, 12–18.
18. Haiduc, I. *Coord. Chem. Rev.* **1997**, 158, 325–358.
19. Haiduc, I. *Phosphorus Sulfur* **1994**, 93/94, 345–348.
20. Ly, T. Q.; Woollins, J. D. *Coord. Chem. Rev.* **1998**, 176, 451–481.
21. Haiduc, I. *J. Organomet. Chem.* **2001**, 623, 29–42.
22. Wang, F. T.; Najdzionek, J.; Leneker, K. L.; Wasserman, H.; Braitsch, D. M. *Synth. React. Inorg. Met.-Org. Chem.* **1978**, 8, 119–125.
23. Williams, D. J. *Inorg. Nucl. Chem. Lett.* **1980**, 16, 189–193.
24. Cupertino, D.; Keyte, R.; Slawin, A. M. Z.; Williams, D. J.; Woollins, J. D. *Inorg. Chem.* **1996**, 35, 2695–2697.
25. Bereman, R. D.; Wang, F. T.; Najdzionek, J.; Braitsch, D. M. *J. Am. Chem. Soc.* **1976**, 98, 7266–7268.
26. Haiduc, I. *Inorganic Experiments*; Woollins, J. D., Ed., VCH Weinheim 1994, pp 145–149.
27. Gilby, L. M.; Piggott, B. *Polyhedron* **1999**, 18, 1077–1082.
28. Cupertino, D.; Birdsall, D. J.; Slawin, A. M. Z.; Woollins, J. D. *Inorg. Chim. Acta* **1999**, 290, 1–7.
29. Bhattacharyya, P.; Novosad, J.; Phillips, J.; Slawin, A. M. Z.; Williams, D. J.; Woollins, J. D. *J. Chem. Soc., Dalton Trans.* **1995**, 1607–1613.
30. Bhattacharyya, P.; Slawin, A. M. Z.; Williams, D. J.; Woollins, J. D. *J. Chem. Soc., Dalton Trans.* **1995**, 2489–2495.
31. Schmidpeter, A.; Groeger, H. *Chem. Ber.* **1967**, 100, 3979–3991.
32. Steinberger, H.; Kuchen, W. Z. *Naturforsch. B: Chem. Sci.* **1974**, 29, 611–613.
33. Slawin, A. M. Z.; Smith, M. B.; Woollins, J. D. *J. Chem. Soc., Dalton Trans.* **1996**, 3659–3665.
34. Bhattacharyya, P.; Slawin, A. M. Z.; Smith, M. B. *J. Chem. Soc., Dalton Trans.* **1998**, 2467–2475.
35. Yang, J.; Drake, J. E.; Hernandez-Ortega, S.; Rösler, R.; Silvestru, C. *Polyhedron* **1997**, 16, 4061–4071.
36. Rösler, R.; Stanciu, M.; Yang, J.; Drake, J. E.; Silvestru, C.; Haiduc, I. *Phosphorus Sulfur* **1998**, 132, 231–250.
37. Balázs, G.; Drake, J. E.; Silvestru, C.; Haiduc, I. *Inorg. Chim. Acta* **1999**, 287, 61–71.
38. Schmidpeter, A.; Groeger, H. Z. *Anorg. Allg. Chem.* **1966**, 345, 106–118.
39. Necas, M.; Foreman, M. R. St. J.; Marek, J.; Woollins, J. D.; Novosad, J. *New. J. Chem.* **2001**, 25, 1256–1263.
40. Nouaman, M.; Zak, Z.; Herrmann, E.; Navratil, O. Z. *Anorg. Allg. Chem.* **1993**, 619, 1147–1153.
41. Cupertino, D. C.; Keyte, R. W.; Slawin, A. M. Z.; Woollins, J. D. *Polyhedron* **1998**, 17, 4219–4226.
42. Herrmann, E.; Nouaman, M.; Zak, Z.; Grossmann, G.; Ohms, G. Z. *Anorg. Allg. Chem.* **1994**, 620, 1879–1888.
43. Cupertino, D. C.; Keyte, R. W.; Slawin, A. M. Z.; Woollins, J. D. *Polyhedron* **1999**, 18, 311–319.
44. Cupertino, D. C.; Keyte, R. W.; Slawin, A. M. Z.; Woollins, J. D. *Polyhedron* **1999**, 18, 707–716.
45. Birdsall, D. J.; Slawin, A. M. Z.; Woollins, J. D. *Polyhedron* **2001**, 20, 125–134.
46. Sekar, P.; Ibers, J. A. *Inorg. Chim. Acta* **2001**, 319, 117–122.
47. Necas, M.; Foreman, M. R. St. J.; Dastych, D.; Novosad, J. *Inorg. Chem. Commun.* **2001**, 4, 36–40.
48. Schmidpeter, A.; Ebeling, J. *Chem. Ber.* **1968**, 101, 815–823.
49. Silvestru, C.; Rösler, R.; Haiduc, I.; Cea-Olivares, R.; Espinosa-Perez, G. *Inorg. Chem.* **1995**, 34, 3352–3354.
50. Chen, H. W.; Pappazios, C.; Fackler, J. P., Jr. *Inorg. Chim. Acta* **1985**, 96, 137–149.
51. Fluck, E.; Richter, H.; Schwarz, W. Z. *Anorg. Allg. Chem.* **1983**, 498, 161–166.
52. Pavlenko, N. V.; Matyushecheva, G. I.; Semenii, V. Ya.; Yagupolskii, L. M. *Zhur. Obshch. Khim.* **1985**, 55, 1586–1590 [*J. Gen. Chem. USSR (Engl. Trans.)*, **1985**, 55, 1410–1414] (*Chem. Abstr.*, **1986**, 105, 42926).
53. Bödeker, J.; Zärtner, H. *J. Prakt. Chem.* **1976**, 318, 149–156.
54. Zabirow, N. G.; Shamsevaleev, F. M.; Cherkasov, R. A. *Zhur. Obshch. Khim.* **1991**, 61, 1474–1475 [*J. Gen. Chem. USSR (Engl. trans.)*, **1991**, 61, 1348–1349].
55. Riesel, L.; Pich, G.; Ruby, C. Z. *Anorg. Allg. Chem.* **1977**, 430, 227–233.
56. Richter, H.; Fluck, E.; Schwarz, W. Z. *Naturforsch. B: Chem. Sci.* **1980**, 35, 578–583.
57. Bock, H.; Heigel, E.; Nagel, N. Z. *Naturforsch. B: Chem. Sci.* **2000**, 55, 773–784.
58. Bock, H.; Heigel, E.; Havlas, Z. Z. *Naturforsch. B: Chem. Sci.* **2001**, 56, 483–511.
59. Bock, H.; Heigel, E. Z. *Naturforsch. B: Chem. Sci.* **2000**, 55, 785–795.
60. Mukhacheva, O. A.; Razumov, A. I. *Zhur. Obshch. Khim.* **1962**, 32, 2696–2699.
61. Shaw, R. A.; Ibrahim, E. H. M. *Angew. Chem.* **1967**, 79, 575.
62. Shaw, B. A.; Ibrahim, E. H. M. *Angew. Chem., Int. Ed. Engl.* **1967**, 6, 556.
63. Fluck, E.; Goldmann, F. L. *Chem. Ber.* **1963**, 96, 3091–3096.
64. Paciorek, K. L. *Inorg. Chem.* **1964**, 3, 96–100.
65. Gilson, I. T.; Sisler, H. H. *Inorg. Chem.* **1965**, 4, 273–275.
66. Kirsanov, A. V.; Zhmurova, I. N. *Zhur. Obshch. Khim.* **1958**, 28, 2478 (*Chem. Abstr.* **1959**, 53, 31180).
67. Kireev, V. V.; Kolesnikov, G. S.; Titov, S. S. *Zhur. Obshch. Khim.* **1970**, 40, 2015–2019 [*J. Gen. Chem. USSR (Engl. Trans.)*, **1970**, 40, 2002–2005].
68. Kabachnik, M. I.; Gilyarov, V. A. *Izvest. Akad. Nauk SSSR, Otdel. Khim. Nauk* **1961**, 55, 819–823 (*Chem. Abstr.*, **1961**, 55, 27014).
69. Gilyarov, V. A.; Tsvetkov, E. N.; Kabachnik, M. I. *Zh. Obshch. Khim.* **1966**, 36, 274–282 (*Chem. Abstr.*, 1966, 64, 17408).
70. Gilyarov, V. A.; Matrosova, E. I.; Bel'skii, F. I.; Kabachnik, M. I. *Zhur. Obshch. Khim.* **1980**, 50, 44–47 [*J. Gen. Chem. USSR (Engl. Trans.)*, **1980**, 50, 35–38].



71. Riesel, L.; Claussnitzer, A.; Ruby, C. Z. *Anorg. Allg. Chem.* **1977**, *433*, 200–206.
72. Nielsen, M. L. *Inorg. Chem.* **1964**, *3*, 1760.
73. Browning, C. S.; Farrar, D. H.; Frankel, D. C. *Inorg. Chim. Acta* **1996**, *241*, 111–115.
74. Magennis, S. W.; Parsons, S.; Corval, A.; Woollins, J. D.; Pikramenou, Z. *Chem. Commun.* **1999**, 61–62.
75. Ellermann, J.; Sutter, J.; Knoch, F. A.; Moll, M. *Chem. Ber.* **1994**, *127*, 1015–1020.
76. Rietzel, M.; Roesky, H. W.; Katti, K. V.; Noltemeyer, M.; Symons, M. C.; Abu-Raqabah, A. *J. Chem. Soc., Dalton Trans.* **1991**, 1285–1290.
77. Rietzel, M.; Roesky, H. W.; Katti, K. V.; Schmidt, H. G.; Herbst-Irmer, R.; Noltemeyer, M.; Sheldrick, G.; Symons, M. C. R.; Abu-Raqabah, A. *J. Chem. Soc. Dalton Trans.* **1990**, 2387–2392.
78. Nielsen, M. L.; Pustinger, J. V. *J. Phys. Chem.* **1964**, *68*, 152.
79. Matrosov, E. I.; Gilyarov, V. A.; Kabachnik, M. I. *Izv. Akad. Nauk SSSR* **1965**, 1331–1336 (*Chem. Abstr.*, **1966**, *65*, 16262).
80. RazuMOV, A. I.; Zaburova, N. G. *Zhur. Obshch. Khim.* **1962**, *32*, 2696–2699 (*Chem. Abstr.*, **1963**, *58*, 9119).
81. Zuniga-Villareal, N.; Reyes-Lezama, M.; Hernandez-Ortega, S.; Silvestru, C. *Polyhedron* **1998**, *17*, 2679–2685.
82. Ghesner, I.; Palotas, C.; Silvestru, A.; Silvestru, C.; Drake, J. E. *Polyhedron* **2001**, *20*, 1101–1105.
83. Day, R. O.; Holmes, R. R.; Schmidpeter, A.; Stoll, K.; Howe, L. *Chem. Ber.* **1991**, *124*, 2443–2448.
84. Riesel, L.; Mauck, M.; Herrmann, H. Z. *Anorg. Allg. Chem.* **1974**, *405*, 109–112.
85. Czernuszewicz, R.; Maslowski, E., Jr.; Nakamoto, K. *Inorg. Chim. Acta* **1980**, *40*, 199–202.
86. Richter, H.; Fluck, E.; Riffel, H.; Hess, H. Z. *Anorg. Allg. Chem.* **1983**, *496*, 109–116.
87. Williams, D. J.; Slawin, A. M. Z.; Phillips, J. R.; Woollins, D. J. *Polyhedron* **1996**, *15*, 3175–3181.
88. Bock, H.; Heigel, E. Z. *Naturforsch. B: Chem. Sci.* **2001**, *56*, 469–482.
89. Rösler, R.; Silvestru, C.; Espinosa-Perez, G.; Haiduc, I.; Cea-Olivares, R. *Inorg. Chim. Acta* **1996**, *241*, 47–54.
90. Valderrama, M.; Contreras, R.; Munoz, P.; Pilar-Lamata, M.; Carmona, D.; Lahoz, F. J.; Felipe, S.; Oro, L. A. *J. Organomet. Chem.* **2001**, *633*, 182–188.
91. Slawin, A. M. Z.; Ward, J.; Williams, D. J.; Woollins, J. D. *J. Chem. Soc. Chem. Commun.* **1994**, 421–422.
92. Cea-Olivares, R.; Munoz, M. A. *Monatsh. Chem.* **1993**, *124*, 471–476.
93. Cea-Olivares, R.; Nöth, H. Z. *Naturforsch. B: Chem. Sci.* **1987**, *42*, 1507–1509.
94. Siiman, O.; Vetuskey, J. *Inorg. Chem.* **1980**, *19*, 1672–1680.
95. Blake, A. J.; Darr, J. A.; Howdle, S. M.; Poliakov, M.; Li, W. S.; Webb, P. B. *J. Chem. Crystallogr.* **1999**, *29*, 547–554.
96. Haiduc, I.; Cea-Olivares, R.; Hernandez-Ortega, S.; Silvestru, C. *Polyhedron* **1995**, *14*, 2041–2046.
97. Krauter, G.; Sunny, S. K.; Rees, W. S., Jr. *Polyhedron* **1998**, *17*, 391–396.
98. Ebert, K. H.; Cea-Olivares, R.; Garcia-Montalvo, V.; Espinosa-Perez, G.; Estrada, M. R.; Novosad, J.; Woollins, J. D. *Z. Naturforsch.* **1996**, *51b*, 1145–1149.
99. Rösler, R.; Drake, J. E.; Silvestru, C.; Yang, J.; Haiduc, I. *J. Chem. Soc., Dalton Trans.* **1996**, 391–399.
100. Navratil, O.; Fofana, M.; Smola, J. Z. *Chem.* **1984**, *24*, 30.
101. Kabachnik, M. I.; Gilyarov, V. A.; Popov, E. M. *Izvest. Akad. Nauk SSSR, Otdel. Khim. Nauk* **1961**, 1022–1030 (*Chem. Abstr.*, **1961**, *55*, 27014).
102. Fluck, E.; Rheinisch, R. M. *Chem. Ber.* **1963**, *96*, 3085–3090.
103. Abou Ali, S.; Lang, G.; Herrmann, E.; Ehrentreich, F.; Werner, G. Z. *Chem.* **1986**, *26*, 182–183.
104. Herrmann, E.; Hoang ba Nang, Dreyer, R. Z. *Chem.* **1979**, *19*, 187–188.
105. Herrmann, E.; Navratil, O.; Sladek, P.; Nouaman, M. In *Value Adding through Solvent Extraction*: Shallcross, D. C.; Painin, R.; Prvic, L. M. Eds.; Univ. Melbourne, Australia, 1996, pp 353–358.
106. Bock, H.; Schodel, H.; Havlas, Z.; Herrmann, E. *Angew. Chem.* **1995**, *107*, 1441–1443.
107. Bock, H.; Schodel, H.; Havlas, Z.; Herrmann, E. *Angew. Chem. Int. Ed. Engl.* **1995**, *34*, 1355–1357.
108. Ly, T. Q.; Slawin, A. M. Z.; Woollins, J. D. *Main Group Chem.* **2000**, *3*, 73–77.
109. Schmidpeter, A.; Brecht, H.; Groeger, H. *Chem. Ber.* **1967**, *100*, 3063–3068.
110. McQuillan, G. P.; Oxtton, L. A. *Inorg. Chim. Acta* **1978**, *29*, 69–75.
111. Nöth, H. Z. *Naturforsch. B: Chem. Sci.* **1982**, *37*, 1491–1498.
112. Kulpe, S.; Seidel, I.; Herrmann, E. *Crystal Res. Technol.* **1984**, *19*, 661–668.
113. Husebye, S.; Maartmann-Moe, K. *Acta Chem. Scand.* **1983**, *A37*, 439–441.
114. Hitchcock, P. B.; Nixon, J. F.; Silaghi-Dumitrescu, I.; Haiduc, I. *Inorg. Chim. Acta* **1985**, *96*, 77–80.
115. Pernin, C. G.; Ibers, J. A. *Acta Crystallogr., Sect. C* **2000**, *56*, 376–378.
116. Wilton-Ely, J. D. E. T.; Schier, A.; Schmidbauer, H. *J. Chem. Soc., Dalton Trans.* **2001**, 3647–3651.
117. Crespo, O.; Conception Gimeno, M.; Jones, P. G.; Laguna, A. *Inorg. Chem.* **1994**, *33*, 6128–6131.
118. Cupertino, D.; Keyte, R.; Slawin, A. M. Z.; Woollins, J. D.; Williams, D. J. *Polyhedron* **1996**, *15*, 4441–4445.
119. Pauli, J.; Riesel, L.; Il'in, E. G.; Ignatov, M. G.; Buslaev, Yu. A. Z. *Anorg. Allg. Chem.* **1989**, *576*, 235–241.
120. Haiduc, I. *Rev. Inorg. Chem.* **1981**, *3*, 353–370.
121. Haiduc, I.; Sowerby, D. B.; Lu, S. F. *Polyhedron* **1995**, *14*, 3389–3472.
122. Smith, M. B.; Slawin, A. M. Z. *Polyhedron* **2000**, *19*, 695–704.
123. Slawin, A. M. Z.; Smith, M. B.; Woollins, J. D. *J. Chem. Soc., Dalton Trans.* **1998**, 1537–1539.
124. Slawin, A. M. Z.; Smith, M. B. *New J. Chem.* **1999**, 777–783.
125. Ellermann, J.; Bauer, W.; Dötzer, M.; Heinemann, F. W.; Moll, M. *Monatsh. Chem.* **1999**, *130*, 1419–1430.
126. Varga, R.; Silvestru, C.; Haiduc, I. *Syn. React. Inorg. Met.-Org. Chem.* **2000**, *30*, 485–498.
127. Abbati, G. C.; Aragoni, M. C.; Arca, M.; Devillanova, F. A.; Fabretti, A. C.; Garau, A.; Isaia, I.; Lippolis, V.; Gaetano, V. *J. Chem. Soc., Dalton Trans.* **2001**, 1105–1110.
128. Haiduc, I.; Cea-Olivares, R.; Toscano, R. A.; Silvestru, C. *Polyhedron* **1995**, *14*, 1067–1071.
129. Novosad, J.; Necas, M.; Marek, J.; Veltsistas, P.; Papadimitriou, C.; Haiduc, I.; Watanabe, M.; Woollins, J. D. *Inorg. Chim. Acta* **1999**, *290*, 256–260.
130. Herndon, W. C.; Haiduc, I. *J. Mol. Struct.* **2001**, *598*, 127–131.
131. Laguna, A.; Laguna, M.; Fraile, M. N.; Fernandez, E.; Jones, P. G. *Inorg. Chim. Acta* **1988**, *150*, 233–236.
132. Phillips, J. R.; Slawin, A. M. Z.; White, A. J. P.; Williams, D. J.; Woollins, D. J. *J. Chem. Soc., Dalton Trans.* **1995**, 2467–2468.

133. Casas, J. S.; Castineiras, A.; Haiduc, I.; Sanchez, A.; Sordo, J.; Vasquez-Lopez, E. M. *Polyhedron* **1995**, *14*, 805–809.
134. Haiduc, I.; Silvestru, C.; Roesky, H. W.; Schmidt, H. G.; Noltemeyer, M. *Polyhedron* **1993**, *12*, 69–75.
135. Necas, M.; Novosad, J.; Husebye, S. *J. Organomet. Chem.* **2001**, *623*, 124–130.
136. García-Montalvo, V.; Zamora-Rosete, M. K.; Gorostieta, D.; Cea-Olivares, R.; Toscano, R. A.; Hernández-Ortega, S. *Eur. J. Inorg. Chem.* **2001**, 2279–2285.
137. Drake, J. E.; Drake, R. J.; Silvestru, A.; Yang, J. *Can. J. Chem.* **1999**, *77*, 356–366.
138. Husebye, S.; Maartmann-Moe, K. *Acta Chem. Scand.* **1983**, *A37*, 219–225.
139. Garcia-Montalvo, V.; Cea-Olivares, R.; Williams, D. J.; Espinosa-Perez, G. *Inorg. Chem.* **1996**, *35*, 3948–3953.
140. Silvestru, A.; Haiduc, I.; Toscano, R. A.; Breunig, H. J. *Polyhedron* **1995**, *14*, 2047–2053.
141. Drake, J. E.; Silvestru, A.; Yang, J.; Haiduc, I. *Inorg. Chim. Acta* **1998**, *271*, 75–82.
142. Haiduc, I.; Fischer, A.; Edelmann, F. T. *unpublished results*.
143. Smith, M. B.; Slawin, A. M. Z. *Inorg. Chim. Acta* **2000**, *299*, 172–179.
144. Wilton-Ely, J. D. E. T.; Schier, A.; Schmidbaur, H. *Inorg. Chem.* **2001**, *40*, 4656–4661.
145. Husebye, S.; Maartmann-Moe, K.; Mikalsen, O. *Acta Chem. Scand.* **1990**, *44*, 802–805.
146. Molloy, K. C.; Mahon, M. F.; Haiduc, I.; Silvestru, C. *Polyhedron* **1995**, *14*, 1169–1174.
147. Ho, E. N. M.; Wong, W. T. *J. Chem. Soc., Dalton Trans.* **1997**, 915–916.
148. Székely, I.; Silvestru, C.; Drake, J. E.; Balázs, G.; Fărcas, S. I.; Haiduc, I. *Inorg. Chim. Acta* **2000**, *299*, 247–252.
149. Zuniga-Villareal, N.; Reyes-Lezama, M.; Espinosa, G. *J. Organomet. Chem.* **2001**, *626*, 113–117.
150. Birdsall, D. J.; Slawin, A. M. Z.; Woollins, J. D. *Inorg. Chem.* **1999**, *38*, 4152–4155.
151. Magull, J. <http://achpc1.ac.chemie.uni-goettingen.de/index/muenzenmetall.pdf>.
152. Garcia-Montalvo, V.; Cea-Olivares, R.; Espinosa-Perez, G. *Polyhedron* **1996**, *15*, 829–834.
153. Pernin, C. G.; Ibers, J. A. *Inorg. Chem.* **2000**, *39*, 1222–1226.
154. Pernin, C. G.; Ibers, J. A. *Inorg. Chem.* **2000**, *39*, 1216–1221.
155. Pernin, C. G.; Ibers, J. A. *Inorg. Chem.* **1999**, *38*, 5478–5483.
156. Zak, Z.; Fofana, M.; Kamenicek, J.; Glowiak, T. *Acta Crystallogr., Sect. C* **1989**, *45*, 1686–1689.
157. Rudler, H.; Denise, B.; Gregorio, J. R.; Vaissermann, J. *Chem. Commun.* **1997**, 2299–2300.
158. Casas, J. S.; Castineiras, A.; Haiduc, I.; Sanchez, A.; Sordo, J.; Vasquez-Lopez, E. M. *Polyhedron* **1994**, *13*, 2873–2879.
159. Mazzah, A.; Gosink, H. J.; Liebermann, J.; Roesky, H. W. *Chem. Ber.* **1991**, *124*, 753–756.
160. Paciorek, K. L.; Kratzer, R. H. *Inorg. Chem.* **1966**, *5*, 538–541.
161. Haiduc, I.; Zukerman-Schpector, J.; Castellano, E.; Cea-Olivares, R. *Heteroatom. Chem.* **2000**, *11*, 244–248.
162. Il'in, E. G.; Kovalev, V. V.; Aleksandrov, G. G.; Schmidpeter, A.; Buslaev, Yu. A. *Doklady-Chemistry (Engl.)* **2000**, *372*, 111–116 [*Doklady Akad.Nauk (Russ.)* **2000**, *372*, 773–777].
163. Székely, I.; Drake, J. E.; Silvestru, C. *Phosphorus Sulfur* **1997**, *124&125*, 557–560.
164. Rossi, R.; Marchi, A.; Magon, L.; Casellato, U.; Tamburini, S.; Graziani, R. *J. Chem. Soc., Dalton Trans.* **1991**, 263–268.
165. Rossi, R.; Marchi, A.; Marvelli, L.; Magon, L.; Peruzzini, M.; Casellato, C.; Graziani, R. *J. Chem. Soc., Dalton Trans.* **1993**, 723–729.
166. Ellermann, J.; Gabold, P.; Knoch, F. A.; Moll, M.; Schmidt, A.; Schutz, M. *Z. Naturforsch. B: Chem. Sci.* **1996**, *51*, 201–208.
167. Davison, A.; Switkes, E. S. *Inorg. Chem.* **1971**, *10*, 837–842.
168. Rudler, H.; Denise, B. *J. Mol. Catal. A: Chem.* **2000**, *154*, 277–279.
169. Silvestru, A.; Rotar, A.; Drake, J. E.; Hursthouse, M. B.; Light, M. E.; Farcas, S. I.; Silvestru, C. *Can. J. Chem.* **2001**, *79*, 983–991.
170. Schmidpeter, A.; Böhm, R.; Groeger, H. *Angew. Chem.* **1964**, *76*, 860.
171. *Angew. Chem., Int. Ed. Engl.* **1964**, *3*, 704.
172. Uhl, W.; Spies, T.; Saak, W. *Z. Anorg. Allg. Chem.* **1999**, *625*, 2095–2102.
173. Cea-Olivares, R.; Toscano, R. A.; Carreon, G.; Valdes-Martinez, J. *Monatsh. Chem.* **1992**, *123*, 391–396.
174. Cea-Olivares, R.; Garcia-Montalvo, V.; Novosad, J.; Woollins, J. D.; Toscano, R. A.; Espinosa-Perez, G. *Chem. Ber.* **1996**, *129*, 919–923.
175. Schmidpeter, A.; Stoll, K. *Angew. Chem.* **1967**, *79*, 242–243.
176. Schmidpeter, A.; Stoll, K. *Angew. Chem., Int. Ed. Engl.* **1967**, *6*, 252–253.
177. Silvestru, C.; Haiduc, I.; Cea-Olivares, R.; Zimbron, A. *Polyhedron* **1994**, *13*, 3159–3165.
178. Silvestru, C.; Rösler, R.; Haiduc, I.; Toscano, R. A.; Sowerby, D. B. *J. Organomet. Chem.* **1996**, *515*, 131–138.
179. Gudima, A. O.; Berezhnoi, E. O.; Kalibabchuk, V. A. *Koord. Khim.* **1991**, *16*, 1147–1151 (*Chem. Abstr.*, **1991**, *114*, 16508).
180. Rodriguez, I.; Alvarez, C.; Gomez-Lara, J.; Toscano, R. A.; Plazer, N.; Mulheim, C.; Rudler, H. *J. Chem. Soc., Chem. Commun.* **1987**, 1502–1503.
181. Alvarez, C.; Goasdoue, N.; Plazer, N.; Rodriguez, I.; Rudler, H. *J. Chem. Soc., Chem. Commun.* **1988**, 1002–1004.
182. Alvarez, C.; Barkaoui, L.; Goascone, N.; Daran, J. C.; Plazer, N.; Rudler, H.; Vaissermann, J. *J. Chem. Soc., Chem. Commun.* **1989**, 1507–1509.
183. Plazer, N.; Rudler, H.; Alvarez, C.; Barkaoui, L.; Denise, B.; Goascone, N.; Rager, M. N.; Vaisermann, J.; Daran, J. C. *Bull. Soc. Chim. France* **1995**, *132*, 95–113.
184. Barkaoui, L.; Charrouf, M.; Raeger, M. N.; Denise, B.; Plazer, N.; Rudler, H. *Bull. Soc. Chim. France* **1997**, *134*, 167–175.
185. Christou, V.; Salata, O. V.; Ly, T. Q.; Capecchi, S.; Bailey, N. J.; Cowley, A.; Chippindale, A. M. *Synth. Met.* **2000**, *111/112*, 7–10.
186. Carvalho, A.; Garcia-Montalvo, V.; Domingos, A.; Cea-Olivares, R.; Marques, N.; Pires de Matos, A. *Polyhedron* **2000**, *19*, 1699–1705.
187. Bonfada, E.; Schulz-Lang, E.; Zana, R. A.; Abraham, U. *Z. Naturforsch. B: Chem. Sci.* **2000**, *55*, 285–290.
188. Dvorkin, A. A.; Kalibabchuk, V. A.; Gudima, A. O.; Rudzevich, V. L.; Simonov, Yu. A. *Zhur. Neorg. Khim.* **1990**, *35*, 3024–3028 (*Chem. Abstr.*, **1991**, *115*, 61554).
189. Rudzevich, V. L.; Gudima, A. O.; Kalibabchuk, V. A. *Zhur. Neorg. Khim.* **1990**, *35*, 2748–2752.
190. Navratil, O.; Herrmann, E.; Grossmann, G.; Teply, J. *Coll. Czech. Chem. Commun.* **1990**, *55*, 364–371.

191. Navratil, O.; Ciganek, M.; Herrmann, E. *Coll. Czech. Chem. Commun.* **1983**, *48*, 2009–2014.
192. Riesel, L.; Pauli, J.; Porzel, A.; Il'in, E. G. *Z. Anorg. Allg. Chem.* **1989**, *571*, 127–132.
193. Richter, H.; Fluck, E.; Riffel, H.; Hess, H. *Z. Anorg. Allg. Chem.* **1982**, *491*, 266–270.
194. Kulpe, S.; Seidel, I.; Herrmann, E. *Z. Chem.* **1981**, *21*, 333–335.
195. Kulpe, S.; Seidel, I.; Szulzewsky, K.; Kretschmer, G. *Acta Crystallogr., Sect. B* **1982**, *38*, 2813–2817.
196. Herrmann, E.; Scheller, D. *Z. Anorg. Allg. Chem.* **1983**, *496*, 134–142.
197. Herrmann, E.; Navratil, O.; Hoang ba Nang, Smola, J.; Friedrich, J.; Prihoda, J.; Dreyer, R.; Chalkin, V. A.; Kulpe, S. *Coll. Czech. Chem. Commun.* **1984**, *49*, 201–217.
198. Rodriguez, I.; Alvarez, C.; Gomez-Lara, J.; Cea-Olivares, R. *Lanthanide-Actinide Res.* **1985**, 253–260 (Publ. 1986) *1*, 253–260 (*Chem. Abstr.* **1987**, *106*, 42884).
199. Churchill, M. R.; Wormald, J. *Chem. Commun.* **1970**, 703–704.
200. Churchill, M. R.; Wormald, J. *Inorg. Chem.* **1971**, *10*, 1778–1782.
201. Churchill, M. R.; Cooke, J.; Wormald, J.; Davison, A.; Switkes, E. S. *J. Am. Chem. Soc.* **1969**, *91*, 6518–6519.
202. Churchill, M. R.; Cooke, J.; Fennessey, J. P.; Wormald, J. *Inorg. Chem.* **1971**, *10*, 1031–1035.
203. Bilec, D.; Silvestru, A.; Silvestru, C.; Haiduc, I.; Drake, J. E. *Rev. Soc. Quim. Mexico* **2000**, *44*, 116–121.
204. Siiman, O. *Inorg. Chem.* **1981**, *20*, 2285–2292.
205. Williams, D. J.; Travis, J. B.; Bergbauer, K. L. *J. Coord. Chem.* **1987**, *16*, 315–317.
206. Birdsall, D. J.; Novosad, J.; Slawin, A. M. Z.; Woollins, J. D. *J. Chem. Soc., Dalton Trans.* **2000**, 435–439.
207. Leung, W. H.; Zheng, H.; Chim, J. L.; Chan, J.; Wong, W. T.; Williams, I. D. *J. Chem. Soc., Dalton Trans.* **2000**, 423–430.
208. Zhang, Q. F.; Lau, K. K.; Kim, J. L. C.; Wong, T. K. T.; Wong, W. T.; Williams, I. D.; Leung, W. H. *J. Chem. Soc., Dalton Trans.* **2000**, 3027–3033.
209. Birdsall, D. J.; Cupertino, D.; Woollins, J. D.; Slawin, A. M. Z. *Phosphorus Sulfur* **1997**, *124&125*, 465–468.
210. Darwin, K.; Gilby, L. M.; Hodge, P. R.; Piggott, B. *Polyhedron* **1999**, *18*, 3729–3733.
211. Berau, V.; Pernin, C. G.; Ibers, J. A. *Inorg. Chem.* **2000**, *39*, 854–856.
212. Niu, Y.-Y.; Song, Y.-L.; Zheng, H.-G.; Long, D.-L.; Fun, H.-K.; Xin, X.-Q. *New J. Chem.* **2001**, 945–948.
213. Siiman, O.; Wrighton, M.; Gray, H. B. *J. Coord. Chem.* **1972**, *2*, 159–161.
214. Siiman, O.; Gray, H. B. *Inorg. Chem.* **1974**, *13*, 1185–1191.
215. Zuniga-Villareal, N.; Silvestru, C.; Reyes-Lezama, M.; Hernandez-Ortega, S.; Alvarez-Toledano, C. *J. Organomet. Chem.* **1995**, *496*, 169–174.
216. Abram, U.; Schulz-Lang, E.; Abram, S.; Wegmann, J.; Dilworth, J. R.; Kirmse, R.; Woollins, J. D. *J. Chem. Soc., Dalton Trans.* **1997**, 623–630.
217. Abram, U.; Abram, S.; Schibli, R.; Alberto, R.; Dilworth, J. R. *Polyhedron* **1998**, *17*, 1303–1309.
218. Leung, W. H.; Chim, J. L. C.; Williams, I. D.; Wong, W. T. *Inorg. Chem.* **1999**, *38*, 3000–3005.
219. Hoggins, J. T.; Steinfink, H. *Inorg. Chem.* **1976**, *15*, 1682–1685.
220. Slawin, A. M. Z.; Smith, M. B.; Woollins, J. D. *J. Chem. Soc., Dalton Trans.* **1997**, 1877–1881.
221. Slawin, A. M. Z.; Smith, M. B. *Phosphorus Sulfur* **1997**, *124&125*, 481–484.
222. Garcia-Baez, E. V.; Rozales-Hoz, M. J.; Nöth, H.; Haiduc, I.; Silvestru, C. *Inorg. Chem. Commun.* **2000**, *3*, 173–177.
223. Leung, W. H.; Lau, K. K.; Zhang, Q. F.; Wong, W. T.; Tang, B. *Organometallics* **2000**, *19*, 2084–2089.
224. Parr, J.; Smith, M. B.; Slawin, A. M. Z. *J. Organomet. Chem.* **1999**, *588*, 99–106.
225. Simon-Manso, E.; Valderrama, M.; Boys, D. *Inorg. Chem.* **2001**, *40*, 3647–3649.
226. Goyal, M.; Novosad, J.; Necas, N.; Ishii, H.; Nagahata, R.; Sugiyama, J.-I.; Ueda, M.; Takeuchi, K. *Appl. Organomet. Chem.* **2000**, *14*, 629–633.
227. Talanova, G. G.; Yatsimirskii, K. B.; Kuraeva, I. N.; Nazarenko, A. Y.; Aladzheva, I. M.; Bikhovskaya, O. V.; Leont'eva, I. V.; Kalyanova, R. M. *J. Coord. Chem.* **2000**, *51*, 21–32.
228. Smith, M. B.; Slawin, A. M. Z. *New J. Chem.* **2000**, *24*, 65–71.
229. Siiman, O.; Huber, C. P.; Post, M. L. *Inorg. Chim. Acta* **1977**, *25*, L11–L14.
230. Huber, C. P.; Post, M. L.; Siiman, O. *Acta Crystallogr., Sect. B* **1978**, *34*, 2629–2632.
231. Uson, R.; Laguna, A.; Laguna, M.; Conception Gimeno, M. *J. Chem. Soc., Dalton Trans.* **1989**, 1883–1886.
232. Laguna, A.; Laguna, M.; Rojo, A.; Fraile, M. N. *J. Organomet. Chem.* **1986**, *315*, 269–276.
233. Conception Gimeno, M.; Laguna, A.; Laguna, M.; Sanmartin, F.; Jones, P. G. *Organometallics* **1993**, *12*, 3984–3991.
234. Haiduc, I.; Fischer, A.; Edelman, F. T. *Rev. Roumaine Chim.* **1999**, *44*, 805–809.
235. Slawin, A. M. Z.; Smith, M. B.; Woollins, J. D. *Polyhedron* **1999**, *18*, 1135–1140.
236. Morley, J. O.; Charlton, M. H. *J. Phys. Chem. A* **1998**, *102*, 6871–6876.
237. Rösler, R.; Silvestru, C.; Haiduc, I.; Kayser, F.; Gielen, M.; Mathieu, B. *Main Group Metal Chem.* **1993**, *16*, 435–443.
238. Niu, Y.; Wang, Y.; Song, Y.; Liu, S.; Zheng, H.; Xin, X. *Chem. Lett.* **2001**, 1004–1005.
239. Arca, M.; Garau, A.; Devillanova, F. A.; Isaia, F.; Lippolis, V.; Verani, G.; Abbati, G. L.; Cornia, A. *Z. Anorg. Allg. Chem.* **1999**, *625*, 517–520.
240. Williams, D. J.; Quicksall, C. O.; Barkigia, K. M. *Inorg. Chem.* **1982**, *21*, 2097–2100.
241. Bjornevag, S.; Husebye, S.; Maartmann-Moe, K. *Acta Chem. Scand.* **1982**, *A36*, 195–202.
242. Novosad, J.; Törnroos, K. W.; Necas, M.; Slawin, A. M. Z.; Woollins, J. D.; Husebye, S. *Polyhedron* **1999**, *18*, 2861–2867.
243. Drake, J. E.; Hursthouse, M. B.; Kulcsar, M.; Light, M. E.; Silvestru, A. *J. Organomet. Chem.* **2001**, *623*, 153–160.
244. Berau, V.; Sekar, P.; McLauchlan, C. C.; Ibers, J. A. *Inorg. Chim. Acta* **2000**, *308*, 91–96.
245. Berau, V.; Ibers, J. A. *C.R. Acad. Sci., Ser. IIc: Chim.* **2000**, *3*, 123–129.
246. Rossi, R.; Marchi, A.; Marvelli, L.; Peruzzini, M.; Casellato, U.; Graziani, R. *J. Chem. Soc., Dalton Trans.* **1992**, 435–437.
247. Valderrama, M.; Contreras, R.; Lamata, M. P.; Viguri, F.; Carmona, D.; Lahoz, F. J.; Felipe, S.; Oro, L. A. *J. Organomet. Chem.* **2000**, *607*, 3–11.
248. Papadimitriou, C.; Veltistas, P.; Novosad, J.; Cea-Olivares, R.; Toscano, A.; Garcia y Garcia, P.; Lopez-Cardosa, M.; Slawin, A. M. Z.; Woollins, J. D. *Polyhedron* **1997**, *16*, 2727–2729.
249. Cea-Olivares, R.; Novosad, J.; Woollins, J. D.; Slawin, A. M. Z.; Garcia-Montalvo, V.; Espinosa-Perez, G.; Garcia y Garcia, P. *Chem. Commun.* **1996**, 519–520.

250. Silaghi-Dumitrescu, I.; Silaghi-Dumitrescu, L.; Cea-Olivares, R. *Main Group Metal Chem.* **1999**, *22*, 5–8.
251. Cea-Olivares, R.; Canseco-Melchor, G.; Garcia-Montalvo, V.; Hernandez-Ortega, S.; Novosad, J. *Eur. J. Inorg. Chem.* **1998**, 1573–1576.
252. Novosad, J.; Lindeman, S. V.; Marek, J.; Woollins, J. D.; Husebye, S. *Heteroatom Chem.* **1998**, *9*, 615–621.
253. Silvestru, A.; Bile, D.; Rösler, R.; Drake, J. E.; Haiduc, I. *Inorg. Chim. Acta* **2000**, *305*, 106–110.
254. Ly, T. Q.; Mabbs, F. E.; McInnes, E. J. C.; Slawin, A. M. Z.; Woollins, J. D. *Inorg. Chem. Commun.* **1998**, *1*, 143–146.
255. Slawin, A. M. Z.; Smith, M. B.; Woollins, J. D. *Polyhedron* **1998**, *17*, 4465–4473.
256. Cea-Olivares, R.; Toscano, R. A.; Hernandez-Ortega, S.; Novosad, J.; Garcia-Montalvo, V. *Eur. J. Inorg. Chem.* **1999**, 1613–1616.
257. Trofimenko, S. *Scorpionates. The Coordination Chemistry of Polypyrazolylborate Ligands*; Imperial College Press: London, 1999.

# 1.15

## 1,1-Dithiolato Ligands

I. HAIDUC

*Universitatea "Babes-Bolyai", Cluj-Napoca, Roumania*

---

1.15.1	INTRODUCTION	349
1.15.2	DITHIOPHOSPHINATES, DITHIOPHOSPHATES, AND DITHIOPHOSPHONATES	350
1.15.2.1	General	350
1.15.2.2	Synthesis	350
1.15.2.2.1	<i>Dithiophosphinic acids, <math>R_2P(S)SH</math></i>	350
1.15.2.2.2	<i>Dithiophosphoric acids (diesters) <math>(RO)_2P(S)SH</math></i>	351
1.15.2.2.3	<i>Dithiophosphonic acids, <math>R^1(R^2O)P(S)SH</math></i>	351
1.15.2.3	Coordination patterns	351
1.15.2.4	Metal complexes	352
1.15.2.4.1	<i>Dithiophosphinates</i>	352
1.15.2.4.2	<i>Dithiophosphates</i>	354
1.15.2.4.3	<i>Dithiophosphonates</i>	355
1.15.3	DITHIOARSINATES	357
1.15.3.1	General	357
1.15.3.2	Synthesis	357
1.15.3.3	Coordination patterns	357
1.15.3.4	Metal complexes	357
1.15.4	DITHIOCARBONATES (XANTHATES)	359
1.15.4.1	General	359
1.15.4.2	Synthesis	359
1.15.4.3	Coordination patterns	361
1.15.4.4	Metal complexes	362
1.15.5	DITHIOCARBOXYLATES	363
1.15.5.1	General	363
1.15.5.2	Synthesis	364
1.15.5.3	Coordination patterns	364
1.15.5.4	Metal complexes	365
1.15.6	DITHIOCARBAMATES	367
1.15.6.1	General	367
1.15.6.2	Synthesis	367
1.15.6.3	Coordination patterns	367
1.15.6.4	Metal complexes	367
1.15.7	REFERENCES	369

---

### 1.15.1 INTRODUCTION

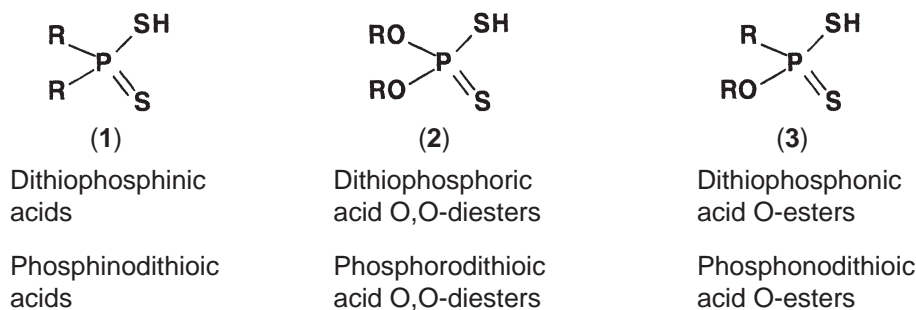
In *Comprehensive Coordination Chemistry* (CCC, 1987), practically all known types of sulfur-containing ligands, e.g., dithiocarbamates, dithiocarbonates (xanthates), dithiocarboxylates, dithiophosphates, and related ligands<sup>1,2</sup> were well covered. Here only the most popular sulfur-containing ligands will be treated, i.e., those which continued to be used frequently in coordination chemistry, with emphasis on new results. The 1,1-dithiolato ligands and their complexes have been reviewed rather comprehensively in other earlier publications,<sup>3-5</sup> which are still useful sources of information about older literature. In this section, those ligands that have not

been reviewed recently (e.g., dithiophosphonates, dithioarsinates, dithiocarboxylates) will be treated more extensively.

## 1.15.2 DITHIOPHOSPHINATES, DITHIOPHOSPHATES, AND DITHIOPHOSPHONATES

### 1.15.2.1 General

This section deals with a series of phosphor-1,1-dithiolates, which includes dithiophosphinates,  $M(S_2PR_2)_n$ , dithiophosphates,  $M[S_2P(OR)_2]_n$ , and dithiophosphonates,  $M[S_2PR^1(OR^2)]_n$ . Alternative names are phosphinodithioates, phosphorodithioates, and phosphonodithioates, respectively. The parent acids (proligands), (1)–(3) are shown in Scheme 1.



Scheme 1

These ligands have been briefly covered in *CCC* (1987).<sup>1</sup> They are interesting due to their diverse coordination patterns (*vide infra*), often leading to the formation of inorganic (carbon-free) chelate rings.<sup>6</sup> Due to their ready availability, dithiophosphates enjoy an extensive chemistry and are often used to create sulfur-rich environments in metal complexes. Dithiophosphinates are seldom available commercially and their synthesis is somewhat cumbersome, at least in the case of alkyl derivatives. Dithiophosphonates became more popular only in recent years, although some of their coordination chemistry has been explored earlier. Their coordination patterns are expected to be very similar, but peripheric groups, i.e., the substituents at phosphorus, can dramatically change the structure and properties of the respective metal complexes,<sup>7</sup> and this justifies their parallel study.

The early literature on dithiophosphates has been reviewed (sometimes also including dithiophosphinates) as a general subject<sup>8–11</sup> or in some particular aspects, i.e., main group,<sup>12</sup> group 14,<sup>13–15</sup> group 15,<sup>16,17</sup> and tellurium derivatives.<sup>18,19</sup> The dithiophosphinates have also been reviewed.<sup>20,21</sup> The synthesis of metal complex and organometallic dithiophosphinates and -phosphates through reactions of bis(thiophosphinyl- and -phosphoryl)disulfanes with metal species has been reviewed in detail recently.<sup>22</sup>

The literature of metal complexes and organometallic derivatives of dithiophosphato ligands is very extensive and well covered by the available reviews cited above; therefore, only a few recent highlights will be mentioned here.

### 1.15.2.2 Synthesis

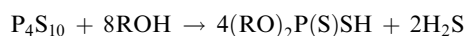
#### 1.15.2.2.1 Dithiophosphinic acids, $R_2P(S)SH$

Dithiophosphinic acids,  $R_2P(S)SH$ , are prepared by adding sulfur to primary phosphines,  $R_2PH$ , an old reaction, described in 1892 (!),<sup>23</sup> and still used.<sup>24</sup> Aryl dithiophosphinic acids, e.g.,  $Ph_2P(S)SH$ , can be conveniently prepared by  $AlCl_3$ -catalyzed reaction of  $P_4S_{10}$  with benzene.<sup>25</sup> Mixed alkylphenyldithiophosphinic acids,  $RPhP(S)SH$ , can be similarly prepared from cyclic  $[RP(S)S]_2$  with benzene and  $AlCl_3$  catalyst.<sup>26</sup> Alkali metal salts of dialkyldithiophosphinic acids,  $MS_2PR_2$ , are obtained by cleavage of  $R_2(S)P-P(S)R_2$  with metal sulfides and sulfur.<sup>27</sup>

Bifunctional dithiophosphinic acids, HS(S)RPZPR(S)SH, R = Me, Ph, *p*-anisyl; Z = 1,4-C<sub>6</sub>H<sub>4</sub>, (CH<sub>2</sub>)<sub>*n*</sub> with *n* = 4–10, and some of their salts and complexes, have been prepared from cyclic [RP(S)S]<sub>2</sub> with di-Grignard reagents, BrMgZMgBr.<sup>28,29</sup>

#### 1.15.2.2 Dithiophosphoric acids (diesters) (RO)<sub>2</sub>P(S)SH

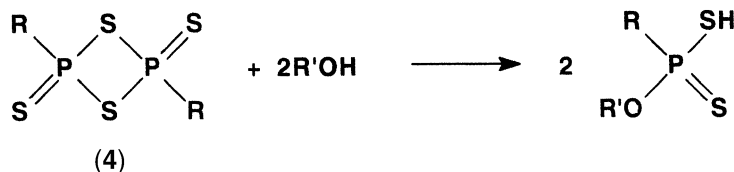
The preparation methods of dithiophosphoric acid diesters, (RO)<sub>2</sub>P(S)SH, which are the proligands for dithiophosphato complexes, use almost exclusively the reaction of alcohols with tetraphosphorus decasulfide:



This reaction has been known for a long time (Pishchimuka, 1912)<sup>30</sup> and newer work made these ligands readily available, and microwave heating greatly improved the reaction conditions (better yields, much shorter reaction times).<sup>31–33</sup> It is still the best preparation for these compounds. It has been extensively used and the early literature is reviewed in the Kosolapoff–Mayer compilation, where many known compounds are listed with their properties.<sup>34,35</sup> Alkali metal salts are readily obtained by neutralization of the acids with the corresponding carbonates, hydroxides, or alkoxides; ammonium salts are formed by passing ammonia gas through a solution of the acid in an organic solvent.<sup>36</sup> Quite frequently, the acids (diesters) are used directly for the synthesis of metal complexes or organometallic derivatives. Especially the latter are conveniently prepared from organometallic oxides or hydroxides with the free acids.

#### 1.15.2.3 Dithiophosphonic acids, R<sup>1</sup>(R<sup>2</sup>O)P(S)SH

Dithiophosphonic acids can be conveniently prepared by cleavage of organodithiophosphonic anhydrides, which are cyclic dimers (diphosphetane disulfides) (4) [RP(S)S]<sub>2</sub> (R = alkyl, cycloalkyl, Ph, *p*-MeOC<sub>6</sub>H<sub>4</sub>, ferrocenyl)<sup>37</sup> with alcohols, silanols, or trialkylsilylalcohols (Scheme 2).<sup>38</sup> Thus, esterification of [R<sup>1</sup>P(S)S]<sub>2</sub> with R<sup>2</sup>OH gave 55–100% yields of R<sup>1</sup>P(S)(OR<sup>2</sup>)SH, which were complexed with metal ions to give M[S<sub>2</sub>PR<sup>1</sup>(OR<sup>2</sup>)]<sub>2</sub> (M = Ni, R<sup>1</sup> = Cy, R<sup>2</sup> = Bu; M = Zn, R<sup>1</sup> = chlorocyclopentyl, chlorocyclohexyl, R<sup>2</sup> = Bu, Cy, BuEtCHCH<sub>2</sub>).<sup>39</sup>



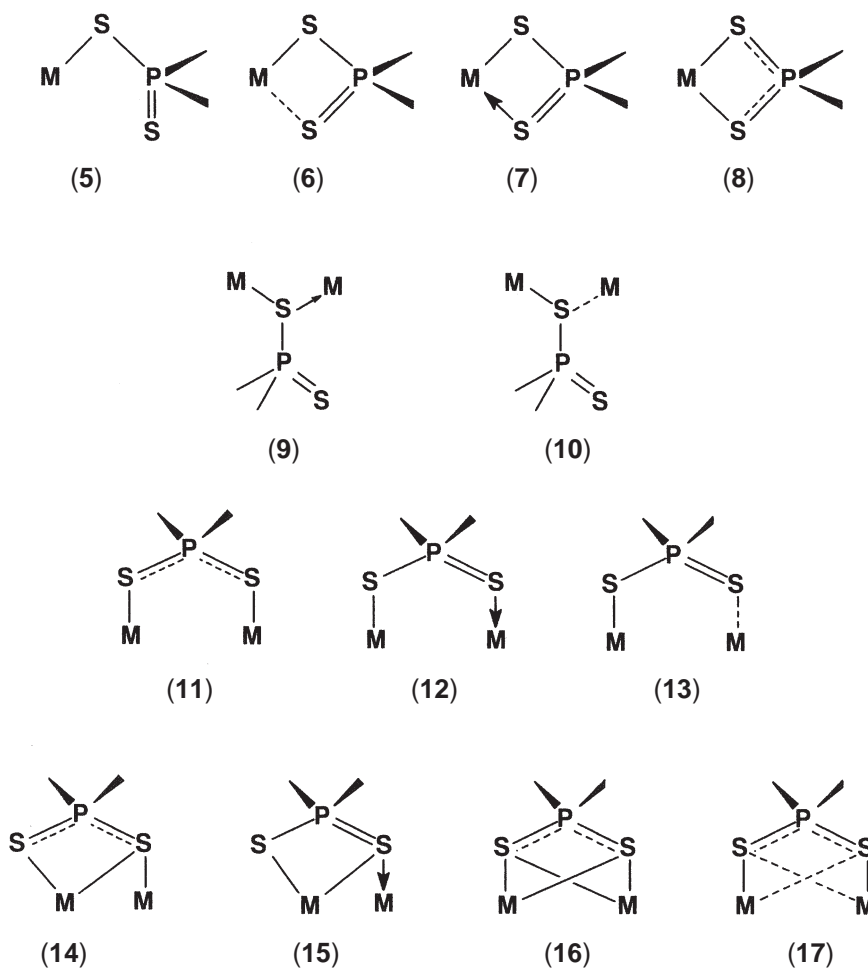
Scheme 2

The well-known Lawesson's reagent, [*p*-MeOC<sub>6</sub>H<sub>4</sub>P(S)S]<sub>2</sub> (prepared directly from P<sub>4</sub>S<sub>10</sub> and anisole) is the most readily available such cyclic dimer. Recently, the anion (N<sub>3</sub>C<sub>6</sub>H<sub>4</sub>CH<sub>2</sub>O)(C<sub>5</sub>H<sub>5</sub>FeC<sub>5</sub>H<sub>4</sub>)P(S)S<sup>−</sup>, has been prepared in two steps from ferrocene, tetraphosphorus decasulfide, and hydroxymethylbenzotriazole in the presence of triethylamine. The salt was used for the synthesis of rhodium and nickel complexes.<sup>40</sup>

#### 1.15.2.3 Coordination patterns

The phosphor-1,1-dithiolato ligands display a broad diversity of coordination patterns (Scheme 3). Monodentate (monometallic monoconnective) (5)<sup>9,10</sup> coordination is relatively rare. Bidentate chelating (monometallic biconnective) coordination can be unsymmetrical, with distinct single P–S and double P=S bonds, associated with longer (secondary) M···S (6) or just slightly longer than covalent (dative coordinate) M←S bonds (7), or symmetrical, with practically identical P–S and M–S bonds (8). A monodentate, bimetallic biconnective coordination of only one sulfur (with the second dangling) (9) is rare, e.g., in PhTeS(S)PPh<sub>2</sub>. Symmetrical (11) and unsymmetrical

((12) and (13)) bridging (bimetallic biconnective) and bimetallic triconnective ((14) and (15)) or even tetraconnective ((16) and (17)) bridging patterns are also possible. In general, unsymmetrical coordination of phosphor-1,1-dithiolato ligands is observed in main group metal complexes, and symmetrical coordination in transition metal complexes. For numerous illustrations of the coordination modes, see refs.<sup>9,10</sup>



Scheme 3

### 1.15.2.4 Metal complexes

#### 1.15.2.4.1 Dithiophosphinates

Metal phosphinato complexes are usually prepared by metathesis of metal halides with alkali metal or ammonium dithiophosphinates. They can also be conveniently prepared by reactions of bis(thiophosphinyl)disulfanes,  $[R_2P(S)S]_2$ , with metal species.<sup>22</sup> The electrochemical oxidation of metals in acetonitrile solution, in the presence of diphenylphosphine,  $Ph_2PH$ , and sulfur affords  $M(S_2PPh_2)_2$  ( $M = Co, Zn, Cd$ ).<sup>41</sup>

Yttrium and lanthanides form neutral tris- and anionic tetrakis complexes with dithiophosphinato (also dithiophosphato) ligands, of the types  $M(S_2PR_2)_3$  and  $[M(S_2PR_2)_4]^-$ , ( $M = Y, La-Lu$  excluding Pm;  $R = Me, Cy, OEt$ ).<sup>42</sup> A detailed theoretical study of lanthanide dimethyldithiophosphinates was performed to analyze the energetic and structural effects of sterical crowding.<sup>43</sup>

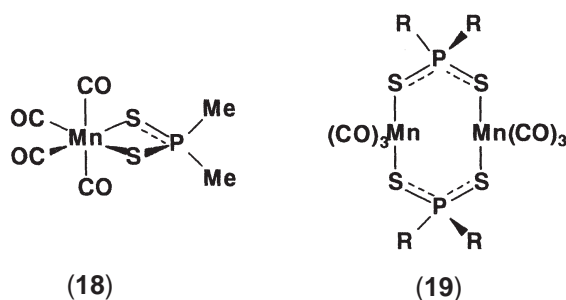
Bis(cyclopentadienyl)titanium dithiophosphinates,  $Cp_2TiS_2PR_2$  ( $R = Me, Et, Cy, Ph$ ), were prepared by photolysis of  $Cp_2Ti(CO)_2$  in the presence of  $[R_2P(S)S]_2$  or  $R_2P(S)H$  and were also formed slowly from thiophosphinito complexes  $Cp_2TiSPR_2$  on standing.<sup>44</sup>



The first vanadium dithiophosphinates reported were  $\text{VO}(\text{S}_2\text{PPh}_2)_2$ ,  $\text{V}(\text{S}_2\text{PPh}_2)_3$ , and  $\text{VO}(\text{S}_2\text{PX}_2)_2$  ( $\text{X} = \text{Me}, \text{Ph}, \text{CF}_3$ , also  $\text{OEt}, \text{F}$ ). The compounds were characterized by spectroscopic techniques, including ESR.<sup>45-47</sup> Recently, adducts of  $\text{VO}(\text{S}_2\text{PR}_2)_2$  ( $\text{R} = \text{Et}$ , also  $\text{EtO}$ ) with sulfur-containing heterocycles were studied by ESR.<sup>48</sup> Organometallic derivatives,  $[\text{Cp}_2\text{V}(\text{S}_2\text{PR}_2)]^+[\text{S}_2\text{VCp}_2]^-$  ( $\text{R} = \text{Et}$ , also  $\text{EtO}, \text{Pr}^i\text{O}$ ) have also been reported.<sup>49</sup> Cyclopentadienylchromium dithiophosphinates,  $\text{CpCr}(\text{CO})_2(\text{S}_2\text{PPh}_2)$  and  $\text{CpCr}(\text{S}_2\text{PPh}_2)_2$  have been obtained and structurally characterized.<sup>50</sup>

There is an extensive dithiophosphinate chemistry of group 6 metals. This deals with cluster compounds, e.g.,  $\text{Mo}_3\text{SnS}_4(\text{S}_2\text{PEt}_2)_6$ ,<sup>51</sup>  $\text{Mo}_3\text{S}_4(\text{S}_2\text{PR}_2)_4\text{HgI}_2$  ( $\text{R} = \text{Et}, \text{Pr}$ ),<sup>52</sup>  $\text{Mo}_2\text{WCuS}_4\text{I}(\text{S}_2\text{PR}_2)_4$  ( $\text{R} = \text{Et}, \text{Pr}$ ),<sup>53</sup> and organometallic nitrosyl complexes, e.g.,  $\text{Cp}^R\text{M}(\text{NO})\text{I}(\text{S}_2\text{PR}^1_2)$  ( $\text{R}^1 = \text{H}, \text{Me}$ ;  $\text{M} = \text{Mo}, \text{W}$ ;  $\text{R}^2 = \text{Me}$ , also  $\text{MeO}$ ).<sup>54</sup>

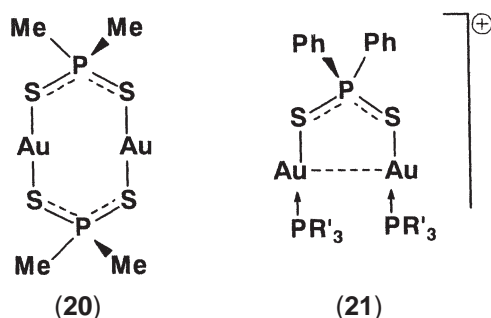
Monomeric  $\text{M}(\text{CO})_4(\text{S}_2\text{PR}_2)$  (**18**) and dimeric  $[\text{M}(\text{CO})_3(\text{S}_2\text{PR}_2)]_2$  (**19**,  $\text{M} = \text{Mn}, \text{Re}$ ;  $\text{R} = \text{Et}, \text{Ph}$ ) (Scheme 4) have been described quite early,<sup>55</sup> but the crystal structure of  $\text{Mn}(\text{CO})_4(\text{S}_2\text{PMe}_2)$  was reported only recently.<sup>56</sup> Technetium derivatives, important for radiological imaging, such as  $^{99\text{m}}\text{TcN}(\text{S}_2\text{PR}_2)_2$  ( $\text{R} = \text{Me}, \text{Et}, \text{Pr}, \text{Pr}^i$ ), have been described.<sup>57,58</sup>



Scheme 4

Group 8 metal complexes of dithiophosphinato ligands include  $\text{Fe}(\text{S}_2\text{PPh}_2)_3$  (magnetic and Mössbauer studies),<sup>59</sup>  $\text{M}(\text{S}_2\text{PAR}_2)_3$  ( $\text{M} = \text{Fe}, \text{Ru}, \text{Os}$ ;  $\text{Ar} = 2,4,5\text{-Me}_3\text{C}_6\text{H}_2$ , ESR studies),<sup>60</sup> and  $\text{CpRu}(\text{S}_2\text{PR}^1_2)(\text{PR}^2_3)$  ( $\text{R}^1 = \text{Ph}$ , also  $\text{EtO}, \text{PrO}, \text{Pr}^i\text{O}, \text{BuO}$ ,  $\text{R}^2 = \text{Ph}, p\text{-Tol}$ ).<sup>61</sup>

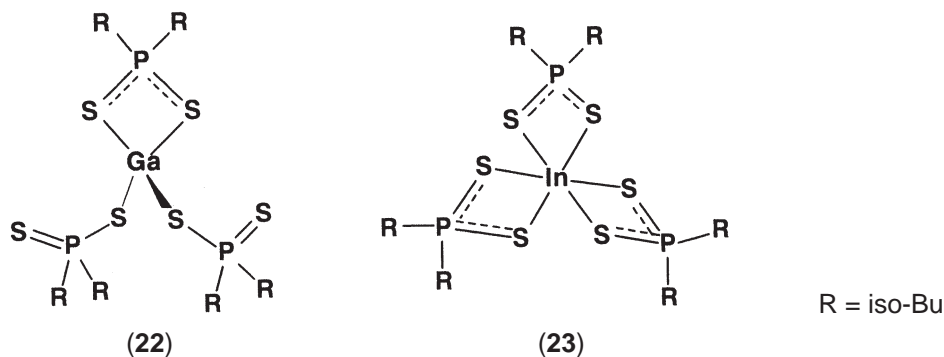
Gold dithiophosphinates,  $[\text{Au}(\text{S}_2\text{PMe}_2)]_2$ ,<sup>62</sup>  $[\text{Au}(\text{S}_2\text{PBu}^i_2)]_2$ ,<sup>63</sup>  $[\text{Au}(\text{S}_2\text{PPh}_2)]_2$ ,<sup>64</sup>  $[\text{Au}_2(\mu\text{-CH}_2)\{\mu\text{-(CH}_2)_2\text{PPh}_2\}_2](\text{S}_2\text{PPh}_2)_2$ ,<sup>65</sup> and other luminescent gold dithiophosphinates,<sup>66</sup> have been recently structurally characterized. (Phosphine)gold(I) dithiophosphinates  $\text{Me}_2\text{P}(\text{S})\text{SAu}(\text{PR}^2_3)$  were obtained from  $\text{NaS}_2\text{PMe}_2$  and chloro(phosphine)gold complexes ( $\text{R}^2 = \text{Me}, \text{Ph}$ , or  $o\text{-Tol}$ ). With  $(\text{Me}_2\text{S})\text{AuCl}$  as a precursor, the product of the reaction with  $\text{NaS}_2\text{PMe}_2$  was  $[\text{Au}(\text{S}_2\text{PMe}_2)]_2$ , a dinuclear complex containing an eight-membered ring in a chair conformation (**20**). In an attempt to carry out polyauration of dithiophosphinate units, diphenyldithiophosphinic acid,  $\text{Ph}_2\text{P}(\text{S})\text{SH}$ , was treated with the reagents  $[\{(\text{R}^2_3\text{P})\text{Au}\}_3\text{O}]^+[\text{BF}_4]^-$  to give  $[\text{Ph}_2\text{P}\{\text{SAu}(\text{PR}^2_3)\}_2]^+[\text{BF}_4]^-$  (**21**),  $\text{R}^2 = \text{Ph}, \text{Me}$ , or  $o\text{-Tol}$ , based upon  $\text{Au}\cdots\text{Au}$  aurophilic interactions (Scheme 5).<sup>62</sup>



Scheme 5

Zinc and cadmium dialkyldithiophosphinates,  $M(S_2PR_2)_2$  ( $M = Zn, Cd$ ;  $R = Bu^i$ ),<sup>67</sup> and their phenanthroline and bipyridyl adducts,<sup>68</sup> which are of interest as precursors for chemical vapor deposition (CVD) of metal sulfide films, have been prepared and structurally characterized.

Variable coordination modes in compounds of similar general formula but different compositions (heterogeometrism)<sup>7</sup> has been observed in the case of gallium–indium di-*iso*-butyldithiophosphate pair,  $M(S_2P Bu^i)_3$ ,  $M = Ga$  or  $In$ ; the gallium compound is four-coordinate, distorted tetrahedral (**22**), whereas the indium compound is six-coordinate, distorted octahedral (**23**) (Scheme 6).<sup>69</sup> Dimeric  $[Bu^i_2GaS_2PPh_2]_2$  and monomeric  $Ga(S_2PR_2)_3$  ( $R = Me, Et$ ) have been described.<sup>70</sup> Diorganothallium diethyldithiophosphinates,  $R_2TlS_2PEt_2$ , are supramolecular compounds based upon intermolecular  $Tl \cdots S$  secondary interactions.<sup>71</sup>



Scheme 6

The conformational trends and intermolecular association in dialkyldithiophosphate arsocane and stibocane derivatives,  $X(CH_2CH_2S)_2MS_2PR_2$ ,  $X = O, S$ ;  $R = Me, Et$  or  $Ph$ ;  $M = As$ <sup>72</sup> or  $Sb$ ,<sup>73</sup> have been analyzed with the aid of single crystal X-ray diffraction. The crystal structures of  $M(S_2PR_2)_3$  ( $M = Sb, R = Et$ ;  $M = In, R = Me, Ph$ ) have been investigated in order to assess the role of the lone pair.<sup>74</sup>

#### 1.15.2.4.2 Dithiophosphates

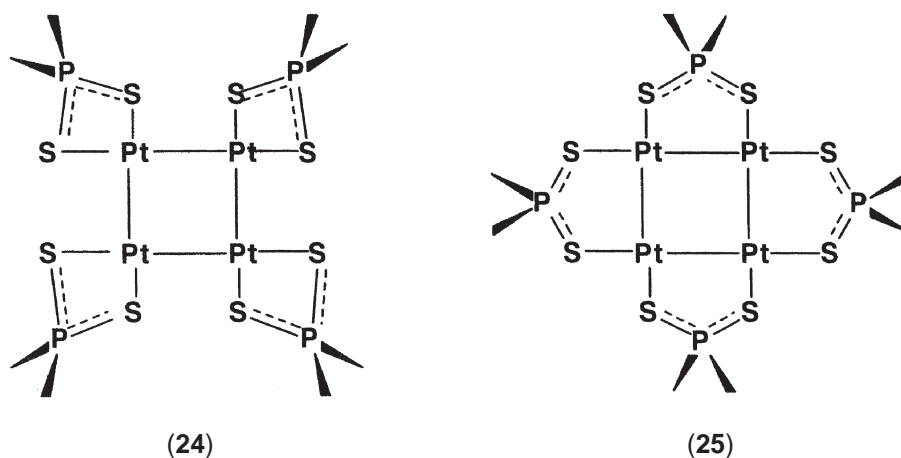
Dithiophosphato metal complexes are commonly prepared by metathesis of metal halides with alkali metal or ammonium salts of the ligands. A convenient method is based upon the reaction of bis(thiophosphoryl)disulfanes with metal species, covered comprehensively in a recent review.<sup>22</sup>

Dinuclear niobium sulfido and selenido dithiophosphates,  $Nb_2Q_4[S_2P(OR)_2]_4$ ,<sup>75,76</sup> ( $Q = S, Se$ ;  $R = Et$ ) (also xanthates and dithiocarbamates) have been prepared but no crystal structure was reported. Optically active chromium complexes,  $Cr[S_2P(OR)_2]_3$  derived from *D*-borneol and *L*-menthol, have been described.<sup>77</sup>

In addition to dinuclear molybdenum complexes, e.g.,  $Mo_2O_3[S_2P(OR)_2]_4$  ( $R = Pr^i, Ph$ ) and  $Mo_2O_2S_2[S_2P(OEt)_2]_2$ ,<sup>78,79</sup> an impressive number of cubane-based clusters containing molybdenum or tungsten, alone or in combination with other heterometallic elements and dithiophosphato ligands are known. A selection includes:  $MoAg_3S_4[S_2P(OBu^i)_2](PPh_3)_3$ ,<sup>80</sup>  $[Mo_3OS_3PbX_3(OAc)_2[S_2P(OEt)_2]_2(Py)_3O]_2$ ,  $Mo_3OS_3SbX_3(OAc)[S_2P(OEt)_2]_3(Py)$ , ( $X = Cl, Br, I$ )<sup>81,82</sup>  $Mo_3Te_4[S_2P(OR)_2]_3(PhCO_2)(PBu_3)$  ( $R = Pr^i$ ),<sup>83</sup>  $Mo_3OS_3[S_2P(OR)_2]_4(H_2O)$  ( $R = Et$ ),<sup>84</sup>  $W_3Te_7[S_2P(OR)_2]_3I$  ( $R = Et, Pr^i$ ),<sup>85</sup>  $WCu_3S_4[S_2P(OR)_2](PPh_3)_3$  ( $R = CH_2Ph$ ), and  $WAg_3OS_3[S_2P(OR)_2](PPh_3)_3$  ( $R = Pr^i$ ),<sup>86</sup> and many others.

Numerous crystal structures of dithiophosphato metal complexes have been reported in recent years, including mononuclear,  $Ru^{III}[S_2P(OR)_2]_3$  and dinuclear  $[{(RO)_2PS_2}_2Ru^{IV}(\mu-S)_2Ru^{IV}\{S_2P(OR)_2\}_2]$  complexes,<sup>87</sup> and octahedral cadmium complex  $Cd(phen)[S_2P(OPr^i)_2]_2$  (and of its isomorphous iron analogue).<sup>88</sup> The supramolecular self-assembled system in  $Hg[S_2P(OPr^i)_2]_2$  has been analyzed in detail.<sup>89</sup> Some unusual copper and silver clusters,  $M_6[S_2P(OPr^i)_2]_6$  and  $M_8(\mu_8-S)[S_2P(OEt)_2]_6$  ( $M = Cu, Ag$ ) have been described.<sup>90–93</sup>

Two isomeric forms of the unique tetrameric platinum complex,  $Pt_4(OAc)_4[S_2P(OEt)_2]_4$  have been isolated and structurally characterized (Scheme 7); one contains chelating (**24**) and the other one contains bridging dithiophosphato ligands (**25**) (acetato groups not shown for clarity).<sup>94</sup>



Scheme 7

Organometallic derivatives of dithiophosphato ligands are also of interest. Dicyclopentadiene-titanium and -zirconium alkylendithiophosphates,  $\text{Cp}_2\text{M}(\text{ORO})$ , ( $\text{M} = \text{Ti}, \text{Zr}$ ;  $\text{R} = \text{CMeCH}_2$ ,  $\text{CHMe}$ ,  $\text{CH}_2\text{CMe}_2\text{CH}_2$ ,  $\text{CMe}_2\text{CMe}_2$ ) have been added to the list of group 4 metal dithiophosphates.<sup>95</sup> Other recently reported organometallic derivatives include  $\text{Mo}(\eta^3\text{-C}_3\text{H}_5)(\text{MeCN})[\text{S}_2\text{P}(\text{OEt})_2]$  and  $[\text{NEt}_4][\text{Mo}(\text{CO})_4\text{S}_2\text{P}(\text{OEt})_2]$ ,<sup>96</sup>  $\text{Cp}^*\text{MCl}_3[\text{S}_2\text{P}(\text{OEt})_2]$  ( $\text{M} = \text{Mo}, \text{W}$ ; also dithiocarbamates),<sup>97</sup>  $(\eta^6\text{-arene})\text{RuCl}[\text{S}_2\text{P}(\text{OR})_2]$  (arene = benzene, *p*-cymene;  $\text{R} = \text{Et}, \text{Pr}, \text{Pr}^i, \text{Bu}, \text{Bu}^s$ ), and  $(\eta^6\text{-}p\text{-cymene})\text{RuS}_2\text{P}(\text{OEt})_2$ ,<sup>98</sup>  $\text{Cp}^*\text{RhCl}[\text{S}_2\text{P}(\text{OR})_2]$  ( $\text{R} = \text{Et}, \text{Pr}, \text{Pr}^i$ ) and  $\text{Cp}^*\text{Rh}[\text{S}_2\text{P}(\text{OEt})_2]_2$ .<sup>99</sup> Organobismuth derivatives,  $\text{R}^1\text{Bi}[\text{S}_2\text{P}(\text{OR}^2)_2]_2$  and  $\text{R}^1_2\text{Bi}[\text{S}_2\text{P}(\text{OR}^2)_2]$  ( $\text{R}^1 = \text{Me}, \text{Ph}, p\text{-Tol}$ ;  $\text{R}^2 = \text{Me}, \text{Et}, \text{Pr}^i, \text{Ph}$ ),<sup>100</sup> and organotellurium derivatives,  $\text{PhTe}[\text{S}_2\text{P}(\text{OR})_2]_2$  and  $\text{Ph}_3\text{TeS}_2\text{P}(\text{OR})_2$ ,<sup>101,102</sup> have also been reported. Electrochemical and  $^{125}\text{Te}$  NMR studies of exchange and redox reactions of organotellurium(IV) complexes,  $\text{Ph}_2\text{TeL}_2$  ( $\text{L} = 1,1\text{-dithiolato}$  ligand) established that the rates of disproportionation into  $\text{TePh}_2$  and  $\text{L}_2$  decrease in the order: dithiocarbamato > dithiophosphato > xanthato, and are temperature and solvent dependent.<sup>103</sup>

Photoelectron spectra and *ab initio* calculations correlated for  $\text{Me}_3\text{ES}_2\text{P}(\text{OR})_2$  ( $\text{E} = \text{Si}, \text{Ge}, \text{Sn}$ ).<sup>104</sup> Some organotin and organoantimony dithiophosphates (and -phosphinates) have been found to possess antitumor activity.<sup>105,106</sup>

#### 1.15.2.4.3 Dithiophosphonates

Transition metal complexes of dithiophosphonato ligands,  $\text{M}[\text{S}_2\text{PR}^1(\text{OR}^2)]_2$  ( $\text{M} = \text{Ni}, \text{Pd}, \text{Pt}$ ) can be obtained directly from the Lawesson's reagent, without isolation of the acid or of an alkali metal salt intermediate. Thus, the reaction between  $\text{NiCl}_2$  and Lawesson's reagent in the appropriate alcohol,  $\text{ROH}$  ( $\text{R} = \text{Me}, \text{Et}, \text{Pr}^i, \text{Bu}, \text{benzyl}$ ) as solvent and reactant, gave the bis[*O*-alkyl/aryl-(4-methoxyphenyl)phosphonodithioato] $\text{Ni}^{\text{II}}$  complexes in high yields (64–91%). The crystal structure of *trans*-bis[*O*-ethyl-(4-methoxyphenyl)phosphonodithioato] $\text{Ni}^{\text{II}}$  was confirmed by X-ray diffraction measurements. A similar reaction can be performed with  $\text{Pd}^{\text{II}}$  and  $\text{Pt}^{\text{II}}$  salts, but the yields were not as satisfactory as for  $\text{Ni}^{\text{II}}$ .<sup>107,108</sup> The square planar nickel dithiophosphonates thus prepared readily form octahedral amine adducts, and the crystal structures of  $\text{Ni}[\text{S}_2\text{P}(\text{OMe})(\text{C}_6\text{H}_4\text{OMe-}p)]_2 \cdot 2\text{Py}$  and  $\text{Ni}[\text{S}_2\text{P}(\text{OMe})(\text{C}_6\text{H}_4\text{OMe-}p)]_2 \cdot 2(4\text{-MePy})$  have been reported.<sup>109</sup>

Zinc salts,  $\text{Zn}[\text{S}_2\text{PR}^1(\text{OR}^2)]_2$ , have been obtained in 80–99% yields, by adding the acid ester  $\text{R}^1\text{P}(\text{S})(\text{OR}^2)(\text{SH})$  to a suspension of zinc dust in anhydrous benzene, ( $\text{R}^1/\text{R}^2$ :  $\text{Bu}/\text{Et}$ ;  $\text{Bu}/\text{Cy}$ ;  $\text{Bu}/\text{isohexyl}$ ;  $\text{isopentyl}/\text{Pr}^i$ ;  $\text{isopentyl}/\text{isohexyl}$ ;  $\text{amyl}/\text{isopentyl}$ ;  $\text{pentyl}/\text{hexyl}$ ;  $\text{pentyl}/\text{Cy}$ ;  $\text{pentyl}/\text{isooctyl}$ ;  $\text{amyl}/\text{isooctyl}$ ;  $\text{hexyl}/\text{Me}$ ;  $\text{hexyl}/\text{Et}$ ;  $\text{isohexyl}/\text{Pr}^i$ ;  $\text{hexyl}/\text{isopentyl}$ ;  $\text{hexyl}/\text{hexyl}$ ;  $\text{hexyl}/\text{octyl}$ ; and  $\text{hexyl}/\text{octadecyl}$ ). Also, the zinc salt with  $\text{R}^1 = \text{pentyl}$  and  $\text{R}^2 = \text{cyclohexyl}$  was obtained in a 63% yield from  $\text{ZnCl}_2$  and the acid ester. Analogous barium salts were similarly prepared, in 54–86% yields, by using  $\text{Ba}(\text{OH})_2$ , or by adding  $\text{Et}_3\text{N}$  to a mixture of  $[\text{R}^1\text{PS}(\text{S})]_2$  and  $\text{R}^2\text{OH}$  in anhydrous benzene, to form the  $[\text{NEt}_3\text{H}]^+$  salt of  $\text{R}^1\text{P}(\text{S})(\text{OR}^2)(\text{SH})$ , followed by addition of solid  $\text{Ba}(\text{OH})_2$ .

Liquid nickel salts have been obtained from an ether solution of the K salt of the acid ester and aqueous NiSO<sub>4</sub> solution at room temperature.<sup>110</sup>

Thiophosphonyl chlorides have been used as starting materials. Thus, R<sup>1</sup>P(S)Cl(OR<sup>2</sup>) in benzene was treated with Na<sub>2</sub>S·9H<sub>2</sub>O in ethanol, followed by addition of NiCl<sub>2</sub>·6H<sub>2</sub>O in H<sub>2</sub>O to give Ni[S<sub>2</sub>PR<sup>1</sup>(OR<sup>2</sup>)<sub>2</sub>] (R<sup>1</sup> = Cy, R<sup>2</sup> = Bu<sup>i</sup>, C<sub>8</sub>H<sub>17</sub>, and C<sub>10</sub>H<sub>21</sub>).<sup>111</sup> In another preparation, treatment of Cl<sub>3</sub>CP(S)Cl<sub>2</sub> with EtOH containing 2 mol of KSH gave 73% Cl<sub>3</sub>CP(S)(OEt)SH, whereas with EtOH containing 3 mol of KSH, a yield of 60% K[S<sub>2</sub>P(CCl<sub>3</sub>)(OEt)] was obtained. The acid ester was converted to zinc and nickel salts.<sup>112</sup>

The reaction of several 2,4-diaryl- and 2,4-diferrocenyl-1,3-dithiaphosphetane disulfide dimers were treated with a variety of alcohols, silanols, and trialkylsilyl alcohols, to form dithiophosphonic acids, and their salts reacted with chlorogold(I) complexes to produce the first dinuclear gold(I) dithiophosphonate complexes [AuS<sub>2</sub>PR<sup>1</sup>(OR<sup>2</sup>)<sub>2</sub>] (R<sup>1</sup> = Ph, R<sup>2</sup> = Et; R<sup>1</sup> = *p*-C<sub>6</sub>H<sub>4</sub>OMe, R<sup>2</sup> = SiPh<sub>3</sub>) in high yield (>70%). Their molecular structure was established by single crystal X-ray diffraction.<sup>113</sup> The gold complexes of dithiophosphonate ligands display luminescent properties.<sup>66</sup>

Few other crystal structures of metal dithiophosphonates have been reported. These include the *trans* isomers of the *O*-ethylphenyldithiophosphonates of palladium(II) and platinum(II), M[S<sub>2</sub>P(OEt)Ph]<sub>2</sub> (M = Pd, Pt), along with a report of *cis-trans* isomerization of the planar palladium(II) complex.<sup>114</sup> The crystal structures of palladium and platinum *trans*-bis[*O*-methyl (4-methoxyphenyl)phosphonodithioato] complexes, M[S<sub>2</sub>P(OMe)C<sub>6</sub>H<sub>4</sub>OMe-*p*]<sub>2</sub>, (M = Pd and Pt) have also been reported.<sup>107,108</sup>

Several dithiophosphonate complexes have been investigated only in solution and their stability constants have been determined. These include Ag<sup>+</sup> complexes of [Me(RO)PS<sub>2</sub>]<sup>-</sup> and [Et(RO)PS<sub>2</sub>]<sup>-</sup> anions,<sup>115</sup> and iron(III) complexes of [Me(RO)PS<sub>2</sub>]<sup>-</sup> ligands.<sup>116</sup>

Various spectroscopic studies of metal dithiophosphonates have been performed. Thus, a comparative analysis of the IR spectra of metal complexes with dithiophosphoric, -phosphinic, and -phosphonic acids was conducted in the range of vibrational coupling of phosphorus with sulfur. The substitution of alkoxy groups by alkyls produces a low frequency shift of the ν(PS) band absorption. The change of ν(PS) frequency agrees with changes of donor properties of the ligand.<sup>117</sup>

The coordination behavior of [R<sub>2</sub>PS<sub>2</sub>]<sup>-</sup> ligands may be inferred from Δν(PS), taken as the difference between symmetrical and unsymmetrical vibration frequencies of PS<sub>2</sub> groups. Thus, for dithiophosphonate, [R<sup>1</sup>(R<sup>2</sup>O)PS<sub>2</sub>]<sup>-</sup> and dithiophosphinate, [R<sub>2</sub>PS<sub>2</sub>]<sup>-</sup> ligands Δν(PS) values from 50 cm<sup>-1</sup> to 75 cm<sup>-1</sup> show isobidentate bonding, while differences larger than 100 cm<sup>-1</sup> are illustrative for monodentate ligation. Intermediate values of Δν(PS) such as 85–95 cm<sup>-1</sup> are found mostly in compounds with anisobidentate dithiophosphinate and -phosphonate ligands. This result does not apply for dithiophosphates, [(RO)<sub>2</sub>PS<sub>2</sub>]<sup>-</sup>.<sup>118,119</sup> Electronic spectra of NiL<sub>2</sub>, PtL<sub>2</sub>, PdL<sub>2</sub>, RhL<sub>3</sub>, IrL<sub>3</sub>, where L = [Me(EtO)PS<sub>2</sub>]<sup>-</sup>, were studied and the crystal field splitting parameter, Δ, the interelectronic interaction parameter, B', and the nephelauxetic parameter, β, were calculated from the spectra and were compared with the same constants for metal complexes with [(EtO)<sub>2</sub>PS<sub>2</sub>]<sup>-</sup>, [Me<sub>2</sub>PS<sub>2</sub>]<sup>-</sup>, and [Ph<sub>2</sub>PS<sub>2</sub>]<sup>-</sup>. Substitution of acceptor alkoxy groups for the donor alkyl group leads to a weakening of bonding of the strongly polar ligand.<sup>120</sup>

ESR and IR investigations on some oxovanadium dithiophosphonates, VO[S<sub>2</sub>P(OR)(C<sub>6</sub>H<sub>4</sub>OMe-*p*)<sub>2</sub>] (R = Me, Et, Pr, Pr<sup>i</sup>, Bu, Bu<sup>i</sup>, Bu<sup>s</sup>) suggest the presence of dimeric species for R = Me and Et derivatives in solid state and of monomeric species for the other complexes.<sup>121</sup> ESR spectra were also studied for the bis-chelates VO[S<sub>2</sub>PR<sup>1</sup>(OR<sup>2</sup>)<sub>2</sub>] (R<sup>1</sup> = Et, Ph; R<sup>2</sup> = Me, Et, Pr, Pr<sup>i</sup>, Cy) and <sup>51</sup>V hyperfine and <sup>31</sup>P superhyperfine splitting constants were determined.<sup>122</sup>

Copper(II) bis[(*O*-alkyl)-4-ethoxyphenyldithiophosphonate] and chromium(III) tris[(*O*-alkyl)-4-ethoxyphenyldithiophosphonate] complexes (alkyl = Me, Et, Pr<sup>i</sup>) were prepared and studied by magnetic measurements, and electronic, IR, and EPR spectroscopy. The valence vibrations of the PS<sub>2</sub> group show that this group coordinates as isobidentate. The powder EPR spectra are typical for square-planar monomeric species and present hyperfine and superhyperfine structure. The EPR bands of the chromium(III) complexes may be attributed to metal ions in a pseudo-octahedral environment, coupled by dipole-dipole interaction.<sup>123</sup>

The metal (zinc, nickel, etc.) dithiophosphonates are attractive antioxidants in lubricants and plastics,<sup>124,125</sup> and vulcanization accelerators (more active than analogous dithiophosphates).<sup>126</sup> Many metal dithiophosphonates can be extracted with organic solvents and this property can be exploited for analytical applications, e.g., for copper(II) and bismuth(III) (*O*-hexyl)butyldithiophosphonates,<sup>127</sup> nickel(II), cobalt(II), and palladium(II) (*O*-ethyl)methyldithiophosphonates,<sup>128</sup> platinum(IV), palladium(II), and gold(III) (*O*-ethyl)methyldithiophosphonates,<sup>129</sup> and noble and rare metal (*O*-methyl)methyldithiophosphonates.<sup>130</sup>

Several organometallic derivatives of dithiophosphonato ligands have been reported. Dimethylgold(III) complexes were prepared by reacting  $\text{Me}_2\text{AuI}$  with dithiophosphonate salts to form  $\text{Me}_2\text{AuS}_2\text{P}(\text{OEt})\text{Ph}$ .<sup>131</sup> Organothallium phosphor-1,1-dithiolates, including dithiophosphonates, have been prepared. The reaction of  $\text{PhTiCl}_2$  with an alkali metal (*O*-ethyl)phenyldithiophosphonate (also *O,O*-dimethyl- and diphenyl dithiophosphate and diphenyldithiophosphinate), gave  $\text{PhTi}(\text{S}_2\text{PR}^1\text{R}^2)_2$  ( $\text{R}^1 = \text{Ph, OMe, OPh}$ ;  $\text{R}^2 = \text{OMe, OPh, OEt, Ph}$ ). A similar reaction of  $\text{Ph}_2\text{TlBr}$  afforded  $\text{Ph}_2\text{TlS}_2\text{PR}^1(\text{OR}^2)$ , with  $\text{R}^1 = \text{Ph, OMe, OEt, OPh}$ ;  $\text{R}^2 = \text{Me, Et, Ph}$ .<sup>132</sup>

Organotin derivatives have been obtained by reacting  $\text{R}^1\text{R}^2\text{P}(\text{S})\text{SH}$  ( $\text{R}^1, \text{R}^2 = \text{MeO, EtO, PrO, Me, Et}$  in various combinations) with  $\text{SnR}_4$  ( $\text{R} = \text{Et, Pr, Bu}$ ) neat or in benzene, to give  $\text{R}^1_3\text{SnS}_2\text{PRR}^2$  and  $\text{R}^1\text{H}$  as a result of  $\text{Sn}-\text{C}$  bond cleavage. The organotin derivatives have fungistatic properties.<sup>133</sup>

Numerous organometallic derivatives,  $\text{R}_n\text{MS}_2\text{P}(\text{OMe})\text{C}_6\text{H}_4\text{OMe-}p$  have been prepared directly from Lawesson's reagent,  $[p\text{-MeOC}_6\text{H}_4\text{P}(\text{S})\text{S}]_2$ , or homologues of Davy's reagent  $[\text{RP}(\text{S})\text{S}]_2$  (e.g.,  $\text{R} = \text{Et, Bu}^i$ ), with metal alkoxides or thiolates ( $\text{M} = \text{Al}$ ,<sup>134</sup>  $\text{Si, Ge, Sn}$ ,<sup>135-137</sup>  $\text{Pb}$ ,<sup>138</sup>  $\text{Sb}$ ,<sup>139,140</sup>  $\text{Bi}$ ;<sup>141</sup>).

### 1.15.3 DITHIOARSINATES

#### 1.15.3.1 General

Dithioarsinates contain the  $[\text{R}_2\text{AsS}_2]^-$  anion and are isologues of dithiophosphinates. Therefore, they are expected to behave in a similar manner as complex-forming ligands. However, there are some significant differences and they deserve a parallel, comparative study. The chemistry of dithioarsinates is less developed compared to that of phosphorus isologues, probably because of their toxicity, foul smell of the alkyl derivatives, and the somewhat cumbersome synthesis. The dithioarsinates have not been covered in *CCC* (1987). For this reason they will be discussed here. Dithioarsenates, containing  $[(\text{RO})_2\text{AsS}_2]^-$  anions, i.e., analogues of dithiophosphates, are apparently not known.

#### 1.15.3.2 Synthesis

The preparation methods of dithioarsinates (also referred to as dithiocacodylates) are in general old and have been described in the nineteenth century (Bunsen, 1843).<sup>142</sup> Modern works include the preparation of sodium dimethyldithioarsinate,  $\text{Na}[\text{S}_2\text{AsMe}_2]$ , by passing  $\text{H}_2\text{S}$  into a boiling ethanolic solution of sodium cacodylate,  $\text{Na}[\text{O}_2\text{AsMe}_2]$ .<sup>143</sup> The potassium salt,  $\text{K}[\text{S}_2\text{AsPh}_2]$  was prepared by the reaction of  $\text{Ph}_2\text{AsCl}$  with elemental sulfur and  $\text{KHS}$  or of  $\text{K}[\text{O}_2\text{AsPh}_2]$  with  $\text{H}_2\text{S}$  in 20% or 80% yield, respectively.<sup>144</sup> The crystal structure of  $\text{K}[\text{S}_2\text{AsMe}_2] \cdot 2\text{H}_2\text{O}$  contains infinite sheets formed by edge sharing between two different types of  $\text{K}(\text{H}_2\text{O})_4\text{S}_2$  octahedra in which the sulfur occupies either *cis* or *trans* positions and weak  $\text{O}-\text{H} \cdots \text{S}$  hydrogen bonds in a supra-molecular architecture.<sup>145</sup> Dibenyldithioarsinic acid,  $(\text{PhCH}_2)_2\text{AsS}_2\text{H}$ , was prepared by the reaction of  $\text{H}_2\text{S}$  with dibenzylarsinic acid,  $(\text{PhCH}_2)_2\text{AsO}_2\text{H}$ .<sup>146</sup>

#### 1.15.3.3 Coordination patterns

Although less investigated than dithiophosphinates, the dithioarsinato complexes seem to present similar coordination modes. So far, monodentate, bidentate-chelating (symmetrical and unsymmetrical), and bridging patterns have been substantiated by single crystal X-ray diffraction analysis.

#### 1.15.3.4 Metal complexes

Dithioarsinato complexes are readily formed by metathesis between metal salts and alkali metal dithioarsinates. This procedure was used for the synthesis of numerous dithioarsinato metal complexes, containing  $\text{Cr}^{\text{III}}$ ,  $\text{Ni}^{\text{II}}$ ,  $\text{Co}^{\text{II}}$ ,  $\text{Zn}^{\text{II}}$ , and  $\text{Cd}^{\text{II}}$ .<sup>143</sup> Dithioarsinato complexes of



Cr<sup>III</sup>, In<sup>III</sup>, Mn<sup>II</sup>, Co<sup>II</sup>, Ni<sup>II</sup>, Zn<sup>II</sup>, and Cu<sup>I</sup> have been prepared either from Na[S<sub>2</sub>AsMe<sub>2</sub>] or directly, by passing H<sub>2</sub>S through a methanolic solution of the metal arsenite in the presence of HCl.<sup>147</sup> The metal dithioarsinates M(S<sub>2</sub>AsMe<sub>2</sub>)<sub>2</sub> (M = Zn, Cd, Hg, Pb, Co, and Ni), Cr(S<sub>2</sub>AsMe<sub>2</sub>)<sub>3</sub>, In(S<sub>2</sub>AsMe<sub>2</sub>)<sub>3</sub>, and TlS<sub>2</sub>AsMe<sub>2</sub> can be precipitated from aqueous solutions. The pyridine adduct, Ni(S<sub>2</sub>AsMe<sub>2</sub>)<sub>2</sub>Ni·2Py was formed from the nickel salt in pyridine.<sup>148</sup> A large nephelauxetic effect and low ligand-field strength produced by the dimethyldithioarsinato ligand in complexes with Ni<sup>2+</sup>, Co<sup>2+</sup>, and Cr<sup>3+</sup> is explained in terms of significant covalency of the metal—S bonds. The Mn<sup>2+</sup> compound, however, has properties consistent with considerable ionic character.<sup>149</sup> Similarly M<sup>I</sup>(S<sub>2</sub>AsPh<sub>2</sub>)<sub>2</sub> (M<sup>I</sup> = Ni, Co, Zn) and M<sup>2</sup>(S<sub>2</sub>AsPh<sub>2</sub>)<sub>3</sub> (M<sup>2</sup> = In, Cr, V) were prepared from K[S<sub>2</sub>AsPh<sub>2</sub>] and M<sup>I</sup>Cl<sub>2</sub> or M<sup>2</sup>Cl<sub>3</sub>, respectively, in aqueous or alcoholic solution. It was shown that the nephelauxetic effect is about the same for [Ph<sub>2</sub>AsS<sub>2</sub>]<sup>-</sup> and [Ph<sub>2</sub>PS<sub>2</sub>]<sup>-</sup> and the spectrochemical series is [Ph<sub>2</sub>PS<sub>2</sub>]<sup>-</sup> ~ [Ph<sub>2</sub>AsS<sub>2</sub>]<sup>-</sup> > [Me<sub>2</sub>AsS<sub>2</sub>]<sup>-</sup> ~ [Me<sub>2</sub>PS<sub>2</sub>]<sup>-</sup> > [Et<sub>2</sub>PS<sub>2</sub>]<sup>-</sup> > [Et<sub>2</sub>P(S)Se]<sup>-</sup> > [Et<sub>2</sub>PSe<sub>2</sub>]<sup>-</sup>.<sup>144</sup>

An alternative route (rarely used) to dithioarsinato complexes involves the oxidative addition of elemental sulfur to thioarsinito complexes, e.g., the formation of (Me<sub>3</sub>P)<sub>2</sub>(CO)<sub>3</sub>MnS<sub>2</sub>AsMe<sub>2</sub> from (Me<sub>3</sub>P)<sub>2</sub>(CO)<sub>3</sub>Mn—SAsMe<sub>2</sub>.<sup>150</sup>

A tetranuclear, hexa- $\mu$ -dithioarsinatotetrazinc sulfide, Zn<sub>4</sub>S(S<sub>2</sub>AsMe<sub>2</sub>)<sub>6</sub>, has been reported and its X-ray crystal structure determined. The compound contains a central sulfur atom bonded to four zinc atoms located at the corners of a tetrahedron, bridged by six anionic ligands [Me<sub>2</sub>AsS<sub>2</sub>]<sup>-</sup>.<sup>151</sup> The molecular and electronic structures of M<sub>4</sub>( $\mu_4$ -S)( $\mu$ -S<sub>2</sub>AsMe<sub>2</sub>)<sub>6</sub> (M = Zn, Cd) have been investigated by combining X-ray diffraction measurements, electrospray mass spectrometry, UV absorption spectroscopy, and density functional calculations.<sup>152</sup>

Oxovanadium(IV), VO(S<sub>2</sub>AsR<sub>2</sub>)<sub>2</sub>, and oxomolybdenum(IV) MoO(S<sub>2</sub>AsR<sub>2</sub>)<sub>2</sub> complexes of dimethyldithioarsinate have also been prepared and their electronic and ESR spectra investigated in detail.<sup>153–157</sup>

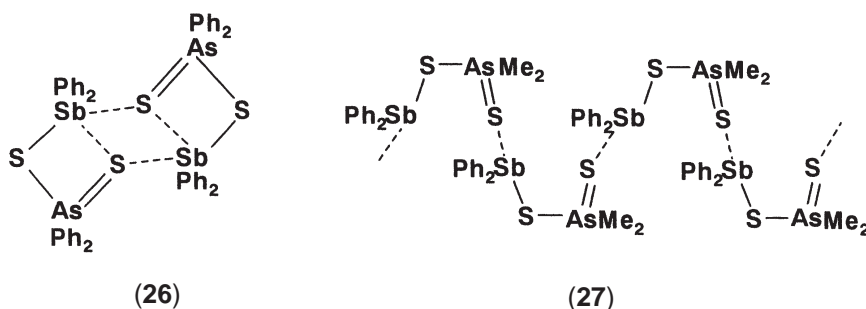
Dimethyl- and diphenyldithioarsinates, M(S<sub>2</sub>AsR<sub>2</sub>)<sub>n</sub>, R = Me, Ph, of some main group metals, i.e., Sn<sup>IV</sup>, Pb<sup>II</sup>, As<sup>III</sup>, Sb<sup>III</sup>, and Bi<sup>III</sup> have been prepared by metathesis and characterized spectroscopically.<sup>158</sup> The crystal structures of In(S<sub>2</sub>AsR<sub>2</sub>)<sub>3</sub> (R = Me, Ph) (monomeric with isobidenate ligands),<sup>159</sup> and bismuth dimethyldithioarsinate, Bi(S<sub>2</sub>AsMe<sub>2</sub>)<sub>3</sub> (a dimer formed through Bi···S secondary bonds)<sup>160</sup> and Cr(S<sub>2</sub>AsMe<sub>2</sub>)<sub>3</sub> (monomeric with trigonally distorted octahedron)<sup>161</sup> have been reported. Octahedral dinitrosylmetal complexes of the type *cis*-M(NO)<sub>2</sub>(S<sub>2</sub>AsMe<sub>2</sub>)<sub>2</sub>, with M = Cr, Mo, or W, have been synthesized.<sup>162</sup>

Several organometallic derivatives of dithioarsinato ligands, including bis(cyclopentadienyl) vanadium derivatives,<sup>163,164</sup> manganese and rhenium carbonyl derivatives, M(CO)<sub>4</sub>(S<sub>2</sub>AsMe<sub>2</sub>) (M = Mn, Re),<sup>165</sup> and dinuclear [Me<sub>3</sub>PtS<sub>2</sub>AsMe<sub>2</sub>]<sub>2</sub> and mononuclear Me<sub>3</sub>Pt(S<sub>2</sub>AsMe<sub>2</sub>)L (L = pyridine, phosphines) trimethylplatinum complexes<sup>166</sup> are known.

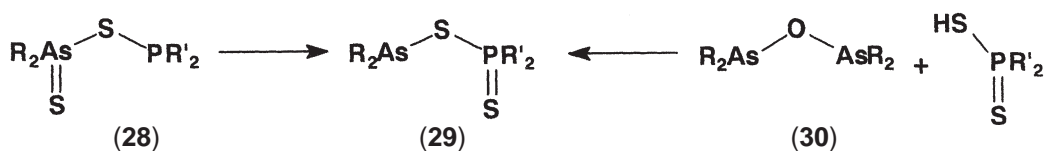
Main group organometallic derivatives of dithioarsinates have been prepared and sometimes characterized by X-ray diffraction, and include organotin compounds, R<sup>1</sup><sub>2</sub>Sn(S<sub>2</sub>AsR<sub>2</sub>)<sub>2</sub>, (R<sup>1</sup> = Me, Bu, Cy, Ph; R<sup>2</sup> = Me, Ph) and R<sup>1</sup><sub>3</sub>SnS<sub>2</sub>AsR<sub>2</sub><sup>2</sup> in addition to inorganic derivatives Cl<sub>2</sub>As(S<sub>2</sub>AsMe<sub>2</sub>)<sub>2</sub> and Sn(S<sub>2</sub>AsMe<sub>2</sub>)<sub>4</sub>, which contain both mono- and bidentate ligands.<sup>167,168</sup> Organosilicon, -germanium, and -lead derivatives of dimethyl- and diphenyldithioarsinic acids, Ph<sub>4- $\eta$</sub> M(S<sub>2</sub>AsR<sub>2</sub>)<sub>n</sub> (M = Si, Ge, Pb; R = Me, Ph; n = 1, 2) were synthesized and characterized by IR and <sup>1</sup>H NMR spectroscopy. The data are consistent with monodentate coordination of the dithioarsinato group to silicon and germanium, but there seems to be bidentate coordination to the organolead moiety.<sup>169</sup>

The synthesis of diphenylantimony(III) diphenyldithioarsinate Ph<sub>2</sub>SbS<sub>2</sub>AsPh<sub>2</sub> and its crystal structure determination provided an example of dimerization through Sb···S secondary bonds and formation of an eight-membered Sb<sub>2</sub>S<sub>4</sub>As<sub>2</sub> ring (**26**) with transannular Sb···S interactions (Scheme 8).<sup>170</sup> Antimony(III) and phenylantimony(III) dimethyldithioarsinates, Ph<sub>n</sub>Sb(S<sub>2</sub>AsMe<sub>2</sub>)<sub>3-n</sub> with n = 0–2, have been prepared and characterized by their IR and FAB mass spectra and the structure of Ph<sub>2</sub>SbS<sub>2</sub>AsMe<sub>2</sub> has been determined by single crystal X-ray diffraction. The Ph<sub>2</sub>SbS<sub>2</sub>AsMe<sub>2</sub> molecular units are associated into a chain-like supramolecular structure (**27**) via S—AsMe<sub>2</sub>—S bridging ligands, with short (covalent, 2.655 Å) and long (secondary bonding, 2.830 Å) antimony—sulfur bonds.<sup>171</sup>

A sulfotropic molecular rearrangement of diphenylphosphinyl diorganodithioarsinates, with formation of diorganoarsenic(III) diphenyldithiophosphinates was observed in the reaction of Ph<sub>2</sub>PCl with Na[S<sub>2</sub>AsR<sub>2</sub>] (R = Me, Ph), which gave R<sub>2</sub>AsSP(S)Ph<sub>2</sub> rather than the expected R<sub>2</sub>(S)AsSPPH<sub>2</sub>, due to sulfur migration from As<sup>V</sup> to P<sup>III</sup>. The identity of R<sub>2</sub>AsSP(S)Ph<sub>2</sub> was determined by NMR and IR spectroscopy and direct synthesis from Ph<sub>2</sub>P(S)SH and (Ph<sub>2</sub>As)<sub>2</sub>O (Scheme 9).<sup>172</sup>

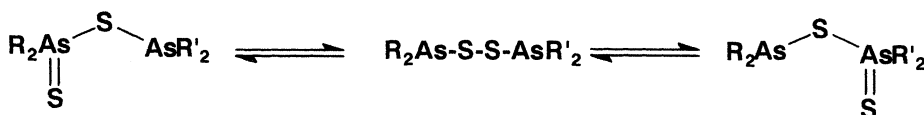


Scheme 8



Scheme 9

The reaction of sodium diorganodithioarsinates with diphenylarsenic chloride provides a mixture of isomeric compounds, identified by IR and  $^1\text{H}$  NMR spectroscopy as  $\text{Ph}_2\text{AsSAs}(\text{S})\text{R}_2$ ,  $\text{Ph}_2(\text{S})\text{AsSAsR}_2$ , and  $\text{Ph}_2\text{AsSSAsR}_2$  ( $\text{R} = \text{Me}, \text{Ph}$ ) as a result of another sulfotropic molecular rearrangement (Scheme 10).<sup>173</sup>



Scheme 10

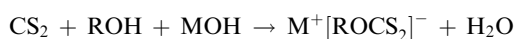
## 1.15.4 DITHIOCARBONATES (XANTHATES)

### 1.15.4.1 General

Alkyl(aryl) thiocarbonates (xanthates) are *O*-alkyl(aryl) esters of the hypothetical dithiocarbonic acid,  $\text{HSC}(\text{S})\text{OH}$ .<sup>174,175</sup> These esters are unknown in the free state and only their alkali metal salts,  $\text{M}[\text{S}_2\text{COR}]$ , are readily available, and stable enough to be used as starting materials for metal complexes. Alkyl(aryl) dithiocarbonates (xanthates) were discussed in *CCC* (1987) and continued to be used as ligands, with some interesting new results being reported.

### 1.15.4.2 Synthesis

The alkali metal dithiocarbonates (xanthates) are prepared by reacting carbon disulfide with alcohols or phenols in the presence of an alkali metal hydroxide (usually  $\text{KOH}$ ) using as solvent an excess of alcohol reagent,<sup>176</sup> a hydrocarbon, or acetone.<sup>177</sup>



The most common are the alkylxanthates derived from monoalcohols. Xanthates derived from phenols (e.g.,  $K[S_2COAr]$ ,  $Ar = Ph, o-, m-, \text{ and } p\text{-tolyl}$ , prepared in 76–85% yields from  $ArOH$ ,  $CS_2$ , and aqueous  $KOH$  in dioxane)<sup>178</sup> are also known, but much less used as ligands. Diols react in a similar manner, producing hydroxoalkyl xanthates, e.g.,  $M[S_2CO(CH_2)_nOH]_2$ , ( $M = Mn, Fe, Co, Ni, Cu$ )<sup>179</sup> or dixanthates,  $M[S_2CO(CH_2)_nOCS_2]_2M$ , depending upon the molar ratio of the reagents.<sup>180</sup>

In some cases xanthato complexes can be obtained directly from  $CS_2$ , an alcohol, and the appropriate metal reagents. Thus,  $[NMe_4]_2[Cu_4(SePh)_6]$  reacts with  $CS_2$  in  $MeCN/MeOH$  or  $DMF/MeOH$  to form polymeric  $(CuS_2COMe)_n$ , a 2D complex.<sup>181</sup> The nickel complex salt  $[NBu_4][\{(C_6F_5)_2Ni(\mu-OH)\}_2]$  reacts with  $CS_2$  in alcohols ( $MeOH, EtOH$ ) to give xanthato complexes  $[NBu_4][\{(C_6F_5)_2Ni(S_2COR)\}]$  ( $R = Me, Et$ ); in acetone the same starting material reacts with  $CS_2$  and  $[NBu_4]OH$  leading to the dealkylated dithiocarbonato complex  $[NBu_4]_2[(C_6F_5)_2Ni(S_2CO)]$ .<sup>182</sup>

Xanthate metal complexes can also be obtained by insertion of carbon disulfide into MOR bond of metal alkoxides. Such reactions converted *fac,cis*- $(CO)_3(PMe_3)_2ReOC_6H_4Me$ <sup>183</sup> into the corresponding xanthates. Similarly, *fac*- $(CO)_3LM(S_2COR)$  (where  $M = Mn, Re$ ;  $L = dppe$  or  $dppp$ ;  $R = Me, Et, CF_3CH_2$ )<sup>184</sup> and  $(CO)_3L_2Re(S_2COR)$  (where  $L = 2PMe_3$  or diars;  $R = Me, etc.$ ),<sup>185</sup> have been prepared by insertion of  $CS_2$  into the  $M-OR$  bond of the corresponding alkoxides. Carbon disulfide insertion has also been observed with  $Cp^*W(NO)(OBU^t)(CH_2CMe_3)$ , leading to the corresponding xanthato complex.<sup>186</sup> Facile insertion of  $CS_2$  into  $M-OPh$  bonds of  $M(CO)_5OPh$  occurs, leading to  $M(CO)_5(S_2COPh)$ .<sup>187</sup> Phenoxides, e.g.,  $Ph_3MOC_6Cl_5$ ,  $M = Sn, Ge,$  and  $Pb$ ,<sup>189</sup>  $Cd(OC_6H_3R_{2-2,6})_2(base)_n$ ,  $R = Me, Bu^t, Ph$ ,  $base = Py, THF, THT$ , also formed xanthato complexes in reactions with  $CS_2$ .<sup>190</sup>

A unique insertion reaction of  $CS_2$  into a metal–hydrogen bond, occurred with the hydrido complex  $[Cp_2WH \cdot THF][CF_3SO_3]$  in  $d^6$ -acetone, leading to  $[Cp_2W(\eta^2-S_2COCH(CD_3)_2)[CF_3SO_3]$ .<sup>191</sup> This suggests that the reactions of metal hydrido complexes with carbon disulfide might be an interesting subject for further research.

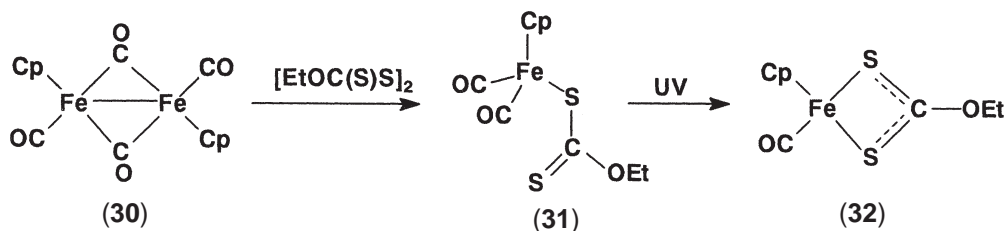
Metal xanthato complexes can be conveniently obtained by electrochemical oxidation of metal anodes in the presence of ethyldixanthogen  $[EtOC(S)S]_2$ . The electrochemical synthesis has been employed for the preparation of  $Mn^{III}, VO^{II}, Ag^I, Cd^{II}, Fe^{II}, Co^{III}, Ni^{II}$ , and  $Cu^{II}$  xanthates.<sup>192</sup>

An alternative route to xanthato complexes is the oxidative cleavage of metal–metal compounds with dixanthogens. Thus, the dimers  $[\eta^5-C_5R_5Fe(CO)_2]_2$  (**30**) react with  $[EtOC(S)S]_2$  to form  $\eta^5-C_5R_5Fe(CO)_2(\eta^1-S_2COEt)$ -containing monodentate xanthato ligands (**31**); UV photolysis of the latter results in decarbonylation, leading to  $\eta^5-C_5R_5Fe(CO)(S_2COEt)$ , with bidentate chelating xanthato ligands (**32**,  $R = H, Me$ ) (Scheme 11).<sup>194,195</sup>

An internal redox reaction of a thiometalate,  $[NEt_4][Re^{VII}S_4]$ , and a dixanthogen,  $[Bu^tOC(S)S]_2$ , afforded dinuclear xanthato complexes,  $Re^{IV}_2(\mu-S)_2(S_2COBu^t)_4$  (**33**) and  $[NEt_4][Re^{IV}_2(\mu-S)(\mu-S_2)(\mu-S_2COR)(S_2COBu^t)_2]$  (**34**) (Scheme 12).<sup>196</sup>

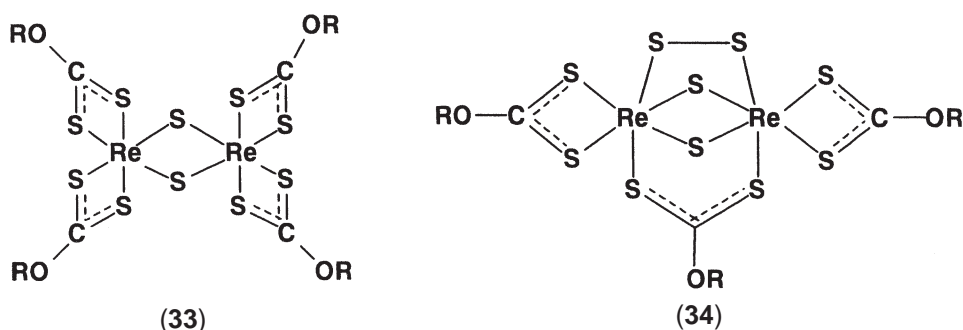
The xanthates are stable in the solid state, but in acidic aqueous solutions they are readily decomposed into the starting materials. The thermal decomposition of xanthates can be a useful route to metal sulfides,<sup>197</sup> e.g., using the CVD technique.<sup>198</sup> Nickel xanthates serve as precursors for photochemical (laser) and thermal vapor deposition of metal sulfide films.<sup>199</sup>

An interesting reaction is the reductive decomposition of  $Ni(S_2COR)_2$  in fused tertiary phosphines, to form  $Ni(CO)_2(PR_3)_2$ ; thus, a 50% yield of  $Ni(CO)_2(PPh_3)_2$  was obtained by melting  $Ni(S_2COEt)_2$  with  $PPh_3$ .<sup>200</sup>



Scheme 11



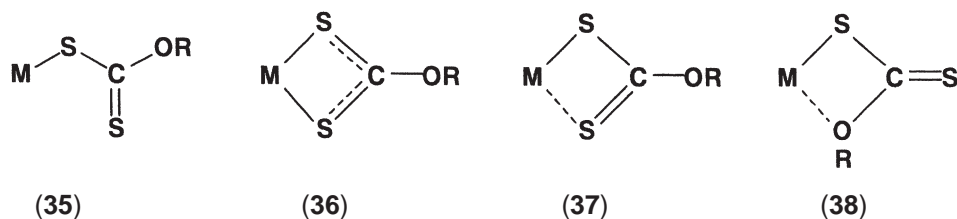


Scheme 12

Dealkylation occurs sometimes in attempts to prepare xanthate complexes. Thus, instead of palladium(II) and platinum(II) tris-xanthato complexes mixed derivatives containing the dithiocarbonato ligand,  $[M(S_2COR)(S_2CO)]^-$  are isolated. When  $[Pt(S_2COEt)(Ph_2POMe)_2]Cl$  reacts with NaI in acetone the product is a dithiocarbonato complex,  $Pt(S_2CO)(Ph_2POMe)_2$ .<sup>201</sup> Similarly, the dithiocarbonato complex  $Co^{III}(dppe)(S_2COEt)(S_2CO)$  is formed when a  $Co^{2+}$  salt reacts with dppe and ethylxanthate in ethanol.<sup>202</sup> The reaction of  $TcNCl_2(PPh_3)_2$  with  $KS_2COEt$ , in aqueous media, also afforded a dithiocarbonato complex,  $K_2[TcN(S_2CO)_2] \cdot 2H_2O$ .<sup>203</sup> A partial dealkylation of the xanthato ligands in the molybdenum-acyl complexes  $Mo(COMe)(S_2COR)(CO)(PMe_3)_2$  occurs at room temperature with concomitant insertion of the sulfur atom into the Mo-acetyl bond to afford a monothioacetato complex,  $Mo(OSCMe)[C(S)OR](CO)(PMe_3)_2$ .<sup>204,205</sup>

#### 1.15.4.3 Coordination patterns

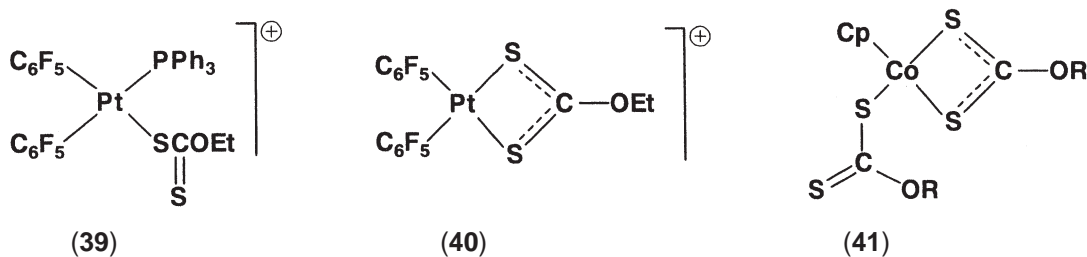
Xanthates display a broad diversity of coordination patterns (Scheme 13) and can display monodentate (monometallic monoconnective (35), symmetrical (36), or unsymmetrical (37) bidentate chelating (monometallic biconnective), bridging (bimetallic biconnective) coordination patterns, similar to those of phosphor-1,1-dithiolates, shown above. The coordination chemistry of xanthato ligands has been reviewed.<sup>206,207</sup> The coordination versatility of these ligands is illustrated by the dependence of the crystal packing upon the molecular geometry of some metal xanthato complexes, e.g., diorganotin systems.<sup>208</sup> In some cases a rotation of the ligand leads to coordination (however weak) of the oxygen (38).<sup>209</sup>



Scheme 13

An unprecedented coordination of xanthate, with one sulfur bridging three platinum centers, was observed in  $[NBu_4][Pt_4(C_6F_5)_8(S_2COEt)_2]$ . Small changes in the composition induce different coordination patterns (Scheme 14); thus, in  $[NBu_4][(C_6F_5)_2Pt(\eta^1-S_2COEt)(PPh_3)]$  the xanthato ligand is monodentate (39), whereas in  $[NBu_4][(C_6F_5)_2Pt(\kappa^2-S_2COEt)]$  the ligand is bidentate chelating (40).<sup>210</sup> In the organometallic complexes  $CpCo(S_2COR)_2$  ( $R = Me, Et$ ) one ligand is monodentate and the other one is bidentate, and the complexes are  $CpCo(\eta^1-S_2COR)(\kappa^2-S_2COR)$

(41).<sup>211</sup> The reaction of potassium alkylxanthates with  $\text{CpRuCl}(\text{PEt}_3)_2$  affords  $\text{CpRu}(\eta^1\text{-S}_2\text{COR})(\text{PEt}_3)_2$  containing a monodentate xanthate, whereas with  $\text{Cp}^*\text{RuCl}(\text{PEt}_3)_2$  yields  $\text{Cp}^*\text{Ru}(\kappa^2\text{-S}_2\text{COR})(\text{PEt}_3)_2$  containing bidentate xanthate ( $\text{R} = \text{Me}, \text{Et}, \text{Pr}^i$ ).<sup>212</sup>



Scheme 14

Among the recent reports on metal xanthate chemistry the following are mentioned, dealing with the structural diversity of nickel(II),<sup>213</sup> zinc(II),<sup>214</sup> mercury(II),<sup>215</sup> and tellurium(II) bis(xanthate) complexes,<sup>216</sup> based upon different coordination patterns and supramolecular self-assembly.

#### 1.15.4.4 Metal complexes

Dinuclear niobium xanthato complexes,  $\text{Nb}_2\text{S}_4(\text{S}_2\text{COR})_4$  ( $\text{R} = \text{Et}, \text{Pr}^i, \text{Cy}$ ; also dithiocarbamates and dithiophosphates) have been prepared from  $[\text{NET}_4][\text{Nb}_2\text{S}_4(\text{NCS})_8]$  by replacing the thiocyanato ligands.<sup>76</sup>

Few chromium xanthato complexes have been reported, but the crystal structure of  $\text{Cr}(\text{S}_2\text{CO-Pr}^i)_3$  has been determined.<sup>217</sup> Molybdenum and tungsten carbonyl xanthato complex anions  $[\text{M}(\text{CO})_5(\eta^1\text{-S}_2\text{COR})]^-$  and  $[\text{M}(\text{CO})_4(\kappa^2\text{-S}_2\text{COR})]^-$  ( $\text{M} = \text{Mo}, \text{W}$ ) are formed in the reactions of metal carbonyls with alkali metal xanthates,<sup>218,219</sup> and partial CO replacement, in addition to that of chlorine, occurred in the reaction of  $\text{MoCl}_2(\text{CO})_2(\text{PMe}_3)_2$  with potassium alkylxanthates, to give  $\text{Mo}(\kappa^2\text{-S}_2\text{COR})_2(\text{CO})(\text{PMe}_3)_2$  ( $\text{R} = \text{Me}, \text{Et}, \text{Pr}^i, \text{Bu}^i$ ).<sup>220</sup> The cluster complex  $\text{WCu}_3\text{S}_3(\text{S}_2\text{-COEt})(\text{O})(\text{PPh}_3)_3$  was obtained from  $\text{WCu}_2\text{S}_3(\text{O})(\text{PPh}_3)_3$  and  $\text{CuS}_2\text{COEt}$ ,<sup>221,222</sup> and the clusters  $\text{MoCu}_3\text{S}_3(\text{S}_2\text{COEt})(\text{O})(\text{PPh}_3)_3$ ,<sup>223</sup> and  $\text{Mo}_4\text{S}_4(\text{S}_2\text{COR})_6$  have also been reported.

A series of lipid soluble <sup>99m</sup>Tc nitrido alkylxanthate complexes have been prepared and their biodistribution and myocardial uptake have been investigated, for possible biomedical applications as imaging agents.<sup>224</sup> Other technetium xanthato complexes  $\text{TcCl}_2(\text{S}_2\text{COEt})_3(\text{PMe}_2\text{Ph})$ ,<sup>225</sup> and  $\text{TcCl}(\text{S}_2\text{COBu}^i)(\text{NO})(\text{PPh}_3)_2$ ,<sup>226</sup> have been prepared by partial halogen and phosphine or acetonitrile replacement in  $\text{TcCl}_3(\text{PMe}_2\text{Ph})_3$  and  $\text{TcCl}_2(\text{NO})(\text{PPh}_3)_3(\text{NCMe})$ , respectively. The rhenium complex xanthate,  $\text{Re}(\text{CO})_5(\text{S}_2\text{COEt})$  was obtained from  $\text{Re}(\text{CO})_5\text{Cl}$  and  $\text{KS}_2\text{COEt}$ , without displacement of carbon monoxide.<sup>227</sup>

Osmium complexes, *cis*- and *trans*- $\text{Os}(\text{S}_2\text{COR})_2(\text{PPh}_3)_2$ , have been prepared from  $\text{Os}(\text{PPh}_3)_2\text{Br}_2$  and potassium xanthates.<sup>228</sup>

The complex cluster  $\text{Co}_3\text{S}(\text{CO})_7(\text{S}_2\text{COMe})$  was formed from MeOH solutions of  $\text{CoCl}_2$  with  $\text{K}[\text{S}_2\text{COMe}]$ , under CO atmosphere.<sup>229</sup> The crystal structure of  $\text{Co}(\text{S}_2\text{COPr}^i)_3$  has been reported.<sup>230</sup> The rhodium complexes,  $\text{Rh}(\text{CO})_2(\text{S}_2\text{COR})$ , have been screened as cytostatic and antitumor agents.<sup>231</sup>

A series of new metal xanthato complexes of group 10 metals have been prepared and structurally characterized. These include: nickel (methoxyethyl)xanthates (containing a new xanthato ligand),<sup>232</sup> nickel(II) complexes of ethylxanthate,<sup>233,234</sup> trifluoroethylxanthate,<sup>235</sup> *n*-propyl and isopropylxanthate,<sup>236,237</sup> butylxanthate,<sup>238</sup> 3-methylbutylxanthate,<sup>239</sup> 3,3-dimethylbutylxanthate,<sup>240</sup> benzylxanthate, and a benzene clathrate of its 1,10-phenanthroline adduct.<sup>241</sup> Numerous nickel xanthate amine adducts<sup>242–245</sup> and phosphine adducts<sup>246–248</sup> have been investigated. Nickel bis(xanthate) adducts of 4,4'-bipyridyl and of 2,2-dipyridylamine form reversible and nonreversible inclusion compounds.<sup>249</sup>

Nickel(III) xanthates,  $\text{Ni}(\text{S}_2\text{COR})_3$ , with  $\text{R} = \text{Me}, \text{Et}, \text{Pr}, \text{Pr}^i, \text{Bu}, \text{Bu}^i, \text{Bu}^s$ , can be quantitatively generated in acetonitrile solution by electrooxidation of anionic  $[\text{Ni}(\text{S}_2\text{COR})_3]^-$  or by oxidative addition of ethyldixanthogen,  $[\text{EtOC}(\text{S})\text{S}]_2$  to  $\text{Ni}(\text{S}_2\text{COEt})_2$ . Solutions of  $\text{Ni}(\text{S}_2\text{COR})_3$  readily disproportionate into  $\text{Ni}(\text{S}_2\text{COEt})_2$  and  $[\text{EtOC}(\text{S})\text{S}]_2$ .<sup>250</sup>

The crystal structure of platinum ethylxanthate,  $\text{Pt}(\text{S}_2\text{COEt})_2$ ,<sup>251</sup> NMR spectroscopic studies of platinum xanthate-multidentate polyphosphine complexes,<sup>252–254</sup> and a comparative study of the electronic spectra of Ni, Pd, and Pt xanthates<sup>255</sup> have been reported.

The crystal structures of some key silver and gold compounds, including  $(\text{Ph}_3\text{P})_2\text{AgS}_2\text{COEt}$ ,<sup>256</sup>  $\text{Ph}_3\text{P}\cdot\text{AuS}_2\text{COEt}$ ,<sup>257</sup>  $\text{Cy}_3\text{P}\cdot\text{Au}(\text{S}_2\text{COR})$  ( $\text{R} = \text{Et}, n\text{-Pr}, \text{Pr}^i$ ),<sup>258</sup>  $\text{R}_3\text{P}\cdot\text{AuS}_2\text{COCy}$  ( $\text{R} = \text{Et}, \text{Cy}, \text{Ph}$ ),<sup>259</sup> and  $(o\text{-Tol})_3\text{P}\cdot\text{AuS}_2\text{COR}$  ( $\text{R} = \text{Pr}^i, \text{CH}_2\text{CH}_2\text{OMe}$ ),<sup>260</sup> illustrate the unsymmetrical chelating coordination of xanthate ligands. In  $\text{Au}_2(\mu\text{-dppe})(\mu\text{-S}_2\text{COR})\text{X}_2$  ( $\text{R} = \text{Me}, \text{Et}, \text{Pr}^i; \text{X} = \text{Cl}, \text{Br}, \text{I}$ ), the xanthate coordinates as a bridging ligand.<sup>261</sup> The luminescent properties and crystal structures of  $(\text{R}_3\text{P})_2\text{AuS}_2\text{COEt}$  ( $\text{R} = \text{Ph}$  or  $\text{CH}_2\text{CH}_2\text{CN}$ ), have also been investigated.<sup>262</sup>

Zinc bis(xanthates) are useful for the photochemical deposition of zinc sulfide<sup>263</sup> and were investigated quite extensively. The crystal structures of  $\text{Cd}(\text{S}_2\text{COPr}^i)_2$ <sup>264</sup> and  $[\text{NEt}_4][\text{Cd}(\text{S}_2\text{COCH}_2\text{CH}_2\text{OMe})_3]$ ,<sup>265</sup> have been reported. An interesting result is the formation of the cluster compound  $[\text{Cd}_{17}\text{S}_4(\text{SPh})_{24}(\text{S}_2\text{COMe})_{4/2}]_n \cdot x\text{MeOH}$  from  $[\text{Cd}_4(\text{SPh})_6(\text{SPh})_{4/2}]$  with  $\text{CS}_2$  and  $\text{MeOH}$  in  $\text{DMF}$ .<sup>266</sup>

The crystal structures of several mercury bis(xanthates),<sup>267,268</sup> and organomercury derivatives, including methylmercury xanthates,  $\text{MeHg}(\text{S}_2\text{COR})$  and their supramolecular self-assembly,<sup>269</sup> and phenylmercury xanthates,  $\text{PhHg}(\text{S}_2\text{COR})$  ( $\text{R} = \text{Me}, \text{Pr}^i, \text{Et}$ ),<sup>270,271</sup> have been reported.

Xanthate ligands were less frequently used with group 13 metals. The synthesis of several indium xanthates,  $\text{In}(\text{S}_2\text{COR})_3$  ( $\text{R} = \text{Et}, \text{Pr}^i, \text{MeEtCH}, \text{Cy}$ ) can be mentioned,<sup>272</sup> and the use of  $\text{In}(\text{S}_2\text{COPr}^i)_3$  as volatile precursor for deposition of conductive  $\text{In}_2\text{S}_3$  films.<sup>273</sup>

A number of group 14 metal xanthates have been investigated. New organotin xanthates,  $\text{R}^1_2\text{Sn}(\text{S}_2\text{COR}^2)_2$  and  $\text{R}^1_3\text{Sn}(\text{S}_2\text{COR}^2)$  ( $\text{R}^1 = \text{Me}, \text{Ph}; \text{R}^2 = \text{Me}, \text{Ph}, \text{CH}_2\text{Ph}$ ) have been prepared<sup>274</sup> and the crystal structures of  $\text{Me}_2\text{Sn}(\text{S}_2\text{COPr}^i)_2$ ,<sup>275</sup>  $\text{Ph}_2\text{Sn}(\text{S}_2\text{COR})_2$  ( $\text{R} = \text{Me}, \text{Et}, \text{Pr}^i, \text{Ph}$ ),<sup>276,277,278</sup> and  $[(\text{ROCS}_2)\text{SnMe}_2(\text{OR})\text{OSnMe}_2]_2$  ( $\text{R} = \text{Pr}^i, \text{CH}_2\text{Ph}$ )<sup>279,280</sup> among others) have been determined. A comparative study of the  $^{119}\text{Sn}$ ,  $^{13}\text{C}$ , and  $^{31}\text{P}$  NMR spectra of organotin xanthates, dithiocarbamates, and dithiophosphates is available.<sup>281,282</sup>

In group 15 comparative X-ray crystal structure analyses of  $\text{M}(\text{S}_2\text{COR})_3$  (with  $\text{M} = \text{As}, \text{Sb}, \text{Bi}$  and  $\text{R} = \text{Me}, \text{Pr}^i, \text{CH}_2\text{CH}_2\text{CMe}_3$ )<sup>283</sup> and the correlation of the  $^{13}\text{C}$  NMR spectra and crystal structures of  $\text{M}(\text{S}_2\text{COR})_3$  (with  $\text{M} = \text{As}, \text{Sb}, \text{Bi}$  and  $\text{R} = \text{Me}, \text{Et}, \text{Pr}^i$ )<sup>286</sup> have been reported. In addition the crystal structures of  $\text{PhAs}(\text{S}_2\text{COPr}^i)_2$ ,<sup>287</sup>  $\text{PhSb}(\text{S}_2\text{COEt})_2$ ,<sup>288</sup>  $\text{Bi}(\text{S}_2\text{COR})_3$  ( $\text{R} = \text{Et}, \text{Bu}, \text{Cy}, \text{CH}_2\text{Ph}$ )<sup>291</sup> are worth mentioning.

Several tellurium(II) xanthates,  $\text{Te}(\text{S}_2\text{COR})_2$  ( $\text{R} = \text{Et}, \text{Pr}, \text{Pr}^i, \text{and } \text{CH}_2\text{CH}_2\text{Me}_3$ ) have been structurally characterized<sup>216,292–294</sup> and a review covered numerous tellurium derivatives.<sup>18</sup> Diorganotellurium, mixed halide-xanthato complexes,  $\text{Me}_2\text{TeX}(\text{S}_2\text{COR})$  ( $\text{X} = \text{Cl}, \text{I}$ ),<sup>295</sup> triorganotellurium  $\text{Me}_3\text{TeS}_2\text{COR}$  ( $\text{R} = \text{Me}, \text{Et}, \text{Pr}^i, \text{Bu}^i, \text{Ph}$ )<sup>296</sup> and dimeric  $[\text{Ph}_3\text{TeS}_2\text{COEt}]_2$  (with unsymmetrical bridging xanthato ligands)<sup>297</sup> have also been reported.

## 1.15.5 DITHIOCARBOXYLATES

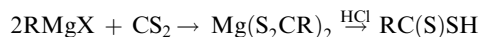
### 1.15.5.1 General

Dithiocarboxylic acids,  $\text{RC}(\text{S})\text{SH}$ , and their salts have been known for a long time, and their anions,  $\text{RCS}_2^-$ , have occasionally been used as ligands. They are only mentioned briefly in *CCC* (1987).<sup>298</sup> The early chemistry of dithiocarboxylic acids (including salts and complexes) has been thoroughly reviewed in an early review,<sup>299</sup> and in a book published in 1979.<sup>300</sup> Since this book may not be readily available, a brief presentation of this class is made here, for the benefit of a potential user. In spite of the fact that there is little activity in the coordination chemistry of dithiocarboxylates (probably because of their sometimes cumbersome preparation, low stability, and unpleasant smell), this class of ligands deserves more attention, for comparison with the more popular 1,1-dithiolates such as dithiophosph(in)ates and xanthates or dithiocarbamates, and also for the interesting chemistry they can produce, as demonstrated in some recent studies (*vide infra*). There are some reviews covering the analytical chemistry<sup>301–303</sup> and the nickel triad complexes of dithiocarboxylates.

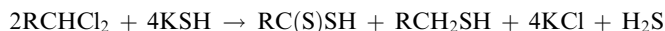
### 1.15.5.2 Synthesis

The dithiocarboxylic acids can be isolated as such, but in most cases their salts, in particular alkali metal salts, are preferred for further use. The synthetic methods used for the preparation of dithiocarboxylic acids or their salts include:<sup>300</sup>

- (a) Insertion of carbon disulfide into M—R bonds of organometallic compounds, usually Grignard reagents, an old but efficient method, and still used frequently (e.g., R = Me, Et, Pr, Cy, Ph, tolyl):<sup>304–312</sup>



- (b) Replacement of chlorine in geminal di- and trihalides (including chloroform), in reactions with alcoholic solutions of alkali metal sulfides (R = H, aryl, etc.):<sup>313–315</sup>



Other reactions leading to dithiocarboxylic acids or their salts can be mentioned:<sup>300</sup> reactions of nitriles with hydrogen sulfide, reactions of aromatic aldehydes with hydrogen polysulfides, and oxidation of benzyl chlorides with sulfur in the presence of alkalis. Alkali metal cyanides react with carbon disulfide in DMF to form cyanodithioformates,  $\text{MS}_2\text{C}=\text{CN}$ .<sup>316</sup> In the presence of strong bases (alkali metal hydroxides, alkoxides, hydrides, amides) the acidic hydrogen in numerous organic compounds (ketones, aldehydes, esters, nitriles, heterocyclic compounds, etc.) reacts with carbon disulfide to form dithiocarboxylates.<sup>300</sup> A recent example is the formation of  $\text{RC}\equiv\text{CCS}_2^-$  anions (further used for the synthesis of ruthenium carbonyl complexes) by insertion of carbon disulfide into Li—C bonds of acetylides,  $\text{LiC}\equiv\text{CR}$  (R = Ph, Bu<sup>t</sup>, Mes).<sup>317</sup> Aromatic phenols or metal phenoxides may react with carbon disulfide either at the —OH position, to form xanthates, or in the *ortho*- and *para*- carbon positions, to form dithiocarboxylates.<sup>318</sup> Thus, 2,6-di(*t*-butyl)phenol was deprotonated with sodium hydride in THF, and reacted with  $\text{CS}_2$  to form sodium 3,5-di(*t*-butyl)-4-hydroxybenzene dithiocarboxylate, which was converted into a zinc complex.<sup>319</sup>

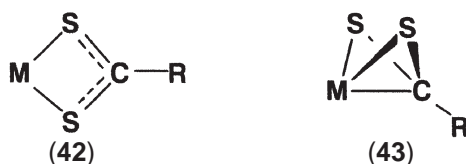
Convenient syntheses for ammonium<sup>311,320</sup> and alkali metal salts (from trimethylsilyl dithiocarboxylates and alkali metal fluorides),<sup>321,322</sup> useful for preparative purposes of their metal complex and organometallic derivatives, are now available. The reactions of bis(thioacyl)disulfanes,  $[\text{RC}(\text{S})\text{S}]_2$  (R = Pr<sup>i</sup>, Ph, *p*-MeOC<sub>6</sub>H<sub>4</sub>, *p*-Tol, *p*-ClC<sub>6</sub>H<sub>4</sub>,  $\alpha$ -C<sub>10</sub>H<sub>7</sub>) with secondary amines yield substituted ammonium dithiocarboxylates,  $[\text{R}^2_2\text{NH}_2][\text{R}^1\text{CS}_2]$ .<sup>323</sup>

Dithiocarboxylic acids are moderately strong acids, with  $\text{p}K_{\text{a}} = 2.55$  for MeC(S)SH,  $\text{p}K_{\text{a}} = 2.05$  for PhCH<sub>2</sub>C(S)SH and  $\text{p}K_{\text{a}} = 1.92$  for PhC(S)SH. In the IR spectra, they display  $\nu_{\text{C}=\text{S}}$  stretching frequencies close to 1,200 cm<sup>-1</sup>, which are also observed in some metal complexes and organometallic derivatives.<sup>300</sup>

### 1.15.5.3 Coordination patterns

The coordination patterns of dithiocarboxylates are expected to be similar to those of xanthates and other 1,1-dithiolato ligands. Relatively few X-ray crystal structure determinations have been reported, and bidentate chelating (monometallic biconnective) and bridging (bimetallic biconnective) coordination modes are well documented. In addition to these common coordination patterns, typical for 1,1-dithiolato complexes, in the case of dithiocarboxylato ligand a rare tridentate coordination pattern (Scheme 15) has been reported. The latter differs from the approximately coplanar four-membered ring pattern (42) and displays a butterfly motif (43), with an approximately tetrahedral arrangement of the metal, two sulfur atoms, and a participating carbon atom. This rare coordination pattern has been established by X-ray diffraction in an iron

complex,  $\eta^5\text{-CpFe}(\kappa^3\text{-S}_2\text{CMe})(\kappa^1\text{-dppm})$ ,<sup>324</sup> and two molybdenum complexes  $\text{MoO}(\kappa^3\text{-S}_2\text{CPh})[\kappa^2\text{-SS(S)CPh}]$ ,<sup>325</sup> and  $\text{MoO}(\kappa^3\text{-S}_2\text{CC}_6\text{H}_4\text{Me-}p)(\kappa^3\text{-HBPz}_3)$ .<sup>326</sup>



Scheme 15

### 1.15.5.4 Metal complexes

A number of main group and transition metal dithiocarboxylates have been described. They are commonly prepared by metathesis between alkali metal dithiocarboxylates and metal halides. Heavy metal derivatives usually precipitate from aqueous solutions, but are soluble in organic solvents and can be solvent extracted. The alkali metal, ammonium, phosphonium, and arsonium salts are water soluble.<sup>300</sup> The composition of metal complexes is sensitive to preparation conditions and is frequently pH dependent.

Metal complex dithiocarboxylates can be directly prepared by insertion of  $\text{CS}_2$  into  $\text{M-R}$  or  $\text{M-H}$  bonds. Thus,  $\text{R-M}(\text{CO})_5$  ( $\text{M} = \text{Mn, Re}$ ) insert carbon disulfide to form  $\text{M}(\text{CO})_4\text{S}_2\text{CR}$  (following release of  $\text{CO}$ ),<sup>327,328</sup> and copper(I) alkyls or aryls,  $\text{R}^2_3\text{P}\cdot\text{Cu}^{\text{I}}\text{R}^1$ , to form  $\text{R}^2_3\text{P}\cdot\text{CuS}_2\text{CR}^1$  (preferably in the presence of *N*-chelating ligands to afford  $\text{CuS}_3\text{CAR}\cdot\text{Phen}$  and other adducts).<sup>329,330</sup> Insertion of  $\text{CS}_2$  into metal hydrides affords dithiocarboxylato complexes of ruthenium, osmium, iridium, platinum, and rhenium.<sup>331–335</sup> An unusual formation of a dithioformato complex,  $[\text{Ru}(\text{S}_2\text{CH})(\text{ppy})_2]\text{PF}_6$ , was reported to occur on treatment of the formato complex,  $[\text{Ru}(\text{O}_2\text{CH})(\text{ppy})_2]\text{PF}_6$ , with carbon disulfide ( $\text{ppy} = 1\text{-diphenylphosphino-2-(2-pyridyl)ethane}$ ).<sup>336</sup>

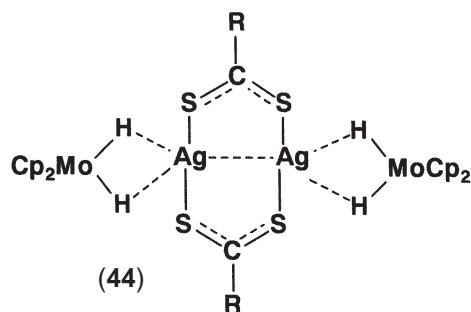
The reactions of tetraethylammonium tetrathiometalates,  $[\text{NET}_4][\text{M}^{\text{VI}}\text{S}_4]$  ( $\text{M} = \text{Mo, W}$ ) and  $[\text{NET}_4][\text{Re}^{\text{VII}}\text{S}_4]$ , with disulfides,  $[\text{RC}(\text{S})\text{S}]_2$ , afford dithiocarboxylato complexes. This method has been used for the synthesis of  $\text{Mo}^{\text{IV}}(\text{S}_2\text{CPh})_4$ ,  $\text{W}^{\text{VI}}\text{S}(\text{S}_2)(\text{S}_2\text{CPh})_2$ ,  $[\text{NET}_4][\text{W}^{\text{VI}}\text{O}(\text{S}_2)(\text{S}_2\text{CPh})]$ , and  $\text{Re}^{\text{III}}(\text{S}_2\text{CPh})(\text{S}_3\text{CPh})_2$ .<sup>196</sup>

Crystal structures of  $\text{V}(\text{S}_2\text{CMe})_4$  (containing both dodecahedral and square prismatic eight-coordinate molecules in the same crystal),<sup>337</sup>  $\text{Ni}(\text{S}_2\text{CPh})_2$ ,<sup>338</sup>  $\text{Ni}(\text{S}_2\text{CCH}_2\text{Ph})_2$ ,<sup>339</sup>  $\text{Ni}(\text{S}_2\text{CCH}_2\text{Ph})_2\cdot 2\text{Py}$ ,<sup>340</sup>  $[\text{Ni}(\text{S}_2\text{CPh})_3]^-$  anion,<sup>341</sup>  $\text{Pd}(\text{S}_2\text{CPh})_2$ ,<sup>342</sup> platinum,<sup>343,344</sup> dioxouranium,<sup>345</sup> chromium, molybdenum, zinc dithiocarboxylates, among others,<sup>333,346–348</sup> deserve mention. Some nickel, palladium, and platinum dithiocarboxylates are dimers, e.g.,  $\text{Pt}_2(\text{S}_2\text{CPr}^1)_4$ , containing two bridging and two chelating dithiocarboxylato ligands.<sup>349</sup> The structures of potassium dithioformate,  $\text{KS}_2\text{CH}$ ,<sup>350</sup> and dithioacetate,  $\text{KS}_2\text{CMe}$ ,<sup>351</sup> have also been reported.

Copper, silver, and gold complexes of the type  $\text{M}(\text{PR}_3)_n(\text{S}_2\text{CC}_5\text{Me}_5)$  containing both monodentate and bidentate ligands,<sup>352</sup> and dinuclear complexes  $[\text{Cp}_2\text{MoH}_2\text{AgS}_2\text{CR}]_2$  ( $\text{R} = \text{Me, Ph}$ ) (44) with bridging dithiocarboxylato (also dithiophosphato, xanthato, and dithiocarbamato)<sup>353,354</sup> ligands have been described (Scheme 16). Square planar complexes,  $\text{Cl}_2\text{Au}(\text{S}_2\text{CC}_6\text{H}_4\text{OC}_n\text{H}_{2n+1})$  display liquid crystal properties,<sup>355,356</sup> and conducting dendrite crystals of  $[\text{Pt}_2(\text{S}_2\text{CMe})_4(\text{ClO}_4)]_x$  are formed by electrochemical oxidation of  $\text{Pt}_2(\text{S}_2\text{CMe})_4$  with iodine in perchlorate media.<sup>357</sup> Sulfur-rich, bis(perthiobenzoato)(dithiobenzoato)-technetium(III) heterocomplexes have been reported.<sup>358</sup> A technetium nitrido dithiocarboxylato complex  $[\text{}^{99\text{m}}\text{TcN}(\text{S}_2\text{CR})_2]$  has been investigated as leucocyte-specific radiopharmaceutical.<sup>359,360</sup>

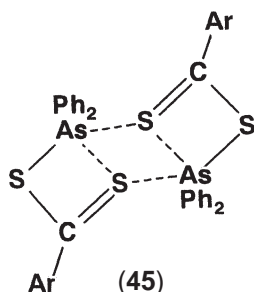
The silver(I) dithiocarboxylates are frequently associated, to form clusters, such as  $[\text{Ag}(\text{C}_2\text{SC}_{10}\text{H}_7)\text{Py}]_4$  and  $[\text{AgS}_2\text{CCPh}_3]_6$ , or polymers, such as  $[\text{Ag}_2(\text{S}_2\text{CPh})_2]_x$ . The formation of  $\text{Cu}^{\text{I}}$  dithiocarboxylates from  $\text{Cu}^{\text{II}}$  salts frequently results in the oxidation of the ligand to perthiocarboxylates, and cluster complexes, e.g.,  $[\text{CuSS}(\text{S})\text{CC}_{10}\text{H}_7]_4$  and  $\text{Cu}_4(\text{S}_2\text{CPh})_2[\text{SS}(\text{S})\text{CPh}]_2(\text{Py})_2$  are obtained.<sup>361</sup>

Some organometallic derivatives of dithiocarboxylato ligands have been described. These include  $\text{M}(\kappa^2\text{-CO})_4\text{S}_2\text{CR}$  ( $\text{M} = \text{Mn, Re}$ ;  $\text{R} = \text{Ph, CH}_2\text{Ph, } p\text{-Tol, } p\text{-ClC}_6\text{H}_4, \text{CPh}_3$ ),<sup>315,362–365</sup>  $\text{M}(\text{CO})_5(\eta^1\text{-S}_2\text{CPh})$  ( $\text{M} = \text{Cr, W}$ ),<sup>187</sup>  $\text{CpM}(\text{CO})_2(\text{S}_2\text{CCN})$  ( $\text{M} = \text{Mo, W}$ ),<sup>366</sup>  $\text{Rh}^{\text{I}}(\text{CO})(\text{PPh}_3)(\text{S}_2\text{CR})$ ,<sup>367</sup>  $\text{CpNi}(\text{S}_2\text{CPh})$ ,<sup>368</sup> also  $\text{R}^1_3\text{MS}_2\text{CR}^2$  and  $\text{R}^1_2\text{M}(\text{S}_2\text{CR}^2)_2$  ( $\text{M} = \text{Si, Ge, Sn, Pb}$ ;  $\text{R}^1 = \text{Me, Ph}$ ;  $\text{R}^2 = \text{Me, Pr}^i, \text{Ph, etc.}$ ),<sup>369–374</sup> and  $\text{Ph}_n\text{As}(\text{S}_2\text{CR})_{3-n}$  ( $\text{R} = \text{Me, Et, Pr}^i, \text{Ph, other}$



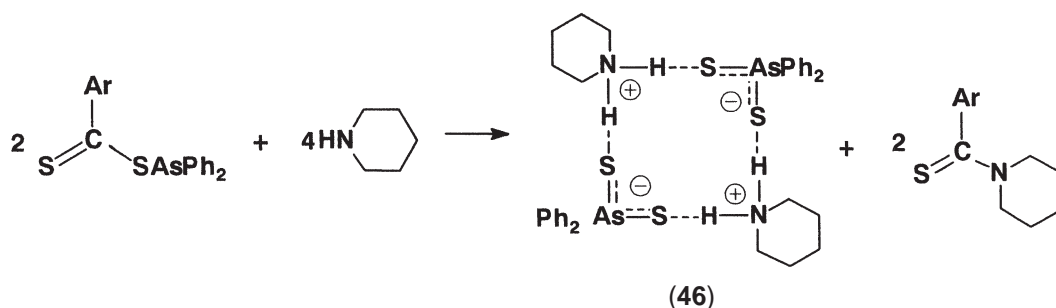
Scheme 16

aryls;  $n = 0-2$ ).<sup>375</sup> Among these compounds, the structure of dimeric  $[\text{Ph}_2\text{AsS}_2\text{CC}_6\text{H}_4\text{OMe-}p]_2$  (45) is remarkable (Scheme 17).



Scheme 17

The  $\text{Ph}_2\text{AsS}_2\text{CC}_6\text{H}_4\text{Me-}4$  derivative reacts with piperidine to form piperidinium diphenyl-dithioarsinate (a hydrogen bond dimer, (46)) and *N*-4-methylthiobenzoyl-piperidine, thus converting a dithiocarboxylate into a dithioarsinate (Scheme 18).<sup>375</sup>



Scheme 18

The molybdenum complex  $\text{Mo}(\text{CO})_3(\text{S}_2\text{CPh})_2$  reacts with acetylene, oxygen, etc. to eliminate carbon monoxide and to form  $\text{Mo}_2(\text{S}_2\text{CPh})_4$  and  $\text{Mo}(\text{C}_2\text{H}_2)(\text{S}_2\text{CPh})_2$ .<sup>376</sup> Supramolecular systems of organotin derivatives of 2-amino-1-cyclopentene-1-carbodithioic acid connected through intermolecular hydrogen bonds have been reported.<sup>377</sup>

Dithiocarboxylato anions are versatile ligands and it is hoped that the interest for this class will increase in the future.



## 1.15.6 DITHIOCARBAMATES

### 1.15.6.1 General

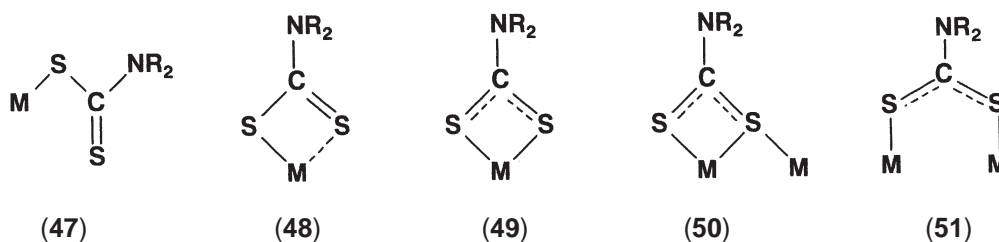
Dithiocarbamates have been covered in *CCC* (1987),<sup>378</sup> in a comprehensive early review (together with xanthates)<sup>379</sup> and in a book.<sup>380</sup> They continue to be extensively used and much interesting novel chemistry has been reported since. Several reviews on dithiocarbamates cover the electrochemistry,<sup>381</sup> photoelectron spectroscopy,<sup>382</sup> analytical applications of dithiocarbamates (e.g., for the determination of metals in foodstuff, water and environmental samples and the analysis of dithiocarbamate pesticides),<sup>383–386</sup> their use as NO trapping agents,<sup>387–389</sup> or in the heavy-metal removal from wastewaters.<sup>390</sup>

### 1.15.6.2 Synthesis

Dithiocarbamic acids,  $R_2NC(S)SH$ , are rather unstable and seldom isolated or used as such. Usually their alkali metal or (substituted) ammonium salts are prepared for further use as starting materials in the synthesis of various metal complexes or organometallic derivatives. The most common is the reaction of primary or secondary amines with carbon disulfide in alkaline medium.

### 1.15.6.3 Coordination patterns

The most common coordination patterns of dithiocarbamate ligands (Scheme 19) are monodentate (monometallic monoconnective, (47)), bidentate chelating (monometallic biconnective, unsymmetrical (48), and symmetrical, (49)), chelating-bridging (bimetallic triconnective, (50)) and bridging (bimetallic biconnective, (51)). In  $[Co_2(\kappa^2-S_2CNMe_2)_2(\mu_3-S_2CNMe_2)_2\{PPh(OMe)_2\}_2][PF_6]$  two ligands are bimetallic triconnective (50).<sup>391</sup>



Scheme 19

Tri- and tetraconnective coordination of dithiocarbamate ligands was observed in  $[Ag_{11}(\mu_5-S)(\mu_4-S_2CNEt_2)_6(\mu_3-S_2CNEt_2)]$ .<sup>392</sup>

The structural systematics, coordination modes, crystal packing and supramolecular self-assembly patterns of nickel,<sup>213</sup> zinc,<sup>214</sup> cadmium,<sup>393</sup> mercury,<sup>394</sup> organotin,<sup>395</sup> and tellurium<sup>216,396</sup> complexes of dithiocarbamate ligands have been analyzed.

In arsocane derivatives the molecular geometry is influenced by a competition between transannular and exocyclic  $As \cdots S$  secondary bonding, the dithiocarbamate groups being coordinated as typical anisobidentate ligands.<sup>397</sup>

### 1.15.6.4 Metal complexes

Metal dithiocarbamate complexes are usually prepared by metathesis of metal halide compounds and alkali metal carbamates. Other methods include the direct synthesis by insertion of carbon disulfide into  $M-N$  bonds, e.g., the preparation of  $WS(S_2)(S_2CNMe_2)_2$  from  $W_2(NMe_2)_6$  and sulfur in  $CS_2$ , or the formation of  $W_2S_4(S_2CNMe_2)_2$  in the reaction with selenium in  $CS_2$  (selenium not reacting).<sup>398</sup> An attractive alternative seems to be the reaction of trimethylsilyl dithiocarbamates, e.g.,  $TMSS(S)CNEt_2$ , in reaction with metal halide complexes, under mild conditions. The reaction was used to prepare  $M_2(\mu-N_2)(S_2CNEt_2)_6$  from  $(MCl_3)_2(\mu-N_2)(THF)_4$

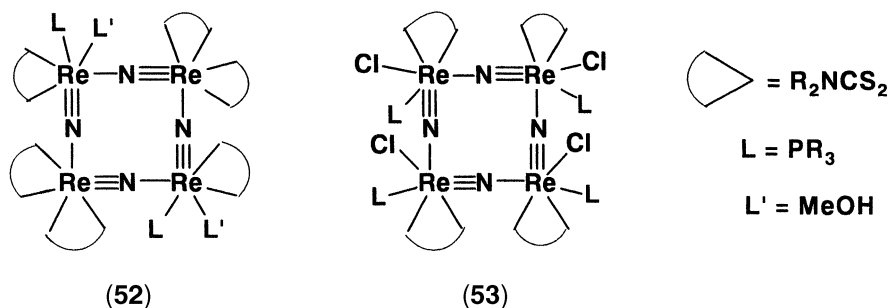
(M = Nb, Ta).<sup>399</sup> An interesting reaction of NbCl<sub>5</sub> with TMSS(S)CNEt<sub>2</sub> afforded two coordination isomers, namely NbCl<sub>3</sub>(S<sub>2</sub>CNEt<sub>2</sub>)<sub>2</sub> and [Nb(S<sub>2</sub>CNEt<sub>2</sub>)<sub>4</sub>][NbCl<sub>6</sub>].<sup>400</sup> A similar CS<sub>2</sub> insertion into the Mo—N bond of (η<sup>3</sup>-C<sub>3</sub>H<sub>5</sub>)(CO)<sub>2</sub>Mo(HNC<sub>5</sub>H<sub>10</sub>)[η<sup>1</sup>-S<sub>2</sub>P(OEt)<sub>2</sub>] leads to (η<sup>3</sup>-C<sub>3</sub>H<sub>5</sub>)(CO)<sub>2</sub>Mo(κ<sup>2</sup>-S<sub>2</sub>CNC<sub>5</sub>H<sub>10</sub>), with release of the dithiophosphate ligand.<sup>96</sup>

Convenient preparations of dithiocarbamate complexes use thiuram disulfides as starting materials mostly in oxidative addition reactions. These preparations have been thoroughly reviewed.<sup>401,402</sup> Dithiocarbamate complexes of aluminum(III) and gallium(III), M(S<sub>2</sub>CNR<sub>2</sub>)<sub>3</sub>, have been prepared by reductive cleavage of thiuram disulfides, [R<sub>2</sub>NC(S)S]<sub>2</sub>, with trimethylamine-metal hydrides, Me<sub>3</sub>N·MH<sub>3</sub> (M = Al, Ga; R = Me, Et, CH<sub>2</sub>Ph). Alternatively, the same compounds can be obtained by transmetallation reactions between Et<sub>2</sub>O·AlH<sub>3</sub> and M(S<sub>2</sub>CNEt<sub>2</sub>)<sub>3</sub>, which is a novel preparative method for metal dithiocarbamates.<sup>403</sup> The reaction of tetraethylthiuram disulfide, [Et<sub>2</sub>NC(S)S]<sub>2</sub>, with [NH<sub>4</sub>][WSe<sub>4</sub>] in acetonitrile afforded seven-coordinate, green WS(Se<sub>2</sub>)(κ<sup>2</sup>-S<sub>2</sub>CNEt<sub>2</sub>)<sub>2</sub> and red WO(Se<sub>2</sub>)(κ<sup>2</sup>-S<sub>2</sub>CNEt<sub>2</sub>)<sub>2</sub>.<sup>404</sup> The reaction of M(CO)<sub>6</sub> with elemental selenium and [Et<sub>2</sub>NC(S)S]<sub>2</sub> in refluxing dichloroethane afforded trinuclear [M<sub>3</sub>(μ<sub>3</sub>-Se)(μ<sub>2</sub>-Se)<sub>2</sub>(S<sub>2</sub>CNEt<sub>2</sub>)<sub>3</sub>]<sub>2</sub>Se (M = Mo, W) and other products, whereas Cr(CO)<sub>6</sub> produced only Cr(S<sub>2</sub>CNEt<sub>2</sub>)<sub>3</sub>.<sup>405</sup> Cyclopentadienylchromium tricarbonyl dimer, [CpCr(CO)<sub>3</sub>]<sub>2</sub>, reacted with [Et<sub>2</sub>NC(S)S]<sub>2</sub> to give Cp<sub>6</sub>Cr<sub>8</sub>S<sub>8</sub>(S<sub>2</sub>CNEt<sub>2</sub>)<sub>2</sub>, in addition to several unexpected C—S bond cleavage and CC coupling products.<sup>406</sup> Numerous other molybdenum and tungsten clusters of the type [M<sup>1</sup><sub>3</sub>YS<sub>3</sub>M<sup>2</sup>]<sup>n+</sup> (Y = O, S; M<sup>1</sup> = Mo or W; M<sup>2</sup> = Cd, Hg, Sn, Pb, Sb, Bi) with dithiocarbamate (also dithiophosphato) ligands have been structurally analyzed and their chemistry is now better understood. These compounds display nonlinear optical properties.<sup>407</sup>

The dithiocarbamate ligands stabilize high oxidation states, like Co<sup>IV</sup> in [Co<sup>IV</sup>(S<sub>2</sub>CNR<sub>2</sub>)<sub>3</sub>]<sup>+</sup> (R = Et, Cy) prepared by electrochemical<sup>408</sup> or chemical<sup>409</sup> oxidation methods. A mixed-valence copper(II)-copper(III) dithiocarbamate catenane has been also described<sup>410</sup> and the crystal structures of Cu<sup>III</sup>(S<sub>2</sub>CNPr<sub>2</sub>)<sub>2</sub>I<sub>5</sub>,<sup>411,402</sup> and square planar [Cu<sup>III</sup>(S<sub>2</sub>CNMe<sub>2</sub>)<sub>2</sub>][ClO<sub>4</sub>] and [Cu<sup>III</sup>(S<sub>2</sub>CNEt<sub>2</sub>)<sub>2</sub>][FeCl<sub>4</sub>] have been determined.<sup>413</sup> A nanoarchitecture formed by metal-directed self-assembly and containing four dithiocarbamate-functionalized resorcarene ligands, assembled by eight Cu<sup>III</sup> ions, has been described.<sup>414</sup> A nickel(IV) dithiocarbamate complex, containing three ferrocenyl building blocks linked to a central nickel(IV) core, with interesting electrochemical properties, should also be mentioned.<sup>415</sup> Supramolecular macrocyclic molecular boxes were obtained by metal-directed self-assembly of polyferrocenyl dithiocarbamate complexes.<sup>416</sup> The photochemistry of Fe<sup>III</sup>, Fe<sup>IV</sup>, Mo<sup>IV</sup>, and Ni<sup>IV</sup> has been covered in a review.<sup>417</sup>

Some interesting polynuclear vanadium dithiocarbamate complexes have been synthesized and structurally characterized, including [NEt<sub>4</sub>][V<sub>3</sub>(μ<sup>3</sup>-S)(η<sup>2</sup>-μ<sub>2</sub>-S<sub>2</sub>)<sub>3</sub>(S<sub>2</sub>CNEt<sub>2</sub>)<sub>3</sub>]·3MeCN,<sup>418</sup> [NEt<sub>4</sub>]<sub>3</sub>[V<sub>2</sub>-S<sub>2</sub>O<sub>2</sub>(S<sub>2</sub>CNEt<sub>2</sub>)<sub>2</sub>K], or [NEt<sub>4</sub>]<sub>3</sub>{(V<sub>2</sub>S<sub>2</sub>O<sub>2</sub>)(S<sub>2</sub>CNMe<sub>2</sub>)<sub>2</sub>}<sub>3</sub>Na<sub>3</sub>(H<sub>2</sub>O),<sup>419</sup> and the cubane-like cluster compound [NEt<sub>4</sub>][V<sub>4</sub>S<sub>4</sub>(S<sub>2</sub>CNC<sub>4</sub>H<sub>8</sub>)<sub>6</sub>].<sup>420</sup> The dinuclear anion [NEt<sub>4</sub>][Mo<sub>2</sub>(μ-SPh)<sub>2</sub>(CO)<sub>6</sub>(S<sub>2</sub>CNEt<sub>2</sub>)<sub>2</sub>]<sup>-</sup> with a planar Mo<sub>2</sub>S<sub>2</sub> core, is formed from Mo<sub>2</sub>(SPh)<sub>2</sub>(CO)<sub>8</sub> and NaS<sub>2</sub>CNEt<sub>2</sub>,<sup>421</sup> and metal-metal bonded cations [Mo<sub>2</sub>(S<sub>2</sub>CNR<sub>2</sub>)<sub>6</sub>]<sup>2+</sup> have been reported as a source of Mo<sup>III</sup>(S<sub>2</sub>CNR<sub>2</sub>)<sub>3</sub> fragments.<sup>422</sup> Uncommon trinuclear palladium(II) complexes, containing both bridging and terminal dithiocarbamate ligands, have also been reported.<sup>423</sup>

Cyclic rhenium dithiocarbamate complexes (Scheme 20), containing an eight-membered Re<sub>4</sub>N<sub>4</sub> ring, with distinct single (Re—N 2.03 Å) and triple (Re—N 1.69 Å) bonds alternating, *cyclo*-[ReN(S<sub>2</sub>CNEt<sub>2</sub>)Cl(PMe<sub>2</sub>Ph)]<sub>4</sub> (**52**) and *cyclo*-[Re<sub>4</sub>N<sub>4</sub>(S<sub>2</sub>CNEt<sub>2</sub>)<sub>6</sub>(MeOH)<sub>2</sub>(PPh<sub>3</sub>)<sub>2</sub>][BPh<sub>4</sub>]<sub>2</sub>, (**53**) and other Re<sub>4</sub>N<sub>4</sub> ring derivatives have been described.<sup>424,425</sup>



Scheme 20



Unusual heterobimetallic  $\mu$ -nitrido dithiocarbamato ruthenium(II) complexes, e.g.,  $(\text{Ph}_3\text{P})(\text{Et}_2\text{NCS}_2)(\text{CO})\text{RuNOsO}_3$  and  $(\text{Ph}_3\text{P})(\text{Et}_2\text{NCS}_2)(\text{CO})\text{RuNRe}(\text{S}_2\text{CNEt}_2)_2$ , have been structurally characterized.<sup>426</sup> A nitride coupling reaction between  $\text{MoN}(\text{S}_2\text{CNEt}_2)_3$  and  $\text{OsNCl}_2(\text{BPZ}_3)$  afforded  $(\text{Et}_2\text{NCS}_2)_3\text{Mo}=\text{N}-\text{OsCl}_2(\text{HBPZ}_3)$  and released  $\text{N}_2$ .<sup>427</sup>

Luminescent, trinuclear mixed dithiocarbamato-xanthato gold complexes,  $[\text{Au}_3\text{Cl}(\text{S}_2\text{CNR}_2)(\text{S}_2\text{COEt})(\mu\text{-dpmp})]$  (where  $\text{R} = \text{Me}$ ,  $\text{CH}_2\text{Ph}$  and  $\text{dpmp} = \text{bis}(\text{diphenylmethyl})\text{phenylphosphine}$ ,  $\text{PhP}(\text{CH}_2\text{PPh}_2)_2$ ) have been prepared and their optical properties were investigated.<sup>428</sup>

Among the novel organometallic dithiocarbamato derivatives, the nickel derivatives  $\text{C}_6\text{F}_5\text{Ni}(\text{S}_2\text{CNR}_2)$ ,<sup>429</sup> the dimesitylgold derivatives,  $\text{Mes}_2\text{AuS}_2\text{CNR}_2$  ( $\text{R} = \text{Me}$ ,  $\text{Et}$ ,  $\text{CH}_2\text{Ph}$ ),<sup>430</sup> and the tetrahydrotellurophene derivatives  $\text{C}_4\text{H}_8\text{TeI}(\text{S}_2\text{CNR}_2)$  (with  $\text{R} = \text{Et}$ ;  $\text{R}_2 = \text{C}_4\text{H}_6$ ) (also dithiophosphinates),<sup>431</sup> are mentioned. Organotin dithiocarbamates display a remarkable structural diversity.<sup>216,432</sup> Several new crystal structures, including those of  $\text{C}_3\text{SnS}_2\text{CNBu}_2$ ,<sup>433</sup>  $\text{PhSnCl}(\text{S}_2\text{CNBu}^i)_2$ , and  $\text{BuSnCl}(\text{S}_2\text{CNBu}^i)_2$ ,<sup>434,435</sup> are mentioned.

Metal dithiocarbamates have been investigated as single-source precursors for MOCVD nano-sized particles of metal sulfides, such as  $\text{PtS}$  and  $\text{PdS}$ ,<sup>436</sup>  $\text{PbS}$ ,<sup>437,438</sup> and  $\text{Bi}_2\text{S}_3$ ,<sup>439</sup> and tin sulfide thin films.<sup>440</sup> In this respect the thermochemistry of dithiocarbamates (periodically reviewed<sup>441-444</sup>) is important. Molybdenum dialkyldithiocarbamates are highly effective antiwear, antiseize, and antifriction additives for lubricating oils,<sup>445</sup> and are used as vulcanization accelerators.<sup>446</sup>

Dithiocarbamato metal complexes seem to attract some interest as biologically active compounds. Nitrido-technetium ( $^{99\text{m}}\text{Tc}$ ) dithiocarbamato complexes have been prepared and investigated as potential brain<sup>447</sup> or myocardial<sup>448,449</sup> perfusion agents, and as radiological imaging agents.<sup>450</sup> Their uptake by tumor cells has also been investigated.<sup>451,452</sup> Some bis(dialkyldithiocarbamato) cobalt(III) complexes have been evaluated as potential hypoxia-selective cytotoxic agents.<sup>453</sup> The dicyclopentadienyl-vanadium dithiocarbamato derivative  $[\text{Cp}_2\text{V}(\text{S}_2\text{CNEt}_2)][\text{BF}_4]$  was investigated as a novel spermicide (contraceptive).<sup>454</sup> Several aspects of the biological activity of dithiocarbamates,<sup>455</sup> and their toxicity and environmental hazards,<sup>456,457</sup> have been reviewed.

## 1.15.7 REFERENCES

- Livingstone, S. E. In *Comprehensive Coordination Chemistry*; Wilkinson, G.; Gillard, R. D.; McCleverty, J. A., Eds.; Pergamon: Oxford, 1987, Vol. 2, pp 633–659.
- Cras, J. A.; Willemsse, J. In *Comprehensive Coordination Chemistry*; Wilkinson, G.; Gillard, R. D.; McCleverty, J. A., Eds.; Pergamon Press: Oxford, 1987, Vol. 2, pp 588–589.
- Coucovanis, D. *Progr. Inorg. Chem.* **1970**, *11*, 233.
- Eisenberg, R. *Progr. Inorg. Chem.* **1970**, *12*, 295.
- Coucovanis, D. *Progr. Inorg. Chem.* **1979**, *26*, 301.
- Haiduc, I.; Silaghi-Dumitrescu, I. *Coord. Chem. Rev.* **1986**, *74*, 127–270.
- Haiduc, I. *Coord. Chem. Rev.* **1997**, *158*, 325–358.
- Wasson, J. R.; Woltermann, G. M.; Stoklosa, H. J. *Fortschr. Chem. Forsch. (Topics Curr. Chem.)* **1973**, *35*, 65–129.
- Haiduc, I. *Revs. Inorg. Chem.* **1981**, *3*, 353–370.
- Haiduc, I.; Sowerby, D. B.; Lu, S. F. *Polyhedron* **1995**, *14*, 3389–3472.
- Haiduc, I. *J. Organomet. Chem.* **2001**, *623*, 29–42.
- Mehrotra, R. C.; Srivastava, G.; Chauhan, B. P. S. *Coord. Chem. Revs.* **1984**, *55*, 207.
- Molloy, K. C.; Zukerman, J. J. *Acc. Chem. Res.* **1983**, *16*, 386–390.
- Mehrotra, R. C. *Silicon, Germanium, Tin and Lead Compounds* **1986**, *9*, 185–210.
- Tiekink, E. R. T. *Main Group Met. Chem.* **1992**, *15*, 161–169.
- Silvestru, C.; Haiduc, I. *Coord. Chem. Rev.* **1996**, *147*, 117–146.
- Chauhan, H. P. S. *Coord. Chem. Rev.* **1998**, *173*, 1–30.
- Haiduc, I.; King, R. B.; Newton, M. G. *Chem. Rev.* **1994**, *94*, 301–326.
- Husebye, S. *Phosphorus, Sulfur Silicon Relat. Elem.* **1998**, *136–138*, 377–395.
- Kuchen, W.; Hertel, H. *Angew. Chem., Int. Ed. Engl.* **1969**, *8*, 89–97.
- Haiduc, I.; Sowerby, D. B. *Polyhedron* **1996**, *15*, 2469–2521.
- Haiduc, I.; Goh, L. Y. *Coord. Chem. Rev.* **2002**, *224*, 151–170.
- Hoffmann, A. W.; Mahla, F. *Chem. Ber.* **1892**, *25*, 2436.
- Kosolapoff, G. M.; Maier, L. *Organic Phosphorus Compounds*; Wiley-Interscience: New York, 1973, Vol. 6, p 6.
- Higgins, W. A.; Vogel, P. W.; Craig, W. G. *J. Am. Chem. Soc.* **1955**, *77*, 1864.
- Newallis, P. E.; Chupp, J. P.; Groenweghe, C. D. *J. Org. Chem.* **1962**, *27*, 3829.
- Kuchen, W.; Stroelenberg, K.; Metten, *Chem. Ber.* **1963**, *96*, 1733.
- Diemert, K.; Haas, P.; Kuchen, W. *Chem. Ber.* **1978**, *111*, 629–638.
- Diemert, K.; Haas, P.; Kuchen, W. *Z. Anorg. Allg. Chem.* **1982**, *492*, 148–156.
- Pishchimuka, P. *J. Prakt. Chem.* **1911**, *84*, 746; *Chem. Abs.* **1912**, *6*, 989.
- Mastin, T. V.; Norman, G. R.; Wellmeister, W. A. *J. Am. Chem. Soc.* **1945**, *67*, 1662 ( $\text{R} = \text{alkyl}$ ).
- Fletcher, J. H.; Hamilton, J. C.; Hechenbleikner, I.; Hoegberg, E. I.; Sertl, B. J.; Cassaday, J. T. *J. Am. Chem. Soc.* **1950**, *72*, 2461 ( $\text{R} = \text{aryl}$ ).
- Gümgüm, B.; Biricik, N.; Baysal, A. *Phosphorus, Sulfur Silicon Relat. Elem.* **2000**, *167*, 111–116.

34. Kosolapoff, G. M.; Maier, L. *Organic Phosphorus Compounds*; Wiley-Interscience: New York, 1973, Vol. 7, pp 519–521, 587–595.
35. Sasse, K. *Methoden der Organischen Chemie (Houben-Weyl) Band XII/2. Organische Phosphorverbindungen*; G. Thieme Verlag: Stuttgart 1964, pp 684–686.
36. Lefferts, J. L.; Molloy, K. C.; Zukerman, J. J.; Haiduc, I.; Guta, C.; Ruse, D. *Inorg. Chem.* **1980**, *19*, 1662–1670.
37. Andreev, N. A.; Grishina, O. N. *Zh. Obshch. Khim.* **1982**, *52*, 1785–1792; *Chem. Abs.* **1982**, *97*, 216328.
38. Van Zyl, W. E.; Fackler, J. P., Jr. *Phosphorus, Sulfur Silicon Relat. Elem.* **2000**, *167*, 117–132.
39. Grishina, O. N.; Andreev, N. A.; Babkina, E. I. *Zh. Obshch. Khim.* **1978**, *48*, 1321–1324; *Chem. Abs.* **1978**, *89*, 129596.
40. Thomas, C. M.; Neels, A.; Stöckly-Evans, H.; Süß-Fink, G. *J. Organomet. Chem.* **2001**, *633*, 85–90.
41. Annan, T. A.; Kumar, R.; Tuck, D. G. *J. Chem. Soc., Dalton Trans.* **1991**, 11–18.
42. Pinkerton, A. A.; Meseri, Y.; Rieder, C. *J. Chem. Soc., Dalton Trans.* **1978**, 85–90.
43. Boehme, C.; Wipff, G. *Chem. Eur. J.* **2001**, *7*, 1398–1407.
44. Gelmini, L.; Stephan, D. W. *Organometallics* **1987**, *6*, 1515–1522.
45. Müller, A.; Rao, V. V. K.; Diemann, E. *Chem. Ber.* **1971**, *104*, 461–472.
46. Cavell, R. G.; Day, E. D.; Byers, W.; Watkins, P. M. *Inorg. Chem.* **1971**, *10*, 2716–2719.
47. Cavell, R. G.; Day, E. D.; Byers, W.; Watkins, P. M. *Inorg. Chem.* **1972**, *11*, 1591–1597.
48. Baratova, Z. R.; Ivanov, A. V. *Koord. Khim.* **1992**, *18*, 59–63.
49. Moran, M.; Cuadrado, I. *J. Organomet. Chem.* **1986**, *311*, 333–338.
50. Goh, L. Y.; Leong, W. K.; Leung, P.-H.; Weng, Z.; Haiduc, I. *J. Organomet. Chem.* **2000**, *607*, 64–71.
51. Bahn, C. S.; Tan, A.; Harris, S. *Inorg. Chem.* **1998**, *37*, 2770–2778.
52. Diller, H. J.; Keck, H.; Wunderlich, H.; Kuchen, W. *Z. Anorg. Allg. Chem.* **1994**, *620*, 1422–1426.
53. Diller, H. J.; Keck, H.; Wunderlich, H.; Kuchen, W. *J. Organomet. Chem.* **1995**, *489*, 123–127.
54. Jin, G. X.; Herberhold, M. *Transition Met. Chem.* **1999**, *24*, 317–320.
55. Lindner, E.; Matejcek, K. M. *J. Organomet. Chem.* **1972**, *34*, 195–204.
56. Almond, M. J.; Drew, M. G. B.; Sarikahya, F.; Senturk, O. S. *Polyhedron* **1995**, *14*, 1433–1437.
57. Abram, S.; Abram, U.; Spies, H.; Muenze, R. *J. Radioanal. Nucl. Chem.* **1986**, *102*, 309–320.
58. Bellande, E.; Comazzi, V.; Laine, J.; Lecayon, M.; Pasqualini, R.; Duatti, A.; Hoffschir, D. *Nucl. Med. Biol.* **1995**, *22*, 315–320.
59. Leon, B.; Straub, D. K. *Inorg. Chim. Acta* **1989**, *156*, 17–19.
60. Mukherjee, R. N.; Shastri, B. B. S. *Indian J. Chem., Sect. A* **1990**, *29A*, 809–810.
61. Jain, V. K. *Transition Met. Chem.* **1993**, *18*, 312–314.
62. Preisenberger, M.; Bauer, A.; Schier, A.; Schmidbaur, H. *J. Chem. Soc., Dalton Trans.* **1997**, 4753–4758.
63. Gysling, H. J.; Blanton, T. N.; McMillan, S. M.; Lushington, K. J. *Z. Kristallogr.* **1999**, *214*, 309–312.
64. Siasios, G.; Tiekink, E. R. T. *Z. Kristallogr.* **1995**, *210*, 698–698.
65. Neitling, D. C.; Staples, R. J.; Fackler, J. P., Jr. *Inorg. Chim. Acta* **1997**, *263*, 35–48.
66. Van Zyl, W. E.; Lopez-de-Luzuriaga, J. M.; Fackler, J. P., Jr. *J. Mol. Struct.* **2000**, *516*, 99–106.
67. Byron, C.; Malik, M. A.; O'Brien, P.; White, A. J. P.; Williams, D. J. *Polyhedron* **2000**, *19*, 211–215.
68. Shchukin, V. G.; Glinkaya, L. A.; Klevtsova, R. F.; Larionov, S. V. *Russ. J. Coord. Chem.* **2000**, *26*, 331–337.
69. Park, J. H.; O'Brien, P.; White, A. J. P.; Williams, D. J. *Inorg. Chem.* **2001**, *40*, 3629–3631.
70. Landry, C. C.; Hynes, A.; Barron, A. R.; Haiduc, I.; Silvestru, C. *Polyhedron* **1996**, *15*, 391–402.
71. Carballo, R.; Casas, J.; Castellano, E. E.; Sanchez, A.; Sordo, J.; Vazquez-Lopez, E. M.; Zukerman-Schpector, J. *Polyhedron* **1997**, *16*, 3609–3614.
72. Munoz-Hernandez, M. A.; Cea-Olivares, R.; Espinosa-Perez, G.; Hernandez-Ortega, S. *J. Chem. Soc., Dalton Trans.* **1996**, 4135–4141.
73. Munoz-Hernandez, M. A.; Cea-Olivares, R.; Toscano, R. A.; Hernandez-Ortega, S. *Z. Anorg. Allg. Chem.* **1997**, *623*, 642–648.
74. Zukerman-Schpector, J.; Haiduc, I.; Silvestru, C.; Cea-Olivares, R. *Polyhedron* **1995**, *14*, 3087–3094.
75. Sokolov, M. N.; Tkachev, S. V.; Fedorov, V. E.; Fedin, V. P. *Zh. Neorg. Khim.* **1996**, *41*, 1124–1127.
76. Sokolov, M.; Virovets, A.; Nadolinnyi, V.; Hegetschweiler, K.; Fedin, V.; Podberezskaya, N.; Fedorov, V. *Inorg. Chem.* **1994**, *33*, 3503–3509.
77. Ohta, H.; Kita, M.; Kanno, H.; Kojima, M. *Inorg. Chim. Acta* **2000**, *311*, 75–79.
78. Xu, L.; Huang, J.; Yan, D.; Zhang, Q. *Inorg. Chem.* **1996**, *35*, 1389–1392.
79. Drake, J.; Mislankar, A. G.; Ratnani, R. *Inorg. Chem.* **1996**, *35*, 2665–2673.
80. Long, D. L.; Shi, S.; Xin, X. Q.; Luo, B. S.; Chen, L. R.; Huang, X. Y.; Kang, B. S. *J. Chem. Soc., Dalton Trans.* **1996**, 2617–2622.
81. Yu, R. M.; Lu, S. F.; Huang, X. Y.; Wu, Q. J.; Huang, J. Q. *Inorg. Chem.* **1999**, *38*, 3313–3315.
82. Lu, S. F.; Huang, J. Q.; Huang, X. Y.; Wu, Q. J.; Yu, R. M. *Inorg. Chem.* **1999**, *38*, 3801–3805.
83. Lin, X.; Chen, H.; Chi, L.; Lu, C.; Zhuang, H. *Polyhedron* **2000**, *19*, 925–929.
84. Peng, Y.; Lu, S. F.; Fan, H. J.; Wu, Q. J.; Yu, R. M.; Huang, J. Q. *Polyhedron* **2000**, *19*, 733–738.
85. Chen, H.; Lin, X.; Chi, L.; Lu, C.; Zhuang, H.; Huang, J. *Inorg. Chem. Commun.* **2000**, *3*, 331–336.
86. Zheng, H. G.; Tan, W. L.; Low, M. K. L.; Ji, W.; Long, D. L.; Wong, W. T.; Yu, K. B.; Xin, X. Q. *Polyhedron* **1999**, *18*, 3115–3121.
87. Jain, P. U.; Munshi, P.; Walawalkar, M. G.; Rath, S. P.; Rajak, K. K.; Lahiri, G. K. *Polyhedron* **2000**, *19*, 801–808.
88. Hao, Q.; Yang, X.; Jian, F.; Lu, L.; Wang, X.; AbdulRazak, I.; Chantrapromma, S.; Fun, H.-K. *Acta Crystallogr., Sect. C* **2001**, *C57*, 42–44.
89. Casas, J. S.; Castellano, E. E.; Ellena, J.; Haiduc, I.; Sanchez, A.; Sordo, J. *J. Chem. Crystallogr.* **1999**, *29*, 831–836.
90. Liu, C. W.; Pitts, J. T.; Fackler, J. P., Jr. *Polyhedron* **1997**, *16*, 3899–3909.
91. Liu, C. W.; Stubbs, T.; Staples, R. J.; Fackler, J. P., Jr. *J. Am. Chem. Soc.* **1995**, *117*, 9778–9779.
92. Fackler, J. P., Jr.; Staples, R. J.; Liu, C. W.; Stubbs, R. T.; Lopez, C.; Pitts, J. T. *Pure Appl. Chem.* **1998**, *70*, 839–844.
93. Matsumoto, K.; Tanaka, R.; Shimomura, R.; Nakao, Y. *Inorg. Chim. Acta* **2000**, *304*, 293–296.
94. Yamaguchi, T.; Saito, H.; Maki, T.; Ito, T. *J. Am. Chem. Soc.* **1999**, *121*, 10738–10742.
95. Tripathi, U. N. *Phosphorus, Sulfur Silicon Relat. Elem.* **2000**, *159*, 47–54.
96. Yyih, K. H.; Lee, G. H.; Wang, Y. *J. Organomet. Chem.* **1999**, *588*, 125–133.

97. Galakhov, M. V.; Gomez-Sal, P.; Pedraz, T.; Pellinghelli, M. A.; Royo, P.; Tiripicchio, A.; Vazquez de Miguel, A. *J. Organomet. Chem.* **1999**, *579*, 190–197.
98. Jain, V. K.; Jakkal, V. S. *J. Organomet. Chem.* **1996**, *515*, 81–87.
99. Jain, V. K.; Varghese, B. *J. Organomet. Chem.* **1999**, *584*, 159–163.
100. Wieber, M.; Schröpf, M. *Phosphorus, Sulfur Silicon Relat. Elem.* **1995**, *102*, 265–277.
101. Wieber, M.; Lang, S. *Z. Anorg. Allg. Chem.* **1994**, *620*, 1397–1402.
102. Wieber, M.; Lang, S.; Graf, N. *Phosphorus, Sulfur Silicon Relat. Elem.* **1993**, *85*, 31–40.
103. Bond, A. M.; Dakternieks, D.; DiGiacomo, R.; Hollenkamp, A. F. *Organometallics* **1991**, *10*, 3310–3319.
104. Zverev, V. V.; Nizamov, I. S.; Batyeva, E. S.; Al'fonsov, V. A. *Russ. J. Gen. Chem.* **1998**, *68*, 887–892.
105. Keppler, B. K.; Silvestru, C.; Haiduc, I. *Metal-based Drugs* **1994**, *1*, 73–77.
106. Bara, A.; Socaciu, C.; Silvestru, C.; Haiduc, I. *Anticancer Res.* **1991**, *11*, 1651–1655.
107. Arca, M.; Cornia, A.; Devillanova, F. A.; Fabretti, A. C.; Isaia, F.; Lippolis, V.; Verani, G. *Inorg. Chim. Acta* **1997**, *262*, 81–84.
108. Aragoni, M. C.; Arca, M.; Demartin, F.; Devillanova, F. A.; Graiff, C.; Isaia, F.; Lippolis, V.; Tiripicchio, A.; Verani, G. *Eur. J. Inorg. Chem.* **2000**, 2239–2244.
109. Aragoni, M. C.; Arca, M.; Demartin, F.; Devillanova, F. A.; Graiff, C.; Isaia, F.; Lippolis, V.; Tiripicchio, A.; Verani, G. *J. Chem. Soc., Dalton Trans.* **2001**, 2671–2677.
110. Grishina, O. N.; Potekhina, M. I. *Neftekhimiya* **1969**, *9*, 620–624; *Chem. Abs.* **1969**, *71*, 114471.
111. Klamann, D.; Wache, H.; Weyerstahl, P. *Monatsh. Chem.* **1967**, *98*, 911–915; *Chem. Abs.* **1967**, *67*, 73651.
112. Grishina, O. N.; Kosova, L. M. *Zh. Obshch. Khim.* **1975**, *45*, 1758–1760; *Chem. Abs.* **1975**, *83*, 206380.
113. Van Zyl, W. E.; Staples, R. J.; Fackler, J. P., Jr. *Inorg. Chem. Commun.* **1998**, *1*, 51–54.
114. Fackler, J. P., Jr.; Thompson, L. D., Jr. *Inorg. Chim. Acta* **1981**, *48*, 45–52.
115. Toropova, V. F.; Cherkasov, R. A.; Savel'eva, N. I.; Grigor'eva, L. A.; Shergina, I. V.; Ovchinnikov, V. V.; Pudovik, A. N. *Zh. Obshch. Khim.* **1971**, *41*, 1673–1676; *Chem. Abs.* **1972**, *76*, 28373.
116. Gabdullin, M. G.; Garifzyanov, A. R.; Toropova, V. F. *Zh. Neorg. Khim.* **1984**, *29*, 2420–2421; *Chem. Abs.* **1984**, *101*, 199024.
117. Usova, S. V.; Rakitina, E. V.; Grishina, O. N. *Zh. Neorg. Khim.* **1984**, *29*, 145–149; *Chem. Abs.* **1984**, *100*, 164520.
118. Silaghi-Dumitrescu, I.; Grecu, R.; Silaghi-Dumitrescu, L.; Haiduc, I. *Studia Univ. Babeş-Bolyai, Chem.* **1989**, 97–101; *Chem. Abs.* **1991**, *114*, 195075.
119. Haiduc, I.; Silaghi-Dumitrescu, I.; Grecu, R.; Constantinescu, R.; Silaghi-Dumitrescu, L. *J. Mol. Struct.* **1984**, *114*, 467–470.
120. Solozhenkin, P. M.; Usova, S. V.; Grishina, O. N. *Zh. Neorg. Khim.* **1975**, *20*, 2737–2741; *Chem. Abs.* **1976**, *84*, 53318.
121. Cozar, O.; Semeniuc, R.; Znamirovski, V.; Haiduc, I. *Rev. Roum. Phys.* **1988**, *33*, 1131–1138.
122. Lorenz, D. R.; Johnson, D. K.; Stoklosa, H. J.; Wasson, J. R. *J. Inorg. Nucl. Chem.* **1974**, *36*, 1184–1186.
123. Haiduc, I.; David, L.; Cozar, O.; Micu-Semeniuc, R.; Mezei, G.; Armenean, M. *J. Mol. Struct.* **1999**, 153–157, 482–483.
124. Colclough, T.; Brois, S. J. *Eur. Pat. Appl.* **1987**, *107*, 216596; *Chem. Abs.* **1987**, *107*, 23500.
125. Cherezova, E. N.; Cherkasova, O. A.; Mukmeneva, N. A. *Zh. Obshch. Khim.* **1992**, *62*, 781–785; *Chem. Abs.* **1993**, *118*, 213171.
126. Andreev, N. A.; Ovcharov, V. I.; Grishina, O. N.; Mazitova, F. N. *Izv. Vyssh. Uchebn. Zaved., Khim. Khim. Tekhnol.* **1986**, *29*, 101–105; *Chem. Abs.* *105*, 25586.
127. Solozhenkin, P. M.; Kabanova, L. K.; Grishina, O. N.; Bondarenko, V. A. *Izv. Akad. Nauk Tadzh. SSR, Otd. Fiz.-Mat. Geol.-Khim. Nauk* **1970**, *73*, 48–54; *Chem. Abs.* **1970**, *72*, 115497.
128. Solozhenkin, P. M.; Usova, S. V.; Grishina, O. N. *Izv. Akad. Nauk Tadzh. SSR, Otd. Fiz.-Mat. Geol.-Khim. Nauk* **1975**, *83*, 62–69; *Chem. Abs.* **1975**, *83*, 212149.
129. Turaev, Kh.; Khudaibergenov, U.; Ganiev, A. G.; Yuldasheva, K. T. *Dokl. Akad. Nauk UzSSR* **1987**, *109*, 31–33; *Chem. Abs.* **1988**, *109*, 28316.
130. Turaev, Kh.; Ganiev, A. G. *Uzb. Khim. Zh.* **1998**, *133*, 14–17; *Chem. Abs.* **2000**, *133*, 22976.
131. Chen, H. W.; Paparizos, C.; Fackler, J. P., Jr. *Inorg. Chim. Acta* **1985**, *96*, 137–149.
132. Walther, B. Z. *Anorg. Allg. Chem.* **1972**, *395*, 112–118.
133. Pudovik, A. N.; Cherkasov, R. A.; Bykova, I. V.; Evstaf'ev, G. I.; Zemskaya, Z. I.; Nazypov, M. N. *Zh. Obshch. Khim.* **1972**, *42*, 76–80; *Chem. Abs.* **1972**, *77*, 19753.
134. Nizamov, I. S.; Sergeenko, G. G.; Batyeva, E. S.; Pudovik, A. N. *Zh. Obshch. Khim.* **1996**, *66*, 521; *Chem. Abs.* **1997**, *126*, 8220.
135. Nizamov, I. S.; Kuznetsov, V. A.; Batyeva, E. S.; Al'fonsov, V. A. *Izv. Akad. Nauk, Ser. Khim.* **1992**, *118*, 2457–2458; *Chem. Abs.* **1993**, *118*, 169217.
136. Nizamov, I. S.; Kuznetsov, V. A.; Batyeva, E. S. *Phosphorus, Sulfur Silicon Relat. Elem.* **1994**, *88*, 67–73.
137. Nizamov, I. S.; Kuznetsov, V. A.; Batyeva, E. S.; Al'fonsov, V. A.; Pudovik, A. N. *Heteroat. Chem.* **1994**, *5*, 107–111.
138. Nizamov, I. S.; Kuznetsov, V. A.; Batyeva, E. S. *Heteroat. Chem.* **1997**, *8*, 323–328.
139. Nizamov, I. S.; Matseevskii, A. V.; Batyeva, E. S. *Russ. J. Gen. Chem.* **1998**, *68*, 1677–1678.
140. Nizamov, I. S.; Matseevskii, A. V.; Batyeva, E. S.; Azancheev, N. M.; Vandyukova, I. I.; Shagidullin, R. R. *Heteroat. Chem.* **1999**, *10*, 399–403.
141. Nizamov, I. S.; Matseevskii, A. V.; Batyeva, E. S. *Russ. Chem. Bull.* **1998**, *47*, 2049–2050.
142. Bunsen, R. *Liebigs Ann. Chem.* **1843**, *46*, 21.
143. Foerster, M.; Hertel, H.; Kuchen, W. *Angew. Chem., Int. Ed. Engl.* **1970**, *9*, 811.
144. Müller, A.; Werle, P. *Chem. Ber.* **1971**, *104*, 3782–3793.
145. Pascu, S.; Silaghi-Dumitrescu, L.; Blake, A. J.; Haiduc, I.; Sowerby, D. B. *Polyhedron* **1998**, *17*, 4115–4119.
146. Müller, A.; Werle, P.; Christophliemk, P.; Tossidis, I. *Chem. Ber.* **1973**, *106*, 3601–3607.
147. Casey, A. T.; Ham, N. S.; Mackey, D. J.; Martin, R. L. *Aust. J. Chem.* **1970**, *23*, 1117–1123.
148. Kuchen, W.; Foerster, M.; Hertel, H.; Hoehn, B. *Chem. Ber.* **1972**, *105*, 3310–3316.
149. Casey, A. T.; Mackey, D. J.; Martin, R. L. *Aust. J. Chem.* **1971**, *24*, 1587–1598.
150. Kury, R.; Vahrenkamp, H. J. *J. Chem. Res., Synop.* **1982**, 31.

151. Johnstone, D.; Fergusson, J. E.; Robinson, W. T.; *Bull. Chem. Soc. Jap.* **1972**, *45*, 3721.
152. Albinati, A.; Casarin, M.; Maccato, C.; Pandolfo, L.; Vittadini, A. *Inorg. Chem.* **1999**, *38*, 1145–1152.
153. McCormick, B. J.; Featherstone, J. L.; Stoklosa, H. J.; Wasson, J. R. *Inorg. Chem.* **1973**, *12*, 692–693.
154. Day, E. D.; McClung, R. E. D. *Inorg. Chem.* **1976**, *15*, 571–577.
155. Baratova, Z. R.; Solozhenkin, P. M.; Semenov, E. V. *Dokl. Akad. Nauk SSSR [Phys. Chem.]* **1977**, *236*, 1137–1139; *Chem. Abs.* **1978**, *88*, 15311.
156. Baratova, Z. R.; Solozhenkin, P. M.; Semenov, E. V.; Mel'nik, Ya. I.; Grishina, O. N. *Dokl. Akad. Nauk Tadzh. SSR* **1979**, *22*, 478–482; *Chem. Abs.* **1980**, *92*, 101872.
157. Baratova, Z. R.; Semenov, E. V.; Solozhenkin, P. M.; Prabhananda, B. S. *Inorg. Chem.* **1982**, *21*, 57–60.
158. Silaghi-Dumitrescu, L.; Avila-Diaz, L. A.; Haiduc, I. *Rev. Roum. Chim.* **1986**, *31*, 335–340.
159. Silaghi-Dumitrescu, L.; Silaghi-Dumitrescu, I.; Haiduc, I.; Toscano, R. A.; Garcia-Montalvo, V.; Cea-Olivares, R. Z. *Anorg. Allg. Chem.* **1999**, *625*, 347–351.
160. Cea-Olivares, R.; Ebert, K. H.; Silaghi-Dumitrescu, L.; Haiduc, I. *Heteroatom. Chem.* **1997**, *8*, 317–321.
161. Silaghi-Dumitrescu, L.; Haiduc, A.; Cervantes-Lee, F.; Pannell, K. H. *Rev. Roum. Chim.* **1997**, *42*, 587–592.
162. Herberhold, M.; Haumaier, L. *Chem. Ber.* **1983**, *116*, 2896–2902.
163. Casey, A. T.; Thackeray, J. R. *Aust. J. Chem.* **1975**, *28*, 471–479.
164. Bond, A. M.; Casey, A. T.; Thackeray, J. R. *Inorg. Chem.* **1974**, *13*, 84–89.
165. Lindner, E.; Ebinger, H. M. *J. Organometal. Chem.* **1974**, *66*, 103–110.
166. Abel, E. W.; Beckett, M. A.; Bates, P. A.; Hursthouse, M. B. *Polyhedron* **1988**, *7*, 1855–1859.
167. Haiduc, I.; Silaghi-Dumitrescu, L. *J. Organomet. Chem.* **1982**, *225*, 225–232.
168. Silaghi-Dumitrescu, L.; Haiduc, I.; Weiss, J. *J. Organomet. Chem.* **1984**, *263*, 159–165.
169. Silaghi-Dumitrescu, L.; Haiduc, I. *J. Organomet. Chem.* **1983**, *259*, 65–69.
170. Silvestru, C.; Silaghi-Dumitrescu, L.; Haiduc, I.; Begley, M. J.; Nunn, M.; Sowerby, D. B. *J. Chem. Soc., Dalton Trans.* **1986**, 1031–1034.
171. Sowerby, D. B.; Begley, M. J.; Silaghi-Dumitrescu, L.; Silaghi-Dumitrescu, I.; Haiduc, I. *J. Organomet. Chem.* **1994**, *469*, 45–53.
172. Silaghi-Dumitrescu, L.; Haiduc, I. *J. Organomet. Chem.* **1983**, *252*, 295–299.
173. Silaghi-Dumitrescu, L.; Silaghi-Dumitrescu, I.; Haiduc, I. *Rev. Roum. Chim.* **1989**, *34*, 305–315.
174. Rao, S. R. *Xanthates and Related Compounds* **1971**, Marcell Dekker: New York.
175. Reid, E. E. *Organic Chemistry of Bivalent Sulphur* **1962**, Vol. 4; Chemical Publishing: New York.
176. Vogel, A. I. *A Textbook of Practical Organic Chemistry* **1968**, Wiley, London.
177. Hunt, M. R.; Winter, G. *Aust. J. Chem.* **25**, 417.
178. Kadyrov, A. K.; Alavidinov, L. B.; Islamova, D. V.; Ismatullaeva, M. G. *Dokl. Akad. Nauk Uzbek. SSR* **1989**, 40–41.
179. Kumar, R.; Ansari, M. N.; Jain, M. C.; Khan, A. A. *Indian J. Chem., Sect. A* **1987**, *26A*, 74–75.
180. Kumar, R.; Ansari, M. N.; Jain, M. C.; Khan, A. A. *J. Indian Chem. Soc.* **1987**, *64*, 12–14.
181. Tang, K.; Jin, X.; Long, Y.; Cui, P.; Tang, Y. *J. Chem. Res., Synop.* **2000**, 452–453.
182. Lopez, G.; Sanchez, G.; Garcia, G.; Garcia, J.; Sanmartin, A.; Santana, M. D. *Polyhedron* **1991**, *10*, 2821–2825.
183. Simpson, R. D.; Bergman, R. G. *Angew. Chem. Int., Ed. Engl.* **1992**, *31*, 220–223.
184. Mandal, S. K.; Ho, D. M.; Orchin, M. *Organometallics* **1993**, *12*, 1714.
185. Simpson, R. D.; Bergman, R. G. *Organometallics* **1992**, *11*, 4306–4315.
186. Legzdins, P.; Rettig, S. J.; Ross, K. J. *Organometallics* **1994**, *13*, 569–577.
187. Darensbourg, D. J.; Sanchez, K. M.; Reibenspies, J. H.; Rheingold, A. L. *J. Am. Chem. Soc.* **1989**, *111*, 7094–7103.
188. Bhattacharya, S. N.; Pakdamana, A. S. *Asian J. Chem.* **1989**, *1*, 370–375.
189. Pakdamana, A. S.; Fadayan, M. *Asian J. Chem.* **1993**, *5*, 287; *Chem. Abs.* **1993**, *119*, 226097.
190. Darensbourg, J.; Niezgoda, S. A.; Draper, J. D.; Reibenspies, J. H. *J. Am. Chem. Soc.* **1998**, *120*, 4690–4698.
191. Carmichael, A. J.; Duncalf, D. J.; Wallbridge, M. G. H.; McCamley, A. *J. Chem. Soc., Dalton Trans.* **2000**, 1219–1223.
192. Casey, A. T.; Vecchio, A. M. *J. Coord. Chem.* **1988**, *16*, 375–381.
193. Casey, A. T.; Vecchio, A. M. *Trans. Met. Chem.* **1986**, *11*, 366–368.
194. Moran, M.; Cuadrado, I.; Munoz-Reja, C.; Masaguer, J. R.; Losada, L. *J. Chem. Soc., Dalton Trans.* **1988**, 149–154.
195. Moran, M.; Cuadrado, I.; Masaguer, J. R.; Losada, J.; Foces-Foces, C.; Cano, F. H. *Inorg. Chim. Acta* **1988**, *143*, 59–70.
196. McConnachie, C. A.; Stiefel, E. I. *Inorg. Chem.* **1999**, *38*, 964–972.
197. Singhal, G. H.; Botto, R. I.; Brown, L. D.; Colle, K. S. *J. Solid State Chem.* **1994**, *109*, 166–171.
198. Bessergenev, V. G.; Ivanova, E. N.; Kovalevskaya, Y. A.; Gromylov, S. A.; Kirichenko, V. N. *Mater. Res. Bull.* **1995**, *30*, 1393–1400.
199. Cheon, J.; Talaga, D. S.; Zink, J. I. *Chem. Mater.* **1997**, *9*, 1208–1212.
200. Ballester, L.; Gutierrez-Alonso, A.; Perez-Serrano, S.; Perpignan, M. F. *Inorg. Chem.* **1991**, *30*, 2954.
201. Contreras, R.; Valderama, M.; Riveros, O.; Moscoso, R.; Boys, D. *Polyhedron* **1996**, *15*, 183–190.
202. Pradhan, P.; Mukhopadhyay, S.; Bera, D. C.; Simonnet, C.; Secheresse, F.; Bhattacharyya, R. *Inorg. Chem. Comm.* **1999**, *2*, 495–497.
203. Rossi, R.; Marchi, A.; Magon, L.; Casellato, U.; Grazziani, R. *J. Chem. Soc., Dalton Trans.* **1990**, 2923.
204. Contreras, R.; Lainez, R. F.; Pizzano, A.; Sanchez, L.; Carmona, E.; Monge, A.; Ruiz, C. *Organometallics* **2000**, *19*, 261–268.
205. Contreras, R.; Lainez, R. F.; Pizzano, A.; Sanchez, L.; Carmona, E.; Monge, A.; Ruiz, C. *Organometallics* **1995**, *14*, 589–591.
206. Tiekink, E. R. T.; Winter, G. *Revs. Inorg. Chem.* **1992**, *12*, 183–302.
207. Cox, M. J.; Tiekink, E. R. T. *Revs. Inorg. Chem.* **1997**, *17*, 1–23.
208. Buntine, M. A.; Hall, V. J.; Kosovel, F. J.; Tiekink, E. R. T. *J. Phys. Chem.* **1998**, *A102*, 2472–2482.
209. Siasios, G.; Tiekink, E. R. T. *Z Kristallogr.* **1992**, *198*, 139.
210. Uson, R.; Fornies, J.; Falvello, L. R.; Thomas, M.; Ara, I.; Uson, I. *Inorg. Chim. Acta* **1995**, *232*, 35–42.
211. Cullen, E. P.; Doherty, J.; Manning, A. R.; McArdle, P.; Cunningham, D. *J. Organomet. Chem.* **1988**, *348*, 109–122.
212. Coto, A.; Tenorio, M. J.; Puerta, M. C.; Valerga, P. *Organometallics* **1998**, *17*, 4392–4399.

213. Cox, M. J.; Tiekink, E. R. T. *Z. Kristallogr.* **1999**, *214*, 242–250.
214. Cox, M. J.; Tiekink, E. R. T. *Z. Kristallogr.* **1999**, *214*, 184–190.
215. Cox, M. J.; Tiekink, E. R. T. *Z. Kristallogr.* **1999**, *214*, 486–491.
216. Cox, M. J.; Tiekink, E. R. T. *Z. Kristallogr.* **1999**, *214*, 584–590.
217. Bhargava, S.; Bohra, R.; Mehrotra, R. C. *J. Cryst. Spectrosc. Res.* **1991**, *21*, 281–285.
218. Sanchez-Pelaez, A. E.; Perpignan, M. F.; Gutierrez-Puebla, E.; Monge, A.; Ruiz-Valero, C. *J. Organomet. Chem.* **1990**, *384*, 79–92.
219. Sanchez-Pelaez, A. E.; Perpignan, M. F.; Santos, A. *J. Organomet. Chem.* **1985**, *296*, 367–375.
220. Carmona, E.; Contreras, L.; Sanchez, L. J.; Gutierrez-Puebla, E.; Monge, A. *J. Chem. Soc., Dalton Trans.* **1989**, 2003–2009.
221. Du, S.; Zhu, N.; Chen, P.; Wu, X. *Angew. Chem.* **1992**, *104*, 1098–1100.
222. Du, S.; Zhu, N.; Chen, P.; Wu, X. *Angew. Chem., Int. Ed. Engl.* **1992**, *31*, 1085–1087.
223. Zhu, N.; Du, S.; Chen, P.; Wu, X. *J. Cluster Chem.* **1992**, *3*, 201–218.
224. He, J.; Wu, Y.; Wang, X.; Liu, Y. *J. Labelled Compd. Radiopharm.* **1997**, *39*, 645–650.
225. Lorenz, B.; Schmidt, K.; Hiller, W.; Abram, U.; Huebner, R. *Inorg. Chim. Acta* **1993**, *208*, 195–199.
226. Blanchard, S. S.; Nicholson, T.; Davidson, A.; Jones, A. G. *Inorg. Chim. Acta* **1996**, *241*, 95–100.
227. Leirer, M.; Knorr, G.; Vogler, A. *Inorg. Chem. Commun.* **1998**, 49–50.
228. Pramanik, A.; Bag, N.; Ray, D.; Lahiri, G. K.; Chakravorty, A. *Inorg. Chem.* **1991**, *30*, 410–417.
229. Marko, L.; Gervasio, G.; Stanghellini, P. L.; Bor, G. *Transition Met. Chem.* **1985**, *10*, 344–348.
230. Cox, M. J.; Tiekink, E. R. T. *Z. Kristallogr.* **1996**, *211*, 753–754.
231. Craciunescu, D. G.; Scarcia, V.; Furlani, A.; Papaioannou, A.; Iglesias, E. P.; Alonso, M. P. *In Vivo* **1991**, *5*, 329–332.
232. Abrahams, B. F.; Hoskins, B. F.; Tiekink, E. R. T.; Winter, G. *Aus. J. Chem.* **1988**, *41*, 1117–1122.
233. Hoskins, B. F.; Tiekink, E. R. T.; Winter, G. *Z. Kristallogr.* **1985**, *172*, 257–261.
234. Prisyazhnik, A. I.; Bel'skii, V. K.; Kolchinskii, E. V. *Koord. Khim. (Russ.)* **1987**, *13*, 119–120.
235. Romanenko, G. V.; Podberezhskaya, N. V.; Bakakin, V. *Zh. Strukt. Khim.* **1997**, *28*, 98–104.
236. Cox, M. J.; Tiekink, E. R. T. *Z. Kristallogr.* **1996**, *211*, 111–113.
237. Travnicek, Z.; Pastorek, R.; Marek, J. *Coll. Czech. Chem. Commun.* **1994**, *59*, 616–619.
238. Cox, M. J.; Tiekink, E. R. T. *Z. Kristallogr.* **1997**, *211*, 350.
239. Cox, M. J.; Tiekink, E. R. T. *Z. Kristallogr.* **1996**, *211*, 750.
240. Cox, M. J.; Tiekink, E. R. T. *Z. Kristallogr.* **1996**, *211*, 575.
241. Edwards, A. J.; Hoskins, B. F.; Winter, G. *Aust. J. Chem.* **1986**, *39*, 1983–1991.
242. Travnicek, Z.; Pastorek, R.; Sindelar, Z.; Klicka, R.; Marek, J. *Polyhedron* **1995**, *14*, 3627–3633.
243. Travnicek, Z.; Pastorek, R.; Sindelar, Z.; Kamenicek, J.; Marek, J. *Polyhedron* **1996**, *15*, 2975–2981.
244. Travnicek, Z.; Pastorek, R.; Sindelar, Z.; Marek, J. *J. Coord. Chem.* **1998**, *44*, 193–204.
245. Travnicek, Z.; Pastorek, R.; Sindelar, Z.; Marek, J. *Transition Met. Chem.* **1999**, *24*, 38–41, 633–637.
246. Travnicek, Z.; Pastorek, R.; Sindelar, Z.; Klicka, R.; Marek, J. *Transition Met. Chem.* **1996**, *21*, 81–84.
247. Travnicek, Z.; Malon, M.; Sindelar, Z.; Marek, J. *Transition Met. Chem.* **1999**, *24*, 156–159.
248. Travnicek, Z.; Pastorek, R.; Sindelar, Z.; Kasperek, F.; Marek, J. *Polyhedron* **1997**, *16*, 2573–2579.
249. Gable, R. W.; Hoskins, B. F.; Winter, G. *Inorg. Chim. Acta* **1985**, *96*, 151–159.
250. Choudhury, S. B.; Ray, D.; Chakravorty, A. *Inorg. Chem.* **1990**, *29*, 4603–4611.
251. Rogers, R. D.; Adrowski, M. J.; Bond, A. H. *J. Chem. Crystallogr.* **1994**, *24*, 707–710.
252. Colton, R.; Tedesco, V. *Inorg. Chim. Acta* **1991**, *183*, 161–166.
253. Colton, R.; Tedesco, V. **1992**, *202*, 95–100.
254. Colton, R.; Tedesco, V. **1993**, *210*, 193–201.
255. Isci, H.; Dag, O.; Mason, W. R. *Inorg. Chem.* **1993**, *32*, 3909–3914.
256. Tiekink, E. R. T. *J. Coord. Chem.* **1988**, *17*, 239–243.
257. Jin, X.; Liu, T.; Tang, K. L.; Xia, T. B.; Tang, Y. O. *Jiegou Huaxue* **1995**, *14*, 224–228; *Chem. Abs.* **1995**, *123*, 101297.
258. Siasios, G.; Tiekink, E. R. T. *Z. Kristallogr.* **1993**, *205*, 261–270.
259. Siasios, G.; Tiekink, E. R. T. *Z. Kristallogr.* **1993**, *204*, 95–105.
260. Collins, A. J.; Tiekink, E. R. T. *Z. Kristallogr.* **1995**, *210*, 51–55.
261. Bardaji, M.; Jones, P. G.; Laguna, A.; Laguna, M. *Organometallics* **1995**, *14*, 1310–1315.
262. Assefa, Z.; Staples, R. J.; Fackler, J. P., Jr. *Inorg. Chem.* **1994**, *33*, 2790–2793.
263. Cheon, J.; Talaga, D. S.; Zink, J. L. *J. Am. Chem. Soc.* **1997**, *119*, 163–168.
264. Tomlin, D. W.; Cooper, T. M.; Zelmon, D. E.; Gebeyehu, Z.; Hughes, J. M. *Acta Crystallogr., Sect. C* **1999**, *C55*, 717–719.
265. Abrahams, B. F.; Hoskins, B. F.; Winter, G.; Tiekink, E. R. T. *Inorg. Chim. Acta* **1988**, *150*, 147–148.
266. Jin, X.; Tang, K.; Jia, S.; Tang, Y. *Polyhedron* **1996**, *15*, 2617–2622.
267. Tiekink, E. R. T. *Acta Crystallogr., Sect. C* **1987**, *C43*, 448–450.
268. Hounslow, A. M.; Tiekink, E. R. T. *J. Cryst. Spectr. Res.* **1991**, *21*, 133–137.
269. Casas, J. S.; Castellano, E. E.; Ellena, J.; Haiduc, I.; Sanchez, A.; Semeniuc, R. F.; Sordo, J. *Inorg. Chim. Acta* **2002**, *329*, 71–78.
270. Tiekink, E. R. T. *J. Organomet. Chem.* **1987**, *322*, 1–10.
271. Tiekink, E. R. T. *Acta Crystallogr., Sect. C* **1994**, *C50*, 861–862.
272. Abram, S.; Abram, U. *Inorg. Chim. Acta* **1988**, *153*, 135–136.
273. Bessergenev, V. G.; Ivanova, E. N.; Kovalevsky, Yu. A.; Gromilov, S. A.; Kirichenko, V. N.; Larionov, S. V. *Inorg. Mater. (Transl. of Neorg. Mater.)* **1996**, *32*, 592–596.
274. Casas, J. S.; Castineiras, A.; Haiduc, I.; Sanchez, A.; Semeniuc, R. F.; Sordo, J. *Syn. React. Inorg. Metal-Org. Chem.* **2001**, *31*, 725–736.
275. Leonova, T. G.; Glinskaya, L. A.; Klevtsova, R. F.; Batrachenko, N. I.; Larionov, S. V. *Russ. J. Coord. Chem.* **2000**, *26*, 616–620.
276. Donoghue, N.; Tiekink, E. R. T. *Appl. Organomet. Chem.* **1993**, *7*, 109–117.
277. Donoghue, N.; Tiekink, E. R. T. *J. Organomet. Chem.* **1991**, *420*, 179–184.
278. Ng, S. W.; Rae, A. D. *Acta Crystallogr., Sect. C* **2000**, *C56*, e47–e48.

279. Cox, M. J.; Mohamed-Ibrahim, M. I.; Tiekink, E. R. T. *Main Group Met. Chem.* **1997**, *20*, 207–212.
280. Cox, M. J.; Mohamed-Ibrahim, M. I.; Tiekink, E. R. T. *Z. Kristallogr.-New Cryst. Str.* **1998**, *213*, 383–384.
281. Dakternieks, D.; Zhu, H.; Masi, D.; Mealli, C. *Inorg. Chem.* **1992**, *31*, 3601–3606.
282. Dakternieks, D.; Zhu, H.; Masi, D.; Mealli, C. *Inorg. Chim. Acta* **1993**, *211*, 155–160.
283. Snow, M. R.; Tiekink, E. R. T. *Aust. J. Chem.* **1987**, *40*, 743–750.
284. Hoskins, B. F.; Tiekink, E. R. T. *Inorg. Chim. Acta* **1985**, *99*, 177–182.
285. Cox, M. J.; Tiekink, E. R. T. *Z. Kristallogr.* **1998**, *213*, 487–492.
286. Hounslow, A. M.; Lincoln, S. F.; Tiekink, E. R. T. *J. Chem. Soc., Dalton Trans.* **1989**, 233–236.
287. Karra, R.; Singh, Y. P.; Bohra, R.; Rai, A. K. *J. Crystallogr. Spectrosc. Res.* **1992**, *22*, 721–724.
288. Blake, A. J.; Pearson, M.; Sowerby, D. B.; Woodhead, P. P. *Acta Crystallogr., Sec. C* **1997**, *C53*, 583–585.
289. Tiekink, E. R. T. *Main Group Met. Chem.* **1994**, *17*, 727–736.
290. Cox, M. J.; Tiekink, E. R. T. *Z. Kristallogr.-New Cryst. Str.* **1998**, *213*, 533–534.
291. Tiekink, E. R. T. *J. Crystallogr. Spectrosc. Res.* **1992**, *22*, 231–236.
292. Tiekink, E. R. T. *Acta Crystallogr., Sect. C* **1986**, *C42*, 633–634.
293. Hoskins, B. F.; Tiekink, E. R. T. *Inorg. Chim. Acta* **1985**, *96*, L79–L81.
294. Cox, M. J.; Tiekink, E. R. T. *Z. Kristallogr.* **1997**, *212*, 811–814.
295. Drake, J. E.; Drake, R. J.; Khasrou, L. N.; Ratnani, R. *Inorg. Chem.* **1996**, *35*, 2831–2835.
296. Wieber, M.; Rohse, S. *Phosphorus, Sulfur Silicon Relat. Elem.* **1991**, *55*, 79–83.
297. Srivastava, V.; Basumatary, J. K.; Singh, A. K.; Singh, T. P.; Saxena, A. R. *Phosphorus, Sulfur Silicon Relat. Elem.* **1993**, *85*, 175–181.
298. Cras, J. A.; Willemse, J. In *Comprehensive Coordination Chemistry*; Wilkinson, G.; Gillard, R. D.; McCleverty, J. A., Eds.; Pergamon Press: Oxford, 1987, Vol. 1, pp 584–585, 646.
299. Jansons, E. *Usp. Khim.* **1976**, *45*, 2030–2049.
300. Scheithauer, S.; Mayer, R. *Thio- and Dithiocarboxylic Acids and their Derivatives (Topics in Sulfur Chemistry)*; Senning, A., Ed. Vol. 4) Georg Thieme: Stuttgart, 1979.
301. Jansons, E. *Latv. Kim. Z.* **1992**, 408–411.
302. Mezaraups, G. *Latv. PSR Zinat Akad. Vestis* **1987**, 192–198.
303. Bellitto, C. *Comments Inorg. Chem.* **1988**, *8*, 101–124.
304. Houben, J. *Chem. Ber.* **1906**, *39*, 3503.
305. Houben, J.; Pohl, H. *Chem. Ber.* **1907**, *40*, 1303, 1725.
306. Houben, J.; Schultze, K. M. L. *Chem. Ber.* **1911**, *44*, 3226.
307. Roberie, T.; Hoberman, A. E.; Selbin, J. *J. Coord. Chem.* **1979**, *9*, 79.
308. Bost, R. W.; Shealy, O. I. *J. Am. Chem. Soc.* **1951**, *73*, 24.
309. Mayer, R.; Scheithauer, S.; Kunz, D. *Chem. Ber.* **1965**, *98*, 829.
310. Mayer, R.; Scheithauer, S.; Kunz, D. *Chem. Ber.* **1966**, *99*, 1393.
311. Kato, S.; Mizuta, M. *Bull. Chem. Soc. Jpn.* **1972**, *45*, 3492.
312. Trepanier, D. L.; Reifschneider, W.; Shumaker, W.; Tharpe, D. S. *J. Org. Chem.* **1965**, *30*, 2228.
313. Wood, J. H.; Bost, R. W. *J. Am. Chem. Soc.* **1937**, *59*, 1011.
314. Kurzer, F.; Lawson, A. *Org. Syn.* **1962**, *42*, 100.
315. Cohen, I. A.; Basolo, F. *Inorg. Chem.* **1964**, *3*, 1641.
316. Bähr, G.; Schleitzer, G. *Chem. Ber.* **1955**, *88*, 1771.
317. Adams, H.; McHugh, P. E.; Morris, M. J.; Spey, S. F.; Wright, P. J. *J. Organomet. Chem.* **2001**, *619*, 209–217.
318. Gomper, R.; Schmidt, R. R.; Kutter, E. *Liebigs Ann. Chem.* **1965**, *684*, 37.
319. Darensbourg, D. J.; Adams, M. J.; Yarbrough, J. C. *Inorg. Chem. Commun.* **2002**, *5*, 38–41.
320. Kato, S.; Chiba, S.; Mizuta, M.; Ishida, M. *Z. Naturforsch., Teil B.* **1982**, *37b*, 736.
321. Kato, S.; Yamada, S.; Goto, H.; Terashima, K.; Mizuta, M.; Katada, T. *Z. Naturforsch., Teil B* **1980**, *35*, 458.
322. Kato, S.; Kitaoka, N.; Niyomura, O.; Kitoh, Y.; Kanda, T.; Ebihara, M. *Inorg. Chem.* **1999**, *38*, 496–506.
323. Kato, S.; Mizuta, M. *Int. J. Sulfur Chem.* **1972**, *2A*, 275–277.
324. Benn, R.; Cronje, S.; Kruger, G. J.; Lombard, A.; Raubenheimer, H. G.; Rufinska, A.; Scott, F. *Organometallics* **1990**, *9*, 1071.
325. Matsubayashi, G.; Nakatsu, K.; Nishigaki, S.; Tanaka, T.; Tatsumisago, M. *J. Chem. Soc., Dalton Trans.* **1982**, 121.
326. Hughes, A. K.; Malget, J. M.; Goeta, A. E. *J. Chem. Soc., Dalton Trans.* **2001**, 1927–1928.
327. Lindner, E.; Grimmer, R.; Weber, H. *Angew. Chem.* **1970**, *82*, 639.
328. Lindner, E.; Grimmer, R.; Weber, H. *J. Organomet. Chem.* **1970**, *25*, 493.
329. Miyashita, A.; Yamamoto, A. *J. Organomet. Chem.* **1976**, *113*, 187.
330. Camus, A.; Marsich, N.; Manotti, J.; Lanfredi, A. M.; Ugozzoli, F. *Inorg. Chim. Acta* **1990**, *175*, 193–202.
331. Commereuc, D.; Douek, I.; Wilkinson, G. *J. Chem. Soc. A* **1970**, 1771.
332. Plazzi, A.; Busetto, L.; Graziani, M. *J. Organomet. Chem.* **1971**, *30*, 273.
333. Albano, V. G.; Bellon, P. L.; Ciani, G. *J. Organomet. Chem.* **1971**, *31*, 75.
334. Ashworth, T. V.; Singleton, E.; Laing, M. *J. Chem. Soc., Chem. Commun.* **1976**, 875.
335. Robinson, S. D.; Sahajpal, A. *J. Organomet. Chem.* **1975**, *99*, C65.
336. DelZotto, A.; Rocchini, E.; Pichierri, F.; Zangrando, E.; Rigo, P. *Inorg. Chim. Acta* **2000**, *299*, 180–191.
337. Haigh, C. W. *Polyhedron* **1995**, *14*, 2871–2878.
338. Bonamico, M.; Dessy, G.; Fares, V. *Chem. Commun.* **1969**, 324.
339. Bonamico, M.; Dessy, G.; Fares, V. *Chem. Commun.* **1969**, 1106.
340. Bonamico, M.; Dessy, G.; Fares, V.; Flamini, A.; Scaramuzza, L. *J. Chem. Soc., Dalton Trans.* **1976**, 1743.
341. Fackler, J. P., Jr.; Del Niera, R.; Campana, C.; Trzcinka-Bancroft, B. *J. Am. Chem. Soc.* **1984**, *106*, 7883.
342. Bonamico, M.; Dessy, G. *Chem. Commun.* **1968**, 843.
343. Fackler, J. P., Jr.; Fetchin, J. A.; Fries, D. C. *J. Am. Chem. Soc.* **1972**, *94*, 7323.
344. Burke, J. M.; Fackler, J. P., Jr. *Inorg. Chem.* **1972**, *11*, 3000.
345. Bombieri, G.; Croato, U.; Forsellini, E. *J. Chem. Soc. A* **1972**, 561.
346. Bonamico, M.; Dessy, G.; Fares, V.; Scaramuzza, J. *J. Chem. Soc., Dalton Trans.* **1972**, 2515.
347. Bonamico, M.; Dessy, G.; Fares, V.; Scaramuzza, J. *J. Chem. Soc., Dalton Trans.* **1975**, 2079.

348. Churchill, M. R.; Gold, K. *Inorg. Chem.* **1971**, *10*, 1928.
349. Fackler, J. P., Jr. *J. Am. Chem. Soc.* **1972**, *94*, 1009.
350. Engler, R.; Kiel, G.; Gattow, G. *Z. Anorg. Allg. Chem.* **1974**, *404*, 71.
351. Borel, M. M.; Ledesert, M. *Z. Anorg. Allg. Chem.* **1975**, *415*, 285.
352. Otto, H.; Werner, H. *Chem. Ber.* **1987**, *120*, 97–104.
353. Brunner, H.; Hollman, A.; Zabel, M.; Nuber, B. *J. Organomet. Chem.* **2000**, *609*, 44–52.
354. Brunner, H.; Hollman, A.; Zabel, M.; Nuber, B. *J. Organomet. Chem.* **2001**, *630*, 169–176.
355. Adams, H.; Bailey, N. A.; Bruce, D. W.; Dhillon, R.; Dunmar, D. A.; Maitlis, P. M. *Polyhedron* **1988**, *7*, 1861.
356. Maitlis, P. M.; Bruce, D. W.; Dhillon, R.; Dunmarr, D. A. *New J. Chem.* **1990**, *14*, 549.
357. Okura, H.; Oyama, M.; Okazaki, S. *Electrochem. Commun.* **2000**, *2*, 367–370.
358. Mevelac, F.; Tisato, F.; Refosco, F.; Roucoux, A.; Noiret, N.; Patin, H.; Bandoli, G. *Inorg. Chem.* **2002**, *41*, 598–601.
359. Demaimay, F.; Roucoux, A.; Dazord, L.; Noiret, N.; Mosan, A.; Patin, H. *Nucl. Med. Biol.* **1999**, *26*, 225–231.
360. Demaimay, F.; Noiret, N.; Roucoux, A.; Patin, H.; Bellande, E.; Pasqualini, R.; Moisan, A. *Nucl. Med. Biol.* **1997**, *24*, 439–445.
361. Tang, K.; Tang, Y. In *Heteroatom Chemistry*; Block, E., Ed., VCH Publishers: New York, **1990**, pp 345–370.
362. Hieber, W.; Gscheidmeier, M. *Chem. Ber.* **1966**, *99*, 2312.
363. Lindner, E.; Langner, D. *Z. Naturforsch.* **1969**, *B24*, 1402.
364. Sato, F.; Kramolowsky, R.; Steinhäuser, K. G.; Kunze, U.; Antoniadis, A. *Inorg. Chim. Acta* **1983**, *73*, 243–247.
365. Thiele, G.; Liehr, G. *Chem. Ber.* **1971**, *104*, 1877.
366. Epley, L. J.; Honk, L. W. *J. Organomet. Chem.* **1975**, *87*, 317.
367. Steyn, G. J. J.; Roodt, A.; Osetrova, L. V.; Varshavsky, Y. S. *J. Organomet. Chem.* **1997**, *536/537*, 197–205.
368. Sato, F.; Nakamura, K.; Sato, M. *J. Organomet. Chem.* **1974**, *67*, 141.
369. Kato, S.; Mizuta, M.; Ishii, Y. *J. Organomet. Chem.* **1973**, *55*, 121.
370. Kato, S.; Kato, T.; Yamauki, T.; Shibahashi, Y.; Kakuda, E.; Mizuta, M.; Ishii, Y. *J. Organomet. Chem.* **1974**, *76*, 215.
371. Katada, T.; Kato, S.; Mizuta, M. *Chem. Lett.* **1975**, 1037; *Chem. Abs.* **1976**, *84*, 59686.
372. Kato, S.; Tani, K.; Kitaoka, N.; Yamada, K.; Mifune, H. *J. Organomet. Chem.* **2000**, *611*, 190–199.
373. Coldea, V.; Haiduc, I. *Syn. React. Inorg. Metal-org. Chem.* **1980**, *10*, 417–424.
374. Tarassoli, A.; Asadi, A.; Hitchcock, P. B. *J. Organomet. Chem.* **2002**, *645*, 105–111.
375. Tani, K.; Hanabusa, S.-i.; Kato, S.; Mutoh, S.-y.; Suzuki, S.-I.; Ishida, M. *J. Chem. Soc., Dalton Trans.* **2001**, 518–527.
376. Nakamoto, M. *Kagaku to Kogyo (Osaka)* **1991**, *65*, 141–145; *Chem. Abstr.* **1991**, *115*, 173303.
377. Tarassoli, A.; Sedaghat, T.; Neumüller, B.; Ghassemzadeh, M. *Inorg. Chim. Acta* **2001**, *318*, 15–22.
378. Cras, J. A.; *Comprehensive Coordination Chemistry* Willemse, J.; Wilkinson, G.; Gillard, R. D.; McCleverty, J. A., Ed., **1987**, *2*, 585–586. Pergamon Press: Oxford, p 579.
379. Magee, R. J. *Rev. Anal. Chem.* **1973**, *1*, 335–377.
380. Thorn, D. G.; Ludwig, R. *The Dithiocarbamates and Related Compounds* **1981**, Elsevier: Amsterdam.
381. Bond, A. M.; Martin, R. L. *Coord. Chem. Rev.* **1984**, *54*, 23–98.
382. Hill, J. O.; Magee, R.; Liesegang, J. *Comments Inorg. Chem.* **1985**, *5*, 1–27.
383. Malik, A. K.; Seidel, B. S.; Faubel, W.; Rao, A. L. *J. Chem. Environ. Res.* **2000**, *9*, 3–16.
384. Malik, A. K.; Faubel, W. *Pestic. Sci.* **1999**, *55*, 965–970.
385. Magee, R. J.; Hill, J. O. *Rev. Anal. Chem.* **1985**, *8*, 5–72.
386. Neeb, R. *Pure Appl. Chem.* **1982**, *54*, 847–852.
387. Fujii, S.; Yoshimura, T. *Coord. Chem. Rev.* **2000**, *198*, 89–99.
388. Vanin, A. F. *Methods Enzymol.* **1999**, *301*, 269–279.
389. Butler, A. R.; Glidewell, C.; Li, M. *Adv. Inorg. Chem.* **1988**, *32*, 335–393.
390. Standish, M. L. *Ind. Water Treat.* **1995**, *27*, 53–57.
391. Suzuki, T.; Takagi, H. D.; Kashiwabara, K. *Acta Crystallogr., Sect. C* **2002**, *58C*, m95–m97.
392. Su, W.; Hong, M.; Jiang, F.; Liu, H.; Zhou, Z.; Wu, D.; Mak, T. C. W. *Polyhedron* **1996**, *15*, 4047–4051.
393. Cox, M. J.; Tiekink, E. R. T. *Z. Kristallogr.* **1999**, *214*, 670–676.
394. Cox, M. J.; Tiekink, E. R. T. *Z. Kristallogr.* **1999**, *214*, 571–579.
395. Tiekink, E. R. T.; Hall, V. J.; Buntine, M. A. *Z. Kristallogr.* **1999**, *214*, 124–134.
396. Husebye, S.; Lindeman, S. V. *Main Group Chem. News* **1995**, *3*, 8–16.
397. Cea-Olivares, R.; Estrada, M.; Espinosa-Perez, G.; Haiduc, I.; Garcia y Garcia, P.; Lopez-Cardoso, M.; Lopez-Vaca, M.; Coterio-Villegas, A.-M. *Main Group Chem.* **1995**, *1*, 159–164.
398. Ziegler, M. L.; Blechschmidt, K.; Bock, H.; Guggolz, E.; Korswagen, R. P. *Z. Naturforsch., Teil B* **1988**, *43b*, 590–598.
399. Dilworth, J. R.; Henderson, R. A.; Hills, A.; Hughes, D. L.; McDonald, C. J. *J. Chem. Soc., Dalton Trans.* **1990**, 1077–1085.
400. Henderson, R. A.; Hughes, D. L.; Stephens, A. N. *J. Chem. Soc., Dalton Trans.* **1990**, 1097–1099.
401. Victoriano, L. I. *Coord. Chem. Rev.* **2000**, *196*, 383–398.
402. Victoriano, L. I. *Polyhedron* **2000**, *19*, 2269–2275.
403. Andrews, P. C.; Lawrence, S. M.; Raston, C. L.; Skelton, B. W.; Tolhurst, V.-A.; White, A. H. *Inorg. Chim. Acta* **2000**, *300/302*, 56–64.
404. Tiekink, E. R. T.; Eagle, A. A.; Young, C. G. *Aust. J. Chem.* **2000**, *53*, 779–784.
405. Almond, M. J.; Drew, M. G. B.; Redman, H.; Rice, D. A. *Polyhedron* **2000**, *19*, 2127–2133.
406. Goh, L. Y.; Weng, Z.; Leong, W. K.; Leung, P. H. *Angew. Chem. Int., Ed. Engl.* **2001**, *40*, 3236–3239.
407. Lu, S. F.; Huang, J.-Q.; Yu, R.-M.; Huang, X.-Y.; Wu, Q.-J.; Peng, Y.; Chen, J.; Huang, Z.-X.; Zheng, Y.; Wu, D.-X. *Polyhedron* **2001**, *20*, 2339–2352.
408. Webster, R. D.; Heath, G. A.; Bond, A. M. *J. Chem. Soc., Dalton Trans.* **2001**, 3189–3195.
409. Barbier, J. P.; Ondo, B. M.; Hugel, R. P. *J. Chem. Soc., Dalton Trans.* **1985**, 597–600.
410. Padilla-Tosta, M. E.; Fox, O. D.; Drew, M. G. B.; Beer, P. D. *Angew. Chem., Int. Ed. Engl.* **2001**, *40*, 4235–4239.
411. Pervukhina, N. V.; Podberezhkaya, N. V.; Patrina, L. A.; Larionov, S. V. *Zhur. Strukt. Khim. (Russ.)* **1989**, *30*, 184–187.

412. Pervukhina, N. V.; Podberezskaya, N. V.; Patrino, L. A.; Larionov, S. V. *J. Struct. Chem. (Engl. transl.)* **1989**, *30*, 184–187.
413. Hogarth, G.; Pateman, A.; Redmond, S. P. *Inorg. Chim. Acta* **2000**, *306*, 232–236.
414. Fox, O. D.; Drew, M. G. B.; Beer, P. D. *Angew. Chem., Int. Ed. Engl.* **2000**, *39*, 135–140.
415. Oyaizu, K.; Yamamoto, K.; Ishii, Y.; Tsuchida, E. *Chem. -Eur. J.* **1999**, *5*, 3193–3201.
416. Lai, S.-W.; Drew, M. G. B.; Beer, P. D. *J. Organomet. Chem.* **2001**, *637/639*, 89–93.
417. Plyusnin, V. F.; Grivin, V. P.; Larionov, S. V. *Coord. Chem. Rev.* **1997**, *159*, 121–133.
418. Zhu, H.; Liu, Q.; Deng, Y.; Wen, T.; Chen, C.; Wu, D. *Inorg. Chim. Acta* **1999**, *286*, 7–10.
419. Zhu, H.; Chen, C.; Zhang, X.; Liu, Q.; Liao, D.; Li, L. *Inorg. Chim. Acta* **2002**, *328*, 96–104.
420. Zhu, H.; Liu, Q.; Chen, C.; Wu, D. *Inorg. Chim. Acta* **2000**, *306*, 131–136.
421. Zhuang, B.; Sun, H.; Pan, G.; He, L.; Wei, Q.; Zhou, Z.; Peng, S.; Wu, K. *J. Organomet. Chem.* **2001**, *640*, 127–139.
422. Seymore, S. B.; Brown, S. N. *Inorg. Chem.* **2001**, *40*, 6676–6683.
423. Blake, A. J.; Kathirgamanathan, P.; Toohey, M. J. *Inorg. Chim. Acta* **2000**, *303*, 137–139.
424. Griffiths, D. V.; Parrot, S. J.; Togrou, M.; Dilworth, J. R.; Zheng, Y.; Ritter, S.; Abram, U. *Z. Anorg. Allg. Chem.* **1998**, *624*, 1409–1414.
425. Stelzer, J. B.; Hagenbach, A.; Abram, U. *Z. Anorg. Allg. Chem.* **2002**, *628*, 703–706.
426. Zheng, H.; Leung, W.-H.; Chim, J. L. C.; Lai, W.; Lam, C.-H.; Williams, I. D.; Wong, W.-T. *Inorg. Chim. Acta* **2000**, *306*, 184–192.
427. Seymore, S. B.; Brown, S. N. *Inorg. Chem.* **2002**, *41*, 469–469.
428. Bardaji, M.; Laguna, A. *Inorg. Chim. Acta* **2001**, *318*, 38–44.
429. Sanchez, G.; Ruiz, F.; Serrano, J. L.; Ramirez de Arellano, M. C.; Lopez, G. *Eur. J. Inorg. Chem.* **2000**, *10*, 2185–2191.
430. Contel, M.; Edwards, A. J.; Garido, J.; Hursthouse, M. B.; Laguna, M.; Terroba, R. *J. Organomet. Chem.* **2000**, *607*, 129–136.
431. Garcia-Montalvo, V.; Marcelo-Polo, A.; Montoya, R.; Toscano, R. A.; Hernandez-Ortega, S.; Cea-Olivares, R. *J. Organomet. Chem.* **2001**, *623*, 74–80.
432. Tiekink, E. R. T. *Main Group Chem. News* **1995**, *3*, 12–16.
433. Song, X.; Cahill, C.; Eng, G. *Main Group Met. Chem.* **2002**, *25*, 13–14.
434. Clarke, D. J.; Dakternieks, D.; Tiekink, E. R. T. *Main Group Met. Chem.* **2001**, *24*, 305–306.
435. Clarke, D. J.; Dakternieks, D.; Tiekink, E. R. T. *Main Group Met. Chem.* **2001**, *24*, 307–308.
436. Malik, M. A.; O'Brien, P.; Revaprasadu, N. *J. Mater. Chem.* **2002**, 92–97.
437. Trindade, T.; O'Brien, P.; Zhang, X.-M.; Majid, M. *J. Mater. Chem.* **1997**, 1011–1016.
438. Trindade, T.; O'Brien, P. *Chem. Vap. Deposition* **1997**, *3*, 75–77.
439. Monteiro, O. C.; Trindade, T.; Park, J.-H.; O'Brien, P. *Chem. Vap. Deposition* **2000**, *6*, 230–232.
440. Hibbert, T. G.; Kana, A. T.; Mahon, M. F.; Molloy, K. C.; Price, L. S.; Parkin, I. P.; Venter, M. M. *Main Group Met. Chem.* **2001**, *24*, 633–636.
441. Hill, J. O.; Murray, J. P.; Patil, K. C. *Rev. Inorg. Chem.* **1994**, *14*, 363–387.
442. Hill, J. O.; Chirawongaram, S. *J. Therm. Anal.* **1994**, *41*, 511–518.
443. Hill, J. O.; Murray, J. P. *Rev. Inorg. Chem.* **1993**, *13*, 183–197.
444. Sharma, A. K. *Thermochim. Acta* **1986**, *104*, 339–372.
445. Zaimovskaya, T. A.; Lozovoi, Yu. A.; Kuz'mina, G. N.; Parenago, O. P. *Neftekhimiya (Russ.)* **1995**, *35*, 364–369; *Chem. Abs.* **1996**, *125*, 226196.
446. Nieuwenhuizen, P. J.; Reedijk, J.; van Duin, M.; McGill, W. J. *Rubber Chem. Technol.* **1997**, *70*, 368–429.
447. Zhang, J.; Wang, X.; Lu, G.; Tang, Z. *J. Labelled Compd. Radiopharmac.* **2000**, *43*, 693–700.
448. Kailasnath, P.; Sinusas, A. J. *Cardiol. Rev.* **1998**, *9*, 160–172.
449. Takehada, K.; Beller, G. A.; Ruiz, M.; Petruzella, F. D.; Watson, D. D.; Glover, D. *J. Nucl. Med.* **2001**, *42*, 1388–1394.
450. Johnson, G. III; Nguyen, K. N.; Liu, Z.; Gao, P.; Pasqualini, R.; Okada, R. D. *J. Nucl. Cardiol.* **1997**, *4*, 217–225.
451. Stalteri, M. A.; Parrott, S. J.; Griffiths, V. A.; Dilworth, J. R.; Mather, S. J. *Nucl. Med. Commun.* **1997**, *18*, 870–877.
452. Auzeloux, P.; Papon, J.; Masnada, T.; Borel, M.; Moreau, M.-F.; Veyre, A.; Pasqualini, R.; Madelmont, J.-C. *J. Labelled Compd. Radiopharmac.* **1999**, *42*, 325–335.
453. Ware, D. C.; Palmer, H. R.; Prujin, F. B.; Anderson, R. F.; Brothers, P. J.; Denny, W. W. R. *Anticancer Drug Des.* **1998**, *13*, 81–103.
454. Ghosh, P.; Ghosh, S.; D'Cruz, O. J.; Uckun, F. M. *J. Inorg. Biochem.* **1998**, *72*, 89–98.
455. Orrenius, S.; Nobel, C. S. I.; van den Dobbelen, D. J.; Burkitt, M. J.; Slater, A. F. G. *Biochem. Soc. Trans.* **1996**, *24*, 1032–1038.
456. Miller, D. B. *Neurobehavioral Toxicol. Teratol.* **1982**, *4*, 779–787.
457. Fishbein, L. J. *Toxicol. Environm. Health* **1976**, *1*, 713–735.



# 1.16

## Acyclic Arsine, Stibine, and Bismuthine Ligands

W. LEVASON and G. REID  
*University of Southampton, UK*

---

1.16.1	INTRODUCTION	377
1.16.1.1	Arsine Synthesis	378
1.16.1.2	Stibine Synthesis	379
1.16.1.3	Bismuthine Synthesis	382
1.16.1.4	Arsines, Stibines, and Bismuthines as Ligands	383
1.16.1.4.1	<i>Bonding</i>	383
1.16.1.4.2	<i>Coordination modes</i>	385
1.16.2	REFERENCES	387

---

### 1.16.1 INTRODUCTION

The coordination chemistry of arsine ligands dates back well over 100 years, with triethylarsine complexes of Pd, Pt, and Au reported as long ago as 1870. In the period 1900–1930 the development of organoarsenic chemistry was driven both by the therapeutic uses and by studies of poison gases during and after the First World War, and out of this grew the studies of tertiary arsine coordination chemistry by Mann, Turner, Jensen, and others.<sup>1</sup> Although there were parallel developments in phosphine coordination chemistry, the somewhat easier preparations and often lower air sensitivity of arsines resulted in many developments in arsine chemistry preceding those of the phosphorus analogs. For example, the syntheses of “diars”, *o*-C<sub>6</sub>H<sub>4</sub>(AsMe<sub>2</sub>)<sub>2</sub>, whose outstanding coordination ability exceeded those of other known Group 15 ligands,<sup>2</sup> and tridentates such as MeAs(CH<sub>2</sub>CH<sub>2</sub>CH<sub>2</sub>AsMe<sub>2</sub>)<sub>2</sub>,<sup>3</sup> appeared some years before the corresponding phosphines. Only from the mid-1960s did phosphine coordination chemistry overtake arsine chemistry, driven by both the superior coordination ability of analogous phosphines especially to harder metal centers, and the enormous advantages conferred by the spin 1/2 <sup>31</sup>P nucleus as NMR techniques developed. All isotopes of As, Sb, and Bi are quadrupolar and in the low-symmetry environments in ER<sub>3</sub> ligands no resonances are observable due to fast quadrupolar relaxation. Simple alkyl substituents (Me, <sup>i</sup>Pr, <sup>t</sup>Bu) on the donor atom provide a partial solution to this problem, via <sup>1</sup>H or <sup>13</sup>C NMR spectroscopy.

The coordination chemistry of stibines, although begun in the early years of the twentieth century, has always received much less effort than that of the lighter analogs, and was largely confined to soft metals at the lower right of the d-block. It is also notable that often “stibine” referred to only SbPh<sub>3</sub>, and many stibine complexes received cursory study in papers dealing predominantly with PR<sub>3</sub> or AsR<sub>3</sub> ligands. Studies of ditertiary stibines only appeared post 1970. The donor ability of bismuthines is very poor, and coupled with the weak and easily broken Bi—C bonds, has resulted in very few complexes, but again much scope for thorough study remains.

The earlier work on arsine, stibine, and bismuthine ligands and their complexes has been described in a number of reviews, of which the most important are listed in [Table 1](#).

**Table 1** Some reviews of arsine, stibine and bismuthine chemistry.

Topic	References
Transition metal complexes containing monotertiary arsines and stibines	4
Metal complexes of ditertiary arsines	5
Phosphine, arsine and stibine complexes of the transition elements	6
Phosphorus, arsenic, antimony and bismuth ligands	7
Organoantimony compounds (includes metal complexes)	8
Organobismuth compounds (includes metal complexes)	9
Coordination chemistry of stibine and bismuthine ligands	10
Synthesis of organoantimony and organobismuth compounds	11
Synthesis of organoarsenic compounds	12
Organoarsenic and organoantimony compounds	13
Organobismuth compounds	14
Synthesis of organoarsenic, -antimony, and -bismuth compounds	15

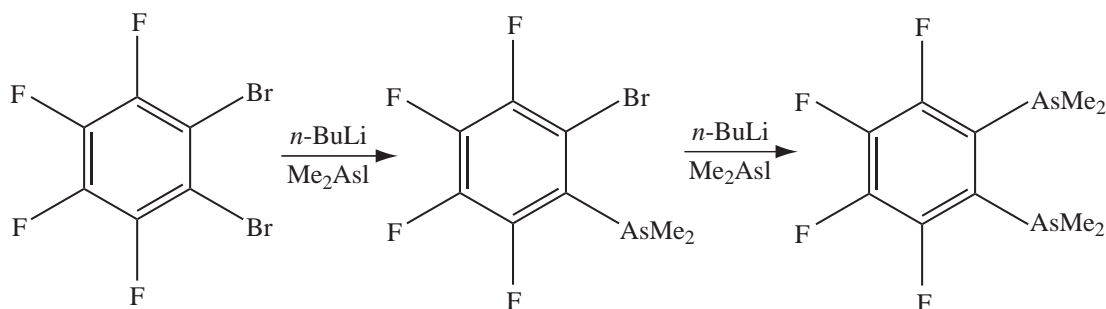
### 1.16.1.1 Arsine Synthesis

Arsine  $\text{AsH}_3$ , is usually made by  $\text{NaBH}_4$  reduction of  $\text{AsCl}_3$  or  $\text{As}_2\text{O}_3$ ,<sup>16</sup> or by hydrolysis of alkali–metal arsenides.<sup>17</sup> Small amounts of very pure  $\text{AsH}_3$  can be obtained by heating  $\text{As}_2\text{O}_3$  with  $\text{LiAlH}_4$ , although the overall yield is low.<sup>18</sup> The need for ultrapure  $\text{AsH}_3$  for CVD processes in the electronics industry and its very high toxicity has resulted in many patents dealing with on-site synthesis and purification of arsine. The storage of  $\text{AsH}_3$  as  $[(\text{C}_6\text{F}_5)_3\text{BAsH}_3]$ , from which it is liberated on gentle heating has been proposed.<sup>19</sup> Primary ( $\text{AsRH}_2$ ) and secondary ( $\text{AsR}_2\text{H}$ ) arsines have rarely been used as ligands, but can be made by reduction of the corresponding haloarsines, e.g., the preparation of  $\text{Me}_3\text{SiCH}_2\text{AsH}_2$  and  $(\text{Me}_3\text{SiCH}_2)_2\text{AsH}$ ,<sup>20</sup> of arsonic or arsenic acids, e.g.,  $\text{AsMe}_2\text{H}$ ,<sup>21</sup> and  $\text{AsBuH}_2$ ,<sup>22</sup> or by hydrolysis of metal organoarsenides, e.g.,  $\text{AsPh}_2\text{H}$ .<sup>23</sup> Sterically hindered  $\text{AsRH}_2$  ( $\text{R} = 2,6\text{-di-isopropylphenyl}$ ,  $2,4,6\text{-tri-isopropylphenyl}$ ) have been synthesized and characterized in detail.<sup>24</sup>

A substantial number of triorganoarsines have been prepared,<sup>7,12,13,15,25,26</sup> although a much smaller number have been used as ligands. Traditional routes involve the reaction of  $\text{AsX}_3$  or  $\text{AsR}_{3-n}\text{X}_n$  ( $n = 1$  or  $2$ ) with  $\text{RMgX}$  or  $\text{RLi}$  in ether solution. Yields vary from poor to good depending upon the R group. Common  $\text{AsR}_3$  made by this route are:  $\text{AsMe}_3$ ,<sup>27</sup>  $\text{AsEt}_3$ ,<sup>28,29</sup>  $\text{As}^n\text{Pr}_3$ ,<sup>29</sup>  $\text{As}(\text{cyclo-C}_6\text{H}_{11})_3$ ,<sup>29</sup>  $\text{As}(\text{cyclo-C}_5\text{H}_9)_3$ ,<sup>30</sup>  $\text{As}(\text{SiMe}_3)_3$ <sup>31</sup> and  $\text{As}^t\text{Bu}_3$ .<sup>31</sup> Alkali–metal organoarsenides  $\text{Li}(\text{Na})\text{AsR}_2$  may be reacted with  $\text{R}'\text{X}$  to form  $\text{AsR}_2\text{R}'$ .<sup>32</sup>

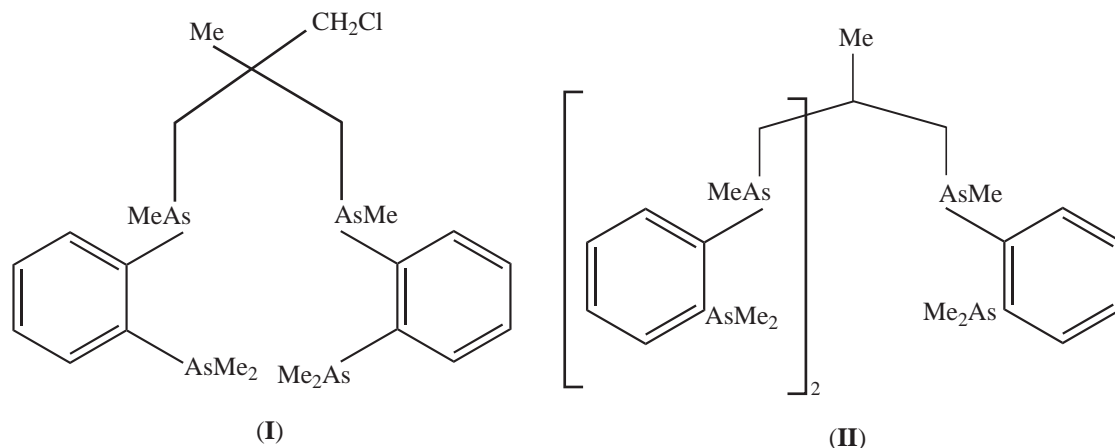
Other organometallic reagents have been used less frequently, for example the synthesis of  $\text{As}(\text{CF}_3)_3$  from  $\text{Hg}(\text{CF}_3)_2$ ,<sup>33</sup> or  $\text{AsMe}_2(\text{SMe})$  prepared from  $\text{AsMe}_2\text{Cl}$  and  $\text{Pb}(\text{SMe})_2$ .<sup>34</sup> More recently,  $\text{AlR}_3$  reagents have been used, which are claimed to give high yields and under appropriate conditions purer products than the Grignard or  $\text{RLi}$  routes. Thus,  $\text{AlMe}_3$  and  $\text{As}_2\text{O}_3$  in  $\text{Bu}_2\text{O}$ -diglyme gives a high yield of  $\text{AsMe}_3$  which is distilled out of the reaction mixture.<sup>35</sup> A wide range of  $\text{AsR}_3$  ( $\text{R} = \text{Et}$ ,  $^n\text{Pr}$ ,  $^i\text{Pr}$ ,  $^n\text{Bu}$ ,  $^i\text{Bu}$ ,  $^t\text{Bu}$ ,  $\text{CH}_2=\text{CH}$ ,  $\text{MeCH}=\text{CH}$ ,  $\text{Me}_3\text{SiCH}_2$ ,  $\text{Ph}$ ,  $\text{Bz}$ , mesityl) may be obtained in high purity from  $\text{AlR}_3$  and the chlorodioxarsolane,  $\text{OCH}_2\text{CH}_2\text{OAsCl}$  (itself made from  $\text{AsCl}_3$  and 1,2-ethanediol).<sup>26</sup> Heating  $\text{AlR}_3$  or  $\text{RMgX}$  with  $\text{As}(\text{NMe}_2)_3$  gave good yields of  $\text{AsR}_3$  ( $\text{R} = \text{Et}$ ,  $^n\text{Pr}$ ,  $^n\text{Bu}$ ,  $\text{CH}_2=\text{CH}$ ), but the route fails with sterically hindered R-groups.<sup>36</sup> The route can be successfully extended to the synthesis of  $\text{AsMe}_2\text{R}$  using  $\text{AsMe}_2\text{NMe}_2$ .<sup>37</sup> A large body of  $^1\text{H}$  and  $^{13}\text{C}$  NMR data of tertiary arsines has been compiled.<sup>26,36,37</sup> Trialkyl- and mixed arylalkyl-arsines are typically air-sensitive, highly toxic liquids with repulsive odors. Triarylarisines are air-stable solids. The synthesis and resolution of chiral arsines has been comprehensively reviewed by Wild.<sup>38</sup>

Ditertiary arsines are usually prepared from the appropriate dihalo–organic compound and  $\text{Li}(\text{Na}\backslash\text{K})\text{AsR}_2$  in liquid ammonia or thf. The commonest examples made by this route are:  $\text{Ph}_2\text{As}(\text{CH}_2)_n\text{AsPh}_2$  ( $n = 1-3$ ),  $\text{Me}_2\text{As}(\text{CH}_2)_3\text{AsMe}_2$ , *cis*- $\text{R}_2\text{AsCH}=\text{CHAsR}_2$  ( $\text{R} = \text{Me}$  or  $\text{Ph}$ ), *o*- $\text{C}_6\text{H}_4(\text{AsMe}_2)_2$ .<sup>6,7,21,32</sup> The same route yields  $\text{Ph}_2\text{AsCH}_2\text{AsPh}_2$ ,<sup>39</sup> and  $\text{Me}_2\text{AsCH}_2\text{AsMe}_2$ .<sup>40</sup> The reaction of  $\text{NaAsMe}_2$  with  $\text{BrCH}_2\text{CH}_2\text{Br}$  affords  $\text{Me}_2\text{AsAsMe}_2$  and  $\text{CH}_2=\text{CH}_2$ , but a very poor yield of  $\text{Me}_2\text{AsCH}_2\text{CH}_2\text{AsMe}_2$  can be obtained from  $\text{NaAsMe}_2$  and  $\text{ClCH}_2\text{CH}_2\text{Cl}$  in liquid ammonia at  $-78^\circ\text{C}$ , and at least one series of complexes has been described.<sup>41,42</sup> Using  $\text{NaAsMePh}$  and *o*- $\text{C}_6\text{H}_4\text{Cl}_2$  produces *o*- $\text{C}_6\text{H}_4(\text{AsMePh})_2$  from which the  $\text{R}^*\text{R}^*$  and  $\text{R}^*\text{S}^*$  diastereoisomers were separated.<sup>43,44</sup> The *o*- $\text{C}_6\text{H}_4(\text{AsMe}_2)_2$  is made as in Scheme 1 and provides an analog of *o*- $\text{C}_6\text{H}_4(\text{AsMe}_2)_2$  with identical steric properties but reduced donor power.<sup>45</sup>



Scheme 1

As stated in the Introduction, polydentate arsine ligands have been known since the 1960s, and a variety of tripodal and facultative tri- and tetra-arsines is known.<sup>6,7</sup> Their syntheses are usually via variations on the routes used for diarsines. Recently reported examples include  $\text{ClCH}_2\text{C}(\text{CH}_2\text{AsMe}_2)_3$  prepared from  $\text{NaAsMe}_2$  and  $\text{C}(\text{CH}_2\text{Cl})_4$  (the fourth chlorine is not substituted),<sup>46</sup> and  $\text{PhAs}(o\text{-C}_6\text{H}_4\text{AsMe}_2)_2$  prepared from  $\text{PhAsCl}_2$ ,  $n\text{-BuLi}$ , and  $o\text{-BrC}_6\text{H}_4\text{AsMe}_2$ .<sup>47</sup> The reaction of  $\text{MeC}(\text{CH}_2\text{Cl})_3$  with  $o\text{-C}_6\text{H}_4(\text{AsMe}_2)(\text{AsMeNa})$  in  $\text{thf}$  produces a tetratertiary and a hexatertiary arsine (**I** and **II**) which were separated via their  $\text{Co}^{\text{III}}$  complexes.<sup>48</sup> The diastereoisomers of the tetradentate arsine have been identified.

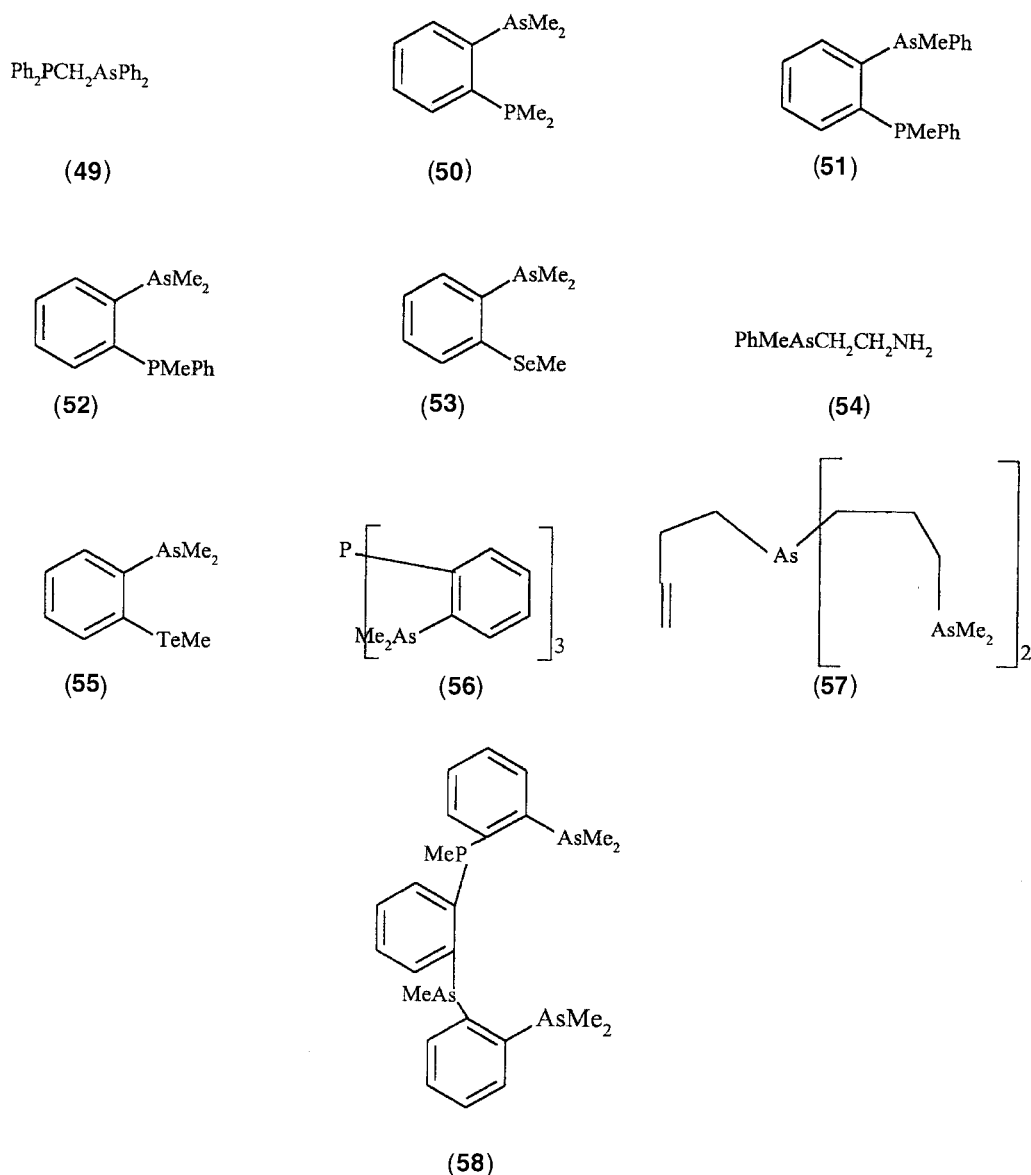


Bi- and polydentate ligands containing arsenic in combination with other Group 15 or 16 donors have also been known for many years.<sup>6,7</sup> Some new examples are shown in Figure 1.

The  $\text{R}_2\text{AsCH}_2\text{CH}_2\text{PR}'_2$  ( $\text{R} = {}^t\text{Bu}$ ,  $\text{Cy}$ ,  $\text{R}' = \text{Ph}$ ,  ${}^i\text{Pr}$ ) have been prepared from the cyclic sulfate  $\text{O}_2\text{SOCH}_2\text{CH}_2\text{O}$  treated sequentially with the appropriate lithium arsenide and phosphide, the key being to add the stronger nucleophile first, otherwise mixtures result.<sup>59</sup> New, extremely air-sensitive arsino(phosphino)methanes  $\text{R}_2\text{PCH}_2\text{AsR}'_2$  ( $\text{R} = {}^i\text{Pr}$ ,  $\text{R}' = {}^i\text{Pr}$ ,  ${}^t\text{Bu}$ ,  $\text{Cy}$ ;  $\text{R}$ ,  $\text{R}' = \text{Cy}$ ) are obtained in good yield from reaction of  $\text{R}_2\text{PCH}_2\text{SnR}'_3$  with  $\text{RLi}$ ,  $\text{Me}_2\text{NCH}_2\text{CH}_2\text{NMe}_2$ , and  $\text{R}'_2\text{AsCl}$ .<sup>60</sup>

### 1.16.1.2 Stibine Synthesis

Trialkyl- and triaryl-stibines are usually made from  $\text{SbCl}_3$  and the appropriate Grignard reagent in diethyl ether or sometimes tetrahydrofuran. A relatively limited number of stibines has been used as ligands, and details of the syntheses can be found in previous compilations.<sup>6,8,10,13,15,25</sup> Trimethylstibine forms an azeotrope with diethyl ether and hence cannot be separated by



**Figure 1** Some hybrid ligands containing arsenic donors (numbers under structures are literature references to syntheses).

distillation. It may be prepared in  ${}^n\text{Bu}_2\text{O}$  solvent, but is usually made in  $\text{Et}_2\text{O}$ , halogenated with  $\text{X}_2$  ( $\text{X} = \text{Cl}$  or  $\text{Br}$ ) to the white air-stable solid  $\text{Me}_3\text{SbX}_2$ , and these are subsequently reduced with zinc dust or  $\text{LiAlH}_4$ .<sup>27</sup> Other trialkylstibines are separated from  $\text{Et}_2\text{O}$  by distillation, usually under reduced pressure for the larger R groups. Good experimental accounts of the syntheses are  $\text{SbPh}_3$ ,<sup>61</sup>  $\text{Sb}^i\text{Pr}_3$ ,<sup>62</sup>  $\text{Sb}(\text{C}_6\text{H}_2\text{Me}_3-2,4,6)_3$ ,<sup>63</sup>  $\text{Sb}(\text{CH}_2\text{CMe}_3)_3$ , and  $\text{Sb}(\text{CH}_2\text{SiMe}_3)_3$ .<sup>64</sup>

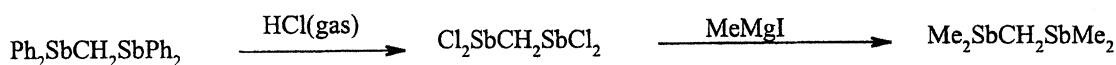
Other metal alkyls have been used less often; for example, the reaction of  $\text{R}_3\text{Al}$  with  $\text{Sb}(\text{NMe}_2)_3$  in the absence of a solvent gives good yields of  $\text{SbR}_3$  ( $\text{R} = \text{Me}$ ,  $\text{Et}$ ,  ${}^n\text{Pr}$ ,  ${}^n\text{Bu}$ ,  ${}^i\text{Bu}$ ) which distill directly out of the reaction mixture.<sup>36</sup> Tris(dimethylphenylsilyl)stibine,  $\text{Sb}(\text{Me}_2\text{PhSi})_3$  has been made in moderate yield (35%) from  $\text{Na}_3\text{Sb}$  and  $\text{Me}_2\text{PhSiCl}$ .<sup>65</sup> Generally, triarylstibines are air-stable solids, trialkylstibines and alkylarylstibines air-sensitive oils with characteristic unpleasant odors, and the lower trialkylstibines ignite in air at ambient temperatures or slightly above.

Unlike trialkylphosphines, trialkylstibines ( $\text{SbR}_3$ ) can be cleaved to  $\text{NaSbR}_2$  with Na in liquid ammonia, and subsequent treatment with alkyl halide affords mixed trialkylstibines such as  $\text{SbEt}_2{}^n\text{Bu}$  or  $\text{SbMe}_2\text{Et}$ .<sup>32,66</sup> Extension of this route produces  $\text{SbEt}^n\text{Pr}{}^n\text{Bu}$  from  $\text{SbEt}_2{}^n\text{Bu}$ , Na, and  ${}^n\text{PrCl}$ .<sup>66</sup> A one-pot synthesis for  $\text{Sb}^i\text{Bu}_n\text{Me}_{3-n}$  ( $n = 1$  or  $2$ ) has been developed,<sup>67</sup> from  $\text{SbCl}_3$

treated successively with  ${}^t\text{BuMgCl}$  then  $\text{MeMgBr}$  in  $\text{Et}_2\text{O}$ , which affords  $\text{Sb}^t\text{Bu}_2\text{Me}$  (6%) and  $\text{Sb}^t\text{BuMe}_2$  (64%).

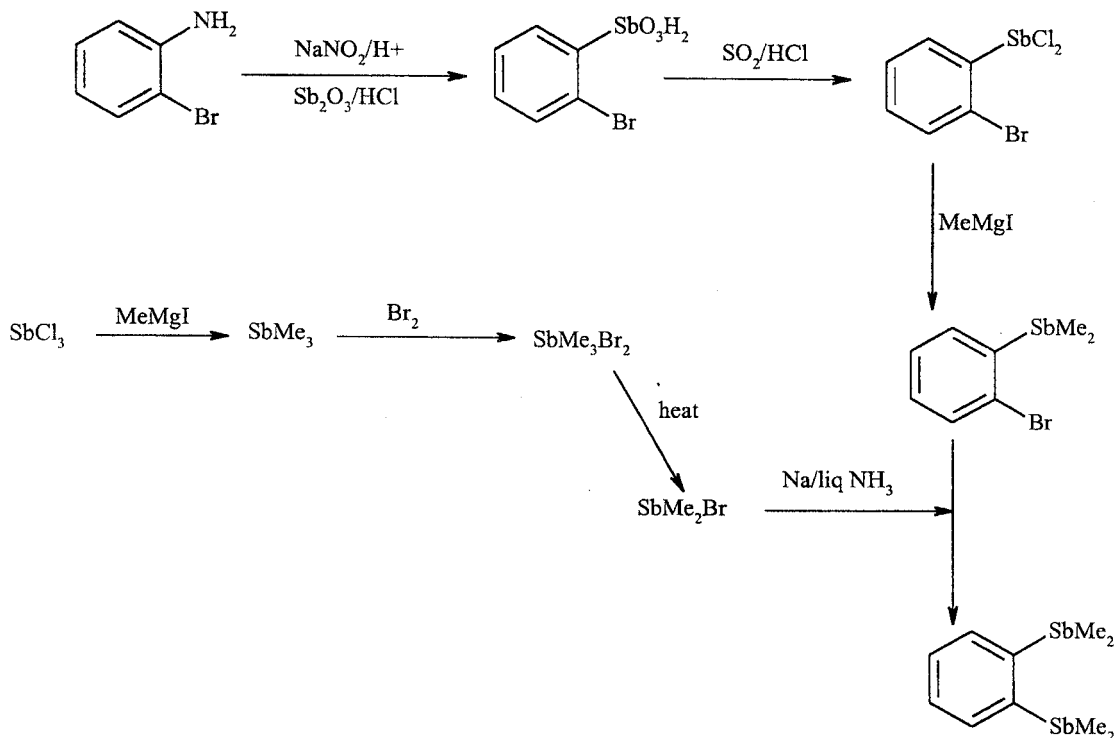
Mixed arylalkylstibines  $\text{SbRR}'_2$  (aryl is almost always Ph) are made by two routes. The first is via halostibines  $\text{SbR}_{3-n}\text{X}_n$  ( $n = 1$  or  $2$ ). For example, reaction of  $\text{SbPh}_3$  with  $\text{SbCl}_3$  in either 1:2 or 2:1 ratios in the absence of solvent to give respectively  $\text{PhSbCl}_2$  or  $\text{Ph}_2\text{SbCl}$ ,<sup>68</sup> which then react with  $\text{RLi}$  or  $\text{RMgX}$  to give the appropriate  $\text{SbPh}_{3-n}\text{R}_n$ .  $\text{Sb(alkyl)}_2\text{X}$  are usually made by heating  $(\text{alkyl})_3\text{SbX}_2$  although the conditions must be carefully controlled or mixtures with  $\text{SbR}_3$  and  $\text{RSbX}_2$  can result.<sup>9,11,15,62</sup> The second route is cleavage of an R group from a tertiary stibine usually with  $\text{Na/liquid NH}_3$  to give  $\text{R}_2\text{SbNa}$ ,<sup>8,11</sup> which then reacts with  $\text{R}'\text{X}$  to give  $\text{SbR}_2\text{R}'$ . Since  $\text{R}_2\text{Sb}^-$  anions are thermally unstable, cleavage of  $\text{R}_3\text{Sb}$  with  $\text{Li}$  in tetrahydrofuran is little used (in contrast to analogous  $\text{Ph}_3\text{P}$  or  $\text{Ph}_3\text{As}$  systems) although  $\text{Ph}_2\text{SbLi}$  has been made in this way.<sup>32,69,70</sup>

Ditertiary stibines are more difficult to obtain, and in contrast to phosphorus or arsenic analogs, there are limitations in the backbones which have been incorporated. Thus,  $\text{R}_2\text{SbCH}_2\text{CH}_2\text{SbR}_2$  and *cis*  $\text{R}_2\text{SbCH}=\text{CHSbR}_2$  are unknown, attempts to prepare them yielding  $\text{R}_2\text{SbSbR}_2$  and ethene or ethyne.<sup>71,72</sup> The reaction of  $\text{CH}_2\text{Cl}_2$  with  $\text{Me}_2\text{SbNa}$  or  $\text{Ph}_2\text{SbNa}$  in liquid ammonia gave the white, air-stable solid  $\text{Ph}_2\text{SbCH}_2\text{SbPh}_2$  and the pyrophoric oil  $\text{Me}_2\text{SbCH}_2\text{SbMe}_2$ .<sup>73</sup> A more convenient synthesis (Scheme 2) for the latter has been reported.<sup>74</sup>



Scheme 2

The reactions of  $\text{Cl}(\text{CH}_2)_n\text{Cl}$  ( $n = 3-6$ ) with  $\text{R}_2\text{SbNa}$  ( $\text{R} = \text{Ph}$  or  $\text{Me}$ ) afford the appropriate  $\text{R}_2\text{Sb}(\text{CH}_2)_n\text{SbR}_2$ .<sup>66</sup> The strongest binding ditertiary stibine is *o*- $\text{C}_6\text{H}_4(\text{SbMe}_2)_2$  made by the lengthy route in Scheme 3 but the overall yield is very poor.<sup>50</sup>



Scheme 3

The *o*- $\text{C}_6\text{H}_4(\text{SbPh}_2)_2$  is also known but little used.<sup>75</sup> The synthetic difficulties arising from the weak  $\text{Sb}-\text{C}$  bonds have seriously hindered attempts to make polydentate stibines and in marked contrast to the many P or As examples, only one tritertiarystibine is known. This is  $\text{MeC}(\text{CH}_2\text{SbPh}_2)_3$  made in 15% yield from  $\text{MeC}(\text{CH}_2\text{Br})_3$  and  $\text{Ph}_2\text{SbNa}$  in liquid ammonia.<sup>76</sup>

Neither facultative tridentate nor tetradentate stibines have been prepared, and these remain a worthwhile challenge for the coordination chemist. The problems in such syntheses lie in the weak Sb—C bond where sequential establishment of new Sb—C linkages often compete with cleavage of existing Sb—C bonds.

It is notable that a significant number of polydentate ligands containing a single antimony donor in combination with P, As, S, N, etc. donors have been made, often in good yield.<sup>10</sup> Some examples are shown in Figure 2.

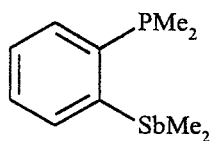
The synthetic routes are variations on those used for tertiary and ditertiary stibines, either reaction of  $R_2SbNa$  with a halo-organic containing the heteroatom donor group; reaction of  $R_2SbX$  or  $SbX_3$  with organolithium derivatives containing the second donor group; or rarely as in  $o\text{-C}_6\text{H}_4(\text{EMe}_2)(\text{SbMe}_2)$  ( $E = \text{As}$  or  $\text{P}$ ) from  $\text{NaEMe}_2$  and  $o\text{-C}_6\text{H}_4\text{Br}(\text{SbMe}_2)$ .

Notable recent additions to this list are the  $R_2\text{PCH}_2\text{SbR}'_2$  ( $R = \text{}^i\text{Pr}$ ,  $R' = \text{}^i\text{Pr}, \text{}^t\text{Bu}$ ;  $R = \text{Cy}$ ,  $R' = \text{}^t\text{Bu}$ ) prepared by Werner and co-workers<sup>80</sup> by reaction of  $\text{Ph}_3\text{SnCH}_2\text{PR}_2$  with  $\text{PhLi}$ ,  $\text{Me}_2\text{NCH}_2\text{CH}_2\text{NMe}_2$ , and  $R'_2\text{SbX}$ .

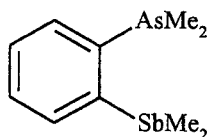
Tetraorganodistibines  $R_2\text{SbSbR}_2$ , catenapolystibines  $R_2\text{Sb}(\text{SbR})_n\text{SbR}_2$ , and cyclopolystibines  $(\text{RSb})_n$  ( $n = 3\text{--}6$ ) can also behave as ligands. These have been the subject of two reviews by Breunig and Rosler, which should be consulted for details.<sup>81,82</sup>

### 1.16.1.3 Bismuthine Synthesis

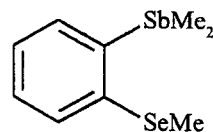
Many trialkyl- and triaryl-bismuthines are known, although only a very small number have been used as ligands. References to specific  $\text{BiR}_3$  from earlier literature can be found in various reviews.<sup>9,10,12,15</sup> The most widely used route is reaction of bismuth trihalide with the appropriate Grignard or organolithium reagent in diethyl ether or tetrahydrofuran. The air-stable



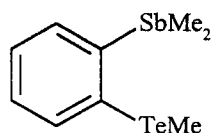
(50)



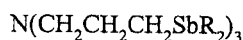
(50)



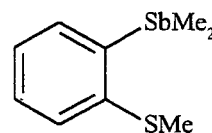
(53)



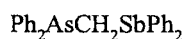
(55)



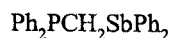
(77)



(78)



(39,79)



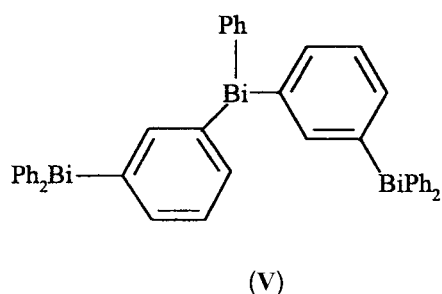
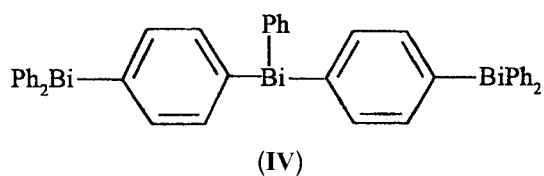
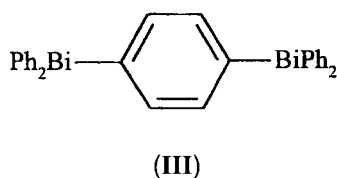
(39,79)

**Figure 2** Some hydride ligands containing antimony donors (numbers under structures are literature references to syntheses).

triarylbismuthines are isolated by hydrolysis, extraction into diethyl ether, and recrystallization. The pyrophoric  $\text{BiMe}_3$  can be distilled at atmospheric pressure, but most other trialkylbismuthines must be distilled in vacuum to avoid decomposition. Yields are usually good to excellent. Good descriptions of experimental procedures are given for  $\text{Bi}^i\text{Pr}_3$ ,<sup>83</sup> and  $\text{Bi}^t\text{Bu}_3$ .<sup>84</sup> Unsymmetrical triarylbismuthines  $\text{BiRR}'_2$  can be made from  $\text{RBiCl}_2$  or  $\text{R}'_2\text{BiCl}$  and the appropriate organolithium reagent.<sup>85</sup> Early workers failed to isolate mixed alkylaryl bismuthines and reported that they were prone to scrambling of substituents, but more recently  $\text{BiPh}_2(\text{alkyl})$ ,  $\text{BiPh}(\text{alkyl})_2$ , and mixed trialkylbismuthines have all been isolated and fully characterized. The thermally relatively stable, although air-sensitive  $\text{BiPh}_2\text{R}$  ( $\text{R} = \text{Me}$ ,  $\text{Et}$ ,  $^n\text{Bu}$ ,  $^n\text{C}_5\text{H}_{11}$ ,  $^n\text{C}_6\text{H}_{13}$ ) are prepared from  $\text{Ph}_2\text{BiCl}$  and  $\text{RLi}$  in diethyl ether at  $-70^\circ\text{C}$  and purified by distillation in high vacuum.<sup>86</sup> Dimethyl(alkyl)bismuthines  $\text{BiMe}_2\text{R}$  ( $\text{R} = \text{Et}$ ,  $^n\text{Pr}$ ,  $^n\text{Bu}$ ,  $^i\text{Pr}$ ) are made by reaction of  $\text{Me}_2\text{BiNa}$  (made *in situ* from  $\text{Me}_2\text{BiBr}$  and  $\text{Na}$ ) in liquid ammonia with  $\text{RBr}$  at  $-78^\circ\text{C}$ .<sup>87</sup> The products are air-sensitive, thermolabile liquids which are prone to disproportionation into  $\text{BiMe}_3$  and  $\text{BiMeR}_2$ . The final type,  $\text{BiMe}_2\text{R}$  ( $\text{R} = (p\text{-tolyl})$ ,  $p\text{-MeOC}_6\text{H}_4$ ,  $2,4,6\text{-Me}_3\text{C}_6\text{H}_2$ ) are best made from  $\text{Me}_2\text{BiBr}$ , lithium metal, and  $\text{RBr}$  in tetrahydrofuran at  $-78^\circ\text{C}$ , and are quantitatively decomposed into  $\text{BiMeR}_2$  and  $\text{BiMe}_3$  on gentle heating.<sup>87</sup>

Few dibismuthines have been obtained, but these include  $\text{Ph}_2\text{BiCH}_2\text{BiPh}_2$  an air-sensitive solid made from  $\text{Ph}_2\text{BiNa}$  and  $\text{CH}_2\text{Cl}_2$  in liquid ammonia.<sup>88</sup> The reaction of  $\text{Me}_2\text{BiNa}$  with  $\text{XCH}_2\text{CH}_2\text{X}$  gives only  $\text{Me}_2\text{BiBiMe}_2$  and  $\text{CH}_2=\text{CH}_2$ , but with  $\text{Br}(\text{CH}_2)_n\text{Br}$  ( $n = 3, 4$ , or  $5$ )  $\text{Me}_2\text{Bi}(\text{CH}_2)_n\text{BiMe}_2$  form, although only  $\text{Me}_2\text{Bi}(\text{CH}_2)_5\text{BiMe}_2$  has been isolated in the pure state. For  $n = 3$  the product is mixed with  $\text{Me}_2\text{BiBiMe}_2$  and for  $n = 4$  the co-product is the cyclic  $\text{MeBi}(\text{CH}_2)_4$ .<sup>89</sup>

The *o*-phenylenedibismuthines  $o\text{-C}_6\text{H}_4(\text{BiR}_2)_2$  have not been obtained as yet (although  $o\text{-C}_6\text{H}_4(\text{SbPh}_2)(\text{BiPh}_2)$  is known)<sup>90</sup> but an improved synthesis for  $p\text{-C}_6\text{H}_4(\text{BiPh}_2)_2$  from  $p\text{-C}_6\text{H}_4\text{Li}_2$  and  $\text{Ph}_2\text{BiCl}$  has been reported.<sup>91</sup> Under different conditions reaction of  $\text{Ph}_2\text{BiCl}$  with  $p\text{-C}_6\text{H}_4\text{Li}_2$ ,  $p\text{-C}_6\text{H}_4(\text{MgBr})_2$ , and *m*- or *p*- $\text{C}_6\text{H}_4(\text{Cu}\cdot\text{Me}_2\text{S})_2$  gave *m*- or *p*-phenylene bridged bismuthines (III–V).<sup>92</sup>



Highly branched and dendritic polybismuthanes have been prepared.<sup>92</sup>

A number of hybrid ligands containing one  $\text{BiPh}_2$  in combination with  $\text{PPh}_2$ ,  $\text{AsPh}_2$ ,  $\text{SMe}$ ,  $\text{NMe}_2$  donor groups is known.<sup>10</sup> The successful syntheses incorporate the  $\text{BiPh}_2$  group in the final stage of the synthesis to avoid problems arising from  $\text{Bi-C}$  bond fission.

#### 1.16.1.4 Arsines, Stibines, and Bismuthines as Ligands

##### 1.16.1.4.1 Bonding

Historically, the theoretical background to bonding of Group 15 ligands to metals has been developed for phosphines, and treatment of the heavier analogs is in terms of the trends down the group and any differences relative to the  $\text{PR}_3$ . In recent years the metal–phosphine bonding model



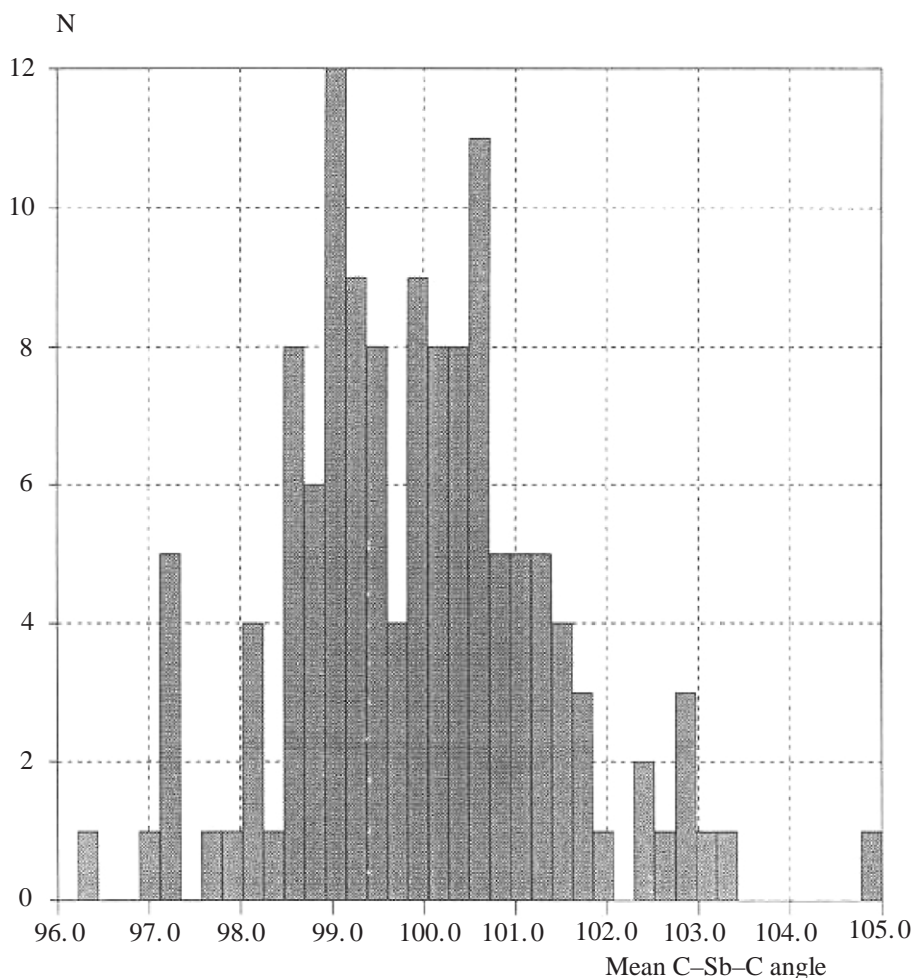
of Chatt,<sup>6,7</sup>  $\sigma$  donation from the phosphorus-based lone pair and  $\pi$  acceptance into the phosphorus 3d orbitals, has been modified. Calculations have demonstrated that the 3d orbitals are too diffuse and too high in energy to be a significant component of the  $\pi$  bond, and the acceptor orbitals are viewed as predominantly P—C  $\sigma^*$ .<sup>93</sup> Although detailed calculations for the heavier ligands are unavailable, it is assumed that the same model applies. The detailed spectroscopic data on which comparisons of bonding between a common acceptor and  $\text{PR}_3$ ,  $\text{AsR}_3$ ,  $\text{SbR}_3$ , and  $\text{BiR}_3$  have been discussed in previous reviews,<sup>7,10,94,95</sup> and more recent data have not challenged the basic trends. The present view is that as Group 15 is descended the ligands become both weaker  $\sigma$  donors and weaker  $\pi$  acceptors. The weaker  $\sigma$  donation is usually attributed to the increase in energy between the valence  $s$  and  $p$  orbitals as the atom becomes heavier, which results in increasing  $p$  component in the E—C bonds (E = P, As, Sb, Bi) a suggestion supported by the decreased C—E—C angles as the central atom becomes heavier. This results in an increased  $s$  character in the lone pair, with poorer directional properties, and coupled with more diffuse orbitals and weaker bonds formed by heavier atoms in general, accounts for the poorer ligand properties. On coordination to an acceptor it has been argued that increased  $s$ - $p$  hybridization is necessary, but this is also less effective as the  $s$ - $p$  orbital energies become more disparate. Correspondingly, the  $\pi$  acceptance is also expected to decrease down the group due to the reduced electronegativity of the acceptor atom and the more diffuse orbitals.<sup>94,95</sup> Theoretical modeling of the heavy element–metal bonding would be welcome confirmation (or lead to modification) of this view, and would hopefully lead to more precise description of the trends.

Steric effects in Group 15 ligand chemistry are conventionally approached via Tolman's cone angle model.<sup>96</sup> For fixed R groups, the cone angles decrease slightly as Group 15 is descended, although the changes are small, usually a few degrees between P and Bi. Listings of cone angles for many ligands have been given in previous reviews.<sup>7,96</sup> It is perhaps worth restating the point made in the original model, but sometimes overlooked, that the model is semi-quantitative, and for all but the very simplest ligands, the orientations adopted by the R groups in real compounds can vary, and real ligands are not solid cones but allow intermeshing of substituents. Both effects can substantially change the space occupied by a particular ligand.

The exponential increase in X-ray crystallographic data in recent years has allowed studies of ligand steric effects utilizing the X-ray structural databases. For example, Orpen and co-workers<sup>97</sup> examined a wide range of  $\text{Ph}_3\text{P—E}$  fragments where E is a wide range of transition metal and main group elements, and found a correlation between the C—P—C angle and the P—C bond length. The C—P—C angles markedly increase towards the tetrahedral angle when E is C (phosphonium  $\text{PC}_4$  unit) or a light non-metal, but most significantly, the study concluded that when E is a transition-series element the complexes show  $\text{PPh}_3$  geometries close to that of triphenylphosphine itself. An indication that this might not be generally true in Group 15 ligand chemistry came from studies<sup>98</sup> on monodentate coordinated complexes of  $\text{Ph}_2\text{SbCH}_2\text{SbPh}_2$  where the coordinated  $\text{SbPh}_2$  group has C—Sb—C angles all larger than in the "free" ligand. To establish the generality of such an observation and its statistical validity, one needs X-ray structural data on the "free" ligand and on a large number of complexes, and hence  $\text{SbPh}_3$  complexes were subsequently studied.<sup>99</sup> This established that compared with  $\text{SbPh}_3$  itself, C—Sb—C<sub>av</sub> = 96.27(0.21)°, all examples of M—SbPh<sub>3</sub> (M = transition metal) had larger angles ranging up to 104°. This result is shown as a histogram in Figure 3.

There appeared to be no correlation between C—Sb—C and  $d(\text{Sb—M})$ , but there does appear to be a correlation with  $d(\text{Sb—C})$ , although one should recognize that in many structures Sb—C distances are not of high precision. A similar study of  $\text{Ph}_3\text{As—M}$  complexes showed that C—As—C also increased on coordination [mean complex = 102.3(1.3)° "free"  $\text{AsPh}_3$  (mean) 99.4(4)°],<sup>99</sup> although any correlation with  $d(\text{As—C})$  was less clear. Structural data on metal–bismuthine complexes is limited to only five examples, but the effect appears even larger [mean complex C—Bi—C 99.1(9)°, "free"  $\text{BiPh}_3$  93.9(1)°].<sup>91,100</sup> This increase in angle in the heavier Group 15 ligands on coordination can be rationalized in various ways,<sup>99</sup> although it clearly correlates with the discussion above, in that in the free ligand the E—C (E = P, As, Sb, or Bi) bonds have higher  $p$  character as Group 15 is descended, and that on coordination more  $s$ - $p$  mixing would increase the C—E—C angle. However, more detailed understanding must await high-level M.O. calculations, which particularly for Sb and Bi will be very difficult due to the number of electrons and relativistic effects. The correlation between reduced  $d(\text{E—C})$  and increased C—E—C also fits with changes in the proportion of  $s/p$  character in the E—C bond. However, since any  $\pi$  back-bonding into C—E $\sigma^*$  should increase  $d(\text{E—C})$  on coordination, it is likely that more than one effect is operating and some care is necessary in interpreting such trends. In passing, one should note that this effect of increasing C—E—C angles in the heavy donor ligands on coordination has implications for





**Figure 3** Histogram showing mean C–Sb–C angles in  $\text{Ph}_3\text{Sb}$  complexes.

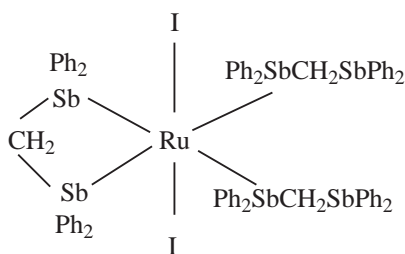
the cone angle model, and reinforces the view that one should not overinterpret small differences in cone angles.

#### 1.16.1.4.2 Coordination modes

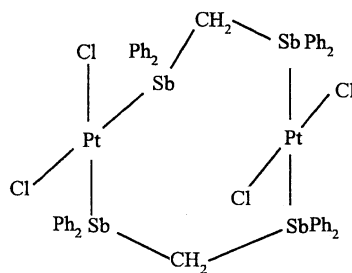
Typically,  $\text{ER}_3$  (E = As, Sb, or Bi) behave as (terminal) monodentate ligands to metal or metalloid acceptors. However, Werner and co-workers<sup>101</sup> found that in several  $\text{Rh}^{\text{I}}$  carbene complexes,  $\text{trans}[\text{Rh}_2\text{Cl}_2(\mu\text{-CR}_2)_2(\mu\text{-SbR}_3)_2]$  (R = *i*Pr, Et, Me) the stibines bridge the two rhodium centers. More recently,<sup>102</sup> examples of bridging  $\text{PR}_3$  in related  $\text{Rh}^{\text{I}}$  carbenes have been described. Phenyl-substituted Group 15 ligands  $\text{EPh}_3$  may also bond to metals via an  $\eta^6\text{-Ph}$  group rather than the E lone pair, examples including the chromium carbonyl complexes,  $[\{(\text{CO})_3\text{Cr}(\eta^6\text{-Ph})\}_n\text{SbPh}_{3-n}]$  and  $[\{(\text{CO})_3\text{Cr}(\eta^6\text{-Ph})\}_n\text{BiPh}_{3-n}]$ .<sup>103</sup> Under different synthesis conditions, more conventional  $[\text{Cr}(\text{CO})_{6-n}(\text{EPh}_3)_n]$  where coordination is via the lone pair on E, are formed.<sup>6,10</sup>

Diphosphinomethanes  $\text{R}_2\text{PCH}_2\text{PR}_2$  have a particularly rich structural chemistry with many examples of chelation, monodentate and bridging bidentate coordination modes established. When phosphorus is replaced by heavier Group 15 donor atoms, their larger size increases the strain in the four-membered chelate rings, and this coupled with reduced donation tends to disfavor chelation. For the distibinomethane  $\text{Ph}_2\text{SbCH}_2\text{SbPh}_2$ , monodentate or bridging bidentate coordination modes are preferred as in  $[\text{W}(\text{CO})_5(\eta^1\text{-Ph}_2\text{SbCH}_2\text{SbPh}_2)]$ ,  $[\{\text{W}(\text{CO})_5\}_2(\mu^2\text{-Ph}_2\text{SbCH}_2\text{SbPh}_2)]$ , or  $[\text{Co}_2(\text{CO})_6(\mu^2\text{-Ph}_2\text{SbCH}_2\text{SbPh}_2)]$ ,<sup>74,104</sup> and chelation is rare; one example containing both chelating and monodentate ligands is  $[\text{RuI}_2(\text{Ph}_2\text{SbCH}_2\text{SbPh}_2)_3]$  (VI).<sup>105</sup> This ligand also forms the unusual *cis-trans* dimers with  $\text{Pd}^{\text{II}}$  and  $\text{Pt}^{\text{II}}$  (VII).<sup>105</sup> Diarsinomethanes

appear to be intermediate between phosphorus and antimony analogs in their coordination preferences.<sup>106</sup>



(VI)



(VII)

Two-carbon-backboned diarsines usually chelate to metal centers forming favored 5-membered chelate rings, although even *o*-C<sub>6</sub>H<sub>4</sub>(AsMe<sub>2</sub>)<sub>2</sub>, justly famed for its strong chelating ability, can behave (rarely) as a bridging bidentate in [ $\{(\text{MeC}_5\text{H}_4)\text{Mn}(\text{CO})_2\}_2\text{-}\mu\text{-}o\text{-C}_6\text{H}_4(\text{AsMe}_2)_2$ ],<sup>107</sup> or as a monodentate ligand in  $[\text{OsBr}_2(\text{CO})(\eta^1\text{-}o\text{-C}_6\text{H}_4(\text{AsMe}_2)_2)(\eta^2\text{-}o\text{-C}_6\text{H}_4(\text{AsMe}_2)_2)]$ .<sup>108</sup>

Three-carbon-backboned diarsines or distibines R<sub>2</sub>E(CH<sub>2</sub>)<sub>3</sub>ER<sub>2</sub> also typically chelate, and in contrast to diphosphine analogs, there is little coordination chemistry of heavier Group 15 donor ligands with longer carbon backbones, although a few examples of *trans*-chelation have been reported.<sup>109</sup> The variety of coordination modes available to tri-, tetra-, and hexatertiary arsines are too complex to be discussed here, and previous reviews should be consulted.<sup>6,7,48,110</sup> In contrast to the extensive chemistry of polydentate arsines, complexes of only one tritibine MeC(CH<sub>2</sub>SbPh<sub>2</sub>)<sub>3</sub> have been described,<sup>76</sup> which behaves as a tridentate in  $[\text{M}(\text{CO})_3\{\text{MeC}(\text{CH}_2\text{SbPh}_2)_3\}]$  (M = Cr, Mo, or W) and a bidentate in  $[\text{PtCl}_2\{\text{MeC}(\text{CH}_2\text{SbPh}_2)_3\}]$ .

Relatively few complexes of bismuthine ligands have been described,<sup>10</sup> and in many of these characterization is incomplete by modern standards. Most of the work has used BiPh<sub>3</sub>, which is a very weak donor, e.g., it even fails to displace CO from Ni(CO)<sub>4</sub>,<sup>91</sup> although  $[\text{Ni}(\text{CO})_3(\text{BiR}_3)]$  (R = Me, Et, <sup>n</sup>Bu, etc.) are known.<sup>111</sup> Only four examples of R<sub>3</sub>Bi—M bonds have been established by X-ray crystallography:  $[\text{M}(\text{CO})_5(\text{Ph}_3\text{Bi})]$  (M = Cr, Mo, or W),  $[(\text{C}_5\text{H}_5)\text{Fe}(\text{CO})_2(\text{Ph}_3\text{Bi})]\text{-BF}_4$ ,<sup>91,100,112,113</sup> The only examples of dibismuthine complexes are with *p*-C<sub>6</sub>H<sub>4</sub>(BiPh<sub>2</sub>)<sub>2</sub> which coordinates as a monodentate in  $[\text{M}(\text{CO})_5\{p\text{-C}_6\text{H}_4(\text{BiPh}_2)_2\}]$  and a bridging bidentate in  $[\{(\text{CO})_5\}_2\{p\text{-C}_6\text{H}_4(\text{BiPh}_2)_2\}]$  (M = Cr or W).<sup>91</sup>

The majority of complexes of arsine ligands are with low-oxidation-state metal acceptors or with the soft metals towards the lower right of the *d* block. In such complexes the differences between analogous PR<sub>3</sub> and AsR<sub>3</sub> complexes are often small. However, the importance of comparing analogs is worth stressing (i.e., fixed R groups). For example, in platinum metal halide systems such as  $[\text{OsX}_4(\text{ER}_3)_2]^{0/-}$  or  $[\text{IrX}_4(\text{ER}_3)_2]^{0/-}$  the effect on the redox potentials of changing R from Me to Ph is similar to that of changing E from P to As, and is greater than the effect of changing X from Cl to Br.<sup>114</sup> In harder metal-acceptor systems such as 3*d* element halides or high oxidation states of the heavy *d*-block element halides, complexes with soft aryl arsines either do not form or are highly unstable. Trialkylarsines are stronger donors and  $[\text{NiX}_2(\text{AsMe}_3)_3]$ ,<sup>115</sup>  $[\text{NiI}_3(\text{AsMe}_3)_2]$ , and  $[\text{CoI}_3(\text{AsMe}_3)_2]$ ,<sup>116</sup> are known. The ligand *o*-C<sub>6</sub>H<sub>4</sub>(AsMe<sub>2</sub>)<sub>2</sub> is exceptional in that complexes with most *d*-block metals have been known

for many years,<sup>5</sup> and this diarsine is a stronger binding ligand than many diphosphines such as  $\text{Ph}_2\text{PCH}_2\text{CH}_2\text{PPh}_2$ . However, comparison with the diphosphine analog  $o\text{-C}_6\text{H}_4(\text{PMe}_2)_2$  shows that in demanding systems such as complexes of  $\text{Mn}^{\text{II}}$ ,  $\text{Fe}^{\text{IV}}$ ,  $\text{Ni}^{\text{IV}}$ , or  $\text{Cu}^{\text{III}}$ , the diphosphine has superior binding ability.<sup>117,118</sup> The exceptional coordinating ability of the two- $o\text{-C}_6\text{H}_4(\text{EMe}_2)_2$  ligands results from a combination of strong  $\sigma$  donor power, modest steric requirements, and the rigid aromatic backbone which resists dissociation from the metal (the “ $o$ -phenylene backbone” effect).<sup>117</sup> Variation of these factors by replacing the Me groups by bulkier or less-electron-releasing R groups, the  $o\text{-C}_6\text{H}_4\text{—}$  by flexible  $o\text{-(CH}_2)_n\text{—}$  linkages or with the electron-withdrawing  $o\text{-C}_6\text{F}_4\text{—}$  result in ligands with markedly less ability to coordinate to the most demanding metal systems.<sup>5,45,118</sup> Little effort has been devoted to studies of arsine complexes with p-block metals or metalloids, but a few examples are known including structurally characterized complexes of  $o\text{-C}_6\text{H}_4(\text{AsMe}_2)_2$  with halides of  $\text{Sn}^{\text{IV}}$ ,  $\text{Bi}^{\text{III}}$ ,  $\text{Sb}^{\text{III}}$ , and even  $\text{As}^{\text{III}}$ .<sup>119,120</sup>

For stibines, the bulk of the coordination chemistry is with metals in low oxidation states, or with platinum metal or Group 11 metal halides.<sup>10</sup> Whilst further work is unlikely to change the overall pattern, the isolation of complexes such as  $[\text{NiX}_2(\text{SbMe}_3)_3]$ ,<sup>121</sup>  $[\text{CoI}_3(\text{SbPh}_3)_3]$ ,<sup>122</sup> or  $[\text{ReOCl}_3(\text{SbPh}_3)_2]$ ,<sup>123</sup> show that complexes outside this area can be isolated, and much early transition metal chemistry of these ligands remains unexplored. The distibine  $o\text{-C}_6\text{H}_4(\text{SbMe}_2)_2$ , which has the key structural features of the corresponding diarsine (above), is the strongest binding antimony donor ligand and forms stable complexes with  $\text{Ni}^{\text{II}}$  or  $\text{Co}^{\text{III}}$ ,<sup>124</sup> and should be able to form complexes with most d-block elements, although its difficult synthesis has severely limited studies.

Studies pre-1950 described the reaction of p-block halides such as  $\text{PCl}_3$ ,  $\text{SbCl}_3$ , or  $\text{TiCl}_3$  with  $\text{SbPh}_3$  resulting in scrambling of substituents to give  $\text{SbPh}_{3-n}\text{Cl}_n$  or in some cases oxidation to  $\text{SbPh}_3\text{Cl}_2$ .<sup>10</sup> Similar scrambled products were reported with  $\text{BiPh}_3$ . Re-examination of these reactions with modern spectroscopic techniques would be worthwhile. Cleavage of C—Sb bonds is known on reaction of  $\text{SbPh}_3$  with some transition metals, for example  $\text{PdCl}_2$  gives both the expected  $[\text{PdCl}_2(\text{SbPh}_3)_2]$  and the fragmentation product  $[\text{PdCl}(\sigma\text{-Ph}(\text{SbPh}_3)_2)]$ .<sup>125</sup> Such fragmentations are more common with  $\text{BiPh}_3$ , including the reactions with  $\text{Pd}(\text{OAc})_2$  and  $\text{Ni}(\text{COD})_2$  when quantitative generation of biphenyl and metallic bismuth occurs.<sup>126</sup>

## 1.16.2 REFERENCES

1. Chatt, J. Forward. In *Transition Metal Complexes of Phosphorus, Arsenic and Antimony Ligands*, McAuliffe, C. A., Ed., Macmillan: London, 1973, pp vii–ix.
2. Chatt, J.; Mann, F. G. *J. Chem. Soc.* **1939**, 1622–1625.
3. Barclay, G. A.; Nyholm, R. S. *Chem. Ind. (London)* **1953**, 378–379.
4. Cloyd, J. C., Jr.; McAuliffe, C. A. Transition metal complexes containing monotertiary arsines and stibines. In *Transition Metal Complexes of Phosphorus, Arsenic and Antimony Ligands*, McAuliffe, C. A., Ed., Macmillan: London, 1973, Chapter 3, pp 207–267.
5. Alyea, E. C. Metal complexes with ditertiary arsines. In *Transition Metal Complexes of Phosphorus, Arsenic and Antimony Ligands*; McAuliffe, C. A., Ed., Macmillan: London, 1973; Chapter 5, pp 311–373.
6. McAuliffe, C. A.; Levason, W. *Studies in Inorganic Chemistry, Vol. 1: Phosphine, Arsine and Stibine Complexes of the Transition Elements*; Elsevier: Amsterdam, 1978.
7. McAuliffe, C. A. Phosphorus, arsenic, antimony and bismuth ligands. *CCC (1987)*; Pergamon: Oxford, 1987, Chapter 14, pp 989–1066.
8. *Gmelin Handbuch der Anorganische Chemie, Organoantimony Compounds. Part 1*. 8th Ed.; Springer Verlag, New York, 1981.
9. *Gmelin Handbook of Inorganic Chemistry. Supplementary Work, Vol. 47: Bismuth–Organic Compounds*. 8th Ed., 1978.
10. Champness, N. R.; Levason, W. *Coord. Chem. Rev.* **1994**, 133, 115–217.
11. Akiba, K.-Y.; Yamamoto, Y. Syntheses of organoantimony and organobismuth compounds. In *Chem. Org. Arsenic, Antimony Bismuth Compd.*, Patai, S., Ed., Wiley: New York, 1994; pp 761–812.
12. Yamamoto, Y.; Akiba, K.-Y. Syntheses of organoarsenic compounds. In *Chem. Org. Arsenic, Antimony Bismuth Compd.*, Patai, S., Ed., Wiley: New York, 1994, 813–881.
13. Cross, W. J.; Godfrey, S. M.; McAuliffe, C. A.; Mackie, A. G.; Pritchard, R. B. Organoarsenic and organoantimony compounds: synthesis properties and uses in organic transformations. In *The Chemistry of Arsenic, Antimony and Bismuth*, Norman, N. C., Ed., Blackie: London, 1998, Chapter 5, pp 207–282.
14. Suzuki, H.; Matano, Y. Organobismuth compounds: synthesis properties and uses in organic transformations. In *The Chemistry of Arsenic, Antimony and Bismuth*, Norman, N. C., Ed., Blackie: London, 1998, Chapter 6, pp 263–343.
15. Samaan, Samir. *Methods in Organic Chemistry (Houben-Weyl) Vol. 13, Pt. 8: Metalloorganic Compounds, Arsenic, Antimony, Bismuth* Georg Thieme Verlag, Stuttgart, 1978.
16. Jolly, W. L.; Drake, J. E. *Inorg. Synth.* **1963**, 7, 34–44.
17. Drake, J.; Riddle, C. *Inorg. Synth.* **1971**, 10, 14–17.
18. Bellama, J. M.; MacDiarmid, A. G. *Inorg. Chem.* **1968**, 7, 2070–2072.

19. Bradley, D. C.; Zheng, D. H. Method for safe handling of arsine and phosphine using reversible complexes with haloarylboron compounds. *Eur. Pat. Appl.* 443,739, 1991.
20. Wells, R. L.; Kwag, C. Y.; Purdy, A. P.; McPhail, A. T.; Pitt, C. G. *Polyhedron* **1990**, *9*, 319–327.
21. Feltham, R. D.; Silverthorn, W. E. *Inorg. Synth.* **1967**, *10*, 159–164.
22. Tzschach, A.; Schwarzer, R. *Justus Liebigs Ann. Chem.* **1967**, *709*, 248–256.
23. Mann, F. G.; Pragnell, M. J. *J. Chem. Soc.* **1965**, 4120–4126.
24. Twamley, B.; Hwang, C.-S.; Hardman, N. J.; Power, P. P. *J. Organomet. Chem.* **2000**, *609*, 152–160.
25. Dub, M. *Organometallic Compounds: Methods of Synthesis, Physical Constants, and Chemical Reactions, Vol. 3: Compounds of Arsenic, Antimony, and Bismuth*, 2nd ed.; Springer Verlag, New York, 1968.
26. Srivastava, D. K.; Krannich, L. K.; Watkins, C. L. *Inorg. Chem.* **1990**, *29*, 3502–3506.
27. Mente, D. C.; Mills, J. L.; Mitchell, R. E. *Inorg. Chem.* **1975**, *14*, 123–126.
28. Zingaro, R. A. *Synth. Methods Organomet. Inorg. Chem.* **1996**, 200–202.
29. Appel, R.; Rebhan, D. *Chem. Ber.* **1969**, *102*, 3955–3957.
30. Baiada, A.; Jardine, F. H.; Willett, R. D. *Inorg. Chem.* **1990**, *29*, 3042–3046.
31. Schumann, H.; Frank, U.; Du Mont, W. W.; Marschner, F. *J. Organomet. Chem.* **1981**, *222*, 217–225.
32. Wolfsberger, W. *Chem.-Ztg.* **1991**, *115*, 7–13.
33. Ganja, E. A.; Ontiveros, C. D.; Morrison, J. A. *Inorg. Chem.* **1988**, *27*, 4535–4538.
34. Abel, E. W.; Beckett, M. A. *J. Chem. Soc., Dalton Trans.* **1987**, 417–420.
35. Gavrilenko, V. V.; Chekulaeva, L. A.; Pisareva, I. V. *Izv. Akad. Nauk, Ser. Khim.* **1996**, 2122–2123.
36. Thomas, C. J.; Krannich, L. K.; Watkins, C. L. *Polyhedron* **1993**, *12*, 389–399.
37. Thomas, C. J.; Krannich, L. K.; Watkins, C. L. *Synth. React. Inorg. Met.-Org. Chem.* **1992**, *22*, 461–479.
38. Wild, S. B. Optically active arsines: preparation uses and chiroptical properties. In *Chem. Org. Arsenic, Antimony, Bismuth Compd.* Patai, S., Ed., Wiley: New York, 1994.
39. Kauffmann, T.; Altepeter, B.; Klas, N.; Kriegsmann, R. *Chem. Ber.* **1985**, *118*, 2353–2364.
40. Chiffey, A. F.; Evans, J.; Levason, W.; Webster, M. *Polyhedron* **1996**, *15*, 591–596.
41. Sommer, K. *Z. Anorg. Allg. Chem.* **1970**, *377*, 278–286.
42. Iwata, K.; Kojima, M.; Fujita, J. *Bull. Chem. Soc. Jpn.* **1985**, *58*, 3003–3009.
43. Henrick, K.; Wild, S. B. *J. Chem. Soc., Dalton Trans.* **1975**, 1506–1516.
44. Grocott, S. C.; Wild, S. B. *Inorg. Chem.* **1982**, *21*, 3526–3534.
45. Hanton, L. R.; Evans, J.; Levason, W.; Perry, R. J.; Webster, M. *J. Chem. Soc., Dalton Trans.* **1991**, 2039–2044.
46. Ellermann, J.; Brehm, L. *Chem. Ber.* **1985**, *118*, 4794–4805.
47. Fitzpatrick, M. G.; Hanton, L. R.; McMorran, D. A. *Inorg. Chem.* **1995**, *34*, 4821–4827.
48. Doyle, R. J.; Habermehl, N.; Salem, G.; Willis, A. C. *J. Chem. Soc., Dalton Trans.* **2000**, 3603–3608.
49. Enlow, P. D.; Woods, C. *Organometallics* **1983**, *2*, 64–68.
50. Levason, W.; Smith, K. G.; McAuliffe, C. A.; McCullough, F. P.; Sedgwick, R. D.; Murray, S. G. *J. Chem. Soc., Dalton Trans.* **1979**, 1718–1724.
51. Salem, G.; Wild, S. B. *Inorg. Chem.* **1983**, *22*, 4049–4054.
52. Doyle, R. J.; Salem, G.; Willis, A. C. *J. Chem. Soc., Dalton Trans.* **1995**, 1867–1872.
53. Hope, E. G.; Kemmitt, T.; Levason, W. *J. Chem. Soc., Perkin Trans. 2* **1987**, 487–490.
54. Martin, J. W. L.; Palmer, J. A. L.; Wild, S. B. *Inorg. Chem.* **1984**, *23*, 2664–2670.
55. Kemmitt, T.; Levason, W. *Organometallics* **1989**, *8*, 1303–1308.
56. Grimley, E.; Meek, D. W. *Inorg. Chem.* **1986**, *25*, 2049–2053.
57. Ashmawy, F. M.; Benn, F. R.; McAuliffe, C. A.; Watson, D. G. *J. Organomet. Chem.* **1985**, *287*, 65–79.
58. Doyle, R. J.; Salem, G.; Willis, A. C. *J. Chem. Soc., Dalton Trans.* **1997**, 2713–2723.
59. Fries, G.; Wolf, J.; Pfeiffer, M.; Stalke, D.; Werner, H. *Angew. Chem., Int. Ed.* **2000**, *39*, 564–566.
60. Wolf, J.; Manger, M.; Schmidt, U.; Fries, G.; Barth, D.; Weberndorfer, B.; Vivic, D. A.; Jones, W. D.; Werner, H. *J. Chem. Soc., Dalton Trans.* **1999**, 1867–1876.
61. Hiers, G. H. *Org. Synth.* **1927**, *7*, 80–82.
62. Breunig, H. J.; Kanig, W. *Phosphorus Sulfur* **1982**, *12*, 149–159.
63. Breunig, H. J.; Ates, M.; Soltani-Neshan, A.; Ebert, K. H. *Synth. Methods Organomet. Inorg. Chem.* **1996**, *3*, 208–210.
64. Hendershot, D. G.; Pazik, J. C.; George, C.; Berry, A. D. *Organometallics* **1992**, *11*, 2163–2168.
65. Sladek, A.; Schmidbaur, H. *Chem. Ber.* **1995**, *128*, 565–567.
66. Meinema, H. A.; Martens, H. F.; Noltes, J. G. *J. Organomet. Chem.* **1973**, *51*, 223–230.
67. Gedridge, R. W., Jr. *Organometallics* **1992**, *11*, 967–969.
68. Nunn, M.; Sowerby, D. B.; Wesolek, D. M. *J. Organomet. Chem.* **1983**, *251*, C45–C46.
69. Bartlett, R. A.; Rasika Dias, H. V.; Hope, H.; Murray, B. D.; Olmstead, M. M.; Power, P. P. *J. Am. Chem. Soc.* **1986**, *108*, 6921–6926.
70. Breunig, H. J.; Knobloch, T. P. *Z. Anorg. Allg. Chem.* **1978**, *444*, 119–125.
71. Meinema, H. A.; Martens, H. F.; Noltes, J. G. *J. Organomet. Chem.* **1976**, *110*, 183–193.
72. Chow, K.-K.; Levason, W.; McAuliffe, C. A. *J. Chem. Soc., Dalton Trans.* **1976**, 1429–1432.
73. Matsumura, Y.; Okawara, R. *Inorg. Nucl. Chem. Lett.* **1971**, *7*, 113–114.
74. Hill, A. M.; Levason, W.; Webster, M.; Albers, I. *Organometallics* **1997**, *16*, 5641–5647.
75. Levason, W.; McAuliffe, C. A.; Murray, S. G. *J. Organomet. Chem.* **1975**, *88*, 171–174.
76. Chiffey, A. F.; Evans, J.; Levason, W.; Webster, M. *Organometallics* **1996**, *15*, 1280–1283.
77. Levason, W.; Sheikh, B. *J. Organomet. Chem.* **1981**, *209*, 161–168.
78. Levason, W.; Sheikh, B. *J. Organomet. Chem.* **1981**, *208*, 1–9.
79. Kauffmann, T.; Jousen, R.; Klas, N.; Vahrenhorst, A. *Chem. Ber.* **1983**, *116*, 473–478.
80. Manger, M.; Wolf, J.; Laubender, M.; Teichert, M.; Stalke, D.; Werner, H. *Chem. Eur. J.* **1997**, *3*, 1442–1450.
81. Breunig, H. J.; Rosler, R. *Coord. Chem. Rev.* **1997**, *163*, 33–53.
82. Breunig, H. J.; Rosler, R. *Chem. Soc. Rev.* **2000**, *29*, 403–410.
83. Breunig, H. J.; Mueller, D. *Z. Naturforsch. B:* **1983**, *38*, 125–129.
84. Schumann, H.; Breunig, H. J. *J. Organomet. Chem.* **1975**, *87*, 83–92.
85. Rahman, Md. M.; Matano, Y.; Suzuki, H. *Organometallics* **1997**, *16*, 3565–3568.

86. Kauffmann, T.; Steinseifer, F. *Chem. Ber.* **1985**, *118*, 1031–1038.
87. Wieber, M.; Sauer, I. *Z. Naturforsch., B* **1985**, *40*, 1476–1480.
88. Kauffmann, T.; Steinseifer, F.; Klas, N. *Chem. Ber.* **1985**, *118*, 1039–1044.
89. Wieber, M.; Rudolph, K. *Z. Naturforsch., B* **1988**, *43*, 739–743.
90. Levason, W.; Sheikh, B.; McCullough, F. P. *J. Coord. Chem.* **1982**, *12*, 53–57.
91. Holmes, N. J.; Levason, W.; Webster, M. *J. Organomet. Chem.* **1999**, *584*, 179–184.
92. Matano, Y.; Kurata, H.; Murafuji, T.; Azuma, N.; Suzuki, H. *Organometallics* **1998**, *17*, 4049–4059.
93. Gilheany, D. G. Structure and bonding in organophosphorus(III) compounds. In *Chem. Organophosphorus Compd.* Hartley, F. R., Ed., Wiley: New York, 1990, *1*, 9–49.
94. Nagase, S. General and theoretical aspects. In *Chem. Org. Arsenic, Antimony Bismuth Compd.* Patai, S., Ed., Wiley: New York, Chapter 1, 1994, 1–24.
95. Lange, K. C. H.; Klapoetke, T. M. Lewis acidity, basicity, H-bonding and complexing of organic arsenic antimony and bismuth compounds. *Chem. Org. Arsenic, Antimony Bismuth Compd.* Patai, S., Ed., Wiley: New York, 1994, 66–315.
96. Tolman, C. A. *Chem. Rev.* **1977**, *77*, 313–348.
97. Dunne, B. J.; Morris, R. B.; Orpen, A. G. *J. Chem. Soc., Dalton Trans.* **1991**, 653–661.
98. Hill, A. M.; Holmes, N. J.; Genge, A. R. J.; Levason, W.; Webster, M.; Rutschow, S. *J. Chem. Soc., Dalton Trans.* **1998**, 825–832.
99. Holmes, N. J.; Levason, W.; Webster, M. *J. Chem. Soc., Dalton Trans.* **1998**, 3457–3462.
100. Holmes, N. J.; Levason, W.; Webster, M. *J. Organomet. Chem.* **1997**, *545–546*, 111–115.
101. Schwab, P.; Mahr, N.; Wolf, J.; Werner, H. *Angew. Chem.* **1994**, *106*, 4–82.
102. Pechmann, T.; Brandt, C. D.; Werner, H. *Angew. Chem., Int. Ed.* **2000**, *39*, 3909–3911.
103. Zakharov, L. N.; Struchkov, Yu. T.; Aladin, A. A.; Artemov, A. N. *Koord. Khim.* **1981**, *7*, 1705–1707.
104. Hill, A. M.; Holmes, N. J.; Genge, A. R. J.; Levason, W.; Webster, M.; Rutschow, S. *J. Chem. Soc., Dalton Trans.* **1998**, 825–832.
105. Even, T.; Genge, A. R. J.; Hill, A. M.; Holmes, N. J.; Levason, W.; Webster, M. *J. Chem. Soc., Dalton Trans.* **2000**, 655–662.
106. Colton, R. *Coord. Chem. Rev.* **1971**, *6*, 269–284.
107. Nyholm, R. S.; Sandhu, S. S.; Stiddard, M. H. B. *J. Chem. Soc.* **1963**, 5916–5919.
108. Bottomley, F.; Lin, I. J. B.; White, P. S. *J. Chem. Soc., Dalton Trans.* **1978**, 1726–1732.
109. Minahan, D. M. A.; Hill, W. E.; McAuliffe, C. A. *Coord. Chem. Rev.* **1984**, *55*, 31–54.
110. Chiswell, B. Chemistry of multidentate ligands containing heavy Group VA donors. *Transition Metal Complexes of Phosphorus, Arsenic and Antimony Ligands.* McAuliffe, C. A., Ed., Macmillan: London, Chapter 4, 1973, 269–307.
111. Schumann, H.; Breunig, H. J. *J. Organomet. Chem.* **1975**, *87*, 83–92.
112. Schumann, H.; Eguren, L. *J. Organomet. Chem.* **1991**, *403*, 183–193.
113. Carty, A. J.; Taylor, N. J.; Coleman, A. W.; Lappert, M. F. *Chem. Commun.* **1979**, 639–640.
114. Cipriano, R. A.; Levason, W.; Mould, R. A. S.; Pletcher, D.; Webster, M. *J. Chem. Soc., Dalton Trans.* **1990**, 339–347.
115. Hem, C. D.; Dartiguenave, M.; Dartiguenave, Y. *Inorg. Nucl. Chem. Lett.* **1974**, *10*, 1039–1043.
116. Bricklebank, N.; Godfrey, S. M.; McAuliffe, C. A.; Pritchard, R. G. *J. Chem. Soc., Dalton Trans.* **1996**, 157–160.
117. Warren, L. F.; Bennett, M. A. *Inorg. Chem.* **1976**, *15*, 3126–3140.
118. Levason, W. *Comments Inorg. Chem.* **1990**, *9*, 331–361.
119. Genge, A. R. J.; Levason, W.; Reid, G. *Inorg. Chim. Acta* **1999**, *288*, 142–149.
120. Hill, N. J.; Levason, W.; Reid, G. *J. Chem. Soc., Dalton Trans.*, **2002**, 1188–1192.
121. Ludmann, M. F.; Dartiguenave, M.; Dartiguenave, Y. *Inorg. Chem.* **1977**, *16*, 440–446.
122. Godfrey, S. M.; McAuliffe, C. A.; Pritchard, R. G. *Chem. Commun.* **1994**, 45–46.
123. Costello, M. T.; Fanwick, P. E.; Meyer, K. E.; Walton, R. A. *Inorg. Chem.* **1990**, *29*, 4437–4441.
124. Jewiss, H. C.; Levason, W.; Spicer, M. D.; Webster, M. *Inorg. Chem.* **1987**, *26*, 2102–2106.
125. Mentos, A.; Kemmitt, R. D. W.; Fawcett, J.; Russell, D. R. *J. Organomet. Chem.* **1997**, *528*, 59–63.
126. Barton, D. H. R.; Ozbalik, N.; Ramesh, M. *Tetrahedron* **1988**, *44*, 5661–5668.

# 1.17

## Acyclic Thio-, Seleno-, and Telluroether Ligands

W. LEVASON and G. REID  
*University of Southampton, UK*

---

1.17.1	INTRODUCTION	391
1.17.2	SYNTHESIS OF ACYCLIC THIO-, SELENO-, AND TELLUROETHER LIGANDS	391
1.17.2.1	Thioethers	391
1.17.2.2	Selenoethers	392
1.17.2.3	Telluroethers	393
1.17.3	ACYCLIC THIO-, SELENO-, AND TELLUROETHERS AS LIGANDS	395
1.17.3.1	Bonding	395
1.17.3.2	Coordination Modes and Properties	396
1.17.4	REFERENCES	396

---

### 1.17.1 INTRODUCTION

Although thioethers have been used as ligands for many years now,<sup>1</sup> their chemistry has attracted considerable interest since the mid 1980s. The main impetus for this has been the development of good synthetic methods in particular for thioether macrocycles, which permitted their study with transition metal ions, with many of the resulting complexes exhibiting very unusual properties.<sup>2,3</sup>

Selenoether and telluroether ligand chemistry has developed more recently.<sup>4-8</sup> The growing interest in these systems may be attributed, in part, to the availability of reliable synthetic routes to the ligands, increasing availability of FT NMR to study their solution behavior, and increasing evidence of enhanced ligating properties of the heavier telluroether and selenoether ligands compared to the previously much more widely explored thioethers. Both selenium and tellurium have useful nuclei for NMR spectroscopic measurements, <sup>77</sup>Se (I=1/2, 7.58%, receptivity relative to <sup>13</sup>C, D<sub>c</sub>=2.98) and <sup>125</sup>Te (I=1/2, 6.99%, D<sub>c</sub>=12.5). This leads to significant advantages over sulfur (only <sup>33</sup>S is NMR-active with I=3/2, but it has a low natural abundance, 0.76%, and very low receptivity relative to <sup>13</sup>C, D<sub>c</sub>=9.78 × 10<sup>-2</sup>) in terms of following the chemistry of Se- and Te-containing ligands and complexes in solution.<sup>6,7,9</sup>

### 1.17.2 SYNTHESIS OF ACYCLIC THIO-, SELENO-, AND TELLUROETHER LIGANDS

#### 1.17.2.1 Thioethers

A vast amount of organosulfur chemistry has been reported<sup>10,11</sup> and it is not our intention to provide a review of this, but rather to provide references for some representative syntheses for the main classes of ligand (most of which have been known for many years) and to discuss the syntheses of new thioether ligands reported since the mid 1980s. Some of the more frequently used



simple monodentate thioethers are now commercially available, e.g., Me<sub>2</sub>S, Et<sub>2</sub>S, Pr<sub>2</sub>S, <sup>i</sup>Pr<sub>2</sub>S, Ph<sub>2</sub>S.

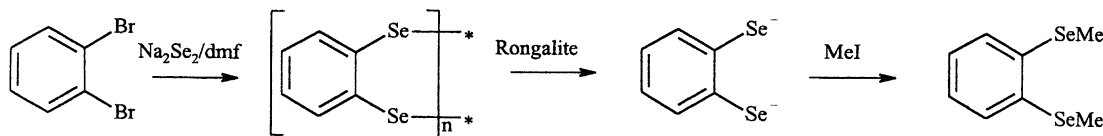
The bi- and poly-dentates with aliphatic backbones are generally produced by attack of RS<sup>-</sup> on the appropriate haloalkane. This is usually the method of choice for RS(CH<sub>2</sub>)<sub>n</sub>SR (R = Me or Ph),<sup>12</sup> the tripodal MeC(CH<sub>2</sub>SR)<sub>3</sub><sup>13,14</sup> and the linear RS(CH<sub>2</sub>)<sub>n</sub>S(CH<sub>2</sub>)<sub>n</sub>SR (*n* = 2 or 3) and RS(CH<sub>2</sub>)<sub>n</sub>S(CH<sub>2</sub>)<sub>n</sub>S(CH<sub>2</sub>)<sub>n</sub>SR.<sup>14,15</sup> (Caution: These syntheses often involve sulfur mustards as intermediates which are very powerful vesicants.) The tridentates RS(CH<sub>2</sub>)<sub>3</sub>S(CH<sub>2</sub>)<sub>3</sub>SR (R = Et, <sup>i</sup>Pr or Ph) are obtained from nucleophilic attack by RS<sup>-</sup> on the ditosylate TsO(CH<sub>2</sub>)<sub>3</sub>S(CH<sub>2</sub>)<sub>3</sub>OTs.<sup>16</sup> Tetradentate thioethers involving *o*-phenylene interdonor linkages are also known.<sup>17</sup> More recently, the preparation and coordination chemistry of the silicon-apex derivative MeSi(CH<sub>2</sub>SMe)<sub>3</sub> has been described.<sup>18</sup> Cooper and co-workers have synthesized an acyclic hexathioether, MeC(CH<sub>2</sub>SCH<sub>2</sub>CH<sub>2</sub>SMe)<sub>3</sub>, by reaction of 1,1,1-*tris*(hydroxymethyl)ethane tritosylate with NaSCH<sub>2</sub>CH<sub>2</sub>SMe. This ligand promotes homoleptic hexathia coordination with some 3d metal ions.<sup>19</sup>

The *o*-C<sub>6</sub>H<sub>4</sub>(SR)<sub>2</sub> (R = alkyl or phenyl) can be obtained by several methods. The original route involved reaction of the appropriate copper thiolate with dihalobenzene in quinoline/pyridine. Thus, for example, CuSPh reacts with *o*-dibromobenzene in quinoline/pyridine to give *o*-C<sub>6</sub>H<sub>4</sub>(SPh)<sub>2</sub>.<sup>12</sup> For *o*-C<sub>6</sub>H<sub>4</sub>(SMe)<sub>2</sub>, alkylation of *o*-C<sub>6</sub>H<sub>4</sub>(SMe)(SH) with MeI in Na/EtOH avoids the rather dirty copper reagents.<sup>12</sup> Subsequent reports from Testaferri and co-workers used reaction of nitrobenzenes or halobenzenes with NaSR in HMPA to give *o*-C<sub>6</sub>H<sub>4</sub>(SR)<sub>2</sub>. Other aryl thioethers with different substitution patterns may be obtained similarly.<sup>20,21</sup> Reaction of *o*-C<sub>6</sub>H<sub>4</sub>Cl<sub>2</sub> with NaSMe and MeI in dmf, followed by treatment of the resulting *o*-C<sub>6</sub>H<sub>4</sub>(Cl)(SMe) with BuLi and Me<sub>2</sub>S<sub>2</sub> probably represents the cleanest route to *o*-C<sub>6</sub>H<sub>4</sub>(SMe)<sub>2</sub>.<sup>22</sup>

### 1.17.2.2 Selenoethers

Monodentate selenoether ligands R<sub>2</sub>Se are very well known and their syntheses have been reviewed elsewhere.<sup>23,24</sup> Variants are generally prepared by modifications of standard procedures. Compounds of the type RSeR' are usually prepared from treatment of RLi with elemental selenium followed by further reaction of the resultant RSeLi with R'I. A convenient route to Me<sub>2</sub>Se involves treatment of LiSeMe with excess MeI to give Me<sub>3</sub>SeI, followed by dealkylation with PPh<sub>3</sub>.<sup>25</sup> Me<sub>2</sub>Se, Et<sub>2</sub>Se, and Ph<sub>2</sub>Se are commercially available, and the low-molecular-weight ligands are air stable and highly malodorous.

Diselenoethers of the form RSe(CH<sub>2</sub>)<sub>n</sub>SeR (*n* = 1–3, 6, 12, etc.) are obtained readily and in good yield by reaction of RSeLi with the appropriate dihaloalkane in thf solution.<sup>26</sup> This is more convenient than the alternative method, which uses RSeNa in liquid NH<sub>3</sub>.<sup>27</sup> *cis*-RSeCH=CHSeR requires reaction of *cis*-ClCH=CHCl and RSeNa in NaOEt/ethanol.<sup>26</sup> Addition of RSeSeR to HC≡CH in the presence of base gives RSeC=CSeR,<sup>28</sup> which can be formed similarly from NaC≡CH, Se, and RI.<sup>29</sup> The more rigid ligands *o*-C<sub>6</sub>H<sub>4</sub>(SeR)<sub>2</sub> are less straightforward since RSeLi does not lead to disubstitution of *o*-dihalobenzenes in ether or alcohol solutions. The R = Me or Ph compound may be obtained from RSeSeR addition to benzyne,<sup>26</sup> although for R = Me, reduction of the [*o*-C<sub>6</sub>H<sub>4</sub>(Se)<sub>2</sub>]<sub>n</sub> polymer<sup>30</sup> with Rongalite (NaSO<sub>2</sub>CH<sub>2</sub>OH) and subsequent treatment with MeI is more effective (Scheme 1).<sup>31</sup> An alternative route to *o*-C<sub>6</sub>H<sub>4</sub>(SeR)<sub>2</sub> using electrophilic cleavage of (η<sup>5</sup>-<sup>t</sup>BuC<sub>6</sub>H<sub>4</sub>)<sub>2</sub>Zr(Se<sub>2</sub>C<sub>6</sub>H<sub>4</sub>-*o*) with RCl has been reported. The resulting (η<sup>5</sup>-<sup>t</sup>BuC<sub>6</sub>H<sub>4</sub>)<sub>2</sub>ZrCl<sub>2</sub> can be recycled.<sup>32</sup>

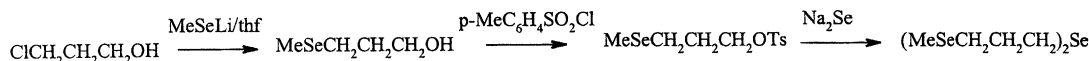


Scheme 1

The compound *o*-C<sub>6</sub>H<sub>4</sub>Cl(SeMe), obtained from *o*-C<sub>6</sub>H<sub>4</sub>Cl<sub>2</sub> and LiSeMe in dmf solution, is a potentially useful synthon for other ligands.<sup>22</sup>

A more limited range of polyselenoethers is known. The tripodal MeC(CH<sub>2</sub>SeR)<sub>3</sub> (R = Me or Ph) are obtained readily from RSeLi with MeC(CH<sub>2</sub>Br)<sub>3</sub> in thf.<sup>26</sup> The linear tri- and tetradentates

MeSe(CH<sub>2</sub>)<sub>2</sub>Se(CH<sub>2</sub>)<sub>2</sub>SeMe,<sup>33</sup> MeSe(CH<sub>2</sub>)<sub>3</sub>Se(CH<sub>2</sub>)<sub>3</sub>SeMe,<sup>26</sup> and MeSe(CH<sub>2</sub>)<sub>2</sub>Se(CH<sub>2</sub>)<sub>3</sub>Se(CH<sub>2</sub>)<sub>2</sub>-SeMe<sup>34</sup> require the Se to be introduced stepwise as shown, for example, in Scheme 2.



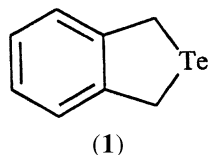
Scheme 2

### 1.17.2.3 Telluroethers

The development of useful synthetic routes to di- and polytelluroether ligands in general has been hindered by a number of factors including the instability of Te—H bonds which render tellurools (RTeH) useless as synthons, the weakness of the Te—C bond which leads to Te—C fission occurring much more readily than for thio- or selenoethers and the accessibility of the Te<sup>IV</sup> oxidation state which leads to telluroethers being susceptible to oxidation and also a much increased likelihood that unwanted reaction chemistry will occur at Te during ligand syntheses.

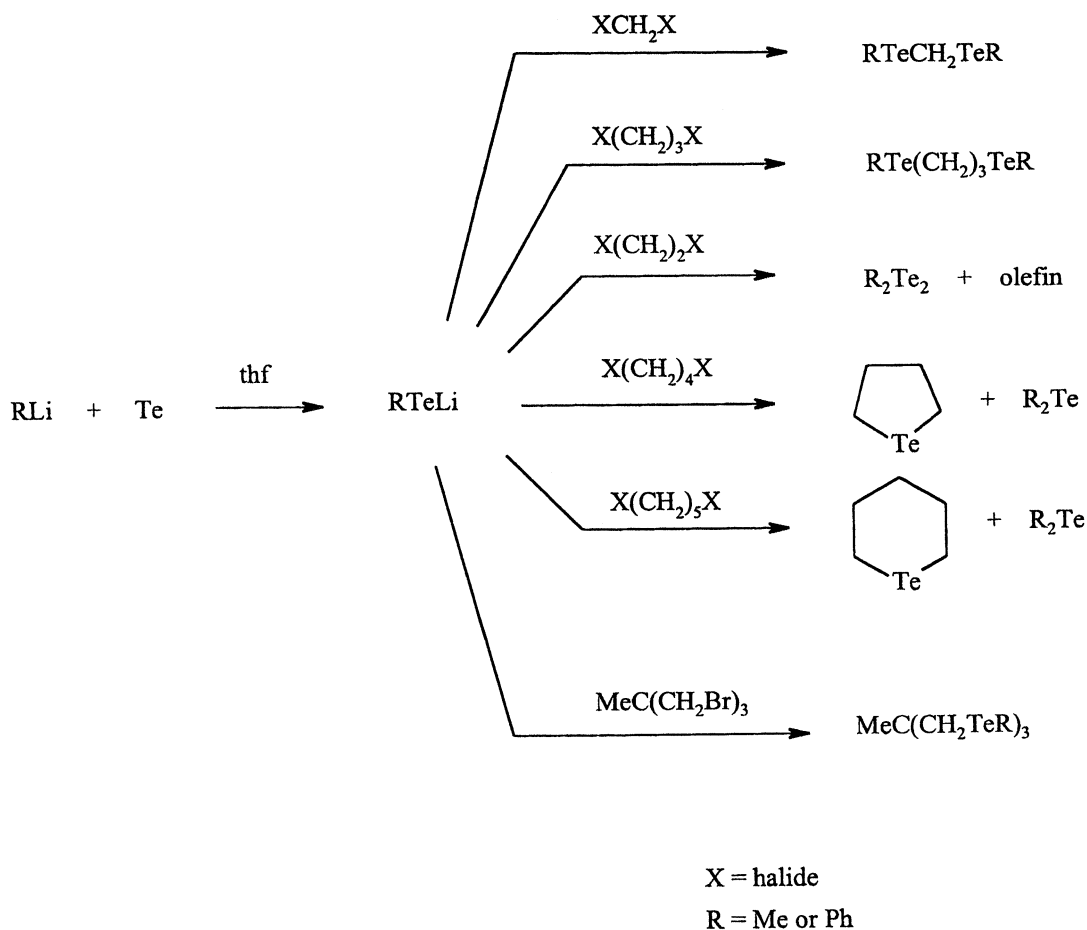
The synthetic methods used for the preparation of monodentate telluroether ligands, R<sub>2</sub>Te, have been discussed previously in standard texts<sup>35</sup> and new ligands of this type are generally prepared by variations of known methods, e.g., diallyltellurium is formed by allyl bromide and disodium telluride.<sup>36</sup> Disodium telluride can be obtained *in situ* from the elements in dmf at 110 °C and is easily alkylated.<sup>37</sup> Dimethyltellurium may also be obtained from MeTeLi and excess MeI, followed by dealkylation with PPh<sub>3</sub>.<sup>25</sup> The low-molecular-weight telluroethers are air-sensitive, extremely malodorous yellow/orange oils.

The tellurophene derivative 1,3-dihydrobenzo[*c*]tellurophene (**1**) was originally obtained from treatment of  $\alpha,\alpha'$ -dichloro-*o*-xylene with Te and NaI in 2-methoxyethanol to give 2,2-diiodo-1,3-dihydrobenzo[*c*]tellurophene<sup>38</sup> and subsequent treatment with NaBH<sub>4</sub> in methanol.<sup>39</sup> More recently it has been isolated as a by-product from reaction of  $\alpha,\omega$ -dichloro-*o*-xylene with two molar equivalents of KTeCN and subsequent treatment with a further equivalent of dichloro-*o*-xylene in EtOH/NaBH<sub>4</sub>.<sup>40</sup>



Ditelluroether ligands, RTe(CH<sub>2</sub>)<sub>*n*</sub>TeR, have proved much more difficult to synthesize than the corresponding thio- and selenoethers and are known only for certain values of *n*. These are typically formed by reaction of lithium organotelluride with the appropriate dihaloalkane in thf solution according to Scheme 3. For *n* = 1, successful routes include reaction of RTeTeR with diazomethane (R = Me, Et, <sup>n</sup>Pr, <sup>i</sup>Pr, <sup>n</sup>Bu, etc.),<sup>41</sup> or via treatment of RTe<sup>-</sup> with CH<sub>2</sub>X<sub>2</sub> (for R = Me, Ph, 4-EtOC<sub>6</sub>H<sub>4</sub>)<sup>42,43</sup> Unlike the thio- and selenoether analogs, which are readily obtained, attempts to obtain RTe(CH<sub>2</sub>)<sub>2</sub>TeR from RTe<sup>-</sup> and X(CH<sub>2</sub>)<sub>2</sub>X have failed, affording R<sub>2</sub>Te<sub>2</sub> and eliminating ethene.<sup>42-44</sup> The outcomes of similar reactions with longer-chain  $\alpha,\omega$ -dihaloalkanes depend very much on the reaction conditions employed. Thus, while telluronium salts are obtained from reaction of X(CH<sub>2</sub>)<sub>*n*</sub>X (X = Br or I; *n* = 3,4) with (4-EtOC<sub>6</sub>H<sub>4</sub>)TeNa in aqueous ethanol, similar reactions with *n* = 6–10 affords the ditelluroethers, RTe(CH<sub>2</sub>)<sub>*n*</sub>TeR, and X(CH<sub>2</sub>)<sub>5</sub>X affords both products.<sup>43,44</sup> However, using thf solutions of RTeLi (R = Me or Ph), quite different reactivity is observed. Notably, while Cl(CH<sub>2</sub>)<sub>3</sub>Cl gives R<sub>2</sub>Te<sub>2</sub> and olefin at ambient temperature, using low temperatures gives high yields of RTe(CH<sub>2</sub>)<sub>3</sub>TeR.<sup>45</sup> The reaction of R<sub>2</sub>Te<sub>2</sub> with benzyne affords *o*-C<sub>6</sub>H<sub>4</sub>(TeR)<sub>2</sub> (R = *p*-tolyl, *p*-MeOC<sub>6</sub>H<sub>4</sub>).<sup>46,47</sup> The *o*-C<sub>6</sub>H<sub>4</sub>(TeR)<sub>2</sub> (R = Me or Ph) are obtained by treatment of *o*-C<sub>6</sub>H<sub>4</sub>Br<sub>2</sub> with RTe<sup>-</sup> in thf.<sup>22</sup> This disubstitution reaction does not occur for RSe<sup>-</sup> or RS<sup>-</sup> under similar conditions, indicating the much increased nucleophilicity of RTe<sup>-</sup>. Zirconocene derivatives of *o*-ditellurophenylene may also prove to be useful synthons for other telluroethers incorporating this rigid backbone.<sup>48</sup>

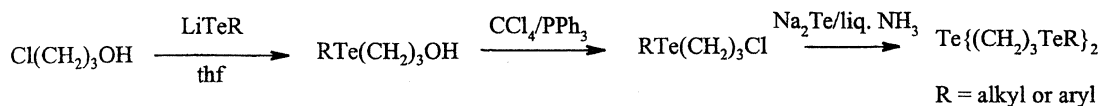




Scheme 3

While in general the alkyl-substituted ditelluroethers are yellow, extremely malodorous, air-sensitive oils, those with phenyl substituents are low melting solids or oils and are rather less susceptible to oxidation.

A very limited range of polytelluroethers is known. The synthesis of the tripod telluroether  $\text{MeC(CH}_2\text{TeMe)}_3$  utilizes reaction of  $\text{MeC(CH}_2\text{Br)}_3$  with excess  $\text{MeTeLi}$  in thf.<sup>42</sup> This method has been modified to produce the Ph-substituted analog,  $\text{MeC(CH}_2\text{TePh)}_3$ .<sup>49</sup> The preparations of the first facultative tritelluroethers,  $\text{RTe(CH}_2)_3\text{Te(CH}_2)_3\text{TeR}$  ( $\text{R} = \text{Me or Ph}$ ), were reported only very recently via the reaction of  $\text{RTe(CH}_2)_3\text{Cl}$  with  $\text{Na}_2\text{Te}$  according to Scheme 4.<sup>50</sup> Notably,



Scheme 4

attempts to prepare these ligands via the tosylate  $\text{RTe-(CH}_2)_3\text{OTs}$  lead to decomposition. The conversion of  $\text{RTe(CH}_2)_3\text{OH}$  to  $\text{RTe(CH}_2)_3\text{Cl}$  is a key step and occurs in good yield. This conversion offers exciting prospects for new routes to other polytelluroethers and macrocycles.

Finally, a number of mixed donor ligands containing tellurium are also known, e.g.,  $\text{Te}\{\text{CH}_2\text{CH}_2\text{NR}_2\}_2$ <sup>51</sup> and  $\text{N}\{\text{CH}_2\text{CH}_2\text{TeR}\}_3$ .<sup>52</sup> Other examples are reviewed by Singh and Sharma.<sup>8</sup> Hybrid telluroethers incorporating the *o*- $\text{C}_6\text{H}_4$  unit are also known, *o*- $\text{C}_6\text{H}_4(\text{TeMe})(\text{Y})$  ( $\text{Y} = \text{OMe, SMe, SeMe, NMe}_2, \text{PMe}_2, \text{AsMe}_2, \text{SbMe}_2$ ).<sup>22</sup>

### 1.17.3 ACYCLIC THIO-, SELENO-, AND TELLUROETHERS AS LIGANDS

#### 1.17.3.1 Bonding

The bonding of Group 15 ligands, especially phosphines, to transition metals, has been the focus of considerable attention since the 1950s.<sup>53</sup> Steric effects are also important for these and are usually qualitatively discussed via the Cone Angle model. In contrast, for thio-, seleno- and telluroethers in which the Group 16 atom carries only two R substituents, steric effects are much less important, although the nature of the interdonor linkages and the resulting chelate ring sizes will influence the coordination of polydentates and macrocycles in the usual way. Whilst data on seleno- or telluroethers have been much too limited until recently, the paucity of studies on bonding in thioether complexes is very surprising. The neutral chalcogenoethers, R<sub>2</sub>E, have two lone pairs on each chalcogen atom, one of which may form a  $\sigma$ -bond to a metal acceptor. The second lone pair may form a  $\sigma$ -bond to a second metal, resulting in a bridging R<sub>2</sub>E group, and examples of such behavior are well established via single-crystal X-ray studies for R<sub>2</sub>E (E = S, Se, or Te). Alternatively, the second lone pair on the R<sub>2</sub>E could behave as a  $\pi$ -donor to a suitable metal *d*-orbital, particularly to electron-poor metals. However, there seems to be little evidence that this is a significant component of the bonding. For R<sub>2</sub>E, exactly like the well-known PR<sub>3</sub> case, the E atom can in principle behave as a  $\pi$ -acceptor either into the lowest empty *d*-orbital (as in the original Chatt model<sup>54</sup>), or more likely, as proposed for group 15 donors,<sup>55</sup> into the E–C  $\sigma^*$  orbitals which are of more suitable energy. It is possible that to electron rich metal centers the second lone pair will be a source of  $\pi$ -repulsion in M–ER<sub>2</sub>.

Although there have been occasional suggestions of some weak  $\pi$ -back-bonding, usually based upon M–E distances being slightly less than the sum of the appropriate covalent radii, these effects have been of borderline statistical significance, and consensus has been that thioethers are weak  $\sigma$ -donors with little or no  $\pi$ -component to the bonding.<sup>1–3</sup> However, it has recently been suggested that  $\pi$ -acceptance may be a significant component of the bonding for some macrocyclic thioether complexes.<sup>56</sup>

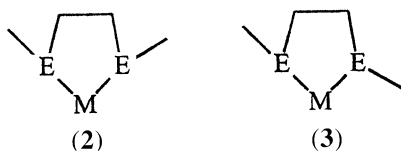
Detailed experimental studies by Schumann and co-workers on the cationic  $[(\eta^5\text{-C}_5\text{H}_5)\text{Fe}(\text{CO})_2\text{L}]^+$  (where L was a Group 15 or 16 donor ligand), subsequently extended to a theoretical study by Schumann and Hoffman using extended Huckel MO theory,<sup>57</sup> showed that within Group 16, both the inertness and the stability of the Fe–E bond increased  $\text{Te} \gg \text{Se} > \text{S} > \text{O}$ . The study concluded that  $\pi$ -effects are insignificant, and that the unusually strong binding of telluroethers is due to enhanced  $\sigma$ -donation. More recently, studies<sup>49,58</sup> on  $[\text{Mn}(\text{CO})_3\text{X}(\text{L-L})]$  (L–L = dithioether, diselenoether, or ditelluroether) and  $[\text{Mn}(\text{CO})_3(\text{tripod})]^+$  (tripod =  $\text{MeC}(\text{CH}_2\text{EMe})_3$ , E = S, Se, or Te), including analysis of the force constants resulting from the IR spectra of the Mn(CO)<sub>3</sub> groups and the magnitude of the NMR chemical shifts (<sup>55</sup>Mn, <sup>77</sup>Se, <sup>125</sup>Te) have shown similar trends, with increased electron density at the manganese center  $\text{S} < \text{Se} \ll \text{Te}$ . Similar trends within Group 16 also occur in  $[\text{M}(\text{CO})_4(\text{L-L})]$  (M = Cr, Mo, or W).<sup>59</sup> For these low-valent metal acceptors, the data were interpreted as due to increased  $\sigma$ -donation as Group 16 is descended, resulting from decreased electronegativity of the donors. For low-valent metals, the spatial extension of the *d*-orbitals will be such that good overlap with the large Te  $\sigma$ -orbital is not a problem. As the metal oxidation state increases, the metal becomes harder and the orbitals contract, consistent with decreased bonding to the large soft tellurium. This effect is clearly manifested in the inability of telluroethers to bond to high oxidation states of the platinum metals (see Section 1.17.3.2), whereas thio- and selenoether complexes of Pt<sup>IV</sup>, Ru<sup>III</sup>, and Os<sup>IV</sup> are all known. Recently,<sup>60</sup> the <sup>77</sup>Se and <sup>125</sup>Te NMR coordination shifts on M<sup>I</sup> and M<sup>III</sup> centers (M = Rh or Ir) have been compared. In the M<sup>I</sup> complexes  $[\text{M}(\text{COD})\{\text{MeC}(\text{CH}_2\text{EMe})_3\}]^+$ , the evidence is for strongest donation  $\text{Te} > \text{Se}$ , but for the higher oxidation state M<sup>III</sup> in  $[(\eta^5\text{-C}_5\text{Me}_5)\text{M}\{\text{MeC}(\text{CH}_2\text{EMe})_3\}](\text{PF}_6)_2$  the interaction appears to be  $\text{Se} > \text{Te}$ . Further studies on a much wider range of metal centers are required in order to explore the factors involved and to refine the model, but it appears that within Group 16 the relative donor strength varies with the metal acceptor: to high or medium oxidation state metals it is  $\text{S} < \text{Se} > \text{Te}$ , whereas to low valent centers  $\text{S} < \text{Se} \ll \text{Te}$ . This should be contrasted with Group 15 where the donation always appears to be  $\text{P} > \text{As} > \text{Sb}$ .

Theoretical studies have been undertaken to establish whether  $\pi$ -acceptor ability is important in the M–ER<sub>2</sub> bond. For example, Ziegler and co-workers<sup>61</sup> used density functional theory to examine a series of  $[(\text{CO})_5\text{Cr-L}]$  species where L = CO, NR<sub>3</sub>, PR<sub>3</sub>, SR<sub>2</sub>, SeR<sub>2</sub>, and R = H, Me, or F. They concluded that thio- and selenoethers are moderate  $\sigma$ -donors and weak  $\pi$ -acceptors. It was also concluded that SF<sub>2</sub> and SeF<sub>2</sub> (both are highly unstable in the free state) would be strong  $\pi$ -acceptors and, more surprisingly, good  $\sigma$ -donors.

### 1.17.3.2 Coordination Modes and Properties

The chalcogenoethers typically function as  $\sigma$ -donors to metal ions through one lone pair, although examples where they behave as bridging ligands by using both lone pairs are also known, e.g., in the chain polymeric  $[\text{Ag}\{\text{MeS}(\text{CH}_2)_3\text{SMe}\}]^+$ ,<sup>62</sup>  $[\{(\eta^5\text{-MeC}_5\text{H}_4)\text{Mn}(\text{CO})_2\}_2(\mu^2\text{-Me}_2\text{Se})]^{63}$  and  $[\{\text{CuCl}(\text{Et}_2\text{Te})\}_n]$ .<sup>64</sup>

It is well known that where  $\text{ER}_2$  carries two different R groups, coordination via one lone pair leads to chirality at the E donor atom. Similarly, coordination of a bi- or polydentate chalcogenoether leads to chirality, e.g., a bidentate chalcogenoether gives rise to a *meso* form (**2**) and a pair of enantiomeric *DL* isomers (**3**). The process by which these stereoisomers (invertomers) interconvert—pyramidal inversion—often occurs on the NMR time-scale and has been the subject of several reviews, with quantitative data available for thio-, seleno- and telluroethers.<sup>65–67</sup> The main factors influencing the energy barrier to inversion include donor type ( $\text{S} < \text{Se} < \text{Te}$ ), metal and oxidation state, the *trans* ligand, the substituent on E, and chelate ring-size.



While bi- and polydentate chalcogenoethers with di- or trimethylene or *o*-phenylene interdonor linkages often chelate, the  $\text{MeECH}_2\text{EMe}$  usually behave as bridging ligands owing to the strain involved in forming a 4-membered chelate ring. The  $\text{Sn}^{\text{IV}}$  adducts  $[\text{SnCl}_4(\text{MeSCH}_2\text{SMe})]$  and  $[\text{SnCl}_4(\text{MeSeCH}_2\text{SeMe})]$  are notable exceptions where strained 4-membered chelate rings do occur.<sup>68</sup> The only examples of telluroether complexes incorporating 4-membered chelate rings are  $[\text{MCl}_2\{(4\text{-MeOC}_6\text{H}_4\text{Te})_2\text{CH}_2\}]^{69,70}$  and  $[\text{Pd}(\text{Ph}_2\text{PCH}_2\text{CH}_2\text{PPh}_2)\{(4\text{-MeOC}_6\text{H}_4\text{Te})_2\text{CH}_2\}](\text{ClO}_4)_2$ .<sup>70</sup>

Examples where two- or three-carbon backboned bi- and tridentates bridge adjacent metal centers are also known, e.g., with  $\text{Cu}^{\text{I}}$ ,  $\text{Ag}^{\text{I}}$ ,  $\text{Sb}^{\text{III}}$ , and  $\text{Bi}^{\text{III}}$ , giving rise to one-, two-, or three-dimensional polymers.<sup>71–74</sup>

Traditionally, the majority of reported coordination complexes with thio-, seleno-, and telluroethers involve low or medium oxidation states of the later *d*-block elements.<sup>1,4,6</sup> However, while telluroethers do not stabilize high oxidation states such as  $\text{Pt}^{\text{IV}}$  or  $\text{Os}^{\text{IV}}$ , thio- and selenoether examples are obtained straightforwardly.<sup>6</sup> The versatility of the thio- and selenoether ligands is further demonstrated by their ability to coordinate readily to hard, early transition metals such as  $\text{Ti}^{\text{IV}}$  and  $\text{Zr}^{\text{IV}}$ , although to-date reported examples are few.<sup>75</sup> The key to their preparation is the use of strictly anhydrous conditions and the avoidance of strong coordinating solvents. There is also a growing literature describing complexes of these ligands with *p*-block metals/metalloids.<sup>76</sup>

A specific feature of the coordinated (heavier) chalcogenoethers is their ability to undergo E—C bond cleavage under certain conditions. For sulfur this process (*S*-dealkylation) has been known for many years,<sup>1,77</sup> however, Se/Te-dealkylation also occurs, although relatively few systems have been characterized in detail.<sup>78,79</sup>

### 1.17.4 REFERENCES

- Murray, S. G.; Hartley, F. R. *Chem. Rev.* **1981**, *81*, 365–414.
- Blake, A. J.; Schröder, M. *Adv. Inorg. Chem.* **1990**, *35*, 1–80.
- Cooper, S. R.; Rawle, S. C. *Struct. Bonding (Berlin)* **1990**, *72*, 1–72.
- Gysling, H. J. *The Chemistry of Organoselenium and Organotellurium Compounds*; Patai, S.; Rappoport, Z., Eds.; Wiley, 1986, Vol. 1, Ch. 18, pp 679–835.
- McWhinnie, W. R. In *The Chemistry of Organoselenium and Organotellurium Compounds*; Patai, S.; Rappoport, Z., Eds.; Wiley, 1987, Vol. 2, Ch. 13, pp 495–539.
- Hope, E. G.; Levason, W. *Coord. Chem. Rev.* **1993**, *122*, 109–170.
- Levason, W.; Orchard, S. D.; Reid, G. *Coord. Chem. Rev.* **2001**, *225*, 159–199.
- Singh, A. K.; Sharma, S. *Coord. Chem. Rev.* **2000**, *209*, 49–98.
- Duddeck, H. *Prog. NMR Spectr.* **1995**, *27*, 1–323.
- Klamann, D. *Houben-Wehl, Methoden der Organische Chemie*, Georg Thieme, Verlag Stuttgart, 1985, E11, Ch. 6, pp 158–187.
- Tagaki, W. In *The Organic Chemistry of Sulfur*; Oae, S., Ed.; Plenum New York, 1977, Ch. 6, pp 231–302.
- Hartley, F. R.; Murray, S. G.; Levason, W.; Soutter, H. E.; McAuliffe, C. A. *Inorg. Chim. Acta* **1979**, *35*, 265–277.

13. Brodersen, K.; Roelz, W.; Jordan, G.; Gerbeth, R.; Ellermann, J. *Chem. Ber.* **1978**, *111*, 132–142.
14. Ali, R.; Higgins, S. J.; Levason, W. *Inorg. Chim. Acta* **1984**, *84*, 65–69.
15. Levason, W.; McAuliffe, C. A.; Murray, S. G. *Inorg. Chim. Acta* **1976**, *17*, 247–252.
16. Loeb, S. J.; Mansfield, J. R. *Can. J. Chem.* **1996**, *74*, 1377–1390.
17. Levason, W.; McAuliffe, C. A.; Murray, S. G. *J. Chem. Soc., Dalton Trans.* **1975**, 1566–1570.
18. Yim, H. W.; Tran, L. M.; Dobbin, E. D.; Rabinovich, D.; Liable-Sands, L. M.; Incarvito, C. D.; Lam, K.-C.; Rheingold, A. L. *Inorg. Chem.* **1999**, *38*, 2211–2215.
19. Thorne, C. M.; Rawle, S. C.; Admans, G. A.; Cooper, S. R. *Inorg. Chem.* **1986**, *25*, 3848–3850.
20. Cogolli, P.; Testaferri, L.; Tingoli, M.; Tiecco, M. *J. Org. Chem.* **1979**, *44*, 2636–2642.
21. Cogolli, P.; Maiolo, F.; Testaferri, L.; Tingoli, M.; Tiecco, M. *J. Org. Chem.* **1979**, *44*, 2642–2646.
22. Kemmitt, T.; Levason, W. *Organometallics* **1989**, *8*, 1303–1308.
23. Klayman, D. L.; Gunther, W. H. H. *The Chemistry of Organometallic Compounds, a Series of Monographs: Organic Selenium Compounds*, Wiley New York, 1973.
24. Paulmier, C. *Selenium Reagents and Intermediates in Organic Synthesis*, Pergamon: Oxford, UK, 1986, Ch. 4, pp 84–123.
25. Kuhn, N.; Faupel, P.; Zauder, E. *J. Organomet. Chem.* **1986**, *302*, C4–C6.
26. Gulliver, D. J.; Hope, E. G.; Levason, W.; Murray, S. G.; Potter, D. M.; Marshall, G. L. *J. Chem. Soc., Perkin Trans. 2* **1984**, 429–434.
27. Abel, E. W.; Kite, K.; Orrell, K. G.; Sik, V.; Williams, B. L. *J. Chem. Soc., Dalton Trans.* **1981**, 2439–2446.
28. Brandsma, L. *Recl. Trav. Chim. Pays Bas* **1964**, *83*, 307–314.
29. Kataeva, L. M.; Kataeva, E. G.; Idiyatullina, D. Y. *Zh. Strukt. Khim.* **1966**, *7*, 380–384.
30. Sandman, D. J.; Allen, G. W.; Acampora, L. A.; Stark, J. C.; Jansen, S.; Jones, M. T.; Ashwell, G. J.; Foxman, B. M. *Inorg. Chem.* **1987**, *26*, 1664–1669.
31. Hope, E. G.; Kemmitt, T.; Levason, W. *J. Chem. Soc., Perkin Trans. 2* **1987**, 487–490.
32. Meunier, P.; Gautheron, B.; Mazouz, A. *Chem. Commun.* **1986**, 424–425.
33. Abel, E. W.; Kite, K.; Perkins, P. S. *Polyhedron* **1986**, *5*, 1459–1465.
34. Levason, W.; McAuliffe, C. A.; Murray, S. G. *J. Chem. Soc., Dalton Trans.* **1976**, 269–271.
35. Hamann, D. *Houben-Wehl, Methods of Organic Chemistry*, 4th Edn., Georg Thieme, Verlag, Stuttgart 1990, Ch. 36, pp 370–498.
36. Higa, K. T.; Harris, D. C. *Organometallics* **1989**, *8*, 1674–1678.
37. Engman, L. *Organometallics* **1986**, *5*, 427–431.
38. Ziolo, R. F.; Gunther, W. H. H. *J. Organomet. Chem.* **1978**, *146*, 245–251.
39. Al-Rubaie, A. Z.; McWhinnie, W. R.; Granger, P.; Chapelle, S. *J. Organomet. Chem.* **1982**, *234*, 287–298.
40. Levason, W.; Reid, G.; Tolhurst, V.-A. *J. Chem. Soc., Dalton Trans.* **1998**, 3411–3416.
41. Jones, C. H. W.; Sharma, R. D. *Organometallics* **1986**, *5*, 805–808.
42. Hope, E. G.; Kemmitt, T.; Levason, W. *Organometallics* **1988**, *7*, 78–83.
43. DeSilva, K. G. K.; Monsef-Mirzai, Z.; McWhinnie, W. R. *J. Chem. Soc., Dalton Trans.* **1983**, 2143–2146.
44. Pathirana, H. M. K. K.; McWhinnie, W. R. *J. Chem. Soc., Dalton Trans.* **1986**, 2003–2005.
45. Hope, E. G.; Kemmit, T.; Levason, W. *Organometallics* **1987**, *6*, 206–207.
46. Petragnani, N.; Toscano, V. G. *Chem. Ber.* **1970**, *103*, 1652–1653.
47. Bonilha, J. B. S.; Petragnani, N.; Toscano, V. G. *Chem. Ber.* **1978**, *111*, 2510–2516.
48. Meunier, P.; Gautheron, B.; Mazouz, A. *J. Organomet. Chem.* **1987**, *320*, C39–C43.
49. Connolly, J.; Genge, A. R. J.; Levason, W.; Orchard, S. D.; Pope, S. J. A.; Reid, G. *J. Chem. Soc., Dalton Trans.* **1999**, 2343–2352.
50. Barton, A. J.; Levason, W.; Reid, G.; Ward, A. *J. Organometallics* **2001**, *20*, 3644–3649.
51. Srivastava, V.; Batheja, R.; Singh, A. K. *J. Organomet. Chem.* **1994**, *484*, 93–96.
52. Singh, A. K.; Srivastava, V. *J. Coord. Chem.* **1990**, *21*, 39–42.
53. For a summary see Levason, W. In *The Chemistry of Organophosphorus Compounds*; Hartley, F. R., Ed.; Wiley New York, 1990, Vol. 1, pp 568–641.
54. Chatt, J. *Nature* **1950**, *165*, 637–638.
55. Orpen, A. G.; Connelly, N. G. *Organometallics* **1990**, *9*, 1206–1210.
56. Mullen, G. E. D.; Fassler, T. F.; Went, M. J.; Howland, K.; Stein, B.; Blower, P. J. *J. Chem. Soc., Dalton Trans.* **1999**, 3759–3766 and refs therein.
57. Schumann, H.; Arif, A. M.; Rheingold, A. L.; Janiak, C.; Hoffmann, R.; Kuhn, N. *Inorg. Chem.* **1991**, *30*, 1618–1625.
58. Levason, W.; Orchard, S. D.; Reid, G. *Organometallics* **1999**, *18*, 1275–1280.
59. Barton, A. J.; Levason, W.; Reid, G. *J. Organomet. Chem.* **1999**, *579*, 235–242.
60. Levason, W.; Orchard, S. D.; Reid, G.; Street, J. M. *J. Chem. Soc., Dalton Trans.* **2000**, 2537–2543.
61. Kraatz, H.-B.; Jacobsen, H.; Ziegler, T.; Boorman, P. M. *Organometallics* **1993**, *12*, 76–80.
62. Black, J. R.; Champness, N. R.; Levason, W.; Reid, G. *Chem. Commun.* **1995**, 1277–1278.
63. Belforte, A.; Calderazzo, F.; Vitali, D.; Zanazzi, P. F. *Gazzetta* **1985**, *115*, 125–135.
64. Chadha, R. K.; Drake, J. E. *J. Organomet. Chem.* **1985**, *286*, 121–128.
65. Abel, E. W.; Bhargava, S. K.; Orrell, K. G. *Prog. Inorg. Chem.* **1984**, *32*, 1–118.
66. Orrell, K. G. *Coord. Chem. Rev.* **1989**, *96*, 1–48.
67. Abel, E. W.; Orrell, K. G.; Scanlan, S. P.; Stephenson, D.; Kemmitt, T.; Levason, W. *J. Chem. Soc., Dalton Trans.* **1991**, 591–595.
68. Genge, A. R. J.; Levason, W.; Reid, G. *J. Chem. Soc., Dalton Trans.* **1997**, 4479–4480.
69. Khandalwal, B. L.; Khalid, A.; Singh, A. K.; Singh, T. P.; Karthikeyan, S. *J. Organomet. Chem.* **1996**, *507*, 65–68.
70. Drake, J. E.; Yang, J.; Khalid, A.; Srivastava, V.; Singh, A. K. *Inorg. Chim. Acta* **1997**, *254*, 57–62.
71. Black, J. R.; Champness, N. R.; Levason, W.; Reid, G. *Inorg. Chem.* **1996**, *35*, 4432–4438.
72. Liaw, W.-F.; Lai, C.-H.; Chiou, S.-J.; Horng, Y.-C.; Chou, C.-C.; Liaw, M.-C.; Lee, G.-H.; Peng, S.-M. *Inorg. Chem.* **1995**, *34*, 3755–3759.
73. Barton, A. J.; Hill, N. J.; Levason, W.; Reid, G. *J. Chem. Soc., Dalton Trans.* **2001**, 1621–1627.
74. Barton, A. J.; Genge, A. R. J.; Levason, W.; Reid, G. *J. Chem. Soc., Dalton Trans.* **2000**, 859–865.

75. Levason, W.; Reid, G. *J. Chem. Res. (s)* **2002**, 467–472.
76. Levason, W.; Reid, G. *J. Chem. Soc., Dalton Trans.* **2001**, 2953–2960.
77. Sellmann, D.; Reisser, W. *J. Organomet. Chem.* **1985**, 297, 319–329.
78. Abel, E. W.; Evans, D. G.; Koe, J. R.; Hursthouse, M. B.; Mazid, M.; Mahon, M. F.; Molloy, K. C. *J. Chem. Soc., Dalton Trans.* **1990**, 1697–1704.
79. Kemmitt, T.; Levason, W.; Spicer, M. D.; Webster, M. *Organometallics* **1990**, 9, 1181–1184.

# 1.18

## Macrocyclic Thio-, Seleno-, and Telluroether Ligands

W. LEVASON and G. REID  
*University of Southampton, UK*

---

1.18.1	INTRODUCTION	399
1.18.2	THIOETHER MACROCYCLES	400
1.18.3	COORDINATION CHEMISTRY AND PROPERTIES	401
1.18.4	SELENOETHER MACROCYCLES	403
1.18.5	TELLUROETHER MACROCYCLES	406
1.18.6	COORDINATION CHEMISTRY AND PROPERTIES	408
1.18.7	ABBREVIATIONS	408
1.18.8	REFERENCES	409

---

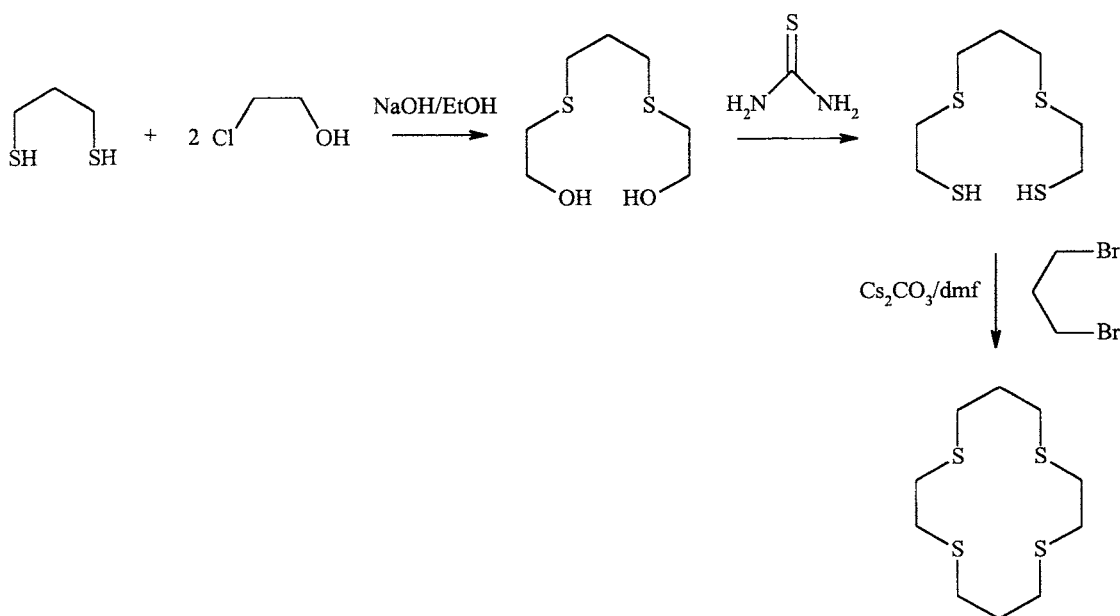
### 1.18.1 INTRODUCTION

For the purposes of this review we will restrict macrocycles to those cyclic compounds with at least three heteroatoms within the ring and with at least two carbon atoms between each adjacent pair of heteroatoms. The following discussion will concentrate on macrocycles containing only S or Se or Te donor atoms, with occasional reference to mixed-donor macrocycles containing one or more of these donor types as appropriate.

Traditionally, acyclic thioether ligands attracted much less interest than their phosphine analogs, probably due to the widely held belief that they were only rather modest  $\sigma$  donors and therefore weakly coordinating ligands. There can be little doubt that the much increased interest in the coordination chemistry of thioether ligands since the mid-1980s is a direct consequence of the availability of good synthetic routes to macrocyclic thioethers. These have been shown to impart unusual structural, spectroscopic, and electrochemical properties to transition metal ions, supporting the stabilization of, for example, monomeric Pd<sup>III</sup><sup>1</sup> and Rh<sup>II</sup><sup>2</sup> species, and have proved effective ligands for elements from across the transition series and much of the *p*-block, e.g., [(AlMe<sub>3</sub>)<sub>4</sub>([14]aneS<sub>4</sub>)]<sup>3</sup> and [BiCl<sub>3</sub>([15]aneS<sub>5</sub>)]<sup>4</sup>. In many cases the ligating ability of these thiacyclics is enhanced by the *macrocyclic effect*. The synthesis and coordination chemistry of thioether macrocycles has been the subject of several reviews in the literature.<sup>5-8</sup> The coordination chemistry of macrocyclic derivatives of the heavier Group 16 elements Se and Te has been much less studied, mainly due to the perception that these would be poorer ligands and more toxic than thioethers, and the lack of reliable syntheses. However, new routes have become available for some derivatives (although macrocyclic telluroethers are extremely rare even now—see below) and both theoretical and experimental studies have shown that to low-valent metals the  $\sigma$ -donor capacity increases  $SR_2 < SeR_2 \ll TeR_2$ , while to medium-oxidation-state metals the trend is  $SeR_2 > SR_2 > TeR_2$ —see Chapter 1.17.

### 1.18.2 THIOETHER MACROCYCLES

Although there are earlier reports claiming the synthesis of [9]aneS<sub>3</sub>, the first substantiated reports which produced useful quantities of macrocyclic thioethers are probably those of Rosen and Busch who obtained [14]aneS<sub>4</sub> in 7.5% yield by reaction of 1,4,8,11-tetrathiaundecane with 1,3-dibromopropane.<sup>9–11</sup> Using high dilution techniques the yield was later improved significantly to 55%.<sup>12</sup> Around the same time Black and McLean reported the synthesis of [18]aneS<sub>6</sub>.<sup>13,14</sup> These and other cyclic polythioethers are now available in even higher yields through modified routes developed by Ochrymowycz and co-workers<sup>15</sup> and Kellogg and co-workers.<sup>16–18</sup> They identified that Cs<sub>2</sub>CO<sub>3</sub> was much more effective than Na<sub>2</sub>CO<sub>3</sub> or K<sub>2</sub>CO<sub>3</sub> in promoting ring closure over the statistically favored polymerization reactions in the formation of thioether macrocycles, giving yields often of 75% or better. It was later shown from <sup>133</sup>Cs NMR studies that the role of the Cs<sup>+</sup> ion is in forming a strongly solvent-separated Cs<sup>+</sup> thiolate<sup>−</sup> ion pair in dmf solution. The resulting highly nucleophilic thiolate anion then reacts very readily, under conditions of high dilution, to afford the cyclic polythioethers.<sup>19</sup> This approach has been used successfully for a substantial range of thioether macrocycles with varying ring sizes and numbers of S atoms. For example, [14]aneS<sub>4</sub> is obtained in 65–70% yield according to Scheme 1.<sup>20</sup>



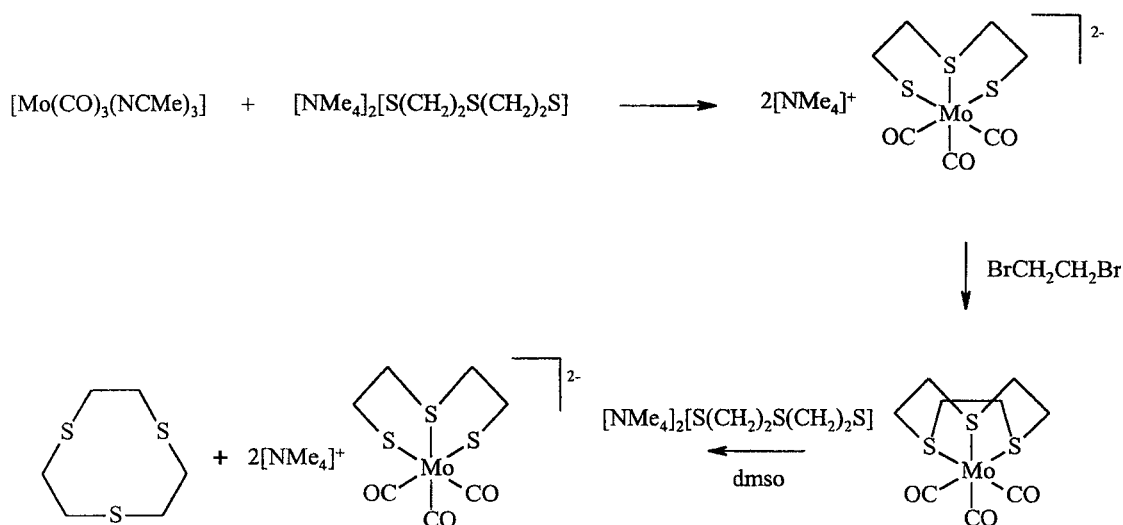
Scheme 1

While the vast majority of sulfur-donor macrocycles utilize the high dilution Cs<sub>2</sub>CO<sub>3</sub>/dmf approach for their preparation, there are one or two notable exceptions. Sellmann and Zapf have shown that [9]aneS<sub>3</sub> can be obtained in 60% yield using the Mo(CO)<sub>3</sub> fragment as a template (Scheme 2).<sup>21,22</sup> The crown trithioether is liberated from the molybdenum center by addition of a further equivalent of [NMe<sub>4</sub>]<sub>2</sub>[S(CH<sub>2</sub>)<sub>2</sub>S(CH<sub>2</sub>)<sub>2</sub>S]. Also, dibenzo-[18]aneS<sub>6</sub> and dibenzo-[15]aneS<sub>5</sub> have been prepared via an iron dicarbonyl template.<sup>23,24</sup>

More recently, metal-induced cyclo-oligomerization reactions of thietane using transition metal carbonyl complexes such as [Re<sub>3</sub>(CO)<sub>10</sub>(μ-SCH<sub>2</sub>CH<sub>2</sub>CH<sub>2</sub>)(μ-H)<sub>3</sub>] have been shown to yield [12]aneS<sub>3</sub>, [16]aneS<sub>4</sub>, and [24]aneS<sub>6</sub>, albeit not yet in synthetically useful quantities.<sup>25,26</sup>

While the majority of thioether macrocycles in the literature involve saturated aliphatic frameworks, examples involving rigid *o*-phenylene linkages or *o*- or *m*-xylyl linkages are also known. For example, Ochrymowycz and co-workers have prepared a range of derivatives of [14]aneS<sub>4</sub> incorporating 1,2-benzene and/or 1,2-cyclohexane units in place of the dimethylene linkages.<sup>27</sup> Also, 2,5,8-trithia[9]-*o*-benzenophane (TTOB), 2,5,8-trithia[9]-*m*-benzenophane (TTMB) have been obtained from reaction of KS(CH<sub>2</sub>)<sub>2</sub>S(CH<sub>2</sub>)<sub>2</sub>SK with α,α'-dibromo-*o*-xylene and α,α'-dibromo-*m*-xylene, respectively.<sup>28</sup> Tetrathia and hexathia cyclophane derivatives have also been reported.<sup>29–32</sup>





Scheme 2

A range of the macrocyclic thioethers whose coordination chemistry has been most studied in recent years is illustrated in Figure 1, and references to their synthesis are given in Table 1.

In contrast to polyaza macrocycles, which may be functionalized conveniently via introduction of the R substituents on the nitrogen atoms after the cyclization step, the presence of only two substituents on the sulfur atom, both of which are required for ring formation in a macrocyclic thioether, means that functionalization of these rings requires modification of the carbon backbone and is rather more difficult to achieve. A variety of C-functionalized derivatives of [9]aneS<sub>3</sub> have been reported in which the appropriate C-functionality is introduced prior to the macrocyclization step. The Mo(CO)<sub>3</sub> template route, which gives moderate yields of the C-functionalized rings, is preferred over the Cs<sub>2</sub>CO<sub>3</sub>/dmf route which gives polymeric products in some cases.<sup>33,34</sup> However, the presence of bulky R groups in the Mo-mediated reactions lead to unfavorable steric effects and therefore the yields are substantially lower than for [9]aneS<sub>3</sub> itself. A variety of other functionalities, including ketone, alcohol, amine, alkene, and thiophene groups have been incorporated into the carbon framework of other thiamacrocycles.<sup>35–41</sup>

Finally, Sargeson and co-workers have prepared a series of thioether-containing cage ligands, typically using template reactions. Transition metal complexes of these compounds exhibit interesting properties and the extremely robust nature of the complexes is attributed to the “cryptate effect.”<sup>50,51</sup>

### 1.18.3 COORDINATION CHEMISTRY AND PROPERTIES

A considerable range of coordination complexes of thioether macrocycles has been reported, and although the vast majority involve middle and late transition metal ions in low or medium oxidation states, examples with early transition metals such as V<sup>III</sup> and V<sup>IV</sup> (e.g., [VCl<sub>3</sub>([9]aneS<sub>3</sub>)]<sup>52</sup> and [VOCl<sub>2</sub>([9]aneS<sub>3</sub>)]<sup>52</sup>), Cr<sup>III</sup> (e.g., *cis*-[CrCl<sub>2</sub>([14]aneS<sub>4</sub>)]PF<sub>6</sub><sup>53</sup>) and high oxidation states such as Re<sup>VII</sup> (in [ReO<sub>3</sub>([9]aneS<sub>3</sub>)]BF<sub>4</sub><sup>54</sup>) are known. A range of complexes involving elements from the *p*-block, e.g., Tl<sup>I</sup>, Sn<sup>IV</sup>, Sb<sup>III</sup>, Bi<sup>III</sup>, Pb<sup>II</sup>, etc.<sup>55</sup> has also been characterized. One of the most significant findings has been the ability of thioether macrocycles to facilitate stabilization of very unusual oxidation states and to allow a series of stepwise one-electron oxidation and/or reduction products to be accessed, e.g., mononuclear [Pd([9]aneS<sub>3</sub>)<sub>2</sub>]<sup>2+/3+/4+</sup>,<sup>1</sup> [Au([9]aneS<sub>3</sub>)<sub>2</sub>]<sup>+ /2+/3+</sup>,<sup>56</sup> [Ni([9]aneS<sub>3</sub>)<sub>2</sub>]<sup>2+/3+</sup>,<sup>57</sup> and [Rh([9]aneS<sub>3</sub>)<sub>2</sub>]<sup>+ /2+/3+</sup>.<sup>2,58</sup> In most cases it appears to be the ability of the crown thioethers to readily adjust their coordination modes and conformations to accommodate the geometric preference of the particular metal oxidation state that is of key importance in this chemistry.

In certain systems the crown thioether ligand itself may undergo some chemical transformation when coordinated to a metal ion. For example, in mildly basic conditions, [Rh([9]aneS<sub>3</sub>)<sub>2</sub>]<sup>3+</sup> undergoes deprotonation at an  $\alpha$  carbon, with subsequent ring opening to afford the vinyl thioether



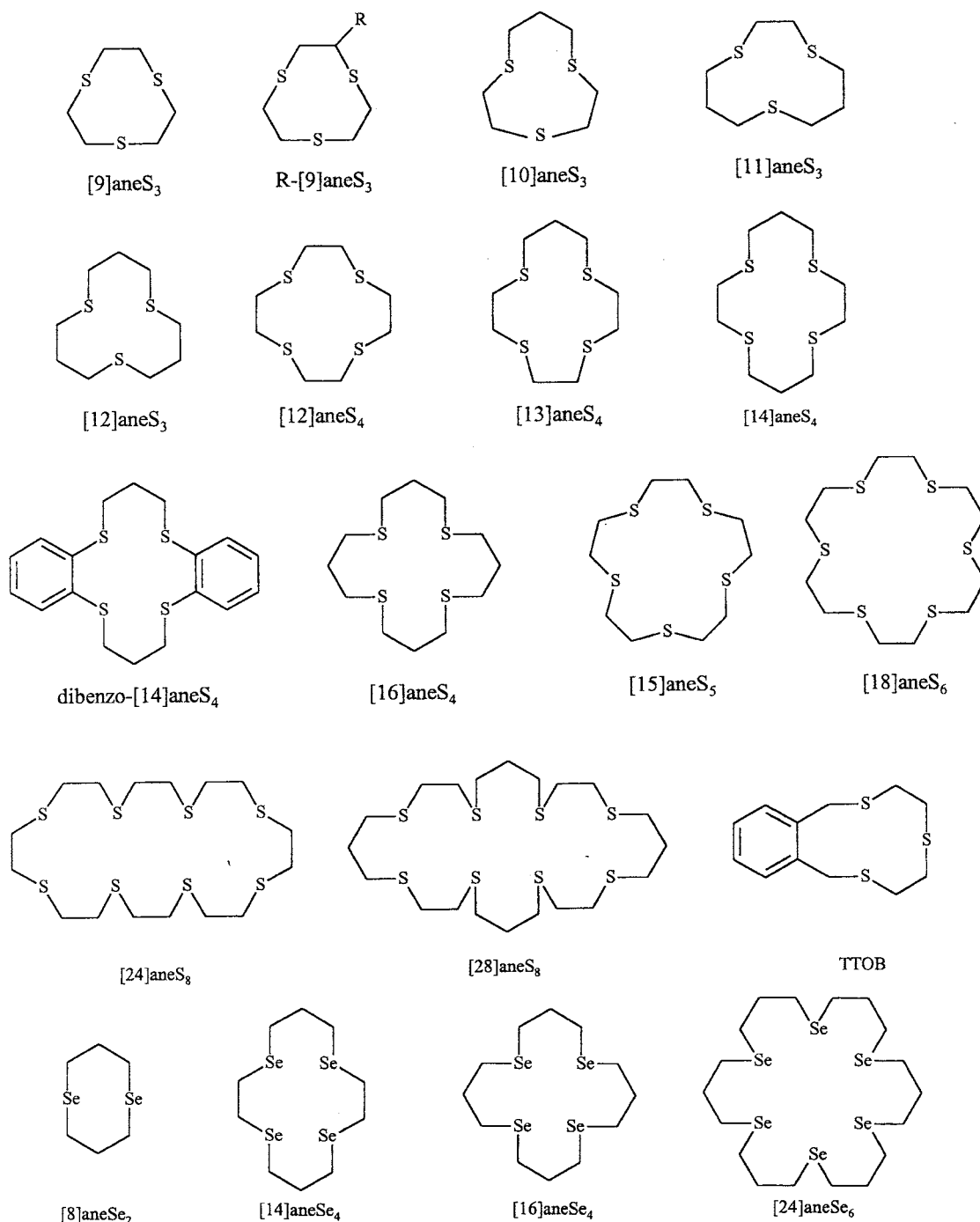


Figure 1 Sulfur and selenium macrocycles.

derivative,  $[\text{Rh}(\text{[9]aneS}_3)\{\text{S}(\text{CH}_2)_2\text{S}(\text{CH}_2)_2\text{SCH}=\text{CH}_2\}]^{2+}$ , which has been structurally characterized.<sup>59</sup> Also, oxidation of  $[\text{Fe}(\text{[9]aneS}_3)_2]^{2+}$  with  $\text{PbO}_2$  in 1M  $\text{H}_2\text{SO}_4$  gives the corresponding  $\text{Fe}^{\text{III}}$  complex, whereas using aqueous  $\text{Na}_2\text{S}_2\text{O}_8$  gives the  $\text{Fe}^{\text{II}}$ -sulfoxide derivative,  $[\text{Fe}(\text{[9]aneS}_3)\{\text{[9]aneS}_2(\text{S}=\text{O})\}]^{2+}$ , through oxidation of one of the thioether sulfur atoms.<sup>60</sup>

$[\text{9]aneS}_3$  has proved to be an exceptionally strongly ligating thioether. It typically functions as a tridentate, face-capping ligand, but examples exist where it behaves as a monodentate (e.g., in  $[\text{Au}(\text{[9]aneS}_3)_2]^+$ <sup>61</sup>) or bidentate (e.g., in  $[\text{Pd}(\text{[9]aneS}_3)_2]^{2+}$ , with additional weak  $\text{Pd}\cdots\text{S}$  interactions<sup>62</sup>). The tetra- and penta-thia macrocycles may coordinate metal ions either *exo* or *endo* to the ring.<sup>6,7</sup>  $[\text{12]aneS}_4$  and  $[\text{14]aneS}_4$  usually prefer to adopt a folded conformation in octahedral species, leaving two mutually *cis* coordination sites for other co-ligands. However, in the square

**Table 1** Ligands and their synthesis.

Ligand	References
[9]aneS <sub>3</sub>	21,22,42,43
R-[9]aneS <sub>3</sub>	33,34
[10]aneS <sub>3</sub>	44
[11]aneS <sub>3</sub>	35
[12]aneS <sub>3</sub>	45
[12]aneS <sub>4</sub>	15,17,46
[13]aneS <sub>4</sub>	11,17
[14]aneS <sub>4</sub>	17,20
dibenzo-[14]aneS <sub>4</sub>	27
[16]aneS <sub>4</sub>	15
[15]aneS <sub>5</sub>	15
[18]aneS <sub>6</sub>	15,47
[24]aneS <sub>6</sub>	15
[21]aneS <sub>7</sub>	48
[24]aneS <sub>8</sub>	15,48
[28]aneS <sub>8</sub>	49
TTOB	29

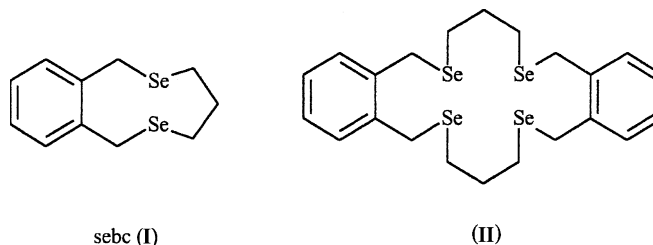
planar  $[\text{Pt}([\text{12]aneS}_4)]^{2+}$  the metal is displaced out of the mean S<sub>4</sub> plane, reflecting the mismatch between the metal ion radius and the macrocyclic hole size.<sup>63</sup> [16]aneS<sub>4</sub> comfortably accommodates many transition metals within the ring, giving *trans* octahedral species. There are numerous examples where [18]aneS<sub>6</sub> promotes homoleptic hexathia coordination in an octahedral metal complex and complexes of this ligand (and [9]aneS<sub>3</sub>) are considerably more resistant to hydrolysis/solvolysis compared to the larger-ring [24]aneS<sub>6</sub> (and [12]aneS<sub>3</sub>).<sup>6</sup> Larger-ring octathia-macrocycles usually behave as binucleating ligands.<sup>6</sup>

#### 1.18.4 SELENOETHER MACROCYCLES

The development of reliable synthetic routes to selenoether macrocycles has occurred only since the late 1980s. The availability of the new ligands in reasonable yields has allowed their coordination to elements from across much of the *d*-block and, more recently, a range of *p*-block elements to be explored.

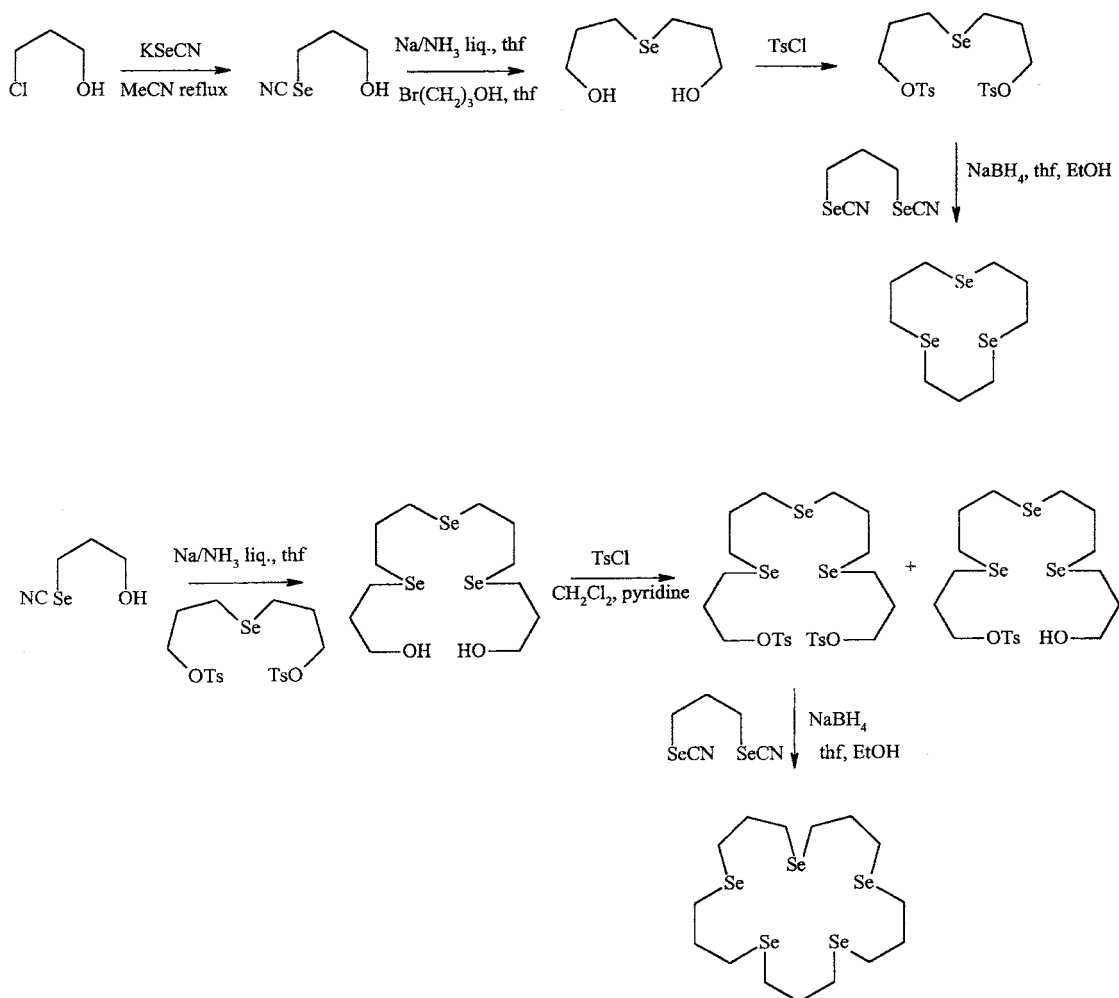
Probably the most significant contribution in this area came from Pinto and co-workers in 1989, when they described the preparations of the first series of cyclic selenoethers [8]aneSe<sub>2</sub>, [14]aneSe<sub>4</sub>, [16]aneSe<sub>4</sub> and [24]aneSe<sub>6</sub>. These are formed via Na/NH<sub>3</sub> liq reduction of the appropriate NCSe(CH<sub>2</sub>)<sub>*n*</sub>SeCN (*n* = 2 or 3) and subsequent treatment of the resulting disodium salt with Br(CH<sub>2</sub>)<sub>3</sub>Br at low temperature.<sup>64</sup> This methodology has been modified subsequently to afford the hydroxy-functionalized di- and tetra-selenoether macrocycles [8]aneSe<sub>2</sub>(OH), [16]aneSe<sub>4</sub>(OH), and [16]aneSe<sub>4</sub>(OH)<sub>2</sub>, using the appropriate hydroxy-functionalized bis-selenocyanate precursor.<sup>65</sup>

Reaction of *o*-C<sub>6</sub>H<sub>4</sub>(CH<sub>2</sub>SeCN)<sub>2</sub> with Br(CH<sub>2</sub>)<sub>3</sub>Br under similar conditions affords the cyclic diselenoether sebc (**I**) in high yield, although there was no sign of the [2 + 2] cyclization product (**II**) via this particular route.<sup>66</sup> However, this is contrary to an earlier report which claimed yields of 55% and 18% for (**I**) and (**II**) respectively, although few experimental details were provided.<sup>67</sup>



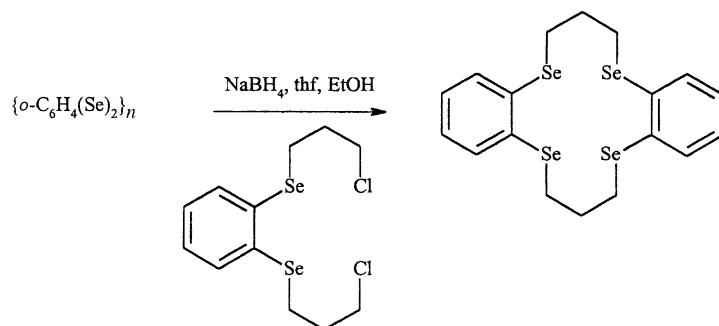
Macrocycles with odd numbers of donor atoms are generally more difficult to synthesize than those with even numbers irrespective of donor type, and the preparations of [12]aneSe<sub>3</sub> and [20]aneSe<sub>5</sub> are no exceptions. Their syntheses involve stepwise introduction of the Se atoms,

with ring closure occurring via a high-dilution cyclization of  $\text{NaSe}(\text{CH}_2)_3\text{SeNa}$  (generated *in situ*) with  $\text{TsO}(\text{CH}_2)_3\{\text{Se}(\text{CH}_2)_3\}_n\text{OTs}$ ,  $n = 1$  or 3 respectively, according to Scheme 3.<sup>68</sup>



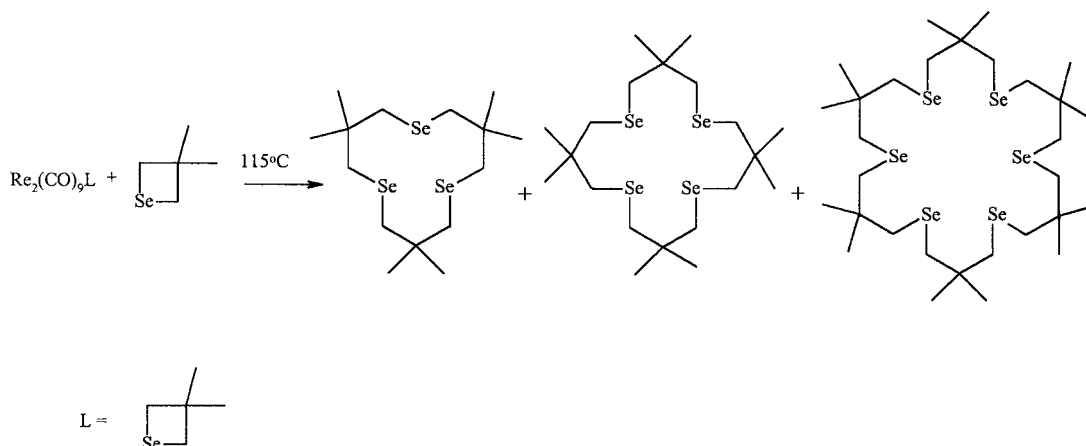
Scheme 3

Dibenzo[14]aneSe<sub>4</sub> is synthesized by a similar method to that employed for [16]aneSe<sub>4</sub> (Scheme 4).<sup>69</sup> The mixed thiaselena macrocycle [16]aneS<sub>2</sub>Se<sub>2</sub><sup>69</sup> uses a [1 + 1] cyclization of the appropriate  $\alpha,\omega$ -diselenoetherdithiol with  $\text{Br}(\text{CH}_2)_3\text{Br}$  under high dilution conditions in  $\text{dmf}/\text{Cs}_2\text{CO}_3$ . This is analogous to the route used for the preparation of [16]aneS<sub>4</sub> and other polythioether macrocycles.<sup>15</sup>



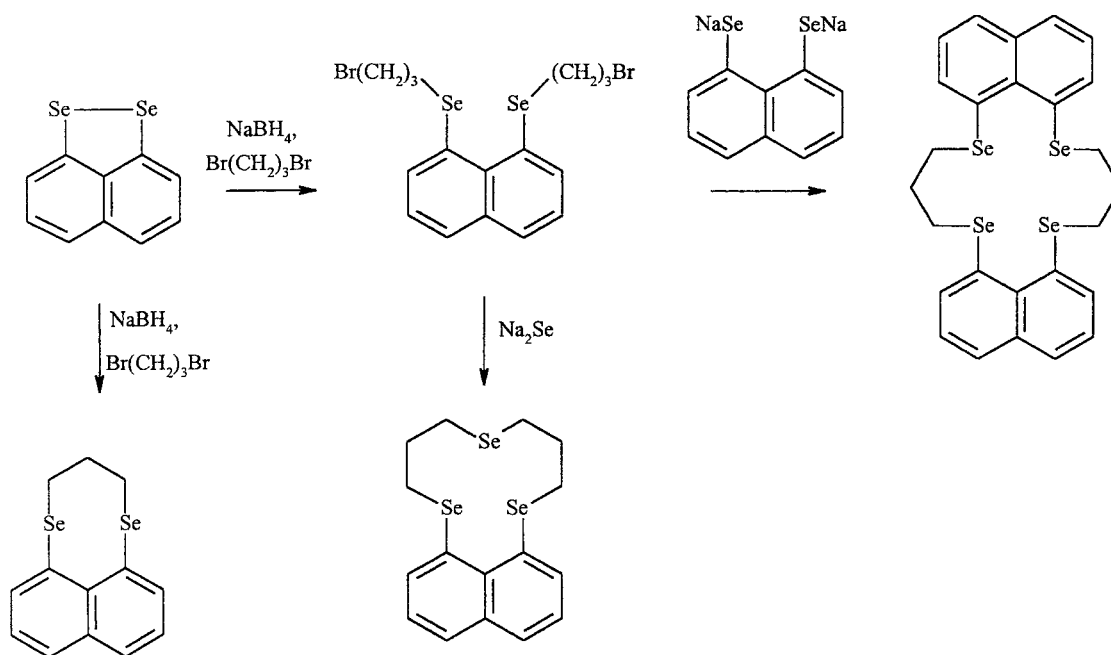
Scheme 4

Adams and co-workers have also demonstrated a new route to cyclic selenoether ligands. Thus, the catalytic cyclo-oligomerization of 3,3-dimethylselenetane to  $\text{Me}_4[8]\text{aneSe}_2$ ,  $\text{Me}_6[12]\text{aneSe}_3$ , and  $\text{Me}_8[16]\text{aneSe}_4$  occurs effectively using  $[\text{Re}_2(\text{CO})_8(\text{SeCH}_2\text{CMe}_2\text{CH}_2)]$  or  $[\text{Re}_2(\text{CO})_9(\text{NCMe})]$  at  $115^\circ\text{C}$  (Scheme 5).<sup>70</sup> This is a similar approach to that which they have used to obtain a range of thioether macrocycles (Section 1.18.1.2).<sup>25,26</sup>



Scheme 5

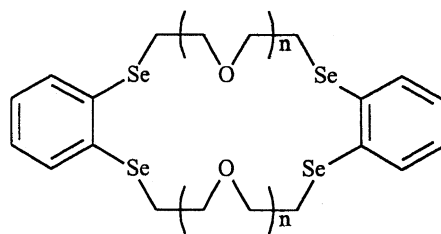
The naphthalene-derivatized selenoether macrocycles dinaphtho-[16]aneSe<sub>4</sub>, naphtho-[8]aneSe<sub>2</sub>, and naphtho-[12]aneSe<sub>3</sub> have been isolated from reactions depicted in Scheme 6. Hydrolysis of dinaphtho-[16]aneSe<sub>4</sub> with sulfuric acid leads to formation of the ring-contracted species naphtho-[8]aneSe<sub>2</sub>.<sup>71,72</sup>



Scheme 6

A series of mixed  $\text{Se}_4\text{O}_x$ -donor macrocycles **III–V** and related  $\text{Se}_2\text{O}_n$ -donor macrocycles have been obtained in moderate yield via reaction of  $o\text{-C}_6\text{H}_4(\text{SeK})_2$  with either  $o\text{-C}_6\text{H}_4\{\text{SeCH}_2(\text{CH}_2\text{OCH}_2)_n\text{CH}_2\text{X}\}_2$  ( $\text{X} = \text{Cl}$ ,  $n = 1\text{--}3$  or  $\text{X} = \text{Br}$ ,  $n = 3, 4$ ) or with  $\text{X}(\text{CH}_2\text{CH}_2\text{O})_n\text{CH}_2\text{CH}_2\text{X}$  ( $n = 1, 2$ ,  $\text{X} = \text{Cl}$ ;  $n = 3$ ,  $\text{X} = \text{Br}$ ) via [1 + 1] cyclization processes.<sup>73,74</sup> The yields of **III–V** are

increased if  $o\text{-C}_6\text{H}_4(\text{SeH})_2$  is treated with the  $\alpha,\omega$ -dichloroselenoether in  $\text{Cs}_2\text{CO}_3/\text{dmf}$ , utilizing the "cesium effect."<sup>75</sup> Other crown ether derivatives incorporating one Se or Te atom within the ring have been reported.<sup>75</sup>



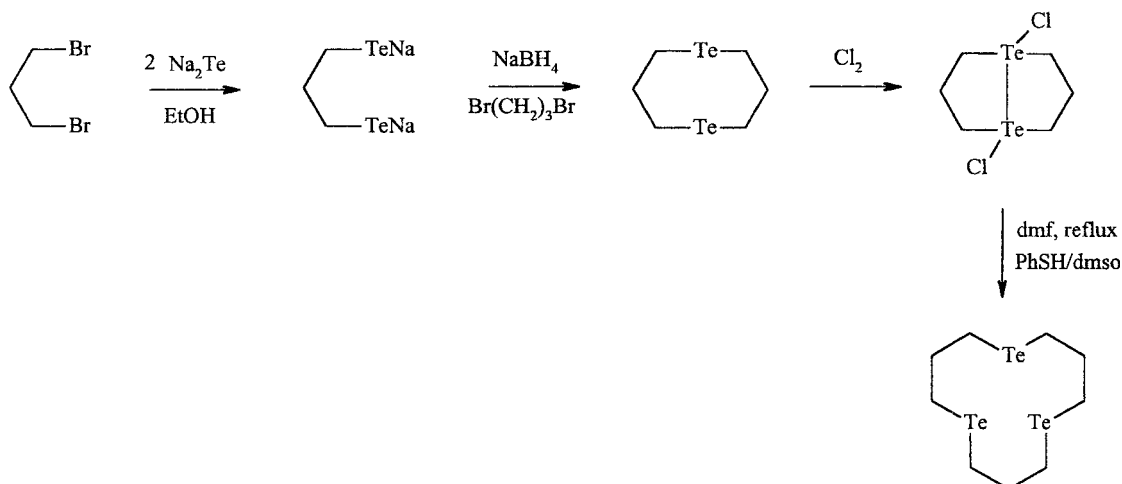
( $\text{Se}_2\text{O}_x$  ligands)  $n = 1, 2, 3$   
(III-V)

A mixed  $\text{N}_3\text{Se}_3$ -donor sarcophagine ligand has been prepared as its cobalt(III) complex by treating  $[\text{Co}\{\text{MeC}(\text{CH}_2\text{Se}(\text{CH}_2)_2\text{NH}_2)_3\}]\text{Cl}_3$  with  $\text{HCHO}$  and  $\text{MeNO}_2$ .<sup>76</sup>

### 1.18.5 TELLUROETHER MACROCYCLES

Synthetic routes to macrocyclic ligands containing tellurium are still very limited, mainly because of the difficulties in sequentially introducing the necessary Te centers into organic fragments, the weakness of the  $\text{Te}-\text{C}$  bonds, and the unavailability of many of the Te-containing analogs of the precursors for thio- and selenoether macrocycles.

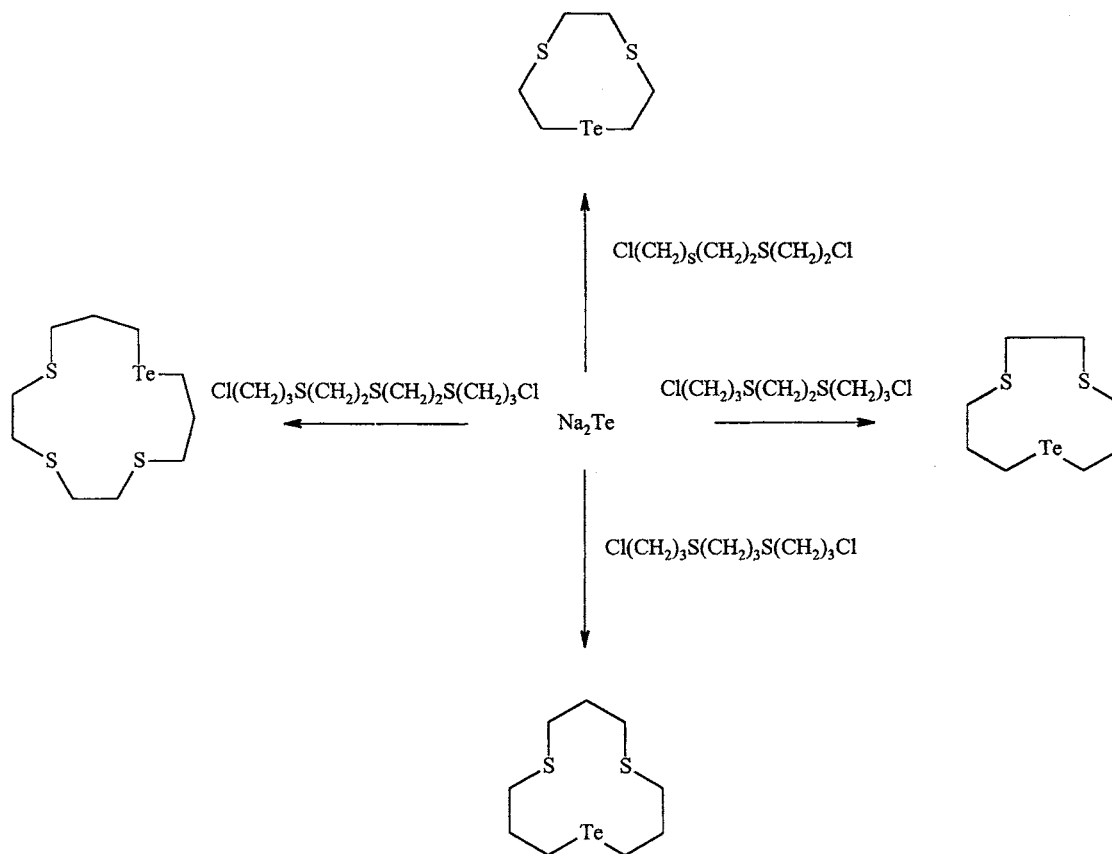
However, the cyclic ditelluroether [8]ane $\text{Te}_2$  is reported to form by treatment of  $\text{Na}_2\text{Te}$  with 0.5 molar equivalents of 1,3-dibromopropane in ethanol, followed by addition of  $\text{NaBH}_4$  and a further equivalent of 1,3-dibromopropane.<sup>77</sup> The first example of a macrocyclic tritelluroether, [12]ane $\text{Te}_3$ , has been isolated as a product from the pyrolysis of ditellurane in  $\text{dmf}$  at  $160^\circ\text{C}$ , followed by reduction (Scheme 7).<sup>78</sup> The crystal structure of the hexachloro telluronium derivative serves to authenticate the incorporation of three Te centers within the 12-membered ring. There have been no reports to date concerning the coordination chemistry of this potentially very interesting tritelluroether macrocycle. It seems likely that this will be the focus of considerable further research effort in the future.



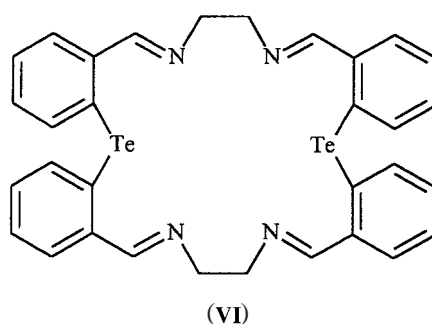
Scheme 7

A small number of mixed-donor Te-containing macrocyclic ligands has been reported. The synthesis of the first series of mixed thia/tellura macrocycles, [9]aneS<sub>2</sub>Te, [11]aneS<sub>2</sub>Te, [12]aneS<sub>2</sub>Te, and [14]aneS<sub>3</sub>Te, has been reported very recently. These are obtained according to Scheme 8, in which Na<sub>2</sub>Te in liquid NH<sub>3</sub> is treated with the appropriate  $\alpha,\omega$ -dichlorothioalkane. Following work-up, the macrocyclic ligands are obtained as light yellow, poorly soluble solids in moderate yields.<sup>79</sup> The only structurally characterized derivative is the complex [Ag([11]aneS<sub>2</sub>Te)]BF<sub>4</sub>, which shows coordination to Ag<sup>I</sup> through all three donor atoms to give a cationic chain polymer.<sup>79</sup>

Finally, the telluroether Schiff-base macrocycle (VI) has been obtained by condensation of bis(2-formylphenyl)telluride with 1,2-diaminoethane.<sup>80</sup>



Scheme 8



### 1.18.6 COORDINATION CHEMISTRY AND PROPERTIES

Studies on the coordination chemistry of selenoether macrocycles have focused mainly on [8]aneSe<sub>2</sub>, [16]aneSe<sub>4</sub>, and [24]aneSe<sub>6</sub>. While [8]aneSe<sub>2</sub> behaves as either a bidentate chelate or a bridging ligand linking adjacent metal centers, a variety of coordination modes have been identified for [16]aneSe<sub>4</sub>, including both *endocyclic* coordination, e.g., in the Pt<sup>IV</sup> species *trans*-[PtCl<sub>2</sub>([16]aneSe<sub>4</sub>)]<sup>2+</sup><sup>81</sup> and *exocyclic* coordination, which occurs, for example, in a variety of *p*-block element complexes, such as [BiBr<sub>3</sub>([16]aneSe<sub>4</sub>)].<sup>82</sup> [Pd([16]aneSe<sub>4</sub>)]<sup>2+</sup> has been identified crystallographically in two different invertomer forms; the PF<sub>6</sub><sup>-</sup> salt occurs in the *up, up, down, down* form,<sup>83</sup> while the BF<sub>4</sub><sup>-</sup> salt is in the *all up* form.<sup>84</sup> To date there have been only two structural reports on complexes of the large ring [24]aneSe<sub>6</sub>. In [(PdCl<sub>2</sub>)<sub>2</sub>([24]aneSe<sub>6</sub>)]<sup>2+</sup><sup>84</sup> and [(AsCl<sub>3</sub>)<sub>4</sub>([24]aneSe<sub>6</sub>)],<sup>85</sup> the macrocycle can accommodate two Pd<sup>II</sup> (or As<sup>III</sup>) centers *endo* to the ring. In the latter, a further two As centers are coordinated *exo* to the ring. The coordination chemistry of Te-containing macrocycles is, by comparison with S and Se analogs, still a very underdeveloped research area, although some ligands have become available recently.

The combination of the availability of sensitive NMR probes in both <sup>77</sup>Se and <sup>125</sup>Te, together with the superior  $\sigma$  donation (to low valent metals) from SeR<sub>2</sub> and TeR<sub>2</sub> compared with SR<sub>2</sub> and the emergence of useful preparative methods for the Se- and Te-containing macrocycles themselves, strongly suggest that these areas will be the subject of much further research effort in the future.

### 1.18.7 ABBREVIATIONS

- [9]aneS<sub>3</sub> = 1,4,7-trithiacyclononane (1.1.18.2)  
 [10]aneS<sub>3</sub> = 1,4,7-trithiacyclodecane (1.1.18.3)  
 [11]aneS<sub>3</sub> = 1,4,8-trithiacycloundecane (1.1.18.3)  
 [12]aneS<sub>3</sub> = 1,5,9-trithiacyclododecane (1.1.18.3)  
 [12]aneS<sub>4</sub> = 1,4,7,10-tetrathiacyclododecane (1.1.18.3)  
 [13]aneS<sub>4</sub> = 1,4,7,10-tetrathiacyclotridecane (1.1.18.3)  
 [14]aneS<sub>4</sub> = 1,4,8,11-tetrathiacyclotetradecane (1.1.18.3)  
 dibenzo[14]aneS<sub>4</sub> = 6,7,13,14-dibenzo-1,5,8,12-tetrathiacyclotetradecane (1.1.18.3)  
 [16]aneS<sub>4</sub> = 1,5,9,13-tetrathiacyclohexadecane (1.1.18.2)  
 [15]aneS<sub>5</sub> = 1,4,7,10,13-pentathiacyclopentadecane (1.1.18.3)  
 [18]aneS<sub>6</sub> = 1,4,7,10,13,16-hexathiacyclooctadecane (1.1.18.3)  
 [24]aneS<sub>6</sub> = 1,5,9,13,17,21-hexathiacyclotetrasocane (1.1.18.3)  
 [21]aneS<sub>7</sub> = 1,4,7,10,13,16,19-heptathiacycloheptacosane (1.1.18.3)  
 [24]aneS<sub>8</sub> = 1,4,7,10,13,16,19, 21-octathiacyclotetrasocane (1.1.18.3)  
 [28]aneS<sub>8</sub> = 1,4,8,11,14,17,21,24-octathiacyclooctacosane (1.1.18.3)  
 TTMB = 2,5,8-trithia[9]-*m*-benzophane (1.1.18.2)  
 TTOB = 2,5,8-trithia[9]-*o*-benzophane (1.1.18.3)  
 Naphtho-[8]aneSe<sub>2</sub> = 3,4-dihydro-2*H*-naphtho[1,8-*bc*]-1,5-diselenocine (1.1.18.4)  
 [8]aneSe<sub>2</sub> = 1,5-diselenacyclooctane (1.1.18.4)  
 Me<sub>4</sub>[8]aneSe<sub>2</sub> = 3,3,7,7-tetramethyl-1,5-diselenacyclooctane (1.1.18.4)  
 sebc = 3*H*-1,4,5,7-tetrahydro-2,6-benzodiselenonine (1.1.18.4)  
 [9]aneS<sub>2</sub>Te = 1,4-dithia-7-telluracyclononane (1.1.18.5)  
 [11]aneS<sub>2</sub>Te = 1,4-dithia-8-telluracycloundecane (1.1.18.5)  
 [12]aneS<sub>2</sub>Te = 1,5-dithia-9-telluracyclododecane (1.1.18.5)  
 [14]aneS<sub>3</sub>Te = 1,4,7-trithia-11-telluracyclotetradecane (1.1.18.5)  
 naphtho-[12]aneSe<sub>3</sub> = 3,4,7,8-tetrahydro-2*H*,6*H*-naphtho-[1,8-*bc*]-1,5,9-triselenacyclododecane (1.1.18.4)  
 [12]aneSe<sub>3</sub> = 1,5,9-triselenacyclododecane (1.1.18.4)  
 Me<sub>6</sub>[12]aneSe<sub>3</sub> = 3,3,7,7,11,11-hexamethyl-1,5,9-triselenacyclododecane (1.1.18.4)  
 [14]aneSe<sub>4</sub> = 1,4,8,11-tetraselenacyclotetradecane (1.1.18.4)  
 [16]aneS<sub>2</sub>Se<sub>2</sub> = 1,5-diselena-9,13-dithiacyclohexadecane (1.1.18.4)  
 dinaphtho-[16]aneSe<sub>4</sub> = 9,10,20,21-tetrahydro-8*H*,19*H*-dinaphtho[1',8'-*jk*;1,8-*bc*]-1,5,9,13-tetraselenacyclohexadecane (1.1.18.4)  
 [16]aneSe<sub>4</sub> = 1,5,9,13-tetraselenacyclohexadecane (1.1.18.4)  
 [16]aneSe<sub>4</sub>(OH) = 1,5,9,13-tetraselenacyclohexadecane-3-ol (1.1.18.4)  
 [16]aneSe<sub>4</sub>(OH)<sub>2</sub> = 1,5,9,13-tetraselenacyclohexadecane-3,11-diol (1.1.18.4)

- Me<sub>8</sub>[16]aneSe<sub>4</sub>** = 3,3,7,7,11,11,15,15-octamethyl-1,5,9,13-tetraselenacyclohexadecane (1.1.18.4)  
**[20]aneSe<sub>5</sub>** = 1,5,9,13,17-pentaseenacycloicosane (1.1.18.4)  
**[24]aneSe<sub>6</sub>** = 1,5,9,13,17,21-hexaselenacyclotetracosane (1.1.18.4)  
**[8]aneTe<sub>2</sub>** = 1,5-ditelluracyclooctane (1.1.18.5)  
**[12]aneTe<sub>3</sub>** = 1,5,9-tritelluracyclododecane (1.1.18.5)

## 1.18.8 REFERENCES

- Blake, A. J.; Holder, A. J.; Hyde, T. I.; Schröder, M. *Chem. Commun.* **1987**, 987–988.
- Rawle, S. C.; Yagbasan, R.; Prout, K.; Cooper, S. R. *J. Am. Chem. Soc.* **1987**, *109*, 6181–6182.
- Robinson, G. H.; Zhang, H.; Atwood, J. L. *Organometallics* **1987**, *6*, 887–889.
- Willey, G. R.; Lakin, M. T.; Alcock, N. W. *J. Chem. Soc., Dalton Trans.* **1992**, 591–596.
- Cooper, S. R. *Acc. Chem. Res.* **1988**, *21*, 141–146.
- Blake, A. J.; Schröder, M. *Adv. Inorg. Chem.* **1990**, *35*, 1–80.
- Cooper, S. R.; Rawle, S. C. *Struct. Bonding (Berlin)* **1990**, *72*, 1–72.
- Kellogg, R. M. In *Crown Compounds: Toward Future Applications*, Cooper, S. R., Ed., Wiley VCH, New York, 1992.
- Rosen, W.; Busch, D. H. *Chem. Commun.* **1969**, 148–149.
- Rosen, W.; Busch, D. H. *J. Am. Chem. Soc.* **1969**, *91*, 4694–4697.
- Rosen, W.; Busch, D. H. *Inorg. Chem.* **1970**, *9*, 262–265.
- Travis, K.; Busch, D. H. *Inorg. Chem.* **1974**, *13*, 2591–2598.
- Black, D. St.C.; McLean, I. A. *Tetrahedron Lett.* **1969**, 3961–3964.
- Black, D. St.C.; McLean, I. A. *Aust. J. Chem.* **1971**, *24*, 1401–1411.
- Ochrymowycz, L. A.; Mak, C.-P.; Michna, J. D. *J. Org. Chem.* **1974**, *39*, 2079–2084.
- Buter, J.; Kellogg, R. M. *Chem. Commun.* **1980**, 466–467.
- Buter, J.; Kellogg, R. M. *J. Org. Chem.* **1981**, *46*, 4481–4485.
- Buter, J.; Kellogg, R. M.; Van Bolhuis, F. *Chem. Commun.* **1990**, 282–284.
- Dijkstra, G.; Kruizinga, W. H.; Kellogg, R. M. *J. Org. Chem.* **1987**, *52*, 4230–4234.
- Buter, J.; Kellogg, R. M. *Org. Synth.* **1987**, *65*, 150–158.
- Sellmann, D.; Zapf, L. *Angew. Chem.* **1984**, *96*, 799–800.
- Sellmann, D.; Zapf, L. *J. Organomet. Chem.* **1985**, *289*, 57–69.
- Sellmann, D.; Frank, P. *Angew. Chem.* **1986**, *98*, 1115–1116.
- Sellmann, D.; Frank, P.; Knoch, F. J. *J. Organomet. Chem.* **1988**, *339*, 345–356.
- Adams, R. D.; Falloon, S. B. *J. Am. Chem. Soc.* **1994**, *116*, 10540–10547.
- Adams, R. D.; Cortopassi, J.; Falloon, S. B. *J. Organomet. Chem.* **1993**, *463*, C5–C7.
- Aronne, L.; Dunn, B. C.; Vyvyan, J. R.; Souvignier, O. W.; Mayer, M. J.; Howard, T. A.; Salhi, C. A.; Goldie, S. N.; Ochrymowycz, L. A.; Rorabacher, D. B. *Inorg. Chem.* **1995**, *34*, 357–369.
- DeGroot, B.; Loeb, S. J. *Inorg. Chem.* **1990**, *29*, 4081–4090.
- Loeb, S. J.; Shimizu, G. K. H. *Can. J. Chem.* **1994**, *72*, 1728–1734.
- De Groot, B.; Loeb, S. J.; Shimizu, G. K. H. *Inorg. Chem.* **1994**, *33*, 2663–2667.
- Loeb, S. J.; Smith, K. D. L. *Inorg. Chem.* **1993**, *32*, 1297–1300.
- Loeb, S. J.; Shimizu, G. K. H. *Synlett* **1992**, 823–824.
- Smith, R. J.; Salek, S. N.; Went, M. J.; Blower, P. J.; Barnard, N. J. *J. Chem. Soc., Dalton Trans.* **1994**, 3165–3170.
- Smith, R. J.; Adams, G. D.; Richardson, A. P.; Kupperts, H.-J.; Blower, P. J. *Chem. Commun.* **1991**, 475–476.
- Setzer, W. N.; Afshar, S.; Burns, N. L.; Ferrante, L. A.; Hester, A. M.; Meehan, E. J. Jr. *Heteroat. Chem.* **1990**, *1*, 375–387.
- Setzer, W. N.; Cacioppo, E. L.; Guo, Q.; Grant, G. J.; Kim, D. D.; Hubbard, J. L.; VanDerveer, D. G. *Inorg. Chem.* **1990**, *29*, 2672–2681.
- Champness, N. R.; Bruce, D. W.; Schröder, M. *New J. Chem.* **1999**, *23*, 571–674.
- Edema, J. J. H.; Buter, J.; Schoonbeek, F. S.; Meetsma, A.; van Bolhuis, F.; Kellogg, R. M. *J. Org. Chem.* **1993**, *58*, 5624–5627.
- Sutton, L. R.; Blake, A. J.; Cooke, P. A.; Gould, R. O.; Parsons, S.; Schröder, M. *Synlett* **1999**, 921–924.
- Lucas, C. R.; Shuang, L.; Newlands, M. J.; Charland, J.-P.; Gabe, E. J. *Can. J. Chem.* **1988**, *66*, 1506.
- Lucas, C. R.; Shuang, L.; Newlands, M. J.; Charland, J.-P.; Gabe, E. J. *Can. J. Chem.* **1989**, *67*, 639–647.
- Blower, P. J.; Cooper, S. R. *Inorg. Chem.* **1987**, *26*, 2009–2010.
- Setzer, W. N.; Ogle, C. A.; Wilson, G. S.; Glass, R. S. *Inorg. Chem.* **1983**, *22*, 266–271.
- Grant, G. J.; Carpenter, J. P.; Setzer, W. N.; VanDerveer, D. G. *Inorg. Chem.* **1989**, *28*, 4128–4131.
- Rawle, S. C.; Admans, G. A.; Cooper, S. R. *J. Chem. Soc., Dalton Trans.* **1988**, 93–96.
- Wolf, R. E., Jr.; Hartman, J. R.; Storey, J. M. E.; Foxman, B. M.; Cooper, S. R. *J. Am. Chem. Soc.* **1987**, *109*, 4328–4335.
- Wolf, R. E. Jr.; Hartman, J. R.; Ochrymowycz, L. A.; Cooper, S. R. *Inorg. Synth.* **1989**, *25*, 122–126.
- Edema, J. J. H.; Buter, J.; Kellogg, R. M. *Tetrahedron* **1994**, *50*, 2095–2098.
- Travis, K.; Busch, D. H. *J. Chem. Soc. D* **1970**, 1041–1042.
- Osvath, P.; Sargeson, A. M. *Chem. Commun.* **1993**, 40–42.
- Osvath, P.; Sargeson, A. M.; Skelton, B. W.; White, A. H. *Chem. Commun.* **1991**, 1036–1038.
- Davies, S. C.; Durrant, M. C.; Hughes, D. L.; Le Floch, C.; Pope, S. J. A.; Reid, G.; Richards, R. L.; Sanders, J. R. *J. Chem. Soc., Dalton Trans.* **1998**, 2191–2198.
- Champness, N. R.; Jacob, S. R.; Reid, G.; Frampton, C. S. *Inorg. Chem.* **1995**, *34*, 396–398.
- Küppers, H.-J.; Nuber, B.; Weiss, J.; Cooper, S. R. *Chem. Commun.* **1990**, 979–980.



55. Levason, W.; Reid, G. *J. Chem. Soc., Dalton Trans.* **2001**, 2953–2960, and references therein.
56. Blake, A. J.; Greig, J. A.; Holder, A. J.; Hyde, T. I.; Schröder, M.; Taylor, A. *Angew. Chem.* **1990**, *102*, 203–204.
57. Blake, A. J.; Gould, R. O.; Halcrow, M. A.; Holder, A. J.; Hyde, T. I.; Schröder, M. *J. Chem. Soc., Dalton Trans.* **1992**, 3427–3431.
58. Blake, A. J.; Gould, R. O.; Holder, A. J.; Hyde, T. I.; Schröder, M. *J. Chem. Soc., Dalton Trans.* **1988**, 1861–1865.
59. Blake, A. J.; Holder, A. J.; Hyde, T. I.; Küppers, H.-J.; Schröder, M.; Stotzel, S.; Wieghardt, K. *Chem. Commun.* **1989**, 1600–1602.
60. Küppers, H.-J.; Wieghardt, K.; Nuber, B.; Weiss, J.; Bill, E.; Trautwein, A. X. *Inorg. Chem.* **1987**, *26*, 3762–3769.
61. Blake, A. J.; Gould, R. O.; Greig, J. A.; Holder, A. J.; Hyde, T. I.; Schröder, M. *Chem. Commun.* **1989**, 876–878.
62. Wieghardt, K.; Küppers, H.-J.; Raabe, E.; Kruger, C. *Angew. Chem.* **1986**, *98*, 1136–1138.
63. Blake, A. J.; Holder, A. J.; Reid, G.; Schröder, M. *J. Chem. Soc., Dalton Trans.* **1994**, 627–631.
64. Batchelor, R. J.; Einstein, F. W. B.; Gay, I. D.; Gu, J.-H.; Johnston, B. D.; Pinto, B. M. *J. Am. Chem. Soc.* **1989**, *111*, 6582–6591.
65. Cordova-Reyes, I.; Hu, H.; Gu, J.-H.; VandenHoven, E.; Mohammed, A.; Holdcroft, S.; Pinto, B. M. *Can. J. Chem.* **1996**, *74*, 533–543.
66. Booth, D. G.; Levason, W.; Quirk, J. J.; Reid, G.; Smith, S. M. *J. Chem. Soc., Dalton Trans.* **1997**, 3493–3500.
67. Kumagai, T.; Akabori, S. *Chem. Lett.* **1989**, 1667–1670.
68. Cordova-Reyes, I.; VandenHoven, E.; Mohammed, A.; Pinto, B. M. *Can. J. Chem.* **1995**, *73*, 113–116.
69. Batchelor, R. J.; Einstein, F. W. B.; Gay, I. D.; Gu, J.-H.; Mehta, S.; Pinto, B. M.; Zhou, X.-M. *Inorg. Chem.* **2000**, *39*, 2558–2571.
70. Adams, R. D.; McBride, K. T.; Rogers, R. D. *Organometallics* **1997**, *16*, 3895–3901.
71. Fujihara, H.; Yabe, M.; Ikemori, M.; Furukawa, N. *J. Chem. Soc., Perkin Trans. I* **1993**, 2145–2146.
72. Fujihara, H.; Yabe, M.; Furukawa, N. *J. Chem. Soc., Perkin Trans. I* **1996**, 1783–1785.
73. Mazouz, A.; Meunier, P.; Kubicki, M. M.; Hanquet, B.; Amardeil, R.; Bornet, C.; Zahidi, A. *J. Chem. Soc., Dalton Trans.* **1997**, 1043–1048.
74. Mazouz, A.; Bodiguel, J.; Meunier, P.; Gautheron, B. *Phosphorus, Sulfur Silicon Relat. Elem.* **1991**, *61*, 247–249.
75. See for example Yam, V. W.-W.; Pui, Y.-L.; Li, W.-P.; Lo, K. K.-W.; Cheung, K.-K. *J. Chem. Soc., Dalton Trans.* **1998**, 3615–3622.
76. Bhula, R.; Arnold, A. P.; Gainsford, G. J.; Jackson, W. G. *Chem. Commun.* **1996**, 143–144.
77. Fujihara, H.; Ninoi, T.; Akaishi, R.; Erata, T.; Furukawa, N. *Tetrahedron Lett.* **1991**, *32*, 4537–4540.
78. Takaguchi, Y.; Horn, E.; Furukawa, N. *Organometallics* **1996**, *15*, 5112–5115.
79. Levason, W.; Orchard, S. D.; Reid, G. *Chem. Commun.* **2001**, 427–428.
80. Menon, S. C.; Singh, H. B.; Patel, R. P.; Kulshreshtha, S. K. *J. Chem. Soc., Dalton Trans.* **1996**, 1203–1207.
81. Levason, W.; Quirk, J. J.; Reid, G.; Frampton, C. S. *Inorg. Chem.* **1994**, *33*, 6120–6122.
82. Barton, A. J.; Genge, A. R. J.; Levason, W.; Reid, G. *J. Chem. Soc., Dalton Trans.* **2000**, 2163–2166.
83. Champness, N. R.; Kelly, P. F.; Levason, W.; Reid, G.; Slawin, A. M. Z.; Williams, D. J. *Inorg. Chem.* **1995**, *34*, 651–657.
84. Batchelor, R. J.; Einstein, F. W. B.; Gay, I. D.; Gu, J.; Pinto, B. M.; Zhou, X. *Inorg. Chem.* **1996**, *35*, 3667–3674.
85. Barton, A. J.; Hill, N. J.; Levason, W.; Reid, G. *J. Am. Chem. Soc.* **2001**, *123*, 11801–11802.

# 1.19

## Acyclic and Macrocyclic Schiff Base Ligands

R. HERNÁNDEZ-MOLINA and A. MEDEROS

*Universidad de La Laguna, Canary Islands, Spain*

---

1.19.1	INTRODUCTION	411
1.19.2	GENERAL PROPERTIES	412
1.19.2.1	General Synthetic Method	412
1.19.2.2	General Spectroscopic Properties	413
1.19.2.3	Tautomerism	413
1.19.2.4	Intramolecular Nucleophilic Attack	414
1.19.3	MONODENTATE SCHIFF BASES	414
1.19.4	BIDENTATE SCHIFF BASES	415
1.19.4.1	N,N and N,O Donors	415
1.19.4.2	N,S(Se) Donors	416
1.19.4.3	N,P Donors	417
1.19.5	TRIDENTATE SCHIFF BASES	417
1.19.5.1	N,O Donors	417
1.19.5.2	Other Donors	418
1.19.6	TETRADENTATE SCHIFF BASES	420
1.19.6.1	N,O and N,N Donors	420
1.19.6.1.1	Asymmetrical	420
1.19.6.1.2	Symmetrical	422
1.19.6.2	N,S, N,O,S and Other Donors	425
1.19.6.3	Chiral Tetradentate Schiff Bases	426
1.19.6.4	Equilibrium Studies	427
1.19.7	PENTADENTATE SCHIFF BASES	428
1.19.8	COMPARTMENTAL ACYCLIC SCHIFF BASES	428
1.19.8.1	Phenol-based Derivatives	429
1.19.8.2	Di- and Triketone Derivatives	431
1.19.8.3	End-off Ligands	432
1.19.8.4	Polypodal Ligands	433
1.19.9	MACROCYCLIC SCHIFF BASES	435
1.19.9.1	Compartmental Macrocycles	437
1.19.9.2	Noncompartmental Macrocycles	439
1.19.9.3	Bibracchial Macrocycles	440
1.19.9.4	Ring Contraction and Expansion	441
1.19.10	REFERENCES	443

---

### 1.19.1 INTRODUCTION

This chapter deals with the Schiff base (SB) ligands with special emphasis on the recent developments in this area.

The SB ligands are one of the most widely used ligands due to the ease of formation and remarkable versatility, and therefore they have played an important role in the development of coordination chemistry as they readily form stable complexes with most of the transition metals.

The research field dealing with SB metal complexes is very broad due in part to their potential interest for a number of interdisciplinary areas that include bioinorganic chemistry, catalysis, and magnetochemistry.<sup>1-5</sup> In the area of bioinorganic chemistry the interest in the SB complexes lies in that they provide synthetic models for the metal-containing sites in metalloproteins and enzymes. Dinuclear SB complexes have also contributed enormously to the development of magnetochemistry and to the understanding of the mechanism of exchange coupling between two metal ions. Also, chiral SB complexes have been found to be efficient catalysts for some organic reactions.<sup>4</sup> SB complexes have also been used as models for the activation of small molecules.<sup>6</sup> As a consequence of this the number of publications concerning SBs is extensive and a detailed comprehensive coverage of the whole area would be impossible. We will focus on SBs as potential ligands, their synthetic procedure, their denticity, the steric restriction imposed by the ligand conditioning the geometry and the structure of their complexes, the chirality; the special properties that they may induce in the complexes formed (spin crossover, magnetic coupling) will be considered.

A classification of the SB ligands taking into account their denticity (number of donor atoms) and type of donor atom set will be made. The majority of the SB ligands comprise N and O donors, SBs containing mixed donors, i.e., P,S also exist and will be considered here. It is our aim to provide a brief overview of this research field ranging from monodentate SBs to multidentate SBs, including both acyclic and macrocyclic SB ligands. For the latter, readers are also referred to the chapter devoted to macrocycles of the present edition of *Comprehensive Coordination Chemistry*. Those aspects related to the spectroscopic and structural properties of SBs will be only considered briefly since the chapter dedicated to SBs of *CCC* (1987) has provided good coverage of this aspect.<sup>7</sup>

The number of SB complexes crystallographically characterized is very broad, however, comparatively only a limited number of crystal structures of metal-free SBs has been reported.<sup>8-15</sup> In those cases in which the structures of both the metal-free SB and their complexes are available, a comparative analysis can be made to establish how the conformation of the ligand is affected upon coordination to a metal. Several representative examples have been selected for this chapter.<sup>16-19</sup>

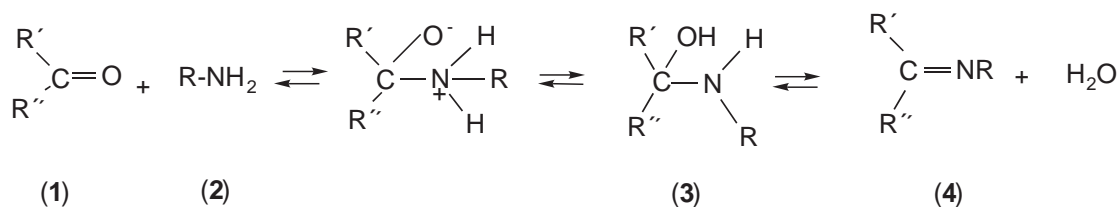
Numerous reviews dealing with SB complexes have appeared.<sup>1-3,7,20-31</sup> Other reviews prior to 1982 can be found in the first edition.<sup>7</sup>

## 1.19.2 GENERAL PROPERTIES

### 1.19.2.1 General Synthetic Method

The general method of preparation of SBs (Scheme 1) is quite straightforward and consists of the condensation reaction of primary amines (2) with a carbonyl precursor (1) usually in alcoholic solution and sometimes under reflux conditions.<sup>7</sup> This reaction is reversible, progressing through a carbinolamine intermediate (3) (Scheme 1), and requires the removal of water, often by azeotropic distillation with benzene, to achieve high yields. The reaction is acid catalyzed but catalysts are not generally required when aliphatic amines are involved. The resulting compound (4) contains an imine or azomethine group (C=N) and is referred to as SB.

Since the free SBs are not always stable, many SB complexes are prepared by template synthesis which implies carrying out the condensation reaction in the presence of a metal ion. This is a very common method for the preparation of macrocyclic SB complexes.<sup>2,3</sup> In this case large alkaline earth metal cations (i.e., Ba<sup>II</sup>, lanthanoids, or Pb<sup>II</sup>) have proved to be efficient templates. The size



Scheme 1

of the macrocycle cavity is a determining factor in the choice of the metal ion template. Transmetallation reactions have been successfully used to prepare macrocyclic complexes of other metal ions, generally 3d metals, from the barium or lead complexes.

### 1.19.2.2 General Spectroscopic Properties

The stretching frequencies of the azomethine group (C=N) of the SB ligands are in the range 1,603–1,680  $\text{cm}^{-1}$  depending on the different substituents on the C and N.<sup>7</sup> The existence of this very well defined band at such a narrow range allows the identification of this group by means of IR spectroscopy. In general, upon coordination to metal ions this band, corresponding to the stretching of the group C=N, is shifted about 10–15  $\text{cm}^{-1}$  toward lower frequencies with respect to the free ligand. When dinuclear complexes are formed the introduction of the second metal causes small or no further shifts. The C–O stretching frequency is also important in the characterization by IR of SBs. This band appears in the range 1,235–1,288  $\text{cm}^{-1}$  for the free base and is also affected upon coordination to a metal. The stretching frequency of the phenolic group  $\nu(\text{O–H})$  present in many SBs, such as those derived from salicylaldehydes appears at  $\sim 3,400 \text{ cm}^{-1}$ , and plays an important role for establishing whether or not deprotonation occurs upon complexation, resulting in the formation of a chelate complex or adduct. SB containing OH groups may be involved in intramolecular hydrogen bond formation which may form six- or five-membered rings. Hydrogen bonds participating in six-membered rings are essentially stronger than those of five-membered rings due to the acquisition of a quasi-aromatic type in the former case.

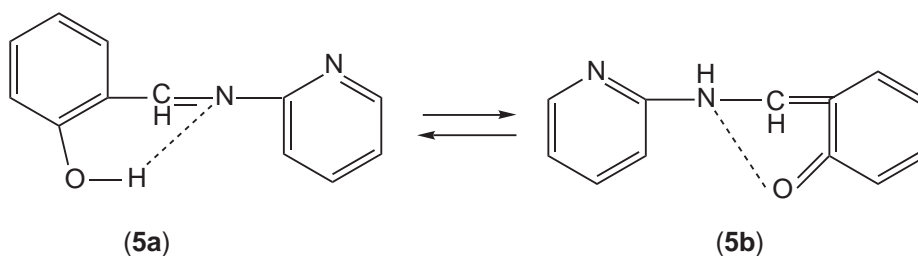
<sup>1</sup>H NMR studies are also a powerful tool to elucidate the structural features of SBs in solution and have been crucial in the study of the keto–enol and thione–thiol tautomerisms.

UV–Vis spectra of compounds containing an unconjugated chromophore are characterized by bands due to  $n \rightarrow \pi^*$  transitions in the range 235–272 nm.<sup>7</sup> However, conjugation with alkenic or aryl groups cause large changes in the spectrum since strong bands due to  $\pi \rightarrow \pi^*$  transitions overlap the rather weak  $n \rightarrow \pi^*$ .<sup>32</sup>

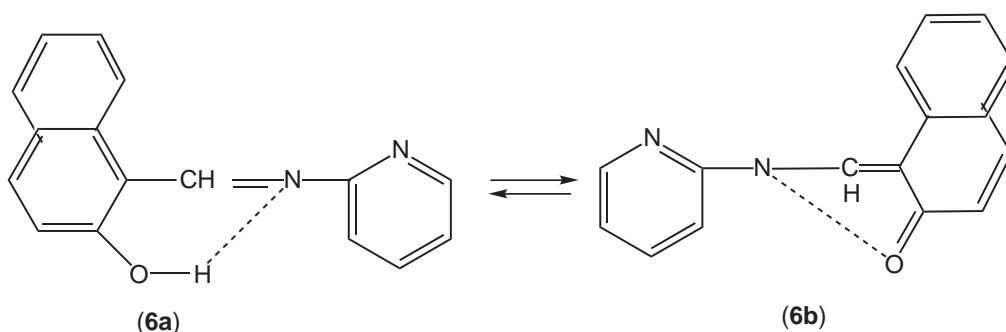
### 1.19.2.3 Tautomerism

SBs may exhibit tautomerism between the phenol-imine and the keto-amine forms  $\text{O–H–N} \rightleftharpoons \text{O–H–N}$  depending on the intramolecular hydrogen bonding.<sup>9–11</sup> (Scheme 2). Salicylaldimines frequently gives the enol–imine tautomer (5a) in solution, with few exceptions. In contrast, 2-hydroxy-1-naphthaldimines (Scheme 3) generally show keto–amine predominance (6b), while 3-hydroxy-2-naphthaldimines are almost exclusively in the enol–imine form.<sup>24</sup> The dominant tautomer does depend on the kind of the carbonyl precursor but not on the stereochemistry of the molecule or substituent on the N imino atom. The position of the tautomeric equilibrium is strongly affected by the solvent. Protonic and aprotic solvents with high dielectric constants shift the equilibrium toward the quinoidal tautomer. Investigations of this phenomenon have been carried out using IR, UV, and NMR spectroscopy, the latter being the most powerful tool for the study of this phenomenon.

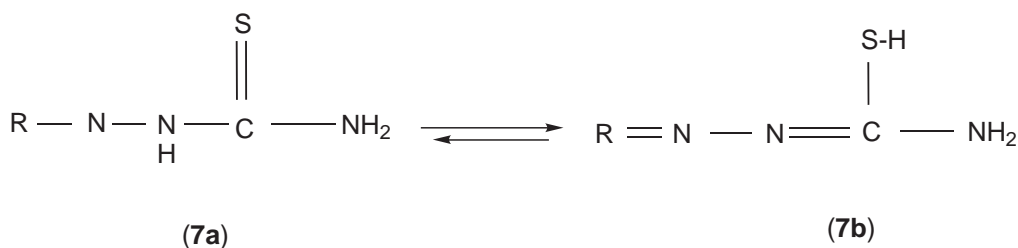
Phenol–imine and keto–amine forms do also exist in the solid state. X-ray structural analyses have shown that when the phenol–imine form is transformed into the keto–amine form an appreciable increase in the C=N distance is observed. In the solid state the shortening in the C–O bond distance from 1.279 Å to 2.263 Å and the lengthening of the C=N distance from 1.317 Å to 1.330 Å is due to the dominance of the quinoidal structure (keto–amine form).<sup>11</sup>



Scheme 2



Scheme 3



Scheme 4

Sulfur-containing SBs such as thiosemicarbazones or selenosemicarbazones may also exhibit in solution a tautomerism between the thione (**7a**) and the thiol forms (**7b**) as indicated in Scheme 4. The tautomer (**7a**) acts as a neutral bidentate ligand, while the loss of the thiol proton of tautomer (**7b**) yields a single-charged bidentate ligand.<sup>29</sup>

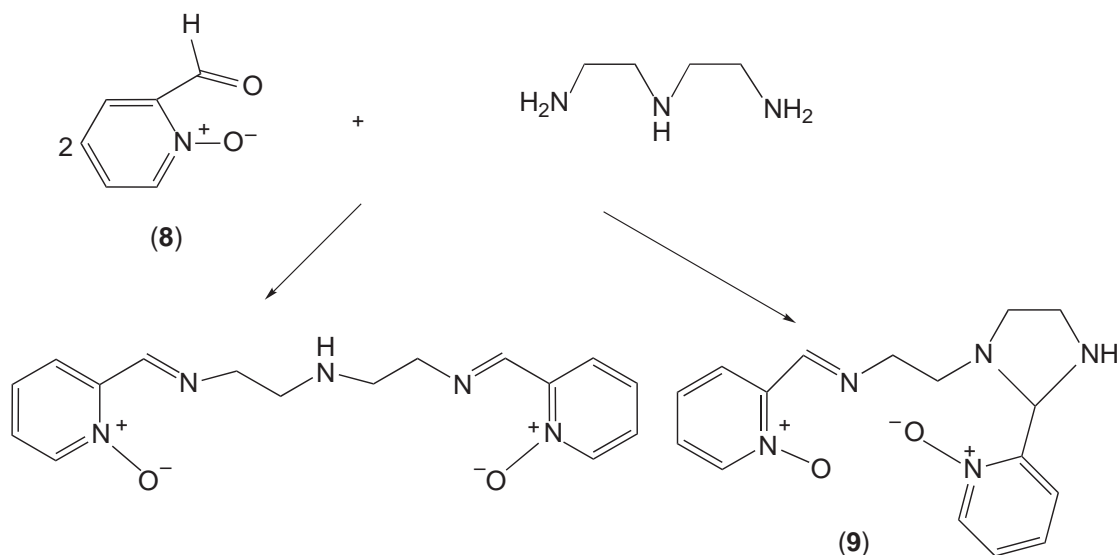
#### 1.19.2.4 Intramolecular Nucleophilic Attack

The carbon atom of the azomethine group (C=N) is partially positively charged so it is susceptible to a nucleophilic attack. For SBs derived from carboxaldehydes, or amines containing another nucleophilic group, e.g., -SH or -NH, an intramolecular nucleophilic attack is possible leading to the formation of different isomers containing five- and six-membered saturated heterocyclic rings identified by <sup>1</sup>H NMR spectroscopy.<sup>3</sup> Most of such examples have been described for macrocyclic SBs leading to isomerization to imidazolidines.<sup>3</sup> This phenomenon is responsible for the well-known contraction of the macrocycle cavity which will be described in the macrocycle section. However, a few examples of intramolecular nucleophilic attack have been described for metal-free acyclic SBs. In this context, for SBs derived from 2-pyridinecarboxaldehyde,<sup>3,33</sup> and for those derived from condensation of 2-pyridinecarboxaldehyde-N-oxide (**8**) with polyamines (diethylenetriamine, triethylenetetraimine, dipropylenetriamine),<sup>34</sup> an isomerization has been described. Scheme 5 shows the different isomers that can be obtained from the reaction of 2-pyridinecarboxaldehyde-N-oxide (**8**) with diethylenetriamine. The product bearing an imidazolidine ring (**9**) was obtained in a higher yield.

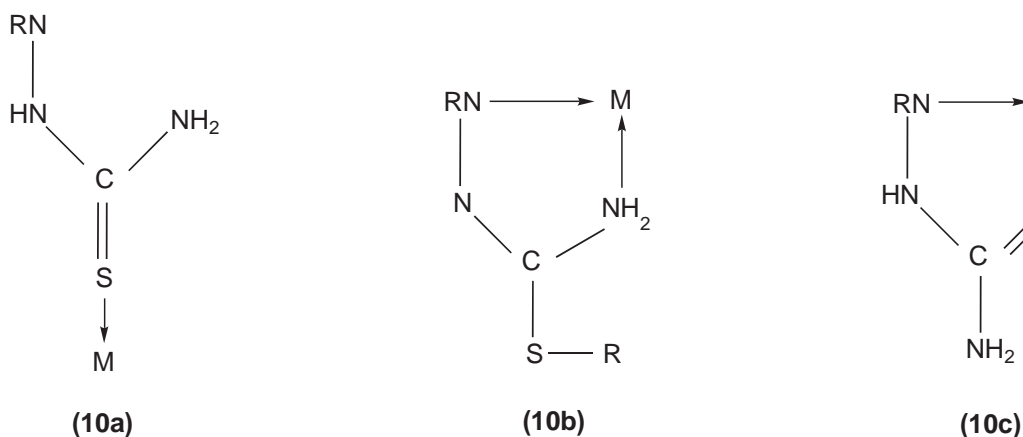
### 1.19.3 MONODENTATE SCHIFF BASES

There are only a few examples of complexes of monodentate SB ligands. One of them is the SB PhCH=NMe which acts as a monodentate ligand in a Pd complex.<sup>7</sup> Another example is provided by the SB Ph<sub>3</sub>P=CHC(=NPh)Ph which coordinates in a monodentate manner in a nickel complex.<sup>35</sup>

There are also some ligands that behave in a monodentate fashion despite having several potential donor atoms. This is the case with thiosemicarbazone<sup>29</sup> SBs (Scheme 6) when they are present in



Scheme 5



Scheme 6

*trans* configuration (10a). They behave as monodentate, bonding only through the sulfur atom. In other configurations (10b,10c) the thiosemicarbazones act as bidentate ligands, coordinating through the hydrazine nitrogen and the amide nitrogen if the sulfur center is substituted or through the thione/thiol sulfur atom and the hydrazine nitrogen atom (Scheme 6). As an example, the potentially bidentate thiosemicarbazones of general formula NH<sub>2</sub>—CS—NH—N=CR<sup>1</sup>R<sup>2</sup> may behave as monodentate ligands when R<sup>1</sup> and/or R<sup>2</sup> is an aryl group. In the case of 4-phenylthiosemicarbazone complexes of cobalt(II), the ligand with alkyl substituents behaves as bidentate and gives trigonal-bipyramidal geometry,<sup>36</sup> whereas the ligand bearing aryl substituents are monodentate and give tetrahedral complexes.

## 1.19.4 BIDENTATE SCHIFF BASES

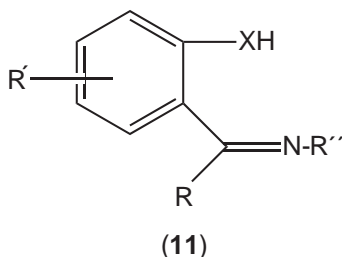
### 1.19.4.1 N,N and N,O Donors

SBs containing two nitrogen atoms as donors may be derived either from condensation of dialdehydes or diketones with an amine in the ratio 1:2 or from reaction of diamines with aldehydes or ketones (ratio 1:2). Alternatively, they can be prepared by condensation of either

pyridine-2-carboxaldehyde or aniline-2-carboxaldehyde with a monoamine. These ligands may form both mono- and bis-chelate complexes. Most of them were prepared before 1980 and readers are referred to *CCC* (1987)<sup>7</sup> for detailed information.

New N,N bidentate SB ligands derived from 3-acetyl-pyridine and hydrazine have been prepared and crystallographically characterized.<sup>37</sup> The specific geometry of these ligands gives coordination polymers with novel network patterns.

Bidentate SBs having a NO donor set are generally prepared by condensation of substituted salicylaldehydes or *o*-hydroxy-acetophenones with a monoamine in a 1:1 ratio. The OH group is deprotonated upon complexing. By varying the substituents on the aromatic ring ( $R'$ ) and/or the C (or N) atoms of the azomethine group ( $R$ ,  $R''$ ) a large number of bidentate N-alkyl-substituted-salicylideneamines  $R'C_6H_3(OH)(CR=NR'')$  bearing a NO donor set have been prepared (**11**,  $X=O$ ).<sup>38,39</sup> Metal(II) complexes of bidentate N-substituted salicylaldimines may have different geometries around the metal ion depending on the substituents, and this phenomenon in the  $Cu^{II}$  and  $Ni^{II}$  complexes has been reviewed.<sup>27,40</sup>



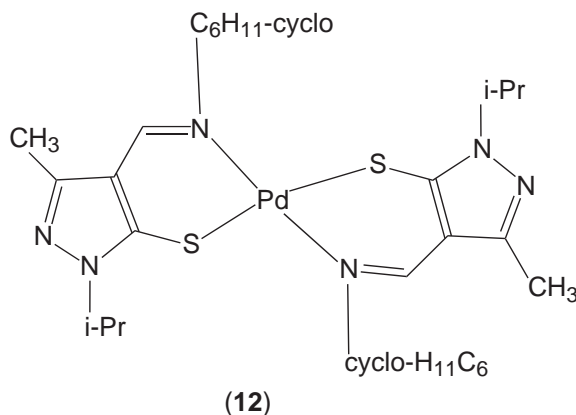
$X = O, S, Se$   
 $R = H, CH_3$   
 $R' = H, 3-Me, 3-OMe, etc$   
 $R'' = H, C_2H_5, n-C_3H_7, n-C_4H_9, etc$

Much interest has been devoted to ferrocene-containing SBs<sup>41,42</sup> since the early 1990s, and many SBs of such type have been prepared including those bidentate SBs having a NN or NS donor set.<sup>43</sup>

#### 1.19.4.2 N,S(Se) Donors

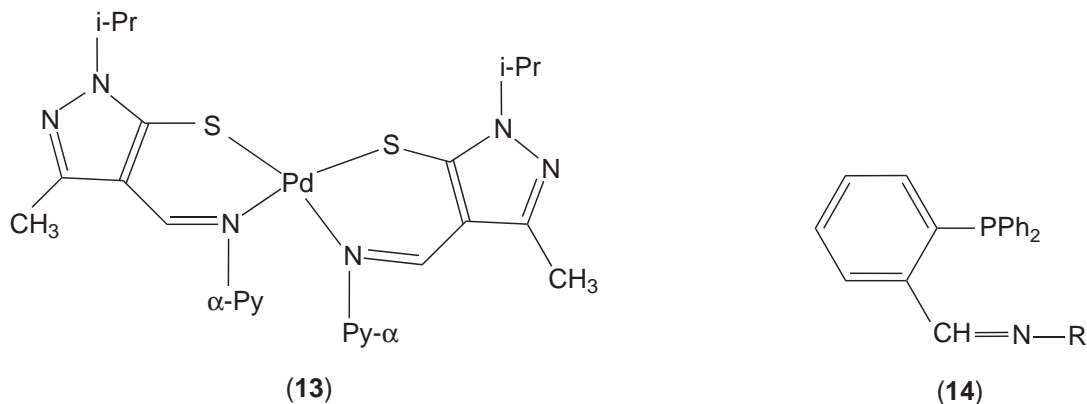
Bidentate ligands bearing a NS donor set have been prepared from either 2-formyl-thio(seleno)-phenol (or derivatives) or heterocyclic thio(seleno)-aldehydes and different monoamines (or substituted monoamines)<sup>31</sup> (**11**,  $X=S, Se$ ). When the monoamine is 2-aminopyridine, the potentially tridentate  $N_2S$  SB behaves as bidentate since pyridine is not involved in coordination.<sup>43</sup>

The coordination environment of metal complexes derived from N-alkyl(aryl)imines of heterocyclic thio(seleno)aldehydes is affected by the replacement of ligating oxygen atom by chalcogen, by the size of the chelate ring, by the bulkiness of substituents attached to the ligating atoms, and also by annelation of heterocyclic rings to the metallocycle.<sup>31</sup> In this regard, it has been established that the pyrazole ring annelating to metallocycles in tetracoordinated SB complexes of 3d metals with the  $MN_2X_2$  ( $X=S, Se$ ) coordination sphere, leads to a significant stabilization of tetrahedral structures.<sup>44</sup> Also, tetrahedral structures can be obtained by increasing the steric hindrance of the substituent attached to the coordinated nitrogen atom, which may introduce additional steric strains in favor of the tetrahedral geometry. The influence of substituents in the geometry of the metal chelate is also evident in the  $Pd^{II}$  complex of a NS bidentate SB, containing



a bulky N-C<sub>6</sub>H<sub>11</sub>-cyclo substituent (**12**), which gives a bis-chelate with Pd<sup>II</sup>.<sup>45</sup> The Pd is tetra-coordinated by two sulfur and two nitrogen atoms, the sulfur atoms are located in *trans* position which is unusual in complexes having the MN<sub>2</sub>S<sub>2</sub> coordination unit which prefers the *cis* form.<sup>46</sup> This unusual geometry is accounted for by the presence of bulky N-C<sub>6</sub>H<sub>11</sub>-cyclo substituents which prevents the formation of the *cis* structure due to strong sterical constraints. Therefore, the replacement of this group by the less bulky N-Py- $\alpha$  (**13**) gives the expected *cis* planar configuration, but the PdN<sub>2</sub>S<sub>2</sub> moiety shows a large tetrahedral distortion.

Bidentate thiosemicarbazones having a NS donor set are also known.<sup>29</sup>



#### 1.19.4.3 N,P Donors

Mixed-donor iminophosphine bidentate ligands *o*-Ph<sub>2</sub>PC<sub>6</sub>H<sub>4</sub>CH=NR (**14**) (R = Me, Et, Pr<sup>n</sup>, Pr<sup>i</sup>, Bu<sup>t</sup>, Ph, MeNH) with a NP donor set containing both hard and soft donor atoms have received considerable interest in recent years.<sup>47-51</sup> They are prepared by the reaction of 2-(diphenylphosphino)benzaldehyde and the corresponding amine (en, pn, <sup>i</sup>Pr, <sup>t</sup>Bu, Ph, methylhydrazine).<sup>47,48</sup> The variation of the alkylimino groups allows the modulation of the steric crowding around the metal center and this affects the reactivity of the metal chelate as has been reported for the oxygenation reaction of Rh<sup>I</sup> complexes of iminophosphines.<sup>47</sup> These ligands give bis-chelate complexes in which P and N donors are *trans* to each other. They form complexes with soft metal ions such as Pd<sup>II</sup> and Pt<sup>II</sup>, which are good precursors in catalytic processes.<sup>47,48,51,52</sup>

### 1.19.5 TRIDENTATE SCHIFF BASES

#### 1.19.5.1 N,O Donors

Much research has been carried out with ligands resulting from the condensation of two molecules of a carbonyl precursor and one molecule of diamine. However, relatively few ligands reported arise from the single condensation of the carbonyl function with only one end of the diamine. These ligands are referred to as “half units” (**15**, R = -(CH<sub>2</sub>)<sub>2</sub>- (**15a**), -(CH<sub>2</sub>)<sub>3</sub>- (**15b**), -CH<sub>2</sub>-C(CH<sub>3</sub>)<sub>2</sub>- (**15c**), -CH<sub>2</sub>-CH(CH<sub>3</sub>)-, (**15d**), -(CH<sub>2</sub>)<sub>4</sub>-, (**15e**)<sup>53</sup>, R = -(CH<sub>2</sub>)<sub>5</sub>-<sup>53</sup>, (**15f**)). It was generally believed that reactions of  $\beta$ -diketones and aliphatic diamines led to 1:2 condensation products, yielding symmetrical tridentate SBs whatever the proportion of the two reagents.<sup>54</sup> In order to get the 1:1 condensation (“half unit”) product between a  $\beta$ -diketone and an aliphatic diamine having an unreacted NH<sub>2</sub> group at one end, careful control of the reaction conditions is required, such as slow addition of acac to an excess of en (or pn).<sup>55</sup> Alternatively, the “half unit” (**15a**) can also be obtained by the reaction of equimolar amounts of acac with en in highly diluted solutions. Much better synthetic results have been obtained by the reaction of a diketone such as acac or 2-hydroxyacetophenone with 1,2-diamino-2-methylpropane (**15c**) which possesses an amine function sterically hindered by two methyl groups so that it can react only by its nonhindered amine function.<sup>56</sup> In contrast to the formation of (**15c**), the formation of (**15d**) requires special reaction conditions since the steric effect of one methyl substituent in 1,2-diaminopropane does not reduce the reactivity of the neighboring amino group to such an extent that the single over double condensation would be preferred.<sup>57,58</sup> Therefore, the single condensed product was obtained only by slow addition



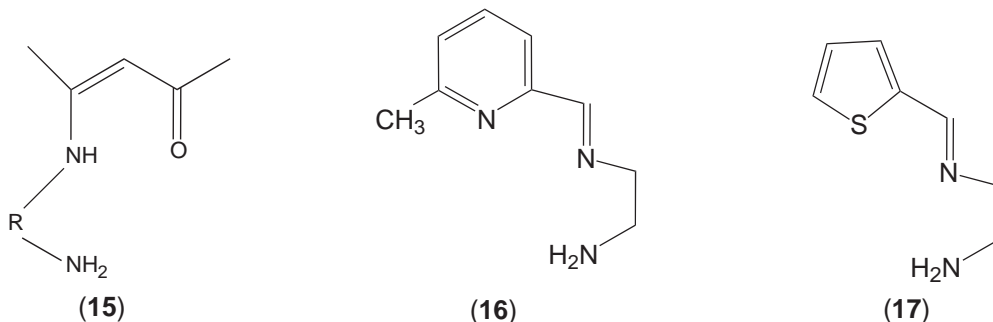
of acac to an excess of 1,2-diaminopropane cooled below  $-20^{\circ}\text{C}$ . The product is chiral and has two geometrical isomers with the methyl group located either in the vicinity or being remote from the imino nitrogen, and a 70/30 mixture of both isomers is obtained. Several metal complexes derived from chiral tridentate “half units” have been prepared, stimulated by their potential application as catalysts of some organic reactions.<sup>57,58</sup>

Another synthetic route to the “half units” involves the partial hydrolysis of the tetradentate SBs. Using this method “half unit” complexes derived from 6-methyl-pyridine-2-carbaldehyde, or thiophene-2-carbaldehyde and en (**16** and **17**, respectively) were prepared.<sup>59</sup> Other routes for the preparation of different “half unit” complexes have been described.<sup>59</sup>

“Half units” have much synthetic potential as shown in Scheme 7. They can be used as tridentate ligands or as good precursors for the preparation of a large variety of asymmetrical tetradentate (Scheme 8) and heptadentate SBs by condensation of their free primary amino group with a variety of reagents comprising a carbonyl group.<sup>60</sup> The tridentate “half unit” allows the preparation of complexes with outer coordinating atoms useful in the preparation of homo- and heterometallic complexes via the synthetic pathway of “complexes as ligands.” This is the case with asymmetrical SBs with an imidazole group (**18**) with a free nitrogen which may coordinate further to give homo- or heterobinuclear imidazolate-bridged complexes (**19**).<sup>56</sup>

The “half unit” (**15a**) and (**15b**) forms a trinuclear  $\text{Cu}^{\text{II}}$  complex where a  $\text{Cu}_3\text{OH}$  core is held by peripheral bridging ligands.<sup>57,61</sup> and also gives dimeric copper<sup>II</sup> complexes with two chloro,<sup>62</sup> two bromo,<sup>63</sup> or acetate<sup>58,64</sup> groups bridging the copper atoms.

As already mentioned the formation of “half units” requires special reaction conditions, however some SB complexes containing a  $\text{N}_2\text{O}$  “half unit” are easily obtained if the condensation reaction is carried out in the presence of certain metals with the reagents in 1:1:1 ratio.<sup>65,66</sup> Subtle factors, e.g., the order of reagent addition, are very important in some cases.<sup>65</sup> In this regard, the “half unit” SBs resulting from 1:1 condensation of sal with either en or pn were obtained unexpectedly by the reaction of  $[\text{MoO}(\text{CN})_4(\text{H}_2\text{O})]^{2-}$  with sal and en or pn, instead of the expected symmetrical tetradentate SBs.<sup>66</sup> The potentially tridentate ensal coordinates to Mo in a bidentate fashion only through the phenolic oxygen and the imine nitrogen. Also, a wide range of vanadium “half unit” SB complexes have been prepared by the *in situ* addition of the diamine to an ethanolic solution of  $\text{VO}(\text{OEt})_3$  followed by addition of the appropriate aldehyde or ketone (sal, substituted-sal, or *o*-hydroxyacetophenone).<sup>65</sup> Analogously, the reaction of  $[\text{Mo}(\text{CO})_3(\text{C}_6\text{H}_5\text{Me})]$  with *o*-phenylenediamine and *o*-phthalaldehyde in a 1:1:1 ratio gives also the mono-imine complex having unreacted carbonyl and amino groups.<sup>67</sup>

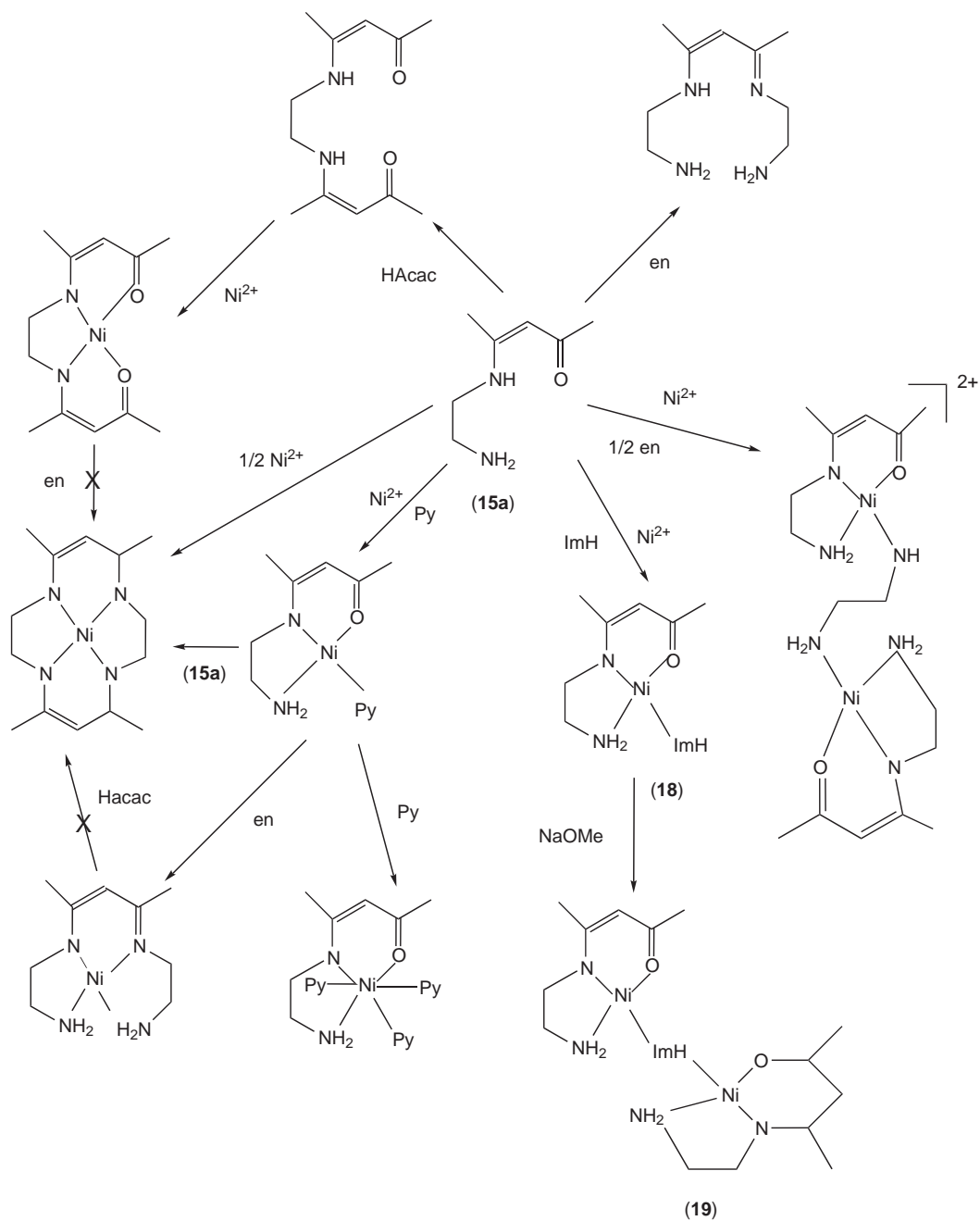


The 1:1 reaction of sal with 2-aminomethylpyridine or 2-(2'-aminoethyl)pyridine gives a potentially tridentate  $\text{N}_2\text{O}$  SB.<sup>68</sup> Tridentate  $\text{N}_3$  SBs are also known.<sup>69</sup>

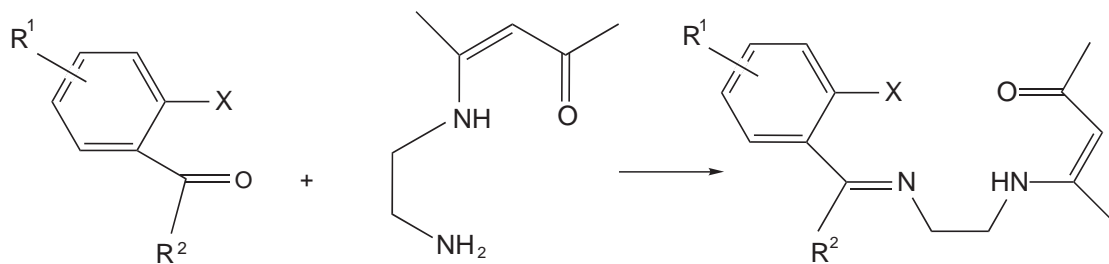
The spin-crossover phenomenon in tridentate SB complexes of  $\text{Fe}^{\text{III}}$ ,  $\text{Fe}^{\text{II}}$  and  $\text{Co}^{\text{II}}$  has been extensively investigated.<sup>70-72</sup> Iron(III) SB complexes having a  $(\text{N}_2\text{O})_2$  donor set may exhibit spin-crossover phenomena.<sup>73-77</sup> The  $(\text{N}_2\text{O})_2$  donor set is provided by coordination of two tridentate  $\text{N}_2\text{O}$  SBs. Thus, a thermal-induced spin-crossover phenomenon has been observed for  $\text{Fe}^{\text{III}}$  complexes of the “half unit” (**15a**)<sup>77</sup> and for other  $\text{N}_2\text{O}$  tridentate SBs.<sup>76</sup>

### 1.19.5.2 Other Donors

Tridentate SB ligands having a NPO donor set, combining hard and soft donor atoms, are prepared either by reacting the appropriate (aminoalkyl)diphenylphosphine with sal<sup>16</sup> (**20**,  $\text{R} = -\text{CH}_2-$  (**20a**),  $-(\text{CH}_2)_3-$ , (**20b**),  $o\text{-C}_6\text{H}_4$  (**20c**)), or by reacting 2-(diphenylphosphino)benzaldehyde



Scheme 7



Scheme 8

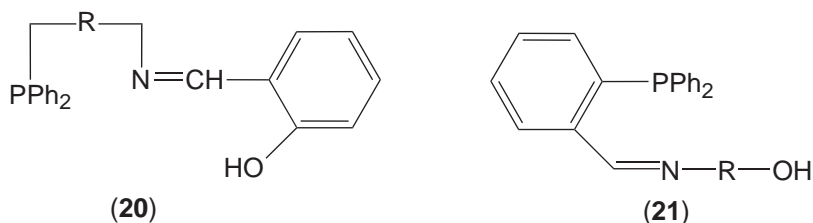
with different monoamines<sup>78</sup> (**21**), i.e., 2-aminoethanol (**21**, R = CH<sub>2</sub>-CH<sub>2</sub>OH, (**21a**); 2-aminophenol, R = *o*-C<sub>6</sub>H<sub>4</sub>-OH, (**21b**)), (1R,2S)-norephedrine, or (R)-2-aminobutanol (**21**, R = CH(CH<sub>3</sub>)-CH<sub>2</sub>-CH<sub>2</sub>OH, (**21c**)). The last two give chiral ligands. A tridentate SB containing a NSO donor set was synthesized from 2-aminoethanol and 2-(tert-butylthio)benzaldehyde. Ruthenium(II) complexes of NPO and NSO ligands have been prepared.<sup>78</sup>

The free SB (**20b**) resulting from (3-aminopropyl)diphenylphosphine and sal was characterized by IR, <sup>1</sup>H NMR, <sup>31</sup>P NMR, and by X-ray crystallography.<sup>16</sup> This constitutes one of the limited number of SBs which have been crystallographically characterized. It is neutral, monobasic, and contains three potential donors. The N···H-O distance of 2.638 Å indicates the existence of a strong hydrogen bond between the imine nitrogen and the hydroxyl hydrogen of the sal ring, which produces rigidity in the salicylalimine moiety contributing to the linear conformation of the metal-free ligand. This ligand forms a complex with ReO<sup>3+</sup> whose structure was also determined.<sup>16</sup> It changes conformation upon coordination to ReO<sup>3+</sup>. For the metal-free ligand, the geometry around the phosphorus atom is distorted trigonal-pyramidal whereas a tetrahedral geometry is found in the complex. The ligand is sufficiently flexible to twist and achieve facial coordination.

The structure of the metal-free PNO ligand derived from 2-(diphenylphosphino)benzaldehyde and 2-aminophenol (**21b**) was reported alongside that of its (1:2) (M:L) cobalt (II) complex. The coordination geometry around Co is pseudo-octahedral with two ligand molecules arranged in *fac* configuration with *cis*-PPh<sub>2</sub> groups.<sup>17</sup> The reaction of 2-(diphenylphosphino)benzaldehyde with 2-aminobenzenethiol in an attempt to make a NPS SB gave a five-membered thiazole ring structure, unable to form stable transition-metal complexes.<sup>17</sup>

Tridentate NOS SBs can also be prepared by condensation of sal with 2-aminothiophenol.<sup>79</sup>

Tridentate thiosemicarbazones having a N<sub>2</sub>S donor set are known<sup>80</sup> as well as the crystal structure of the N<sub>2</sub>S free SB 2-pyridineformamide 3-piperidylthiosemicarbazone.<sup>81</sup> Metal complexes of thiosemicarbazones have been reviewed and numerous examples of sulfur-containing SB ligands may be found in Casas *et al.*<sup>29</sup>



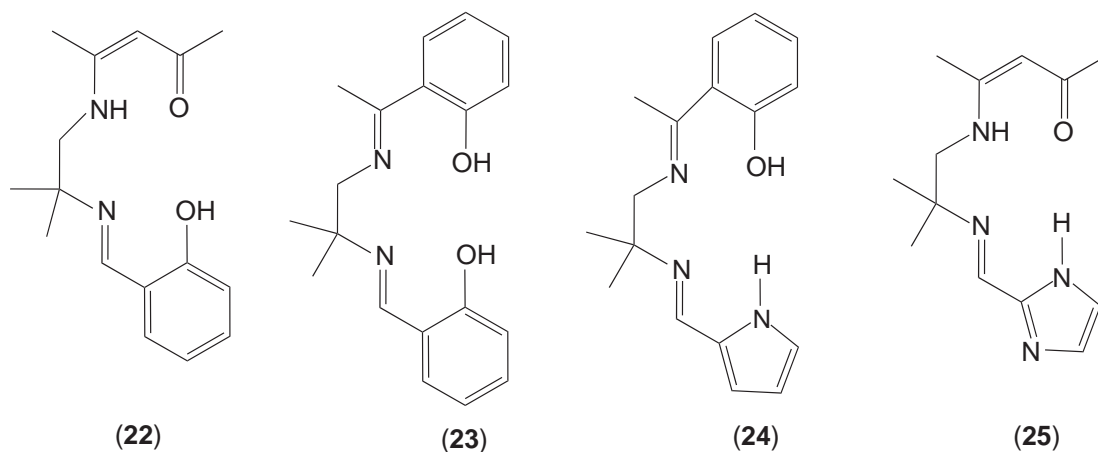
## 1.19.6 TETRADENTATE SCHIFF BASES

### 1.19.6.1 N,O and N,N Donors

#### 1.19.6.1.1 Asymmetrical

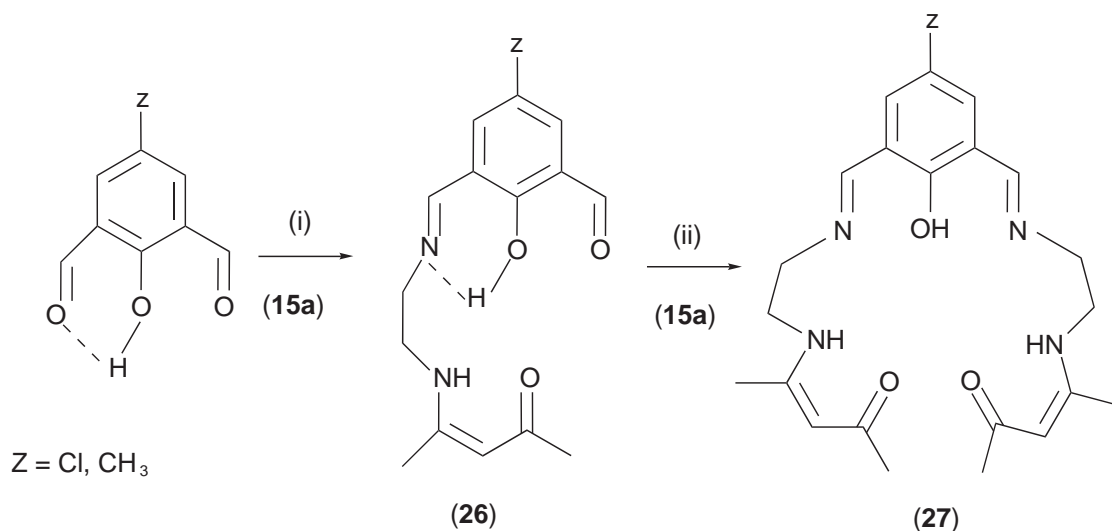
Tridentate SBs derived from the monocondensation of diamines (“half units”) with diketones provide excellent synthons for the preparation of asymmetrical tetradentate SBs (Scheme 8).<sup>56,57</sup> The “half units” derived from monocondensation<sup>55–57,82,83</sup> of acac or 2-hydroxyacetophenone with en, pn, 1,2-diamino-2-methylpropane<sup>56</sup> or 1,2-diaminopropane<sup>57</sup> can be reacted with sal, substituted sal (5-chloro, 5-methoxy, 3-ethoxy or 3,5-dibromo), pyrrole-2-carboxaldehyde, 2-imidazolecarboxaldehyde, 4-methyl-imidazole-3-carboxaldehyde, pyridine-2-carboxaldehyde, isoquinoline-3-carboxaldehyde or 2-acetylpyrazine to give asymmetrical N<sub>3</sub>O tetradentate SBs (**22–25**). The imidazole derivatives (**25**) offer the possibility of using the outer nitrogen atom of the imidazole ring for the preparation of homo- and heterodinuclear complexes.<sup>56,77,84,85</sup>

The formation of asymmetrical tetradentate SBs according to Scheme 8 is sensitive to the nature of the substituents X and R<sup>2</sup>. The presence of an acidic hydrogen atom on the X substituent facilitates the reaction, while bulkier and/or electron donating groups have the opposite effect. When X = OH the intramolecular hydrogen bond between the phenolic oxygen and the carbonyl oxygen atom favors the condensation reaction and the tetradentate SB is obtained in good yields independently of R<sup>2</sup> (H, CH<sub>3</sub> or C<sub>6</sub>H<sub>5</sub>). When X = NH<sub>2</sub> the reaction is less efficient and only the derivative with R<sup>2</sup> = H can be obtained, but the derivatives with R<sup>2</sup> = CH<sub>3</sub> or C<sub>6</sub>H<sub>5</sub> could not be isolated. The intramolecular

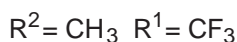
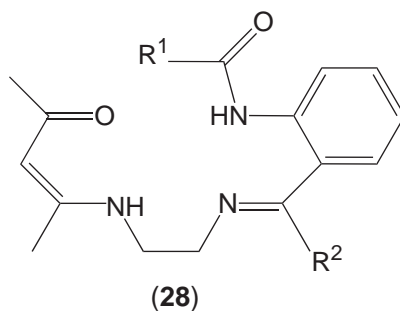


hydrogen bond formation between the phenolic hydrogen and the carbonyl oxygen atom in 2,6-diformylphenols also explains the ease of the first step of the condensation with a “half unit” (i) to give a tetradentate SB (Scheme 9).<sup>60</sup> However, the second step (ii) of the reaction which implies the condensation of the free carbonyl group of the tetradentate SB with a second molecule of “half unit” to give the binucleating heptadentate SB is more difficult since the hydrogen bond forms now between the phenolic hydrogen and the more basic imino nitrogen, and this makes the condensation reaction less favorable. The difference in the reactivity of the two carbonyl groups of the precursor allows the preparation of either mononucleating tetradentate SB (26) or dinucleating heptadentate SB (27) depending on the reaction conditions employed. At room temperature the reaction stops at the first stage and (26) is obtained, whereas at high temperature (27) is formed. Mononuclear and dinuclear nickel(II) complexes of (26) and (27) were prepared.<sup>60</sup>

The influence of X and R<sup>2</sup> substituents was also evident in the preparation of a series of asymmetrical tetradentate SBs having a pendant N-acyl substituents (28) by condensation of the “half unit” (15a) with N-acetyl and N-trifluoroacetyl derivatives of 2-aminobenzaldehyde, 2-aminoacetophenone and 2-aminobenzophenone (28) (R<sup>2</sup> = H, R<sup>1</sup> = CH<sub>3</sub>, (28a); R<sup>2</sup> = H, R<sup>1</sup> = CF<sub>3</sub>, (28b); R<sup>2</sup> = CH<sub>3</sub>, R<sup>1</sup> = CF<sub>3</sub>, (28c)). These reactions were monitored by field desorption mass spectrometry and the reactivity towards the “half unit” follows the increase in acidity of the hydrogen of the NH group; that is NH<sub>2</sub> < NHCOCH<sub>3</sub> < NHCOCF<sub>3</sub>. The higher acidity makes hydrogen bonding stronger and this facilitates the reaction. The benzophenone derivatives do not react.<sup>55</sup>



Scheme 9



Asymmetrical tetradentate trianionic SB ligands bearing both amide and imine groups which are capable of stabilizing high oxidation states of metal ions when coordinated to deprotonated nitrogen have been prepared and characterized by IR,  $^1\text{H}$  NMR and  $^{13}\text{C}$  NMR.<sup>86</sup> The  $\text{Mn}^{\text{III}}$  complexes were prepared electrochemically by oxidation of a Mn anode in an acetonitrile solution of the ligand.<sup>86</sup>

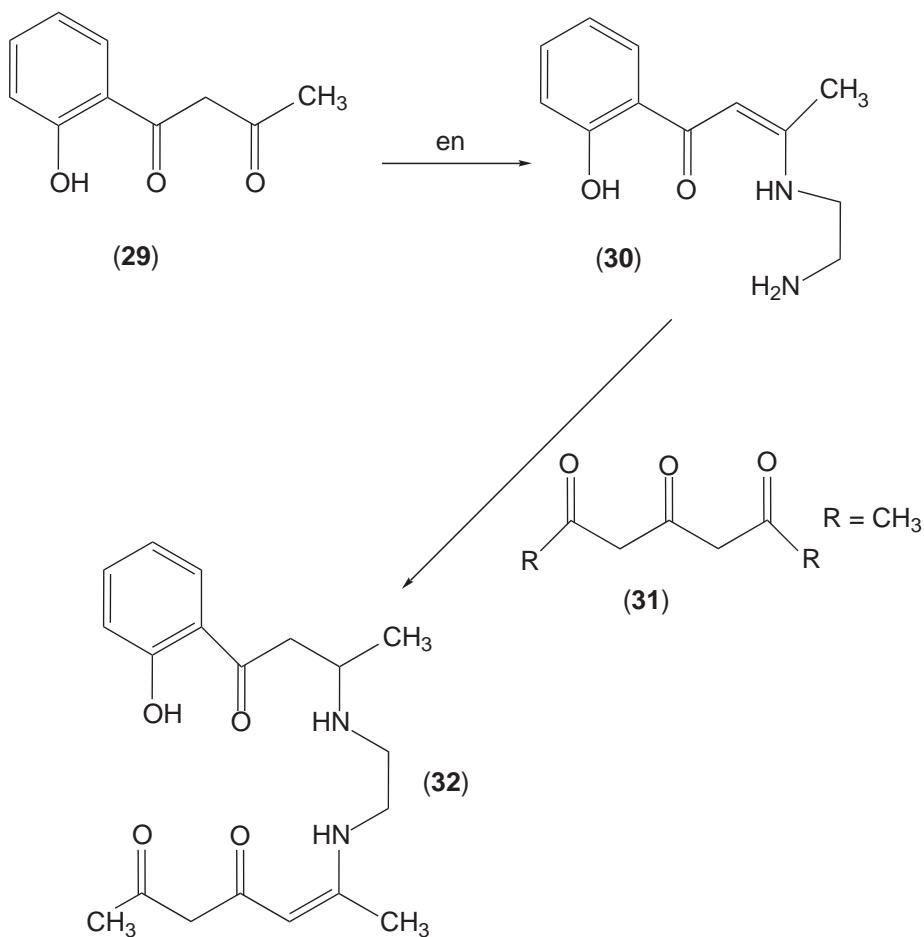
Other asymmetrical  $\text{N}_2\text{O}_2$  and  $\text{N}_3\text{O}$  tetradentate SBs have also been described.<sup>55,59,87–89</sup>

Irradiation of the  $\text{Mn}^{\text{III}}$  complexes of asymmetrical tetradentate SBs derived from 1:1:1 condensation of acac, sal, and en in aqueous solution gives a mixture of two complexes.<sup>83</sup> One of them contains the symmetrical tetradentate ligand salen, which means that the asymmetrical ligand undergoes an unexpected rearrangement under the above conditions. Such ligand rearrangement was also observed for  $\text{Mn}^{\text{III}}$  complexes of the asymmetrical tetradentate SB derived from 1:1:1 condensation of acac, pn, and 3-EtO-sal, to give  $\text{Mn}^{\text{III}}$  complexes of the symmetrical ligand bearing two sal moieties. A mechanism for this rearrangement has been proposed.<sup>90</sup>

A potentially tetradentate SB (30) was prepared (Scheme 10) by the reaction of 1-(*o*-hydroxyphenyl)-butane-1,3-dione (29) and en in a 1:1 ratio under high dilution in chloroform. The NMR spectra show that this ligand exists in the ene-amino form. The “half unit” was used to prepare the asymmetrical compartmental ligand (32) by reaction with an equimolar amount of heptane-2,4,6-trione (31). The IR showed a band at  $1,700\text{ cm}^{-1}$  attributable to the carbonyl in the outer compartment of (32) and bands in the region  $3,070\text{--}3,030\text{ cm}^{-1}$  from the inner compartment NH—O groups. The  $^1\text{H}$  NMR indicated that the base exists as the keto-tautomer, although very weak signals attributable to the presence of the enol-tautomer were detected. Detailed  $^1\text{H}$  and  $^{13}\text{C}$  {H} NMR and IR data for (30) and (32) are given in Costes *et al.*<sup>59</sup>

### 1.19.6.1.2 Symmetrical

Symmetrical tetradentate SBs having  $\text{N}_2\text{O}_2$  (33) are probably the most common SBs, especially salen and acen which have been the most widely studied SBs. The parent salen ligands were prepared before the period covered in this chapter and for detailed information the reader is referred to CCC (1987) and to the relevant reviews and references cited therein.<sup>7,25,26</sup> Based on the parent salen, new  $\text{N}_2\text{O}_2$  tetradentate SBs derived from aromatic aldehydes or ketones and aliphatic/aromatic diamines similar to salen and acen have been prepared by extensive modifications of the substituents on the aromatic rings and in the bridging group.<sup>38,91–93</sup> Some examples are given in Scheme 11. The salen and acen ligands have a strong tendency towards planarity which can be explained in terms of  $\pi$ -electron delocalization over the tetradentate ligand. In tetracoordinate complexes the ligand is approximately planar, whereas deviations from planarity to give umbrella-shape and stepped-shape conformations seem to be preferred in penta- and hexa-coordinate complexes. These nonplanar conformations of the penta- and hexa-coordinate complexes can be attributed to interactions of the tetradentate SB with axial ligands, as confirmed by the fact that the bulkier are the latter, the larger are the distortions in the tetradentate ligands. Structural aspects of complexes derivatives of salen and acen have been reviewed and are out of the scope of this chapter.<sup>26</sup>

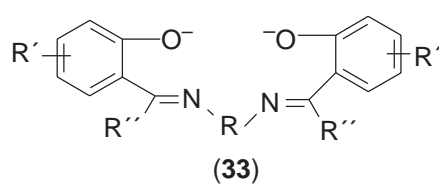


Scheme 10

Recently, several “short” salen homologs have been prepared by condensation of sal (or substituted sal) with either methylenediamine or some phenylsubstituted methylenediamines, i.e., (33h–33p) (Scheme 11).<sup>94,95</sup> The structures of the dinuclear Cu<sup>II</sup> complex of H<sub>2</sub>-33n and several dinuclear cobalt(II) complexes have been determined. An interesting structural feature is that in contrast to salen, which gives usually mononuclear complexes with a nearly planar coordination geometry, “short” salen acts as bis-bidentate bridging two metal ions and consequently giving dinuclear complexes. The steric constraint that would be present in the four-membered chelate M–N–C–N rings of the hypothetical mononuclear complexes of “short” salen may account for the structural differences between salen and “short” salen complexes.

Tetradentate N<sub>2</sub>O<sub>2</sub> SBs have also contributed to the understanding of the spin-crossover phenomenon since many octahedral N<sub>4</sub>O<sub>2</sub> Fe<sup>III</sup> SB complexes are known to exhibit thermal-induced spin-crossover behavior. Therefore, the N<sub>4</sub>O<sub>2</sub> donor set can be provided by a tetradentate N<sub>2</sub>O<sub>2</sub> SB and by two molecules of a nitrogen-donor ligand such as imidazole. Several Fe<sup>III</sup> complexes of salen, acen, or salophen derivatives with imidazole as axial ligand have been prepared and exhibit thermal-induced spin-crossover behavior.<sup>72–75</sup>

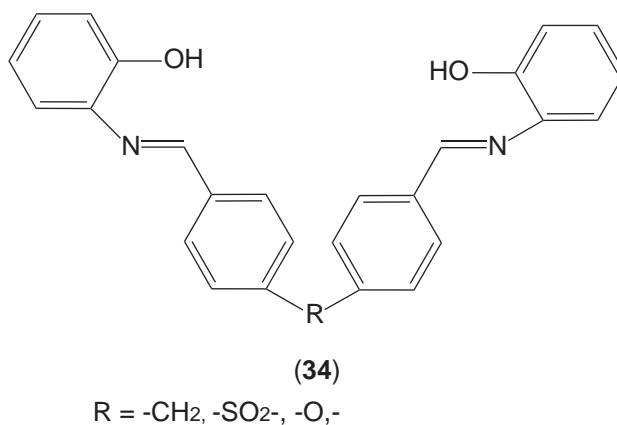
New potentially tetradentate SB ligands have been employed to construct supramolecular structures. In this regard, the condensation reaction of bis(4-aminophenyl)methane, bis(4-aminophenyl)sulfone, bis(3-aminophenyl)sulfone or bis(4-aminophenyl)ether with sal (34, R = –CH<sub>2</sub>–, (34a), –SO<sub>2</sub>–, (34b), –O–, (34c)) and in the case of the diphenylmethane derivatives also with pyridine-2-aldehyde (35) and 2-quinolinecarbaldehyde gives potentially tetradentate ligands with large and flexible spacer groups (R) which behave as bis-bidentate ligands since the presence of a large aromatic spacer (–C<sub>6</sub>H<sub>4</sub>CH<sub>2</sub>C<sub>6</sub>H<sub>4</sub>–, –C<sub>6</sub>H<sub>4</sub>SO<sub>2</sub>C<sub>6</sub>H<sub>4</sub>–, –C<sub>6</sub>H<sub>4</sub>OC<sub>6</sub>H<sub>4</sub>–) prevents coordination of all the four donor atoms to the same metal.<sup>96–99</sup> This specific ligand geometry promotes



	R	R'	R''	Ref.
33a	(CH <sub>2</sub> ) <sub>2</sub>	H	H	38
33b	(CH <sub>2</sub> ) <sub>2</sub>	3-OMe	H	92
33c	(CH <sub>2</sub> ) <sub>2</sub>	5-F	CH <sub>3</sub>	92
33d	(CH <sub>2</sub> ) <sub>3</sub>	H	H	92
33e	(CH <sub>2</sub> ) <sub>3</sub>	H	CH <sub>3</sub>	92
33f	(CH <sub>2</sub> ) <sub>4</sub>	H	H	102
33g	CH(CH <sub>3</sub> )CH <sub>2</sub>	3-Br, 5-NO <sub>2</sub>	H	91
33h	CH <sub>2</sub>	H	H	94
33i	CH <sub>2</sub>	5-Me	H	95
33j	CH <sub>2</sub>	5-OMe	H	95
33k	CH-C <sub>6</sub> H <sub>5</sub>	H	H	94
33l	CH(p-CH <sub>3</sub> C <sub>6</sub> H <sub>4</sub> )	H	H	95
33m	CH(p-FC <sub>6</sub> H <sub>4</sub> )	H	H	95
33n	CH(p-ClC <sub>6</sub> H <sub>4</sub> )	H	H	94
33o	CH(p-NO <sub>2</sub> C <sub>6</sub> H <sub>4</sub> )	H	H	94
33p	CH(p-CF <sub>3</sub> C <sub>6</sub> H <sub>4</sub> )	H	H	95
33q	<i>o</i> -C <sub>6</sub> H <sub>4</sub>	H	H	23
33r	<i>m</i> -C <sub>6</sub> H <sub>4</sub>	H	H	23
33s	<i>o</i> -C <sub>6</sub> H <sub>4</sub>	H	H	23

Scheme 11

the self-assembly of supramolecular complexes. Multiple  $\pi$ -stacking interactions between the aromatic rings of the bridging groups of the ligands are an important factor in the construction of these supramolecular architectures.

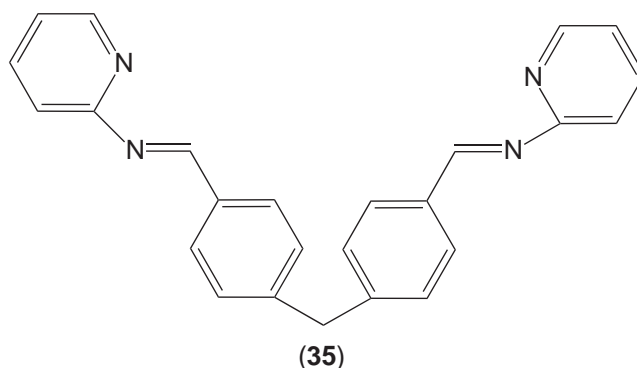


The SB (35) gives a helical dinuclear Zn<sup>II</sup> complex, where Zn<sup>II</sup> is coordinated by six nitrogens from three ligands in an octahedral environment. The SB (34a) gives a double helical dinuclear complex, with both Zn<sup>II</sup> metal ions having a distorted tetrahedral environment with two wrapped ligands. Each Zn<sup>II</sup> is coordinated with two phenolate oxygens and two azomethine nitrogens.<sup>96</sup>

The influence of the ligand spacer group (R) on the formation of the supramolecular compounds was investigated. A rigid and short spacer such as phenylene, as in the case of the ligand formed by condensation of 1,4-phenylenediamine and pyridine-2-aldehyde (36, R = *p*-C<sub>6</sub>H<sub>4</sub>, 36a), prevents the ligand from wrapping around the metal ion, resulting in a one-dimensional zigzag polymeric structure where the  $\pi$ -stacking interactions also operate between linking ligands.<sup>96</sup>

Subtle changes in the bridging spacer between two phenylene rings (C<sub>6</sub>H<sub>4</sub>SO<sub>2</sub>C<sub>6</sub>H<sub>4</sub> or C<sub>6</sub>H<sub>4</sub>OC<sub>6</sub>H<sub>4</sub>) drastically affect the structure, as can be seen in the Cu<sup>II</sup> complexes of SBs derived from sal and bis(3-aminophenyl)sulfone, which exhibit a tetranuclear double helical structure, where Cu<sup>II</sup> adopts both square-planar and tetrahedral geometry.<sup>99</sup> For the ligand with an ether spacer group, (R = C<sub>6</sub>H<sub>4</sub>OC<sub>6</sub>H<sub>4</sub>), bis(N-salicylidene-4,4'-diaminodiphenyl)ether the Cu<sup>II</sup> complex has a double helical dinuclear structure.<sup>99</sup>

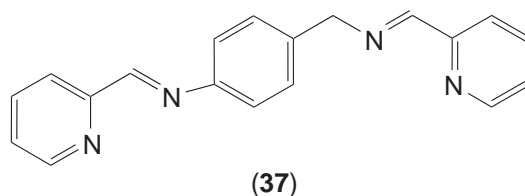
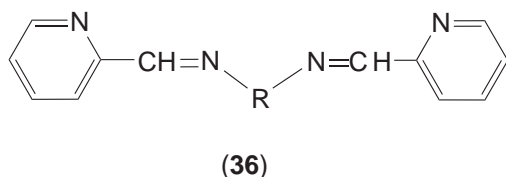




In the previous examples symmetrical spacer bridging groups were employed. The effect of introducing an asymmetrical spacer was also investigated.<sup>100</sup> For this, the SB resulting from the 2:1 condensation of 2-pyridinecarbaldehyde and 4-aminobenzylamine was prepared (37). This ligand, the same as (35) and (36), acts as bis-bidentate since it has two binding domains sterically prevented from binding to the same metal center.<sup>100</sup> It reacts with  $\text{Ag}^{\text{I}}$  to give a dinuclear helical complex containing each  $\text{Ag}^{\text{I}}$  in a pseudo-tetrahedral geometry coordinated to the pyridyl-phenylimine donor unit of one ligand and the pyridyl-methylimine unit of the other, giving a head-to-tail configuration. This shows that by careful selection of the spacer group between the ligand binding sites the directionality of a helicate may be controlled.<sup>100</sup>

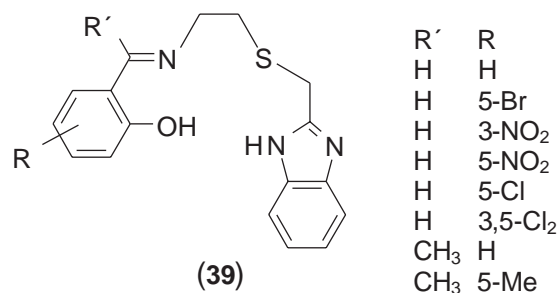
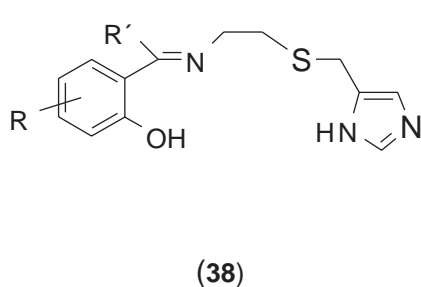
The SB resulting from the reaction of pyridine-2-aldehyde and en (36,  $\text{R} = -(\text{CH}_2)-$ , 36b) in the 2:1 ratio gives a double-stranded helical structure with  $\text{Ag}^{\text{I}}$  where the ligand acts as bis-bidentate. Thus, each  $\text{Ag}^{\text{I}}$  is coordinated to two nitrogen donors from two different ligand molecules.<sup>101</sup>

The SB resulting from the condensation of 1,4-diaminobutane and sal (33f) in the 1:2 ratio is potentially tetradentate, which, however, can act as bis-monodentate coordinating only through neutral phenol groups to  $\text{Ag}^{\text{I}}$  to give a self-assembled three-dimensional polymeric complex.<sup>102</sup> Each  $\text{Ag}^{\text{I}}$  atom is coordinated by three phenol groups from three different ligands in a perfect trigonal arrangement. In contrast, other similar ligands use both N and O for coordination.<sup>97</sup>



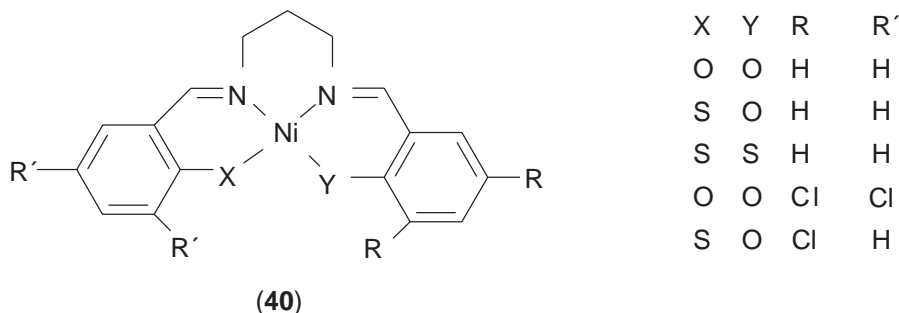
### 1.19.6.2 N,S, N,O,S and Other Donors

Imidazol-containing SBs have received much attention in the last decades as possible models for metalloenzymes. Thus, a series of asymmetrical tetradentate  $\text{N}_2\text{OS}$  SBs (38,39) containing both imidazole and thioether functions derived from the precursors 4-[(2'-aminoethyl)thiomethyl] (5-methylimidazole, 2-[(2'-aminoethyl)thiomethyl]-benzimidazole and either sal (or derivatives), acetophenones, or acac have been prepared.<sup>103-106</sup> These ligands behave as mono- or dianionic





tetradentate ligands in di- and monocationic complexes, respectively. The major difference between the IR spectra of the ligands and those of the complexes is the absence of bands corresponding to phenolic OH and benzimidazole NH groups, and the shift of the  $\nu(\text{C}=\text{N})$  to lower frequency in the complexes.



Complexes of 3d metals and  $\text{Cd}^{\text{II}}$  of SBs bearing a  $\text{N}_2\text{SO}$  donor set derived from aminothioether imidazole<sup>103–107</sup> and the reduced form of these  $\text{N}_2\text{OS}$  SBs have been prepared.<sup>108</sup> The reduced form  $\text{Ni}^{\text{II}}$  complexes with  $\text{N}_2\text{OS}$  coordination spheres (40) were prepared by a stepwise condensation of pn with sal in the presence of nickel acetate followed by further condensation with bis(thiosalicylaldehyde)nickel(II).<sup>109</sup> The free ligands could not be prepared in the absence of the metal, since in all cases the 1:2 condensation products were obtained even using a large excess of diamine. The  $\text{Ni}^{\text{II}}$  complex has a tetrahedrally distorted square-planar geometry as other complexes having a  $\text{N}_2\text{OS}$  donor set.<sup>110</sup> Also,  $\text{Ni}^{\text{II}}$  complexes of the SB resulting from the reaction between thiosalicylaldehyde and pn having a  $\text{N}_2\text{S}_2$  donor set have been obtained. The complete set of coordination spheres  $\text{N}_2\text{O}_2$ ,  $\text{N}_2\text{OS}$ , and  $\text{N}_2\text{S}_2$  allows to study the stereochemical and electronic changes induced by a gradual replacing of oxygen donors by sulfur donors in the coordination sphere of the  $\text{Ni}^{\text{II}}$  tetracoordinate complexes.<sup>109</sup>

In contrast to the  $\text{MN}_2\text{O}_2$  metal-chelates, the synthesis of their  $\text{MN}_2\text{S}_2(\text{Se}_2)$  analogs must be carried out with the precautions necessary to avoid the oxidation of the  $-\text{SH}$  and  $-\text{SeH}$  ligand groups. Metal chelates of tetracoordinated SBs having  $\text{N}_2\text{X}_2$  donor set ( $\text{X} = \text{O}, \text{S}, \text{Se}$ ) have been reviewed.<sup>31</sup> The effect of the ligand environment in the structure of SB complexes have been considered. The  $\text{MN}_2\text{S}_2(\text{Se}_2)$  chelates give predominantly complexes in the *cis* planar form contrary to the *trans* form known for the  $\text{MN}_2\text{O}_2$  analogs. As a possible explanation for the preference of a *cis*- $\text{MN}_2\text{S}_2$  structure, attractive sulfur-sulfur interaction was suggested. Another distinguishing feature of  $\text{MN}_2\text{S}_2(\text{Se}_2)$  with respect to their  $\text{MN}_2\text{O}_2$  analogs is the relative stability of the planar geometry compared to the tetrahedral form.

Symmetrical  $\text{N}_2\text{S}_2$  tetradentate SBs incorporating pyrazole or isoxazole have been prepared and their complexes with different 3d metal ions investigated.<sup>111</sup> A  $\text{Co}^{\text{II}}$  complex having a  $\text{N}_3\text{S}_2$  environment was found to exhibit thermal-induced spin-crossover behavior and its structure was determined at two temperatures corresponding to the different spin states.<sup>112</sup>

$\text{N}_2\text{S}_2$  SBs bearing sterically protected thiol groups as well as imine, imidazole, and thioether groups<sup>113</sup> and other  $\text{N}_2\text{S}_2$  SB complexes have also been prepared.<sup>114,115</sup>

Other tetradentate SB ligands having either  $\text{N}_2\text{P}_2$  or  $\text{N}_3\text{P}$  donor atom set containing both hard and soft donors and their complexes with some soft metals have been investigated.<sup>116,117</sup>

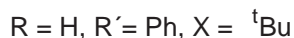
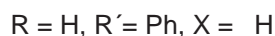
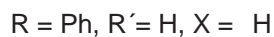
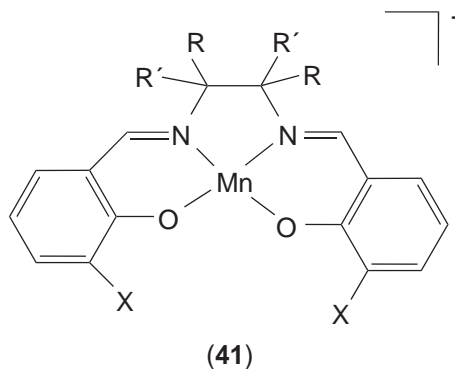
### 1.19.6.3 Chiral Tetradentate Schiff Bases

Jacobsen reported in 1990 that  $\text{Mn}^{\text{III}}$  complexes of chiral salen ligands (41) were the most efficient catalysts available for the enantioselective epoxidation of alkyl- and aryl-substituted olefins.<sup>118</sup> This stimulated a rapid development in the chemistry and applications of chiral SB complexes, which offer promising catalytic applications to several organic reactions, such as enantioselective cyclopropanation of styrenes, asymmetric aziridination of olefins, asymmetric Diels-Alder cycloaddition, and enantioselective ring opening of epoxides.<sup>4,119</sup>

Asymmetric tetradentate chiral SB ligands having either two different salicylaldehyde derivatives or a combination of sal and acac units are prepared by the stepwise protocol, preparing first the chiral "half unit" intermediate which is reacted further to give the desired asymmetric

tetradentate SB. This allows simultaneous tuning of electronic and sterical properties of the ligand to maximize the performance of the catalysts.<sup>120,121</sup>

The salen-based catalysts mentioned above are not soluble in water, which constitutes a limitation; this is overcome by the preparation of new amphiphilic salen-type transition metal complexes. Therefore, several bulky salen-type SB ligands containing both tert-butyl and methyl(triphenylphosphonium) substituents have been prepared.<sup>122</sup> The introduction of both lipophilic and ionic substituents in the ligands increases the solubility of the complexes of these ligands, which are found to be soluble both in water and in most common organic solvents and this may enhance the catalytic properties of the complexes.



#### 1.19.6.4 Equilibrium Studies

Equilibrium studies for salicylaldimines are in general scarce due mainly to their insolubility in water which is the most common solvent for potentiometric determination of stability constants. Some potentiometric studies have been carried out for tetradentate  $\text{N}_2\text{O}_2$  SB ligands in aqueous-organic mixtures such as dioxane-water or dmsO-water.<sup>123-125</sup> The ionization constants of the tetradentate ligands (**33a**, **33q**, **33r**) derived from sal and diamines have  $\text{pK}_a \sim 9-10$ , indicating that these ligands behave as weak diprotic acids. The species distribution diagrams as a function of pH for (**33a**), (**33q**), (**33r**) and related ligands show that in the pH range 5-8, the only existing species is the fully protonated ligand ( $\text{H}_2\text{L}$ ), whereas in the pH range 9-11 the species  $\text{H}_2\text{L}$ ,  $\text{HL}^-$ , and  $\text{L}^{2-}$  coexist. The deprotonation of both  $\text{OH}^-$  is completed at  $\text{pH} > 12$ , the only existing species being  $\text{L}^{2-}$ .

It was observed that the ethylenediamine derivative (**33a**) and its metal complexes undergo hydrolysis in strongly acidic dmsO-water 80:20 wt/wt media, induced by the highly basic character of the nitrogen atoms of the aliphatic diamine.<sup>126,127</sup> However, solutions in neutral or basic conditions were found to be stable. In contrast, (**33q**) and (**33r**), derived from *o*-phenylenediamine and *m*-phenylenediamine respectively, do not hydrolyze at pH higher than 2.5.<sup>123,124,128</sup> The greater difficulty in protonating aromatic diamines compared to aliphatic diamines is believed to be responsible for the stability of these SBs and their complexes in acidic dmsO-water solution.

The tetradentate  $\text{N}_2\text{O}_2$  SBs derived from *o*-phenylenediamines give very stable complexes with 3d metal ions such as  $\text{Fe}^{\text{III}}$ ,  $\text{Ni}^{\text{II}}$ ,  $\text{Co}^{\text{II}}$  as can be deduced from the high values obtained for their stability constants.<sup>123-125</sup> In these complexes both nitrogen donors coordinate to the same metal to give mononuclear species with the ligand fully deprotonated. Monoprotonated species are also found.

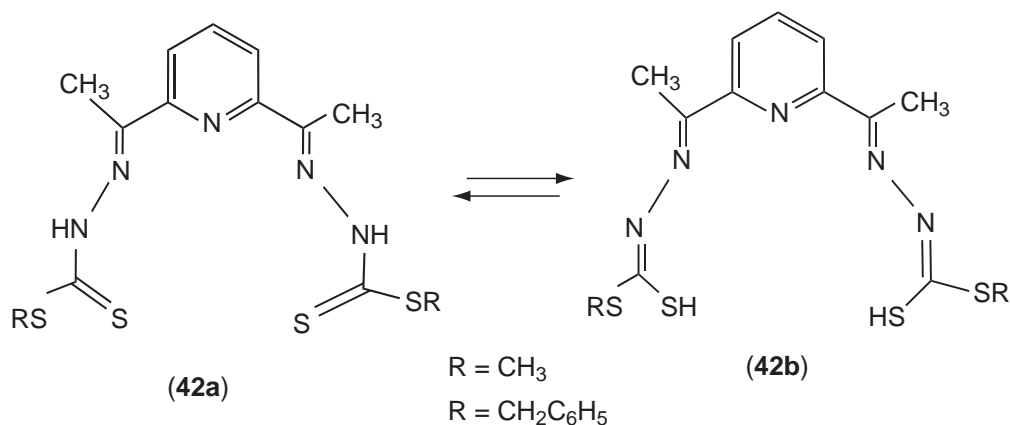
When the  $\text{N}_2\text{O}_2$  tetradentate SB is derived from *m*-phenylenediamine,<sup>128</sup> (**33r**) the specific geometry of the ligand with the nitrogen donors in the *meta* position on the aromatic ring prevents their simultaneous coordination to the same metal ion, thus behaving as bis-bidentate giving dinuclear complexes with the ligand bridging both metal ions, as shown by the X-ray structure determination of  $\text{Co}_2(\text{33r})_2$ <sup>128</sup> and  $\text{Mn}^{\text{III}}_4(\text{X-33r})_6$  ( $\text{X} = \text{H}, 5\text{-Br}$ ).<sup>129</sup> For (**33r**) and derivatives monomers, dimers, 2:1 and 1:2 ligand/metal ratio species have been found in solution and their stability constants determined.

SBs derived from phenylenediamines have been reviewed.<sup>23</sup> This review includes a collection of thermodynamic data available in the literature for such compounds.

Many SB complexes have been used as models for biological systems. In this regard, Co<sup>II</sup> complexes of SBs such as (33a) and analogs are well-known potential dioxygen carriers, and the dioxygen affinities for several SB complexes have been studied.<sup>125,130–134</sup> The ligands were modifications of the parent salen. Substituents on the aromatic rings of the SB seem to increase the affinity for dioxygen. It was also observed that Co (33a) itself does not bind dioxygen sufficiently without a basic monodentate ligand, i.e., 4-methylpyridine, that coordinates Co<sup>II</sup> in the position *trans* to the dioxygen. The reactivity toward oxygen of dinuclear Co<sup>II</sup>Cu<sup>II</sup> macrocyclic complexes having Co<sup>II</sup> in a “salen”-like N<sub>2</sub>O<sub>2</sub> site have also been investigated.<sup>133</sup>

### 1.19.7 PENTADENTATE SCHIFF BASES

The condensation of 2,6-diacetylpyridine and either S-benzylthiocarbamate or S-methylthiocarbamate gives SBs that behave as dinegatively charged pentadentate N<sub>3</sub>S<sub>2</sub> ligands despite bearing more potential donor atoms, since sterical reasons allow only a maximum of five donor atoms to coordinate to a metal atom.<sup>135,136</sup> These SBs may exhibit thione–thiol tautomerism (42a and 42b) (Scheme 12). The IR spectra do not show any band corresponding to  $\nu(\text{S–H})$  at *ca.* 2,570 cm<sup>-1</sup> but show instead the  $\nu(\text{N–H})$  band at *ca.* 3,200 cm<sup>-1</sup> indicating that in the solid state it exists as the thione form (42a). Accordingly, the <sup>1</sup>H NMR spectra does not show any signal at 4.00 ppm due to the S–H proton, but rather a signal at 10.05 ppm due to the N–H proton, indicating that even in solution it exists predominantly as the thione tautomer. However, upon complexing, the ligand converts to the thiol form (42b), and the N–H group is deprotonated. The  $\nu(\text{C=N})$  band of the complexes show the characteristic shift by about 30 cm<sup>-1</sup> to lower frequencies with respect to the free ligands, indicating that the azomethine group is involved in coordination. Similarly, the  $\nu(\text{N–N})$  frequency shows a displacement from 1,068 cm<sup>-1</sup> to *ca.* 1,040 cm<sup>-1</sup> upon coordination.



Scheme 12

The pentadentate N<sub>3</sub>S<sub>2</sub> SB ligand 2,6-diacetylpyridinebis(thiosemicarbazone) was prepared and its different coordination modes towards zinc<sup>II</sup> discussed.<sup>137</sup>

Also, pentadentate N<sub>3</sub>O<sub>2</sub> SBs and their complexes have been reported.<sup>138,139</sup> The spin-crossover phenomenon was investigated for Fe<sup>III</sup> SB complexes derived from a pentadentate SB having a N<sub>3</sub>O<sub>2</sub> donor set.<sup>140</sup>

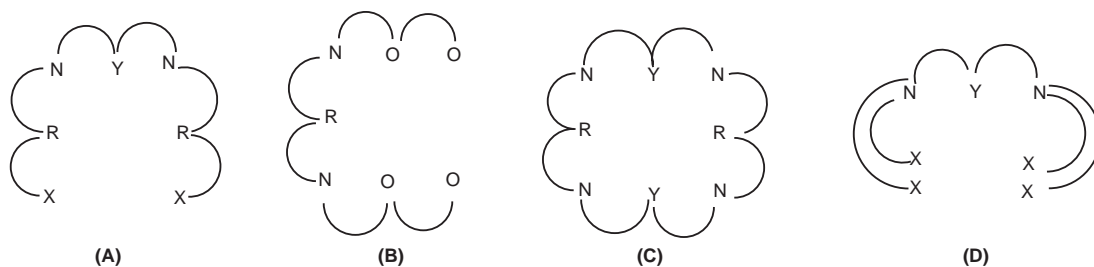
Potentially pentadentate and trianionic asymmetrical N<sub>2</sub>O<sub>3</sub> SBs containing a hard amido donor atom have recently been prepared.<sup>141</sup> The presence of the amido donor group stabilizes high-oxidation-state metal complexes. This ligand can twist to give a helical complex with Mn<sup>III</sup>.

### 1.19.8 COMPARTMENTAL ACYCLIC SCHIFF BASES

Binucleating ligands can be divided into compartmental and noncompartmental. Compartmental ligands are those which contain a central bridging atom (i.e., phenolic, alcoholic, thiophenolic, or

keto-oxygen atom) which can coordinate simultaneously to two metal ions thus giving dinuclear or polynuclear complexes. Noncompartmental ligands are those in which their donor atoms are not shared.

Different ligand types (Scheme 13) can be obtained depending on the ratio between the carbonyl precursor and the diamine employed in the condensation reaction. Therefore, the [1 + 2] condensation gives the end-off acyclic ligands (A), the [2 + 1] condensation forms the side-off acyclic (B), and the [2 + 2] condensation gives a macrocycle (C). Type (D) are poly podal ligands. In the related metal complexes, Y provides an endogenous bridge; a further exogenous bridge may be provided by a mono- or bidentate anion.



Scheme 13

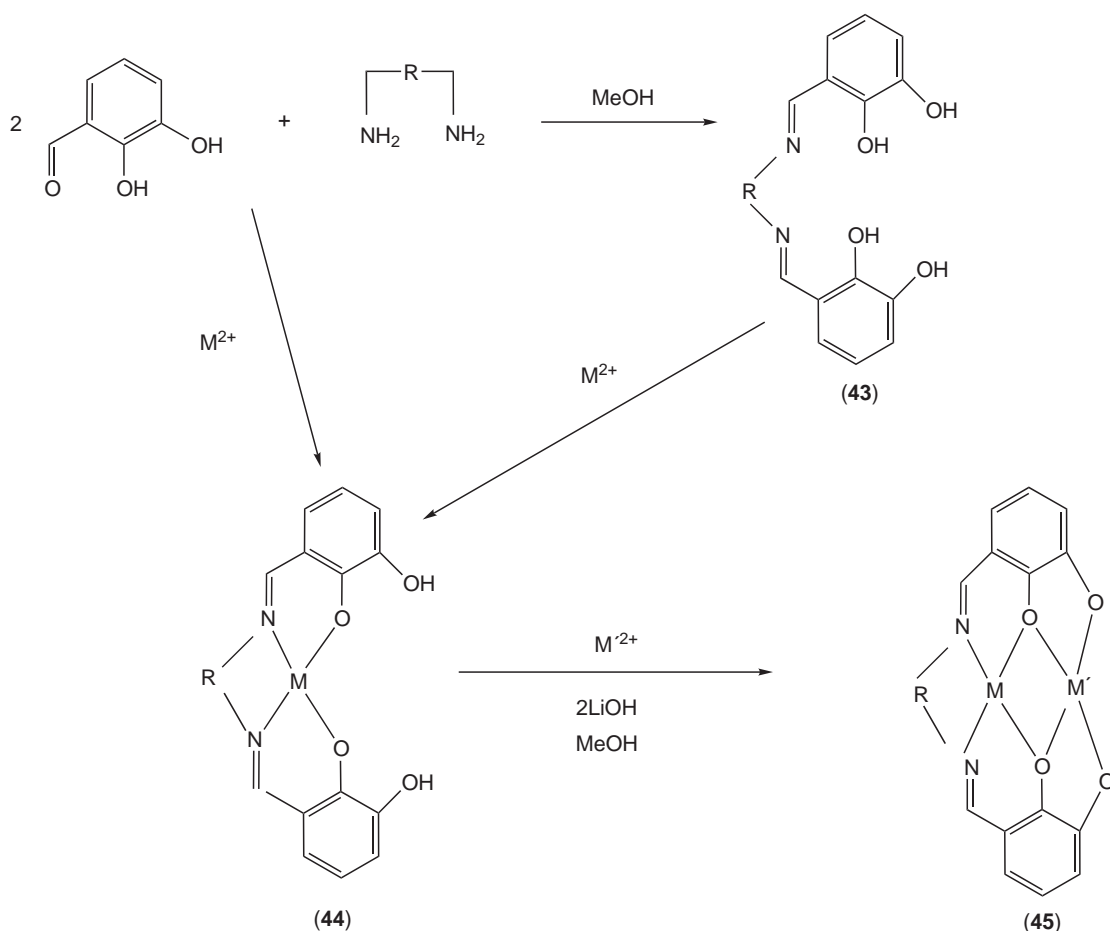
The compartmental ligands<sup>5</sup> are predominantly SBs (or the analogous compounds where the C=N bonds have been reduced to CH–NH) derived from 2,6-disubstituted phenols, thiophenols, 1,3,5-triketones,  $\beta$ -ketophenols, keto-acids, or diamino alcohols and polyamines.<sup>22</sup> The compartmental SB ligands, both acyclic and macrocyclic, have received considerable attention since the early 1990s due to the peculiar properties of their related homo- and hetero-di(poly)nuclear complexes, which are of interest for many areas such as magnetochemistry and bioinorganic chemistry. Several reviews dealing with compartmental SB ligands have appeared.<sup>2,3,21,22</sup>

#### 1.19.8.1 Phenol-based Derivatives

Acyclic potentially hexadentate (**43**) or decadentate (**44**) compartmental SB ligands<sup>1,14</sup> (Scheme 14) have been obtained by condensation in methanol of 2,3-dihydroxybenzaldehyde with different diamines (**43**, R =  $-(\text{CH}_2)_2-$ , **43a**; R =  $-(\text{CH}_2)_3-$ , **43b**; R =  $-(\text{CH}_2)_4-$ , **43c**; R =  $-\text{CH}(\text{CH}_3)-\text{CH}_2-$ , **43d**; R =  $-\text{CH}_2-\text{C}(\text{CH}_3)_2-\text{CH}_2-$ , **43e**; R =  $-o\text{-C}_6\text{H}_4-$ , **43f**) and tren (**51**) in a 2:1 or 3:1 ratios as appropriate.<sup>1,14</sup> The synthetic procedure for the preparation of these SBs is quite straightforward. Reactions are almost quantitative and produce yellow–orange or red solids, stable in air and soluble in common organic solvents. For this series of ligands, the stretching frequencies for  $\nu(\text{C}=\text{N})$  lie between 1,611 and 1,661  $\text{cm}^{-1}$  and  $\nu(\text{OH})$  about 3,250–3,400  $\text{cm}^{-1}$ . The <sup>1</sup>H NMR spectra are discussed in the relevant papers.<sup>1,14</sup> The crystal structure of the free ligand (**43e**) has been reported.<sup>14</sup>

These ligands can give mononuclear complexes (**44**) by reaction of the preformed ligands with the appropriate metal(II) acetate (Scheme 14) or by template reaction of 2,3-dihydroxybenzaldehyde and the desired diamine. The Cu<sup>II</sup> and Ni<sup>II</sup> complexes have been prepared in this way.<sup>142</sup> The metal(II) coordinates into the inner N<sub>2</sub>O<sub>2</sub> site in a quasi-square planar geometry.

These complexes can act as ligands for the formation of heterodinuclear complexes (**45**) of the type [MM'(43a-4H)(X)(solv)<sub>n</sub>] (M = d-metal ion (Cu or Ni); M' = f-metal ion (La<sup>III</sup>, Y<sup>III</sup> or Gd<sup>III</sup>); **43a-4H** = fully deprotonated **43a**; X = NO<sub>3</sub>, Cl or [MM'(43a-4H)(solv)<sub>n</sub>] (M = Cu or Ni, M' = UO<sub>2</sub> or Ba) (solv = H<sub>2</sub>O, methanol or dmsO) which can be obtained by the reaction of the mononuclear complexes with the desired metal salt in the presence of a base.<sup>142</sup> The use of base may cause dimerization as has been observed for tetranuclear species such as [CuY(43a-4H)(dmsO)<sub>2</sub>]. The Cu<sup>II</sup> is four-coordinated in the inner N<sub>2</sub>O<sub>2</sub> compartment and the Y<sup>III</sup> is eight-coordinated in the outer O<sub>2</sub>O<sub>2</sub>. Two Y<sup>III</sup> are held together by phenolic oxygen bridges.<sup>142</sup> The use of 3-methoxy- or 3-ethoxysalicylaldehyde as formyl precursors instead of 2,3-dihydroxybenzaldehyde precludes the dimerization observed for the SB derived from 2,3-dihydroxybenzaldehydes and allows the formation of well-defined and stable dinuclear entities.<sup>143</sup>



Scheme 14

It is well known that the inner N<sub>2</sub>O<sub>2</sub> compartment of the ligands derived from en and pn is particularly adequate for d-metal ions, while the outer O<sub>2</sub>O<sub>2</sub> compartment always prefers larger f-metal ions.<sup>14</sup> This selectivity is evident by the exclusive formation of the desired heterodinuclear complexes even when two metals (3d and 4f) are simultaneously added to the ligand, without prior separation and purification of the mononuclear complex. The coordination of the metal in the outer O<sub>2</sub>O<sub>2</sub> may induce changes in the conformation of the ligand. Thus, in the mononuclear Cu<sup>II</sup> complex of (43a), the ligand is in a slightly stepped conformation. On coordination of the second metal the ligand changes from a “stepped” to an “umbrella” conformation.<sup>142</sup>

The resulting complexes have been of considerable value to study the magnetic interaction between a 3d and a f-metal ion in heterodinuclear complexes.<sup>1,143</sup>

The influence of the size of aliphatic spacer of (43a), (43b), and (43c) on the geometry of the related Cu<sup>II</sup> and Ni<sup>II</sup> complexes was investigated.<sup>144</sup> The ligands having the spacer (CH<sub>2</sub>)<sub>2</sub> or (CH<sub>2</sub>)<sub>3</sub> give mononuclear complexes with a quasi-square planar geometry around the metal ion. In contrast, (43c), having a larger and more flexible (CH<sub>2</sub>)<sub>4</sub> spacer, can twist and coordinate simultaneously three copper atoms held together by  $\mu$ -phenoxo oxygen bridges.<sup>145</sup> The resulting trinuclear copper complex has a bishelical structure.<sup>145</sup> The three copper atoms form approximately an isosceles triangle. The complex has two molecules of ligand, one behaves as tetraionic (43c-4H) and the other as dianionic (43c-2H). The fully deprotonated SB (43c-4H) acts as a trinucleating helicand with three metal-binding domains (O<sub>2</sub> + N<sub>2</sub>O<sub>2</sub> + O<sub>2</sub>) while (43c-2H) acts a bis-bidentate and binucleating ligand using two NO donor sets for coordination to two different metals. This bis-bidentate bonding fashion (NO + NO) of (43c-2H) has also been observed for other acyclic imines.<sup>94,95</sup> One of the Cu<sup>II</sup> lies in the inner N<sub>2</sub>O<sub>2</sub> compartment of (43c-4H). This donor set is usually quasi-planar in homo- and heterodinuclear complexes containing related ligands but with a (CH<sub>2</sub>)<sub>2</sub> or (CH<sub>2</sub>)<sub>3</sub> chain.<sup>1,142</sup> However, that of the larger (CH<sub>2</sub>)<sub>4</sub> chain is

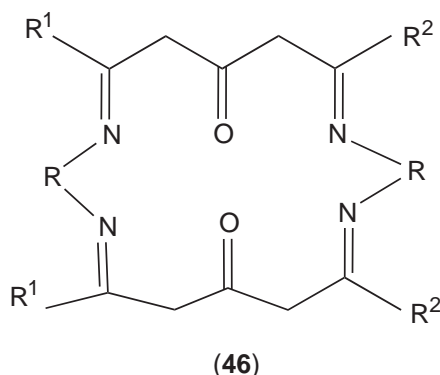
tetrahedrally distorted. The structural versatility of the potentially hexadentate ligand (**43c**) is also evident in the formation of an unusual octanuclear zinc complex. The structure of this complex contains a pseudo-tetrahedral  $Zn_8O_{13}$  core assembled by thirteen  $\mu$ -phenoxo bridges, where  $Zn^{II}$  ions are pentacoordinated.<sup>146</sup>

### 1.19.8.2 Di- and Triketone Derivatives

The reaction of a diamine with one terminal keto-function of a triketone, keto-phenol or keto-carboxylic acid leads to the formation of a SB having available adjacent dissimilar coordination compartments. Condensation at the central carbonyl was not observed.

Symmetrical or asymmetrical 1,3,5-triketones (**31**,  $R = Me, Et, Pr^n$ , or  $Pr^i$ ) can be used as precursors for the synthesis of a wide range of either compartmental acyclic or compartmental macrocyclic SBs by condensation with the appropriate  $\alpha,\omega$ -alkanediamines.<sup>147</sup> Condensation of equimolar ratios of symmetrical 1,3,5-triketones with different diamines (en, pn, 1,4-butanediamine) in ethanol afforded [2 + 2] macrocyclic SBs (**46**). These macrocycles can be hydrolyzed by a dilute aqueous solution of acetic acid which cleaves one of the diamine bridges affording the acyclic SB (**47**). When excess of acetic acid was employed, cleavage of the two diamine bridges occurred.<sup>148</sup>

When asymmetrical triketones (i.e., 1-phenylhexane-1,3,5-trione and 7,7-dimethyloctane-2,4,6-trione) were used as precursors, condensation with the appropriate diamines in 2:1 ratio occurred only at the carbon group adjacent to the methyl group, affording the acyclic SB, which are designed as side-off acyclic SB where [2 + 1] condensation occurs (Scheme 13, B). Therefore, the reaction of 1,3,5-triketones with  $\alpha,\omega$ -alkanediamines led to two classes of ligand (acyclic and macrocyclic SBs) depending on the nature of the substituents present in the triketone.<sup>148</sup>



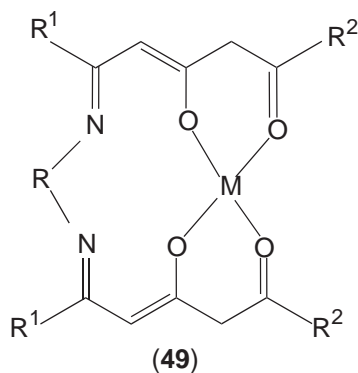
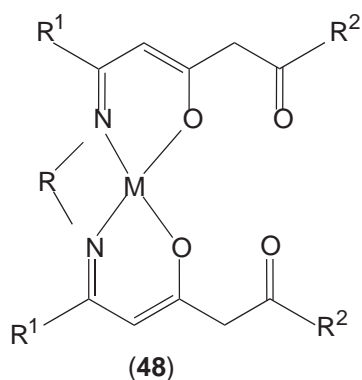
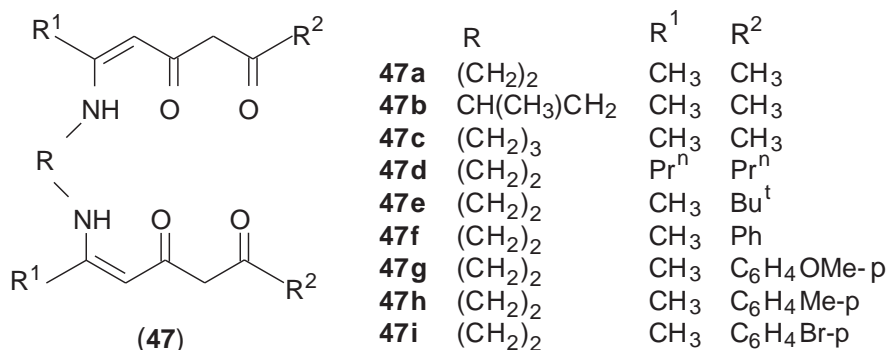
The IR spectra of the acyclic SB (**47**) showed broad bands in the 3,000–3,400  $cm^{-1}$  region, attributed to O—H—O and N—H—O stretches. Also, compound (**47a**) shows a strong band at 1,700  $cm^{-1}$ , attributable to the free carbonyl indicating that the SB exists mainly in the keto-form in solid state. However, the  $^1H$  NMR spectrum in  $CDCl_3$  showed the coexistence of the keto and enol tautomers. When the spectrum was recorded immediately after dissolution, 100% of the keto-tautomer was present. However, after 2–3 weeks the ratio of the enol tautomer increased to 30%. This series of acyclic compartmental SBs (**47**) are potentially tetra-anionic and have available for coordination two adjacent dissimilar compartments, one comprising  $N_2O_2$  and the other  $O_2O_2$  donor sets, and their coordination selectivity towards various metals was investigated. Thus,  $Ni^{II}$  shows a strong preference for the  $N_2O_2$  site, and  $VO^{2+}$  and  $UO_2^{2+}$  were found to occupy the  $O_2O_2$  site.<sup>59,149,150</sup>  $Cu^{II}$  displayed a more ambivalent character; when  $R^1 = alkyl, R^2 = Ph$ , the  $O_2O_2$  compartment was occupied; when  $R^1 = R^2 = alkyl$ , the  $N_2O_2$  compartment was filled. For the case  $R^1 = R^2 = Me$ , it was possible to isolate the  $N_2O_2$  and  $O_2O_2$  positional isomers (**48**) and (**49**) depending upon the nature of the ligand and conditions of reaction. These pure mononuclear isomers of this series of acyclic SB ligands can be used as precursors for the preparation of binuclear species.<sup>59,148,151</sup>

The crystal structures of the free ligand (**47a**) and that of its copper(II) complex were reported.<sup>18</sup> In both cases the terminal  $\beta$ -diketone residue is present in the keto tautomeric form. The  $\beta$ -ketoimine fragment of the free ligand is planar and is stabilized by an internal hydrogen bond. The crystal structure of the copper complex shows the metal coordinated in the inner  $N_2O_2$  site.<sup>18</sup>

A series of acyclic compartmental SBs having dissimilar adjacent coordination sites derived from different  $\beta$ -diketones have been reported. Thus, 1-(pyrrol-2-yl)butane-1,3-dione<sup>152</sup> and

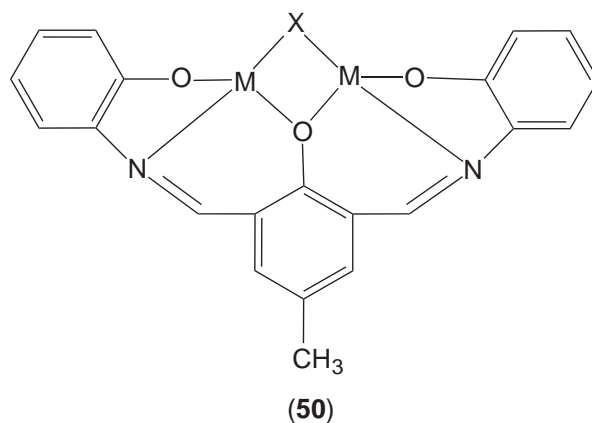


1-(*o*-hydroxyphenyl)butane-1,3-dione<sup>59</sup> were used as diketo precursors and reacted in 2:1 ratio with different diamines (**48**). Cu<sup>II</sup> complexes from these ligands were prepared. Cu<sup>II</sup> was found to coordinate in the outer compartment in a square-planar geometry which is retained with ligands having bridges containing up to five units.



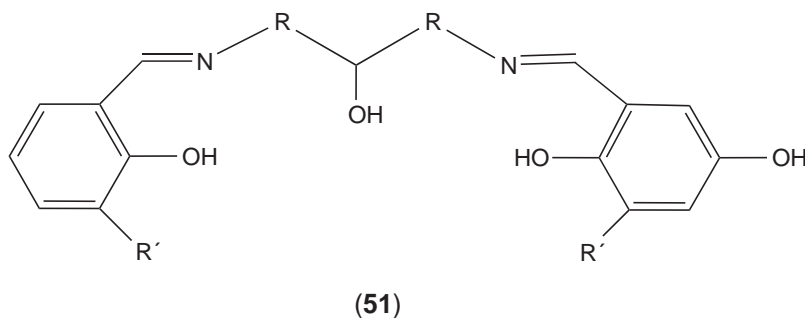
### 1.19.8.3 End-off Ligands

Potentially pentadentate binucleating ligands derived from condensation of sal, acac, pyridine-2-carboxaldehyde and pyrrole-2-carboxaldehyde with 1,3-diaminopropan-2-ol and 1,5-diaminopentan-3-ol in 2:1 ratio have been prepared.<sup>153,154</sup> These compartmental ligands provide only one endogenous bridging donor and so have a labile bridging site available between the metals into which a variety of anions (X<sup>-</sup>) can be introduced as exogenous bridges. This bridging ligand X may donate one (OH, OR, Cl, etc.) or two atoms (acetate, pyrazolate, etc.). The original ligands have been modified extensively and a wide range of new binucleating compounds have been prepared with the same basic structural framework.<sup>22</sup> A prototype of these series of ligands is (**50**).



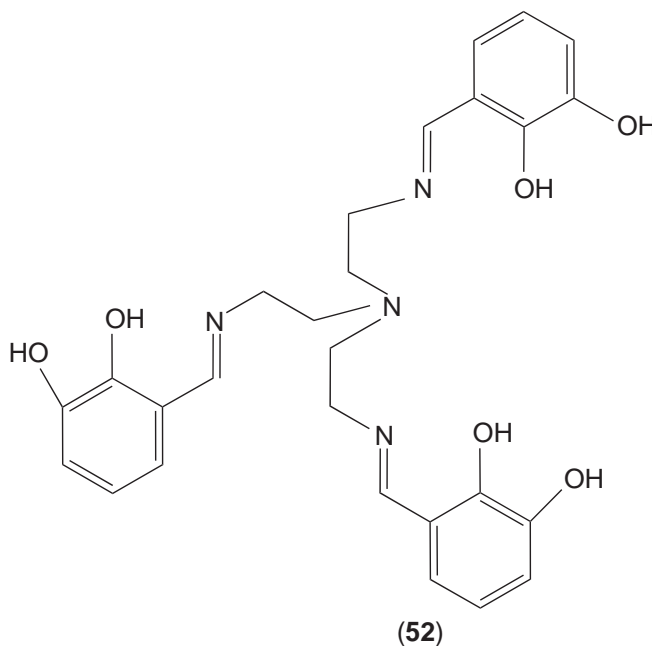
This ligand type has also been prepared by condensation in alcoholic media of 2,6-diformyl-4-methyl-phenol with aminophenols, aminothiophenol, amino acids, dialkylalkanediamines, 2-amino-alkylpyridines, histamine, thiosemicarbazide and diamines.<sup>22,155</sup> Similar ligands incorporating bulky substituents in order to increase the solubility of the resultant dinuclear complexes have also been prepared.<sup>156</sup> Dinucleating ligands containing sulfur as bridging ligand especially designed for coordination of two soft metal centers have also been described, these and other examples can be found in Zanello *et al.*<sup>22</sup>

The potentially pentadentate ligand (**51a**), (**51**, R = -CH<sub>2</sub>-, R' = H, **51a**) is very versatile and may coordinate in different fashions, behaving as tridentate, tetradentate, or as compartmental pentadentate ligand giving dinuclear complexes where the metal ions are bridged by the alcoholic oxygen atom.<sup>157</sup> The related (**51b**), having a larger and more flexible spacer (**51**, R = -(CH<sub>2</sub>)<sub>2</sub>-, R' = H, **51b**), gives novel supramolecular structures.<sup>158</sup> The condensation of 2,3-dihydroxybenzaldehyde with 1,3-diamino-2-propanol in 2:1 molar ratio gives (**51c**) (**51**, R = -CH<sub>2</sub>-, R' = OH, **51c**). IR, <sup>1</sup>H NMR, and UV-Vis spectra are reported for the free ligand.<sup>159</sup> The coordination modes of (**51c**) are very versatile since the presence of four phenolic groups favors the formation of polynuclear complexes. It can behave simply as a mononucleating N<sub>2</sub>O<sub>2</sub> ligand or can even behave as a tetracompartamental coordinating up to four metal centers in O<sub>2</sub> + ONO + ONO + O<sub>2</sub> compartments. All oxygen atoms could act as bridges between the metal centers. Mono- and polynuclear complexes of some 3d metals and Cd<sup>II</sup> have been prepared by electrochemical synthesis.<sup>159</sup> In these complexes no evidence was found for coordination through the hydroxyl group of the methylene chain which remains protonated in these neutral complexes.



#### 1.19.8.4 Polyodal Ligands

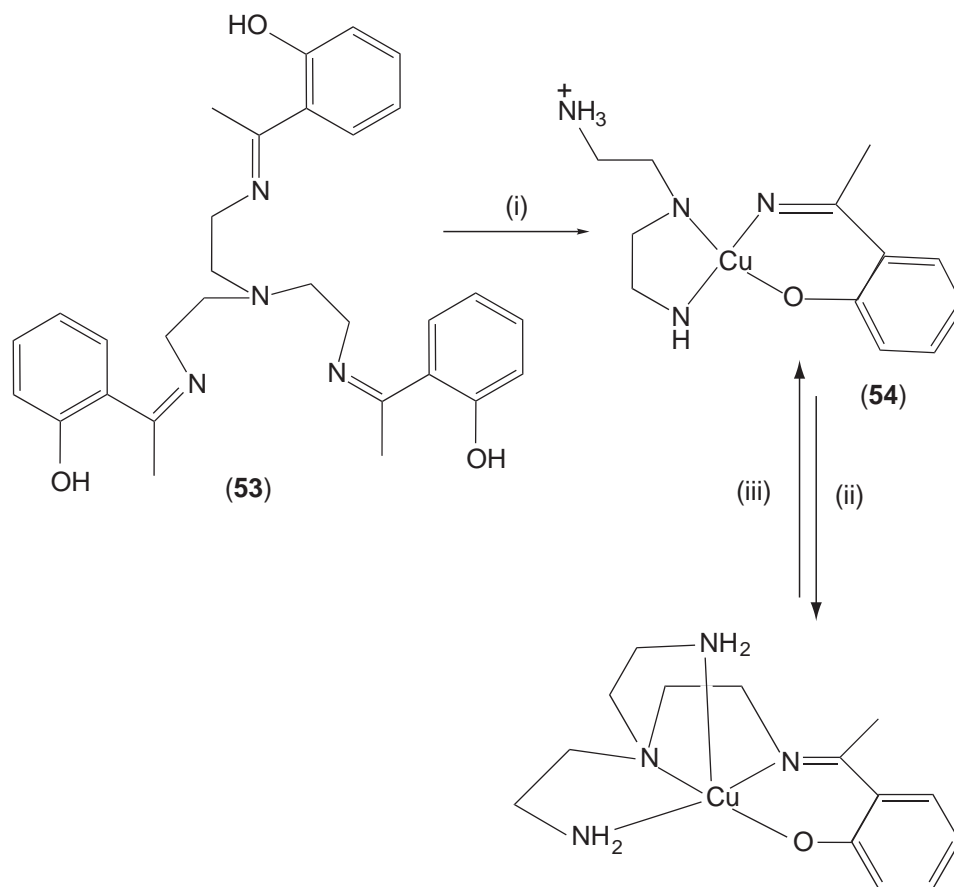
Condensation of tren with 2,3-dihydroxybenzaldehyde, sal (**52**) (or derivatives), acac, 2-hydroxyacetophenone (or derivatives), pyridine carboxaldehydes, pyrrole carboxaldehydes and





2,6-diformylphenols, in the ratio 1:3 gives tripodal SB ligand containing three pendant arms.<sup>14,160–168</sup> For the derivative of 2,6-diformyl-4-methyl-phenol, X-ray analysis was performed, showing that each arm of the potentially nonadentate SB ligand contains four potential binding sites, an imine nitrogen, a phenolic oxygen, and two acetal oxygens, the latter being formed by reaction of a formyl group with methanol used as solvent during the synthesis.<sup>168</sup> These ligands have been designed for the encapsulation of large cations such as lanthanide<sup>III</sup> (or Bi<sup>III</sup>) in the inner N<sub>4</sub>O<sub>3</sub> cavity in addition to the coordination of another lanthanide or another metal ion in the outer O<sub>3</sub>O<sub>3</sub> compartment.<sup>14,160</sup> Several lanthanide complexes of these ligands have been isolated. The tripodal SB resulting from condensation of tren with acac or hydroxyacetophenone may exhibit two coordination types, behaving as heptadentate coordinating through the N<sub>4</sub>O<sub>3</sub> donor set of the inner compartment if the starting lanthanide salt contains a poorly coordinating anion such as chloride and an early large lanthanoid or behaving as neutral O<sub>3</sub> tridentate when the anion is nitrate.<sup>160</sup>

On reacting the tripodal ligand derived from tren and 2-hydroxyacetophenone (**53**) (or pyridine-2-carboxaldehyde) with divalent 3d metal ions such as copper<sup>II</sup>, nickel<sup>II</sup>, or zinc<sup>II</sup> partial hydrolysis of the ligand occurs, giving a new ligand formed by the removal of two of the three 2-hydroxyacetophenone pendants (Scheme 15) where two of the three imine bonds in the ligands have been hydrolyzed to NH<sub>2</sub>.<sup>169,170</sup> This ligand containing four distinct donor atom types offers the possibility of preparing asymmetric tripodal ligands. The ligand (**54**) is a zwitterion with the amine nitrogen atom of one tripod arm being protonated instead of the phenol oxygen atom. The protonated tripod arm is orientated away from the metal environment presumably as a result of charge repulsion. The reaction of Sn<sup>II</sup> chloride dihydrate with such tripodal ligand leads, in contrast



Hydrolysis of the tripodal SB (**52**) upon complexation with Cu(II). (i) CuX<sub>2</sub> (X = NO<sub>3</sub><sup>-</sup> or ClO<sub>4</sub><sup>-</sup>), EtOH, reflux; (ii) NEt<sub>3</sub>, EtOH; (iii) concentrated HCl, NaClO<sub>4</sub>, EtOH.

Scheme 15

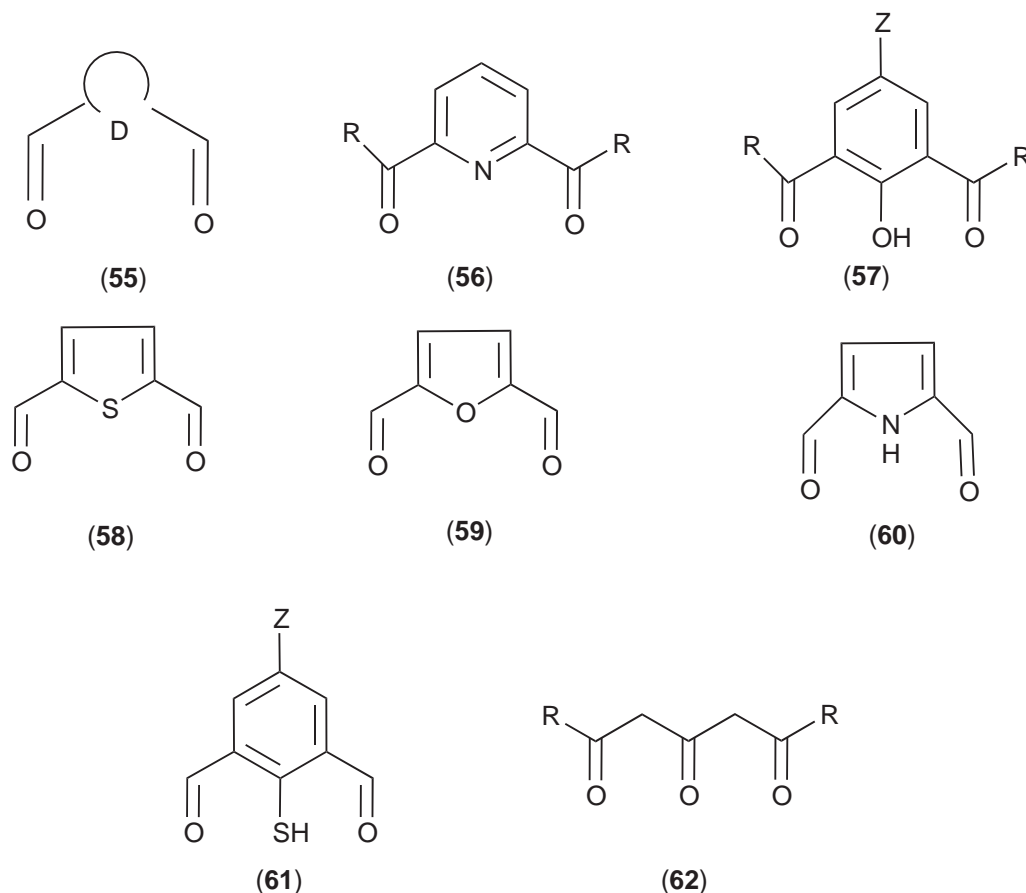
to  $\text{Cu}^{\text{II}}$ , to total destruction of the imine phenol yielding the starting compounds accompanied by oxidation of the metal to  $\text{Sn}^{\text{IV}}$ .  $\text{Pb}^{\text{II}}$  does not promote hydrolysis of the ligand but the non-coordination of imine nitrogen atoms or phenolate oxygens atoms is a remarkable feature.<sup>163</sup>

Tripodal SBs containing three free terminal carbonyl groups may be involved in further functionalization. Therefore, several [3 + 1] functionalized acyclic SBs have been prepared from 2,6-diformyl-4-chlorophenol and tren as precursors. Some of these SBs contain the crown ether function.<sup>171</sup>

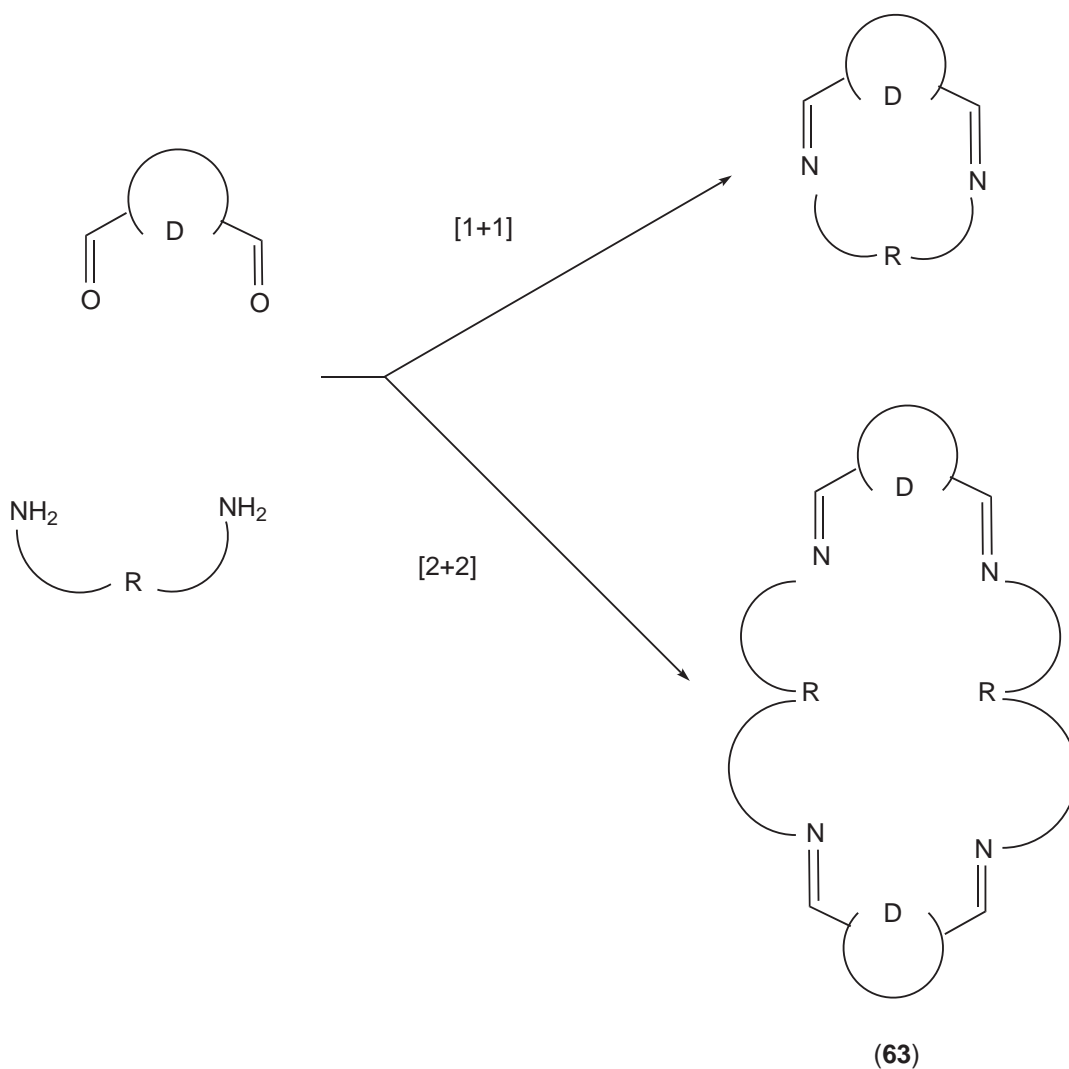
### 1.19.9 MACROCYCLIC SCHIFF BASES

Macrocyclic SB complexes have attracted much attention since the early 1980s, and several reviews covering this area of research have appeared.<sup>2,3,6,20-22,30</sup> Hexaimino macrobicycles are also known.<sup>172-176</sup>

Many macrocyclic SBs have been prepared by condensation of different dicarbonyl precursors (head units (55), see Scheme 16) such as 2,6-diformylpyridine (56,  $\text{R} = \text{H}$ , 56a), 2,6-diacetylpyridine (56,  $\text{R} = \text{CH}_3$ , 56b), 2,6-diformyl-4-Z-phenol (57,  $\text{Z} = \text{Cl}$ — 57a,  $\text{CH}_3$ —, 57b), 2,6-diacetyl-4-Z-phenol (57,  $\text{Z} = \text{Cl}$ —, 57c,  $\text{Z} = \text{CH}_3$ , 57d) thiophene-2,5-dicarbaldehyde (58), furan-2,5-dicarbaldehyde (59), pyrrole-2,5-dicarbaldehyde (60), 2,6-diformyl-4Z-thiophenol (61,  $\text{Z} = \text{CH}_3$ , 61a;  $\text{Z} = \text{Bu}^t$ , 61b) or  $\beta$ -triketones (62) with a wide range of different diamines (lateral chains). The majority of SB macrocycles are symmetrical and contain either phenol or pyridine as head units. Asymmetrical SB macrocycles have also been prepared. The SB macrocycles are designated [1 + 1] and [2 + 2] depending on the number of head and lateral units present (see Scheme 17). With certain precursors (i.e., 2,6-diacetylpyridine and 1,3-diamino-2-hydroxypropane) [3 + 3] and [4 + 4] macrocyclic complexes have also been synthesized.<sup>177-179</sup> The [2 + 3] condensation products have also



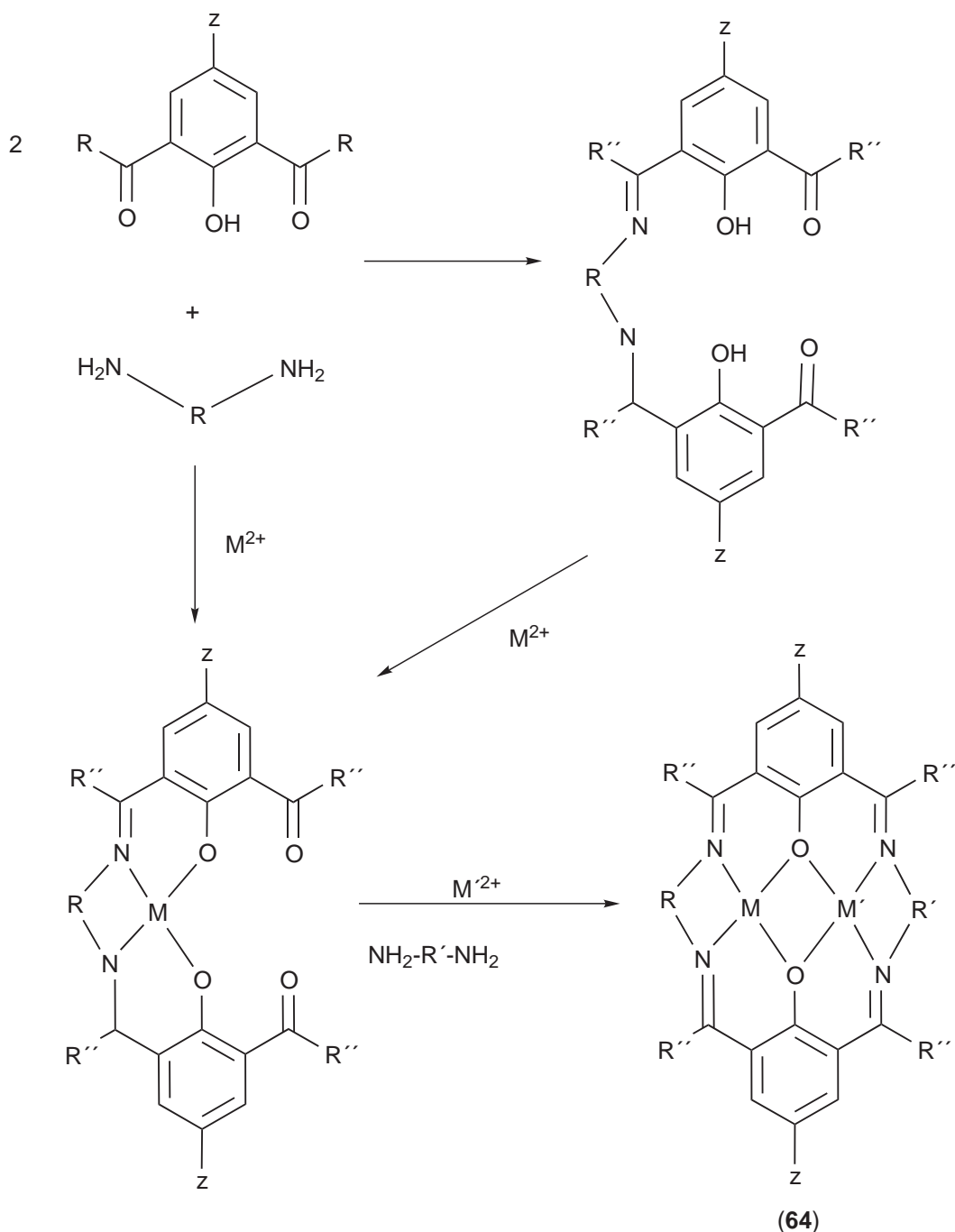
Scheme 16



Scheme 17

been prepared by reaction of tripodal triamines (tren or trpn) (trpn = tris(aminopropyl)amine) with dialdehydes to give hexaimine macrobicycles.<sup>176</sup>

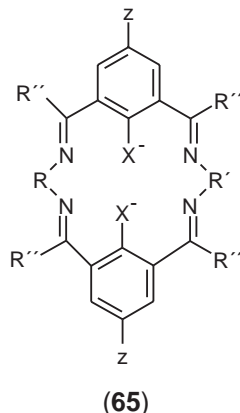
Many modifications can be made to the basic structure of the [2 + 2] condensation product such as provision of different lateral chains and head units, introduction of an additional donor atom on one lateral chain, and partial or full saturation of the azomethine linkages. These variations in the basic framework give macrocycles with different donor atoms and/or different cavity sizes. For the reduced azomethine groups a potentially donating auxiliary group can be introduced at the amino nitrogens as a pendant arm. The preparation of the free macrocycle is not always possible, and generally macrocyclic complexes are prepared by template synthesis. However, macrocycles derived from thiophene-2,5-dicarbaldehyde have been prepared as free macrocycles. For [2 + 2] macrocycles, alkaline-earth, lead<sup>II</sup>, and lanthanide cations are efficient templating agents which promote cyclization. The kinetic lability of these metals allowed the preparation of the corresponding transition metal macrocyclic complexes through transmetallation reactions. Homodinuclear SB complexes can be prepared using a template synthesis, by reaction of the appropriate polyamine with a dicarbonyl precursor in the presence of a metal ion in alcoholic solution. For the preparation of heterodinuclear complexes, step by step reactions have been employed. Homo- and heterodinuclear complexes (64) of both acyclic and cyclic SBs have been prepared according to Scheme 18.



Scheme 18

### 1.19.9.1 Compartmental Macrocycles

Much research has been focused on compartmental SB macrocycles derived from 2,6-diformyl (diacetyl)phenols as head units (see Scheme 19). The coordination chemistry of the phenol-based compartmental ligands was reviewed.<sup>2</sup> A series of symmetrical and less extensively asymmetrical macrocycles (having dissimilar lateral chains) have been prepared (Scheme 19). The variation of the lateral chains of the macrocycle gives ligands with different cavity size and flexibility. Thus, the N<sub>2</sub>O<sub>2</sub> cavity of the ethylenediamine derivative (65a) can accommodate only the small Cu<sup>II</sup> and Ni<sup>II</sup> ions because it has little flexibility. The replacement of the dimethylene by a trimethylene



	Z	X	R	R'	R''	Ref.
<b>65a</b>	CH <sub>3</sub>	O	(CH <sub>2</sub> ) <sub>2</sub>	(CH <sub>2</sub> ) <sub>2</sub>	H	12
<b>65b</b>	CH <sub>3</sub>	O	(CH <sub>2</sub> ) <sub>3</sub>	(CH <sub>2</sub> ) <sub>3</sub>	H	12
<b>65c</b>	CH <sub>3</sub>	O	(CH <sub>2</sub> ) <sub>4</sub>	(CH <sub>2</sub> ) <sub>4</sub>	H	2
<b>65d</b>	Bu <sup>t</sup>	O	(CH <sub>2</sub> ) <sub>3</sub>	(CH <sub>2</sub> ) <sub>3</sub>	H	12
<b>65e</b>	CH <sub>3</sub>	O	(CH <sub>2</sub> ) <sub>2</sub>	(CH <sub>2</sub> ) <sub>4</sub>	H	2
<b>65f</b>	CH <sub>3</sub>	O	(CH <sub>2</sub> ) <sub>2</sub>	(CH <sub>2</sub> ) <sub>2</sub>	CH <sub>3</sub>	12
<b>65g</b>	CH <sub>3</sub>	O	(CH <sub>2</sub> ) <sub>2</sub>	(CH <sub>2</sub> ) <sub>4</sub>	H	2
<b>65h</b>	CH <sub>3</sub>	O	C <sub>6</sub> H <sub>4</sub>	(CH <sub>2</sub> ) <sub>2</sub>	H	14
<b>65i</b>	CH <sub>3</sub>	O	(CH <sub>2</sub> ) <sub>2</sub>	(CH <sub>2</sub> ) <sub>2</sub> NH(CH <sub>2</sub> ) <sub>2</sub>	H	181,182
<b>65j</b>	Cl	O	(CH <sub>2</sub> ) <sub>2</sub> NH(CH <sub>2</sub> ) <sub>2</sub>	(CH <sub>2</sub> ) <sub>2</sub> NH(CH <sub>2</sub> ) <sub>2</sub>	H	14
<b>65k</b>	H	O	(CH <sub>2</sub> ) <sub>2</sub> N(CH <sub>2</sub> ) <sub>4</sub> N(CH <sub>2</sub> ) <sub>3</sub>	(CH <sub>2</sub> ) <sub>3</sub> N(CH <sub>2</sub> ) <sub>4</sub> N(CH <sub>2</sub> ) <sub>3</sub>	H	14
<b>65l</b>	CH <sub>3</sub>	O	(CH <sub>2</sub> ) <sub>2</sub>	(CH <sub>2</sub> ) <sub>2</sub> S(CH <sub>2</sub> ) <sub>2</sub>	H	182
<b>65m</b>	CH <sub>3</sub>	O	(CH <sub>2</sub> ) <sub>2</sub>	CH <sub>2</sub> CH(OH)CH <sub>2</sub>	H	183
<b>65n</b>	CH <sub>3</sub>	O	(CH <sub>2</sub> ) <sub>2</sub>	(CH <sub>2</sub> ) <sub>2</sub> CH(OH)(CH <sub>2</sub> ) <sub>2</sub>	H	183
<b>65o</b>	CH <sub>3</sub>	O	(CH <sub>2</sub> ) <sub>3</sub>	CH <sub>2</sub> CH(OH)CH <sub>2</sub>	H	183
<b>65p</b>	CH <sub>3</sub>	O	(CH <sub>2</sub> ) <sub>3</sub>	(CH <sub>2</sub> ) <sub>2</sub> CH(OH)(CH <sub>2</sub> ) <sub>2</sub>	H	183
<b>65q</b>	CH <sub>3</sub>	S	(CH <sub>2</sub> ) <sub>3</sub>	(CH <sub>2</sub> ) <sub>3</sub>	H	12
<b>65r</b>	Bu <sup>t</sup>	S	(CH <sub>2</sub> ) <sub>3</sub>	(CH <sub>2</sub> ) <sub>3</sub>	H	30
<b>65s</b>	CH <sub>3</sub>	S	(CH <sub>2</sub> ) <sub>4</sub>	(CH <sub>2</sub> ) <sub>4</sub>	H	30
<b>65t</b>	CH <sub>3</sub>	S	(CH <sub>2</sub> ) <sub>2</sub> NH(CH <sub>2</sub> ) <sub>2</sub>	(CH <sub>2</sub> ) <sub>2</sub> NH(CH <sub>2</sub> ) <sub>2</sub>	H	30
<b>65u</b>	CH <sub>3</sub>	S	(CH <sub>2</sub> ) <sub>2</sub> NH(CH <sub>2</sub> ) <sub>3</sub>	(CH <sub>2</sub> ) <sub>3</sub> NH(CH <sub>2</sub> ) <sub>3</sub>	H	30
<b>65v</b>	CH <sub>3</sub>	S	(CH <sub>2</sub> ) <sub>2</sub> NH(CH <sub>2</sub> ) <sub>4</sub> NH	(CH <sub>2</sub> ) <sub>2</sub> NH(CH <sub>2</sub> ) <sub>4</sub> NH	H	30
<b>65x</b>	CH <sub>3</sub>	S	CH <sub>2</sub> CH(OH)CH <sub>2</sub>	CH <sub>2</sub> CH(OH)CH <sub>2</sub>	H	30
<b>65y</b>	CH <sub>3</sub>	S	(CH <sub>2</sub> ) <sub>2</sub> CH(OH)(CH <sub>2</sub> ) <sub>2</sub>	(CH <sub>2</sub> ) <sub>2</sub> CH(OH)(CH <sub>2</sub> ) <sub>2</sub>	H	30

Scheme 19

bridge leads to a decreased ligand field and increased flexibility of the complexes and provides an appropriate size to accommodate a wide range of metal ions within its cavity.

Asymmetric SBs (**65i**) having an additional amine nitrogen on one lateral chain to provide a four- and a potential five-coordinate binding site have been prepared by a stepwise template reaction to give mixed Cu<sup>II</sup>Pb<sup>II</sup> complexes. The amine nitrogen is involved in coordination to the Pb<sup>II</sup> ion. The Cu<sup>II</sup>Pb<sup>II</sup> complexes are good precursors for the preparation by transmetalation reactions of Cu<sup>II</sup>M<sup>II</sup> complexes (M = Mn, Fe, Co, Ni, Cu, Zn).<sup>180</sup> A series of Ni<sup>II</sup>M<sup>II</sup> (M = Fe, Mn, Co, Ni, Cu, Zn) have also been described.<sup>181</sup>

A similar template reaction using as a diamine 1,5-diamino-3-thiapentane gives a mononuclear Cu<sup>II</sup> complex of the sulfur-containing macrocycle (**65l**). Although Pb<sup>II</sup> was used as a templating agent, the product did not contain Pb<sup>II</sup> but this metal ion nevertheless was found to be essential for cyclization. However, the metal-free macrocycle (**65l**) was also prepared and characterized. It contains dissimilar N<sub>2</sub>O<sub>2</sub> and N<sub>2</sub>O<sub>2</sub>S coordination sites. Cu<sup>II</sup>M<sup>II</sup> complexes (M = Cu, Co, Ni, Zn) were prepared.<sup>182</sup> For the Cu<sup>II</sup>Zn<sup>II</sup> complex, the sulfur in the lateral chain was not involved in coordination.

Asymmetrical macrocycles with an alcoholic hydroxy group on one lateral chain have been obtained (**65m**, **65n**, **65o**, **65p**) and their Cu<sup>II</sup>Pb<sup>II</sup> complexes prepared by stepwise template reactions. The macrocycles contain two dissimilar coordination sites: a four-coordinate N<sub>2</sub>O<sub>2</sub> donor set, and a five-coordinate N<sub>2</sub>O<sub>3</sub> donor set sharing two bridging phenolic oxygens. The structure of the Cu<sup>II</sup>Pb<sup>II</sup> complex of (**65m**) was obtained. The Cu<sup>II</sup> occupies the N<sub>2</sub>O<sub>2</sub> site and adopts a square-planar coordination, and the Pb<sup>II</sup> is bound to the N<sub>2</sub>O<sub>3</sub> site. The hydroxy group is involved in coordination to the Pb<sup>II</sup> in the Cu<sup>II</sup>Pb<sup>II</sup> complexes. However, the OH group is not coordinated in the transition metal dinuclear complexes though it can play a role in association of dinucleating units in bulk.<sup>183</sup>

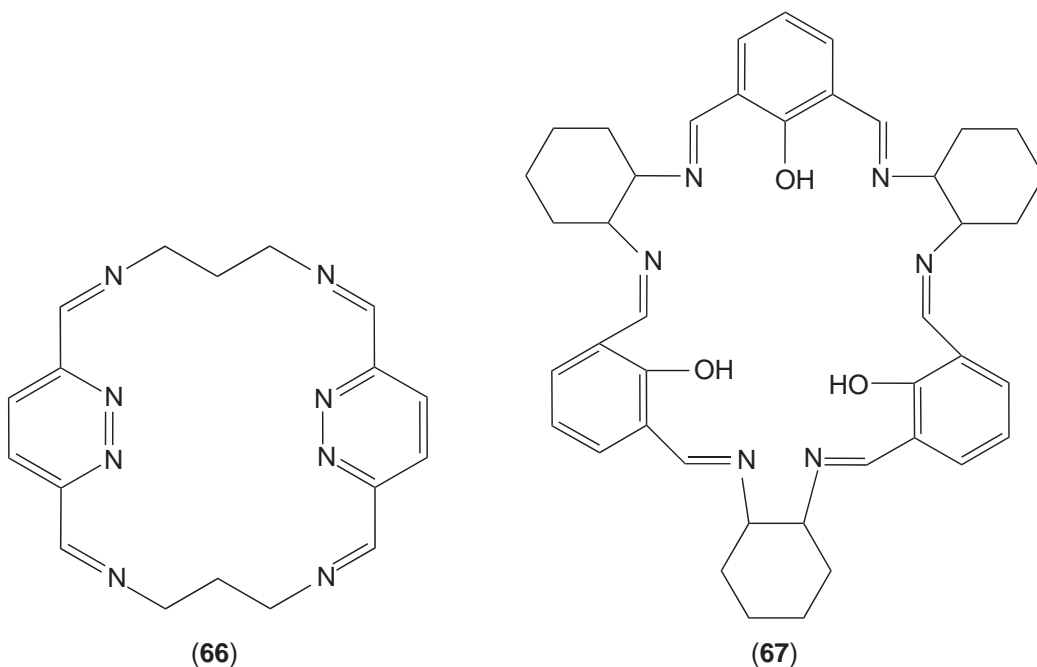
The SB (**65k**) was obtained as a metal-free tetraprotonated macrocycle [H<sub>4</sub>(**65k**)](ClO<sub>4</sub>)<sub>2</sub> in the template condensation of the precursor (**57a**) with 1,4-bis(2-aminopropyl)piperazine in the presence of lanthanum(III) perchlorate. The metal-free asymmetric macrocycle (**65h**) was prepared by stepwise reaction<sup>14</sup> of (**57b**), en and *o*-phenylenediamine.<sup>14</sup>

Metal-free protonated macrocycles (**65b**) have been prepared using H<sup>+</sup> as template and isolated as hexafluorophosphate salts.<sup>12</sup> X-ray structures have been determined for (**65b**). The [H<sub>4</sub>(**65b**)](PF<sub>6</sub>)<sub>2</sub> adopts a highly unusual folded conformation with the two phenyl rings involved in inter- and intra-molecular stacking interactions. For [H<sub>4</sub>(**65d**)](PF<sub>6</sub>)<sub>2</sub> the conformation is similar but the dihedral angles between the planes of the phenyl rings are bigger due to the greater steric hindrance of the *tert*-butyl groups. For [H<sub>4</sub>(**65a**)](PF<sub>6</sub>)<sub>2</sub> and [H<sub>4</sub>(**65f**)](PF<sub>6</sub>)<sub>2</sub> with shorter lateral chains, a more planar conformation ("stepped") of the macrocycle is obtained. Therefore the degree of folding of the macrocycle can be controlled by both the steric bulk of the substituent at the 4-position of the phenyl groups and by the size of the linker unit.<sup>12</sup>

The [H<sub>4</sub>(**65b**)]<sup>2+</sup> gives dinuclear nickel complexes, where the macrocycle is essentially planar. Each nickel is octahedral. When the reaction is carried out using nickel acetate, a tetranuclear

cluster  $[\text{Ni}_4(\mathbf{65b})_2(\text{O}_2\text{CMe})_2]^{2+}$  having a  $\text{Ni}_4\text{O}_4$  cubane-type structure is obtained.<sup>13</sup>  $[\text{H}_4(\mathbf{65f})]^{2+}$  gives dinuclear nickel complexes, where each nickel adopts a square-planar geometry in contrast to  $[\text{H}_4(\mathbf{65b})]^{2+}$ . Thus, reducing the ring size by replacing  $\text{C}_3$  with  $\text{C}_2$  linkers, the ligand field increased and afforded potentially square-planar nickel(II) products. The stereochemistry of the metal ion in the resulting complex can be controlled by variation of the ring size of the macrocycle.<sup>12</sup>

The reaction of (**57b**) with *trans*-(1*R*,2*R*)-cyclohexanediamine in a 1:1 ratio in methanol under conditions of high dilution gives in high yield the first metal-free [3 + 3] hexamine triphenolic macrocycle (**66,67**).<sup>184</sup> The [3 + 3] macrocycle is optically active and was crystallographically characterized. The reaction of the free [3 + 3] macrocycle with 3d metals under reflux conditions gave a ring-contracted [2 + 2] macrocyclic complex. When such reaction was carried out at room temperature an acyclic mononuclear SB was obtained.<sup>185</sup>



Macrocyclic SBs (**65q–65y**) derived from thiophenolate (**61**) (i.e., 2,6-diformyl-4-methylthiophenolate and 2,6-diformyl-4-*tert*-butylthiophenolate) as head units were prepared in the last decade of the twentieth century and are shown in Scheme 19.<sup>30</sup> Similarly to the phenol-based analogs, the thiophenolate-based macrocycles can be regarded as compartmental where the sulfur atom may bridge two metal ions. Some differences with respect to the phenol-based macrocycles are expected. The differences in the donor properties of bridging phenolate and thiophenolate have been discussed and are here illustrated by the structures of the complexes formed by nickel acetate and the macrocycles (**65b**) and (**65q**). For (**65b**) the nickel complex is tetranuclear having a  $\text{Ni}_4\text{O}_4$  cubane-type structure with nickel(II) having octahedral geometry, whereas for (**65q**), the nickel(II) complex is dinuclear where each nickel shows square-planar coordination.<sup>13</sup> Differences in the macrocycle conformation are also observed. Macrocyclic SBs containing both bridging thiophenolate and phenolate moieties and amine analogs of the thiophenolate macrocycles have been prepared.<sup>30</sup>

A limited number of asymmetrical compartmental macrocycles having two amine and two imine donors, prepared by partial reduction of the tetraimine macrocycle, are also known. Thus, a partially reduced macrocycle is obtained by the reaction of (**57a**) and (**57b**) with *o*-phenylenediamine in methanol.<sup>14</sup> The reduction of two imine groups takes place during the synthetic procedure. The nature of this macrocycle was confirmed by X-ray determination.<sup>14</sup>

### 1.19.9.2 Noncompartmental Macrocycles

Dinucleating macrocyclic SBs derived from the condensation of thiophene-2,5-dicarbaldehyde with different diamines have been prepared in their uncomplexed state.<sup>186</sup> Considering the [2 + 2] product (**63**) of Scheme 17 with (**58**) as head unit, the different lateral chains of the thiophene-based macrocycles that have been prepared are:  $\text{R} = (\text{CH}_2)_3$ ,  $(\text{CH}_2)_4$ ,  $(\text{CH}_2)_5$ ,  $(\text{CH}_2)_6$ ,

$(\text{CH}_2)_2\text{S}(\text{CH}_2)_2$ ,  $(\text{CH}_2)_2\text{NH}(\text{CH}_2)_2$ ,  $(\text{CH}_2)_3\text{NH}(\text{CH}_2)_3$ ,  $(\text{CH}_2)_2\text{O}(\text{CH}_2)_2$ ,  $(\text{CH}_2)_2\text{O}(\text{CH}_2)_2\text{O}(\text{CH}_2)_2$ ,  $(\text{CH}_2)_2\text{O}(\text{CH}_2)_2\text{O}(\text{CH}_2)_2\text{O}(\text{CH}_2)_2$ . From this series, the structure was reported for the macrocycle derived from **(58)** and 1,5-diamino-3-oxapentene.

Macrocyclic  $\text{Ba}^{\text{II}}$  and  $\text{Pb}^{\text{II}}$  complexes derived from [2 + 2] condensation of either 2,6-diacetylpyridine or furan-2,5-dicarbaldehyde with diamines containing a hydroxy function (i.e., 1,3-diamino-2-hydroxypropane, 1,4-diamino-2-hydroxybutane, and 1,5-diamino-3-hydroxypentane) have been prepared.<sup>187</sup> The reaction of 2,6-diacetylpyridine and 1,3-diamino-2-hydroxypropane with  $\text{Ba}^{\text{II}}$  as template gives the [2 + 2] macrocyclic complex. However, when the same reaction is carried out in the presence of  $\text{Pb}^{\text{II}}$  a ring contraction of the macrocyclic cavity takes place with formation of two oxazolidine rings.<sup>187</sup>

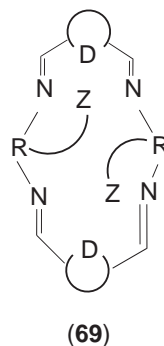
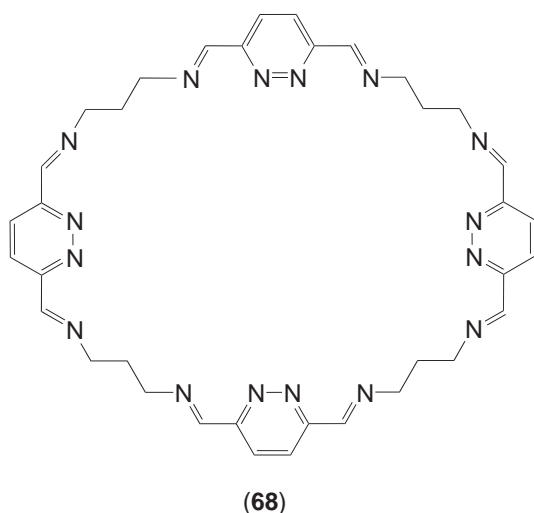
Pyridazine-based macrocyclic (**(68)**) SB complexes have been prepared by template condensation of 3,6-diformylpyridazine and pn in the presence of lead(II) perchlorate.<sup>188,189</sup> When a 2:2:1 ratio of the reactants was used, the resulting compound was  $[\text{Pb}_2(4+4)](\text{ClO}_4)_4$ , whereas when a 1:1:1 ratio was employed  $[\text{Pb}_2(2+2)](\text{ClO}_4)_4$  was obtained. The ability of  $\text{Pb}^{\text{II}}$  perchlorate to template the formation of two macrocyclic ring sizes is unprecedented. Transmetalation reactions of  $[\text{Pb}_2(4+4)](\text{ClO}_4)_4$  with  $\text{Co}^{\text{II}}$  or  $\text{Mn}^{\text{II}}$  ( $\text{M}^{\text{II}}$ ) gave  $[\text{M}_2(2+2)](\text{ClO}_4)_4$  indicating that on transmetalation a ring contraction from [4 + 4] to [2 + 2] occurs.<sup>188,190</sup> This pyridazine-containing macrocycle is able to stabilize low oxidation states of transition metal ions, thus allowing the isolation of unusually low oxidation state complexes.<sup>188</sup> The explanation for this is due to the  $\pi$  acceptor properties of the pyridazine alongside the strong chelating ability of the macrocycle which hinders any subsequent decomposition reaction. This has been confirmed for the [2 + 2] cobalt macrocyclic complex which may exhibit five different oxidation states.<sup>188</sup> This complex also shows very interesting magnetic properties since it exhibits both exchange coupling and spin-crossover effects.<sup>191</sup>

Dinucleating bis(dithiadimine) macrocycles having two  $\text{N}_2\text{S}_2$  compartments have been prepared and characterized alongside their dinuclear  $\text{Cu}^{\text{I}}$  complexes.<sup>192</sup>

SB-containing ferrocene groups have received much attention in the late 1990s. Thus, [1 + 1] and [2 + 2] macrocycles and a variety of acyclic SB-containing ferrocene groups have been prepared by reaction of formyl- and 1,1'-diformylferrocene with the appropriate diamine or by condensation of aminomethylferrocene with **(56a)**, **(57a)**, or 3-methoxy-2-hydroxybenzaldehyde.<sup>41</sup> The compounds have been characterized by IR, NMR, Mössbauer spectroscopy, and FAB mass spectroscopy.

### 1.19.9.3 Bibracchial Macrocycles

The metal-templated cyclocondensation of the appropriate dicarbonyl precursor with a functionalized diamine gives the so-called bibracchial (doubly pendant-armed) SB macrocycles (**Scheme 20**). This area has been reviewed.<sup>20</sup> Pendant arm macrocycles and their metal complexes have also attracted attention. Arms bearing additional potential ligating groups have been introduced at both carbon and nitrogen atoms of macrocycles which have generally been based on polyaza or



D = Head unit (phenol, thiophene, furan, pyrrole etc.)  
Z = amines, carboxylic acids, pyridine etc.

**Scheme 20**



polyoxa donor sets. A potential importance of these ligands derives from the concept that the presence of two pendant arms, bearing ligating groups attached at appropriate positions to a macrocyclic framework, would result in an opened cryptand thus leading to modified complexation properties relative to the simple macrocycle precursors. The incorporation of functionalized pendant arms into SB macrocycles has given rise to a series of compounds which provides molecular clefts for metal ion complexation. These have a similarity to the clefts which exist in proteins and enzymes and so give opportunity for biomimetic studies.

Bibracchial tetraimine SB macrocycle complexes derived from cyclocondensation of functionalized triamines with (56a), (56b), (58), (59), and (60) have been prepared in the presence of appropriate metal templates such as barium(II) and silver(I).<sup>193</sup>

#### 1.19.9.4 Ring Contraction and Expansion

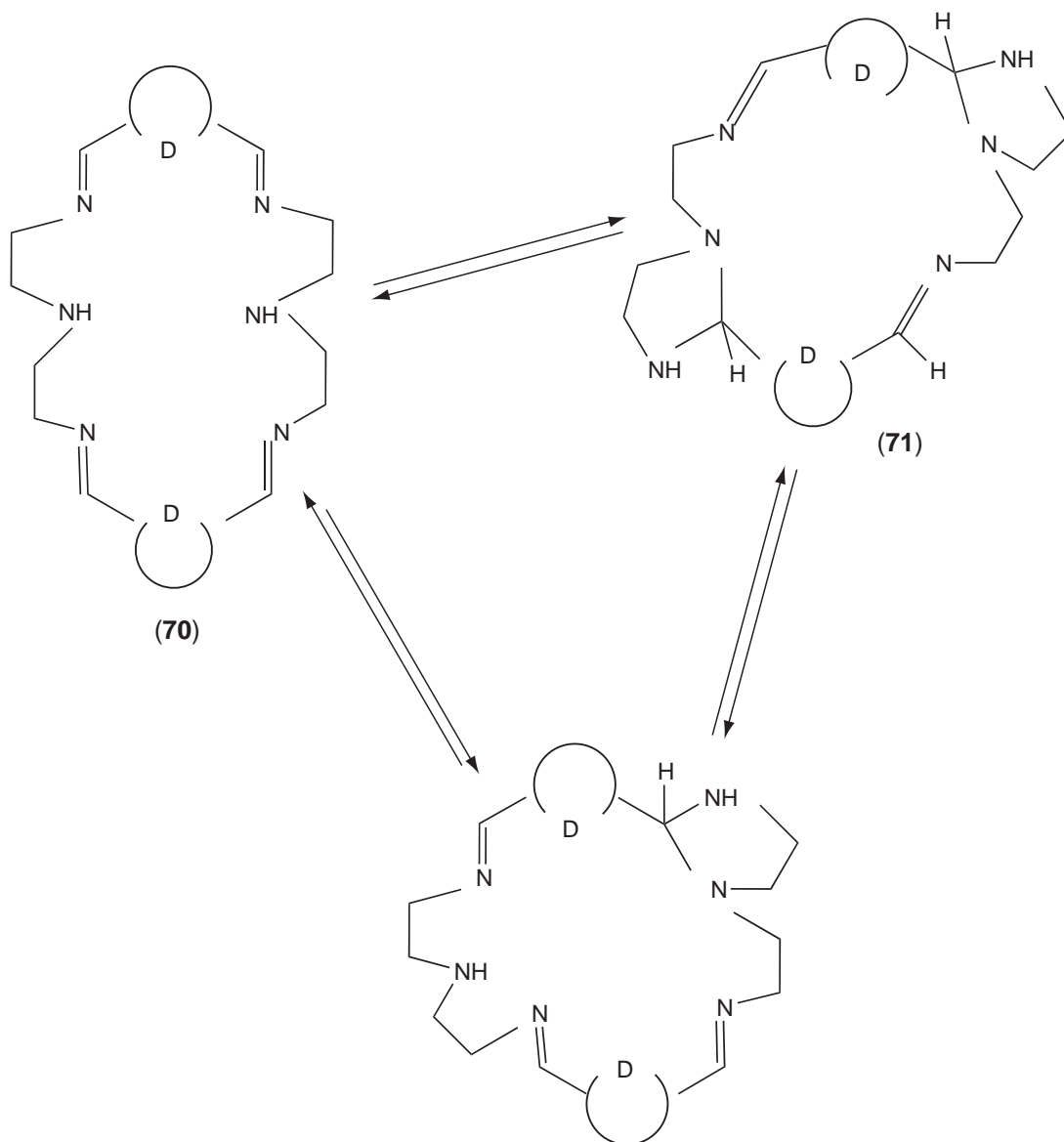
When in a macrocycle there is a functional group available ( $-\text{NH}-$ ,  $-\text{OH}$ , or  $-\text{SH}$ ) for addition to the imine bond and the metal ion used as template is too small for the macrocyclic cavity, a ring contraction reaction may occur during the condensation reaction.<sup>3</sup> Thus, ring contraction and ring expansion was observed (Scheme 21) in the [2 + 2] condensation reaction of (57a) and 1,5-diamino-3-azapentane which was carried out in the presence of lanthanide(III) salts. The lanthanide(III) was coordinated to only one chamber of the macrocycle. The other chamber not involved in coordination undergoes a ring contraction which allows a decrease in the macrocyclic cavity size and a reduction in the ligand denticity. The ring-closure phenomenon of the macrocycle leads to the existence of different isomers which have been evidenced by  $^1\text{H}$  NMR.<sup>3</sup>

The reaction of (56b) with diethylenetriamine (Scheme 21) in the presence of  $\text{Ba}^{\text{II}}$ ,  $\text{Sr}^{\text{II}}$ , or  $\text{Ca}^{\text{II}}$  forms complexes of the [2 + 2] macrocyclic ligand, when the reaction is carried out at high temperatures. While  $\text{Mg}^{\text{II}}$  is ineffective as template, the barium-containing macrocycle has a structure containing an 18-membered inner ring (71) (formed by nucleophilic addition of the two secondary amine groups across adjacent azomethine bonds with formation of two imidazolidine rings from the inner large ring) rather than the expected 24-membered larger ring. The extended macrocycle is not well suited to the encapsulation of a single metal ion. A ring expansion of the  $[\text{Sr}(71)](\text{ClO}_4)_2$  occurs when treated with  $\text{AgClO}_4$  where the binuclear  $[\text{Ag}_2(70)](\text{ClO}_4)_2$  was obtained. This ring expansion on exchange of a coordinated alkaline-earth metal ion by two  $\text{Ag}^{\text{I}}$  was found to be reversible.<sup>33</sup> Therefore, when the dinuclear silver complex was treated with  $\text{BaCl}_2$  the ring-contracted macrocycle  $[\text{Ba}(71)](\text{ClO}_4)_2$  and  $\text{AgCl}$  were obtained.

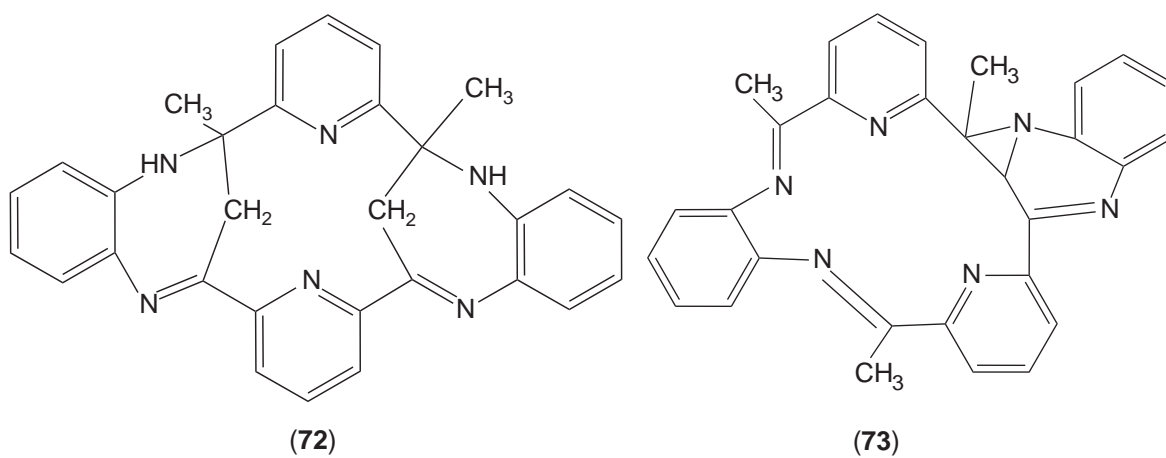
A ring closure process was also evident in the [2 + 2] 20-membered  $\text{Ba}^{\text{II}}$  macrocycle derived from (56b) and 1,3-diamino-2-hydroxypropane which upon transmetalation in the presence of  $\text{Pb}^{\text{II}}$  gives a ring-contracted (18-membered ring)  $\text{Pb}^{\text{II}}$  macrocycle.<sup>187</sup>

The structure of the metal-free macrocycle resulting from condensation of (56b) with *o*-phenylenediamine contains one 12-membered and two 7-membered inner rings (72) and not a single 18-membered inner ring as initially proposed.<sup>15</sup> The adoption of the structure with three inner rings instead of the one having 18-membered ring can be explained in terms of the steric hindrance which would exist in the latter between the methyl groups and the *ortho*-hydrogen atoms of the phenyl rings which would favor a tautomeric shift to the enamine form. Free rotation about the single C—N bond so formed allows the nucleophilic attack by the electron-rich  $\text{C}=\text{CH}_2$  function at the imino carbon atom of the neighboring azomethine linkage to give a 7-membered ring. The structure adopted by this ligand explains its failure to form stable metal complexes with a range of metal ions. Molecular models show that the ligand can only act as monodentate to any metal ion. The central 12-membered ring is too small to accommodate a metal ion and besides the positions and orientations of the two pyridine nitrogen lone pairs are such that they can not chelate to a metal ion sitting outside the ring. However, this ligand may undergo unusual rearrangement and form a stable complex with  $\text{Cu}^{\text{II}}$ . Thus, in the presence of  $\text{Cu}^{\text{II}}$  and dioxygen a rearrangement of the ligand from a structure containing a (7 + 12 + 7) inner ring system (72) to another containing a (15 + 6 + 3) inner ring system (73) with loss of two hydrogen atoms is observed.<sup>19</sup> The  $\text{Cu}^{\text{II}}$  is located in the 15-membered ring and is bound to the two pyridine nitrogen atoms and the two imino nitrogen atoms. In the ligand rearrangement the reverse reaction of the  $\text{C}=\text{CH}_2$  to  $\text{C}=\text{N}$  addition occurs, and the aziridine ring formation via dehydrogenation. The driving force of the rearrangement is the stability gained by providing a suitably sized macrocycle cavity for the metal ion.





Scheme 21



## ACKNOWLEDGEMENTS

We wish to thank to Dr. Maxim Sokolov and Dr. Joaquín Sanchiz for helpful suggestions.

## 1.19.10 REFERENCES

1. Guerreiro, P.; Tamburini, S.; Vigato, P. A.; Russo, U.; Benelli, C. *Inorg. Chim. Acta* **1993**, *213*, 279–287.
2. Okawa, H.; Furutachi, H.; Fenton, D. E. *Coord. Chem. Rev.* **1998**, *174*, 51–75.
3. Guerreiro, P.; Tamburini, S.; Vigato, P. A. *Coord. Chem. Rev.* **1995**, *139*, 17–243.
4. Canali, L.; Sherrington, D. C. *Chem. Soc. Rev.* **1999**, *28*, 85–93.
5. Fenton, D. E. *Chem. Soc. Rev.* **1988**, *17*, 69–90.
6. Vigato, P. A.; Tamburini, S.; Fenton, D. E. *Coord. Chem. Rev.* **1990**, *106*, 25–170.
7. Calligaris, M.; Randaccio, L. *Comprehensive Coordination Chemistry*, Wilkinson, G.; Guillard, R. D.; McCleverty, J. A., Ed., Pergamon: Oxford, 1987, Vol 2, Chap. 20, pp 715–738.
8. Wozniak, K.; Kolodziejski, W.; Anulewicz, R.; Pawlak, D.; Jackowski, K.; Dziembowska, T.; Rozwadowski, Z. *J. Mol. Struct.* **1999**, *478*, 267–274.
9. Yildiz, M.; Kiliç, Z.; Hökelek, T. *J. Mol. Struct.* **1998**, *441*, 1–10.
10. Hökelek, T.; Kiliç, Z.; Isiklan, M.; Toy, M. *J. Mol. Struct.* **2000**, *523*, 61–69.
11. Nazir, H.; Yildiz, M.; Yilmaz, H.; Tahir, M. N.; Ülkü, D. *J. Mol. Struct.* **2000**, *524*, 241–250.
12. Atkins, A. J.; Black, D.; Blake, A. J.; Merin-Becerra, A.; Parsons, S.; Ruiz-Ramirez, L.; Schröder, M. *Chem. Commun.* **1996**, 457–464.
13. Atkins, A. J.; Blake, A. J.; Schröder, M. *J. Chem. Soc., Chem. Commun.* **1993**, 1662–1665.
14. Aguiari, A.; Bullita, E.; Casellato, U.; Guerreiro, P.; Tamburini, S.; Vigato, P. A. *Inorg. Chim. Acta* **1992**, *202*, 157–171.
15. Cabral, J. O.; Cabral, M. F.; Drew, M. G. B.; Esho, F. S.; Haas, O.; Nelson, S. M. *J. Chem. Soc., Chem. Commun.* **1982**, 1066–1067.
16. Banbery, H. J.; Hussain, W.; Hamor, T. A.; Jones, C. J.; McCleverty, J. A. *J. Chem. Soc., Dalton Trans.* **1990**, 657–661.
17. Dilworth, J. R.; Howe, S. D.; Hutson, A. J.; Miller, J. R.; Silver, J.; Thompson, R. M.; Harman, M.; Hursthouse, M. B. *J. Chem. Soc. Dalton Trans.* **1994**, 3553–3562.
18. Bailey, N. A.; Fenton, D. E.; Gayda, S. E.; Phillips, C. A. *J. Chem. Soc., Dalton Trans.* **1984**, 2289–2292.
19. Cabral, J. O.; Cabral, M. F.; Drew, M. G. B.; Esho, F. S.; Nelson, S. M. *J. Chem. Soc., Chem. Commun.* **1982**, 1068–1069.
20. Collinson, S. R.; Fenton, D. E. *Coord. Chem. Rev.* **1996**, *148*, 19–40.
21. Fenton, D. E.; Vigato, P. A. *Chem. Soc. Rev.* **1988**, *17*, 69–90.
22. Zanello, P.; Tamburini, S.; Vigato, P. A.; Mazzocchin, G. A. *Coord. Chem. Rev.* **1987**, *77*, 165–273.
23. Mederos, A.; Domínguez, S.; Hernández-Molina, R.; Sanchiz, J.; Brito, F. *Coord. Chem. Rev.* **1999**, *193–195*, 857–911.
24. Costamagna, J.; Vargas, J.; Latorre, R.; Alvarado, A.; Mena, G. *Coord. Chem. Rev.* **1992**, *119*, 67–88.
25. Aly, M. M. *J. Coord. Chem.* **1998**, *98*, 89–113.
26. Calligaris, M.; Nardin, G.; Randaccio, L. *Coord. Chem. Rev.* **1972**, *7*, 385–403.
27. Yamada, S.; Takeuchi, A. *Coord. Chem. Rev.* **1982**, *43*, 187–204.
28. Maurya, M. R.; Syamal, A. *Coord. Chem. Rev.* **1989**, *95*, 183–238.
29. Casas, J. S.; Garcia-Tasende, M. S.; Sordo, J. *Coord. Chem. Rev.* **2000**, *209(1)*, 197–261.
30. Brooker, S. *Coord. Chem. Rev.* **2001**, *222*, 33–56.
31. Garnovskii, A. D.; Nivorozhkin, A. L.; Minkin, V. I. *Coord. Chem. Rev.* **1993**, *126*, 1–69.
32. Mederos, A.; Domínguez, S.; Hernández-Molina, R.; Sanchiz, J.; Brito, F. *Coord. Chem. Rev.* **1999**, *193–195*, 913–939.
33. Drew, M. G. B.; Nelson, J.; Nelson, S. M. *J. Chem. Soc., Dalton Trans.* **1981**, 1678–1684.
34. Boca, M.; Valigura, D.; Linert, W. *Tetrahedron* **2000**, *56*, 441–446.
35. Braunstein, P.; Pietsch, J.; Chauvin, Y.; Mercier, S.; Saussine, L.; DeCian, A.; Fischer, J. *J. Chem. Soc., Dalton Trans.* **1996**, 3571–3574.
36. Dessy, G.; Fares, V.; Scaramuzza, L.; Tomlinson, A. A. G. *J. Chem. Soc., Dalton Trans.* **1978**, 1549–1553.
37. Dong, Y. B.; Smith, M. D.; Loye, H. *Inorg. Chem.* **2000**, *39*, 4927–4935 and references cited therein.
38. Choudhary, N.; Hughes, D. L.; Kleinkes, U.; Larkworthy, L. F.; Leigh, G. J.; Maiwald, M.; Marmion, C. J.; Sanders, J. R.; Smith, G. W.; Sudbrake, C. *Polyhedron* **1997**, *16*, 1517–1528.
39. Torayama, H.; Asada, H.; Fujiwara, M.; Matsushita, T. *Polyhedron* **1998**, *17*, 3859–3874.
40. Yamada, S. *Coord. Chem. Rev.* **1999**, *190–192*, 537–555.
41. Bullita, E.; Casellato, U.; Ossola, F.; Tomasin, P.; Vigato, P. A.; Russo, U. *Inorg. Chim. Acta* **1999**, *287*, 117–133 and references cited therein.
42. Caubet, A.; López, C.; Bosque, C.; Solans, X.; Font-Bardia, M. *J. Organomet. Chem.* **1999**, *577*, 292–304.
43. García-Vázquez, J. A.; Romero, J.; Duran, M. L.; Sousa, A.; Garnovskii, A. D.; Burlov, A. S.; Garnovskii, D. A. *Polyhedron* **1998**, *17*, 1547–1552.
44. Nivorozhkin, A. L.; Nivorozhkin, L. E.; Minkin, V. I.; Takhirov, T. G.; Diachenko, O. A. *Polyhedron* **1991**, 179–185.
45. Antsishkina, A. S.; Porai-Koshits, M. A.; Nivorozhkin, A. L.; Vasilchenko, I. S.; Nivorozhkin, L. E.; Garnovsky, A. D. *Inorg. Chim. Acta* **1991**, *180*, L151–152.
46. Nivorozhkin, A. L.; Sukhholenko, E. V.; Nivorozhkin, L. E.; Borisenko, N. I.; Minkin, V. I.; Grishin, Y. K.; Diachenko, O. A.; Takhirov, T. G.; Tagiev, D. B. *Polyhedron* **1989**, *8*, 569–575.
47. Ghilardi, C. A.; Midollini, S.; Moneti, S.; Orlandini, A.; Scapacci, G. *J. Chem. Soc., Dalton Trans.* **1992**, 3371–3376.
48. Sánchez, G.; Serrano, J. L.; Moral, M. A.; Pérez, J.; Molins, E.; López, G. *Polyhedron* **1999**, *18*, 3057–3064.
49. Crociani, L.; Bandoli, G.; Dolmella, A.; Basato, M.; Corain, B. *Eur. J. Inorg. Chem.* **1998**, 1811–1820.
50. Mudalige, D. C.; Ma, E. S.; Rettig, S. J.; James, B. R.; Cullen, W. R. *Inorg. Chem.* **1997**, *36*, 5426–5427.
51. Sánchez, G.; Serrano, J. L.; Momblona, F.; Ruiz, F.; García, J.; Pérez, J.; López, G.; Chaloner, P. A.; Hitchcock, P. *Polyhedron* **2001**, *20*, 571–578.

52. Brunner, H.; Fürst, J. *Inorg. Chim. Acta* **1994**, *220*, 63–66.
53. Kwiatkowski, M.; Kwiatkowski, E.; Olechnowicz, A.; Ho, D. M.; Deutsch, E. *Inorg. Chim. Acta* **1988**, *150(1)*, 65–73.
54. Costes, J. P. *Polyhedron* **1987**, *6*, 2169–2175.
55. Kwiatkowski, M.; Kwiatkowski, E.; Olechnowicz, A.; Ho, D. M.; Deutsch, E. *J. Chem. Soc., Dalton Trans.* **1990**, 2497–2502.
56. Costes, J. P.; Fernández-García, M. I. *Inorg. Chim. Acta* **1995**, *237*, 57–63.
57. Kwiatkowski, E.; Klein, M.; Romanowski, G. *Inorg. Chim. Acta* **1999**, *293*, 115–122.
58. Costes, J. P.; Dahan, F.; Dominguez-Vera, J. M.; Laurent, J. P.; Ruiz, J.; Sotiropoulos, J. *Inorg. Chem.* **1994**, *33*, 3908–3913.
59. Costes, J. P.; Fenton, D. E. *J. Chem. Soc., Dalton Trans.* **1983**, 2235–2239.
60. Kwiatkowski, M.; Kwiatkowski, E.; Olechnowicz, A.; Ho, D. M.; Deutsch, E. *J. Chem. Soc., Dalton Trans.* **1990**, 3063–3069.
61. Costes, J. P.; Dahan, F.; Laurent, J. P. *Inorg. Chem.* **1986**, *25*, 413–416.
62. Kwiatkowski, M.; Kwiatkowski, E.; Olechnowicz, A.; Bandoli, G. *Inorg. Chim. Acta* **1991**, *182*, 117–121.
63. Costes, J. P.; Dahan, F.; Laurent, J. *J. Coord. Chem.* **1984**, *13*, 355–362.
64. Costes, J. P.; Dahan, F.; Laurent, J. P. *Inorg. Chem.* **1985**, *24*, 1018–1022.
65. Root, C. A.; Hoeschele, J. D.; Cornman, C. R.; Kampf, J. W.; Pecoraro, V. L. *Inorg. Chem.* **1993**, *32*, 3855–3861.
66. Nowicka, B.; Samotus, A.; Szklarzewicz, J.; Heinemann, F. W.; Kisch, H. *J. Chem. Soc., Dalton Trans.* **1998**, 4009–4013.
67. Leoni, P.; Grilli, E.; Pasquali, M.; Tomassini, M. *J. Chem. Soc., Dalton Trans.* **1986**, 879–881.
68. Tandon, S. S.; Chander, S.; Thompson, L. K. *Inorg. Chim. Acta* **2000**, *300–302*, 683–692.
69. Creber, M. L.; Orrell, K. G.; Osborne, A. G.; Sik, V.; Coles, S. J.; Hibbs, D. E.; Hursthouse, M. B. *Inorg. Chim. Acta* **2000**, *299*, 209–220.
70. Gütllich, P.; Hauser, A. *Coord. Chem. Rev.* **1990**, *97*, 1–22.
71. Goodwin, H. A. *Coord. Chem. Rev.* **1976**, *18*, 293–325.
72. Hernández-Molina, R.; Mederos, A.; Dominguez, S.; Gili, P.; Ruiz-Pérez, C.; Castiñeiras, A.; Solans, X.; Lloret, F.; Real, J. A. *Inorg. Chem.* **1998**, *37*, 5102–5108.
73. Maeda, Y.; Takashima, Y.; Matsumoto, N.; Ohyoshi, A. *J. Chem. Soc., Dalton Trans.* **1986**, 1115–1123.
74. Fukuya, M.; Ohba, M.; Motoda, K.; Matsumoto, N.; Okawa, H.; Maeda, Y. *J. Chem. Soc., Dalton Trans.* **1993**, 3277–3281.
75. Kennedy, B. J.; McGrath, A. C.; Murray, K. S.; Skelton, B. W.; White, A. H. *Inorg. Chem.* **1987**, *26*, 483–495.
76. Oshio, H.; Toriumi, Maeda, Y.; Takashima, Y. *Inorg. Chem.* **1991**, *30*, 4252–4260.
77. Matsumoto, N.; Maeda, Y.; Okawa, H.; Akui, T.; Kawaji, T.; Ohyoshi, A.; Kodera, M.; Oshio, H.; Kida, S. *J. Chem. Soc., Dalton Trans.* **1989**, 943–946.
78. Nakajima, K.; Ishibashi, S.; Inamo, M.; Kojima, M. *Inorg. Chim. Acta* **2001**, *325*, 36–44.
79. Chen, X.; Femia, F. J.; Babich, J. W.; Zubieta, J. *Inorg. Chim. Acta* **2000**, *307*, 149–153.
80. Souza, P.; Matesanz, A. I.; Fernández, V. *J. Chem. Soc., Dalton Trans.* **1996**, 3011–3013.
81. Ketcham, K. A.; Swearingen, J. K.; Castiñeiras, A.; Garcia, I.; Bermejo, E.; West, D. X. *Polyhedron* **2001**, *20*, 3265–3273.
82. Fernández-García, M. I.; Fernández-Fernández, B.; Fondo, M.; García-Deibe, A. M.; Gómez-Fórneas, E.; Bermejo, M. R.; Sanmartín, J.; González, A. M. *Inorg. Chim. Acta* **2000**, *304*, 144–149.
83. García-Deibe, A.; Bermejo, M. R.; Soisa, A.; McAuliffe, C. A.; McGlynn, P.; Ndifon, P. T.; Pritchard, R. G. *J. Chem. Soc., Dalton Trans.* **1993**, 1605–1610.
84. Matsumoto, N.; Akui, T.; Murakami, H.; Kanesaka, J.; Ohyoshi, A.; Okawa, H. *J. Chem. Soc., Dalton Trans.* **1988**, 1021–1035.
85. Matsumoto, N.; Yamashita, S.; Ohyoshi, A.; Kohata, S.; Okawa, H. *J. Chem. Soc., Dalton Trans.* **1988**, 1943–1948.
86. Bermejo, M. R.; González, A. M.; Fondo, M.; Maneiro, M.; Rey, M.; Vázquez, M.; Hoyos, O. L.; García-Montegudo, J. C. *Inorg. Chim. Acta* **2000**, *307*, 106–114.
87. Brewer, G.; Kamaras, P.; May, L.; Prytkov, S.; Rapta, M. *Inorg. Chim. Acta* **1998**, *279*, 111–115.
88. Burke, P. J.; McMillin, D. R. *J. Chem. Soc., Dalton Trans.* **1980**, 1794–1796.
89. Luo, H.; Fanwick, P. E.; Green, M. A. *Inorg. Chem.* **1998**, *37*, 1127–1130.
90. Bermejo, M. R.; García-Deibe, A. M.; Rey, M.; Sanmartín, J.; Sousa, A.; Aurangzeb, N.; Hulme, C. E.; McAuliffe, C. A.; Pritchard, R. G.; Watkinson, M.; Helliwell, M. *J. Chem. Soc., Dalton Trans.* **1994**, 1265–1269.
91. Bermejo, M. R.; Fondo, M.; García-Deibe, A. M.; Rey, M.; Sanmartín, J.; Sousa, A.; Watkinson, M. *Polyhedron* **1996**, *15*, 4185–4194.
92. Choudhary, N. F.; Connelly, N. G.; Hitchcock, P. B.; Leigh, G. J. *J. Chem. Soc., Dalton Trans.* **1999**, 4437–4446.
93. Bermejo, M. R.; Castiñeiras, A.; García-Montegudo, J. C.; Rey, M.; Sousa, A.; Watkinson, M.; McAuliffe, C. A.; Pritchard, R. G.; Beddoes, R. L. *J. Chem. Soc., Dalton Trans.* **1996**, 2935–2944.
94. Pasini, A.; Demartin, F.; Piovesana, O.; Chiari, B.; Cinti, A.; Crispu, O. *J. Chem. Soc., Dalton Trans.* **2000**, 3467–3472.
95. Chiari, B.; Cinti, A.; Crispu, O.; Demartin, F.; Pasini, A.; Piovesana, O. *J. Chem. Soc., Dalton Trans.* **2001**, 3611–3616.
96. Yoshida, N.; Ichikawa, K.; Shiro, M. *J. Chem. Soc., Perkin Trans.* **2000**, *2*, 17–26.
97. Yoshida, N.; Ichikawa, K. *Chem. Commun.* **1997**, 1091–1092.
98. Yoshida, N.; Oshio, H.; Ito, T. *Chem. Commun.* **1998**, 63–64.
99. Yoshida, N.; Oshio, H.; Ito, T. *J. Chem. Soc., Perkin Trans.* **1999**, *2*, 975–983.
100. Hannon, M. J.; Bunce, S.; Clarke, A. J.; Alcock, N. W. *Angew. Chem., Int. Ed. Engl.* **1999**, *38*, 1277–1278.
101. Bowyer, P. K.; Porter, K. A.; Rae, A. D.; Willis, A. C.; Wild, S. B. *Chem. Commun.* **1998**, 1153–1154.
102. Tong, M.-L.; Chen, X.-M.; Ye, B.-H.; Ji, L.-N. *Angew. Chem., Int. Ed. Engl.* **1999**, *38*, 2237–2238.
103. Bastida, R.; Blas, A.; Fenton, D. E.; Rodríguez, T. *Polyhedron* **1992**, 2739–2745.
104. Bailey, N. A.; Bastida, R.; Fenton, D. E.; Lockwood, S. J.; McLean, C. H. *J. Chem. Soc., Dalton Trans.* **1988**, 839–845.
105. Bastida, R.; Lage, T.; Parrado, C.; Rodríguez, T.; Sousa, A.; Fenton, D. E. *J. Chem. Soc., Dalton Trans.* **1990**, 2101–2104.

106. Bermejo, M. R.; Sousa, A.; García-Deibe, A. M.; Maneiro, M.; Sanmartín, J.; Fondo, M. *Polyhedron* **1998**, *17*, 1–8.
107. Bastida, R.; Blas, A.; Rodríguez, T.; Sousa, A.; Fenton, D. E. *Inorg. Chim. Acta* **1993**, *203*, 1–3.
108. Bastida, R.; Blas, A.; Fenton, D. E.; Rial, C.; Rodríguez, T.; Sousa, A. *J. Chem. Soc., Dalton Trans.* **1993**, 265–268.
109. Gomes, L.; Pereira, E.; Castro, B. *J. Chem. Soc., Dalton Trans.* **2000**, 1373–1379.
110. Pereira, E.; Gomes, L.; Castro, B. *J. Chem. Soc., Dalton Trans.* **1998**, 629–636.
111. Cour, A.; Findeisen, M.; Hazell, R.; Hazell, R.; Zdobinsky, G. *J. Chem. Soc., Dalton Trans.* **1997**, 121–128.
112. Nivorozhkin, A. L.; Toftlund, H.; Nielsen, M. *J. Chem. Soc., Dalton Trans.* **1994**, 361–367.
113. Casella, L.; Gulloti, M.; Suardi, E.; Sisti, M.; Pagliarin, R.; Zanello, P. *J. Chem. Soc., Dalton Trans.* **1990**, 2843–2851.
114. Becher, J.; Brockway, D. J.; Murray, K. S.; Newman, P. J.; Toftlund, H. *Inorg. Chem.* **1982**, *21*, 1791–1798.
115. Casella, L. *Inorg. Chem.* **1984**, *23*, 2781–2787.
116. Ligtenbarg, A. G. J.; van den Beuken, E. K.; Meetsma, A.; Veldman, N.; Smeets, W. J. J.; Spek, A. L.; Feringa, B. L. *J. Chem. Soc., Dalton Trans.* **1998**, 263–270.
117. Watkins, S. E.; Craig, D. C.; Colbran, S. B. *Inorg. Chim. Acta* **2000**, *307*, 134–138.
118. Zhang, W.; Loebach, J. L.; Wilson, S. R.; Jacobsen, E. N. *J. Am. Chem. Soc.* **1990**, *112*, 2801–2803.
119. Tokunaga, M.; Larrow, J. F.; Kakiuchi, F.; Jacobsen, E. N. *Science* **1997**, *277*, 936–937.
120. López, J.; Mintz, E. A.; Hsu, F.-L.; Bu, X. R. *Tetrahedron Asymmetry* **1998**, *9*, 3741–3744.
121. López, J.; Liang, S.; Bu, X. R. *Tetrahedron Lett.* **1998**, *39*, 4199–4202.
122. Haikarainen, A.; Sipilä, J.; Pietikäinen, P.; Pajunen, A.; Mutikainen, I. *J. Chem. Soc., Dalton Trans.* **2001**, 991–995.
123. Hernández-Molina, R.; Mederos, A.; Gili, P.; Domínguez, S.; Núñez, P.; Germain, G.; Debaerdemaeker, T. *Inorg. Chim. Acta* **1997**, *256*, 319–325.
124. Hernández-Molina, R.; Mederos, A.; Gili, P.; Domínguez, S.; Núñez, P. *Polyhedron* **1997**, *16*, 4191–4196.
125. Motekaitis, R. J.; Martell, A. E. *Inorg. Chem.* **1988**, *27*, 2718–2724.
126. Lloret, P.; Moratal, J.; Faus, J. *J. Chem. Soc., Dalton Trans.* **1983**, 1743–1748.
127. Lloret, F.; Mollar, M.; Faus, J.; Julve, M.; Castro, I.; Diaz, V. *Inorg. Chim. Acta* **1991**, *189*, 195–206.
128. Hernández-Molina, R.; Mederos, A.; Gili, P.; Domínguez, S.; Lloret, F.; Cano, J.; Julve, M.; Ruiz-Pérez, C.; Solans, X. *J. Chem. Soc., Dalton Trans.* **1997**, 4327–4334.
129. Torayama, H.; Nishida, T.; Asada, H.; Fujiwara, M.; Matsushita, T. *Polyhedron* **1997**, *16*, 3787–3794.
130. Chen, D.; Martell, A. E.; Sun, Y. *Inorg. Chem.* **1989**, *28*, 2647–2652.
131. Motekaitis, R. J.; Martell, A. E. *Inorg. Chem.* **1988**, *27*, 2718–2724.
132. Chen, D.; Martell, A. E. *Inorg. Chem.* **1987**, *26*, 1026–1030.
133. Furutachi, H.; Fujinami, S.; Suzuki, M.; Okawa, H. *J. Chem. Soc., Dalton Trans.* **2000**, 2761–2769.
134. Park, S.; Mathur, V. K.; Planalp, R. P. *Polyhedron* **1998**, *17*, 325–330.
135. Ali, M. A.; Mirza, A. H.; Butcher, R. J.; Tarafder, M. T. H.; Ali, M. A. *Inorg. Chim. Acta* **2001**, *320*, 1–6.
136. Majumder, S. M. M. H.; Ali, M. A.; Smith, F. E.; Mridha, M. A. U. *Polyhedron* **1988**, 2183–2187.
137. Bino, A.; Cohen, N. *Inorg. Chim. Acta* **1993**, *210*, 11–16.
138. Liu, S.; Rettig, S. J.; Orvig, C. *Inorg. Chem.* **1991**, *30*, 4915–4919.
139. Refosco, L.; Tisato, F.; Mazzi, U.; Bandoli, G.; Nicolini, M. *J. Chem. Soc., Dalton Trans.* **1988**, 611–615.
140. Boca, R.; Fukuda, Y.; Gembický, M.; Herchel, R.; Jarosciak, R. LinertW.; Renz, F.; Yuzurihara, J. *Chem. Phys. Lett.* **2000**, *325*, 411–419.
141. Hoyos, O. L.; Bermejo, M. R.; Fondo, M.; García-Deibe, A.; González, A. M.; Maneiro, M.; Pedrido, R. *J. Chem. Soc., Dalton Trans.* **2000**, 3122–3127.
142. Casellato, U.; Guerreiro, P.; Tamburini, S.; Sitran, S.; Vigato, P. A. *J. Chem. Soc., Dalton Trans.* **1991**, 2145–2152.
143. Costes, J. P.; Dahan, F.; Dupuis, A. *Inorg. Chem.* **2000**, *39*, 165–168.
144. Sanmartín, J.; Bermejo, M. R.; García-Deibe, A. M.; Nascimento, O. R.; Costa-Filho, A. J. *Inorg. Chim. Acta* **2001**, *318*, 135–142.
145. Sanmartín, J.; Bermejo, M. R.; García-Deibe, A. M.; Piro, O.; Castellano, E. E. *Chem. Commun.* **1999**, 1953–1954.
146. Sanmartín, J.; Bermejo, M. R.; García-Deibe, A. M.; Llamas-Saiz, A. L. *Chem. Commun.* **2000**, 795–796.
147. Fenton, D. E.; Gayda, S. E. *J. Chem. Soc., Dalton Trans.* **1977**, 2095–2101.
148. Fenton, D. E.; Gayda, S. E. *J. Chem. Soc., Dalton Trans.* **1977**, 2101–2109.
149. Adams, H.; Bailey, N. A.; Fenton, D. E.; Leal González, M. S.; Phillips, C. A. *J. Chem. Soc., Dalton Trans.* **1983**, 371–379.
150. Bailey, N. A.; Cox, K. C.; Falshaw, C. P.; Fenton, D. E.; Grundy, S. E.; Haigh, P.; Phillips, C. A.; King, T. J. *J. Chem. Soc., Dalton Trans.* **1983**, 2241–2249.
151. Fenton, D. E.; Gayda, S. E. *J. Chem. Soc., Dalton Trans.* **1977**, 2109–2115.
152. Adams, H.; Bailey, N. A.; Fenton, D. E.; Leal González, M. S. *J. Chem. Soc., Dalton Trans.* **1983**, 1345–1349.
153. Mazurek, W.; Berry, K. J.; Murray, K. S.; O'Connor, M. J.; Snow, M. R.; Wedd, A. G. *Inorg. Chem.* **1982**, *21*, 3071–3080.
154. Mazurek, W.; Kennedy, B. J.; Murray, K. S.; O'Connor, M. J.; Rodgers, J. R.; Snow, M. R.; Wedd, A. G.; Zwack, P. R. *Inorg. Chem.* **1985**, *24*, 3258–3264.
155. Grzybowski, J. J.; Merrell, P. H.; Urbach, F. L. *Inorg. Chem.* **1978**, *17*, 3078–3082.
156. Drago, R. S.; Desmond, M. J.; Corden, B. B.; Miller, K. A. *J. Am. Chem. Soc.* **1983**, *105*, 2287–2296.
157. Zhang, Z.-Y.; Brouca-Cabarrecq, C.; Hemmert, C.; Dahan, F.; Tuchagues, J. P. *J. Chem. Soc., Dalton Trans.* **1995**, 1453–1460.
158. Stelzig, L.; Steiner, A.; Chansou, B.; Tuchagues, J. P. *Chem. Commun.* **1998**, 771–772.
159. Sanmartín, J.; Bermejo, M. R.; García-Deibe, A. M.; Maneiro, M.; Lage, C.; Costa-Filho, A. J. *Polyhedron* **2000**, *19*, 185–192.
160. Smith, A.; Rettig, S. J.; Orvig, C. *Inorg. Chem.* **1988**, *27*, 3929–3934.
161. Costes, J. P.; Dupuis, A.; Commenges, G.; Lagrave, S.; Laurent, J. P. *Inorg. Chim. Acta* **1999**, *285*, 49–54.
162. Sato, T.; Takeda, H.; Sakai, K.; Tsubomura, T. *Inorg. Chim. Acta* **1996**, *246*, 413–421.
163. Parr, J.; Ross, A. T.; Salwin, A. M. Z. *J. Chem. Soc., Dalton Trans.* **1996**, 1509–1512.
164. Casellato, U.; Tamburini, S.; Tomasin, P.; Vigato, P. A.; Botta, M. *Inorg. Chim. Acta* **1996**, *247*, 143–145.
165. Liu, S.; Gelmini, L.; Rettig, S. J.; Thompson, R. C.; Orvig, C. *J. Am. Chem. Soc.* **1992**, *114*, 6081–6087.
166. Costes, J. P.; Dahan, F.; Dupuis, A.; Lagrave, S.; Laurent, J. P. *Inorg. Chem.* **1998**, *37*, 153–155.

167. Archibald, S. J.; Blake, A. J.; Schröder, M.; Winpenny, R. E. P. *J. Chem. Soc., Chem. Commun.* **1994**, 1669–1670.
168. Archibald, S. J.; Blake, A. J.; Parsons, S.; Schröder, M.; Winpenny, R. E. P. *J. Chem. Soc., Dalton Trans.* **1997**, 173–179.
169. Fenton, D. E.; Westwood, G. P.; Bashall, A.; Mcpartlin, M.; Scowen, I. J. *J. Chem. Soc., Dalton Trans.* **1994**, 2213–2214.
170. Bhattacharyya, P.; Parr, J.; Slawin, A. M. Z. *J. Chem. Soc., Dalton Trans.* **1998**, 3263–3267.
171. Brianese, N.; Casellato, U.; Tamburini, S.; Tomasin, P.; Vigato, P. A. *Inorg. Chim. Acta* **1998**, 272, 235–251.
172. McDowell, D.; Nelson, J. *Polyhedron* **1989**, 8, 1143–1145.
173. MacDowell, D.; Nelson, J. *Tetrahedron Lett.* **1988**, 29, 385–386.
174. Jazwinski, J.; Lehn, J. M.; Lilienbaum, D.; Ziessel, R.; Guilhem, J.; Pascard, C. *J. Chem. Soc., Chem. Commun.* **1987**, 1691–1694.
175. Harding, C. J.; Lu, Q.; Malone, J. F.; Marrs, D. J.; Martin, N.; McKee, V.; Nelson, J. *J. Chem. Soc., Dalton Trans.* **1995**, 1739–1747.
176. Nelson, J.; McKee, V.; Morgan, G. *Prog. Inorg. Chem.* **1998**, 47, 167–316.
177. McKee, V.; Shepard, W. B. *J. Chem. Soc., Chem. Commun.* **1985**, 158–159.
178. Brooker, S.; McKee, V.; Shepard, W. B.; Pannell, L. K. *J. Chem. Soc., Dalton Trans.* **1987**, 2555–2562.
179. Fenton, D. E.; Kitchen, S. J.; Spencer, C. M.; Tamburini, S.; Vigato, P. A. *J. Chem. Soc., Dalton Trans.* **1988**, 685–690.
180. Okawa, H.; Nishio, J.; Ohba, M.; Tadakoro, M.; Matsumoto, N.; Koikawa, M.; Kida, S.; Fenton, D. E. *Inorg. Chem.* **1993**, 32, 2949–2957.
181. Nishio, J.; Okawa, H.; Ohtsuka, S.; Tomono, M. *Inorg. Chim. Acta* **1994**, 218, 27–32.
182. Ohtsuka, S.; Koda, M.; Motoda, K.; Ohba, M.; Okawa, H. *J. Chem. Soc., Dalton Trans.* **1995**, 2599–2604.
183. Takodoro, M.; Sakiyama, H.; Naohide Matsumoto, Koda, M.; Okawa, H. *J. Chem. Soc., Dalton Trans.* **1992**, 313–317.
184. Korupoju, S. R.; Zacharias, P. S. *Chem. Commun.* **1998**, 1267–1268.
185. Korupoju, S. R.; Mangayarkarasi, Ameerunisha, S.; Valente, E. J.; Zacharias, P. S. *J. Chem. Soc., Dalton Trans.* **2000**, 2845–2852.
186. Bailey, N. A.; Eddy, M. M.; Fenton, D. E.; Moss, S.; Mukhopadhyay, A.; Jones, G. *J. Chem. Soc., Dalton Trans.* **1984**, 2281–2288.
187. Adams, H.; Bailey, N. A.; Fenton, D. E.; Good, R. J.; Moody, R.; Rodríguez de Barbarín, C. O. *J. Chem. Soc., Dalton Trans.* **1987**, 207–218.
188. S. Brooker, S.; Kelly, R. J.; Plieger, P. G. *Chem. Commun.* **1998**, 1079–1080.
189. Brooker, S.; Kelly, R. J.; Sheldrick, G. M. *J. Chem. Soc., Chem. Commun.* **1994**, 487–488.
190. Brooker, S.; Kelly, R. J. *J. Chem. Soc., Dalton Trans.* **1996**, 2117–2122.
191. Brooker, S.; Plieger, P. G.; Moubaraki, B.; Murray, K. S. *Angew. Chem., Int. Ed. Engl.* **1999**, 38, 408–410.
192. Wei, G.; Lawrance, G. A.; Richens, D. T.; Hambley, T. W.; Turner, P. *J. Chem. Soc., Dalton Trans.* **1998**, 623–627.
193. Adams, H.; Elsegood, M. R. J.; Fenton, D. E.; Heath, S. L.; Ryan, S. J. *J. Chem. Soc., Dalton Trans.* **1999**, 2031–2037.

# 1.20

## N Macrocyclic Ligands

N. F. CURTIS

*Victoria University of Wellington, New Zealand*

---

1.20.1	INTRODUCTION AND SCOPE	447
1.20.2	CYCLIC SECONDARY AMINES	449
1.20.3	AZAMACROCYCLES WITH IMINE FUNCTIONS	450
1.20.3.1	Ketone and $\beta$ -enone–Amine Reactions	451
1.20.3.2	2,6-Dicarbonyl Pyridine–Amine Reactions	452
1.20.3.3	Aromatic Aldehyde–Amine Reactions	452
1.20.3.4	$\beta$ -Keto Imine–Amine Reactions, Cyclidenes	452
1.20.3.5	$\alpha$ -Dicarbonyl–Amine Reactions	453
1.20.3.6	$\beta$ -Dicarbonyl–Amine Reactions	453
1.20.3.7	Compartmental Macrocycles	454
1.20.4	AZAMACROCYCLES WITH AMIDE OR AMIDATE FUNCTIONS	454
1.20.5	MACROCYCLES FORMED BY MANNICH CONDENSATIONS, AZACYCLAMS	457
1.20.6	AZAMACROCYCLES WITH C-SUBSTITUENTS	458
1.20.6.1	Functionalized C-substituents	458
1.20.6.2	Substituents Introduced via Amide Formation	459
1.20.6.3	Substitution of 1,3-diimine or Iminato Six-membered Chelate Rings	459
1.20.6.4	Nitro- and Amine-substituents	459
1.20.6.5	Nitromethyl and Aminomethyl Substituents	460
1.20.6.6	Carboxyl Substituents	461
1.20.6.7	2-Pyridyl Substituents	462
1.20.6.8	Hydroxymethyl Substituents	462
1.20.6.9	C-pendants that Coordinate Exocyclic Cations	462
1.20.7	AZAMACROCYCLES WITH N-SUBSTITUENTS	463
1.20.7.1	Unfunctionalized Substituents	464
1.20.7.2	Carboxyalkyl Substituents	464
1.20.7.3	Carbamoylmethyl Substituents	465
1.20.7.4	Hydroxyalkyl Substituents	465
1.20.7.5	Nitrile Substituents	465
1.20.7.6	$\omega$ -Aminoalkyl Substituents	465
1.20.7.7	Pyridylmethyl Substituents	466
1.20.7.8	N-pendants that Coordinate an Exocyclic Cation	466
1.20.7.9	Other N-substituents	466
1.20.8	BI- AND TRICYCLIC AZAMACROCYCLES	467
1.20.9	LINKED AZAMACROCYCLES	468
1.20.9.1	Cyclic Amines with a Shared C—C Bond	468
1.20.9.2	Spiro-azamacrocycles	468
1.20.9.3	C—C'-linked Bisazamacrocycles	469
1.20.9.4	N—X—N' Linked Bisazamacrocycles	469
1.20.10	CONCLUSIONS	471
1.20.11	REFERENCES	471

---

### 1.20.1 INTRODUCTION AND SCOPE

This chapter covers the coordinating properties of azamacrocycles, concentrating on developments since the publication of *Comprehensive Coordination Chemistry CCC* (1987),<sup>1,2</sup> excluding

porphyrins and phthalocyanines, which are covered in Chapters 1.23 and 1.24. Azamacrocycles with substituents with any donor atom are included. Monocycles with nine or more ring atoms with three or more nitrogen atoms, and bi- and tricyclic azamolecules where the coordinating nitrogen atoms are all within the primary macrocycle, and which otherwise fall within the scope of the chapter are included. Polycyclic macrocycles with donor nitrogen atoms on subsidiary links (clathrochelates) are not included. The subject area is subdivided according to the character of the *macrocycle* nitrogen atoms. Azamacrocycles can often be categorized in several ways, e.g., by having secondary or tertiary amine, amide, or imine functions within the macrocycle, by being bi- or tricyclic, or by having particular *C*- and/or *N*-substituents; in this chapter macrocycles are placed where first encountered.

Only a selection of the great diversity of reported azamacrocycles could be included. Most examples shown are of 14-membered tetraazamacrocycles, though usually analogues with other ring sizes, numbers of nitrogen atoms, or configurations are known, as well as variants incorporating other heteroatoms. The properties of tri- and pentadentate macrocycles<sup>3</sup> and cyclic hexamines<sup>4</sup> have been reviewed.

The macrocyclic porphyrins and phthalocyanines have been known since the 1910s and 1930s, respectively. The focus of study for the porphyrins was largely on their natural product origins and physiological significance, or for the phthalocyanines their utility as pigments, rather than their metal ion coordinating properties. Azamacrocycles were first studied primarily as ligands in the 1960s, after their serendipitous discovery as the products of metal ion-mediated “template” reactions. Imine formation was the usual ring-closing step and Ni<sup>II</sup> or Cu<sup>II</sup> the usual template ions.<sup>5</sup> The reactions were often idiosyncratic, usually with little ability to vary the cation, ring size, or substituents. Interest in these compounds was sparked by a variety of “anomalous” properties of compounds with first-row *d*-transition cations, when compared with their noncyclic analogues, which were ascribed to various “macrocyclic effects.” The main issues were about kinetics (exceptional resistance to acid demetallation, particularly of compounds with normally labile Ni<sup>II</sup> and Cu<sup>II</sup> ions), thermodynamic (unusually large formation constants), spectral (high ligand field strengths), and structural (short M—N distances).

The development of generic cyclic amine syntheses allowed systematic preparation of cyclic amines and the clarification of the dependence of their properties on ring-size, chelate ring arrangement, donor number, etc. By the time of *CCC* (1987) the macrocyclic effects had been largely explained. Acid resistance arises largely because of the absence of a terminal nitrogen function that can initiate an “unzipping” mechanism, and even cyclic diamines show the effect. The short bond lengths and high ligand field strengths arise from the inherently greater donor strength of secondary relative to primary amine nitrogen, without the steric penalties of additional *N*-substituents that occur for noncyclic secondary amines. Arguments about the relationship between optimum M—N distances, minimum-strain “hole sizes” of tetraaza macrocycles and observed M—N distances<sup>6</sup> have been largely resolved by recognition that angular deformations of the macrocycle, or of bond angles about the metal ion, generally cause less strain than distorting M—N distances. M—N distances are largely determined by intraligand repulsive interactions, which are usually smaller for macrocycles, thus permitting M—N distances to approach optimal values more closely. In consequence, M—N distances for sequences of cyclic tetraamines are usually essentially independent of ring size, strain being accommodated by angle deformations. The thermodynamic stability enhancement has both enthalpic and entropic components, the former influenced by the higher ligand field strength of the secondary amine macrocycle donor atoms, and the latter by the “preorganization” of the macrocycle, though both have high solvation components. The thermodynamic “macrocyclic enhancement” arises from the presence of the macrocycle and does not require a metal ion to be coordinated within the “hole.”

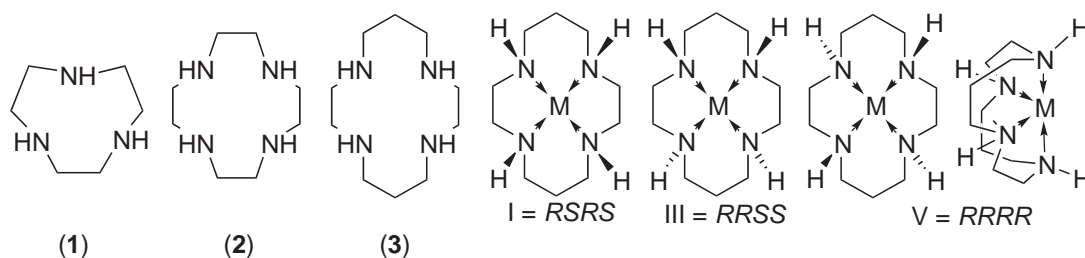
Important areas of growth since the publication of *CCC* (1987) in 1987 have included the synthesis of macrocycles with amide and amidate functions, the cyclization of metal-amine compounds by Mannich reactions, the preparation of polycyclic and of linked azamacrocycles, and the preparation of azamacrocycles with a diversity of functionalized *N*- and *C*-substituents. Much recent interest has been focused on azamacrocycles functionalized in some fashion, and much of the research has only marginally been about the “coordination chemistry” which is the primary focus of this chapter.

The coordination of aliphatic azamacrocycles with secondary amine, tertiary amine, and/or imine donor atoms is largely restricted to cations of the later *d*-transition elements, but macrocycles with aromatic functions and/or extensive delocalization coordinate with a wider range of cations. The introduction of *N*- or *C*-substituents with *O*-donor functions (such as carboxyl, carbamoyl, phenol, or alcohol groups) increases this range to include most cations. Compounds of such macrocycles with lanthanide ions have been studied extensively as possible spin relaxation agents for magnetic resonance imaging, or as carriers and targeting agents for radiopharmaceuticals. Much research has focused on the physiological compatibility of azamacrocyclic compounds and the elaboration of substituents that

confer biomimetic or biomedically useful properties.<sup>7</sup> Interest in linked azamacrocycles has been spurred by indications that their compounds show antiviral activity and inhibit human immunodeficiency virus (HIV) replication, at least *in vitro*.<sup>8,9</sup> More generally there has been increasing interest in azamacrocyclic compounds as biomimetic models and as catalysts, particularly for peroxidation reactions and for electrochemical CO<sub>2</sub> fixation.

Kinetic and thermodynamic properties of azamacrocycles and their complexes have been tabulated,<sup>10</sup> and the structural features that influence these values have been analyzed,<sup>11–14</sup> giving some understanding of metal ion selectivity. Many structures of azamacrocyclic compounds have been reported.<sup>15–20</sup>

Where a topic has been included in a recent review, that is usually referenced, and usually only the most recent in a sequence of papers on any topic, or by any author is referenced. Systematic names have been avoided, compounds being shown in figures, or as derivatives of tacn (1,5,9-triazacyclonone (1)), cyclen (1,4,7,10-tetraazacyclododecane (2)), or cyclam (1,4,8,11-tetraazacyclotetradecane (3)) (Scheme 1). Configurations are described using the Bosnich terminology.<sup>21</sup> The abbreviations en (ethane-1,2-diamine), tmd (propane-1,3-diamine), 2,2-tri (3-azapentan-1,5-diamine), 2,3-tri (3-azahexan-1,6-diamine), 2,2,2-tet (3,6-diazaoctan-1,8-diamine), 2,3,2-tet (3,7-diazanonan-1,9-diamine = (6)), 3,2,3-tet (4,7-diazadecan-1,10-diamine), etc. are used. Ring size is shown as [n].



Scheme 1

### 1.20.2 CYCLIC SECONDARY AMINES

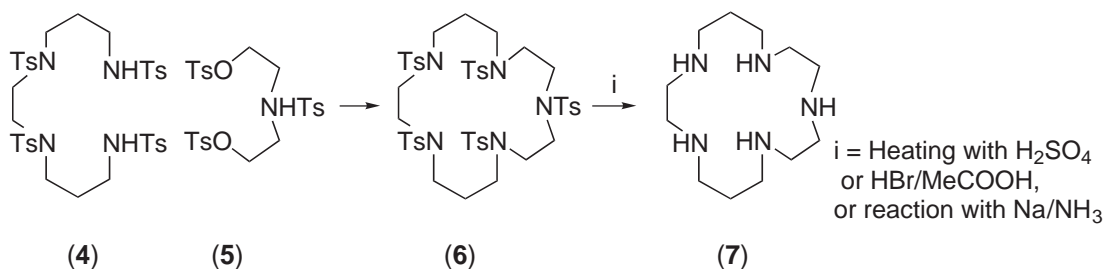
Studies of compounds of the prototypic cyclic secondary amines tacn (1), cyclen (2), and cyclam (3), and of the cyclen homologues cyclo[(CH<sub>2</sub>)<sub>2</sub>(NH)]<sub>n</sub>, provided much of the basic understanding of the thermodynamic,<sup>10</sup> kinetic,<sup>22</sup> structural, and spectroscopic properties of azamacrocyclic metal ion compounds. Analogues have been prepared with a diversity of ring sizes, number of nitrogen atoms, and inclusion of a variety of other heteroatoms. The cyclo[(CH<sub>2</sub>)<sub>2</sub>(NH)]<sub>n</sub> sequence has been extended to  $n = 12$ <sup>23</sup> and comparisons of formation constants with those of linear analogues with terminal MeHN- groups show the thermodynamic advantage of the cyclic structure (the thermodynamic macrocycle effect) to be insignificant beyond N<sub>6</sub>. Likewise the kinetic macrocycle effect, manifest as resistance to acid demetallation, particularly for Ni<sup>II</sup> and Cu<sup>II</sup> compounds, becomes insignificant beyond N<sub>6</sub>. Formation constants for these amines have the largest value for Cu<sup>II</sup>, and peak at N<sub>6</sub> for Co<sup>II</sup> and Ni<sup>II</sup>, and at N<sub>5</sub> for Cu<sup>II</sup> and Zn<sup>II</sup>. The very large rings can bind two or three cations; e.g., for  $n < 8$  [Pb(L)]<sup>2+</sup>; for  $n = 8–10$  [Pb(L)]<sup>2+</sup> and [Pb<sub>2</sub>(L)]<sup>4+</sup>; and for  $n = 11, 12$  [Pb<sub>2</sub>(L)]<sup>4+</sup> and [Pb<sub>3</sub>(L)]<sup>6+</sup> are present.<sup>22</sup>

The coordinating abilities of mono-, di-, and tetrafluorinated cyclams (and -dioxocyclams) have been investigated. Successive *F*-substitutions cause a reduction in the amine basicities and the ligand field strengths for their Cu<sup>II</sup> and Ni<sup>II</sup> complexes.<sup>24</sup>

The Richman Atkins synthesis, in which a tosyl (toluene sulfonyl) protected amine, e.g., (4), is reacted with a tosylated diol, e.g., (5), to form the tosylated cyclic amine, e.g., (6), remains the most general method for synthesis of cyclic amines (7) (Scheme 2).<sup>25</sup> The condensation does not require high dilution conditions to produce acceptable yields and the major disadvantage is the vigorous conditions required for the removal of the tosyl protecting groups. The preparation is readily extended to permit the preparation of macrocycles with a variety of ring sizes and chelate ring combinations and the incorporation into the ring of other heteroatoms and of functions such as 2,6-pyridyl,<sup>26</sup> 1,4-piperazindyl, or bipyridyl.

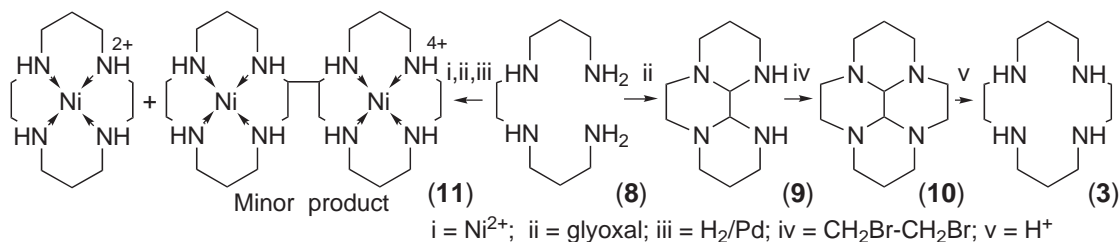
Cyclam and cyclen can be prepared by reduction of bisaminals formed by reaction of glyoxal with [Ni(2,3,2-tet)]<sup>2+</sup> (8) or [Ni(2,2,2-tet)]<sup>2+</sup>, respectively.<sup>27</sup> Aminals formed by these amines with glyoxal (9), or butane-2,4-dione, react with nucleophiles Br(CH<sub>2</sub>)<sub>2,3</sub>Br to form aminals of the [12], [13] or [14]- (10) membered cyclic tetraamines, which release the amines when reacted with dilute acid.<sup>28</sup>





Scheme 2

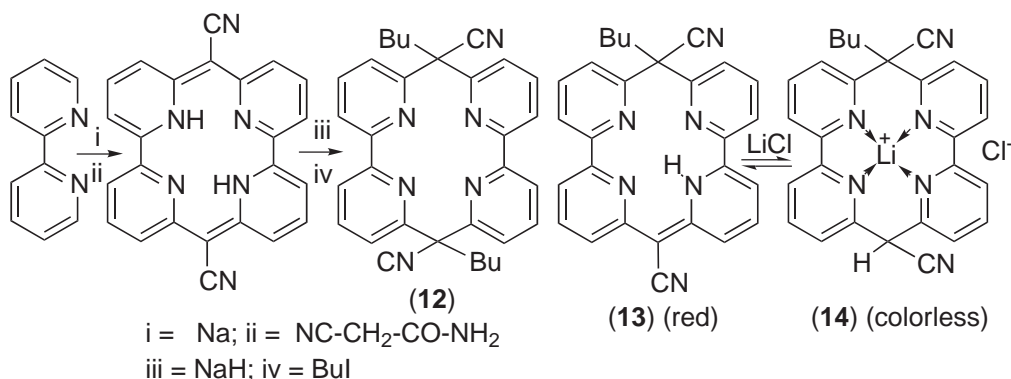
Reduction of the amination formed by  $[\text{Ni}(2,3,2\text{-tet})]^{2+}$  with glyoxal forms  $[\text{Ni}(\text{cyclam})]^{2+}$ , with the biscyclam compound (**11**) as a minor product (Scheme 3).<sup>29</sup>



Scheme 3

Many cyclic amines are prepared by reduction of cyclic imines (see Section 1.20.3), or amides (see Section 1.20.4). Nitro-, amine- and carboxyl-substituted cyclic amines are formed by Mannich condensations (see Section 1.20.6).

The aromatic tetraaza [14]-membered macrocycle (**12**), derived from 2,2'-bipyridyl, coordinates cations with an associated color change. The related macrocycle (**13**) that reversibly binds  $\text{LiCl}$  has been used to isolate lithium from seawater (Scheme 4).<sup>30</sup>



Scheme 4

### 1.20.3 AZAMACROCYCLES WITH IMINE FUNCTIONS

Most azamacrocycle compounds described in the initial period of azamacrocycle chemistry, other than cyclam, were imines, or amine-imines, mainly with [14]- or [16]-membered tetraaza rings, formed by template reactions of  $\text{Ni}^{\text{II}}$  or  $\text{Cu}^{\text{II}}$  amine compounds with carbonyl compounds, with imine formation as the ring-closing step.<sup>5</sup> Compounds of aliphatic imine and amine-imine macrocycles are largely restricted to the later *d*-transition elements, with a wider range if they have *o*-phenylene or 2,6-pyridiyl components.

Coordinated imine functions within macrocycles are generally resistant to hydrolysis. They can sometimes be reduced to secondary amines, and conversely secondary amine functions can

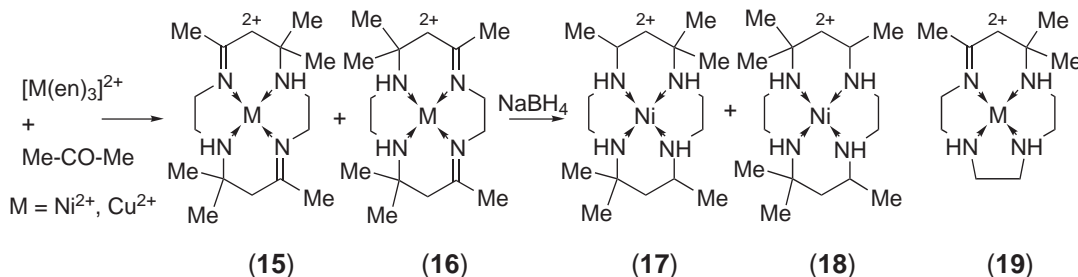
sometimes be oxidized to imines, but the reactions are very metal ion specific, often involving lower or higher oxidation states of the metal. Reduction is most facile for the Ni<sup>II</sup> compounds, with NaBH<sub>4</sub> or catalytic hydrogenation usually effective, forming cyclic amine compounds, e.g., (17), (18), and (25). Oxidation of amine to imine for Ni<sup>II</sup> compounds requires a vigorous oxidant, such as nitric acid, and the presence of substituents which limit degradation of the macrocycle, while oxygen is often effective for the Fe<sup>II</sup> or Ru<sup>II</sup> compounds, particularly if *cis*-diimine functions result or can be formed by imine bond migration. The compounds of Zn<sup>II</sup>, Co<sup>III</sup>, and Cr<sup>III</sup> are generally resistant towards both amine oxidation and imine reduction.

Reactions of coordinated imine functions with nitromethane in base to form *C*-nitromethyl-substituted azamacrocycle compounds are discussed in Section 1.20.6.

A great diversity of imine and amine-imine macrocycle-forming reactions have been reported. Historically significant reactions, see below, continue to be extended, and are still widely used.

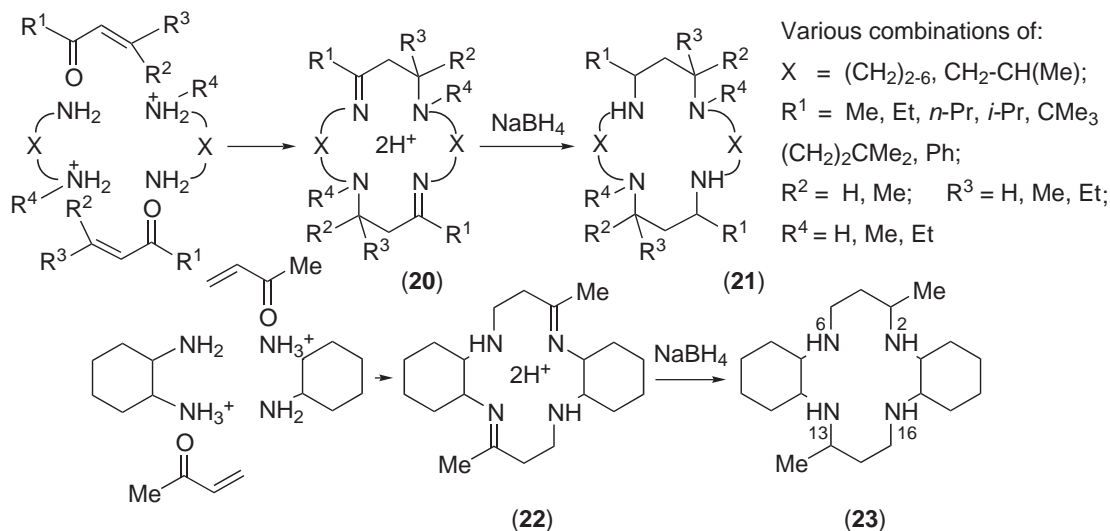
### 1.20.3.1 Ketone and $\beta$ -enone-Amine Reactions

Complexes of Ni<sup>II</sup> or Cu<sup>II</sup> with 1,2-, 1,3-, or 1,4-diamines react with acetone in 2+2 condensations to form [14]-, [15]-, [16]-, or [18]-membered diamine-diimine macrocycle compounds, e.g., (15) and (16), formed from en, or with 3,3-tri or tetraamines in 1+1 condensations to form a diamine-monoimine or triamine-monoimine macrocycle compounds, respectively, e.g., (19) formed from 2,2,2-tet (Scheme 5).<sup>31</sup>



Scheme 5

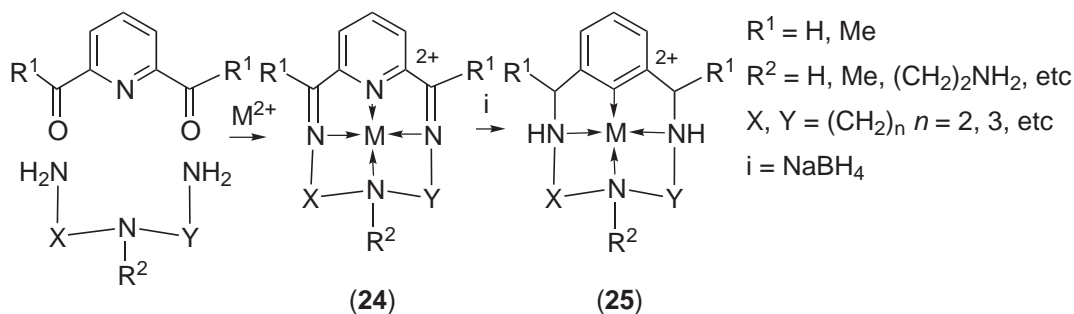
Monoprotonated diamines react with acetone or  $\beta$ -enones, to form diamine-diimine macrocycle salts (20), with rings of up to [22]-members,<sup>32</sup> with a variety of *C*-substituents<sup>33</sup> (including 1,2-cyclohexdiyl (22), formed from *trans*-cyclohexane-1,2-diamine),<sup>34</sup> or with *N*-substituents (Scheme 6).<sup>35</sup>



Scheme 6

### 1.20.3.2 2,6-Dicarbonyl Pyridine–Amine Reactions

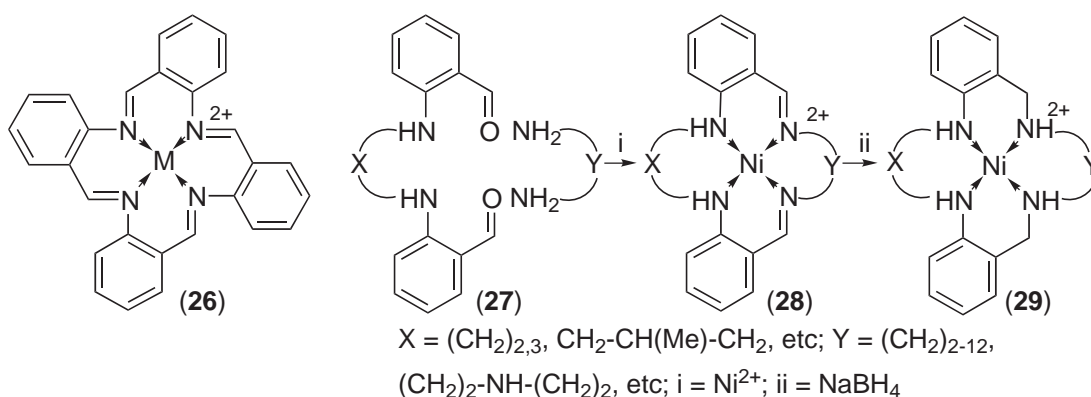
2,5-Diacetyl-pyridine and 2,6-diformyl-pyridine condense with  $\alpha,\omega$ -triamines in the presence of a variety of templating ions to form 2,5-pyridiyl-diimine macrocycles, e.g., (24) (Scheme 7). Similar reactions occur for tetra-, etc., amines,  $\alpha,\omega$ -diamines with a variety of intermediate links, including internal tertiary amine and/or other heteroatoms, or with other internal functions. Bispyridiyl macrocycles, e.g., (42) are formed by 2 + 2 condensations around a large templating ion such as  $\text{Ba}^{\text{II}}$  or  $\text{Pb}^{\text{II}}$ . For the  $\text{Ni}^{\text{II}}$  compounds the imine functions are reduced by  $\text{NaBH}_4$ , and also the pyridine ring by  $\text{H}_2/\text{Raney nickel}$ .<sup>36</sup>



Scheme 7

### 1.20.3.3 Aromatic Aldehyde–Amine Reactions

*o*-Amino benzaldehyde self-condenses in the presence of metal ions to form cyclic tri- and tetraamines, e.g., (26) (Scheme 8).<sup>37</sup> Related “Schiff base” reactions occur in a variety of other macrocycle syntheses.<sup>38</sup> Condensation of dialdehydes (27) with  $\alpha,\omega$ -diamines has led to many cyclic diimine-amines, e.g., (28), and by reduction the amines, e.g., (29). Extensions of this reaction have been used to produce pentaaza and mixed heteroatom macrocycles which have been extensively studied to elucidate factors determining metal ion selectivity.<sup>12</sup>

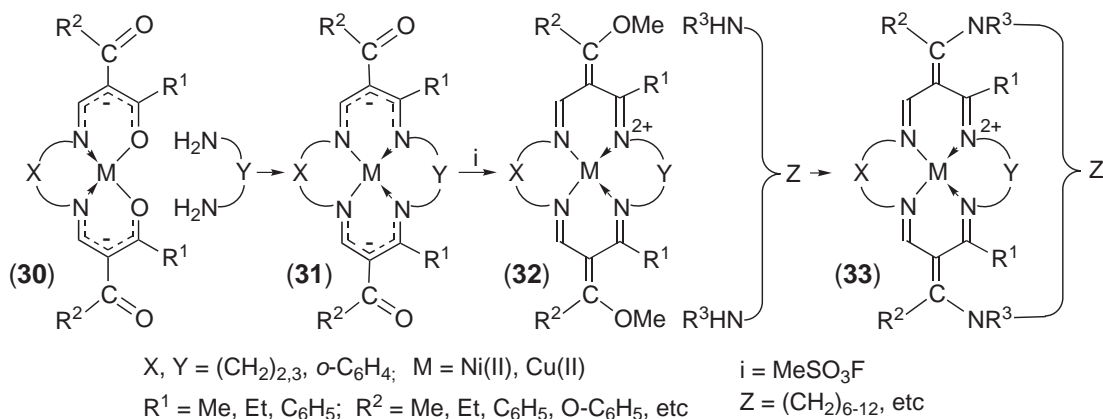


Scheme 8

### 1.20.3.4 $\beta$ -Keto Imine–Amine Reactions, Cyclidenes

*Cis*-diimine macrocycle compounds (31) are formed by “Jaeger” template condensations of diamines with acyl-substituted  $\beta$ -keto imines (30) (Scheme 9). The acyl substituents on the macrocycles are labile and undergo a variety of reactions. Reaction with trifluoromethyl sulfonate produces reactive methoxy ethylidene diimine compounds (32), which react with amines to form saddle-shaped “cyclidenes.” With bulky substituents these compounds have a hydrophobic void above the metal ion which can accommodate a “guest” molecule, an effect enhanced when the

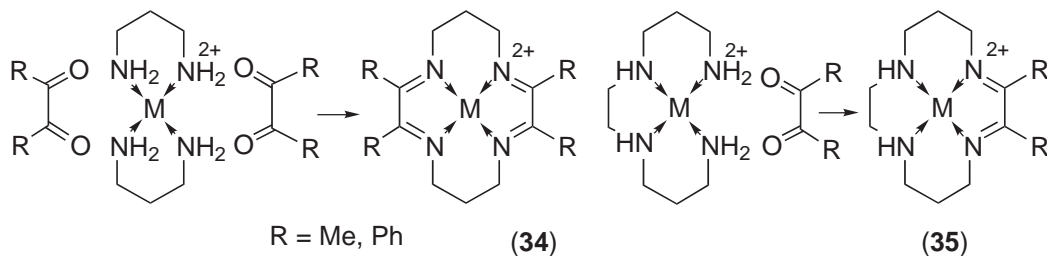
acyl functions are linked to form a bicyclic “lacunar cyclidene” (33).<sup>39–41</sup> The link, typically as  $C=C(R)NHNHC(R)=C$ , where X is most simply an alkyl chain,  $(CH_2)_{6-12}$ , can include a variety of internal functions and may contain heteroatoms. The hydrophobic void space between the macrocycle and the bridge is much larger for the [15]- and [16]-membered than for the [14]-membered macrocycles. The iron(II) and cobalt(II) compounds, in particular, reversibly bind small molecules, such as  $O_2$  or  $CO$ , and extensive studies of this process with different azamacrocycle ring sizes, linking groups, and substituents have been made. While  $O_2$  absorption is generally reversible, applications are limited by slow oxidative degradation, which is lessened by the absence of methyl substituents.<sup>42,43</sup> Doubly bridged “face-to-face” dinuclear compounds are formed by analogous 2 + 2 reactions.



Scheme 9

### 1.20.3.5 $\alpha$ -Dicarbonyl–Amine Reactions

*Cis*-diimine macrocycle compounds are formed by template condensations of an  $\alpha$ -diketone (usually 2,3-butanedione or benzil), 2 + 2 with diamines, e.g., (34), or 1 + 1 with tetraamines, e.g., (35) (Scheme 10). The resulting flat macrocycle cations form many “stacked” compounds, often with flat metal ion-containing anions, which exhibit spin coupling. The imine groups for the Ni<sup>II</sup> compounds are reduced with  $NaBH_4$  and one of each *cis*-diimine function for the Co<sup>III</sup> compounds by hypophosphorous acid.<sup>44</sup>

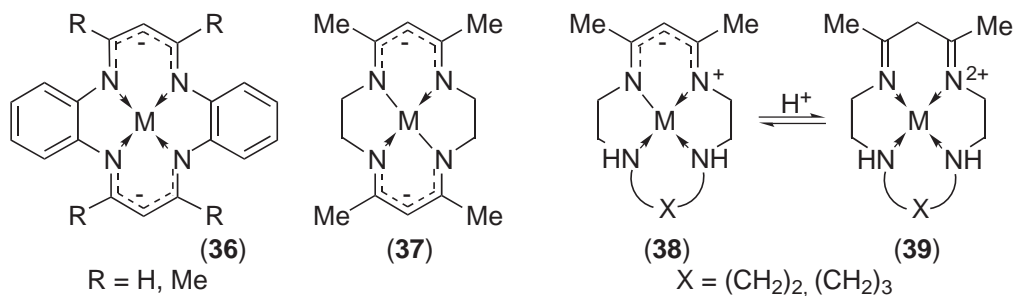


Scheme 10

### 1.20.3.6 $\beta$ -Dicarbonyl–Amine Reactions

Macrocycle compounds with six-membered delocalized “ $\beta$ -enato” chelate rings are formed by reaction of *o*-phenylenediamine complexes with propynal (propargylaldehyde,  $CH\equiv C-CHO$ ) or acetals thereof, (36) R = H, and 5,7,12,14-tetramethyl homologues (36) R = Me, by reaction with pentan-2,4-dione (Scheme 11). The highly delocalized dibenzo-tetraenato (dibenzo[14]dihydroannulenato) compounds can be prepared with a wide range of cations (lanthanide compounds have been suggested for use as medical magnetic resonance relaxation agents) and have been used in many

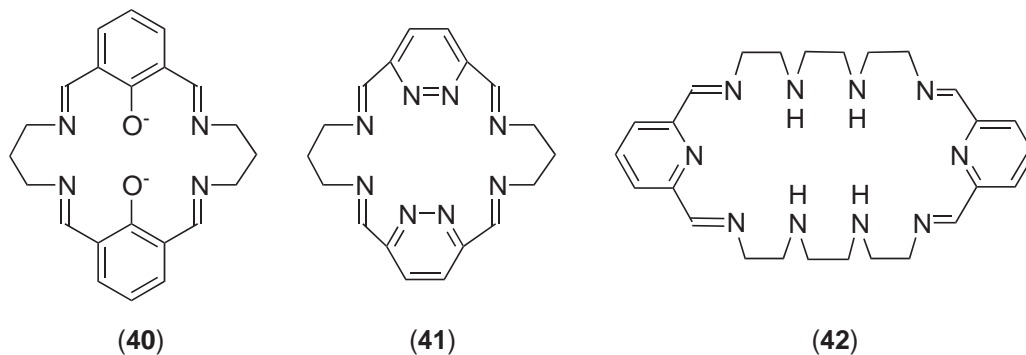
electrocatalytic studies. The solids when “doped” by reaction with an oxidant such as  $I_2$  often exhibit high electrical conductance. Compounds with a variety of *R*-substituents have been prepared and reduced to 1,2-cyclohexdiyl-substituted cyclams.<sup>45</sup> Related reactions of pentane-2,4-dione with aliphatic diamines (37) or tetraamines (38) are less facile for the usual templating ions  $Ni^{II}$  and  $Cu^{II}$  but occur readily for the  $Au^{III}$  and  $Pt^{IV}$  compounds.<sup>46</sup> The  $\beta$ -enato compounds (38) are reversibly protonated to form the diimine compounds (39). Substitution at the central carbon of the dienato chelate ring of these compounds is facile, and chemical (sometimes aerial) or electrochemical oxidation generates radical species which often form C—C or C=C linked bismacrocyces (see Section 1.20.9).



Scheme 11

### 1.20.3.7 Compartmental Macrocycles

Many large multidonor atom macrocycles are capable of binding more than one cation, but some that use specific sets of donor atoms for each cation are referred to as “compartmental” or “bibracchial.”<sup>47</sup> The “compartments” can be the same or different, occupied by cations of the same or different elements, in the same or different oxidation or spin states, with the same or different coordination geometries; this gives rise to very diverse properties.<sup>48</sup> The prototype is the Robson macrocycle (40), with phenolate<sup>38</sup> (or thiophenolate<sup>49</sup>) bridging groups (Scheme 12). Reaction of 3,6-diformylpyridazine tmd with  $Pb^{II}$  as template, forms a 4 + 4  $Pb^{II}$ -macrocyclic compound, which *trans*-metallates with  $Cu^{II}$  to form the 2 + 2 bispyridazine macrocycle compound (41).<sup>50</sup> Bis2,6-pyridiyl macrocycles, e.g., (42), are formed by 2 + 2 condensations of 2,6-diacetyl- or diformyl-pyridine with  $\alpha, \omega$ -triamines (or more generally, with  $\alpha, \omega$ -di- or polyamines, which may have other internal heteroatoms or functionalities) around large template ions such as  $Pb^{II}$  or  $Ba^{II}$ .<sup>51</sup>

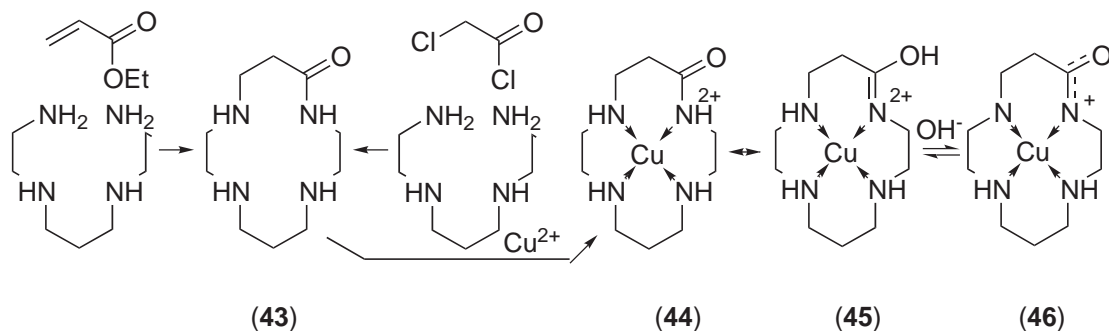


Scheme 12

### 1.20.4 AZAMACROCYCLES WITH AMIDE OR AMIDATE FUNCTIONS

Azamacrocycles with amide functions (oxo-aza macrocycles) are usually prepared by conventional nontemplate methods not requiring high dilution techniques. Yields are commonly low and extensive purification is often required. Examples shown are mainly of oxo-cyclams but similar reactions form amido-macrocyces with other ring sizes, numbers of nitrogen atoms, and including other heteroatoms. The amide functions of oxo-azamacrocycles are generally reduced by  $B_2H_6$ /thf, providing versatile syntheses of cyclic amines.

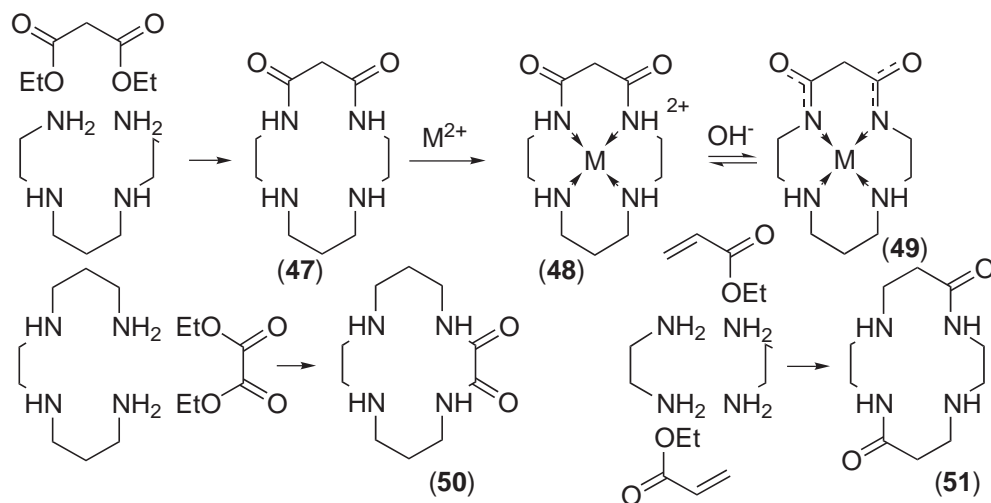
The cyclic amine-amides and cyclic peptides have many properties analogous to linear peptides and their metal ion compounds show functionalities resembling those of metalloproteins, making them of biomedical interest.<sup>52</sup> They react with a wide range of cations, these reactions and the reverse acid-demetalation reactions generally being more rapid than for amine or imine analogues, but slower than for noncyclic peptides. The dimensions of the Cu<sup>II</sup> compound of 5-oxo-cyclam (**44**) indicate that the enol tautomer (**45**), is present (Scheme 13).<sup>53</sup> Coordinated amide compounds readily deprotonate to form amidate compounds, e.g., (**46**) and (**49**), which show dimensions indicative of partial bond delocalization of the amidate group. For amidate compounds, relative to amide, amine, or imine analogues, the ligand field strength is increased and reduction potentials M<sup>III</sup>/M<sup>II</sup> are less positive, with resulting increased stability of higher oxidation states.



Scheme 13

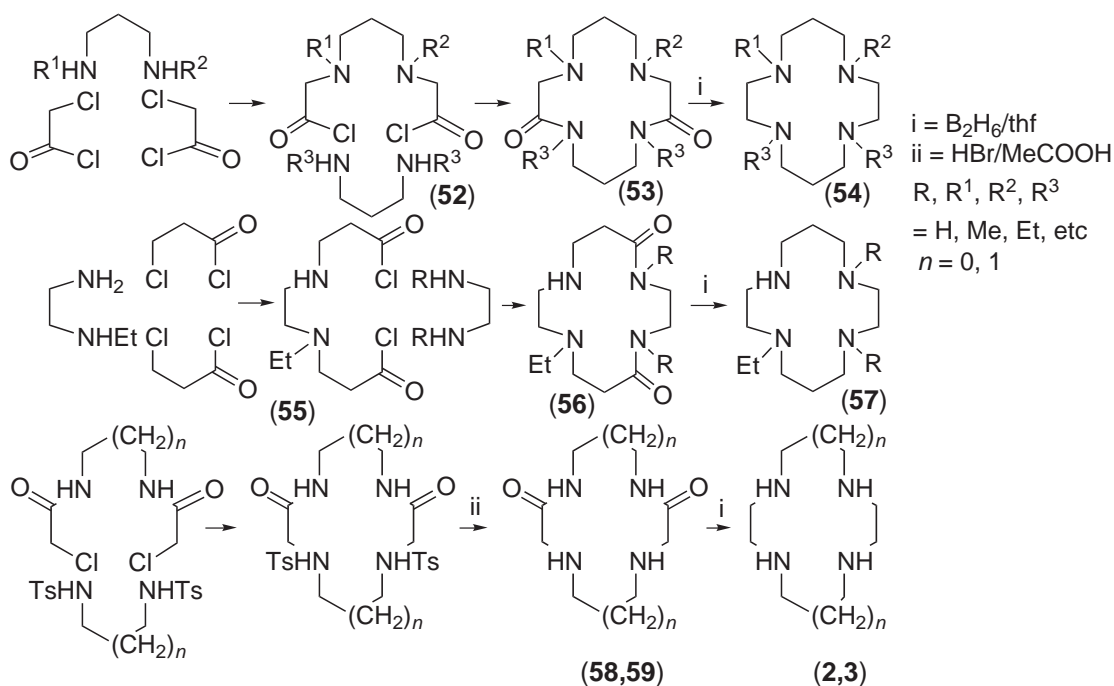
The monoamide 5-oxo-cyclam (**43**) is prepared from 2,3,2-tet by a Michael addition/amide condensation reaction with (m)ethylacrylate, or by reaction with the bifunctional nucleophile chloroacetyl chloride.

The 1,3-bisamide 5,7-(*cis*)-dioxo-cyclam (**47**) is prepared by reaction of 2,3,2-tet with a bisacylating reagent, commonly diethylmalonate, and the 1,2-bisamide 2,3-dioxo-cyclam (**50**) is similarly prepared from 3,2,3-tet by reaction with diethyl oxalate (Scheme 14).<sup>54</sup> The (5,12)-(*trans*)-dioxo-cyclam (**51**) is prepared by a 2 + 2 condensation of en with (m)ethylacrylate.<sup>55</sup>



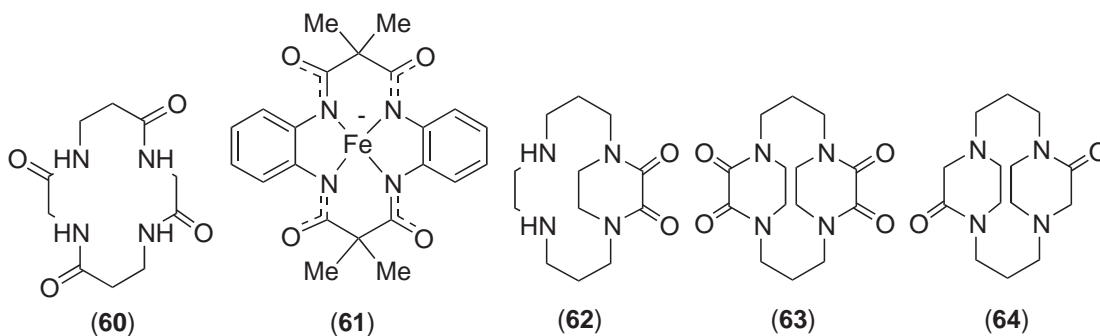
Scheme 14

A variety of *N*-substituted dioxo-cyclams, e.g., (**53**), (**56**), and homologues, have been prepared by reaction of “crab-like”  $\alpha,\omega$ -bis- $\alpha$ -chloroacetamides, (**52**), (**55**), with diamines, and the corresponding amines, (**54**), (**57**), formed by reduction (Scheme 15).<sup>56–58</sup> Unsubstituted dioxo-cyclam and -cyclen (**58**) and (**59**) can be prepared similarly, via tosyl-protected amines.



Scheme 15

Cyclic peptides are formed in great variety by standard peptide condensations of amino acid esters. Cyclization of  $\alpha$ -amino acids produces  $cyclo(CH_2CONH)_n$  and of  $\beta$ -amino acids  $cyclo(CH_2CH_2CONH)_n$  macrocycles, from  $n=3$  upwards, though few metal ion compounds have been described. Cyclic peptides formed from chiral amino acids have inherent chirality, which can affect their ability to bind metal ions. Cyclo(glycine- $\beta$ -alanine-glycine- $\beta$ -alanine) = 5,9,12,14-tetraoxo-cyclam (**60**) forms tetra-deprotonated complex anions with  $Cu^{II}$  and  $Cu^{III}$  (Scheme 16).<sup>59</sup> A report that 5,7,12,14-tetraoxo-cyclam could be formed from diethyl malonate and coordinated en was shown to be incorrect.<sup>60</sup>

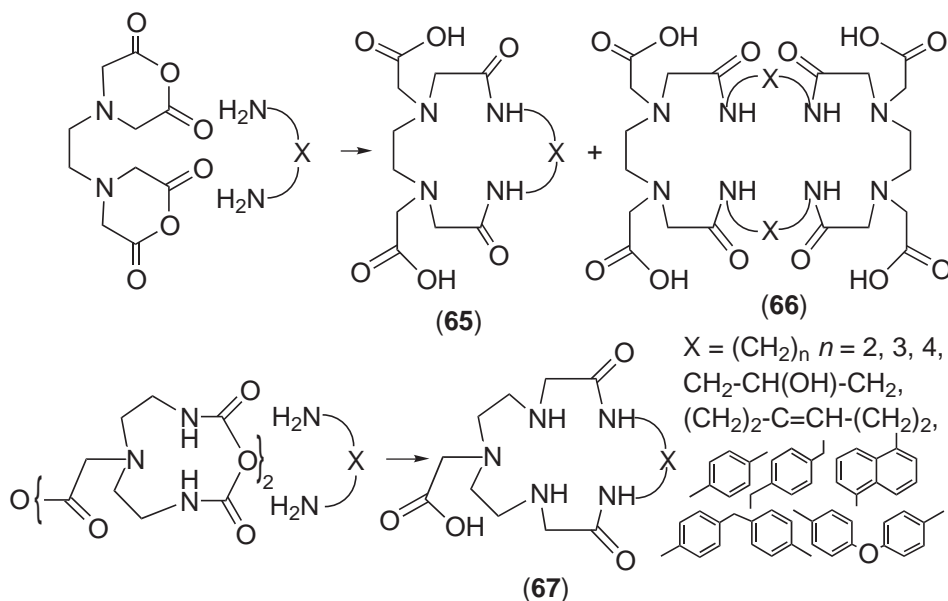


Scheme 16

A variety of cyclic tetraamides, e.g., (**61**), which stabilize metal ions in high oxidation states and are resistant to oxidation, have been synthesized for use as oxidation catalysts for peroxide bleaching.<sup>61</sup>

Cyclic amines react with diethyl oxalate to form bi- and tricyclic amides, e.g., (**62**) and (**63**), while 1,8-bis(carboxymethyl)-cyclam forms the intramolecular tricyclic lactam (**64**).<sup>62</sup>

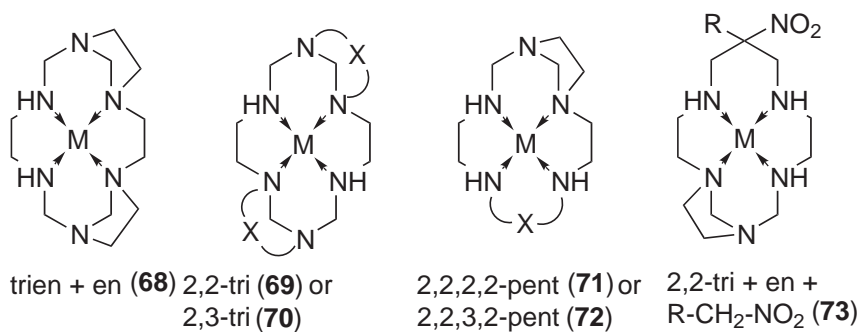
N-carboxymethyl-substituted cyclic amides have been formed by reaction of  $\alpha,\omega$ -diamines with the anhydrides of EDTA (1 + 1, (**65**)) or (2 + 2, (**66**)), or of diethylenetriamine-pentaacetic acid, (**67**) (Scheme 17).<sup>63</sup>



Scheme 17

### 1.20.5 MACROCYCLES FORMED BY MANNICH CONDENSATIONS, AZACYCLAMS

A variety of azamacrocyclic compounds are formed by Mannich condensations<sup>64,65</sup> of amines with an aldehyde, usually methanal, in the presence of a templating metal ion, usually Ni<sup>II</sup> or Cu<sup>II</sup> (though the reactions are often facile with Pd<sup>II</sup>, Pt<sup>II</sup>, or Au<sup>III</sup>). Condensations of methanal and ammonia with combinations of mono-, di-, tri-, tetra-, and pentaamines form a variety of bi- and tricyclic azamacrocyclic compounds, (68)–(72), usually based upon the 1,5,8,12-tetracoordinated 1,3,5,8,10,12-hexaazacyclotetradecane framework, with fused 1,4-piperazindiyl or 1,4-diazacycloheptandiyl rings (Scheme 18).<sup>66</sup> The resulting complex cations are generally resistant to acid degradation. The reactions can be combined with other Mannich-style condensations, e.g., with nitroalkanes (73).

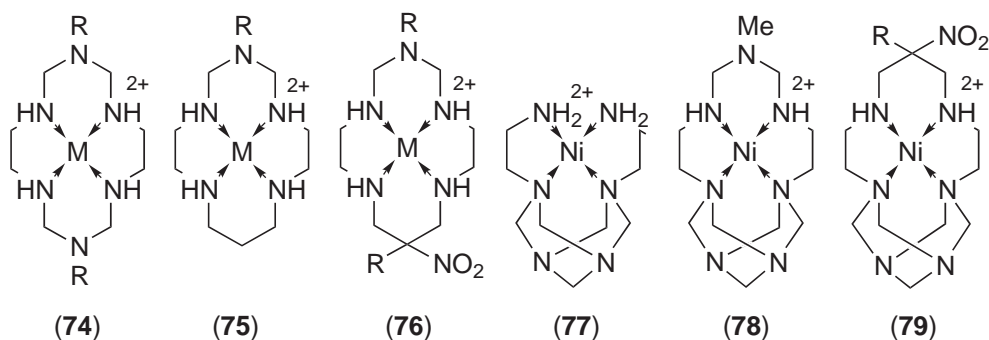


Scheme 18

Related reactions incorporating a “locking” or “padlock” reagent *R*-NH<sub>2</sub> form “azacyclam” macrocycles with N·C·(NR)·C·N chelate rings, with the central nitrogen atom not coordinated. Facile condensations of [M(en)<sub>2</sub>]<sup>m+</sup> ions with methanal and *R*-NH<sub>2</sub> yield 6,13-di(NR)azacyclam compounds (74) while similar 1 + 1 condensations for [M(2,3,2-tet)]<sup>m+</sup> yield 6(NR)azacyclam compounds (75) (Scheme 19). Homologues with ring sizes of [13]–[16] are formed with appropriate  $\alpha,\omega$ -tetraamines.

A variety of *R*-NH<sub>2</sub> “locking” reagents have been described, including primary amines, amine alcohols, nitriles, amides, and sulfonamides.<sup>67</sup> *N*-Substituents displaying multielectron redox activity have been described, including ferrocenylsulfonamide.<sup>68</sup>





Scheme 19

The reaction of  $[\text{Co}(\text{en})_3]^{3+}$  with  $\text{NH}_3/\text{methanal}$  forms the clathrochelate “sepulchrates” in high yield, but for  $[\text{Ni}(\text{en})_3]^{2+}$  this is a minor product, the main product being the tetradentate ligand compound (77) with the 1,3,5,7-tetraazabicyclo[3.3.1]non-1,3-diy “cap,”<sup>69</sup> which has been cyclized by reaction with methanal and methylamine (78), or nitroethane (79).<sup>70</sup>

Related bismacrocycles with N–X–N links are described in Section 1.20.9.

### 1.20.6 AZAMACROCYCLES WITH C-SUBSTITUENTS

Many macrocycle syntheses yield products with alkyl or aryl C-substituents, or with fused 2,6-pyridiyl, *o*-phenylene, or 1,2-cyclohexdiyl rings. Template-style syntheses (see Section 1.20.3) are often substituent-sensitive, and yield products with particular substituent patterns. The  $\beta$ -enone/(diamineH<sup>+</sup>) method for preparing cyclic amines (Section 1.20.2) introduces a variety of substituents on the six-membered chelate rings of cyclam, but only 3-methyl and 3,10-dimethyl substituents on the five-membered rings. Cyclams with a variety of methyl and 1,2-cyclohexdiyl substituents on the five-membered chelate rings have been prepared and structurally characterized.<sup>71</sup>

Cyclic imines with C-substituents may be formed as geometric isomers, e.g., (15) and (16), and reduction often generates enantiomeric cyclic amines. These isomers usually have different coordination stereochemistry. Configurations with the faces of the macrocycle identical (commonly *trans*- or *meso*-isomers) favor octahedral coordination with planar macrocycle in configuration III with *trans* additional ligands, while configurations with the faces inequivalent (commonly *cis*- or *rac*-isomers) favor octahedral coordination with the macrocycle folded in configuration V, with a chelate, or two *cis* unidentate additional ligands. The presence of C-substituents generally lowers protonation and complex formation constants, and slows both metal ion insertion and acid demetallation reactions.<sup>10,22</sup>

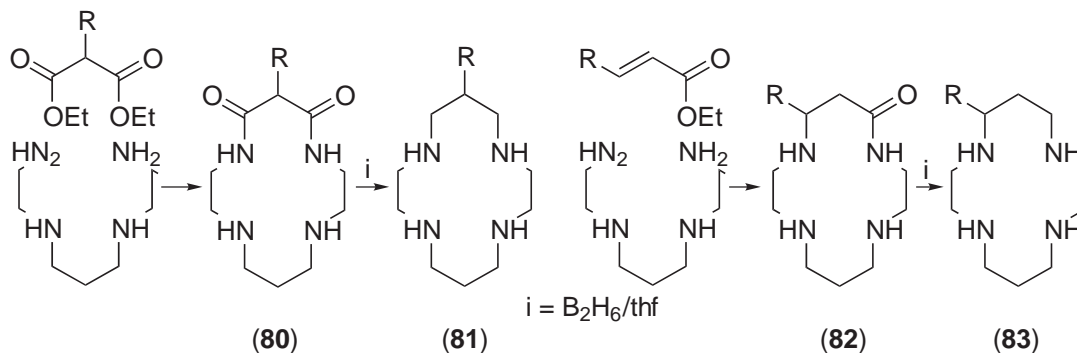
#### 1.20.6.1 Functionalized C-substituents

Macrocycles with a variety of functionalized C-substituents have been described, including “pendant donor groups” which have a donor atom able to coordinate to the same or another cation,<sup>72</sup> with specific redox or spectroscopic character, or designed to enhance some biochemical property. Donor atoms on substituents coordinate if a relatively strain-free five- or six-membered chelate ring is formed. Substituents on the central carbon atom of a six-membered chelate ring (6- and 13-substituents for cyclam) coordinate with the chelate ring in a boat conformation, forming an exocyclic five-membered ring for amine, or six-membered ring for carboxylate or 2-pyridyl pendants. Substituent *cis* to nitrogen ring atoms require a spacer atom between ring and donor atoms for a five-membered chelate ring to be formed.

For usually labile cations such as  $\text{Ni}^{\text{II}}$ ,  $\text{Cu}^{\text{II}}$ , or  $\text{Zn}^{\text{II}}$ , the macrocycle nitrogen atoms are nonlabile, while coordinated pendant substituents are labile. Coordination of basic groups such as amine or carboxylate groups is pH dependent. Cyclam with *trans*-6,13-pendant donors adopts relatively strain-free octahedral coordination in configuration III, while for the *cis*-6,13-disubstituted macrocycle both pendants can coordinate only *cis*, with the macrocycle in folded configuration V.

### 1.20.6.2 Substituents Introduced via Amide Formation

C-Substituted cyclic amines have been prepared by reduction of substituted amide (oxo) azamacrocycles, usually with  $B_2H_6$ /thf. 6*R*-5,7-Dioxo-cyclams (**80**) prepared by reaction of 2,3,2-tet with substituted malonic esters,  $R\text{-CH}(\text{COOEt})_2$ , reduce to form 6*R*-cyclams (**81**) ( $R = \text{Ph}$ , 2-ethylpyridyl, alkyl, benzyl,  $-(\text{CH}_2)_2\text{OH}$ , etc.) (Scheme 20).<sup>73</sup>



Scheme 20

5*R*-7-Oxo-cyclams (**82**) formed by addition of substituted acrylic esters,  $R\text{CH}=\text{CH}_2\text{COOEt}$ , to 2,3,2-tet reduce to form 5*R*-cyclams (**83**) ( $R =$  variously substituted 2-hydroxyphenyls (from coumarin derivatives), imidazolyls, furanyl, thiophenyls, 2-pyridyl, carboxyphenyls, (4-pyridyl)-methyl, (4-bipyridyl)methyl, (4-terpyridyl)methyl,<sup>74</sup> 4-nitro- (and 2,4-dinitro-)benzyl- (used to couple macrocycles with antibodies), etc.). Homologues with [13]–[16]-membered rings are similarly obtained from other linear tetraamines. 6*R*-cyclams were also prepared by reducing the 6*R*-5,7,12-trioxo-cyclam, prepared starting from en by reacting first with 2*R*-diethyl malonate, then with ethyl acrylate.<sup>73</sup>

### 1.20.6.3 Substitution of 1,3-diimine or Iminato Six-membered Chelate Rings

Hydrogen atoms on the central carbon atom of 1,3-diimine or iminato macrocycles (**36**)–(**38**) (and of their 1,3-diketone or 1,3-dicarboxyl ester precursors) undergo facile substitution, leading to 6- or 6,13-substituted cyclams (or oxo-cyclams), and their homologues. The acyl substituent groups of Jaeger tetraazamacrocycles (**35**) are readily substituted.

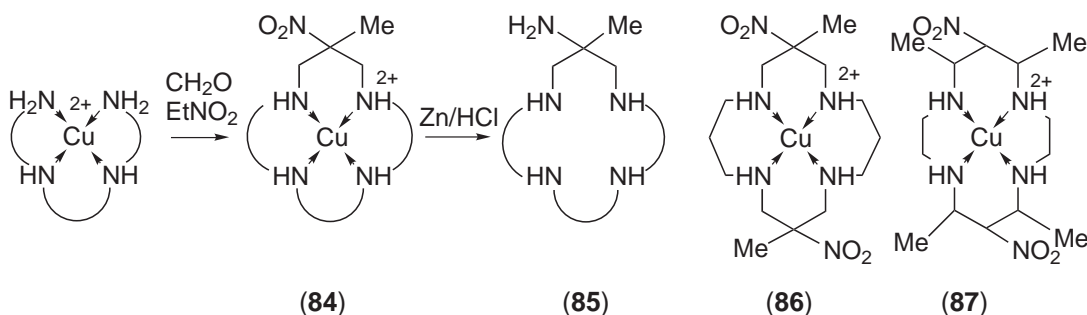
### 1.20.6.4 Nitro- and Amine-substituents

5,7-Dioxo-6-nitro-cyclam was prepared by reaction of 2-nitro-malonic ester with 2,3,2-tet, and reduced to 6-amino-cyclam.<sup>75</sup> 6,13-Dinitro-5,7,12,14-tetramethyl-1,4,8,11-tetraazacyclotetradeca-1,5,7,12-tetraene)copper(II) was prepared by reaction of bis(3-nitro-2,4-pentanedionato) $\text{Cu}^{\text{II}}$  with en (cf. **37**).<sup>76</sup>

Mannich reactions<sup>64,72,77</sup> of metal ion amine compounds with an aldehyde,  $R\text{-CHO}$ , and a compound with an “active methylene group” or “diprotic carbon acid,” e.g.,  $R^1\text{-CH}_2\text{NO}_2$  or  $\text{CH}_2(\text{COOEt})_2$  yield products with terminal amine functions linked by  $\text{NH}\cdot\text{CHR}\cdot\text{C}(\text{R}^1)\text{NO}_2\cdot\text{CHR}\cdot\text{NH}$  or  $\text{NH}\cdot\text{CHR}\cdot\text{C}(\text{COOEt})_2\cdot\text{CHR}\cdot\text{NH}$  groups, derived from one “carbon acid” and two aldehyde molecules. Reactions of nitroethane with  $\alpha,\omega$ -tetraamine compounds of  $\text{Ni}^{\text{II}}$  or  $\text{Cu}^{\text{II}}$  form nitromethyl-substituted [13]–[16]-membered tetraaza macrocycles, e.g., (**84**)<sup>78</sup> and (**79**). Similar reactions for 1,4-bis(2-aminoethyl)diazacycloheptane forms a bicyclic analogue, and the linear pentaamine 2,2,2,2-pent forms a pentaaza analogue.<sup>79</sup> The reactions also occur with 1-nitropropane, 1-nitrododecane, 12-nitrododecanoic acid, 3-nitropropanoic acid, tetrahydro-2-(2'-nitroethoxy)-2H-pyran, and phenyl- (and 4-nitrophenyl) -nitromethane.<sup>80</sup>

Similar reactions occur for  $[\text{M}(\text{en})_2]^{n+}$  ( $\text{M} = \text{Ni}^{\text{II}}$ ,  $\text{Cu}^{\text{II}}$ ,  $\text{Pd}^{\text{II}}$ ,  $\text{Pt}^{\text{II}}$ , and  $\text{Au}^{\text{III}}$ ) with methanal/nitroethane to form 6,13-dimethyl-6,13-dinitro-cyclam compounds (**88**) mainly *trans*, with a small proportion of *cis* for  $\text{Ni}^{\text{II}}$  and  $\text{Cu}^{\text{II}}$ , *trans* for  $\text{Pd}^{\text{II}}$ , and *cis* for  $\text{Au}^{\text{III}}$ . Under rigorously anhydrous conditions with  $[\text{Cu}(\text{tmd})_2]^{2+}$  the *cis*-[16]-membered homologue (**86**) forms in low yield, while

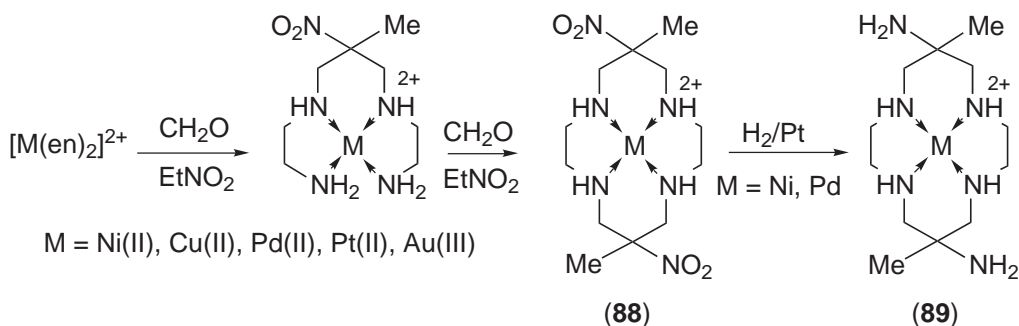
$[\text{Pd}(\text{tmd})_2]^{2+}$  and  $[\text{Pd}(\text{NH}_2(\text{CH}_2)_4\text{NH}_2)_2]^{2+}$  form the *cis*-[16]- and *cis*-[18]-membered macrocycles, respectively, in high yields (Scheme 21).<sup>79</sup>



Scheme 21

Reaction of  $[\text{Cu}(\text{en})_2]^{2+}$  with benzaldehyde and nitroethane forms the 5,7,12,14-tetrabenzyl-6,13-dinitro-6,13-dimethyl-cyclam<sup>80</sup> and reaction with ethanal and nitromethane forms the 5,7,12,14-tetramethyl-6,13-dinitro-cyclam compound (87).<sup>81</sup>

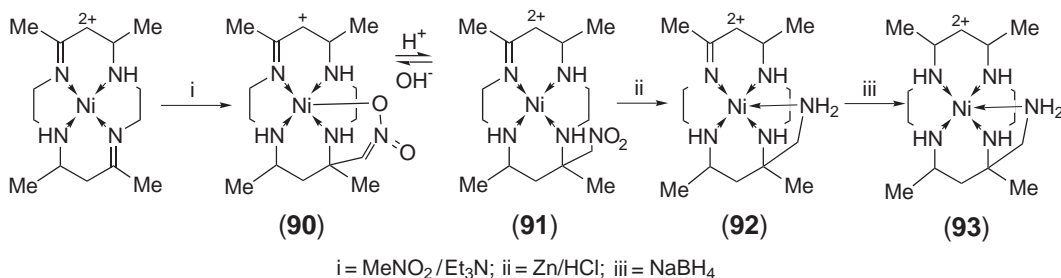
The nitro-substituents are reduced by  $\text{Zn}/\text{HCl}$  for the  $\text{Cu}^{\text{II}}$  compounds to form the amine-substituted macrocycles, e.g., (85), or by hydrogenation for the  $\text{Ni}^{\text{II}}$  or  $\text{Pd}^{\text{II}}$  compounds to form the amine-substituted macrocycle complex, e.g., (89) (Scheme 22). The monoamine-substituted [13]–[16]-membered cyclic tetraamines coordinate as pentadentate ligands in configuration III. *Trans*-6,13-diamine-cyclam compounds *trans*-(89) with both, or neither, pendant amine groups coordinated have the macrocycle in planar configuration III; compounds with one pendant coordinated adopt configuration I.<sup>82</sup> The *cis*-6,13-diamine macrocycle *cis*-(89) forms square-planar compounds in configuration III with the amine groups not coordinated, or *cis*-octahedral compounds with the macrocycle in folded configuration V with both amine groups coordinated.<sup>83</sup> The hexadentate *trans*-diamine cations have short intracyclic M–N bonds and high ligand field strengths, while these values are more normal for the isomeric *cis*-diamine cations. The amine groups of the *trans*-diamine have been alkylated and arylated (by reduction of the iminal formed with methanal, benzaldehyde, naphthalene-1-, or anthracene-9-carbaldehyde),<sup>84</sup> nitrosated (to form mainly the *exomethene*),<sup>85</sup> chlorinated (for the  $\text{Pt}^{\text{II}}$  compound),<sup>86</sup> reacted with methanal (to form a tricyclic  $\text{Cu}^{\text{II}}$  product with the pendant  $\text{NH}_2$  and adjacent  $\text{NH}$  groups linked by a methylene group),<sup>87</sup> and converted to ferrocenylmethylamine.<sup>88</sup>



Scheme 22

### 1.20.6.5 Nitromethyl and Aminomethyl Substituents

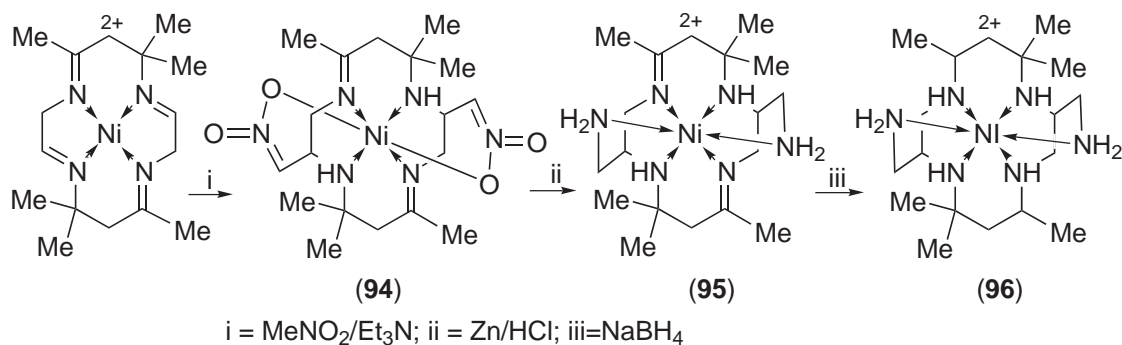
Imine functions of azamacrocycle compounds are generally unreactive, other than to reduction. However, one imine group of  $[(1,4,8,11\text{-tetraazacyclotetradeca-4,11-diene})\text{Ni}^{\text{II}}](\text{ClO}_4)_2$ , with assorted 5,12-; 7,14-; and/or 3,10-dimethyl substituents, reacts with nitromethane in acetonitrile plus  $\text{NEt}_3$  to introduce one nitromethyl substituent (91) which in base coordinates as an *aci*-nitromethyl (nitronato,  $-\text{CH}=\text{NO}_2^-$ ) group (90) (Scheme 23).<sup>89</sup> Compounds of more hindered macrocycles, such as (15) form fulminato compounds or do not react. The  $\text{Ni}^{\text{II}}$  and  $\text{Cu}^{\text{II}}$  compounds of (22) react similarly, to form the mononitromethyl compound.<sup>90</sup>



Scheme 23

The nitromethyl-imine macrocycle compounds are reduced by Zn/HCl to aminomethyl-imine compounds (**92**), which are reduced by NaBH<sub>4</sub> to 5-aminomethyl-cyclam compounds (**93**).

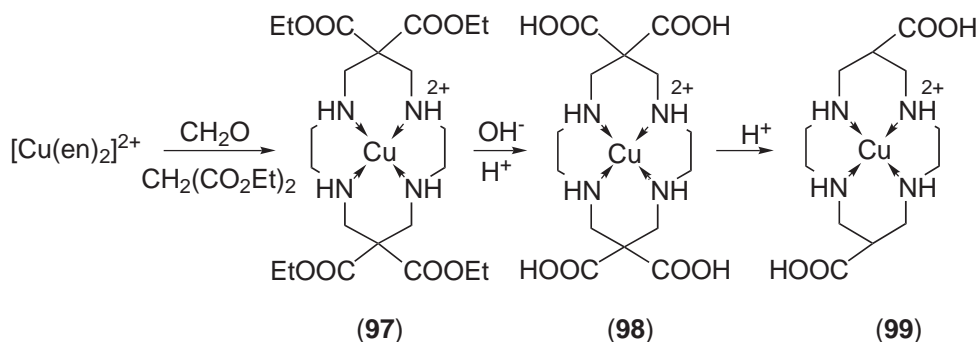
Various methyl-substituted [(1,4,8,11-tetrazacyclotetra-1,4,8,11-tetraene)Ni](ClO<sub>4</sub>)<sub>2</sub> salts react with nitromethane under similar conditions to form 2,9-bis-*aci*-nitromethyl compounds (**94**), which can be reduced by Zn/HCl to the bisaminomethyl-diimines (**95**), and these by NaBH<sub>4</sub> to 2,9-bisaminomethyl-cyclams (**96**), isolated as *cis*- and *trans*-isomers (Scheme 24).<sup>91</sup>



Scheme 24

### 1.20.6.6 Carboxyl Substituents

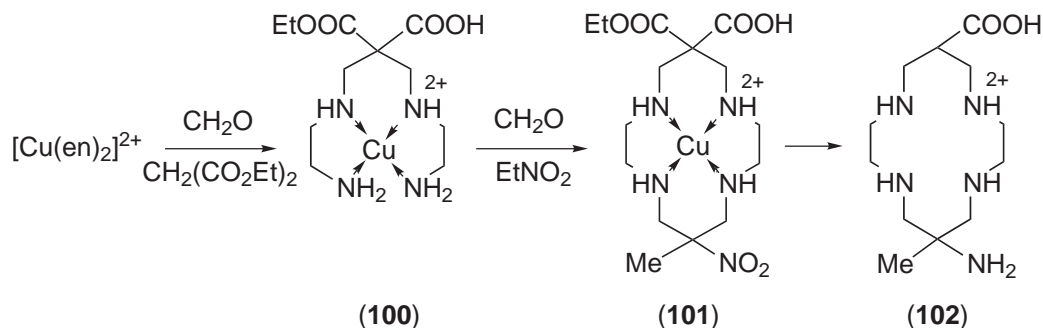
Mannich condensation of [Cu(en)<sub>2</sub>]<sup>2+</sup> with methanal and di(m)ethyl-malonate forms [(6,6,13,13-tetrakis(carbo(m)ethoxy)-cyclam)copper(II)]<sup>2+</sup> (**97**), in approximately 10% yield in methanol,<sup>92</sup> approximately 20% in DMF,<sup>93</sup> with lower yield for the reaction with Ni<sup>II</sup> (Scheme 25). The ester functions are hydrolyzed in base to form the tetrakis(carboxyl)-substituted cation (**98**), which readily decarboxylates in acid to form the *trans*-6,13-bis(carboxyl)-substituted cation (**99**).<sup>92</sup> The carboxyl groups of (**99**) have been converted to carbomethoxyl, carbamoyl, (m)ethylcarbamoyl, and hydrazinocarbonyl functions.<sup>94</sup>



Scheme 25

Analogous reactions for Cu<sup>II</sup> compounds of 2,2,2-tet, 2,3,2-tet, 3,2,3-tet, and *N,N'*-bis(3-amino-propyl)-1,4-diazacycloheptane form monocarboxyl-substituted macrocycles, also usually in low yield.

Reaction of [Cu(en)<sub>2</sub>]<sup>2+</sup> with methanal and 1 mol proportion of diethyl malonate forms a tetradentate carboxyl ligand compound (**100**), which reacts further with methanal and nitroethane to form 6-carboxyl-13-methyl-13-nitro-cyclam (**101**), as *trans*- and *cis*-isomers in approximately 9:1 ratio, which reduce and decarboxylate to form isomeric *trans*- and *cis*-6-amino-13-carboxyl-6-methyl-cyclams (**102**) (Scheme 26).<sup>95</sup>



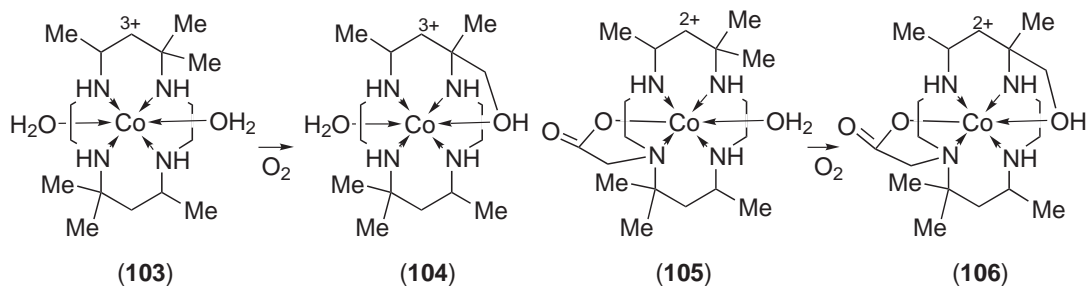
Scheme 26

### 1.20.6.7 2-Pyridyl Substituents

Mannich reaction of [Cu(en)<sub>2</sub>]<sup>2+</sup> with methanal and ethyl-2-pyridylacetate forms the 6,13-bis(2-pyridyl)-cyclam compound in 6% yield as *trans*- and *cis*-isomers in 9:1 mole ratio.<sup>96</sup> (see also Section 1.20.6.2)

### 1.20.6.8 Hydroxymethyl Substituents

C-Alkyl substituents on azamacrocycles are generally unreactive, but one methyl substituent of the Co<sup>III</sup> cation with *meso*-(**17**),<sup>97</sup> (**103**), (and of the 1-carboxymethyl derivative (**105**))<sup>98</sup> is aerielly oxidized to form 5-hydroxymethyl compounds, (**104**) and (**106**) (Scheme 27).



Scheme 27

### 1.20.6.9 C-pendants that Coordinate Exocyclic Cations

6-(4-Pyridylmethyl)-cyclam was reacted with [Ru(2,2'-bipyridyl)<sub>2</sub>Cl<sub>2</sub>] to form a 6-(4-pyridylmethyl)-bis(2,2'-bipyridyl)Ru<sup>II</sup> pendant. It was also linked to 4-methyl(2,2'-bipyridyl) via the pyridine nitrogen, then reacted with [Ru(2,2'-bipyridyl)<sub>2</sub>Cl<sub>2</sub>] to form a 6-(4-pyridylmethyl) linked tris(2,2'-bipyridyl)Ru<sup>II</sup> pendant.<sup>73</sup> Reaction of cyclam with *o*-diphenylphosphine ethyl cinnamate formed a pendant triphenylphosphine group, which coordinated exocyclic cations.<sup>99</sup> The Ru<sup>II</sup> center of these compounds can act as a photosensitizer, while a cation such as Ni<sup>II</sup> coordinated within the macrocycle can act as a catalytic site, e.g., for CO<sub>2</sub> reduction (see Section 1.20.7.8 for *N*-substituted analogues).

### 1.20.7 AZAMACROCYCLES WITH N-SUBSTITUENTS

The nitrogen atoms of cyclic amines are readily substituted by reaction with nucleophiles (usually alkyl halides in base), or with Michael acceptors (usually acrylic compounds). A variety of *N*-substituted cyclams, e.g., (54), (57), and homologues, has been prepared by reducing substituted dioxo cyclams (53) and (56). *N*-Functionalization can be introduced for precursors before cyclization, e.g., (20), (24), (52), and (55), and the “azacyclam” macrocycles (74)–(79).

Coordinated tertiary nitrogen atoms are chiral centers and tetrakis-*N*-substituted cyclam compounds have five possible configurations (see (3)). Tetrakis-*N*-substitution of coordinated cyclam produces square-planar complexes in the stable configuration III, but reaction of the tetrakis-*N*-substituted amine with cations usually forms complexes in the thermodynamically less stable basket configuration I, which are much more rapidly demetallated in acid (though preparation of [tetrakis(*N*-methyl-cyclam)Cu]<sup>2+</sup> in configuration III from the amine has been reported).<sup>100</sup> Deprotonation of a coordinated NH group provides a mechanism for epimerization for cyclic secondary amines, which is usually rapid in base, but there is no simple mechanism for inter-conversion of isomers for tertiary amines. Configurations observed are dependent on preparative details and it is often uncertain whether the structure has been determined by kinetic or thermodynamic factors.

*N*-substituents may be functionalized, such as with a group able to coordinate, or with some specific redox, spectroscopic or biomedical characteristic.<sup>72,101,102</sup> Donor atoms on substituents coordinate as for their *C*-substituent analogues (see Section 1.20.6). Macrocycles with amine pendants form compounds mainly with the later *d*-cations, those with oxygen donor functions, such as alcohol, carboxylate, or carbamoyl, form compounds with a wide range of cations, while those with 2-pyridyl pendants show intermediate character. Many *N*-substituted azamacrocycles have been described, with many variations and combinations of substituents designed primarily to optimize the properties of the Gd<sup>III</sup> compounds as <sup>1</sup>H NMR contrast-enhancing spin-relaxation agents, or as carriers and targeting agents for radiopharmaceuticals, such as <sup>64</sup>Cu, <sup>67</sup>Cu, <sup>105</sup>Rh, or <sup>99m</sup>Tc. The variety of “structural adjustments” possible permits many strategies for enhancing desired properties and there is an extensive literature, largely with a biomedical focus.<sup>7,103</sup>

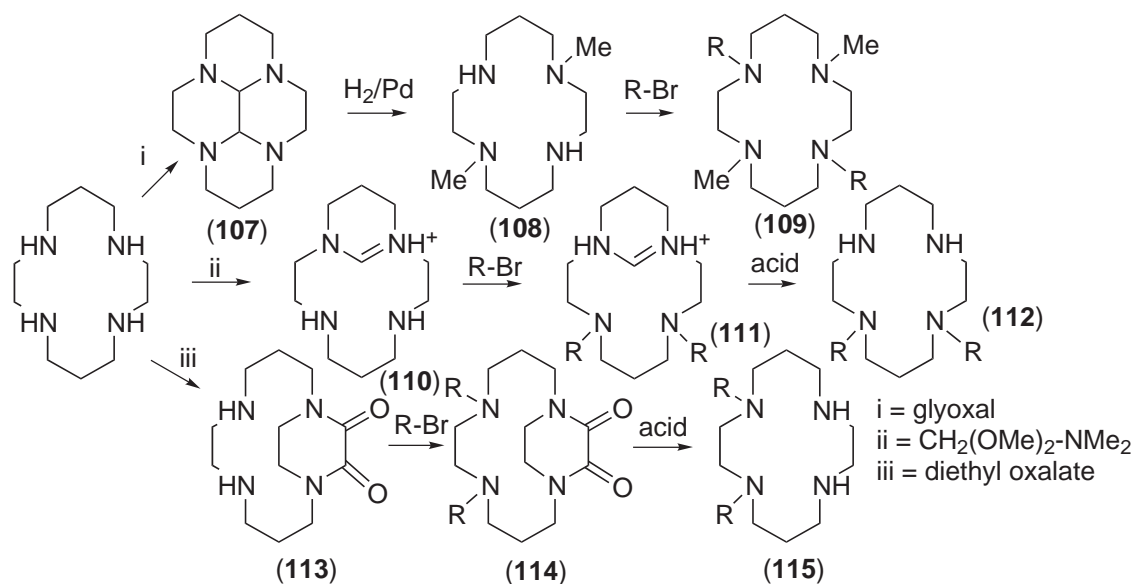
Many reactions that produce specific numbers and/or distributions of *N*-substituents, or combinations of different *N*-substituents, have been devised. The protecting groups boc (*t*-butyloxycarbonyl)<sup>104</sup> and trityl (triphenylmethyl)<sup>105</sup> are convenient since they can be removed under mild conditions. *C*-Substitution can alter the relative reactivity of nitrogen atoms by steric or inductive effects to determine substitution patterns (e.g., for the bis(1,2-cyclohexdiyl) cyclam (23), which preferentially bis-substitutes at the six and 16 sites).<sup>101</sup> The presence of imine or amide functions also determine substitution patterns and the substituted imine or amide macrocycles can be reduced to the substituted cyclic amine.

Mono-*N*-substitution of cyclic amines by nucleophiles occurs under controlled reaction conditions. For example, reaction of equimolar amounts of a cyclic amine, tosyl acid, and acrylonitrile, or an acrylic ester or amide, introduces a single  $-(\text{CH}_2)_2\text{CN}$ ,  $-\text{CH}_2=\text{CHCO}(\text{OR})$ , or  $-\text{CH}_2=\text{CHCO}(\text{NHR})$  substituent, respectively, with a variety of alkyl, sulfonic acid, sugar, or cyclic ether *R*-functions. Hydrolysis/reduction of these results in  $-(\text{CH}_2)_2\text{CONH}_2$ ,  $-(\text{CH}_2)_2\text{CO}_2\text{H}$ , or  $-(\text{CH}_2)_3\text{NHR}$  substituents.<sup>106</sup> Mono-*N*-substituted azamacrocycles have coordinating properties like the parent cyclic amine, predominantly forming compounds with the later *d*-transition cations, in configuration III, with pH-dependent axial coordination/protonation of basic pendants.

Bis(*N*-substituted)-cyclams have been prepared by a variety of reactions. Dioxo- or diiminecyclams can be bis-substituted and then reduced. Starting from cyclam, 1,8-dimethyl-cyclam (108) can be prepared and further *trans*-bis-substituted to form (109) (Scheme 28). The formamidinium salt (110) is 1,11-bis-substituted (111), and then hydrolyzed to form (112).<sup>107</sup> The bicyclic oxamide (113) is 1,4-bis-substituted (114), and then hydrolyzed to form (115).<sup>108</sup> Substitution for (30), *R*<sup>2</sup> = Me, (CH<sub>2</sub>)<sub>2</sub>NH<sub>2</sub>, etc. produces *trans*-bis-*N*-substituted 2,6-pyridiyl macrocycles.

Tetrakis-*N*-substituted tetraamines with coordinating substituents are potentially octadentate, and for large cations can coordinate in “basket” configuration I arrangements utilizing all donor atoms. For smaller cations, they are often hexadentate, with two pendants coordinated and the others uncoordinated, protonated, or coordinated to another cation. For small cations, they commonly form compounds with the macrocycle in exocyclic coordination.





Scheme 28

### 1.20.7.1 Unfunctionalized Substituents

Cyclic tertiary amines have been formed with a variety, in both number and type, of *N*-alkyl substituents. Many studies have been reported of compounds with a variety of (mainly *d*-transition element) cations of tetrakis(*N*-methyl)cyclam, of homologues with other ring sizes and of analogues with other numbers of nitrogen and/or other hetero atoms present. The rate of cation insertion for the per-*N*-alkyl-substituted amines is slower than for the unsubstituted amines and so decreases with size of the substituents that macrocycles with bulky substituents do not readily incorporate cations.<sup>109</sup> Formation constants are also generally reduced by *N*-alkyl substitution. Substituents with long alkyl chains impart lipophilic character, useful for solvent extraction of cations, and conversely, long chains with terminal hydrophilic functions impart detergent properties. *N*-(2-Propyl)- and *N*-(2-methylpropyl)cyclams have been reported to inhibit tumor growth.<sup>110</sup>

### 1.20.7.2 Carboxyalkyl Substituents

Azamacrocycles with *N*-carboxymethyl substituents,<sup>111,112</sup> often described as “acetic acid” derivatives, have been studied extensively, particularly tetrakis(*N*-carboxymethyl)cyclam, “H<sub>4</sub>teta,” and -cyclen, “H<sub>4</sub>dota.” They have many properties analogous to the noncyclic polyamine-carboxymethyl ligands such as EDTA, and form compounds with a very wide range of cations. The combination of macrocyclic and multichelate entropic enhancements lead to thermodynamically very stable compounds.<sup>113</sup> Complexes of dota<sup>4-</sup> with usually labile lanthanide cations have high thermodynamic stability and exhibit slow release of the cation under physiological conditions, combined with rapid exchange of coordinated water molecules, which makes them attractive as <sup>1</sup>H NMR contrast-enhancing agents.

The tetrakis(*N*-carboxymethyl) cyclic tetraamines compounds are generally prepared by reaction of the amine with excess bromo- (or chloro-)acetic acid or by cyanomethylation with methanal and cyanide, followed by hydrolysis. They form compounds with cations across the periodic table, with a variety of pH-dependent coordination modes. Teta<sup>4-</sup> and dota<sup>4-</sup> form complex anions with larger cations, including the lanthanides, with the carboxylato groups on the same side of the configuration I macrocycle forming a basket-shaped cavity with the cation surrounded by four nitrogen, carboxylato, and water oxygen atoms forming a distorted dodecahedron. The cations Ni<sup>II</sup>, Cu<sup>II</sup>, and Zn<sup>II</sup> form dinuclear compounds [M<sub>2</sub>(teta)] with each cation in exocyclic coordination by two nitrogen and two carboxylate oxygen atoms of a teta<sup>4-</sup> ligand. In contrast, Ba[Cu(teta)] and [Zn(H<sub>2</sub>teta)] have endocyclic planar coordination in configuration III, with *trans*-coordinated

carboxylato groups.<sup>114</sup> Compounds  $[M(H_2dota)]$  ( $M = Ni^{II}$ ,  $Cu^{II}$ , and  $Zn^{II}$ ) have endocyclic folded configuration I structures with two *cis*-coordinated carboxylato groups.<sup>114</sup> For  $[Mg(H_2teta)(H_2O)_4] \cdot 4H_2O$  there is no interaction between  $Mg^{2+}$  ions and nitrogen atoms, the macrocycle apparently functioning essentially as an “organizer” of carboxylato and water oxygen atoms.<sup>115</sup>

1,4-Biscarboxymethylcyclam is formed by an intramolecular reaction for a  $Co^{III}$  compound of *N,N'*-biscarboxymethyl-en and  $[Cl(CH_2)_3NHCH_2-]_2$ .<sup>116</sup>

*N*-carboxyethyl-substituted macrocycles have been prepared by nucleophilic substitution using 2-bromopropionic acid, and by Michael addition of acrylic acid, acrylonitrile, or acrylamide, followed by hydrolysis. The formation constants with cations are lower than for carboxymethyl analogues and structures of lanthanide compounds are generally  $\mu$ -carboxylato polymeric, often with the nitrogen atoms not coordinated.

### 1.20.7.3 Carbamoylmethyl Substituents

*N*-Carbamoylmethyl-substituted azamacrocycles,<sup>112,117</sup> often described as “acetamide” derivatives, have been prepared by substitution using 2-bromoacetamide, or by addition using acrylamide. The oxygen atoms of the amide pendants coordinate to a wide range of cations, much like carboxylatomethyl groups, except that coordination of the amido function is not pH sensitive. The cationic complexes formed are less soluble and generally easier to crystallize than carboxylatomethyl analogues. The tetrakis(*N*-carbamoylmethyl) compounds with lanthanide cations, particularly of the cyclen and cyclam derivatives “dotam” and “tetam,” and variants with substituted amides, have been studied as spin-relaxation agents.<sup>113,118</sup>  $[Cu(tetam)]SO_4 \cdot 4.5H_2O$  has a centrosymmetrical configuration III structure with two carbamoyl groups weakly *trans*-coordinated.<sup>119</sup> The tetrakis(methylcarbamoylmethyl)-cyclen compound  $[Gd(L)(H_2O)](ClO_4)_3 \cdot NaClO_4 \cdot 3H_2O$  has the  $Gd^{III}$  in a coordination environment defined by four nitrogen atoms of the ring, eight amide oxygen atoms, and an oxygen atom of a water molecule.<sup>113</sup>

Tris(*N*-carbamoylmethyl)cyclam has been prepared by reacting cyclam with iodoacetamide in acetone plus di-isopropylethylamine.<sup>120</sup> 1,8-Bis[*N*-(*N,N*-dimethylcarbamoylmethyl)]-4,11-dimethylcyclam forms isomeric configuration I and III compounds,  $[Cu(L)](BF_4)_2$ , for which interconversion is promoted by electrochemical reduction.<sup>121</sup>

### 1.20.7.4 Hydroxyalkyl Substituents

Cyclic amines react with oxirane to introduce 2-hydroxyethyl *N*-substituents. The *N*-hydroxyethyl-substituted cyclic amines form complexes with a wide range of cations, the formation constants being smaller than for the unsubstituted amine for the later *d*-cations, larger for hard and large cations. Structures usually have some OH groups coordinated. Tetrakis(2-hydroxyethyl)-substituted cyclic tetraamines insert cations much more rapidly than the unsubstituted amines, and the complexes are also more rapidly demetallated in acid. Studies with differing patterns of *N*-hydroxyethyl substitution showed that at least two *cis*-hydroxyethyl groups were required for this rate enhancement, and no enhancement was observed for mono- or *trans*-bis-substituted tetraamines.<sup>122</sup>

Cyclic amines react with oxetane or 3-bromo-1-propanol to introduce 3-hydroxypropyl *N*-substituents. The compounds show reduced formation constants compared with the hydroxyethyl compounds and the OH groups show little tendency to coordinate.<sup>123</sup>

### 1.20.7.5 Nitrile Substituents

Addition of acrylonitrile to cyclic amines yields the per-*N*-(2-cyanoethyl)-substituted macrocycles,<sup>124</sup> which can be reduced to form the 2-aminopropyl compounds,<sup>125</sup> or hydrolyzed to form the 2-carbamoylethyl compounds.<sup>126</sup> Pendant nitrile groups coordinate only weakly.

### 1.20.7.6 $\omega$ -Aminoalkyl Substituents

2-Aminoethyl substituents are introduced by reaction of the cyclic amine with tolyl-aziridine, or by cyanomethylation with methanal/cyanide, followed by reduction. Tetrakis[*N*-(2-aminoethyl)]-cyclam,



“taec,” and its [15]- and [16]-membered homologues form dinuclear compounds with  $M^{II}$  cations, with each cation in exocyclic coordination by two ring and two pendant nitrogen atoms in face-to-face square-planar arrangements, with a strong (and selective) affinity for an exchangeable anion bound between the metal centers.<sup>127,128</sup> The  $Cr^{II}$  and  $Co^{II}$  compounds resist oxidation. 1,7-Bis(2-aminoethyl)-4,10-dimethyl-cyclen forms a  $Ni^{II}$  complex with a distorted octahedral geometry with the two pendant amino groups coordinated *cis*.<sup>129</sup>

3-Aminopropyl-substituted cyclic amines are formed by reduction of *N*-(2-cyanoethyl) compounds.<sup>124</sup> Compounds of tetrakis[*N*-(3-aminopropyl)]-cyclam with  $Ni^{II}$ ,<sup>130</sup>  $Co^{III}$ , and  $Rh^{III}$ <sup>131</sup> have the ligand in pentadentate coordination, with one pendant amine coordinated. Only one pendant of 1,8-bis(3-aminopropyl)-4,11-dimethylcyclam coordinates with  $Ni^{II}$  or  $Cu^{II}$ .<sup>132</sup> The coordinated/protonated equilibria of the pendants for 1-(2-aminoethyl)- and 1-(3-aminopropyl)-cyclam with  $Cu^{II}$  have been compared.<sup>133</sup>

### 1.20.7.7 Pyridylmethyl Substituents

Per-*N*-(2-pyridylmethyl) substitution of cyclic amines is effected by reaction with 2-(2-chloromethyl)pyridine. The coordination behavior of 2-pyridylmethyl-substituted amines is similar to that of the 2-ethylamine analogues, but compounds are formed with a wider range of cations.

Tetrakis[*N*-(2-pyridylmethyl)]-cyclam forms dinuclear cations with  $Cu^{II}$  in exocyclic coordination by two amine and two pyridine nitrogen atoms. Tetrakis[*N*-(2-pyridylmethyl)]cyclen coordinates by all eight nitrogen atoms for  $[M(L)](ClO_4)_2$ , by the four ring nitrogen and two *cis*-pyridine nitrogen atoms for  $[M(L)](ClO_4)_2$  ( $M = Ni^{II}$ ,  $Cu^{II}$ , and  $Zn^{II}$ ),<sup>134</sup> and has two amine and two pyridine nitrogen atoms in exocyclic coordination for eight-coordinate  $[La_2(L)(NO_3)_6]$ .<sup>135</sup> 1,4,7-Tris(2-pyridylmethyl)-10-methylcyclen is seven-coordinate for  $[M(L)](ClO_4)_2$  ( $M = Mn^{II}$ ,  $Fe^{II}$ ) but six-coordinate with one coordinated pyridine for  $Co^{II}$ .<sup>136</sup> The  $Ni^{II}$  compound of 6,16-bis(2-pyridylmethyl)-(23) has the pyridine nitrogen atoms coordinated *trans* and they remain coordinated even in 3 mol dm<sup>-3</sup>  $HClO_4$ .<sup>137</sup>

### 1.20.7.8 N-pendants that Coordinate an Exocyclic Cation

The pyridine nitrogen atoms of 5- or 6-pyridylmethyl-substituted cyclic amines (and their bipyridylmethyl and terpyridylmethyl analogues) cannot coordinate to a cation which is coordinated within the macrocycle, but can coordinate to another exocyclic cation. 1-(2,2'-Bipyrid-6-yl-methyl)-cyclam<sup>138</sup> and 1,4,8,11-tetrakis(2,2'-bipyrid-5-yl-methyl)cyclam<sup>139,140</sup> react with  $[Ru(2,2'-bipyridyl)_2Cl_2]$  to form bis(2,2'-bipyridyl)(2,2'-bipyrid-6-ylmethyl)ruthenium (II) pendants. Similarly, 1-(1,10-phenanthrol-5-ylmethyl)cyclam forms a tris(1,10-phenanthroline) $Ru^{II}$  pendant.<sup>141</sup> *C*-substituted analogues, and the redox significance of these substituents, are described in Section 1.20.6.9.

Compounds of ferrocenylmethyl-substituted azamacrocycles are of interest because of potential electrocatalytic properties associated with the coupling of coordination and redox centers. 1-Ferrocenylmethyl-5,7-dioxocyclam and 1-ferrocenylmethyl-3,15-dioxo-1,4,7,11,14-pentaazacyclohexadecane have been prepared by reaction of *N*-ferrocenylmethyl-functionalized iminodiacetate with linear di- and triamines.<sup>142</sup> Reaction of a 1,1'-ferrocenyl-bis(methylenepyridinium) salt with 5,12-dioxocyclam forms the *trans*-bridged dioxo macrocycle (123),  $X = 1,1'$ -ferrocenyldimethyl, which is reduced to the (1,1'-ferrocenyldimethyl)-1,8-bridged-cyclam.<sup>143</sup> 1,1'-(1,1'-Ferrocenyldimethyl)-bis(cyclam) has been prepared.<sup>144</sup> Reaction of tetrakis[*N*-(2-aminoethyl)]cyclam with ferrocenecarbaldehyde followed by reduction with  $LiAlH_4$  gave the redox-active receptor tetrakis[*N*-(4-ferrocenyl-3-azabutyl)]cyclam.<sup>145</sup> 3,11-Bis(*N*-ferrocenylmethyl)-(25) ( $R^1 = H$ ,  $R^2 = Me$ ) has been prepared and formation constants with  $Ni^{II}$ ,  $Cu^{II}$ ,  $Zn^{II}$ ,  $Cd^{II}$ , and  $Pb^{II}$  measured.<sup>146</sup>

### 1.20.7.9 Other N-substituents

Cyclic amines with a great variety of *N*-substituents have been described, many with biologically significant groups, e.g., imidazolyl. Others include methyl-phosphonic and -phosphinic acids,<sup>147</sup> methyl-sulfonate,<sup>148</sup> quinolin-2-ylmethyl, anthraquinon-2-ylmethyl, 2-(3-hydroxypyridyl)methyl, 2-methoxyethyl,<sup>149</sup> 2-methylthioethyl,<sup>150</sup> thiophenyl, pyrazolyl, etc.

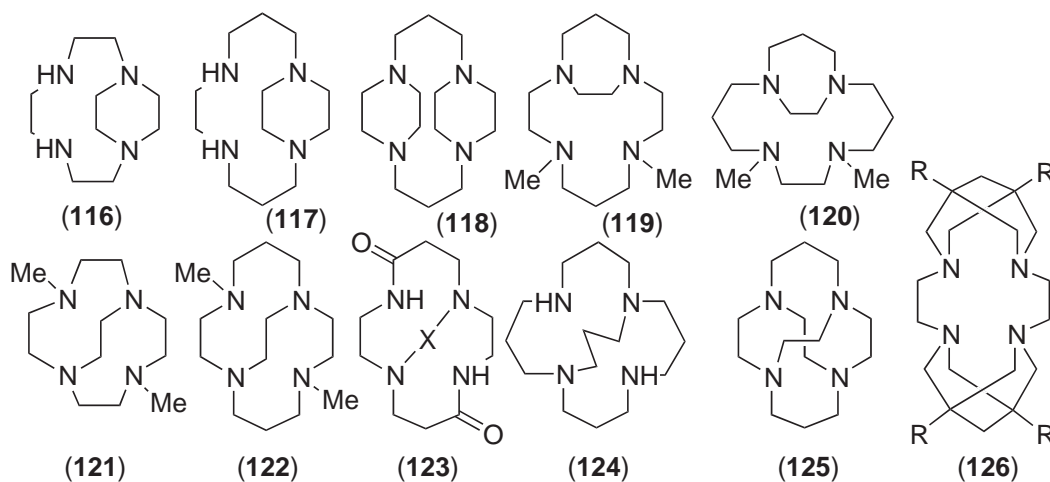
Mixed-*N*-substitution of azamacrocycles is of increasing interest for fine-tuning properties, and many examples have been reported. A variety of 3,11-bis-substituted derivatives of the 2,6-pyridyl macrocycle (**25**) (and the 7-(2-pyridylmethyl)- and 7-(2-aminoethyl)-substituted variants) has been prepared. NMR studies of lanthanide(III) compounds of 1,7-bis(carboxymethyl)-4,10-bis(1-methylimidazol-2-ylmethyl)-cyclen have been described.<sup>151</sup> A compound of 1-(*N,N*-dimethylcarbamoylmethyl)-8-(2-pyridylmethyl)-cyclam has Cu<sup>I</sup> coordinated by four in-plane ring nitrogen atoms and an axial amide nitrogen atom.<sup>152</sup> 1,4,7-Tris(carboxymethyl)-10-(2-aminoethyl)-cyclen and 1,4,8-tris(carboxymethyl)-11-(2-aminoethyl)-cyclam have been prepared.<sup>153</sup>

### 1.20.8 BI- AND TRICYCLIC AZAMACROCYCLES

Many bi- and tricyclic azamacrocycles have been prepared, though often the coordination chemistry has been little explored. Azamacrocycles with fused *o*-phenylene (Sections 1.20.3 and 1.20.4), 2,6-pyridyl (Section 1.20.3.2), 1,2-cyclohexdiyl (Section 1.20.3.1), 1,4-piperazindiyl and 1,4-diazacycloheptdiyl (Section 1.20.5) rings and the bicyclic cyclidenes (Section 1.20.3.4) are discussed above.

“Bridged” or “reinforced” azamacrocycles, which have pairs of nitrogen atoms of an azamacrocyclic linked, usually by an  $\alpha,\omega$ -alkandiyl “bridge,”<sup>154</sup> are prepared by reaction of a cyclic amine with a bifunctional nucleophile, such as an  $\alpha,\omega$ -dibromoalkane or an  $\alpha,\omega$ -ditosyl-alkane-diol. Bis(acyl esters), amides, and halides react with amines to form bicyclic amides which can be reduced to the bicyclic amines.<sup>155</sup> The “bridge” can have internal functions, such as C=C or *o*-C<sub>6</sub>H<sub>4</sub> (or include hetero atoms, thus forming clathrochelates).<sup>156</sup>

Cyclen and cyclam (and also 2,6- and 5,12-dioxocyclam) react with a bisnucleophile under high-dilution conditions to selectively form macro-bi- or tricycles.<sup>157</sup> Reaction with 1,2-ethandiyl reagents forms 1,4- “side-bridged” 1,4-piperizindiyl functions, e.g., (**116**) and (**117**) (Scheme 29). Reactions of 4,8-bis-substituted cyclam with bisnucleophiles form 1,11-bridged bicycles (**119**), or the [15]-homologue (**120**),<sup>158</sup> while substitution of *trans*-protected macrocycles leads to “cross-bridged” cyclic amines, e.g., (**121**) and (**122**). The oxamide (**62**) reduces to the bicycle (**117**) while the bisoxamide (**63**) and bislactam (**64**) reduce to the tricycle (**118**).<sup>159</sup> 1,8-Bridged dioxo-macrocycles (**123**) with a variety of X-bridges, including *o*-xylenediyl and 1,1'-ferrocenyldimethyl, are formed from 5,12-dioxocyclam and reduce to the cross-bridged cyclam.<sup>160</sup>



Scheme 29

The “side-bridged” bicyclic-amines are very rigid ligands, which coordinate square-planar with short M—N bonds.<sup>154</sup> The Ni<sup>II</sup> and Cu<sup>II</sup> compounds are extremely resistant to acid demetallation.

The *trans*- or “cross-bridged” bicyclic-cyclams, e.g., (**121**) and (**122**), are very strong bases for the first protonation step (“proton sponges”) and form salts with a proton, or Li<sup>+</sup>, incorporated within the N<sub>4</sub> cavity. Inserting metal ions into these macrocycles is difficult because of their high base strength, but has been accomplished under rigorously anhydrous conditions.<sup>161</sup> These ligands generally coordinate with the macrocycle in a folded conformation, with the metal ion in distorted tetrahedral, pyramidal (with one additional labile ligand), or octahedral (with two *cis* additional labile ligands) arrangements.<sup>162</sup> The combination of their chemical inertness, low

values for  $M^{III}/M^{II}$  reduction potentials, and presence of labile additional coordination sites has led to interest in their use as oxidation catalysts for bleaching using peroxide.<sup>162</sup> The [16]-cross-bridged homologue (**124**) has been prepared from the doubly cross-bridged tricycle, and cation compounds described.<sup>163,164</sup> Doubly cross-bridged cyclams, e.g., (**125**) are very strong bases, but no coordination chemistry has been reported.

The very rigid bis(bispidine) macrocycle (**126**) ( $R = \text{Me}$ ) has the highest reported ligand field strength for a  $\text{Cu}^{II}\text{N}_4$  chromophore.<sup>165</sup> The unsubstituted molecule (**126**) ( $R = \text{H}$ ) has also been synthesized.<sup>166</sup>

Substituted bicyclic or tricyclic azamacrocycles have been formed by cyclization of precursors with piperazindiyl; 1,4-diazacycloheptdiyl; 1,3,5,7-tetraazabicyclo[3.3.1]nondiyl; etc. functions. Large macrocycles incorporating 1,4-piperazindiyl groups (up to [66]-N<sub>22</sub>),<sup>167</sup> pyridiyl,<sup>168</sup> or dipyridiyl groups have been described.

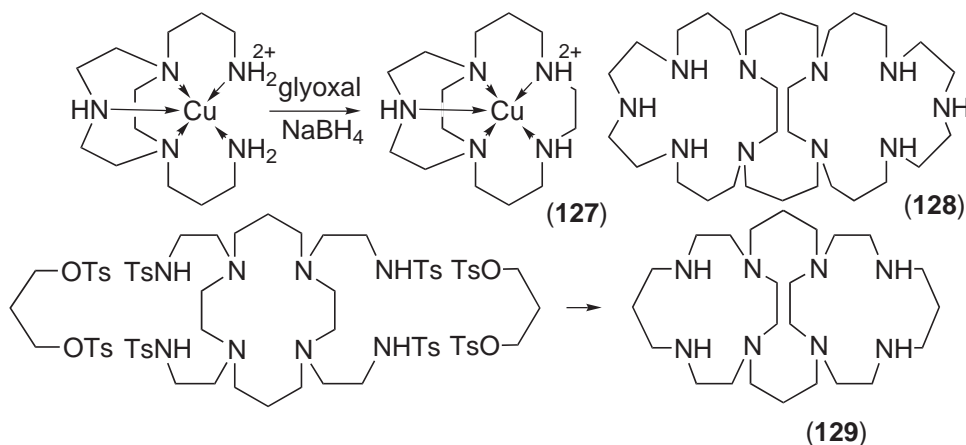
### 1.20.9 LINKED AZAMACROCYCLES

Azamacrocycles may be linked in a variety of fashions; by sharing a bond (bicyclic), by sharing an atom (spirocyclic), directly C—C or C=C bonded, or with a linking group, C—X—C or N—X—N (with the N-atoms coordinating or not).<sup>169–172</sup> The macrocycles are usually, but need not be, the same.<sup>173</sup> The bismacrocycles generally coordinate two cations, which may be the same or different, though 1,1'-(1,2-ethandiyl)-bistacn forms hexadentate octahedral compounds.<sup>173</sup>

The observation that compounds of bismacrocycles inhibit replication of HIV virus *in vitro*<sup>7,8</sup> has led to the synthesis of a variety of linked macrocycles. Interactions between cations, especially with different coordinated cations/oxidation states, have been investigated spectroscopically, magnetochemically, and electrochemically, the last with particular interest in electrocatalytic processes.

#### 1.20.9.1 Cyclic Amines with a Shared C—C Bond

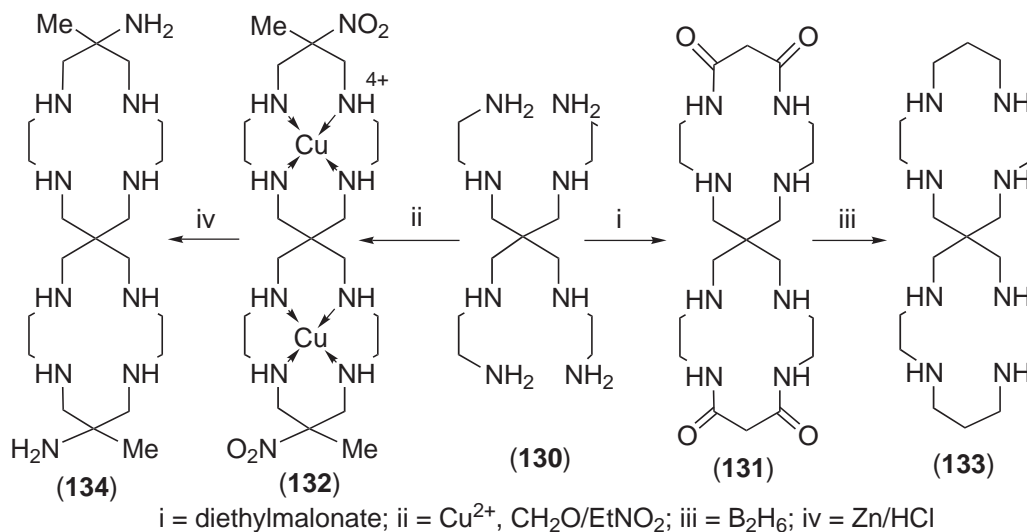
A bicyclic azamacrocycle (**127**) has been prepared from [bis*N*-(2-aminoethyl)-tacn]Cu<sup>II</sup> by reduction of the aminal formed with glyoxal (Scheme 30). The tricyclic ligands (**128**) and (**129**) formed by Richman-Atkins synthesis from tetrakis(3-aminopropyl)- and tetrakis(2-aminoethyl)-cyclam, respectively, form binuclear compounds.<sup>174</sup>



Scheme 30

#### 1.20.9.2 Spiro-azamacrocycles

6-6'-Spiro-biscyclam (**133**) has been prepared by reduction of the spiro-bis(dioxo-cyclam) (**131**),<sup>171</sup> formed from the spiro-octaamine (**130**) by reaction with diethyl malonate (Scheme 31). A nitroethane/methanal Mannich condensation of the  $\text{Cu}^{II}$  compound of (**130**) formed the spiro-bis(nitro-methyl-cyclam) (**132**), which reduces to the spiro-bis(amino-methyl-cyclam) compound (**134**).<sup>175</sup>

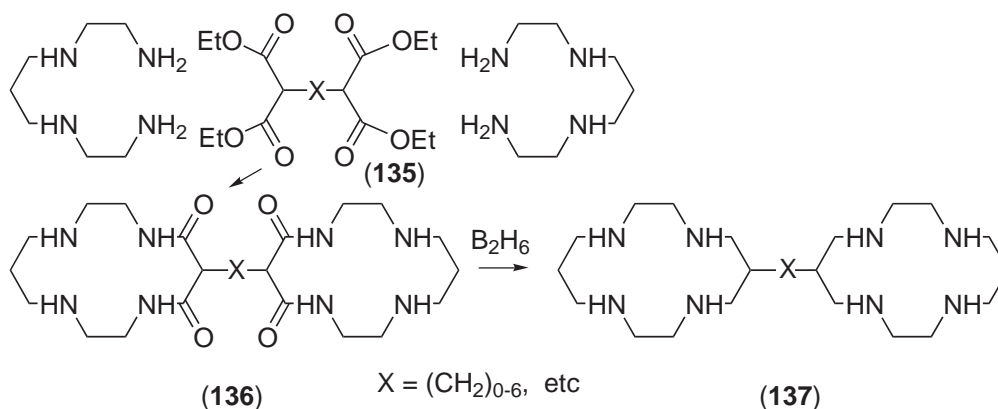


Scheme 31

### 1.20.9.3 C—C'-linked Bisazamacrocycles

The 2-2'-linked bicyclam (**4**) is formed as a minor by-product of the preparation of cyclam by  $\text{NaBH}_4$  reduction of the condensation product of  $[\text{Ni}(2,3,2\text{-tet})]^{2+}$  and glyoxal<sup>29</sup> (see Section 1.20.2.2).

6,6'-Bis(5,7-dioxo-cyclam)s with various linking groups (**136**) were prepared from the tetraesters (**135**) and reduced to form 6-6'-biscyclams (**137**) (Scheme 32).<sup>176</sup>

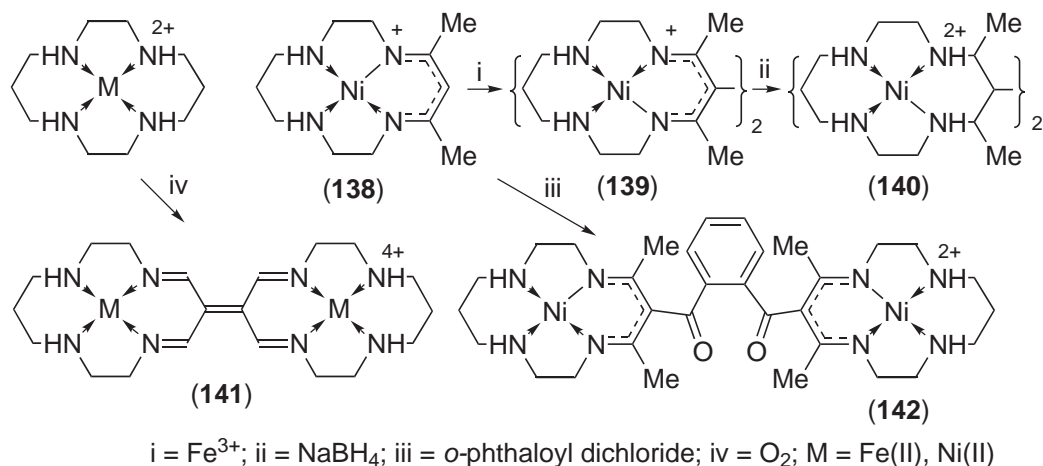


Scheme 32

Compounds with enato 1,3-diaza chelate rings, e.g., (**138**) (cf. (**37**) and (**38**)), are oxidized to radical species which form 6,6'-C—C (**139**), and 6,6'-C=C linked bismacrocycles, which can be reduced to form 6,6'-biscyclams (**140**) (Scheme 33).<sup>177</sup>  $[\text{Ni}(\text{cyclam})]^{2+}$  and  $[\text{Fe}(\text{cyclam})(\text{MeCN})_2]^{3+}$  are aerially oxidized to the 6-6'-ethylidene linked cations (**141**) which reduce to the 6,6'-biscyclam cations. Reaction of (**138**) with bifunctional *o*-phthaloyl dichloride gave bisacyl-linked macrocycles (**142**).<sup>178</sup>

### 1.20.9.4 N—X—N' Linked Bisazamacrocycles

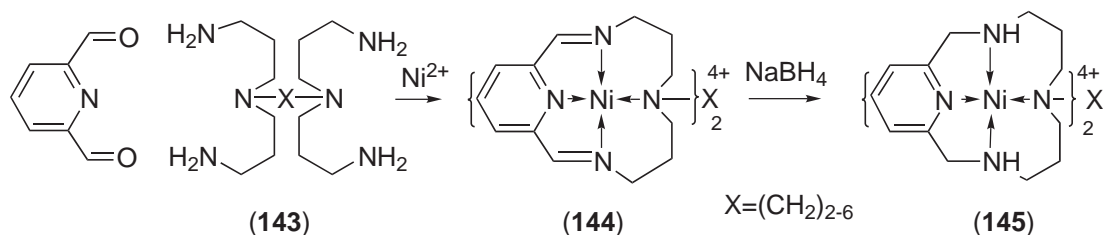
N—X—N' linked azamacrocycles have been prepared by reaction of the amine (**143**) with bifunctional nucleophiles,  $\text{Br—X—Br}$  (generally requiring protection of all but one amine group), and by Michael addition of bisacrylamides,  $(\text{CH}_2=\text{CHCONH})_2\text{X}$ . Compounds with a variety of linking groups X have been described, including alkyl chains, links including aromatic



Scheme 33

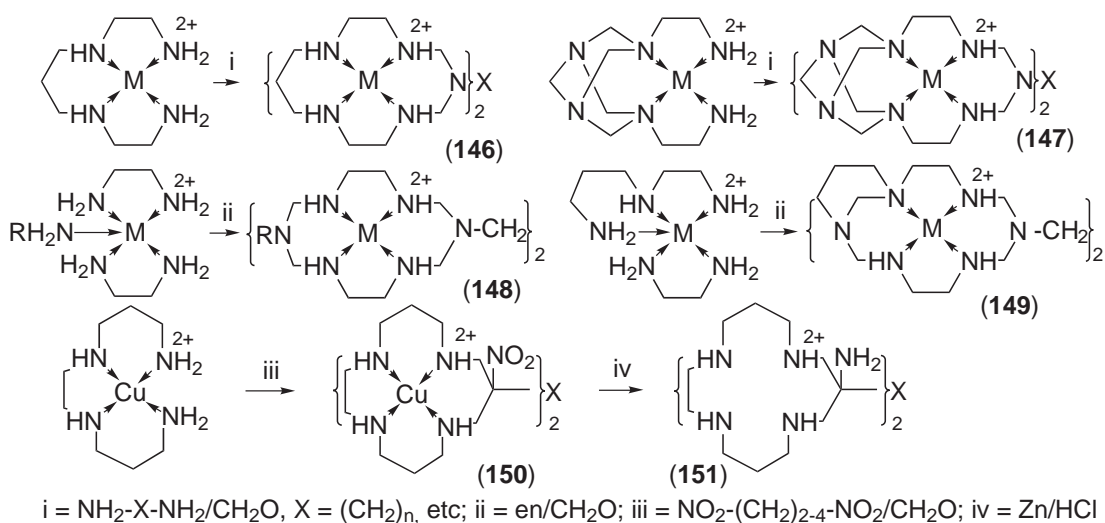
or heterocyclic rings, heterosubstituents, and 1,1'-ferrocenyldimethyl. A triangular triscyclen with 1,3,5-trimethylenebenzene linkers has been similarly prepared.<sup>179</sup>

2,6-Diformylpyridine and 2,6-diacetylpyridine undergo template condensations with hexaamines (**143**) to form dinuclear diimine cations (**144**), which reduce to the bis(2,5-pyridyl)tetraamines (**145**) (Scheme 34).



Scheme 34

N—X—N'-linked bis-“azacyclam” cations (**146**)–(**149**) are formed by Mannich reactions (Section 1.20.5), with  $\alpha,\omega$ -diamine “locking” reagents. Triangular trismacrocycle analogues are similarly formed with triamino triazine linkers (Scheme 35).<sup>180</sup> Extension of the nitroalkane/



Scheme 35

methanal condensations (see Section 1.20.6.3) to  $\alpha,\omega$ -dinitro compounds leads to the nitro- and amine-substituted bismacrocycles (**150**) and (**151**).

### 1.20.10 CONCLUSIONS

Studies of azamacrocycles started with serendipitous discoveries of idiosyncratic imine condensations of transition element compounds of suitably configured amines with carbonyl compounds. The compounds were primarily of interest to inorganic chemists, concerned with coordination properties. Systematic methods of synthesis of cyclic amines, and synthesis of cyclic amides greatly expanded the available range of azamacrocycles. Methods for C- and N-substitution with a great variety of functionalized substituents has opened up new areas in which the azamacrocycle serves as a framework about which diverse functionalities can be developed. The ability to build azamacrocycles with appended functionalities into macrostructures is a field the implications of which are just beginning to be realized. The biomedical possibilities of azamacrocycles seem boundless. The present macrocyclic magnetic resonance imaging agents, though effective, are very simple-minded, and the development of substituent patterns designed to target particular sites appears probable.<sup>181</sup> Similarly, the ability to safely convey radiopharmaceutical nuclei to targeted sites looks to be achievable.<sup>103,182,183</sup> Reported interactions of azamacrocycle compounds with specific peptide and DNA sequences offer interesting therapeutic possibilities. The ability of azamacrocycles to bind cations (effectively irreversibly), while leaving some coordination sites labile, has implications for catalytic activity in a variety of fields.<sup>184,185</sup> Azamacrocycles have now grown beyond their nursery in coordination chemistry and look to have a promising and diverse future.

### 1.20.11 REFERENCES

1. Melson, G. A., Ed., *Coordination Chemistry of Macrocyclic Compounds*; Plenum: New York, 1979.
2. Lindoy, L. F. *The Chemistry of Macrocyclic Ligand Complexes*; Cambridge University Press: Cambridge, UK, 1992.
3. Bhula, R.; Osvath, P.; Weatherburn, D. C. *Coord. Chem. Rev.* **1988**, *91*, 89–213.
4. Mitewa, M.; Bontchev, P. R. *Coord. Chem. Rev.* **1994**, *135*, 129–163.
5. Melson, G.A.; Melson, G. A., Ed., *Coordination Chemistry of Macrocyclic Compounds*; Plenum: New York, 1979.
6. Henrick, K.; Tasker, P. A.; Lindoy, L. F. *Prog. Inorg. Chem.* **1985**, *33*, 1–58.
7. Schwietert, C. W.; McCue, J. P. *Coord. Chem. Rev.* **1999**, *184*, 67–89.
8. Kimura, E.; Koike, T.; Inouye, Y. *Perspect. Bioinorg. Chem.* **1999**, *4*, 145–164.
9. Inouye, Y.; Kanamori, T.; Yoshida, T.; Bu, X.; Shionoya, M.; Koike, T.; Kimura, E. *Biol. Pharm. Bull.* **1994**, *17*, 243–250.
10. Izatt, R. M.; Pawlak, K.; Bradshaw, J. S.; Bruening, R. L. *Chem. Rev.* **1995**, *95*, 2529–2586.
11. Hay, B. P.; Hancock, R. D. *Coord. Chem. Rev.* **2001**, *212*, 61–78.
12. Adam, K. R.; Atkinson, I. M.; Farquhar, S.; Leong, A. J.; Lindoy, L. F.; Mahinay, M. S.; Tasker, P. A.; Thorp, D. *Pure Appl. Chem.* **1998**, *70*, 2345–2350.
13. Lindoy, L. F. *Pure Appl. Chem.* **1997**, *69*, 2179–2186.
14. Hancock, R. D.; Martell, A. E. *Supramol. Chem.* **1996**, *6*, 401–407.
15. Cambridge Structural Database; Cambridge Crystallographic Data Centre: Cambridge, UK, 2002.
16. Donnelly, M. A.; Zimmer, P. *Inorg. Chem.* **1999**, *38*, 1650–1658.
17. Cooper, C. G.; Zimmer, M. *Struct. Chem.* **1999**, *10*, 17–27.
18. Bakaj, M.; Zimmer, M. J. *Mol. Struct.* **1999**, *508*, 59–72.
19. Zimmer, M. *Coord. Chem. Rev.* **2001**, *212*, 133–163.
20. Curtis, N. F. Structural Aspects. In *Coordination Chemistry of Macrocyclic Compounds*; Melson, G. A., Ed.; Plenum: New York, 1979; pp 219–344.
21. Bosnich, B.; Poon, C. K.; Tobe, M. L. *Inorg. Chem.* **1965**, *4*, 1102–1108.
22. Elias, H. *Coord. Chem. Rev.* **1999**, *187*, 37–73.
23. Andres, A.; Bazzicalupi, C.; Bencini, A.; Bianchi, A.; Fusi, V.; Garciaespana, E.; Giorgi, C.; Nardi, N.; Paoletti, P.; Ramirez, J. A.; Valtancoli, B. J. *Chem. Soc., Perkin Trans. II* **1994**, 2367–2373.
24. Shionoya, M.; Kimura, E.; Iitaka, Y. *J. Am. Chem. Soc.* **1990**, *112*, 9237–9245.
25. Atkins, T. J.; Richman, J. E.; Oettle, W. F. *Org. Synth.* **1978**, *58*, 86.
26. Felix, V.; Costa, J.; Delgado, R.; Drew, M. G. B.; Duarte, M. T.; Resende, C. J. *Chem. Soc., Dalton Trans.* **2001**, 1462–1471.
27. Barefield, E. K.; Wagner, F.; Herlinger, A. W.; Dahl, A. R. *Inorg. Synth.* **1976**, *16*, 220–225.
28. Herve, G.; Bernard, H.; Le Bris, N.; Le Bacon, M.; Yaouane, J. J.; Handel, H. *Tetrahedron Lett.* **1999**, *40*, 2517–2520.
29. Barefield, E. K.; Chueng, D.; Van Derveer, D. G.; Wagner, F. J. *Chem. Soc., Chem. Commun.* **1981**, 302–304.
30. Tsuchiya, S.; Nakatani, Y.; Ibrahim, R.; Ogawa, S. *J. Am. Chem. Soc.* **2002**, *124*, 4936–4937.
31. Curtis, N. F. *Coord. Chem. Rev.* **1968**, *3*, 3–47.
32. Hay, R. W.; Pujari, M. P. *Inorg. Chim. Acta* **1985**, *99*, 75–79.
33. Kolinski, R. A.; Korybut-Daszkiewicz, B. *Pol. J. Chem.* **1983**, *56*, 1033–1044.



34. Kang, S.-G.; Kweon, J. K.; Jung, S. K. *Bull. Korean Chem. Soc.* **1991**, *12*, 483–487.
35. Park, Y.-C.; Kwak, Y.-W.; Kim, S.-S. *Polyhedron* **1994**, *13*, 2061–2066.
36. Barefield, E. K. *Inorg. Chem.* **1980**, *19*, 3186–3189.
37. Kolchinski, A. G. *Coord. Chem. Rev.* **1998**, *174*, 207–239.
38. Guerriero, P.; Tamburini, S.; Vigato, P. A. *Coord. Chem. Rev.* **1995**, *139*, 17–243.
39. Busch, D. H.; Alcock, N. W. *Chem. Rev.* **1994**, *94*, 585–623.
40. Rybak-Akimova, E. V.; Kuczera, K.; Jas, G. S.; Deng, Y.; Busch, D. H. *Inorg. Chem.* **1999**, *38*, 3423–3434.
41. Kolchinski, A. G.; Alcock, N. W.; Busch, D. H. *Inorg. Chem.* **1997**, *36*, 2754–2759.
42. Kolchinski, A. G.; Korybut-Daszkiewicz, B.; Rybak-Akimova, E. V.; Busch, D. H.; Alcock, N. W.; Clase, H. J. *J. Am. Chem. Soc.* **1997**, *119*, 4160–4171.
43. Alcock, N. W.; Busch, D. H.; Chmielewski, P. J.; Coltrain, B. K.; Meade, T. *J. Inorg. Chim. Acta* **1996**, *246*, 109–118.
44. Tait, A. M.; Busch, D. H. *Inorg. Chem.* **1977**, *16*, 966–968.
45. Konig, B.; Pelka, M.; Moller, O.; Dix, I.; Jones, P. G. *Chem. Ber.* **1997**, *130*, 521–527.
46. Costes, J. P. *Polyhedron* **1987**, *6*, 2169–2175.
47. Collinson, S. R.; Fenton, D. E. *Coord. Chem. Rev.* **1996**, *148*, 19–40.
48. Okawa, H.; Furutachi, H.; Fenton, D. E. *Coord. Chem. Rev.* **1998**, *174*, 51–75.
49. Brooker, S. *Coord. Chem. Rev.* **2001**, *222*, 33–56.
50. Brooker, S.; Davidson, T. C.; Hay, S. J.; Kelly, R. J.; Kennepohl, D. K.; Plieger, P. G.; Moubaraki, B.; Murray, K. S.; Bill, E.; Bothe, E. *Coord. Chem. Rev.* **2001**, 3–30216–217.
51. Dhont, K. I.; Herman, G. G.; Fabretti, A. C.; Lippens, W.; Goeminne, A. M. *J. Chem. Soc., Dalton Trans.* **1996**, 1753–1760.
52. Miyake, H.; Kojima, Y. *Coord. Chem. Rev.* **1996**, *148*, 301–314.
53. Siegfried, L.; Neuburger, M.; Zehnder, M.; Kaden, T. A. *J. Chem. Soc., Chem. Commun.* **1994**, 951–952.
54. Motekaitis, R. J.; Sun, Y.; Martell, A. E.; Welch, M. J. *Can. J. Chem.* **1999**, *77*, 614–623.
55. Hubin, T. J.; Tyryshkin, N.; Alcock, N. W.; Busch, D. H. *Acta Crystallogr.* **2001**, *57C*, 359–362.
56. Bradshaw, J. S.; Krakowiak, K. E.; Izatt, R. M. *J. Heterocycl. Chem.* **1989**, *26*, 1431–1435.
57. Krakowiak, K. E.; Bradshaw, J. S.; Izatt, R. M. *Synlett* **1993**, 611–620.
58. Hu, K.; Krakowiak, K. E.; Bradshaw, J. S.; Dalley, N. K.; Xue, G.; Izatt, R. M. *J. Heterocycl. Chem.* **1999**, *36*, 347–354.
59. Rybka, J. S.; Margerum, D. W. *Inorg. Chem.* **1980**, *19*, 2784–2790.
60. Hay, R. W.; Danby, A.; Lightfoot, P. *Polyhedron* **1997**, *16*, 3261–3266.
61. Bartos, M. J.; Gordon-Wylie, S. W.; Fox, B. G.; James Wright, L.; Weintraub, S. T.; Kauffmann, K. E.; Munck, E.; Kostka, K. L.; Uffelman, E. S.; Rickard, C. E. F.; Noon, K. R.; Collins, T. J. *Coord. Chem. Rev.* **1998**, *174*, 361–390.
62. Helps, I. M.; Parker, D.; Chapman, J.; Ferguson, G. J. *J. Chem. Soc., Chem. Commun.* **1988**, 1094–1095.
63. Montebault, V.; Mouaziz, H.; Blondeau, V.; Touchard, R.; Soutif, J. C.; Brosse, J. C. *Synth. Commun.* **1999**, *29*, 4279–4294.
64. Costisor, O.; Linert, W. *Rev. Inorg. Chem.* **2000**, *20*, 63–127.
65. Bordunov, A. V.; Bradshaw, J. S.; Pastushok, V. N.; Izatt, R. M. *Synlett* **1996**, 933–948.
66. Suh, M. P. *Adv. Inorg. Chem.* **1996**, *44*, 93–146.
67. De Blas, A.; De Santis, G.; Fabbri, L.; Licchelli, M.; Pallavicini, P. *Pure Appl. Chem.* **1993**, *65*, 455–459.
68. Desantis, G.; Fabbri, L.; Licchelli, M.; Mangano, C.; Pallavicini, P.; Poggi, A.; Sacchi, D.; Taglietti, A. *Supramol. Chem.* **1996**, *6*, 239–250.
69. Suh, M.; Shin, W.; Kim, D. *Inorg. Chem.* **1984**, *23*, 618–620.
70. Bernhardt, P. V.; Curtis, L. S.; Curtis, N. F.; Lawrance, G. A.; Skelton, B. W.; White, A. H. *Aust. J. Chem.* **1989**, *42*, 797–811.
71. Kobiro, K.; Nakayama, A.; Hiro, T.; Suwa, M.; Tobe, Y. *Inorg. Chem.* **1992**, *31*, 676–685.
72. Bernhardt, P. V.; Lawrance, G. A. *Coord. Chem. Rev.* **1990**, *104*, 297–343.
73. Kimura, E.; Wada, S.; Shionoya, M.; Okazaki, Y. *Inorg. Chem.* **1994**, *33*, 770–778.
74. Bu, X.; Chen, Y.; Shionoya, M.; Kimura, E. *Polyhedron* **1994**, *13*, 325–331.
75. Kimura, E.; Haruta, M.; Koike, T.; Shionoya, M.; Takenouchi, K.; Itaka, Y. *Inorg. Chem.* **1993**, *32*, 2779–2784.
76. Fujiwara, M.; Matsushita, T.; Shono, T. *Polyhedron* **1984**, *3*, 1357–1363.
77. Lawrance, G. A.; Maeder, M.; Wilkes, E. N. *Rev. Inorg. Chem.* **1993**, *13*, 199–232.
78. Comba, P.; Curtis, N. F.; Lawrance, G. A.; O’Leary, M. A.; Skelton, B. W.; White, A. H. *J. Chem. Soc., Dalton Trans.* **1988**, 2145–2152.
79. Rossignoli, M.; Allen, C. C.; Hambley, T. W.; Lawrance, G. A.; Maeder, M. *Inorg. Chem.* **1996**, *35*, 4961–4966.
80. Fabbri, L.; Licchelli, M.; Lanfredi, A. M. M.; Vassalli, O.; Ugozzoli, F. *Inorg. Chem.* **1996**, *35*, 1582–1589.
81. Bernhardt, P. V.; Sharpe, P. C. *Inorg. Chem.* **1998**, *37*, 1629–1636.
82. Curtis, N. F.; Robinson, W. T.; Weatherburn, D. C. *Aust. J. Chem.* **1992**, *45*, 1663–1680.
83. Bernhardt, P. V. *Acta Crystallogr.* **2000**, *56C*, 744–746.
84. Bernhardt, P. V.; Jones, L. A. *J. Chem. Soc., Dalton Trans.* **1998**, 1757–1761.
85. Bernhardt, P. V.; Comba, P. J. *J. Chem. Soc., Chem. Commun.* **1993**, 113–114.
86. Bernhardt, P. V.; Lawrance, G. A.; Hambley, T. W. *Inorg. Chem.* **1992**, *31*, 631–634.
87. Bernhardt, P. V.; Hetherington, J. C.; Jones, L. A. *J. Chem. Soc., Dalton Trans.* **1996**, 4325–4330.
88. Beer, P. D.; Bernhardt, P. V. *J. Chem. Soc., Dalton Trans.* **2001**, 1428–1431.
89. Krajewski, J. W.; Gluzinski, P.; Korybut-Daszkiewicz, B.; Mishnev, A.; Kemme, A. *J. Chem. Soc., Dalton Trans.* **1991**, 53–56.
90. Kang, S.-G.; Kim, M.-S.; Whang, D.; Kim, K. *J. Chem. Soc., Dalton Trans.* **1994**, 853–857.
91. Gluzinski, P.; Krajewski, J. W.; Kolinski, R. A.; Korybut-Daszkiewicz, B.; Mishnev, A.; Kemme, A. *Pol. J. Chem.* **1995**, *69*, 350–360.
92. Li, X.; Curtis, N. F.; Weatherburn, D. C. *Trans. Met. Chem. (London)* **1992**, *17*, 147–154.
93. Fabbri, L.; Licchelli, M.; Poggi, A.; Vassalli, O.; Ungaretti, L.; Sardone, N. *Inorg. Chim. Acta* **1996**, *246*, 379–385.
94. Li, X.; Curtis, N. F. *Aust. J. Chem.* **1992**, *45*, 1087–1094.
95. Wilkes, E. N.; Hambley, T. W.; Lawrance, G. A.; Maeder, M. *Aust. J. Chem.* **2000**, *53*, 517–521.

96. Comba, P.; Luther, S. M.; Maas, O.; Pritzkow, H.; Vielfort, A. *Inorg. Chem.* **2001**, *40*, 2335–2345.
97. House, D. A.; Harnett, M.; Robinson, W. T.; Couldwell, M. C. *J. Chem. Soc., Chem. Commun.* **1984**, 979–980.
98. Panneerselvam, K.; Lu, T.-H.; Ch, T.-Y.; Tung, S.-F.; Chung, C.-S. *Acta Crystallogr.* **2000**, *C56*, 659–660.
99. Kimura, E.; Kodama, Y.; Shionoya, M.; Koike, T. *Inorg. Chim. Acta* **1996**, *246*, 151–158.
100. Bucher, C.; Duval, E.; Espinosa, E.; Barbe, J.-M.; Verpeaux, J.-N.; Amatore, C.; Guillard, R. *Eur. J. Inorg. Chem.* **2001**, 1077–1079.
101. Wainwright, K. P. *Coord. Chem. Rev.* **1997**, *166*, 35–90.
102. Costamagna, J.; Ferraudi, G.; Matsuhira, B.; Campos-Vallette, M.; Canales, J.; Villagran, M.; Vargas, J.; Aguirre, M. *J. Coord. Chem. Rev.* **2000**, *196*, 125–164.
103. Yam, V. W. W.; Lo, K. K. W. *Coord. Chem. Rev.* **1999**, *184*, 157–240.
104. Krakowiak, K. E.; Bradshaw, J. S. *Synth. Commun.* **1996**, *26*, 3999–4004.
105. Krakowiak, K. E.; Bradshaw, J. S. *Synth. Commun.* **1998**, *28*, 3451–3459.
106. Fensterbank, H.; Zhu, J. R.; Riou, D.; Larpent, C. *J. Chem. Soc., Perkin Trans. 1* **1999**, 811–815.
107. Davies, P. J.; Taylor, M. R.; Wainwright, K. P. *J. Chem. Soc., Chem. Commun.* **1998**, 827–828.
108. Bellouard, F.; Chuburu, F.; Kervarec, N.; Toupet, L.; Triki, S.; Le Mest, Y.; Handel, H. *J. Chem. Soc., Perkin Trans. 1* **1999**, 3499–3505.
109. Oberholzer, M. R.; Neuburger, M.; Zehnder, M.; Kaden, T. A. *Helv. Chim. Acta* **1995**, *78*, 505–513.
110. Sibert, J. W.; Cory, A. H.; Cory, J. G. *J. Chem. Soc., Chem. Commun.* **2002**, 154–155.
111. Kaden, T. A. *Pure Appl. Chem.* **1993**, *65*, 1477–1483.
112. Meyer, M.; Dahoui-Gindrey, V.; Lecomte, C.; Guillard, L. *Coord. Chem. Rev.* **1998**, *180*, 1313–1405.
113. Bianchi, A.; Calabi, L.; Giorgi, C.; Losi, P.; Mariani, P.; Paoli, P.; Rossi, P.; Valtancoli, B.; Virtuani, M. *J. Chem. Soc., Dalton Trans.* **2000**, 697–705.
114. Riesen, A.; Zehnder, M.; Kaden, T. A. *Acta Crystallogr.* **1991**, *C47*, 531–533.
115. Maurya, M. R.; Zaluzec, E. J.; Pavkovic, S. F.; Herlinger, A. W. *Inorg. Chem.* **1991**, *30*, 3657–3662.
116. Ware, D. C.; Toney, D. M.; Baker, L.-J.; Brothers, P. J.; Clark, G. R. *J. Chem. Soc., Chem. Commun.* **1996**, 1303–1304.
117. Hancock, R. D.; Maumela, H.; de Sousa, A. S. *Coord. Chem. Rev.* **1996**, *148*, 315–347.
118. Maumela, H.; Hancock, R. D.; Carlton, L.; Reibenspies, J. H.; Wainwright, K. P. *J. Am. Chem. Soc.* **1995**, *117*, 6698–6707.
119. Espinosa, E.; Meyer, M.; Berard, D.; Guillard, R. *Acta Crystallogr.* **2002**, *C58*, m119–m121.
120. Lazar, I. *Tetrahedron Lett.* **1999**, *40*, 381–382.
121. Bucher, C.; Duval, E.; Barbe, J. M.; Verpeaux, J. N.; Amatore, C.; Guillard, R. *C. R. Acad. Sci.* **2000**, *3*, 211–222.
122. Rahardjo, S. B.; Wainwright, K. P. *Inorg. Chim. Acta* **1997**, *255*, 29–34.
123. Davies, P. J.; Wainwright, K. P. *Inorg. Chim. Acta* **1999**, *294*, 103–108.
124. Gros, C.; Chollet, H.; Mishra, A. K.; Guillard, R. *Synth. Commun.* **1996**, *26*, 35–47.
125. Hay, R. W.; Clifford, T.; Klein, J.; Lightfoot, P. *Polyhedron* **1996**, *15*, 2315–2319.
126. Siegfried, L.; Kowallick, R.; Kaden, T. A. *Supramol. Chem.* **2001**, *13*, 357–367.
127. Asato, E.; Ozutsumi, K.; Ishiguro, S.; Kida, S.; Murase, I. *Inorg. Chim. Acta* **1990**, *167*, 189–193.
128. Tan, L. H.; Taylor, M. R.; Wainwright, K. P.; Duckworth, P. A. *Spec. Publ. R. Soc. Chem.* **1993**, *131*, 102–105.
129. Liu, Y.; Xue, G. P.; Wu, C. T.; Luo, B. S. *Chin. J. Chem.* **1998**, *16*, 16–21.
130. Wainwright, K. P. *J. Chem. Soc., Dalton Trans.* **1983**, 1149–1152.
131. Bembli, R.; Jhanji, A. K. *Trans. Met. Chem. (London)* **1989**, *14*, 143–146.
132. Comparone, A.; Kaden, T. A. *Helv. Chim. Acta* **1998**, *81*, 1765–1772.
133. Schiegg, A.; Riesen, A.; Kaden, T. A. *Helv. Chim. Acta* **1991**, *74*, 1689–1696.
134. Bu, X.-H.; Cao, X.-C.; Yuan, M.-X.; Wan, X.-B.; Chen, R.-T. *Jiegou Huaxue* **1996**, *15*, 499–502.
135. Bu, X.-H.; Lu, S.-L.; Zhang, R.-H.; Wang, H.-M. *Synth. React. Inorg. Met.-Org. Chem.* **1998**, *28*, 1127–1143.
136. Bu, X.-H.; Chen, W.; Zhang, Z.-H.; Zhang, R.-H.; Kuang, S.-M.; Clifford, T. *Inorg. Chim. Acta* **2000**, *310*, 110–114.
137. Choi, K.-Y. *J. Chem. Crystallogr.* **2000**, *30*, 335–338.
138. Kimura, E.; Wada, S.; Shionoya, M.; Takahashi, T.; Iitaka, Y. *J. Chem. Soc., Chem. Commun.* **1990**, 397–398.
139. Josceanu, A. M.; Moore, P.; Sheldon, P. *Rev. Roum. Chim.* **1998**, *43*, 945–955.
140. Alcock, N. W.; Clarke, A. J.; Errington, W.; Josceanu, A. M.; Moore, P.; Rawle, S. C.; Sheldon, P.; Smith, S. M.; Turonek, M. L. *Supramol. Chem.* **1996**, *6*, 281–291.
141. Kimura, E.; Bu, X.; Shionoya, M.; Wada, S.; Maruyama, S. *Inorg. Chem.* **1992**, *31*, 4542–4546.
142. Xue, P.; Fu, E.; Wang, G.; Gao, C.; Fang, M.; Wu, C. *J. Organomet. Chem.* **2000**, *598*, 42–48.
143. Plenio, H.; Aberle, C.; Al Shihadeh, Y.; Lloris, J. M.; Martinez-Manez, R.; Pardo, T.; Soto, J. *Chem. Eur. J.* **2001**, *7*, 2848–2861.
144. Bellouard, F.; Chuburu, F.; Yaouanc, J. J.; Handel, H.; Le Mest, Y. *New J. Chem.* **1999**, *23*, 1133–1135.
145. Lloris, J. M.; Martinez-Manez, R.; Padilla-Tosta, M. E.; Pardo, T.; Soto, J.; Garcia-Espana, E.; Ramirez, J. A.; Burguete, M. I.; Luis, S. V.; Sinn, E. *J. Chem. Soc., Dalton Trans.* **1999**, 1779–1784.
146. Costa, J.; Delgado, R.; Drew, M. G. B.; Felix, V.; Saint-Maurice, A. *J. Chem. Soc., Dalton Trans.* **2000**, 1907–1916.
147. Lukes, I.; Kotek, J.; Vojtisek, P.; Hermann, P. *Coord. Chem. Rev.* **2001**, *216*, 287–312.
148. Schmid, C.; Neuburger, M.; Zehnder, M.; Kaden, T. A.; Hubner, T. *Polyhedron* **1998**, *17*, 4065–4070.
149. Dhillon, R.; Lincoln, S. F.; Madbak, S.; Stephens, A. K.; Wainwright, K. P.; Whitbread, S. L. *Inorg. Chem.* **2000**, *39*, 1855–1858.
150. Schmid, C. L.; Neuburger, M.; Zehnder, M.; Kaden, T. A.; Bujno, K.; Bilewicz, R. *Helv. Chim. Acta* **1997**, *80*, 241–252.
151. Keire, D. A.; Jang, Y. H.; Li, L.; Dasgupta, S.; Goddard, W. A. III; Shively, J. E. *Inorg. Chem.* **2001**, *40*, 4310–4318.
152. Kurosaki, H.; Bucher, C.; Espinosa, E.; Barbe, J. M.; Guillard, R. *Inorg. Chim. Acta* **2001**, *322*, 145–149.
153. Mishra, A. K.; Chatal, J. F. *New J. Chem.* **2001**, *25*, 336–339.
154. Hancock, R. D.; Patrick, G.; Wade, P. W.; Hosken, G. D. *Pure Appl. Chem.* **1993**, *65*, 473–476.
155. Krajewski, J. W.; Gluzinski, P.; Kolinski, R. A.; Kemme, A.; Mishnev, A. *Pol. J. Chem.* **1994**, *68*, 703–711.
156. Ingham, A.; Rodopoulos, M.; Coulter, K.; Rodopoulos, T.; Subramanian, S.; McAuley, A. *Coord. Chem. Rev.* **2002**, *233–234*, 255–271.



157. Brandes, S.; Denat, F.; Lacour, S.; Rabiet, F.; Barbette, F.; Pullumbi, P.; Guillard, R. *Eur. J. Org. Chem.* **1998**, 2349–2360.
158. Collinson, S. R.; Alcock, N. W.; Hubjn, T. J.; Busch, D. H. *J. Coord. Chem.* **2001**, 52, 317–331.
159. Chapman, J.; Ferguson, G.; Gallagher, J. F.; Jennings, M. C.; Parker, D. *J. Chem. Soc., Dalton Trans.* **1992**, 345–53.
160. Hubin, T. J.; Tyryshkin, N.; Alcock, N. W.; Busch, D. H. *Acta Crystallogr.* **1999**, C55, 1888–1889.
161. Hubin, T. J.; McCormick, J. M.; Collinson, S. R.; Buchalova, M.; Perkins, C. M.; Alcock, N. W.; Kahol, P. K.; Raghunathan, A.; Busch, D. H. *J. Am. Chem. Soc.* **2000**, 122, 2512–2522.
162. Hubin, T. J.; McCormick, J. M.; Alcock, N. W.; Busch, D. H. *Inorg. Chem.* **2001**, 40, 435–444.
163. Broge, L.; Sotofte, I.; Olsen, C. E.; Springborg, J. *Inorg. Chem.* **2001**, 40, 3124–3129.
164. Broge, L.; Pretzmann, U.; Jensen, N.; Sotofte, I.; Olsen, C. E.; Springborg, J. *Inorg. Chem.* **2001**, 40, 2323–2334.
165. Comba, P.; Pritzkow, H.; Schiek, W. *Angew. Chem. Int. Ed. Engl.* **2001**, 40, 2465–2468.
166. Miyahara, Y.; Goto, K.; Inazu, T. *Tetrahedron Lett.* **2001**, 42, 3097–3099.
167. Bencini, A.; Formica, M.; Fusi, V.; Giorgi, C.; Giorgi, L.; Micheloni, M.; Pontellini, R.; Valtancoli, B. *Inorg. Chim. Acta* **2001**, 318, 152–158.
168. Fronczek, F. R.; Schilling, P. J.; Watkins, S. F.; Majestic, V. K.; Newkome, G. R. *Inorg. Chim. Acta* **1996**, 246, 119–123.
169. Chartres, J. D.; Lindoy, L. F.; Meehan, G. V. *Coord. Chem. Rev.* **2001**, 216, 249–286.
170. Lindoy, L. F. *Adv. Inorg. Chem.* **1998**, 45, 75–125.
171. McAuley, A.; Subramanian, S. *Coord. Chem. Rev.* **2000**, 200, 75–103.
172. Kaden, T. A. *Coord. Chem. Rev.* **1999**, 192, 371–389.
173. Grochala, W.; Jagielska, A.; Wozniak, K.; Wieckowska, A.; Bilewicz, R.; Korybut-Daszkiewicz, B.; Bukowska, J.; Piela, L. *J. Phys. Org. Chem.* **2001**, 14, 63–73.
174. Murase, I.; Vuckovic, G.; Kodera, M.; Harada, H.; Matsumoto, N.; Kida, S. *Inorg. Chem.* **1991**, 30, 728–723.
175. Bernhardt, P. V.; Comba, P.; Gahan, L. R.; Lawrance, G. A. *Aust. J. Chem.* **1990**, 43, 2035–2044.
176. Comba, P.; Gavriš, S. P.; Hay, R. W.; Hilfenhaus, P.; Lampeka, Y. D.; Lightfoot, P.; Peters, A. *Inorg. Chem.* **1999**, 38, 1416–1421.
177. Mochizuki, K. *Chem. Lett.* **2000**, 26–27.
178. Kido, H.; Takada, M.; Suwabe, M.; Yamaguchi, T.; Ito, T. *Inorg. Chim. Acta* **1995**, 228, 133–138.
179. Kimura, E.; Aoki, S.; Koike, T.; Shiro, M. *J. Am. Chem. Soc.* **1997**, 119, 3068–3076.
180. Bernhardt, P. V.; Hayes, E. J. *Inorg. Chem.* **1998**, 37, 4214–4219.
181. Comblin, V.; Gilsoul, D.; Hermann, M.; Humblet, V.; Jacques, V.; Mesbahi, M.; Sauvage, C.; Desreux, J. F. *Coord. Chem. Rev.* **1999**, 186, 451–470.
182. Nosco, D. L.; Beaty-Nosco, J. A. *Coord. Chem. Rev.* **1999**, 184, 91–123.
183. Thunus, L.; Lejeune, R. *Coord. Chem. Rev.* **1999**, 184, 125–155.
184. Costamagna, J.; Ferraudi, G.; Canales, J.; Vargas, J. *Coord. Chem. Rev.* **1996**, 148, 221–248.
185. Fujita, E. *Coord. Chem. Rev.* **1999**, 185, 373–384.

# 1.21

## Macrocyclic Phosphine and Arsinic Ligands

W. LEVASON and G. REID  
*University of Southampton, UK*

---

1.21.1	INTRODUCTION	475
1.21.2	PHOSPHINE MACROCYCLES	475
1.21.3	ARSINIC MACROCYCLES	482
1.21.4	REFERENCES	484

---

### 1.21.1 INTRODUCTION

For the purposes of this discussion we will restrict macrocycles to those cyclic organic compounds with at least three heteroatoms within the ring and with at least two carbon atoms between each adjacent pair of heteroatoms. Phosphorus-containing rings involving P—O, P—N, etc. bonds are not included in this account, however these are reviewed elsewhere.<sup>1</sup> The following discussion will concentrate mainly on macrocycles containing only P or As donor atoms. Some reference to mixed-donor macrocycles containing one or more of these donor types will be made as appropriate.

Earlier relevant reviews on phosphine and arsine macrocycles are given by Stelzer and Langhans<sup>2</sup> and Wild.<sup>3</sup> There are no examples of stibine or bismuthine macrocycles.

### 1.21.2 PHOSPHINE MACROCYCLES

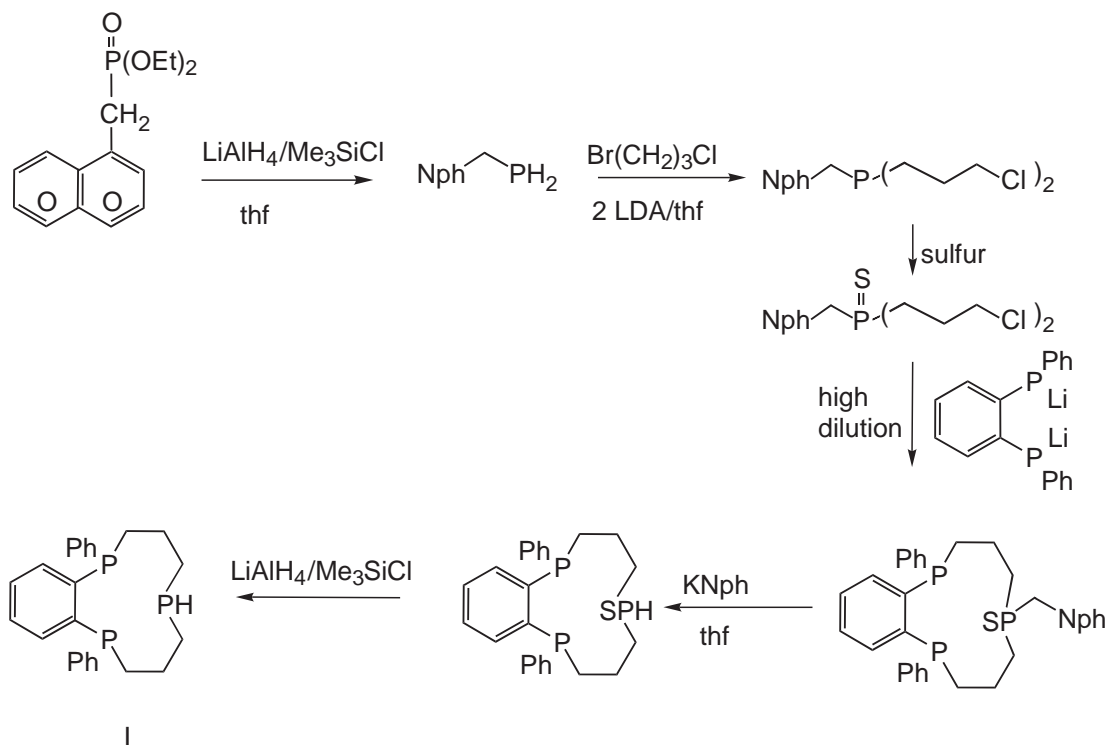
There has been much interest in the preparation and properties of phosphine macrocycles since the early 1980s.<sup>4</sup> While simple mono- and diphosphines, on account of the balance of their  $\sigma$ -donor and  $\pi$ -acceptor capabilities, represent an important class of ligands to a wide range of transition metal centers, incorporation of phosphine functions within a macrocyclic environment introduces additional factors affecting their behavior as ligands due to the macrocyclic effect. The synthesis of P-containing macrocycles has been reviewed previously.<sup>1,2,4</sup>

Preparative routes to phosphine macrocycles still represent a very significant synthetic challenge. The chemistry is often hindered by difficulties in handling conveniently many of the precursors, especially over the duration of a high dilution synthesis. The majority of syntheses generally utilize primary (RPH<sub>2</sub>) or disubstituted phosphine (HRP <sup>$\sigma$</sup> PRH) precursors, with P—C bond formation effected by either radical induced hydrophosphination reactions or nucleophilic substitution using a phosphide and an appropriate haloalkane. The primary and secondary phosphines are often volatile, toxic, and extremely air sensitive, while their phosphides are also very moisture sensitive. As with other macrocyclic compounds, ring closure invariably uses either high-dilution cyclization or template-assisted cyclization reactions. One further problem often encountered is the substantial weakening of the P—H bonds upon coordination to a metal ion

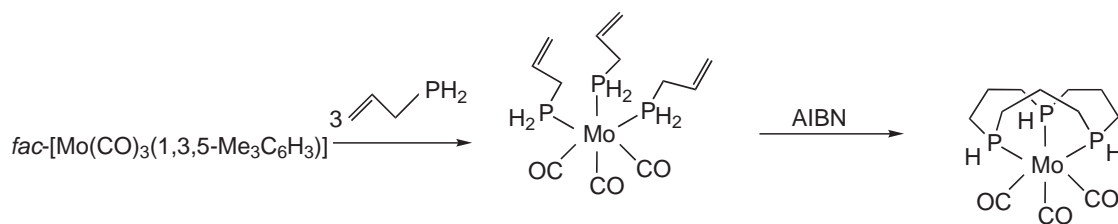
template. Thus, spontaneous (and uncontrolled) deprotonation may occur, and further reactions of the resulting phosphides can lead to phosphido-bridged dimers or clusters which are not suitable for macrocyclization. Another facet of the chemistry is the considerable stability of the transition metal template complexes of the phosphine precursors, which can also hinder cyclization. Therefore, choice of template is a particularly important issue here. Most success has been achieved using  $\text{Ni}^{\text{II}}$ ,  $\text{Pd}^{\text{II}}$ , and especially organometallic complexes of  $\text{Cr}^0$ ,  $\text{Mo}^0$ ,  $\text{W}^0$ , and  $\text{Fe}^{\text{II}}$  as templates—see below.

Major contributions to the early work on phosphine-only macrocycles were made by Kyba and co-workers and Stelzer and co-workers, and much of this chemistry is discussed in the first edition of this work.<sup>4</sup>

The  $\text{P}_3$ -macrocycle **I**, involving a secondary phosphine function, has been obtained (as a mixture of two stereoisomers) via a high dilution reaction shown in Scheme 1. The use of the 1-naphthylmethyl protecting group permits the secondary phosphine function to be incorporated, and thus should lead to opportunities for further functionalization and tuning of the macrocycle through reactions at this site.<sup>5</sup> One particular drawback of the high dilution approach, which was employed very successfully in the work of Kyba *et al.* was the occurrence of mixtures of stereoisomers which are generally difficult to separate. This is a significant and widely recognized problem which occurs as a result of the high energy barrier to inversion at the P atoms, hence if a synthesis generates a mixture of stereoisomers, these are often extremely difficult to interconvert to a single preferred form. In 1982, Norman and co-workers described the synthesis of [12]ane $\text{P}_3$  via a template-mediated hydrophosphination reaction on a *fac*- $\text{Mo}(\text{CO})_3$  fragment (Scheme 2).<sup>6</sup> The use of this particular template is important as it sets up three facial coordination sites for macrocycle formation and the low-spin  $d^6$   $\text{Mo}^0$  shows a strong propensity for octahedral coordination. The molybdenum complex of the 12-membered ring triphospha macrocycle is obtained in very high yield as a single (*syn, syn*) isomer. The analogous [15]ane $\text{P}_3$  may be obtained similarly using  $\text{H}_2\text{PCH}_2\text{CH}_2\text{CH}=\text{CH}_2$ .<sup>7</sup> However, these macrocyclic complexes proved very resistant to demetallation and this severely hindered development of this chemistry for some years.



Scheme 1



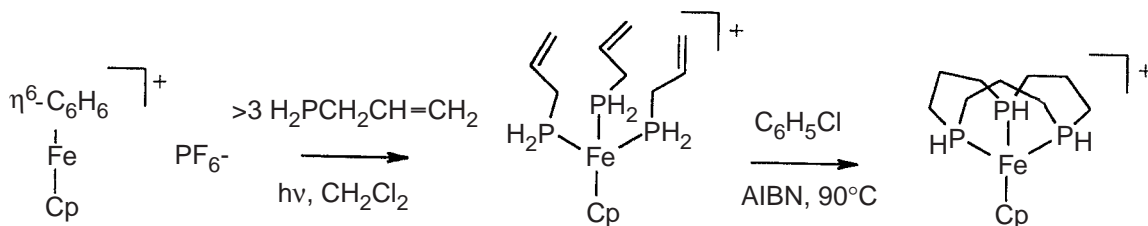
Scheme 2

Significant progress has been made concerning the development of new synthetic routes to triphosphorus macrocycles with varying ring sizes over the last few years. Edwards and co-workers have examined the chemistry of this  $[\text{Mo}(\text{CO})_3(12\text{-aneP}_3)]$  system (and the corresponding  $\text{Co}^0$  and  $\text{W}^0$  systems) in some detail. Various alkyl,  $\omega$ -aminoalkyl, alkenyl<sup>8,9</sup> and aryl<sup>10</sup> substituents may be introduced readily via substitution reactions (or via phenylcopper or diphenylcuprate for the aryl derivatives) at the secondary phosphine functions. The liberation of the 12-membered ring triphospha macrocycles from the template represents a major advance. This is achieved by halogen oxidation of the  $\text{Mo}^0$  macrocyclic complex to the much more labile, 7-coordinate  $\text{Mo}^{\text{II}}$ , followed by hydrolysis with strong base.<sup>11,12</sup> The release of the  $\text{P}_3$ -macrocycles has permitted more detailed studies of their coordination chemistry with other transition metal ions.<sup>13,14</sup> Attempts to form smaller ring sizes via similar intramolecular hydrophosphination of  $[\text{M}(\text{CO})_3(\text{H}_2\text{PCH}=\text{CH}_2)_3]$  ( $\text{M} = \text{Cr}$  or  $\text{Mo}$ ) have failed.<sup>15</sup> This failure has been attributed to the large ionic radius of the Group 6  $\text{M}^0$  ion, disfavoring the small 9-membered ring. It should be noted however that the 9-membered ring trithia macrocycle,  $[9\text{-aneS}_3]$ , forms in good yield via a template cyclization reaction on a *fac*- $\text{Mo}(\text{CO})_3$  fragment.<sup>16</sup> This  $\text{S}_3$ -donor ring has similar steric requirements to the simplest  $[9\text{-aneP}_3]$ .

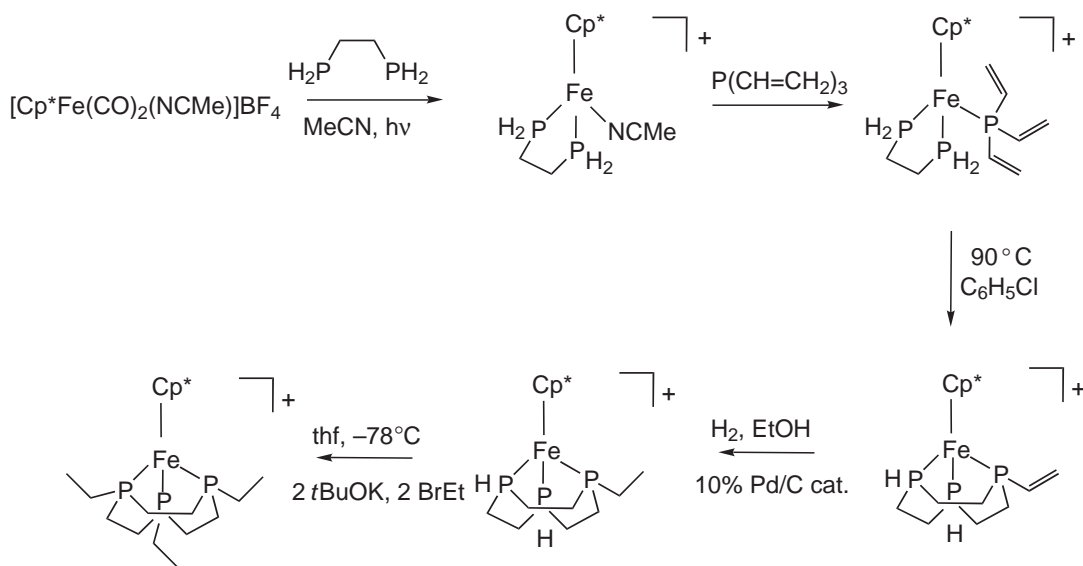
The  $(\eta^5\text{-C}_5\text{H}_5)\text{Fe}^+$  ( $\text{CpFe}^+$ ) fragment also functions as an effective template for the formation of macrocycles based on the  $[12\text{-aneP}_3]$  framework, via intramolecular hydrophosphination reactions (Scheme 3).<sup>17</sup> Conversion of the trisecondary phosphine macrocycle to the triethyl tritertiary derivative uses ethene (2 atm) and AIBN in chlorobenzene. The resulting  $\text{Et}_3[12\text{-aneP}_3]$  macrocycle is liberated from the template via reduction using  $\text{Na}/\text{NH}_3(\text{l})$ . Importantly, the pentamethylcyclopentadienyl iron(II) fragment has proved capable of facilitating the template (stereoselective) synthesis of several smaller 9- and 10-membered ring triphospha macrocycles.<sup>18–20</sup> Scheme 4 illustrates the preparation of a 9-membered  $\text{P}_3$ -donor ring based upon this chemistry.<sup>18</sup> Thus, the photochemical reaction of  $[\text{Fe}(\text{MeCN})(\text{CO})_2(\eta^5\text{-Me}_5\text{C}_5)]\text{BF}_4$  with the diprimary phosphine  $\text{H}_2\text{PCH}_2\text{CH}_2\text{PH}_2$  in toluene leads to substitution of the CO ligands and incorporation of the phosphine. Treatment of this species with trivinylphosphine followed by hydrogenation and reaction with potassium tert-butoxide in presence of bromoethane gives  $[\text{Fe}(\eta^5\text{-Me}_5\text{C}_5)(\text{Et}_3[9\text{-aneP}_3])^+]$ . The mixed bromide/ $\text{BF}_4^-$  salt of this species has been structurally characterized.<sup>20</sup> These are the first routes to triphosphacyclo-nonane and -decane macrocycles. The small ionic radius of the  $\text{Fe}^{\text{II}}$ , together with the steric requirements of the pentamethylcyclopentadienyl ligand, are considered to play important roles in this chemistry. This approach also permits introduction of other interdonor linkages such as *o*-phenylene (*o*- $\text{C}_6\text{H}_4$ ) units in II.<sup>18</sup> These small-ring,  $\text{P}_3$  macrocycles have not yet been liberated from the template. The resistance of these macrocyclic systems to demetallation may reflect the fact that complexes of these ligands show a significant macrocyclic effect. As routes to the “free” small-ring  $\text{P}_3$  macrocycles do become available, so the coordination chemistry and organometallic chemistry of these ligands will be the focus of considerable interest.

Early examples of tetradentate  $\text{P}_4$ -donor macrocycles came from Kyba *et al.* and Stelzer *et al.*<sup>4</sup> Few new examples have been prepared since then. A reaction particularly worthy of note is the synthesis of III incorporating *o*-xylyl interdonor linkages, prepared according to Scheme 5. The ring closure reaction uses a square planar  $\text{Pd}^{\text{II}}$  template complex of the disecundary phosphine  $\text{HMePCH}_2\text{CH}_2\text{PMeH}$ , *o*- $\text{C}_6\text{H}_4(\text{CH}_2\text{Cl})_2$  and  $\text{K}_2\text{CO}_3$  as base, and occurs in very good yield. Most significantly, however, the  $\text{Pd}^{\text{II}}$  ion can be removed by cyanolysis giving the “free”  $\text{P}_4$  macrocycle in 22% yield.<sup>21</sup> This represents a rare example where demetallation of phosphine macrocyclic complexes is achieved in moderate yield using “conventional” methods. Further work has examined how the nature of the organodichloride influences the ring closure step in the Stelzer system.<sup>22</sup> The reaction appears to be very dependent upon the precise organodihalide used.

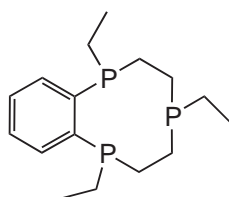
While Stelzer showed that ring closure is almost quantitative using  $o\text{-C}_6\text{H}_4(\text{CH}_2\text{Br})_2$ ,  $\text{ClCH}_2\text{CH}=\text{CHCH}_2\text{Cl}$  affords 95% ring closure (this was also shown by Stelzer and co-workers<sup>21</sup>) and  $\text{CH}_2=\text{C}(\text{CH}_2\text{Cl})_2$ , ca. 40% ring closure, whereas neither  $\text{Cl}(\text{CH}_2)_3\text{Cl}$  nor  $\text{Cl}(\text{CH}_2)_4\text{Cl}$  afford any macrocyclic complex after three days.<sup>22</sup> Using  $\text{Br}(\text{CH}_2)_3\text{Br}$  and  $\text{K}_2\text{HPO}_4$  as base does afford the 14-membered tetraphosphine macrocyclic complex  $[\text{Pd}(\text{IV})]\text{Br}_2$ , although the yield is relatively low (10%). The analogous  $\text{Pt}^{\text{II}}$  macrocyclic complex is also obtained in ca. 10% yield via this method and crystal structures of both the  $\text{Pd}^{\text{II}}$  and  $\text{Pt}^{\text{II}}$  complexes authenticate the macrocyclic structure.<sup>23</sup>

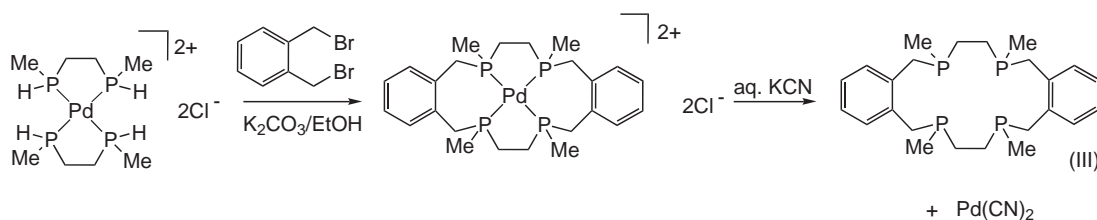


Scheme 3

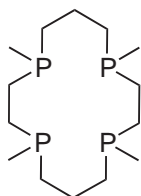


Scheme 4



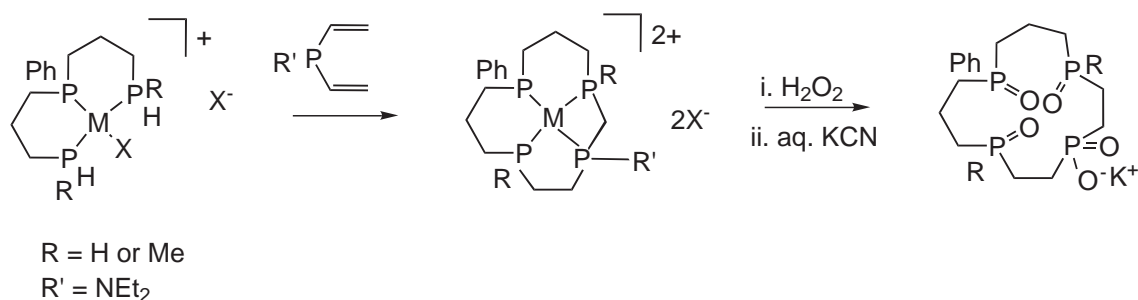


Scheme 5



IV

An alternative method for producing P<sub>4</sub> macrocycles is via transition metal-mediated addition of P—H functions across olefinic double bonds as in Scheme 6. Treatment of the resulting complex with H<sub>2</sub>O<sub>2</sub> and CN<sup>−</sup> gives the corresponding phosphine oxide macrocycle.<sup>2,24</sup> Various reactions at the coordinated PNEt<sub>2</sub> function in the coordinated macrocycle have also been investigated.<sup>25</sup>



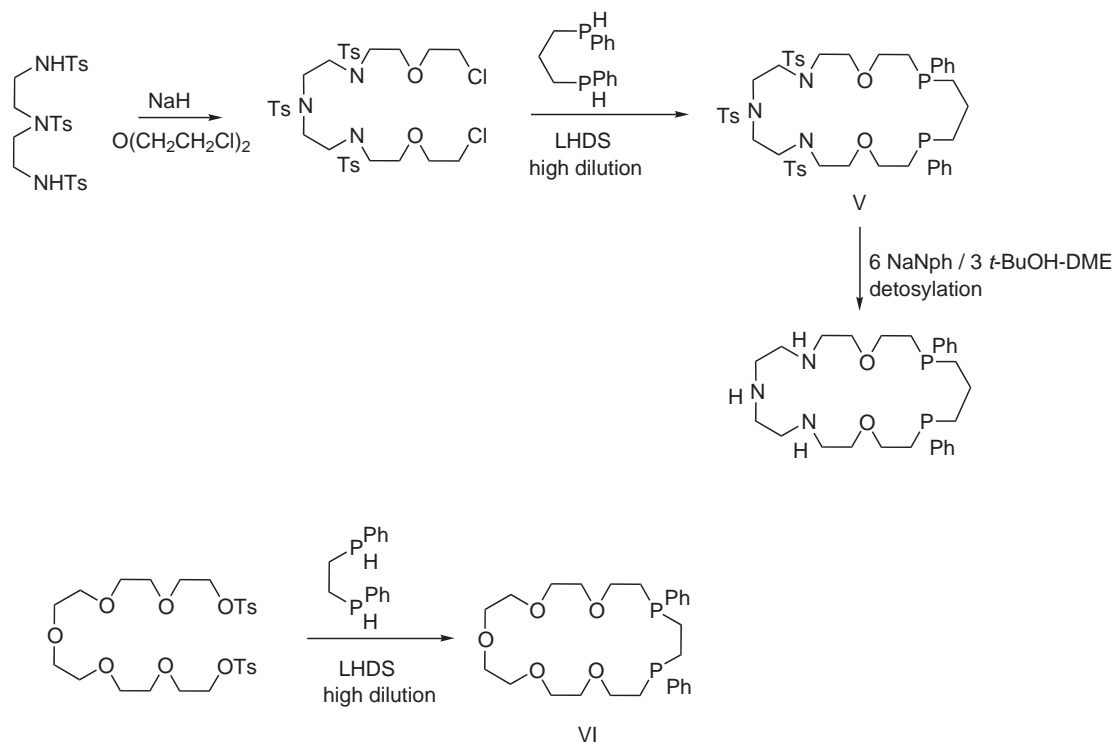
Scheme 6

Macrocyclic tetraphosphines based upon tetraphosphole precursors have also been prepared.<sup>26</sup>

Much of the early work on mixed-donor phosphine macrocycles came from the groups of Kyba *et al.*, Stelzer *et al.*, and Ciampolini *et al.* This and related work is described in detail in the first edition of this work.<sup>4</sup> Subsequently, a number of mixed donor macrocycles involving phosphine functions have been described by these and other workers.

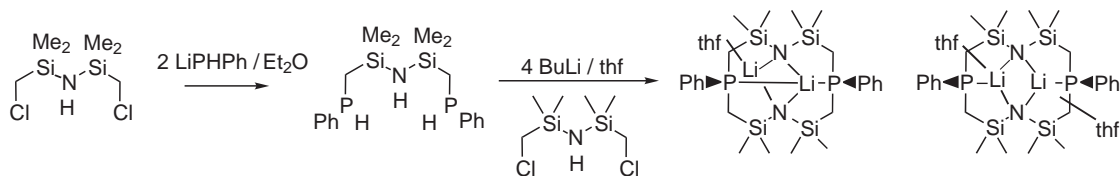
The preparations of new heterotopic macrocycles (V) and (VI) incorporating mixed P/O/N and mixed P/O functions have been shown to occur by high dilution reactions (Scheme 7). In THF solution, 1,3-bis(phenylphosphino)propane and 6,9,12-tris(*p*-tolylsulfonyl)-1,17-dichloro-3,15-dioxa-6,9,12-triazaheptadecane react in the presence of Li hexamethyldisilazide (LHDS) giving 16,20-diphenyl-4,7,10-tritosyl-1,13-dioxa-16,20-diphospha-4,7,10-triazacyclodocosane, V, in 68% yield. Similarly, VI was prepared from 1,2-bis(phenylphosphino)ethane and 1,19-ditosyl-1,4,7,10,13,16,18-heptaoxanonadecane. The *syn* and *anti* diastereoisomers may be separated prior to detosylation by selective precipitation of [NiCl<sub>2</sub>(L)] for (V) or chromatographic separation of [Ni(NCS)<sub>2</sub>(L)] for (VI), followed by demetallation via cyanolysis. Detosylation is effected at −78 °C by sodium naphthalenide in glyme containing *t*-BuOH as a proton source.<sup>27,28</sup> These large-ring binucleating macrocycles offer both hard and soft donor domains within each

individual ligand and are therefore capable of binding to metals in both high and low oxidation states in close proximity.



Scheme 7

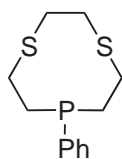
An unusual  $P_2N_2$ -donor macrocycle is obtained in high yield by a lithium ion template reaction of  $HN(SiMe_2CH_2PPhH)_2$  with  $HN(SiMe_2CH_2Cl)_2$  as depicted in Scheme 8. The presence of the  $SiMe_2$  units are considered to play an important role in this particular reaction and the crystal structures of lithium salts of both the *syn* and *anti* isomers have been determined.<sup>29</sup> This macrocycle displays very good ligating properties to early transition metal centers as its diamide dianion, leading to interesting organometallic chemistry.<sup>30,31</sup>



Scheme 8

The small-ring tridentate  $PS_2$ -donor macrocycle, Ph[9]ane $PS_2$  (VII), may be prepared via either a template or a high-dilution approach.<sup>32,33</sup> The former is a modification of the template synthesis of [9]ane $S_3$ .<sup>16</sup> Thus, treatment of  $[Me_4N]_2[PhP(CH_2CH_2S)_2]$  with *fac*- $[Mo(CO)_3(NCMe)_3]$  affords the reactive intermediate  $[Me_4N]_2[Mo(CO)_3\{PhP(CH_2CH_2S)_2\}]$ , which reacts further with  $ClCH_2CH_2Cl$  to produce *fac*- $[Mo(CO)_3(Ph[9]anePS_2)]$  in 70% yield.<sup>32,33</sup> A variety of other dichloroalkanes such as  $ClCH_2CH_2CH_2Cl$ ,  $ClCH_2CHMeCl$  or  $ClCH_2CH(OH)CH_2Cl$  react similarly to yield larger-ring phosphadithia macrocycles or C-functionalized analogs.<sup>33</sup> Demetallation of these systems is achieved with some difficulty and is not accomplished using the analogous method to that used for [9]ane $S_3$ . Thus, addition of a further equivalent of  $[NMe_4]_2[PhP(CH_2CH_2S)_2]$  to the macrocyclic complex does not liberate the macrocycle. However, reaction with elemental sulfur in refluxing toluene does result in loss of the  $Mo(CO)_3$  fragment and liberation of the macrocycle as its phosphine sulfide

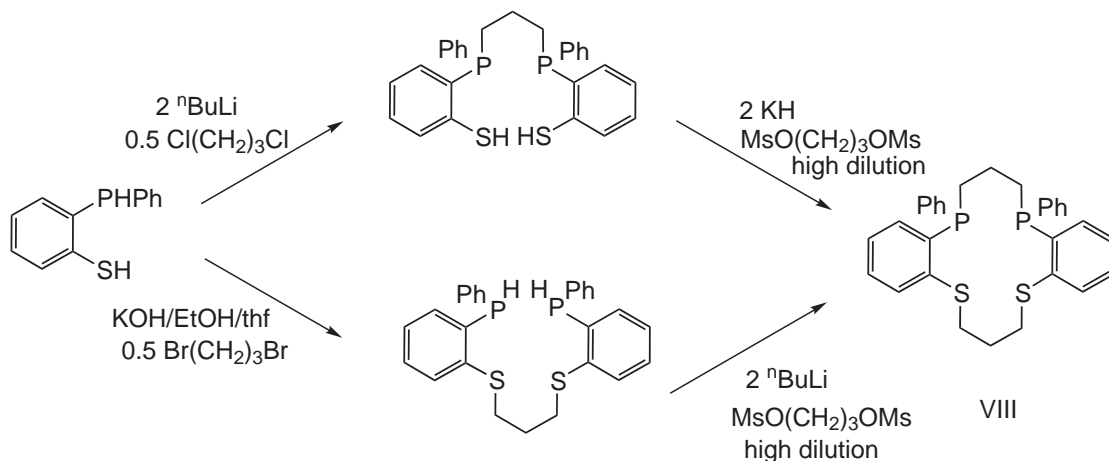
derivative, Ph[9]aneS<sub>2</sub>P=S in 18% yield. Reduction of this species with sodium naphthalenide affords the parent ligand Ph[9]anePS<sub>2</sub>.<sup>33</sup>

Ph[9]anePS<sub>2</sub>

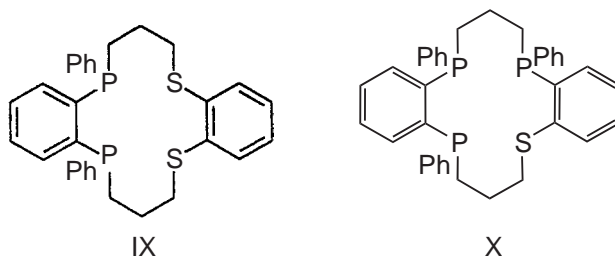
VII

The high-dilution route to Ph[9]anePS<sub>2</sub> is also achieved via a modification of the preparation of [9]aneS<sub>3</sub>.<sup>34</sup> In this case the reaction of PhP(CH<sub>2</sub>CH<sub>2</sub>SH)<sub>2</sub> with ClCH<sub>2</sub>CH<sub>2</sub>Cl in dmf/Cs<sub>2</sub>CO<sub>3</sub> is utilized. The macrocycle is obtained as a colorless oil in 52% yield.<sup>35</sup> The presence of only one phosphine function in this ring eliminates the stereoisomer issue here.

The *o*-phenylene P<sub>2</sub>S<sub>2</sub>-donor macrocycle VIII has been prepared by Kyba and co-workers (Scheme 9).<sup>36</sup> This is an isomer of ligand IX reported by these workers previously.<sup>37</sup> Incorporation of the *o*-phenylene linkages between the adjacent P and S atoms is thought to enhance the coordinating ability of this ligand, allowing complexation through both the P and the S functions. The P<sub>3</sub>S-donor macrocycle (X) has been obtained similarly from reaction of *o*-C<sub>6</sub>H<sub>4</sub>(PPh(CH<sub>2</sub>)<sub>3</sub>Cl)<sub>2</sub> with *o*-C<sub>6</sub>H<sub>4</sub>(S(CH<sub>2</sub>)<sub>3</sub>Cl) under high-dilution conditions.<sup>36</sup>



Scheme 9



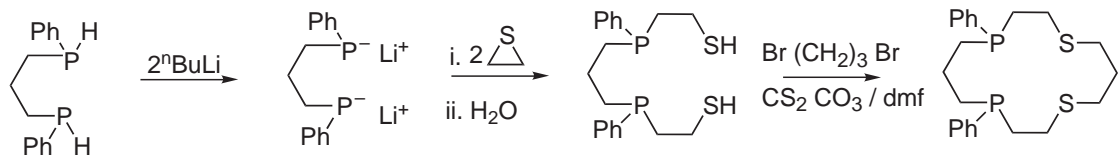
IX

X

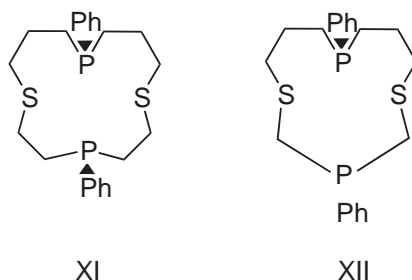
The saturated tetradentate diphosphadithia macrocycle, Ph<sub>2</sub>[14]aneP<sub>2</sub>S<sub>2</sub>, may be prepared as a mixture of *syn* and *anti* stereoisomers via a high-dilution cyclization procedure according to Scheme 10.<sup>38</sup> The pure *syn* isomer may be obtained as a white powder by virtue of its lower solubility in acetone. This compound behaves as a tetradentate P<sub>2</sub>S<sub>2</sub>-donor ligand to a range of platinum metal ions including Pd<sup>II</sup>, Pt<sup>II</sup>, and Rh<sup>III</sup>.<sup>38</sup> A subsequent report details the high-dilution synthesis of the related *syn* and *anti* diphosphadithia macrocycles, XI and XII, via reaction of the dilithium salt of



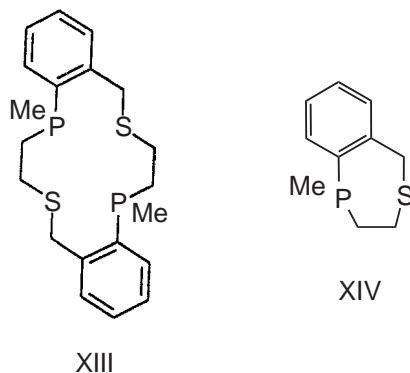
3-phenyl-3-phosphapentan-1,5-dithiol with bis(3-chloropropyl)phenylphosphine. This gives the macrocycle in 4.4% yield as a mixture of isomers. Separation is achieved on the basis of the different solubilities of the isomers by addition of toluene to a cooled solution of the *syn* and *anti* isomers in diethyl ether.<sup>39</sup>



Scheme 10



Wild and co-workers have obtained the *trans*-P<sub>2</sub>S<sub>2</sub>-donor macrocycle XIII via a template reaction on Pt<sup>II</sup>. Demetallation is achieved by treatment of the macrocyclic complexes with aqueous hydroxide and then aqueous potassium cyanide. Separation of the stereoisomers uses chromatography on silica gel, however, the yields of the P<sub>2</sub>S<sub>2</sub>-donor rings are very low. The 7-membered P,S-donor ring, XIV, is obtained as a by-product in 6% yield, while the BBr<sub>3</sub> adduct of XIII is the dominant product, isolated in 76% yield.<sup>40</sup>

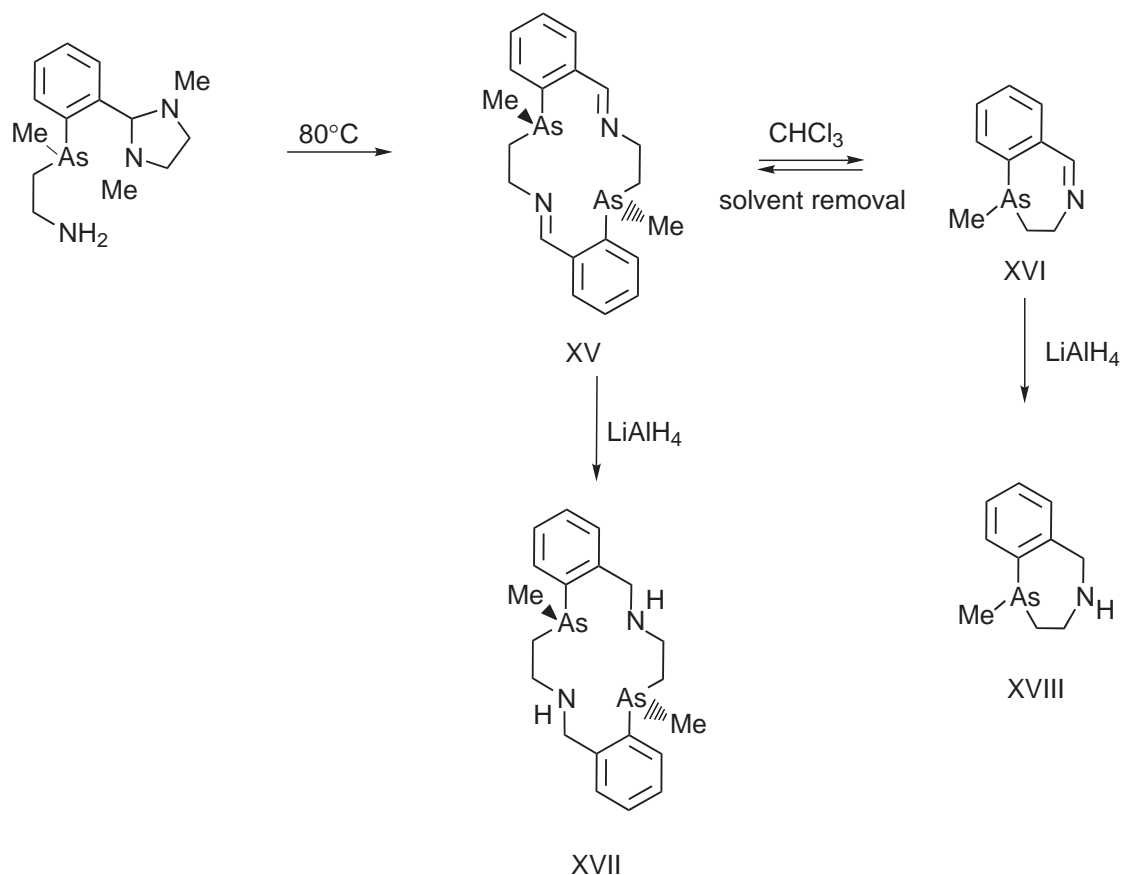


### 1.21.3 ARSINE MACROCYCLES

As for phosphine macrocycles, arsine macrocycles involve very difficult synthetic chemistry. The reasons for the difficulties are essentially threefold: (i) the volatility and well-known toxicity of the arsenic-containing precursors; (ii) the instability of coordinated As—H functions, which renders template cyclizations of limited use for arsenic macrocycles; (iii) the high energy barrier to inversion at arsenic (167.4 kJ mol<sup>-1</sup>),<sup>41</sup> which means that high-dilution cyclizations of polydentate arsine macrocycles leads to mixtures of stereoisomers which are not at all trivial to separate. On the other hand, the macrocyclic (tertiary) arsines are less susceptible to oxidation than their phosphine analogs.

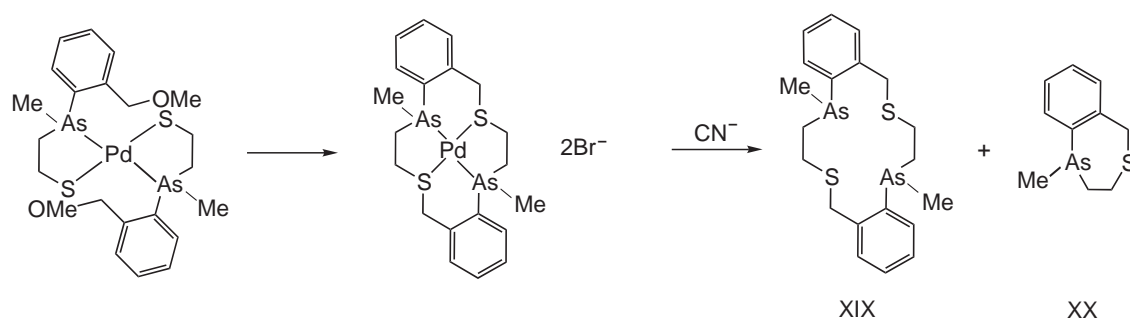
There have been surprisingly few developments in the synthesis of arsine macrocycles since the early work of Kyba and co-workers and Kaufmann and Ennen, described in *CCC* (1987)<sup>4</sup> No new macrocycles involving only arsine functions have been reported. However, Wild and co-workers have described the highly stereoselective syntheses of new mixed As<sub>2</sub>S<sub>2</sub>- and As<sub>2</sub>N<sub>2</sub>-donor

macrocycles.<sup>42–44</sup> Thus, XV is obtained stereoselectively and quantitatively by elimination of 1,2-bis(methylamino)ethane (Scheme 11). This 14-membered ring rearranges slowly and quantitatively into the chiral 7-membered As/N-donor ring XVI in chloroform, although removal of the solvent regenerates XV quantitatively. XV and XVI undergo reduction with  $\text{LiAlH}_4$  to give the corresponding amine derivatives XVII and XVIII. The other stereoisomers of diimino macrocycle XV may be obtained stereoselectively from the appropriate precursors and these may be reduced to the diamino analogs similarly using  $\text{LiAlH}_4$ .<sup>43</sup>



Scheme 11

The air-stable enantiomers of the  $\text{As}_2\text{S}_2$  macrocycle XIX have been obtained stereoselectively via a  $\text{Pd}^{\text{II}}$ -assisted cyclization reaction as illustrated in Scheme 12. Demetallation is via treatment with  $\text{CN}^-$ . The use of racemic precursors has been investigated and quantitative interconversion of stereoisomers is detailed in this work, together with ring contraction to give the 7-membered ring As/S ring compound XX.<sup>44</sup>



Scheme 12

## 1.21.4 REFERENCES

1. Caminade, A.-M.; Majoral, J. P. *Chem. Rev.* **1994**, *94*, 1183–1213.
2. Stelzer, O.; Langhans, K.-P. In *The Chemistry of Organophosphorus Compounds*, Hartley, F. R., Eds.; Wiley: New York, 1990, Vol. 1, Ch. 8, pp 192–254.
3. Wild, S. B. In *Chemistry of Organo Arsenic, Antimony and Bismuth Compounds*, Patai, S. Ed.; Wiley: UK, 1994, pp 89–152.
4. McAuliffe, C. A. Phosphorus, Arsenic, Antimony and Bismuth Ligands. In *Comprehensive Coordination Chemistry*, Wilkinson, G.; Gillard, R. D.; McCleverty, J. A., Eds.; Pergamon: Oxford, 1987; Vol. 2, Chapter 14.
5. Kyba, E. P.; Lui, S. T. *Inorg. Chem.* **1985**, *24*, 1613–1616.
6. Diel, B. N.; Haltiwanger, R. C.; Norman, A. D. *J. Am. Chem. Soc.* **1982**, *104*, 4700–4701.
7. Diel, B. N.; Brandt, P. F.; Haltiwanger, R. C.; Hackney, M. L. J.; Norman, A. D. *Inorg. Chem.* **1989**, *28*, 2811–2816.
8. Coles, S. J.; Edwards, P. G.; Fleming, J. S.; Hursthouse, M. B. *J. Chem. Soc., Dalton Trans.* **1995**, 1139–1145.
9. Edwards, P. G.; Fleming, J. S.; Liyanage, S. S. *J. Chem. Soc., Dalton Trans.* **1997**, 193–197.
10. Jones, D. J.; Edwards, P. G.; Tooze, R. P.; Albers, T. *J. Chem. Soc., Dalton Trans.* **1999**, 1045–1046.
11. Coles, S. J.; Edwards, P. G.; Fleming, J. S.; Hursthouse, M. B.; Liyanage, S. S. *Chem. Commun.* **1996**, 293–294.
12. Edwards, P. G.; Fleming, J. S.; Liyanage, S. S. *Inorg. Chem.* **1996**, *35*, 4563–4568.
13. Edwards, P. G.; Fleming, J. S.; Coles, S. J.; Hursthouse, M. B. *J. Chem. Soc., Dalton Trans.* **1997**, 3201–3206.
14. Edwards, P. G.; Ingold, F.; Coles, S. J.; Hursthouse, M. B. *Chem. Commun.* **1998**, 545–546.
15. Edwards, P. G.; Fleming, J. S.; Liyanage, S. S.; Coles, S. J.; Hursthouse, M. B. *J. Chem. Soc., Dalton Trans.* **1996**, 1801–1807.
16. Sellmann, D.; Zapf, L. *Angew. Chem.* **1984**, *96*, 799–800.
17. Price, A. J.; Edwards, P. G. *Chem. Commun.* **2000**, 899–900.
18. Edwards, P. G.; Whatton, M. L.; Haigh, R. *Organometallics* **2000**, *19*, 2652–2654.
19. Edwards, P. G.; Newman, P. D.; Hibbs, D. E. *Angew. Chem., Int. Ed.* **2000**, *39*, 2722–2724.
20. Edwards, P. G.; Newman, P. D.; Malik, K. M. A. *Angew. Chem., Int. Ed.* **2000**, *39*, 2922–2924.
21. Brauer, D. J.; Gol, F.; Hietkamp, S.; Peters, H.; Sommer, H.; Stelzer, O.; Sheldrick, W. S. *Chem. Ber.* **1986**, *119*, 349–365.
22. Toulhoat, C.; Vidal, M.; Vincens, M. *Phosphorus, Sulfur and Silicon* **1992**, *71*, 127–136.
23. Mizutani, T.; Okano, A.; Sasaki, T.; Nakazawa, H.; Miyoshi, K. *Inorg. Chem.* **1997**, *36*, 200–203.
24. Brauer, D. J.; Lebbe, T.; Stelzer, O. *Angew. Chem.* **1988**, *100*, 432–434.
25. Brauer, D. J.; Doerrenbach, F.; Lebbe, T.; Stelzer, O. *Chem. Ber.* **1992**, *125*, 1785–1794.
26. Laporte, F.; Mercier, F.; Ricard, L.; Mathey, F. *J. Am. Chem. Soc.* **1994**, *116*, 3306–3311.
27. Wei, L.; Bell, A.; Ahn, K. H.; Holl, M. M.; Warner, S.; Williams, I. D.; Lippard, S. J. *Inorg. Chem.* **1990**, *29*, 825–837.
28. Wei, L.; Bell, A.; Warner, S.; Williams, I. D.; Lippard, S. J. *J. Am. Chem. Soc.* **1986**, *108*, 8302–8303.
29. Fryzuk, M. D.; Love, J. B.; Rettig, S. J. *Chem. Commun.* **1996**, 2783–2784.
30. Fryzuk, M. D.; Johnson, S. A.; Rettig, S. J. *Organometallics* **2000**, *19*, 3931–3941.
31. Fryzuk, M. D.; Kozak, C. M.; Bowdridge, M. R.; Jin, W.; Tung, D.; Patrick, B. O.; Rettig, S. J. *Organometallics* **2001**, *20*, 3752–3761.
32. Smith, R. J.; Powell, A. K.; Barnard, N.; Dilworth, J. R.; Blower, P. J. *Chem. Commun.* **1993**, 54–56.
33. Blower, P. J.; Jeffery, J. C.; Miller, J. R.; Salek, S. N.; Schmaljohann, D.; Smith, R. J.; Went, M. J. *Inorg. Chem.* **1997**, *36*, 1578–1582.
34. Blower, P. J.; Chadwick, A. V.; Jeffery, J. C.; Mullen, G. E. D.; Powell, A. K.; Salek, S. N.; Smith, R. J.; Went, M. J. *Inorg. Chim. Acta* **1999**, *294*, 170–178.
35. Blower, P. J.; Cooper, S. R. *Inorg. Chem.* **1987**, *26*, 2009–2010.
36. Kyba, E. P.; Clubb, C. N.; Larson, S. B.; Schueler, V. J.; Davis, R. E. *J. Am. Chem. Soc.* **1985**, *107*, 2141–2148.
37. Kyba, E. P.; Davis, R. E.; Hudson, C. W.; Meredith, J. A.; Brown, S. B.; McPhaul, M. J.; Liu, L.-K.; Glover, A. C. *J. Am. Chem. Soc.* **1981**, *103*, 3868–3875.
38. Champness, N. R.; Frampton, C. S.; Reid, G.; Tocher, D. A. *J. Chem. Soc., Dalton Trans.* **1994**, 3031–3037.
39. Muñoz, J. A.; Escriche, L.; Casabó, J.; Pérez-Jiménez, C.; Kivekäs, R.; Sillanpää, R. *Inorg. Chem.* **1997**, *36*, 947–949.
40. Jones, T. L.; Willis, A. C.; Wild, S. B. *Inorg. Chem.* **1992**, *31*, 1411–1416.
41. Braechler, R. C.; Mislow, K.; Casey, J. P.; Cook, R. J.; Senkler, G. H. Jr. *J. Am. Chem. Soc.* **1972**, *94*, 2859–2861.
42. Wild, S. B. *Pure Appl. Chem.* **1990**, *62*, 1139–1144.
43. Martin, J. W. L.; Stephens, F. S.; Weerasuria, K. D. V.; Wild, S. B. *J. Am. Chem. Soc.* **1988**, *110*, 4346–4356.
44. Kerr, P. G.; Leung, P. H.; Wild, S. B. *J. Am. Chem. Soc.* **1987**, *109*, 4321–4328.

# 1.22

## Calixarenes

D. M. ROUNDHILL

*Texas Tech University, Lubbock, TX, USA*

---

1.22.1	INTRODUCTION	485
1.22.2	UNSUBSTITUTED CALIXARENES	486
1.22.2.1	Aryloxides	488
1.22.3	SUBSTITUTED CALIXARENES	489
1.22.3.1	Oxygen and Nitrogen Donor Atoms	489
1.22.3.2	Sulfur and Phosphorus Donor Atoms	490
1.22.3.3	Calixcrowns	490
1.22.4	REFERENCES	490

---

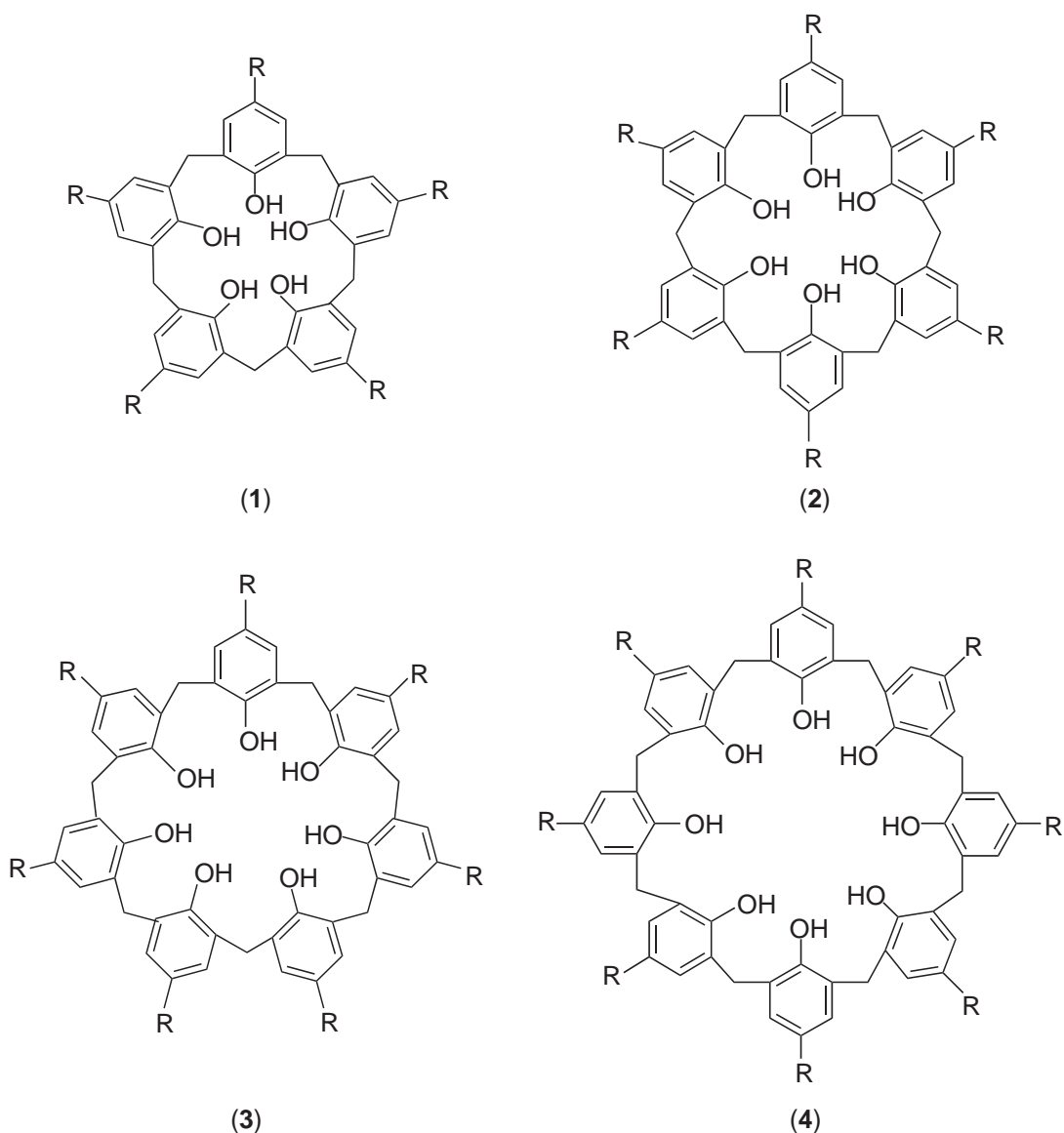
### 1.22.1 INTRODUCTION

Calixarenes are cyclic oligomers obtained by condensation reactions between *para-t*-butyl phenol and formaldehyde. By judicious choice of base, reaction temperature, and reaction time, calixarenes having different ring sizes can be prepared in good yield. Calixarenes are like crowns in that they are preorganized complexants, yet, unlike crowns, they can be readily synthesized in large quantities. Unlike porphyrins, calixarenes are not fully conjugated, and the three-dimensional structure leads to cavities.

The name calixarene derives from the Greek word for a vase, which aptly describes their molecular structure. The structures of the *para-t*-butyl calix[*n*]arenes (*n* = 5, 6, 7, 8) **(1)–(4)** differ only in the size of the ring oligomer. Other ring sizes are available, but few metal ion complexes have been isolated with them.

The structures and abbreviations used for designating the calix[4]arenes are shown in **(5)**. These calix[4]arenes, have both a wide (upper) and a narrow (lower) rim that can be chemically modified to produce complexants that are selective for particular metal ions. In the simple calixarene framework the wide rim has hydrocarbon functionalities, and the narrow rim phenolic groups. Calixarenes are conformationally mobile, and the extreme structures for the calix[4]arenes have been termed the cone, partial cone, 1,3-alternate, and 1,2-alternate conformations **(6)**. Because of the conical geometry of the calix[4]arene structure, the cavity size of the wide rim is larger than that of the narrow rim.

In the cone conformation, which is often the one having the highest stability, the preorganization puts all of the functional groups in positions where they can coordinate with a metal ion. As a result, functionalized calix[4]arenes can be designed that have a large number of donor atoms that can bind to a metal center. This feature is particularly important for the complexation of metals such as lanthanides that commonly have high coordination numbers such as 8, 9, or 10. Calix[4]arene complexants offering such high coordination numbers can be prepared from the parent calix[4]arene in single-step reactions. This is a particularly useful feature of calixarenes because the design and synthesis of high coordination number complexants usually requires a multistep approach which leads to lower yields and higher costs. Alternatively, metal complexes can be prepared from the other calix[4]arene conformers, which allows for other coordination



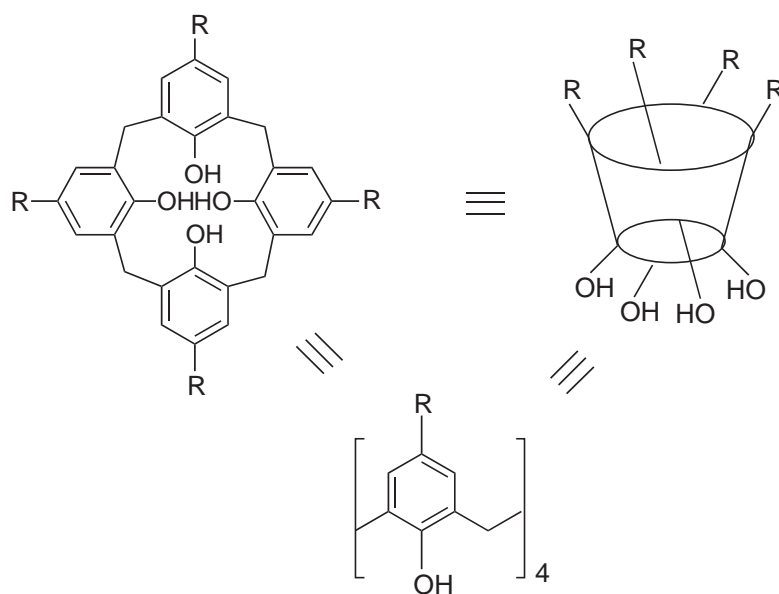
Scheme 1

geometries to be designed. Calix[ $n$ ]arenes with  $n$  greater than 4 have lower barriers to conformational change than do the calix[4]arenes.

There are some 3,000 publications reporting calixarenes, many of which can be obtained by searching databases under the term “calix.” In addition, several books have been written on calixarenes, and metal complexes are described in all of them.<sup>1–6</sup> Reviews on metal complexes of calixarenes has been published,<sup>7–10</sup> and a book published in 2001 also makes numerous references to them.<sup>11</sup> Among the other calixarenes are the calix[4]arene thiol (7) and the thiocalix[4]arene (8). Related compounds are the oxacalix[3]arene (9) and the azacalix[3]arene (10), both of which have been used as complexants for metal ions.

### 1.22.2 UNSUBSTITUTED CALIXARENES

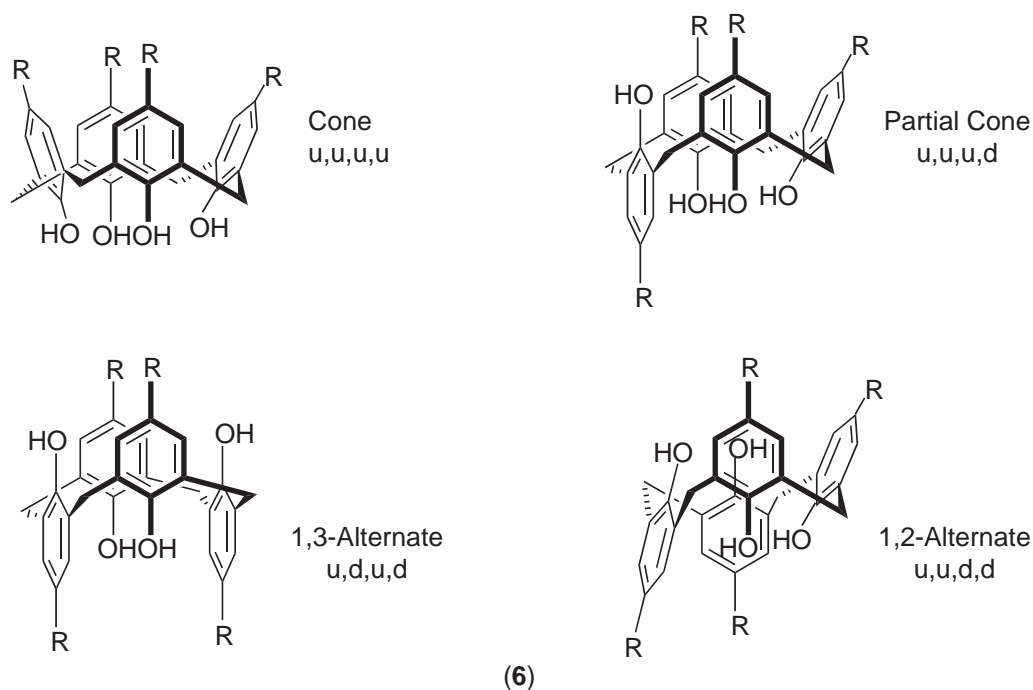
Calixarenes are synthesized by heating a mixture of *para-t*-butylphenol and formaldehyde. Since all of the common ring isomers are obtained by the same procedure, both the reaction time and



(5)

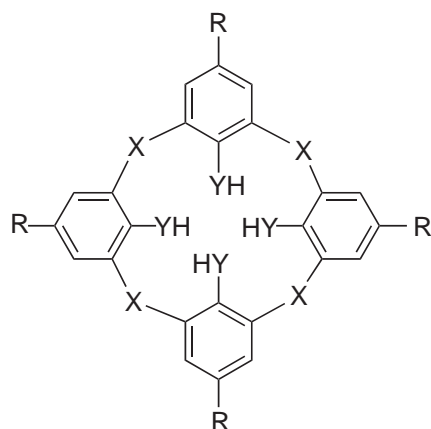
Scheme 2

temperature are important. Calixarenes are air stable, therefore no precautions need to be carried out to exclude oxygen when they are synthesized and subsequently stored. In general, calixarenes are chemically very robust, and are stable to both strong acids and bases. The detailed syntheses of *para-t*-butyl calix[*n*]arene ( $n=4, 6,$  and  $8$ ) have been published, and strict adherence to these reaction conditions is strongly recommended if pure product is to be consistently obtained.<sup>12-14</sup> Typically the reaction involves refluxing a mixture of *para-t*-butylphenol and formaldehyde in an



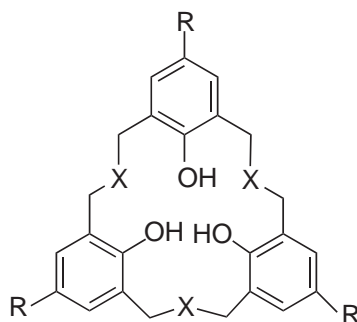
(6)

Scheme 3



(X = CH<sub>2</sub>, Y = S, (7). X = S, Y = O, (8).)

Scheme 4



X = O, (9). NR<sub>1</sub>, (10).

Scheme 5

organic solvent in the presence of a strong base. For the calix[4]arene the base is sodium hydroxide, and the solvent is diphenyl ether. For the calix[6]arene the base is potassium hydroxide and the solvent is xylene. For the calix[8]arene sodium hydroxide and xylene are used. A drawback to the use of calixarenes as ligands, however, is that they are insoluble in water, and that they frequently have only limited solubility in organic solvents. As the reaction chemistry of calixarenes has developed, these initial limitations have been overcome.

### 1.22.2.1 Aryloxides

The unsubstituted *para-t*-butyl calixarenes themselves complex metals via their aryloxy groups. Since aryloxy complexes are frequently oligomeric, the simple calixarenes do not give monomeric complexes. Aryloxides are hard ligands, therefore they readily form complexes with oxophilic hard metal ions such as alkali metals, early transition metals, lanthanides, and actinides. Complexation is often inferred because the calixarene acts as a carrier for the metal ion from an aqueous to an organic phase. With the *para-t*-butylcalix[*n*]arenes in alkaline solution, a value of *n* = 6 gives the best carrier for lithium(I), sodium(I), and potassium(I), with a value of *n* = 8 giving the best carrier for rubidium(I) and caesium(I).<sup>15,16</sup> Titanium(IV) complexes have been characterized,<sup>17-19</sup> as well as those of niobium(V) and tantalum(V).<sup>20-22</sup> These complexes are classified as

koilands. The calix[4]arene forms a complex with the quadruply bonded  $\text{Mo}_2(\text{acetate})_2$ .<sup>23</sup> Homoleptic complexes have also been formed with a triply bonded dimolybdenum center, with the calix[4]arene acting as either a terminal or a bridging tetradentate ligand.<sup>24,25</sup> The calix[4]arene stabilizes a series of imido complexes of molybdenum, tungsten, and titanium.<sup>26,27</sup>

### 1.22.3 SUBSTITUTED CALIXARENES

Calixarenes can be chemically modified to be selective complexants for a wide range of metal ions. The synthetic strategies involve viewing them as a simple phenol. The wide rim therefore has the reactivity of a hydrocarbon, and the narrow rim that of a hydroxyl group. Since the *t*-butyl groups can be readily removed by reaction with aluminum chloride to generate an unsubstituted arene moiety, the wide rim can be adapted to the reactivity of either an aliphatic or an aromatic hydrocarbon. Either rim can be chemically modified to incorporate either metal binding groups or functionalities that confer preferred solubility or lipophilicity characteristics. Calixarene complexants have been used in the liquid–liquid extraction of metals, in medical applications, and in materials applications. Metal binding sites can be designed at either the narrow or the wide rim. After removal of the *t*-butyl groups, the *para* positions can undergo the expected reactions of an aromatic hydrocarbon. Among the reactions that have been carried out are chloromethylation using chloromethyloctyl ether, dimethylaminomethylation via the *p*-quinonemethide route, and electrophilic substitution to introduce nitro, sulfonic acid, chlorosulfonyl, formyl, acetyl, benzoyl, or arylazo functionalities. The *para*-Claisen reaction can be used to transfer an allyl group from the narrow to the wide rim. The narrow rim can be esterified with acyl or acroyl halides or etherified by alkylation. These reactions are usually carried out in the presence of sodium carbonate, hydroxide, or hydride as base. By having different functionalities on the alkylating agents, or by carrying out subsequent reactions on the product ethers or esters, a wide range of functional groups can be appended to the narrow rim. In addition to introducing ligating functionalities onto calixarenes, these reactions can also be used to confer desired solubility properties. Nitro, sulfonic acid, and methylenephosphonic acid functionalities lead to aqueous solubility, and the introduction of long chain alkyl functionalities leads to hydrophobic calixarenes.<sup>1,2</sup>

Introducing functionalities allows for the synthesis of preorganized multidentate ligands. For calix[4]arenes the second substituent generates the 1,3-disubstituted isomer, and for complete substitution the final step requires more forcing experimental conditions. These experimental conditions may involve higher temperatures, longer reaction times, or the use of a stronger base such as sodium hydride.<sup>28</sup>

#### 1.22.3.1 Oxygen and Nitrogen Donor Atoms

For alkali metal complexants ketone or ester groups can be appended. These derivatives show a size-related affinity for these metals. For calix[*n*]arenes, *n* = 4 shows a preference for sodium(I), *n* = 5 discriminates poorly between the larger alkali metal ions, and *n* = 6 favors the larger ones. For the 1,3-alternate conformation binding can occur via two carbonyl oxygens of the ester group and two phenyl rings of the calix[4]arene. For other hard metals, ether, amine, amide, carboxylate, hydroxamate, phosphoramidate, and phosphonate groups have been appended.<sup>29–36</sup> These ligands have been used as complexants for alkali and alkaline earths, lanthanides and actinides, transition metal ions such as copper(II) and nickel(II), and post-transition metal ions such as silver(I) and thallium(I). Calix[*n*]arene carboxylates (*n* = 4, 8) are tetraanionic ligands for prae-sodymium(III), europium(III), ytterbium(III), and thorium(IV). Both mononuclear and binuclear complexes are formed.<sup>37</sup> In liquid–liquid extraction the ligand with *n* = 4 shows a selectivity ratio of 1,000 for thorium(IV) over uranium(VI). The ligand is also highly selective for actinium(III) against alkali and alkaline earth metal ions.<sup>38</sup> Calixarene hydroxamates form complexes with iron(III) and other transition metal ions.<sup>39,40</sup> Azocalixarenes are ligands for transition metal and post-transition metal ions. A *trans* geometry at the azo group results in higher stability constants for the complexes than does the *cis* form. This selectivity can be used to develop a photo-switch for metal ion binding.<sup>41</sup> Schiff base functionalities can be appended to the 1,3-positions on the narrow rim of a calixarene to give ligands for transition metal ions. Selectivity can be modified by changing the length of the methylene spacer chain between the two Schiff base nitrogens.<sup>42</sup> Mixed tetrasubstituted calix[4]arene ligands have been synthesized by sequentially substituting each



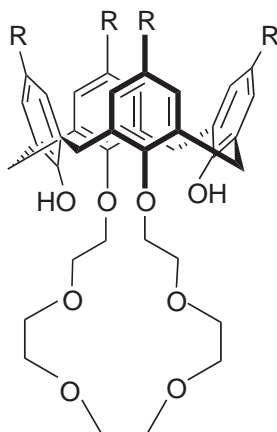
alternate functional group pair onto the narrow rim. Examples are the 1,3-carboxylic acid-2,4-amide and 1,3-carboxylic acid-2,4-phosphine oxide combinations, and the 1,3-ester-2,4-phosphine oxide and 1,3-ester-2,4-pyridine combinations. Calixarene amides bind to europium(III) and influence its emission properties and relaxivity.<sup>43,44</sup> Transition metal ions bind via the amide oxygens.<sup>45</sup>

### 1.22.3.2 Sulfur and Phosphorus Donor Atoms

For soft metals, functionalities having either sulfur or phosphorus donors are available. The sulfur donor ligands have thiolate, thioether, thiamide, and dithiocarbamate groups,<sup>46,47</sup> and the phosphorus analogs have either a tertiary phosphine or diphenylphosphinite groups.<sup>36,48,49</sup> These ligands have been used for mercury(II), palladium(II), gold(III), rhodium(I), lead(II), and cadmium(II). Because these calixarenes are synthesized by the sequential introduction of functional groups, mixed functionalized derivatives can also be prepared.

### 1.22.3.3 Calixcrowns

Calixcrowns (**11**), which incorporate a ligating size-selective crown ether cavity onto a preorganized calixarene, coordinate metal ions. These calixcrowns can be synthesized with different ring sizes for both the calixarene and crown, and with different conformations for the calixarene. Calixcrowns have been designed that give extremely high stability constants and selectivities for caesium(I) complexation.<sup>50</sup> Caesium(I) is a particularly interesting metal because it can also bind within the phenyl group cavity of the wide rim.<sup>51</sup> Calixarenes having both a ligating site and a reporter molecule have been used as either redox or optical sensors. The ferrocene/ferrocenyl couple is frequently used as the redox reporter, and anthracene as the optical reporter molecule. These sensors take advantage of electronic and conformational changes that occur in the calixarene binding site upon metal ion complexation.<sup>52</sup> Calculations have been carried out on metal complexes of functionalized calixarenes. These include molecular mechanics and semiempirical methods. Molecular dynamics and free energy perturbation simulations that include solvent molecules have also been carried out.<sup>53</sup> Calix[4]arene-crown-6, which shows a very high caesium(I)/sodium(I) selectivity, is shown by Hartree-Fock level calculations to have a favored structure for caesium(I). The nitrate anion is also shown to be important.<sup>54</sup> Thermodynamic data for metal complexation cannot yet, however, be extrapolated to other systems because they relate to no other particular ligand model.<sup>55</sup>



(11)

Scheme 6

### 1.22.4 REFERENCES

1. Gutsche, C. D. *Calixarenes*; Royal Society of Chemistry: Cambridge, UK, 1989.
2. Gutsche, C. D. *Calixarenes Revisited*; Royal Society of Chemistry: Cambridge, UK, 1998.

3. Vicens, J.; Böhmer, V., Eds.; *Calixarenes: A Versatile Class of Macrocyclic Compounds*; Kluwer: Dordrecht, The Netherlands, 1991.
4. Vicens, J.; Asfari, Z.; Harrowfield, J. McB., Eds.; *Calixarenes: 50th Anniversary*; Kluwer: Dordrecht, The Netherlands, 1994.
5. Asfari, Z.; Böhmer, V.; Harrowfield, J. McB., Vicens, J., Eds.; *Calixarenes 2001*; Kluwer: Dordrecht, The Netherlands, 2001.
6. Lumetta, G. J.; Rogers, R. D.; Gopalan, A. S., Eds.; *Calixarenes for Separations*; ACS Symposium Series 757; American Chemical Society: Washington, DC, 2000.
7. Roundhill, D. M. *Prog. Inorg. Chem.* **1995**, *43*, 533–592.
8. Atwood, J. L.; Barbour, L. J.; Hardie, M. J.; Raston, C. L. *Coord. Chem. Rev.* **2001**, *222*, 3–32.
9. Alexandratos, S. D.; Natesan, S. *Ind. Eng. Chem. Res.* **2000**, *39*, 3998–4010.
10. Wiser, C.; Dieleman, C. B.; Matt, D. *Coord. Chem. Rev.* **1997**, *165*, 93–161.
11. Roundhill, D. M. *Extraction of Metals from Soils and Waters*; Plenum: New York, 2001.
12. Gutsche, C. D.; Iqbal, M. *Org. Synth.* **1990**, *68*, 234–237.
13. Gutsche, C. D.; Dhawan, B.; Leonis, M.; Stewart, D. *Org. Synth.* **1990**, *68*, 238–242.
14. Munch, J. H.; Gutsche, C. D. *Org. Synth.* **1990**, *68*, 243–246.
15. Izatt, R. M.; Lamb, J. D.; Hawkins, R. T.; Brown, P. R.; Izatt, S. R.; Christensen, J. J. *J. Am. Chem. Soc.* **1983**, *105*, 1782–1785.
16. Izatt, S. R.; Hawkins, R. T.; Christensen, J. J.; Izatt, R. M. *J. Am. Chem. Soc.* **1985**, *107*, 63–66.
17. Andretti, G. D.; Calestani, G.; Ugozzoli, F.; Arduini, A.; Ghidini, E.; Pochini, A.; Ungaro, R. *J. Inclusion Phenom.* **1987**, *5*, 123–126.
18. Olmstead, M. M.; Sigel, G.; Hope, H.; Xu, X.; Power, P. P. *J. Am. Chem. Soc.* **1985**, *107*, 8087–8091.
19. Clegg, W.; Elsegood, M. R. J.; Teat, S. J.; Redshaw, C.; Gibson, V. C. *J. Chem. Soc., Dalton Trans.* **1998**, 3037–3039.
20. Corazza, F.; Floriani, C.; Chiesi-Villa, A.; Guastini, C. *J. Chem. Soc., Chem. Commun.* **1990**, 1083–1084.
21. Delaigue, X.; Hosseini, M. W.; Leize, E.; Kieffer, S.; Van Dorsselaer, A. *Tetrahedron Lett.* **1993**, *34*, 7561–7564.
22. Hajek, F.; Graf, E.; Hosseini, M. W.; De Cian, A.; Fischer, J. *Tetrahedron Lett.* **1997**, *38*, 4555–4558.
23. Acho, J. A.; Lippard, S. J. *Inorg. Chim. Acta* **1995**, *229*, 5–8.
24. Radius, U. *Eur. J. Inorg. Chem.* **1998**, 299–303.
25. Chisholm, M. H.; Foltling, K.; Streib, W. E.; Wu, D.-D. *Inorg. Chem.* **1999**, *38*, 5219–5229.
26. Radius, U.; Attner, J. *Eur. J. Inorg. Chem.* **1999**, 2221–2231.
27. Radius, U.; Friedrich, A. *Z. Anorg. Allg. Chem.* **1999**, *625*, 2154–2159.
28. Wolf, N. J.; Georgiev, E. M.; Yordanov, A. T.; Whittlesey, B. R.; Koch, H. F.; Roundhill, D. M. *Polyhedron* **1999**, *18*, 885–896.
29. Iwamoto, K.; Araki, K.; Shinkai, S. *Tetrahedron* **1991**, *47*, 4325–4342.
30. Groenen, L. C.; Ruël, B. H. M.; Casnati, A.; Verboom, W.; Pochini, A.; Ungaro, R.; Reinhoudt, D. N. *Tetrahedron* **1991**, *47*, 8379–8384.
31. Gutsche, C. D.; Nam, K. C. *J. Am. Chem. Soc.* **1988**, *110*, 6153–6162.
32. Barrett, G.; McKervey, M. A.; Malone, J. F.; Walker, A.; Arnaud-Neu, F.; Guerra, L.; Schwing-Weill, M.-J.; Gutsche, C. D.; Stewart, D. R. *J. Chem. Soc., Perkin Trans.* **1993**, *2*, 1475–1479.
33. Arnaud-Neu, F.; Barrett, G.; Cremin, S.; Deasy, M.; Ferguson, G.; Harris, S. J.; Lough, A. J.; Guerra, L.; McKervey, M. A.; Schwing-Weill, M.-J.; Schwinté, P. *J. Chem. Soc., Perkin Trans.* **1992**, *2*, 1119–1125.
34. Yilmaz, M.; Deligoz, H. *Sep. Sci. Technol.* **1996**, *31*, 2395–2402.
35. Barbosa, S.; Carrera, A. G.; Matthews, S. E.; Arnaud-Neu, F.; Böhmer, V.; Dozol, J.-F.; Rouquette, M. -J.; Schwing-Weill, M.-J. *J. Chem. Soc., Perkin Trans.* **1999**, *2*, 719–723.
36. Floriani, C.; Jacoby, D.; Chiesi-Villa, A.; Guastini, C. *Angew. Chem., Int. Ed. Engl.* **1989**, *28*, 1376–1377.
37. Arnaud-Neu, F.; Cremin, S.; Harris, S. J.; McKervey, M. A.; Schwing-Weill, M. J.; Schwinté, P.; Walker, A. *J. Chem. Soc., Dalton Trans.* **1997**, 329–334.
38. Montavon, G.; Duplâtre, G.; Asfari, Z.; Vicens, J. *Solvent Extr. Ion Exch.* **1997**, *15*, 169–188.
39. Deligoz, H.; Pekacar, M. A.; Özler, M.; Ersöz, M. *Sep. Sci. Technol.* **1999**, *34*, 3297–3304.
40. Deligoz, H.; Yilmaz, M. *Solvent Extr. Ion Exch.* **1995**, *13*, 19–26.
41. Hamada, F.; Masuda, T.; Kondo, Y. *Supramol. Chem.* **1995**, *5*, 129–131.
42. Seangprasertkij, R.; Asfari, Z.; Arnaud, F.; Vicens, J. *J. Org. Chem.* **1994**, *59*, 1741–1744.
43. Sabbatini, N.; Guardigli, M.; Mecati, A.; Balzani, V.; Ungaro, R.; Ghidini, E.; Casnati, A.; Pochini, A. *J. Chem. Soc., Chem. Commun.* **1990**, 878–879.
44. Georgiev, E.; Roundhill, D. M. *Inorg. Chim. Acta* **1997**, *258*, 93–96.
45. Beer, P. D.; Drew, M. G. B.; Leeson, P. B.; Ogdén, M. I. *J. Chem. Soc., Dalton Trans.* **1995**, 1273–1283.
46. Yordanov, A. T.; Whittlesey, B. R.; Roundhill, D. M. *Inorg. Chem.* **1998**, *37*, 3526–3531.
47. Arnaud-Neu, F.; Barrett, G.; Corry, D.; Cremin, S.; Ferguson, G.; Gallagher, J. F.; Harris, S. J.; McKervey, M. A.; Schwing-Weill, M.-J. *J. Chem. Soc., Perkin Trans.* **1997**, *2*, 575–579.
48. Loeber, C.; Matt, D.; Briard, P.; Grandjean, D. *J. Chem. Soc., Dalton Trans.* **1996**, 513–524.
49. Hamada, F.; Fukugaki, T.; Murai, K.; Orr, G. W.; Atwood, J. L. *J. Incl. Phenom. Mol. Recogn. Chem.* **1991**, *10*, 57–61.
50. Bonnesen, V.; Haverlock, J.; Engle, L.; Sachleben, A.; Moyer, B. A. *ACS Sympos. Ser.* **2000**, *757*, 26–44.
51. Harrowfield, J. M.; Ogdén, M. I.; Richmond, W. R.; White, A. H. *J. Chem. Soc., Chem. Commun.* **1991**, 1159–1161.
52. Roundhill, D. M. Optical Sensors with Metal Ions. In *Optoelectronic Properties of Inorganic Compounds*; Roundhill, D. M., Fackler, J. P., Eds.; Plenum: New York, 1998, Chapter 9.
53. Guilbaud, P.; Varnek, A.; Wipff, G. *J. Am. Chem. Soc.* **1993**, *115*, 8298–8312.
54. Thuéry, P.; Nierlich, M.; Lamare, V.; Dozol, J. F.; Asfari, Z.; Vicens, J. *Supramol. Chem.* **1997**, *8*, 319–332.
55. Danil de Namor, A. F.; Cleverly, R. M.; Zapata-Ormachea, M. L. *Chem. Rev.* **1998**, *98*, 2495–2525.

# 1.23

## Porphyrins

K. M. SMITH

*Louisiana State University, Baton Rouge, LA, USA*

---

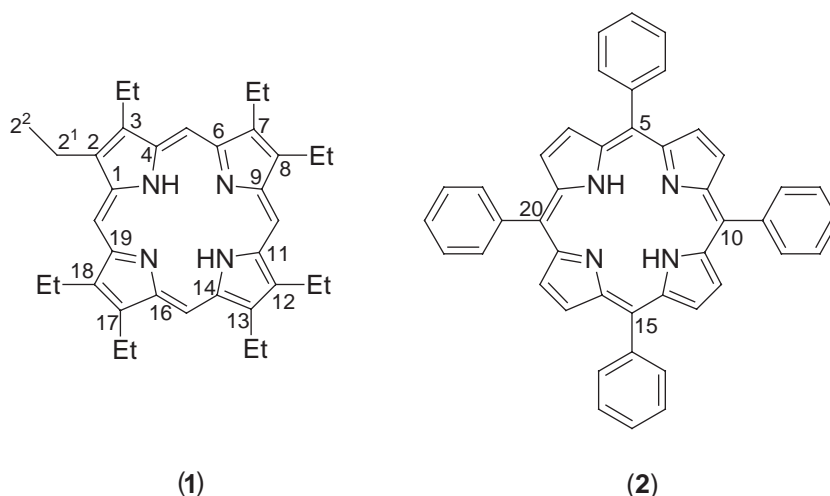
1.23.1	INTRODUCTION	493
1.23.2	STRATEGIC CONSIDERATIONS IN PORPHYRIN SYNTHESIS	494
1.23.3	PORPHYRIN SYNTHESSES USING A MONOPYRROLE TETRAMERIZATION APPROACH	495
1.23.3.1	2,3,7,8,12,13,17,18-Octaethylporphyrin (H <sub>2</sub> OEP (1))	495
1.23.3.2	5,10,15,20-Tetraphenylporphyrin (H <sub>2</sub> TPP (2))	499
1.23.4	PORPHYRIN SYNTHESSES USING REACTIONS OF DIPYRROLES	500
1.23.4.1	Using Dipyrrromethenes	500
1.23.4.1.1	<i>Syntheses of dipyrrromethenes</i>	500
1.23.4.1.2	<i>Transformation of dipyrrromethenes into porphyrins</i>	500
1.23.4.2	Using Dipyrrromethanes	501
1.23.4.2.1	<i>Syntheses of dipyrrromethanes</i>	501
1.23.4.2.2	<i>Transformation of dipyrrromethanes into porphyrins</i>	502
1.23.5	5,15-DIARYL AND 5,15-DIALKYLPORPHYRINS	505
1.23.6	REFERENCES	506

---

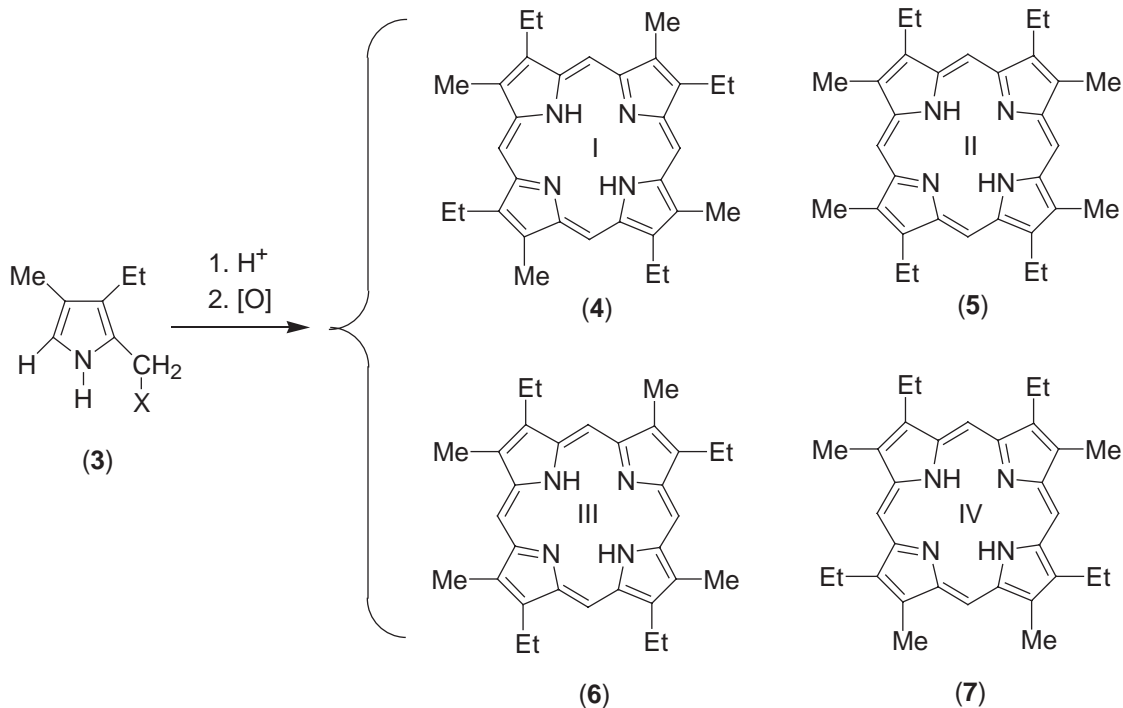
### 1.23.1 INTRODUCTION

Porphyrins and their reduced or otherwise modified derivatives are unquestionably the ligands par excellence of biology. The most common examples are the hemes (found in hemoglobins, myoglobins, cytochromes, catalases, and peroxidases), chlorophylls, and bacteriochlorophylls. Iron is the chelating metal found in hemes,<sup>1</sup> and magnesium is found in the numerous chlorophylls and bacteriochlorophylls.<sup>2</sup> In more highly reduced tetrapyrrole-derived natural products, other metal ions are found; these include vitamin B<sub>12</sub> (containing cobalt) and factor 430 (containing nickel). The mechanisms utilized in the mode of action of many tetrapyrrole metabolites often involve changes in the oxidation state of the central metal. Tetrapyrrole-derived macrocycles are able to accommodate the various oxidation state (and therefore metal ion size) changes due to the flexibility and adaptability of the basic chelating system.

For the purposes of this treatise, only common routes to a number of very popular porphyrins will be discussed. Though methodology has been developed to enable the synthesis of the most complex porphyrins imaginable,<sup>3</sup> discussion of the approaches to highly unsymmetrical natural porphyrins would be inappropriate to the organometallic focus of this volume. Instead, the discussion will be mostly focused on the two most common porphyrin types; these are the peripherally octasubstituted porphyrins exemplified by 2,3,7,8,12,13,17,18-octaethylporphyrin (H<sub>2</sub>OEP, (1)) and *meso*-tetrasubstituted systems such as 5,10,15,20-tetraphenylporphyrin (H<sub>2</sub>TPP, (2)) (Scheme 1). Some variations on the themes of these two systems will also be mentioned; however, it should also be noted that, for example, porphyrin (3) and 2,3,7,8,12,13,17,18-octamethylporphyrin (4) (Scheme 2) are so insoluble in most organic solvents that they are rarely, if ever, used by porphyrin practitioners.



Scheme 1



Scheme 2

### 1.23.2 STRATEGIC CONSIDERATIONS IN PORPHYRIN SYNTHESIS

In designing a porphyrin synthesis, or indeed in making the decision about exactly which published approach to use, substituent symmetry considerations are of the utmost importance. Clearly, if all of the substituents on the pyrrole positions, or on the *meso* positions are identical, then tetramerization of a single monopyrrole is the method of choice. Porphyrins, *per se*, are comprised of a cyclic array of four pyrrole subunits linked by four methine carbons; one therefore needs to assemble four pyrroles and four linking (*meso*) carbons into one macrocycle. Thus, the origin and type of *meso*-carbon to be employed is also an essential component to be considered. Likewise, whether or not the future *meso*-carbons should be attached to the pyrrole component or added into the reaction mixture separately is an issue to consider.

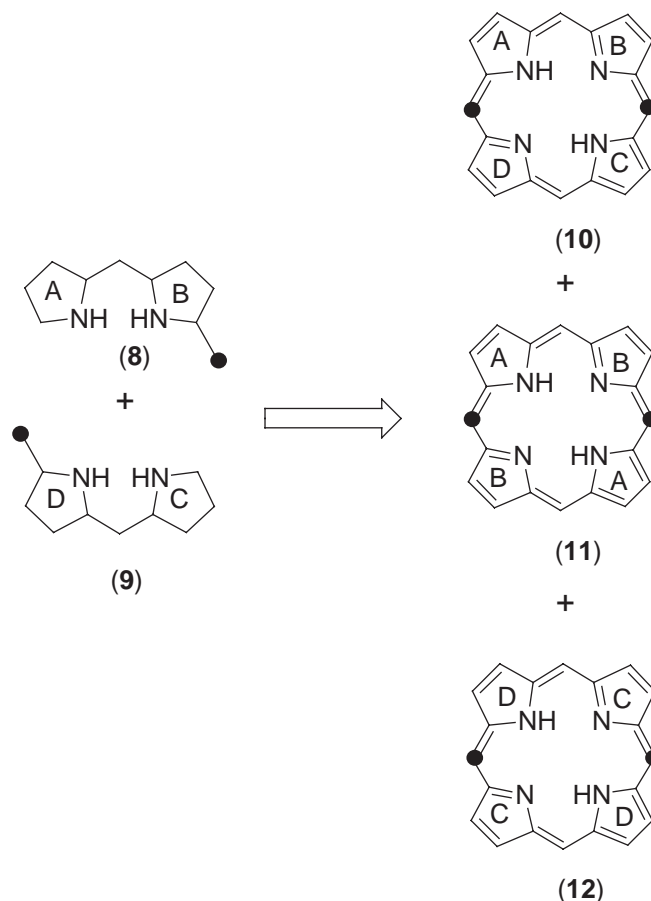
Because of so-called pyrrole redistribution reactions<sup>4</sup> that are acid-promoted, use of monopyrroles (e.g., **(3)**) which do not have identical 3- and 4-substituents will result in a mixture of porphyrins. Thus, pyrrole **(3)** gives a mixture of trivially named etioporphyrins I–IV **(4)**–**(7)** when it is cyclotetramerized under acidic conditions. Such a mixture of ligands, similar as they are, still makes the characterization of a subsequent metal complex almost impossible, and should therefore be avoided.

Pure individual porphyrins such as **(4)**–**(7)** can, however, be synthesized using dipyrroles, and these approaches will be briefly discussed later in this section. If two dipyrrole units **(8)** and **(9)** with an appropriate future *meso*-carbon are reacted together with the intention of preparing porphyrin **(10)**, there is actually a maximum of three possible products, **(10)**–**(12)** (Scheme 3). This is because the two dipyrroles can either react with themselves, or (as required) with each other. If the dipyrroles do not possess attached (future) *meso*-carbon atoms (e.g., **(13)** and **(14)**) and also bear an unsymmetrical arrangement of substituents (indicated by the A and B labels on each pyrrole—oxidation levels, i.e., dipyrromethene or dipyrromethane, not defined), even greater mixtures can occur—in this case, porphyrins **(15)**–**(20)** (Scheme 4). Such symmetry problems are common with all so-called [2 + 2] syntheses. However, if a porphyrin synthesis involving two dipyrroles is to be attempted, the symmetry problems can often be overcome if one of the two dipyrroles is symmetrical about its interpyrrolic (5-) carbon atom (e.g., synthesis of **(6)** from **(21)** and **(22)**, Scheme 5).

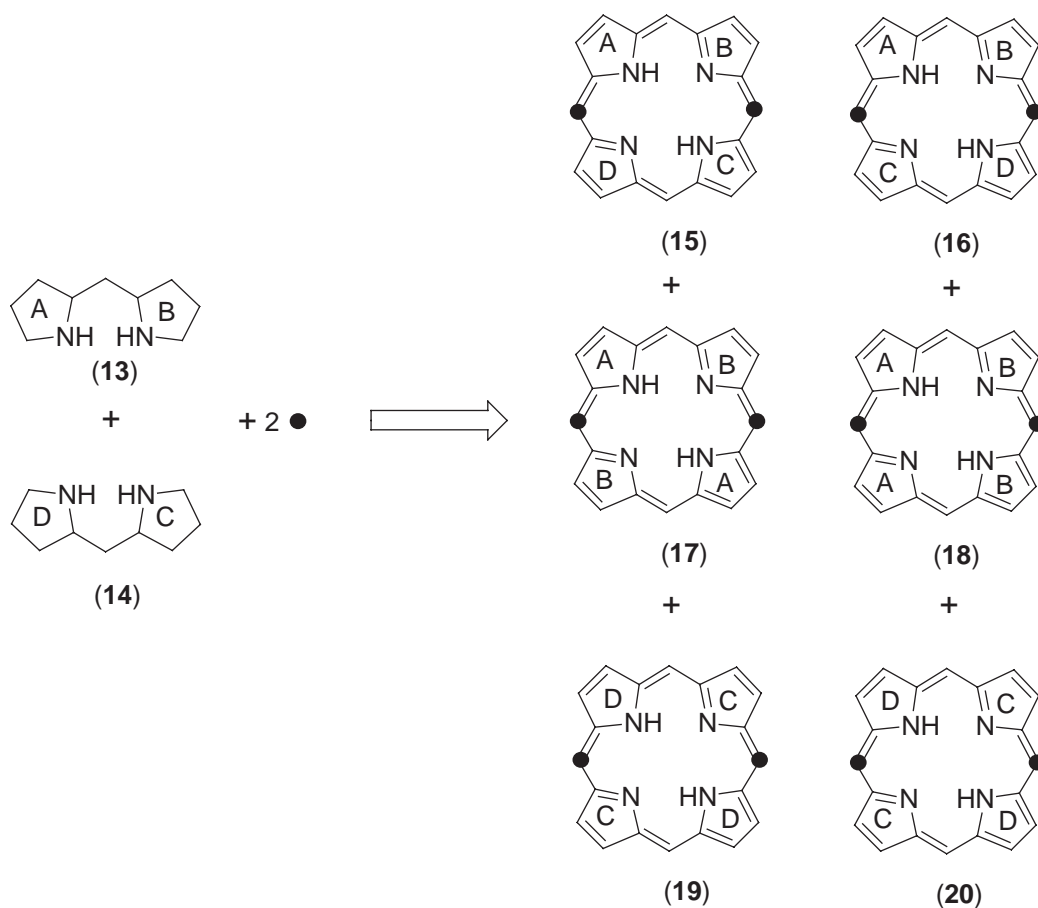
### 1.23.3 PORPHYRIN SYNTHESSES USING A MONOPYRROLE TETRAMERIZATION APPROACH

#### 1.23.3.1 2,3,7,8,12,13,17,18-Octaethylporphyrin (H<sub>2</sub>OEP) (**(1)**)

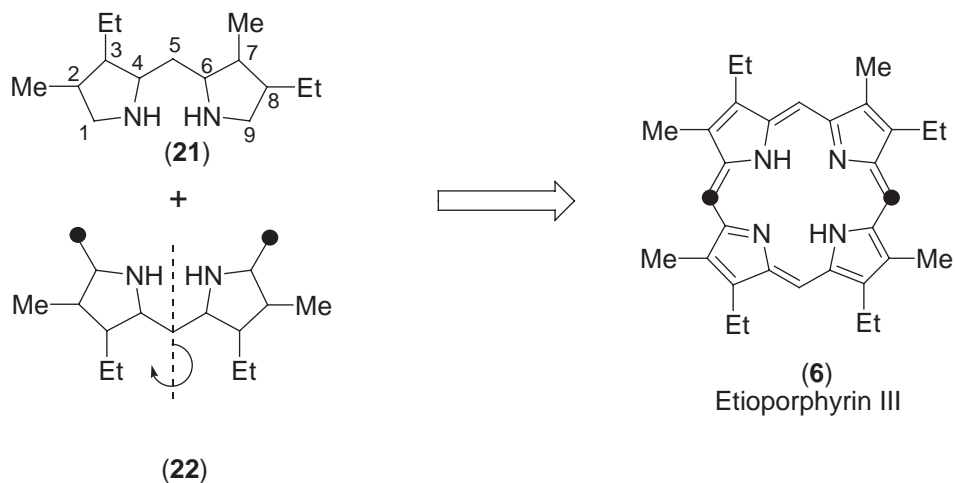
As mentioned above, the future porphyrin *meso*-carbons can be covalently attached to the monopyrrole being subjected to tetramerization, or added separately from the pyrrole. H<sub>2</sub>OEP, **(1)**,



Scheme 3

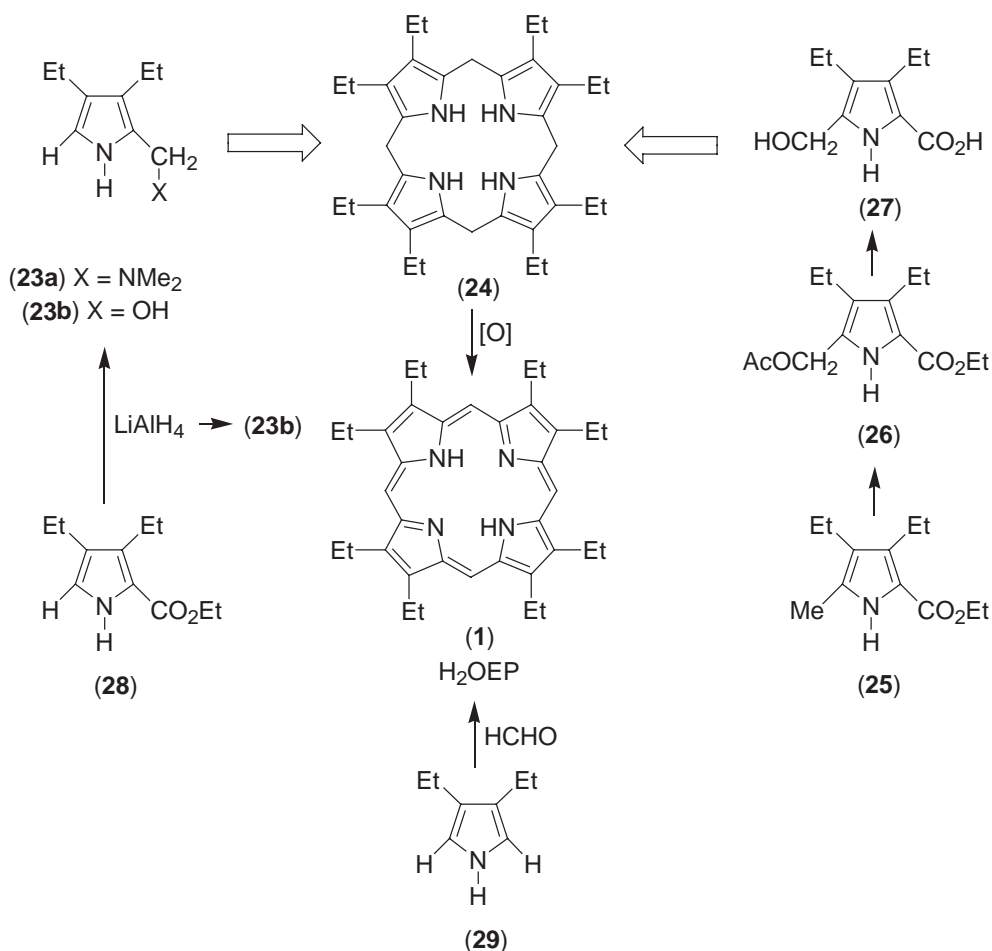


Scheme 4



Scheme 5

can be prepared using both of these methodologies. For example, cyclotetramerization of pyrroles (**23**) bearing 2-CH<sub>2</sub>X substituents affords good yields of H<sub>2</sub>OEP (Scheme 6). Since the 2-unsubstituted positions of pyrroles are nucleophilic, the benzylic X group must be a good leaving group; the methylene carbon of the 2-substituent (to which the X group is attached)



Scheme 6

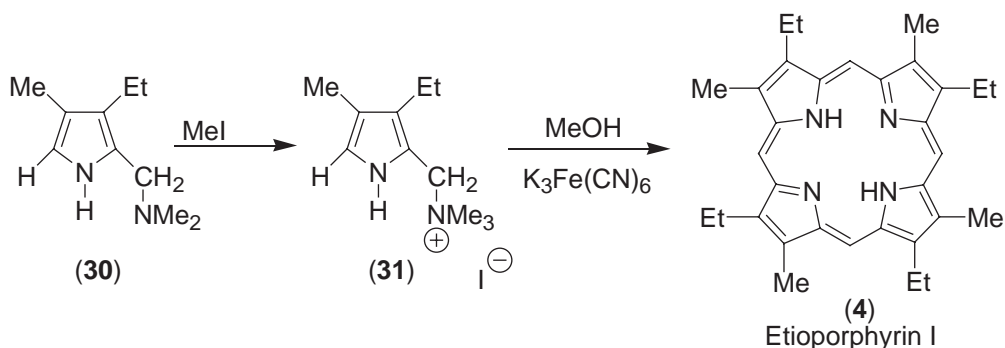
will eventually be the source of the 5-,10-,15-, and 20-carbons of the porphyrin (1). Mechanistically, such a cyclotetramerization would yield a porphyrinogen (24) after the condensation reaction, so an oxidation step is necessary in order to obtain the porphyrin. Occasionally, adventitious air acts as the oxidant, but on other occasions an external oxidant (e.g., 2,3-dichloro-5,6-dicyanobenzoquinone (DDQ) or potassium ferricyanide) is added.

Numerous variations of the X group in the CH<sub>2</sub>X of (23) have been investigated. Such groups can be directly attached to a 2-unsubstituted pyrrole, using, for example, formaldehyde and dimethylamine [or directly with (*N,N*-dimethylmethylene)ammonium iodide (Eschenmoser's reagent)<sup>5,6</sup> which can be purchased] to give the 2-(*N,N*-dimethylaminomethyl)pyrrole (23a); heating of this in acetic acid gives a greater than 50% yield of (1).<sup>7,8</sup> Alternatively, oxidation of pyrrole (25) with lead(IV) tetraacetate gives (26), which can be hydrolyzed to give (27) and then cyclotetramerized to give (1) in a little less than 50% yield by heating in acetic acid containing potassium ferricyanide.<sup>9,10</sup> The Barton-Zard pyrrole synthesis<sup>11</sup> has significantly facilitated access to pyrroles such as (28), and these can be reduced to the 3,4-diethyl-2-methylcarbinol (23b) simply by using lithium aluminum hydride. Cyclotetramerization of the pyrrole-2-methylcarbinol (23b) under acidic conditions, gives (1) in greater than 50% yield.<sup>12,13</sup>

The second approach employs reactions of pyrroles in the presence of reagents that can separately provide the interpyrrolic carbon atoms. Thus, cyclotetramerization of 3,4-diethylpyrrole (29) with formaldehyde affords H<sub>2</sub>OEP in yields as high as 75%.<sup>14</sup>

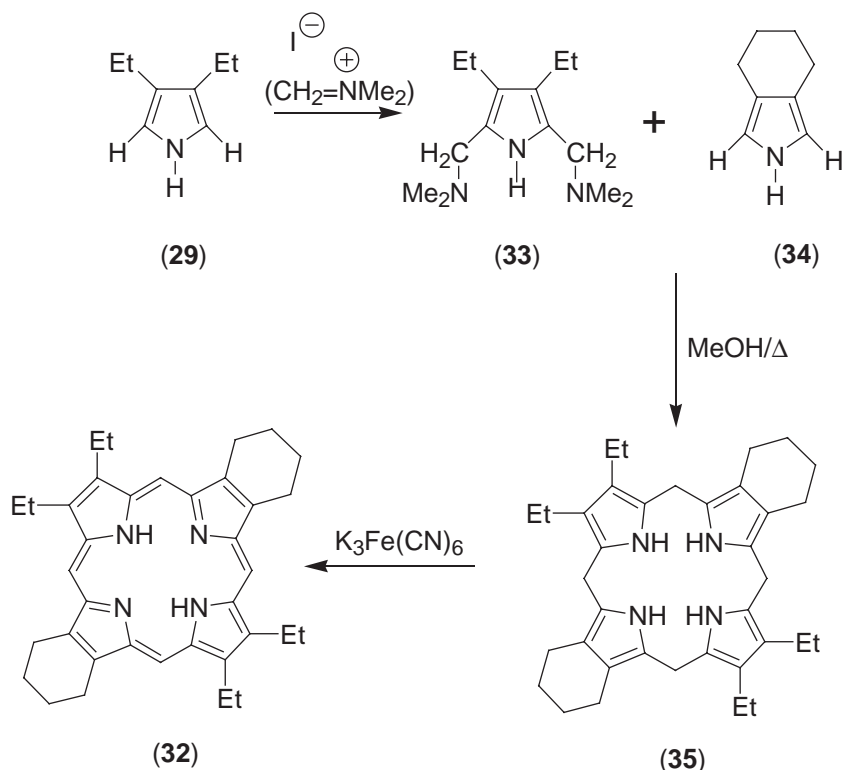
It was mentioned earlier that the acid-catalyzed cyclotetramerization of pyrrole (3) results in formation of a mixture of the four etioporphyrin type isomers ((4)–(7)). This involves a redistribution of the pyrrole subunits in intermediate pyrrole oligomers initiated by protonation of these electron-rich porphyrin precursors. Through a series of equilibria, the reaction produces

a complex mixture of precursors, and eventually porphyrins.<sup>15</sup> However, a method has been developed which does produce only porphyrin from cyclotetramerization of a pyrrole; as might be expected, the key step in the development of this approach involves the avoidance of acid catalysts. Thus, treatment of 2-(*N,N*-dimethylaminomethyl)pyrroles (e.g., **(30)**) with methyl iodide gives **(31)** which has a very labile leaving group that can be displaced even under neutral conditions.<sup>16,17</sup> Reaction of **(31)** in methanol containing potassium ferricyanide (as an *in situ* oxidant) gives a good yield of pure etioporphyrin I (**(4)**) (Scheme 7).



Scheme 7

A “one-pot” synthetic procedure which involves the combination of two different pyrroles to give a pure porphyrin with each type of pyrrole ring sited opposite to itself has been reported.<sup>17,18</sup> Only one regiochemically pure porphyrin (**(32)**) is produced. For example, treatment of the 2,5-bis-(*N,N*-dimethylaminomethyl)pyrrole (**(33)**) (obtained from 3,4-diethylpyrrole (**(29)**) by treatment with excess Eschenmoser’s reagent) with the 3:4-butanopyrrole (**(34)**) in methanol containing potassium ferricyanide, affords the porphyrin (**(32)**) (Scheme 8). This reaction again proceeds through the



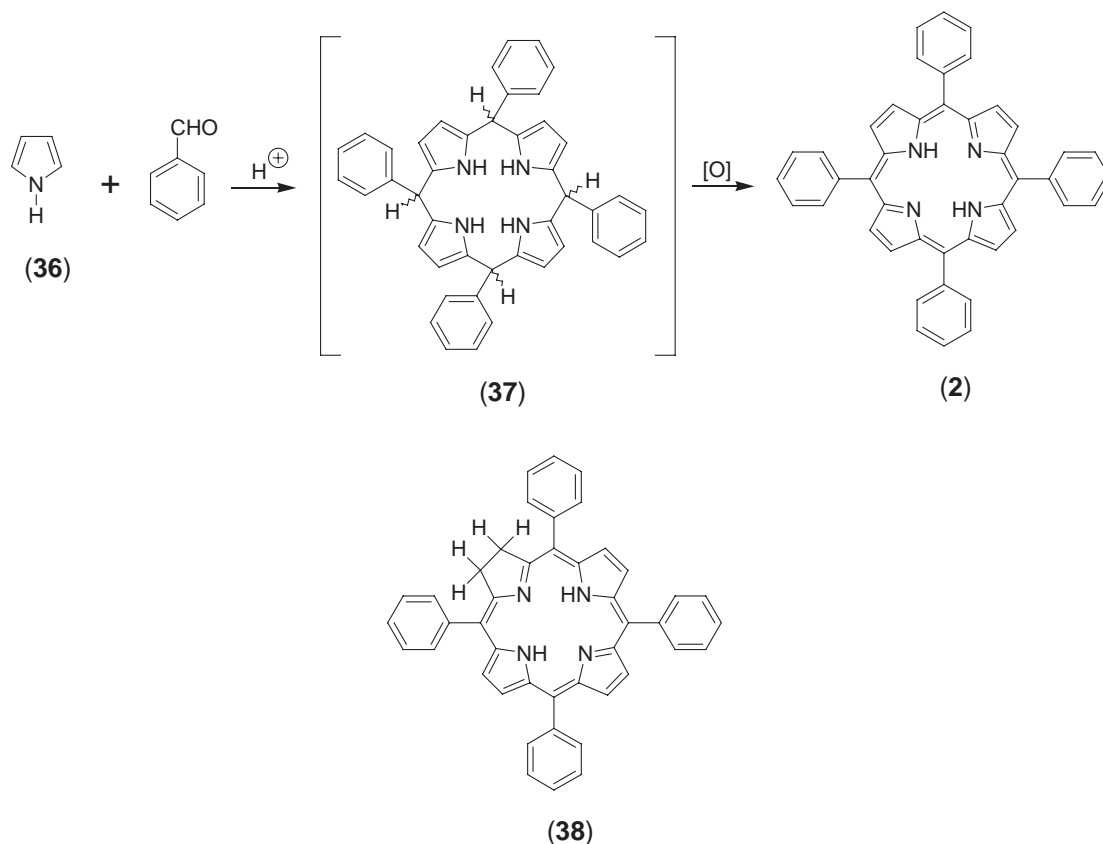
Scheme 8



porphyrinogen (**35**), which is not isolated; the avoidance of acidic reagents and utilization of an in situ oxidant (potassium ferricyanide) avoids pyrrole ring redistribution reactions on the intermediate species (such as **35**) prior to porphyrin (**32**) formation.

### 1.23.3.2 5,10,15,20-Tetraphenylporphyrin ( $H_2$ TPP (**2**))

$H_2$ TPP (**2**) has served researchers as their workhorse porphyrin ligand for more than 60 years. This is largely because it is possible to prepare large quantities of  $H_2$ TPP simply by heating pyrrole (**36**) with benzaldehyde (Scheme 9). This simple route was first reported by Rothmund<sup>19,20</sup> and involved heating of the reactants in a sealed tube. Somewhat later the approach was modified by Adler, Longo and their colleagues, who conveniently used admixture of pyrrole and benzaldehyde to refluxing propionic acid.<sup>21</sup> The crude  $H_2$ TPP can then be filtered off directly from the cooled reaction mixture in upwards of 20% yield. The approach was finally optimized and generalized in the form of a two-step procedure by Lindsey's group,<sup>22</sup> and applied to a wider variety of arylaldehydes (and therefore tetraarylporphyrins); the sequence first involves formation of a porphyrinogen (**37**) by acid-catalyzed reaction between the pyrrole and arylaldehyde, followed by an oxidation step (usually with DDQ). With just a few exceptions, the reaction tolerates substitution of other arylaldehydes in place of benzaldehyde, and good yields of a variety of tetraarylporphyrins can be obtained.<sup>23</sup>

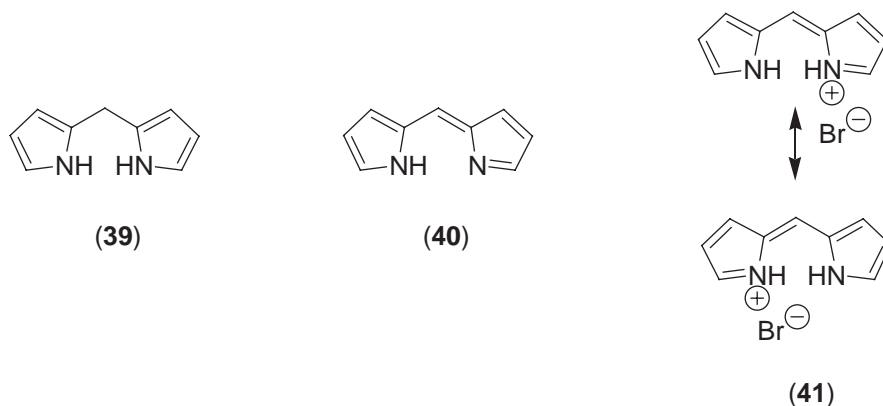


Scheme 9

The material obtained from both the Rothmund and Adler *et al.* approaches is crystalline but crude and usually contains up to 5% of 5,10,15,20-tetraphenyl-2,3-chlorin (**38**).<sup>24</sup> Earlier methodology utilized the chromatographic separation of the porphyrin and chlorin, but a better method involves brief treatment of the crude product with DDQ.<sup>25</sup> In this way (**38**) is transformed *into* (**2**) instead of being laboriously separated from it.

### 1.23.4 PORPHYRIN SYNTHESSES USING REACTIONS OF DIPYRROLES

The two most common dipyrroles used in porphyrin syntheses are the dipyrromethanes (**39**) and dipyrromethenes (**40**); the latter are usually handled as their highly crystalline hydrohalide salts (e.g., **41**) (Scheme 10). Collectively, such syntheses of porphyrins using dipyrroles are known as [2 + 2] approaches.



Scheme 10

#### 1.23.4.1 Using Dipyrromethenes

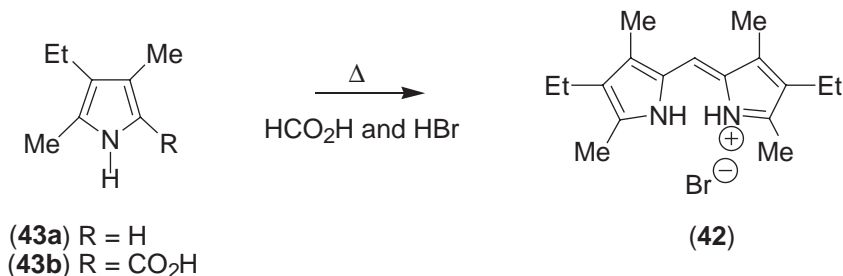
The first dipyrroles to be exploited for the purpose of porphyrin synthesis were the dipyrromethenes, and most syntheses of this type were developed by Hans Fischer and his group in Munich, Germany.<sup>26</sup>

##### 1.23.4.1.1 Syntheses of dipyrromethenes

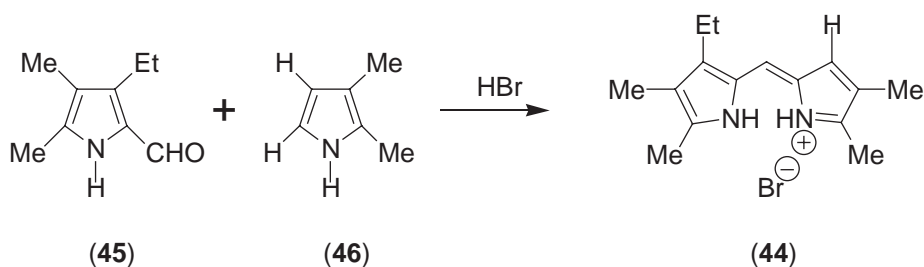
Dipyrromethenes (e.g., **(42)**) with a symmetrical arrangement of substituents can be prepared by self-condensation of 2-unsubstituted pyrroles (**(43a)**) or the corresponding pyrrole-2-carboxylic acids (**(43b)**) in boiling formic acid containing hydrobromic acid (Scheme 11).<sup>27</sup> The synthetically more useful unsymmetrically substituted dipyrromethene salts (e.g., **(44)**) are best obtained by the condensation of a 2-formylpyrrole (**(45)**) with a 2-unsubstituted pyrrole (**(46)**) in the presence of acid (usually HBr) (Scheme 12). Heating of 2-bromomethylpyrroles (**(47)**) with 2-bromopyrroles (**(48)**) (synthesized by bromination of 2-unsubstituted pyrroles, **(49)**) in presence of bromine also gives good yields of unsymmetrical dipyrromethene hydrobromides (**(50)**) (Scheme 13).

##### 1.23.4.1.2 Transformation of dipyrromethenes into porphyrins

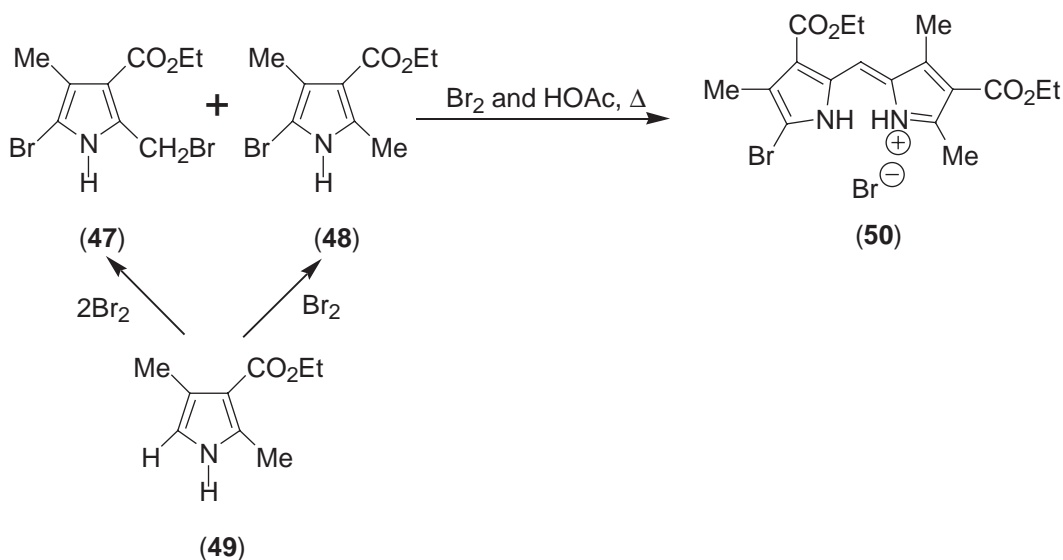
Self-condensation of 1-bromo-9-methyldipyrromethenes (e.g., **(51a)**) in hot formic acid or in fused organic acid melts (succinic, tartaric, etc.) at temperatures sometimes exceeding 200 °C affords



Scheme 11



Scheme 12



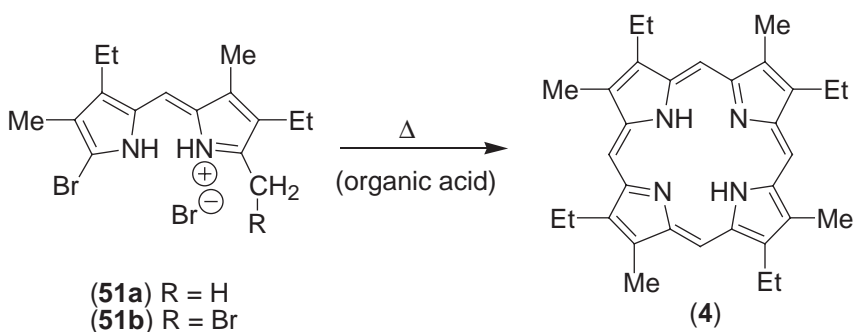
Scheme 13

porphyrins (e.g., (4)) in modest yields.<sup>28</sup> The temperature of the fusion reaction, and therefore the choice of organic acid used, followed no set protocol and was invariably determined experimentally. The reaction also works well if 1-bromo-9-bromomethyldipyrromethene hydrobromides, e.g., (51b),<sup>29</sup> are heated in formic acid; this affords good yields of centrosymmetrically substituted porphyrins such as (4) (Scheme 14).<sup>30</sup> Similar approaches can be used to obtain more complex porphyrins with the natural heme substituent array (e.g., mesoporphyrin IX, (52)) by condensation of 1,9-dibromodipyrromethenes (53) with 1,9-di(bromomethyl)- (54a) or 1,9-dimethyldipyrromethenes (54b) in the typical organic acid melts (Scheme 15). As already emphasized, the formation of a mixture of porphyrins is strategically avoided by choosing one of the dipyrromethenes ((53) in this case) to be symmetrically substituted about its 5-carbon.

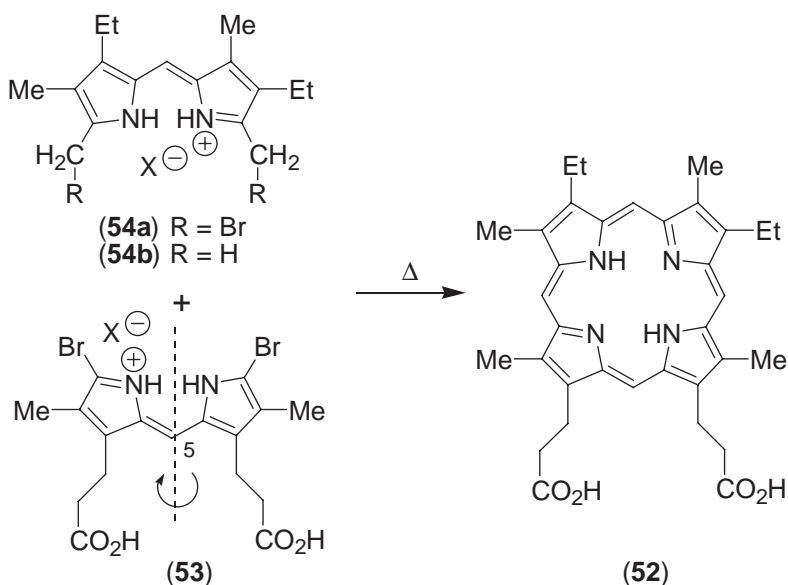
#### 1.23.4.2 Using Dipyrrromethanes

##### 1.23.4.2.1 Syntheses of dipyrrromethanes

Symmetrically substituted and unsymmetrical dipyrrromethanes can be obtained by using a number of different approaches. Dipyrrromethanes (e.g., (55) and (56)) which are symmetrically substituted about their *meso*- (i.e., 5-) carbon are obtained in moderate to good yield by self-condensation of bromomethylpyrroles (57) (obtained from the corresponding 2-methylpyrrole (58) by bromination) in hot methanol,<sup>31</sup> or by heating 2-acetoxymethylpyrroles (59) (obtained from the appropriate 2-methylpyrrole (60) by treatment with lead tetraacetate) in methanol



Scheme 14



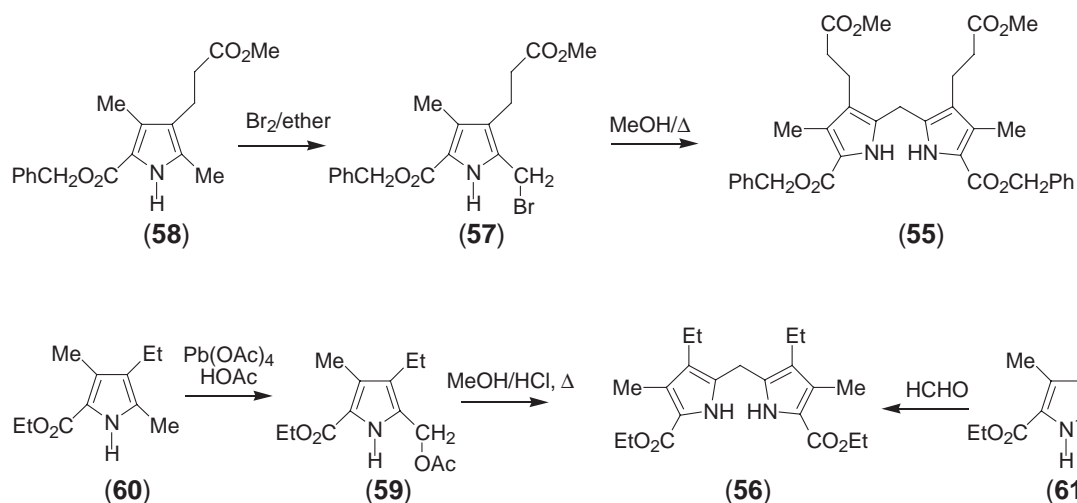
Scheme 15

containing a small amount of hydrochloric acid (to give (56)) (Scheme 16).<sup>32</sup> 2-Unsubstituted pyrroles (e.g., (61)), upon treatment with formaldehyde, also give dipyrrromethanes, e.g., (56).<sup>33,34</sup> Good yields of 5-substituted dipyrrromethanes (e.g., (62)) are obtained<sup>35</sup> by treatment of a 2-unsubstituted pyrrole (e.g., (63)) with dimethylacetals of aliphatic aldehydes in the presence of an acid catalyst (Scheme 17). The related 5-aryldipyrrromethanes (e.g., (64)) can be prepared by treatment of an arylaldehyde (e.g., benzaldehyde) with excess 2-unsubstituted pyrrole (and even pyrrole (36), itself) in the presence of an acid catalyst (Scheme 18).<sup>36</sup>

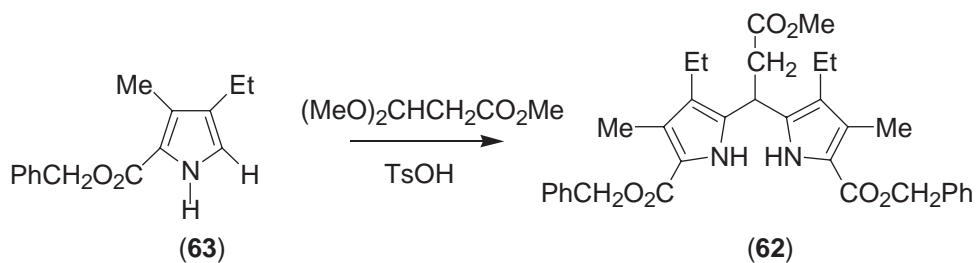
Dipyrrromethanes, e.g., (65), with an unsymmetrical arrangement of pyrrole substituents can be obtained in good yield by reaction of 2-acetoxymethylpyrroles (66) with 2-unsubstituted pyrroles (67) in methanol containing a small amount of toluene *p*-sulfonic acid (Scheme 19).<sup>37</sup> Alternatively, the same reagents can be heated in glacial acetic acid containing sodium acetate,<sup>38</sup> or in glacial acetic acid alone.<sup>39</sup> Acidic Montmorillonite K-10 clay has also been shown to be a very useful catalyst for syntheses of unsymmetrical (and symmetrical) dipyrrromethanes from starting materials such as (66) and (67).<sup>40,41</sup>

#### 1.23.4.2.2 Transformation of dipyrrromethanes into porphyrins

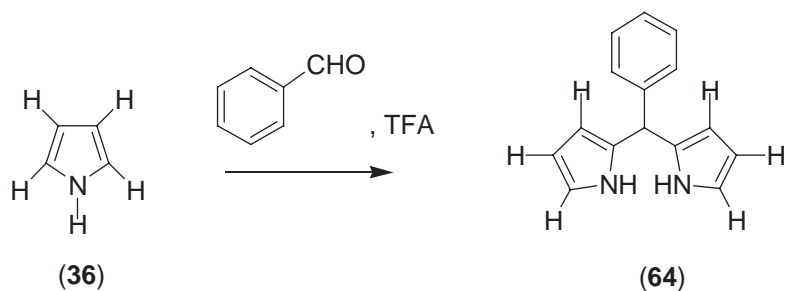
MacDonald's group in Ottawa, Canada, was the first to show<sup>42</sup> that a 1,9-di-unsubstituted dipyrrromethane (68a) or its corresponding 1,9-dicarboxylic acid (68b) reacts with a



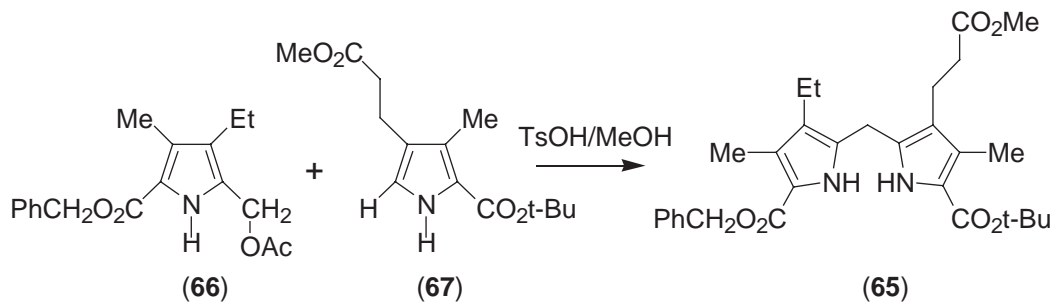
Scheme 16



Scheme 17

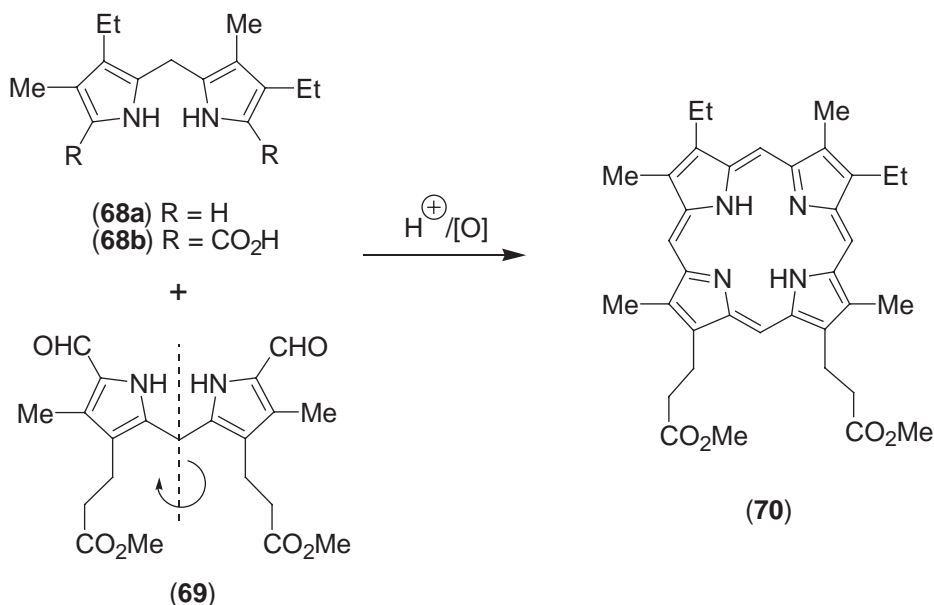


Scheme 18



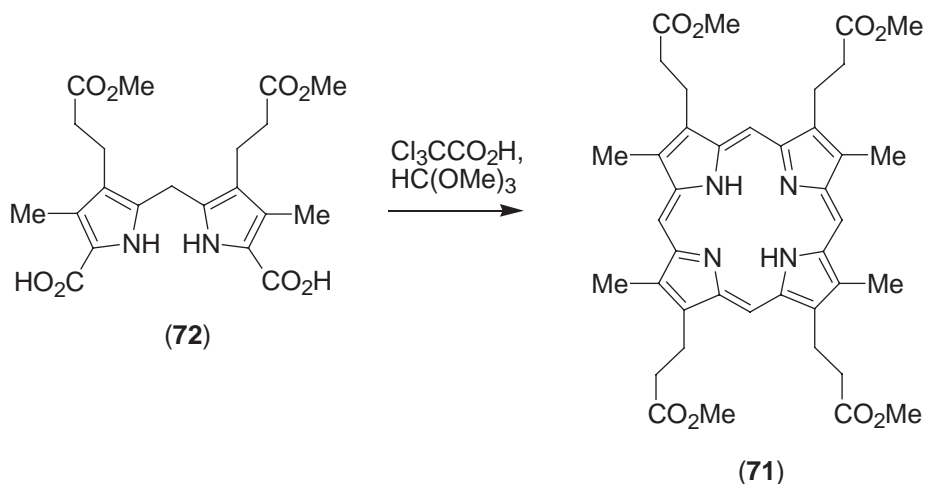
Scheme 19

1,9-diformyldipyrromethane, (such as (69)) in the presence of an acid catalyst to give pure porphyrin (e.g., mesoporphyrin IX dimethyl ester, (70)) in good yields (Scheme 20). Initial studies used hydriodic acid as the catalyst, but toluene *p*-sulfonic acid has since been shown to be a more convenient choice.<sup>43,44</sup> As is the situation for porphyrin synthesis from dipyrromethenes, in order to avoid the formation of a mixture of porphyrins, one of the two dipyrromethanes ((69) in this case) needs to be symmetrically substituted about the 5-carbon. In this case, once again, no mixture is produced because both of the future linking *meso*-carbons are sited on the same dipyrromethane (preventing either of the two individual dipyrromethanes from reacting with themselves).



Scheme 20

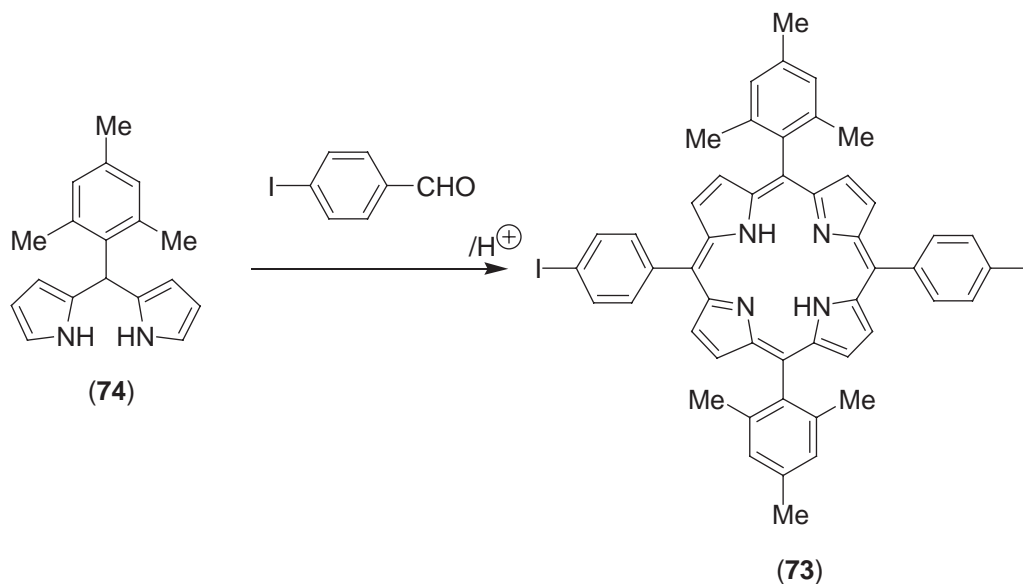
It is also possible to self-condense 1,9-diunsubstituted dipyrromethanes in the presence of a one-carbon unit (formaldehyde, orthoformic ester). Because of the non-nucleophilicity of protonated dipyrromethenes (e.g., (41)) this approach only works well for dipyrromethanes. Using this methodology, and with trimethyl orthoformate as the one-carbon unit and trichloroacetic acid as the catalyst, coproporphyrin-II tetramethyl ester (71) can be obtained in good yield from the dipyrromethane-1,9-dicarboxylic acid (72) (Scheme 21).<sup>45</sup>



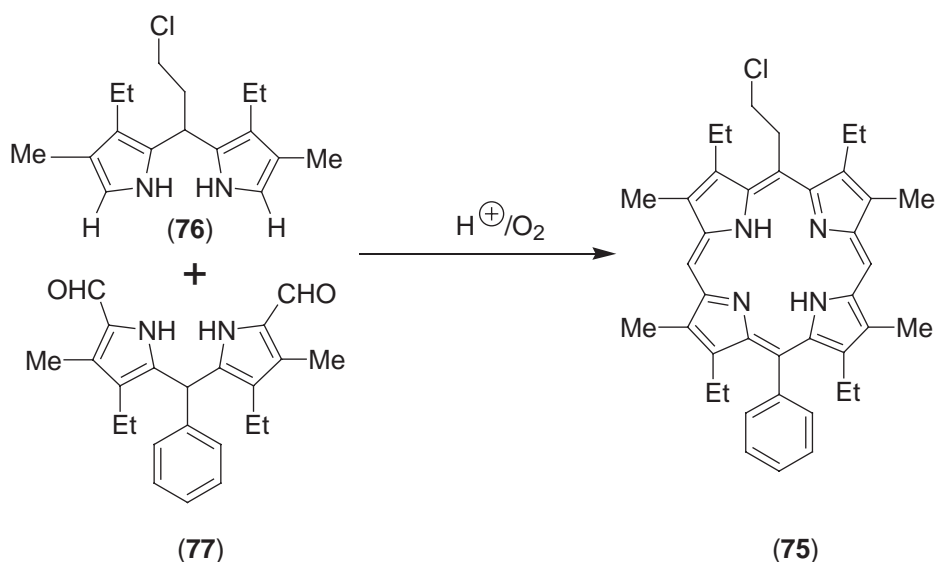
Scheme 21

## 1.23.5 5,15-DIARYL AND 5,15-DIALKYLPORPHYRINS

Using an approach similar to that described in the preceding paragraph, this methodology enables the synthesis of 5,15-diaryl- or 5,15-dialkyl-porphyrins from a dipyrromethane and an alkyl- or arylaldehyde linker molecule.<sup>36</sup> In the example shown, porphyrin (73) can be obtained from the 5-mesityldipyrromethane (74) (prepared in a manner similar to that described for (64)) and 4-iodobenzaldehyde; if the dipyrromethane (74) had been unsubstituted at the 5-position, a 5,15-diarylporphyrin would have resulted (Scheme 22). Mixed 5-alkyl-15-arylporphyrins, such as (75), can be prepared<sup>35,46</sup> by treatment of 1,9-di-unsubstituted 5-alkyldipyrromethanes (e.g., (76)) with 1,9-diformyl-5-aryldipyrromethanes (77) in a MacDonald-type [2 + 2] approach (Scheme 23).



Scheme 22



Scheme 23

## ACKNOWLEDGMENTS

I would like to thank the National Institutes of Health (HL 22252) and the National Science Foundation (CHE 99-04076) for uninterrupted support of our research efforts in the field of porphyrin synthesis over the past 25 years.

## 1.23.6 REFERENCES

- Vicente, M. G. H.; Smith, K. M. In *Embryonic Encyclopedia of Life Sciences* 1999, Nature Publishing Group: London; [www.els.net](http://www.els.net).
- Scheer, H. (Ed). *Chlorophylls* CRC Press: Boca Raton, FL.
- Smith, K. M. In *The Porphyrin Handbook*, Kadish, K. M.; Smith, K. M.; Guillard, R., Eds.; Academic Press: Boston 1999; Vol. 1, Chapter 1, pp 1–43.
- Mauzerall, D. *J. Am. Chem. Soc.* **1960**, *82*, 2601–2605.
- Ono, M.; Lattmann, R.; Imomota, K.; Lehmann, C.; Früh, T.; Eschenmoser, A. *Croat. Chem. Acta* **1985**, *58*, 627.
- Schreiber, J.; Maag, H.; Hashimoto, N.; Eschenmoser, A. *Angew. Chem. Int. Ed. Engl.* **1971**, *10*, 330–331.
- Eisner, U.; Lichtarowicz, A.; Linstead, R. P. *J. Chem. Soc.* **1957**, 733–739.
- Whitlock, H. W.; Hanauer, R. *J. Org. Chem.* **1968**, *33*, 2169–2171.
- Siedel, W.; Winkler, F. *Liebigs Ann. Chem.* **1943**, *554*, 162–201.
- Inhoffen, H. H.; Fuhrhop, J.-H.; Voigt, H.; Brockmann, Jr., H. *Liebigs Ann. Chem.* **1966**, *695*, 133–143.
- Barton, D. H. R.; Kervagoret, J.; Zard, S. Z. *Tetrahedron* **1990**, *46*, 7587–7598.
- Aoyagi, K.; Haga, T.; Toi, H.; Aoyama, Y.; Mizutani, T.; Ogoshi, H. *Bull. Chem. Soc. Jpn.* **1997**, *70*, 937–943.
- Ono, N.; Kawamura, H.; Bougauchi, M.; Maruyama, K. *Tetrahedron* **1990**, *46*, 7483–7496.
- Sessler, J. L.; Mozaffari, A.; Johnson, M. R. 1991. *Org. Synth.* **1991**, *70*, 68–78.
- Smith, K. M. In *The Porphyrin Handbook*, Kadish, K. M.; Smith, K. M.; Guillard, R., Eds.; Academic Press: Boston 1999; Vol. 1, Chapter 1, pp 8, 20.
- Nguyen, L. T.; Smith, K. M. *Tetrahedron Lett.* **1996**, *37*, 7177–7180.
- Nguyen, L. T.; Senge, M. O.; Smith, K. M. *J. Org. Chem.* **1996**, *61*, 998–1003.
- Nguyen, L. T.; Senge, M. O.; Smith, K. M. *Tetrahedron Lett.* **1994**, *35*, 7581–7584.
- Rothmund, P. *J. Am. Chem. Soc.* **1935**, *57*, 2010–2011.
- Rothmund, P.; Menotti, A. R. *J. Am. Chem. Soc.* **1941**, *63*, 267–270.
- Adler, A. D.; Longo, F. R.; Finarelli, J. D.; Goldmacher, J.; Assour, J.; Korsakoff, L. *J. Org. Chem.* **1967**, *32*, 476.
- Lindsey, J. S.; Schreiman, I. C.; Hsu, H. C.; Kearney, P. C.; Marguerettaz, A. M. *J. Org. Chem.* **1987**, *52*, 827–836.
- Lindsey, J. S. In *The Porphyrin Handbook*, Kadish, K. M.; Smith, K. M.; Guillard, R., Eds.; Academic Press: Boston 1999; Vol. 1, Chapter 2, pp 45–118.
- Badger, G. M.; Jones, R. A.; Laslett, R. L. *Aust. J. Chem.* **1964**, *17*, 1028–1035.
- Barnett, G. H.; Hudson, M. F.; Smith, K. M. *J. Chem. Soc., Perkin Trans. 1* **1975**, 1401–1403.
- Fischer, H.; Orth, H. *Die Chemie des Pyrrols*, Akademische Verlag.: Leipzig, 1934, Vol. I; 1937, Vol. II, part i; 1940, Vol. II, part ii.
- Fischer, H.; Orth, H. *Die Chemie des Pyrrols*, Akademische Verlag.: Leipzig, 1937, Vol. II, part i; p 3.
- Fischer, H.; Klarer, J. *Ann. Chem.* **1926**, *448*, 178–193; Fischer, H.; Friedrich, H.; Lamatsch, W.; Morgenroth, K. *Ann. Chem.* **1928**, *466*, 149, 158; ref. 27, p 169.
- Fischer, H.; Orth, H. *Die Chemie des Pyrrols*, Akademische Verlag.: Leipzig, 1937, Vol. II, part i, p 193.
- Bonnett, R.; McManus, K. A. *J. Chem. Soc., Chem. Commun.* **1994**, 1129–1130.
- Fischer, H.; Orth, H. *Die Chemie des Pyrrols*, Akademische Verlag.: Leipzig, 1934, Vol. I, p 333.
- Mironov, A. F.; Ovsepyan, T. R.; Evstigneeva, R. P.; Preobrazenskii, N. A. *Zh. Obshch. Khim.* **1965**, *35*, 324–328.
- Fischer, H.; Orth, H. *Die Chemie des Pyrrols*, Akademische Verlag.: Leipzig, 1934, Vol. I, p 332.
- Fischer, H.; Nenitzescu, C. *Liebigs Ann. Chem.* **1925**, *433*, 113–129.
- Lee, D. A.; Smith, K. M. *J. Chem. Soc., Perkin Trans. 1*, **1997**, 1215–1227.
- Lee, C.-H.; Lindsey, J. S. *Tetrahedron* **1994**, *50*, 11427–11440.
- Cavaleiro, J. A. S.; Rocha Gonsalves, A. M. d'A.; Kenner, G. W.; Smith, K. M. *J. Chem. Soc., Perkin Trans. 1*, **1973**, 2471–2478.
- Tarlton, E. J.; MacDonald, S. F.; Baltazzi, E. *J. Am. Chem. Soc.* **1960**, *82*, 4389–4395.
- Clezy, P. S.; Liepa, A. J. *Aust. J. Chem.* **1970**, *23*, 2443–2459.
- Jackson, A. H.; Pandey, R. K.; Rao, K. R. N.; Roberts, E. *Tetrahedron Lett.* **1985**, *26*, 793–796.
- Freeman, B. A.; Smith, K. M. *Synth. Commun.* **1999**, *29*, 1843–1855.
- Arsenault, G. P.; Bullock, E.; MacDonald, S. F. *J. Am. Chem. Soc.* **1960**, *82*, 4384–4389.
- Cavaleiro, J. A. S.; Gonsalves, A. M. d'A. R.; Kenner, G. W.; Smith, K. M. *J. Chem. Soc., Perkin Trans. 1*, **1974**, 1771–1781.
- Cavaleiro, J. A. S.; Kenner, G. W.; Smith, K. M. *J. Chem. Soc., Perkin Trans. 1* **1974**, 1188–1194.
- Jackson, A. H.; Kenner, G. W.; Wass, J. *J. Chem. Soc., Perkin Trans. 1* **1972**, 1475–1483.
- Lee, D. A.; Brisson, J. M.; Smith, K. M. *Heterocycles* **1995**, *40*, 131–135.



# 1.24

## Phthalocyanines

N. B. McKEOWN

*University of Manchester, UK*

---

1.24.1	INTRODUCTION	507
1.24.2	GENERAL SYNTHETIC CONSIDERATIONS	508
1.24.3	SUBSTITUTED PHTHALOCYANINE LIGANDS	509
1.24.4	THE PREPARATION OF SUBSTITUTED DERIVATIVES BY THE REACTION OF PREFORMED PCS	510
1.24.5	NONUNIFORMLY SUBSTITUTED PCS	510
1.24.6	AZAPHTHALOCYANINES	511
1.24.7	TETRAAZAPORPHYRINS	512
1.24.8	EXTENDED PHTHALOCYANINES	512
1.24.9	REFERENCES	513

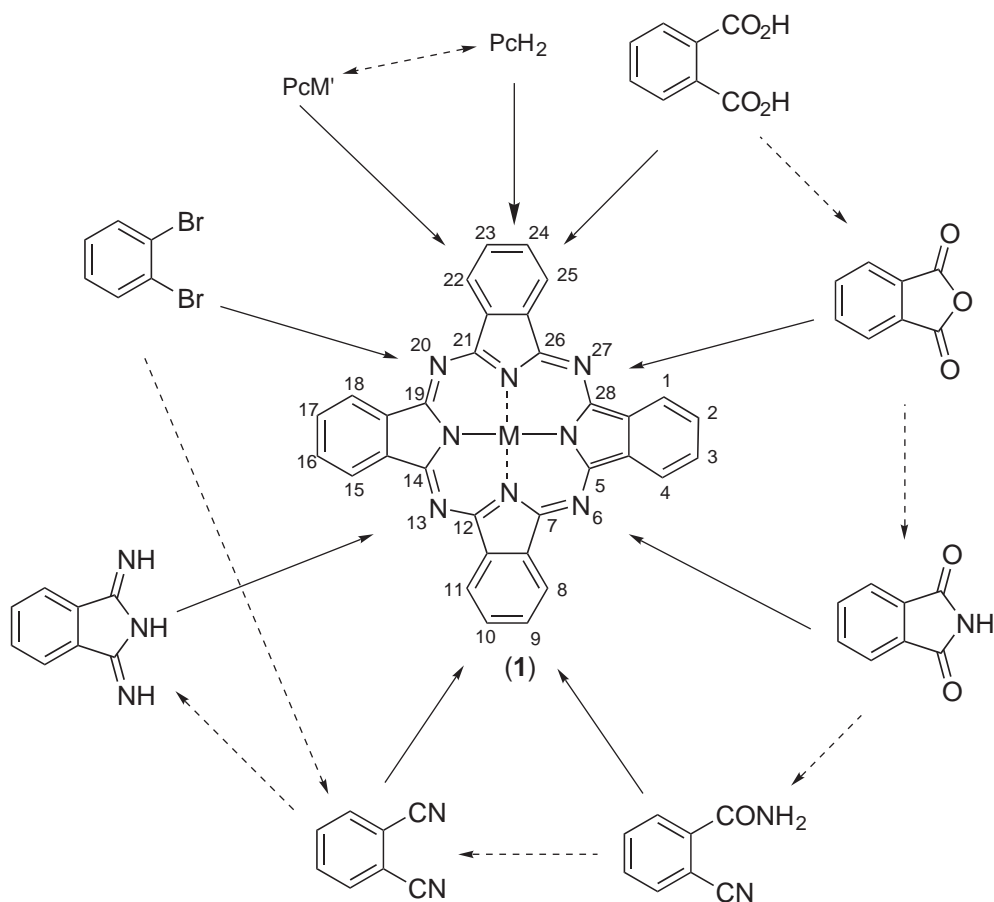
---

### 1.24.1 INTRODUCTION

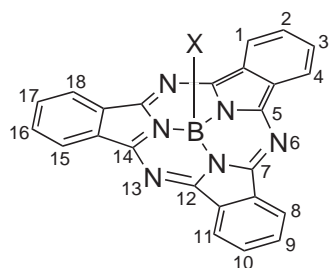
Phthalocyanine (Pc; **(1)**), together with its derivatives, comprises one of the most studied classes of functional organic materials.<sup>1,2</sup> It is a planar, aromatic macrocycle comprised of four iminoisoindole units that can play host to ions derived from over 70 elements. The coordination chemistry of the Pc ligand, which usually possesses a formal charge of  $2^-$ , is a rich and extensive subject.<sup>2,3</sup> Without the intervention of a metal ion, only the simple tetraiminoisoindoline ligand exists. In addition, subphthalocyanine<sup>4,5</sup> (**(2)**), composed of three iminoisoindoline subunits, and superphthalocyanine,<sup>6</sup> composed of five iminoisoindoline units, are known, but only as complexes with  $B^{3+}$  and  $UO^{2+}$ , respectively. Other unusual metal complexes involving the Pc ligand are sandwich dimers<sup>7</sup> and trimers,<sup>8</sup> in which two Pc ligands share the same metal ion. There are also nonaromatic, stapled sandwich complexes,<sup>9</sup> and bicyclic Pcs in which six iminoindole units ligate a single metal ion.<sup>10</sup>

The diverse and useful functionality of the Pc macrocycle originates from its 18- $\pi$ -electron aromatic system, which is closely related to that of the naturally occurring porphyrin ring. The additional  $\pi$ -orbital conjugation afforded by the four benzo-moieties, and the orbital perturbation caused by the nitrogen atoms at the four meso-positions, have a profound effect on the molecular orbital structure of the porphyrin chromophore. This results in a bathochromic shift of the lowest-energy absorption band (the Q-band) in the visible region of the spectrum, and a strong enhancement of its intensity (typically  $\lambda_{\max} \sim 680$  nm,  $\epsilon \sim 2 \times 10^5$  cm<sup>2</sup> mol<sup>-1</sup>). The basic spectroscopic properties of Pcs were covered in *CCC* (1987).<sup>11</sup> Their strong color, coupled with renowned chemical and thermal stability, explains the ubiquitous use of phthalocyanines as highly stable blue (or green) pigments and dyes, and this important commercial aspect has been reviewed<sup>12</sup> and outlined in *CCC* (1987).<sup>13</sup> In addition, phthalocyanines are exploited commercially for optical data storage, catalysis, and as photoconductors in xerography. They are also of interest as materials for nonlinear optics, liquid crystals, ordered thin films, photodynamic cancer therapy, molecular semiconductors, components of highly conducting charge-transfer salts and polymers, photovoltaic devices, electrochromic devices, fuel cells, and sensors.<sup>1,2</sup> The synthesis of phthalocyanine and its substituted derivatives is often driven by the desire to exploit and improve performance in one

of these technological arenas. Unlike Pc itself, many substituted derivatives are soluble in common organic solvents. There are a number of useful reviews dealing with the synthesis of Pcs.<sup>14-17</sup>



**Scheme 1**



### 1.24.2 GENERAL SYNTHETIC CONSIDERATIONS

The most common synthetic method for the synthesis of metal-containing Pcs involves the cyclotramerization of phthalic acid, phthalic anhydride, 2-cyanobenzamide, phthalimide, diiminoisoindoline, or phthalonitrile at elevated temperatures (>200°C) in the presence of a metal or metal salt. These reactions can be carried out either in a suitable solvent or in the melt. It should be noted that the use of a metal halide in the melt often leads to a monohalogenated Pc. Except for phthalonitrile and diiminoisoindoline cyclotramerizations, a nitrogen source is required,

which is usually urea. In addition, 1,2-dibromobenzene can be used as a precursor to  $\text{PcCu}^{\text{II}}$  by the *in situ* preparation and cyclotetramerization of phthalonitrile by the action of copper(I) cyanide (the Rosenmund–von Braun reaction). Metal complexes can be prepared by the addition of a metal ion to the free ligand (**1**) ( $\text{M} = 2\text{H}^+$ ), or by transmetalation using labile complexes containing alkali-metal ions (e.g.,  $\text{Li}_2(\mathbf{1})$  or  $\text{Na}_2(\mathbf{1})$ ). The latter method exploits the solubility of alkali-metal Pcs in polar solvents.<sup>18</sup> The synthetic connectivities between these various precursors are shown in Scheme 1.

Most syntheses of the metal-free ligand (**1**) ( $\text{M} = 2\text{H}^+$ ) use either phthalonitrile or diiminoisindoline as the starting material. Great care must be taken during its preparation to avoid unintentional incorporation of metal ions. The direct cyclotetramerization of phthalonitrile to give phthalocyanine requires a two-electron reduction and the donation of two protons from a co-reactant or solvent. Reagents such as hydroquinone and 1,2,3,6-tetrahydropyridine are particularly effective, and a good yield of phthalocyanine can be achieved from the incorporation of these reducing agents into cyclotetramerizations carried out in the melt ( $\sim 275^\circ\text{C}$ ).<sup>19,20</sup> Alternatively, cyclotetramerization can be achieved by heating phthalonitrile in a solution of lithium (or sodium) dissolved in a primary alcohol (e.g., pentanol) and washing out the labile alkali-metal ion from the resulting Pc with aqueous acid (this is known as the “Linstead method”).<sup>18</sup> A recent modification of the Linstead method involves leaving a solution of the phthalonitrile and alkoxide in alcohol (particularly, octan-1-ol) for prolonged periods at moderate ( $\sim 60^\circ\text{C}$ ) or even at room temperature.<sup>21,22</sup> A related procedure to that of the Linstead reaction involves the use of a catalytic amount of a non-nucleophilic base, such as 1,8-diazabicyclo[5.4.0]undec-7-ene (DBU) or 1,5-diazabicyclo[4.3.0]non-5-ene (DBN), to initiate cyclotetramerization in a protic solvent such as *n*-pentan-1-ol or 2-(*N,N*-dimethylamino)ethanol (DMAE).<sup>23</sup> Diiminoisindoline, an addition product of ammonia and phthalonitrile, can form Pc in good yield simply by heating in a protic solvent.<sup>24</sup>

### 1.24.3 SUBSTITUTED PHTHALOCYANINE LIGANDS

The Pc ligand offers a total of sixteen sites—four on each benzo unit—for the attachment of substituents, and an astonishing number of substituted derivatives of (**1**) have been prepared since the start of the 1980s.<sup>14,17</sup> In most cases, a substituted phthalonitrile or the derived diiminoisindoline is used as precursor. However, the commercially important chlorinated Pcs<sup>25</sup> and the water-soluble tetrasulfonate Pcs<sup>26</sup> derivatives are usually prepared from the metal-ion-induced cyclotetramerization of the appropriate phthalic acid derivative in a urea melt. The examples of substituted Pcs given in Table 1 are restricted to metal-free systems, although metal-containing derivatives were often reported, prepared either by a metal-ion-mediated cyclotetramerization or by insertion of a metal ion into the preformed ligand.

Tetrasubstituted derivatives substituted at four of the peripheral (2,3,9,10,16,17,23,24) or the nonperipheral (1,2,8,11,15,18,22,25) sites are usually prepared as a statistical mixture of four isomers of  $C_{4h}$ ,  $C_{2v}$ ,  $C_s$ , and  $D_{2h}$  symmetry. The isomeric heterogeneity of Pcs derived from 4-substituted phthalonitriles is beneficial for attaining soluble derivatives. For example, (**1b**) is highly soluble in common organic solvents, but the four *t*-butyl substituents do not affect the spectroscopic or electrochemical properties of the ligand significantly.<sup>33</sup> However, it is possible to prepare isomerically pure 1,8,15,22-tetrasubstituted Pcs ( $C_{4h}$  isomer) by exploiting steric and electronic factors that result in a regioselective cyclotetramerization of the 3-substituted phthalonitrile (e.g., (**1a**)).<sup>27–29</sup> The mild conditions afforded by low-temperature cyclotetramerization reactions favour regiospecific formation.<sup>21,22</sup> Even for nonregioselective reactions, it is often possible to isolate this isomer by chromatography (e.g., HPLC)<sup>30,31</sup> or by recrystallization.<sup>32</sup>

Soluble and isomerically pure derivatives, such as (**1c–1e**), can be obtained by the cyclotetramerization of 3,6- or 4,5-disubstituted phthalonitriles to give 1,4,8,11,15,18,22,25 and 2,3,9,10,16,17,23,24-octasubstituted Pcs, respectively. Octa-alkyl derivatives with long alkyl chains ( $>C_5H_{11}$ ) form columnar liquid crystals.<sup>34,35</sup> Nonperipheral substitution with alkyloxy side chains, e.g., (**1d**), results in a large red shift of the primary absorption band in the visible region of the spectrum from  $\sim 680\text{ nm}$  to  $\sim 780\text{ nm}$ .<sup>36</sup> Similarly, Pcs with hexadeca alkyloxy<sup>37</sup> or pyrazol-1-yl<sup>38</sup> substituents (e.g., (**1g**)) also have Q-bands in the near-IR region of the spectrum. An active area of research since the mid-1980s has been the synthesis and study of Pcs with crown ether<sup>39</sup> or aza-crown<sup>40,41</sup> units fused to their peripheral sites (e.g., (**1f**)). These systems can be used for the assembly of multinuclear metal-ion complexes.

**Table 1** Examples of substituted Pcs.

	<i>Substituents</i>	<i>Reagents and conditions</i>	<i>Yield</i>	<i>References</i>
(1a)	1,8,15,22-(OCH <sub>2</sub> - <i>t</i> -Bu) <sub>4</sub>	1. 3-neopentylphthalonitrile, Li, 1-octanol, 60 °C, 2 h; 100 °C, 12 h; 120 °C, 2 h; 2. H <sub>2</sub> O	30	27
(1b)	2,9(10),16(17),23(24)-( <i>t</i> -Bu) <sub>4</sub>	1. 4- <i>t</i> -butylphthalonitrile, Na, <i>i</i> -pentan-1-ol, reflux, 5 h; 2. MeOH, rt, 3 h	57	33
(1c)	1,4,8,11,15,18,22,15-( <i>n</i> -C <sub>7</sub> H <sub>15</sub> ) <sub>8</sub>	1. 3,6-di- <i>n</i> -heptylphthalonitrile, Li, pentan-1-ol, reflux, 1 h; 2. AcOH, rt, 10 min	22	47
(1d)	1,4,8,11,15,18,22,15-(OEt) <sub>8</sub>	1. 3,6-diethyloxyphthalonitrile, Li, pentan-1-ol, reflux, 0.25 h; 2. AcOH, rt, 0.5 h pentanol, 130 °C	20	36
(1e)	2,3,9,10,16,17,23,24-( <i>n</i> -C <sub>5</sub> H <sub>11</sub> ) <sub>8</sub>	5,6-di- <i>n</i> -pentyl-diiminoisindoline, DMAE, reflux, 1 h	21	76
(1f)	2□3,9□10,16□17,23□24-[O(CH <sub>2</sub> CH <sub>2</sub> O) <sub>5</sub> ] <sub>4</sub> <sup>a</sup>	4',5'-dicyanobenzo-18-crown-6, DMAE, reflux, 20 h	26	39
(1g)	1,2,3,4,8,9,10,11,14,16,17,18,22,23,24,15-(pyrazol-1-yl) <sub>16</sub>	3,4,5,6-tetra(pyrazol-1-yl)phthalonitrile, hydroquinone, 180 °C	70	38
(1h)	1,4,8,11,15,18,22,15-octaaza-2,3,9,10,16,17,23,24-( <i>n</i> -C <sub>12</sub> H <sub>25</sub> ) <sub>8</sub>	2,3-dicyano-5,6-di- <i>n</i> -dodecylpyrazine, DBU, EtOH, reflux, 20 h	14	67
(2)	X = Cl	Phthalonitrile, BCl <sub>3</sub> , 1-chloronaphthalene, 150–180 °C	40	4
(2a)	2,3,9,10,16,17-(SC <sub>6</sub> H <sub>13</sub> ) <sub>6</sub> ; X = Cl	4,5-dihexylsulfanylphthalonitrile; BCl <sub>3</sub> , 1-chloronaphthalene, argon, 100 °C, 4 h	28	51
(3a)	2,3,7,8,12,13,17,18-(SC <sub>8</sub> H <sub>17</sub> ) <sub>8</sub>	1. 1,2-dioctylsulfanylmaleonitrile; Mg(OPr) <sub>2</sub> , PrOH, reflux; 2. TFA, CH <sub>2</sub> Cl <sub>3</sub> , reflux, 0.5 h	43	70
(4a)	3,4,12,13,21,22,26,27-( <i>n</i> -decyl) <sub>8</sub>	1. 6,7-di- <i>n</i> -decylnaphthalonitrile, 1 equiv. LiOPe, pentanol, reflux, 6 h; 2. AcOH	26	77

<sup>a</sup> The symbols □ indicate that each of the four crown ether substituents are fused across the peripheral sites.

#### 1.24.4 THE PREPARATION OF SUBSTITUTED DERIVATIVES BY THE REACTION OF PREFORMED PCS

Standard aromatic electrophilic substitution reactions on unsubstituted phthalocyanines (e.g., sulfonylation,<sup>42</sup> halogenation,<sup>43</sup> and nitration<sup>44</sup>) are commonly performed in industry. However, the 16 possible sites for substitution offered by the phthalocyanine ring result in the formation of complex product mixtures from these reactions.<sup>43</sup> Nevertheless, the substitution or modification of substituents on a preformed Pc, using routine and efficient reactions, is especially suited to the introduction of functional groups which are not accessible using classical cyclotetramerization reactions. For example, simple methyl ether cleavage reactions can provide 2,3,9,10,16,17,23,24-octahydroxyphthalocyanines from 2,3,9,10,16,17,23,24-octamethyloxyphthalocyanines.<sup>45,46</sup> The resulting hydroxyl groups can undergo exhaustive alkylation.<sup>45</sup>

#### 1.24.5 NONUNIFORMLY SUBSTITUTED PCS

Phthalocyanines that possess two types of substituents on different benzo units are termed nonuniformly substituted, or unsymmetrical, phthalocyanines. There are three possible substitution patterns: (i) where one of the benzo units is substituted differently from the other three (AAAB); (ii) where adjacent benzo units possess the same substituents (“adjacent,” or AABB);

and (iii) where opposite benzo units possess the same substituents (“opposite,” or ABAB). Mixed cyclotetramerizations between two different Pc precursors (e.g., A and B) can give up to six distinct products (AAAB, AABB, ABAB, and ABBA, and the two symmetrical phthalocyanines (AAAA and BBBB), derived from four molecules of the same precursor. The amount of each phthalocyanine obtained is related to the molar ratio of the two precursors and to their relative reactivity. For a reaction of an equimolar amount of two precursors of equal reactivity, a statistical analysis estimates that, of the total phthalocyanine yield, a product mixture of 6.25% AAAA (and BBBB), 25% AAAB (and ABBA), 12.5% ABAB, and 25% AABB will be produced.<sup>47</sup> Clearly, careful separation of this complex product mixture is required if pure materials are to be isolated. Chromatographic separation is made far easier if the two types of substituents are of differing polarity (e.g., alkyl and polyethyleneoxy side chains).<sup>48</sup>

It is possible to optimize the formation of the AAAB product by using an excess of precursor A relative to precursor B. This ensures that the only two phthalocyanine products formed in significant quantities are the symmetrical AAAA derivative and the required AAAB phthalocyanine.<sup>49</sup> An alternative route to AAAB-type unsymmetrical Pcs is provided by the ring-expansion reaction of a subphthalocyanine (**2**) (itself prepared by the cyclotrimerization of a phthalonitrile about a borane: Table 1) with a diiminoisoindoline.<sup>50,51</sup> Although this method appears to offer greater selectivity over the mixed cyclotetramerization approach, there are a number of drawbacks. These include possible halogenation of the resulting phthalocyanine;<sup>52</sup> the need for removal of excess subphthalocyanine or isoindolinediimine by chromatography;<sup>50</sup> and the scrambling of components, leading to unwanted phthalocyanine products, due to the partial fragmentation of the subphthalocyanine.<sup>52–55</sup> Despite these problems, useful yields can be achieved for particular combinations of substituents, especially for reaction systems in which the subphthalocyanine possesses electron-withdrawing groups and the isoindolinediimine has an electron-donating substituent.<sup>56,57</sup> Polymer-supported methodology, in which the B precursor is attached to polymer substrate via an acid-labile linking group during the mixed cyclotetramerization, has also been shown to provide a selective route to AAAB-type Pcs.<sup>58</sup>

The dimeric intermediate formed from the initial stages of phthalonitrile cyclotetramerization can be used to form AABB-type Pcs (“adjacent” isomer) selectively. The required “dimer” has been prepared from the reaction of phthalonitrile, 4-nitrophthalonitrile, or 4,5-bis(3',3'-dimethyl-1'-butynyl)phthalonitrile with lithium methoxide in refluxing methanol. These intermediates react with different phthalonitriles under conventional cyclotetramerization conditions to give reasonable yields of AABB Pc, although significant quantities of the other unsymmetrical Pcs are formed.<sup>59</sup> Similarly, the mixed cyclotetramerization of an appropriate bis(phthalonitrile), or its isoindolinediimine derivative, with an excess of another phthalonitrile (or isoindolinediimine) can provide AABB-type phthalocyanines which possess a single bridging unit between two adjacent benzo units of the macrocycle.<sup>60,61</sup>

A useful route to ABAB-type (“opposite” isomer) uses the two-stage cross-condensation of 1,3,3-trichloroisoindoline and isoindolinediimine.<sup>62,63</sup> The success of this reaction relies on the inability of 1,3,3-trichloroisoindoline to undergo self-condensation, and the greater reactivity of isoindolinediimine towards 1,3,3-trichloroisoindoline, rather than self-cyclotetramerization. Although some AAAB-type phthalocyanine has been isolated from such a cross-cyclotetramerization reaction,<sup>64</sup> the desired ABAB-type phthalocyanine is usually formed with high selectivity. The use of phthalonitrile precursors with bulky substituents in the 3,6-positions can help to improve the relative yield of ABAB-type Pcs in conventional mixed cyclotetramerization reactions.

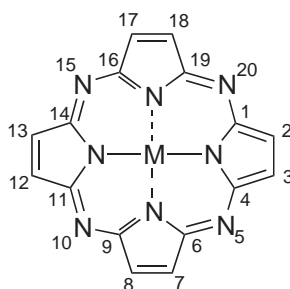
#### 1.24.6 AZAPHTHALOCYANINES

There are many examples of phthalocyanine derivatives, given the general designation azaphthalocyanines, in which one (or two) of the carbons in each benzo unit is replaced by a nitrogen. The synthesis and properties of such macrocycles has been the subject of a detailed review.<sup>65</sup> The physical properties of azaphthalocyanines differ from those of phthalocyanines. For example, they form hydrates readily, which complicates purification; and they are protonated by, and soluble in, dilute acids. In addition, the Q-band in the UV/visible absorption spectrum is blue shifted relative to that of phthalocyanine.<sup>65</sup> Importantly, the aza moiety can be quaternized to give water-soluble or amphiphilic derivatives.<sup>66</sup> Thus, the cyclotetramerization of symmetrical 2,3-dicyanopyrazines provides a route to isomerically pure 1,4,8,11,15,18,22,25-octaazaphthalocyanines.

The ease of synthesis of substituted 2,3-dicyanopyrazines has allowed the preparation of 1,4,8,11,15,18,22,15-octaazaphthalocyanines with a variety of substituents attached to each of the remaining 2,3,9,10,16,17,23,24 positions (e.g., (**1h**)). These include alkyl and alkyloxy side-chains.<sup>67,68</sup>

### 1.24.7 TETRAAZAPORPHYRINS

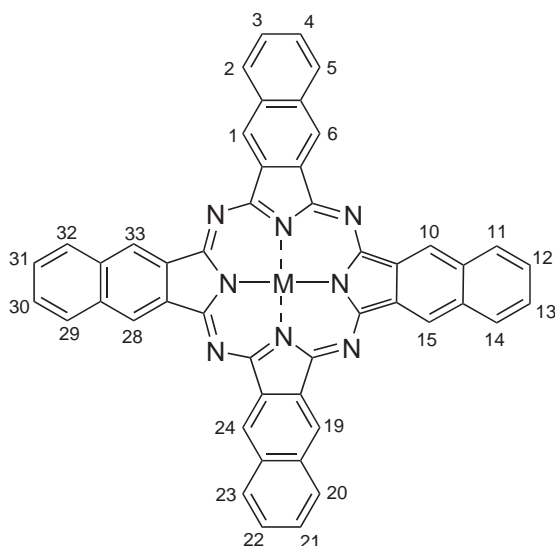
Tetraazaporphyrin (**3**) (or porphyrazine) differs from Pc only in the absence of the four benzo units. The Q-band absorption of tetraporphyrins is found at shorter wavelengths ( $\sim 600$  nm)<sup>69</sup> and they are less prone to oxidation, which is advantageous for their use in catalysis. The cyclo-tetramerization of maleonitrile by the Linstead method, usually initiated by magnesium alkoxide, is by far the most important route to tetraazaporphyrins (Table 1).<sup>70</sup> The preparation and properties of substituted maleonitriles have been reviewed.<sup>71</sup>



(3)

### 1.24.8 EXTENDED PHTHALOCYANINES

Phthalocyanines that contain four benzo units fused to the ring are termed naphthalocyanines. If the benzo units are fused to the 1,2,8,9(10,11),15,16(17,18),22,23(24,25)-positions, the parent compound is termed 1,2-naphthalocyanine; alternatively, if fused to the 2,3,8,9,16,17,23,24-positions, it is called 2,3-naphthalocyanine (**4**). The linear benzoannulation of 2,3-naphthalocyanines results in a bathochromic shift of the Q-band in the absorption spectrum of  $\sim 100$  nm as compared to phthalocyanine.<sup>36,69</sup> In addition, their enhanced ability to generate singlet oxygen makes them candidates for photodynamic therapy. Most synthetic routes to 2,3-naphthalocyanines



(4)



involve either a 2,3-dicyanonaphthalene (2,3-naphthalonitrile) or benzoisindolinediimine derivative as precursor, and the “normal” cyclotetramerization reaction conditions work well (Table 1). However, purification and characterization can be problematic, as 2,3-naphthalocyanines show an even greater tendency than phthalocyanines to aggregate in solution. For some derivatives, especially those containing  $Zn^{2+}$  ions in the central cavity, care must be taken during purification to avoid exposure to strong light, as these compounds are prone to photodegradation via singlet oxygen generation.

Other extended Pcs can be derived from the cyclotetramerization of 9,10-dicyanophenanthrene (phenanthrocyanine),<sup>72,73</sup> from 2,3-dicyanotriphenylene (2,3-triphenylenocyanine),<sup>74</sup> and from 2,3-dicyanoanthracene (2,3-anthracenocyanines).<sup>69,75</sup>

## 1.24.9 REFERENCES

1. McKeown, N. B. *Phthalocyanine Materials: Synthesis, Structure and Function* 1998, Cambridge University Press, Cambridge, UK.
2. Leznoff, C. C.; Lever, A. B. P. *Phthalocyanines: Properties and Applications* 1989, VCH, New York, Vols. 1–4.
3. Lever, A. B. P. *Adv. Inorg. Radiochem.* 1965, 27, 27–114.
4. Meller, A.; Ossko, A. *Monatsh. Chem.* 1972, 103, 150–155.
5. Geyer, M.; Plenzig, F.; Rauschnabel, J.; Hanack, M.; del Rey, B.; Sastre, A.; Torres, T. *Synthesis* 1996, 1139–1151.
6. Cuellar, E. A.; Marks, T. J. *Inorg. Chem.* 1981, 20, 3766–3770.
7. De Cian, A.; Moussavi, M.; Fischer, J.; Weiss, R. *Inorg. Chem.* 1985, 24, 3162–3167.
8. Takahashi, H.; Itoh, M.; Tomita, Y.; Nojima, K.; Kasuga, K.; Sogabe, K.; Tokii, T. *Chem. Lett.* 1993, 1915.
9. Capobianchi, A.; Ercolani, C.; Paoletti, A. M.; Pennesi, G.; Rossi, G.; Chiesi-Villa, A.; Rizzoli, C. *Inorg. Chem.* 1993, 32, 4605–4611.
10. Janczak, J.; Kubiak, R. *J. Chem. Soc., Dalton Trans.* 1994, 2539–2543.
11. Mashiko, T.; Dolphin, D. Azaporphyrins. In *Comprehensive Coordination Chemistry*; Wilkinson, G., Ed.; Pergamon, Oxford, UK, 1987; Vol. 2, Chapter 21.1.2, pp 856–871.
12. Moser, F. H.; Thomas, A. L. *The Phthalocyanines* 1983, CRC Press, Boca Raton, FL. Vols. 1–2.
13. Price, R. Metal Complexes of Azo Compounds. In *Comprehensive Coordination Chemistry*; Wilkinson, G., Ed.; Pergamon, Oxford, UK, 1987; Vol. 6, Chapter 58.2, pp 40–77.
14. McKeown, N. B. *Science of Synthesis*; Weinreb, S., Ed.; Georg Thieme Verlag: Stuttgart, Germany, 2003; Vol. 17, in press.
15. McKeown, N. B. In *The Porphyrin Handbook*; Kadish, K. M., Ed.; Academic Press, New York, 2003; Vol. 15, pp 61–124.
16. Leznoff, C. C. In *Phthalocyanines: Properties and Applications*; Leznoff, C. C. Lever, A. B. P., Eds.; VCH, New York, 1989; Vol. 1, pp 1–56.
17. Hanack, M.; Heckmann, H.; Polley, R. In *Houben Weyl: Methods in Organic Chemistry*; Hanack, M., Ed.; Georg Thieme Verlag, Stuttgart, Germany, 1997; Vol. 9, pp 717–832.
18. Barrett, P. A.; Frye, D. A.; Linstead, R. P. *J. Chem. Soc.* 1938, 1157–1165.
19. Snow, A. W.; Griffith, J. R.; Marullo, N. P. *Macromolecules* 1984, 17, 1614–1624.
20. Thompson, J. A.; Murata, K.; Miller, D. C.; Stanton, J. L.; Broderick, W. E.; Hoffman, B. M.; Ibers, J. A. *Inorg. Chem.* 1993, 32, 3546–3553.
21. Leznoff, C. C.; Hu, M. G.; Nolan, K. J. M. *Chem. Commun.* 1996, 1245–1246.
22. Leznoff, C. C.; D’Ascanio, A. M.; Yildiz, S. Z. *J. Porphyr. Phthalocyanines* 2000, 4, 103–111.
23. Tomoda, A.; Saito, S.; Ogawa, S.; Shiraiishi, S. *Chem. Lett.* 1980, 1277.
24. Brach, P. J.; Grammatica, S. J.; Ossanna, O. A.; Weinberger, L. *J. Heterocycl. Chem.* 1970, 7, 1403.
25. Mikhalenko, S. A.; Korobkova, E. V.; Luk’yanets, E. A. *Zh. Obshch. Khim.* 1970, 40, 400.
26. Weber, J. H.; Busch, D. H. *Inorg. Chem.* 1965, 4, 469.
27. Hu, M.; Brasseur, N.; Yildiz, S. Z.; van Lier, J. E.; Leznoff, C. C. *J. Med. Chem.* 1998, 41, 1789–1802.
28. Kasuga, K.; Kawashima, M.; Asano, K.; Sugimori, T.; Abe, K.; Kikkawa, T.; Fujiwara, T. *Chem. Lett.* 1996, 867–868.
29. Kasuga, K.; Asano, K.; Lin, L.; Sugimori, T.; Handa, M.; Abe, K.; Kikkawa, T.; Fujiwara, T. *Bull. Chem. Soc. Jpn.* 1997, 70, 1859–1865.
30. Hanack, M.; Meng, D. Y.; Beck, A.; Sommerauer, M.; Subramanian, L. R. *J. Chem. Soc., Chem. Commun.* 1993, 58–60.
31. Sommerauer, M.; Rager, C.; Hanack, M. *J. Am. Chem. Soc.* 1996, 118, 10085–10093.
32. Brewis, M.; Clarkson, G. J.; Humberstone, P.; Makhseed, S.; McKeown, N. B. *Chem. Eur. J.* 1998, 4, 1633–1640.
33. Mikhalenko, S. A.; Barknova, S. V.; Lebedev, O. L.; Luk’yanets, E. A. *Zh. Obshch. Khim.* 1971, 41, 2735–2739.
34. Piechocki, C.; Simon, J.; Skoulios, A.; Guillon, D.; Weber, P. *J. Am. Chem. Soc.* 1982, 104, 5245–5247.
35. Cook, M. J.; Daniel, M. F.; Harrison, K. J.; McKeown, N. B.; Thomson, A. J. *J. Chem. Soc., Chem. Commun.* 1987, 1086–1088.
36. Cook, M. J.; Dunn, A. J.; Howe, S. D.; Thomson, A. J.; Harrison, K. J. *J. Chem. Soc., Perkin Trans. 1* 1988, 2453–2458.
37. Eberhardt, W.; Hanack, M. *Synthesis* 1997, 95–98.
38. Jagerovic, N.; Alkorta, I.; Elguero, J.; Fernandez Castano, C.; Foces Foces, C.; Llamas Saiz, A. L. *New J. Chem.* 1996, 20, 1081–1086.
39. Sielcken, O. E.; van Tilborg, M. M.; Roks, M. F. M.; Hendriks, R.; Drenth, W.; Nolte, R. J. M. *J. Am. Chem. Soc.* 1987, 109, 4261–4265.
40. Ahsen, V.; Gürek, A.; Musluoglu, E.; Bekaroglu, Ö. *Chem. Ber.* 1989, 122, 1073–1074.
41. Koçak, M.; Okur, A. I.; Bekaroglu, O. *J. Chem. Soc., Dalton Trans.* 1994, 323–326.

42. Linstead, R. P.; Weiss, F. T. *J. Chem. Soc.* **1950**, 2975.
43. Jackson, A. H. In *The Porphyrins*; Dolphin, D., Ed.; Academic Press: New York, 1977; Vol. 1, pp 374–388.
44. Hedayatullah, M. *Compt. Rend. Acad. Sci. Ser. II C* **1983**, 296, 621–623.
45. van der Pol, J. F.; Neeleman, E.; van Miltenburg, J. C.; Zwikker, J. W.; Nolte, R. J. M.; Drenth, W. *Macromolecules* **1990**, 23, 155–162.
46. Leznoff, C. C.; Vigh, S.; Svirskaya, P. I.; Greenberg, S.; Drew, D. M.; Ben-Hur, E.; Rosenthal, I. *Photochem. Photobiol.* **1989**, 49, 279–284.
47. McKeown, N. B.; Chambrier, I.; Cook, M. J. *J. Chem. Soc., Perkin Trans. 1* **1990**, 1169–1177.
48. Clarkson, G. J.; McKeown, N. B.; Treacher, K. E. *J. Chem. Soc., Perkin Trans. 1* **1995**, 1817–1823.
49. Clarkson, G. J.; Cook, A.; McKeown, N. B.; Treacher, K. E.; Ali-Adib, Z. *Macromolecules* **1996**, 29, 913–917.
50. Kobayashi, N.; Kondo, R.; Nakajima, S.; Osa, T. *J. Am. Chem. Soc.* **1990**, 112, 9640–9641.
51. Dabak, S.; Gül, A.; Bekaroglu, Ö. *Chem. Ber.* **1994**, 127, 2009–2012.
52. Weitemeyer, A.; Kliesch, H.; Wöhrle, D. *J. Org. Chem.* **1995**, 60, 4900–4904.
53. de la Torre, G.; Claessens, C. G.; Torres, T. *Eur. J. Org. Chem.* **2000**, 2821–2830.
54. Sastre, A.; Torres, T.; Hanack, M. *Tetrahedron Lett.* **1995**, 36, 8501–8504.
55. Sastre, A.; del Rey, B.; Torres, T. *J. Org. Chem.* **1996**, 61, 8591–8597.
56. Kudrevich, S.; Brasseur, N.; LaMadeleine, C.; Gilbert, S.; van Lier, J. E. *J. Med. Chem.* **1997**, 40, 3897–3904.
57. Kudrevich, S. V.; Gilbert, S.; van Lier, J. E. *J. Org. Chem.* **1996**, 61, 5706–5707.
58. Leznoff, C. C.; Hall, T. W. *Tetrahedron Lett.* **1982**, 23, 3023–3026.
59. Nolan, K. J. M.; Hu, M.; Leznoff, C. C. *Synlett* **1997**, 593–594.
60. Miwa, H.; Kobayashi, N. *Chem. Lett.* **1999**, 1303–1304.
61. Kobayashi, N. *Chem. Commun.* **1998**, 487–488.
62. Idelson, E. M. US Patent 4061654 (1977) *Chem. Abstr.*, (1978) **88**, 171797.
63. Young, J. G.; Onyebuagu, W. *J. Org. Chem.* **1990**, 55, 2155–2159.
64. Stihler, P.; Hauschel, B.; Hanack, M. *Chem. Ber.* **1997**, 130, 801–806.
65. Kudrevich, S. V.; van Lier, J. E. *Coord. Chem. Rev.* **1996**, 156, 163–182.
66. Palacin, S.; Lesieur, P.; Stefanelli, I.; Barraud, A. *Thin Solid Films* **1988**, 159, 83–90.
67. Ohta, K.; Watanabe, T.; Hasebe, H.; Morizumi, Y.; Fujimoto, T.; Yamamoto, I.; Lelievre, D.; Simon, J. *Mol. Cryst. Liq. Cryst.* **1991**, 196, 13–26.
68. Mørkved, E. H.; Kjosén, H.; Ossletten, H.; Erchak, N. *J. Porphyr. Phthalocyanines* **1999**, 3, 417–423.
69. Kobayashi, N.; Nakajima, S.; Osa, T. *Inorg. Chim. Acta* **1993**, 210, 131–133.
70. Doppelt, P.; Huille, S. *New J. Chem.* **1990**, 14, 607–609.
71. Kopranenkov, V. N.; Lukyanets, E. A. *Russ. Chem. Bull.* **1995**, 44, 2216–2232.
72. Snow, A. W.; Price, T. R. *Synth. Met.* **1984**, 9, 329–340.
73. Hanack, M.; Renz, G. *Chem. Ber.* **1990**, 123, 1105.
74. Mikhalenko, S. A.; Yagodina, L. A.; Luk'yanets, E. A. *Zh. Obshch. Khim.* **1976**, 46, 1598.
75. Kopranenkov, V. N.; Luk'yanets, E. A. *Zh. Obshch. Khim.* **1971**, 41, 2341.
76. Engel, M. K.; Bassoul, P.; Bosio, L.; Lehmann, H.; Hanack, M.; Simon, J. *Liq. Cryst.* **1993**, 15, 709–722.
77. Cammidge, A. N.; Chambrier, I.; Cook, M. J.; Garland, A. D.; Heeney, M. J.; Welford, K. *J. Porphyr. Phthalocyanines* **1997**, 1, 77–86.



# 1.25

## Metal Aqua Ions

S. F. LINCOLN

*University of Adelaide, Australia*

D. T. RICHENS

*University of St. Andrews, UK*

and

A. G. SYKES

*University of Newcastle upon Tyne, UK*

---

1.25.1	INTRODUCTION	516
1.25.1.1	Representative Nature of Aqua Ions	516
1.25.1.2	Geometry of Aqua Ligands	516
1.25.2	SURVEY OF GROUPS IN THE PERIODIC TABLE	517
1.25.2.1	Group 1: $\text{Li}^+(\text{aq})$ , $\text{Na}^+(\text{aq})$ , $\text{K}^+(\text{aq})$ , $\text{Rb}^+(\text{aq})$ , $\text{Cs}^+(\text{aq})$	517
1.25.2.2	Group 2: $\text{Be}^{2+}(\text{aq})$ , $\text{Mg}^{2+}(\text{aq})$ , $\text{Ca}^{2+}(\text{aq})$ , $\text{Sr}^{2+}(\text{aq})$ , $\text{Ba}^{2+}(\text{aq})$ , $\text{Ra}^{2+}(\text{aq})$	518
1.25.2.3	Group 3: Scandium, Yttrium, the Lanthanides, and Actinides	518
1.25.2.4	Group 4: Titanium, Zirconium, and Hafnium	520
1.25.2.5	Group 5: Vanadium, Niobium, and Tantalum	522
1.25.2.6	Group 6: Chromium, Molybdenum, and Tungsten	524
1.25.2.7	Group 7: Manganese, Technetium, and Rhenium	527
1.25.2.8	Group 8: Iron, Ruthenium, and Osmium	529
1.25.2.9	Group 9: Cobalt, Rhodium, and Iridium	530
1.25.2.10	Group 10: Nickel, Palladium, and Platinum	533
1.25.2.11	Group 11: Copper, Silver, and Gold	533
1.25.2.12	Group 12: Zinc, Cadmium, and Mercury	534
1.25.2.13	Group 13: Boron, Aluminum, Gallium, Indium, and Thallium	535
1.25.2.14	Group 14: Germanium, Tin, and Lead	536
1.25.2.15	Group 15: Arsenic, Antimony, and Bismuth	537
1.25.2.16	Group 16: Sulfur, Selenium, and Tellurium	537
1.25.3	LIGAND SUBSTITUTION REACTIONS	537
1.25.3.1	Range of Labilities of Aqua Metal Ions	537
1.25.3.2	Formation of Metal Complexes	539
1.25.3.3	Classification of Mechanisms	540
1.25.3.4	Volume of Activation	541
1.25.4	SUBSTITUTION OF MAIN GROUP METAL IONS	543
1.25.4.1	Group 1 $\text{Li}^+$ , $\text{Na}^+$ , $\text{K}^+$ , $\text{Rb}^+$ , $\text{Cs}^+$	543
1.25.4.2	Group 2: $\text{Be}^{2+}$ , $\text{Mg}^{2+}$	543
1.25.4.3	Group 3: $\text{Al}^{3+}$ , $\text{Ga}^{3+}$ , $\text{In}^{3+}$	544
1.25.5	SUBSTITUTION OF TRANSITION METAL AQUA IONS	544
1.25.5.1	Six-coordination Divalent Transition Metal Aqua Ions	544
1.25.5.2	Six-coordinate Trivalent Transition Metal Aqua Ions	547
1.25.5.3	Divalent Square-Planar Transition Metal Ions	548
1.25.5.4	Transition Metal Oxo/Aqua Ions	548
1.25.6	SUBSTITUTION OF LANTHANIDE METAL IONS	549
1.25.6.1	Trivalent Lanthanide Metal Ions	549
1.25.6.2	Divalent Lanthanide Metal Aqua Ions	551
1.25.7	REFERENCES	551

---

### 1.25.1 INTRODUCTION

The chemistry of aqua metal ions has received attention recently as a self-contained subject,<sup>1</sup> which provides literature coverage up to 1996, and highlights both preparative and reactivity studies. This follows earlier works by Burgess,<sup>2</sup> and Baes and Mesmer.<sup>3</sup> The latter provides an excellent cover of thermodynamic aspects including acid dissociation constants, which are known to increase with ionic strength,<sup>1</sup> see, e.g.,  $\text{Fe}^{3+}(\text{aq})$  section. Other relevant reviews have appeared.<sup>4-7</sup> The chapter draws attention to recent developments in the area, with its potential for carrying out environmentally clean chemistry.

#### 1.25.1.1 Representative Nature of Aqua Ions

Aqua ions are prototypes illustrating the solution properties of complexes in a particular oxidation state. The properties displayed generally reflect size, charge, and effects such as crystal field splitting, as well as the tendency to form polynuclear oxo/hydroxo-bridged species, and metal-metal bonded species. Residence times of water ligands on aqua ions across the periodic table cover a remarkable 20 orders of magnitude from the most labile (<1 ns) to the most inert (>300 years), which is an important feature to understand.

Coordination number six is very common. It possesses high symmetry and the arrangement is appropriate in balancing the size of the available cavity (radius of  $\text{M}^{n+}$ ) and that of the adjacent water ligands, while providing an appropriate  $\text{M}-\text{OH}_2$  distance to facilitate good bonding. Other coordination geometries are tetrahedral ( $\text{Li}^+$ ,  $\text{Be}^{2+}$ ,  $\text{Ag}^+$ ), square-planar ( $\text{Pd}^{2+}$ ,  $\text{Pt}^{2+}$ ) coordination number five ( $\text{Cu}^{2+}$ ), seven ( $\text{Sc}^{3+}$ ,  $\text{Eu}^{2+}$ ), eight ( $\text{Ca}^{2+}$ ,  $\text{Sr}^{2+}$ ,  $\text{Ba}^{2+}$ , heavier  $\text{Ln}^{3+}$ ), and nine ( $\text{Bi}^{3+}$ , lighter  $\text{Ln}^{3+}$ ). Mononuclear ions are not as common for the second and third transition series. For example,  $[\text{Ru}(\text{H}_2\text{O})_6]^{2+}$  is the only II state hexaaqua ion, and III state hexaaqua ions are known only for Mo, Ru, Rh, and Ir. The absence of mononuclear aqua species for Zr, Hf, Nb, Ta, Tc, and Re reflects a preference in the higher oxidation states for oxo-bridged oligomers or oxo (hydroxo) anions. Thus, the simplest  $\text{Zr}^{4+}(\text{aq})$  species is a hydroxo-bridged tetramer,  $[\text{Zr}_4(\mu\text{-OH})_8(\text{H}_2\text{O})_{16}]^{8+}$  (see Section 1.25.2.4), while  $\text{Nb}^{\text{V}}(\text{aq})$  and  $\text{Ta}^{\text{V}}(\text{aq})$  form hydrated pentoxides even in strong acid (Section 1.25.2.5). The lower oxidation states are more reducing and there is a greater tendency towards metal-metal bond formation promoted largely by the more effective  $d-d$  overlap of spatially extended  $4d$  and  $5d$  orbitals. For example,  $\text{Mo}^{2+}$  and  $\text{Rh}^{2+}$  exist as  $\text{M}-\text{M}$  bonded  $[\text{Mo}_2(\text{H}_2\text{O})_8]^{4+}$  and  $[\text{Rh}_2(\text{H}_2\text{O})_{10}]^{4+}$  species respectively, contrasting with the mononuclear aqua ions of  $\text{Cr}^{2+}$  and  $\text{Co}^{2+}$ . In some cases  $\text{M}-\text{M}$  bonding can extend to the  $\text{M}^{\text{IV}}$ ,  $\text{M}^{\text{V}}$ , and even  $\text{M}^{\text{VI}}$  states. Thus, air-free  $\text{Mo}^{\text{IV}}(\text{aq})$ , as trinuclear  $\text{M}-\text{M}$  bonded  $[\text{Mo}_3(\mu_3\text{-O})(\mu\text{-O})_3(\text{H}_2\text{O})_9]^{4+}$ , is stable, whereas  $\text{Cr}^{\text{IV}}(\text{aq})$  as  $[\text{CrO}(\text{H}_2\text{O})_5]^{2+}$  has only a short half-life ( $t_{1/2} \sim 0.5$  min) at  $25^\circ\text{C}$ .

#### 1.25.1.2 Geometry of Aqua Ligands

The structures of crystalline hydrates and of concentrated aqueous solutions have been investigated using neutron scattering.<sup>4,7</sup> The first investigations centered on solutions of  $\text{NiCl}_2$  in  $\text{D}_2\text{O}$ . Independent measurement of the  $\text{M}-\text{O}$  and  $\text{M}-\text{D}$  distances led to detection of a tilt angle ( $\theta = 42^\circ$ ) at the oxygen, as in Figure 1. Since  $\theta$  becomes zero at  $[\text{NiCl}_2] < 0.1$  M it was concluded that differences in the extent of hydrogen bonding with bulk water and hydration around the  $\text{Cl}^-$  are important as salt concentrations are varied.

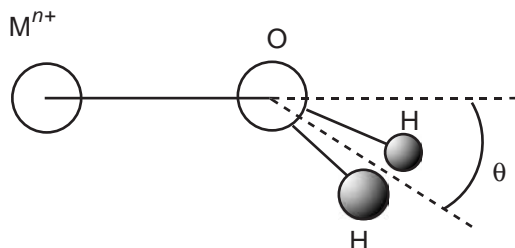
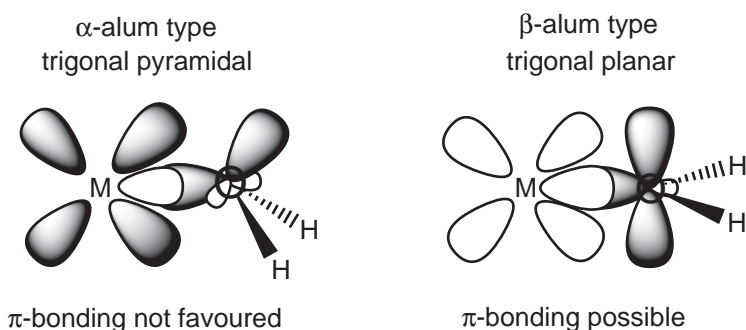
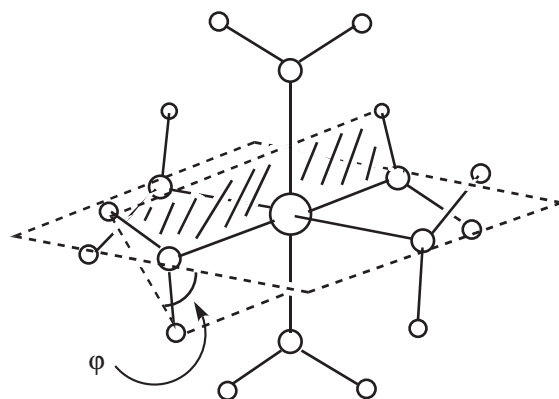


Figure 1 Definition of tilt angle of  $\text{H}_2\text{O}$  ligand to metal ion  $\text{M}^{n+}$ .<sup>4</sup>



**Figure 2** Stereochemistry of M—OH<sub>2</sub> interactions in two alum types.<sup>9</sup>



**Figure 3** Definition of the twist angle  $\phi$  for a hexaaqua metal ion, with a  $\beta$ -alum structure.<sup>8</sup>

For M<sup>III</sup> state ions of cesium alums, Cs[M<sup>III</sup>(H<sub>2</sub>O)<sub>6</sub>]·6H<sub>2</sub>O<sup>5,8</sup> neutron diffraction studies have allowed correlations with the electronic structure of M<sup>III</sup> to be made. In the  $\alpha$  alums ( $\theta > 0$ ) a pyramidal oxygen is present, whereas in the  $\beta$  forms ( $\theta = 0$ ) the oxygen is planar. Interestingly, the  $\alpha$  modification is preferred by low spin  $t_{2g}^6$  alums of the group 6 metals, Co, Rh, and Ir (no  $O p_{\pi}$ – $M d_{\pi}$  overlap possible). All other cesium alums (M = Al, Ga, In, Ti, V, Cr, Mo, Mn, Fe, and Ru) exist in the  $\beta$  form with extensive hydrogen bonding to the secondary shell waters (Figure 2). UV–vis spectra for the ammonium vanadium alum have confirmed  $\pi$  bonding in the plane perpendicular to the water ligand plane.<sup>9</sup> Thus, the preference for pyramidal oxygen coordination within the group 6 trivalent metal aqua ions relates to the electron population. Also, [Rh(H<sub>2</sub>O)<sub>6</sub>]<sup>3+</sup> has a lower acidity  $pK_a \sim 4$  ( $\alpha$  alum), than, for example, [Ru(H<sub>2</sub>O)<sub>6</sub>]<sup>3+</sup>,  $pK_a$  2.7 ( $\beta$  alum). However, this does not explain why the group 13 alums, (M = Al, Ga, and In) with unavailable  $t_{2g}$  orbitals should adopt the  $\beta$  structure. A further parameter within  $\beta$  alums is the twist angle  $\phi$  (Figure 3). Studies on the Mo and Ru alums show that the M—OH<sub>2</sub> distance is sensitive to the twist angle,  $\phi$ , reflecting greater covalence of the  $4d(t_{2g})$  orbitals.<sup>8</sup>

## 1.25.2 SURVEY OF GROUPS IN THE PERIODIC TABLE

### 1.25.2.1 Group 1: Li<sup>+</sup> (aq), Na<sup>+</sup> (aq), K<sup>+</sup> (aq), Rb<sup>+</sup> (aq), Cs<sup>+</sup> (aq)

In this group there is a variability in coordination numbers brought about by the rapidity of exchanges of solvent H<sub>2</sub>O between inner and outer spheres, giving a range of different M—O distances. Coordination numbers are sensitive to extraneous factors, e.g., anions present, in a way not observed elsewhere in the periodic table.

(a) *Li<sup>+</sup> (aq)*. The coordination number of Li<sup>+</sup> is variable, ranging between three and six (Li—O, 195–228 pm). This is dependent on H<sub>2</sub>O/salt ratios.<sup>10</sup> Neutron scattering measurements indicate a coordination number six at the dilute limit, and below four at higher concentrations. Measurements on <3.0 M LiClO<sub>4</sub> have been interpreted in terms of [Li(H<sub>2</sub>O)<sub>6</sub>]<sup>+</sup>,<sup>4</sup> as have MD

simulations on 2.2 M solutions of LiI. Anion hydration is relevant, and the larger less-well solvated  $\text{I}^-$  and  $\text{ClO}_4^-$  give higher coordination numbers than corresponding solutions of LiCl or LiBr.<sup>11</sup> *Ab initio* calculations aimed at modeling the symmetric ( $255\text{ cm}^{-1}$ )  $\text{Li}-\text{OH}_2$  Raman vibration from concentrated solutions indicate a structure in which a secondary shell of four water molecules is associated with  $[\text{Li}(\text{H}_2\text{O})_4]^+$ .<sup>12</sup>

(b)  $\text{Na}^+(\text{aq})$ . Coordination of  $\text{Na}^+$  is believed to be in the 4–8 range ( $\text{Na}-\text{O}$ , 240–250 pm) with evidence for 6 from X-ray diffraction data.<sup>13</sup> Glauber's salt  $\text{Na}_2\text{SO}_4 \cdot 10\text{H}_2\text{O}$  ( $\text{Na}-\text{O}$ , 243 pm), the isomorphous series  $\text{Na}_2[\text{MO}_4] \cdot 10\text{H}_2\text{O}$  ( $\text{M} = \text{Se}, \text{Cr}, \text{Mo}, \text{and W}$ ), borax  $\text{Na}_2[\text{B}_4\text{O}_7] \cdot 10\text{H}_2\text{O}$  ( $\text{Na}-\text{O}$ , 242 pm) all indicate  $[\text{Na}(\text{H}_2\text{O})_6]^+$ . Six coordination is also acceptable from computer simulations, and there have been attempts at fully optimizing the geometry of  $[\text{Na}(\text{H}_2\text{O})_6]^+$ .<sup>14</sup>

(c)  $\text{K}^+(\text{aq})$ . Larger coordination numbers  $>6$  are relevant in this case.<sup>15</sup> Square-antiprismatic  $[\text{K}(\text{H}_2\text{O})_8]^+$  is present in  $\text{CaK}[\text{AsO}_4] \cdot 8\text{H}_2\text{O}$ . Solution measurements are more difficult because the  $\text{K}-\text{OH}_2$  distance is comparable to  $\text{H}_2\text{O}-\text{H}_2\text{O}$  and knowledge of the water structure is required. Computer simulations have suggested coordination numbers in the range 6.3–7.8 ( $\text{K}-\text{O}$ , 265–286 pm).

(d)  $\text{Rb}^+(\text{aq})$  and  $\text{Cs}^+(\text{aq})$ . No XRD studies have been carried out. In the  $\text{Rb}^+$  case, fluorescence occurs on irradiation with an Mo X-ray source. Coordination numbers for  $\text{Cs}^+$  are quoted as between six and eight ( $\text{Cs}-\text{O}$ , 295–321 pm). Computer simulations give values of between 5.3 and 8.2 ( $\text{Cs}-\text{O}$ , 303–320 pm).

### 1.25.2.2 Group 2: $\text{Be}^{2+}(\text{aq})$ , $\text{Mg}^{2+}(\text{aq})$ , $\text{Ca}^{2+}(\text{aq})$ , $\text{Sr}^{2+}(\text{aq})$ , $\text{Ba}^{2+}(\text{aq})$ , $\text{Ra}^{2+}(\text{aq})$

(a)  $\text{Be}^{2+}(\text{aq})$ . The small  $\text{Be}^{2+}$  is tetrahedrally coordinated, and discrete  $[\text{Be}(\text{H}_2\text{O})_4]^{2+}$  ions are present in hydrates such as  $\text{BeX}_2 \cdot 4\text{H}_2\text{O}$  ( $\text{X} = \text{IO}_3^-, \text{IO}_4^-$ ).<sup>16</sup> On dissolving the pure metal or oxide in acid,  $[\text{Be}(\text{H}_2\text{O})_4]^{2+}$  is obtained.<sup>17</sup> The structure of  $\text{BeSO}_4 \cdot 4\text{H}_2\text{O}$  has been determined by neutron diffraction.<sup>18</sup> Variations in  $\text{Be}-\text{OH}_2$  (161–175 pm) have been observed. The value from solution XRD is 169 pm. The acid dissociation constant for  $[\text{Be}(\text{H}_2\text{O})_4]^{2+}$  ( $\text{p}K_a$  5.7;  $\text{I} = 0.1\text{ M}$   $\text{ClO}_4^-$ ) is unusually small. Other products:  $\text{Be}(\text{OH})_2(\text{aq})$ ,  $\text{Be}_2(\text{OH})^{3+}(\text{aq})$ , and “cyclic”  $\text{Be}_3(\text{OH})_3^{3+}(\text{aq})$  have been identified.

(b)  $\text{Mg}^{2+}(\text{aq})$ . The larger  $\text{Mg}^{2+}$  ion exists as  $[\text{Mg}(\text{H}_2\text{O})_6]^{2+}$  in solution and in  $>30$  X-ray structures, *ab initio* and density functional theory (DFT) calculations, Raman measurements and MD simulations have been reported.<sup>19</sup> The  $\text{Mg}-\text{O}$  bonds (200–215 pm) are less covalent than those in  $[\text{Be}(\text{H}_2\text{O})_4]^{2+}$ , giving the weaker hydrogen bonding between the first and second hydration shells and a much larger  $\text{p}K_a$  (11.44;  $\text{I} = 0.1\text{ M}$ ). The formation of tetrameric  $\text{Mg}_4(\text{OH})_4^{4+}(\text{aq})$  is characteristic of solutions of  $\text{Mg}^{2+}(\text{aq}) \geq 1.0\text{ M}$ .

(c)  $\text{Ca}^{2+}(\text{aq})$ . The coordination number of  $\text{Ca}^{2+}(\text{aq})$  is concentration dependant, and is generally  $\geq 6$  ( $\text{Ca}-\text{O}$ , 233–241 pm). EXAFS- and LAXS-based MD simulations support 8 coordinations in solution ( $\text{Ca}-\text{O}$ , = 246 pm),<sup>20</sup> although the situation is less clear from DFT calculations. Square-antiprismatic/dodecahedral  $[\text{Ca}(\text{H}_2\text{O})_8]^{2+}$  units are present in  $\text{CaK}[\text{AsO}_4] \cdot 8\text{H}_2\text{O}$  and  $2\text{CaCl}_2 \cdot 11\text{HgCl}_2 \cdot 16\text{H}_2\text{O}$ . In  $\text{CaX}_2 \cdot 6\text{H}_2\text{O}$  ( $\text{X} = \text{Cl}, \text{Br}$ ) the  $\text{Ca}^{2+}$  is coordinated by six water and three halide ions.

(d)  $\text{Sr}^{2+}(\text{aq})$  and  $\text{Ba}^{2+}(\text{aq})$ . XRD studies have been carried out on  $[\text{Sr}(\text{H}_2\text{O})_8](\text{OH})_2$  ( $\text{Sr}-\text{O}$ , 262 pm), and  $[\text{Ba}(\text{H}_2\text{O})_8](\text{OH})_2$ : ( $\text{Ba}-\text{O}$ , 279 pm).<sup>21</sup> The  $[\text{Sr}(\text{H}_2\text{O})_8]^{2+}$  and  $[\text{Ba}(\text{H}_2\text{O})_8]^{2+}$  ions are distorted square-antiprismatic. The coordination of  $\text{Sr}^{2+}(\text{aq})$  and  $\text{Ba}^{2+}(\text{aq})$  in solution using LAXS and EXAFS methods provide independent evidence for a primary coordination of 8 ( $\text{Sr}-\text{O}$ , 263 pm;  $\text{Ba}-\text{O}$ , 281 pm). Using an improved theoretical approach, a first shell coordination number of 8.0 ( $\text{Sr}-\text{O}$ , 260 pm) has been obtained.<sup>22</sup> The second coordination sphere is diffuse with 15–16  $\text{H}_2\text{O}/\text{OH}^-$  at similar distances. Enthalpies of hydration for  $\text{Mg}^{2+}(\text{aq})$ ,  $\text{Ca}^{2+}(\text{aq})$ ,  $\text{Sr}^{2+}(\text{aq})$ , and  $\text{Ba}^{2+}(\text{aq})$  correlate well with the reciprocal  $\text{M}-\text{OH}_2$  distances, and support largely ionic  $\text{M}-\text{OH}_2$  bonding. Significantly,  $\text{Be}^{2+}$  lies well off the line consistent with covalent  $\text{Be}-\text{OH}_2$ .

### 1.25.2.3 Group 3: Scandium, Yttrium, the Lanthanides, and Actinides

These elements are considered together because of certain similarities. Thus, all the elements are highly electropositive and form stable trivalent aqua ions in solution.

(a)  $\text{Sc}^{3+}(\text{aq})$ . Solutions of  $\text{Sc}^{3+}(\text{aq})$  are obtained on dissolving  $\text{Sc}^{\text{III}}$  salts or  $\text{Sc}_2\text{O}_3$  in non-complexing acids. However, much debate still surrounds the coordination number in solution.<sup>23</sup> The structure of dinuclear  $[(\text{H}_2\text{O})_5\text{Sc}(\mu\text{-OH})_2\text{Sc}(\text{H}_2\text{O})_5](\text{C}_6\text{H}_5\text{SO}_3)_4 \cdot 4\text{H}_2\text{O}$  (Figure 4) obtained by evaporation of solutions of  $\text{Sc}_2\text{O}_3$  in 6.0 M HCl and subsequent crystallization from aqueous benzenesulfonic acid, and of the chloride salts,  $[(\text{H}_2\text{O})_5\text{Sc}(\mu\text{-OH})_2\text{Sc}(\text{H}_2\text{O})_5]\text{Cl}_4 \cdot 4\text{H}_2\text{O}$  and  $\text{ScCl}_3 \cdot 7\text{H}_2\text{O}$  indicate hepta-coordination.<sup>24</sup> The average Sc—O distance over all seven bonds ( $\sim 216$  pm) compares well with those for monomeric  $\text{Sc}^{3+}(\text{aq})$  for which distorted pentagonal–bipyramidal coordination has been proposed (Sc—O axial, 209 pm; Sc—O equatorial, 216–221 pm). Hepta-coordination is also suggested from variable-temperature XRD studies on  $\text{Sc}(\text{ClO}_4)_3$  and  $\text{ScCl}_3$  in  $\text{H}_2\text{O}$  (Sc—O, 215 pm), and is consistent with EXAFS and Raman investigations.<sup>25</sup>

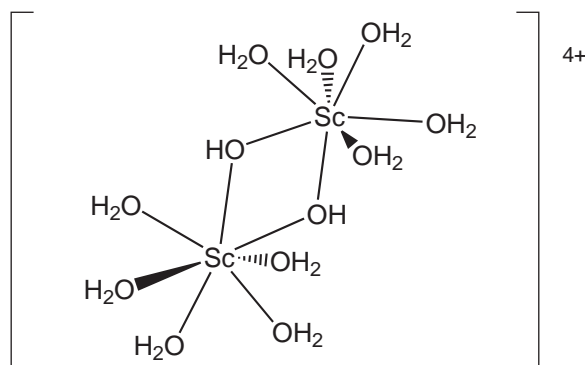
Anion effects can be important in the solid state. Thus, tri-capped trigonal prismatic  $[\text{Sc}(\text{H}_2\text{O})_9]^{3+}$  is found in the X-ray structure of the  $\text{CF}_3\text{SO}_3^-$  salt. In  $\text{Sc}(\text{pts})_3 \cdot 6\text{H}_2\text{O}$ , four waters and two pts<sup>−</sup> (toluene-4-sulfonate) anions are coordinated, and six coordination appears to be adopted in chloro-aqua complexes. Clearly, coordination numbers of 6–9 can be adopted with little trouble. Acid dissociation gives  $\text{ScOH}^{2+}(\text{aq})$  ( $\text{p}K_{\text{a}}$  4.8;  $I = 0.1 \text{ M ClO}_4^-$ ).

(b)  $\text{Y}^{3+}(\text{aq})$  and the Lanthanide  $\text{Ln}^{3+}(\text{aq})$  Ions. Trivalent aqua ions are readily obtained by dissolving the oxides in non-complexing acids. As with  $\text{Sc}^{3+}$ , coordination numbers across the series are influenced by anions. For example, crystal structures of the hydrated bromate and ethylsulfate salts of  $\text{M} = \text{Pr}, \text{Nd}, \text{Ho},$  and  $\text{Yb}$  show nine coordinated  $\text{Ln}^{3+}(\text{aq})$  ions in a tricapped trigonal–prismatic arrangement. In  $\text{La}_2(\text{SO}_4)_3 \cdot 9\text{H}_2\text{O}$ , the  $\text{La}^{3+}$  ion has tricapped trigonal–prismatic coordination to six waters and three sulfates, while in the isomorphous pts<sup>−</sup> salts,  $\text{M}(\text{pts})_3 \cdot 9\text{H}_2\text{O}$  ( $\text{M} = \text{Y}, \text{Sm}, \text{Gd}, \text{Dy}, \text{Ho}, \text{Er},$  and  $\text{Yb}$ ) the  $\text{M}^{3+}$  ions have square antiprismatic coordination to six waters and two pts<sup>−</sup> anions. Current evidence is for a change in coordination number from nine to eight at around Sm to Gd (the so-called “gadolinium break”) on the basis of water-exchange activation volumes, Raman, XRD, neutron diffraction. EXAFS and LAXS measurements have been followed by MD simulations.<sup>26</sup> Eight-coordination around  $\text{Y}^{3+}$  has been confirmed ( $\text{Y—O}$ , 237 pm) in recent EXAFS and LAXS studies.<sup>27</sup>

UV–vis  $f$ – $f$  transitions can also give some information on coordination numbers. Thus,  $\text{Nd}^{3+}(\text{aq})$  is present as  $[\text{Nd}(\text{H}_2\text{O})_9]^{3+}$  from spectra of hydrated bromate, chloride, and sulfate salts. Spectra of  $\text{Ho}^{3+}$  and  $\text{Er}^{3+}$ , on the other hand, are largely unchanged at different HCl concentrations and on replacing 11.0 M  $\text{HClO}_4$  by 11.0 M HCl, consistent with coordination numbers of eight. These two geometries are believed to be important in water exchange studies (see Section 1.25.6).

The pattern of acid dissociation on  $\text{Y}^{3+}(\text{aq})$  and the  $\text{Ln}^{3+}(\text{aq})$  ions is similar to that of  $\text{Sc}^{3+}(\text{aq})$ . Thus, for the formation of  $\text{MOH}^{2+}(\text{aq})$ ,  $\text{p}K_{\text{a}}$  8.9 (La) to 8.0 (Lu) ( $I = 0.1 \text{ M ClO}_4^-$ ) are consistent with an increase in acidity as the charge/size ratio increases along the lanthanide series. The  $\text{Y}^{3+}(\text{aq})$  ion has  $\text{p}K_{\text{a}}$  8.2 ( $I = 0.1 \text{ M ClO}_4^-$ ) consistent with a radius similar to that of  $\text{Ho}^{3+}$  and  $\text{Er}^{3+}$ . The lanthanide trihydroxides, like  $\text{Sc}(\text{OH})_3$ , are weakly amphoteric with evidence for the formation of  $\text{Ln}(\text{OH})_4^-(\text{aq})$ .

(c)  $\text{Ce}^{\text{IV}}(\text{aq})$ . This is the most extensively studied of the IV state ions. Solutions of  $\text{Ce}^{\text{IV}}(\text{aq})$  are metastable in non-complexing  $\text{HClO}_4$ ; and decay to  $\text{Ce}^{3+}(\text{aq})$  within hours at 25 °C. A coordination number of eight seems likely from a radius of 97 pm for  $\text{Ce}^{4+}$ , as compared to 114 pm for  $\text{Ce}^{3+}$ . Eight coordination is observed for  $\text{CeO}_2$  (fluorite structure), and for dodecahedral



**Figure 4** Structure of the distorted pentagonal–bipyramidal 7-coordinate dinuclear  $\text{Sc}^{\text{III}}$  ion  $[(\text{H}_2\text{O})_5\text{Sc}(\mu\text{-OH})_2\text{Sc}(\text{H}_2\text{O})_5]^{4+}$ .<sup>24</sup>

[Ce(acac)<sub>4</sub>]. Higher coordination numbers are, however, well established (e.g., 12 in [Ce(NO<sub>3</sub>)<sub>6</sub>]<sup>2-</sup>), with a Ce—O distance (~114 pm) similar to that of Ce<sup>3+</sup>. The best source of uncomplexed Ce<sup>IV</sup>(aq) is by dissolving (NH<sub>4</sub>)<sub>2</sub>[Ce(NO<sub>3</sub>)<sub>6</sub>] in HClO<sub>4</sub>, or the use of commercial H<sub>2</sub>Ce(ClO<sub>4</sub>)<sub>6</sub>/6M HClO<sub>4</sub>, which remains unchanged over several months. Alternatively, precipitation of “Ce(OH)<sub>4</sub>” with aqueous ammonia over 48 h can be employed, and the solid re-dissolved in acid. The Ce<sup>IV</sup> ion is a useful oxidant in organic chemistry.<sup>28</sup>

Large variations in  $E^{\circ}$  (Ce<sup>IV</sup>/Ce<sup>III</sup>) are observed in different acids ranging from +1.87 V (8 M HClO<sub>4</sub>) to +1.42 V (6 M H<sub>2</sub>SO<sub>4</sub>) (vs. nhe). The first pK<sub>a</sub> has been determined as 1.1 (I = 3.0 M ClO<sub>4</sub><sup>-</sup>) and ~50% is therefore hydrolyzed in 1.0 M H<sup>+</sup>. The formation of dimeric and higher oligomeric forms has been proposed. The Pr<sup>IV</sup> and Tb<sup>IV</sup> oxidation states have also been obtained under alkaline conditions.

Divalent Ln<sup>2+</sup>(aq) ions are strong reductants with reduction potentials  $E^{\circ}$  vs. nhe for Ln<sup>III</sup>/Ln<sup>II</sup> couples of -0.35 V (Eu), -1.1 V (Yb), and -1.5 V (Sm). Solutions of Eu<sup>2+</sup> are generated by Zn/Hg reduction of Eu<sup>3+</sup>(aq) under acidic conditions. Alternatively, freshly precipitated EuCO<sub>3</sub> or Eu(OH)<sub>2</sub>(aq) can be used. The more highly reducing Yb<sup>2+</sup>(aq) and Sm<sup>2+</sup>(aq) ions can be prepared using alkali metal amalgam or by electrolytic reduction. Pulse radiolysis procedures in which the strongly reducing formate radical CO<sub>2</sub><sup>-</sup> (-1.9 V) is generated have also been used. Solutions of Eu<sup>2+</sup>(aq) (yellow-green) are stable in the absence of O<sub>2</sub> for more than ten days. The green Yb<sup>2+</sup>(aq) and red Sm<sup>2+</sup>(aq) are less stable and decay to the III state within hours. In studies on Yb<sup>2+</sup>(aq), prepared by reduction at a mercury cathode, the half-life was in the range 0.5–2.5 h in HClO<sub>4</sub>–LiClO<sub>4</sub>, [H<sup>+</sup>] = 0.01–0.9 M. Electrolytically generated Sm<sup>2+</sup>(aq) decays with a half-life of <1 h. Solutions of Tm<sup>2+</sup>(aq), Er<sup>2+</sup>(aq), and Gd<sup>2+</sup>(aq) ( $t_{1/2}$  < 1 min) have also been generated using pulse radiolysis, and Ho<sup>2+</sup>(aq) has been reported to persist  $t_{1/2}$  ~ 1 h following  $\gamma$  irradiation of Ho<sub>2</sub>O<sub>3</sub>.

Coordination numbers for the Ln<sup>2+</sup>(aq) ions have been addressed in the Eu<sup>2+</sup>(aq) case. Whereas Eu<sup>3+</sup> occurs as an equilibrium between [Eu(H<sub>2</sub>O)<sub>8</sub>]<sup>3+</sup> and [Eu(H<sub>2</sub>O)<sub>9</sub>]<sup>3+</sup>, Eu<sup>2+</sup> occurs as an equilibrium between [Eu(H<sub>2</sub>O)<sub>7</sub>]<sup>2+</sup> and [Eu(H<sub>2</sub>O)<sub>8</sub>]<sup>2+</sup>. A recent EXAFS investigation supports seven coordination of Eu<sup>2+</sup>(aq).<sup>22</sup>

(d) *Actinide aqua ions.* The actinide oxides readily dissolve in mineral acids to generate solutions of aqua ions. The 5*f*, 6*d*, 7*s*, and 7*p* orbitals have similar energies, and for elements up to americium greater variations in oxidation state are observed as compared to the lanthanides. Thus, the cations of four actinide oxidation states *trans*-An(O)<sub>2</sub><sup>2+</sup>(aq), *trans*-An(O)<sub>2</sub><sup>+</sup>(aq), An<sup>4+</sup>(aq), and An<sup>3+</sup>(aq) are well known. For uranium the most stable form is *trans*-U(O)<sub>2</sub><sup>2+</sup>(aq), whereas for americium it is Am<sup>3+</sup>(aq). The coordination numbers are not always well established, however. EXAFS measurements are consistent with coordination numbers 9–11 for Th<sup>4+</sup>, U<sup>4+</sup>, and Np<sup>4+</sup>.<sup>29</sup> For Th<sup>4+</sup> these findings agree with earlier <sup>1</sup>H NMR measurements. The Ac<sup>4+</sup>—O distances are in the range 240–242 pm.<sup>30</sup> No X-ray structure exists for mononuclear *trans*-U(O)<sub>2</sub><sup>2+</sup>(aq), although the *trans*-[U(O)<sub>2</sub>(H<sub>2</sub>O)<sub>5</sub>]<sup>2+</sup> structure is supported by EXAFS measurements. Acid dissociation of *trans*-[U(O)<sub>2</sub>(H<sub>2</sub>O)<sub>5</sub>]<sup>2+</sup> (pK<sub>a</sub> 5.8; I → 0) gives *trans*-[U(O)<sub>2</sub>(H<sub>2</sub>O)<sub>4</sub>(OH)]<sup>+</sup>. There is a strong tendency for *trans*-U(O)<sub>2</sub>(OH)<sup>+</sup>(aq) to dimerize to *trans*-[(UO<sub>2</sub>)<sub>2</sub>( $\mu$ -OH)<sub>2</sub>(H<sub>2</sub>O)<sub>6</sub>]<sup>2+</sup>(aq) (Figure 5). The U<sup>4+</sup>(aq) ion is estimated to have a pK<sub>a</sub> of 0.7 (I → 0).

#### 1.25.2.4 Group 4: Titanium, Zirconium, and Hafnium

(a) *Ti<sup>2+</sup>(aq).* This state persists for short times in ice-cold hydrochloric acid solutions of TiO but remains little studied. Pulse radiolysis generation of the formate radical CO<sub>2</sub><sup>-</sup> and reduction

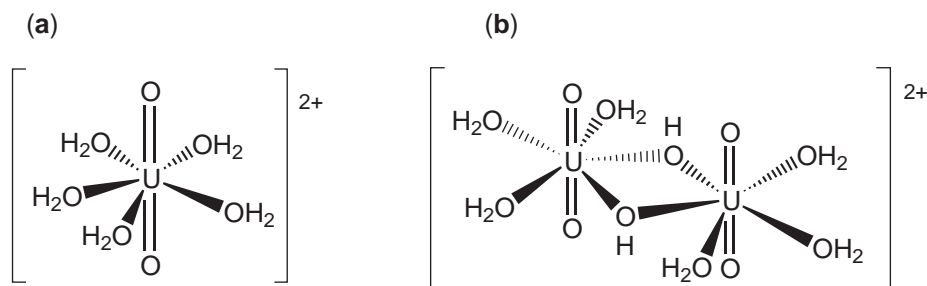


Figure 5 Structure of uranium(VI) aqua ions.



of  $\text{Ti}^{3+}(\text{aq})$  to  $\text{Ti}^{2+}(\text{aq})$  ( $k \sim 5 \times 10^6 \text{ M}^{-1}\text{s}^{-1}$ ) has been reported.<sup>31</sup> The reduction potential for the  $\text{Ti}^{3+/2+}(\text{aq})$  couple has been estimated as  $-1.29 \text{ V}$ .<sup>32</sup>

(b)  $\text{Ti}^{3+}(\text{aq})$ . Violet–purple air-sensitive  $[\text{Ti}(\text{H}_2\text{O})_6]^{3+}$  is the principal species present in dilute  $\text{HCl}$  or  $\text{H}_2\text{SO}_4$  solutions of  $\text{TiCl}_3$  or the oxide  $\text{Ti}_2\text{O}_3$ , and in  $\text{TiCl}_3 \cdot 6\text{H}_2\text{O}$  and the cesium alum. The Ti–O distance in the alum is 203 pm. The X-ray crystal structure of the *p*-toluene sulfonate ( $\text{pts}^-$ ) salt  $[\text{Ti}(\text{H}_2\text{O})_6]^{3+}(\text{pts})_3 \cdot 3\text{H}_2\text{O}$  has also been reported.<sup>33</sup> Here, the geometry at the Ti is essentially octahedral with Ti–O bond lengths ranging from 202 pm to 205 pm. Solutions of  $[\text{Ti}(\text{H}_2\text{O})_6]^{3+}$  can be obtained by dissolving titanium metal in acid or by reduction of aqueous solutions of  $\text{Ti}^{\text{IV}}(\text{aq})$  with zinc. The anhydrous solid triflate  $\text{Ti}(\text{CF}_3\text{SO}_3)_3$  has also been used to prepare solutions of  $\text{Ti}^{3+}(\text{aq})$ .<sup>34</sup>

Solutions of  $[\text{Ti}(\text{H}_2\text{O})_6]^{3+}$  are air-sensitive. The reduction potential for  $\text{Ti}^{\text{IV}}(\text{aq})/[\text{Ti}(\text{H}_2\text{O})_6]^{3+}$  is  $\sim 0.1 \text{ V}$  (vs. nhe). The geometry,  $\text{H}_2\text{O}$  orientation, and electronic states of  $[\text{Ti}(\text{H}_2\text{O})_6]^{3+}$  have been studied. Acid dissociation of  $[\text{Ti}(\text{H}_2\text{O})_6]^{3+}$  gives  $\text{p}K_{\text{a}} = 2.5$  ( $I = 3.0 \text{ M Br}^-$ ). Dimeric  $\text{Ti}_2(\text{OH})_2^{4+}(\text{aq})$  is also formed. The  $\text{Ti}^{\text{III}}$  in  $[\text{Ti}(\text{C}_2\text{O}_4)_3(\text{H}_2\text{O})]^{3-}$  is seven coordinate.<sup>35</sup> The tendency of  $d^1$   $[\text{Ti}(\text{H}_2\text{O})_6]^{3+}$  to take up an extra water molecule has been considered, and is reflected in the associative mechanism assigned to water exchange.<sup>34</sup>

(c)  $\text{Ti}^{\text{IV}}(\text{aq})$ . An X-ray structure of  $(\text{NEt}_4)_2[\text{TiOCl}_4]$  has indicated the presence of  $\text{Ti}=\text{O}$  bonds. Other  $\text{Ti}^{\text{IV}}$  compounds containing Ti–O bonds as in  $\text{TiOX}_2$  ( $X = \text{F, Cl, Br, I}$ ) and  $[\text{TiO}(\text{SO}_4)_2]^{2-}$  have polymeric –Ti–O–Ti–O chains. The “titanyl” ion has proved more difficult to characterize than  $\text{VO}^{2+}(\text{aq})$ , and the oxo group is more labile.<sup>36</sup> Mononuclear  $\text{Ti}^{\text{IV}}(\text{aq})$  predominates in the concentration ranges  $0.5 < [\text{H}^+] < 2.0 \text{ M}$  and  $1.5 \times 10^{-3} < [\text{Ti}^{\text{IV}}] < 0.05 \text{ M}$ . From  $^{17}\text{O}$  NMR studies on acidified water–methanol solutions of  $\text{Ti}^{\text{IV}}$  perchlorate at  $\sim 196 \text{ K}$ , a peak of around 1,000–1,100 ppm suggests that  $\text{TiO}^{2+}(\text{aq})$  is present in rapid equilibrium with  $\text{Ti}(\text{OH})_2^{2+}(\text{aq})$ . In the same studies at varying temperatures and  $[\text{H}^+]$ , evidence for a range of polynuclear species has been obtained as the  $[\text{Ti}^{\text{IV}}]$  increases.<sup>36</sup>

(d)  $\text{Zr}^{\text{III}}(\text{aq})$ . UV–vis color changes observed on dissolving  $\text{ZrI}_3$  in water have been attributed to  $\text{Zr}^{3+}(\text{aq})$  (absorbance peak at 410 nm), which oxidizes over 40 minutes to  $\text{Zr}^{\text{IV}}(\text{aq})$ .

(e)  $\text{Zr}^{\text{IV}}(\text{aq})$  and  $\text{Hf}^{\text{IV}}(\text{aq})$ . The  $\text{Zr}^{\text{IV}}$  compound  $\text{ZrOCl}_2 \cdot 8\text{H}_2\text{O}$  was thought to have a  $\text{ZrO}^{2+}$  structure (analogous to  $\text{VO}^{2+}$ ), and is still referred to as zirconyl chloride. However, from XRD studies (and other measurements<sup>37</sup>) it has a tetrameric structure. This has a square–planar arrangement of four  $\text{Zr}^{\text{IV}}$  atoms with each pair bridged by two hydroxides, and four terminal  $\text{H}_2\text{O}$ 's to each Zr, giving eight coordinations at each metal center (Figure 6). The formula can alternatively be written as  $[\text{Zr}_4(\text{OH})_8(\text{H}_2\text{O})_{16}]\text{Cl}_8 \cdot 12\text{H}_2\text{O}$ . A similar structure has been demonstrated for the  $\text{Hf}^{\text{IV}}$  analogue.<sup>38</sup> The metal–metal separations for these  $d^0$  atoms are identical at 357 pm.

On adjustment of  $\text{HClO}_4$  levels to 2.0–4.0 M,  $I = 4.0 \text{ M} (\text{ClO}_4^-)$ , the tetranuclear form dissociates. The  $\text{Zr}^{\text{IV}}$  ( $d^0$ ) ion is colorless, but its formation can be monitored by UV–vis spectrophotometry using the colored ligand 2-thenoyltrifluoroacetone (HT) (Figure 6), which coordinates (giving a color change) to a dissociated form of  $\text{Zr}_4$ . This is most likely the mononuclear form in such high

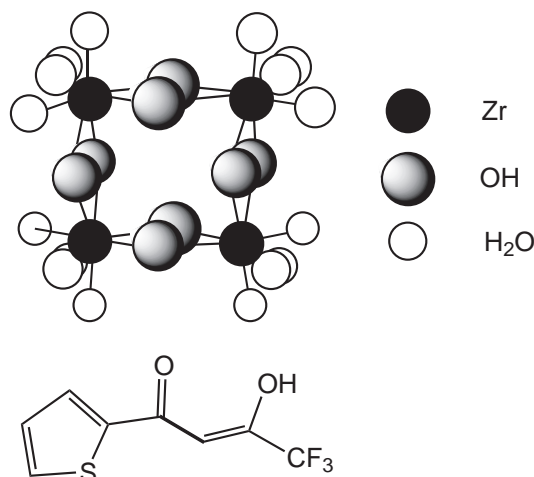


Figure 6 Structure of  $[\text{Zr}_4(\mu\text{-OH})_8(\text{H}_2\text{O})_{16}]^{8+}$ , and formula of HT ligand.<sup>37–39</sup>

acid, with HT coordination via the two O atoms.<sup>39</sup> The rate law can be expressed as  $k[\text{H}^+][\text{Zr}_4]$  with  $k = 3.7 \times 10^{-3} \text{ M}^{-1} \text{ s}^{-1}$  at 25 °C. An interesting question is why (HT) should coordinate to the mononuclear form and not to  $\text{Zr}_4$ ? It could be that mononuclear  $[\text{Zr}(\text{H}_2\text{O})_x]^{4+}$  ( $x = 6$  or  $7$ ) is generated, with a bite angle more accommodating for HT coordination.

### 1.25.2.5 Group 5: Vanadium, Niobium, and Tantalum

(a)  $V^{2+}(\text{aq})$ . Violet  $[\text{V}(\text{H}_2\text{O})_6](\text{CF}_3\text{SO}_3)_2$  has been isolated (V—O, 212 pm),<sup>40</sup> after refluxing aqueous  $\text{CF}_3\text{SO}_3\text{H}$  with vanadium metal under nitrogen. The  $V^{II}$  complexes, e.g.,  $[\text{V}(\text{H}_2\text{O})_6]\text{Br}_2$ ,  $[\text{V}(\text{H}_2\text{O})_6](\text{BF}_4)_2$ ,  $[\text{VCl}_2(\text{H}_2\text{O})_4]$ , dissolve in acetone, methanol, ethanol, ethyl acetate, and 1,2-dimethoxyethane. Air-free conditions are required to study  $[\text{V}(\text{H}_2\text{O})_6]^{2+}$ . The  $V^{3+}/V^{2+}$  reduction potential is  $-0.255 \text{ V}$  (vs. nhe).

(b)  $V^{3+}(\text{aq})$ . The best source of  $[\text{V}(\text{H}_2\text{O})_6]^{3+}$  is via the anhydrous triflate  $\text{V}(\text{CF}_3\text{SO}_3)_3$  prepared from  $\text{VCl}_3$  and triflic acid by the same procedure as for  $\text{Ti}(\text{CF}_3\text{SO}_3)_3$ . Solutions of  $[\text{V}(\text{H}_2\text{O})_6]^{3+}$  are dark blue in such non-complexing acids. The cesium alum has been extensively studied. Neutron diffraction studies on  $[\text{V}(\text{H}_2\text{O})_6][\text{H}_5\text{O}_2](\text{CF}_3\text{SO}_3)_4$ ,<sup>41</sup> prepared by crystallization of  $\text{V}_3(\mu_3\text{-O})(\mu\text{-CH}_3\text{CO}_2)_6(\text{CH}_3\text{CO}_2\text{H})_2(\text{thf})$  from 2.0 M triflic acid show the position of coordinated  $\text{H}_2\text{O}$  protons which affect the  $\text{VO}_6$  symmetry ( $O_h$  to  $D_{3d}$ ). Low-temperature UV-vis studies on the ammonium alum have confirmed that  $\pi$  bonding in the plane of each water ligand is weaker than that perpendicular to it.<sup>42</sup>

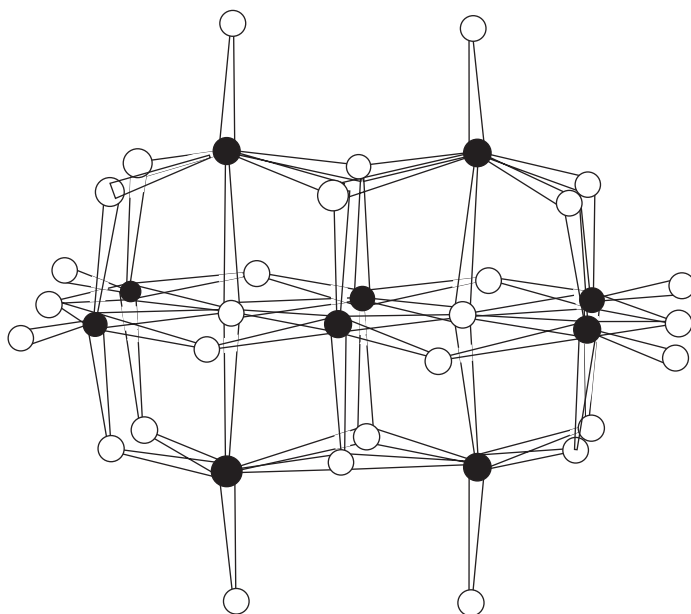
Acid dissociation of  $[\text{V}(\text{H}_2\text{O})_6]^{3+}$  to  $[\text{V}(\text{H}_2\text{O})_5(\text{OH})]^{3+}$  is observed ( $\text{p}K_a$  2.9;  $I = 1.0 \text{ M Cl}^-$ ), followed by formation of dimeric  $[\text{V}_2(\mu\text{-OH})_2(\text{H}_2\text{O})_8]^{4+}$ . A brown  $\mu$ -oxo dimer is observed from the reaction of  $[\text{V}(\text{H}_2\text{O})_6]^{2+}$  with  $[\text{VO}(\text{H}_2\text{O})_5]^{2+}$ . However, structurally characterized dinuclear  $V^{III}$  complexes have a single  $\mu$ -oxo bridge, which is supported by resonance Raman studies, and it appears that the  $\mu$ -oxo form is dominant.<sup>43</sup> The  $V^{3+}(\text{aq})$  ion reacts slowly with  $\text{O}_2$ ; the reduction potential for  $V^{IV}(\text{aq})/[\text{V}(\text{H}_2\text{O})_6]^{3+}$  is  $0.361 \text{ V}$  (vs. nhe).

(c)  $V^{IV}(\text{aq})$ . In contrast to  $\text{Ti}^{IV}$ , the terminal  $\text{V}=\text{O}^{2+}$  group dominates the solution chemistry of bright blue  $[\text{VO}(\text{H}_2\text{O})_5]^{2+}$ . The most convenient source is from commercial vanadyl sulfate, which can be converted to  $[\text{VO}(\text{H}_2\text{O})_5]^{2+}$  in non-complexing  $\text{HClO}_4$  or triflic acid solutions by Dowex 50W-X2 cation-exchange chromatography. From solutions in  $\text{HClO}_4$  the blue deliquescent salt  $[\text{VO}(\text{H}_2\text{O})_5](\text{ClO}_4)_2$  has been isolated. Crystalline  $\text{VOSO}_4 \cdot 5\text{H}_2\text{O}$  contains both  $[\text{VO}(\text{H}_2\text{O})_5]^{2+}$  and square-pyramidal  $[\text{VO}(\text{H}_2\text{O})_4]^{2+}$ . The  $\text{V}=\text{O}$  bond is short (159 pm), and the  $\text{V}-\text{OH}_2(\text{ax})$  long at 228 pm in  $\text{VOSO}_4 \cdot 5\text{H}_2\text{O}$ , with bonds to the equatorial  $\text{H}_2\text{O}$ 's 200–205 pm. Acid dissociation of  $[\text{VO}(\text{H}_2\text{O})_5]^{2+}$  to  $[\text{VO}(\text{H}_2\text{O})_4(\text{OH})]^+$  gives  $\text{p}K_a = 5.67$  ( $I \rightarrow 0$ ). The reduction potential for  $\text{V}(\text{O})_2^+(\text{aq})/\text{VO}^{2+}(\text{aq})$  is  $1.0 \text{ V}$  (vs. nhe).

(d)  $V^V(\text{aq})$ . The aqueous chemistry of  $V^V$  ( $>10^{-2} \text{ M}$ ) in the pH range 2–13 is dominated by a range of polynuclear anionic species. Altogether twelve species have been identified. At the extremes of pH, yellow  $\text{cis-}[\text{V}(\text{O})_2(\text{H}_2\text{O})_4]^+$  (pH < 2) and colorless tetrahedral  $[\text{VO}_4]^{3-}$  (pH > 13) are obtained. The  $\text{cis-oxo}$  configuration arises from the need to maximize  $d_\pi-p_\pi$  bonding. Pure solutions of  $\text{cis-}[\text{V}(\text{O})_2(\text{H}_2\text{O})_4]^+$  are obtained by dissolving  $\text{Na}_6[\text{V}_{10}\text{O}_{28}] \cdot 18\text{H}_2\text{O}$  in water, passing down a column of Dowex 50W-X8 resin ( $\text{H}^+$  form), rinsing with water, and eluting with 70% aqueous  $\text{HClO}_4$ .<sup>44</sup> Solutions of  $\text{cis-}[\text{V}(\text{O})_2(\text{H}_2\text{O})_4]^+$  ( $\sim 0.2 \text{ M}$ ) in 1.0 M  $\text{HClO}_4$  have been prepared. Acid dissociation of  $\text{cis-}[\text{V}(\text{O})_2(\text{H}_2\text{O})_4]^+$  at  $<2 \times 10^{-2} \text{ M}$  yields  $\text{V}(\text{O})_2(\text{OH})(\text{aq})$  ( $\text{p}K_a$  3.2;  $I = 0.5 \text{ M ClO}_4^-$ ). A change from octahedral to tetrahedral coordination occurs at  $[\text{V}^V] > 10^{-2} \text{ M}$ , pH 2–13. Decavanadate,  $[\text{V}_{10}\text{O}_{28}]^{6-}$ , is the predominant species in the pH range 2–7. The mechanism of formation is of interest, and exchange processes involving the various oxygen sites have been studied (Figure 7). Seven structurally distinct oxygen atoms have been identified by  $^{17}\text{O}$  NMR and exchange at similar rates observed.<sup>45</sup>

(e) *Aqua Ions of  $M_6\text{Cl}_{12}^{n+}$  ( $M = \text{Nb}, \text{Ta}$ ;  $n = 2, 3, 4$ ) Clusters*. Hexanuclear  $M_6$  clusters with oxidation states per metal of between II and III, give  $M_6(\mu_3\text{-X})_8(\mu\text{-X})_4^{n+}$  core units, ( $X = \text{Cl}, \text{Br}$ ;  $n = 2, 3, 4$ ) to which six additional ligands  $\text{H}_2\text{O}$  or  $\text{X}^-$  are attached. Salts of  $M_6\text{X}_{12}\text{X}_6^{m-}$  ( $m = 2, 3, 4$ ) have been characterized. Thus, on treating  $\text{Ta}_6\text{Cl}_{12}\text{Cl}_2 \cdot 8\text{H}_2\text{O}$  in methanol with  $\text{Me}_4\text{NOH}$  followed by acidification with concentrated  $\text{HBr}$  (or  $\text{HCl}$ ), a red precipitate of  $[\text{Ta}_6(\mu_3\text{-Cl})_8(\mu\text{-Cl})_4(\text{OH})_4] \cdot 10\text{H}_2\text{O}$  forms, which redissolves in excess acid. On standing overnight a color change from red ( $\text{Ta}_6\text{Cl}_{12}^{2+}$ ) to olive green ( $\text{Ta}_6\text{Cl}_{12}^{3+}$ ) occurs, and crystals of the latter separate as the double salt  $\text{NH}_4[\text{Ta}_6(\mu_3\text{-Cl})_8(\mu\text{-Cl})_4(\text{H}_2\text{O})_6]\text{Br}_4$ , which is the best-characterized aqua ion.<sup>46</sup> Recently, a number of preparative routes to the  $\text{Nb}_6$  analog species  $[\text{Nb}_6(\mu_3\text{-Cl})_8(\mu\text{-Cl})_4(\text{H}_2\text{O})_6]^{2+}$  have been described.<sup>47</sup> The  $M_6$  clusters have  $M-M$  close to 280 pm.



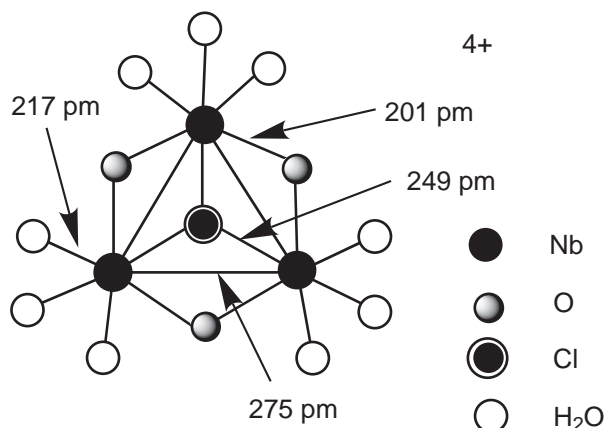


**Figure 7** Structure of decavanadate  $[V_{10}O_{28}]^{6-}$ . Seven structurally distinct oxygen atoms have been identified in  $^{17}O$  NMR studies.<sup>45</sup>

(f)  $[Nb_3(\mu_3-Cl)(\mu-O)_3(H_2O)_9]^{4+}$ . Hydrolysis of  $\{NbCl_3(1,2\text{-dimethoxyethane})\}_x$  in HCl (4–12 M) produces a brown–green product which can be purified by Dowex 50W-X2 cation-exchange chromatography. Elution with 2–4 M solutions of HCl or Hpts yields air-sensitive green solutions, which from  $^{17}O$ ,  $^{93}Nb$  NMR and Nb K edge EXAFS<sup>48</sup> is mixed-valent  $[Nb_3(\mu_3-Cl)(\mu-O)_3(H_2O)_9]^{4+}$  (Figure 8). The same product is obtained by zinc reduction of ethanolic–HCl solutions of niobium pentachloride.<sup>49</sup>  $^{93}Nb$  NMR studies show that the Nb's are equivalent. Three  $^{17}O$  NMR resonances at 34 ppm and –15 ppm (coordinated water) and 305 ppm ( $\mu-O$ ) in a 2:1:1 ratio are consistent with the structure indicated, rather than the previously proposed  $[Nb_3(\mu_3-O)(\mu-O)_3(H_2O)_9]^+$ .<sup>50</sup> The  $\mu_3-Cl$  cap can be replaced by  $S^{2-}$  by adding NCS<sup>-</sup> as in the isolation of  $[Nb_3(\mu_3-S)(\mu-O)_3(NCS)_9]^{6-}$ .

(g)  $[Nb_2(\mu-S_2)_2(H_2O)_8]^{4+}$  and  $[Nb_2(\mu-S)_2(H_2O)_8]^{4+}$ . The polymeric form  $\{Nb^{IV}S_2Cl_2\}_x$  has been obtained by heating Nb/S/Cl<sub>2</sub> at 350 °C. Conversion to  $K_4[Nb_2(\mu-S_2)_2(NCS)_8]$ ,  $[Nb_2(\mu-S_2)Cl_8]^{4-}$  and then in 4M Hpts to  $[Nb_2(\mu-S_2)_2(H_2O)_8]^{4+}$  in 4M Hpts is followed by Dowex purification to give  $[Nb_2(\mu-S_2)_2(H_2O)_8](pts)_4 \cdot 4H_2O$  (Figure 9) Nb–Nb separation 285 pm.<sup>51</sup> A structure of the cucurbituril adduct of  $[Nb_2(\mu-S_2)_2(H_2O)_8]^{4+}$  has also been determined.<sup>52</sup> Abstraction of S with PPh<sub>3</sub> gives the green air-sensitive  $\mu-S$  product  $[Nb_2(\mu-S)_2(H_2O)_8]^{4+}$ .<sup>51</sup>

(h)  $Nb^V(aq)$  and  $Ta^V(aq)$ . No cationic aqua products have been isolated, the dominant forms being polyoxo anions, e.g.,  $[H_xNb_6O_{19}]^{(8-x)-}$  and  $[Ta_6O_{19}]^{8-}$ . Earlier reports of  $Nb(OH)_4^+(aq)$  at



**Figure 8** Structure of  $[Nb_3(\mu_3-Cl)(\mu-O)_3(H_2O)_9]^{4+}$  from  $^{17}O$  NMR and Nb K edge EXAFS measurements.<sup>48</sup>

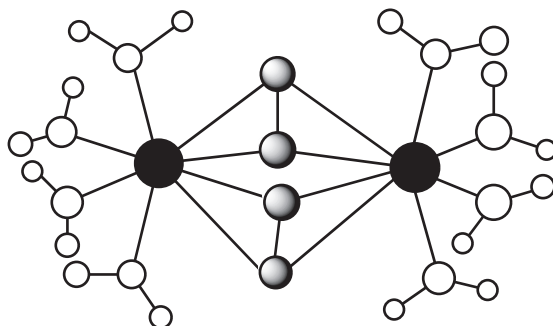


Figure 9 Structure of  $[\text{Nb}^{\text{IV}}_2(\mu\text{-S}_2)_2(\text{H}_2\text{O})_8]^{4+}$ .<sup>51</sup>

high dilution have not been substantiated, acidification leading in all cases to quantitative precipitation of the pentoxide. Complexes  $[\text{NbO}(\text{H}_2\text{O})_2(\text{C}_2\text{O}_4)_2]^-$  and  $[\text{NbO}(\text{OH})_2(\text{C}_6\text{H}_7\text{O}_6)]$  ( $\text{C}_6\text{H}_7\text{O}_6^-$  = ascorbate) have been isolated, but not the parent  $[\text{NbO}(\text{H}_2\text{O})_5]^{3+}$ . No aqua ions of tantalum have been prepared.

### 1.25.2.6 Group 6: Chromium, Molybdenum, and Tungsten

$\text{Cr}^{2+}(\text{aq})$ ,  $\text{Mo}^{2+}(\text{aq})$  and  $\text{W}^{2+}(\text{aq})$ . Blue  $[\text{Cr}(\text{H}_2\text{O})_6]^{2+}$  is readily prepared by reduction of the higher states or by dissolution of the pure metal in  $\text{O}_2$ -free acids. The reduction potential for  $\text{Cr}^{3+}(\text{aq})/\text{Cr}^{2+}(\text{aq})$  is  $-0.41$  V (vs. nhe). EXAFS measurements have confirmed the Jahn–Teller tetragonal distortion structure in solution, (Cr–O equatorial 199 pm; Cr–O axial, 230 pm).<sup>53</sup> The crystalline salt  $[\text{Cr}(\text{H}_2\text{O})_6](\text{SiF}_6)_2$  is unusual in having all Cr–OH<sub>2</sub> bonds identical,<sup>54</sup> and the J–T distortion is believed to be suppressed by a combination of strong hydrogen bonding (to  $\text{SiF}_6^{2-}$ ) and crystal packing. However, recrystallization gives the Jahn–Teller distorted salt *trans*- $[\text{Cr}(\text{H}_2\text{O})_4(\text{SiF}_6)_2]$ .<sup>55</sup> In solution  $[\text{Cr}(\text{H}_2\text{O})_6]^{2+}$  is extremely labile, and very reactive with  $\text{O}_2$ . The 1:1 reaction has one of the largest bimolecular rate constants for an  $\text{O}_2$  reaction ( $1.6 \times 10^8 \text{ M}^{-1} \text{ s}^{-1}$ ).<sup>56</sup> The product  $[\text{Cr}^{\text{III}}(\text{H}_2\text{O})_5(\text{O}_2^-)]^{2+}$  is stable for several hours making this one of the more stable superoxo complexes. It readily abstracts a hydrogen atom from a variety of C–H substrates.<sup>57</sup> Further reaction with  $[\text{Cr}(\text{H}_2\text{O})_6]^{2+}$  gives first the peroxo dimer  $[(\text{H}_2\text{O})_5\text{CrOOCr}(\text{H}_2\text{O})_5]^{4+}$ , and with a further  $[\text{Cr}(\text{H}_2\text{O})_6]^{2+}$  the  $\text{Cr}^{\text{IV}}$  product  $[\text{CrO}(\text{H}_2\text{O})_5]^{2+}$  and  $\text{Cr}^{\text{III}}$  dimer  $[(\text{H}_2\text{O})_4\text{Cr}(\text{OH})_2\text{Cr}(\text{H}_2\text{O})_4]^{4+}$  are formed. The reaction of  $[\text{Cr}(\text{H}_2\text{O})_6]^{2+}$  with alkyl halides is a facile route to  $[\text{RCr}(\text{H}_2\text{O})_5]^{2+}$  species.<sup>58</sup>

In sharp contrast,  $\text{Mo}^{\text{II}}$  exists as the quadruply bonded dimer  $[\text{Mo}_2(\text{H}_2\text{O})_8]^{4+}$  prepared by  $\text{Ba}^{2+}$ -induced aquation of  $[\text{Mo}_2(\mu\text{-SO}_4)_4]^{4-}$ . There is no crystal structure but an intense band at 510 nm assigned to a  $\delta \rightarrow \delta^*$  transition is observed in common with other  $\text{Mo}^{\text{II}}$  dimers, and it can be concluded that an eclipsed configuration with quadruple M–M bonding is present (Figure 10).<sup>59</sup> The Mo–Mo bond is close to 212 pm.<sup>60</sup> Studies on anion for  $\text{H}_2\text{O}$  substitution indicate similarities to  $\text{VO}^{2+}$  with initial association along the axial Mo–Mo direction followed by isomerization into the equatorial positions.<sup>59</sup> No corresponding aqua ion of  $\text{W}^{\text{II}}$  is known.

(a)  $\text{Cr}^{\text{III}}(\text{aq})$ ,  $\text{Mo}^{\text{III}}(\text{aq})$ , and  $\text{W}^{\text{III}}(\text{aq})$ . Blue–violet  $[\text{Cr}(\text{H}_2\text{O})_6]^{3+}$  is well characterized in its alum,<sup>61</sup> in crystals of  $\text{H}_2\text{Cr}_4(\text{SO}_4)_7 \cdot 24\text{H}_2\text{O}$ , the hydrated nitrate, and in solution.<sup>62</sup> The Cr–OH<sub>2</sub> bond is 196 pm in the alum, and from LAXS and EXAFS studies.<sup>62</sup> The  $[\text{Cr}(\text{H}_2\text{O})_6]^{3+}$  ion is the most inert in the first transition series ( $k_{\text{H}_2\text{O}} = 2.4 \times 10^{-6} \text{ s}^{-1}$ ). Its inert behavior has allowed detailed IR studies of the Cr–OH<sub>2</sub> vibrations with the  $\nu_{\text{as}}$  stretch at  $555 \text{ cm}^{-1}$  and the  $\nu_{\text{as}}$  bend

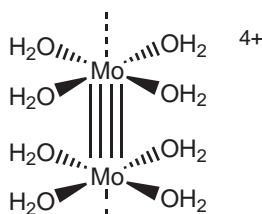


Figure 10 Quadruple Mo–Mo bonded  $[\text{Mo}^{\text{II}}_2(\text{H}_2\text{O})_8]^{4+}$ , showing weakly bonded  $\text{H}_2\text{O}$ s in axial positions.<sup>59</sup>

at  $329\text{ cm}^{-1}$ . In water, a well-defined second coordination shell has also been established. Strong hydrogen bond formation due to polarization of first-coordination sphere water molecules leads to a second-shell coordination number of 12.94 with first shell hydrogen to second shell oxygen distance of about 140 pm, and to a residence time of 128 ps (144 ps from MD simulations).<sup>63</sup> Acid dissociation  $\text{p}K_{\text{a}}$  values ( $I=0.1\text{ M ClO}_4^-$ ) are for formation of  $[\text{Cr}(\text{H}_2\text{O})_5\text{OH}]^{2+}$  (4.1), and  $[\text{Cr}(\text{H}_2\text{O})_4(\text{OH})_2]^+$  (9.7).<sup>64</sup> In addition, dinuclear blue-green  $\text{Cr}_2(\mu\text{-OH})_2^{4+}(\text{aq})$  has been characterized.<sup>65</sup> Trinuclear, tetranuclear, and higher oligomeric forms have also been isolated following  $\text{O}_2$  oxidation of  $[\text{Cr}(\text{H}_2\text{O})_6]^{2+}$  ( $>0.5\text{ M}$ ) (Figure 11).<sup>65,66</sup> Each oligomer is inert enough to be separated by cation-exchange chromatography. The crystal structure of  $[(\text{H}_2\text{O})_4\text{Cr}(\mu\text{-OH})_2\text{Cr}(\text{H}_2\text{O})_4](1,3,5\text{-Me}_3\text{C}_6\text{H}_2\text{O}_3)_4\cdot\text{H}_2\text{O}$  reveals a Cr—Cr distance of 301 pm.<sup>64</sup> The structures of  $[\text{Cr}_3(\mu\text{-OH})_4(\text{H}_2\text{O})_{16}]^{5+}$  and  $[\text{Cr}_4(\mu\text{-OH})_6(\text{H}_2\text{O})_{12}]^{6+}$  are cyclic with only  $\mu\text{-OH}$  bridges.<sup>67,68</sup> The kinetics of the  $[\text{H}^+]$ -assisted conversion of  $[(\text{H}_2\text{O})_4\text{Cr}(\mu\text{-OH})_2\text{Cr}(\text{H}_2\text{O})_4]^{4+}$  to  $[(\text{H}_2\text{O})_5\text{Cr}(\mu\text{-OH})\text{Cr}(\text{H}_2\text{O})_5]^{5+}$  and ultimately  $[\text{Cr}(\text{H}_2\text{O})_6]^{3+}$ , and the reverse processes have been studied.<sup>69</sup>

Mixed dinuclear  $\text{Cr}^{\text{III}}\text{-Rh}^{\text{III}}$  and  $\text{Cr}^{\text{III}}\text{-Ir}^{\text{III}}$  di- $\mu$ -hydroxo-bridged aqua ions,<sup>70</sup> and trinuclear  $\text{Cr}^{\text{III}}\text{-Rh}^{\text{III}}$  aqua ions of  $\text{Cr}_2\text{Rh}(\text{OH})_4^{5+}$  and  $\text{CrRh}_2(\text{OH})_4^{5+}$  have been prepared.<sup>71</sup>

Improved synthetic routes to pale-yellow  $\text{O}_2$ -sensitive  $[\text{Mo}(\text{H}_2\text{O})_6]^{3+}$  have been reported via  $[\text{H}^+]$ -assisted aquation of  $\text{Na}_3[\text{Mo}(\text{HCO}_2)_6]^{72}$  or  $\{\text{Mo}(\text{CF}_3\text{SO}_3)_3\}_x^{73}$  followed by cation-exchange chromatography. A polarized neutron diffraction study on the cesium alum<sup>74</sup> provides evidence of significant  $\pi$  bonding of the Mo to trigonal planar oxygens.<sup>75</sup> The  $4d$   $[\text{Mo}(\text{H}_2\text{O})_6]^{3+}$  ion is unusual in being  $\sim 10^5$  more labile than  $3d$   $[\text{Cr}(\text{H}_2\text{O})_6]^{3+}$ , a feature explained by the greater associative behavior observed for the larger  $4d$  orbitals of  $\text{Mo}^{\text{III}}$ .<sup>76</sup> Air oxidation of  $[\text{Mo}(\text{H}_2\text{O})_6]^{3+}$  gives the di- $\mu$ -oxo form  $[(\text{Mo}^{\text{V}}\text{O})_2(\mu\text{-O})_2(\text{H}_2\text{O})_6]^{2+}$ . Kinetic studies on oxidations of  $[\text{Mo}(\text{H}_2\text{O})_6]^{3+}$  have been reported.<sup>77</sup> The reduction of  $[(\text{Mo}^{\text{V}}\text{O})_2(\mu\text{-O})_2(\text{H}_2\text{O})_6]^{2+}$  (or  $[\text{Mo}^{\text{VI}}\text{O}_4]^{2-}$ ) with Zn/Hg yields green  $[\text{Mo}^{\text{III}}_2(\mu\text{-OH})_2(\text{H}_2\text{O})_8]^{4+}$ .<sup>78</sup> The trinuclear  $\text{Mo}^{\text{III}}_3$  ion is obtained by reduction of  $[\text{Mo}^{\text{IV}}_3\text{O}_4(\text{H}_2\text{O})_9]^{4+}$ .<sup>79</sup> From  $^{17}\text{O}$  NMR studies<sup>80</sup> a core structure  $\text{Mo}^{\text{III}}_3(\text{OH})_4^{5+}$  is indicated. The oxidation of  $\text{Mo}^{\text{III}}_3(\text{OH})_4^{5+}$  to  $\text{Mo}^{\text{IV}}_3\text{O}_4^{4+}$  has also been studied. There is as yet no evidence for  $[\text{W}^{\text{III}}(\text{H}_2\text{O})_6]^{3+}$ , for which strong reducing properties are predicted. The aqua ion of the chalcogenide cube  $[\text{Mo}^{\text{III}}_4\text{S}_4(\text{H}_2\text{O})_{12}]^{4+}$  and related  $[\text{Mo}_4\text{S}_4(\text{H}_2\text{O})_{12}]^{5+,6+}$  cubes have been prepared,<sup>81</sup> and recently the mixed-valent tungsten analogs  $[\text{W}_4\text{S}_4(\text{H}_2\text{O})_{12}]^{5+,6+}$  have been obtained.<sup>82</sup>

(b)  $\text{Cr}^{\text{IV}}(\text{aq})$ ,  $\text{Mo}^{\text{IV}}(\text{aq})$ , and  $\text{W}^{\text{IV}}(\text{aq})$ . Formation of the metastable  $\text{Cr}^{\text{IV}}(\text{aq})$  ion (15–50% yields) is observed in the reaction of  $[\text{Cr}(\text{H}_2\text{O})_6]^{2+}$  with  $\text{O}_2$  (as already described),<sup>56</sup> or in the two-equivalent reduction of  $\text{Ti}^{3+}(\text{aq})$  with equimolar amounts of  $[\text{Cr}(\text{H}_2\text{O})_6]^{2+}$ . The half-life is  $\sim 0.5\text{ min}$  at  $25^\circ\text{C}$ ,  $I=1.0\text{ M}$ . The product reacts with  $\text{Ph}_3\text{P}$  to give  $\text{OPPh}_3$  and  $[\text{Cr}(\text{H}_2\text{O})_6]^{2+}$ , consistent with the chromyl  $[\text{CrO}(\text{H}_2\text{O})_5]^{2+}$  formulation. An extensive list of hydride and H-atom abstraction reactions with organic reagents has been reported.<sup>56</sup>

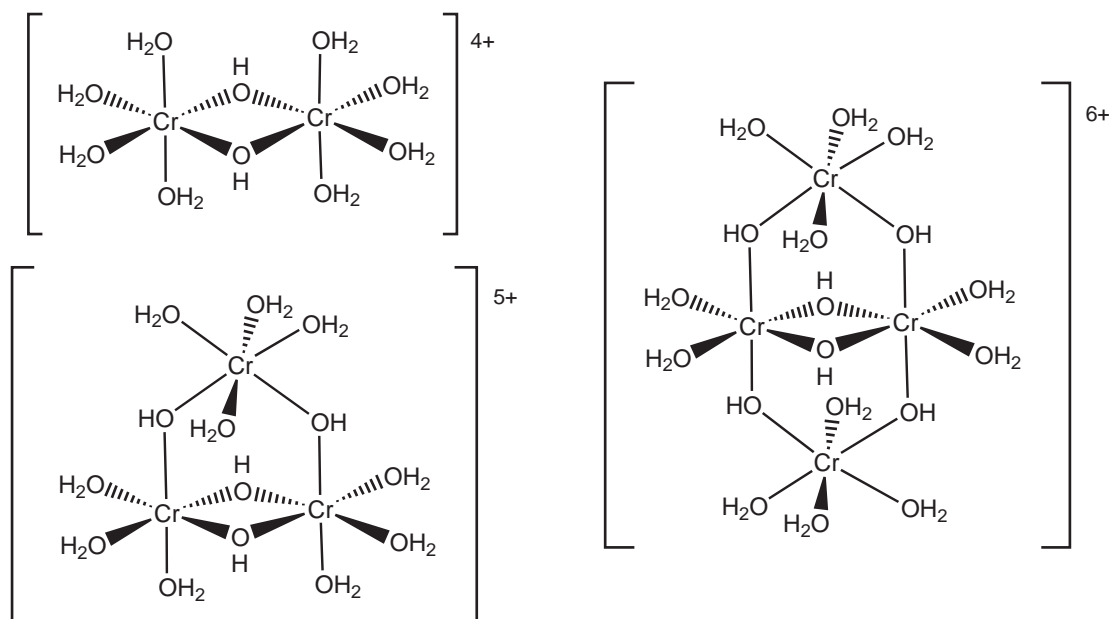
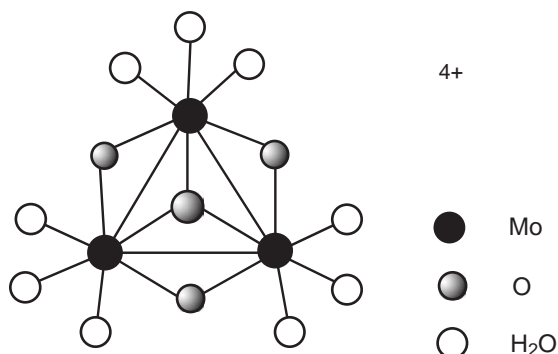


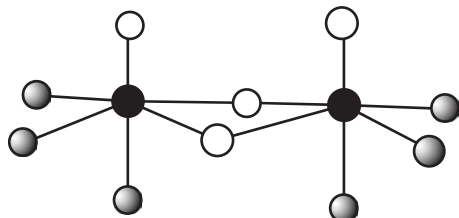
Figure 11 Dinuclear, trinuclear, and tetranuclear  $\text{Cr}^{\text{III}}$  derivatives of  $[\text{Cr}(\text{H}_2\text{O})_6]^{3+}$ .<sup>65,66</sup>



**Figure 12** The trinuclear  $[\text{Mo}^{\text{IV}}_3(\mu_3\text{-O})(\mu\text{-O})_3(\text{H}_2\text{O})_9]^{4+}$  as the simplest  $\text{Mo}^{\text{IV}}$  aqua ion.<sup>83</sup>

Aqua ions of  $\text{Mo}^{\text{IV}}(\text{aq})$  and  $\text{W}^{\text{IV}}(\text{aq})$  are obtained as M—M bonded trinuclear  $[\text{Mo}^{\text{IV}}_3(\mu_3\text{-O})(\mu\text{-O})_3(\text{H}_2\text{O})_9]^{4+}$  (red) and  $[\text{W}^{\text{IV}}_3(\mu_3\text{-O})(\mu\text{-O})_3(\text{H}_2\text{O})_9]^{4+}$  (orange) species. The former has been characterized by XRD (Figure 12)<sup>83</sup> and both structures have been verified in solution by  $^{17}\text{O}$  NMR.<sup>84</sup> Preparation of  $[\text{Mo}^{\text{IV}}_3(\mu_3\text{-O})(\mu\text{-O})_3(\text{H}_2\text{O})_9]^{4+}$  is by reacting  $\text{Mo}^{\text{III}}(\text{aq})$  (or  $[\text{MoCl}_6]^{3-}$  with some heating) with  $\text{Mo}^{\text{V}}(\text{aq})$  or  $\text{Mo}^{\text{VI}}(\text{aq})$ , whereas  $[\text{W}^{\text{IV}}_3(\mu_3\text{-O})(\mu\text{-O})_3(\text{H}_2\text{O})_9]^{4+}$  is made by dissolving  $\text{K}_2[\text{WCl}_6]$  in acid, e.g., HCl or Hpts.<sup>85</sup> Electrochemical (or chemical) reduction of  $[\text{Mo}^{\text{IV}}_3(\mu_3\text{-O})(\mu\text{-O})_3(\text{H}_2\text{O})_9]^{4+}$  at an Hg pool electrode,<sup>86</sup> gives the orange mixed-valence  $\text{Mo}^{\text{III}}_2\text{-Mo}^{\text{IV}}$  trinuclear core  $\text{Mo}_3(\mu\text{-OH})_4^{6+}(\text{aq})$  and ultimately the  $\text{Mo}^{\text{III}}_3$  product,<sup>87</sup> whereas  $[\text{W}^{\text{IV}}_3(\mu_3\text{-O})(\mu\text{-O})_3(\text{H}_2\text{O})_9]^{4+}$  gives  $\text{W}^{\text{III}}_2\text{W}^{\text{IV}}(\text{aq})$  as final product. Oxidation of  $[\text{Mo}^{\text{IV}}_3(\mu_3\text{-O})(\mu\text{-O})_3(\text{H}_2\text{O})_9]^{4+}$  to  $\text{Mo}^{\text{VI}}(\text{aq})$  has been studied.<sup>88,89</sup> Oxidation of the  $\text{W}^{\text{IV}}_3$  analog occurs more readily, but has so far been little studied. Elution from cation-exchange columns with formic acid/sodium formate mixtures affords a range of formate complexes which can be aquated to give different substituted products.<sup>90</sup> The Mo—Mo (248 pm) and Mo—O (core O and  $\text{OH}_2$ ) distances are typical of complexes containing the  $\text{Mo}_3(\mu_3\text{-O})(\mu\text{-O})_3^{4+}$  core. The water ligands *trans* to  $\mu\text{-O}$  on  $[\text{Mo}^{\text{IV}}_3(\mu_3\text{-O})(\mu\text{-O})_3(\text{H}_2\text{O})_9]^{4+}$  acid dissociate ( $K_a = 0.4 \text{ M}$ ), and the monohydroxo product contributes to both water exchange and substitution reactions.<sup>83,91</sup> A mixed  $[\text{Mo}^{\text{IV}}_2\text{W}^{\text{IV}}(\mu_3\text{-O})(\mu\text{-O})_3(\text{H}_2\text{O})_9]^{4+}$  product has been synthesized from 2:1 mixtures of  $\text{K}_2[\text{MoCl}_6]$  and  $\text{K}_2[\text{WCl}_6]$  in HCl followed by cation-exchange purification.<sup>92</sup> Reduction of  $[\text{Mo}^{\text{IV}}_2\text{W}^{\text{IV}}(\mu_3\text{-O})(\mu\text{-O})_3(\text{H}_2\text{O})_9]^{4+}$  gives the mixed-valent  $\text{Mo}^{\text{III}}_2\text{W}^{\text{IV}}(\text{aq})$  product. Attempts to prepare  $[\text{Mo}^{\text{IV}}\text{W}_2^{\text{IV}}(\mu_3\text{-O})(\mu\text{-O})_3(\text{H}_2\text{O})_9]^{4+}$  by using 1:2 Mo to W ratios salts produces  $[\text{Mo}^{\text{IV}}\text{W}_2^{\text{IV}}(\mu_3\text{-O})(\mu\text{-O})_3(\text{H}_2\text{O})_9]^{4+}$  along with  $[\text{W}^{\text{IV}}_3(\mu_3\text{-O})(\mu\text{-O})_3(\text{H}_2\text{O})_9]^{4+}$ . These experiments again demonstrate that  $\text{Mo}^{\text{IV}}$  is easier to reduce than  $\text{W}^{\text{IV}}$ .

(c)  $\text{Cr}^{\text{V}}(\text{aq})$ ,  $\text{Mo}^{\text{V}}(\text{aq})$ , and  $\text{W}^{\text{V}}(\text{aq})$ . No aqua ion of  $\text{Cr}^{\text{V}}(\text{aq})$  has been identified. In contrast, yellow dinuclear  $[(\text{Mo}^{\text{VO}})_2(\mu\text{-O})_2(\text{H}_2\text{O})_6]^{2+}$  and  $[(\text{W}^{\text{VO}})_2(\mu\text{-O})_2(\text{H}_2\text{O})_6]^{2+}$  have been prepared and are well established (Figure 13). The preparations involve respectively use of a mild reductant (e.g.,  $\text{N}_2\text{H}_4$  or controlled electrochemistry) to reduce  $[\text{MoO}_4]^{2-}$ , and aquation of  $[\text{WOCl}_5]^{2-}$ . In the latter,  $\text{O}_2$ -free conditions are required to avoid W-blue products.<sup>93</sup> The  $\text{W}_2$  product reacts with  $\text{O}_2$  ( $t_{1/2} \sim 1 \text{ h}$ ). No X-ray structure exists for either ion, but the diamagnetism, XRD studies on a number of derivative complexes, and EXAFS data indicate M—M bonding ( $\sim 254 \text{ pm}$ ). Electrochemical studies in 2.0 M  $\text{CF}_3\text{SO}_3\text{H}$  provide evidence for the monomer, *cis*- $[\text{Mo}^{\text{VO}}(\text{O})_2(\text{H}_2\text{O})_4]^+$ , as a transient at  $10^{-5} \text{ M}$  levels.<sup>94</sup> A number of kinetic studies on the oxidation of  $[(\text{Mo}^{\text{VO}})_2(\mu\text{-O})_2(\text{H}_2\text{O})_6]^{2+}$  to  $\text{Mo}^{\text{VI}}(\text{aq})$  have been reported, notably with  $[\text{IrCl}_6]^{2-}$  and  $[\text{Fe}(\text{phen})_3]^{3+}$ .<sup>95</sup> Rate law terms zero-order in oxidant are observed corresponding to a rate determining step involving



**Figure 13** The dinuclear  $[(\text{Mo}^{\text{VO}})_2(\mu\text{-O})_2(\text{H}_2\text{O})_6]^{2+}$  as the simplest  $\text{Mo}^{\text{V}}$  aqua ion.<sup>59</sup>

breakdown to a monomeric Mo<sup>V</sup> species. The mixed aqua ion [(Mo<sup>V</sup>O)(W<sup>V</sup>O)(μ-O)<sub>2</sub>(H<sub>2</sub>O)<sub>6</sub>]<sup>2+</sup> has been reported.<sup>96</sup>

(d) *Cr<sup>VI</sup>, Mo<sup>VI</sup>, and W<sup>VI</sup>(aq)*. The chemistry of Cr<sup>VI</sup> at basic and acidic pH respectively is dominated by [CrO<sub>4</sub>]<sup>2-</sup> and [Cr<sub>2</sub>O<sub>7</sub>]<sup>2-</sup> forms.<sup>97</sup> The aqueous chemistry of the Mo<sup>VI</sup> state has been an area of intense research activity for several decades.<sup>98</sup> It is dominated by isopolymolybdate and heteropolymolybdate forms. In the present context Mo<sup>VI</sup> exists as a monomeric tetrahedral ion [MoO<sub>4</sub>]<sup>2-</sup> at pH > 7. Protonation gives [HMoO<sub>4</sub>]<sup>-</sup>, or, more precisely, [MoO<sub>3</sub>(OH)]<sup>-</sup> (pK<sub>a</sub> 3.47; 1 M HCl), and [H<sub>2</sub>MoO<sub>4</sub>] (pK<sub>a</sub> 3.7; 1 M NaCl). The latter at least is believed to be octahedral and is sometimes referred to as [Mo(OH)<sub>6</sub>], written alternatively as *cis*-[Mo(O)<sub>2</sub>(H<sub>2</sub>O)<sub>2</sub>(OH)<sub>2</sub>]. Mononuclear *cis*-[Mo(O)<sub>2</sub>(H<sub>2</sub>O)<sub>4</sub>]<sup>2+</sup> is present in strongly acidic solutions. Between [H<sup>+</sup>] = 0.2 M and 3.0 M a monomer–dimer equilibrium involving *cis*-[Mo(O)<sub>2</sub>(H<sub>2</sub>O)<sub>3</sub>OH]<sup>+</sup> is effective. Although less extensively studied, W<sup>VI</sup> as [WO<sub>4</sub>]<sup>2-</sup> shows some similar trends.<sup>98</sup> Rate constants (25 °C) from the rate law terms for the exchange with H<sub>2</sub><sup>18</sup>O are [CrO<sub>4</sub>]<sup>2-</sup> (3.2 × 10<sup>-7</sup> s<sup>-1</sup>), [MoO<sub>4</sub>]<sup>2-</sup> (0.33 s<sup>-1</sup>) and [WO<sub>4</sub>]<sup>2-</sup> (0.44 s<sup>-1</sup>), which relate to metal radii of Cr (128 pm), Mo (139 pm), and W (139 pm).

### 1.25.2.7 Group 7: Manganese, Technetium, and Rhenium

(a) *Mn<sup>I</sup>(aq)*. Aquation of the acetone complex *fac*-[Mn(CO)<sub>3</sub>(acetone)<sub>3</sub>](CF<sub>3</sub>SO<sub>3</sub>) and Dowex 50W-X2 cation-exchange purification gives yellow light-sensitive *fac*-[Mn(CO)<sub>3</sub>(H<sub>2</sub>O)<sub>3</sub>]<sup>+</sup>. Such species are interesting hybrids between classical Werner coordination and low-oxidation-state organometallic compounds. Solutions are not air sensitive and can be stored indefinitely in the dark. The half-life for water exchange is ~30 ms at 25 °C.

(b) *Mn<sup>2+</sup>(aq)*. The pale-pink color of [Mn(H<sub>2</sub>O)<sub>6</sub>]<sup>2+</sup> is the result of spin-forbidden *d-d* transitions from the singlet <sup>6</sup>A<sub>1g</sub>(t<sub>2g</sub><sup>3</sup>e<sub>g</sub><sup>2</sup>) ground state.<sup>99</sup> It has a characteristic 6-line EPR spectrum (coupling to <sup>55</sup>Mn nucleus I = 5/2). An average Mn–O distance of 218 pm has been established from EXAFS studies. The reduction potential of the [Mn(H<sub>2</sub>O)<sub>6</sub>]<sup>3+</sup>/[Mn(H<sub>2</sub>O)<sub>6</sub>]<sup>2+</sup> couple is 1.5 V (vs. nhe) reflecting the difficulty of oxidizing, [Mn(H<sub>2</sub>O)<sub>6</sub>]<sup>2+</sup>. Redox interconversions involving [Mn(H<sub>2</sub>O)<sub>6</sub>]<sup>3+</sup> are difficult to study because of the tendency of [Mn(H<sub>2</sub>O)<sub>6</sub>]<sup>3+</sup> to disproportionate with the precipitation of MnO<sub>2</sub>.

(c) *Mn<sup>3+</sup>(aq)*. Solutions of green [Mn(H<sub>2</sub>O)<sub>6</sub>]<sup>3+</sup><sup>100</sup> are obtained by treating, e.g., a 30-fold excess of [Mn(H<sub>2</sub>O)<sub>6</sub>]<sup>2+</sup> with [MnO<sub>4</sub>]<sup>-</sup> in high acid, e.g., 4 M HClO<sub>4</sub>. The [Mn(H<sub>2</sub>O)<sub>6</sub>]<sup>3+</sup> is stable for several days. In the cesium alum the average Mn–O distance is 199 pm with [Mn(H<sub>2</sub>O)<sub>6</sub>]<sup>3+</sup> in a threefold symmetry environment consistent with the expected dynamic Jahn–Teller distortion of a high-spin *d*<sup>4</sup> configuration. The ion is strongly acidic (pK<sub>a</sub> ~ 0.7; I = 6.0 M ClO<sub>4</sub><sup>-</sup>), reflecting four strongly bound waters. Aqueous solutions of Mn<sup>3+</sup> tend to have higher ε values than those found for Mn<sup>3+</sup> in the alum, and may be indicative of the presence of variable amounts of hydrolyzed species such as Mn<sub>2</sub>(OH)<sub>2</sub><sup>4+</sup>(aq) and/or higher oligomers.<sup>101</sup>

(d) *Mn<sup>IV</sup>(aq)*. The Mn<sup>4+</sup>(aq) ion may have a transient existence at high dilution in strongly acidic solutions before hydrolysis occurs with deposition of the black hydrated MnO<sub>2</sub>. In strongly alkaline solution Mn<sup>IV</sup> is soluble, but undergoes disproportionation to Mn<sup>III</sup> and Mn<sup>V</sup>.

(e) *[MnO<sub>4</sub>]<sup>-</sup>*<sup>102</sup>. The only stable aqueous species at pH 7.0 is the intensely purple tetrahedral [MnO<sub>4</sub>]<sup>-</sup>. The corresponding green [MnO<sub>4</sub>]<sup>2-</sup><sup>102</sup> and blue [MnO<sub>4</sub>]<sup>3-</sup> are only stable in >1.0 M OH<sup>-</sup> and >8.0 M OH<sup>-</sup> solutions, respectively. Under other conditions rapid disproportionation to MnO<sub>2</sub> (alkaline solution) or [Mn(H<sub>2</sub>O)<sub>6</sub>]<sup>2+</sup> and [MnO<sub>4</sub>]<sup>-</sup> occurs. In concentrated H<sub>2</sub>SO<sub>4</sub> the MnO<sub>3</sub><sup>+</sup>(aq) ion may have some existence.

(f) *Tc<sup>I</sup>(aq) and Re<sup>I</sup>(aq)*. Ag<sup>+</sup> catalyzed aquations *fac*-[ReBr<sub>3</sub>(CO)<sub>3</sub>]<sup>2-</sup> and *trans*-[ReBr<sub>2</sub>(CO)<sub>4</sub>]<sup>-</sup> yield *fac*-[Re(H<sub>2</sub>O)<sub>3</sub>(CO)<sub>3</sub>]<sup>+</sup> and *trans*-[Re(H<sub>2</sub>O)<sub>2</sub>(CO)<sub>4</sub>]<sup>+</sup>.<sup>103</sup> *Trans*-[Re(H<sub>2</sub>O)<sub>2</sub>(CO)<sub>4</sub>]<sup>+</sup> transforms slowly into the aqua-pentacarbonyl species. However, *fac*-[Re(H<sub>2</sub>O)<sub>3</sub>(CO)<sub>3</sub>]<sup>+</sup> is stable in aqueous solution with no decomposition detectable in air over several weeks. Kinetic studies of a number of 1:1 anation reactions have been carried out on the latter. The water ligands are quite labile in technetium (<sup>99</sup>Tc and <sup>99m</sup>Tc) analogs.<sup>104</sup> Treatment of *fac*-[Re(H<sub>2</sub>O)<sub>3</sub>(CO)<sub>3</sub>]<sup>+</sup> with OH<sup>-</sup> yields *fac*-[Re<sub>3</sub>(μ<sub>3</sub>-OH)(μ-OH)<sub>3</sub>(CO)<sub>9</sub>]<sup>-</sup> and [Re<sub>2</sub>(μ-OH)<sub>3</sub>(CO)<sub>6</sub>]<sup>-</sup>.

(g) *Tc<sup>II</sup>(aq) and Re<sup>II</sup>(aq)*. Acetonitrile-solvated cations such as [Tc(NCCH<sub>3</sub>)<sub>6</sub>]<sup>2+</sup>, [Tc<sub>2</sub>(NCCH<sub>3</sub>)<sub>10</sub>]<sup>4+</sup>, [Re<sub>2</sub>(NCCH<sub>3</sub>)<sub>8</sub>]<sup>4+</sup>, and [Re<sub>2</sub>(NCCH<sub>3</sub>)<sub>10</sub>]<sup>4+</sup> have been prepared, suggesting that aqua species may exist.

(h) *Tc<sup>III</sup>(aq) and Re<sup>III</sup>(aq)*. Since compounds such as [Tc(thiourea)<sub>6</sub>]Cl<sub>3</sub> are known,<sup>105</sup> the existence of [Tc(H<sub>2</sub>O)<sub>6</sub>]<sup>3+</sup> seems likely. Stable solutions of Tc<sup>III</sup>(aq) are obtained at low concentrations (≤1 mM) in SO<sub>4</sub><sup>2-</sup>, PO<sub>4</sub><sup>3-</sup>, or Cl<sup>-</sup>. The electrochemical 1e<sup>-</sup> reduction of [TcBr<sub>6</sub>]<sup>2-</sup>



indicates ready loss of six  $\text{Br}^-$ . The corresponding reduction of  $[\text{TcCl}_6]^{2-}$  gives mononuclear  $[\text{TcCl}_4(\text{H}_2\text{O})_2]^-$ . Controlled potential reduction of mM solutions of  $\text{Tc}^{\text{VII}}$  in 0.5 M  $\text{HClO}_4$  at a Hg pool electrode yield  $\text{Tc}^{\text{III}}$  and then a deposit of black  $\text{TcO}_2$ .

(i)  $[\text{Re}_6(\mu_3\text{-S})_8(\text{H}_2\text{O})_6]^{2+}$ . Slow (hours)  $\text{Ag}^+(\text{aq})$  catalyzed aqution of  $\text{Cs}_5[\text{Re}_6\text{S}_8\text{Cl}_6]$  in 1 M  $\text{HClO}_4$  yields  $[\text{Re}_6(\mu_3\text{-S})_8(\text{H}_2\text{O})_6]^{2+}$ , which can be purified by cation exchange chromatography.<sup>106</sup> The cluster consists of an octahedron of  $\text{Re}^{\text{III}}$  atoms capped at the triangular faces by  $\text{S}^{2-}$  ions, and each further coordinated by  $\text{H}_2\text{O}$  (Figure 14). Solutions of the orange–yellow cluster are air stable. Water–ligand replacement reactions are slow (days!) at room temperature.<sup>106</sup>

(j)  $\text{Tc}^{\text{IV}}(\text{aq})$  and  $\text{Re}^{\text{IV}}(\text{aq})$ . A  $\text{Tc}^{\text{IV}}(\text{aq})$  species was detected in polarographic work on aqueous  $[\text{TcO}_4]^-$  in the 1940s. Since then there have been claims for  $\text{Tc}^{\text{IV}}(\text{aq})$  species such as  $\text{Tc}_2\text{O}_2(\text{OH})^{3+}(\text{aq})$ ,  $\text{TcO}^{2+}(\text{aq})$ ,  $\text{TcO}(\text{OH})^+(\text{aq})$ , and  $\text{Tc}(\text{OH})_2^{2+}(\text{aq})$ . Further studies are required.

(k)  $\text{Tc}^{\text{V}}(\text{aq})$  and  $\text{Re}^{\text{V}}(\text{aq})$ . Three core structures,  $\text{MO}^{3+}$ , *trans*- $\text{ReO}_2^+$ , and  $(\text{MO})_2(\mu\text{-O})^{4+}$  ( $\text{M} = \text{Tc}, \text{Re}$ ) are known. No aqua ions have been established.

(l)  $\text{Tc}^{\text{VI}}$  and  $\text{Re}^{\text{VI}}$ . Paramagnetic  $\text{Cs}_2[\text{TcNCl}_5]^{107}$  dissolves in water with the formation of a brown precipitate, which in Hpts or  $\text{CF}_3\text{SO}_3\text{H}$  gives diamagnetic yellow solutions.<sup>108</sup> IR bands at  $1046\text{ cm}^{-1}$  and  $734\text{ cm}^{-1}$  are assigned to  $\nu(\text{Tc}\equiv\text{N})$  and  $\nu_{\text{asym}}(\text{Tc}\text{--}\text{O}\text{--}\text{Tc})$  stretches respectively and confirm the presence of  $\mu$ -oxo bridged species (Figure 15).<sup>108</sup>

The UV–vis spectrum of  $[(\text{TcN})_2(\mu\text{-O})_2(\text{H}_2\text{O})_6]^{2+}$  in 1.0 M  $\text{CF}_3\text{SO}_3\text{H}$  has  $\lambda$  peaks/nm ( $\epsilon/\text{M}^{-1}\text{cm}^{-1}$  per  $\text{Tc}_2$ ) at 251 (2760), 295 (2580), and 331 (sh,  $\sim 1930$ ).<sup>109</sup> In  $\geq 7.0\text{ M}$   $\text{CF}_3\text{SO}_3\text{H}$  the spectrum gives an intense peak at 474 ( $>3500$ ) which has been assigned to the single  $\mu$ -oxo bridged cation,  $[(\text{TcN})_2(\mu\text{-O})(\text{H}_2\text{O})_8]^{4+}$ .<sup>110</sup> Pulse radiolysis reduction of  $[\text{TcO}_4]^-$  and  $[\text{ReO}_4]^-$  are believed to give  $[\text{MO}_4]^{2-}$ .<sup>111</sup>

(m)  $\text{Tc}^{\text{VII}}$  and  $\text{Re}^{\text{VII}}$ . Yellow  $\text{Re}_2\text{O}_7(\text{H}_2\text{O})_2$  is obtained on evaporation of solutions of  $\text{HReO}_4$ . An X-ray structure shows that both  $\text{H}_2\text{O}$ s are bound to one  $\text{Re}^{\text{VII}}$  atoms. Cationic  $[\text{ReO}_3(\text{OH}_2)]^+$  has been proposed as an intermediate species when  $[\text{ReO}_4]^-$  exchanges with solvent water under acid catalysis. Nitrido- and sulfido-oxo  $\text{Re}^{\text{VII}}$  ions,  $[\text{ReO}_3\text{N}]^{2-}$  and  $[\text{ReO}_4\text{-}n\text{S}_n]^-$  are also known.

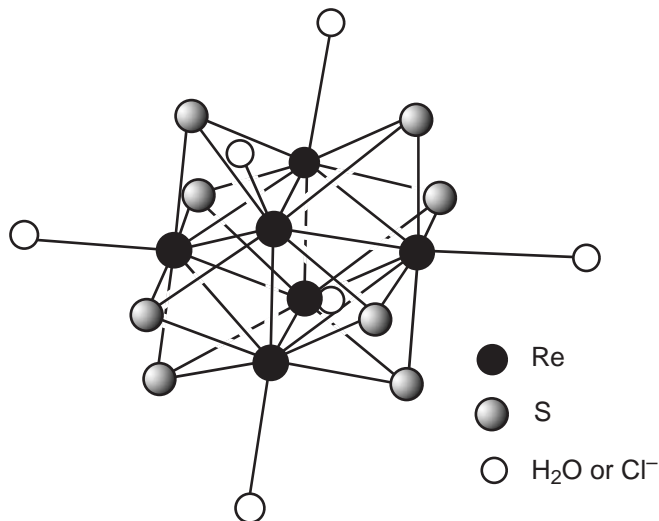


Figure 14 Structure of  $[\text{Re}_6\text{S}_8(\text{H}_2\text{O})_6]^{2+}$  cluster.

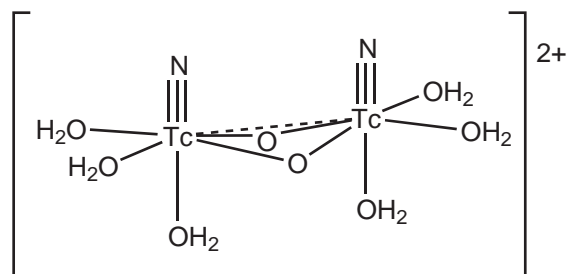


Figure 15 The dinuclear nitrido  $\text{Tc}^{\text{VI}}$  complex  $[(\text{Tc}^{\text{VI}}\text{N})_2(\mu\text{-O})_2(\text{H}_2\text{O})_6]^{2+}$ .<sup>108</sup>

### 1.25.2.8 Group 8: Iron, Ruthenium, and Osmium

(a)  $Fe^{2+}(aq)$ . Pale green  $[Fe(H_2O)_6]^{2+}$  is well characterized by XRD, neutron scattering,  $^{17}O$  and  $^1H$  NMR and EXAFS. Spectroscopic and magnetic properties are consistent with the high-spin  $t_{2g}^4e_g^2$  configuration. At room temperature the magnetic moment is 5.4 BM. The  $FeO_6$  geometry is close to regular octahedral with  $Fe-O$  213 pm. The  $Fe^{3+/2+}(aq)$  electron-exchange reaction has also been studied at high pressures using  $^{59}Fe$ .<sup>112</sup> The results can be accounted for by the Marcus-Hush theory in terms of an adiabatic outer-sphere reaction of  $[Fe(H_2O)_6]^{3+/2+}$  ( $\Delta V^\ddagger = -11.1 \pm 0.4 \text{ cm}^{-1} \text{ mol}^{-1}$ ), and an OH-bridged (more compact) inner-sphere reaction of  $[Fe(H_2O)_5(OH)]^{2+}/[Fe(H_2O)_6]^{2+}$  ( $\Delta V^\ddagger = +0.8 \pm 0.9 \text{ cm}^3 \text{ mol}^{-1}$ ). The reduction potential of the  $[Fe(H_2O)_6]^{3+}/[Fe(H_2O)_6]^{2+}$  couple is 770 mV (vs. nhe).

(b)  $Fe^{3+}(aq)$ . The pale violet color of  $t_{2g}^3e_g^2 [Fe(H_2O)_6]^{3+}$  is due to the spin-forbidden nature of transitions from the  $^6A_{1g}$  ground state. It is present in  $Fe^{III}$  salts such as  $Fe(ClO_4)_3 \cdot 10H_2O$ ,  $Fe(NO_3)_3 \cdot 6 \cdot 9H_2O$ , and alums  $M[Fe(H_2O)_6](XO_4)_2 \cdot 6H_2O$  ( $X = S, Se$ ).<sup>113</sup> In neutron diffraction studies the sulfate alum has waters trigonal planar at O-atoms ( $\beta$ -forms), whereas the selenate has tetrahedral geometry at the oxygen ( $\alpha$ -form). These effects are attributed to different hydrogen bonding effects. The hexaqua structure has been confirmed by XRD, neutron scattering, and EXAFS measurements, and the  $Fe-O$  bond is 200 pm. The hexaqua ion has  $pK_a$  of 2.2 ( $I \rightarrow 0$ ), and 2.8 ( $I = 1.0 \text{ M ClO}_4^-$ ). Yellow  $FeOH^{2+}$  dimerizes and oligomerizes to give brown products.<sup>114</sup> The aqua dimer has been formulated having a di- $\mu$ -hydroxo or single  $\mu$ -oxo linkage. Complexes of  $Fe^{III}$  with pyridine dicarboxylic (i.e., dipicolinic) acids give both forms, and the energy difference may therefore be quite small. From magnetic and infrared data the di- $\mu$ -hydroxo formulation  $[Fe_2(\mu-OH)_2(H_2O)_8]^{4+}$  is favored, but attempts to determine the structure using X-ray diffraction methods has not been successful. Only at small  $Fe^{III}$  concentrations ( $< 10^{-5} \text{ M}$ ) do mononuclear hydrolysis products become more relevant.

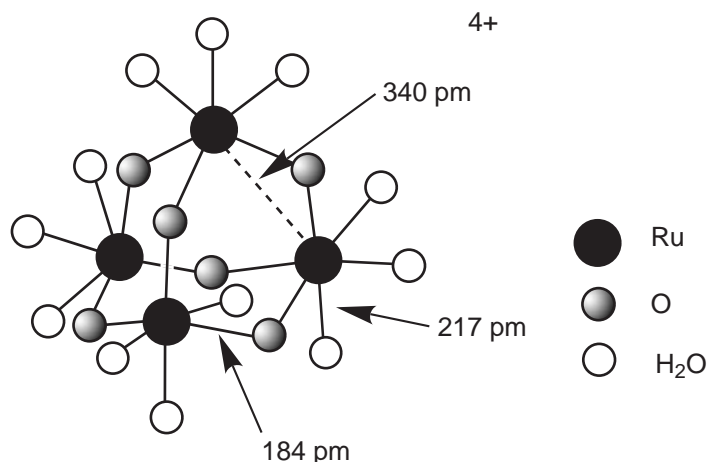
(c)  $Fe^{IV}(aq)$ . Structural, magnetic, and Mössbauer properties of iron(IV) oxides  $Ba_2[FeO_4]$  and  $Ba_2[FeO_4] \cdot BaO$  have been reported.<sup>115</sup>

(d)  $Fe^{VI}(aq)$ . Tetrahedral  $[FeO_4]^{2-}$  can be prepared in  $> 0.5 \text{ M KOH}$  by electrolysis of an iron anode or by alkaline  $KOCl$  oxidation of  $Fe^{III}(aq)$ . Rapid precipitation of  $K_2[FeO_4]$  from cold solutions is achieved by addition of  $KOH$  and is necessary to avoid decomposition. Water exchange on  $[FeO_4]^{2-}$  with solvent water has been investigated using  $^{18}O$  labeling. Decomposition of  $[FeO_4]^{2-}$  occurs rapidly at lower pH with evolution of  $O_2$ . The reduction potential of the  $Fe^{VI}/Fe^{III}$  couple is  $\sim +2.0 \text{ V}$ , making it a stronger oxidant than  $[MnO_4]^-$ . Oxidation of  $[Fe(CN)_6]^{4-}$  and  $[Fe(CN)_5H_2O]^{3-}$ , phenols and alcohols have all been studied.<sup>116</sup>

(e)  $Ru^{2+}(aq)$ . Solutions of  $Ru^{2+}(aq)$  are air sensitive. The preparation of pink salts from Ru metal or  $RuO_2$  have been described. An XRD of  $[Ru(H_2O)_6](pts)_2$  has been reported with  $Ru-O$  212 pm.<sup>117</sup> A wide range of ruthenium aqua organo-metallic compounds have been prepared;  $N_2$  and  $CO$  mono-substituted derivatives are also known.<sup>118,119</sup> It has been found that  $[Ru(H_2O)_6]^{2+}$  is an active catalyst for alkene isomerization, and for alkene polymerization reactions. In the dimerization of ethene, reactive intermediates  $[Ru(CH_2=CH_2)(H_2O)_5](pts)_2$  and  $[Ru(CH_2=CH_2)_2(H_2O)_4](pts)_2$  have been identified by  $^{17}O$  NMR spectroscopy.<sup>120</sup> Reaction of  $[Ru(H_2O)_6]^{2+}$  with 1,4-cyclohexadiene (or the 1,3 isomer) in ethanol gives the  $\pi$ -arene complex  $[Ru(\pi-C_6H_6)(H_2O)_3]^{2+}$ .<sup>121</sup> The reactions of these and corresponding osmium analogs have been studied extensively. Considerable labilization of the water ligands is apparent from stopped-flow studies.<sup>122</sup> The reduction potential of the  $[Ru(H_2O)_6]^{3+}/[Ru(H_2O)_6]^{2+}$  couple is 0.217 V (vs. nhe).

(f)  $Ru^{3+}(aq)$ . Solutions containing yellow  $[Ru(H_2O)_6]^{3+}$  are best prepared by simple air oxidation of  $[Ru(H_2O)_6]^{2+}$ . Crystals of  $[Ru(H_2O)_6](pts)_3 \cdot 3H_2O$  give  $Ru-O$  of 203 pm. The UV-vis and EPR spectra for  $[Ru(H_2O)_6]^{3+}$  have been reported.<sup>123</sup> Acid dissociation of  $[Ru(H_2O)_6]^{3+}$  gives  $pK_a \sim 2.7$  ( $I = 1.0 \text{ M ClO}_4^-$ ). The relatively slow water-exchange processes allow a direct measurement of the self-exchange processes using both  $^{17}O$  and  $^{99}Ru$  NMR spectroscopy.<sup>124</sup> Both the  $[Ru(H_2O)_6]^{3+/2+}$  reactions are slower than electron exchange,  $k_{H_2O} (25^\circ C) = 20 \text{ M}^{-1} \text{ s}^{-1}$ . This leads to the  $[Ru(H_2O)_6]^{3+/2+}$  couple exhibiting good diffusion-controlled reversible behavior on a range of surfaces in cyclic voltammetric experiments.

(g)  $Ru^{IV}(aq)$ . The diamagnetic reddish-brown  $Ru^{IV}(aq)$  cation has been known since the 1950s. Initially, monomeric  $RuO^{2+}(aq)$  (ruthenyl), or  $Ru(OH)_2^{2+}(aq)$ , and dimeric  $Ru^{IV}(aq)$  structures were proposed. However, more recent work favors a tetranuclear  $\mu$ -oxo-bridged species.<sup>125</sup> Methods of preparation include electrochemical oxidation of either  $[Ru(H_2O)_6]^{3+}$ , and the reaction of  $[RuBr_6]^{2-}$  with  $BrO_3^-$ .<sup>126</sup> From Ru K edge EXAFS studies, an adamantane-like structure was obtained. A structure  $[Ru_4(\mu-O)_6(H_2O)_{12}]^{4+}$  has been deduced



**Figure 16** Structure of tetrameric aqua  $\text{Ru}^{\text{IV}}$  ion  $[\text{Ru}_4(\mu\text{-O})_6(\text{H}_2\text{O})_{12}]^{4+}$  deduced from  $^{17}\text{O}$  NMR and Ru K edge EXAFS data.<sup>127</sup>

(Figure 16).<sup>127</sup> The strong downfield 1,150 ppm for the  $\mu\text{-O}$  group in  $^{17}\text{O}$  NMR studies, and short  $\text{Ru}\text{-}\mu\text{O}$  distances (184 pm) suggest a strong covalent component.<sup>125</sup> The  $\text{Ru}_4(\mu\text{-O})_6^{4+}(\text{aq})$  core is labile and readily decomposes, e.g., with excess  $\text{NCS}^-$  to give S-bonded  $[\text{Ru}(\text{SCN})_6]^{3-}$ .

(h)  $\text{Ru}^{\text{V}}$  to  $\text{Ru}^{\text{VIII}}(\text{aq})$ . Oxo forms are dominant in the chemistry of these states. The dichloro species  $[\text{Ru}^{\text{V}}\text{OCl}_2(\text{H}_2\text{O})_3]^+$ , detected as an intermediate in the oxidation of  $[\text{Ru}^{\text{III}}\text{Cl}_2(\text{H}_2\text{O})_4]^+$ , can be viewed as a derivative of  $[\text{Ru}^{\text{V}}\text{O}(\text{H}_2\text{O})_5]^{3+}$ . Ruthenium(VI) is known as the diprotonated trigonal bipyramidal form  $[\text{RuO}_3(\text{OH})_2]^{2-}$  in the solid state, while  $[\text{RuO}_4]^{2-}$  is stable in IMKOH. In the case of  $\text{Ru}^{\text{VII}}$  the  $[\text{RuO}_4]^-$  is most stable in neutral solution. At low pH disproportionation is observed. While at high pH oxidation of  $\text{OH}^-$  occurs. Both  $\text{Ru}^{\text{VII}}$  and  $\text{Ru}^{\text{VIII}}(\text{aq})$  give tetraoxo species,  $\text{RuO}_4^-$  and  $\text{RuO}_4$  respectively. Aqueous solutions of  $\text{RuO}_4$  are weakly acidic, and the formulation  $\text{RuO}_4\cdot\text{H}_2\text{O}$  may actually be  $\text{RuO}_3(\text{OH})_2$ . The half life for  $\text{Ru}^{\text{VII}/\text{VI}}$  electron exchange is quite short ( $<5$  s). The use of  $\text{RuO}_4$  as a powerful if largely unselective oxidizing agent has been extensively reported. Care is required in handling this reagent.

(i)  $\text{Os}^{\text{II}}(\text{aq})$ ,  $\text{Os}^{\text{III}}(\text{aq})$ ,  $\text{Os}^{\text{IV}}(\text{aq})$ . Advances in osmium chemistry have been reviewed.<sup>128</sup> Oxo species such as *trans*- $[\text{Os}^{\text{VI}}(\text{O})_2(\text{OH})_4]^{2-}$ , *cis*- $\text{Os}^{\text{VIII}}(\text{O})_4(\text{OH})_2]^{2-}$ , and tetrahedral  $\text{OsO}_4$  are known. A number of aqua-chloro species, e.g.,  $[\text{OsCl}_4(\text{H}_2\text{O})_2]^-$ , are formed in the electrochemical reduction of *trans*- $[\text{Os}^{\text{VI}}(\text{O})_2\text{Cl}_4]^{2-}$  in aqueous HCl.<sup>129</sup> However, in non-complexing acids, *trans*- $[\text{Os}^{\text{VI}}(\text{O})_2(\text{OH})_4]^{2-}$  disproportionates to give  $\text{OsO}_4$  and  $\text{OsO}_2\cdot n\text{H}_2\text{O}$ . Polarographic waves for the reduction of  $\text{Os}^{\text{VIII}}$  to  $\text{Os}^{\text{III}}$  in both acidic and alkaline solutions of  $\text{OsO}_4$  suggest the existence of  $\text{Os}^{3+}(\text{aq})$ . There is, however, as yet no confirmation of  $[\text{Os}(\text{H}_2\text{O})_6]^{3+}$ .

(j)  $\text{Os}^{\text{VIII}}(\text{aq})$ . Pale yellow  $\text{OsO}_4$  has quite high solubility in water ( $72.4\text{ gL}^{-1}$  at  $25^\circ\text{C}$ ). Aqueous solutions are weakly acidic with a small conductance due to formation of  $\text{H}_2[\text{Os}(\text{O})_4(\text{OH})_2]$ . It finds use as a specific *cis*-hydroxylating agent in reactions of olefins and more generally as a biological stain. Like  $\text{RuO}_4$ ,  $\text{OsO}_4$  should be used with care, as it is volatile and can react with the cornea and damage eyesight.

### 1.25.2.9 Group 9: Cobalt, Rhodium, and Iridium

(a)  $\text{Co}^{2+}(\text{aq})$ . Solutions of reddish-pink  $[\text{Co}(\text{H}_2\text{O})_6]^{2+}$  are obtained from commercially available  $\text{Co}(\text{ClO}_4)_2\cdot 6\text{H}_2\text{O}$ ,  $\text{Co}(\text{NO}_3)_2\cdot 6\text{H}_2\text{O}$ , and  $\text{CoSO}_4\cdot 7\text{H}_2\text{O}$ . Recent crystal structures give  $\text{Co}\text{-OH}_2$  distances of 208–210 pm, and the octahedral structure in solution has been verified by EXAFS and XRD measurements. High-temperature solutions of  $\text{Co}^{2+}(\text{aq})$  contain small but significant amounts of the  $[\text{Co}(\text{H}_2\text{O})_4]^{2+}$ <sup>130</sup> presumed tetrahedral. The electronic spectrum of  $\text{Co}^{2+}(\text{aq})$  has been re-interpreted using *ab initio* methods.<sup>131</sup> Acid dissociation gives  $[\text{Co}(\text{H}_2\text{O})_5(\text{OH})]^+$  ( $\text{p}K_{\text{a}} 9.7$ ;  $I=0.1\text{ M ClO}_4^-$ ) with significant amounts of tetranuclear  $\text{Co}_4(\text{OH})_4^{4+}(\text{aq})$  forming at higher  $[\text{Co}^{\text{II}}]$  ( $>0.1\text{ M}$ ) prior to precipitation of hydrated  $\text{Co}(\text{OH})_2$  at  $\sim\text{pH } 11$ . At  $\text{pH } >12$ , the amphoteric hydroxide redissolves to form blue solutions of tetrahedral  $[\text{Co}(\text{OH})_3(\text{H}_2\text{O})]^-$  and  $[\text{Co}(\text{OH})_4]^{2-}$ .



(b)  $\text{Co}^{3+}(\text{aq})$ . The highly oxidizing low-spin blue–green  $[\text{Co}(\text{H}_2\text{O})_6]^{3+}$  ion is present in solid alums and in the hydrated sulfate  $\text{Co}_2(\text{SO}_4)_{2.1} \cdot 8\text{H}_2\text{O}$ . Care is required to avoid reduction by water where  $E^\circ$  for the  $[\text{Co}(\text{H}_2\text{O})_6]^{3+/2+}$  couple is 1.85 V vs. nhe. Solutions are best prepared by electrolytic oxidation of  $2 \times 10^{-2} \text{ M Co}(\text{ClO}_4)_2 \cdot 6\text{H}_2\text{O}$  at a Pt gauze electrode (current  $< 20 \text{ mA cm}^{-2}$ ) in 3.0 M  $\text{HClO}_4$ .<sup>132</sup> An Hg-pool cathode is used, and the temperature maintained at  $0^\circ\text{C}$  for 15–17 h to give  $\sim 70\%$ , sometimes 85%, conversion. Solutions are stored under  $\text{N}_2$  or argon and should be kept covered and “dust” free at all times. Under these rigorous conditions the product solutions at  $25^\circ\text{C}$  are stable ( $< 3\%$  decay) for at least 8 h. Solutions can be standardized from the peak at 605 nm ( $\epsilon = 35.3 \text{ M}^{-1} \text{ cm}^{-1}$ ). The acid dissociation constant ( $K_a$ ) for  $[\text{Co}(\text{H}_2\text{O})_6]^{3+}$  is  $(2 \pm 1) \times 10^{-3} \text{ M}^{-1}$ . Kinetic data for oxidations of a wide range of substrates by  $\text{Co}^{3+}(\text{aq})$  have been determined.<sup>133</sup> In all reactions  $\text{CoOH}^{2+}(\text{aq})$  is the dominant reactant. Efforts to elucidate the precise mechanism of reactions of  $[\text{Co}(\text{H}_2\text{O})_6]^{3+}$  are complicated by unavoidable amounts of the more labile  $[\text{Co}(\text{H}_2\text{O})_6]^{2+}$  and by a possible high-spin  $\text{Co}^{3+}(\text{aq})$  component.<sup>134</sup> It should be noted that  $[\text{Co}(\text{H}_2\text{O})_6]^{3+}$  promotes the polymerization of acrylonitrile and methyl–methacrylate and is a useful oxidant for a range of organic reactions.

(c)  $\text{Rh}^{2+}(\text{aq})$ . Green Rh–Rh bonded  $[\text{Rh}_2(\text{H}_2\text{O})_{10}]^{4+}$ , first reported by Taube in 1968, is prepared via reduction from  $\text{Rh}^{3+}(\text{aq})$  or  $\text{RhCl}_2^+(\text{aq})$  by  $\text{Cr}^{2+}(\text{aq})$ .<sup>135,136</sup> Solutions stored air-free can be kept at  $0^\circ\text{C}$  for several weeks without significant deterioration. The weak paramagnetism of  $\text{Rh}_2^{4+}(\text{aq})$  contrasts with  $[\text{Co}(\text{H}_2\text{O})_6]^{2+}$ . As yet there are no X-ray structures of  $\text{Rh}_2^{4+}(\text{aq})$ . The acetonitrile solvate  $[\text{Rh}_2(\text{NCCH}_3)_{10}](\text{BF}_4)_4$  has a “staggered” arrangement of “ $\text{Rh}(\text{NCCH}_3)_4$ ” units and longer bonds to the two axial ligands.<sup>137</sup> Kinetically distinct equatorial and axial water ligands on  $[\text{Rh}_2(\text{H}_2\text{O})_{10}]^{4+}$  are apparent from  $^{17}\text{O}$  NMR studies (Figure 17).<sup>135</sup> Complexation of monodentate  $\text{Cl}^-$  and  $\text{Br}^-$  on  $[\text{Rh}_2(\text{H}_2\text{O})_{10}]^{4+}$  leads to disproportionation giving  $\text{Rh}^{\text{III}}$  and Rh metal. However, potential bridging ligands preserve the Rh–Rh dimer unit and form stable  $\text{Rh}_2^{4+}$  complexes such as  $[\text{Rh}_2(\text{O}_2\text{CCH}_3)_4(\text{H}_2\text{O})_2]$ .

The reaction of  $[\text{Rh}_2(\text{H}_2\text{O})_{10}]^{4+}$  with  $\text{O}_2$  leads to the formation of the superoxo-bridged  $\text{Rh}^{\text{III}}_2$  species  $[\text{Rh}_2(\mu\text{-O}_2^-)(\mu\text{-O})(\text{H}_2\text{O})_8]^{3+}$ .<sup>138</sup> The  $[\text{Rh}_2(\text{H}_2\text{O})_{10}]^{4+}$  ion, quadruply bonded  $[\text{Mo}_2(\text{H}_2\text{O})_8]^{4+}$ , and singly bonded  $[\text{Hg}_2(\text{H}_2\text{O})_2]^{2+}$  are examples of M–M bonded aqua ions with no bridging ligands in support.

(d)  $\text{Rh}^{3+}(\text{aq})$ . Yellow needles of  $[\text{Rh}(\text{H}_2\text{O})_6](\text{ClO}_4)_3 \cdot 3\text{H}_2\text{O}$  separate on cooling concentrated solutions of  $[\text{Rh}(\text{H}_2\text{O})_6]^{3+}$  prepared by treatment of  $\text{RhCl}_3 \cdot x\text{H}_2\text{O}$  with 72%  $\text{HClO}_4$  followed by dilution and cation-exchange chromatography. The crystals can be dried at  $110^\circ\text{C}$  *in vacuo*.<sup>139</sup> The X-ray structure reveals long Rh–O bonds (213 pm) as found in the cesium  $\alpha$  alum,<sup>140</sup> which are attributed to specific  $\text{ClO}_4^- - \text{H}_2\text{O}$  interactions and/or disorder. EXAFS and large-angle X-ray scattering (LAXS) studies on  $\text{Rh}^{3+}(\text{aq})$  solutions give a distance of 203 pm,<sup>141</sup> broadly in line with the  $\alpha$  alum structure. Thus, a significant tilt of the H–O–H plane from the M–O bond vector is seen<sup>140</sup> indicating  $sp^3$  hybridization at oxygen-permitting strong  $\sigma$ -bonding into the empty  $e_g$  orbitals of the low-spin  $t_{2g}^6$  center (Figure 1). Evidence of a well-defined secondary hydration shell of  $13 \pm 1$  water molecules at a Rh–O distance of  $402 \pm 2 \text{ pm}$  is also apparent.<sup>141</sup> The rigid H-bonding network between primary and secondary hydration shells is believed to be responsible for the anomalously slow proton exchange kinetics in solutions of  $[\text{Rh}(\text{H}_2\text{O})_6]^{3+}$ . Hydrolytic dimers and higher oligomers of  $\text{Rh}^{3+}(\text{aq})$  have recently been structurally characterized.<sup>139</sup> The conjugate base  $[\text{Rh}(\text{H}_2\text{O})_5(\text{OH})]^{2+}$  is a dominant contributor to both water replacement on  $\text{Rh}^{3+}$  and reduction of  $\text{Rh}^{3+}(\text{aq})$  to  $\text{Rh}_2^{4+}(\text{aq})$ .<sup>136</sup> A  $\text{p}K_a$  of  $\sim 4$  ( $25^\circ\text{C}$ ) is in agreement with a number of earlier studies at 1.0 M ionic strength. The dimer  $[\text{Rh}_2(\mu\text{-OH})_2(\text{H}_2\text{O})_8]^{4+}$ , trimer  $[\text{Rh}_3(\mu\text{-OH})_4(\text{H}_2\text{O})_{10}]^{5+}$ , and tetramer  $[\text{Rh}_4(\mu\text{-OH})_6(\text{H}_2\text{O})_{12}]^{6+}$  structures have been determined by XRD, as well as by  $^{103}\text{Rh}$  and  $^{17}\text{O}$  NMR.<sup>142</sup> Co-crystallization of each oligomer within bilayers of  $\text{Na}^+[\text{18-crown-6}]$  and *p*-sulfonated

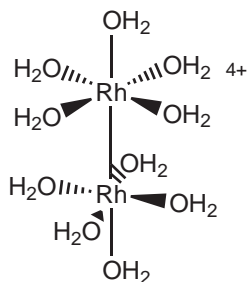


Figure 17 Structure of  $[\text{Rh}_2(\text{H}_2\text{O})_{10}]^{4+}$ .<sup>135</sup>

calix-[4]-arenes has been reported. Cyclic structures as with  $\text{Cr}^{\text{III}}$  are relevant for trinuclear and tetranuclear forms.

(e)  $\text{Rh}^{\text{IV}}(\text{aq})$ . An alleged high valent aqueous rhodium species has been shown to be more probably dimeric  $\mu$ -superoxo  $\text{Rh}^{\text{III}}(\text{aq})$ ,<sup>143</sup> with an EPR spectrum matching that of the product of  $\text{O}_2$  oxidation of  $\text{Rh}_2^{4+}(\text{aq})$ .<sup>138</sup>

(f)  $\text{Ir}^{3+}(\text{aq})$ . Pale yellow air-sensitive  $[\text{Ir}(\text{H}_2\text{O})_6]^{3+}$  was first prepared in 1976.<sup>144</sup> In contrast to  $[\text{Rh}(\text{H}_2\text{O})_6]^{3+}$  it is readily oxidized to higher valent aqua species.<sup>145</sup> From anation and water-exchange studies it is the most inert aqua ion.<sup>146,147</sup> It is obtained by acidification of solid  $[\text{Ir}(\text{OH})_3(\text{H}_2\text{O})_3]$ , prepared by base hydrolysis of  $[\text{IrCl}_6]^{3-}$  to  $[\text{Ir}(\text{OH})_6]^{3-}$  at pH 8.<sup>144</sup> Solutions of  $[\text{Ir}(\text{H}_2\text{O})_6]^{3+}$  have been made strong enough (0.37 M) to allow recording of the natural abundance  $^{17}\text{O}$  NMR spectrum of the bound waters ( $\delta = -154$  ppm from bulk  $\text{H}_2\text{O}$ ). An X-ray structure of the  $\alpha$  alum has been determined.<sup>148</sup> The UV-vis spectrum gives  $\lambda/\text{nm}$  peaks ( $\epsilon/\text{M}^{-1}\text{cm}^{-1}$ ) at 271 (44) and 314 (40).<sup>148</sup> Acid dissociation of  $[\text{Ir}(\text{H}_2\text{O})_6]^{3+}$  to  $[\text{Ir}(\text{H}_2\text{O})_5\text{OH}]^{2+}$  occurs with  $\text{p}K_{\text{a}} = 4.37$  ( $I = 1.0 \text{ M ClO}_4^-$ ). Dimeric  $[\text{Ir}_2(\mu\text{-OH})_2(\text{H}_2\text{O})_8]^{4+}$  and  $[\text{Ir}_2(\mu\text{-OH})(\text{H}_2\text{O})_{10}]^{5+}$  can be isolated by reduction of dimeric forms of  $\text{Ir}^{\text{IV}}(\text{aq})$  (see Scheme in Figure 18).

(g)  $\text{Ir}^{\text{IV}}(\text{aq})$  and  $\text{Ir}^{\text{V}}(\text{aq})$ . In contrast to  $\text{Rh}^{3+}(\text{aq})$ , higher valent  $\text{Ir}^{\text{IV}}$  and  $\text{Ir}^{\text{V}}$  (aq) forms have been prepared from  $\text{Ir}^{3+}(\text{aq})$  and characterized. Oxidation is achieved using  $\text{Ce}^{\text{IV}}(\text{aq})$ ,  $\text{O}_3$  or at a Pt electrode to generate green-brown solutions of  $\text{Ir}^{\text{V}}(\text{aq})$  ( $5d^4$ ). These can be reduced (electrochemically or with  $\text{Fe}^{2+}(\text{aq})$  or  $\text{I}^-$ ) to blue-purple  $\text{Ir}^{\text{IV}}(\text{aq})$  solutions and eventually to yellow  $\text{Ir}^{\text{III}}(\text{aq})$ . Two dinuclear  $\text{Ir}^{\text{III}}$  products  $[\text{Ir}_2(\mu\text{-OH})_2(\text{H}_2\text{O})_8]^{4+}$  and  $[\text{Ir}_2(\mu\text{-OH})(\text{H}_2\text{O})_{10}]^{5+}$  have been separated from these solutions by Dowex 50W cation-exchange chromatography.<sup>143</sup> Both have been characterized by  $^{17}\text{O}$  NMR. On oxidation  $[\text{Ir}_2(\mu\text{-OH})_2(\text{H}_2\text{O})_8]^{4+}$  and  $[\text{Ir}_2(\mu\text{-OH})(\text{H}_2\text{O})_{10}]^{5+}$  give blue ( $\lambda_{\text{max}} 584 \text{ nm}$ ,  $\epsilon = 1190 \text{ M}^{-1}\text{cm}^{-1}$ ) and purple ( $\lambda_{\text{max}} 547 \text{ nm}$ ,  $\epsilon = 1700$ ) forms of dinuclear  $\text{Ir}^{\text{IV}}(\text{aq})$  products (Figure 18). The blue converts to purple within minutes in aqueous  $\text{HClO}_4$  solutions with an inverse dependence on  $[\text{H}^+]$ .<sup>145</sup> The green-brown  $\text{Ir}^{\text{V}}(\text{aq})$  ( $\lambda_{\text{max}} \sim 450 \text{ nm}$ ,  $\epsilon \sim 1300$ ) is reduced spontaneously in water with formation of  $\text{Ir}^{\text{IV}}(\text{aq})$ . Reduction potentials (vs. nhe) for the  $\text{Ir}^{\text{V}/\text{IV}}(\text{aq})$  and  $\text{Ir}^{\text{IV}/\text{III}}(\text{aq})$  couples have been determined (Figure 18).<sup>145</sup>

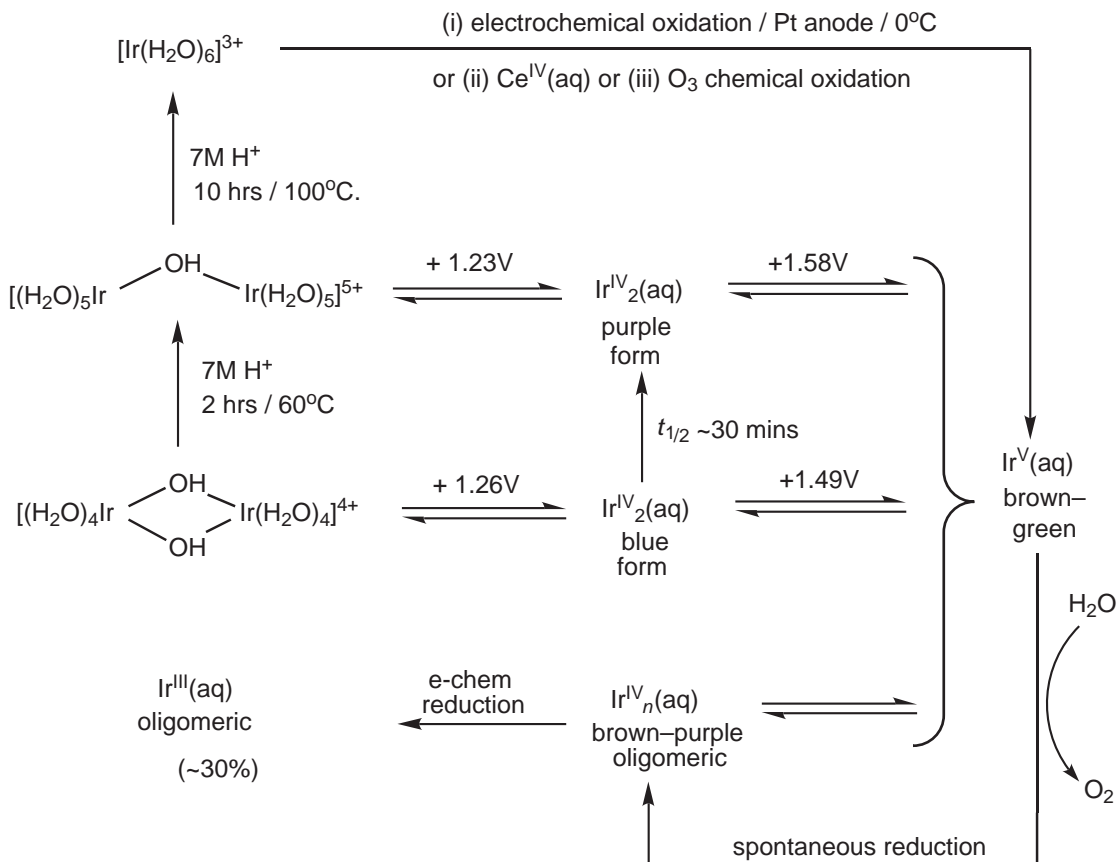


Figure 18 Scheme showing interconversion of  $\text{Ir}^{\text{III}}$ ,  $\text{Ir}^{\text{IV}}$ , and  $\text{Ir}^{\text{V}}$  forms.<sup>145</sup>

### 1.25.2.10 Group 10: Nickel, Palladium, and Platinum

(a)  $Ni^{2+}(aq)$ . Whereas  $[Ni(H_2O)_6]^{2+}$  is octahedral, both  $[Pd(H_2O)_4]^{2+}$  and  $[Pt(H_2O)_4]^{2+}$  are square-planar. The X-ray structure of  $[Ni(H_2O)_6](C_6H_5SO_3)_2$  has been reported.<sup>149</sup> The coordination number has also been verified by both neutron scattering, and by NMR peak area measurements on concentrated aqueous solutions of  $Ni^{2+}$  salts. Alkaline conditions are required to generate  $[Ni(H_2O)_5OH]^+$  ( $pK_a$  10.5;  $I = 1.0 M ClO_4^-$ ) prior to precipitation of green hydrated  $Ni(OH)_2$  at pH 10. At high concentrations ( $>0.1 M$ ) the tetranuclear cuboidal ion  $[Ni_4(OH)_4]^{4+}(aq)$  is formed at pH  $>8$ . Much more is known of  $[Ni_4(OH)_4]^{4+}(aq)$  than of the corresponding  $Co^{II}$  species. The kinetics of the formation and acid decomposition of the tetramer has been studied.

(b)  $Ni^{3+}(aq)$ . Two forms of hydrated “ $Ni_2O_3$ ,” referred to as  $\alpha$ - and  $\beta$ - $NiO(OH)$ , are reported to dissolve in acids with the formation of  $Ni^{3+}(aq)$  before evolution of dioxygen and reduction to  $[Ni(H_2O)_6]^{2+}$ .<sup>150</sup> However, the most stable  $Ni^{III}$  complexes are those with ligands favoring a low-spin  $d^7$  configuration such as certain tetrazamacrocycles, peptides, and sulfido ligands.

(c)  $Pd^{2+}(aq)$  and  $Pt^{2+}(aq)$ . The successful synthesis and characterization of  $[Pd(H_2O)_4]^{2+}$  and  $[Pt(H_2O)_4]^{2+}$  is largely due to the work of Elding.<sup>151</sup> The lead-in compounds are  $[PdCl_4]^{2-}$  and  $[PtCl_4]^{2-}$  ions. Rapid aquation of  $[PdCl_4]^{2-}$  occurs in non-complexing acidic solution and ultimately  $[Pd(H_2O)_4]^{2+}$  is formed. Other methods make use of precipitation of the chloride-free hydrated hydroxide or dissolution of Pd metal in fuming nitric acid. Similar acid-catalyzed aquation of  $[PtCl_4]^{2-}$  only produces micromolar quantities of  $[Pt(H_2O)_4]^{2+}$  owing to the higher kinetic and thermodynamic stability of  $[PtCl(H_2O)_3]^+$ . As a result, metal-catalyzed equation with  $Hg^{2+}(aq)$  or  $Ag^+(aq)$  is employed, the latter being preferred since excess  $Ag^+$  is readily removed.<sup>151</sup> A  $pK_a$  of 2.3 has been determined for  $[Pd(H_2O)_4]^{2+}$ . Estimates for  $[Pt(H_2O)_4]^{2+}$  are  $\geq 2.5$ .

(d)  $Pd^{III}(aq)$  and  $Pt^{III}(aq)$ . Although a number of Pt–Pt bonded dinuclear complexes have been characterized such as  $(NH_4)_2[Pt_2(SO_4)_4(H_2O)_2]$ ,<sup>152</sup> no corresponding aqua ions have been characterized for either metal.

(e)  $Pd^{IV}(aq)$  and  $Pt^{IV}(aq)$ . There are few well-characterized  $Pd^{IV}(aq)$  complexes. Oxidation of  $[Pt(H_2O)_4]^{2+}$  with dry chlorine gas gives  $[PtCl(H_2O)_5]^{3+}$ . Formation of  $[Pt(H_2O)_6]^{4+}$  has not so far been observed, and 5–10 M non-complexing concentrated acids are a likely requirement to retain the hexaaqua ion. The  $pK_a$  of  $[Pt(NH_3)_6]^{4+}$  is 7.1, and that of  $[Pt(H_2O)_6]^{4+}$  is estimated to be  $<1$ . It has also been observed that  $[Pt(OH)(NH_3)_5]^{3+}$  and not the aqua complex crystallizes from concentrated HCl. Should  $[Pt(H_2O)_6]^{4+}$  be isolated it would be expected to be more inert than  $[Ir(H_2O)_6]^{3+}$ .

### 1.25.2.11 Group 11: Copper, Silver, and Gold

(a)  $Cu^+(aq)$ . The  $Cu^+(aq)$  ion undergoes disproportionation to  $Cu^{2+}(aq)$  and Cu metal. Disproportionation can be quite slow, however, and 0.01 M  $Cu^+(aq)$  is stable for up to 10 h in 0.1 M  $HClO_4$  at 0°C. The coordination number of  $Cu^+(aq)$  is not clear. EXAFS studies on aqueous CuBr suggest the presence of weakly solvated linear  $[Br-Cu-OH_2]$  ( $Cu-O \sim 206$  pm).<sup>153</sup> However, MD simulations of the EXAFS data failed to identify the extent of water coordination in the absence of halide. The ability of  $\pi$ -acceptor ligands such as acetonitrile to stabilize  $Cu^I$  (also  $Ag^I$  and  $Au^I$ ) is well documented, and tetrahedral  $[Cu(CH_3CN)_4]^+$  is well characterized.<sup>154</sup> In water–acetonitrile mixes  $[Cu(CH_3CN)_x(H_2O)_y]^+$  doubtless exist, but  $x$  and  $y$  remain uncertain. Electron transfer within the  $Cu^{2+/+}(aq)$  couple at a copper electrode has been shown to be adiabatic.<sup>155</sup>

(b)  $Cu^{2+}(aq)$ . The bright blue  $Cu^{2+}(aq)$  ion dominates aqueous copper chemistry and until recently this has been assumed to be present as the tetragonally distorted octahedral species  $[Cu(H_2O)_4(H_2O)_2]^{2+}$ .<sup>156</sup> The ion is in rapid flux due to a dynamic Jahn–Teller process. A number of X-ray and neutron diffraction studies on  $Cu^{2+}(aq)$  and in solid hydrates show a clear tetragonal distortion. The four equatorial waters are at a mean Cu–O distance of between 196 pm and 200 pm, but accurate distance information for the axial waters is made difficult to measure due to interference from the secondary hydration shell and, in some cases, counter-ions. The structure of the dinuclear cation present in the salt  $[Cu_2(H_2O)_{10}][Cu(H_2O)_6](ZrF_7)_2$  reveals four short equatorial waters (Cu–O = 194 pm) and two longer “axial” waters (Cu–O = 250 pm). Four short bonds to equatorial water molecules (Cu–O = 197 pm) are also a feature of structural investigations on  $CuSO_4 \cdot 5H_2O$ ,<sup>157</sup> and a very pronounced distortion is present in  $[Cu(H_2O)_4](SiF_6)_2$  (Cu–O = 195 pm) with  $Cu-F_{ax} = 234$  pm.<sup>158</sup> However, recent neutron diffraction investigations on the first solvation

shell of  $\text{Cu}^{2+}(\text{aq})$  coupled to MD simulations indicate a rapid interconversion between square-pyramidal and trigonal-bipyramidal five-coordinated  $[\text{Cu}(\text{H}_2\text{O})_5]^{2+}$ .<sup>159</sup> Acid dissociation of  $[\text{Cu}(\text{H}_2\text{O})_5]^{2+}$  to  $\text{CuOH}^+(\text{aq})$  ( $\text{p}K_{\text{a}} 7.3$ ;  $I = 0.1 \text{ M NO}_3^-$ ) is observed.

(c)  $\text{Cu}^{3+}(\text{aq})$ . Transient  $\text{Cu}^{\text{III}}(\text{aq})$  can be generated by pulse radiolysis  $\text{OH}\cdot$  oxidation of  $[\text{Cu}(\text{H}_2\text{O})_5]^{2+}$ , when at neutral pH a characteristic absorption peak at 290 nm ( $\epsilon \sim 5,700$ ) is observed.<sup>160</sup> The product is short lived. No conventional oxidants able to oxidize  $\text{Cu}^{\text{II}}(\text{aq})$  to  $\text{Cu}^{\text{III}}(\text{aq})$  have been identified, and the reduction potential is high. However, a variety of deprotonated peptide complexes of  $\text{Cu}^{\text{III}}$  are stable in alkaline solutions, when  $\text{Cu}^{\text{III}}/\text{Cu}^{\text{II}}$  reduction potentials in the range 0.45–1.02 V have been observed.<sup>161</sup>

(d)  $\text{Ag}^+(\text{aq})$ . The insolubility in water of many  $\text{Ag}^+$  compounds suggests poor hydration and indeed many insoluble  $\text{Ag}^+$  salts, e.g.,  $\text{AgCl}$ ,  $\text{AgBr}$ , etc. are anhydrous. However, water soluble hydrated forms of  $\text{Ag}^+$  with  $\text{F}^-$ ,  $\text{NO}_3^-$ , and  $\text{ClO}_4^-$  are obtained. Considerable debate has surrounded the coordination number. EXAFS investigations on  $\text{Ag}^+(\text{aq})$  in nitrate and perchlorate solutions favor a tetrahedral arrangement ( $\text{Ag}-\text{O} \sim 240 \text{ pm}$ ).<sup>162</sup> With nitrate, coordination of  $\text{NO}_3^-$  appears to be relevant. Complexation reactions of  $[\text{Ag}(\text{H}_2\text{O})_4]^+$  are fast with estimated rate constants  $\sim 10^6 \text{ M}^{-1}\text{s}^{-1}$ , but are slower than those of comparable group 1 ions.<sup>163</sup> Acid dissociation of  $[\text{Ag}(\text{H}_2\text{O})_4]^+$  gives  $\text{AgOH}(\text{aq})$  ( $\text{p}K_{\text{a}} 12$ ;  $I \rightarrow 0$ ).

(e)  $\text{Ag}^{2+}(\text{aq})$ . The  $\text{Ag}^+(\text{aq})$  ion is known to catalyze a range of oxidations when the  $d^9$  ion  $\text{Ag}^{2+}(\text{aq})$  is involved as an intermediate. A number of oxidants including  $\text{S}_2\text{O}_8^{2-}$ ,  $\text{O}_3$ ,  $\text{PbO}_2$ ,  $\text{BiO}_2$ ,  $\text{F}_2$ , or  $\text{OH}\cdot$  are known to generate  $\text{Ag}^{2+}(\text{aq})$  from acidic solutions of  $[\text{Ag}(\text{H}_2\text{O})_4]^+$ . The preferred method is, however, via freshly precipitated “ $\text{AgO}$ .” Solutions of  $\text{Ag}^{2+}(\text{aq})$  have a peak at 475 nm ( $\epsilon = 140 \text{ M}^{-1}\text{cm}^{-1}$ ) suggesting square-planar  $[\text{Ag}(\text{H}_2\text{O})_4]^{2+}$  or square-pyramidal  $[\text{Ag}(\text{H}_2\text{O})_5]^{2+}$ , with neither form substantiated. The acid dissociation constant  $\text{p}K_{\text{a}}$  is in the range 0.15–1.0, with anions responsible for reported variations. The reduction potential of the  $\text{Ag}^{2+}/\text{Ag}^+(\text{aq})$  couple is 1.45–2.00 V (vs. nhe) depending on anions present.<sup>164</sup> The value in 4 M  $\text{HClO}_4$  at 25 °C (2.00 V) is the one most quoted. Kinetic studies on  $\text{Ag}^{2+}(\text{aq})$  decay have been carried out,<sup>165</sup> and suggest a disproportionation step  $2\text{Ag}^{\text{II}} \rightleftharpoons \text{Ag}^{\text{I}} + \text{Ag}^{\text{III}}$ .

(f)  $\text{Ag}^{\text{III}}(\text{aq})$ . In alkaline solution  $\text{Ag}^{\text{III}}(\text{aq})$  forms the square-planar  $[\text{Ag}(\text{OH})_4]^-$ . The synthetic procedure most used involves oxidation of a silver foil anode in aqueous alkali usually using a Pt cathode.<sup>166</sup> Solution of  $[\text{Ag}(\text{OH})_4]^-$  at 25 °C decay with  $t_{1/2} \sim 100 \text{ min}$  in 1.2 M  $\text{NaOH}$ , and  $< 30 \text{ min}$  in 0.1 M  $\text{NaOH}$ . Kinetic studies on oxidation reactions of  $[\text{Ag}(\text{OH})_4]^-$  in 0.12–1.2 M  $\text{OH}^-$ ,  $I = 1.2 \text{ M}$ , have been carried out.<sup>167</sup>

(g)  $\text{Au}(\text{aq})$  ions. Gold is one of the few metals to be found in its elemental state, a fact reflecting its reluctance to exhibit an extensive aqueous chemistry. For  $\text{Au}^+$  the reason is the high reduction potential for the  $\text{Au}^{+}/\text{Au}^0(\text{aq})$  couple of 1.69 V vs. nhe,<sup>168</sup> and the highly favorable disproportionation to the metal and  $\text{Au}^{\text{III}}$ . The  $\text{Au}^{\text{II}}$  state is likewise unstable, and  $\text{Au}^+$  is a stronger oxidant than  $\text{Au}^{\text{II}}$ . Partially aquated  $\text{Au}^+$  ( $\sim 10^{-4} \text{ M}$ ) is stable for a few minutes in acetonitrile–water mixtures. Aqua ligands to  $\text{Au}^{3+}(\text{aq})$  are highly acidic, e.g.,  $\text{p}K_{\text{a}}$  of 2.72 for  $[\text{AuCl}_3(\text{H}_2\text{O})]$ , and to obtain  $[\text{Au}(\text{H}_2\text{O})_4]^{3+}$  concentrated non-coordinating acids are expected to be an essential requirement. Freshly precipitated  $\text{Au}(\text{OH})_3$  is stable over a wide range of pH.

### 1.25.2.12 Group 12: Zinc, Cadmium, and Mercury

(a)  $\text{Zn}^+(\text{aq})$  and  $\text{Cd}^+(\text{aq})$ . Aqueous solutions containing  $\text{Zn}^+(\text{aq})$  and  $\text{Cd}^+(\text{aq})$  are obtained by pulse radiolysis reduction of dilute solutions of  $\text{Zn}^{2+}(\text{aq})$  and  $\text{Cd}^{2+}(\text{aq})$ .<sup>169</sup> Recently, the dimer  $\text{Cd}_2^{2+}$  has been prepared by treating  $\text{O}_2$ -free solutions of  $10^{-3} \text{ M}$  solutions of  $\text{Cd}(\text{ClO}_4)_2$  or  $\text{Cd}(\text{O}_3\text{SCF}_3)_2$  with Cd powder at 65 °C.<sup>170</sup> The comproportionation constant for  $\text{Cd}^{2+} + \text{Cd} \rightleftharpoons \text{Cd}_2^{2+}$  is estimated to be 0.018, and the reduction potential of  $\text{Cd}^{\text{II}}/\text{Cd}^{\text{I}}$  couple as  $-0.45 \text{ V}$ . The kinetics of the  $\text{Cd}_2^{2+}(\text{aq})$  reduction of  $\text{I}_3^-$  [ $\text{IrCl}_6]^{2-}$ ,  $[\text{Ru}(\text{NH}_3)_5(\text{py})]^{3+}$ , and  $[(\text{NH}_3)_5\text{CoO}_2\text{Co}(\text{NH}_3)_5]^{5+}$  have been studied. Attempts to generate  $\text{Zn}_2^{2+}$  have so far proved unsuccessful.

(b)  $\text{Zn}^{2+}(\text{aq})$  and  $\text{Cd}^{2+}(\text{aq})$ . Typical Zn–O distances for  $[\text{Zn}(\text{H}_2\text{O})_6]^{2+}$  of 209–210 pm are sensitive to the presence of hydrogen bonding. Hexaaqua  $[\text{Zn}(\text{H}_2\text{O})_6]^{2+}$  persists at most concentrations of non-coordinating anions, but as the mole fraction of water is decreased or the temperature raised, a change to tetrahedral coordination occurs. However, these observations have been challenged.<sup>171</sup> The presence of  $[\text{Zn}(\text{H}_2\text{O})_6]^{2+}$  is supported by  $^{67}\text{Zn}$  NMR linewidth studies on 2.0 M  $\text{Zn}(\text{ClO}_4)_2$  solutions. An X-ray structure on  $\text{Cd}(\text{ClO}_4)_2 \cdot 6\text{H}_2\text{O}$ , indicates a Cd–O of  $\sim 230 \text{ pm}$ . Acid dissociation of  $[\text{Zn}(\text{H}_2\text{O})_6]^{2+}$  to  $\text{ZnOH}^+(\text{aq})$  gives  $\text{p}K_{\text{a}} 9.1$ ; ( $I = 2.0 \text{ M Cl}^-$ ), and



of  $[\text{Cd}(\text{H}_2\text{O})_6]^{2+}$  to  $\text{CdOH}^+(\text{aq})$ ,  $\text{p}K_{\text{a}} 10.4$ ;  $I = 0.1 \text{ M ClO}_4^-$ . The formation of  $\text{Zn}_4(\text{OH})_4^{4+}$  and  $\text{Cd}_4(\text{OH})_4^{4+}(\text{aq})$  has been reported.

(c)  $\text{Hg}^+(\text{aq})$ . The  $\text{Hg}^{\text{I}}$  dimer has a more extensive chemistry than that of  $\text{Cd}^{12+}$ . The linear  $[\text{H}_2\text{O}-\text{Hg}-\text{Hg}-\text{H}_2\text{O}]^{2+}$  unit ( $\text{Hg}-\text{Hg} = 250 \text{ pm}$ ,  $\text{Hg}-\text{O} = 214 \text{ pm}$ ) is present in  $\text{Hg}_2(\text{NO}_3)_2 \cdot 2\text{H}_2\text{O}$ ,  $\text{Hg}_2\text{SiF}_6 \cdot 2\text{H}_2\text{O}$ ,  $\text{Hg}_2(\text{ClO}_4)_2 \cdot n\text{H}_2\text{O}$  ( $n = 2$  or  $4$ ), and in solution.<sup>172</sup> The  $\text{Hg}-\text{Hg}-\text{O}$  bonds are almost linear ( $160-180^\circ$ ) in different compounds, and the  $\text{H}_2\text{O}$  has a  $\text{p}K_{\text{a}}$  of 5.0. Solutions of  $\text{Hg}_2^{2+}(\text{aq})$  have a peak at  $237 \text{ nm}$  ( $\epsilon = 2.67 \times 10^4 \text{ M}^{-1} \text{ cm}^{-1}$ ) arising from  $\sigma(6s)-\sigma^*(6s)$  transitions.<sup>173</sup> Mononuclear  $\text{Hg}^+(\text{aq})$  ( $\lambda_{\text{max}} = 272 \text{ nm}$ ,  $\epsilon = 7800 \text{ M}^{-1} \text{ cm}^{-1}$ ) is formed by pulse radiolysis of  $\text{Hg}^{2+}(\text{aq})$ .<sup>173</sup> The ion decays slowly to give  $\text{Hg}^0$  and  $\text{Hg}^{2+}(\text{aq})$ , which then combine to give  $\text{Hg}_2^{2+}(\text{aq})$ . The solution chemistry of  $\text{Hg}_2^{2+}(\text{aq})$  is limited by the reluctance of  $\text{Hg}^+$  to form coordinate bonds, and by its ready disproportionation to the more strongly complexing  $\text{Hg}^{2+}(\text{aq})$  as in  $\text{Hg}_2^+ \rightleftharpoons \text{Hg}^{\text{II}} + \text{Hg}^0$  with  $K = [\text{Hg}^{\text{II}}]/[\text{Hg}_2^+] = 0.0061$ . Redox properties are summarized by reduction potentials vs. nhe:  $2\text{Hg}^{\text{II}} + 2\text{e}^- \rightleftharpoons \text{Hg}_2^+$  (0.92 V), and  $\text{Hg}_2^+ + 2\text{e}^- \rightleftharpoons 2\text{Hg}^0$  (0.79 V). At equilibrium  $\text{Hg}_2^{2+}$  solutions contain 0.6% of  $\text{Hg}^{2+}$  (and  $\text{Hg}^0$ ). The upper limit of the equilibrium constant for  $\text{Hg}_2^{2+} \rightleftharpoons 2\text{Hg}^+$  is  $10^{-7} \text{ M}$ , and no evidence has been obtained for this step in redox studies. The solubility of  $\text{Hg}^0$  (metal) in  $\text{H}_2\text{O}$  is estimated to be  $2.8 \times 10^{-7} \text{ M}$ .

(d)  $\text{Hg}^{2+}(\text{aq})$ . X-ray scattering studies on  $\text{Hg}^{2+}(\text{aq})$  in perchloric acid supports the presence of  $[\text{Hg}(\text{H}_2\text{O})_6]^{2+}$  ( $\text{Hg}-\text{O}$ , 234–241 pm) as in the X-ray structure of  $\text{Hg}(\text{ClO}_4)_2 \cdot 6\text{H}_2\text{O}$ .<sup>174</sup> X-ray scattering studies have indicated that the stronger tendency of  $[\text{Hg}(\text{H}_2\text{O})_6]^{2+}$  to acid dissociate to  $\text{HgOH}^+(\text{aq})$ ,  $\text{p}K_{\text{a}} 3.7$  ( $I = 0.5 \text{ M ClO}_4^-$ ), is due to the formation of the more covalent  $\text{Hg}-\text{OH}$  bond. Thus in  $\text{HgOH}^+(\text{aq})$  the  $\text{Hg}-\text{OH}$  bond shortens to 190–210 pm at the expense of a lengthening of the  $\text{Hg}-\text{OH}_2$  bonds to  $\sim 250 \text{ pm}$ .<sup>175</sup> Much of the environmental toxicity of  $\text{Hg}^{2+}(\text{aq})$  stems from the ready formation of the methyl mercury cation,  $\text{CH}_3\text{HgOH}_2^+$ , in marine environments.

### 1.25.2.13 Group 13: Boron, Aluminum, Gallium, Indium, and Thallium

(a)  $\text{B}^{\text{III}}(\text{aq})$ . The radius of  $\text{B}^{3+}$  (11 pm) is too small to allow an aqua ion to form due to the expected polarization of such  $\text{B}-\text{O}$  bonds. The chemistry is therefore that of the tetrahedral tetrahydroxoborate ion,  $[\text{B}(\text{OH})_4]^-$  ( $\text{B}-\text{O} = 147.1 \text{ pm}$ ) and derivatives.<sup>176</sup>

(b)  $\text{Al}^{3+}(\text{aq})$ . The  $[\text{Al}(\text{H}_2\text{O})_6]^{3+}$  ion is well characterized in solution,<sup>177,178</sup> hydrated salts, and in sulfate and selenate alums. Typical  $\text{Al}-\text{O}$  distances are 187–190 pm. Acid dissociation of  $\text{Al}^{3+}(\text{aq})$  to  $\text{AlOH}^+(\text{aq})$  gives  $\text{p}K_{\text{a}} 5.3$  ( $I = 0.1 \text{ M ClO}_4^-$ ). Other hydrolysis products are formed and the chemistry of these solutions is complex. Tetrahedral and octahedral  $\text{Al}^{3+}$  sites can be distinguished by  $^{27}\text{Al}$  NMR.<sup>179</sup>

(c)  $\text{Ga}^{\text{I}}(\text{aq})$ ,  $\text{In}^{\text{I}}(\text{aq})$ , and  $\text{Tl}^{\text{I}}(\text{aq})$ . Gould and co-workers have recently reported procedures for the preparation of the  $s^2$  ions  $\text{Ga}^{\text{I}}(\text{aq})$  and  $\text{In}^{\text{I}}(\text{aq})$ . Solutions of 0.2 M  $\text{Ga}^{\text{I}}(\text{aq})$  are prepared by dissolving  $\text{Ga}_2\text{Cl}_4$  ( $\text{Ga}^{\text{I}}\text{Ga}^{\text{III}}$ ) in dry acetonitrile followed by dilution with  $\text{O}_2$ -free water.<sup>180</sup> The  $\text{Ga}^{\text{III}}$  precipitates out as  $\text{GaCl}_3$ . An improved procedure for  $\text{In}^{\text{I}}(\text{aq})$  involves treating indium amalgam with  $\text{AgCF}_3\text{SO}_3$  in dry acetonitrile followed by dilution with  $\text{O}_2$ -free water, giving 0.27 M solutions.<sup>181</sup>  $\text{In}^{\text{I}}(\text{aq})$  solutions are stable for over 5 h at  $25^\circ\text{C}$  whereas solutions of  $\text{Ga}^{\text{I}}(\text{aq})$  have a half-life of about 3 h at  $0^\circ\text{C}$ . Little is known about the extent of  $\text{H}_2\text{O}$  coordination. Both  $\text{Ga}^{\text{I}}(\text{aq})$  and  $\text{In}^{\text{I}}(\text{aq})$  are strong reductants undergoing two-electron oxidation to the III state products. Kinetic studies with a range of oxidants have been carried out. Features are the high reactivity of the intermediate  $s^1$   $\text{Ga}^{\text{II}}$  and  $\text{In}^{\text{II}}$  states. The  $\text{Tl}^{\text{I}}(\text{aq})$  ion is much more stable than its lighter congeners and is obtained by reduction of  $[\text{Tl}(\text{H}_2\text{O})_6]^{3+}$ . It is often assumed to be  $[\text{Tl}(\text{H}_2\text{O})_6]^{+182}$  although recent LAXS and EXAFS studies suggest two waters at 273 pm, a further two at 318 pm and a stereochemically active lone pair.<sup>183</sup> The acid dissociation constant  $\text{p}K_{\text{a}}$  of 13.2 ( $I \rightarrow 0$ ) for formation of  $\text{TlOH}(\text{aq})$  is similar to those of group 1 metals.

(d)  $\text{Tl}^{2+}(\text{aq})$ . The short-lived  $\text{Tl}^{2+}(\text{aq})$  ion has been detected by pulse radiolysis on aqueous solutions of  $\text{Tl}^{\text{I}}$  sulfate and in  $\gamma$ -irradiated frozen aqueous solutions and has been invoked as an intermediate in the photochemical reduction of  $\text{Tl}^{3+}(\text{aq})$  solutions. In two-equivalent electrochemical studies on the reduction of  $\text{Tl}^{3+}(\text{aq})$  to  $\text{Tl}^+(\text{aq})$ , an intermediate state with a formal reduction potential  $E_1^* = 1.04 \text{ V}$  vs. nhe has been detected, which is different from the value of 0.33 V determined for the  $\text{Tl}^{3+}(\text{aq})/\text{Tl}^+(\text{aq})$  couple.<sup>184</sup> Examination of cyclic voltammetry (CV) and rotating disk electrode results, along with CV-curve computer simulation and literature data indicate that the formal potential observed cannot be the property of an electrode absorbed species, but rather of a covalently interacting dithallium  $\text{Tl}^{\text{II}}-\text{Tl}^{\text{II}}$  intermediate. Covalent

interactions between two  $Tl^{2+}$  ions have been observed in crystal structures of  $Tl^{II}_{0.8}Sn_{0.6}Mo_7O_{11}$ ,<sup>185</sup> and tetrakis(hypersilyl)dithallium(II),<sup>186</sup> with a thallium(II)—thallium(II) separation of 280–290 pm. Structural data also exist for the stable isoelectronic ( $6s-6s$  bonded) dimers  $Au^0-Au^0$ ,<sup>187</sup> and  $Hg^I-Hg^I$ .<sup>188</sup> In other two-equivalent reactions of  $Hg^0 + Tl^{III}$  and  $Pt^{II} + Tl^{III}$  intermediate metastable binuclear intermediates  $Hg^I-Tl^{II}$  and  $Pt^{III}-Tl^{II}$  have been proposed. In non-complementary reactions such as the  $2Fe^{II}$  reduction of  $Tl^{III}$ , kinetic evidence in support of  $Tl^{II}$  has been obtained.

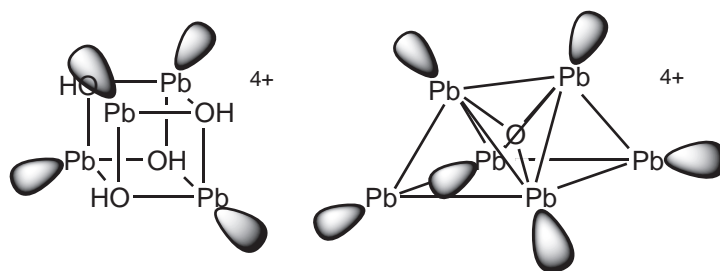
(e)  $Ga^{3+}(aq)$ ,  $In^{3+}(aq)$ , and  $Tl^{3+}(aq)$ . Both  $[Ga(H_2O)_6]^{3+}$  and  $[In(H_2O)_6]^{3+}$  have been characterized in cesium alums.<sup>189</sup> For  $Ga^{3+}$  a number of studies have confirmed the hexaaqua structure in solution ( $Ga-O=196$  pm).<sup>190</sup> The acid dissociation  $pK_a$  is 2.7 ( $I=1.0$  M  $ClO_4^-$ ).<sup>191</sup> The nature of the products obtained at different pH values has been studied using  $^{71}Ga$  NMR. An interesting species from 0.1 M aqueous sulfate solutions is  $[Ga_{13}O_4(OH)_{24}(H_2O)_{12}]^{7+}$ .<sup>192</sup> Hexaaqua  $In^{3+}$  has been identified in aqueous perchlorate and nitrate solutions of  $In^{3+}(aq)$ . The short  $In-O$  bond (213–215 pm) suggests some covalency.<sup>193</sup> The acid dissociation constant for the formation of  $InOH^{2+}(aq)$  is  $pK_a=4.3$  ( $I=3.0$  M  $ClO_4^-$ ). Water exchange on  $[In(H_2O)_6]^{3+} \sim 1 \times 10^7 s^{-1}$  is much faster than on  $[Ga(H_2O)_6]^{3+}$  or  $[Al(H_2O)_6]^{3+}$ .<sup>178</sup> The hydrate  $Tl(ClO_4)_3 \cdot 6H_2O$  contains regular octahedral  $[Tl(H_2O)_6]^{3+}$  ions which are retained in solution.<sup>194</sup> The  $Tl-O$  bond length (221–223 pm), its high lability, and acid dissociation constant ( $pK_a$  0.5;  $I=0.1$  M  $ClO_4^-$ ) suggest a significant degree of covalency. The ion is labile and oxidizing with respect to  $Tl^+(aq)$ .<sup>195,196</sup> The high acidity of  $[Tl(H_2O)_6]^{3+}$  promotes hydrolysis on bound substrates such as the thiolurethanes and organo isothiocyanates.<sup>197</sup> The strong oxidizing nature of  $[Tl(H_2O)_6]^{3+}$  is in contrast to other group 13 metals in this oxidation state.

#### 1.25.2.14 Group 14: Germanium, Tin, and Lead

(a)  $Ge^{II}$ ,  $Ge^{III}$ , and  $Ge^{IV}$ . The chemistry is best studied in halide solutions, and the extent of aqua ligand participation is therefore uncertain. The preparation of  $Ge^{II}$  solutions (0.2–0.4 M) stable for up to three weeks via the reduction of  $Ge^{IV}(aq)$  in 6M HCl with  $H_3PO_2$  has been reported.<sup>198</sup> Solutions diluted  $\sim 200$  fold with dilute HCl give  $GeCl_3^-$  which can be used in redox studies. To convert to  $Ge^{IV}$  powerful oxidants are required, and solutions need to be halide rich. With  $[IrCl_6]^{2-}$  formation of  $Ge^{III}$  is rate determining, followed by rapid conversion to  $Ge^{IV}$ .

(b)  $Sn^{2+}(aq)$  and  $Pb^{2+}(aq)$ . X-ray scattering and EXAFS measurements on 3 M aqueous acidic  $Sn^{2+}$  perchlorate solutions reveal a highly asymmetric hydration sphere consisting of three—possibly four—water ligands at a distance of around 233–234 pm in a distorted trigonal pyramidal arrangement with the  $Sn^{2+}$  lone pair occupying the remaining spacial position.<sup>199</sup> A number of weakly bonded waters may also be relevant at distances of around 280–290 pm. The results have been discussed in terms of aqua  $Sn^{2+}$ , although it is likely that trinuclear  $Sn_3(OH)_4^{2+}(aq)$  is present along with some  $Sn_2(OH)_2^{4+}(aq)$ . The cyclic trinuclear unit in the basic sulfate  $[Sn_3O(OH)_2](SO_4)$  has led to the suggestion that similar units might be present in the  $Sn^{2+}(aq)$  solutions. It has proved difficult, however, to match up  $Sn-O$  and  $Sn-Sn$  distances in the basic sulfate with those from XRD data on the trinuclear species in solution. In the latter, the  $Sn-O$  and  $Sn-Sn$  distances would be perfectly consistent with an expanded cyclic  $Sn_3(OH)_4^{2+}$  structure with the longer  $Sn-O$  distance of 280–290 pm assigned to the weakly bonded waters. Similarly, evidence for monomeric  $Pb^{2+}(aq)$  ion is lacking, the species characterized being a  $\mu$ -hydroxo ion displaying stereochemically active lone pairs.<sup>200</sup> Cuboidal  $Pb_4(OH)_4^{4+}(aq)$  is present in the solid state structures of  $[Pb_4(OH)_4](ClO_4)_4$  and  $[(Pb_4(OH)_4)_3(CO_3)](ClO_4)_{10} \cdot 6H_2O$ , and  $\mu_4$ -oxo-bridged  $Pb_6$  units are present in the  $\alpha$  and  $\beta$  forms of  $[Pb_6O(OH)_6](ClO_4)_4 \cdot H_2O$  (Figure 19).<sup>199</sup> In both forms of  $[Pb_6O(OH)_6](ClO_4)_4 \cdot H_2O$  the central oxide is tetrahedrally coordinated to four Pb atoms with the six OH groups capping six outer trigonal faces. A single weakly bound water ligand is present at 274 pm from one corner lead atom. As in the cuboidal form the active lone pairs point outwards from the cage and restrict hydration. Recently, a larger  $Pb_{13}O_8(OH)_6^{4+}$  aggregate has been found in a thermally synthesized basic nitrate.<sup>201</sup>

(c)  $Sn^{IV}(aq)$  and  $Pb^{IV}(aq)$ . There is good  $^{119}Sn$  NMR evidence in support of the existence of monomeric octahedral aqua—chloro(bromo) species  $[SnX_n(H_2O)_{6-n}]^{(4-n)+}$ , in addition to  $[Sn(H_2O)_6]^{4+}$  itself, in dilute acidic aqueous solutions of  $Sn^{IV}$  in the presence of  $Cl^-$  and  $Br^-$ .<sup>202</sup> In alkaline solution  $[Sn(OH)_6]^{2-}$  appears to be present. Tetravalent lead is highly oxidizing in aqueous media and extensively hydrolyzed, although the nature of the soluble product is



**Figure 19** Structures of cuboidal  $\text{Pb}_4\text{OH}_4^{4+}(\text{aq})$  and hexameric  $\text{Pb}_6\text{O}(\text{OH})_6^{4+}(\text{aq})$  (trigonal-face capping OH ligands omitted).

uncertain. In alkaline solutions  $[\text{Pb}(\text{OH})_6]^{2-}$  is believed to be present as found in many solid hexahydroxo-plumbates.

#### 1.25.2.15 Group 15: Arsenic, Antimony, and Bismuth

(a)  $\text{As}^{\text{III}}(\text{aq})$ ,  $\text{Sb}^{\text{III}}(\text{aq})$ , and  $\text{Bi}^{\text{III}}(\text{aq})$ . There are no aqua cations for  $\text{As}^{\text{III}}$  although for  $\text{Sb}^{\text{III}}$  the existence of  $\text{Sb}(\text{OH})_2^+(\text{aq})$  at  $\text{pH} < 2$  has been invoked in order to fit the solubility profile of  $\text{Sb}_2\text{O}_3$ . Indeed,  $\text{Sb}^{3+}(\text{aq})$  may have existence in very dilute, strongly acidic  $\text{Sb}^{\text{III}}(\text{aq})$  solutions, but this has not been substantiated. It is likely that  $\text{Sb}^{3+}(\text{aq})$  is extensively hydrolyzed. At  $\text{pH} > 11$  the  $\text{Sb}(\text{OH})_4^-(\text{aq})$  ion is formed. In dilute aqueous solutions of  $\text{As}^{\text{III}} < 0.1 \text{ M}$  the principal species are  $\text{As}(\text{OH})_3(\text{aq})$ ,  $\text{As}(\text{OH})_4^-(\text{aq})$ ,  $\text{AsO}_2(\text{OH})^{2-}(\text{aq})$ , and  $\text{AsO}_3^{3-}(\text{aq})$ . An XRD study on the triflate salt of  $\text{Bi}^{\text{III}}$  has indicated a monomeric  $\text{Bi}^{3+}(\text{aq})$  ion with nine water molecules coordinated in a tricapped trigonal-prismatic arrangement.<sup>203</sup> Similarities to the larger  $\text{Ln}^{3+}(\text{aq})$  ions are apparent. There is no evidence for any lone-pair stereoactivity. The Bi—O distances are 245 pm (corner waters) and 258 pm (face capping waters). It is not clear whether  $[\text{Bi}(\text{H}_2\text{O})_9]^{3+}$  or  $[\text{Bi}(\text{H}_2\text{O})_8]^{3+}$  is the species present in strongly acidic solution; support for the latter comes from recent LAXS and EXAFS studies (Bi—O = 241 pm).<sup>204</sup> Estimates of the  $\text{p}K_a$  of  $[\text{Bi}(\text{H}_2\text{O})_8]^{3+}$  are  $\sim 1.6$  ( $I = 3.0 \text{ M ClO}_4^-$ ). As a result,  $\text{Bi}^{3+}(\text{aq})$  solutions readily hydrolyze below  $1 \text{ M H}^+$  to hexanuclear  $\text{Bi}_6\text{O}_4(\text{OH})_4^{6+}$  species exhibiting lone-pair stereoactivity.<sup>205</sup> This unit is well characterized in solid  $\text{Bi}^{\text{III}}$  complexes such as  $[\text{Bi}_6\text{O}_4(\text{OH})_4](\text{ClO}_4)_6 \cdot 7\text{H}_2\text{O}$  and  $[\text{Bi}_6\text{O}_4(\text{OH})_4](\text{NO}_3)_6 \cdot n\text{H}_2\text{O}$  ( $n = 1$  or  $4$ ). There are no aqua ions of the V state group 15 elements.

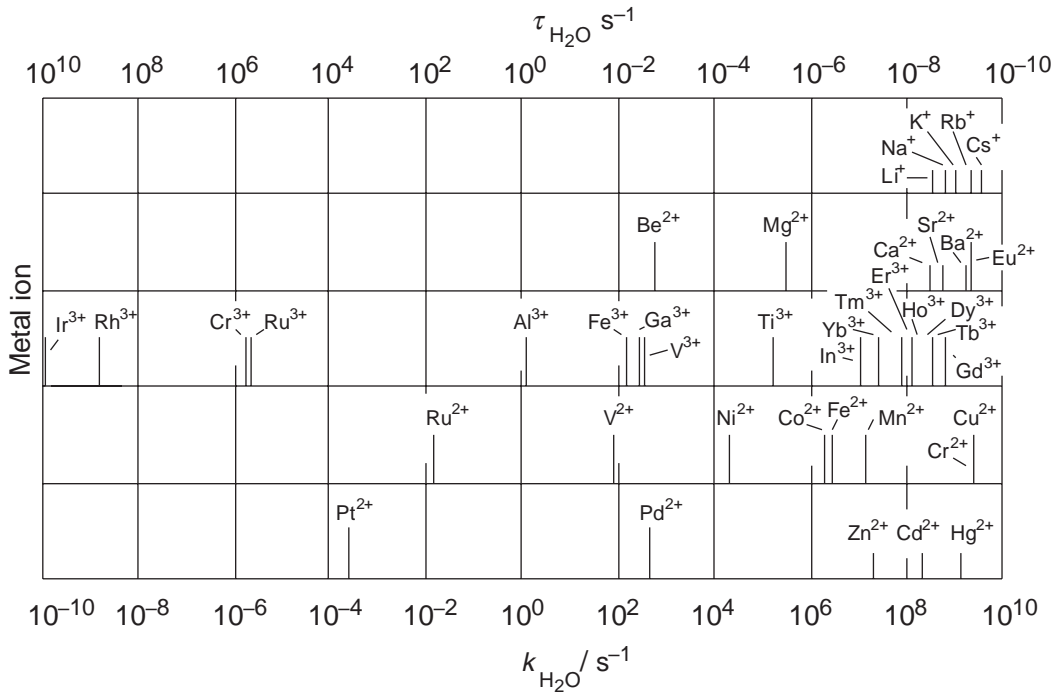
#### 1.25.2.16 Group 16: Sulfur, Selenium, and Tellurium

No aqua cations exist for sulfur or selenium. However, there is substantial evidence for a  $\text{Te}^{\text{IV}}(\text{aq})$  cation from measurements on the solubility of  $\text{TeO}_2$  in acidic solutions with additional evidence coming from solvent extraction studies.<sup>206</sup> Speciation studies show that a monocationic ion  $\text{Te}^{\text{IV}}(\text{aq})$  should persist in dilute solutions ( $< \text{mM}$ ) at  $\text{pH} < 2$ . Electrochemical reduction of  $\text{Te}^{\text{IV}}(\text{aq})$  is also consistent with the existence of a cationic form in strongly acidic solution. Whether this is  $\text{Te}(\text{OH})_3^+(\text{aq})$ ,  $\text{TeO}(\text{OH})^+(\text{aq})$ , or  $\text{HTeO}_2^+(\text{aq})$  is less certain.

### 1.25.3 LIGAND SUBSTITUTION REACTIONS

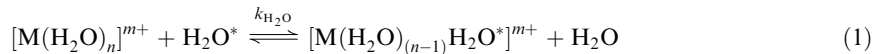
#### 1.25.3.1 Range of Labilities of Aqua Metal Ions

Water exchange between the first and second coordination spheres of an aqua metal ion has a range of rate constants covering many orders of magnitude as the identity of the metal ion changes (Figure 20)<sup>26,147,207,208</sup> An understanding of variations in substitution properties is fundamental to the interpretation of metal-ion complexation and ligand substitution processes in chemical and biological systems. Relaxation techniques were first used for many of the faster reactions by Eigen and colleagues in the early 1950s. More recently effects of high pressure, the determination of volumes of activation, and the use of NMR have all played their part. Accordingly,



**Figure 20** Water-exchange rate constants ( $k_{\text{H}_2\text{O}}$ ) and mean lifetimes ( $\tau_{\text{H}_2\text{O}} = 1/k_{\text{H}_2\text{O}}$ ) for  $\text{H}_2\text{O}$  in first-coordination sphere of metal ion. Short bars indicate values obtained indirectly from ligand substitution studies.

water exchange has been much studied and may be represented for the aqua ion,  $[\text{M}(\text{H}_2\text{O})_6]^{m+}$ , as Equation (1) where the asterisk is a typographical distinction only:



The mean lifetime (or residence time) of a particular water molecule in the first coordination sphere  $\tau_{\text{H}_2\text{O}}$  is given by  $1/k_{\text{H}_2\text{O}}$ , where  $k_{\text{H}_2\text{O}}$  is the rate constant for the exchange of a single water molecule from the first coordination sphere. The rate of water exchange on  $[\text{M}(\text{H}_2\text{O})_n]^{m+}$  is given by Equation (2)

$$\text{Rate} = nk_{\text{H}_2\text{O}}[\text{M}(\text{H}_2\text{O})_n]^{m+} \quad (2)$$

Recently, water-exchange rate constants have been determined for two extreme cases. The reaction of  $[\text{Ir}(\text{H}_2\text{O})_6]^{3+}$  is at the slow extreme of the lability scale with  $\tau_{\text{H}_2\text{O}}$  (25 °C) =  $9.1 \times 10^9$  s, which corresponds to  $\sim 300$  years and a water exchange on each  $\text{Ir}^{3+}$  every  $\sim 50$  years.<sup>147</sup> At the fast extreme is  $[\text{Eu}(\text{H}_2\text{O})_7]^{2+}$  with  $\tau_{\text{H}_2\text{O}}$  (25 °C) =  $2.0 \times 10^{-10}$  s, a period in which light travels  $\sim 6$  cm, and a water exchange event occurs every  $\sim 2.8 \times 10^{-11}$  s.<sup>20</sup> In an earlier study, assuming  $[\text{Eu}(\text{H}_2\text{O})_8]^{2+}$  to be dominant, a value  $\tau_{\text{H}_2\text{O}}$  (25 °C) =  $2.3 \times 10^{-10}$  s was reported.<sup>209</sup> A similar lability is observed for ligand substitution studies on  $[\text{Cs}(\text{H}_2\text{O})_8]^+$ . Within this extraordinary range of lability the more labile metal ions are those of large ionic radius, ( $r_{\text{M}}$ ), and low charge resulting in a low surface charge density,<sup>210</sup> while the least labile are those of high surface charge density provided that they are not transition metal ions whose lability is strongly influenced by the electronic occupancy of  $d$  orbitals. Thus, three broad categories may be distinguished: i) the main-group metal ions, ii) the transition metal ions, and iii) the trivalent lanthanide ions. Within the main-group metal ions, the labilities of the alkali metal ions are encompassed by an approximately one order of magnitude variation consistent with the increase in lability from  $\text{Li}^+$  to  $\text{Cs}^+$  being dominated by a decrease in surface charge density and an increase in coordination number.



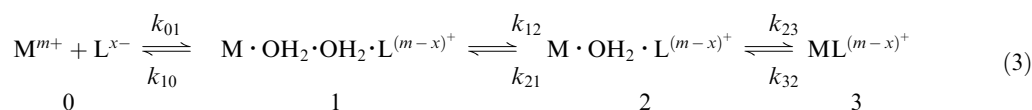
The alkaline earth metal ions show almost six orders of magnitude variation in lability with  $[\text{Be}(\text{H}_2\text{O})_4]^{2+}$  being the least labile while  $[\text{Ba}(\text{H}_2\text{O})_8]^{2+}$  is one of the most labile metal ions. The labilities of the  $d^{10}$   $[\text{Zn}(\text{H}_2\text{O})_6]^{2+}$ ,  $[\text{Cd}(\text{H}_2\text{O})_6]^{2+}$ , and  $[\text{Hg}(\text{H}_2\text{O})_6]^{2+}$  ions are at the higher end of the lability scale as anticipated for metal ions of moderate to low surface charge density and span two orders of magnitude as a consequence of increasing ionic radius as the group is descended. The lability of trivalent  $[\text{Al}(\text{H}_2\text{O})_6]^{3+}$  falls in the middle of the lability range in Figure 20, consistent with the small size and high charge of  $\text{Al}^{3+}$ . The decrease in surface charge density of the metal center from  $[\text{Al}(\text{H}_2\text{O})_6]^{3+}$  to  $[\text{In}(\text{H}_2\text{O})_6]^{3+}$  results in a  $10^7$ -fold increase in lability.

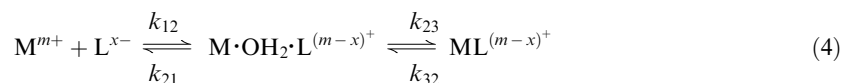
The second category is represented by the transition metal ions, all of which in Figure 20 are six-coordinate with the exception of square-planar  $[\text{Pd}(\text{H}_2\text{O})_4]^{2+}$  and  $[\text{Pt}(\text{H}_2\text{O})_4]^{2+}$ . Their labilities encompass almost twenty orders of magnitude largely as a consequence of differing  $d$  orbital electronic occupancies, which influence transition state energetics and stereochemistries as discussed below. In the third category, that of the large and labile trivalent lanthanide ions, coordination numbers decrease from nine for  $[\text{Ce}(\text{H}_2\text{O})_9]^{3+}$  to eight for  $[\text{Lu}(\text{H}_2\text{O})_8]^{3+}$  as the lanthanide contraction occurs with increasing atomic number and a corresponding 18-fold decrease in lability for the series as a whole.

Although there are aqua ions still to be identified, many have been characterized as already described. On the other hand, information about the number of water molecules in the second-coordination sphere of metal ions and their residence times is scarce, and the only experimentally determined lifetime of a water molecule exchanging between the 12  $\text{H}_2\text{O}$  of the second-coordination sphere and bulk water is  $1.28 \times 10^{-10}$  s ( $k_{\text{H}_2\text{O}} = 7.8 \times 10^9 \text{ s}^{-1}$ ) at  $25^\circ\text{C}$  for  $[\text{Cr}(\text{H}_2\text{O})_6]^{3+}$  which compares with  $1.44 \times 10^{-10}$  s from molecular dynamics calculations.<sup>24,63</sup> Similar calculations show  $\text{Nd}^{3+}$ ,  $\text{Sm}^{3+}$ , and  $\text{Yb}^{3+}$  to have 17.61, 17.13, and 16.74 water molecules in the second-coordination sphere, with residence times of  $1.3 \times 10^{-11}$  s,  $1.2 \times 10^{-11}$  s, and  $1.8 \times 10^{-11}$  s, respectively.<sup>211</sup> These studies are consistent with the exchange of water between the second-coordination sphere and the bulk solvent being close to diffusion controlled, as has generally been assumed in mechanistic models for the substitution of water in the first-coordination sphere.

### 1.25.3.2 Formation of Metal Complexes

Only in the case of the most labile metal ions are rates of substitution of a water molecule in the first-coordination sphere within an order of magnitude of its entry to the second-coordination sphere, and consequently all substitution rate-limiting events occur in the first-coordination sphere of  $[\text{M}(\text{H}_2\text{O})_n]^{m+}$ . The substitution of a ligand,  $\text{L}^{x-}$ , into the first-coordination sphere is preceded by its entry into the second-coordination sphere, and there is often evidence for the formation at close to diffusion controlled rates of an outer sphere or encounter complex,  $[\text{M}(\text{H}_2\text{O})_n] \cdot \text{L}^{(m-x)}$ , where  $\text{L}^{x-}$  resides in the second-coordination sphere. While a variety of kinetic methods have been applied in water exchange and ligand substitution studies, it is seldom the case that more than one stage of the transfer of a monodentate ligand,  $\text{L}^{x-}$ , from bulk water to the first-coordination sphere is detected other than by the ultrasonic method where up to three steps have been detected.<sup>212</sup> These steps were identified in early studies as shown in Equation (3), where **0** represents  $\text{M}^{m+}$  and  $\text{L}^{x-}$  separated by more than two water molecules, **1** represents  $\text{M}^{m+}$  and  $\text{L}^{x-}$  separated by two water molecules, **2** represents  $\text{M}^{m+}$  and  $\text{L}^{x-}$  separated by one water molecule in the outer-sphere complex, and **3** represents  $\text{M}^{m+}$  and  $\text{L}^{x-}$  in contact in the new complex  $[\text{M}(\text{H}_2\text{O})_{(n-1)}\text{L}]^{(m-x)}$ .<sup>213</sup> The diffusion-controlled formation of **1** ( $k_{01}/k_{10}$ ) is followed by the fast formation of **2** ( $k_{12}/k_{21}$ ), which leads to the slower formation of **3** ( $k_{23}/k_{32}$ ). In most ligand substitution studies **1** is not detected and the simplified sequence of the Eigen–Wilkins mechanism (written as in Equation (4)) is often discussed instead.<sup>214</sup>





The sequential equilibria in Equation (4) are characterized by  $K_{12} = k_{12}/k_{21}$  (often denoted as  $K_o$ ) and  $K_{23} = k_{23}/k_{32}$ , respectively. When  $K_{12}$  cannot be directly determined it is often estimated using the electrostatic Fuoss equation.<sup>215</sup> Usually, it is only possible to characterize the kinetics of the second equilibrium of Equation (4) so that the overall equilibrium is expressed as in Equation (5) irrespective of the intimate mechanism of ligand substitution. The pseudo-first-order rate constant for the approach to equilibrium,  $k_{\text{obs}}$ , is given by Equation (6)



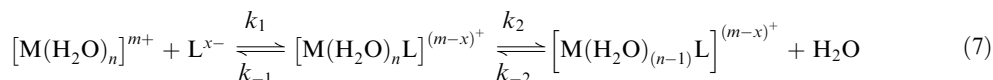
$$k_{\text{obs}} = \{(k_i K_o [\text{L}^{x-}]) / (1 + K_o [\text{L}^{x-}])\} + k_{-i} \quad (6)$$

where the first and second right-hand terms equate to  $k_f$  and  $k_b$ , respectively, when  $[\text{L}^{x-}] \gg [\text{M}^{m+}]$ . When  $K_o [\text{L}^{x-}] \ll 1$ ,  $k_{\text{obs}} \approx k_i K_o [\text{L}^{x-}] + k_{-i}$  and when  $K_o [\text{L}^{x-}] \gg 1$ ,  $k_{\text{obs}} \approx k_i + k_{-i}$ , where  $k_i$  and  $k_{-i}$  characterize  $\text{L}^{x-}$  interchange between the first and second coordination spheres. Equivalent expressions apply when  $[\text{M}^{m+}] \gg [\text{L}^{x-}]$ . If  $\text{L}^{x-}$  is uncharged the stability of the outer-sphere complex may be so low that its concentration does not differ significantly from that arising from diffusion controlled collisions. It is within this kinetic framework that the intimate mechanism of the ligand substitution process has to be identified.

### 1.25.3.3 Classification of Mechanisms

A ligand substitution mechanism is a philosophical construct designed to explain the energetic and stereochemical changes which occur along the reaction coordinate as reactants progress through one or more transition states to the products. Kinetic measurements provide information about the transition state stoichiometry and the enthalpic and entropic changes characterizing the transition state. However, these do not directly provide details of stereochemical changes occurring along the reaction coordinate. Nevertheless, kinetic variations coinciding with changes in  $\text{M}^{m+}$  size and electronic configuration give some stereochemical clues,<sup>214,216,217</sup> and the stereoretentive reactions of square-planar  $\text{Pd}^{2+}$  and  $\text{Pt}^{2+}$  complexes give strong insight into stereochemical changes along the reaction coordinate.<sup>218,219</sup> These aspects and the increasing use of modeling are discussed in the sections that follow, but it is first necessary to sketch the framework on which most mechanistic discussion is now based.

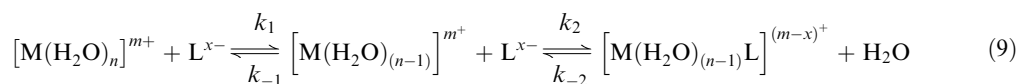
Two extreme mechanistic possibilities arise for the substitution of a water ligand in  $[\text{M}(\text{H}_2\text{O})_n]^{m+}$  by  $\text{L}^{x-}$  and are conveniently discussed using the nomenclature of Langford and Gray.<sup>220</sup> The first occurs when  $[\text{M}(\text{H}_2\text{O})_n]^{m+}$  and  $\text{L}^{x-}$  pass through a first transition state to form a reactive intermediate,  $[\text{M}(\text{H}_2\text{O})_n\text{L}]^{(m-x)+}$ , in which the coordination number of  $\text{M}^{m+}$  is increased by one (Equation (7)):



This intermediate survives several molecular collisions before passing through a second transition state to form the product  $[\text{M}(\text{H}_2\text{O})_{(n-1)}\text{L}]^{(m-x)+}$ . Thus, the rate determining step ( $k_1$ ) is the bond making between  $\text{L}^{x-}$  with  $\text{M}^{m+}$  and the mechanism is termed associatively (**a**) activated and the mechanism associative, **A**. (In the back reaction the rate determining step is characterized by  $k_{-2}$ ). The rate of approach to equilibrium in the presence of excess  $[\text{L}^{x-}]$ , characterized by  $k_{\text{obs}}$  in Equation (8) is dependent on the nature of  $\text{L}^{x-}$ :

$$k_{\text{obs}} = k_1 [\text{L}^{x-}] + k_{-2} \quad (8)$$

The second extreme mechanism operates when  $[M(H_2O)_n]^{m+}$  passes through a first transition state to form a reactive intermediate,  $[M(H_2O)_{(n-1)}]^{m+}$ , in which the coordination number of  $M^{m+}$  is decreased by one (Equation (9)):



This intermediate also survives several molecular collisions before passing through a second transition state to form the product  $[M(H_2O)_{(n-1)}L]^{(m-x)+}$ . Thus, the rate determining step ( $k_1$ ) is bond breaking and the mechanism is dissociatively (**d**) activated and the mechanism is dissociative, **D**. (In the back reaction the rate determining step is characterized by  $k_{-2}$ ). The rate of approach to equilibrium in the presence of excess  $[L^{x-}]$  is characterized by  $k_{\text{obs}}$  in Equation (10) and is independent of the nature of  $L^{x-}$ :

$$k_{\text{obs}} = (k_1 k_2 [L^{x-}] + k_{-1} k_{-2}) / (k_{-1} + k_2 [L^{x-}]) \quad (10)$$

However, the tendency for oppositely charged reactants to form outer-sphere complexes often prevents the observation of either of the rate laws shown in Equations (8) and (10), but this does not preclude the operation of either an **A** or a **D** mechanism within an outer-sphere complex.

Between the **A** and **D** mechanistic extremes there exists a continuum of mechanisms in which the entering and leaving ligands make varying contributions to the transition state energetics. They extend from the **a**-activated associative interchange (**I<sub>a</sub>**) mechanism where bond making is of major importance, through the interchange (**I**) mechanism where bond making and breaking are of similar importance, to the **d**-activated interchange mechanism (**I<sub>d</sub>**) where bond breaking is of major importance. Distinction between the **a**- and **d**-activated mechanisms should be possible through a comparison of the rate of exchange on  $[M(H_2O)_n]^{m+}$  and the rate at which  $L^{x-}$  substitutes into the first coordination sphere. For the **A** and **I<sub>a</sub>** mechanisms the rate of substitution by  $L^{x-}$  may vary from being much less than, to much greater than, the rate of water exchange with corresponding variations in  $\Delta H^\ddagger$  and  $\Delta S^\ddagger$ . In contrast, for the **D** mechanism the rate of substitution by  $L^{x-}$  cannot be faster than the rate of water exchange and may be significantly slower as a consequence of statistical factors.<sup>221-224</sup> Also,  $\Delta H^\ddagger$  should be similar to that for the water exchange process. Correspondingly, the selectivity for  $L^{x-}$  is expected to decrease from the **I<sub>a</sub>** to the **I<sub>d</sub>** mechanism. These generalizations are subject to the  $L^{x-}$  selectivity range being substantially contracted for  $L^{x-}$  hard bases substituting on  $M^{m+}$  hard acids,<sup>225-229</sup> and  $L^{x-}$  selectivity ranges decreasing as the lability of  $M^{m+}$  increases to the point at which no selectivity is exhibited when water exchange approaches diffusion controlled rates where  $k_{H_2O} \approx 3.6 \times 10^{11} \text{ s}^{-1}$  and the frequency at which encounters between  $L^{x-}$  and  $[M(H_2O)_n]^{m+}$  leads to very high substitution rates.<sup>228</sup> For each mechanism, microscopic reversibility requires that the same reaction coordinate should be traversed from left to right and vice versa so that the same mechanism operates in both directions.

Clearly it is desirable to have additional criteria through which mechanisms may be assigned. To some extent the variation of the magnitude of  $\Delta H^\ddagger$  and  $\Delta S^\ddagger$ , and the sign of the latter parameter within a series of similar ligand substitution systems, gives a guide to mechanistic change. Thus, in similar systems **a**-activated substitutions tend to have smaller  $\Delta H^\ddagger$  magnitudes than do **d**-activated substitutions, and  $\Delta S^\ddagger$  tends to be negative and positive for **a**- and **d**-activated substitutions, respectively. Even so, it is often difficult to find a series of similar ligand substitutions from which mechanistic deductions may be made from  $\Delta H^\ddagger$  and  $\Delta S^\ddagger$ , and the magnitudes of the contributions to them arising from interactions occurring beyond the first coordination sphere can be uncertain. Fortunately, the volume of activation,  $\Delta V^\ddagger$ , has proven to be an additional powerful parameter through which water, other solvent exchange, and some ligand substitution mechanisms may be assigned.<sup>216,217,229,230</sup>

### 1.25.3.4 Volume of Activation

For water exchange on  $[M(H_2O)_n]^{m+}$  the volume of activation,  $\Delta V^\ddagger$ , is the difference between the partial molar volumes of the ground state and the transition state and is related to the variation of  $k_{H_2O}$  with pressure through Equations (11) and (12)

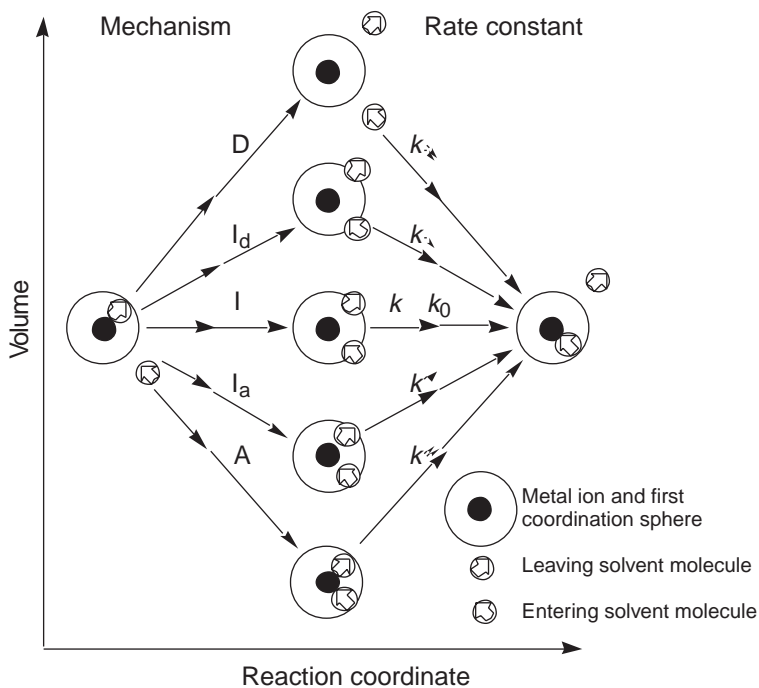
$$(\delta \ln k_{\text{H}_2\text{O}} / \delta P)_T = -\Delta V^\ddagger / RT \quad (11)$$

$$\ln k_{(P)\text{H}_2\text{O}} = \ln k_{(0)\text{H}_2\text{O}} - \Delta V^\ddagger P / RT + \Delta \beta^\ddagger P^2 / 2RT \quad (12)$$

where  $k_{(P)\text{H}_2\text{O}}$  and  $k_{(0)\text{H}_2\text{O}}$  are the rate constants at an applied pressure and ambient pressure, respectively. The  $\Delta \beta^\ddagger P^2 / 2RT$  term, where  $\Delta \beta^\ddagger$  is the compressibility of the transition state, is small for water exchange so that its contribution in Equation (11) is often not significant. Thus, when the application of pressure causes  $k_{\text{H}_2\text{O}}$  to increase,  $\Delta V^\ddagger$  is negative and vice versa and the transition state contracts and expands with respect to the ground state, respectively. On this basis, a contracted transition state involves a greater degree of bond making than breaking, and the reverse is the case for an expanded transition state coincident with **a**- and **d**-activation, respectively. The effects of pressure on water exchange according to the mechanism through which it occurs is encapsulated in the Merbach diagram shown in Figure 21.<sup>208,229</sup>

Two components compose  $\Delta V^\ddagger$ . The intrinsic component,  $\Delta V^\ddagger_{\text{int}}$ , arises from changes in the internuclear distances of the reactants during the formation of the transition state and the electrostriction component,  $\Delta V^\ddagger_{\text{elect}}$  arises from changes in the electrostriction of solvent in the second coordination sphere and beyond as charge distribution changes when the transition state forms. When charged reactants are involved,  $\Delta V^\ddagger_{\text{elect}}$  may dominate  $\Delta V^\ddagger$  so that  $\Delta V^\ddagger_{\text{int}}$ , which contains most of the mechanistic information, cannot be readily determined. However, water exchange on  $[\text{M}(\text{H}_2\text{O})_n]^{m+}$  involves negligible differences in electrostriction between the reactants and the transition state such that  $\Delta V^\ddagger_{\text{elect}} \sim 0 \text{ cm}^3 \text{ mol}^{-1}$  and  $\Delta V^\ddagger \approx \Delta V^\ddagger_{\text{int}}$ . As a consequence, the increases in  $k_{\text{H}_2\text{O}}$  observed for water exchange on  $[\text{M}(\text{H}_2\text{O})_6]^{2+}$  when  $\text{M}^{2+} = \text{V}^{2+}$  and  $\text{Mn}^{2+}$  and the decreases in  $k_{\text{H}_2\text{O}}$  observed when  $\text{M}^{2+} = \text{Fe}^{2+}$ ,  $\text{Co}^{2+}$ , and  $\text{Ni}^{2+}$  and the respective  $\Delta V^\ddagger = -4.1$ ,  $-5.4$ ,  $+3.8$ ,  $+6.1$  and  $+7.2 \text{ cm}^3 \text{ mol}^{-1}$  values are consistent with **a**-activated mechanisms operating for the first two  $[\text{M}(\text{H}_2\text{O})_6]^{2+}$  and **d**-activated mechanisms operating for the others.<sup>229,231,232</sup>

The variations in the sign and magnitude of  $\Delta V^\ddagger_{\text{int}}$  reflect the extent of bond making and bond breaking occurring in the transition state, and the concurrent lengthening or shortening of non-



**Figure 21** Representation of transition states for water, other solvent, or symmetrical ligand exchange processes. The positive (upward) inclination of the arrow superscript of  $k_{\text{H}_2\text{O}}$  indicates that increasing applied pressure accelerates the water exchange process, whereas a negative inclination indicates the opposite. Two superscript arrows indicate that  $k_{\text{H}_2\text{O}}$  is strongly sensitive to pressure and that the magnitude of  $\Delta V^\ddagger$  is large, while a single arrow indicates a lesser sensitivity of  $k_{\text{H}_2\text{O}}$  to pressure and a lesser magnitude of  $\Delta V^\ddagger$ .

exchanging ligand to metal center distances. Thus, a continuous variation of transition state configurations is envisaged as shown for water, other solvent, or identical ligand exchange in Figure 21 where  $\Delta V_{\text{int}}^{\ddagger} \sim \Delta V^{\ddagger}$ . The **A** mechanism is characterized by a much contracted transition state where the decrease in volume arising from the entry of the incoming ligand into the first-coordination sphere is partially offset by the expansion of the volume of the first-coordination sphere, and  $\Delta V^{\ddagger}$  is large and negative. The **D** mechanism is characterized by a much expanded transition state where the increase in volume arising from the dissociation of the leaving ligand is partially compensated for by the contraction of the first-coordination sphere volume and  $\Delta V^{\ddagger}$  is large and positive. For the **I** mechanism, equal amounts of bond breaking and bond making balance one another in their contributions so that  $\Delta V^{\ddagger} \approx 0$ . To either side of the **I** mechanism are the **I<sub>a</sub>** and **I<sub>d</sub>** mechanisms, where the bond-making contribution to the transition state is greater than the bond-breaking contribution and vice versa so that they are characterized by negative and positive  $\Delta V^{\ddagger}$  values, respectively. Thus, both the sign and magnitude of  $\Delta V^{\ddagger}$  changes as the contributions of bond making and bond breaking in the transition state change.

No method is available to detect the reactive intermediate species characterizing **A** and **D** mechanisms for water exchange on  $[\text{M}(\text{H}_2\text{O})_n]^{m+}$  and experimental distinction between them and **I<sub>a</sub>** and **I<sub>d</sub>** mechanisms, respectively, is not a simple matter. As a result, Swaddle used semi empirical calculations to show that  $\Delta V^{\ddagger}$  for **A** and **D** water exchange mechanisms on first-row transition  $[\text{M}(\text{H}_2\text{O})_6]^{2+/3+}$  has little dependence on  $r_{\text{M}}$  and should have values of  $-13.5 \pm 1$  and  $+13.5 \pm 1 \text{ cm}^3 \text{ mol}^{-1}$ , respectively, with smaller values for **I<sub>a</sub>** and **I<sub>d</sub>** mechanisms.<sup>208,228,233–235</sup> (These values include either an increase or a decrease of  $r_{\text{M}}$  by  $\sim 6 \text{ pm}$  when  $n$  changes from 6 to either 7 or 5, respectively.)

## 1.25.4 SUBSTITUTION OF MAIN GROUP METAL IONS

### 1.25.4.1 Group 1 $\text{Li}^+$ , $\text{Na}^+$ , $\text{K}^+$ , $\text{Rb}^+$ , $\text{Cs}^+$

The labilities of the alkali metals are close to the diffusion-controlled limit. Rate constants increase by approximately one order of magnitude, the increase in lability from  $\text{Li}^+$  to  $\text{Cs}^+$  being dominated by a decrease in surface charge density and an increase in coordination number which changes from values of 4–6 for  $\text{Li}^+$  to 8 for  $\text{Cs}^+$ , with intermediate values for  $\text{Na}^+$ ,  $\text{K}^+$ , and  $\text{Rb}^+$ . The residence time for a coordinated water on the  $\text{Cs}^+(\text{aq})$  ion of  $<1 \text{ ns}$  makes its behavior closely similar to that of  $\text{Eu}^{2+}(\text{aq})$ , where these are the two most rapidly exchanging aqua ions.

### 1.25.4.2 Group 2: $\text{Be}^{2+}$ , $\text{Mg}^{2+}$

Water-exchange rate constants have been determined for only  $[\text{Be}(\text{H}_2\text{O})_4]^{2+}$  and  $[\text{Mg}(\text{H}_2\text{O})_6]^{2+}$  ions. As a consequence of its small size,  $\text{Be}^{2+}$  forms tetrahedral complexes exemplified by  $[\text{Be}(\text{H}_2\text{O})_4]^{2+}$ . This is the only tetrahedral metal aqua ion it has been possible to study in depth. Interestingly, the  $\Delta V^{\ddagger} = -13.6 \text{ cm}^3 \text{ mol}^{-1}$  for water exchange is the largest negative value observed for water exchange on any metal ion consistent with the operation of an **A** mechanism, and compares with the molar volume of water,  $\Delta V^0 = 18.0 \text{ cm}^3 \text{ mol}^{-1}$  and  $\Delta V^{\ddagger} = -12.9 \text{ cm}^3 \text{ mol}^{-1}$  estimated for an **A** water exchange mechanism.<sup>236</sup> Because the concentration of bulk water is constant,  $k_{\text{H}_2\text{O}}(25^\circ\text{C}) = 730 \text{ s}^{-1}$  ( $\Delta H^{\ddagger} = 59.2 \text{ kJ mol}^{-1}$ ,  $\Delta S^{\ddagger} = +8.4 \text{ JK}^{-1} \text{ mol}^{-1}$ ) for  $[\text{Be}(\text{H}_2\text{O})_4]^{2+}$  is a pseudo first order rate constant. On the basis that an **A** mechanism operates a second order  $k_{\text{H}_2\text{O}} = 13.2 \text{ M}^{-1} \text{ s}^{-1}$  may be calculated with a corresponding  $\Delta S^{\ddagger} \approx -24.9 \text{ JK}^{-1} \text{ mol}^{-1}$ . The slow exchange rate is consistent with a small  $r_{\text{M}}$  and therefore high surface charge density, giving it a strong electrostatic attraction for the water dipole.

The increase in  $r_{\text{M}}$  for  $\text{Mg}^{2+}$  to  $72 \text{ pm}$  results in octahedral  $[\text{Mg}(\text{H}_2\text{O})_6]^{2+}$  and the water exchange is characterized by  $k_{\text{H}_2\text{O}}(25^\circ\text{C}) = 6.7 \times 10^5 \text{ s}^{-1}$  ( $\Delta H^{\ddagger} = 49.1 \text{ kJ mol}^{-1}$ ,  $\Delta S^{\ddagger} = +31.1 \text{ JK}^{-1} \text{ mol}^{-1}$ ) and  $\Delta V^{\ddagger} = +6.7 \text{ cm}^3 \text{ mol}^{-1}$ , consistent with either a **D** or an **I<sub>d</sub>** mechanism operating.<sup>237</sup> Ligand substitution data for  $[\text{Mg}(\text{H}_2\text{O})_6]^{2+}$  are few, but the pioneering ultrasonic studies of substitution by  $\text{SO}_4^{2-}$  and  $\text{CrO}_4^{2-}$  were characterized both by  $k_{23} = 1 \times 10^5 \text{ s}^{-1}$  in the three-stage Eigen–Tamm mechanism (Equation (3)), which compares with  $k_{\text{H}_2\text{O}} = 6.7 \times 10^5 \text{ s}^{-1}$ .<sup>213</sup> In the same study,  $k_{23} = 2 \times 10^7 \text{ s}^{-1}$  was reported for the substitution of  $\text{CrO}_4^{2-}$  on  $[\text{Ca}(\text{H}_2\text{O})_8]^{2+}$ , consistent with increasing lability towards water exchange and ligand substitution as  $r_{\text{M}}$  increases.



### 1.25.4.3 Group 3: Al<sup>3+</sup>, Ga<sup>3+</sup>, In<sup>3+</sup>

Of the hydrated trivalent main group metal ions [Al(H<sub>2</sub>O)<sub>6</sub>]<sup>3+</sup> ( $k_{\text{H}_2\text{O}}$  (25 °C) = 1.29 s<sup>-1</sup>,  $\Delta H^\ddagger = 84.7 \text{ kJ mol}^{-1}$ ,  $\Delta S^\ddagger = +41.6 \text{ JK}^{-1} \text{ mol}^{-1}$  and  $\Delta V^\ddagger = +5.7 \text{ cm}^3 \text{ mol}^{-1}$ ) and [Ga(H<sub>2</sub>O)<sub>6</sub>]<sup>3+</sup> ( $k_{\text{H}_2\text{O}}$  (25 °C) =  $4.0 \times 10^2 \text{ s}^{-1}$ ,  $\Delta H^\ddagger = 67.1 \text{ kJ mol}^{-1}$ ,  $\Delta S^\ddagger = +30.1 \text{ JK}^{-1} \text{ mol}^{-1}$  and  $\Delta V^\ddagger = +5.0 \text{ cm}^3 \text{ mol}^{-1}$ ) undergo water exchange through **d**-activated water exchange mechanisms as indicated by their positive  $\Delta V^\ddagger$  values.<sup>191,238</sup> While no experimentally determined  $\Delta V^\ddagger$  is available for [In(H<sub>2</sub>O)<sub>6</sub>]<sup>3+</sup>, *ab initio* calculations indicate that an **a**-activated mechanism with a  $\Delta V^\ddagger = -5 \text{ cm}^3 \text{ mol}^{-1}$  is favored over a **d**-activated mechanism as expected from the increase in  $r_{\text{M}}$  from Al<sup>3+</sup> to In<sup>3+</sup>.<sup>178</sup> The lability of [Tl(H<sub>2</sub>O)<sub>6</sub>]<sup>3+</sup> has yet to be determined.

Because of the polarization induced in coordinated water, hydroxo metal ions arise for all hydrated metal ions to some extent and can complicate the interpretation of ligand substitution data. This is particularly so for [Al(H<sub>2</sub>O)<sub>6</sub>]<sup>3+</sup> that forms [Al(H<sub>2</sub>O)<sub>5</sub>(OH)]<sup>2+</sup> at low pH as a consequence of the high surface charge density of the Al<sup>3+</sup> center. This can result in a “proton ambiguity” as the substitution of the conjugate base and acid forms of a ligand, respectively, on [Al(H<sub>2</sub>O)<sub>6</sub>]<sup>3+</sup> and [Al(H<sub>2</sub>O)<sub>5</sub>(OH)]<sup>2+</sup> are experimentally indistinguishable. The substitution of [Al(H<sub>2</sub>O)<sub>6</sub>]<sup>3+</sup> by five hydroxamic acids R<sup>1</sup>C(O)N(OH)R<sup>2</sup>, where R<sup>1</sup> and R<sup>2</sup> are H, alkyl, or aryl groups under conditions where they only exist in the conjugate acid form give  $k_i \{ = k_f / (SK_o) \}$  in the range 2.0 to 3.1 s<sup>-1</sup> at 25 °C where the estimated statistical factor  $S = 0.75$  and  $K_o = 0.1 \text{ M}^{-1}$ .<sup>224</sup> The similarity between these  $k_i$  and  $k_{\text{H}_2\text{O}} = 1.29 \text{ s}^{-1}$  is consistent with a **d**-activated ligand substitution mechanism operating. However, the estimation of  $S$  and  $K_o$  has a crucial effect on the magnitude of the derived  $k_i$ , and variations in the validity of such derivations may account for reported  $k_i$  values varying by up to an order of magnitude on either side of  $k_{\text{H}_2\text{O}}$  for other ligand substitutions. (The hydroxamic acids substitute 10<sup>4</sup> times faster on [Al(H<sub>2</sub>O)<sub>5</sub>(OH)]<sup>2+</sup> than on [Al(H<sub>2</sub>O)<sub>6</sub>]<sup>3+</sup> as anticipated from the labilizing effect of hydroxo ligands on coordinated water.) This is also the case for [Ga(H<sub>2</sub>O)<sub>6</sub>]<sup>3+</sup>.<sup>239</sup> However, the  $\Delta V^\ddagger = +4.0 \text{ cm}^3 \text{ mol}^{-1}$  reported for the substitution of tropolone on [Ga(H<sub>2</sub>O)<sub>6</sub>]<sup>3+</sup> is evidence for a **d**-activated mechanism.<sup>240</sup> Despite these variations in derived  $k_i$  values for [Al(H<sub>2</sub>O)<sub>6</sub>]<sup>3+</sup> and [Ga(H<sub>2</sub>O)<sub>6</sub>]<sup>3+</sup>, they are much smaller than those reported for [Cr(H<sub>2</sub>O)<sub>6</sub>]<sup>3+</sup> and [Fe(H<sub>2</sub>O)<sub>6</sub>]<sup>3+</sup> where **a**-activated mechanisms operate as is discussed below.<sup>241,242</sup>

## 1.25.5 SUBSTITUTION OF TRANSITION METAL AQUA IONS

The lability towards water exchange and ligand substitution generally of the first-row divalent transition metal ions increases in the sequence: Cu<sup>2+</sup> ≈ Cr<sup>2+</sup> > Zn<sup>2+</sup> ≈ Mn<sup>2+</sup> > Fe<sup>2+</sup> > - Co<sup>2+</sup> > Ni<sup>2+</sup> > V<sup>2+</sup> as a consequence of the variations of the electronic occupancy of the their *d*-orbitals. This sequence qualitatively coincides with the expectations arising from ligand field activation energies (LFAEs) calculated for **a**- and **d**-activated mechanisms for the last six metal ions as is also the case for the trivalent metal ions with the same electronic configurations.<sup>243–245</sup> High-spin *d*<sup>3</sup> and *d*<sup>8</sup> metal ions have substantial LFAEs contributing to their  $\Delta H^\ddagger$  with the consequence that V<sup>2+</sup>, Ni<sup>2+</sup>, and Cr<sup>3+</sup> are much less labile than the other di- and trivalent first-row transition metal ions. Similar conclusions arise from molecular orbital calculations.<sup>246</sup> Qualitatively, the change from **a**- to **d**-activation as *d*-orbital electronic occupancy increases may be explained through an increasing repulsion between an entering water molecule approaching an octahedral face of [M(H<sub>2</sub>O)<sub>6</sub>]<sup>2+/3+</sup> and the *t*<sub>2g</sub> electrons disfavoring the increase in coordination number required in an **a**-transition state so that a **d**-transition state is favored as atomic number increases. *Ab initio* calculations for water exchange on the *d*<sup>0</sup> to *d*<sup>10</sup> first-row hexa-coordinate transition metal ions ranging from Sc<sup>3+</sup> to Zn<sup>2+</sup> predict this change from **a**- to **d**-activation so that only **A** mechanisms are possible for Sc<sup>3+</sup>, Ti<sup>3+</sup>, and V<sup>3+</sup>, only **D** mechanisms are possible for Ni<sup>2+</sup>, Cu<sup>2+</sup>, and Zn<sup>2+</sup>, while a gradual change from **a**- to **d**-activation is predicted for other first-row transition metal ions with *d*<sup>2</sup> to *d*<sup>7</sup> electronic configurations.<sup>247–249</sup> In agreement with these conclusions, density function calculations show that water exchange on [Zn(H<sub>2</sub>O)<sub>6</sub>]<sup>2+</sup> occurs through a **D** mechanism.<sup>250</sup> The great labilities of Cu<sup>2+</sup> and Cr<sup>2+</sup> probably arise from stereochemical effects induced by their *d*<sup>9</sup> and *d*<sup>4</sup> electronic configurations as discussed below.

### 1.25.5.1 Six-coordination Divalent Transition Metal Aqua Ions

The mechanistic interpretation of the data for water exchange on the divalent first-row transition metal ions rests on the sign and magnitude of their  $\Delta V^\ddagger$  (Table 1). None of the  $\Delta V^\ddagger$  approach the

**Table 1** Parameters for water exchange on transition metal ions.

$[M(H_2O)_6]^{m+}$	$r_M^q$ (pm)	<i>d</i> -electronic configuration	$k_{H_2O}(25^\circ C)^b$ (s <sup>-1</sup> )	$\Delta H^\ddagger$ (kJ mol <sup>-1</sup> )	$\Delta S^\ddagger$ (J K <sup>-1</sup> mol <sup>-1</sup> )	$\Delta V^\ddagger$ (cm <sup>3</sup> mol <sup>-1</sup> )	Mechanism
$[V(H_2O)_6]^{2+}$	79	$t_{2g}^3$	$8.7 \times 10^1$	61.8	-0.4	-4.1	I <sup>c</sup>
$[Mn(H_2O)_6]^{2+}$	83	$t_{2g}^3 e_g^2$	$2.1 \times 10^7$	32.9	+5.7	-5.4	I <sup>d</sup>
$[Fe(H_2O)_6]^{2+}$	78	$t_{2g}^4 e_g^2$	$4.4 \times 10^6$	41.4	+21.2	+3.8	I <sup>d</sup>
$[Co(H_2O)_6]^{2+}$	74.5	$t_{2g}^5 e_g^2$	$3.2 \times 10^6$	46.9	+37.2	+6.1	I <sup>d</sup>
$[Ni(H_2O)_6]^{2+}$	69	$t_{2g}^6 e_g^2$	$3.2 \times 10^4$	56.9	+32.0	+7.2	I <sup>d</sup>
$[Cu(H_2O)_6]^{2+}$	73	$d^9 e$	$4.4 \times 10^9$	11.5	-21.8	+2.0	I <sup>f</sup>
$[Cu(H_2O)_5]^{2+}$		$d^9 e$	$5.3 \times 10^9$				I <sup>f</sup>
$[Ru(H_2O)_6]^{2+}$	73 <sup>h</sup>	$t_{2g}^6$	$1.8 \times 10^{-2}$	87.8	+16.1	-0.4	I <sup>j</sup>
$[Pd(H_2O)_4]^{2+}$	64	$d^8 i$	$5.6 \times 10^2$	49.5	-26.1	-2.2	I <sup>k</sup>
$[Pt(H_2O)_4]^{2+}$	60	$d^8 j$	$3.9 \times 10^{-4}$	89.7	-9	-4.6	I <sup>l</sup>
$[Ti(H_2O)_6]^{3+}$	67	$t_{2g}^1$	$1.8 \times 10^5$	43.4	+1.2	-12.1	A, I <sup>a,m</sup>
$[V(H_2O)_6]^{3+}$	64	$t_{2g}^2$	$5.0 \times 10^2$	49.4	-27.8	-8.9	I <sup>n</sup>
$[Cr(H_2O)_6]^{3+}$	61.5	$t_{2g}^3$	$2.4 \times 10^{-6}$	108.6	+11.6	-9.6	I <sup>o</sup>
$[Cr(H_2O)_5(OH)]^{2+}$		$t_{2g}^3$	$1.8 \times 10^{-4}$	111.0	+55.6	+2.7	I <sup>o</sup>
$[Fe(H_2O)_6]^{3+}$	64.5	$t_{2g}^3 e_g^2$	$1.6 \times 10^2$	64.6	+12.1	-5.4	I <sup>p</sup>
$[Fe(H_2O)_5(OH)]^{2+}$			$1.14 \times 10^{3q}$			+7.8	I <sup>p</sup>
$[Fe(H_2O)_5(OH)]^{2+}$			$1.2 \times 10^5$	42.4	+5.3	+7.0	I <sup>p</sup>
$[Fe(H_2O)_5(OH)]^{2+}$			$4.0 \times 10^2$	67.1	+30.1	+5.0	I <sup>r</sup>
$[Ga(H_2O)_6]^{3+}$	62	$t_{2g}^6 e_g^4$	$1.4 \times 10^{1q}$	110.9	+149.2	+7.7	I <sup>r</sup>
$[Ga(H_2O)_5(OH)]^{2+}$			$(0.6-2.0) \times 10^5$			+6.2	I <sup>r</sup>
$[Ru(H_2O)_6]^{3+}$	68	$t_{2g}^5$	$3.5 \times 10^{-6}$	89.8	-48.3	-8.3	I <sup>i</sup>
$[Ru(H_2O)_5(OH)]^{2+}$			$1.1 \times 10^{-6q}$	136.9	+100.5	-2.1	I <sup>i</sup>
$[Ru(H_2O)_5(OH)]^{2+}$			$5.9 \times 10^{-4}$	95.8	+14.9	+0.9	I <sup>i</sup>
$[Rh(H_2O)_6]^{3+}$	66.5	$t_{2g}^6$	$2.2 \times 10^{-9}$	131	+29	-4.2	I <sup>s</sup>
$[Rh(H_2O)_5(OH)]^{2+}$			$1.5 \times 10^{-8q}$	136	+61	+1.3	I <sup>s</sup>
$[Rh(H_2O)_5(OH)]^{2+}$			$4.2 \times 10^{-5}$			+1.5	I <sup>s</sup>
$[Ir(H_2O)_6]^{3+}$	68	$t_{2g}^6$	$1.1 \times 10^{-10}$	130.5	+2.1	-5.7	I <sup>t</sup>
$[Ir(H_2O)_5(OH)]^{2+}$			$1.4 \times 10^{-11q}$	138.5	+11.5	-0.2	I <sup>t</sup>
$[Ir(H_2O)_5(OH)]^{2+}$			$5.6 \times 10^{-7}$			+1.3	I <sup>t</sup>

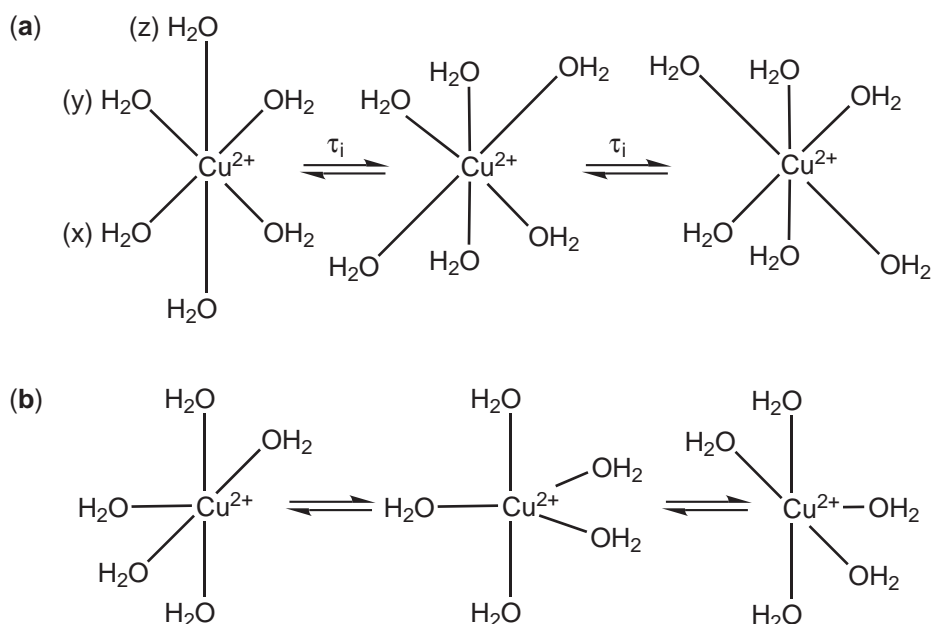
a 210 b Rate constant for the exchange of a particular water molecule. c 232 d 231 e Tetragonal distortion. f 156,251, g 159, five-coordinate. h 117, i 263 j Square-planar. k 260 l 262 m 34 n 238 o 241 p 242,268 q mol kg<sup>-1</sup> s<sup>-1</sup> r 191 s 269 t 147

$-13.5\text{ cm}^3\text{ mol}^{-1}$  and  $+13.5\text{ cm}^3\text{ mol}^{-1}$  anticipated for **A** and **D** mechanisms, respectively, and accordingly, **I<sub>a</sub>** and **I<sub>d</sub>** mechanisms are assigned when  $\Delta V^\ddagger$  is negative and positive, respectively for  $[\text{V}(\text{H}_2\text{O})_6]^{2+}$  to  $[\text{Ni}(\text{H}_2\text{O})_6]^{2+}$ .<sup>229,231,232</sup>

The enhanced lability of  $d^9$   $[\text{Cu}(\text{H}_2\text{O})_6]^{2+}$  has been interpreted in terms of a dynamic Jahn–Teller effect whereby a tetragonal distortion randomly reorientates or inverts about the  $x$ ,  $y$ , and  $z$  axes (Figure 22a) very rapidly so that the lifetime of a given distortion,  $\tau_i = 5.1 \times 10^{-12}$  s is much less than  $\tau_{\text{H}_2\text{O}} = 2.3 \times 10^{-10}$  s at 25 °C for  $[\text{Cu}(\text{H}_2\text{O})_6]^{2+}$ .<sup>156,251</sup> Thus, each coordinated water molecule experiences 45 inversions prior to exchanging. Recently, neutron diffraction and molecular dynamics studies have resulted in an alternative explanation for this lability in terms of five-coordinate  $[\text{Cu}(\text{H}_2\text{O})_5]^{2+}$  rapidly interconverting between square–pyramidal and trigonal–bipyramidal stereochemistries (Figure 22b) to give a recalculated  $\tau_{\text{H}_2\text{O}} = 1.9 \times 10^{-10}$  s.<sup>159</sup> Because  $d^4$   $[\text{Cr}(\text{H}_2\text{O})_6]^{2+}$  experiences similar Jahn–Teller effects to a  $d^9$  system, it is expected to experience similar labilizing effects to  $[\text{Cu}(\text{H}_2\text{O})_6]^{2+}/[\text{Cu}(\text{H}_2\text{O})_5]^{2+}$  but no direct characterization of water exchange has been reported.

The rate of ligand substitution on  $[\text{Fe}(\text{H}_2\text{O})_6]^{2+}$  to  $[\text{Zn}(\text{H}_2\text{O})_6]^{2+}$  shows little dependence on the nature of the substituting ligand as expected for these metal ions for which **d**-activated water exchange mechanisms operate.<sup>208,252–259</sup> The small amount of ligand substitution data for  $[\text{V}(\text{H}_2\text{O})_6]^{2+}$  and  $[\text{Mn}(\text{H}_2\text{O})_6]^{2+}$  shows little evidence of discrimination by the entering ligand. This may reflect the borderline hard acid nature of these ions restricting their substituting ligands to hard bases, which thereby limit the variation of nucleophilicity to too small a range for a rate dependence on the entering ligand to be observed. The contrary situation prevails with the  $d^8$  soft acid square-planar  $[\text{Pd}(\text{H}_2\text{O})_4]^{2+}$  and  $[\text{Pt}(\text{H}_2\text{O})_4]^{2+}$ .<sup>260,261</sup> Nevertheless, the negative  $\Delta V^\ddagger$  values for ligand substitution on  $[\text{V}(\text{H}_2\text{O})_6]^{2+}$  and  $[\text{Mn}(\text{H}_2\text{O})_6]^{2+}$ , and the positive values for  $[\text{Fe}(\text{H}_2\text{O})_6]^{2+}$  to  $[\text{Ni}(\text{H}_2\text{O})_6]^{2+}$ , show a strong correlation with those for water exchange. In contrast to the  $\Delta V^\ddagger = +7.1$  and  $+3.6\text{ cm}^3\text{ mol}^{-1}$ , respectively, for bipyridine substitution on  $[\text{Zn}(\text{H}_2\text{O})_6]^{2+}$  ( $r_{\text{M}} = 74$  pm) and the back reaction, the corresponding values for bipyridine substitution on  $[\text{Cd}(\text{H}_2\text{O})_6]^{2+}$  are  $\Delta V^\ddagger = -5.5$  and  $-6.9\text{ cm}^3\text{ mol}^{-1}$ , consistent with its increased  $r_{\text{M}} = 95$  pm facilitating the operation of an **a**-activated mechanism for the larger metal ion.<sup>262</sup>

Change of electronic configuration within a group can have a profound effect on lability, as exemplified by high-spin  $t_{2g}^4 e_g^2$   $[\text{Fe}(\text{H}_2\text{O})_6]^{2+}$ , which is eight orders of magnitude more labile than low-spin  $t_{2g}^6$   $[\text{Ru}(\text{H}_2\text{O})_6]^{2+}$  as a consequence the higher LFAE, and smaller  $r_{\text{M}} = 73$  pm of the latter metal ion which is reflected in a much greater  $\Delta H^\ddagger$ .<sup>263</sup>



**Figure 22** (a) The inversion of the tetragonal distortion in  $[\text{Cu}(\text{H}_2\text{O})_6]^{2+}$  whereby each coordinated water molecule experiences a bond elongation. (b) The Berry twist mechanism in  $[\text{Cu}(\text{H}_2\text{O})_5]^{2+}$  whereby each apical coordinated water in the square pyramid may exchange with a water in the square plane via the trigonal bipyramidal intermediate.



The  $\pi$ -bonding benzene ligand greatly labilizes  $\text{H}_2\text{O}$  in  $[\text{Ru}(\eta^6\text{-C}_6\text{H}_6)(\text{H}_2\text{O})_3]^{2+}$  ( $k_{\text{H}_2\text{O}}$  ( $25^\circ\text{C}$ ) =  $11.5\text{ s}^{-1}$ ,  $\Delta H^\ddagger = 75.9\text{ kJ mol}^{-1}$ ,  $\Delta S^\ddagger = +29.9\text{ J K}^{-1}\text{ mol}^{-1}$ ,  $\Delta V^\ddagger = +1.5\text{ cm}^3\text{ mol}^{-1}$ ) largely as a consequence of a decrease in  $\Delta H^\ddagger$ .<sup>121,264</sup> While these labilizations are quite impressive, it is to be expected that substitution of a different ligand onto  $[\text{M}(\text{solvent})_n]^{m+}$  will modify the effective surface charge density of the metal center, the LFAE, and the stereochemistry and so alter the lability of the exchanging solvent. Another example of this is the substitution of  $[\text{Ni}(\text{H}_2\text{O})_6]^{2+}$ ,  $k_{\text{H}_2\text{O}}$  ( $25^\circ\text{C}$ ) =  $3.2 \times 10^4\text{ s}^{-1}$ , by amines where substitution by one, two, and three  $\text{NH}_3$  ligands results in an increase in the lability of the remaining waters to  $10^{-6}k_{\text{H}_2\text{O}}$  ( $25^\circ\text{C}$ ) =  $0.25\text{ s}^{-1}$ ,  $0.61\text{ s}^{-1}$ , and  $2.50\text{ s}^{-1}$ , respectively.<sup>265</sup> Substitution by the tripodal tetramine, tren, in  $[\text{Ni}(\text{tren})(\text{H}_2\text{O})_2]^{2+}$  results in the inequivalent waters being characterized by  $10^{-6}k_{\text{H}_2\text{O}}$  ( $25^\circ\text{C}$ ) =  $0.82\text{ s}^{-1}$  and  $9.0\text{ s}^{-1}$ ,<sup>266</sup> while for the equivalent waters in  $[\text{Ni}(\text{cyclam})(\text{H}_2\text{O})_2]^{2+}$   $k_{\text{H}_2\text{O}} = 0.21 \times 10^7\text{ s}^{-1}$ .<sup>267</sup>

### 1.25.5.2 Six-coordinate Trivalent Transition Metal Aqua Ions

Of the trivalent first-row transition hexaaqua metal ions the order of lability increases in the sequence  $\text{Cr}^{3+} \ll \text{Fe}^{3+} \leq \text{V}^{3+} \ll \text{Ti}^{3+}$  coincident with decreasing LFAE contributions to  $\Delta H^\ddagger$ .<sup>34,239,241,242,268,269</sup> All four metal ions are characterized by negative  $\Delta V^\ddagger$  values indicating a-activation modes with that for  $[\text{Ti}(\text{H}_2\text{O})_6]^{3+}$  ( $\Delta V^\ddagger = -12.1\text{ cm}^3\text{ mol}^{-1}$ ) approaching  $\Delta V^\ddagger = -13.5\text{ cm}^3\text{ mol}^{-1}$  calculated for an A mechanism. In contrast,  $[\text{Ga}(\text{H}_2\text{O})_6]^{3+}$  is characterized by  $\Delta V^\ddagger = +5\text{ cm}^3\text{ mol}^{-1}$  consistent with the operation of an  $\text{I}_d$  mechanism as anticipated for its  $t_{2g}^6e_g^4$  electronic configuration.<sup>191</sup> The effect of electronic configuration on lability is powerfully illustrated by  $t_{2g}^2[\text{V}(\text{H}_2\text{O})_6]^{3+}$  being 57 times more labile than  $t_{2g}^3[\text{V}(\text{H}_2\text{O})_6]^{2+}$  because of the large LFAE of the latter species despite the lesser surface charge density of the  $\text{V}^{2+}$  center. Low-spin  $t_{2g}^5[\text{Ru}(\text{H}_2\text{O})_6]^{3+}$  and  $t_{2g}^6[\text{Rh}(\text{H}_2\text{O})_6]^{3+}$  also show the effects of LFAE on lability with the large LFAE of the latter causing it to be three orders of magnitude less labile than the former, largely as a result of its greater  $\Delta H^\ddagger$ .<sup>264,270</sup> The most inert aqua metal ion so far studied is  $t_{2g}^6[\text{Ir}(\text{H}_2\text{O})_6]^{3+}$ . This is a consequence of its large  $\Delta H^\ddagger$ .<sup>147</sup> However, the presence of other ligands can greatly influence the lability of these aqua ions at  $25^\circ\text{C}$  as is the case when the pentamethylcyclopentadienyl anion,  $\text{Cp}^{*-}$  is present in  $[\text{Rh}(\eta^5\text{-Cp}^*)(\text{H}_2\text{O})_3]^{2+}$  ( $k_{\text{H}_2\text{O}} = 1.6 \times 10^5\text{ s}^{-1}$ ,  $\Delta H^\ddagger = 65.6\text{ kJ mol}^{-1}$ ,  $\Delta S^\ddagger = +75.3\text{ J K}^{-1}\text{ mol}^{-1}$ ,  $\Delta V^\ddagger = +0.6\text{ cm}^3\text{ mol}^{-1}$ ) and  $[\text{Ir}(\eta^5\text{Cp}^*)(\text{H}_2\text{O})_3]^{2+}$  ( $k_{\text{H}_2\text{O}} = 2.53 \times 10^4\text{ s}^{-1}$ ,  $\Delta H^\ddagger = 54.9\text{ kJ mol}^{-1}$ ,  $\Delta S^\ddagger = +23.6\text{ J K}^{-1}\text{ mol}^{-1}$ ,  $\Delta V^\ddagger = +2.4\text{ cm}^3\text{ mol}^{-1}$ ) largely as a result of a halving of  $\Delta H^\ddagger$  by comparison with those of the hexaaqua ions, and a change in mechanism to  $\text{I}_d$  as shown by  $\Delta V^\ddagger$  for ligand substitution studies.<sup>122</sup>

Because of the increased polarization of the coordinated waters in  $[\text{M}(\text{H}_2\text{O})_6]^{3+}$  (Table 1), they are quite acidic with  $\text{p}K_a$  values = 3.9, 2.9, 4.1, 2.7, 3.5, and 4.45 when  $\text{M}^{3+} = \text{Ga}^{3+}$ ,  $\text{Fe}^{3+}$ ,  $\text{Cr}^{3+}$ ,  $\text{Ru}^{3+}$ ,  $\text{Rh}^{3+}$ , and  $\text{Ir}^{3+}$  respectively,<sup>147,208</sup> and  $[\text{M}(\text{H}_2\text{O})_5(\text{OH})]^{2+}$  is an effective component in the substitution process. Thus, the overall rate law for water exchange is:

$$k_{\text{H}_2\text{O}(\text{obs})} = k_{\text{H}_2\text{O}} + k_{\text{H}_2\text{O}'}/[\text{H}^+] = k_{\text{H}_2\text{O}} + k_{\text{OH}}K_a/[\text{H}^+] \quad (15)$$

where  $k_{\text{H}_2\text{O}}$  and  $k_{\text{OH}}$  characterize exchange of a particular water molecule on  $[\text{M}(\text{H}_2\text{O})_6]^{3+}$  and  $[\text{M}(\text{H}_2\text{O})_5(\text{OH})]^{2+}$ . The lability of water is greatly increased in  $[\text{M}(\text{H}_2\text{O})_5(\text{OH})]^{2+}$  and the  $\Delta V_{\text{OH}}^\ddagger$  values characterizing it are substantially positive when  $\text{M}^{3+} = \text{Ga}^{3+}$  and  $\text{Fe}^{3+}$ , consistent with an  $\text{I}_d$  mechanism operating, and small and positive when  $\text{M}^{3+} = \text{Cr}^{3+}$ ,  $\text{Ru}^{3+}$ ,  $\text{Rh}^{3+}$ , and  $\text{Ir}^{3+}$ , consistent with an I mechanism operating. Thus, the strong electron-donating character of the hydroxo ligand strengthens the bond between it and the metal center whilst weakening the water to metal center bond, which favors d-activation and labilizes the coordinated water. For  $[\text{M}(\text{H}_2\text{O})_5(\text{OH})]^{2+}$  with the same number of  $d$  electrons the labilization is greater for the lighter metal center as exemplified by  $d^5\text{ Fe}^{3+}$  and  $d^5\text{ Ru}^{3+}$ , and  $d^6\text{ Rh}^{3+}$ , and  $d^6\text{ Ir}^{3+}$ , consistent with the greater electron population of the heavier metal ion in each pair diminishing the effect of  $\sigma$  electron donation by the hydroxo ligand. A more extreme case of polarization arises when the oxidation state of the metal center is high as in the vanadyl ion  $[\text{VO}(\text{H}_2\text{O})_5]^{2+}$ , where the four equatorial  $\text{H}_2\text{O}$  and the one axial  $\text{H}_2\text{O}$  are characterized by  $k_{\text{H}_2\text{O}}$  ( $25^\circ\text{C}$ ) =  $500\text{ s}^{-1}$  and  $\sim 10^9\text{ s}^{-1}$  respectively, with the oxo ligand exchanging much more slowly with  $k_{\text{ex}} = 2.4 \times 10^{-5}\text{ s}^{-1}$ .<sup>273,274</sup>

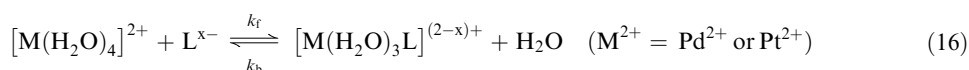
Ligand substitution on  $[\text{M}(\text{H}_2\text{O})_6]^{3+}$  and  $[\text{M}(\text{H}_2\text{O})_5(\text{OH})]^{2+}$  generally follows the pattern that the activation mode of water exchange is also the activation mode for ligand substitution.<sup>208</sup> Thus,  $k_f$  increases 225-fold with the basicity of the substituting  $\text{L}^{x-}$  monoanion as anticipated for a nucleophilic attack on  $[\text{Ti}(\text{H}_2\text{O})_6]^{3+}$  which undergoes water exchange through an A mechanism.<sup>273</sup>

and a similar situation prevails for  $[\text{V}(\text{H}_2\text{O})_6]^{3+}$ .<sup>274</sup> The substitution of  $\text{NCS}^-$  on  $[\text{V}(\text{H}_2\text{O})_6]^{3+}$  is characterized by a  $\Delta V^\ddagger$  value consistent with the operation of an  $\text{I}_a$  mechanism.<sup>275</sup> Monoanion substitution shows a 938- and 15-fold variation in  $k_f$  for  $[\text{Fe}(\text{H}_2\text{O})_6]^{3+}$  and  $[\text{Fe}(\text{H}_2\text{O})_5(\text{OH})]^{2+}$ , respectively, consistent with the ligand-substitution mechanisms being the same as their  $\text{I}_a$  and  $\text{I}_d$  water-exchange mechanisms.<sup>208,276,277</sup> Similarly, 2,050- and 21-fold  $k_f$  ranges indicate that  $\text{I}_a$  and  $\text{I}_d$  mechanisms operate for  $[\text{Cr}(\text{H}_2\text{O})_6]^{3+}$  and  $[\text{Cr}(\text{H}_2\text{O})_5(\text{OH})]^{2+}$ , respectively.<sup>241</sup> Of the same electronic configuration is second-row  $t_{2g}^3$   $[\text{Mo}(\text{H}_2\text{O})_6]^{3+}$ , which exhibits a range of  $k_i$  consistent with an  $\text{I}_a$  substitution mechanism, a conclusion supported by  $\Delta V_i^\ddagger \approx -17 \text{ cm}^3 \text{ mol}^{-1}$  for substitution by  $\text{NCS}^-$ .<sup>76,278</sup> However, despite the greater LFAE anticipated for  $[\text{Mo}(\text{H}_2\text{O})_6]^{3+}$  by comparison with that of  $[\text{Cr}(\text{H}_2\text{O})_6]^{3+}$ ,  $[\text{Mo}(\text{H}_2\text{O})_6]^{3+}$  is much more labile to ligand substitution, which may be a consequence of a greater extent of bond making in the transition state. To summarize; the low-electron-population metal ions  $[\text{Ti}(\text{H}_2\text{O})_6]^{3+}$ ,  $[\text{V}(\text{H}_2\text{O})_6]^{3+}$  and  $[\text{Mo}(\text{H}_2\text{O})_6]^{3+}$  which undergo water exchange by  $\mathbf{a}$ -activated mechanisms have no conjugate-base pathways. All other 3+ ions have an additional  $[\text{H}^+]^{-1}$  dependent term in the rate law.

### 1.25.5.3 Divalent Square–Planar Transition Metal Ions

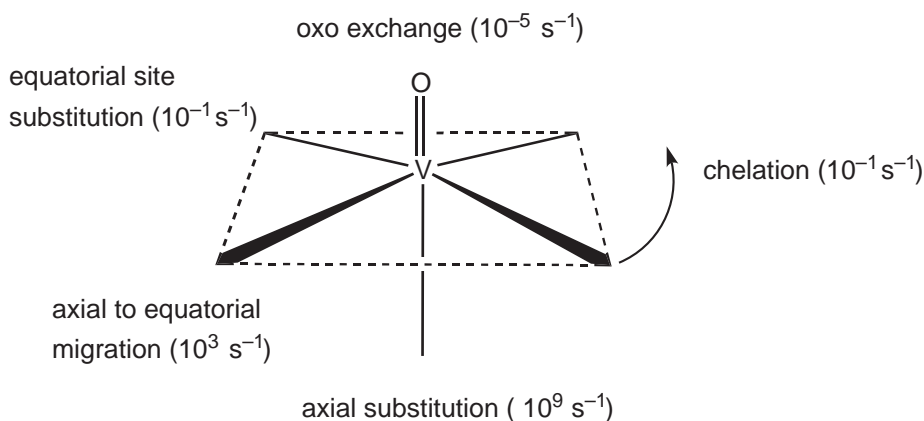
Square–planar stereochemistry is dominated by the  $d^8$  transition metal ions,  $\text{Rh}^+$ ,  $\text{Ir}^+$ ,  $\text{Ni}^{2+}$ ,  $\text{Pd}^{2+}$ ,  $\text{Pt}^{2+}$ , and  $\text{Au}^{3+}$  as a consequence of favorable ligand field effects, but it is the  $\text{Pd}^{2+}$  and  $\text{Pt}^{2+}$  square–planar metal complex ions that have dominated ligand substitution studies, which show that most ligand substitutions occur through an  $\mathbf{a}$ -activated mechanism.<sup>218,219</sup> Thus, the rate of water exchange on  $[\text{Pd}(\text{H}_2\text{O})_4]^{2+}$  is  $1.4 \times 10^6$  faster than on  $[\text{Pt}(\text{H}_2\text{O})_4]^{2+}$  as a consequence of the smaller  $\Delta H^\ddagger$  (Table 1) characterizing the former. It appears that  $\text{Pt}^{\text{II}}$  is more sensitive than  $\text{Pd}^{\text{II}}$  to the nature of the entering ligand, consistent with its softer acid nature and the greater covalency of  $\text{Pt}–\text{L}$  bonds. Both exchanges are characterized by small negative  $\Delta V^\ddagger$  values consistent with  $\mathbf{a}$ -activated mechanisms operating.<sup>260,261</sup> Because of their square–planar stereochemistries it is probable that a very weakly interacting water lies close to the metal ion center on either side of the square plane and that the volume change occurring on formation of the five-coordinate transition state is minimized as a consequence. Density function calculations show  $\mathbf{a}$ -activation to be energetically favored over  $\mathbf{d}$ -activation for both aqua ions.<sup>279</sup> Studies of the exchange of a moderate range of other solvents and ligands show a substantial range of lability for exchange of both hard and soft bases for the  $\text{Pd}^{2+}$  and  $\text{Pt}^{2+}$  centers, with  $\text{Pt}^{2+}$  showing the larger range, consistent with it being the softer acid.<sup>208</sup>

The simplest type of ligand substitution is that on a  $\text{Pd}^{2+}$  or  $\text{Pt}^{2+}$  center where all of the four coordinated solvent molecules are similar (Equation (16)). Here the ligand substitution rate constant,  $k_f$ , for  $[\text{Pd}(\text{H}_2\text{O})_4]^{2+}$  and  $[\text{Pt}(\text{H}_2\text{O})_4]^{2+}$  varies from  $1.8 \times 10^4 \text{ M}^{-1} \text{ s}^{-1}$  to  $1.14 \times 10^6 \text{ M}^{-1} \text{ s}^{-1}$  for  $\text{L}^{x-} = \text{Cl}^-$  and  $\text{I}^-$  when  $\text{M}^{2+} = \text{Pd}^{2+}$  and from  $2.66 \times 10^{-2} \text{ M}^{-1} \text{ s}^{-1}$  to  $7.7 \text{ M}^{-1} \text{ s}^{-1}$  when  $\text{M}^{2+} = \text{Pt}^{2+}$ . Large variations in  $k_f$  are also seen for other substituting ligands, which is evidence for the operation of an  $\mathbf{a}$ -activated mechanism.<sup>208,280</sup> In each case,  $k_f$  for the  $\text{Cl}^-$  and  $\text{I}^-$  is greater than  $k_f$  for water exchange ( $k_f = 4k_{\text{H}_2\text{O}}/55.5 = 40.3$  and  $2.8 \times 10^{-5} \text{ M}^{-1} \text{ s}^{-1}$  for  $[\text{Pd}(\text{H}_2\text{O})_4]^{2+}$  and  $[\text{Pt}(\text{H}_2\text{O})_4]^{2+}$ , respectively)



### 1.25.5.4 Transition Metal Oxo/Aqua Ions

Oxovanadium(IV) is the best characterized and most readily available of the monomeric first-row transition metal oxo ions. The  $\text{V}^{4+}$  center lies 10–30 pm above the plane defined by the four equatorial aqua ligands, and the ligand in the axial site is further from the metal center than the equatorial ligands. Exchange of the equatorial waters of  $[\text{VO}(\text{H}_2\text{O})_5]^{2+}$  occurs much more slowly than the exchange of the axial water, as expected on the basis of the  $\text{V}^{4+}–\text{H}_2\text{O}$  distances. The exchange rate constants summarized in Figure 23 are derived from observations on the relaxation and chemical shift variations of the bulk  $\text{H}_2\text{O}$   $^{17}\text{O}$  NMR. The oxo ligand exchange is characterized by  $k_{\text{ex}} = 2.4 \times 10^{-5} \text{ s}^{-1}$  at  $25^\circ\text{C}$ ,<sup>281</sup> which is much slower than the exchange of the oxo ligand of  $[\text{TiO}(\text{H}_2\text{O})_5]^{2+}$  ( $k_{\text{ex}} = 1.6 \times 10^4 \text{ s}^{-1}$  at  $25^\circ\text{C}$ ). The difference is attributable to the oxo ligand of the latter being more readily protonated and therefore labilized.<sup>36,282</sup> It has been suggested that



**Figure 23** Approximate magnitude of first-order rate constants (25 °C) for exchange or substitution at three different O-atom sites on  $[\text{VO}(\text{H}_2\text{O})_5]^{2+}$ .

the  $k_{\text{ex}}$  for direct substitution at an equatorial site on  $[\text{VO}(\text{H}_2\text{O})_5]^{2+}$  is  $\sim 0.1 \text{ s}^{-1}$ , and that the larger value of  $\sim 10^3 \text{ s}^{-1}$  and arises from a rapid migration between the axial and equatorial sites characterized by  $k_{\text{migration}} \sim 10^3 \text{ s}^{-1}$ .<sup>210</sup> A similar mechanism involving equatorial migration appears to operate for substitution at the equatorial sites on  $[\text{Mo}^{\text{II}}_2(\text{H}_2\text{O})_{10}]^{4+}$  and  $[\text{Rh}^{\text{II}}_2(\text{H}_2\text{O})_{10}]^{4+}$ .<sup>59,135</sup>

Substitution studies on the actinides have been largely confined to those of *trans*  $[\text{U}(\text{O})_2(\text{H}_2\text{O})_5]^{2+}$ . In the solid state  $[\text{U}(\text{O})_2(\text{H}_2\text{O})_5]^{2+}$  is characterized by U—O axial and equatorial distances of 171 pm and 227 pm respectively.<sup>283</sup> Protonation and oligomerization have, however, precluded a direct study of the water exchange.

## 1.25.6 SUBSTITUTION OF LANTHANIDE METAL IONS

### 1.25.6.1 Trivalent Lanthanide Metal Ions

This  $4f$  series has merited much attention because of the gradual decrease in  $r_{\text{M}}$  of the  $3+$  aqua ions with increasing atomic number (the lanthanide contraction). The fifteen trivalent lanthanides or  $f$ -block ions  $\text{La}^{3+}$ ,  $\text{Ce}^{3+}$ ,  $\text{Pr}^{3+}$ ,  $\text{Nd}^{3+}$ ,  $\text{Pm}^{3+}$ ,  $\text{Sm}^{3+}$ ,  $\text{Eu}^{3+}$ ,  $\text{Gd}^{3+}$ ,  $\text{Tb}^{3+}$ ,  $\text{Dy}^{3+}$ ,  $\text{Ho}^{3+}$ ,  $\text{Er}^{3+}$ ,  $\text{Tm}^{3+}$ ,  $\text{Yb}^{3+}$ , and  $\text{Lu}^{3+}$  are the most extended range of similar metal ions and are often collectively denoted  $\text{Ln}^{3+}$ . The sequential electronic filling of the  $4f$  orbitals and increase in nuclear charge results in the lanthanide contraction and a smooth decrease in  $r_{\text{M}}$  from 121.6 to 103.2 pm for nine-coordinate  $\text{La}^{3+}$  to  $\text{Lu}^{3+}$  and from 116.0 to 97.7 pm for eight-coordinate  $\text{La}^{3+}$  to  $\text{Lu}^{3+}$ .<sup>210</sup> Ligand field effects are small because of the diffuseness of the  $4f$  electron cloud and the shielding by the  $5s$  and  $5p$  electrons. Generally, the  $\text{Ln}^{3+}$  behave as large low surface charge density metal ions that exhibit variations in their coordination numbers with change of ligand type. For  $[\text{Ln}(\text{H}_2\text{O})_n]^{3+}$  in water,  $n=9$  for  $\text{La}^{3+}$  to  $\text{Nd}^{3+}$ ,  $n=8$  for  $\text{Gd}^{3+}$  to  $\text{Lu}^{3+}$  and an equilibrium exists between  $[\text{Ln}(\text{H}_2\text{O})_8]^{3+}$  and  $[\text{Ln}(\text{H}_2\text{O})_9]^{3+}$  for  $\text{Pm}^{3+}$  to  $\text{Eu}^{3+}$ .<sup>208,209,228,234,284,285</sup>

Water exchange rates on  $[\text{Gd}(\text{H}_2\text{O})_8]^{3+}$  to  $[\text{Lu}(\text{H}_2\text{O})_8]^{3+}$  decrease with the lanthanide contraction and both  $\Delta S^\ddagger$  and  $\Delta V^\ddagger$  are negative, with the latter being much less negative than either the  $\Delta V^\ddagger = -12.9 \text{ cm}^3 \text{ mol}^{-1}$  calculated for an **A** mechanism for water exchange or the volume change of  $-11 \text{ cm}^3 \text{ mol}^{-1}$  determined for  $[\text{Ce}(\text{H}_2\text{O})_8]^{3+}$  adding a water to form  $[\text{Ce}(\text{H}_2\text{O})_9]^{3+}$  as is seen from Table 2.<sup>286,287</sup> Thus, an **I<sub>a</sub>** mechanism is assigned to water exchange on these  $[\text{Ln}(\text{H}_2\text{O})_8]^{3+}$  and the decrease in  $k_{\text{H}_2\text{O}}$  and the increase in  $\Delta H^\ddagger$  with decrease in  $r_{\text{M}}$  is attributable to increasing steric crowding in the transition state. As the lighter  $\text{Ln}^{3+}$  exist as either  $[\text{Ln}(\text{H}_2\text{O})_9]^{3+}$  or an equilibrium mixture of  $[\text{Ln}(\text{H}_2\text{O})_8]^{3+}$  and  $[\text{Ln}(\text{H}_2\text{O})_9]^{3+}$  in water it is proposed that the **I<sub>a</sub>** water exchange on the heavier  $[\text{Ln}(\text{H}_2\text{O})_8]^{3+}$  occurs through a tricapped trigonal prismatic  $[\text{Ln}(\text{H}_2\text{O})_9]^{3+}$  transition state and that the ground state is an equilibrium mixture of dodecahedral, square-prismatic, and cubic  $[\text{Ln}(\text{H}_2\text{O})_8]^{3+}$  as shown in Figure 24. Attempts to directly determine  $k_{\text{H}_2\text{O}}$  (25 °C) for  $[\text{Pr}(\text{H}_2\text{O})_9]^{3+}$  and  $[\text{Nd}(\text{H}_2\text{O})_9]^{3+}$  only produced lower limit estimates of  $5 \times 10^8 \text{ s}^{-1}$  and  $4 \times 10^8 \text{ s}^{-1}$ , respectively.<sup>288</sup> Overall, the directly determined  $k_{\text{H}_2\text{O}}$  data are consistent with the most labile lanthanide centers being  $\text{Sm}^{3+}$ ,  $\text{Eu}^{3+}$ , and  $\text{Gd}^{3+}$  for which

**Table 2** Parameters for water exchange on trivalent lanthanide ions.<sup>a</sup>

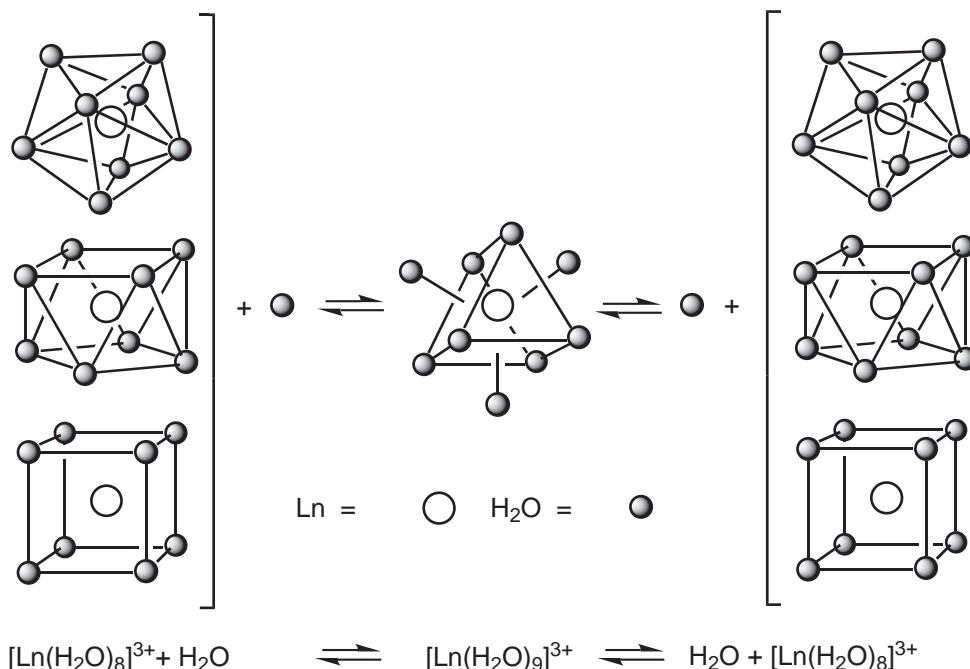
$[\text{Ln}(\text{H}_2\text{O})_8]^{3+}$	$r_M^b$ (pm)	$10^{-7}k_{\text{H}_2\text{O}}(25^\circ\text{C})^c$ ( $\text{s}^{-1}$ )	$\Delta H^\ddagger$ ( $\text{kJ mol}^{-1}$ )	$\Delta S^\ddagger$ ( $\text{J K}^{-1} \text{mol}^{-1}$ )	$\Delta V^\ddagger$ ( $\text{cm}^3 \text{mol}^{-1}$ )
$[\text{Gd}(\text{H}_2\text{O})_8]^{3+}$	105.3	83.0	14.9	-24.1	-3.3
$[\text{Tb}(\text{H}_2\text{O})_8]^{3+}$	104.0	55.8	12.1	-36.9	-5.7
$[\text{Dy}(\text{H}_2\text{O})_8]^{3+}$	102.7	43.4	16.6	-24.0	-6.0
$[\text{Ho}(\text{H}_2\text{O})_8]^{3+}$	101.5	21.4	16.4	-30.5	-6.6
$[\text{Er}(\text{H}_2\text{O})_8]^{3+}$	100.4	13.3	18.4	-27.8	-6.9
$[\text{Tm}(\text{H}_2\text{O})_8]^{3+}$	99.4	9.1	22.7	-16.4	-6.0
$[\text{Yb}(\text{H}_2\text{O})_8]^{3+}$	98.5	4.7	23.3	-21.0	

<sup>a</sup> Data from refs. 286 and 287 <sup>b</sup> 210. <sup>c</sup> Rate constant for the exchange of a particular water molecule.

the energies of  $[\text{Ln}(\text{H}_2\text{O})_8]^{3+}$  and  $[\text{Ln}(\text{H}_2\text{O})_9]^{3+}$  are most similar, and are in accord with ultrasonic studies which show that sulfate substitution occurs most rapidly for  $\text{Sm}^{3+}$ ,  $\text{Eu}^{3+}$ , and  $\text{Gd}^{3+}$  and decreases systematically as atomic number decreases or increases to either side of them.<sup>289</sup> The  $k_i$  for sulfate substitution is similar to  $k_{\text{H}_2\text{O}}$ .

Monte Carlo modeling predicts **a**- and **d**-activated water exchange on  $[\text{Ln}(\text{H}_2\text{O})_8]^{3+}$  and  $[\text{Ln}(\text{H}_2\text{O})_9]^{3+}$ , respectively.<sup>290</sup> Molecular dynamic simulations of water exchange on  $[\text{Nd}(\text{H}_2\text{O})_9]^{3+}$  and  $[\text{Yb}(\text{H}_2\text{O})_8]^{3+}$  indicate the operation of **I<sub>d</sub>** and **I<sub>a</sub>** mechanisms, respectively, but the equilibrium between  $[\text{Sm}(\text{H}_2\text{O})_9]^{3+}$  and  $[\text{Sm}(\text{H}_2\text{O})_8]^{3+}$  is maintained by a ninth water molecule that exchanges rapidly between the first coordination sphere and the bulk in an alternation of addition and elimination reactions that does not readily fit into the **a**- and **d**-activation classifications.<sup>211</sup>

Substitution of multidentate polyaminocarboxylate ligands on to  $\text{Ln}^{3+}$  can change the coordination number, the lability of coordinated water, and the mechanism of exchange as is the case for nine-coordinate  $[\text{Gd}(\text{DOTA})\text{H}_2\text{O}]^-$  for which  $k_{\text{H}_2\text{O}}(25^\circ\text{C}) = 4.8 \times 10^6 \text{ s}^{-1}$ ,  $\Delta H^\ddagger = 48.8 \text{ kJ mol}^{-1}$ ,  $\Delta S^\ddagger = +46.6 \text{ J K}^{-1} \text{mol}^{-1}$  and  $\Delta V^\ddagger = +10.5 \text{ cm}^3 \text{mol}^{-1}$  and the water exchange mechanism is **D** (DOTA<sup>4-</sup> = 1,4,7,10-tetraazacyclododecane-*N',N'',N''',N''''*-tetraacetate).<sup>291</sup> This and related complexes are important in magnetic resonance imaging.<sup>292-294</sup>

**Figure 24** Proposed pathways for water exchange on  $[\text{Ln}(\text{H}_2\text{O})_8]^{3+}$ .

### 1.25.6.2 Divalent Lanthanide Metal Aqua Ions

The only information to date is on  $[\text{Eu}(\text{H}_2\text{O})_7]^{2+}$ . The water exchange rate constant is  $5 \times 10^9 \text{ s}^{-1}$  as measured by  $^{17}\text{O}$  NMR with  $\Delta V^\ddagger = -11.3 \text{ cm}^3 \text{ mol}^{-1}$ . The very negative  $\Delta V^\ddagger$  is attributed to an A mechanism.<sup>22</sup> With the assignment of a coordination number of 7, this suggests that water exchange proceeds through an 8-coordination transition state which would typically be square-antiprismatic. The presence of an equilibrium between coordination numbers of 7 and 8 suggests that the energy differences are small leading to a fast exchange.

### 1.25.7 REFERENCES

- Richens, D. T. *The Chemistry of Aqua Ions* **1997**, Wiley Interscience: New York.
- Burgess, J. *Ions in Solution* **1986**, Ellis Horwood: Chichester, UK.
- Baes, C. F.; Mesmer, R. E. *The Hydrolysis of Cations* **1986**, Krieger: Florida.
- Enderby, J. E. *Chem. Soc. Rev.* **1995**, 159–168.
- Beattie, J. K.; Best, S. P. *Coord. Chem. Rev.* **1997**, *166*, 391–415.
- Ohtaki, H.; Radnai, T. *Chem. Rev.* **1993**, *93*, 1157–1204.
- Johansson, G. *Adv. Inorg. Chem.* **1992**, *39*, 178–232.
- Best, S. P.; Forsyth, J. B.; Treganna-Piggott, P. L. W. *J. Chem. Soc., Dalton Trans.* **1993**, 2711–2715.
- Treganna-Piggott, P. L. W.; Best, S. P.; Gudel, H. U.; Weike, H.; Wilson, C. C. *J. Solid State Chem.* **1999**, *15*, 460–470.
- Keil, R. G.; Johnson, D. W.; Fryling, M. A.; O'Brien, J. F. *Inorg. Chem.* **1989**, *28*, 2764–2766.
- Kameda, Y.; Uemura, O. *Bull. Chem. Soc. Japan* **1993**, *66*, 384–389.
- Pye, C. C.; Rudolph, W.; Poirier, R. A. *J. Phys. Chem.* **1996**, *100*, 601–605.
- Ohtomo, N.; Arakawa, K. *Bull. Chem. Soc. Japan* **1980**, *53*, 1789–1794.
- Heinje, G.; Luck, W. A. P.; Heinzinger, K. *J. Phys. Chem.* **1987**, *91*, 331–338.
- Neilson, G. W.; Skipper, N. *Chem. Phys. Lett.* **1985**, *114*, 35–38.
- Maneva, M.; Georgiev, M. *Polyhedron* **1993**, *12*, 1821–1824.
- Inamo, M.; Ishihara, K.; Funahashi, S.; Dicummon, Y.; Merbach, A. E.; Tanaka, M. *Inorg. Chem.* **1991**, *30*, 1580–1583.
- Kellersohn, T.; Delaplane, R. G.; Olovsson, I. *Acta. Cryst.* **1994**, *B50*, 316–326.
- Pye, C. C.; Rudolph, W. W. *J. Phys. Chem A* **1998**, *102*, 9933–9943.
- Jalilehvand, F.; Spangberg, D.; Lindqvist-Reis, P.; Hermansson, K.; Persson, I.; Sandstrom, M. *J. Am. Chem. Soc.* **2001**, *123*, 431–441.
- Persson, I.; Sandstrom, M.; Yokoyama, H.; Chaudhry, M. Z. *Naturforsch.* **1995**, *A50*, 21–37.
- Moreau, G.; Helm, L.; Purans, J.; Merbach, A. E. *J. Phys. Chem A* **2002**, *106*, 3034–3043.
- Rudolph, W. W.; Pye, C. C. *J. Phys. Chem A* **2000**, *104*, 1627–1639.
- Riport, V.; Hubert-Pfatzgraf, L. G.; Vaissermann, J. *Polyhedron* **1999**, *18*, 1845–1851.
- Smirnov, P.; Wakita, H.; Yamaguchi, T. *J. Phys. Chem B* **1998**, *102*, 4802–4808.
- Helm, L.; Merbach, A. E. *Coord. Chem. Rev.* **1999**, *187*, 151–181.
- Lindqvist-Reis, P.; Lamble, K.; Pattanaik, S.; Persson, I.; Sandstrom, M. *J. Phys. Chem. B* **2000**, *104*, 402–408.
- Molanda, G. A. *Chem. Rev.* **1992**, *92*, 29–68.
- Moll, H.; Denecke, M. A.; Jalilehvand, F.; Sandstrom, M.; Grenthe, I. *Inorg. Chem.* **1999**, *38*, 1795–1799.
- Navaza, A.; Villain, F.; Charpin, P. *Polyhedron* **1984**, *3*, 143–149.
- Ellis, J. D.; Green, M.; Sykes, A. G.; Buxton, G. V.; Sellers, R. M. *J. Chem. Soc., Dalton Trans.* **1973**, 1724–1728.
- Rosseinsky, D. R. *Chem. Rev.* **1965**, *65*, 467–490.
- Aquino, M. A. S.; Clegg, W.; Lui, Q. T.; Sykes, A. G. *Acta Cryst.* **1995**, *C51*, 560–562.
- Hugi, A. D.; Helm, L.; Merbach, A. E. *Inorg. Chem.* **1987**, *26*, 1763–1768.
- Eve, D. J.; Niven, M. L. *Inorg. Chim. Acta.* **1990**, *174*, 205–208.
- Comba, P.; Merbach, A. E. *Inorg. Chem.* **1987**, *26*, 1315–1323.
- Aberg, M.; Glaser, J. *Inorg. Chim. Acta* **1993**, *206*, 53–61.
- Aberg, M. *Acta Chem. Scan. A.* **1977**, *31*, 171–181.
- Devia, D. H.; Sykes, A. G. *Inorg. Chem.* **1981**, *20*, 910–913.
- Holt, D. G. L.; Larkworthy, L. F.; Povey, D. C.; Smith, G. W.; Leigh, G. J. *Inorg. Chim. Acta* **1990**, *169*, 201–205.
- Cotton, F. A.; Fair, C. K.; Lewis, G. E.; Mott, G. N.; Ross, F. K.; Schultz, A. J.; Williams, J. M. *J. Am. Chem. Soc.* **1984**, *106*, 5319–5323.
- Hitemann, M. A.; McDonald, R. G.; Smith, P. W.; Stranger, R. *J. Chem. Soc., Dalton Trans.* **1988**, 1393–1395.
- Kanamori, K.; Ookubo, Y.; Ino, K.; Kawai, K.; Michabata, H. *Inorg. Chem.* **1991**, *30*, 3832–3836.
- Rahmoeller, K. M.; Murmann, R. K. *Inorg. Chem.* **1983**, *22*, 1072–1077.
- Comba, P.; Helm, L. *Helv. Chim. Acta* **1988**, *71*, 1406–1420.
- Brnicevic, N.; Ruzic-Toros, Z.; Kojic-Prodic, B. *J. Chem. Soc., Dalton Trans.* **1985**, 455–460.
- Brnicevic, N.; Planinic, P.; McCarley, R. E.; Antolic, S.; Luic, M.; Kodric-Prodic, B. *J. Chem. Soc., Dalton Trans.* **1995**, 1441–1446.
- Richens, D. T.; Shannon, I. J. *J. Chem. Soc., Dalton Trans.* **1998**, 2611–2613.
- Ooi, B.-L.; Shibahara, T.; Sakane, G.; Mok, K.-F. *Inorg. Chim. Acta* **1997**, *266*, 103–107.
- Cotton, F. A.; Diebold, M. P.; Llusar, R.; Roth, W. J. *J. Chem. Soc., Chem. Commun.* **1986**, 1276–1278.
- Sokolov, M. N.; Hernandez-Molina, R.; Elsegood, M. R. J.; Heath, S. L.; Clegg, W.; Sykes, A. G. *J. Chem. Soc., Dalton Trans.* **1997**, 2059–2065.
- Fedin, V. P.; Virovets, A. V.; Dybtsev, D. N.; Gerasko, O. A.; Hegetschweiler, K.; Elsegood, M. R. J.; Clegg, W. *Inorg. Chim. Acta* **2000**, *304*, 301–304.



53. Micskei, K.; Nagypal, I. *J. Chem. Soc., Dalton Trans.* **1990**, 1301–1304.
54. Cotton, F. A.; Falvello, L. R.; Murillo, C. A.; Quesada, J. F. *J. Solid State Chem.* **1992**, *96*, 192–198.
55. Cotton, F. A.; Daniels, L. M.; Murillo, C. A. *Inorg. Chem.* **1993**, *32*, 4868–4870.
56. Bakac, A. *Prog. Inorg. Chem.* **1995**, *43*, 267–351.
57. Bakac, A.; Nemes, A. *Inorg. Chem.* **2001**, *40*, 746–749.
58. Espenson, J. H. *Acc. Chem. Res.* **1992**, *25*, 222–227.
59. Finholt, J. E.; Leupin, P.; Sykes, A. G. *Inorg. Chem.* **1983**, *22*, 3315–3318.
60. Cramer, S. P.; Eiden, P. K.; Paffett, M. T.; Winkler, J. R.; Dori, Z.; Gray, H. B. *J. Am. Chem. Soc.* **1983**, *105*, 799–802.
61. Figgis, B. N.; Reynolds, P. A.; Sobolev, A. N. *Acta Cryst.* **2000**, *B56*, 731–734.
62. Lindqvist-Reis, P.; Munoz-Paez, A.; Diaz-Moreno, S.; Pattanaik, S.; Persson, I.; Sandstrom, M. *Inorg. Chem.* **1998**, *37*, 6675–6683.
63. Bleuzen, A.; Foglia, F.; Furet, E.; Helm, L.; Merbach, A. E.; Weber, J. *J. Am. Chem. Soc.* **1996**, *118*, 12777–12787.
64. Spiccia, L.; Stocklie-Evans, H.; Marty, W.; Giovanoli, R. *Inorg. Chem.* **1987**, *26*, 474–482.
65. Spiccia, L.; Marty, W. *Polyhedron* **1991**, *10*, 619–628.
66. Rotzinger, F. P.; Stunzi, H.; Marty, W. *Inorg. Chem.* **1986**, *25*, 489–495.
67. Andersen, P.; Damuus, T.; Pedersen, E.; Pedersen, A. *Acta. Chem. Scand.* **1984**, *38*, 359–376.
68. Monsted, O.; Monsted, L.; Springborg, J. *Inorg. Chem.* **1985**, *24*, 3496–3498.
69. Spiccia, L.; Marty, W. *Inorg. Chem.* **1986**, *25*, 266–271.
70. Sanchez-Ortiz, V. A.; Martinez-Jardines, L. G.; Castillo-Blum, S. E.; Sykes, A. G. *J. Chem. Soc., Dalton Trans.* **1998**, 663–665.
71. Crimp, S. J.; Drljaca, A.; Smythe, D.; Spiccia, L. *J. Chem. Soc., Dalton Trans.* **1998**, 375–379.
72. Brorson, M.; Schaffer, C. E. *Acta Chem. Scand.* **1986**, *A40*, 358–360.
73. Mayer, J. M.; Abbott, E. H. *Inorg. Chem.* **1983**, *22*, 2774–2776.
74. Brorson, M.; Gajhede, M. *Inorg. Chem.* **1987**, *26*, 2109–2112.
75. Best, S. P.; Figgis, B. N.; Forsyth, J. B.; Treganna-Pigott, P. L. W. *Inorg. Chem.* **1995**, *34*, 4605–4610.
76. Richens, D. T.; Ducommun, Y.; Merbach, A. E. *J. Am. Chem. Soc.* **1987**, *109*, 603–604.
77. Richens, D. T.; Harmer, M. A.; Sykes, A. G. *J. Chem. Soc., Dalton Trans.* **1984**, 2099–2105.
78. Harmer, M. A.; Sykes, A. G. *Inorg. Chem.* **1981**, *20*, 3963–3967.
79. Richens, D. T.; Sykes, A. G. *Inorg. Chem.* **1982**, *21*, 418–422.
80. Richens, D. T.; Guille-Photin, C. G. *J. Chem. Soc., Dalton Trans.* **1990**, 407–412.
81. Hernandez-Molina, R.; Sykes, A. G. *J. Chem. Soc., Dalton Trans. (Perspective Review)*, **1999**, 3137–3148.
82. Sokolov, M. N.; Dybtsev, D. N.; Virovets, A. V.; Fedin, V. P.; Esparza, P.; Hernandez-Molina, R.; Fenske, D.; Sykes, A. G. *Inorg. Chem.* **2002**, *41*, 1136–1139.
83. Richens, D. T.; Helm, L.; Pittet, P.-A.; Merbach, A. E.; Nicolo, F.; Chapuis, G. *Inorg. Chem.* **1989**, *28*, 1394–1402.
84. Patel, A.; McMahon, M. R.; Richens, D. T. *Inorg. Chim. Acta* **1989**, *163*, 73–78.
85. Segawa, M.; Sasaki, Y. *J. Am. Chem. Soc.* **1985**, *107*, 5565–5566.
86. Richens, D. T.; Sykes, A. G. *Inorg. Chem.* **1982**, *21*, 418–422.
87. Rodgers, K. R.; Murmann, R. K.; Schlemper, E. O.; Shelton, M. E. *Inorg. Chem.* **1985**, *24*, 1313–1322.
88. Harmer, M. A.; Richens, D. T.; Soares, A. B.; Thornton, A. T.; Sykes, A. G. *Inorg. Chem.* **1981**, *20*, 4155–1458.
89. Ghosh, S. P.; Gould, E. S. *Inorg. Chem.* **1991**, *30*, 3662–3666.
90. Brorson, M.; Hazell, A.; Jabobsen, C. J. H.; Schmidt, I.; Villadsen, J. *Inorg. Chem.* **2000**, *39*, 1346–1350.
91. Ooi, B.-L.; Sykes, A. G. *Inorg. Chem.* **1988**, *27*, 310–315.
92. Patel, A.; Siddiqui, S.; Richens, D. T.; Harman, M. E.; Hursthouse, M. B. *J. Chem. Soc. Dalton Trans.* **1993**, 767–774.
93. Sharp, C.; Sykes, A. G. *Inorg. Chem.* **1988**, *27*, 501–503.
94. Paffett, M. T.; Anson, F. C. *Inorg. Chem.* **1981**, *20*, 3967–3972.
95. Cayley, G. R.; Taylor, R. S.; Wharton, R. K.; Sykes, A. G. *Inorg. Chem.* **1977**, *16*, 1377–1381.
96. Wang, B.; Sasaki, Y.; Nagasawa, A.; Ito, T. *J. Coord. Chem.* **1988**, *18*, 45–61.
97. Cieslak-Golonka, M. *Coord. Chem. Revs.* **1991**, *109*, 223–249.
98. Cruywagen, J. J. *Adv. Inorg. Chem.* **1999**, *49*, 127–182.
99. Hunt, J. P.; Friedman, H. L. *Prog. Inorg. Chem.* **1983**, *30*, 359–387.
100. Macartney, D. H.; Sutin, N. *Inorg. Chem.* **1985**, *24*, 3403–3409.
101. Siskos, P. A.; Peterson, N. C.; Huie, R. E. *Inorg. Chem.* **1984**, *23*, 1134–1137.
102. Clark, R. J. H.; Dines, T. J.; Doherty, J. M. *Inorg. Chem.* **1985**, *24*, 2088–2091.
103. Egli, A.; Hegetschweiler, K.; Alberto, R.; Abram, U.; Schibli, R.; Hedinger, R.; Gramlich, V.; Kissner, R.; Schubiger, P. A. *Organometallics*, **1997**, *16*, 1833–1840.
104. Alberto, R.; Schibli, R.; Egli, A.; Schubiger, A. P.; Abram, U.; Kaden, T. A. *J. Am. Chem. Soc.* **1998**, *120*, 7987–7988.
105. Abrams, M. J.; Davison, A.; Faggiani, R.; Jones, A. G.; Lock, C. J. L. *Inorg. Chem.* **1984**, *23*, 3284–3288.
106. Fedin, V. P.; Virovets, A. V.; Sykes, A. G. *Inorg. Chim. Acta* **1998**, *271*, 228–230.
107. Baldas, J.; Colmanet, S. F.; Williams, G. A. *Inorg. Chim. Acta* **1991**, *179*, 189–194.
108. Baldas, J.; Boas, J. F.; Bonnyman, J.; Colmanet, S. F.; Williams, G. A. *Inorg. Chim. Acta* **1991**, *179*, 151–154.
109. Baldas, J.; Boas, J. F.; Bonnyman, J.; Colmanet, S. F.; Williams, G. A. *J. Chem. Soc., Chem. Commun.* **1990**, 1163–1165.
110. Baldas, J.; Boas, J. F.; Ivanov, Z.; James, B. D. *Inorg. Chim. Acta* **1993**, *204*, 199–212.
111. Libson, K.; Sullivan, J. C.; Mulac, W. A.; Gordon, S.; Deutsch, E. *Inorg. Chem.* **1989**, *28*, 375–377.
112. Jolley, W. H.; Stranks, D. R.; Swaddle, T. W. *Inorg. Chem.* **1990**, *29*, 1948–1951.
113. Armstrong, R. S.; Beattie, J. K.; Best, S. P.; Braithwaite, G. P.; Delfavero, P.; Skelton, B. W.; White, A. H. *Aust. J. Chem.* **1990**, *43*, 393–398.
114. Flynn, C. M. *Chem. Rev.* **1984**, *84*, 31–41.
115. Delattre, J. L.; Stacy, A. M. S.; Young, V. G.; Long, G. J.; Hermann, R.; Grandjean, F. *Inorg. Chem.* **2002**, *41*, 2834–2838.

116. Johnson, M. D.; Sharmar, K. D. *Inorg. Chim. Acta* **1999**, *293*, 229–233.
117. Bernhard, P.; Burgi, H.-B.; Hauser, J.; Lehmann, H.; Ludi, A. *Inorg. Chem.* **1982**, *21*, 3936–3941.
118. Laurency, G.; Helm, L.; Merbach, A. E.; Ludi, A. *Inorg. Chim. Acta* **1991**, *189*, 131–133.
119. Laurency, G.; Helm, L.; Ludi, A.; Merbach, A. E. *Helv. Chim. Acta* **1991**, *74*, 1236–1238.
120. Laurency, G.; Merbach, A. E. *J. Chem. Soc., Chem. Commun.* **1993**, 187–189.
121. Stebler-Rothlisberger, M.; Hummel, W.; Pittet, P.-A.; Burgi, H.-B.; Ludi, A.; Merbach, A. E. *Inorg. Chem.* **1988**, *27*, 1358–1363.
122. Dacsi, L.; Elias, H.; Frey, U.; Hornig, A.; Kolele, U.; Merbach, A. E.; Paulus, H.; Schneider, J. S. *Inorg. Chem.* **1995**, *34*, 306–315.
123. Bernhard, P.; Stebler, A.; Ludi, A. *Inorg. Chem.* **1984**, *23*, 2151–2155.
124. Bernhard, P.; Helm, L.; Ludi, A.; Merbach, A. E. *J. Am. Chem. Soc.* **1985**, *107*, 312–317.
125. Patel, A.; Richens, D. T. *Inorg. Chem.* **1991**, *30*, 3789–3792.
126. Deloume, J. P.; Duc, G.; Thomas-David, G. *Polyhedron* **1985**, *4*, 875–877.
127. Osman, J. R.; Richens, D. T.; Crayston, J. A. *Inorg. Chem.* **1998**, *37*, 1665–1668.
128. Lay, P. A.; Harman, W. D. *Adv. Inorg. Chem.* **1991**, *37*, 219–379.
129. Bremard, C.; Mouchel, B. *Inorg. Chem.* **1982**, *21*, 1810–1820.
130. Faherty, K. P.; Thompson, C. J.; Aguirre, F.; Michen, J.; Metz, R. B. *J. Phys. Chem. A* **2001**, *105*, 10054–10059.
131. Fedorchuk, C.; Swaddle, T. W. *J. Phys. Chem. A* **2000**, *104*, 5651–5652.
132. Hyde, M. R.; Davies, R.; Sykes, A. G. *J. Chem. Soc., Dalton Trans.* **1972**, 1838–1843.
133. McAuley, A.; Whitcombe, T. W. *Inorg. Chem.* **1988**, *27*, 3090–3099.
134. Navon, G. *J. Phys. Chem.* **1981**, *85*, 3547–3549.
135. Pittet, P.-A.; Dacsi, L.; Zbinden, P.; Abou-Hamdan, A.; Merbach, A. E. *Inorg. Chim. Acta* **1993**, *206*, 135–140.
136. Hills, E. F.; Moszner, M.; Sykes, A. G. *Inorg. Chem.* **1986**, *25*, 339–341.
137. Dunbar, K. R. *J. Am. Chem. Soc.* **1988**, *110*, 8247–8249.
138. Moszner, M.; Ziolkowski, J. J. *Inorg. Chim. Acta* **1988**, *145*, 299–302.
139. Drljaca, A.; Hardie, M. J.; Ness, T. J.; Raston, C. L. *Eur. J. Inorg. Chem.* **2000**, *10*, 2221–2229.
140. Beattie, J. K.; Best, S. P.; Moore, F. W.; Skelton, B. W.; White, A. H. *Aust. J. Chem.* **1993**, *46*, 1337–1345.
141. Read, M. C.; Sandstrom, M. *Acta. Chem. Scand.* **1992**, *46*, 1177–1182.
142. Spiccia, L.; Aramini, J. M.; Crimp, S. J.; Drljaca, A.; Lawrenz, E. T.; Tedesco, V.; Vogel, H. J. *J. Chem. Soc., Dalton Trans.* **1997**, 4603–4609.
143. Moszner, M.; Ziolkowski, J. J. *J. Coord. Chem.* **1992**, *25*, 255–263.
144. Beutler, P.; Gamsjager, H. *J. Chem. Soc. Chem. Comm.* **1976**, 554–555.
145. Castillo-Blum, S. E.; Richens, D. T.; Sykes, A. G. *Inorg. Chem.* **1989**, *28*, 954–960.
146. Castillo-Blum, S. E.; Sykes, A. G.; Gamsjager, H. *Polyhedron* **1987**, *6*, 101–103.
147. Cusanelli, A.; Frey, U.; Richens, D. T.; Merbach, A. E. *J. Am. Chem. Soc.* **1996**, *118*, 5265–5271.
148. Best, S. P.; Armstrong, R. S.; Beattie, J. K. *J. Chem. Soc., Dalton Trans.* **1992**, 299–304.
149. Groh, S. E.; Riggs, P. J.; Baldacchini, C. J.; Rheingold, A. L. *Inorg. Chim. Acta* **1990**, *174*, 17–20.
150. Bhattacharya, S.; Mukherjee, R.; Chakravorty, A. *Inorg. Chem.* **1986**, *25*, 3448–3452.
151. Elmroth, S.; Burgarcic, Z.; Elding, L. I. *Inorg. Chem.* **1992**, *31*, 3551–3554.
152. Conder, H. L.; Cotton, F. A.; Falvello, L. R.; Han, S.; Walton, R. A. *Inorg. Chem.* **1983**, *22*, 1887–1891.
153. Fulton, J. L.; Hoffmann, M. M.; Darab, J. G.; Palmer, B. J.; Stern, E. A. *J. Phys. Chem.* **2000**, *A*, *104*, 11651–11663.
154. Marcus, Y. *J. Chem. Soc., Dalton Trans.* **1991**, 2265–2268.
155. Halley, J. W.; Smith, B. B.; Walbran, S.; Curtis, L. A.; Rigney, R. O.; Sutjianto, A.; Hung, N. C.; Yonco, R. M.; Nagy, Z. *J. Chem. Phys.* **1999**, *110*, 6538–6552.
156. Powell, D. H.; Furrer, P.; Pittet, P.-A.; Merbach, A. E. *J. Phys. Chem.* **1995**, *99*, 16622–16629.
157. Varghese, J. N.; Maslen, E. N. *Acta. Cryst. Sect.* **1985**, *41*, 184–190.
158. Cotton, F. A.; Daniels, L. M.; Murillo, C. A. *Inorg. Chem.* **1993**, *32*, 4868–4870.
159. Pasquarello, A.; Petri, I.; Salmon, P. S.; Parisel, O.; Car, R.; Toth, E.; Powell, D. H.; Fischer, H. E.; Helm, L.; Merbach, A. E. *Science*, **2001**, *291*, 856–859.
160. Meyerstein, D. *Inorg. Chem.* **1971**, *10*, 638–641.
161. Margerum, D. W.; Owens, G. D. In *Metal Ions in Biological Systems*; Marcel Dekker: New York, 1981, Vol 13.
162. Yamaguchi, T.; Johansson, G.; Holmberg, B.; Maeda, M.; Ohtaki, H. *Acta Chem. Scand.* **1984**, *A38*, 437–451.
163. Cox, B. G.; Garcia-Rosas, J.; Schneider, H.; van Truong, N. *Inorg. Chem.* **1986**, *25*, 1165–1168.
164. Biedermann, G.; Maggio, F.; Romano, V.; Zingales, R. *Acta Chem. Scand.* **1981**, *35A*, 287–294.
165. Arsellini, P.; Baiocchi, C.; Mentasti, E.; Coe, J. S. *J. Chem. Soc., Dalton Trans.* **1984**, 475–477.
166. Kirschenbaum, L. J.; Kouadio, I.; Mentasti, E. *Polyhedron* **1989**, *8*, 1299–1305.
167. Rush, J. D.; Kirschenbaum, L. J. *Inorg. Chem.* **1985**, *24*, 744–748.
168. Kissner, R.; Latal, P.; Geier, G. *J. Chem. Soc. Chem. Commun.* **1993**, 136–137.
169. Ershov, B. G.; Janata, E.; Henglein, A. *J. Phys. Chem.* **1994**, *98*, 7619–7623.
170. Babich, O. A.; Gould, E. S. *J. Chem. Soc. Chem. Commun.* **2001**, 998–999.
171. Kaatze, U.; Lonneck, V.; Pottel, R. *J. Phys. Chem.* **1987**, *91*, 2206–2211.
172. Mason, W. R. *Inorg. Chem.* **1983**, *21*, 147–150.
173. Vogler, A.; Kunkely, H. *Inorg. Chim. Acta* **1989**, *162*, 169–170.
174. Ujita, S.; Horii, H. S.; Taniguchi, S. *J. Phys. Chem.* **1973**, *77*, 2868–2871.
175. Barnum, D. W. *Inorg. Chem.* **1983**, *22*, 2297–2305.
176. Ishihara, K.; Nagasawa, A.; Unemoto, K.; Ito, H.; Saito, K. *Inorg. Chem.* **1994**, *33*, 3811–3816.
177. Rudolph, W. W.; Mason, R.; Pye, C. C. *Phys. Chem. Chem. Phys.* **2000**, *2*, 5030–5040.
178. Kowall, T.; Caravan, P.; Bourgeois, H.; Helm, L.; Rotzinger, F. P.; Merbach, A. E. *J. Am. Chem. Soc.* **1998**, *120*, 6569–6577.
179. Akitt, J. W. *Prog. Nucl. Magn. Reson.* **1989**, *21*, 1–149.
180. Swavey, S.; Gould, E. S. *J. Chem. Soc., Chem. Commun.* **2000**, 2159–2160.
181. Babich, O. A.; Gould, E. S. *Inorg. Chem.* **2001**, *40*, 5708–5710.
182. Berglund, J.; Werndrup, P.; Elding, L. I. *J. Chem. Soc., Dalton Trans.* **1994**, 1435–1439.

183. Persson, I.; Jalilehvand, F.; Sandstrom, M. *Inorg. Chem.* **2002**, *41*, 192–197.
184. Khoshdariya, D. E.; Dolidze, T. D.; Zusman, L. D.; Lindbergh, G.; Glaser, J. *Inorg. Chem.* **2002**, *41*, 1728–1738.
185. Dronskowski, R.; Simons, A. *Angew. Chem., Int. Ed. Engl.* **1989**, *28*, 758–760.
186. Henkel, S.; Klinkhammer, K. W.; Schwarz, W. *Angew. Chem., Int. Ed. Engl.* **1994**, *39*, 681–683.
187. Ermler, W. C.; Lee, Y. S.; Pitzer, K. S. *J. Chem. Phys.* **1979**, *70*, 293–298.
188. Kleier, D. A.; Wadt, W. R. *J. Am. Chem. Soc.* **1980**, *102*, 6909–6913.
189. Beattie, J. K.; Best, J. P.; Skelton, B. W.; White, A. H. *J. Chem. Soc., Dalton Trans.* **1981**, 2105–2111.
190. Lindqvist-Reis, P.; Munoz-Paez, A.; Diaz-Moreno, S.; Pattanaik, S.; Persson, I.; Sandstrom, M. *Inorg. Chem.* **1998**, *37*, 6675–6683.
191. Hugi-Cleary, D.; Helm, L.; Merbach, A. E. *J. Am. Chem. Soc.* **1987**, *109*, 4444–4450.
192. Bradley, S. M.; Kydd, R. A. *J. Chem. Soc., Dalton Trans.* **1993**, 2407–2413.
193. Brown, P. L.; Ellis, J.; Sylva, R. N. *J. Chem. Soc., Dalton Trans.* **1982**, 1911–1914.
194. Glaser, J.; Johansson, G. *Acta. Chem. Scand.* **1982**, *A36*, 125–135.
195. Blixt, J.; Glaser, J.; Solymosi, P. *Inorg. Chem.* **1992**, *31*, 5288–5297.
196. Blixt, J.; Glaser, J.; Mink, J.; Persson, I.; Persson, P.; Sandstrom, M. *J. Am. Chem. Soc.* **1995**, *117*, 5089–5104.
197. Satchell, D. P. N.; Satchell, R. S. *J. Chem. Soc. Perkin. Trans. II.* **1992**, 751–753.
198. Babich, O. A.; Gould, E. S. *Inorg. Chem.* **2000**, *39*, 4119–4122.
199. Yamaguchi, T.; Lindquist, O.; Claeson, T.; Boyce, J. B. *Chem. Phys. Lett.* **1982**, *93*, 528–532.
200. Bengtsson, L. A.; Hoffmann, R. *J. Am. Chem. Soc.* **1993**, *115*, 2666–2676.
201. Li, Y. P.; Krivovichev, S. V.; Burns, P. C. *J. Solid State Chem.* **2001**, *158*, 74–77.
202. Taylor, M. J.; Coddington, J. M. *Polyhedron* **1992**, *11*, 1531–1544.
203. Frank, W.; Reiss, G. J.; Schneider, J. *Angew. Chem., Int. Ed. Engl.* **1995**, *34*, 2416–2417.
204. Naslund, J.; Persson, I.; Sandstrom, M. *Inorg. Chem.* **2000**, *39*, 4012–4021.
205. Sundvall, B. *Acta. Chem. Scand.* **1980**, *A34*, 93–98.
206. Jayasekera, S.; Avraamides, J.; Ritchie, I. M. *Electrochim.* **1996**, *41*, 879–885.
207. Eigen, M. *Pure Appl. Chem.* **1963**, *6*, 97–115.
208. Lincoln, S. F.; Merbach, A. E. *Adv. Inorg. Chem.* **1995**, *42*, 1–88.
209. Caravan, P.; Toth, E.; Rockenbauer, A.; Merbach, A. E. *J. Am. Chem. Soc.* **1999**, *121*, 10403–10409.
210. Shannon, R. D. *Acta Crystallogr. Sect. A: Cryst. Phys. Diffr. Theor. Gen. Crystallogr.* **1976**, *A32*, 751–767.
211. Kowall, T.; Foglia, F.; Helm, L.; Merbach, A. E. *Eur. Chem. J.* **1996**, *2*, 285–294.
212. Wilkins, R. G. *Adv. Inorg. Bioinorg. Mech.* **1983**, *2*, 139–185.
213. Eigen, M.; Tamm, K. Z. *Elektrochem.* **1962**, *66*, 93–107.
214. Eigen, M.; Wilkins, R. G. *Adv. Chem. Ser.* **1965**, *49*, 55–67.
215. Fuoss, R. M. *J. Am. Chem. Soc.* **1958**, *80*, 5059–5061.
216. Merbach, A. E. *Pure Appl. Chem.* **1987**, *59*, 161–172.
217. van Eldik, R.; Merbach, A. E. *Comments Inorg. Chem.* **1992**, *12*, 341–378.
218. Cross, R. J. *Chem. Soc. Rev.* **1985**, *14*, 197–223.
219. Cross, R. J. *Adv. Inorg. Chem.* **1989**, *34*, 219–292.
220. Langford, C. H.; Gray, H. B. *Ligand Substitution Dynamics* **1965**, Benjamin: New York.
221. Langford, C. H.; Muir, W. R. *J. Am. Chem. Soc.* **1967**, *89*, 3141–3144.
222. Neely, J.; Connick, R. E. *J. Am. Chem. Soc.* **1970**, *92*, 3476–3478.
223. Nichols, P. J.; Grant, M. W. *Aust. J. Chem.* **1978**, *31*, 2581–2591.
224. Garrison, J. M.; Crumbliss, A. L. *Inorg. Chem.* **1987**, *26*, 3660–3664.
225. Swaddle, T. W. *Coord. Chem. Rev.* **1974**, *14*, 217–268.
226. Pearson, R. G. *J. Am. Chem. Soc.* **1963**, *85*, 3533–3539.
227. Pearson, R. G. *Coord. Chem. Rev.* **1990**, *100*, 403–425.
228. Swaddle, T. W. *Inorg. Bioinorg. Mech.* **1983**, *2*, 95–138.
229. Merbach, A. E. *Pure Appl. Chem.* **1982**, *54*, 1479–1493.
230. van Eldik, R. *Perspective in Coordination Chemistry*. Williams, A. F.; Floriani, C.; Merbach, A. E., Eds.; VCH: Weinheim, 1992.
231. Ducommun, Y.; Newman, K. E.; Merbach, A. E. *Inorg. Chem.* **1980**, *19*, 3696–3703.
232. Ducommun, Y.; Zbinden, D.; Merbach, A. E. *Helv. Chim. Acta* **1982**, *65*, 1385–1390.
233. Swaddle, T. W. *Inorg. Chem.* **1980**, *19*, 3203–3205.
234. Swaddle, T. W. *Inorg. Chem.* **1983**, *22*, 2663–2665.
235. Swaddle, T. W.; Mak, M. K. S. *Can. J. Chem.* **1983**, *61*, 473–480.
236. Pittet, P.-A.; Elbaze, G.; Helm, L.; Merbach, A. E. *Inorg. Chem.* **1990**, *29*, 1936–1942.
237. Bleuzen, A.; Pittet, P.-A.; Helm, L.; Merbach, A. E. *Magn. Reson. Chem.* **1997**, *35*, 765–773.
238. Hugi-Cleary, D.; Helm, L.; Merbach, A. E. *Helv. Chim. Acta* **1985**, *68*, 545–554.
239. Campisi, A.; Tregloan, P. A. *Inorg. Chim. Acta* **1985**, *100*, 251–259.
240. Yamada, S.; Iwanagawa, A.; Funahashi, S.; Tanaka, M. *Inorg. Chem.* **1984**, *23*, 3528–3532.
241. Xu, F.-C.; Krouse, H. R.; Swaddle, T. W. *Inorg. Chem.* **1985**, *24*, 267–270.
242. Grant, M.; Jordan, R. B. *Inorg. Chem.* **1981**, *20*, 55–60.
243. Spees, S. T.; Perumareddi, J. R.; Adamson, A. W. *J. Phys. Chem.* **1968**, *72*, 1822–1825.
244. Companion, A. L. *J. Phys. Chem.* **1969**, *73*, 739–741.
245. Meyer, F. K.; Newman, K. E.; Merbach, A. E. *J. Am. Chem. Soc.* **1979**, *101*, 5588–5592.
246. Rode, B. M.; Reibnegger, G. J.; Fujiwara, S. *J. Chem. Soc. Faraday Trans. 2.* **1980**, *76*, 1268–1274.
247. Rotzinger, F. P. *J. Am. Chem. Soc.* **1996**, *118*, 6760–6766.
248. Rotzinger, J. *J. Am. Chem. Soc.* **1997**, *119*, 5230–5238.
249. Rotzinger, F. P. *Chimia*, **1997**, *51*, 97–99.
250. Hartmann, M.; Clark, T.; van Eldik, R. *J. Am. Chem. Soc.* **1997**, *119*, 7843–7850.
251. Powell, D. H.; Helm, L.; Merbach, A. E. *J. Chem. Phys.* **1991**, *95*, 9258–9261.
252. Caldin, E. F.; Grant, M. W.; Hasinoff, B. B. *J. Chem. Soc. Faraday Trans. 1.* **1972**, *68*, 2247–2258.
253. Grant, M. W. *J. Chem. Soc. Faraday Trans. 1.* **1973**, *69*, 560–569.



254. Caldin, E. F.; Greenwood, R. C. *J. Chem. Soc. Faraday Trans. 1.* **1981**, *77*, 773–782.
255. Ishihara, K.; Funahashi, S.; Tanaka, M. *Inorg. Chem.* **1983**, *22*, 2564–2567.
256. Doss, R.; van Eldik, R. *Inorg. Chem.* **1982**, *21*, 4108–4109.
257. Nichols, P. J.; Ducommun, G.; Merbach, A. E. *Inorg. Chem.* **1983**, *22*, 3993–3995.
258. Mohr, R.; Mietta, L. A.; Ducommun, Y.; van Eldik, R. *Inorg. Chem.* **1985**, *24*, 757–759.
259. Mohr, R.; van Eldik, R. *Inorg. Chem.* **1985**, *24*, 3396–3399.
260. Helm, L.; Elding, L. I.; Merbach, A. E. *Helv. Chim. Acta* **1984**, *67*, 1453–1460.
261. Helm, L.; Elding, L. I.; Merbach, A. E. *Inorg. Chem.* **1985**, *24*, 1719–1721.
262. Ducommun, Y.; Laurenzy, G.; Merbach, A. E. *Inorg. Chem.* **1988**, *27*, 1148–1152.
263. Rapaport, I.; Helm, L.; Merbach, A. E.; Bernhard, P.; Ludi, A. *Inorg. Chem.* **1988**, *27*, 873–879.
264. Luginbühl, W.; Zbinden, P.; Pittet, P.-A.; Armbruster, T.; Bürgi, H.-B.; Merbach, A. E.; Bernhard, P.; Ludi, A. *Inorg. Chem.* **1981**, *30*, 2350–2355.
265. Desai, A. G.; Dodgen, H.W.; Hunt, J. P. *J. Am. Chem. Soc.* **1970**, *92*, 798–801.
266. Rablen, D. P.; Dodgen, H. W.; Hunt, J. P. *J. Am. Chem. Soc.* **1972**, *94*, 1771–1772.
267. Coates, J. H.; Hadi, D. A.; Lincoln, S. F.; Dodgen, H. W.; Hunt, J. P. *Inorg. Chem.* **1981**, *20*, 707–711.
268. Swaddle, T. W.; Merbach, A. E. *Inorg. Chem.* **1981**, *20*, 4212–4216.
269. Laurenzy, G.; Rapaport, I.; Zbinden, D.; Merbach, A. E. *Magn. Reson. Chem.* **1991**, *29*, S45–S51.
270. Cayemittes, S.; Poth, T.; Fernandez, M. J.; Lye, P. G.; Becker, M.; Elias, H.; Merbach, A. *Inorg. Chem.* **1999**, *38*, 4309–4316.
271. Wüthrich, K.; Connick, R. E. *Inorg. Chem.* **1967**, *6*, 583–590.
272. Kuroia, Y.; Harada, M.; Tomiyasu, H.; Fukutomi, H. *Inorg. Chim. Acta* **1988**, *146*, 7–8.
273. Chaudhuri, P.; Diebler, H. J. *J. Chem. Soc., Dalton Trans.* **1986**, 1693–1695.
274. Perlmutter-Hayman, B.; Tapuhi, E. *Inorg. Chem.* **1979**, *18*, 2872–2874.
275. Sauvageat, P. Y.; Ducommun, Y.; Merbach, A. E. *Helv. Chim. Acta* **1989**, *72*, 1801–1808.
276. Perlmutter-Hayman, B.; Tapuhi, E. *J. Coord. Chem.* **1976**, *6*, 31–37.
277. Hasinoff, B. B. *Can. J. Chem.* **1979**, *57*, 77–82.
278. Sasaki, Y.; Sykes, A. G. *J. Chem. Soc., Dalton Trans.* **1975**, 1048–1054.
279. Deeth, R. J.; Elding, L. I. *Inorg. Chem.* **1996**, *35*, 5019–5026.
280. Elding, L. I.; Olsson, L. F. *Inorg. Chim. Acta* **1986**, *117*, 9–16.
281. Johnson, M. D.; Murman, R. K. *Inorg. Chem.* **1983**, *22*, 1068–1072.
282. Dellavia, I.; Helm, L.; Merbach, A. E. *Inorg. Chem.* **1992**, *31*, 4151–4154.
283. Nassimbeni, L. R.; Rodgers, A. L. *Cryst. Struct. Commun.* **1976**, *5*, 301–308.
284. Cossy, C.; Helm, L.; Powell, D. H.; Merbach, A. E. *N. J. Chem.* **1995**, *19*, 27–35.
285. Kowal, T.; Foglia, F.; Helm, L.; Merbach, A. E. *J. Am. Chem. Soc.* **1995**, *117*, 3790–3799.
286. Cossy, C.; Helm, L.; Merbach, A. E. *Inorg. Chem.* **1989**, *28*, 2699–2703.
287. Micskei, K.; Powell, D. H.; Helm, L.; Brucher, E.; Merbach, A. E. *Magn. Reson. Chem.* **1993**, *31*, 1011–1020.
288. Powell, D. H.; Merbach, A. E. *Magn. Reson. Chem.* **1994**, *32*, 739–745.
289. Fay, D. P.; Litchinsky, D.; Purdie, N. *J. Phys. Chem.* **1969**, *73*, 544–552.
290. Galera, S.; Lluch, J. M.; Oliva, A.; Bertran, J.; Foglia, F.; Helm, L.; Merbach, A. E. *N. J. Chem.* **1993**, *17*, 773–339.
291. Micskei, K.; Helm, L.; Brucher, E.; Merbach, A. E. *Inorg. Chem.* **1993**, *32*, 3844–3850.
292. Graeppl, N.; Powell, D. H.; Laurenzy, G.; Zekany, L.; Merbach, A. E. *Inorg. Chim. Acta* **1995**, *235*, 311–326.
293. Toth, E.; Connac, F.; Helm, L.; Adzamlı, K.; Merbach, A. E. *Eur. J. Inorg. Chem.* **1998**, *12*, 2017–2021.
294. Toth, E.; Connac, F.; Helm, L.; Adzamlı, K.; Merbach, A. E. *J. Biol. Inorg. Chem.* **1998**, *3*, 606–613.

# 1.26

## Solvents and Ionic Liquids

P. J. DYSON

*École Polytechnique Fédérale de Lausanne, Switzerland*

---

1.26.1	INTRODUCTION	557
1.26.2	SOLVENT PROPERTIES	557
1.26.2.1	Assessment of Solvent Polarity	558
1.26.2.1.1	Donor number	558
1.26.2.1.2	Acceptor number	559
1.26.2.1.3	$E_T(30)$ and $E_T^N$ parameters	559
1.26.2.2	Solvent Classification	559
1.26.2.2.1	Classification based on chemical constitution	559
1.26.2.2.2	Classification based on physical constants	560
1.26.2.2.3	Other classification	560
1.26.3	EFFECT OF SOLVENT ON REACTIONS	561
1.26.4	IONIC SOLVENTS	561
1.26.4.1	The Cations	562
1.26.4.2	The Anions	563
1.26.4.2.1	Chlorometalates	563
1.26.4.2.2	$BF_4^-$ or $PF_6^-$ containing ionic liquids	563
1.26.4.3	Solvent Properties of Ionic Liquids	564
1.26.5	PERFLUORINATED SOLVENTS	565
1.26.6	SUPERCRITICAL FLUIDS	565
1.26.7	THE CHALLENGE FOR THE FUTURE	565
1.26.8	REFERENCES	565

---

### 1.26.1 INTRODUCTION

Although all compounds can behave as solvents, it is only those that are liquid at room temperature that tend to be classed as such. Solvents are widely used at all stages of coordination chemistry: in synthesis, chromatographic separation and purification, analysis and spectroscopy, crystal growth, and cleaning. Since any compound is a solvent, at least in principle, selecting the right one for a particular task is essential. From a synthetic perspective, solvents have pronounced effects on reaction equilibria. They influence the formation of geometrical isomers in coordination complexes and effect reaction rates and mechanisms.

In this section on solvents the emphasis is focused on their use in synthesis, since varying the solvent used to conduct a chemical reaction is one of the most effective ways to alter the pre-exponential factor of the Arrhenius equation, and hence the outcome of the reaction. In order to select the appropriate solvent for a particular reaction it helps to have an understanding of solvent properties and solvent classification. Descriptions of solvent structure and solvent–solute interactions are found elsewhere.<sup>1</sup>

### 1.26.2 SOLVENT PROPERTIES

It is perhaps obvious that physical properties such as melting point, boiling point, and viscosity of a solvent are essential when choosing a solvent for a particular application. What is just as

**Table 1** Properties of some common solvents.

Solvent	Melting point (°C)	Boiling point (°C)	Density	DN <sup>N a</sup>	AN <sup>b</sup>
Acetone (propanone)	−94	56	0.791	0.44	12.5
Acetonitrile (ethanenitrile)	−48	81.6–82	0.786	0.36	18.9
Benzonitrile (cyanobenzene)	−13	188	1.010	0.31	15.5
1,2-Dichloroethane	−35	83	1.256	0.00	16.3
Dichloromethane	−97	39–40	1.325	20.4	
<i>N,N</i> -Dimethylacetamide	−20	164.5–166	0.937	0.72	13.6
Dimethyl sulfoxide	17–19	189	1.102	0.77	0.72
1,4-Dioxane	11.8	100–102	1.034	0.38	0.77
Ethyl acetate	−84	76.5–77.5	0.902	0.44	9.3
<i>n</i> -Hexane	−95	68–69	0.659	0.0	0.0
Methanol	−98	64–65	0.791	0.49	41.5
Nitrobenzene	5–6	210–211	1.204	0.21	14.8
Nitromethane	−29	100.8–101	1.127	0.07	20.5
Pyridine	−42	115	0.978	0.85	14.2
Tetrahydrofuran	−108	65.5–66.7	0.889	0.52	8.0
Water	0	100	1.000	0.46	54.8

<sup>a</sup> Determined calorimetrically in dilute 1,2-dichloroethane at room temperature<sup>4</sup>; DN<sup>N</sup> = DN/38.8 kcal mol<sup>−1</sup>. <sup>b</sup> Determined using <sup>31</sup>P NMR spectroscopy at 25° C<sup>3</sup>.

important is to have some assessment of the solvent polarity as this attests the solvation capability of the solvent for a solute. Unfortunately, solvent polarity is not easily quantified since it depends on the interplay of electrostatic, inductive, dispersion, charge-transfer, and hydrogen bonding forces.<sup>2</sup> Despite the problems quantifying solvent polarity, numerous methods have been devised, which are based on various physical and chemical properties. A list of the principal properties of some common solvents is given in Table 1.

### 1.26.2.1 Assessment of Solvent Polarity

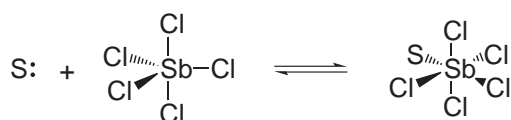
Solvent polarity is very difficult to define, but essentially refers to the solvation power of a solvent. Quantitative determination of solvent polarity is equally difficult, and quantitative methods rely on physical properties such as dielectric constant, dipole moment, and refractive index. It is not possible to determine the solvent polarity by measuring an individual solvent property due to the complexity of solute–solvent interactions and for this reason empirical scales of solvent polarity, based on chemical properties, are most widely used. The principal properties used to estimate solvent polarity are summarized in Table 2 and the most important of these methods are embellished below.

#### 1.26.2.1.1 Donor number

The donor number, DN, of a solvent, proposed by Gutmann, is a measure of the Lewis base donor power of the solvent.<sup>3</sup> The DN is determined by measuring the negative enthalpy for the reaction of the standard Lewis acid, SbCl<sub>5</sub>, with solvent (Scheme 1), and reflects the ability of the solvent to solvate Lewis acids. The scale commences at zero for solvents with no Lewis basicity (1,2-dichloroethane is used as a reference), and extends to 38.8 kcal mol<sup>−1</sup> for hexamethylphosphoramide (HMPA). Certain solvents like alcohols and water solvolyse SbCl<sub>5</sub> and the DN must be estimated by indirect methods. Sometimes values of DN are quoted as DN<sup>N</sup>, which corresponds to the DN/38.8 thereby giving a scale between 0 and 1.<sup>4</sup>

**Table 2** Properties used to assess solvent polarity.

Type of Property	Example
Bulk physical properties	Cohesive pressure Dielectric constant Refractive index
Molecular physical property	Dipole moment
Chemical properties	Donor numbers Acceptor number Solvatochromic properties— $E_t^N$ , $\beta$ , $\alpha$ and $\pi^*$ scale



S: = solvent

**Scheme 1**

### 1.26.2.1.2 Acceptor number

The acceptor number, AN, of a solvent is a measure of the Lewis acid acceptor power of the solvent.<sup>3</sup> Experimental evaluation of the AN involves observing the frequency changes induced by a solvent on the <sup>31</sup>P NMR spectrum when triethylphosphine oxide (Et<sub>3</sub>PO) is dissolved in the solvent. Hexane was used as the reference solvent and has an AN of zero, at the other extreme is trifluoroacetic acid for which AN = 105.3.

### 1.26.2.1.3 $E_T(30)$ and $E_T^N$ parameters

Dimroth and Reichardt devised a scale based on the solvatochromic behavior of the pyridinium-*N*-phenoxide betaine dye shown in Figure 1(a).<sup>5</sup> The UV spectrum varies over several hundred nanometers according to the solvent in which it is dissolved. The wavenumber observed relates to  $E_T(30)$  or normalized  $E_T^N$  values. At one end of the  $E_T^N$  scale is cyclohexane with a value of 0.006, and water lies at the other end with a value of 1.000.

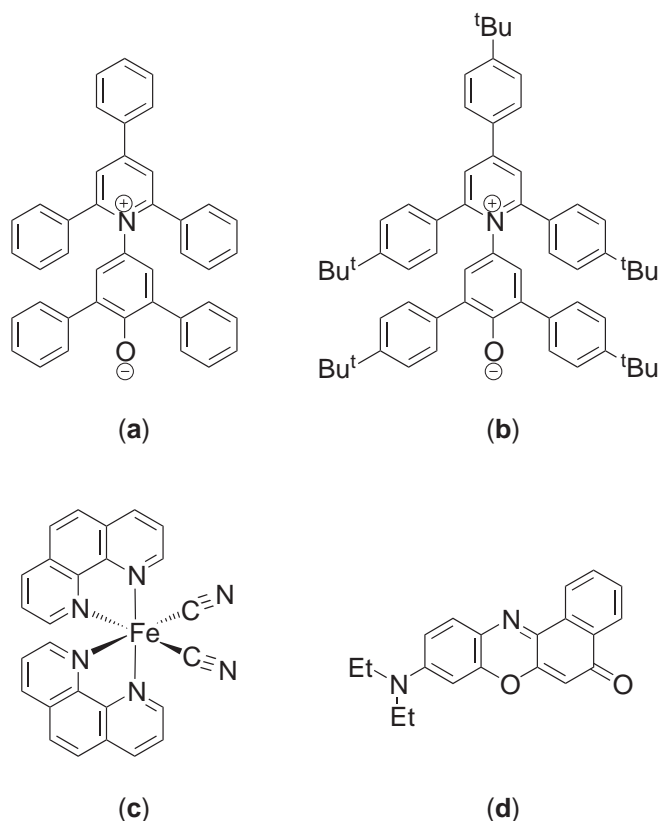
Various other compounds such as those shown in Figures 1b and 1c also exhibit large solvatochromic shifts and these have also been used to assess solvent properties. Solvent properties such as hydrogen bonding capacity can also be estimated using compounds that display solvatochromic shifts.<sup>6,7</sup>

## 1.26.2.2 Solvent Classification

The diversity of solvents makes classification very complex and many different ways of classifying solvents have been used. Broadly, solvents may be classified as aqueous, nonaqueous molecular, nonaqueous ionic, and atomic. The ways in which solvents are classified according to their chemical constitution and then according to their physical properties are briefly discussed below.

### 1.26.2.2.1 Classification based on chemical constitution

Solvents can be classified as molecular (composed of covalent bonds), ionic (made up of ionic bonds), or atomic (metallic) liquids. Molecular solvents, i.e., organic solvents, may be further divided according to their chemical composition—aliphatic, aromatic, alcohol, or other functional group. The general rule is that a coordination compound, or any compound for that matter, which



**Figure 1** Compounds that exhibit large solvatochromatic shifts used to assess solvent polarity.

has a particular functional group attached will dissolve well in a solvent that contains that functional group. Perfluorinated aliphatic solvents are a good example to mention here as they are being explored as solvents for biphasic catalysis (see Chapter 1.38). In order to dissolve catalysts in these solvents lengthy perfluorinated groups are attached to the ligands surrounding the catalyst.

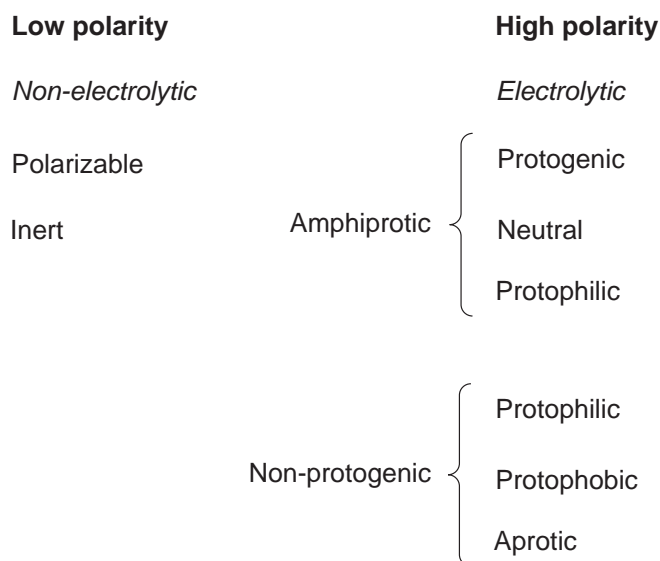
Ionic liquids once referred almost exclusively to molten salts, i.e., salts with melting points well above room temperature, although eutectic mixtures of salts can dramatically reduce melting points. Nowadays, there is a range of ionic compounds that are liquid at room temperature, and often much lower temperatures. Room temperature ionic liquids with properties that are conducive towards synthetic chemistry are described in [Section 1.26.3](#).

#### 1.26.2.2.2 Classification based on physical constants

There are a plethora of physical constants that can be used to classify solvents; key constants include melting and boiling points, viscosity, density, dipole moment, dielectric constant, specific conductivity, and cohesive pressure. The physical constant or constants that are considered most important really depend upon the application. For example, in a synthesis that involves conducting a reaction at elevated temperature, then boiling point may be the most important constant, however, if microwave heating is to be used then knowing the dielectric constant of the solvent is also essential.<sup>8,9</sup>

#### 1.26.2.2.3 Other classification

Solvents may also be classified according to their acid–base properties and in terms of specific solute–solvent interactions. These various classification methods are summarized in [Figure 2](#). The listed classifications facilitate the selection of the appropriate solvent to dissolve a compound, i.e., a solvent of low polarity dissolves covalent compounds of low polarity whereas a highly polar solvent dissolves ionic compounds.



**Figure 2** Solvent classification based on polarity and acid-base properties.

### 1.26.3 EFFECT OF SOLVENT ON REACTIONS

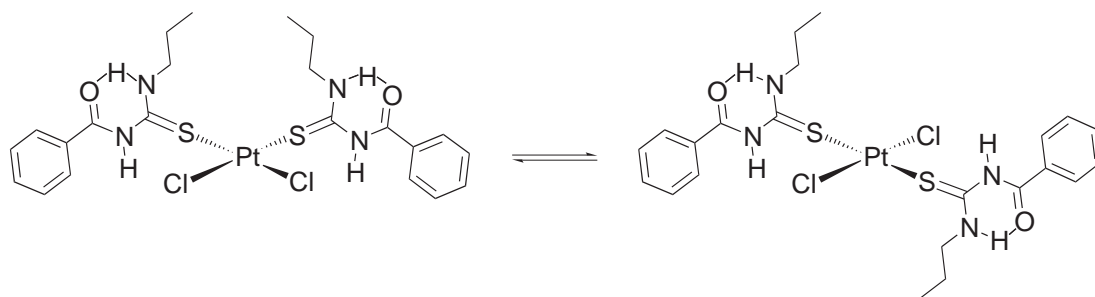
Solvents effect equilibria and rates of reactions, which is not only important in synthesis and catalysis, but in other processes such as the rate of electron transfer. Thus far, the effect of chiral solvents on chiral recognition and enantioselective catalysis has not proven effective, but without further experiments, it is too early to draw any firm conclusions.<sup>10</sup> There are many theories and rules relating to solvent effects on reactions, the majority developed with organic processes in mind, and discussions of these are not relevant here. Rather, the importance of solvent selection relevant to coordination chemistry will be illustrated with some key examples.

Reactions that give a mixture of *cis*- and *trans*-isomers can be tuned by careful choice of solvent to give one isomer in preference to the other. For example, with *cis* and *trans*-[Pt(H<sub>2</sub>L-S)<sub>2</sub>Cl<sub>2</sub>] (where H<sub>2</sub>L = *N*-benzoyl-*N'*-propylthiourea) shown in Figure 3,<sup>11</sup> the *cis*-isomer is favored in solvents of high polarity whereas the *trans*-isomer is dominant in solvents of low polarity. These observations are in accordance with other related observations,<sup>12,13</sup> and represent a case of “like yielding like” since the resulting *cis* complex is more polar than the *trans*-complex. From the table shown in Figure 3 the rate of equilibrium is highly solvent dependent. The relative rates of isomerization are greatest in nonpolar solvents and as polarity is increased the rate of isomerization decreases. With complexes that exist in solution as an equilibrium *cis/trans*-mixture, it has been possible to crystallize the *cis*-isomer from a low polarity solvent and the *trans*-isomer from a polar solvent.<sup>14</sup> It would appear that solvents have a pronounced influence on supramolecular coordination complexes as the resulting cavities are often highly solvent selective,<sup>15</sup> however, the influence that solvents have on supramolecular synthesis has not been systematically studied.

### 1.26.4 IONIC SOLVENTS

Since 1990 room temperature ionic liquids have emerged as alternative solvents for conducting synthesis. With any new solvent comes the possibility of new reactions and new compounds that cannot otherwise be obtained. Ionic liquids have a number of properties that make them suitable media for conducting chemical synthesis:

- They dissolve many metals complexes, catalysts, organic compounds and gases.
- Many have favorable thermal properties.
- They are also immiscible with many organic solvents and water, and both the cations and anions can be modified to give specific physical or chemical properties.
- Some are composed of non-nucleophilic anions and are therefore polar yet non-nucleophilic.



Solvent <sup>a</sup>	Dielectric constant	$E_T^N$	Equilibrium constant, $K$
Benzene	2.27	0.111	0.88
Chloroform	4.70	0.259	0.47
Tetrahydrofuran	7.39	0.207	0.39
Acetone	20.5	0.355	0.28
Dimethylformamide	36.7	0.404	0.23
Nitromethane	38.6	0.481	0.16

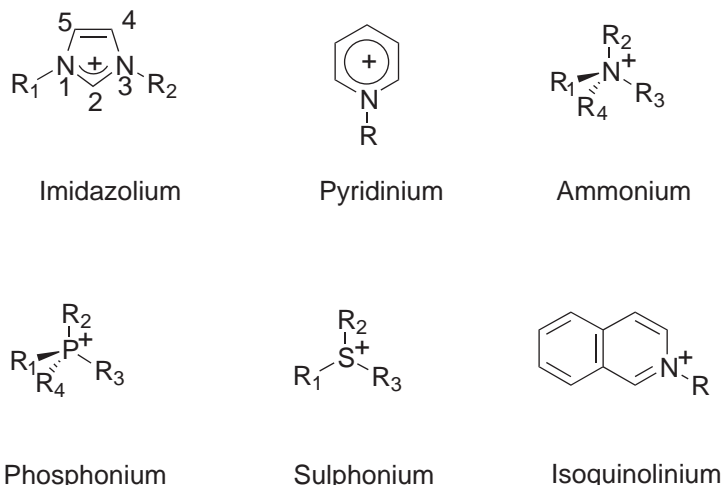
<sup>a</sup> All solvents are perdeuterated.

**Figure 3** Dependence of *cis*- and *trans*-isomers on solvent polarity.

Some contain anions that are reactive and are therefore active reagents or catalytically active. They have no vapor pressure and therefore do not evaporate.

#### 1.26.4.1 The Cations

The types of cations that give rise to low melting salts are shown in [Figure 4](#). In an ionic liquid the nature of the cation is more imperative than the anion in providing a low melting point. Although attempts have been made to correlate the electronic and steric properties of the cations and anions with the melting point they have been of limited success.<sup>16</sup> Ionic liquids are generally viewed as three-dimensional networks of cations and anions linked together by weak interactions such as hydrogen bonds, van der Waals and Coulombic forces. The key feature of the cation seems to be that it should be of low symmetry and have a poorly localized positive charge, preventing lattice formation, thereby lowering the melting point. Ionic liquids containing the



**Figure 4** Key cations that give rise to low melting salts.

1,3-dialkylimidazolium cations have been extensively studied in synthetic chemistry. These cations are relatively inert although the proton in the 2-position of the ring (see Figure 4) is acidic and under certain basic conditions can be removed yielding a carbene, which may be trapped by coordination to metal centers.

#### 1.26.4.2 The Anions

Many anions can be used in combination with the cations shown in Figure 4 to form low melting liquids, including metal halide anions, metal carbonyls,  $\text{BF}_4^-$ ,  $\text{PF}_6^-$ ,  $\text{AsF}_6^-$ ,  $\text{SbF}_6^-$ ,  $\text{NO}_3^-$ ,  $\text{CH}_3\text{CO}_2^-$ ,  $\text{CF}_3\text{SO}_3^-$ ,  $(\text{CF}_3\text{SO}_2)_2\text{N}^-$ ,  $(\text{CF}_3\text{SO}_2)_3\text{C}^-$ ,  $\text{CF}_3\text{COO}^-$ , and metallocarboranes (although these tend to give slightly higher melting points). The nature of the anion is largely responsible for the chemical properties of the ionic liquid (see below).

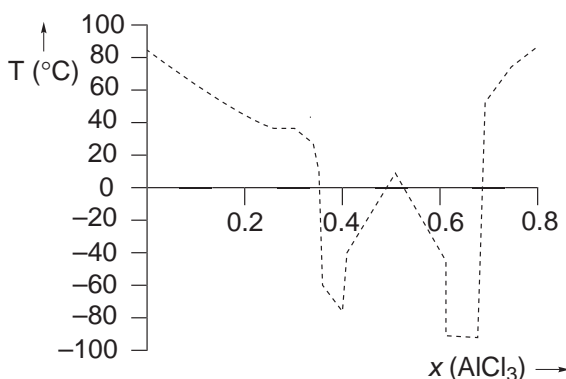
##### 1.26.4.2.1 Chlorometalates

Of the ionic liquids composed of metal–chloride anions, the chloroaluminates are the most widely studied. These liquids are easily prepared by mixing quaternary ammonium salts, especially *N*-alkylpyridinium and 1,3-dialkylimidazolium halides with aluminium(III) halides.<sup>17,18</sup> The actual anion present depends upon the relative molar ratios of the two substrates; the molar ratio also influences the melting point as shown in Figure 5. When the mole fraction of [1,3-dialkylimidazolium]Cl: $\text{AlCl}_3$  is 0.5 then the anion  $\text{AlCl}_4^-$  is the dominant species present and the ionic liquid is described as neutral. If the mole fraction of  $\text{AlCl}_3$  employed is greater than 0.5 then species such as  $\text{Al}_2\text{Cl}_7^-$  and  $\text{Al}_3\text{Cl}_{10}^-$  are formed and the ionic liquid is Lewis acidic. A mole fraction of less than 0.5 gives a basic ionic liquid. The chloroaluminate ionic liquids are very sensitive towards oxygen and water, and they can be harnessed in synthesis.<sup>19</sup>

Chlorocuprate based ionic liquids have also been quite widely studied.<sup>20</sup> Like the chloroaluminates they also contain a complex mixture of anions that include species such as  $[\text{CuCl}_2]^-$ ,  $[\text{Cu}_2\text{Cl}_3]^-$  and  $[\text{Cu}_3\text{Cl}_4]^-$ .

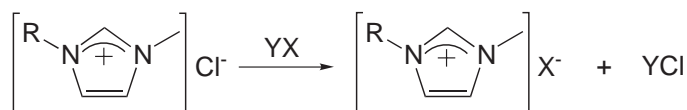
##### 1.26.4.2.2 $\text{BF}_4^-$ or $\text{PF}_6^-$ containing ionic liquids

1,3-Dialkylimidazolium ionic liquids with  $\text{BF}_4^-$  and  $\text{PF}_6^-$  anions are quite stable and while being polar (see below) are also non-nucleophilic. They can be prepared in a variety of ways, most commonly by metathesis reactions<sup>21–23</sup> and also by a methylation reaction.<sup>24</sup> These reactions are illustrated in Schemes 2 and 3, respectively. The chloride produced in the metathesis reactions (Scheme 2) is very difficult to remove completely and it affects the physical properties of the liquid and can also effect certain reactions carried out in the liquid. Figure 6 shows how the viscosity of 1-butyl-3-methylimidazolium tetrafluoroborate varies with chloride concentration.<sup>25</sup>



**Figure 5** Experimental phase diagram for [emim]/ $\text{AlCl}_3$  (where [emim] is the 1-ethyl-3-methylimidazolium cation).





R = alkyl, Y = Na, Ag or H, X = BF<sub>4</sub> or PF<sub>6</sub>

Scheme 2



R = alkyl, X = BF<sub>4</sub> or PF<sub>6</sub>

Scheme 3

### 1.26.4.3 Solvent Properties of Ionic Liquids

Ionic liquids based on 1,3-dialkylimidazolium cations have been widely used in synthetic applications. The proton in the 2-position is quite acidic, as evidenced both spectroscopically and from its reactivity.<sup>24</sup> Such acidity would suggest that it can form hydrogen bonds with the anions as well as with compounds dissolved in it. A number of X-ray diffraction studies have been conducted to probe the solid-state structure of various 1,3-dialkylimidazolium salts revealing the presence of extended hydrogen bonded networks although the shortest interaction does not always involve the proton in the 2-position.<sup>26-29</sup> Evidence for hydrogen bonding in ionic liquids in the solution-state has also been provided by NMR studies.<sup>30</sup> Counter-intuitively, replacement of the 2-proton with, for example, a methyl group results in increased melting points.

The polarity of some 1-alkyl-3-methylimidazolium ionic liquids has been probed using the solvatochromic dye Nile Red (Figure 1(d)), and found to be comparable to that of lower alcohols.<sup>31</sup> As such, polar organic solvents like dichloromethane and diethylether are miscible with ionic liquids, solvents of low polarity show partial miscibility, and nonpolar solvents are essentially immiscible. Extractants such as crown ethers can be used to extract cations such as Na<sup>+</sup>, Cs<sup>+</sup>, and Sr<sup>2+</sup> from ionic liquids.<sup>32</sup>

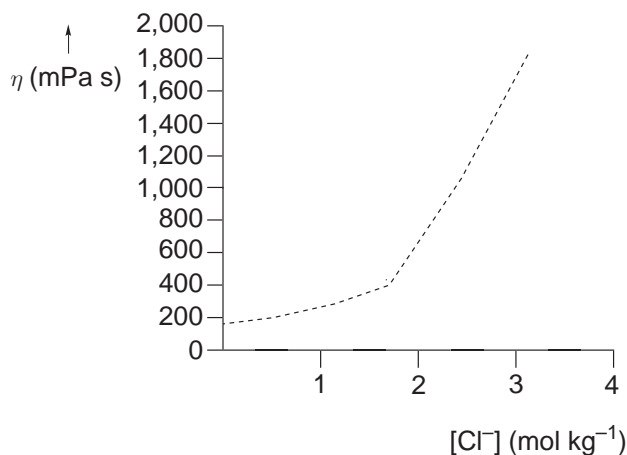


Figure 6 Viscosity of [bmim][BF<sub>4</sub>] versus molal concentration of chloride added as [bmim]Cl at 20°C (where [bmim] is the 1-butyl-3-methylimidazolium cation).

### 1.26.5 PERFLUORINATED SOLVENTS

Although known for many years, perfluorinated alkanes and ethers are becoming widely used as solvents for biphasic catalysis. They have not been employed as solvents for the synthesis of coordination compounds although metal complexes dissolve in them when suitable modifications are made to the ligands (see Chapter 1.38).

### 1.26.6 SUPERCRITICAL FLUIDS

Coordination compounds can be dissolved in supercritical fluids such as CO<sub>2</sub>, N<sub>2</sub>O, pentane, and diethylether by incorporating dionate, carbonyl, and fluorinated groups.<sup>33</sup> Much less work on novel compound synthesis has been reported although a number of inorganic materials and organometallic complexes have been prepared. For example, the amide [Cr<sub>2</sub>(NH<sub>2</sub>)<sub>3</sub>(NH<sub>3</sub>)<sub>6</sub>]I<sub>3</sub> was prepared from CrI<sub>2</sub> by dissolution in supercritical NH<sub>3</sub>.<sup>34</sup>

### 1.26.7 THE CHALLENGE FOR THE FUTURE

Whether we like it or not, as chemists we are being forced to reconsider how we use solvents and which solvents we use. The chemical industry is under considerable pressure from environmentalists and health and safety authorities to avoid using volatile organic compounds, which include the chlorinated compounds targeted by the Montreal protocol.<sup>35</sup> Solvents that were once routinely used in laboratories such as CCl<sub>4</sub> and benzene are either banned under the Montreal protocol or require special facilities. There has been much discussion on carrying out solvent-free synthesis, but solvents facilitate mixing of reactants and help to dissipate energy. Water is also often referred to as the ultimate green solvent, but is restricted in its applications, and furthermore, removal of trace quantities of organic compounds from water is very expensive. Cleaner, safer, and recyclable solutions are required, and while much of the coordination chemistry conducted in academia is a long way from chemical manufacture, this is where new practices begin.

### 1.26.8 REFERENCES

1. Reichardt, C. *Solvents and Solvent Effects in Organic Chemistry*, 2nd ed.; Wiley-VCH: Weinheim, Germany, 1988.
2. Reichardt, C. *Nachr. Chem. Tech. Lab.* **1997**, *45*, 759–763.
3. Fawcett, W. R. *J. Phys. Chem.* **1993**, *97*, 9540–9546.
4. Reichardt, C. In *Organic Liquids: Chemical Reactivity*; Buckingham, A. D.; Lippert, E.; Bratos, S., Eds.; Wiley: Chichester, U.K., 1978; Chapter 16.
5. Reichardt, C. *Chem. Rev.* **1994**, *94*, 2319–2358.
6. Johnson, B. P.; Gabrielsen, B.; Matulenko, M.; Dorsey, J. G.; Reichardt, C. *Anal. Letts.* **1986**, *19*, 939–962.
7. Reichardt, C.; Schafer, G. *Liebigs. Ann.* **1995**, *Chem.*, 1579–1582.
8. Baghurst, D. R.; Mingos, D. M. P. *Chem. Commun.* **1992**, 674–677.
9. Gabriel, C.; Gabriel, S.; Grant, E. H.; Halstead, B. S. J.; Mingos, D. M. P. *Chem. Soc. Rev.* **1998**, *27*, 213–223.
10. Fidler, J.; Rodger, P. M.; Rodger, A. *J. Am. Chem. Soc.* **1994**, *116*, 7266–7273.
11. Koch, K. R.; Wang, Y.; Coetzee, A. *J. Chem. Soc., Dalton Trans.* **1999**, 1013–1016.
12. Jenkins, J. M.; Shaw, B. L. *J. Chem. Soc. A* **1966**, 770–776.
13. Redfield, D. A.; Nelson, J. H. *Inorg. Chem.* **1973**, *12*, 15–19.
14. Real, J.; Prat, E.; Polo, A.; Alvarez-Larena, A.; Piniella, J. F. *Inorg. Chem. Commun.* **2000**, *3*, 221–223.
15. Cotton, F. A.; Lin, C.; Murillo, C. A. *Inorg. Chem.* **2001**, *40*, 478–484.
16. Wasserscheid, P.; Keim, W. *Angew. Chem., Int. Ed. Engl.* **2000**, *39*, 3773–3789.
17. Øye, H. A.; Jagtoyen, M.; Oksefjell, T.; Wilkes, J. S. *Mater. Sci. Forum* **1991**, 73–75, 183.
18. Bonhôte, P.; Dias, A.-P.; Papageorgiou, N.; Kalyanasundaram, K.; Grätzel, M. *Inorg. Chem.* **1996**, *35*, 1168–1178.
19. Dyson, P. J.; Grossel, M. C.; Srinivasan, N.; Vine, T.; Welton, T.; Williams, D. J.; White, A. J.; Zigras, T. *J. Chem. Soc., Dalton Trans.* **1997**, 3465–3469.
20. Chauvin, Y.; Olivier-Bourbigou, H. *Chemtech* **1995**, *25*, 26–30.
21. Suarez, P. A. Z.; Einloft, S.; Dullius, J. E. L.; de Souza, R. F.; Dupont, J. *J. Chim. Phys.* **1998**, *95*, 1626.
22. Wilkes, S. J.; Zaworotko, M. *Chem. Commun.* **1992**, 965–967.
23. Fuller, J.; Carlin, R. T.; De Long, H. C.; Haworth, D. *Chem. Commun.* **1994**, 299–300.
24. Olivier, H.; Favre, F. Preparation of a Molten Salt from Trialkyloxonium Anion and Amine. U.S. Patent 6, 245, 918, June 12, 2001.
25. Seddon, K. R.; Stark, A.; Torres, M.-J. *Pure Appl. Chem.* **2000**, *72*, 2275–2287.
26. Dymek, Jr. C. J.; Grossie, D. A.; Fratini, A. V.; Adams, W. W. *J. Mol. Struct.* **1989**, *213*, 25–34.
27. Elaiwi, A.; Hitchcock, P. B.; Seddon, K. R.; Srinivasan, N.; Tan, Y.-M.; Welton, T.; Zora, J. A. *J. Chem. Soc., Dalton Trans.* **1995**, 3467–3472.

28. Takahashi, S.; Suzuya, K.; Kohara, S.; Koura, N.; Curtiss, L. A.; Saboungi, M.-L. *Z. Phys. Chem.* **1999**, *209*, 209–221.
29. Larsen, A. S.; Holbrey, J. D.; Tham, F. S.; Reed, C. A. *J. Am. Chem. Soc.* **2000**, *122*, 7264–7272.
30. Huang, J.-F.; Chen, P.-Y.; Sun, I.-W.; Wang, S. P. *Inorg. Chim. Acta* **2001**, *320*, 7–11.
31. Carmichael, A. J.; Seddon, K. R. *J. Phys. Org. Chem.* **2000**, *13*, 591–595.
32. Visser, A. E.; Swatloski, R. P.; Reichert, W. M.; Griffin, S. T.; Rogers, R. D. *Ind. Eng. Chem. Res.* **2000**, *39*, 3596–3604.
33. Darr, J. A.; Poliakoff, M. *Chem. Rev.* **1999**, *99*, 495–541.
34. Zachwieja, U.; Jacobs, H. *Z. Kristallogr.* **1993**, *206*, 247–254.
35. Sherman, J.; Chin, B.; Huibers, P. D. T.; Garcia-Valls, R.; Hatton, T. A. *Environ. Health Perspec.* **1998**, *106*, 253–271.

# 1.27

## Chromatographic Methods

R. E. SHEPHERD

*University of Pittsburgh, PA, USA*

---

1.27.1	CHOOSING THE "RIGHT" CHROMATOGRAPHY	567
1.27.2	SCOPE AND REVIEW OF OTHER SOURCES	568
1.27.3	GENERAL SEPARATION TECHNIQUES	568
1.27.3.1	Separations of Chiral Complexes and Isomers	569
1.27.3.2	Capillary and Capillary Zone Electrophoresis of Complexes	570
1.27.3.3	Electrospray Mass Spectral Detection of Metal Complexes	571
1.27.3.4	Size-exclusion Chromatography (SEC) for Metal Complexes	571
1.27.3.5	IMAC Separations via Inorganic Complexes	572
1.27.3.6	Immobilized Metal Complexes for Organic Separations (IMCOS)	573
1.27.4	COMPUTER-AIDED CHROMATOGRAPHY INVOLVING METAL COMPLEXES	574
1.27.5	REFERENCES	576

---

### 1.27.1 CHOOSING THE "RIGHT" CHROMATOGRAPHY

This review describes currently useful methods for the separation and characterization of inorganic complexes. Some separations are required just to remove unreacted reagents or minor side products. Advances for these standard techniques (ion chromatography, normal and reversed-phase chromatography, thin-layer methods) are often limited by the availability of a specialized support material. However, newer, innovative methods for the separation of species have evolved, particularly separation methods needed in biomedical and industrial applications.

This review presents first the recent developments in the separations of small molecule complexes, covering support-phase separation techniques that are routinely applied to separation of charged complex ions, and separations that occur by differences in molecular recognition between a moving phase and a stationary phase. These more general methods are followed in the review by uses of support phases that lend themselves to the separation of isomers and chiral species. Next to be discussed are the newly evolving electrochemically assisted separation methods that may be applied to relatively small samples (capillary zone electrophoresis and derivative methods) and the gas-phase technique that allows for the identification of species charge and number of bound ligands (electrospray mass spectrometry). This section is followed by additional methods of interest to the biomedical community for the separation of ions attached to biopolymers (size exclusion and IMAC). Lastly, developments in the separations of organic feedstocks (IMCOS) that have taken a developmental cue from the biopolymer separations by IMAC are described.

A reader may intend to separate a sample that has certain characteristics as to origin, size of ligands, charged or neutral species, degree of structural functionality or spatial arrangement, and amounts of materials that are desired to be processed. This review may serve as a guide to the selection of the best techniques. For example, someone trying to separate a mixture of charged ions such as a representative  $[\text{Rh}^{\text{III}}(\text{L})_n\text{Cl}_2]^+$ ,  $[\text{Rh}^{\text{III}}(\text{L})_n\text{Cl}(\text{H}_2\text{O})]^{2+}$ ,  $[\text{Rh}^{\text{III}}(\text{L})_{n-2}\text{Cl}_4]^-$  product solution (L = neutral ligand) will find the sections on general methods and new electrophoretic methods of most value. The same experimentalist may deduce the composition of his product solution and the number of ligands ( $\text{L}$ )<sub>n</sub> that are associated with each central metal ion by ion

chromatography, linked in series with electrospray mass spectrometry detection. Another researcher trying to separate a collection of similarly sized neutral complexes or substrates will find necessary information in the general methods and IMCOS sections of this review. A drug design group needing one isomer of a catalyst as a template site for a chiral synthesis of a medicinal supplement would benefit from the section on separation of chiral isomers. An environmental chemist wishing to separate the binding species of  $\text{Hg}^{\text{II}}$  from a lakebed will wish to examine the section on size-exclusion chromatography. And a biochemist wanting to harvest a 10-mer peptide of unique sequence would want to bioengineer the synthesis of a tagged unit by means of *E. coli* with altered DNA structure to allow easy isolation via IMAC methodology. Each researcher will need to assess which chromatographic methods are most suited to their samples. Each of the following sections will provide example cases for developments that have advanced a separation technique. The reported examples serve as models that are similar to a reader's own separation demands and aid in selection of the "right" chromatography for their purposes.

### 1.27.2 SCOPE AND REVIEW OF OTHER SOURCES

Space limitations force this review of an extensive field to be limited to an overview of the major highlights of separation methods for transition metal complexes, or ligands bound to them, that have appeared since 1992. This is a period of significant development in inorganic separations and in the incorporation of new techniques beyond liquid chromatography and thin-layer methods. A comprehensive coverage of the chromatography of transition metals for this period, with discussions in greater detail than allowed for here, appears elsewhere.<sup>1</sup>

Special, highly recommended reviews for individual topics in the separation of metal complexes include the following: classical ion chromatography;<sup>2</sup> simple cation/anion separations;<sup>3</sup> acid/base equilibria on columns;<sup>4</sup> thin-layer chromatographic methods;<sup>5,6</sup> silica gel surface R group modifications that influence the surface polarity and, hence, complex affinity;<sup>7</sup> HPLC methods for transition metal complexes;<sup>8,9</sup> HPLC of platinum-group metal complexes and antitumor agents;<sup>10</sup> gas chromatographic separations;<sup>11</sup> size exclusion of bio-metal complexes;<sup>12,13</sup> CE and CZE separations of metal complexes;<sup>14–18</sup> micellar electrokinetic capillary chromatography (MEKC);<sup>19</sup> separations in supercritical fluids;<sup>20,21</sup> inductively coupled plasma and atomic absorption detection of metallo-biomolecules and metalloproteins;<sup>22,23</sup> ESI-MS detection of complexes and metallo-biopolymers;<sup>24,25</sup> separation of chiral complexes using chiral mobile phase additives;<sup>26</sup> separation of chiral  $\text{Co}^{\text{III}}$  chelates;<sup>27</sup> chiral phase support columns;<sup>28</sup> separations of boron clusters;<sup>29</sup> immobilized metal ion affinity chromatography (IMAC) separations;<sup>30</sup> IMAC-like (IMCOS) separations of organics<sup>31,32</sup> (IMCOS = Immobilized Metal Complexes for Organic Separations); mesoporous hosts for separations;<sup>33</sup> advances in detectors for ion chromatography;<sup>34</sup> and the effects of adding oxalate or succinate carrier anions in the separations of twenty *d*-block metal ions.<sup>35</sup>

### 1.27.3 GENERAL SEPARATION TECHNIQUES

In reversed-phase (RP) chromatography, a relatively nonpolar support phase binds the complexes (species) being separated, and these are moved by a polar solvent phase (water, alcohols, acetonitrile, or mixtures). Generally, as predictable for RP columns, more hydrophobic contacts on the exterior of a metal complex favor column binding, which retards migration. Examples for RP separations are given in the next paragraphs.

Many metal edta complexes of the type  $[\text{M}^{\text{III}}(\text{edta})]^{2-}$  or  $[\text{M}^{\text{III}}(\text{edta})]^{-}$  appear in the processing of geological and environmental samples. Replacing two glycinato arms of  $\text{edta}^{4-}$  with the more hydrophobic benzyl-*o*-phenylate arms affords better separation of ion mixtures containing  $\text{Fe}^{\text{III}}$ ,  $\text{Co}^{\text{III}}$ ,  $\text{Mn}^{\text{III}}$ ,  $\text{Al}^{\text{III}}$ ,  $\text{Cu}^{\text{II}}$ ,  $\text{Ni}^{\text{II}}$ , and  $\text{Zn}^{\text{II}}$  as their  $[\text{M}(\text{hbed})]^{n-}$  complexes, because of higher, more differentiated column affinities.<sup>36</sup>

Likewise, greater retention time for the nonpolar support phase increases for  $\text{M}^{\text{III}}(\text{R-acac})_3$  as more hydrophobic R groups replace  $\text{CH}_3$  of acetylacetonate ( $\text{acac}^-$ ); and if S replaces the O donors in thioacetylacetonates for  $\text{M}^{\text{III}} = \text{Cr}^{\text{III}}$ ,  $\text{Co}^{\text{III}}$ ,  $\text{Ru}^{\text{III}}$ , and lanthanide(III) ions.<sup>37,38</sup>

Adding  $(\text{NH}_4)_2\text{SO}_4$  to the mobile phase increases the residence time of  $\text{Co}^{\text{III}}$  complexes of  $\text{edta}^{4-}$  family ligands, or of  $\text{Co}^{\text{III}}(\text{AA})_3$  (AA = amino-acid) chelates on silica gel, cellulose, polyacrylonitrile, nitrile-modified silica gels, with column support affinity increasing with the expanding size of

the chelate rings/<sup>39–42</sup> Likewise,  $\text{Cu}^{\text{II}}(\text{AA})_2$  complexes separate on RP columns, having column affinities that follow the order of the hydrophobicities of the AA side-chain functionality, and are transported in the mobile phase as a function of the increasing net charge of the complex.<sup>43</sup>

Metal dithiocarbamate ( $\text{R}_2\text{dtc}^-$ ) complexes of  $\text{Zn}^{\text{II}}$ ,  $\text{As}^{\text{III}}$ ,  $\text{Fe}^{\text{III}}$ ,  $\text{Cd}^{\text{II}}$ ,  $\text{Pb}^{\text{II}}$ ,  $\text{Ni}^{\text{II}}$ ,  $\text{Cu}^{\text{II}}$ ,  $\text{Hg}^{\text{II}}$ ,  $\text{Co}^{\text{III}}$ , and  $\text{Cr}^{\text{III}}$  separate on C-18 RP columns with usually the best separations for C-3 to C-5 R groups of the  $\text{R}_2\text{dtc}^-$  ligands.<sup>44</sup> The eluting solutions were methanol/water, acetonitrile/water, or ternary mixture solvents.

Fluorinated R groups ( $\text{C}_2\text{F}_5$ ,  $\text{C}_6\text{F}_5$ , etc.) enhance thermal stabilities and improve volatilization of salicylaldimines, Schiff bases,  $\beta$ -diketonates,  $\beta$ -dithiones, and hexadentate macrocyclic complexes of lanthanides, transition metals, and  $\text{Zn}^{\text{II}}$  for GC separations.<sup>45</sup>

Dye molecule ligands are useful markers of the location of a species on a column support. Separations have been carried out with alizarin violet ( $\text{LH}_2^-$ ), separating  $[\text{Cu}^{\text{II}}(\text{L}^{3-})]^-$  from  $[\text{Co}^{\text{II}}(\text{L}^{3-})(\text{LH}_2^-)]^2-$ ,<sup>46</sup> whereas 4-(2-pyridylazo)resorcinol (=PAR) and 4-(thiazolaza)resorcinol (=TAR), acting as tridentate 1- anions, find uses in separating mixtures of  $\text{Pd}^{\text{II}}$ ,  $\text{Rh}^{\text{III}}$ ,  $\text{Pt}^{\text{II}}$ , and  $\text{Ru}^{\text{III}}$  by RP-HPLC<sup>47</sup> and  $\text{Ta}^{\text{V}}$  from  $\text{Nb}^{\text{V}}$ .<sup>47,48</sup> TAR complexes of  $\text{Ru}^{\text{III}}$ ,  $\text{Rh}^{\text{III}}$ ,  $\text{Os}^{\text{IV}}$ , and  $\text{Co}^{\text{II}}$  are separable by capillary electrophoresis.<sup>49</sup>

$\text{Zn}^{\text{II}}\text{L}_2$  and  $\text{Ni}^{\text{II}}\text{L}_2$  complexes of the para-substituted dithiobenzoic acid ( $\text{C}_{10}\text{H}_{21}\text{OC}_6\text{H}_4\text{CS}_2^-$ ) make unusual liquid crystals—metalmesogens, which are phases that act as self-contained, non-polar support phases that substrates can diffuse into and out of.  $\text{Ni}^{\text{II}}\text{L}_2$ 's separate polyaromatic hydrocarbons (PAHs) and phenols, whereas  $\text{Zn}^{\text{II}}\text{L}_2$ 's separate  $\text{R}_2\text{S}$  and phenol substrates.<sup>50,51</sup>

### 1.27.3.1 Separations of Chiral Complexes and Isomers

Three reviews of chiral molecules have appeared.<sup>52,53,26</sup> The first of these discusses using  $\pi$  contacts from supported metal complexes to separate enantiomers by GC and HPLC.<sup>52</sup> The second is useful to those reading Portuguese.<sup>53</sup> The third addresses changing the transport phase affinity of chiral enantiomers by adding chiral additives such as cyclodextrin or a chiral metal complex that form second-sphere contacts in the mobile phase.<sup>26</sup>

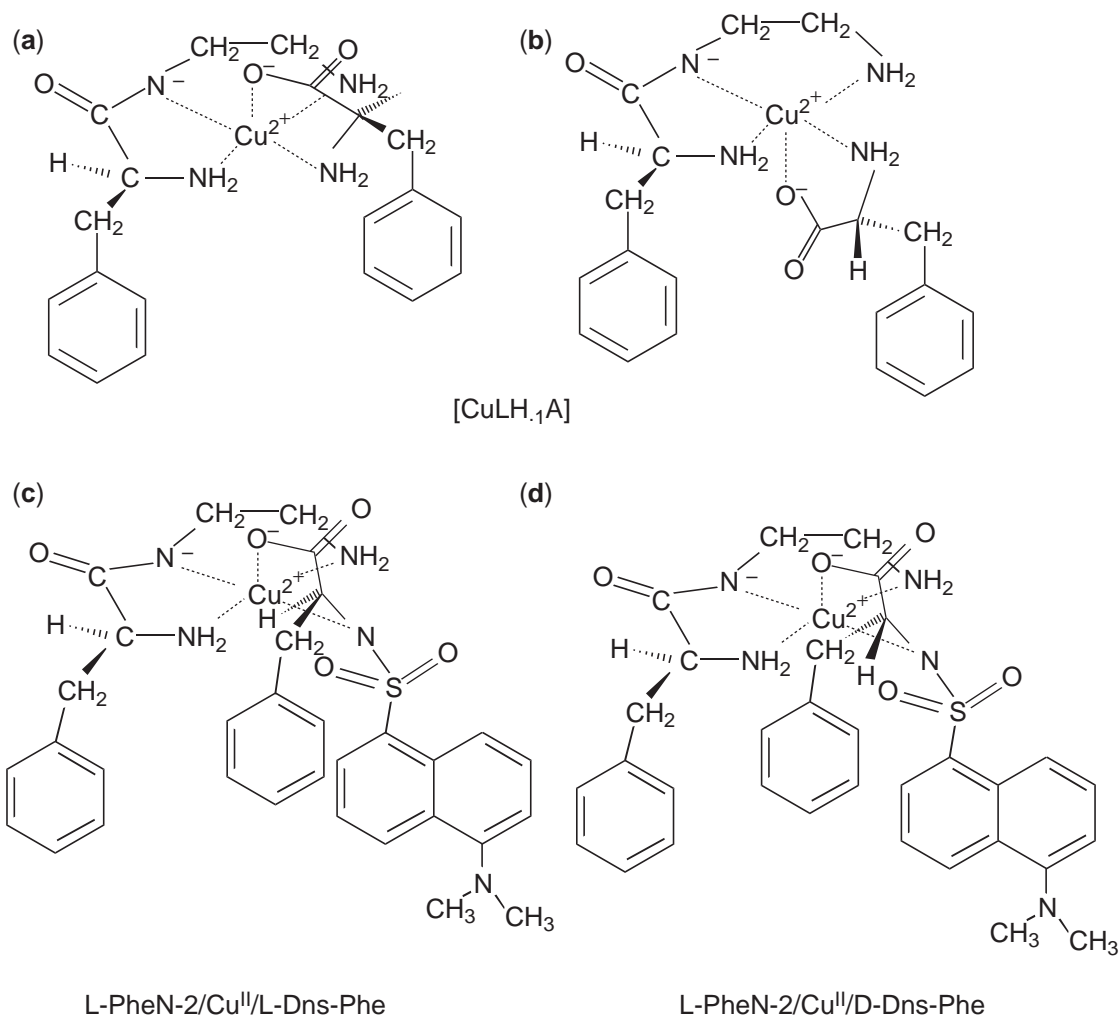
*fac*- and *mer*- $\text{Co}^{\text{III}}\text{L}_3$  ( $\text{L} = 5$ -methoxy-1,2-benzoquinone-2-oxime) were separated on silica gel with 1:1 toluene :  $\text{CH}_2\text{Cl}_2$  as the mobile phase.<sup>54</sup>  $[\text{Co}^{\text{III}}(\text{AA})_3]$  complexes were separated by TLC on polyacrylamide into *fac* and *mer* isomers; the *fac* isomers have three O donors on one face of the octahedral unit.<sup>55</sup> It is argued that *fac* isomers have a three-point contact with support surfaces, which promotes greater association than for *mer* isomers.

$\text{Ru}^{\text{II}}\text{L}_3$  complexes,  $\text{L} =$  bipyridyl or *o*-phen-based ligands, have  $\Lambda$  and  $\Delta$  isomers with differing affinities toward the major groove of B-DNA ( $\Delta$  binds more strongly).<sup>56</sup> Williams and co-workers have prepared DNA-supported HPLC columns, which were then used to separate  $\Lambda$  and  $\Delta$  isomers of  $\text{Ru}^{\text{II}}\text{L}_3^{2+}$  ( $\text{L} =$  *o*-phen, quinoxaline).<sup>57</sup> Such separations are limited by the size of the  $\text{Ru}^{\text{II}}\text{L}_3^{2+}$  complex that can fit into the groove of supported DNA, larger ones not being separated.

$\text{Cu}^{\text{II}}$  or  $\text{Ni}^{\text{II}}$  added to the mobile phase is able to form its own complexes in a preferential isomer distribution with chiral ligands. These chiral  $\text{Ni}^{\text{II}}$  or  $\text{Cu}^{\text{II}}$  complexes can in turn interact with mixtures of other chiral species being separated to influence their mobile phase to stationary phase distribution. Or supported complexes of  $\text{Cu}^{\text{II}}$  or  $\text{Ni}^{\text{II}}$ , which have a discrimination in binding one isomer for chiral ligands in the mobile phase, can be used to enrich the mobile phase in one enantiomer.  $\text{Ni}^{\text{II}}$  Schiff base complexes added to acetonitrile/water as the mobile phase assist the separation of chiral amino alcohols,<sup>58</sup> while ephedrine isomers in cough syrups and medicinal preparations have been separated using  $[\text{Cu}^{\text{II}}(\text{L-proline})_2]$  as a chiral mobile phase additive.<sup>59</sup>

Marchelli used RP-HPLC to separate D,L-amino acids and dansylated amino-acids by adding  $\text{Cu}^{\text{II}}$  terdentate complexes as shown to the mobile phase, forming the three in-plane-coordinated complex, dominant between pH 6 to 9.<sup>60</sup>

Binding of the terminal N donor of an amino-acid, together with an axial donation to  $\text{Cu}^{\text{II}}$  by the carboxylato group, affords two different locations for the placement of the R side-chain functionality (see Figures 1a and 1b) which interact with differing affinity towards the ternary ligand. With phenylalanine, the D-amino acid yields preferential  $\pi$  stacking with the ternary ligand, unavailable for the L-amino acid. This generates complexes with hydrophobic faces which favor the binding of the L form on the support phase, more so than the D form. This produces a better bound L-amino-acid, which translates into retarding the transport of L-amino-acid in the mobile phase, enriching the mobile phase in the D-amino-acid of the D,L pair.<sup>60</sup> Other amino-acids are not so strongly affected, but the same enhanced coordination can be accomplished by dansylating the N-terminus of the



**Figure 1** (a), (b) Two coordination modes of D-phenylalanine with [Cu<sup>II</sup>(N-L-phenyl-alanylethanediamine)] resolving agent; (c) Geometry of L-dansylated phenylalanine complex of [Cu<sup>II</sup>(N-L-phenylalanoethanediamine)] resolving agent;<sup>60</sup> and (d) D-dansylated phenylalanine complex of [Cu<sup>II</sup>(N-L-phenylalanoethanediamine)] resolving agent.<sup>60</sup>

amino-acid (Figures 1c and 1d). Separations in this mode then follow the bulkiness of the R side chain which perturbs the  $\pi$  stacking of the dansyl function with the ternary ligand.<sup>61</sup> Again, the D-amino-acid complex is more labile and elutes first.

Ni<sup>II</sup>(bis(3-heptafluorobutanoyl)-10-methylene-(1R)-camphorate) is termed “Chirasil-Nickel,” which attached to capillary surfaces or polydimethylsilane performs GC separations of chiral ligand mixtures at 170 to 180 °C,<sup>62,63</sup> and may be adapted to the use of supercritical CO<sub>2</sub> solvent for separations of organometallics.

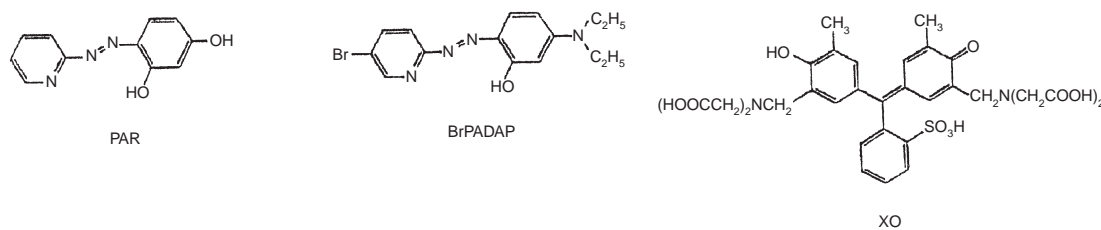
3,5-dimethylphenylcarbamate-derivatized cellulose is termed “Chiracel OD.” This support was used to separate the enantiomers of CpIr(X)<sub>2</sub> and Mo(CO)<sub>3</sub>(R)(X)<sub>2</sub> complexes (X = Cl<sup>-</sup>, Br<sup>-</sup>; R = Cl<sup>-</sup>, CH<sub>3</sub><sup>-</sup>, C(O)CH<sub>3</sub><sup>-</sup>),<sup>64</sup> and Cr(CO)<sub>3</sub>(R'-naphthalenes) (R' = Cl, CH<sub>3</sub>, Si(CH<sub>3</sub>)<sub>3</sub>, and Sn(CH<sub>3</sub>)<sub>3</sub>).<sup>65</sup>

In summary, the differing affinities of chiral molecules for chiral support-phase binding sites, for chiral additives to the mobile phase, or in molecular associations, are being exploited to separate chiral transition metal complexes, and even their achiral isomers.

### 1.27.3.2 Capillary and Capillary Zone Electrophoresis of Complexes

In these methods, ions move in an electrolyte solution between charged plates at a voltage difference of up to 25 kV within a small-bore capillary. Ions of greater net charge move farther





**Figure 2** Metallochromic ligands used in CE and CZE separations.<sup>69</sup>

per unit time, and ions of the same charge, but with different mobilities due to radial size and molecular weight, become sorted into zones (hence capillary *zone* electrophoresis).

Excellent reviews are available from Timerbaev<sup>14–17</sup> on CE and CZE, including critiques on method limitations;<sup>15,66</sup> from Pacakova on the separation of Group I and  $\text{NH}_4^+$  ions, Groups IIA and IIB ions, and forty transition metal ions of oxidation states I to V;<sup>18</sup> and from Cheng on the separation of inorganic cations and metal complexes with and without organic additives to alter ion migration rates.<sup>67,68</sup> Cheng's report includes a review of the influence of azo dyes, quinoline dyes, porphyrins, dithiocarbamates,  $\text{edta}^{4-}$ ,  $\text{cydta}^{4-}$  and other aminocarboxylates,  $\text{CN}^-$ , and  $\text{Cl}^-$  in adjusting the separation of hard and soft ions.

A review of CE and CZE by Haddad covers metallochromic ligands, dye ligands detectable by UV–visible spectroscopy or laser fluorescence for low detection limits (PAR, BrPADAP, XO, as shown in Figure 2) in CE and CZE separations.<sup>69</sup>

Timerbaev has discussed the linkage of CE and CZE to ICP and mass spectral methods in what are called “hyphenated techniques.”<sup>15</sup> He also reviews the use of metallochromic ligands in separations of  $\text{Cr}^{\text{III}}$ ,  $\text{Ni}^{\text{II}}$ ,  $\text{Co}^{\text{II/III}}$ ,  $\text{Cu}^{\text{II}}$ ,  $\text{Fe}^{\text{II/III}}$ ,  $\text{Al}^{\text{III}}$ ,  $\text{Pb}^{\text{II}}$ ,  $\text{Zn}^{\text{II}}$ ,  $\text{Ba}^{\text{II}}$ ,  $\text{Sr}^{\text{II}}$ ,  $\text{U}^{\text{VI}}$ , and  $\text{La}^{3+}$  (lanthanides).<sup>15</sup>

Timerbaev has discussed the advantages of  $\text{cydta}^{4-}$  over  $\text{edta}^{4-}$  of a similar series of ions in CE,<sup>70,71</sup> and of hydroxyquinoline-5-sulfonate in separating metal ions as their  $\text{M}(\text{QS})_2^{n-}$  anions.<sup>72,18,15</sup> Many other separations of ligands by adding metal ions ( $\text{Cu}^{\text{II}}$ ,  $\text{Ni}^{\text{II}}$ ,  $\text{Zn}^{\text{II}}$ ), which bind and then adjust the electrophoretic mobilities of  $\text{edta}$ -family ligands, milk proteins, antibodies, and so on, have been discussed in detail elsewhere.<sup>1</sup>

A most clever procedure, as a modification of normal CE and CZE, is to add micelle-forming molecules to the mobile phase of the CE/CZE cell.<sup>19</sup> The separation method is termed MEKC. The micelles provide a second environment for phase distribution of the migrating complexes, much in the manner of stationary phase-to-mobile phase equilibria in other chromatographies. If a metal ion has a chiral ligand, the separations in the presence of the micelles become enantioselective (reviewed by Haddad<sup>9</sup>). The technique has been applied to analysis of *cis*-platin to identify the amounts of  $[\text{Pt}^{\text{II}}(\text{NH}_3)_2(\text{Cl})_{2-m}(\text{H}_2\text{O})_m]$  ( $m=0$  to 2) using SDS micelles,<sup>73</sup> and to the separation of bis(2-hydroxyethyl)dithiocarbamates of  $\text{Co}^{\text{II}}$ ,  $\text{Pt}^{\text{II}}$ ,  $\text{Pb}^{\text{II}}$ ,  $\text{Cd}^{\text{II}}$ ,  $\text{Ni}^{\text{II}}$ ,  $\text{Bi}^{\text{II}}$ ,  $\text{Cr}^{\text{II}}$ ,  $\text{Cu}^{\text{II}}$ , and  $\text{Hg}^{\text{II}}$ .<sup>74</sup>

### 1.27.3.3 Electro spray Mass Spectral Detection of Metal Complexes

ESI-MS is becoming a detection method of choice, which readily identifies the molecular composition of species separated by flowing mobile phases. For space limitations, the reviews by Stewart for separation and speciation,<sup>24</sup> by Szpunar for metallo-biopolymers,<sup>25</sup> by Shepherd on transition metal complexes,<sup>1,75</sup> by Colton, D'Agostino, and Traeger,<sup>76</sup> and Henderson, Nicholson, and McCaffery<sup>77</sup> for organometallic complexes are highly recommended. The subject of ESI-MS is also presented in Chapter 2.28.

### 1.27.3.4 Size-exclusion Chromatography (SEC) for Metal Complexes

A gel polymer such as a polyacrylamide gel has many channels into which molecules can move and be held back from migration. Larger molecules migrate inside the more open channels and move faster, being “excluded” from the small channels. Haraguchi has reviewed SEC as applied to groundwater testing, where two classes of biopolymer metal ion carriers of 5,000 to 10,000 and  $>300,000$  molecular weight are isolated, and to the analysis metal complexes from blood samples.<sup>12,13</sup> Adding  $\text{Zn}^{\text{II}}$  salts to human milk proteins alter the separation of casein, albumin, lactoferrin, and metallothionines by SEC methods.<sup>78</sup> The binding of  $\text{Pb}^{\text{II}}$ ,  $\text{Be}^{\text{II}}$ ,  $\text{Sr}^{\text{II}}$ ,



Ce<sup>III</sup>, and Bi<sup>III</sup> to polysaccharides of greater than 50 kDa from fruit and plant sources, identified by SEC, has been reported.<sup>79</sup> Numerous other applications are discussed elsewhere.<sup>1</sup>

### 1.27.3.5 IMAC Separations via Inorganic Complexes

Porath and co-workers developed the IMAC technique for separation of proteins and peptides.<sup>80,81</sup> A support phase of cellulose, agarose, polyacrylamide, and so on is derivatized with a metal-chelating ligand, usually iminodiacetate (ida<sup>2-</sup>) coupled through the nitrogen to the support phase. When the binding ligand portion is loaded by labile metal ions such as Cu<sup>II</sup>, Ni<sup>II</sup>, Zn<sup>II</sup>, the supported-M(ida) or similar metal complex is termed an IMAC binding site. The IMAC site can still bind to side-chain groups from a peptide or protein in the mobile phase to form a ternary support phase–metal ion–peptide complex, as shown in Figure 3.

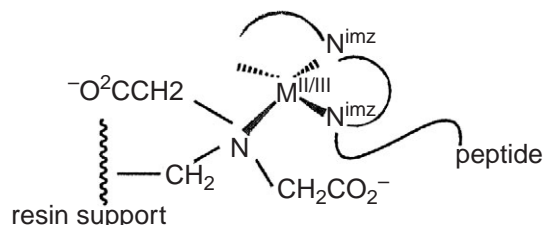
Other commonly used, supported-metal binding groups include the pentadentate chelation of hedta<sup>3-</sup>, the dithiocarbamate group, the iminoethylamine linkage, and short peptide sequences. After binding of the desired substrate ligands to the IMAC site, the system is washed with suitable buffers before final elution with a more acidic eluting buffer. The IMAC technique is widely applied to separations of proteins, antibodies, oligonucleotides, and histidine-bearing peptides.

Originally the technique was restricted to proteins having adventitiously exposed histidyl or thiol side-chain groups that can bind to the M<sup>II</sup>(IMAC) site.<sup>1,82–87</sup> However, the attachment of polyhistidine affinity tails (His<sub>*n*</sub>, *n* = 2 to 6) either as an N-terminal or a C-terminal fusion to a desired protein, affords a better binding site on it than any natural protein.<sup>88,89</sup> This allows selective separation of the tagged protein.

Ataai and co-workers prepared a bio-engineered sequence of Ser–Pro–His–His–Gly–Gly (SPHHGG) which is the optimal, highest-binding affinity tag toward Cu<sup>II</sup>(ida)-based IMAC columns.<sup>90</sup> The SPHHGG sequence was obtained using a phage-displayed library method to search the affinities of all peptide sequences that would bind to the IMAC site. The SPHHGG tag elutes above the harsher pH 4.0 required limit of (His)<sub>6</sub> tags, and below the pH 7.0 fraction of background *E. coli*-generated cellular proteins.<sup>90</sup> The samples are loaded on IMAC columns at pH 7.0, washed, and then eluted at a pH below 7.0.

Shepherd and co-workers obtained the first definitive proof that the affinity tags coordinate to the M<sup>II</sup>(ida)-based IMAC sites on columns by forming a three-point association via the first, third, and fourth side-chain donors of affinity tails such as SPHHGG or His<sub>6</sub> by obtaining the <sup>1</sup>H NMR spectra of [Pd<sup>II</sup>(mida)(peptide)] and the EPR spectra of [Cu<sup>II</sup>(mida)(peptide)] complexes (mida<sup>2-</sup> = methyliminodiacetate) as models for the coordination of peptides on IMAC M<sup>II</sup>(ida) sites.<sup>91,92</sup> Energy-minimized structures of the square-planar Cu<sup>II</sup>(ida)-IMAC sites have been carried out using molecular mechanics (MMFF94) methods that produce [M<sup>II</sup>(mida)(peptide)] structures consistent with the NMR data for the diamagnetic [Pd<sup>II</sup>(mida)(peptide)] complexes as models for IMAC sites.<sup>93</sup>

Ataai and co-workers have prepared 12-mer tandem peptide affinity tails constructed from the two hexamers, SPHHGG and HPHHGG, to obtain the four 12-mer permutations. The four generated 12-mer sequences elute at different pHs. Elution of the 12-mer-tagged proteins from Zn<sup>II</sup>(ida)-Sephacrose Fast Flow 6B columns occurs in pH steps that are selectable in 0.50 increments from 6.5 to 5.0.<sup>94</sup> This affords a choice of IMAC affinity tag in protein purification and elution conditions that may be suited to any desired protein without denaturation. It is believed that the 12-mer tag binds at two adjacent Zn<sup>II</sup>(IMAC) sites, which promotes the resultant pH sensitivity for elution. A green fluorescent protein (GFP<sub>UV</sub>) has been applied as a marker protein in the development of IMAC procedures to assess the location of proteins on the column or at the elution zone for developing IMAC procedures.<sup>94,95</sup>



**Figure 3** IMAC binding site ternary complex with a peptide having histidyl side chains.

Imidazole gradients, as well as pH gradients, are used in the elution of the isolated protein by IMAC. An 11,000 molecular weight polymer of polyvinylimidazole has been prepared and used to displace IMAC-column bound proteins, the polyvinylimidazole polymer being retained on the column.<sup>96,97</sup> The isolated protein is then free of imidazole contamination that is present in the imidazole gradient methods.

Uses of polyacrylamide as a support in IMAC bioseparations are numerous, as are applications as blotting techniques by electrophoresis. It has been found that  $\text{Eu}^{\text{III}}$ (bathophenanthroline-disulfonate)<sub>3</sub> complexes adhere to IMAC-bound or blotting sheet-bound proteins. The  $\text{Eu}^{\text{III}}$  complex does not adhere to the background support or nonlabeled  $\text{M}^{\text{II}}$ (IMAC) regions. Since the  $\text{Eu}^{\text{III}}$  complexes fluoresce, the binding location on columns or blotting sheets can be observed by the luminescence at 590 to 615 nm.<sup>98</sup> The  $\text{Eu}^{\text{III}}$  can be removed by a wash with edta solution to afford  $\text{Eu}^{\text{III}}$ -free protein products. Many examples of various proteins, antibodies, enzymes, protamines, phosphopeptides, T-cell envelope proteins, and so on that have been separated by IMAC methods are discussed in reference 1. Activating metal ions are commonly  $\text{Cu}^{\text{II}}$ ,  $\text{Ni}^{\text{II}}$ ,  $\text{Zn}^{\text{II}}$ ,  $\text{Fe}^{\text{III}}$ , or  $\text{Co}^{\text{II}}$ .

An ingenious modification of the IMAC method has been made by Abudiab and Beitle.<sup>99</sup> Aging agarose-supported  $\text{Fe}^{\text{III}}$ (ida)-IMAC sites form entrapped ferromagnetic particles. The  $\text{Fe}^{\text{III}}$ (ida)-IMAC magnetic support material may be added to a protein mixture wherein one protein has been given an affinity tag to enhance binding to normal IMAC sites. The magnetic polymer, loaded with the selected, tagged protein, is removed from the mixture by adhering to a magnet. The coated magnet is removed by filtration, washed, and the desired protein is then released with a suitable buffer as in the normal IMAC procedure.<sup>99</sup>

### 1.27.3.6 Immobilized Metal Complexes for Organic Separations (IMCOS)

A developing area in separations is the use of supported metal complexes to provide sites of retardation in the mobile phase migration for more hydrophobic molecules in the separation of organic mixtures. This has been termed IMCOS, standing for "immobilized metal complexes for organic separations."<sup>1</sup> The technique parallels the separation of hydrophilic biopolymers by the IMAC methods. Wasiak and co-workers<sup>100</sup> have presented a good overview of IMCOS. A review on modifications to silica supports is presented in the review of Biernat *et al.*<sup>7</sup>

Attachment of trimethoxysilylpropyldiethylenetriamine to silica gel provides a site appearing as follows: silica—O—Si(OCH<sub>3</sub>)<sub>2</sub>(CH<sub>2</sub>)<sub>3</sub>NH(CH<sub>2</sub>)<sub>2</sub>NH(CH<sub>2</sub>)<sub>2</sub>NH<sub>2</sub>.

The pendant polyamine is a good chelating agent for  $\text{Cu}^{\text{II}}$  and  $\text{Cr}^{\text{III}}$ . The metals are introduced by heating the derivatized silica solid with  $\text{CuCl}_2$  or  $\text{CrCl}_3$ . The supported  $\text{Cu}^{\text{II}}$  and  $\text{Cr}^{\text{III}}$  sites afford locations for binding to heteroatoms of species within organic mixtures, and the hydrocarbon linkages afford regions of differing polarity to sort the hydrophobic type of organics. Such metal-supported columns may be used to separate aromatic, linear, and branched hydrocarbons; thioethers; ethers; and organics containing nucleophilic heteroatom substituents,<sup>100</sup> as shown by component  $\text{X} \sim \text{Y} \sim \text{Z} \sim \text{substrate}$  in the ternary binding site depicted in Figure 4.

This more recent design has evolved from earlier supported columns prepared with propylthiol, propyl nitrile, or propyldiphenylphosphine units linked to the silica surface,<sup>101</sup> which separate ketones, thioethers, and ethers.<sup>102</sup> Ethylenediamine-like binding sites were prepared in early developments by linking N-(2-aminoethyl)-3-aminopropyltrimethoxysilane,<sup>103</sup> which derivatized as  $\text{Cu}^{\text{II}}$  or  $\text{Cr}^{\text{III}}$  complexes are able to separate hydrocarbons, esters, ethers, and thioethers.<sup>104</sup>

Another type of metal-support site may be created by the reaction of acetylacetonone with the monoamine-bound derivatized silica gels. This type has imino-acac ligands attached to the surface. There are  $\text{Cu}^{\text{II}}$  species with only one iminoacac chelate in its coordination sphere, and other sites coordinated in a square-planar array by two iminoacac ligands from adjacent surface locations.<sup>105,106</sup> These types of supported IMCOS sites also have been used to separate hydrocarbons, ethers, and thioethers.

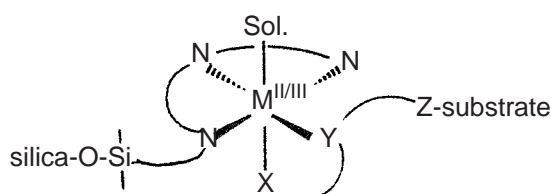


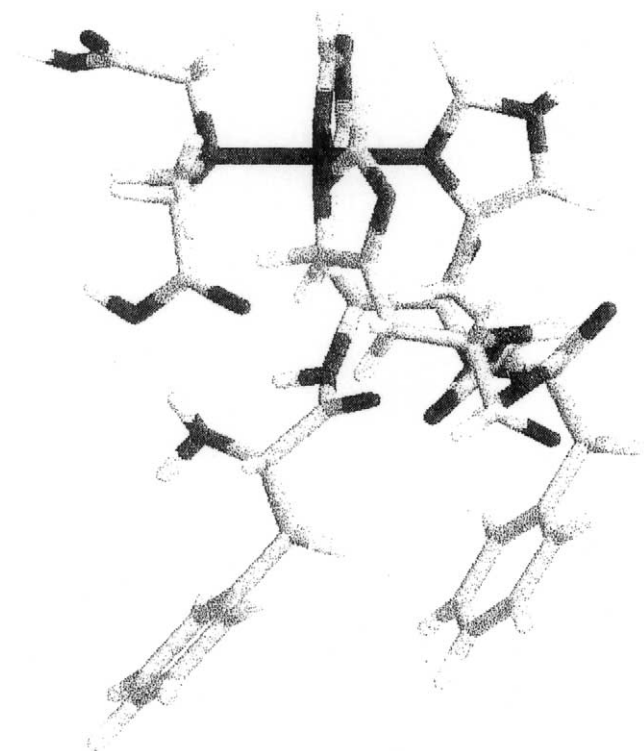
Figure 4 IMCOS binding site using silica-supported diethylenetriamine chelation.

Using silica surfaces derivatized by attached  $\text{acac}^-$  ligands, Wasiak and Rykowska prepared  $\text{Ni}^{\text{II}}(\text{acac})$  and  $\text{Co}^{\text{II}}(\text{acac})$ -supported complexes to separate a variety of olefins. This differentiation of similar olefins shows that the olefins will form  $\eta^2$  complexes with the  $\text{Cu}^{\text{II}}$ - and  $\text{Cr}^{\text{III}}$ -supported metal centers with different binding constants, retarding the passage of the olefins through the column.<sup>107,108</sup> Thus, the  $\eta^2$  coordination of the olefins occurs even toward the relatively hard  $\text{Cu}^{\text{II}}$  and  $\text{Cr}^{\text{III}}$  sites, inducing selective separations. Akapo has prepared  $\text{Co}^{\text{II}}$  and  $\text{Cu}^{\text{II}}$  silica-supported complexes of the dithioamide ligand which separates olefins.<sup>109</sup>

Dithiocarbamate-linked silica will bind to metal ions in the order  $\text{Hg}^{\text{II}} \gg \text{Cu}^{\text{II}} > \text{Cd}^{\text{II}} > \text{Zn}^{\text{II}}$ , with the  $\text{Cu}^{\text{II}}$  form active as a material that removes thioethers from gasoline.<sup>110</sup> A similar complex, made by the reaction of 2,2'-dihydroxyazobenzene with the ethylenediamine-linked silica support, produces a catechol site for metal coordination that lowers the concentration of  $\text{Cu}^{\text{II}}$  in water to  $1 \times 10^{-23}$  M and  $\text{Fe}^{\text{III}}$  to  $1 \times 10^{-16}$  M.<sup>111</sup> It has been proposed for metal ion harvesting from seawater, but the available concentrations of the desired  $\text{Au}^{\text{III}}$ ,  $\text{Pt}^{\text{II}}$ ,  $\text{Ag}^{\text{I}}$ , etc. would be swamped out by the too-high concentration of naturally occurring  $\text{Fe}^{\text{III}}$  and  $\text{Zn}^{\text{II}}$ .

#### 1.27.4 COMPUTER-AIDED CHROMATOGRAPHY INVOLVING METAL COMPLEXES

Advances in molecular mechanics calculations provide encouragement that the binding of substrates to chromatographic sites can be compared in energies as a function of the ligand being bound. This affords the possibility of tuning the molecular structure at the coordination site in such a way as to provide preferential binding that would be of use in the separation of proteins, of chiral ligands, and in the separation of more complex mixtures. The most detailed use of the design of metal binding sites and of tailoring the affinity of binding sites to a substrate has been carried out by Ward, Shepherd, and co-workers.<sup>112,113</sup> In the first of these studies it has been shown that a peptide sequence of  $\text{X}_1\text{-His-X}_3\text{-His-His}$  would be the optimal IMAC affinity tag for separations on  $\text{Zn}^{\text{II}}(\text{ida})$ -agarose columns.<sup>112</sup> It was shown that by placing a phenylalanine amino-acid in the  $\text{X}_1$  and  $\text{X}_3$  positions, a  $\pi$  stacking occurs for the  $[\text{Pd}^{\text{II}}(\text{mida})(\text{FHFHH})]$  model complex (Figure 5) that raises the energy relative to other amino-acid choices.

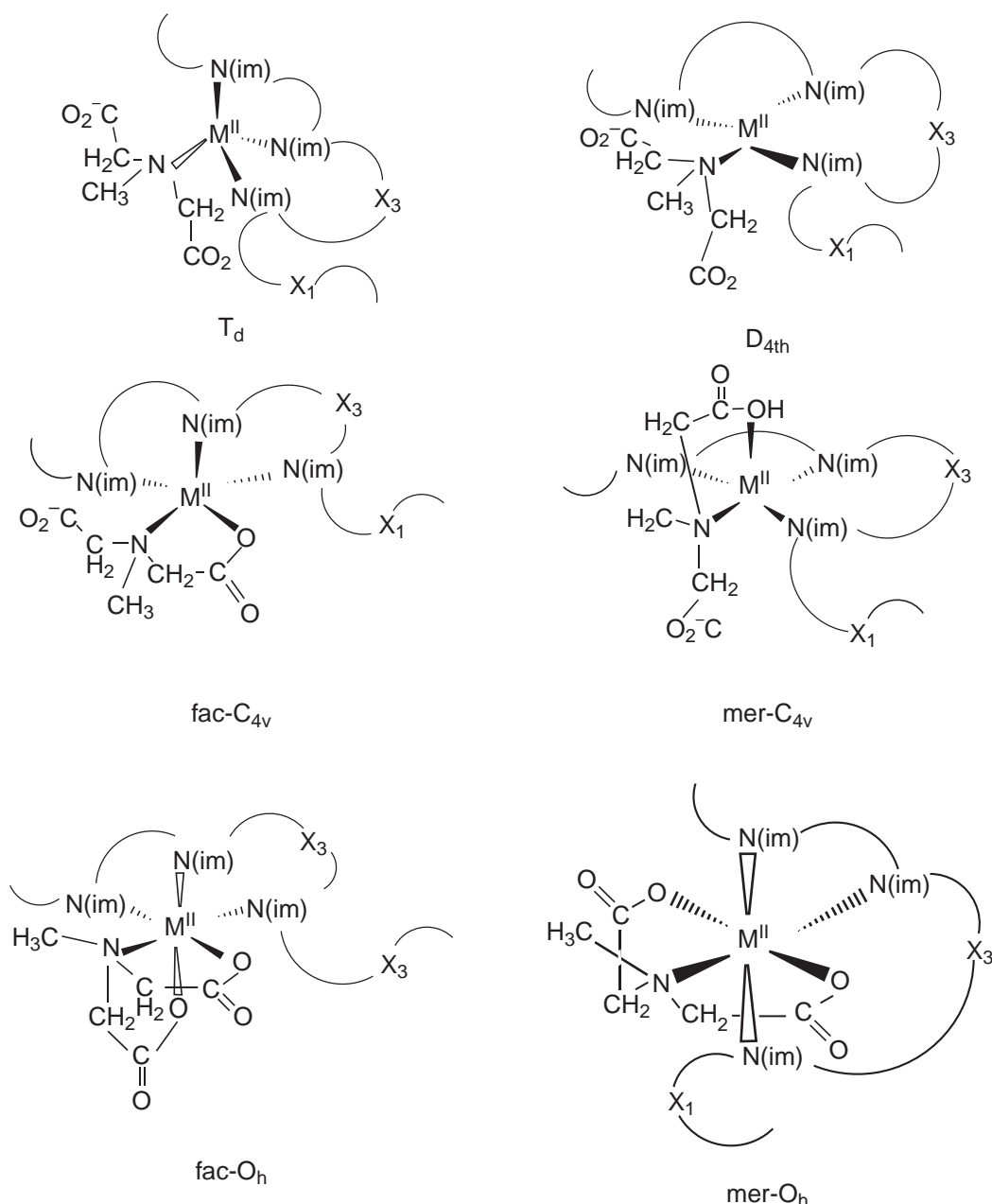


**Figure 5** Energy-minimized structure of  $[\text{Pd}(\text{mida})(\text{FHFHH})]$ .<sup>112</sup> (reprinted with permission from Ward *et al. Biotechnol. Progr.* **2001**, *17*, 712–719; © 2001, American Chemical Society and American Institute of Chemical Engineering.)

The FHFHH affinity tag is therefore released at a higher pH than for the (His)<sub>5</sub> or other analogues, affording easier elution by buffers.<sup>112</sup> More discussion and detail is available.<sup>1</sup> The results are reminiscent of the Cu(amino-acid) separations by Marchelli<sup>60</sup> in separating D- and L-amino-acid pairs.

Ward and Shepherd have also completed computer modeling of M<sup>II</sup>(ida)-IMAC sites in which the geometry of the metal complex was allowed to vary, as shown in Figure 6, from octahedral coordination with *fac* and *mer* isomers, tetrahedral, square pyramidal, trigonal bipyramidal, and square planar using X<sub>1</sub>-His-X<sub>3</sub>-His-His peptides bound to the [M<sup>II</sup>(ida)]-IMAC model.<sup>113</sup> Solvent bonds were allowed to make up any additional required coordination interaction. Local IMAC sites would appear as shown for comparisons, with M<sup>II</sup> being a metal that prefers a given geometry based on its *d<sup>n</sup>* value.

It has been shown that the “best” affinity tag of highest binding, or the affinity tag which would allow the easiest elution step, is not the same for all geometries of coordination<sup>113</sup> (Figure 6). Thus, FHFHH would be predicted as the peptide easiest to elute from a square-planar



**Figure 6** M(ida)-IMAC binding sites induced by variations of the metal center M and its *d* electron count.

Cu<sup>II</sup>(ida)-agarose site. But the tryptophan derivative tag, WHWHH, would give the easiest one to elute from an octahedral coordination site of Ni<sup>II</sup>(ida)-agarose. Therefore, the time will come when IMAC separations are optimized as to the best metal ion and affinity tag to be used, based on computer calculations done in advance of laboratory work. Bio-chromatographers have proceeded empirically in the development of IMAC strategies in the past. Interestingly to bio-inorganic chemists, the molecular mechanics calculations of Ward and Shepherd<sup>112,113</sup> suggest that future methodology can be guided by rational design, using the principles of coordination chemistry. Presumably, such structural design of chromatographic binding sites could be applied in the area of IMCOS separations as well.

### 1.27.5 REFERENCES

1. Shepherd, R. E. *Coord. Chem. Rev.* **2003**, in press.
2. Haddad, P. R. *Anal. Chem.* **2001**, *73*, 266A–273A.
3. Janos, P. *J. Chromatogr. A* **1997**, *789*, 3–19.
4. Janos, P. *J. Chromatogr. A* **1996**, *737*, 129–138.
5. Mohammad, A.; Ajmal, M.; Anwar, S.; Iraqi, E. *J. Planar Chromatogr: Modern TLC* **1996**, *9*, 318–360.
6. Sherma, J. *Anal. Chem.* **1994**, *66*, R67–R83.
7. Biernat, J. F.; Konieczki, P.; Tarbet, B. J. *Sep. Purif. Methods* **1994**, *23*, 77–348.
8. Wang, P.; Lee, H. K. *J. Chromatogr. A* **1997**, *789*, 437–451.
9. Casoli, A.; Mangia, A.; Predieri, G.; Sappa, E.; Volante, M. *Chem. Rev.* **1989**, *89*, 407.
10. Sommer, L.; Vlasankova, R. *Chromatographia* **2000**, *52*, 692–702.
11. Uden, P. C.; Henderson, D. E. *Analyst* **1977**, *102*, 889–916.
12. Haraguchi, H. *Bull. Chem. Soc. Jpn.* **1999**, *72*, 1163–1186.
13. Itoh, A.; Iwata, K.; Chiba, K.; Haraguchi, H. *Bull. Chem. Soc. Jpn.* **2000**, *73*, 121–127.
14. Timerbaev, A. R. *Talanta* **2000**, *52*, 573–606.
15. Timerbaev, A. R.; Buchberger, W. *J. Chromatogr. A* **1999**, *834*, 117–132.
16. Dabek-Zlotorzynska, E.; Lai, E. P. C.; Timerbaev, A. R. *Anal. Chim. Acta* **1998**, *359*, 1–26.
17. Timerbaev, A. R.; Shpigun, O. A. *Electrophoresis* **2000**, *21*, 4179–4191.
18. Pacakova, V.; Coufal, P.; Stulik, K. *J. Chromatogr. A* **1999**, *834*, 257–275.
19. Haddad, P. R.; Macha, M.; Hilder, E. F.; Bogan, D. P. *J. Chromatogr. A* **1997**, *780*, 329–341.
20. Wai, C. M.; Wang, S. F. *J. Chromatogr. A* **1997**, *785*, 369–383.
21. Lojkova, L.; Vejrosta, J. *Chem. Listy* **1998**, *92*, 988–997.
22. Szpunar, J.; Lobinski, R. *Pure Appl. Chem.* **1999**, *71*, 899–918.
23. Sandier, A.; Amiel, C.; Sebille, S.; Rouchand, J.-C.; Fedoroff, M.; Soltes, L. *J. Chromatogr. A* **1997**, *776*, 93–100.
24. Stewart, I. I. *Spectrochim. Acta B: Atomic Spectrosc.* **1999**, *54*, 1649–1695.
25. Szpunar, J. *Analyst* **2000**, *125*, 963–988.
26. Gorog, S.; Gazdag, J. *Chromatogr. B: Biomed. Appl.* **1994**, *695*, 51–84.
27. Davies, M. B. *Coord. Chem. Rev.* **1994**, *134*, A195–A305.
28. Wenz, G. *Angew. Chem. Int. Ed. Engl.* **1994**, *33*, 803–822.
29. Gruner, B.; Plzak, Z. *J. Chromatogr. A* **1997**, *789*, 497–517.
30. Wong, J. W.; Albright, R. L.; Wang, N. H. L. *Sep. Purif. Methods* **1991**, *20*, 49–106.
31. Shi, X. Y.; Fu, R. N. *Chin. J. Anal. Chem.* **2000**, *28*, 118–123.
32. Rykowska, I.; Wasiaik, W. *Chem. Anal. (Warsaw)* **2001**, *46*, 305–316.
33. Moller, K.; Bein, T. *J. Inclusion Chem. and Chem. Mater.* **1988**, *10*, 2950–2963.
34. Lucy, C. A. *J. Chromatogr. A* **1996**, *739*, 3–13.
35. Sharma, S. D.; Sharma, S. C.; Sharma, C. *JPC-J. Planar Chromatogr: Modern TLC* **1999**, *12*, 440–445.
36. Krokhin, O. V.; Hoshino, H.; Shpigun, O. A.; Yotsuyanagi, J. *J. Chromatogr. A* **2000**, *895*, 255–261.
37. Tesic, Z. L.; Baosic, R. M.; Milojkovic-Opsenica, D. M. *J. Chromatogr. A* **1999**, *847*, 303–307.
38. Tesic, Z. L.; Janjic, T. J.; Celap, M. B. *J. Chromatogr. A* **1991**, *585*, 359–363.
39. Vuckovic, G.; Tanaskovic, S. B.; Janjic, T.; Milojkovic-Opsenica, D.; Celap, M. B. *J. Planar Chromatogr: Modern TLC* **1999**, *12*, 461–465.
40. Milojkovic-Opsenica, D. M.; Malinar, M. J.; Tesic, Z. L. *J. Chromatogr. A* **1999**, *847*, 291–296.
41. Janjic, T. J.; Zivkovic, V.; Celap, M. B. *Chromatographia* **1994**, *38*, 355–358.
42. Janjic, T. J.; Zivkovic, V.; Celap, M. B. *Chromatographia* **1994**, *38*, 447–452.
43. Ianni, C.; Baffi, F. *Annal. di. Chim. (Ann. Chim., Rome)* **1998**, *88*, 437–442.
44. Dilli, S.; Tong, P. *Anal. Chim. Acta* **1999**, *395*, 101–112.
45. Robards, K.; Patsalides, E. *J. Chromatogr. A* **1999**, *844*, 181–190.
46. Zhang, H. S.; Mou, W. Y.; Cheng, J. K. *Talanta* **1994**, *41*, 1459–1463.
47. Vachirapatama, N.; Macka, M.; Paull, B.; Munkia, C.; Haddad, P. R. *J. Chromatogr. A* **1999**, *850*, 257–268.
48. Vachirapatama, N.; Doble, P.; Haddad, P. R. *J. Chromatogr. A* **2000**, *885*, 369–375.
49. Liu, B. F.; Liu, L. B.; Chen, H.; Cheng, J. K. *Anal. Chim. Acta* **2001**, *434*, 309–313.
50. Hu, C.-C.; Liu, C.-Y. *Anal. Chim. Acta* **1996**, *332*, 23–30.
51. Liu, C.-Y.; Hu, C.-C.; Chen, J.-L.; Lin, K.-T. *Anal. Chim. Acta* **1999**, *384*, 51–62.
52. Pasutto, F. M. *J. Clin. Pharmacol.* **1992**, *32*, 917–924.
53. Queiroz, S. L.; Batista, A. A. *Quim. Nova* **1998**, *21*, 193–201.
54. Charalambous, J.; Raghvin, D. V.; Carugo, O.; Castellani, C. B. *Polyhedron* **1996**, *15*, 803–808.
55. Tesic, Z. L.; Sabo, T. J.; Trifunovic, S. R.; Milojkovic-Opsenica, D. *J. Chromatogr. A* **1999**, *847*, 297–301.
56. Pyle, A. M.; Barton, J. K. *Prog. Inorg. Chem.* **1990**, *38*, 413–475.

57. Aldrich-Wright, J. R.; Greguric, I.; Vagg, R. S.; Vichery, K.; Williams, P. A. *J. Chromatogr. A* **1995**, *718*, 436–443.
58. Bazylak, G. *J. Chromatogr. A* **1994**, *665*, 75–86.
59. Lam, S.; Malikin, G. *J. Chromatogr. A* **1986**, *368*, 413–422.
60. Galaverna, G.; Corradini, R.; Dossena, A.; Chiavaro, E.; Marchelli, R.; Dallavale, F.; Folesani, G. *J. Chromatogr. A* **1998**, *829*, 101–113.
61. Galli, B.; Gasparrini, F.; Misiti, D.; Villani, C.; Corradini, R.; Dossena, A.; Marchelli, R. *J. Chromatogr. A* **1994**, *666*, 77–89.
62. Schleimer, M.; Schurig, V. *J. Chromatogr. A* **1993**, *638*, 85–96.
63. Schleimer, M.; Fluck, M.; Schurig, V. *Anal. Chem.* **1994**, *66*, 2893–2897.
64. Paisner, S. N.; Bergman, R. G. *J. Organomet. Chem.* **2001**, *621*, 242–245.
65. Oprunenko, Y.; Malyugina, S.; Nesterenko, P.; Mityuk, D.; Malyshev, O. *J. Organomet. Chem.* **2000**, *597*, 42–47.
66. Timerbaev, A. R. *Anal. Chim. Acta* **2001**, *433*, 165–180.
67. Liu, B.-F.; Liu, L.-B.; Cheng, J.-K. *J. Chromatogr. A* **1999**, *834*, 277–308.
68. Liu, B.-F.; Liu, L.-B.; Chen, H.; Cheng, J.-K. *Anal. Chim. Acta* **2001**, *434*, 309–313.
69. Macka, M.; Haddad, P. R.; Buchberger, W. *J. Chromatogr. A* **1995**, *706*, 493–501.
70. Timerbaev, A. R.; Semenova, O. P.; Fritz, J. S. *J. Chromatogr. A* **1996**, *756*, 300–306.
71. Timerbaev, A. R.; Semenova, O. P.; Fritz, J. S. *J. Chromatogr. A* **1998**, *811*, 233–239.
72. Timerbaev, A.; Semenova, O.; Bonn, G. *Chromatographia* **1994**, *38*, 255.
73. Wenclawiak, B. W.; Wollman, M. *J. Chromatogr. A* **1996**, *724*, 317–326.
74. Hilder, E. F.; Macka, M.; Bogan, D. P.; Haddad, P. R. *Anal. Commun.* **1997**, *34*, 63–65.
75. Slocik, J. M.; Somayajula, K. V.; Shepherd, R. E. *Inorg. Chim. Acta* **2001**, *320*, 148–158.
76. Colton, R.; D'Agostino, A.; Traeger, J. C. *Mass Spectrom. Rev.* **1995**, *14*, 79–106.
77. Henderson, W.; Nicholson, B. K.; McCaffery, L. J. *Polyhedron* **1998**, *17*, 4291–4313.
78. Michalke, B.; Munich, D. C.; Schramel, P. *J. Trace Elem. Elect. H.5* **1991**, 251–258.
79. Szpunar, J.; Pellerin, P.; Makarov, A.; Doco, T.; Williams, P.; Lobinski, R. *J. Anal. Atom. Spectrom.* **1999**, *14*, 639–644.
80. Porath, J.; Carlson, I.; Olsson, G. *Nature* **1975**, *258*, 598–591.
81. Hemdan, E. S.; Zhou, Y. J.; Sulkowski, E.; Porath, J. *Proc. Natl. Acad. Sci., USA* **1989**, *86*, 1811.
82. Porath, J. *Protein Expression Purif.* **1992**, *3*, 263–281.
83. Sulkowski, E. *Trends Biotech.* **1985**, *3*, 1–7.
84. Arnold, F. *Bio/Technology* **1991**, *9*, 151–156.
85. Cwirla, S. E.; Peters, E. A.; Barratt, R. W.; Dower, W. J. *Proc. Natl. Acad. Sci., USA* **1990**, *87*, 6378–6382.
86. Wong, J.; Albright, N.; Wang, N. *Sep. Purif. Methods* **1991**, *20*, 49–106.
87. Fatiada, J. A. *CRC Crit. Rev. Anal. Chem.* **1987**, *18*, 1.
88. Hochuli, E.; Bannwarth, W.; Dobeli, H.; Gentz, R.; Studer, D. *Biotechnology* **1988**, *6*, 132.
89. Lilius, G.; Persson, M.; Bulow, L.; Mosbach, K. *Eur. J. Biochem.* **1991**, *198*, 91–100.
90. Patawardham, A. V.; Goud, R. R.; Koepsel, R. R.; Atai, M. M. *J. Chromatogr. A* **1997**, *787*, 91.
91. Chen, Y.; Pasquinelli, R.; Atai, M. M.; Koepsel, R. R.; Kortes, R. A.; Shepherd, R. E. *Inorg. Chem.* **2000**, *39*, 1180–1186.
92. Chen, Y.; Pasquinelli, R.; Atai, M.; Koepsel, R. R.; Stringfield, T. W.; Shepherd, R. E. *J. Inorg. Biochem.* **1999**, *76*, 211–220.
93. Ward, M. S.; Shepherd, R. E. *Inorg. Chim. Acta* **2000**, *311*, 57–68.
94. Pasquinelli, R.; Shepherd, R. E.; Koepsel, R. R.; Zhao, A.; Atai, M. M. *Biotechnol. Prog.* **2000**, *16*, 86–92.
95. Li, Y.; Arawal, A.; Sakon, J.; Beitle, R. R. *J. Chromatogr. A* **2001**, *909*, 183–190.
96. Ivanov, A. E.; Kozakov, S. V.; Galaev, I. Y.; Mattiason, B. *Polymer* **2001**, *42*, 3378–3381.
97. Ivanov, A. E.; Galaev, I. Y.; Kazakov, S. V.; Mattiason, B. *J. Chromatogr. A* **2001**, *907*, 115–130.
98. Lim, M. J.; Patton, W. F.; Lopez, M. F.; Spofford, K. H.; Shojae, N.; Shephro, D. *Anal. Biochem.* **1997**, *245*, 184–195.
99. Abudiab, T.; Beitle, R. R., Jr. *J. Chromatogr. A* **1998**, *795*, 211–217.
100. Rykowska, I.; Smyka, S.; Urbaniak, W.; Wasiak, W. *J. Chromatogr. A* **1999**, *844*, 239–248.
101. Wasiak, W. *Chem. Anal. (Warsaw)* **1994**, *39*, 325–333.
102. Wawrzyniak, R.; Wasiak, W. *Chromatographia* **1999**, *49*, 273–280.
103. Wasiak, W.; Urbaniak, W. *J. Chromatogr. A* **1997**, *757*, 137–143.
104. Rykowska, I.; Wasiak, W. *Chromatographia* **2000**, *51*, 623–629.
105. Wasiak, W.; Rykowska, I. *Anal. Chim. Acta* **1999**, *378*, 104–109.
106. Wasiak, W.; Rykowska, I. *Chromatographia* **1998**, *48*, 284–292.
107. Wasiak, W.; Rykowska, I. *Chem. Anal. (Warsaw)* **1995**, *40*, 731–739.
108. Wasiak, W.; Rykowska, I. *J. Chromatogr. A* **1997**, *773*, 209–217.
109. Akapo, S. O. *Anal. Chim. Acta* **1997**, *341*, 35–42.
110. Yeh, C. F.; Chyueh, S. D.; Chen, W. S. *J. Chromatogr. A* **1993**, *630*, 275–285.
111. Kwon, W. J.; Yoo, C. E.; Chang, W.; Noh, Y. S.; Suh, J. *Bull. Kor. Chem. Soc.* **2000**, *21*, 393–400.
112. Ward, M. S.; Atai, M.; Koepsel, R. R.; Shepherd, R. E. *Biotechnol. Progr.* **2001**, *17*, 712–719.
113. Ward, M. S.; Atai, M. M.; Shepherd, R. E. *Biotechnol. Progr.* **2003**, in press.



# 1.28

## Crystal Growth Methods

W. CLEGG

*University of Newcastle upon Tyne, UK*

---

1.28.1	INTRODUCTION	579
1.28.2	SOLVENT EVAPORATION	580
1.28.3	COOLING	580
1.28.4	SOLVENT LIQUID DIFFUSION	581
1.28.5	SOLVENT VAPOR DIFFUSION	581
1.28.6	SUBLIMATION	581
1.28.7	CRYSTAL GROWTH FROM THE MELT	582
1.28.8	SLOW DIFFUSION OF REACTANTS	582
1.28.9	OTHER APPROACHES TO OBTAINING BETTER CRYSTALS	583

---

### 1.28.1 INTRODUCTION

In coordination chemistry, the most likely reason to be concerned with the growth of crystals is in order to obtain a crystal structure by either X-ray or neutron diffraction from a single crystal. Major points of interest are the quality and size of crystals for this purpose. The size requirements have become less severe in recent years, because of the development of new diffraction techniques, particularly the widespread introduction of area detectors and the use of more powerful sources of X rays (including synchrotron radiation) and neutrons, and it is also possible to obtain structural results from poorer quality crystals than was formerly the case. However, the main factor influencing the quality and precision of a crystal structure is usually the quality of the crystal from which the data are obtained, and a low-precision structure, although of some use, is restricted in value, may not provide the desired information, and is likely to be unpublishable.

Most coordination compounds are solids, and recrystallization is routinely carried out following the synthesis, for a number of reasons. It is a standard procedure in obtaining the product free from impurities. Here, there are usually two primary objectives: high purity, and maximum yield. Methods most often involve the dissolution of the compound in the minimum quantity of a solvent, possibly with heating, and then the reduction of the solubility by cooling and/or by addition of a precipitant, which is a second liquid miscible with the solvent but giving lower solubility of the desired compound in the mixed solvent. Solubility may be further reduced in this procedure by a suitable simultaneous exchange of counter-ions between the original solution and the second liquid, if the coordination compound is charged; see [Sections 1.28.8](#) and [1.28.9](#) for further comments on this. Purity and yield are likely to be optimized by rapid crystallization, but this is the least satisfactory way to produce good-quality crystals for diffraction experiments. In many cases, the crystals thus obtained are, in fact, perfectly adequate for crystallography, but frequently rapid crystallization leads to products that are only microcrystalline powders or that have multiple, twinned, or otherwise defective crystals.

Crystallographic investigation requires only one single crystal, of adequate size and quality; for this purpose, yield is unimportant. Thus, different techniques must sometimes be used to improve the quality and increase the size of crystals. The sample for study must be a single crystal (unless powder diffraction is to be used); this means one that gives a clean diffraction pattern capable of

being indexed on the basis of a single unit cell. In a single crystal, all unit cells are identical by definition (subject to the effects of random variations described by dynamic or static structural disorder), and are aligned in the same direction within a small angular range known as the mosaic spread (like the slight variation in alignment of wall or floor tiles). A twinned crystal is one in which there are two (or more) different orientations or mirror images of the same structure within one crystal, with a well-defined relationship to each other, often based on fortuitous rational relationships among the unit cell parameters. Not all multiple crystals are twins; many are simply intergrowths, conglomerates, surface contacts, or the result of mis-stacking of crystallites such as thin plates. Such faults are more likely to result from rapid crystallization, when molecules are deposited at nucleation sites too quickly for them to be correctly oriented during the crystal growth.

Typical crystal sizes for X-ray diffraction using standard laboratory equipment are about 0.1–0.5 mm, depending on the chemical composition (heavier atoms usually give greater diffraction intensities, but also lead to undesirable absorption effects) and on the diffraction facilities (of the commonly used X-ray tube target materials, Cu gives greater intensities than Mo; rotating anode sources are more intense than conventional sealed X-ray tubes, and modern area detectors can be used with less strongly scattering samples; X-ray beams of homogeneous intensity are usually less than a millimeter in diameter). Much smaller crystals (down to microns in size) can be investigated with synchrotron X rays. Neutron single-crystal diffraction usually requires crystals with millimeter dimensions.

Most methods for the production of good-quality crystals involve growth from solution, by a slow reduction in the solubility. This can be achieved in a number of ways, and is amenable to many variations. There is often a range of solvents available for a given compound, and mixed solvents can be used to obtain a suitable intermediate solubility by taking a combination of a good and a poor solvent that are miscible. Many crystal structures incorporate solvent molecules, so the use of different solvents may give different structures with quite different crystal quality. Facile loss of solvent molecules only weakly held in the structure usually leads to crystal degradation, so solvent-grown crystals should preferably be kept in their mother liquor right up to the time of selection and mounting for the diffraction experiment. Less common recrystallization methods include solidification from a melt, and sublimation. Also important, particularly for polymeric and solid-state network materials, is slow generation of the desired compound itself in the actual synthesis; and slow exchange of counter-ions can be used to produce crystals of ionic coordination compounds.

### 1.28.2 SOLVENT EVAPORATION

One of the simplest methods of crystallization is slow evaporation of solvent from a solution. It can be used easily for air-stable materials, by making a few small holes in the top of a sealed sample container, and can be adapted for air-sensitive compounds, for example by placing this inside a Schlenk tube under an inert atmosphere. As for all the solution-based methods of crystallization, it is important for the apparatus to remain undisturbed and free from vibration while crystals grow; solvents and equipment must be clean and multiple nucleation sites such as scratches, rough surfaces, and dust should be avoided. Large, good-quality crystals are sometimes found in NMR tubes that have been left forgotten at the back of a fume cupboard for months; this is a combination of smooth and clean glassware, very pure solvents, very slow evaporation through an incompletely sealed tube, and complete lack of disturbance. However, evaporation suffers from the fact that the volume of the solution decreases, and this often leaves emerging seed crystals stranded above the liquid, where they can not grow and where they tend to form a polycrystalline crust. When a mixed solvent is used, the better solvent should be the more volatile; otherwise the solubility may increase as the poorer solvent evaporates. In any case, the solvent should not be left to evaporate completely, or separate single crystals are unlikely to be obtained.

### 1.28.3 COOLING

Most solubilities increase with temperature. Cooling methods include making a hot concentrated solution (in a pure solvent or a suitable solvent mixture) and allowing it to cool to room temperature, and taking a solution at room temperature and placing it in a refrigerator or freezer (at a temperature above the freezing point of the solution). This can be combined with solvent



evaporation, or the container can be sealed. The cooling will often be too fast to produce crystals of the desired quality and size unless precautions are taken to avoid this. Slower cooling can be achieved, for example, by immersing the sample container in a larger volume of liquid in a dewar flask, or by wrapping it in thermal insulating material.

A variation of the simple cooling method uses thermal convection. The simplest form of this is to place a solution where it will be subject to a thermal gradient as a result of sunlight or laboratory heating. It is also possible to construct apparatus that allows selective mild heating and cooling at different points to generate a circulating flow of solvent, dissolving excess solid sample from a reservoir and depositing recrystallized material elsewhere.

#### 1.28.4 SOLVENT LIQUID DIFFUSION

This is a variation on the use of a mixed solvent, consisting of one liquid in which the compound is readily soluble (the solvent) and one giving a low solubility (the precipitant), these two being miscible. Instead of mixing the liquids right from the outset, the compound is dissolved in the solvent alone, in a narrow sample tube. The precipitant is carefully added as a separate layer, either above or below the solution, depending on the relative densities. This can conveniently be done by injection from a syringe, to avoid premature mixing of the two liquids. The container is sealed and set aside undisturbed. Slow mixing of the liquids occurs, and crystals should form and grow at the interface. Both the mixing rate and the eventual solubility can be reduced by cooling the sample at the same time, but it must remain undisturbed, possibly for a few days. Factors that can be varied include the choice of solvent and precipitant, the volumes and initial concentration, and the temperature. Common combinations of liquids are chlorinated solvents with hydrocarbons or ethers as precipitants, or tetrahydrofuran as solvent and a hydrocarbon precipitant. The method is widely and successfully used.

#### 1.28.5 SOLVENT VAPOR DIFFUSION

This reduces yet further the rate of diffusion of two liquids, and often works well where cooling and liquid diffusion do not. As for solvent liquid diffusion, a moderately concentrated solution is prepared in the good solvent, and this is placed in a narrow sample tube. The tube, unsealed, stands in a larger container. Instead of having the solution and precipitant in direct physical contact as two liquid layers, the precipitant is placed in the outer container, which is then sealed and left undisturbed away from possible heat sources that might generate convection, usually for several days. The two liquids mix via the vapor phase, each slowly distilling into the other, and this gradually reduces the solubility of the compound in the mixed solvent.

The method has many advantages and is quite adaptable. It can be set up in a Schlenk tube for the recrystallization of an air-sensitive material. The rate of diffusion can be controlled by choice of the sample tube size and by partially sealing this with a pierced cover. Solvents and precipitants can be chosen as widely as for the liquid diffusion method, and there is no initial mixing at the interface, even when the two liquids have the same density. It is an advantage if the precipitant is more volatile than the solvent, since this causes the volume of the solution to increase rather than decrease, avoiding the formation of a crust of solid or the risk of complete removal of liquid from the crystals with resultant accretion and conglomeration.

A micro-scale version of the solvent vapor diffusion method is widely used in protein crystallography (the hanging drop method) and is appropriate for very small quantities of material. The precipitant occupies a depression in a glass plate and the solution is a single drop on the lower surface of a glass microscope slide placed over this plate. Several recrystallization attempts can be made with a single plate having many depressions, and the growth of crystals can be monitored under a microscope.

Other methods of achieving slow diffusion are described below (Section 1.28.8), in the context of slowing down the synthesis of the desired product.

#### 1.28.6 SUBLIMATION

This is a solvent-free method of obtaining crystals, which can be used for a material that has a significant vapor pressure at a temperature below its melting or decomposition point. There are

many variants on the scale and type of apparatus, the essential components of which are a container that can be evacuated, a source of heat for the sample, and a cooled site for the growth of crystals. For some materials with a measurable vapor pressure at room temperature, no heating is necessary. Typically, the solid is placed at the bottom of an evacuated vessel and is gently heated below an inserted cold finger (a hollow probe filled with a coolant). The compound passes directly into the vapor phase and crystallizes on the cold finger. The temperatures used and the degree of evacuation depend on the properties of the compound, but heating should be kept to a minimum, as this usually leads to better quality crystals.

### 1.28.7 CRYSTAL GROWTH FROM THE MELT

This is not a method commonly used for coordination compounds, which do not often melt without decomposition. Where applicable, it can be used by cooling from a high-temperature melt to room temperature, or by cooling a room-temperature liquid to a lower temperature. The latter is a specialized technique, usually carried out *in situ* on a diffractometer, with monitoring of the crystal growth by optical and X-ray methods; the sample is contained in a sealed capillary tube, and selective heating may be applied by an infra-red laser to develop a single crystal. Twins and multiple crystals often result from these methods.

### 1.28.8 SLOW DIFFUSION OF REACTANTS

Although coordination compounds with low nuclearity can usually be dissolved in and recovered unaltered from a suitable solvent, thus allowing recrystallization, larger nuclearity complexes and polymeric compounds are often highly insoluble once they are formed, and can not be further recrystallized. This is increasingly a problem in the study of supramolecular coordination chemistry and in polymeric coordination networks. In this case, crystals of adequate size and quality must be obtained direct from the synthesis. If only microcrystalline powder is produced when solutions of reactants are mixed, a possible approach is to alter the synthetic procedure to slow it down significantly. This involves placing some kind of physical barrier between the reactant solutions, and there are a number of ways of achieving this. Amounts and concentrations of the reactant solutions can be varied.

The simplest approach is to have the two reactant solutions as layers in direct contact, one above the other, just like the solvent diffusion method in [Section 1.28.4](#). This only works when the two solutions differ significantly in density, which usually means they have different solvents; otherwise the initial separation can not be achieved and mixing is too rapid.

A modification that avoids this problem, particularly when the two reactant solutions are in the same solvent, is to separate them by a third liquid through which they have to diffuse. This may be a liquid that takes no other part in the reaction, such as an oil between two solutions in organic solvents, or it may be the same solvent as is used for the two reactant solutions. One way of achieving this is to use a glass apparatus with an H-shape, made from three glass tubes. Each vertical tube contains one of the reactant solutions, initially below the level of the horizontal connecting tube; the apparatus is then filled up carefully with pure solvent to a level above the connecting tube, avoiding initial mixing as far as possible, and is sealed. The solutions slowly diffuse into and through the intervening solvent and gradually mix together; the product may be formed anywhere in the apparatus, depending on its properties and the course of the reaction.

An alternative to the liquid buffer is a solid physical barrier. This may be some form of membrane, or a glass sinter, for which the porosity is a factor that can be varied. In this case, the product is usually formed on one side or on both sides of the barrier, and the apparatus must be constructed in such a way that the crystals can be removed easily without damage.

One of the most versatile forms of barrier is a gel, through which reactant solutions have to diffuse to meet each other. Silica gel is most commonly used, and is easily formed by hydrolysis of an organosilicon precursor. Gels may be water-based, or may be formed with organic solvents. A typical approach involves the generation of a gel in the bottom of a U-tube apparatus, separating reactant solutions in the two arms. Diffusion through the gel is usually very slow; in some cases, reactions can take weeks or months. Crystals are formed within the gel, and must be separated from it afterwards. Since the gel supports the growing crystals, they are usually well separated and can be of good quality and large size; processes such as sedimentation and

convection are minimized. Colorless crystals are not easily seen, and the method works best with strongly colored compounds.

These methods for achieving slow diffusion of reactant solutions are not just applicable in the initial chemical synthesis of a desired product. For ionic coordination compounds, they can also be used when it is desirable to exchange the counter-ion to obtain potentially better quality crystals or to reduce the solubility by better size-matching of the ions. The initially obtained complex salt is in one solution, and a simple salt of the new counter-ion is in the other. Slow mixing of these two may be carried out by any of the techniques described here, or by simple layering of one solution over the other as in Section 1.28.4; obviously, vapor diffusion is not appropriate for this purpose, as it does not transfer the solutes between the two liquids.

Much less control is possible for insoluble products of solvothermal reactions, and here the main factors that can be changed are concentrations and quantities of reactants, temperature and duration of the reaction, and heating and cooling rates.

### 1.28.9 OTHER APPROACHES TO OBTAINING BETTER CRYSTALS

For some compounds, suitable crystals simply can not be obtained and all attempts are frustrated. The reasons are not well understood. In some cases, repeated attempts with varied conditions always produce multiple or twinned crystals. Trying a range of different solvents is the most obvious approach. It is not just that the crystal quality may vary with the solvent used; incorporation of solvent in the crystal structure generates a different crystalline form (a solvate), which will probably have quite different crystal growth characteristics. In most cases the nature of the solvent is unimportant in the quest for a definitive crystal structure analysis. However, the study of different solvates (and different polymorphs) of the same compound can itself be of interest, with significant changes in molecular structure resulting from different intermolecular interactions.

For many compounds, the modification of a chemically less important part of the structure can drastically change the crystallization properties and transform poorly crystalline samples into ideal candidates for diffraction studies. For ionic compounds, this may be achieved simply by exchanging the counter-ion. The substitution of a tetraalkylammonium cation by tetraphenylphosphonium or by  $[\text{Ph}_3\text{PNPPH}_3]^+$  and the substitution of  $\text{BF}_4^-$ ,  $\text{PF}_6^-$ , or  $\text{ClO}_4^-$  by  $[\text{BPh}_4]^-$  often produces much better crystals, through enhanced interactions of aromatic groups. Although it is by no means a universal rule, crystallization is often aided by having cations and anions of comparable size rather than widely different, and equal numerical charges on the cations and anions are also a favorable factor, with singly charged smaller counter-ions as a second preference; imbalances such as 3+:2- should be avoided. For uncharged coordination complexes, it may be possible to substitute a ligand of secondary importance, or change a substituent on a ligand in a similar way. Unless the precise chemical composition is important in every detail, this may solve an otherwise intractable problem or may represent a much easier solution than struggling to obtain a reliable crystal structure from inferior crystals. Large floppy substituents tend to hinder crystallization and to induce structural disorder, which reduces the precision of the determined crystal structure; unfavorable examples are long alkyl chains, including those in large tetraalkylammonium counter-ions used to increase solubility of coordination complex salts in organic solvents. Pseudo-spherical counter-ions such as  $\text{BF}_4^-$ ,  $\text{PF}_6^-$ , and  $\text{ClO}_4^-$  also tend to be disordered, though this problem is usually reduced if diffraction data are collected at low temperature. In the final analysis, the quality of the structure can not usually be greater than that of the sample.

# 1.29

## Ligand Reactivity: General Introduction

A. J. L. POMBEIRO

*Instituto Superior Técnico, Lisbon, Portugal*

and

V. YU. KUKUSHKIN

*St. Petersburg State University, Russian Federation*

---

1.29.1	INTRODUCTION	585
1.29.2	FACTORS AFFECTING LIGAND REACTIVITY	586
1.29.2.1	Electron-acceptor/donor Properties of the Metal Center	586
1.29.2.2	Electron-donor/acceptor Properties of the Ligands	587
1.29.2.3	Effect of Co-ligands	588
1.29.3	REACTIONS OCCURRING UPON COORDINATION	588
1.29.3.1	Acid-Base and Related Reactions	588
1.29.3.2	Internal Redox Reactions between Ligand and Metal Center	589
1.29.3.3	Ligand Coupling	589
1.29.3.4	Template Synthesis	589
1.29.3.5	Metal-induced Rearrangements	590
1.29.3.6	Stabilization of Unstable Species and Protection of Functional Groups by Metal Centers	590
1.29.4	SUMMARY AND CONCLUSIONS	590
1.29.5	REFERENCES	591

---

### 1.29.1 INTRODUCTION

Upon coordination of a substrate (L) to a metal (M) center, a ligand's properties (such as electrophilic or nucleophilic character, acidity, susceptibility to oxidation or reduction) often are significantly changed and therefore its reactivity can be enhanced or inhibited; the coordination can even make possible a reaction that would otherwise not take place. The first example of ligand reactivity (this history is highlighted in ref. 1) was reported even before the beginning of coordination theory (1893)<sup>2</sup> when the term ligand<sup>3,4</sup> had not yet been introduced into chemistry. Thus Buff, in the middle of the nineteenth century, treated  $H_4[Fe(CN)_6]$  with HCl in ethanol and unknowingly prepared a compound with coordinated imino esters, i.e.,  $[Fe\{NH=C(H)OEt\}_6]Cl_2$ , Schutzenberger (1870–1872) studied the hydrolysis and alcoholysis of  $[PtCl_2(PCl_3)_2]$  to furnish  $[PtCl_2\{P(OH)_3\}_2]$  and  $[PtCl_2\{P(OR)_3\}_2]$ , while soon after the recognition of Werner's theory Hofmann and Bugge (1907) observed the hydrolysis of platinum(II)-bound organonitriles to give the platinum blues<sup>5–7</sup> and Chugaev (1921) hydrolyzed coordinated cyanate  $NCO^-$  to obtain ammino complexes. These are important landmarks in studies of ligand reactivity. However, major progress in this field did not start until the second half of the twentieth century when it was generally recognized that the change in reactivity of ligands, as a result of their ligation to a metal

center, forms the basis for the use of metal complexes as stoichiometric reagents and homogeneous catalysts in organic chemistry. Since then the accumulated results have been reflected in a number of books and reviews.<sup>1,8–18</sup>

Significant progress in the identification of reactivity centers, based on the electronic pattern of reagents, was achieved by the application of quantum chemical methods.<sup>19–29</sup> The total interaction energy between reactants is usually considered to result from several energetic contributions where, in some instances, it is possible to ascertain those that dominate. If the energy gap for the HOMO and LUMO of reactants is small, the most plausible pathway of the reaction can be considered in terms of the HOMO–LUMO interaction (predominantly interplay between HOMO<sub>donor</sub> and LUMO<sub>acceptor</sub>). Usually the reaction is expected to take place between two centers having the greatest differences in electronic densities on their frontier MOs. For a large HOMO<sub>donor</sub>–LUMO<sub>acceptor</sub> gap, electrostatic components are often responsible for the interaction between atomic centers. In a more common and practical approach, ligand reactions can be considered from the viewpoint of electrostatics and even such a simplified treatment of chemical processes allows, in a number of cases, one to determine the reaction centers of interacting molecules.

## 1.29.2 FACTORS AFFECTING LIGAND REACTIVITY

### 1.29.2.1 Electron-acceptor/donor Properties of the Metal Center

The electron acceptor and donor properties of a metal center relative to a particular ligand depend, apart from the ligand itself, on a variety of factors associated with the metal (such as its position in the periodic table, its oxidation state and coordination number), to the co-ligands (e.g., their electronic donor/acceptor ability) and to the overall coordination entity (namely the electron count and the net charge). Naturally, all such factors also affect the reactivity of the ligand which is therefore determined by a complexity of combined effects whose relative weight is often not easy to predict.

The first feature of the binding metal center which commonly strikes a coordination chemist's attention is the metal itself and therefore its position in the periodic table, although this is not necessarily the main aspect. General correlations between the electron acceptor and donor properties of transition metal complexes and their position in the periodic table cannot be readily established, but some comments can be made, assuming similar effects of the other factors. The  $\sigma$ -acceptor character is favored by an increase in the atomic number due to the stabilization of the  $d$ -orbital energy levels along any transition metal period, whereas the  $\pi$ -back-bonding capacity (to a  $\pi^*$ -orbital of an unsaturated ligand) is promoted by a decrease of atomic number along the period, thus occurring preferably to the left of the transition groups which, however, have a smaller number of filled  $d$ -orbitals. Hence, effective  $\pi$ -electron donation will result from a compromise between these two tendencies. In accord, the most effective activation of N<sub>2</sub> toward protonation, to give, e.g., hydrazido(2–), M(NNH<sub>2</sub>), derivatives or even ammonia, by coordination to a single phosphinic metal center occurs principally for the group 6 ( $d^6$ ) metal sites {ML<sub>4</sub>}<sup>*n*</sup> (M = Mo, W; *n* = 0; L = organophosphine or 1/2 diphosphine) or, to a lesser extent, to the isoelectronic V(–1) site (M = V, *n* = –1).<sup>30–35</sup> For a poorly defined related Fe<sup>0</sup>,  $d^8$ , center, ammonia formation occurs in a much lower yield,<sup>30,31,35</sup> whereas it is not observed with other transition metals.

Obviously, aside from its position in the periodic table, other factors are also important, such as the metal oxidation state and the charge of the complex, higher values of both of which will favor  $\sigma$ -acceptance while lower values will enhance  $\pi$ -donation. Also important is the nature of the co-ligands which can promote such properties or compete for them. The IR stretching frequency  $\nu(\text{XY})$  value of an unsaturated XY (N≡N, N≡CR, C≡NR, CO) ligand can provide a convenient probe for the study of those factors and, e.g., in the series *trans*-[Mo(N<sub>2</sub>)L(dppe)<sub>2</sub>]<sup>*n*</sup> (dppe = Ph<sub>2</sub>PCH<sub>2</sub>CH<sub>2</sub>PPh<sub>2</sub>)  $\nu(\text{NN})$  decreases in the order L = CO (*n* = 0) > CNPh (*n* = 0) > N<sub>2</sub> (*n* = 1) > N<sub>2</sub> (*n* = 0) > NCR (*n* = 0),<sup>36–38</sup> which reflects the increase of the  $\pi$ -donor ability of {MoL(dppe)<sub>2</sub>}<sup>*n*</sup> toward the ligated N<sub>2</sub>. Further, ligand protonation has not been reported for the cases of L = CO, CNR (*n* = 0) or N<sub>2</sub> (*n* = 1), in contrast to those for L = N<sub>2</sub> (*n* = 0) or NCR (*n* = 0)<sup>37</sup> in which these ligands are readily protonated.

The general implications of the electronic properties of the binding metal center (which are involved in redox potential parametrizations, see below) on the activation of unsaturated small



molecules other than  $N_2$  are also noteworthy. In particular, transition metals of later groups (typically Pt or Pd) behave as efficient  $\sigma$ -acceptors and activate organonitriles<sup>39</sup> (see Chapter 1.34) or isocyanides<sup>40</sup> toward nucleophilic attack, whereas those of earlier groups (namely Mo, W, or Re, in low oxidation states) exhibit a strong  $\pi$ -electron releasing character and can activate those substrates to electrophilic attack.<sup>39,41–43</sup> The former type of addition is much more common since ligands normally undergo an increase in electrophilicity upon coordination. This is usually observed for organonitriles, in spite of the fact that as free ligands they are susceptible to electrophilic addition reactions, e.g., with hydrohalic acids. As an example, the hydrolysis of organonitriles is dramatically accelerated by metal ions, usually by a factor of  $10^6$  to  $10^{10}$  and occasionally by  $10^{18}$ .<sup>44–47</sup> Similarly, the metal-promoted hydrolysis of urea (or derivatives) to cyanate (which can undergo further hydrolysis) has been suggested as an alternative mechanism for the urease-catalyzed hydrolysis of urea to ammonia and carbamate ions.<sup>48–52</sup> Some other examples of metal-mediated hydrolysis include imines,<sup>53–56</sup> oximes, amides (these studies are relevant to investigations of the peptidases),<sup>57–62</sup> thiourea,<sup>63,64</sup> phosphate esters,<sup>65–72</sup> and thio-phosphoric acid esters (well-known pesticides).<sup>73</sup>

Nucleophilic attack on a ligand is favored by a positive charge on the complex. The effect is particularly important when a reagent also bears a charge, as observed for the nucleophilic oxygenation of metal-bound CO ligands by trimethylaminoxide,  $Me_3N^+—O^-$ . Neutral metal carbonyls participate in these oxygenation reactions to give free  $CO_2$  only if  $IR \nu(CO) > 2,000\text{ cm}^{-1}$ . However, the reaction can also occur for lower wavenumbers (in principle corresponding to a weaker CO activation) if the complex is cationic as a result of the increase of its electrophilicity by the positive charge.<sup>74</sup>

### 1.29.2.2 Electron-donor/acceptor Properties of the Ligands

The activation of a ligand upon coordination is determined not only by the electronic properties of the binding metal site, but also by those of the ligand itself, namely its electron-donor/acceptor character. Both have a prominent effect on the redox potential of the complexes which has been the subject of parametrization methods (see also Chapter 2.19) by Pickett<sup>75</sup> and Lever<sup>76–79</sup> who have defined an electrochemical ligand parameter ( $P_L$  or  $E_L$ , respectively) which is a measure of the *net*  $\pi$ -electron acceptor minus  $\sigma$ -donor ability of a ligand.

Concomitantly, electrochemical metal site parameters (“electron richness” and “polarizability”) have been proposed.<sup>75</sup> The approaches, which have been reviewed,<sup>76,80,81</sup> were initially applied to particular series of octahedral-type complexes with 18/17-electron redox pairs, but have been extended by others<sup>82–98</sup> to systems with different ligands and/or metal centers, or with lower electron counts, namely with 17/16-electron redox pairs<sup>99</sup> and also some square-planar 16-electron complexes.<sup>100</sup> Mössbauer spectroscopy can also provide convenient tools for the investigation of the electronic  $\sigma$ -donor/ $\pi$ -acceptor abilities of ligands. It has been applied to a series of  $Fe^{II}$  complexes with ditertiary phosphines.<sup>101–105</sup> In particular, partial isomeric shift (PIS, which reflects the combined ligand  $\sigma + \pi$  character, higher values corresponding to lower summed  $\sigma$ -donor and  $\pi$ -acceptance contributions) and partial quadrupole splitting (PQS, a measure of the ligand net  $\pi - \sigma$  ability) parameters have been estimated for nitrile<sup>101</sup> and cyanamide<sup>102</sup> ligands and rationalized, with the overall IS and QS, in terms of  $\pi$ - and  $\sigma$ -electronic effects.

Such parameters can be of predictive value for ligand or complex reactivity. Hence, e.g., ligands with high  $P_L$  (or  $E_L$ ) and PQS values, like  $N_2$  and NCR, have significant  $\pi$ -electron acceptor ability and therefore, if coordinated to an “electron-rich” metal center with strong  $\pi$ -donor character, they become susceptible to electrophilic attack which can be further promoted by co-ligands that are strong net electron donors (low  $P_L$  or  $E_L$  values). An example is provided by the comparative behavior of  $[ReCl(NCR)(dppe)_2]$  and  $[Re(NCR)_2(dppe)_2]^+$ . In the former, the nitrile ligand undergoes ready protonation<sup>106</sup> favored by the strong electron-donor chloride ligand, whereas in the latter (which has another nitrile co-ligand as a competitor for  $\pi$ -acceptance) no reaction is observed. Protonation in the former occurs at the unsaturated C atom ( $\beta$  position), in spite of the slight positive charge at this atom and the absence of an electron lone pair, being frontier-orbital controlled<sup>107</sup> rather than charge-controlled. Another example was given above for the susceptibility of  $N_2$  to protonation at  $[Mo(N_2)_2(dppe)_2]$  but not at  $[Mo(N_2)L(dppe)_2]$  ( $L = CO, CNR$ ).

### 1.29.2.3 Effect of Co-ligands

In general, a co-ligand with a net electron donor/acceptor ability opposite to that of a specific ligand can assist the metal toward the activation of the latter (e.g., a strong net electron donor, like chloride, can promote the activation of an overall weaker electron donor toward electrophilic attack as exemplified above). However, if both ligands have similar electronic ability, they can compete with each other and feel a reduced activation by the metal center. A diversity of particular situations and effects (apart from the widely documented *trans*-effect, see below and Section 1.29.1) are known; the following concern nitric oxide. Although a linear NO ligand does not react with  $H^+$ , attack of bromide on the metal (which changes the linear to a bent NO geometry) promotes protonation.<sup>108</sup> The linear and bent modes correspond to different electron density distributions in the delocalized M–NO moieties according to the total number of electrons occupying the  $d + \pi^*(NO)$  orbitals, and consequently to different reactivities (also see Chapter 1.31).

A nitrosyl group at the  $\{Ru(NH_3)_4\}^{2+}$  center has nitrosonium character<sup>109</sup> ( $NO^+$  with the linear coordination mode), behaving as a strong  $\pi$ -acceptor (even stronger than CO), and markedly (i) promotes the acidity of a *trans* ligand such as pyrazinium ( $pzH^+$ ) or  $H_2O$  (e.g., the  $K_a$  of *trans*- $H_2O$  increases by 10 orders of magnitude from the *trans*- $NH_3$  to the *trans*- $NO^+$  complex); (ii) decreases the substitution lability of a  $\pi$ -donor *trans* ligand such as  $H_2O$  or chloride, and (iii) decreases the affinity of the  $Ru^{II}$  center for  $\pi$ -acid ligands like pyrazine. The extent of these effects is much more pronounced than that expected by increasing the charge by one unit.

Dinitrogen is particularly sensitive to the properties of co-ligands in view of the tight requirements for its binding. In fact,  $N_2$  with a rather low energy lying  $\sigma$ -donor orbital and a large energy gap to the empty  $\pi^*$ -acceptor orbital, requires, for coordination, specific properties of the metal center and often even a subtle change in the composition of a  $N_2$ -binding center results in the loss of its ability to coordinate  $N_2$ .<sup>30–32</sup> In contrast, nitriles, isocyanides, or carbonyl can often easily adapt to changes to their binding metal sites.

## 1.29.3 REACTIONS OCCURRING UPON COORDINATION

Nucleophilic or electrophilic addition to ligands, promoted by their coordination (see above), are the most typical and most studied reactions; however, other kinds of reactivity can be illustrated.

### 1.29.3.1 Acid–Base and Related Reactions

The effect of coordination on the acidity of coordinated species, namely the oxidation state, electronic structure, polarizability, overall charge of the complex, number of coordinated ligands, geometry of complexes, and  $\pi$ -acceptor properties of co-ligands, has been thoroughly reviewed.<sup>8,9,74</sup> A comparison of the acidities ( $pK_a$  values) of coordinated vs. free ligands provides a good thermodynamic estimate of their activation upon ligation to a metal center. The explanation of this behavior is usually based on charge considerations such that metal ions with larger charges and smaller radii increase the ligand acidity, e.g.,  $pK_{a1}$  for  $[Fe(H_2O)_6]^{3+}$  is ca. 2.<sup>110</sup> The OH acidity of oximes (Chapter 1.33) is also markedly increased by coordination (by 4–10  $pK_a$  units).

The electronic structure of a complex greatly affects the acid–base properties. Thus, terminal coordination of pyrazinium ( $pzH^+$ ) ( $pK_a$  ca. 0.6 when free) to the  $\{Ru^{III}(NH_3)_5\}^{3+}$  fragment results in a decrease of the  $pK_a$  value of the unligated  $NH^+$  moiety to ca.  $-0.8$  but binding to  $\{Ru^{II}(NH_3)_5\}^{2+}$  leads to a  $pK_a$  increase to ca. 2.5 because the  $\pi$ -releasing properties of the metal center increase. The basicity of *pz* is even stronger in  $[Os^{II}(NH_3)_5(pz)]^{2+}$  ( $pK_a$  ca. 7.4).<sup>111,112</sup>

The dependence of ligand acidity on the metal oxidation state has been well documented in particular by electrochemical studies which have shown, e.g., a decrease of  $pK_a$  of ca. 7 or 10, in aprotic media, for the ligated isocyanide or aminocarbene  $CNH_x$  ( $x=1$  or 2, respectively) at phosphinic Fe or Re centers,<sup>113,114</sup> upon single-electron metal oxidation, whereas even more dramatic  $pK_a$  decreases, up to 20–30, have been reported for hydride ligands,<sup>115–117</sup> the processes leading to proton release.

Lewis acids such as metal ions, likewise  $H^+$ , can also be added to unligated electron pairs of ligands to achieve homo- or heterobinuclear metal systems<sup>118</sup> (in some instances the formal reversibility of metallization has been demonstrated<sup>119</sup>), an important topic due to the potential usage of these systems in material science. Other related reactions involve alkylation of such ligands as thiolates<sup>120–123</sup> or dealkylation of coordinated thioethers<sup>124–129</sup> (study motivated by

their relevance to zinc-containing alkyl transfer enzymes), although examples of the formal reversibility, i.e., alkylation of thiolates–dealkylation of thioethers (similar to their reversible protonation<sup>130</sup>) occurring at the same complex, are rare.<sup>131,132</sup>

### 1.29.3.2 Internal Redox Reactions between Ligand and Metal Center

Alteration of the redox potential of a metal center due to coordination is well-documented.<sup>76,80,81</sup> In turn, the metal ion affects the ligated species leading to a redistribution of electron density that results in a modification of their redox properties. These phenomena can lead to internal redox reactions, at least formally, between the metal and ligand(s) (for oxidative coupling involving hydrosulfido and CO<sub>2</sub> ligands see refs. 133 and 134). Thus, e.g., *cis*-[PtCl<sub>4</sub>(R<sub>2</sub>C=NOH)<sub>2</sub>], in acetone, undergoes a spontaneous reaction accompanying 2-electron reduction of the Pt<sup>IV</sup> center and 2-electron oxidation of one oxime with coupling to give *cis*-[PtCl<sub>2</sub>{*N,N*-N(=O)CR<sub>2</sub>ON=CR<sub>2</sub>}].<sup>135,136</sup> The opposite reactivity mode, i.e., reductive coupling of two ligands with concomitant oxidation of the metal center is also known (see Chapter 1.34 and for other examples ref. 137–139).

Internal redox reactions are also involved in the metal-assisted 2-, 4- or even 6-electron reduction of dinitrogen to diazenido [(N<sub>2</sub>)<sup>2-</sup>]<sup>140–144</sup> or hydrazido [(N<sub>2</sub>)<sup>4-</sup>]<sup>145–147</sup> (especially in bridging dinuclear species), or to nitrido (N<sup>3-</sup>) complexes,<sup>147–151</sup> for strongly reducing early transition metal centers (typically of groups 5 and 6) that can also form strong multiple bonds to nitrogen. Such a bimetallic N<sub>2</sub> activation sequence corresponds to a stepwise weakening of the N–N bond until its remarkable complete reductive cleavage to the reduction level of ammonia (nitride), the electrons being provided by the binding metal centers, in some cases assisted by an external reducing agent.

Metal–ligand redox processes are also encountered in other types of reactions. For example the metal-promoted electrophilic additions to unsaturated ligands, like N<sub>2</sub>,<sup>30–35</sup> NCR (Chapter 1.34) or CNR,<sup>41–43</sup> which are known to undergo, at a single electron-rich metal center, protonation or alkylation (acylation, aroylation, or silylation also for N<sub>2</sub>) to afford reduced derivatives (e.g., diazenido NNH<sup>-</sup>, hydrazido NNH<sub>2</sub><sup>2-</sup> from which hydrazine can be obtained, and ammonium, in the case of reductive protonation of N<sub>2</sub>) with concomitant oxidation of the binding metal that behaves as the electron source. The above N<sub>2</sub> reactions are of significance toward the development of mimetic systems of nitrogenases.

Another example of an internal redox reaction induced by an external activator is given by [Pt<sup>II</sup>Cl<sub>2</sub>(Me<sub>2</sub>SO)<sub>2</sub>] which, upon addition of HCl, converts to [Pt<sup>IV</sup>Cl<sub>4</sub>(Me<sub>2</sub>S)<sub>2</sub>].<sup>152</sup> An overall internal redox between a Pd<sup>II</sup> center and ethylene in aqueous solution is a basic reaction in the Wacker process, i.e., metal-catalyzed conversion of ethylene to acetaldehyde.

### 1.29.3.3 Ligand Coupling

Ligand coupling, although very common in organometallic chemistry, is relatively rare for inorganic ligands. Redox and nonredox coupling between ligands are briefly considered in Chapter 1.34 and Section 1.29.3.4, respectively; the major driving force in many instances is the high stability of the five- or six-membered chelates formed, but other situations are known, such as the conversion of a dihydrido into a dihydrogen complex.<sup>153–155</sup> The interaction between ligated species is a basic process for the highly explored reductive elimination reactions.<sup>156–158</sup>

### 1.29.3.4 Template Synthesis

The template synthesis represents an elegant method that uses metal ions to direct reactions of ligands and provides a useful route to macrocyclic structures. Several books<sup>159–161</sup> describe the template processes that involve reactions on matrices used to synthesize polyazamacrocycles, crown ethers, cryptands, rotaxanes, knots,<sup>159</sup> clathrochelates,<sup>160</sup> phthalocyanines,<sup>161</sup> etc. which are applied, e.g., as molecular switches, in ion exchange, electron transfer or catalysis. An example of clathrochelate synthesis is given in Chapter 1.33



### 1.29.3.5 Metal-induced Rearrangements

Rearrangements of ligand(s) on a metal framework include, for example, interligand oxygen transfer and conversion of phosphite to phosphonate complexes,<sup>74,162</sup> reversible and irreversible conversions of dihydrogen–dihydrido complexes,<sup>153–155</sup> changes in metal–ligand binding sites, e.g., linkage isomerization, which were all surveyed.<sup>163–168</sup> Some other examples include metal-induced *E-Z* isomerizations (e.g., of imines,<sup>169–171</sup> amidines,<sup>172,173</sup> imino esters,<sup>174</sup> amino acid esters,<sup>175</sup> substituted thiourea,<sup>176</sup> and diphosphinic ligands<sup>177</sup>), and rearrangements of diphosphinic<sup>178</sup> and ROCS<sub>2</sub>Me<sup>179</sup> ligands at an Fe<sub>2</sub> center.

### 1.29.3.6 Stabilization of Unstable Species and Protection of Functional Groups by Metal Centers

Although enhancement of reactivity of substrates upon ligation is perhaps the most significant consequence of coordination, in some instances a decrease or inhibition of the reactivity occurs. In the latter case, a metal ion might play the role of a protecting group and coordination can even result in stabilization of species that are highly unstable in the free state. Thus, e.g., imine ligands, especially those containing donor groups like N(H)=CMe<sub>2</sub>, exhibit high reactivity toward both hydrolysis and polymerization.<sup>180–183</sup> Stabilization of free imines can only be reached by introducing *acceptor* substituents to the carbon. Alternatively, coordination of imines (with two *donor* substituents) to a metal center leads to their stabilization and they can be stored in this form for a prolonged time (Chapter 1.34).<sup>180–183</sup> Their liberation can be carried out *in situ* when needed. In another case, a Rh<sup>III</sup> center stabilizes the usually unstable imino group toward hydrolysis, although, in contrast, it selectively promotes this type of reaction for the commonly stable oxime group.<sup>184</sup> In addition, coordination to a metal center might result in the predominant stabilization of a tautomer which is the minor one when the ligands are free<sup>185–189</sup> or a resonance form whose contribution is minor in the free state.<sup>190</sup> The coordination of carboxamides, derived from nitrile hydrolysis at both Pt<sup>II</sup> and Pt<sup>IV</sup> centers, in the N-iminol form rather than in the O-amide form, illustrates the former case.<sup>191</sup>

An example of selective stabilization of a functional group with a concomitant promotion of reactivity at another ligand site is given by chlorination by Cl<sub>2</sub> of Pt<sup>II</sup> salicylaldoxime<sup>192,193</sup> and 1,2-quinone monoxime complexes<sup>194</sup> which results—instead of the previously observed (for free oximes) Piloty reaction—in both chlorination of the benzene rings and oxidative addition of Cl<sub>2</sub> to Pt<sup>II</sup>. Hence, the metal center protects the oxime N from the well-known oxidative deoxygenation (Chapter 1.33) and orients the chlorination toward certain positions in the rings making it selective. After the chlorination the newly formed ligands can be liberated.<sup>194</sup> In another example, the Fe(CO)<sub>2</sub> fragment acts as a protecting group for one thiolate function in *cis*-[Fe(S<sub>2</sub>C<sub>6</sub>H<sub>4</sub>)<sub>2</sub>(CO)<sub>2</sub>]<sup>2-</sup> and permits the monoalkylation of *o*-benzenedithiol, a reaction which is not possible by conventional methods.<sup>195</sup>

## 1.29.4 SUMMARY AND CONCLUSIONS

Binding a species to a metal center commonly results in a significant alteration (i) of its electronic (and eventually also structural) properties that can provide a probe toward a better understanding of such properties, and (ii) of its reactivity that can be explored for the synthesis of other ligands and/or derived compounds.

Spectroscopic, structural, and electrochemical parameters are valuable tools for the investigation of ligand properties and can be of predictive value for their reactivity. A considerable understanding of the factors that govern ligand reactivity has already been gained in a number of situations that has allowed the design of metal centers capable of activating certain ligands toward desired reactions, even in some particularly difficult cases of activation, namely of usually inert species like dinitrogen. However, further developments are still required in order to define coordination–reactivity relationships with wide generality. For such a purpose, systematic studies have to be performed more frequently, as well as detailed mechanistic investigations and theoretical interpretations of ligand reactivity by quantum chemical calculations, which so far have only been applied scantily.

The reactions of coordinated ligands can be used for metal-mediated synthesis of new products upon their elimination from the coordination sphere of the complexes. However, the number of

new ligands, which can be eliminated, is still limited, since often a major driving force for their formation is the high stability of the complexes formed. In fact, for instance, the template syntheses normally allow the utilization of only complexes rather than pure organic ligands because their liberation cannot be achieved (due to the high stability of macrocyclic complexes and/or the lack of methods for the liberation) or give products of low stability in the free state. Moreover, the metal ion can play a good protective role for a number of functional groups, but the higher the degree of protection the more difficult it usually is to get rid of the metal center after the performance of the reaction.

Therefore, metal-mediated synthesis is a rather promising field of research in coordination chemistry which still remains to be adequately explored, and further advances are expected not only in stoichiometric synthetic processes but also, and still with higher relevance, in catalysis.

## 1.29.5 REFERENCES

1. Kukushkin, Yu. N. *Reactivity of Coordination Compounds* [in Russian]; Khimia: Leningrad, 1987.
2. Kauffman, G. B. In *Coordination Chemistry: A Century of Progress*, Kauffman, G. B., Ed., ACS Symposium Series No. 565; American Chemical Society: Washington, DC, 1994, pp 2–33.
3. Kauffman, G. B.; Brock, W. H.; Jensen, K. A.; Jørgensen, C. K. *J. Chem. Educ.* **1983**, *60*, 509–510.
4. Brock, W. H.; Jensen, K. A.; Jørgensen, C. K.; Kauffman, G. B. *Polyhedron* **1983**, *2*, 1–7.
5. Matsumoto, K.; Sakai, K. *Adv. Inorg. Chem.*, **2000**, *49*, 375–427.
6. Lippert, B. *Cisplatin*, Lippert, B., Ed.; Verlag Helvetica Chimica Acta: Zurich, 1999, p 379.
7. Tejel, C.; Ciriano, M. A.; Oro, L. A. *Chem. Eur. J.*, **1999**, *5*, 1131–1135.
8. Constable, E. C. *Metals and Ligand reactivity. An Introduction to the Organic Chemistry of Metal Complexes*; VCH: Weinheim, 1995.
9. Braterman, P. S., Ed., Vols. 1, 2: Plenum Press, New York, 1989.
10. Braunstein, P.; Oro, L. A.; Raithby, P. R. *Met. Clusters Chem.* **1999**, *1*, 73–90.
11. Beyer, L.; Cornejo, J. A. *Bol. Soc. Quim. Peru* **1997**, *63*, 17–25.
12. Beyer, L.; Cornejo, J. A. *Chem. Abstr.* **1997**, *127*, 170533.
13. Kukushkin, Yu. N. *Zh. Obshch. Khim.* **1986**, *56*, 514–522.
14. Hay, R. W.; Constable, E. C.; Kane-Maguire, L. A. P. *Mech. Inorg. Organomet. React.* **1994**, *8*, 283–319 and 465–469.
15. Hay, R. W.; Constable, E. C.; Kane-Maguire, L. A. P. *Mech. Inorg. Organomet. React.* **1991**, *7*, 279–308 and 432–435.
16. Hay, R. W.; Constable, E. C.; Kane-Maguire, L. A. P. *Mech. Inorg. Organomet. React.* **1989**, *6*, 307–335 and 500–502.
17. Blackman, A. *Adv. Heterocycl. Chem.* **1993**, *58*, 123–170.
18. Black, D. St. C. *CCC (1987)*, Section 7.4, Vol. 1; Elsevier Science Publishers: Amsterdam, 1986.
19. Niu, S. Q.; Hall, M. B. *Chem. Rev.* **2000**, *100*, 353–405.
20. Siegbahn, P. E. M.; Blomberg, M. R. A. *Chem. Rev.* **2000**, *100*, 421–437.
21. Torrent, M.; Sola, M.; Frenking, G. *Chem. Rev.* **2000**, *100*, 439–493.
22. Dedieu, A. *Chem. Rev.* **2000**, *100*, 543–600.
23. Frenking, G.; Fröhlich, N. *Chem. Rev.* **2000**, *100*, 717–774.
24. Cundari, T. R. *Chem. Rev.* **2000**, *100*, 807–818.
25. Koga, N.; Morokuma, K. *Chem. Rev.* **1991**, *91*, 823–842.
26. Koga, N.; Morokuma, K. *Reviews in Computational Chemistry*, Lipkowitz, K. B.; Boyd, D. B. Ed.; VCH: New York, 1990–1999, Vol. 1–13.
27. Frenking, G.; Bolhme, C.; Pidun, U. *Pauling's Legacy: Modern Modelling of the Chemical Bond. Theoretical and Computational Chemistry*, Maksic, Z. B.; Orville-Thomas, W. J., Eds., Vol. 6; Elsevier: Amsterdam, 1999.
28. Ziegler, T. *Chem. Rev.* **1991**, *91*, 651–667.
29. Kuznetsov, M. L. *Usp. Khim. (Russ. Chem. Rev.)* **2002**, *71*, 307–326.
30. Hidai, M.; Mizobe, Y. *Chem. Rev.* **1995**, *95*, 1115–1133.
31. Fryzuk, M. D.; Johnson, S. A. *Coord. Chem. Rev.* **2000**, *200–202*, 379–409.
32. Richards, R. L. *Coord. Chem. Rev.* **1996**, *154*, 83–97.
33. Rehder, D. *Coord. Chem. Rev.* **1999**, *182*, 297–322.
34. Bazhenova, T. A.; Shilov, A. E. *Coord. Chem. Rev.* **1995**, *144*, 69–145.
35. Eady, R. R.; Leigh, G. J. *J. Chem. Soc., Dalton Trans.* **1994**, 2739–2747.
36. Seino, H.; Arita, C.; Nonokawa, D.; Nakamura, G.; Harada, Y.; Mizobe, Y.; Hidai, M. *Organometallics* **1999**, *18*, 4165–4173.
37. Seino, H.; Tanabe, Y.; Ishii, Y.; Hidai, M. *Inorg. Chim. Acta* **1998**, *280*, 163–171.
38. Chatt, J.; Dilworth, J. R.; Richards, R. L. *Chem. Rev.* **1978**, *78*, 589–625.
39. Kukushkin, V. Yu.; Pombeiro, A. J. L. *Chem. Rev.* **2002**, *102*, 1771–1802.
40. Michelin, R. A.; Pombeiro, A. J. L.; Guedes da Silva, M. F. C. *Coord. Chem. Rev.* **2001**, *218*, 75–112.
41. Pombeiro, A. J. L. *New J. Chem.* **1994**, *18*, 163–174.
42. Pombeiro, A. J. L.; Guedes da Silva, M. F. C.; Michelin, R. A. *Coord. Chem. Rev.* **2001**, *218*, 43–74.
43. Pombeiro, A. J. L.; Richards, R. L. *Coord. Chem. Rev.* **1990**, *104*, 13–38.
44. Fairlie, D. P.; Jackson, W. G.; Skelton, B. W.; Wen, H.; White, A. H.; Wickramasinghe, W. A.; Woon, T. C.; Taube, H. *Inorg. Chem.* **1997**, *36*, 1020–1028.
45. Hay, R. W.; McLaren, F. M. *Transit. Met. Chem.* **1999**, *24*, 398–402.
46. Kim, J. H.; Britten, J.; Chin, J. J. *Am. Chem. Soc.* **1993**, *115*, 3618–3622.
47. Buckingham, D. A.; Morris, P.; Sargeson, A. M.; Zanella, A. *Inorg. Chem.* **1977**, *16*, 1910–1923.
48. Barrios, A. M.; Lippard, S. J. *Inorg. Chem.* **2001**, *40*, 1250–1255.
49. Barrios, A. M.; Lippard, S. J. *J. Am. Chem. Soc.* **2000**, *122*, 9172–9177.

50. Barrios, A. M.; Lippard, S. J. *J. Am. Chem. Soc.* **1999**, *121*, 11751–11757.
51. Meyer, F.; Kaifer, E.; Kircher, P.; Heinze, K.; Pritzkow, H. *Chem. Eur. J.* **1999**, *5*, 1617–1630.
52. Kaminskaia, N. V.; Kostic, N. M. *Inorg. Chem.* **1997**, *36*, 5917–5926.
53. Menon, M.; Pramanik, A.; Chakravorty, A. *Inorg. Chem.* **1995**, *34*, 3310–3316.
54. Cox, M. A.; Newman, P. D.; Stephens, F. S.; Vagg, R. S.; Williams, P. A. *Inorg. Chim. Acta* **1994**, *221*, 191–196.
55. Fogg, D. E.; James, B. R. *Inorg. Chem.* **1995**, *34*, 2557–2561.
56. Pierre, F.; Moinet, C.; Toupet, L. *J. Organomet. Chem.* **1997**, *527*, 51–64.
57. For reviews see: Polzin, G. M.; Burstyn, J. N. *Metal Ions in Biological Systems* **2001**, *38*, 103–143.
58. Murthy, N. N.; Karlin, K. D. *Adv. Chem. Ser.* **1995**, *246*, 165–193.
59. Kaminskaia, N. V.; Ullmann, G. M.; Fulton, D. B.; Kostic, N. M. *Inorg. Chem.* **2000**, *39*, 5004–5013.
60. Matsubara, T.; Hirao, K. *Organometallics* **2001**, *20*, 5056–5066.
61. Djuran, M. I.; Milinkovic, S. U. *Polyhedron* **2000**, *19*, 959–963.
62. Parac, T. N.; Ullmann, G. M.; Kostic, N. M. *J. Am. Chem. Soc.* **1999**, *121*, 3127–3135.
63. Shen, X.; Shi, X.; Kang, B.; Liu, Y.; Gu, L.; Huang, X. *J. Coord. Chem.* **1999**, *47*, 1–15.
64. Fairlie, D. P.; Wickramasinghe, W. A.; Byriel, K. A.; Taube, H. *Inorg. Chem.* **1997**, *36*, 2242–2243.
65. For reviews see: Itoh, T.; Fujii, Y. *Recent Research Developments in Pure & Applied Chemistry* **1998**, *2*, 329–346.
66. Chin, J. Ed.; Berg, D. A. *Proc. ERDEC Sci. Conf. Chem. Biol. Def. Res.*, National Technical Information Service, Springfield, 1996, 275–281.
67. Chin, J. Ed.; Berg, D. A. *Chem. Abs.* **1997**, *127*, 34265.
68. Kluger, R.; Cameron, L. L. *J. Am. Chem. Soc.* **2002**, *124*, 3303–3308.
69. Neves, A.; Terenzi, H.; Horner, R.; Horn, A., Jr.; Szpoganicz, B.; Sugai, J. *Inorg. Chem. Commun.* **2001**, *4*, 388–391.
70. Knöfel, T.; Strater, N. *J. Mol. Biol.* **2001**, *309*, 239–254.
71. Stulz, E.; Burgi, H.-B.; Leumann, C. *Chem. Eur. J.* **2000**, *6*, 523–536.
72. Bazzicalupi, C.; Bencini, A.; Berni, E.; Bianchi, A.; Fedi, V.; Fusi, V.; Giorgi, C.; Paoletti, P.; Valtancoli, B. *Inorg. Chem.* **1999**, *38*, 4115–4122.
73. Kazankov, G. M.; Sergeeva, V. S.; Efremenko, E. N.; Alexandrova, L.; Varfolomeev, S. D.; Ryabov, A. D. *Angew. Chem. Int. Ed.* **2000**, *39*, 3117–3119.
74. Davies, J. A.; Hockensmith, C. M.; Kukushkin, V. Yu.; Kukushkin, Yu. N. *Synthetic Coordination Chemistry: Principles and Practice*; World Scientific: Singapore, 1996.
75. Chatt, J.; Kan, C. T.; Leigh, G. J.; Pickett, C. J.; Stanley, D. R. *Dalton Trans.* **1980**, 2032–2038.
76. Lever, A. B. P.; Dodsworth, E. S. In *Inorganic Electronic Structure and Spectroscopy*, Solomon, E. I.; Lever, A. B. P. Eds., Vol. 2, Wiley, New York, 1999, 227–289.
77. Lever, A. B. P. *Inorg. Chem.* **1990**, *29*, 1271–1285.
78. Lever, A. B. P. *Inorg. Chem.* **1991**, *30*, 1980–1985.
79. Masui, H.; Lever, A. B. P. *Inorg. Chem.* **1993**, *32*, 2199–2201.
80. Lever, A. B. P. In *Molecular Electrochemistry of Inorganic, Bioinorganic and Organometallic Complexes*, Pombeiro, A. J. L.; McCleverty, J. Eds., Kluwer, Dordrecht, The Netherlands, 1993, 41–55.
81. Pombeiro, A. J. L. *New J. Chem.* **1997**, *21*, 649–660.
82. Zhang, L.; Guedes da Silva, M. F. C.; Kuznetsov, M. L.; Gamasa, M. P.; Gimeno, J.; Fraústo da Silva, J. J. R.; Pombeiro, A. J. L. *Organometallics* **2001**, *20*, 2782–2793.
83. Guedes da Silva, M. F. C.; Trzeciak, A. M.; Ziółkowski, J. J.; Pombeiro, A. J. L. *J. Organometal. Chem.* **2001**, *620*, 174–181.
84. Zhang, L.; Gamasa, M. P.; Gimeno, J.; Guedes da Silva, M. F. C.; Pombeiro, A. J. L.; Graiff, C.; Lanfranchi, M.; Tiripicchio, A. *Eur. J. Inorg. Chem.*, **2000**, 1707–1715.
85. Zhang, L.; Gamasa, M. P.; Gimeno, J.; Carbajo, R. J.; López-Ortiz, F.; Guedes da Silva, M. F. C.; Pombeiro, A. J. L. *Eur. J. Inorg. Chem.*, **2000**, 341–350.
86. Pombeiro, A. J. L.; Costa, M. T. A. R. S.; Wang, Y.; Nixon, J. F. *J. Chem. Soc., Dalton Trans.* **1999**, 3755–3758.
87. Almeida, S. S. P. R.; Guedes da Silva, M. F. C.; Fraústo da Silva, J. J. R.; Pombeiro, A. J. L. *J. Chem. Soc., Dalton Trans.* **1999**, 467–472.
88. Meidine, M. F.; Lemos, M. A. N. D. A.; Pombeiro, A. J. L.; Nixon, J. F.; Hitchcock, P. B. *J. Chem. Soc., Dalton Trans.* **1998**, 3319–3323.
89. Almeida, S. S. P. R.; Pombeiro, A. J. L. *Organometallics* **1997**, *16*, 4469–4478.
90. Guedes da Silva, M. F. C.; Fraústo da Silva, J. J. R.; Pombeiro, A. J. L.; Pellinghelli, M. A.; Tiripicchio, A. *J. Chem. Soc., Dalton Trans.* **1996**, 2763–2772.
91. Kaden, L.; Pombeiro, A. J. L.; Wang, Y.; Abram, U. *Inorg. Chim. Acta* **1995**, *230*, 189–192.
92. Guedes da Silva, M. F. C.; Fraústo da Silva, J. J. R.; Pombeiro, A. J. L. *J. Chem. Soc., Dalton Trans.* **1994**, 3299–3304.
93. Ribeiro, M. T. A.; Pombeiro, A. J. L.; Facchin, G.; Mozzon, M.; Michelin, R. A. In *Molecular Electrochemistry of Inorganic, Bioinorganic and Organometallic Compounds*, Pombeiro, A. J. L.; McCleverty, J., Eds., NATO ASI Series, Kluwer, Dordrecht, The Netherlands, 1993, 57–62.
94. Facchin, G.; Mozzon, M.; Michelin, R. A.; Ribeiro, M. T. A.; Pombeiro, A. J. L. *J. Chem. Soc., Dalton Trans.* **1992**, 2827–2835.
95. Carvalho, M. F. N. N.; Pombeiro, A. J. L. *J. Organomet. Chem.* **1991**, *410*, 347–355.
96. Carvalho, M. F. N. N.; Pombeiro, A. J. L. *J. Chem. Soc., Dalton Trans.* **1989**, 1209–1216.
97. Lemos, M. A. N. D. A.; Pombeiro, A. J. L. *J. Organomet. Chem.* **1988**, *356*, C79–C82.
98. El-Shihi, T.; Sigmüller, F.; Herrmann, R.; Carvalho, M. F. N. N.; Pombeiro, A. J. L. *J. Organomet. Chem.* **1987**, *335*, 239–247.
99. Guedes da Silva, M. F. C.; Martins, L. M. D. R. S.; Fraústo da Silva, J. J. R.; Pombeiro, A. J. L. *Collect. Czech. Chem. Commun.* **2001**, *66*, 139–154.
100. Guedes da Silva, M. F. C.; Trzeciak, A. M.; Ziółkowski, J. J.; Pombeiro, A. J. L. *J. Organometal. Chem.* **2001**, *620*, 174–181.
101. Martins, L. M. D. R. S.; Duarte, M. T.; Galvão, A. M.; Resende, C.; Pombeiro, A. J. L.; Henderson, R. A.; Evans, D. J. *J. Chem. Soc., Dalton Trans.* **1998**, 3311–3317.

102. Martins, L. M. D. R. S.; Fraústo da Silva, J. J. R.; Pombeiro, A. J. L.; Henderson, R. A.; Evans, D. J.; Benetollo, F.; Bombieri, G.; Michelin, R. A. *Inorg. Chim. Acta* **1999**, *291*, 39–48.
103. Evans, D. J.; Jimenez-Tenorio, M.; Leigh, G. J. *J. Chem. Soc., Dalton Trans.* **1991**, 1785–1787.
104. Silver, J. *Inorg. Chim. Acta* **1991**, *184*, 234–242.
105. Barclay, J. E.; Leigh, G. J.; Houlton, A.; Silver, J. *J. Chem. Soc., Dalton Trans.* **1988**, 2865–2870.
106. Guedes da Silva, M. F. C.; Fraústo da Silva, J. J. R.; Pombeiro, A. J. L. *Inorg. Chem.* **2002**, *41*, 219–228.
107. Kuznetsov, M. L.; Pombeiro, A. J. L. unpublished studies.
108. Enemark, J. H.; Feltham, R. D. *Inorg. Chem.* **1975**, *14*, 624–632.
109. Bezerra, C. W. B.; da Silva, S. C.; Gambardella, M. T. P.; Santos, R. H. A.; Plicas, L. M. A.; Tfouni, E.; Franco, D. W. *Inorg. Chem.* **1999**, *38*, 5660–5667 and references therein.
110. Miessler, G. L.; Tarr, D. A. *Inorganic Chemistry*, 2nd Edition; Prentice Hall: New Jersey, 1998, p 165.
111. Slep, L. D.; Pollak, S.; Olabe, J. A. *Inorg. Chem.* **1999**, *38*, 4369–4371 and references therein.
112. Taube, H. *Pure Appl. Chem.* **1979**, *51*, 901–912.
113. Almeida, S. S. P. R.; Guedes da Silva, M. F. C.; Fraústo da Silva, J. J. R.; Pombeiro, A. J. L. *J. Chem. Soc., Dalton Trans.* **1999**, 467–472.
114. Lemos, M. A. N. D. A.; Guedes da Silva, M. F. C.; Pombeiro, A. J. L. *Inorg. Chim. Acta* **1994**, *226*, 9–16.
115. Zlota, A. A.; Tilset, M.; Caulton, K. G. *Inorg. Chem.* **1993**, *32*, 3816–3821.
116. Ryan, O. B.; Tilset, M. *J. Am. Chem. Soc.* **1991**, *113*, 9554–9561.
117. Marken, F.; Bond, A. M.; Colton, R. *Inorg. Chem.* **1995**, *34*, 1705–1710.
118. For review see: Von Zelewsky, A.; Balsler, B. *Chimia* **1998**, *52*, 620–628.
119. Goh, L. Y.; Tay, M. S.; Lim, Y. Y.; Chen, W.; Zhou, Z.-Y.; Mak, T. C. W. *J. Organomet. Chem.* **1992**, *441*, 51–61.
120. Brand, U.; Rombach, M.; Seebacher, J.; Vahrenkamp, H. *Inorg. Chem.* **2001**, *40*, 6151–6157.
121. Warthen, C. R.; Hammes, B. S.; Carrano, C. J.; Crans, D. C. *J. Biol. Inorg. Chem.* **2001**, *6*, 82–90.
122. Hammes, B. S.; Carrano, C. J. *Inorg. Chem.* **2001**, *40*, 919–927.
123. Roehm, P. C.; Berg, J. M. *J. Am. Chem. Soc.* **1998**, *120*, 13083–13087.
124. Kim, J. S.; Reibenspies, J. H.; Darensbourg, M. Y. *J. Am. Chem. Soc.* **1996**, *118*, 4115–4123.
125. Kim, J. S.; Reibenspies, J. H.; Darensbourg, M. Y. *Inorg. Chim. Acta* **1996**, *250*, 283–294.
126. Hou, D.-R.; Lin, T.-C.; Hsieh, T.-Y.; Cheng, M.-C.; Peng, S.-M.; Liu, S.-T. *Phosphorus, Sulfur Silicon Relat. Elem.* **1996**, *108*, 61–73.
127. Lin, C.-H.; Huang, S.-T. *Synth. React. Inorg. Met.-Org. Chem.* **1996**, *26*, 357–383.
128. Pal, S.; Poddar, Sailendra N.; Mukherjee, G. *Transition Met. Chem.* **1994**, *19*, 449–452.
129. Cha, M.; Shoner, S. C.; Kovacs, J. A. *Inorg. Chem.* **1993**, *32*, 1860–1863.
130. McGuire, D. G.; Khan, M. A.; Ashby, M. T. *Inorg. Chem.* **2002**, *41*, 2202–2208.
131. Schollhammer, P.; Pétillon, F. Y.; Pichon, R.; Poder-Guillou, S.; Talarmin, J.; Muir, K. W.; Manojlovic-Muir, L. *Organometallics* **1995**, *14*, 2277–2287.
132. Abasq, M.-L.; Pétillon, F.; Schollhammer, P.; Talarmin, J. *New J. Chem.* **1996**, *20*, 1221–1233.
133. Kuwata, S.; Hidai, M. *Coord. Chem. Rev.* **2001**, *213*, 211–305.
134. Yin, X.; Moss, J. R. *Coord. Chem. Rev.* **1999**, *181*, 27–59.
135. Kukushkin, V. Yu.; Belsky, V. K.; Aleksandrova, E. A.; Konovalov, V. E.; Kirakosyan, G. A. *Inorg. Chem.* **1992**, *31*, 3836–3840.
136. Kukushkin, V. Yu.; Tudela, D.; Izotova, Yu. A.; Belsky, V. K.; Stash, A. I. *Inorg. Chem.* **1996**, *35*, 4926–4931.
137. Wayland, B. B.; Sherry, A. E.; Coffin, V. L. *Adv. Chem. Ser.* **1992**, *230*, 249–259.
138. Vrtis, R. N.; Lippard, S. J. *Isr. J. Chem.* **1990**, *30*, 331–341.
139. Dang, Y.; Geise, H. J. *J. Organomet. Chem.* **1991**, *405*, 1–9.
140. O'Donoghue, M. B.; Davis, W. M.; Schrock, R. R. *Inorg. Chem.* **1998**, *37*, 5149–5158.
141. O'Donoghue, M. B.; Zanetti, N. C.; Davis, W. M.; Schrock, R. R. *J. Am. Chem. Soc.* **1997**, *119*, 2753–2754.
142. Kol, M.; Schrock, R. R.; Kempe, R.; Davis, W. M. *J. Am. Chem. Soc.* **1994**, *116*, 4382–4390.
143. Odom, A. L.; Arnold, P. L.; Cummins, C. C. *J. Am. Chem. Soc.* **1998**, *120*, 5836–5837.
144. Ferguson, R.; Solari, E.; Floriani, C.; Osella, D.; Ravera, M.; Re, N.; Chiesi-Villa, A.; Rizzoli, C. *J. Am. Chem. Soc.* **1997**, *119*, 10104–10115.
145. Fryzuk, M. D.; Haddad, T. S.; Mylvaganam, M.; McConville, D. H.; Rettig, S. J. *J. Am. Chem. Soc.* **1993**, *115*, 2782–2792.
146. O'Regan, M. B.; Liu, A. H.; Finch, W. C.; Schrock, R. R.; Davis, W. M. *J. Am. Chem. Soc.* **1990**, *112*, 4331–4338.
147. Caselli, A.; Solari, E.; Scopelliti, R.; Floriani, C.; Re, N.; Rizolli, C.; Chiesi-Villa, A. *J. Am. Chem. Soc.* **2000**, *122*, 3652–3670.
148. Mindiola, D. J.; Meyer, K.; Cherry, J.-P.; Baker, T. A.; Cummins, C. C. *Organometallics* **2000**, *19*, 1622–1624.
149. Laplaza, C. E.; Johnson, M. J. A.; Peters, J. C.; Odom, A. L.; Kim, E.; Cummins, C. C.; George, G. N.; Pickering, I. J. *J. Am. Chem. Soc.* **1996**, *118*, 8623–8638.
150. Laplaza, C. E.; Cummins, C. C. *Science* **1995**, *268*, 861–863.
151. Clentsmith, G. K. B.; Bates, V. M. E.; Hitchcock, P. B.; Cloke, F. G. N. *J. Am. Chem. Soc.* **1999**, *121*, 10444–10445.
152. Kukushkin, V. Yu. *Coord. Chem. Rev.* **1995**, *139*, 375–407.
153. Kubas, G. J. *Metal Dihydrogen and Sigma-Bond Complexes*; Kluwer: The Netherlands, 2001.
154. Jessop, P. G.; Morris, R. H. *Coord. Chem. Rev.* **1992**, *121*, 155–284.
155. Tomas, J.; Lledos, A.; Jean, Y. *Organometallics* **1998**, *17*, 4932–4939.
156. Green, M. *Mech. Inorg. Organomet. React.* **1986**, *4*, 323–358 and 501–505.
157. Chisholm, M. H. *Polyhedron* **1986**, *5*, 25–30.
158. Crabtree, R. H. *The Organometallic Chemistry of the Transition Metals*, 3rd Ed., Wiley, New York, 2001, 161–167.
159. Gerbelet, N. V.; Arion, V. B.; Burgess, J. *Template synthesis of macrocyclic compounds*, Wiley-VCH, Weinheim, 1999, 565 pp.
160. Voloshin, Y. Z.; Kostromina, N. A.; Krämer, R. *Clathrochelates: Synthesis, Structure and Properties* 2002, Elsevier, 2002.
161. McKeown, N. B. *Phthalocyanine Materials: Structure, Synthesis and Function*, Cambridge University Press, Cambridge, 1998, 200 pp.

162. Kukushkin, Yu. N. *Zh. Obshch. Khim.* **1987**, *57*, 1921–1939.
163. Sano, M. *Structure and Bonding (Berlin, Germany)* **2001**, *99*, 117–139.
164. Toma, H. E.; Rocha, R. C. *Croatica Chemica Acta* **2001**, *74*, 499–528.
165. Dash, A. C. *J. Indian Chem. Soc.* **2000**, *77*, 583–592.
166. Garnovskii, A. D.; Garnovskii, D. A.; Vasilchenko, I. S.; Burlov, A. S.; Sadimenko, A. P.; Sadekov, I. D. *Russ. Chem. Rev.* **1997**, *66*, 389–415.
167. Burmeister, L. *Coord. Chem. Rev.* **1990**, *105*, 65–133.
168. Kawaguchi, S. *Coord. Chem. Rev.* **1986**, *70*, 51–84.
169. Olekhnovich, L. P.; Lyubchenko, S. N.; Shcherbakov, I. N.; Kurbatov, S. V.; Kogan, V. A. *Russ. Chem. Zhurn.* **1996**, *40*, 139–147.
170. Al-Diabi, S. S.; Al-Najjar, I. M. *Asian J. Chem.* **1991**, *3*, 78–91.
171. Al-Shalaan, A. M.; Al-Showiman, S. S.; Al-Najjar, I. M. *Inorg. Chim. Acta* **1986**, *121*, 127–129.
172. Olekhnovich, R. Ya.; Korobov, M. S.; Lyubchenko, S. N.; Sukhollenko, E. V.; Ryskina, T. A.; Nivorozhkin, L. E.; Olekhnovich, L. P.; Minkin, V. I. *Zh. Obshch. Khim.* **1992**, *62*, 901–910.
173. Lyubchenko, S. N.; Litvinov, V. V.; Ryskina, T. A.; Ivakhnenko, E. P.; Kogan, V. A.; Olekhnovich, L. P. *Zh. Obshch. Khim.* **1990**, *60*, 1618–1626.
174. Bokach, N. A.; Kuznetsov, M. L.; Garnovskii, D. A.; Natile, G.; Kukushkin, V. Yu.; Pombeiro, A. J. L. *Inorg. Chem.* **2002**, *41*, 2041–2053.
175. Lessmann, F.; Beyer, L.; Richter, R.; Meusinger, R. *Z. Naturforschung, B: Chem. Sci.* **1998**, *53*, 981–990.
176. Koch, K. R.; Sacht, C.; Grimmacher, T.; Bourne, S. S. *Afr. J. Chem.* **1995**, *48*, 71–77.
177. Sigl, M.; Schier, A.; Schmidbaur, H. *Z. Naturforsch., B: Chem. Sci.* **1998**, *53*, 1301–1306.
178. Seyferth, D.; Wood, T. G.; Henderson, R. S. *J. Organomet. Chem.* **1987**, *336*, 163–182.
179. Darchen, A.; El Lhadi, K.; Patin, H. *New J. Chem.* **1988**, *12*, 377–385.
180. Vicente, J.; Chicote, M. T.; Guerrero, R.; Saura-Llamas, I. M.; Jones, P. G.; Ramirez de Arellano, M. C. *Chem. Eur. J.* **2001**, *7*, 638–646.
181. Vicente, J.; Chicote, M.-T.; Abrisqueta, M.-D.; Guerrero, R.; Jones, P. G. *Angew. Chem., Int. Ed. Engl.* **1997**, *36*, 1203–1205.
182. Vicente, J.; Chicote, M. T.; Guerrero, R.; Ramirez de Arellano, M. C. *Chem. Commun.* **1999**, 1541.
183. Metcalfe, R. A.; Lever, A. B. P. *Inorg. Chem.* **1997**, *36*, 4762.
184. Kukushkin, V. Yu.; Ilichev, I. V.; Zhdanova, M. A.; Wagner, G.; Pombeiro, A. J. L. *J. Chem. Soc., Dalton Trans.* **2000**, 1567–1572.
185. Minkin, V. I.; Garnovskii, A. D.; Elguero, J.; Katritzky, A. R.; Denisko, O. V. *Adv. Heterocyclic Chem.* **2000**, *76*, 157–323.
186. Garnovskii, A. D.; Sadimenko, A. P.; Sadimenko, M. I.; Garnovskii, D. A. *Coord. Chem. Rev.* **1998**, *173*, 31–77.
187. Raper, E. S. *Coord. Chem. Rev.* **1997**, *165*, 475–567.
188. Raper, E. S. *Coord. Chem. Rev.* **1996**, *153*, 199–256.
189. Raper, E. S. *Coord. Chem. Rev.* **1994**, *129*, 91–156.
190. Bokach, N. A.; Selivanov, S. I.; Kukushkin, V. Yu.; Haukka, M.; Guedes da Silva, M. F. C.; Pombeiro, A. J. L. *Eur. J. Inorg. Chem.* **2001**, 2805–2809.
191. Luzyanin, K. V.; Haukka, M.; Bokach, N. A.; Kuznetsov, M. L.; Kukushkin, V. Yu.; Pombeiro, A. J. L. *J. Chem. Soc., Dalton Trans.* **2002**, 1882–1887.
192. Kukushkin, Yu. N.; Krylov, V. K.; Kaplan, S. F.; Calligaris, M.; Zangrando, E.; Pombeiro, A. J. L.; Kukushkin, V. Yu. *Inorg. Chim. Acta* **1999**, *285*, 116–121.
193. Kaplan, S. F.; Kukushkin, V. Yu.; Shova, S.; Suwinska, K.; Wagner, G.; Pombeiro, A. J. L. *Eur. J. Inorg. Chem.* **2001**, 1031–1038.
194. Kaplan, S. F.; Kukushkin, V. Yu.; Pombeiro, A. J. L. *J. Chem. Soc., Dalton Trans.* **2001**, 3279–3284.
195. Sellmann, D.; Frank, P.; Knoch, F. *J. Organomet. Chem.* **1988**, *339*, 345–356.

# 1.30

## Reactivity and Structure of Complexes of Small Molecules: Carbon Dioxide

D. H. GIBSON

*University of Louisville, KY, USA*

---

1.30.1	INTRODUCTION	595
1.30.2	CARBON DIOXIDE AS A LIGAND	595
1.30.2.1	Bonding and Structural Types	595
1.30.2.2	Synthesis	597
1.30.2.3	Infrared Spectral Characteristics	597
1.30.3	CHARACTERISTIC REACTIONS	598
1.30.3.1	Decarboxylation	598
1.30.3.2	Oxygen Transfer	598
1.30.3.3	Reactions with Electrophiles	598
1.30.4	INSERTION OF CO <sub>2</sub> IN METAL-X BONDS (X = C, H, O, N, Si, P, METAL)	599
1.30.5	OXIDATIVE COUPLING	599
1.30.6	CATALYTIC REDUCTION OF CO <sub>2</sub>	600
1.30.7	SUMMARY AND FUTURE DIRECTIONS	601
1.30.8	REFERENCES	601

---

### 1.30.1 INTRODUCTION

The possibility of using CO<sub>2</sub> for the synthesis of fine chemicals that are now derived from petroleum has prompted efforts to obtain a broader understanding of the coordination chemistry of CO<sub>2</sub> during the past 20 years.<sup>1-21</sup> Carbon dioxide utilization will inevitably center on metal complexes and their ability to bind CO<sub>2</sub>. In the past decade, many CO<sub>2</sub>-metal complexes have been prepared and the ligand has demonstrated a remarkable variety of coordination modes in its complexes. The sections below outline the synthesis, characterization by X-ray crystallography and IR spectroscopy, and some characteristic reactions of these compounds. Also discussed are CO<sub>2</sub> insertion reactions into M-X bonds and oxidative coupling reactions between CO<sub>2</sub> and unsaturated substrates which occur at some metal centers. Finally, a profile of the research on catalytic reductions of CO<sub>2</sub> is provided. Where possible, references are made to reviews rather than to the primary literature.

### 1.30.2 CARBON DIOXIDE AS A LIGAND

#### 1.30.2.1 Bonding and Structural Types

Theoretical calculations have focused on four basic modes of CO<sub>2</sub> coordination: (i)  $\eta^1$ -C, (ii)  $\eta^2$ -C, O (side-on), (iii)  $\eta^1$ -O (end-on) and (iv)  $\eta^2$ -O,O'. A review of the results of calculations on the organometallic complexes (modes (i) and (ii)) appeared in 1992.<sup>22</sup>

As a heterocumulene, CO<sub>2</sub> has two sets of orthogonal  $\pi$  molecular orbitals. For  $\eta^1$ - and  $\eta^2$ -bonding involving carbon and a metal, these are in two sets: (i) the  $\pi$ ,  $n\pi$ , and  $\pi^*$  MOs which lie in the plane of the metal and CO<sub>2</sub> (parallel) and (ii) an equivalent set which is in a plane perpendicular to the first set (perpendicular). The “parallel” MOs are most important in bonding to transition metals. For the  $\eta^1$ -C mode there is a strong charge transfer interaction between a  $d_{z^2}$  metal orbital and the  $\pi^*$ -orbital of CO<sub>2</sub>. Bonding in the  $\eta^2$  mode has been compared to that in olefin-metal complexes:  $\sigma$ -bonding involving the  $\pi$ -orbital of CO<sub>2</sub> and an empty  $d_{z^2}$  metal orbital together with  $\pi$ -bonding involving a filled  $d_{xz}$  metal orbital and the empty  $\pi^*$ -orbital of CO<sub>2</sub>.

Efforts have been made to determine what circumstances might lead to stabilization of  $\eta^1$ -O or  $\eta^2$ -O,O' carbon dioxide coordination.<sup>23</sup> SCF calculations showed that complexes with linear CO<sub>2</sub> ligands are destabilized. If the CO<sub>2</sub> ligand in Ni(NH<sub>3</sub>)<sub>2</sub>(CO<sub>2</sub>) was allowed to bend, the  $\eta^1$ -O form was only slightly above the  $\eta^2$ -C,O form in energy. For Cu(CO<sub>2</sub>), the end-on and side-on modes were nearly degenerate in energy. For more oxophilic metals, the  $\eta^2$ -O,O' mode can be stabilized. Calculations on the bonding of CO<sub>2</sub> to scandium showed that the  $\eta^2$ -C,O mode and the  $\eta^2$ -O,O' mode were nearly degenerate in energy.

Structural data for metal-CO<sub>2</sub> complexes have been summarized recently;<sup>17</sup> the types which have been characterized are shown in Figure 1. The only structurally characterized  $\eta^1$ -C complex is a rhodium complex reported by Herskovitz *et al.*<sup>17</sup> X-ray structural analysis showed a Rh-C(1) bond distance of 2.05(2) Å and C-O bond distances of 1.20(2) and 1.25(2) Å; the O-C-O angle was 126(2)°. The first  $\eta^2$  compound, Ni(CO<sub>2</sub>) [(Cy)<sub>3</sub>P]<sub>2</sub>, had almost planar coordination about Ni; the CO<sub>2</sub> ligand had unequal C-O bond lengths, 1.17 Å and 1.22 Å, and a large O-C-O angle of 133°. The iron complex, Fe(CO<sub>2</sub>)(depe)<sub>2</sub>, has trigonal bipyramidal geometry about Fe with an equatorial CO<sub>2</sub> ligand. Uniquely among  $\eta^2$ -CO<sub>2</sub> complexes, it showed long C-O bonds, 1.25(3) Å and 1.28(2) Å, and a small O-C-O angle of 124(2)°.

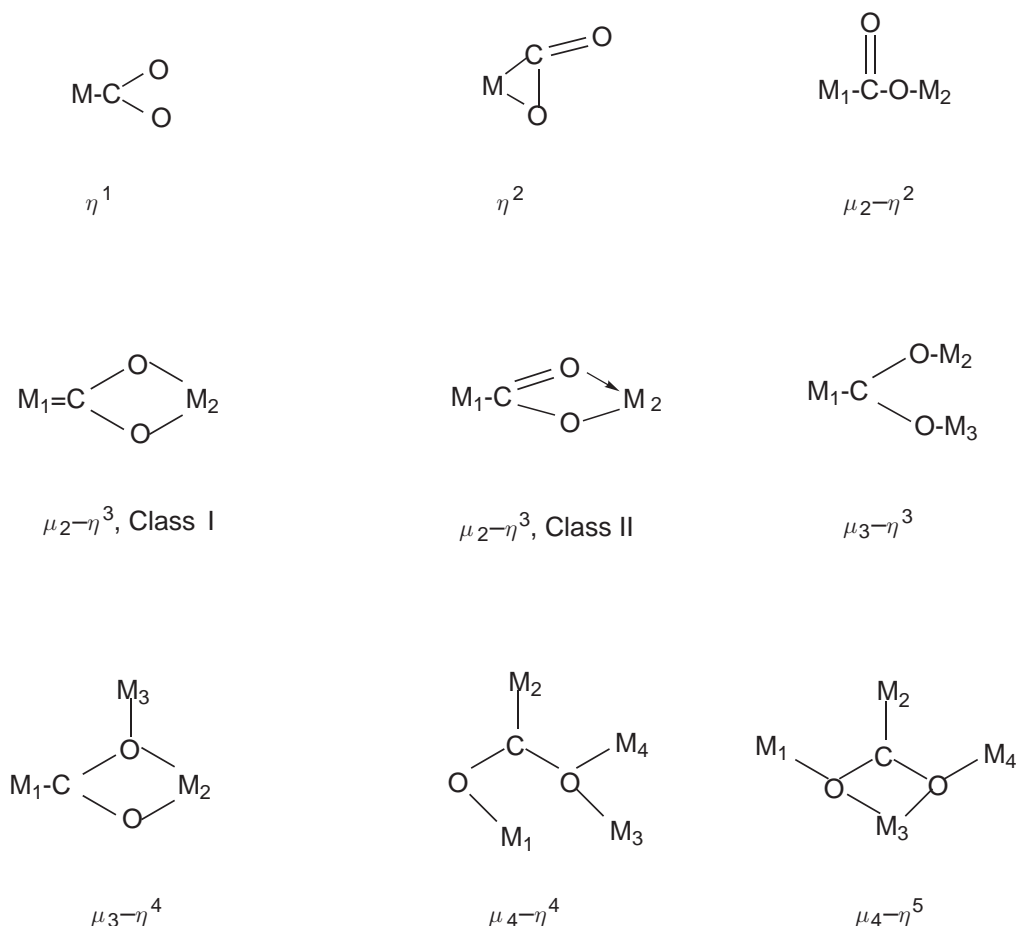


Figure 1 Structural types of metal-CO<sub>2</sub> complexes.

The  $\mu_2-\eta^2$  complexes have the carboxyl carbon bound to one metal and one oxygen bound to a second metal. The first compounds of this type were Ir–Os metallacycles reported by Collins, *et al.* More recently, a related complex with CO<sub>2</sub> bridged between Ir and Zr was described and the polymeric complex, [Co<sup>III</sup>(en)<sub>2</sub>(CO<sub>2</sub>)(ClO<sub>4</sub>)–H<sub>2</sub>O]<sub>n</sub>, was reported. At about the same time, CpFe(CO)(PPh<sub>3</sub>)(CO<sub>2</sub>)Re(CO)<sub>4</sub>(PPh<sub>3</sub>) was reported and showed unequal carboxyl C–O bond lengths, 1.226(3) Å and 1.298(3) Å, and an O–C–O angle of 121.9(3)°. There are two distinct types of compounds with the general formula M<sub>1</sub>μ<sub>2</sub>–η<sup>3</sup>(CO<sub>2</sub>)M<sub>2</sub>. The Class I compounds have nearly equal O–M<sub>2</sub> bond lengths; those in Class II have unequal O–M<sub>2</sub> bond lengths. Also, the O–C–O bond angles of Class II compounds are usually larger. Most compounds in Class I have the CO<sub>2</sub> ligand bridged between two transition metals; O–C–O bond angles are in the range 106–114°. So far, compounds in Class II are ones in which the carboxylate oxygens are bound, unequally, to a tin atom.

The first  $\mu_3-\eta^3$  type to be structurally characterized was an osmium cluster anion. Caulton *et al.*<sup>17</sup> reported a rhodium/osmium complex which has the carboxylate carbon bound to osmium and each oxygen bound to different rhodium centers. Cutler *et al.*<sup>24</sup> characterized additional complexes of this type. Few examples exist of the other two structural types.

### 1.30.2.2 Synthesis

Discussion is limited to compounds which can be studied by IR and NMR spectral techniques to confirm a metal-bound CO<sub>2</sub> ligand.<sup>15,17,19</sup> The  $\eta^1$  and  $\eta^2$  complexes are prepared by direct reactions of metal complexes with CO<sub>2</sub>. Metal centers which have a coordination vacancy (or a labile ligand) and are nucleophilic through the metal, due to charge or the presence of electron-donating ligands, can bind the weakly electrophilic CO<sub>2</sub> molecule through carbon. The  $\eta^1$ –CO<sub>2</sub> complexes are not robust; their isolation often requires low temperature and pressurization with CO<sub>2</sub>. The  $\eta^2$  complex Ni(CO<sub>2</sub>)(PCy<sub>3</sub>)<sub>2</sub> was made by reaction of [Ni(PCy<sub>3</sub>)<sub>3</sub>]N<sub>2</sub> or Ni(PCy<sub>3</sub>)<sub>3</sub>. Reaction of Fe(PMe<sub>3</sub>)<sub>4</sub> with CO<sub>2</sub> gave an  $\eta^2$  complex; the related complex Fe(CO<sub>2</sub>)(depe)<sub>2</sub> was fully characterized. Both direct CO<sub>2</sub> addition and other strategies have been developed for compounds with bridging CO<sub>2</sub> ligands.

Mascetti and Tranquille<sup>25</sup> prepared CO<sub>2</sub> adducts by low-temperature matrix isolation techniques. Recently, matrix isolation studies of Ni atoms with CO<sub>2</sub> were done; the  $\eta^2$ –C,O mode was preferred in CO<sub>2</sub> matrices. These results, and studies of isotopically labeled species, suggest that Ni(N<sub>2</sub>)(CO<sub>2</sub>) and Ni(N<sub>2</sub>)<sub>2</sub>(CO<sub>2</sub>) were formed.<sup>26</sup>

Compounds having CO<sub>2</sub> bound to a metal center through oxygen only have not yet been structurally characterized, but isotopic labeling studies support their existence. Margrave *et al.*<sup>17</sup> studied the reactions of Li atoms with CO<sub>2</sub> in Ar matrices and obtained IR spectra of two LiCO<sub>2</sub> species. At high metal concentration, Li<sub>2</sub>CO<sub>2</sub> was observed. Reactions with Na, K, and Cs and CO<sub>2</sub> in argon, nitrogen and neat matrices gave M<sup>+</sup> CO<sub>2</sub><sup>–</sup> species with C<sub>2v</sub> symmetry. At high metal concentrations, only K and Cs formed M<sub>2</sub>CO<sub>2</sub> species; forms with C<sub>2v</sub> symmetry and C<sub>s</sub> symmetry were found. Manceron *et al.* deposited Al and CO<sub>2</sub> in argon matrices; the adduct converted, reversibly, between two isomers having C<sub>s</sub> and C<sub>2v</sub> symmetries.<sup>17</sup>

### 1.30.2.3 Infrared Spectral Characteristics

In the transition metal complexes which have been structurally characterized, the CO<sub>2</sub> ligands are bent with internal O–C–O angles varying from 101° to 136°.<sup>17</sup> Thus, the vibrational bands for coordinated CO<sub>2</sub> do not resemble those of the linear molecule ( $\nu_{\text{asym}}$  2349,  $\nu_{\text{sym}}$  1388 or 1285 (one due to Fermi resonance; both IR inactive) and  $\delta$  667 cm<sup>–1</sup>), but may be more closely related to metal-bound CO<sub>2</sub><sup>–</sup> or to free radical anion. IR spectral bands for the radical anion are calculated at 1,677 cm<sup>–1</sup>, 1,405 (stretching) cm<sup>–1</sup>, and 607 (bending) cm<sup>–1</sup>.

C–O stretching vibrations for several types of metal–CO<sub>2</sub> complexes are shown in Table 1. In each, the higher frequency band is assigned to  $\nu_{\text{asym}}$  and the lower one is assigned to  $\nu_{\text{sym}}$ . The few  $\eta^1$ -types show  $\nu_{\text{asym}}$  near 1,600 cm<sup>–1</sup> and  $\nu_{\text{sym}}$  near 1,200 cm<sup>–1</sup>. The  $\eta^2$  complexes exhibit much higher  $\nu_{\text{asym}}$  positions and the  $\nu_{\text{sym}}$  band position is lower. The  $\Delta\nu$  is large for  $\mu_2-\eta^2$  complexes, typically 300–400 cm<sup>–1</sup> for the acyclic compounds and can be larger for metallacycles. The magnitude of  $\Delta\nu$  and the band positions will distinguish these from the other types of bimetallic complexes. The  $\nu_{\text{asym}}$  band position for the symmetrical  $\mu_2-\eta^3$  complexes varies with



**Table 1** IR  $\nu_{\text{OCO}}$  bands ( $\text{cm}^{-1}$ ) for several types of  $\text{CO}_2$  complexes.<sup>17</sup>

Compound	Type	$\nu_{\text{asym}}$	$\nu_{\text{sym}}$
Rh(diars) <sub>2</sub> (Cl)(CO <sub>2</sub> )	$h^1$	1610	1210
Ni(PCy <sub>3</sub> ) <sub>2</sub> (CO <sub>2</sub> )	$h^2$	1740	1140,1094
[Pt(PEt <sub>3</sub> ) <sub>2</sub> (Ph)] <sub>2</sub> (CO <sub>2</sub> )	$\mu_2-h^2$	1495	1290,1190
CpFe(CO)(PPh <sub>3</sub> )(CO <sub>2</sub> )Re(CO) <sub>4</sub> (PPh <sub>3</sub> )		1505	1135
Cp*Ir( $\mu$ -t-BuN)( $\mu$ -CO <sub>2</sub> )ZrCp <sub>2</sub>		1569	1015
Cp*Re(CO)(NO)(CO <sub>2</sub> )Re(CO) <sub>3</sub> (PPh <sub>3</sub> )	$\mu_2-h^3$ , Class I	1437	1282
CpRu(CO) <sub>2</sub> (CO <sub>2</sub> )Zr(Cl)Cp <sub>2</sub>		1348	1290
Cp*Re(CO)(NO)(CO <sub>2</sub> )Mo(CO) <sub>2</sub> Cp		1319	1285
CpRe(NO)(PPh <sub>3</sub> )(CO <sub>2</sub> )SnPh <sub>3</sub>	$\mu_2-h^3$ , Class II	1395	1188
Cp*Fe(CO) <sub>2</sub> (CO <sub>2</sub> )SnPh <sub>3</sub>		1450	1152

the coordination geometry at the metal center binding the two carboxyl oxygens; also, the properties of the two classes of  $\mu_2-\eta^3$  compounds are distinct. There are not yet enough examples of the other types of compounds to identify them by IR data alone.

### 1.30.3 CHARACTERISTIC REACTIONS

#### 1.30.3.1 Decarboxylation

Some  $\eta^1$  and  $\eta^2$  complexes bind  $\text{CO}_2$  reversibly.<sup>17,19</sup> With metallocarboxylate anion complexes, the stability is related to that of the metal anion; if the corresponding anion is stable, dissociative loss of  $\text{CO}_2$  from the metallocarboxylate can be expected. In contrast, salts of  $\text{CpFe(CO)(PPh}_3\text{)}^-$ , cannot be made, but salts of  $\text{CpFe(CO)(PPh}_3\text{)(CO}_2\text{)}^-$  are relatively stable. The nature of the alkali metal exerts some control over the reversibility of  $\text{CO}_2$  binding. Sodium and potassium salts of cobalt(salen)( $\text{CO}_2$ )<sup>-</sup> lost  $\text{CO}_2$  under vacuum, but the lithium salt did not. The  $\eta^1$  complexes reported by Herskovitz *et al.*<sup>17</sup> lost  $\text{CO}_2$  readily; the only ones which could be isolated were those with a low-valent metal bearing good  $\sigma$ -donor/poor  $\pi$ -acceptor ligands. The stability of  $\eta^2$ -coordinated compounds parallels the stability of ethylene-metal complexes. With bimetallic compounds, the ones which lose  $\text{CO}_2$  most readily are the  $\mu_2-\eta^2$  and  $\mu_2-\eta^3$  complexes which have O—M bonds to a main group atom such as tin. If both metals are transition metals, the compounds are stable toward decarboxylation.

#### 1.30.3.2 Oxygen Transfer

Metallocarboxylate anions, in particular, are very effective oxide transfer agents.<sup>17,19</sup> Reaction of  $\text{Li}_2\text{W(CO)}_5\text{(CO}_2\text{)}$  with additional  $\text{CO}_2$  results in formation of  $\text{W(CO)}_6$  and  $\text{Li}_2\text{CO}_3$ , a reaction described as reductive disproportionation. This dianion would transfer oxide to  $\text{CpFe(CO)}_3^+\text{BF}_4^-$ ; labeling studies showed that oxygen, but not carbon, of the  $\text{CO}_2$  ligand was incorporated into the iron product  $[\text{CpFe(CO)}_2]_2$ . Intermediate metalloanhydrides have been proposed to rationalize intramolecular oxide transfer from coordinated  $\text{CO}_2$  to coordinated CO in several systems.

#### 1.30.3.3 Reactions with Electrophiles

Some compounds add electrophiles while others undergo O—M or C—O cleavage reactions.<sup>17,19</sup> Herskovitz *et al.* alkylated the iridium complex  $\text{Ir(dmpe)}_2\text{(Cl)(CO}_2\text{)}$  and characterized the methyl ester. The  $\mu_3-\eta^3$  rhodium/osmium complex studied by Caulton *et al.*<sup>17</sup> binds  $\text{ZnBr}_2$  at the carboxylate oxygens. Nicholas *et al.*<sup>17</sup> showed that both O—M and C—O bond scissions can occur with  $\text{Cp}_2\text{Mo(CO)}_2$  and  $\text{Cp}'_2\text{Nb(CO)}_2\text{CH}_2\text{SiMe}_3$ . The reactions of metallocarboxylate anions with electrophiles are varied. The lithium salt of  $\text{W(CO)}_5\text{(CO}_2\text{)}^-$  gave only  $\text{W(CO)}_6$  from reactions with a variety of electrophiles, but  $\text{CpFe(CO)(PPh}_3\text{)CO}_2^-\text{K}^+$  and  $\text{Cp}^*\text{Fe(CO)(PPh}_3\text{)CO}_2^-\text{K}^+$  were cleaved by O—M bond breaking. Gibson *et al.*<sup>17</sup> reported C—O cleavage of  $\text{CpFe(CO)(PPh}_3\text{)-(CO}_2\text{)Re(CO)}_4\text{(PPh}_3\text{)}$  by  $\text{Me}_3\text{SiOTf}$ .

### 1.30.4 INSERTION OF CO<sub>2</sub> IN METAL-X BONDS (X = C, H, O, N, Si, P, METAL)

Carbon dioxide inserts into M—X (X = H, O, C, N, Si, P, or M) bonds yielding M—O—C(O)X products.<sup>1,2</sup> The opposite type of product, M—C(O)OX, seems possible, but the late transition metal M—X complexes which insert CO<sub>2</sub> have electron-rich M—X bonds with high electron density at X; the product will have new M—O and C—X bonds.<sup>5,19</sup> Some early transition metal compounds and main group compounds also insert CO<sub>2</sub> in the same way. These reactions may not involve initial coordination of CO<sub>2</sub> to the metal center. Calculations on Cu—R (R = H, CH<sub>3</sub>, OH) indicated that insertion into the Cu—CH<sub>3</sub> bond occurs with higher energy than insertion into Cu—H. Insertion into the Cu—OH bond proceeds with no barrier; the oxygen lone pairs can initiate bonding to CO<sub>2</sub> without weakening the Cu—OH bond.<sup>27</sup>

Insertion of CO<sub>2</sub> into M—H bonds results only in metal formate complexes, M—OCHO, not M—COOH.<sup>13,21</sup> M—H insertions have received much attention because they are thought to be intermediate in catalytic hydrogenations.<sup>12,13</sup> Calculations indicate only weak M—O interaction in the transition state leading to formate; a stable CO<sub>2</sub> complex may not precede the formate.<sup>28</sup>

Metal-carbon insertions of CO<sub>2</sub> occur in both main group and transition metal complexes.<sup>5,19</sup> The reactions result in a strong M—O bond at the expense of a weak M—C bond (together with a C—C  $\sigma$  bond at the expense of a C—O  $\pi$  bond). Insertion into *threo*-W(CO)<sub>5</sub>—CHDCHDPh<sup>−</sup> gave the *threo* carboxylate, indicating retention of configuration at the  $\alpha$ -carbon, as with CO insertion.<sup>29</sup> *Cis*-RW(CO)<sub>4</sub>L<sup>−</sup> (R = Me, Et or Ph) showed second-order kinetics toward CO<sub>2</sub> insertion, first order in anion and in CO<sub>2</sub>. Replacement of CO by a phosphine or phosphite increased the insertion rate.<sup>30</sup> Palladium catalysis of CO<sub>2</sub> insertion into unreactive Sn—C bonds in allyl stannanes provided three isomeric tetra-carboxylates from tetraallyl tin. Attempted reactions of tetraalkyl, vinyl or aryl tin complexes did not proceed. Insertion into an intermediate  $\eta^1$ -allyl palladium complex was suggested to lead to carboxylate products.<sup>31,32</sup>

Insertions of CO<sub>2</sub> in M—OH and M—OR (R = alkyl, aryl) yield carbonato complexes and occur with complexes of Zr, V, Ta, Mo, W, lanthanoids and main group metals such as tin.<sup>5,19</sup> The reversible insertion of CO<sub>2</sub> into M—OH bonds is believed to be a key step in the hydration of CO<sub>2</sub> to HCO<sub>3</sub><sup>−</sup> that is catalyzed by the zinc-containing enzyme carbonic anhydrase.<sup>33</sup> Also, M—O insertion is believed to occur in CO<sub>2</sub>/epoxide copolymerization and in the preparation of cyclic carbonates and dimethyl carbonate.<sup>16</sup> A zinc pyrazolyl borate complex binds CO<sub>2</sub> reversibly and catalyzes the exchange of oxygen atoms between CO<sub>2</sub> and H<sub>2</sub><sup>17</sup>O, providing a structural and functional model for carbonic anhydrase.<sup>34</sup> Although two pathways are available for reaction CO<sub>2</sub> with M—OH after initial coordination at oxygen (proton transfer or CO<sub>2</sub> insertion), it has not yet been possible to distinguish between them. However, reaction of W(CO)<sub>5</sub>OH<sup>−</sup> with CS<sub>2</sub> led to W—O bond rupture.<sup>35</sup> Insertion of CO<sub>2</sub> into M—O—M complexes may lead to  $\mu$ - $\eta^1$ ,  $\eta^1$  CO<sub>3</sub>-bridged complexes or to species with the carbonato ligand bound in bidentate fashion to both metal centers.<sup>36,37</sup>

Insertion of CO<sub>2</sub> into early transition metal-nitrogen bonds gives carbamates. Similarly, carbamate complexes of zinc and aluminum have been synthesized. In some high-oxidation-state late transition metal amides, CO<sub>2</sub> does not insert into the M—N bond. A ligand exchange process was suggested because the reactions could be accelerated by the free amines.<sup>38</sup> With L<sub>4</sub>Ru( $\eta^2$ -NHC<sub>6</sub>H<sub>4</sub>) insertion occurs via direct attack on nitrogen followed by rearrangement to the carbamate metallacycle.<sup>39</sup> With excess CO<sub>2</sub>, insertion occurred in M—N and M—P bonds in 1,2-M<sub>2</sub>(NMe<sub>2</sub>)<sub>4</sub> (M = Mo, W); however, there was a kinetic preference for the M—P bonds.<sup>40</sup>

A very few insertion reactions of CO<sub>2</sub> into M—Si bonds have been reported. Reaction of CO<sub>2</sub> with Cp<sub>2</sub>Zr( $\eta^2$ -SiMe<sub>2</sub>=N<sup>t</sup>Bu) gave a metallacycle which decarbonylated at room temperature.<sup>41</sup> Tilley *et al.* have shown that Cp<sub>2</sub>Sc(SiR<sub>3</sub>)(THF) complexes react with CO<sub>2</sub> providing dimeric silane carboxylate complexes [Cp<sub>2</sub>Sc( $\mu$ -O<sub>2</sub>CSiR<sub>3</sub>)<sub>2</sub>].<sup>42</sup>

Cutler *et al.* reported CO<sub>2</sub> insertion into transition metal-transition metal bonds.<sup>43</sup> Thus, Cp(CO)<sub>2</sub>M—Zr(Cl)Cp<sub>2</sub> (M = Fe, Ru) with CO<sub>2</sub> afforded Cp(CO)M(CO<sub>2</sub>)Zr(Cl)Cp<sub>2</sub>. Bergman *et al.* reported CO<sub>2</sub> insertion into Cp<sub>2</sub>Zr( $\mu$ -N<sup>t</sup>Bu)IrCp.<sup>44</sup> Again, the carboxylate oxygen was bound to the early transition metal in the resulting metallacycle.

### 1.30.5 OXIDATIVE COUPLING

Although there are many reports of metal-promoted catalytic reactions involving CO<sub>2</sub> and unsaturated hydrocarbons,<sup>3,5-7,13,14,18</sup> this discussion is limited to reactions which have led to observable complexes incorporating these substrates. Such reactions result in a two-unit increase

in the oxidation number of the metal and are appropriately described as oxidative coupling reactions, usually leading to metallalactones.<sup>3,5,6,19,20</sup>

The reaction of Ni(1,4,9-cyclododecatriene) together with a chelating ligand, ethylene and CO<sub>2</sub> yields a five-membered metallalactone.<sup>45,46</sup> Reaction of Fe(C<sub>2</sub>H<sub>4</sub>)<sub>2</sub>[P(CH<sub>2</sub>CH<sub>3</sub>)<sub>3</sub>]<sub>2</sub> with CO<sub>2</sub> gave a five-membered metallalactone when additional phosphine ligand was added.<sup>6</sup> Reaction of ( $\eta^5$ -C<sub>5</sub>Me<sub>5</sub>)<sub>2</sub>Ti(C<sub>2</sub>H<sub>4</sub>) with CO<sub>2</sub> provided the titanalactone.<sup>47</sup> *Trans*-M(C<sub>2</sub>H<sub>4</sub>)<sub>2</sub>(PMe<sub>3</sub>)<sub>4</sub> (M = Mo, W), reacted with CO<sub>2</sub> to provide complexes with  $\mu_2$ - $\eta^3, \eta^1$ -acrylate ligands.<sup>48</sup>

Conjugated dienes and CO<sub>2</sub> react with Ni(0) complexes to yield nickel allylcarboxylates.<sup>49</sup> (Butadiene)Fe(PMe<sub>3</sub>)<sub>3</sub> reacted with CO<sub>2</sub> to provide an allylcarboxylate metallacycle.<sup>50</sup> The anionic (butadiene)Mn(CO)<sub>3</sub><sup>-</sup> reacted readily with CO<sub>2</sub> to give the anionic allylcarboxylate.<sup>51</sup> Similarly, 1,2-dienes reacted with CO<sub>2</sub> on some Ni(0) complexes.<sup>52</sup>

The alkyne complex, ( $\eta^2$ -C<sub>5</sub>H<sub>5</sub>)( $\eta^5$ -C<sub>5</sub>Me<sub>5</sub>)Ti(diphenylacetylene) reacted with CO<sub>2</sub> to give a five-membered metallacycle.<sup>53</sup> Similarly, nickel complexes reacted with alkynes and CO<sub>2</sub> to yield the same type of metallacycles.<sup>54</sup> The oxidative coupling of CO<sub>2</sub> with imines (Schiff bases) at electron-rich nickel(0) centers leads to cyclic carbamate complexes.<sup>55</sup>

### 1.30.6 CATALYTIC REDUCTION OF CO<sub>2</sub>

In spite of its thermodynamic stability and chemical inertness, efforts to catalytically reduce CO<sub>2</sub> to compounds such as CH<sub>3</sub>OH, C<sub>2</sub>H<sub>5</sub>OH, HCOOH, CH<sub>2</sub>O, CO, C<sub>2</sub>H<sub>4</sub>, etc. have been underway for a number of years. The approaches include homogeneous or heterogeneous hydrogenation, photocatalytic reduction and electrocatalytic reduction. In some cases, the pathways appear to involve coordination of CO<sub>2</sub> to a metal center; in others, CO<sub>2</sub> insertion into a metal-hydrogen bond is suggested. Any such processes require a large input of energy; reductions on a large scale will require renewable energy sources.

Hydrogenation of CO<sub>2</sub> occurs on a number of solid catalysts; with CuO/ZnO/Al<sub>2</sub>O<sub>3</sub>, methanol can be prepared but the equilibrium yields are less than 40%. The use of hybrid catalysts, containing solid acids, improves the yields by partial dehydration of the methanol to dimethyl ether.<sup>56</sup> *In situ* IR spectroscopy has been used to identify catalytic intermediates in some processes. With Cu/ZrO/SiO<sub>2</sub>, surface bound formate, gem-diolate and methoxide species could be observed before the final hydrolysis to methanol.<sup>57</sup> Lithium salt-promoted Rh/SiO<sub>2</sub> catalysts increased the ethanol content of reduction mixtures from CO<sub>2</sub> as compared to the unpromoted reactions, but the main product was methane.<sup>58</sup>

Homogeneous catalytic reductions of CO<sub>2</sub> advanced with the report by Jessop *et al.*<sup>12</sup> of the use of supercritical CO<sub>2</sub> as solvent for H<sub>2</sub> and the catalyst, RuCl<sub>2</sub>(PMe<sub>3</sub>)<sub>4</sub>. Dimethyl formamide was produced with rates up to 10,000 h<sup>-1</sup> and methyl formate at 55 h<sup>-1</sup>. The catalyst was modified by Baiker *et al.*<sup>59</sup> to RuCl<sub>2</sub>(dppe) which gave rates of 360,000 h<sup>-1</sup> for dmf and several hundred per hour for methyl formate. Leitner *et al.*<sup>60</sup> used rhodium catalysts with chelating phosphine ligands to reduce CO<sub>2</sub> to formic acid with a turnover frequency of 1,335 h<sup>-1</sup>; an intermediate  $\eta^2$ -formate complex was implicated. Jessop *et al.*<sup>61</sup> reported TOF of 95,000 h<sup>-1</sup> for the hydrogenation of CO<sub>2</sub> to HCOOH using RuCl(OAc)(PMe<sub>3</sub>)<sub>4</sub> together with a trace of alcohol and a stoichiometric amount of base.

Although not yet viable on a large scale, electrocatalytic reduction of CO<sub>2</sub> has been vigorously studied.<sup>62-64</sup> Electron transfer to CO<sub>2</sub> results in its conversion from a linear to a bent species; the reduction potential is -1.9 V vs. NHE and is thus very unfavorable. Copper electrodes were found to catalyze CO<sub>2</sub> reduction to methane with current efficiencies as high as 65% although overpotentials were large. This unusual reduction involves the transfer of eight electrons.<sup>65</sup> Copper oxides on gas diffusion electrodes, again operating at large negative potentials, can reduce CO<sub>2</sub> to ethanol.<sup>66</sup> Homogeneous electrocatalysts generally reduce CO<sub>2</sub> by two electrons and produce formate or CO as well as H<sub>2</sub> (in aqueous systems). A variety of catalysts have been studied: complexes with nitrogen-containing macrocyclic ligands, phosphine complexes, cyclopentadienyl complexes, polypyridine complexes (particularly those of Ru<sup>II</sup> and Re<sup>I</sup> and polymetallic complexes. With nickel cyclam catalysts, selective reduction of CO<sub>2</sub>, without H<sub>2</sub> production, occurs with nearly 100% current efficiency. The preference for CO<sub>2</sub> reduction is thought to arise from selective reaction of 17 electron intermediates with CO<sub>2</sub>.

Several types of transition metal complexes have been used as photocatalysts for CO<sub>2</sub> reduction,<sup>63,67</sup> but the ones most studied are ruthenium (II) and rhenium (I) complexes with polypyridine ligands. Thus, Ru(bpy)<sub>3</sub><sup>2+</sup> can be both photosensitizer and catalyst or another metal complex may serve as catalyst. Alternatively, Re(bpy)(CO)<sub>3</sub>X-type complexes may serve as

photosensitizers. There are also examples of the use of metalloporphyrin complexes as both photosensitizers and catalysts. Generally, the reductions lead to CO and a small amount of formate although H<sub>2</sub> is a product (aqueous media) when the ruthenium compounds are used in combination with a cobalt or nickel macrocyclic complex. Metallo-carboxylic acids (MCOOH) are thought to be the precursors to CO, but not to formate or H<sub>2</sub>. At present, catalytic activities are low (TOF < 100) and costs would be high for commercialization.

### 1.30.7 SUMMARY AND FUTURE DIRECTIONS

Since the early 1980s there has been much research reported about the preparation and characterization of CO<sub>2</sub>-metal complexes and on the reactions of CO<sub>2</sub> with other metal complexes that lead to its incorporation. The driving force for much of this activity has been the prospect for increased CO<sub>2</sub> utilization in the synthesis of chemicals. The number of bonding modes which have been identified for CO<sub>2</sub> to metal centers is surprisingly many and varied, but it is apparent that electron-rich metal centers are needed to bind CO<sub>2</sub> through carbon. Also, electron-rich metal centers are generally needed to promote insertion reactions into M—X bonds, although CO<sub>2</sub> insertions into M—X bonds, particularly M—O bonds, involving very oxophilic metals also occur readily. Characteristic reactions have emerged: oxide transfer from  $\eta^1$ -CO<sub>2</sub> complexes and O—M or C—O cleavage resulting from reactions with electrophiles.

However, in the case of CO<sub>2</sub>-metal complexes, the model compounds that have been well-characterized are not catalytically, or even stoichiometrically, active toward CO<sub>2</sub> reduction. Rapid and efficient homogeneous catalysts for the reduction of CO<sub>2</sub> by more than two electrons (e.g., to formate or CO) are currently unknown. Clearly, fundamental structure/reactivity relationships are not yet well understood. Efforts now are focused on trying to combine the current information about structural and electronic properties of the model compounds and available information about low-efficiency catalytic processes into strategies that will accomplish the goal of CO<sub>2</sub> fixation. Certainly, processes that could utilize sunlight to promote the necessary electron transfer reactions needed for CO<sub>2</sub> reduction are most desirable.

### 1.30.8 REFERENCES

1. Ito, T.; Yamamoto, A. In *Organic and Bioorganic Chemistry of Carbon Dioxide*, Inoue, S.; Yamazaki, N., Eds., Kodansha Ltd., Tokyo, Japan, 1982, Chapter 3.
2. Darensbourg, D. J.; Kudarowski, R. A. *Adv. Organomet. Chem.* **1983**, *22*, 129–168.
3. Walther, D. *Coord. Chem. Rev.* **1987**, *79*, 135–174 and references cited therein.
4. Braunstein, P.; Matt, D.; Nobel, D. *Chem. Rev.* **1988**, *88*, 747–764.
5. See Behr, A. *Angew. Chem., Int. Ed. Engl.* **1988**, *27*, 661–678 and references cited therein.
6. Cutler, A. R.; Hanna, P. K.; Vites, J. C. *Chem. Rev.* **1988**, *88*, 1363–1403.
7. Behr, A. *Carbon Dioxide Activation by Metal Complexes* **1988**, VCH, Weinheim, Germany.
8. Miller, J. D. *Reactions of Coordinated Ligands*, Braterman, P. S., Ed., Plenum Press, New York, 1989, Vol. 2, pp 1–52.
9. Creutz, C. *Electrochemical and Electrocatalytic Reactions of Carbon Dioxide*, Sullivan, B. P.; Krist, K.; Guard, H. E., Eds., Elsevier, Amsterdam, 1993, Chapter 2.
10. Halmann, M. M. *Chemical Fixation of Carbon Dioxide. Methods for Recycling CO<sub>2</sub> into Useful Products* **1993**, CRC Press, Boca Raton, FL.
11. Aresta, M.; Quaranta, E.; Tommasi, I. *New. J. Chem.* **1994**, *18*, 133–142.
12. Jessop, P. G.; Ikariya, T.; Noyori, R. *Chem. Rev.* **1995**, *95*, 259–272.
13. Leitner, W. *Angew. Chem., Int. Ed. Engl.* **1995**, *34*, 2207–2221 and references cited therein.
14. Pandey, K. K. *Coord. Chem. Rev.* **1995**, *140*, 37–114.
15. Leitner, W. *Coord. Chem. Rev.* **1996**, *153*, 257–284 and references cited therein.
16. Darensbourg, D. J.; Holtcamp, M. W. *Coord. Chem. Rev.* **1996**, *153*, 155–174.
17. Gibson, D. H. *Chem. Rev.* **1996**, *96*, 2063–2095 and references cited therein.
18. Dinjus, E.; Fornika, R. In *Applied Homogeneous Catalysis with Organometallic Compounds*, Cornils, B.; Hermann W. A., Eds., VCH, Weinheim, Germany, 1997, Vol. 2, Chapter 3.
19. Yin, X.; Moss, J. R. *Coord. Chem. Rev.* **1999**, *181*, 27–59 and references cited therein.
20. Walther, D.; Ruben, M.; Rau, S. *Coord. Chem. Rev.* **1999**, *182*, 67–100.
21. Gibson, D. H. *Coord. Chem. Rev.* **1999**, *185–186*, 335–355 and references cited therein.
22. Dedieu, A.; Bo, C.; Ingold, F. In *Metal Ligand Interactions from Atoms to Clusters to Surfaces*, NATO ASI Series Ser. C378, Salahub, D. R.; Russo, N., Eds., Kluwer Academic Publishers, Dordrecht, The Netherlands, 1992, 175–197.
23. Sodupe, M.; Branchadell, V.; Oliva, A. *J. Phys. Chem.* **1995**, *99*, 8567–8571.
24. Tetrick, S. M.; Xu, C.; Pinkes, J. R.; Cutler, A. R. *Organometallics* **1998**, *17*, 1861–1867.
25. Mascetti, J.; Tranquille, M. *J. Phys. Chem.* **1988**, *92*, 2177–2184.
26. Galan, F.; Fonassier, M.; Tranquille, M.; Mascetti, J.; Pápai, I. *J. Phys. Chem.* **1997**, *101*, 2626–2633.

27. Sakaki, S.; Musashi, Y. *Inorg. Chem.* **1995**, *34*, 1914–1923.
28. Hutschka, F.; Dedieu, A.; Leitner, W. *Angew. Chem., Int. Ed. Engl.* **1995**, *34*, 1742–1745.
29. Darensbourg, D. J.; Grötsch, G. *J. Am. Chem. Soc.* **1985**, *107*, 7473–7476.
30. Darensbourg, D. J.; Hanckel, R. K.; Bauch, C. G.; Pala, M.; Simmons, D.; White, J. N. *J. Am. Chem. Soc.* **1985**, *107*, 7463–7473.
31. Shi, M.; Nicholas, K. M. *J. Am. Chem. Soc.* **1997**, *119*, 5057–5058.
32. Franks, R. J.; Nicholas, K. M. *Organometallics*, **2000**, *19*, 1458–1460.
33. Bertini, I.; Luchinat, C. *Bioinorganic Chemistry*, Bertini, I.; Gray, H. B.; Lippard, S. J.; Valentine, J. S., Eds., University Science Books, Mill Valley, CA, 1994, p 37.
34. Looney, A.; Han, R.; McNeil, K.; Parkin, G. *J. Am. Chem. Soc.* **1993**, *115*, 4690–4697.
35. Darensbourg, D. J.; Jones, M. L. M.; Reibenspies, J. H. *Inorg. Chem.* **1996**, *35*, 4406–4413.
36. Michelin, R. A.; Strukul, G.; Bresiani-Pahor, N.; Zangrando, E.; Randaccio, C. *Inorg. Chim. Acta* **1984**, *84*, 229–232.
37. Katajima, N.; Hikichi, S.; Tanaka, M.; Moro-oka, Y. *J. Am. Chem. Soc.* **1993**, *115*, 5496–5508.
38. Chisholm, M. H.; Extine, M. W. *J. Am. Chem. Soc.* **1977**, *99*, 792–802.
39. Hartwig, J. F.; Bergman, R. G.; Andersen, R. A. *J. Am. Chem. Soc.* **1991**, *113*, 6499–6508.
40. Buhro, W. E.; Chisholm, M. H.; Martin, J. D.; Huffman, J. C.; Foltling, K.; Streib, W. E. *J. Am. Chem. Soc.* **1989**, *111*, 8149–8156.
41. Procopio, L. J.; Carroll, P. T.; Berry, D. H. *Organometallics*, **1993**, *12*, 3087–3093.
42. Campion, B. K.; Heyn, R. H.; Tilley, T. D. *Inorg. Chem.* **1990**, *29*, 4356–4358.
43. Pinkes, J. R.; Steffey, B. D.; Vites, J. C.; Cutler, A. R. *Organometallics* **1994**, *13*, 21–23.
44. Hanna, T. A.; Baranger, A. M.; Bergman, R. G. *J. Am. Chem. Soc.* **1995**, *117*, 11363–11364.
45. Hoberg, H.; Schaefer, D. *J. Organomet. Chem.* **1983**, C51–C53.
46. Hoberg, H.; Schäfer, D.; Burkhardt, G.; Krüger, C.; Romao, M. J. *J. Organomet. Chem.* **1984**, *266*, 203–224.
47. Cohen, S. A.; Bercaw, J. E. *Organometallics* **1985**, *4*, 1006–1014.
48. Alvarez, R.; Carmona, E.; Galindo, A.; Gutierrez, E.; Marin, J. M.; Monge, A.; Poveda, M. C.; Ruiz, C.; Savariault, J. M. *Organometallics* **1989**, *8*, 2430–2439.
49. Hoberg, H.; Jenni, K. *J. Organomet. Chem.* **1987**, *322*, 193–201.
50. Hoberg, H.; Schaefer, D. *J. Organomet. Chem.* **1983**, C51–C53.
51. Brookhart, M.; Noh, S. K.; Timmers, F. J. *Organometallics* **1987**, *6*, 1829–1831.
52. Hoberg, H.; Oster, B. W. *J. Organomet. Chem.* **1984**, *266*, 321–326.
53. Demersma, B.; Mahé, R.; Dixneuf, P. *J. Chem. Soc., Chem. Comm.* **1984**, 1394–1395.
54. Walther, D.; Braünlich, G.; Kempe, R.; Sieler, J. *J. Organomet. Chem.* **1992**, *436*, 109–119.
55. Walther, D.; Herzog, V. *Z. Chem.* **1987**, *27*, 373–374.
56. DuBois, J.-L.; Sayama, K.; Arakawa, H. *Chem. Lett.* **1992**, 1115–1118.
57. Fisher, I. A.; Bell, A. T. *J. Catal.* **1997**, *172*, 222–237.
58. Kusama, H.; Okabe, K.; Sayama, K.; Arakawa, H. *Catal. Today* **1996**, *28*, 261–266.
59. Kröcher, O.; Köppel, R. A.; Baiker, A. *J. Chem. Soc., Chem. Commun.* **1997**, 453–454.
60. Fornika, R.; Görls, H.; Seemann, B.; Leitner, W. *J. Chem. Soc., Chem. Commun.* **1995**, 1479–1480.
61. Munshi, P.; Main, A. D.; Linehan, J. C.; Tai, C. C.; Jessop, P. G. *J. Am. Chem. Soc.* **2002**, *124*, 7963–7971.
62. Keene, F. R.; Sullivan, B. P. In *Electrochemical and Electrocatalytic Reactions of Carbon Dioxide*, Sullivan, B. P.; Krist, K.; Guard, H. E., Eds., Elsevier, New York, 1993, Chapter 5.
63. DuBois, D. L. *Comments Inorg. Chem.* **1997**, *19*, 307–325.
64. Fujita, E.; Brunshwig, B. S. In *Electron Transfer in Chemistry*, Balzani, V., Ed., Wiley-VCH, New York, 2001, Chapter 3.
65. Hori, Y.; Kikuchi, K.; Murata, A.; Suzuki, S. *Chem. Lett.* **1986**, 897–898.
66. Sammels, A. F.; Cook, R. L. In *Electrochemical and Electrocatalytic Reactions of Carbon Dioxide*, Sullivan, B. P.; Krist, K.; Guard, H. E., Eds., Elsevier, New York, 1993, Chapter 8.
67. Sutin, N.; Creutz, C.; Fujita, E. *Comments Inorg. Chem.* **1997**, *19*, 67–92.

# 1.31

## Reactivity and Structure of Complexes of Small Molecules: Nitric and Nitrous Oxide

J. A. OLABE and L. D. SLEP  
*Universidad de Buenos Aires, Argentina*

---

1.31.1	STRUCTURE AND BONDING	603
1.31.1.1	General Properties of NO, Bonding Models, and the Enemark–Feltham Formalism	603
1.31.1.2	Solid-state Structures of $\eta^1$ -N-Mononuclear Nitrosyls. Coordination Numbers: 6, 5, 4, and Others. Spectroscopic Characterization	605
1.31.1.2.1	Coordination number 6	605
1.31.1.2.2	Coordination number 5	610
1.31.1.2.3	Coordination number 4 and others	612
1.31.1.3	Polynitrosyls, Bridging Nitrosyls, and Clusters	612
1.31.1.4	$\eta^1$ -ON (Isonitrosyls) and $\eta^2$ -NO Complexes	612
1.31.1.5	N <sub>2</sub> O Complexes	613
1.31.2	SYNTHESIS AND REACTIVITY OF NO AND N <sub>2</sub> O COMPLEXES	615
1.31.2.1	Reactions of NO	615
1.31.2.1.1	Synthesis	615
1.31.2.1.2	Formation and dissociation reactions of NO	617
1.31.2.1.3	Nucleophilic additions to bound NO	617
1.31.2.1.4	Reduction of bound NO: chemistry and electrochemistry	618
1.31.2.1.5	Reductive nitrosylation	618
1.31.2.1.6	Electrophilic reactions	619
1.31.2.1.7	Disproportionation of metal-bound NO	619
1.31.2.1.8	Nitrosyl transfer	619
1.31.2.2	Reactions of N <sub>2</sub> O	619
1.31.2.2.1	Synthesis of N <sub>2</sub> O complexes	619
1.31.2.2.2	Reduction of N <sub>2</sub> O involving O-atom transfer	620
1.31.2.2.3	N $\equiv$ N bond cleavage of N <sub>2</sub> O	620
1.31.2.2.4	N <sub>2</sub> O formation involving N-atom transfer	620
1.31.2.2.5	N <sub>2</sub> O from reductive coupling of NO	620
1.31.2.2.6	Catalyzed disproportionation of NO in basic medium	620
1.31.2.2.7	Electroreduction catalyzed by transition-metal complexes	621
1.31.3	CONCLUSIONS AND OUTLOOK	621
1.31.4	REFERENCES	621

---

### 1.31.1 STRUCTURE AND BONDING

#### 1.31.1.1 General Properties of NO, Bonding Models, and the Enemark–Feltham Formalism

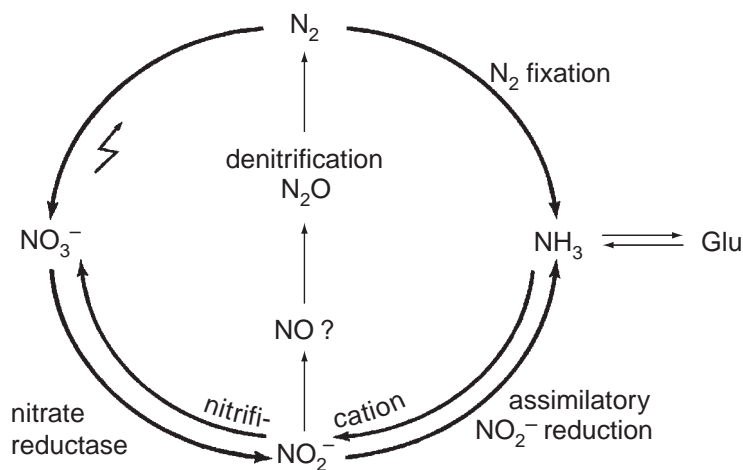
Nitric oxide (also known as nitrogen monoxide, NO) is a diatomic mono-radical with a N—O bond length of 1.154 Å and a  $^2\Pi$  ground state (GS). Books and reviews on its general properties and



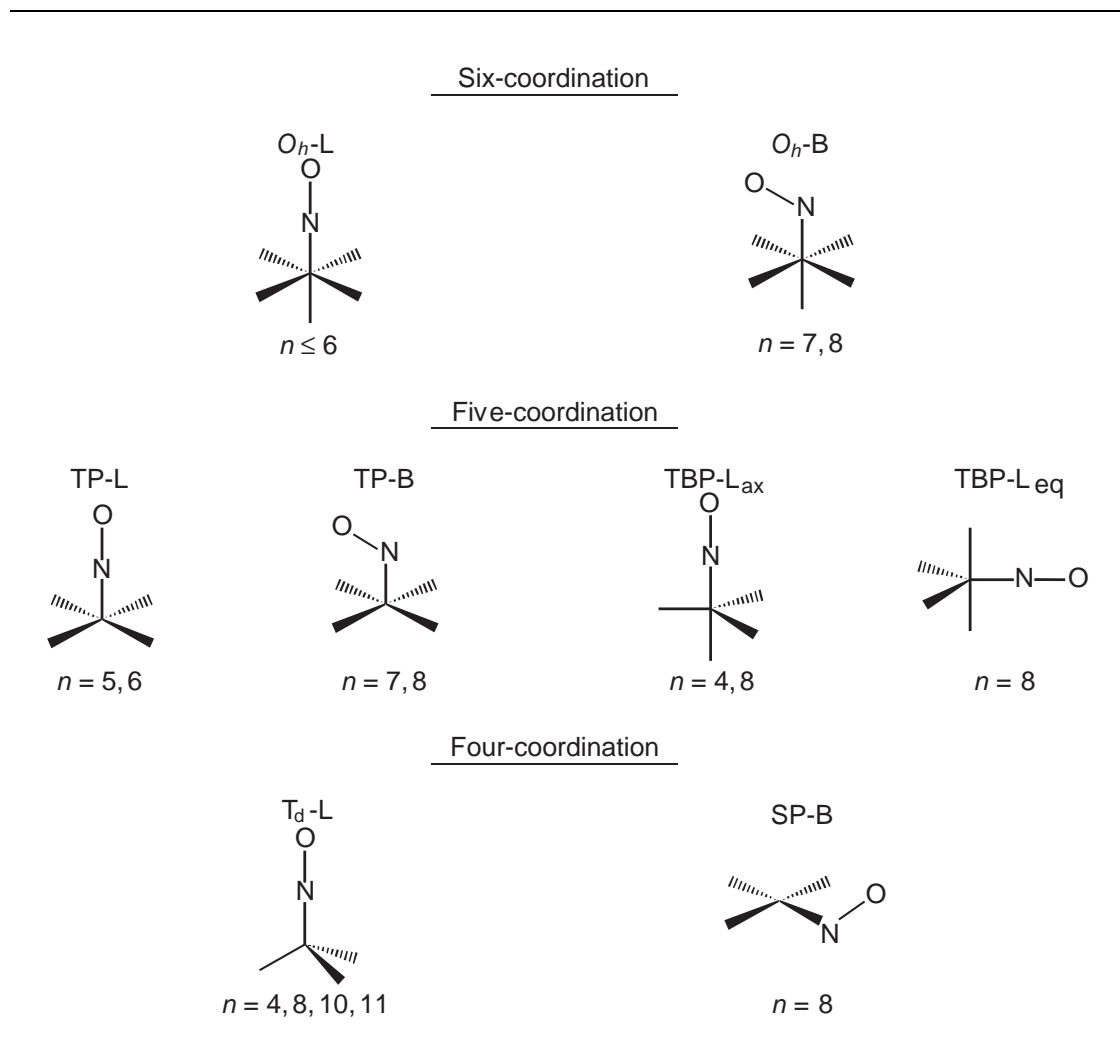
chemistry are available,<sup>1–3</sup> including reports on its biochemical<sup>4–6</sup> and environmental<sup>7,8</sup> significance. NO has a m.p. of 110 K and b.p. of 121 K (1 atm). It dimerizes substantially in the liquid and solid phases, but poorly in the gas phase. Slow disproportionation leads to N<sub>2</sub>O and NO<sub>2</sub> under ambient conditions, being faster at high pressure (see Section 1.31.2.1.7). It is unreactive toward hydrolysis in water and its solubility is 1.9 mM atm<sup>-1</sup> at 298 K, increasing in organic solvents. The aqueous redox chemistry of NO is pH-dependent since both nitrite reduction to NO (2H<sup>+</sup>/e<sup>-</sup>) and NO reduction to nitroxyl, HNO (1 H<sup>+</sup>/1e<sup>-</sup>) are proton-coupled processes. The nitrosonium (NO<sup>+</sup>) cation is readily hydrolyzed to nitrite and is a potent oxidizing and nitrosating agent. The nitroside anion (NO<sup>-</sup>), or its acid–base related HNO, is a precursor of N<sub>2</sub>O. These reactive redox-interconverted forms of NO are usually stabilized by coordination to transition metals.<sup>9,10</sup> Mechanistic studies cover the free-radical chemistry of NO in aqueous solution with other radical partners, O<sub>2</sub>, O<sub>2</sub><sup>-</sup>, and NO<sub>2</sub>, leading to nitrite, peroxyxynitrite (O<sub>2</sub>NO<sup>-</sup>), and N<sub>2</sub>O<sub>3</sub>, respectively. Hydrogen abstraction reactions occur upon reaction with hyponitrous acid (H<sub>2</sub>N<sub>2</sub>O<sub>2</sub>) or hydroxylamine (NH<sub>2</sub>OH), with intermediate HNO.<sup>2</sup>

Transition metal-mediated reactions of nitrogen oxides (NO<sub>x</sub>) are of interest from an environmental perspective, as exemplified by their role in atmospheric pollution,<sup>7,8</sup> and by the nitrification and denitrification processes (release of N<sub>2</sub> and N<sub>2</sub>O) afforded by different enzymes in natural systems (Figure 1).<sup>2,11</sup> Potential applications of nitrosyl complexes for the assembly of devices with novel optical and magnetic properties are also attractive.<sup>12,13</sup> Transition metal nitrosyl-complexes span variable geometries, CNs, and electronic properties due to the differences in electronic configurations of the metal centers and covalent MNO interactions.<sup>14–18</sup> To simplify the bonding description we follow the Enemark–Feltham's (E–F) electron-counting formalism,<sup>14</sup> a MO-based approach which considers the electronic distribution in the overall {MNO} unit, without assumptions on the actual degree of electron density on M and the NO group. This avoids extreme ways of describing the nitrosyl oxidation state as NO<sup>+</sup> or NO<sup>-</sup> based on the NO coordination mode (linear or bent, respectively), which sometimes leads to unusual metal oxidation state assignments. The nitrosyl-containing species are then described as {MNO}<sup>n</sup> (regardless of the coligands), where *n* stands for the number of electrons associated with the metal *d* and π\*<sub>NO</sub> orbitals (or equivalently to the number of *d* electrons on the metal when the nitrosyl ligand is *formally* considered to be NO<sup>+</sup>). The observation of linear or bent MNO groups can then be rationalized in terms of coordination number (CN), number of electrons (*n*), and the nature of the occupied MOs which arise from correlation (Walsh) diagrams based on a one-electron description of the systems. This methodology has proved to be successful to explain and most notably to predict the geometries for the different combinations of CN and *n* collected in Table 1. For a thorough analysis the reader is referred to the literature.<sup>14</sup>

Our discussion will comprise separately the mononitrosyl, polynitrosyl, bridging, and cluster nitrosyl complexes, with emphasis on the first group. We present different types of {MNO} compounds, without attempting to collect all available structures. Examples with either classical coligands (amines, cyanides, water, polypyridines, etc.) or porphyrin compounds have been chosen, in an attempt to illustrate recent developments in the field. Apart from the information contained in the previous *Comprehensive Coordination Chemistry* (CCC, 1987)<sup>17</sup> a comprehensive review on structures



**Figure 1** Inorganic nitrogen cycle, showing the central position of denitrification (reproduced by permission of Averill, 1996;<sup>11</sup> © American Chemical Society).

**Table 1** Idealized geometry for the different CN in mono-nitrosyl compounds.


$O_h\text{-L}$ : octahedral, linear;  $O_h\text{-B}$ : octahedral, bent; TP-L: tetragonal pyramidal, linear; TP-B: tetragonal pyramidal, bent; TBP-L<sub>ax</sub>: trigonal bipyramidal, linear NO in axial position; TBP-L<sub>eq</sub>: trigonal bipyramidal linear NO in equatorial position,  $T_d\text{-L}$ : tetrahedral, linear; SP-B: square planar, bent.

of metal nitrosyls appeared in 1981.<sup>15</sup> Recent reports refer to the synthesis, structural chemistry,<sup>19,20</sup> and reactivity<sup>21</sup> of heme derivatives with NO ligands. A special issue of *Chemical Reviews* devoted to NO chemistry, covers coordination aspects (including organometallics), bonding, spectroscopy (IR, NMR), reactivity, solid-state structures of metalloporphyrin NO<sub>x</sub> compounds, and other specific bio-relevant aspects related to heme and nonheme iron nitrosyls, as well as to denitrification processes.<sup>3</sup>

### 1.31.1.2 Solid-state Structures of $\eta^1\text{-N}$ -Mononuclear Nitrosyls. Coordination Numbers: 6, 5, 4, and Others. Spectroscopic Characterization

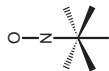
#### 1.31.1.2.1 Coordination number 6

This is the most abundant category, including pseudo-octahedral  $\{\text{MNO}\}^n$  complexes with  $n = 4\text{--}8$ . Table 2 contains structural and spectroscopic information for a representative (though not exhaustive) group of compounds in order of increasing  $n$ . As predicted by the E-F formalism,<sup>14</sup> the MNO fragments in complexes with  $n = 4\text{--}6$  are linear. In the series of  $[\text{Mo}(\text{NO})(\text{L})(\text{S}_4)]$



**Table 2** Selected examples for six-coordinated nitrosyl compounds with different CNs.

Compound number	$d_{M-N}$ (Å)	$d_{N-O}$ (Å)	$\angle MNO$ (°)	$\nu_{NO}$ (cm <sup>-1</sup> ) <sup>a</sup>	References
1	1.761(8)	1.215(11)	175.0(8)	1,515	23
$n = 4$					
2	1.708(14)	1.24(2)	174.0(10)	1,433	24
3	1.73(1)	1.25(1)	179(2)	1,642	25
$n = 5$					
4	1.786(9)	1.198(12)	177.3(7)	1,603	22
5	1.746(6)	1.217	179.8(4)	1,540	26
6	1.652(5)	1.15(0)	174.4(10)	1,937	27
7	1.646.5(17)	1.135(2)	177.28(17)	1,921	28
8	1.668(2)	1.132(3)	180.0	1,893	29
9	1.728(2)	1.153(3)	157.4(2)	1,839	30
10	1.644(4)		171.2(4)	1,907, 1,885	31
$n = 6$					
11	1.634(3)	1.141(3)	179.5(3)	1,893	32
12	1.888(5)	1.138(12)	171.0(7)	1,853	33
13	1.751(5)	1.142(8)	167.4(6)	1,813	34
14	1.758(7)	1.177(9)	174.0(8)	1,835	35
15	1.790(5)	1.123(8)	174.8(6)	1,791	36
16	1.807(3)	1.146(4)	154.9(3)	1,759	27
17	1.793, 1.715(5)	1.142(7)	178.1(5)	1,912	37
$n = 7$					
18	1.747(4)	1.128(5)		1,875	38
19	1.751(6)	1.132(9)	170.4(5)	1,920	40
20	1.773(3)	1.130(4)	174.4(3)	1,926	41
21	1.711(6)		174.3(6)	1,808	42
22	1.704(14)	1.188(19)	176.6(17)	1,865	43
23	1.774(8)	1.14(1)	175.5(7)	1,897	44



24	$\text{Fe}(\text{Me}_3\text{TACN})(\text{NO})(\text{N}_3)_2$	1.738(5)	1.142(7)	155.5(10)	1,690	45
25	<i>trans</i> - $[\text{Fe}(\text{cyclam})\text{Cl}(\text{NO})]\text{ClO}_4$	1.820(4)		144.0(6)	1,611	31
26	$\text{Fe}(\text{NO})(\text{pyS}_4) \cdot 2\text{CH}_2\text{Cl}_2$	1.712(3)	1.211(7)	143.8(5)	1,648	32
27	$[\text{Fe}(\text{NO})(\text{NO}_2)(\text{TpivPP})]^-$	1.792(8)	1.176(8)	137.4(6)	1,616	46
27	$[\text{Fe}(\text{NO})(\text{NO}_2)(\text{TpivPP})]^-$	1.840(6)	1.134(8)	137.4(6)	1,668	46
28	$\text{Ru}(\text{HNO})(\text{pybuS}_4)$	1.875(7)	1.242(9)	130.0(6)	1,358	47

$L \equiv n$



$\infty \equiv n$

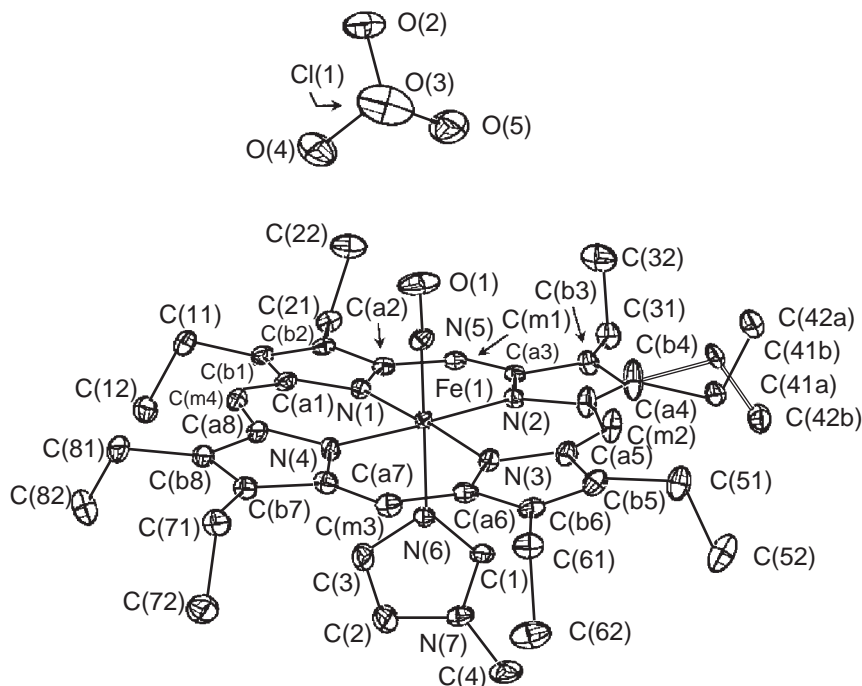
<sup>a</sup> IR frequencies. Abbreviations used for the ligands:  $\text{Pr}_3\text{TACN} = 1,4,7$ -trisopropyl-1,4,7-triazaacyclononane;  $\text{Tp}^* = \text{tris}(3\text{-}i\text{-propyl}, 5\text{-methyl})\text{hydroborate}$ ;  $\text{S}_4 = 1,2$ -bis(2-thiophenylthio)ethane diamine; OEP = octaethylporphyrin dianion; TPP = *meso*-tetraphenylporphyrin dianion; 1-,MeIm = 1-methylimidazole; TACN = 1,4,7-triazaacyclononane; Me<sub>3</sub>TACN = 1,4,7-trimethyl-1,4,7-triazaacyclononane; cyclam = 1,4,8,11-tetraazacyclotetradecane; bpy = 2,2'-bipyridine; terpy = 2,2',6,6'-terpyridine; TpivPP =  $\alpha,\alpha,\alpha,\alpha$ -tetraakis(*o*-pivalamidophenyl)-porphyrin dianion; pyS<sub>4</sub> = 2,6-bis(2-thiophenylthiomethyl)pyridine dianion; pybuS<sub>4</sub> = 2,6-bis(2-thio,3,5-di-*t*-butyl-phenylthiomethyl)pyridine dianion.

complexes ( $S_4 = 1,2$ -bis(2-thiophenylthio)ethane dianion) complex (**4**) ( $n = 5$ ) can be redox interconverted to the  $n = 4$  and 6 forms.<sup>22</sup> Structural data for the related complexes with  $n = 4$  ( $L = \text{Cl}$ ) and  $n = 6$  ( $L = \text{NO}$ ) are also available.<sup>22</sup>

Most of the examples with  $n = 6, 7$ , or 8 involve group 8 metals, particularly ruthenium. For the linear  $\{\text{MNO}\}^6$  complexes, those containing Werner-type coligands are diamagnetic, usually described as low-spin  $\text{M}^{\text{II}}\text{NO}^+$  species. However, the electronic configuration of the metal cannot be merely inferred from structural considerations, requiring the aid of spectroscopic measurements. Among them, EPR,<sup>48</sup> UV-vis,<sup>19</sup> IR,<sup>19</sup> and Mössbauer<sup>31</sup> (for Fe-containing materials) provide valuable though not always conclusive information. Consequently, some of the assignments may be controversial. Complex (**10**) (as well as the oxidized form of complex (**25**)) have been proposed to contain  $\text{Fe}^{\text{IV}}$  centers ( $S = 1$ ) antiferromagnetically coupled to  $\text{NO}^-$  ( $S = 1$ ), based on the decrease in isomer shift upon oxidation of the related  $\{\text{FeNO}\}^7$  species.<sup>31</sup> Recently,<sup>49</sup> a combined experimental and theoretical (DFT) approach based on compounds structurally related to complex (**11**) established that variations of this magnitude do not necessarily reflect metal center oxidation. On the contrary, this study suggests that octahedral  $\{\text{FeNO}\}^6$  species with small isomer shifts ( $\sim 0 \text{ mm s}^{-1}$ ) and large quadrupole splitting Mössbauer parameters should be described as containing low-spin  $\text{Fe}^{\text{II}}\text{NO}^+$ . It is clear from these examples that some of the assignments in the literature might require revision, based on a judicious combination of experiment and theory.

The EPR silent metalloporphyrins are considered to be low-spin  $\text{M}^{\text{III}}$  ( $S = 1/2$ ) coupled to  $\text{NO}$  ( $S = 1/2$ ), as suggested by Mössbauer spectroscopy.<sup>19,20</sup> The first characterized iron derivative  $[\text{Fe}(\text{OEP})(\text{NO})(\text{OH}_2)]^{+15}$  and other related complexes have short  $\text{Fe}-\text{N}(\text{NO})$  lengths (ca.  $1.65 \text{ \AA}$ ), consistent with a strong bond (one  $\sigma$  and two  $\pi$ ). The iron is located on the center, close to the porphyrin plane. Interestingly,  $\text{NO}$  is labile in the porphyrin- $\text{Fe}^{\text{III}}$  systems, in contrast with the substitution-inert complexes with classical coligands, as nitroprusside (NP). Although these ferriheme derivatives are difficult to isolate because of reductive nitrosylation (see Section 1.31.1.5), some  $[\text{Fe}(\text{OEP})(\text{NO})(\text{L})]^+$  complexes have been characterized. Figure 2 shows the structure of the  $L = 1\text{-MeIm}$  derivative.

The  $\text{NO}$ -binding Nitrophorin 1 (NP1), from the saliva of the blood-sucking insect *Rhodnius prolixus*, contains two diamagnetic  $\{\text{FeNO}\}^6$  ferrihemes, with  $\nu_{\text{NO}}$  at  $1,904 \text{ cm}^{-1}$  and  $1,917 \text{ cm}^{-1}$ . They exist in a pH-dependent ratio and bind  $\text{NO}$  reversibly without being reduced. Alternative electronic distribution assignments as  $\text{Fe}^{\text{III}}\text{NO}$  or  $\text{Fe}^{\text{II}}\text{NO}^+$  rely on IR, EPR, NMR, FTIR, and

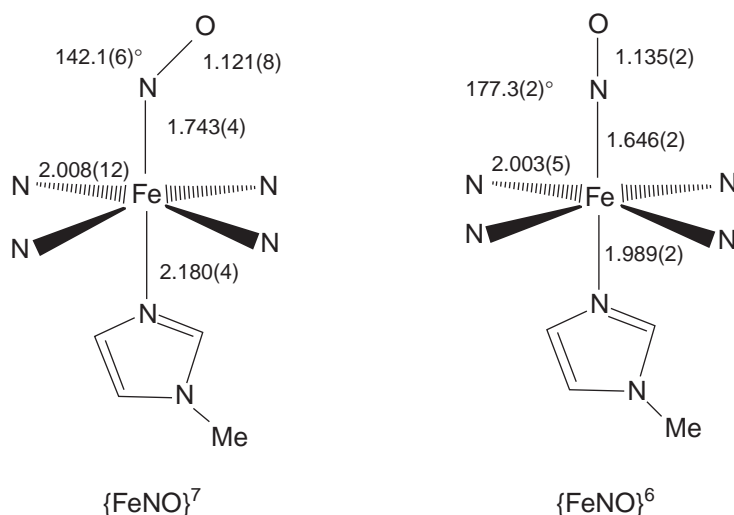


**Figure 2** ORTEP diagram of  $[\text{Fe}(\text{OEP})(1\text{-MeIm})(\text{NO})]\text{ClO}_4$ ; 50% probability ellipsoids (reproduced by permission of Ellison and Scheidt, 1999;<sup>28</sup> © American Chemical Society).

UV–vis spectroscopic analysis.<sup>50</sup> Resonance Raman (RR) has been used to characterize the high-spin and low-spin Fe<sup>III</sup>NO forms of NP1 at room temperature and 77 K, respectively.<sup>51</sup> In general, vibrational spectroscopy allows to discern between linear ferriheme and bent ferroheme compounds (Table 1):  $\nu_{\text{NO}}$  values usually show up higher than 1,800 cm<sup>-1</sup> and lower than 1,700 cm<sup>-1</sup>, respectively.<sup>19,20</sup> Very low  $\nu_{\text{NO}}$  are also characteristic of linear complexes with low oxidation state metals, suggesting strong back donation to  $\pi^*_{\text{NO}}$  (see complexes (1)–(5) in Table 2). Vibrational stark spectroscopy has been used to understand the effects of protein electrostatic fields on  $\nu_{\text{NO}}$ .<sup>52</sup> The NO group does not display a *trans*-effect on L, and the latter has little effect on the FeNO geometry, with the remarkable exception of complexes (9) and (16) with  $\sigma$ -bonded aryls and alkyls, showing unusually smaller angles, longer Fe–N(NO) and *trans*-Fe–C distances, and low  $\nu_{\text{NO}}$  values. Reliable N–O distances are expected to be around 1.14–1.16 Å, for any type of mononitrosyl complexes. Reported N–O distances might be largely affected by thermal motion, crystallographic disorder of the NO atoms, or even by impurities, and marked deviations from the average values should be regarded skeptically.<sup>19</sup> The noniron complexes display a similar pattern of MNO angles and N–O distances.

A few complexes with {MNO}<sup>7</sup> configuration were described earlier, [Fe(NO)(das)<sub>2</sub>(NCS)][BPh<sub>4</sub>] and [Fe(NO)L(TPP)] (L = 1-Melm and 4-Mepy).<sup>15</sup> They are all bent, with MNO around 138–158°, and are not really dependent on the *trans*-ligand. Figure 3 shows a comparison of structural parameters for six-coordinate complexes with *n* = 6 and 7. Table 2 includes recent examples. Complex (24) has a *S* = 3/2 GS, and other spectroscopic results and calculations point to antiferromagnetic coupling between a high-spin Fe<sup>III</sup> (*S* = 5/2) and NO<sup>-</sup> (*S* = 1).<sup>53</sup> A similar description has been proposed recently for [Fe(H<sub>2</sub>O)<sub>5</sub>NO]<sup>2+</sup>,<sup>54</sup> also consistent with results for [Fe(EDTA)NO]<sup>2-</sup> and nonheme metalloproteins.<sup>31</sup> In contrast, complex (26) presents *S* = 1/2, and has been described recently as Fe<sup>II</sup>NO.<sup>49</sup> This picture probably also fits for complex (25), previously described as intermediate-spin Fe<sup>III</sup> (*S* = 3/2) coupled with NO<sup>-</sup> (*S* = 1).<sup>31</sup> Two forms of complex (27) were characterized by UV–vis, IR, EPR, and Mössbauer spectroscopies, showing total *S* = 1/2.<sup>46</sup> It has been suggested<sup>31</sup> that one could be similar to complex (25), while the other would be a low-spin Fe<sup>III</sup> (*S* = 1/2) coupled to NO<sup>-</sup> (*S* = 1). This could be also the case for nitrosylated hemes; EPR studies indicate *S* = 1/2, with nearly 30% spin density on NO.<sup>19</sup> Multiple-scattering EXAFS techniques have been used for determining the Fe–N–O angle in several nonheme {FeNO}<sup>7</sup> complexes.<sup>55</sup>

The solid-state spin equilibrium behavior (*S* = 1/2  $\rightleftharpoons$  *S* = 3/2) reported for [FeL<sup>Pr</sup>(NO)] (L<sup>Pr</sup> = 1-isopropyl-4,7-bis(4-*tert*-butyl-2-thiobenzyl)-1,4,7-triazacyclononane),<sup>49</sup> and studied by magnetic susceptometry, Mössbauer spectroscopy, and theoretical tools, constitutes the first example of this kind of behavior in {FeNO}<sup>7</sup> compounds. The *S* = 1/2 valence tautomer was described as a low-spin Fe<sup>II</sup> (*S* = 0) bound to a NO radical, whereas the *S* = 3/2 isomer involved a high-spin Fe<sup>III</sup> (*S* = 5/2), antiferromagnetically coupled to NO<sup>-</sup> (*S* = 1).



**Figure 3** Structural comparison for six-coordinate {FeNO}<sup>7</sup> and {FeNO}<sup>6</sup> complexes. Values correspond to the structures of [Fe(TPP)(NO)(1-Melm)] and [Fe(TPP)(NO)(1-Melm)]<sup>+</sup> (reproduced by permission of Wyllie and Scheidt, 2002;<sup>20</sup> © American Chemical Society).

In the  $\{\text{MNO}\}^7$  metalloporphyrins, the M—L bond length *trans* to the nitrosyl ligand is remarkably long, revealing a strong structural *trans* effect exerted by nitrosyl. EPR results indicate partial population of the  $d_z^2$  orbital by the unpaired electron, which must be antibonding with respect to the sixth ligand.<sup>19</sup> The very low binding constants preclude the complete formation of six-coordinate  $\text{Fe}^{\text{II}}$  systems in solution, and mixtures of the  $\text{Fe}^{\text{II}}$  and  $\text{Fe}^{\text{III}}$  are usually encountered with neutral L donors.<sup>19,20</sup> The nitrosyl *trans*-effect in  $\text{Fe}^{\text{II}}$ -porphyrinate derivatives is physiologically significant. NO as a signaling agent binds to a five-coordinated ferroheme in the guanylyl cyclase enzyme, breaking the *trans* iron—histidine bond. A conformational change of the multiunit protein is thought to promote the catalytic conversion of GTP to cGMP, leading to regulation of several functions: vasodilation, inhibition of platelet aggregation, cell adhesion, neurotransmission, or penile erection.<sup>2,4</sup> The structure of the photoreduced form of NP1 (see above) showed a bent  $\text{FeNO}$  angle, ca.  $130^\circ$ , with  $\nu_{\text{NO}} = 1,611 \text{ cm}^{-1}$ , consistent with a  $\text{Fe}^{\text{II}}\text{NO}$  distribution.<sup>50</sup> Complexes (25) and (26) can be oxidized and reduced, yielding the complexes with  $n=6$  and 8, respectively. Although the latter is very labile toward the loss of HNO, these systems provide valuable examples for the redox interconversions of NO bound to a common iron fragment.<sup>32</sup> In the related NP system, similar redox transformations have been described,<sup>56</sup> but only the linear  $\{\text{FeNO}\}^6$  species was characterized structurally.<sup>57</sup> EPR measurements and DFT-based analysis of the observed g tensor support a bent structure for the  $\{\text{FeNO}\}^7$  complex,  $[\text{Fe}(\text{CN})_5\text{NO}]^{3-}$ .<sup>58</sup> This ion releases cyanide at low pH,<sup>6</sup> as shown above for *trans*-activated metalloporphyrins. The calculations for  $[\text{M}(\text{CN})_5\text{NO}]^{3-}$  ( $\text{M} = \text{Fe}, \text{Ru}, \text{Os}$ ) establish around 65% ( $\pi^*_{\text{NO}}$ ) and 25% (M) for the composition of the singly occupied molecular orbital (SOMO).<sup>58</sup>

For six-coordinated  $\{\text{MNO}\}^8$  systems, the E–F formalism requires strongly bent MNO angles, around  $120^\circ$ .<sup>14</sup> The results in Table 2 for  $[\text{Ru}(\text{HNO})(\text{py}^{\text{bu}}\text{S}_4)]$ , together with DFT calculations,<sup>47</sup> are consistent with previous information for  $[\text{Os}(\text{Cl})_2(\text{CO})(\text{HNO})(\text{PPh}_3)_2]$ , the first structurally characterized nitroxyl complex.<sup>15</sup> The diamagnetic, *mer,trans*- $[\text{Re}(\text{CO})_3(\text{HNO})(\text{PPh}_3)_2]\text{SO}_3\text{CF}_3$  was isolated and characterized by IR and  $^1\text{H}$ - $^{15}\text{N}$  NMR.<sup>59</sup> No structures are available for metalloporphyrins with CN 6,  $n=8$ , probably because of the enhanced *trans*-effect of nitrosyl. However, an HNO adduct of myoglobin in aqueous solution has been characterized by electrochemistry and NMR.<sup>60</sup>

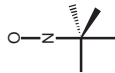
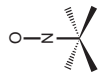
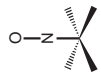
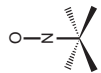
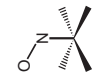
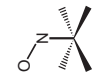
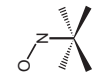
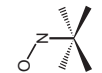
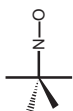
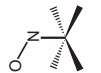
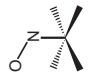
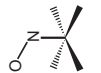
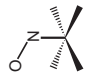
### 1.31.1.2.2 Coordination number 5

CN 5 compounds are the next most numerous cases. Table 3 contains some selected examples. Apart from the early known  $\{\text{MNO}\}^4$  complex,  $[\text{W}(\text{NO})(\text{OBU}^1)_3(\text{py})]$ ,<sup>15</sup> a new trigonal bipyramidal (TBP) complex has been reported,  $\text{Na}[\text{V}(\text{NO})(\text{L})]$ , ( $\text{L} = 2,2,2$ -nitrioltriethoxy), with a linear VNO group and  $\nu = 1,490 \text{ cm}^{-1}$ .<sup>61</sup> Within the  $\{\text{MNO}\}^6$  systems, the early reported  $[\text{Mn}(\text{NO})(\text{TPP})]$ <sup>15</sup> was followed by complex (30), the first characterized five-coordinated  $\{\text{FeNO}\}^6$  porphyrin derivative. It displays a low-spin, linear  $\text{FeNO}$  unit with a short M—N(NO) bond, as shown before for CN 6.<sup>62</sup> The synthesis, as with complex (31), requires careful conditions to prevent reductive nitrosylation and further coordination at the sixth position.<sup>62,63</sup> The use of porphyrin ligands which induce dimerization driven by  $\pi$ – $\pi$  interactions proved to be useful in preparing  $[\text{Fe}(\text{OEP})\text{NO}]^+$ .<sup>19</sup> The high-spin ( $S=2$ ) TBP tropocoronand-complex (32) was investigated in detail by X-ray, IR, and SQUID susceptometry, suggesting a  $\{\text{Mn}^{\text{III}}\text{NO}^-\}^6$  distribution.<sup>64</sup>

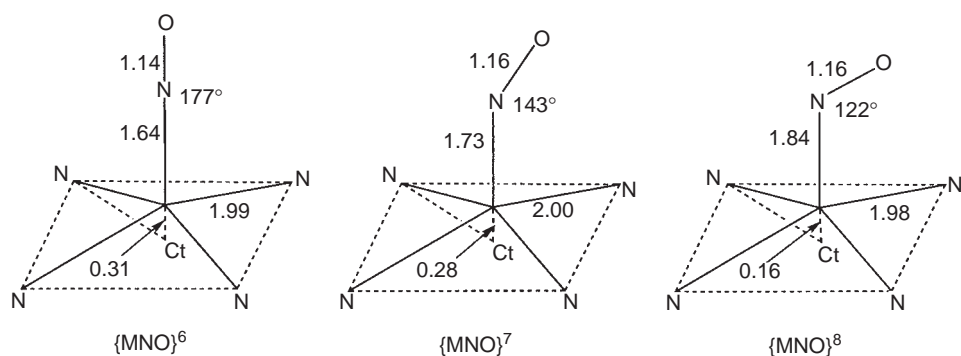
However, complexes with  $n=7$  or 8 constitute the predominant examples. Most of the reported  $\{\text{MNO}\}^7$  complexes are bent TP iron species. The first available  $[\text{Fe}(\text{TPP})(\text{NO})]$  structure, as well as others subsequently reported, displayed highly disordered  $\text{FeNO}$  fragments, limiting the accuracy of M—N(NO) and N—O bond lengths and MNO angles.<sup>19,20</sup> Other examples (complexes (33)–(35), Table 3) lack the complications arising from crystallographic disorder. They show the expected bent  $\text{FeNO}$  angles, ca.  $143$ – $144^\circ$ , with Fe—N(NO) distances around  $1.72 \text{ \AA}$ , longer than in the  $\{\text{MNO}\}^6$  complexes (related to loss of  $\pi$ -strength). The irons are displaced by ca.  $0.3 \text{ \AA}$  out of the porphyrin plane.<sup>69,70</sup> Besides, the Fe—N(O) vector is not perpendicular to the porphyrin plane but is tilted off-axis by  $6.5$ – $8.2^\circ$ , which has a significant effect on the equatorial Fe— $\text{N}_{\text{porph}}$  distances (two long and two short). This “tilt asymmetry” appears as an intrinsic feature of the total bonding interactions in  $\{\text{MNO}\}^7$  porphyrins.<sup>19,20</sup> A MO picture has been suggested to interpret this effect.<sup>68</sup>

Complex (36) constitutes the unique example of a  $n=7$  TBP species, holding a linear NO in the equatorial plane.<sup>65</sup> It was described as a low-spin ( $S=1/2$ )  $\text{Fe}^{\text{III}}\text{NO}^-$  moiety, based on EPR, Mössbauer, and magnetic susceptibility measurements.

**Table 3** Selected examples for five-coordinated nitrosyl compounds with different CN.

Compound number	$d_{M-N}$ (Å)	$d_{N-O}$ (Å)	$\angle MNO$ (°)	$\nu_{NO}$ (cm <sup>-1</sup> ) <sup>a</sup>	References
 29	1.696	1.254	178.9(7)	1,490	61
 30	1.652,8(13)	1.140(2)	173.19(13)	1,838	62
 31	1.631(3)	1.171(4)	176.9(3)	1,758	63
 32	1.699(3)	1.179(3)	174.1(3)	1,662	64
 33	1.716(15)	1.197(9)	143.8(17)	1,665	68
 34	1.722(2)	1.167(3)	144.2(2)	1,666	69
 34	1.730,7(7)	1.167,7(11)	142.74(8)	1,673	69
 35	1.721(4)	1.155(5)	143.7(4)	1,666	70
 36	1.670(4)	1.176(5)	174.3(4)	1,692	65
 37	1.844(9)	1.164,2(13)	122.70(8)	1,677	71
 38	1.837(4)	1.174(4)	121.8(3)	1,667	72
 39	1.785(6)	1.137(7)	127.3(6)	1,656	67
 40	1.779(6)	1.151(9)	128.9(6)	1,584	67

<sup>a</sup> IR frequencies. Abbreviations used for the ligands: L = 2,2,2-nitritoethoxy; OEP = octaethylporphyrin dianion; TpivotPP =  $\alpha,\alpha,\alpha,\alpha$ -tetrakis(*o*-pivalamidophenyl)-porphyrin dianion; OEC = 2,3,7,8,12,13,17,18-octaethylcorrole trianion; TC-3,3 = 6,7,8,9,16,17,18,19-Octahydrocyclohepta[*b*,*h*]1,4,8,11]tetraazaacyclotetradecene ("tropocoronand 3,3") dianion; TC-4,4 = 6,7,8,9,10,17,18,19,20,21-Decahydrocyclohepta[*b*,*h*]1,4,9,12]tetraazaacyclobexadecene ("tropocoronand 4,4") dianion; TC-5,5 = 6,7,8,9,10,11,18,19,20,21,22,23-dodecahydrocyclohepta[*b*,*h*]1,4,10,13]tetraazaacyclooctadecene ("tropocoronand 5,5") dianion; OETAP = 2,3,7,8,12,13,17,18-octaethyl-5,10,15,20-tetraazaporphine; dianion; OC<sub>2</sub>OPor = 5,10,15,20-(benzene-1,2,4,5-tetrakis(2-phenyloxyethoxy)-2,2',2'',2'''-tetraylporphyrinato dianion).



**Figure 4** Formal diagrams for five-coordinate nitrosylmetalloporphyrin  $\{\text{MNO}\}^n$ , ( $n = 6, 7, \text{ and } 8$ ). Distances and angles represent estimates of the “best” geometry (reproduced by permission of Wyllie and Scheidt, 2002;<sup>20</sup> © American Chemical Society).

The  $\{\text{MNO}\}^8$  complexes, essentially Co porphyrins,<sup>71,72</sup> show the predicted strongly bent MNO units. Figure 4 shows formal diagrams of the “consensus” structures for five-coordinated complexes with  $\{\text{MNO}\}^n$ , for  $n = 6, 7, \text{ or } 8$ . All the compounds in Table 3 have a low-spin electronic GS. Note the systematic variation in the MNO angle, M—N(NO) bond length, and metal ion displacements from the porphyrin cores.<sup>19</sup>

### 1.31.1.2.3 Coordination number 4 and others

Four-coordinated mononitrosyls exist mainly for  $n = 10, 8, \text{ and } 4$ .<sup>15</sup> The first are the most numerous. Pseudo-tetrahedral geometry is generally adopted, with three equivalent ligands and a linear MNO group, although distorted species are also found. A unique case for  $n = 11$  has been reported for the family of  $\text{Tp}^{\text{RR}'}\text{CuNO}$  complexes ( $\text{Tp}^{\text{RR}'} = \text{tris}(3\text{R}^1, 5\text{R}^2\text{-pyrazolyl})\text{hydroborate}$ ; (1),  $\text{R}^1 = \text{Bu}^t$ ,  $\text{R}^2 = \text{H}$ ; (2),  $\text{R}^1 = \text{R}^2 = \text{Ph}$ ).<sup>73</sup> Compound (1) was described as a  $\text{C}_{3v}$ -distorted tetrahedral  $\text{Cu}^{\text{I}}\text{-NO}$  complex, with the unpaired electron in a primarily  $\pi^*_{\text{NO}}$  orbital, and models a possible intermediate in nitrite reduction by copper nitrite reductase (NiR), as well as the copper site in zeolite materials with applications in heterogeneous  $\text{NO}_x$  removal from gas streams. For CN lower than four and higher than eight see ref. 15.

### 1.31.1.3 Polynitrosyls, Bridging Nitrosyls, and Clusters

Structure and bonding in polynitrosyl complexes can also be analyzed under the E-Fs framework,  $\{\text{M}(\text{NO})_x\}^n$ .<sup>15</sup> Mononuclear species with different CN and  $x = 2, 3, \text{ or } 4$  as well as bridging nitrosyl complexes have been described, and structural data is available.<sup>15</sup> Tetrahedral dinitrosyliron complexes,  $[\text{Fe}(\text{L})_2(\text{NO})_2]^n$  have been prepared;<sup>74</sup> those with  $\text{L} = \text{thiolates}$  and imidazolate have been studied by EPR, and are related to those observed in biological fluids.<sup>75</sup> A carboxylate-bridged nonheme diiron(II) dinitrosyl complex (a model for hemerythrin and ribonucleotide reductase) was prepared and studied by X-ray, IR, and Mössbauer, suggesting that two  $\{\text{FeNO}\}^7$  moieties are present.<sup>76</sup> A phenoxo-bridged dicopper(I) complex reacted with  $\text{NOBF}_4$  leading to a new dicopper(II) complex bridged by a  $\text{NO}^-$  ligand ( $d_{\text{N-O}} = 1.176 \text{ \AA}$ ,  $\nu_{\text{NO}} = 1,536 \text{ cm}^{-1}$ ).<sup>77</sup> Specific reviews have been published on the chemistry of iron-sulfur cluster nitrosyls, of which the black,  $[\text{Fe}_4(\text{NO})_7\text{S}_3]^-$  and red,  $[\text{Fe}_2(\text{NO})_4\text{S}_2]^{2-}$  Roussin’s salts are early known examples which release NO upon oxidation<sup>75,78</sup> or photochemical activation.<sup>75,79</sup>

### 1.31.1.4 $\eta^1\text{-ON}$ (Isonitrosyls) and $\eta^2\text{-NO}$ Complexes

Back in 1977, low- $T$  Mössbauer studies on irradiated sodium NP revealed a long-living “metastable” state, which could be thermally depopulated. Subsequent work with electronic, IR,<sup>80</sup> and Raman spectroscopies, as well as DSC results, revealed that actually two “metastable” states were involved,  $\text{MS}_1$  and  $\text{MS}_2$ , decaying at ca. 195 K and 151 K to the original GS, respectively. The IR



vibrations of the  $\{\text{FeNO}\}^6$  unit are shifted downwards in the MS states ( $\Delta\nu_{\text{NO}}$ :  $-110\text{ cm}^{-1}$  for  $\text{MS}_1$  and  $-280\text{ cm}^{-1}$  for  $\text{MS}_2$ ).<sup>83</sup>

Crucial evidence coming from X-ray difference maps measured on laser-irradiated samples containing a mixture of the GS together with  $\text{MS}_1$  and  $\text{MS}_2$  allowed identification of the precise nature of these long-living species, as shown in Figure 5.<sup>57</sup>  $\text{MS}_2$  is a sideways-bound,  $\eta^2$ -NO species. A lengthening of  $d_{\text{Fe-N}}$  is observed (1.668 Å to 1.89(2) Å), with  $d_{\text{Fe-O}} = 2.07\text{ Å}$ , and an unchanged  $d_{\text{N-O}}$ . The Fe atom moves toward the NO group while the equatorial cyanides move away from it.  $\text{MS}_1$  involves a nearly linear Fe–nitrosyl moiety, with some lengthening of the distance between Fe and the proximal atom and, again, no significant change in  $d_{\text{N-O}}$ . The interpretation of changes in the temperature parameters of the N and O atoms, supported by a neutron diffraction study, strongly suggest that the MON unit is present in  $\text{MS}_1$ . A recent nuclear inelastic scattering study performed on irradiated single crystals of guanidinium NP provides evidence supporting this interpretation.<sup>85</sup> The  $\text{MS}_1$  structure was confirmed for  $\text{K}_2[\text{Ru}(\text{OH})(\text{NO})(\text{NO}_2)_4]$ , with additional DSC evidence on  $\text{MS}_2$ .<sup>83,84</sup> Both MS states have been also characterized in  $[\text{Ru}(\text{Cl})(\text{NO})(\text{py})_4](\text{PF}_6)_2$ ,<sup>83,84</sup>  $\text{K}_2[\text{RuCl}_5\text{NO}]$ ,<sup>81</sup> and  $\text{Na}_2[\text{M}(\text{CN})_5\text{NO}] \cdot 2\text{H}_2\text{O}$  ( $\text{M} = \text{Ru}, \text{Os}$ ).<sup>80,82</sup> Evidence for  $\text{MS}_1$  also exists for the  $[\text{Ru}(\text{NH}_3)_4(\text{NO})\text{X}]^{n+}$  ions ( $\text{X} = \text{NH}_3, \text{OH}^-, \text{nic}$ ),<sup>83,84</sup> and for a series of Ru–nitrosyl complexes containing ethylenediamine coligands.<sup>83,84,86</sup> With these positively charged complexes, decay temperatures up to 260–277 K have been reached. The preparation of room-temperature stable linkage isomers is essential for using them in information storage devices.

The MS states originate in the decay of an electronically  $d_{xy} \rightarrow \pi^*_{\text{NO}}$  excited state (ES). Figure 6 shows a proposed interconversion scheme. Extended Huckel (EH) and more recently DFT-based methods were used to calculate the correlation diagram for NP undergoing the deformation from  $\eta^1$ -NO, through side-bound  $\eta^2$ -NO to  $\eta^1$ -ON. The calculations show that both  $\text{MS}_1$  and  $\text{MS}_2$  lie in local minima on the GS potential energy surfaces, indicating that these species are better described as isomers rather than long-lived ESs. The calculations also provide relative energies, geometry, and vibrational properties of the GS, MSs, and ESs.<sup>83,84,87,88</sup> The photoirradiation of  $\text{Ni}[\text{Fe}(\text{CN})_5\text{NO}] \cdot 5.3\text{H}_2\text{O}$  and related complexes induces new spin interactions (ordered magnetic clusters with  $S = 5$ ) between the newly appearing spin on Fe and the cyano-bridged  $\text{Ni}^{\text{II}}$  ions. As the solid decays to the disordered magnetic GS upon thermal treatment, it could be used for designing switchable molecular spin devices.<sup>12,13</sup>

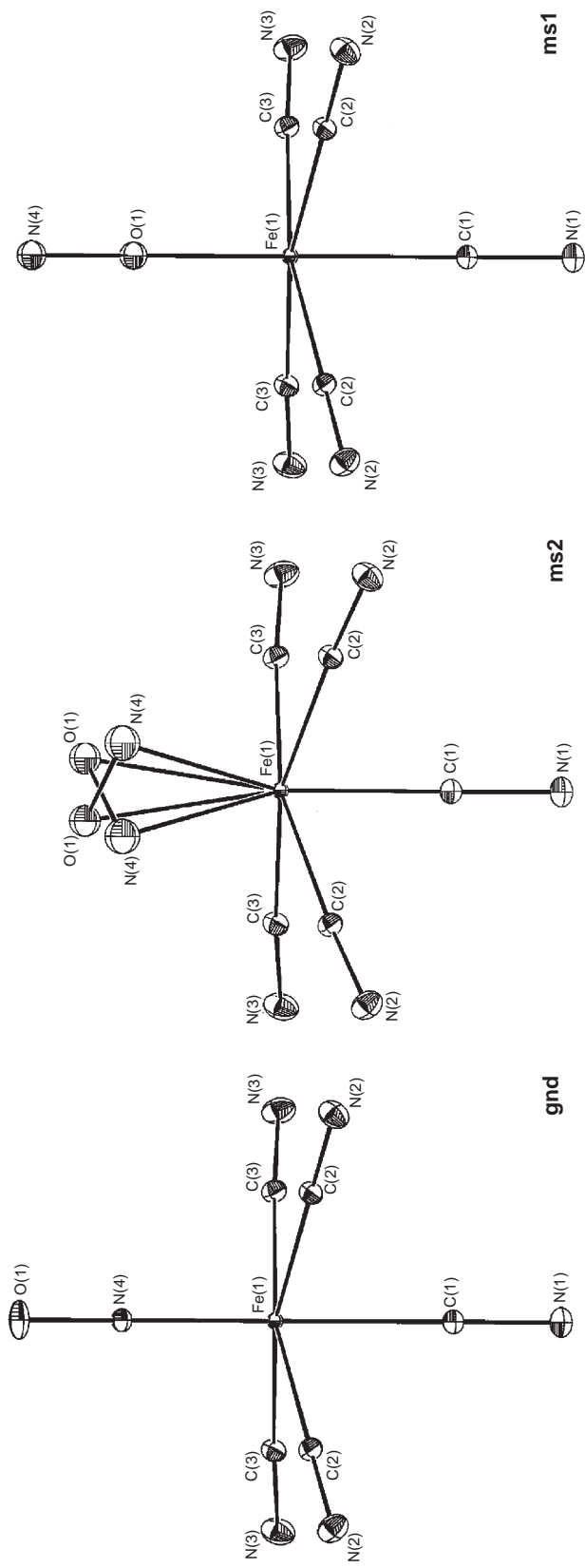
The work comprising new complexes is actively expanding. IR results suggest that both MS states are formed on irradiation at 20 K of several  $\{\text{MNO}\}^6$  metalloporphyrins  $[(\text{OEP})\text{Ru}(\text{NO})\text{L}]$  ( $\text{L} = \text{O}-i\text{-C}_5\text{H}_{11}, \text{SCH}_2\text{CF}_3, \text{Cl}, \text{py}$ ).<sup>83,84</sup> For the first time,  $\text{MS}_1$  was IR-characterized for two  $\{\text{MNO}\}^7$  nitrosyl porphyrins,  $[\text{Fe}(\text{TTP})\text{NO}]$  and  $[\text{Fe}(\text{OEP})\text{NO}]$ .<sup>83,84</sup> Low- $T$  photo-induced, reversible linkage isomerization of stable  $\eta^1$ - $\text{N}_2$  to the  $\eta^2$ - $\text{N}_2$  form has been observed in  $[\text{Os}(\text{NH}_3)_5\text{N}_2]^{2+}$ , showing that these processes are not limited to NO chemistry (see below for  $\text{N}_2\text{O}$ ).<sup>83,84</sup>

### 1.31.1.5 $\text{N}_2\text{O}$ Complexes

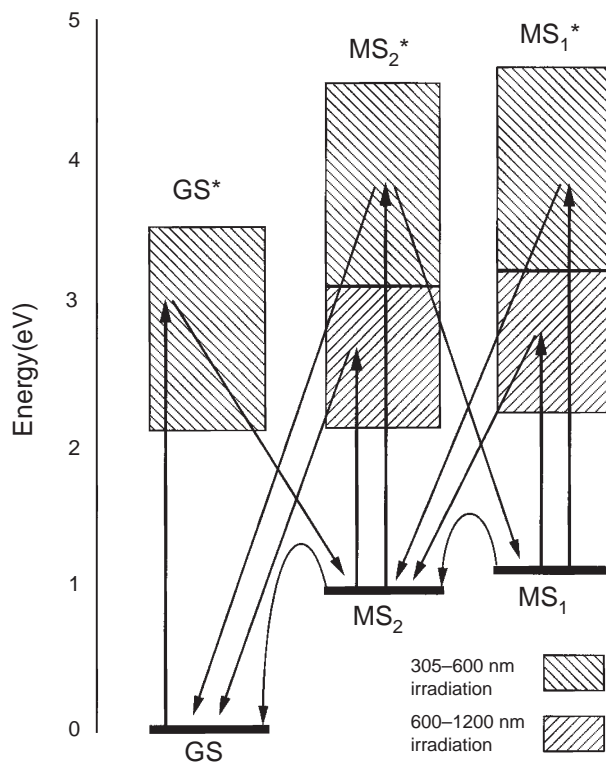
Dinitrogen monoxide,  $\text{N}_2\text{O}$ , is a very inert molecule, and an important trace component of the Earth's atmosphere, with a 120-year residence time. It is a more efficient greenhouse agent than  $\text{CO}_2$  and  $\text{CH}_4$ , and also an ozone antagonist, thus implying concern about its anthropogenic emission (fertilizers, deforestation, and adipic acid synthesis) that greatly surpasses its current use as an anesthetic and propeller.<sup>89</sup>  $\text{N}_2\text{O}$  is a linear molecule, isoelectronic with  $\text{CO}_2$ ,  $\text{NCO}^-$ , and  $\text{N}_3^-$ . The physical properties and chemistry have been reviewed.<sup>90</sup> Valence bond or MO models can be used for discussing the bond structure.

Although coordination to transition metals is likely involved in most of its chemistry, only halide salts of the  $[\text{Ru}(\text{NH}_3)_5\text{N}_2\text{O}]^{2+}$  ion have been characterized earlier (see Equation (14); no structure is available).<sup>91</sup> IR and UV–vis spectroscopies suggest a linear  $N$ -binding mode. The same coordination mode is suggested for the recently prepared  $\text{PPN}^+$  salt of  $[\text{Os}^{\text{II}}(\text{bpy})(\text{Cl})_3(\text{N}_2\text{O})]^-$  ( $\text{PPN}^+ = \text{bistriphenylphosphoranylidene ammonium}$ ), which was characterized by chemical analysis, IR, and  $^1\text{H}$  NMR.<sup>92</sup> Some evidence exists on the bridged  $[(\text{NH}_3)_5\text{RuNNORu}(\text{NH}_3)_5]^{4+}$  ion.<sup>93</sup> Characterization of  $\text{RuCl}_2(\eta^1\text{-N}_2\text{O})(\text{PN})(\text{PPh}_3)$  ( $\text{PN} = [o\text{-}(N,N\text{-dimethylamino})\text{phenyl}]$ diphenylphosphine) was performed by  $^{15}\text{N}$  NMR spectroscopy (the singlet at  $\delta = 125.8$  is evidence of  $\eta^1$ -coordination, while the upfield shift of ca. 25 ppm compared to free  $\text{N}_2\text{O}$  is consistent with  $N$ -binding).<sup>94</sup> A recent theoretical analysis suggests the existence of  $[\text{Fe}(\text{CN})_5(\eta^2\text{-N}_2\text{O})]^{3-}$  and





**Figure 5** Ortep plots of the GS of SNP and its linkage isomers MS<sub>1</sub> and MS<sub>2</sub> at 50 K, 50% ellipsoids (reproduced with permission from Carducci *et al.*, 1997;<sup>57</sup> © American Chemical Society).



**Figure 6** Proposed relationship and interconversion pathways between the different linkage isomers of SNP. Straight vertical arrows are electronic transitions, slanted arrows combine an electronic transition with nuclear motion. Curved arrows indicate thermal decay (reproduced with permission from Carducci *et al.*, 1997;<sup>57</sup> © American Chemical Society).

its  $\eta^1\text{-N}_2\text{O}$  isomer as intermediates in the reaction between NP and hydrazine prior to  $\text{N}_2\text{O}$  release.<sup>95</sup>

## 1.31.2 SYNTHESIS AND REACTIVITY OF NO AND $\text{N}_2\text{O}$ COMPLEXES

### 1.31.2.1 Reactions of NO

A recent review covering the different aspects of NO reactivity is available.<sup>96</sup> We summarize the more relevant aspects below.

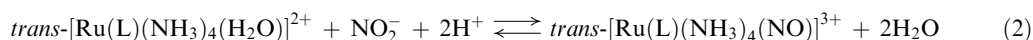
#### 1.31.2.1.1 Synthesis

General accounts of synthetic methods have been published.<sup>18,97,98</sup> We illustrate the most important routes which yield NO or its coordination compounds, particularly those used and studied in the recent years.

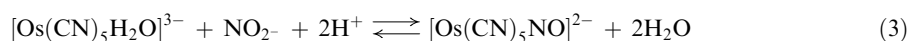
(i) Reaction of  $\text{NO}^+$  or NO at a coordinatively unsaturated metal site<sup>32</sup>



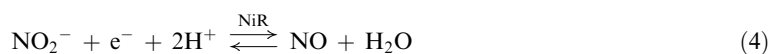
(ii) *Coordination of nitrite and conversion to linear NO on a labile site*<sup>37,44</sup>



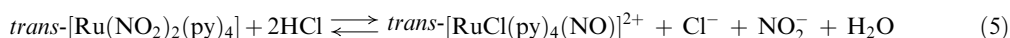
where L = py, l-hist, imN, etc.



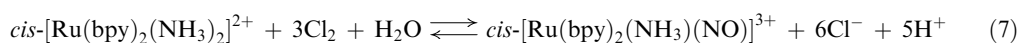
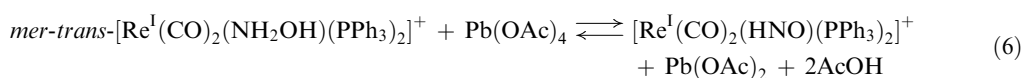
(iii) *Coordination of nitrite and release of NO by the dissimilatory nitrite reductase (NiR) enzymes (either Fe- or Cu-based)*<sup>11</sup>



(iv) *Acidification of nitro-complexes (closely related to Equation (3))*<sup>99</sup>



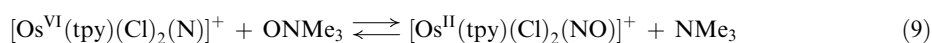
(v) *Oxidation of bound nitrogen hydrides with formation of NO (linear or bent)*<sup>59,100</sup>



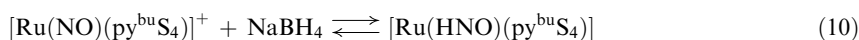
(vi) *Biosynthesis, involving production and release of NO (L-arginine → L-citrulline conversion in NO synthase)*<sup>2</sup>



(vii) *O-atom transfer to a bound nitride*<sup>43</sup>



(viii) Reduction of nitrosyl to “nitroxyl” (linear to bent conversion)<sup>47</sup>

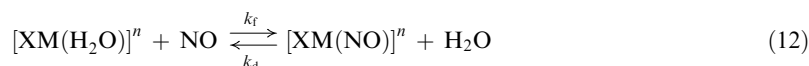


(ix) Reductive nitrosylation<sup>19</sup>



### 1.31.2.1.2 Formation and dissociation reactions of NO

Little work has been done on the free radical chemistry of NO binding to transition metals. Careful removal of impurities in the gas stream and absence of nitrite and/or NO<sub>2</sub> in solution must be ensured.<sup>96</sup> For the general reaction described by Equation (12),



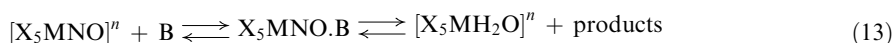
rate constants for a series of iron aminocarboxylates (X = EDTA, nitrilotriacetic acid, and derivatives) have been measured using stopped-flow (SF), T-jump, flash-, and pulse radiolysis techniques.<sup>101,102</sup> The  $k_f$  values (M<sup>-1</sup> s<sup>-1</sup>, 25 °C) lie in the range 10<sup>6</sup>–10<sup>8</sup>, whereas the  $k_d$  values (s<sup>-1</sup>, 25 °C) vary between 10<sup>-1</sup> and 10<sup>3</sup>. The interpretation of  $k_d$  values is complicated by the uncertainties on the electron distribution within the {XFeNO} units. These Fe<sup>II</sup>–chelate systems are potential catalysts for NO removal from gas streams.

Studies on nitrosylation reactions of metalloporphyrins are emerging and have been reviewed.<sup>21</sup> Reactions involving {FeNO}<sup>7</sup> and {FeNO}<sup>6</sup> species (considered as ferroheme and ferriheme, respectively) are crucial to enzymatic functions (activation of guanylyl cyclase, cytochrome oxidase, catalase inhibition). Reversible photodissociations of NO from nitrosyl metalloporphyrins have been studied by ns-pulsed laser techniques, providing values for  $k_f$  and  $k_d$  (Equation (12)). Dissociation processes are very slow, particularly for ferroheme complexes; however,  $k_d$  values in the 10<sup>-5</sup>–10<sup>1</sup> s<sup>-1</sup> range have been measured for several five-coordinated {FeNO}<sup>7</sup> tetraarylporphyrins.<sup>103</sup> The spread in the  $k_d$  values is not well understood yet.

The formation reactions of several metalloporphyrins have been studied using high-pressure <sup>17</sup>O NMR, laser photolysis, and SF techniques, at variable pressure. A dissociative mechanism is suggested for the forward step in Equation (12).<sup>104,105</sup> For other well-characterized mononitrosyl complexes with X = amines, cyanides, polypyridines, etc., no direct measurements of the reaction rates in Equation (12) are available for M<sup>II</sup> or M<sup>III</sup> complexes, with the recent exception of NO coordination into [Fe<sup>III</sup>(CN)<sub>5</sub>(H<sub>2</sub>O)]<sup>2-</sup>, which showed a rate-controlling, one-electron transfer step associated with reduction to Fe<sup>II</sup> and NO oxidation.<sup>106</sup> While NO is extremely stable and inert in these M<sup>II</sup>NO<sup>+</sup> units, the dissociation rates may be higher upon one-electron reduction. The complexes with polypyridine coligands still appear as very inert;<sup>4-6</sup> others become moderately labile, as in the [Ru(NH<sub>3</sub>)<sub>4</sub>L(NO)]<sup>2+</sup> series (L = py, pz, triethylphosphites), or in trans-[RuCl(NO)(cyclam)]<sup>2+</sup> (cyclam = 1,4,8,11-tetraazacyclotetradecane), with  $k_d$  in the range 10–10<sup>-4</sup> s<sup>-1</sup>.<sup>38,39,48</sup> The study of these reactions is important for the controlled NO delivery in biological fluids, as in the case of NP or other NO donors.<sup>107</sup>

### 1.31.2.1.3 Nucleophilic additions to bound NO

These reactions have been extensively studied and reviewed.<sup>96</sup> Equation (13) represents the general stoichiometry and mechanism:



Most studies have been performed with  $\{\text{MNO}\}^6$  low-spin complexes of group 8 metals and  $\text{Ir}^{\text{III}}$ . These linear complexes show high  $\nu_{\text{NO}}$  values, and are usually described as  $\text{M}^{\text{II}}\text{NO}^+$  species that become reactive when  $\nu_{\text{NO}}$  is greater than ca.  $1,880\text{ cm}^{-1}$ . The coligands are mainly polypyridines, ammonia, and cyanides, while the nucleophiles (B) can be  $\text{OH}^-$ ,  $\text{SH}^-$ ,  $\text{SR}^-$ ,  $\text{SO}_3^{2-}$ , and other *N*-binding species such as  $\text{NH}_2\text{OH}$ ,  $\text{N}_2\text{H}_4$ ,  $\text{NH}_3$ , and amines,  $\text{N}_3^-$ . These often called nitrosation reactions begin with reversible adduct formation, with B adding to the N atom of the MNO unit. The addition of  $\text{OH}^-$  to different  $[\text{X}_5\text{MNO}]^n$  complexes involves the reorganization from a linear (MNO) to a bent ( $\text{MNO}_2\text{H}$ ) group, with final deprotonation leading to nitro-complexes. The rates are dependent on the X coligands, which influence the electron density on the MNO electrophilic center.<sup>108</sup> For other nucleophiles the adducts usually decompose upon intramolecular redox changes, with reduction of nitrosyl and oxidation of B. The red adducts formed between NP and different thiolates are generally unstable, with the exception of the one with thiosuccinic acid.<sup>109</sup> Equilibrium data for the first step in Equation (13) are available, but rate constants are still scarce.

The addition of *N*-binding nucleophiles is relevant to the enzymatic redox chemistry of small nitrogenated species in natural media.<sup>11</sup> The  $\text{M}^{\text{II}}\text{NO}^+$  species may be formed upon nitrite coordination, and these can be attacked by the nitrogen hydrides described above, leading to denitrification reactions producing  $\text{N}_2$  and/or  $\text{N}_2\text{O}$ , as shown in Equation (14).<sup>91</sup>



Alternatively, the addition reactions of cysteine or glutathione on bound nitrosyl may be relevant to transport and transfer mechanisms of nitrosyl in biological fluids.<sup>9</sup>

#### 1.31.2.1.4 Reduction of bound NO: chemistry and electrochemistry

Reduction of metal–nitrosyl complexes is a prominent subject in the redox chemistry of small nitrogenated molecules, most relevant to biochemistry and to natural nitrogen-redox cycles.<sup>11</sup>  $\text{M}^{\text{II}}\text{NO}^+$  complexes have low-energy LUMOs and undergo facile one-electron reduction, usually showing reversible CV waves associated with  $\text{MNO}^+/\text{MNO}$  redox couples.<sup>4–6</sup> The  $\{\text{MNO}\}^6$  complexes yield fairly stable  $\{\text{MNO}\}^7$  species in solution, as evident from UV–vis, IR, and EPR. Some of the latter species release NO in the minute time scale; alternatively, the  $[\text{Fe}(\text{CN})_5\text{NO}]^{3-}$  and  $[\text{Ru}(\text{NH}_3)_5\text{NO}]^{2+}$  ions may lose cyanide or ammonia.<sup>4–6</sup> Some metalloporphyrins also afford reversible conversion between  $\text{MNO}^+/\text{MNO}$  forms.<sup>21</sup> The NiR enzymes release NO after nitrite coordination and reduction.<sup>11</sup>

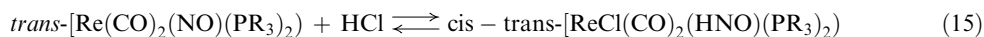
Further one-electron reduction at the nitrosyl site is feasible, but the products (seemingly  $\text{NO}^-$  or HNO) are usually labile in iron centers. The  $[\text{Fe}(\text{NO})(\text{TPPS})]^{4-}$  ion ( $\text{H}_2\text{TPPS}^{4-} = \textit{meso}$ -tetraakis(*p*-sulfonatophenyl)porphyrin) is able to process catalytically the  $6e^-$  reduction of nitrite down to ammonia, as done by the *assimilatory* nitrite reductase enzymes (Figure 1),<sup>11</sup> and different intermediates associated with consecutive one-electron reduction species have been proposed.<sup>110</sup> Final products may be  $\text{N}_2\text{O}$ ,  $\text{N}_2$ ,  $\text{NH}_2\text{OH}$ , or  $\text{NH}_3$ , depending on M, the reductant, and the medium. Different iron- and copper-containing enzymes are associated with these reduction processes in natural media.<sup>11</sup> Sometimes, unusual intermediates can be stabilized by coordination, as was the case with the side-on  $\eta^2\text{-NH}_2\text{O}$  (hydroxylaminy) ligand in the  $[\text{Mo}(\eta^2\text{-NH}_2\text{O})(\text{NO})(\text{S}_4)]^+$  complex ( $\text{S}_4 = 1,2\text{-bis}(2\text{-thiophenylthio})\text{ethane}$ ), obtained by reduction of the dinitrosyl complex with hydrazine.<sup>111</sup>

#### 1.31.2.1.5 Reductive nitrosylation

The term “reductive nitrosylation” was used for the nitrosyl formation reactions starting from high-oxidation state compounds (like  $\text{OsO}_4$  or  $\text{VO}_4^{3-}$ ), with reductants like hydroxylamine.<sup>18,61</sup> It is also used for reactions like Equation (11), as a representative example of ferriheme reactivity toward NO. Reduction to  $\text{Fe}^{\text{II}}$  is associated with one-electron oxidation of NO, which goes to an acceptor species.<sup>19</sup> The reductive nitrosylation rates for Cyt<sup>III</sup>, metMb, and metHb were found to be pH dependent, suggesting an intramolecular  $\text{Fe}^{\text{III}}\text{NO} \rightarrow \text{Fe}^{\text{II}}\text{NO}^+$  conversion, followed by a nucleophilic attack of  $\text{OH}^-$ , with release of nitrite. These mechanistic studies have been reviewed.<sup>96</sup>

### 1.31.2.1.6 Electrophilic reactions

Electrophilic attack at coordinated NO may occur at the nitrosyl nitrogen, at the nitrosyl oxygen, or at the metal.<sup>96</sup> An example of the first situation is the oxidative addition of acids to electron-rich nitrosyl complexes giving nitroxyl species:<sup>112</sup>



In contrast, addition of  $\text{HOSO}_2\text{CF}_3$ , providing a weak-coordinating counterion, leads to  $[\textit{trans},\textit{trans}\text{-}\text{ReH}(\text{CO})_2(\text{NO})(\text{PR}_3)_2]^+[\text{SO}_3\text{CF}_3]^-$ . Electrophilic NO can also be obtained by electrochemical reduction, as shown in the generation of adsorbed  $\text{Mb}(\text{NO}^-)$ .<sup>113</sup>

Other electrophiles, such as  $\text{Li}^+$  and  $\text{BF}_3$ , have been shown to bind weakly to  $\text{Co}^{\text{III}}\text{NO}^-$  complexes, which react with oxygen-forming  $\text{Co}^{\text{III}}\text{NO}_2^-$  complexes, able to oxidize alcohols catalytically. The activity of dioxygen and other oxidants as electrophiles toward nitrosyl complexes has been reviewed.<sup>3</sup>

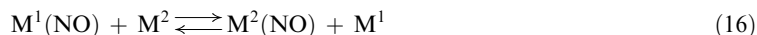
### 1.31.2.1.7 Disproportionation of metal-bound NO

The disproportionation of NO according to  $3\text{NO} \rightarrow \text{N}_2\text{O} + \text{NO}_2$  occurs in aged NO-containing cylinders, and constitutes an important path in the environmentally significant interconversions of NO,  $\text{NO}_x$ , and  $\text{N}_2\text{O}$ .

In solution the slow reaction is assisted by metals, leading to metal–nitrite complexes. With  $\text{Fe}(\text{TPP})$ , coordination of NO is followed by reaction with a second NO to give an N–N coupled intermediate, described as a Fe–hyponitrous species. The latter can transfer an O atom to an uncoordinated NO yielding  $\text{N}_2\text{O}$ ,  $\text{NO}_2$ , and free  $\text{Fe}(\text{TPP})$ .<sup>114</sup> Mechanistic aspects of these reactions are an active area of research.<sup>115</sup> Various Cu complexes with substituted Tp ligands<sup>73,116</sup> ( $\text{T}_p$ :  $\text{HB}(\text{pz})_3$ , hydrotris(pyrazolyl)borate) have been used as models for the NO reductase enzymes (NoR), which transform NO into  $\text{N}_2\text{O}$ .<sup>11</sup> These Cu complexes also disproportionate NO. The  $[\text{Mn}(\text{NO})(\text{TC}-5,5)]$  complex (TC = tropocoronand; see Section 1.31.1.2 and Table 2),<sup>64</sup> reacted in excess of NO releasing  $\text{N}_2\text{O}$  and yielding  $[\text{Mn}(\text{ONO})(\text{NO})(\text{TC}-5,5)]$ . Dinitrosyl and hyponitrite species are postulated as precursors of disproportionation. The strongly electron-donor ligand TC-5,5 favors reduction of NO to bound  $\text{NO}^-$ , stabilizing the  $\{\text{Mn}^{\text{III}}\text{NO}^-\}^6$  moiety which promotes the reductive activation of NO to form  $\text{N}_2\text{O}$ . A similar reaction was found with the  $[\text{Fe}(\text{TC}-5,5)]$  analog, which yields a pentacoordinate  $\{\text{FeNO}\}^7$  complex.<sup>65</sup> Analogous reactivity has been found for ruthenium porphyrins (TPP, OEP, TmTP).<sup>96</sup>

### 1.31.2.1.8 Nitrosyl transfer

Equation (16) describes a case of intermolecular NO transfer between different complexes:



This has been early observed between  $[\text{Co}(\text{NH}_3)_5(\text{NO})]^{2+}$  and  $\text{Cr}^{2+}$ , and between cobalt dimethylglyoximate complexes and hemoglobin. An *in situ* IR spectroscopic and mechanistic study revealed that the Mn-bound NO ligand in the TC complex was transferred quantitatively to the iron analogue (see above).<sup>66</sup> The reaction did not proceed in the reverse sense, showing the much higher affinity of iron for NO. The kinetic analysis suggests that NO dissociation, rather than NO-bridged intermediate formation, could be the general path for intermolecular NO transfer reactions.

## 1.31.2.2 Reactions of $\text{N}_2\text{O}$

### 1.31.2.2.1 Synthesis of $\text{N}_2\text{O}$ complexes

$\text{N}_2\text{O}$  can form in natural nitrogen cycles (mainly in soils) through denitrification pathways (Figure 1).<sup>2,90</sup> The latter involves the NoR enzymes.<sup>11</sup> Large emissions appear as a by-product

of the manufacture of adipic acid (catalyzed oxidations of cyclohexanol/cyclohexanone with nitric acid). Most synthetic routes leading to  $N_2O$  involve coupling reactions between high and low oxidation state nitrogen compounds, with nitrates, nitrites, or NO as oxidants and nitrogen hydrides (ammonia, hydroxylamine, hydrazine, azide) or transition metals as reductants.<sup>89,90</sup> The mechanism for the controlled thermal decomposition of ammonium nitrate, an important fertilizer, has been reviewed,<sup>90</sup> but there are only a few detailed mechanistic studies for most of these redox reactions. They are metal catalyzed, with probable  $N_2O$ -coordination as a very labile species in intermediate steps.<sup>91,92,95</sup>  $N_2O$  can also be formed by disproportionation of hydroxylamine or NO, as well as by decoupling dehydration of hyponitrous acid,  $H_2N_2O_2$ .<sup>90</sup> The reasonably well characterized  $\eta^1-N_2O$  complexes were obtained by substitution at a vacant metal site, by bubbling  $N_2O$  either into aqueous  $[Ru(NH_3)_5H_2O]^{2+}$  (room temperature)<sup>91</sup> or into the five-coordinate  $[RuCl_2(PN)(PPh)_3]$  complex, in  $CD_2Cl_2$ , at  $-78^\circ C$ .<sup>94</sup> The first complex was also prepared according to Equation (14),<sup>91</sup> and a similar reaction using azide as nucleophile.

#### 1.31.2.2.2 Reduction of $N_2O$ involving O-atom transfer

There is evidence of  $N_2O$  binding to  $[Ru^{II}(TMP)(THF)_2]$  (TMP = dianion of tetramesitylporphyrin), with subsequent splitting forming  $Ru^{VI}$ -dioxo species (capable of oxidizing sulfide to sulfoxide). Mechanistic evidence suggesting a  $N_2O$ -bridged dinuclear complex and  $Ru(N_2)(TMP)(THF)$  as intermediates are relevant to the elucidation of oxygen atom transfer mechanisms from  $N_2O$  and its possible applications in industrial and environmental processes.<sup>117</sup> Similar O-transfer reactions have been observed over cobalt porphyrins, polyamine complexes of nickel, transition-metal oxides, and during the oxidation of hydrocarbons over supported metals or zeolites. Selective epoxidation of alkenes by polyoxometalates involves this same kind of  $N_2O$  activation.<sup>118</sup> The two-electron conversion of  $N_2O$  to  $N_2$  in soils is processed by the copper-based nitrous oxide reductase enzyme (Nos).<sup>11,119</sup>

#### 1.31.2.2.3 $N\equiv N$ bond cleavage of $N_2O$

This reaction path was first observed in the three-coordinated  $d^3$  complex,  $Mo(NR\text{Ar})_3$  ( $R = C(CD_3)_2Me$ ,  $Ar = 3,5-C_6H_3Me_2$ ), upon reaction with  $N_2O$  in degassed  $Et_2O$ , at  $25^\circ C$ . The products were the crystalline nitrido-complex,  $MoN(NR\text{Ar})_3$ , and the nitrosyl species,  $Mo(NO)(NR\text{Ar})_3$ , in a 1:1 ratio. The only precedent for  $N\equiv N$  cleavage is the stratospheric production of NO upon reaction of  $N_2O$  with  $O(^1D)$ .<sup>120</sup>

#### 1.31.2.2.4 $N_2O$ formation involving N-atom transfer

This corresponds to a reversal of the  $N\equiv N$  cleavage reaction described above. The reaction of the  $TpOs(N)Cl_2$  complex with 2 mol of NO yielded  $TpOs(NO)Cl_2$  and  $N_2O$ .<sup>121</sup>

#### 1.31.2.2.5 $N_2O$ from reductive coupling of NO

The reaction:  $2NO + CO \rightleftharpoons N_2O + CO_2$  is catalyzed by Pd/Cu complexes (similar to the Wacker process), and has been thoroughly studied mechanistically. A Pd-bound hyponitrite species was proposed as intermediate, formed from Pd-NO plus NO. This mechanism could be relevant to the formation of  $N_2O$  in several biological systems comprising NO reductase activity such as cytochrome c oxidases and the denitrification enzyme P450nor.<sup>90</sup>

#### 1.31.2.2.6 Catalyzed disproportionation of NO in basic medium

The reaction  $4NO + 2OH^- \rightarrow N_2O + 2NO_2^- + H_2O$  is catalyzed by heterogeneous  $Pd^0$  on activated charcoal in 3M NaOH. It offers a new catalytic approach for NO scrubbing from exhaust gases. A critical comparison with other catalytic systems has been presented.<sup>122</sup>



### 1.31.2.2.7 Electroreduction catalyzed by transition-metal complexes

Cobalt porphyrins and phthalocyanines, nickel(II) macrocyclic polyamines, and other metal centers have been reported to catalyze the electroreduction of nitrous oxide according to  $\text{N}_2\text{O} + 2\text{H}^+ + 2\text{e}^- \rightarrow \text{N}_2 + \text{H}_2\text{O}$ . Kinetic experiments suggest the presence of  $\text{N}_2\text{O}$ -metal adducts in the rate-determining step.<sup>123,124</sup>

## 1.31.3 CONCLUSIONS AND OUTLOOK

The coordination chemistry of the nitrosyl ligand is an actively expanding field, with a notorious input of new information regarding synthetic aspects, modern structural, spectroscopic and theoretical methodologies, and new insights into the diverse reactivity modes displayed by bound NO. The use of NO gas as a synthetic precursor to {MNO} complexes (free of oxidizing impurities!) is contributing to discern on the fundamental properties of NO as a ligand, the preservation of its radical character upon coordination and the redox interconversions leading to (formally)  $\text{NO}^+$  or  $\text{NO}^-$  (HNO) bound species. The E-F approach has shown as an invaluable tool to deal with general structural aspects related to the geometry and electronic configurations for more than 25 years. But the strongly delocalized nature of the {MNO} fragment requires the combination of state of the art spectroscopy and theoretical methodologies to assess the non-trivial issue of the electronic distribution among the metal and the NO ligand.

In recent years, low-*T* photocrystallography permitted the identification of NO linkage isomers, species completely unexpected in the past. The studies to identify unusual coordination modes are rapidly extending to other small ligands such as  $\text{N}_2$ , and triatomic molecules like  $\text{NO}_2^-$  and  $\text{SO}_2$ . These species are potential intermediates in many relevant reactions, and their identity and properties can be also interrogated using theoretical methodologies, which eventually confirm or even predict the existence of still undetected species.

New systems have been developed for studying the metal-assisted NO-disproportionation reactions. Controversial issues on this and on other redox reactions of NO associated with nitrification and denitrification processes demonstrate that the field of mechanistic NO-chemistry is still not completely mature. Key advances have been made on the structural and spectroscopic characterization of bound "nitroxyl," HNO, after the successful synthesis starting either from more oxidized or more reduced *N*-ligands. Nevertheless, much is left for better describing its reactivity. Moreover, many reactions reported and studied long ago, such as the *N*- and *S*-binding nucleophilic additions to bound  $\text{NO}^+$ , are being revisited in order to disclose more their mechanistic details clearly. Also in this field, experiment and theory converge to provide explanations for the formation and release of products to the medium, such as gaseous  $\text{N}_2$  or  $\text{N}_2\text{O}$ , or the physiologically relevant nitrosothiolates.

The achievements in these fields have clearly surpassed, at least in number of well-characterized compounds and processes, the advances in the coordination chemistry of  $\text{N}_2\text{O}$ . More should be learnt on the biological role of  $\text{N}_2\text{O}$ . Here, probably more than in other cases, scientists should find inspiration for their work in natural systems.

## 1.31.4 REFERENCES

1. Jones, N. K. *Comprehensive Inorganic Chemistry*; Pergamon: Oxford, 1973; Vol. 4.
2. Feelisch, M.; Stamler, J. S., Ed.; *Methods in Nitric Oxide Research*; Wiley: Chichester, 1996.
3. Richter-Addo, G. B.; Legzdins, P.; Burstyn, J. *Chem. Rev.* **2002**, *102*, 857–859.
4. (a) Lancaster, J. J. Ed.; *Nitric Oxide, Principles and Actions*; Academic Press: San Diego, CA, 1996.
5. Ignarro, J. L., Ed.; *Nitric Oxide, Biology and Pathobiology*; Academic Press: San Diego, CA, 2000.
6. Clarke, M. J.; Gaul, J. B. *Struct. Bond.* **1993**, *81*, 147–181.
7. Armor, J. N., Ed.; *ACS Symp. Ser.* **1993**, 552.
8. Pandey, K. K. *Coord. Chem. Rev.* **1983**, *51*, 69–98.
9. Stamler, J. S.; Singel, D. J.; Loscalzo, J. *Science* **1992**, *258*, 1898–1902.
10. Bonner, F. T.; Hughes, M. N. *Science* **1993**, *260*, 145–146.
11. Averill, B. A. *Chem. Rev.* **1996**, *96*, 2951–2964.
12. Gu, Z. Z.; Sato, O.; Iyoda, T.; Hashimoto, K.; Fujishima, A. *Chem. Mater.* **1997**, *9*, 1092–1097.
13. Clemente-León, M.; Coronado, E.; Galán-Mascarós, J. R.; Gómez-García, C. J.; Woike, T.; Clemente-Juan, J. M. *Inorg. Chem.* **2001**, *40*, 87–94.
14. Enemark, J. H.; Feltham, R. D. *Coord. Chem. Rev.* **1974**, *13*, 339–406.
15. Enemark, J. H.; Feltham, R. D. *Top. Stereochem.* **1981**, *12*, 155–215.



16. Westcott, B. L.; Enemark, J. H. Transition Metal Nitrosyls. In *Inorganic Electronic Structure and Spectroscopy*; Wiley: New York, 1999; Vol. II, pp 403–450.
17. Johnson, B. F. G.; Haymore, B. L.; Dilworth, J. R. Miscellaneous Nitrogen-containing Ligands. In *Comprehensive Coordination Chemistry*; Wilkinson, G.; Gillard, R. D.; McCleverty, J. A. Eds.; Pergamon: Oxford, UK., 1987; Vol. 2, Chapter 13.3, pp 99–160.
18. Richter-Addo, G. B.; Legzdins, P. *Metal Nitrosyls*; Oxford University Press: New York, 1992.
19. Scheidt, W. R.; Ellison, M. K. *Acc. Chem. Res.* **1999**, *32*, 350–359.
20. Wyllie, G. R. A.; Scheidt, W. R. *Chem. Rev.* **2002**, *102*, 1067–1089.
21. Hoshino, M.; Laverman, L.; Ford, P. C. *Coord. Chem. Rev.* **1999**, *187*, 75–102.
22. Sellmann, D.; Kremitzl, H. J.; Knoch, F. *Inorg. Chim. Acta* **1994**, *225*, 163–171.
23. Bohmer, J.; Haselhorst, G.; Wieghardt, K.; Nuber, B. *Angew. Chem. Int. Ed. Engl.* **1994**, *33*, 1473–1476.
24. Bohmer, J.; Wieghardt, K.; Nuber, B. *Angew. Chem. Int. Ed. Engl.* **1995**, *34*, 1435–1437.
25. Cano, M.; Heras, J. V.; Trofimenko, S.; Monge, A.; Gutierrez, E.; Jones, C. J.; McCleverty, J. A. *J. Chem. Soc., Dalton Trans.* **1990**, 3577–3582.
26. Diebold, T.; Schappacher, M.; Chevrier, B.; Weiss, R. *J. Chem. Soc. Chem. Comm.* **1979**, 693–694.
27. Scheidt, W. R.; Lee, Y. J.; Hatano, K. *J. Am. Chem. Soc.* **1984**, *106*, 3191–3198.
28. Ellison, M. K.; Scheidt, W. R. *J. Am. Chem. Soc.* **1999**, *121*, 5210–5219.
29. Ellison, M. K.; Schulz, C. E.; Scheidt, W. R. *Inorg. Chem.* **1999**, *38*, 100–108.
30. Richter-Addo, G. B.; Wheeler, R. A.; Hixson, C. A.; Chen, L.; Khan, M. A.; Ellison, M. K.; Schulz, C. E.; Scheidt, W. R. *J. Am. Chem. Soc.* **2001**, *123*, 6314–6326.
31. Hauser, C.; Glaser, T.; Bill, E.; Weyhermuller, T.; Wieghardt, K. *J. Am. Chem. Soc.* **2000**, *122*, 4352–4365.
32. Sellmann, D.; Blum, N.; Heinemann, F. W.; Hess, B. A. *Chem. Eur. J.* **2001**, *7*, 1874–1880.
33. Yi, G. B.; Khan, M. A.; Richter-Addo, G. B. *Inorg. Chem.* **1996**, *35*, 3453–3454.
34. Bohle, D. S.; Hung, C. H.; Smith, B. D. *Inorg. Chem.* **1998**, *37*, 5798–5806.
35. Miranda, K. M.; Bu, X. H.; Lorkovic, I.; Ford, P. C. *Inorg. Chem.* **1997**, *36*, 4838–4848.
36. Yi, G. B.; Chen, L.; Khan, M. A.; Richter-Addo, G. B. *Inorg. Chem.* **1997**, *36*, 3876–3885.
37. Bezerra, C. W. B.; da Silva, S. C.; Gambardella, M. T. P.; Santos, R. H. A.; Plicas, L. M. A.; Tfouni, E.; Franco, D. W. *Inorg. Chem.* **1999**, *38*, 5660–5667.
38. Lang, D. R.; Davis, J. A.; Lopes, L. G. F.; Ferro, A. A.; Vasconcellos, L. C. G.; Franco, D. W.; Tfouni, E.; Wieraszko, A.; Clarke, M. J. *Inorg. Chem.* **2000**, *39*, 2294–2300.
39. Lopes, L. G. F.; Wieraszko, A.; El-Sherif, Y.; Clarke, M. J. *Inorg. Chim. Acta* **2001**, *312*, 15–22.
40. Nagao, H.; Nishimura, H.; Funato, H.; Ichikawa, Y.; Howell, F. S.; Mukaida, M.; Kakihana, H. *Inorg. Chem.* **1989**, *28*, 3955–3959.
41. Olabe, J. A.; Gentil, L. A.; Rigotti, G. E.; Navaza, A. *Inorg. Chem.* **1984**, *23*, 4297–4302.
42. Chen, L.; Khan, M. A.; Richter-Addo, G. B. *Inorg. Chem.* **1998**, *37*, 533–540.
43. Williams, D. S.; Meyer, T. J.; White, P. S. *J. Am. Chem. Soc.* **1995**, *117*, 823–824.
44. Baraldo, L. M.; Bessega, M. S.; Rigotti, G. E.; Olabe, J. A. *Inorg. Chem.* **1994**, *33*, 5890–5896.
45. Pohl, K.; Wieghardt, K.; Nuber, B.; Weiss, J. *J. Chem. Soc. Dalton Trans.* **1987**, 187–192.
46. Nasri, H.; Ellison, M. K.; Chen, S. X.; Huynh, B. H.; Scheidt, W. R. *J. Am. Chem. Soc.* **1997**, *119*, 6274–6283.
47. Sellmann, D.; Gottschalk-Gaudig, T.; Haussinger, D.; Heinemann, F. W.; Hess, B. A. *Chem. Eur. J.* **2001**, *7*, 2099–2103.
48. McGarvey, B. R.; Ferro, A. A.; Tfouni, E.; Bezerra, C. W. B.; Bagatin, I.; Franco, D. W. *Inorg. Chem.* **2000**, *39*, 3577–3581.
49. Li, M.; Bonnet, D.; Bill, E.; Neese, F.; Weyhermuller, T.; Blum, N.; Sellmann, D.; Wieghardt, K. *Inorg. Chem.* **2002**, *41*, 3444–3456.
50. Ding, X. D.; Weichsel, A.; Andersen, J. F.; Shokhireva, T. K.; Balfour, C.; Pierik, A. J.; Averill, B. A.; Montfort, W. R.; Walker, F. A. *J. Am. Chem. Soc.* **1999**, *121*, 128–138.
51. Maes, E. M.; Walker, F. A.; Montfort, W. R.; Czernuszewicz, R. S. *J. Am. Chem. Soc.* **2001**, *123*, 11664–11672.
52. Park, E. S.; Thomas, M. R.; Boxer, S. G. *J. Am. Chem. Soc.* **2000**, *122*, 12997–12303.
53. Brown, C. A.; Pavlosky, M. A.; Westre, T. E.; Zhang, Y.; Hedman, B.; Hodgson, K. O.; Solomon, E. I. *J. Am. Chem. Soc.* **1995**, *117*, 715–732.
54. Wanat, A.; Schnepfenseper, T.; Stochel, G.; van Eldik, R.; Bill, E.; Wieghardt, K. *Inorg. Chem.* **2002**, *41*, 4–10.
55. Westre, T. E.; Diccio, A.; Filippini, A.; Natoli, C. R.; Hedman, B.; Solomon, E. I.; Hodgson, K. O. *J. Am. Chem. Soc.* **1994**, *116*, 6757–6768.
56. Lebrero, M. C. G.; Scherlis, D. A.; Estiú, G. L.; Olabe, J. A.; Estrin, D. A. *Inorg. Chem.* **2001**, *40*, 4127–4133.
57. Carducci, M. D.; Pressprich, M. R.; Coppens, P. *J. Am. Chem. Soc.* **1997**, *119*, 2669–2678.
58. Wanner, M.; Scheiring, T.; Kaim, W.; Slep, L. D.; Baraldo, L. M.; Olabe, J. A.; Zalis, S.; Baerends, E. J. *Inorg. Chem.* **2001**, *40*, 5704–5707.
59. Southern, J. S.; Hillhouse, G. L.; Rheingold, A. L. *J. Am. Chem. Soc.* **1997**, *119*, 12406–12407.
60. Lin, R.; Farmer, P. J. *J. Am. Chem. Soc.* **2000**, *122*, 2393–2394.
61. Wieghardt, K.; Kleineboyman, M.; Swiridoff, W.; Nuber, B.; Weiss, J. *J. Chem. Soc. Dalton Trans.* **1985**, 2493–2597.
62. Ellison, M. K.; Schultz, C. E.; Scheidt, W. R. *Inorg. Chem.* **2000**, *39*, 5102–5110.
63. Autret, M.; Will, S.; Van Caemelbecke, E.; Lex, J.; Gisselbrecht, J. P.; Gross, M.; Vogel, E.; Kadish, K. M. *J. Am. Chem. Soc.* **1994**, *116*, 9141–9149.
64. Franz, K. J.; Lippard, S. J. *J. Am. Chem. Soc.* **1998**, *120*, 9034–9040.
65. Franz, K. J.; Lippard, S. J. *J. Am. Chem. Soc.* **1999**, *121*, 10504–10512.
66. Franz, K. J.; Lippard, S. J. *Inorg. Chem.* **2000**, *39*, 3722–3723.
67. Franz, K. J.; Doerr, L. H.; Spingler, B.; Lippard, S. J. *Inorg. Chem.* **2001**, *40*, 3774–3780.
68. Nasri, H.; Haller, K. J.; Wang, Y.; Huynh, B. H.; Scheidt, W. R. *Inorg. Chem.* **1992**, *31*, 3459–3467.
69. Ellison, M. K.; Scheidt, W. R. *J. Am. Chem. Soc.* **1997**, *119*, 7404–7405.
70. Bohle, D. S.; Debrunner, P. G.; Fitzgerald, J.; Hansert, B.; Hung, C. H.; Thompson, A. J. *Chem. Commun.* **1997**, 91–92.
71. Ellison, M. K.; Scheidt, W. R. *Inorg. Chem.* **1998**, *37*, 382–383.

72. Jene, P. G.; Ibers, J. A. *Inorg. Chem.* **2000**, *39*, 5796–5802.
73. Ruggiero, C. E.; Carrier, S. M.; Antholine, W. A.; Whitakker, J. M.; Cramer, C. J.; Tolman, W. B. *J. Am. Chem. Soc.* **1993**, *115*, 11285–11298.
74. Atkinson, F. L.; Brown, N. C.; Connelly, N. G.; Orpen, A. G.; Rieger, A. L.; Rieger, P. H.; Rosair, G. M. *J. Chem. Soc. Dalton Trans.* **1996**, 1959–1966.
75. Butler, A. R.; Megson, I. L. *Chem. Rev.* **2002**, *102*, 1155–1165.
76. Feig, A. L.; Bautista, M. T.; Lippard, S. J. *Inorg. Chem.* **1996**, *35*, 6892–6898.
77. Paul, P. P.; Tyeklar, Z.; Farooq, A.; Karlin, K. D.; Liu, S.; Zubieta, J. *J. Am. Chem. Soc.* **1990**, *112*, 2430–2432.
78. Butler, A. R.; Glidewell, C.; Li, M. H. *Adv. Inorg. Chem.* **1988**, *32*, 335–393.
79. Ford, P. C.; Bourassa, J.; Miranda, K.; Lee, B.; Lorkovic, I.; Boggs, S.; Kudo, S.; Laverman, L. *Coord. Chem. Rev.* **1998**, *171*, 185–202.
80. Guida, J. A.; Piro, O. E.; Schaiquevich, P. S.; Aymonino, P. J. *Solid State Commun.* **1997**, *101*, 471–475.
81. Guida, J. A.; Ramos, M. A.; Aymonino, P. J. *J. Mol. Struct.* **2002**, *609*, 39–46.
82. Guida, J. A.; Piro, O. E.; Aymonino, P. J. *Inorg. Chem.* **1995**, *34*, 4113–4116.
83. Coppens, P.; Fomitchev, D. V. V.; Carducci, M. D.; Culp, K. *J. Chem. Soc. Dalton Trans.* **1998**, 865–872.
84. Coppens, P.; Novozhilova, I.; Kovalevsky, A. *Chem. Rev.* **2002**, *102*, 861–883.
85. Paulsen, H.; Rusanov, V.; Benda, R.; Herta, C.; Schunemann, V.; Janiak, C.; Dorn, T.; Chumakov, A. I.; Winkler, H.; Trautwein, A. X. *J. Am. Chem. Soc.* **2002**, *124*, 3007–3011.
86. Kawano, M.; Ishikawa, A.; Morioka, Y.; Tomizawa, H.; Miki, E. I.; Ohashi, Y. *J. Chem. Soc. Dalton Trans.* **2000**, 2425–2431.
87. Gorelsky, S. I.; Lever, A. B. P. *Int. J. Quantum Chem.* **2000**, *80*, 636–645.
88. Boulet, P.; Buchs, M.; Chermette, H.; Daul, C.; Gilardoni, F.; Rogemond, F.; Schlapfer, C. W.; Weber, J. *J. Phys. Chem. A* **2001**, *105*, 8991–8998.
89. Trogler, W. C. *J. Chem. Educ.* **1995**, *72*, 973–976.
90. Trogler, W. C. *Coord. Chem. Rev.* **1999**, *187*, 303–327.
91. Bottomley, F.; Crawford, J. R. *J. Am. Chem. Soc.* **1972**, *94*, 9092–9095.
92. Huynh, M. H. V.; Baker, R. T.; Jameson, D. L.; Laboriau, A.; Meyer, T. J. *J. Am. Chem. Soc.* **2002**, *124*, 4580–4582.
93. Armor, J. N.; Taube, H. *Chem. Commun.* **1971**, 287–288.
94. Pamplin, C. B.; Ma, E. S. F.; Safari, N.; Rettig, S. J.; James, B. R. *J. Am. Chem. Soc.* **2001**, *123*, 8596–8597.
95. Gutierrez, M. M.; Amorebieta, V. T.; Estiú, G. L.; Olabe, J. A. *J. Am. Chem. Soc.* **2002**, *124*, 10307–10319.
96. Ford, P. C.; Lorkovic, I. M. *Chem. Rev.* **2002**, *102*, 993–1017.
97. Caulton, K. G. *Coord. Chem. Rev.* **1975**, *14*, 317–355.
98. Mingos, D. M. P.; Sherman, D. J. *Adv. Inorg. Chem.* **1989**, *34*, 293–377.
99. Coe, B. J.; Meyer, T. J.; White, P. S. *Inorg. Chem.* **1995**, *34*, 593–602.
100. Assefa, Z.; Stanbury, D. M. *J. Am. Chem. Soc.* **1997**, *119*, 521–530.
101. Schneppen sieper, T.; Wanat, A.; Stochel, G.; Goldstein, S.; Meyerstein, D.; van Eldik, R. *Eur. J. Inorg. Chem.* **2001**, 2317–2325.
102. Schneppen sieper, T.; Wanat, A.; Stochel, G.; van Eldik, R. *Inorg. Chem.* **2002**, *41*, 2565–2573.
103. Bohle, D. S.; Hung, C. H. *J. Am. Chem. Soc.* **1995**, *117*, 9584–9585.
104. Laverman, L. E.; Wanat, A.; Oszejka, J.; Stochel, G.; Ford, P. C.; van Eldik, R. *J. Am. Chem. Soc.* **2001**, *123*, 285–293.
105. Schneppen sieper, T.; Zahl, A.; van Eldik, R. *Angew. Chem. Int. Ed. Engl.* **2001**, *40*, 1678–1680.
106. Roncaroli, F.; Olabe, J. A.; van Eldik, R. *Inorg. Chem.* **2002**, *41*, 5417–5425.
107. Wang, P. G.; Xian, M.; Tang, X. P.; Wu, X. J.; Wen, Z.; Cai, T. W.; Janczuk, A. J. *Chem. Rev.* **2002**, *102*, 1091–1134.
108. Roncaroli, F.; Ruggiero, M. E.; Franco, D. W.; Estiú, G. L.; Olabe, J. A. *Inorg. Chem.* **2002**, *41*, 5760–5769.
109. Szacilowski, K.; Stochel, G.; Stasicka, A.; Kisch, H. *New J. Chem.* **1997**, *21*, 893–902.
110. Barley, M. H.; Takeuchi, K. J.; Meyer, T. J. *J. Am. Chem. Soc.* **1986**, *108*, 5876–5885.
111. Sellmann, D.; Seubert, B.; Moll, M.; Knoch, F. *Angew. Chem. Int. Ed. Engl.* **1988**, *27*, 1164–1165.
112. Southern, J. S.; Green, M. T.; Hillhouse, G. L.; Guzei, I. A.; Rheingold, A. L. *Inorg. Chem.* **2001**, *40*, 6039–6046.
113. Bayachou, M.; Lin, R.; Cho, W.; Farmer, P. J. *J. Am. Chem. Soc.* **1998**, *120*, 9888–9893.
114. Lin, R.; Farmer, P. J. *J. Am. Chem. Soc.* **2001**, *123*, 1143–1150.
115. Lim, M. D.; Lorkovic, I.; Wedeking, K.; Zanella, A. W.; Works, C. F.; Massick, S. M.; Ford, P. C. *J. Am. Chem. Soc.* **2002**, *124*, 9737–9743.
116. Schneider, J. L.; Carrier, S. M.; Ruggiero, C. E.; Young, V. G.; Tolman, W. B. *J. Am. Chem. Soc.* **1998**, *120*, 11408–11418.
117. Groves, J. T.; Roman, J. S. *J. Am. Chem. Soc.* **1995**, *117*, 5594–5595.
118. Ben-Daniel, R.; Weiner, L.; Neumann, R. *J. Am. Chem. Soc.* **2002**, *124*, 8788–8789.
119. Chen, P.; Cabrito, I.; Moura, I.; Solomon, E. I. *J. Am. Chem. Soc.* **2002**, *124*, 10497–10507.
120. Cherry, J. P. F.; Johnson, A. R.; Baraldo, L. M.; Tsai, Y. C.; Cummins, C. C.; Kryatov, S. V.; Rybak-Akimova, E. V.; Capps, K. B.; Hoff, C. D.; Haar, C. M.; Nolan, S. P. *J. Am. Chem. Soc.* **2001**, *123*, 7271–7286.
121. McCarthy, M. R.; Crevier, T. J.; Bennett, B.; Dehestani, A.; Mayer, J. M. *J. Am. Chem. Soc.* **2000**, *122*, 12391–12392.
122. MacNeil, J. H.; Berseth, P. A.; Westwood, G.; Trogler, W. C. *Environ. Sci. Technol.* **1998**, *32*, 876–881.
123. Zhang, J.; Tse, Y.; Lever, A. B. P.; Pietro, W. J. *Porphyrins Phthalocyanines* **1997**, *1*, 323–331.
124. Taniguchi, I.; Shimpuku, T.; Yamashita, K.; Ohtaki, H. *J. Chem. Soc. Chem. Commun.* **1990**, 915–917.

# 1.32

## Reactivity and Structure of Complexes of Small Molecules: Dioxygen

R. E. BERRY

*University of Arizona, Tucson, AZ, USA*

---

1.32.1	INTRODUCTION	625
1.32.2	FIRST-ROW TRANSITION METALS	625
1.32.3	SECOND- AND THIRD-ROW TRANSITION METALS	628
1.32.4	REFERENCES	629

---

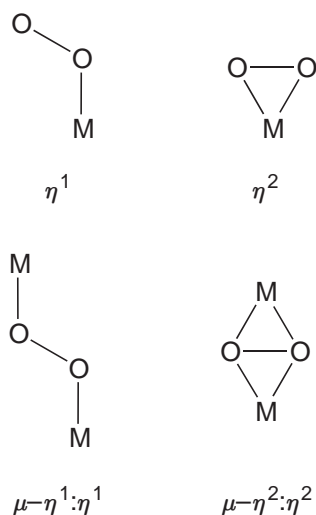
### 1.32.1 INTRODUCTION

Dioxygen is a relatively stable molecule whose reaction with most organic molecules is spin-forbidden. Thus, there is much interest in the activation of the dioxygen molecule by coordination to a metal. These metal-coordinated species can be described as superoxo ( $M-O_2^-$ ) or peroxy ( $M-O_2^{2-}$ ). Reduction of the dioxygen species involves electron donation to the  $2p\pi^*$  antibonding orbitals of dioxygen, and so superoxo and peroxy species can be distinguished in terms of their O—O bond strength. Simply described in terms of the bond order of the O—O bond, molecular dioxygen ( $O_2$ ), superoxide ( $O_2^-$ ), and peroxide ( $O_2^{2-}$ ) with predicted bond orders 2, 1.5, and 1, respectively, can have O—O stretching frequencies of  $1,555\text{ cm}^{-1}$ ,  $1,200\text{--}1,070\text{ cm}^{-1}$ , and  $930\text{--}750\text{ cm}^{-1}$ , respectively.<sup>1</sup> Though a review of vibrational spectra of dioxygen adducts by Nakamoto<sup>2</sup> has observed O—O stretching frequencies to vary continually from  $1,300\text{ cm}^{-1}$  to  $700\text{ cm}^{-1}$ , depending on the nature of the metal and other ligands.

A more clear-cut distinction can be made structurally. Mononuclear dioxygen complexes can be classified as “side-on”  $\eta^2$ , which is typical of peroxy species that also have a longer O—O bond length than the typically “end-on”  $\eta^1$  superoxo species (Figure 1). Typical binuclear bridging peroxy geometries can be described as  $\mu\text{-}\eta^2\text{:}\eta^2$  or  $\mu\text{-}\eta^1\text{:}\eta^1$  bridging complexes (Figure 1). Typical O—O bond lengths of mononuclear peroxy species are 1.4–1.5 Å, and superoxo species are 1.24–1.35 Å,<sup>1</sup> though some can be found between superoxo and peroxy in length.

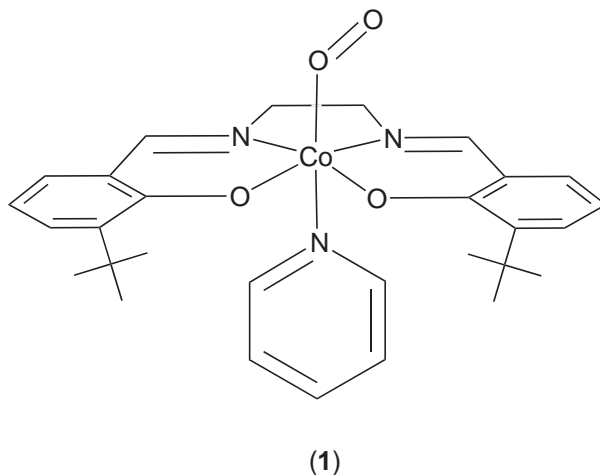
### 1.32.2 FIRST-ROW TRANSITION METALS

First-row transition metal complexes that react with molecular oxygen to coordinate dioxygen in a mononuclear environment typically bind dioxygen as a superoxo species. For example, a  $Co^{II}$  complex will proceed via a one-electron oxidative addition of dioxygen to form a  $Co^{III}$  mononuclear superoxide complex, such as the series of cobalt compounds described as CoSalens. The CoSalen derivative *N,N'*-ethylenebis(3-tert-butylsalicylideneiminato)cobalt(II) binds dioxygen and



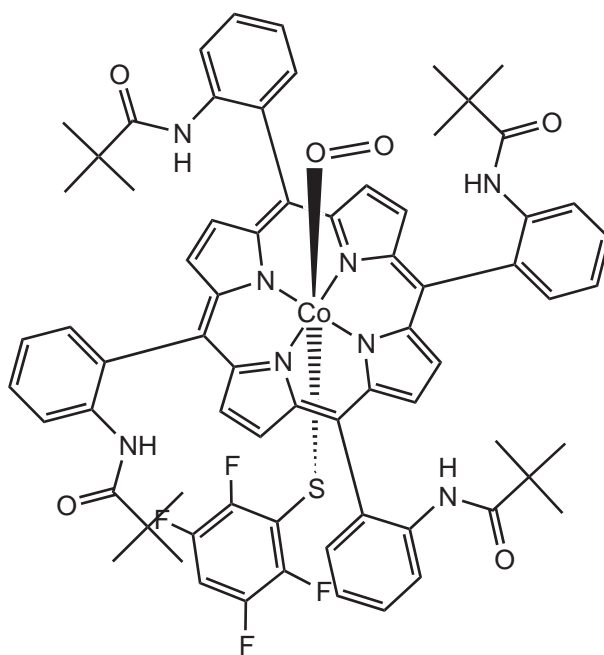
**Figure 1** Mononuclear and binuclear dioxygen complexes classified structurally.

an axial ligand to form a  $\text{Co}^{\text{III}} \eta^1$  superoxide complex (**1**),<sup>3</sup> with a long O—O bond of 1.350(11) Å. Some cobalt porphyrins also coordinate dioxygen, such as the five-coordinate tetrakis(pivalamido-phenyl)porphyrin tetrafluorobenzenethiolatocobalt(II) complex which reacts with dioxygen to coordinate a  $\eta^1$  superoxo species to a  $\text{Co}^{\text{III}}$  metal center (**2**).<sup>4</sup> As  $\text{Co}^{\text{III}}$  does not easily provide further electrons to the dioxygen these Co complexes are relatively unreactive.<sup>5</sup> Dioxygen binding to the iron center in the heme groups of hemoglobin and myoglobin are typical biological examples of dioxygen binding, though due to the propensity of Fe dioxygen species to further dioxygen activation, a great many more Co dioxygen complexes have been isolated due to the relative stability of the  $\text{Co}^{\text{III}}$  dioxygen complex.

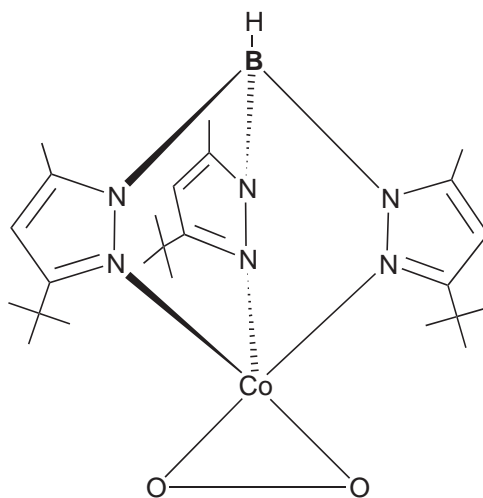


The superoxo species has a tendency towards the nucleophilic attack of another metal center and, unless stabilized by its ligands or its reaction is interrupted, will go on to react with another equivalent of the metal complex precursor to form a bimetallic peroxo-bridging complex. The synthetic bimetallic peroxo-bridging complexes have been the model targets for some biological dioxygen activation systems, the geometry of the peroxo group possibly being important, with the  $\mu\text{-}\eta^2\text{:}\eta^2$  side-on bridging geometry found in dicopper-containing proteins,<sup>6-9</sup> and the  $\mu\text{-}\eta^1\text{:}\eta^1$  bridge geometry occurring in diiron-containing proteins.<sup>10,11</sup>

The superoxide complexes typically bind end-on  $\eta^1$  though this is not always the case, as in  $\text{TpCo}^{\text{II}}\text{O}_2$  (Tp = hydridotris(3-tert-butyl-5-methylpyrazolyl)borate) (**3**),<sup>12</sup> in which the superoxo species was found to bind  $\eta^2$ . Interestingly this compound had an O—O stretching frequency between superoxo and peroxo species of  $961 \text{ cm}^{-1}$ , though the crystal structure showed the O—O bond to be 1.262 Å, identifying it as a superoxo species.



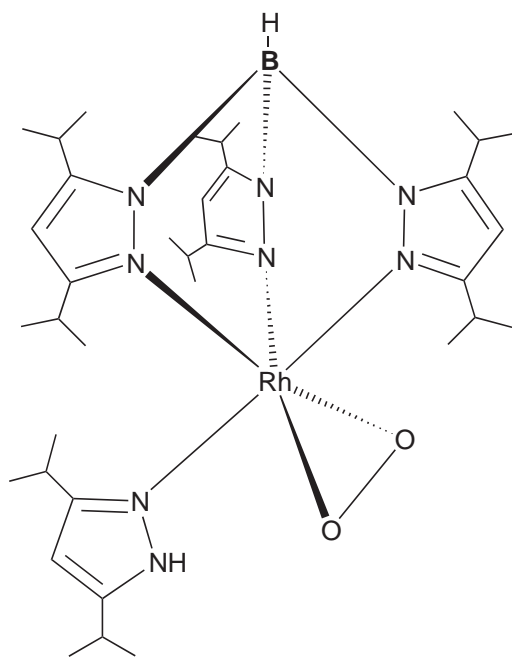
(2)



(3)

Few  $\text{Co}^{\text{II}}$  dioxygen complexes have been characterized, though the tris(pyrazolyl)borate ligand has been found to stabilize some low-valent metal dioxides, allowing the isolation of  $\text{Co}^{\text{II}}$  superoxo complexes as in the previous example.<sup>5</sup> The equivalent second-row transition metal tris(pyrazolyl)borate complexes form peroxo-containing complexes, such as the  $\text{Rh}^{\text{III}}$  complex  $\text{Tp}^{\text{ipr}}\text{Rh}(\eta^2\text{-O}_2)(\text{pz}^{\text{ipr}}\text{H})$  ( $\text{Tp}^{\text{ipr}}$  = hydrotris(3,5-diisopropylpyrazol-1-yl)borate,  $\text{pz}^{\text{ipr}}\text{H}$  = 3,5-diisopropylpyrazole) (4),<sup>13</sup> with an O—O bond length of 1.467(5) Å.

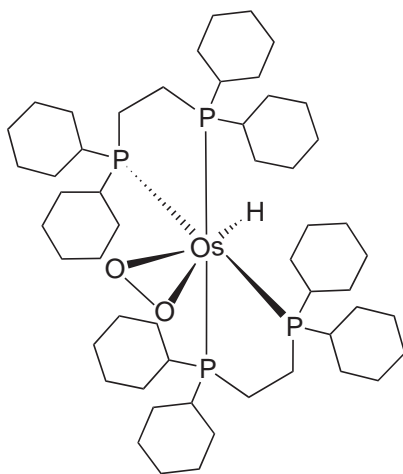
Peroxo examples formed by the direct reaction with molecular dioxygen in the first row of the transition metals are few. One of the first examples of a peroxo vanadium complex formed by the direct reaction with dioxygen is a  $\text{Tp}^{\text{ipr}}$ -bound seven-coordinate pentagonal-bipyramidal  $\text{V}^{\text{V}}$  complex  $\text{Tp}^{\text{ipr}}\text{VO}(\eta^2\text{-O}_2)(\text{pz}^{\text{ipr}}\text{H})$ , with a relatively short O—O distance of 1.379(6) Å and relatively high O—O stretching frequency of  $960\text{ cm}^{-1}$ , relative to typical peroxo species.<sup>14</sup> First-row transition metalloproteins which bond molecular dioxygen are discussed, with their models, in Volume 8.



(4)

### 1.32.3 SECOND- AND THIRD-ROW TRANSITION METALS

Second- and third-row transition metal complexes that react with molecular oxygen to coordinate dioxygen typically bind dioxygen as a  $\eta^2$  peroxy species. Binding of dioxygen is associated with complexes of low oxidation state metals and ligands that are good sigma-donors. The complex precursor will react with dioxygen, undergoing a two electron oxidation to form the peroxy complex  $M(\eta^2-O_2)L_x$ . Most of these can be classified into three groups: an  $M^0$   $d^{10}$  precursor forming the peroxy  $M^{II}$   $d^8$  complex  $M(\eta^2-O_2)L_2$ , as in the four coordinate bathocuproine peroxopalladium(II) complex, formed from a  $Pd^0$  precursor;<sup>15</sup> an  $M^0/M^I$   $d^8$  precursor forming the peroxy complex  $M(\eta^2-O_2)L_4$ , as in the complex  $Tp^{*Pr}Rh(\eta^2-O_2)(pz^{*Pr}H)$  (4) formed from a  $Rh^I$  precursor;<sup>13</sup> and an  $M^{II}$   $d^6$  precursor forming the peroxy complex  $M(\eta^2-O_2)L_5$ .<sup>16</sup> In the case of the third class sigma donation from ligands stabilize the peroxy complex formed, as in the  $Os^{II}$  complex with the 1,2-bis(dicyclohexylphosphino)ethane (dcpe) ligand which reacts with dioxygen to form the  $Os^{IV}$  peroxy complex  $[OsH(\eta^2-O_2)(dcpe)_2]^+$  (5),<sup>17-19</sup> with an O—O bond length of 1.45(1) Å.



(5)

Dioxygen coordination to metal complexes is generally found among complexes of low oxidation state metals, though examples do exist of higher oxidation state precursors such as the Mo<sup>IV</sup> complex [Mo(CN)<sub>4</sub>O(pz)]<sup>2-</sup> (pz = pyrazine), which reacts with dioxygen to form the peroxo Mo<sup>VI</sup> complex [Mo(CN)<sub>4</sub>O(η<sup>2</sup>-O<sub>2</sub>)]<sup>2-</sup>.<sup>20</sup> With the peroxo ligand *cis* to the oxo, in a distorted pentagonal bipyramidal structure and with an O—O bond length of 1.41 Å, dioxygen also reacts with a Mo<sup>IV</sup> metalloporphyrin MoO(tmp) (tmp = tetramesitylporphyrin), to form the peroxo Mo<sup>VI</sup> complex MoO(tmp)(η<sup>2</sup>-O<sub>2</sub>).<sup>21</sup> The metalloporphyrin has the peroxo and oxo ligands *cis* to each other on the same side of the porphyrin, and a peroxo O—O bond length of 1.42(3) Å.

### 1.32.4 REFERENCES

1. Hill, H. A. O.; Tew, D. G. In *Comprehensive Coordination Chemistry*, Wilkinson, G.; McCleverty, J. A., Ed., Pergamon: Oxford, U.K., 1987; Vol. 2, Chapter 15, pp 318–333.
2. Nakamoto, K. *Coord. Chem. Rev.* **1990**, *100*, 363–402.
3. Schaefer, W. P.; Huie, B. T.; Kurilla, M. G.; Ealick, S. E. *Inorg. Chem.* **1980**, *19*, 340–344.
4. Doppelt, P.; Fischer, J.; Ricard, L.; Weiss, R. *New J. Chem.* **1987**, *11*, 357–364.
5. Hikichi, S.; Akita, M.; Moro-oka, Y. *Coord. Chem. Rev.* **2000**, *198*, 61–87.
6. He, C.; DuBois, J. L.; Hedman, B.; Hodgson, K. O.; Lippard, S. J. *Angew. Chem. Int. Ed. Engl.* **2001**, *40*, 1484–1487.
7. Lam, B. M. T.; Halfen, J. A.; Young, V. G., Jr.; Hagadorn, J. R.; Holland, P. L.; Lledos, A.; Cucurull-Sanchez, L.; Novoa, J. J.; Alvarez, S.; Tolman, W. B. *Inorg. Chem.* **2000**, *39*, 4059–4072.
8. Pidcock, E.; Obias, H. V.; Abe, M.; Liang, H.-C.; Karlin, K. D.; Solomon, E. I. *J. Am. Chem. Soc.* **1999**, *121*, 1299–1308.
9. Solomon, E. I.; Sundaram, U. M.; Machonkin, T. E. *Chem. Rev.* **1996**, *96*, 2563–2606.
10. Du Bois, J.; Mizoguchi, T. J.; Lippard, S. J. *Coord. Chem. Rev.* **2000**, *200–202*, 443–485.
11. Ookubo, T.; Sugimoto, H.; Nagayama, T.; Masuda, H.; Sato, T.; Tanaka, K.; Maeda, Y.; Okawa, H.; Hayashi, Y.; Uehara, A.; Suzuki, M. *J. Am. Chem. Soc.* **1996**, *118*, 701–702.
12. Egan, J. W., Jr.; Haggerty, B. S.; Rheingold, A. L.; Sendlinger, S. C.; Theopold, K. H. *J. Am. Chem. Soc.* **1990**, *112*, 2445–2446.
13. Takahashi, Y.; Hashimoto, M.; Hikichi, S.; Akita, M.; Moro-Oka, Y. *Angew. Chem., Int. Ed. Engl.* **1999**, *38*, 3074–3077.
14. Kosugi, M.; Hikichi, S.; Akita, M.; Moro-oka, Y. *J. Chem. Soc., Dalton Trans.* **1999**, *9*, 1369–1372.
15. Stahl, S. S.; Thorman, J. L.; Nelson, R. C.; Kozee, M. A. *J. Am. Chem. Soc.* **2001**, *123*, 7188–7189.
16. Maddock, S. M.; Rickard, C. E. F.; Roper, W. R.; Wright, L. J. *J. Organomet. Chem.* **1996**, *510*, 267–279.
17. Mezzetti, A.; Zangrando, E.; Del Zotto, A.; Rigo, P. *J. Chem. Soc., Chem. Commun.* **1994**, *13*, 1597–1598.
18. Barthazy, P.; Wörle, M.; Rüegger, H.; Mezzetti, A. *Inorg. Chem.* **2000**, *39*, 4903–4912.
19. Martelletti, A.; Gramlich, V.; Zürcher, F.; Mezzetti, A. *New J. Chem.* **1999**, 199–206.
20. Matoga, D.; Szklarzewicz, J.; Samotus, A.; Burgess, J.; Fawcett, J.; Russell, D. R. *Polyhedron* **2000**, *19*, 1503–1509.
21. Fujihara, T.; Ree, N. H.; Umakoshi, K.; Tachibana, J.; Sasaki, Y.; McFarlane, W.; Imamura, T. *Chem. Lett.* **2000**, 102–103.

# 1.33

## Reactivity of Coordinated Oximes

A. J. L. POMBEIRO

*Instituto Superior Técnico, Lisbon, Portugal*

and

V. YU. KUKUSHKIN

*St. Petersburg State University, St. Petersburg, Russian Federation*

---

1.33.1	INTRODUCTION	631
1.33.2	REACTIONS WITH PRESERVATION OF THE {CNO} FRAGMENT	631
1.33.2.1	Reactions Centered at the O-atom	632
1.33.2.2	Reactions Centered at the N- or the C-atom	633
1.33.3	REACTIONS WITH RUPTURE OF THE {CNO} FRAGMENT	635
1.33.3.1	Reactions with N—O Bond Cleavage	635
1.33.3.2	Reactions with Complete N=C Bond Cleavage	636
1.33.4	REFERENCES	636

---

### 1.33.1 INTRODUCTION

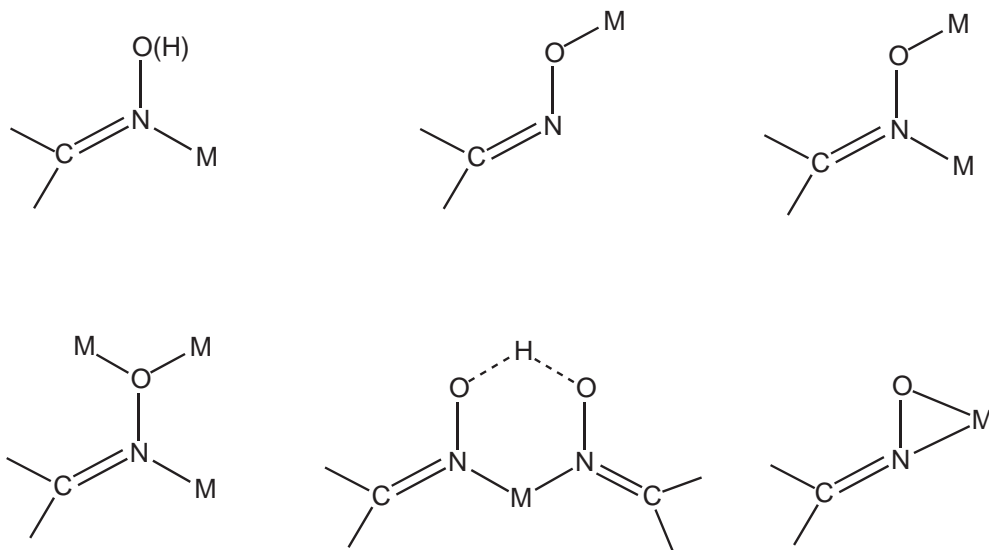
Since the publication of *Comprehensive Coordination Chemistry CCC* (1987), many publications on oxime complexes have appeared, namely in areas of general inorganic and coordination chemistries<sup>1–8</sup> and unconventional methods for their synthesis have been reviewed.<sup>8</sup> Oxime and oximate species can bind a metal in different coordination modes (see [Scheme 1](#)) and exhibit versatile reactivity. Their reactions, for a systematic purpose, can be classified according to the extent of involvement of the {C=NO} moiety and to the bond at which the reaction is centered, as shown below.

The general modes of reactivity concerning nucleophilic or electrophilic additions to the polarized C=N bond are indicated in [Scheme 2](#). Nucleophilic reagents can add to the carbon atom of the azomethine linkage (a reaction that is promoted by coordination of the oxime, in particular via the N-atom), whereas electrophilic reagents can attack the O- or the N-sites.

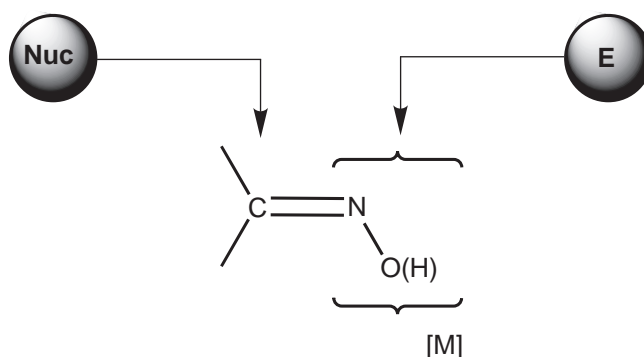
### 1.33.2 REACTIONS WITH PRESERVATION OF THE {CNO} FRAGMENT

The reactions can either be centered at any of the atoms of the {CNO} moiety ([Scheme 3](#)), where the substituent groups are omitted for clarity), leading to oxime (or oximate), imine or other types of complexes (in some cases with metallacycles and in others with formation of unsaturated organic N,O-products) or occur at another part of the oxime molecule. In fact, coordination does not always lead to the activation of the oxime functional group, but instead a protecting effect can result as observed (see Section 1.29.3.6) in the chlorination of some salicylaldoxime Pt<sup>II</sup> complexes which occurs exclusively at the metal and at the benzene ring (*ortho* and *para* positions) of the oxime in contrast with the known reactivity of free oximes.





Scheme 1



Nuc = Nucleophile, E = Electrophile

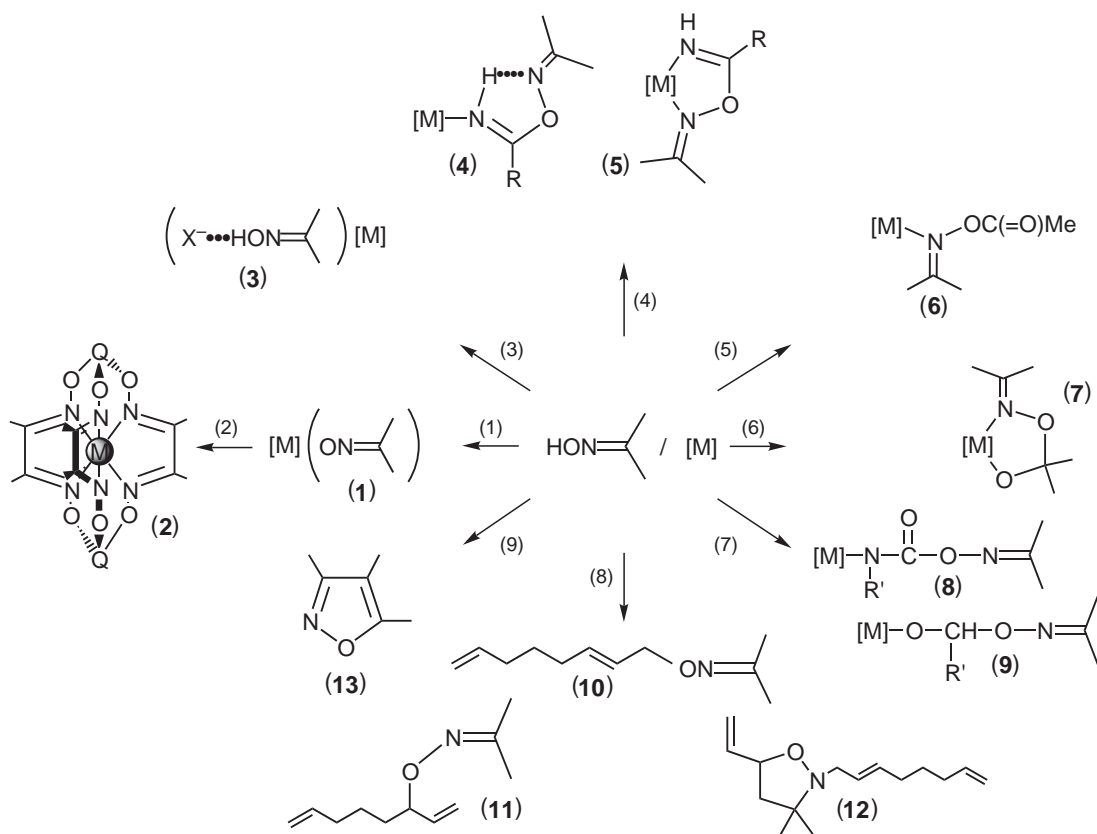
Scheme 2

### 1.33.2.1 Reactions Centered at the O-atom

Oximes are weak oxygen acids whose acidity greatly increases upon coordination,<sup>7,8</sup> thus favoring the formation of oximate ligands (see reaction (1) in [Scheme 3](#)), e.g., in mixed oxime/oximate complexes with intra- and/or intermolecular hydrogen bonds<sup>9-11</sup> (see reaction (3) in [Scheme 3](#)) with possible formation of caged complexes or extended arrays. The basicity of the NO groups of *N*-coordinated oximate ligands toward a Lewis acid (Q) can be applied to the synthesis of clathrochelates such as the biscapped tris-dioximate species (structure **2** in [Scheme 3](#)). A variety of central metals (M) and capping atoms (B, Si, Ge, Sn, or Sb) have been applied<sup>12-17</sup> and cross-linking of square planar dioximate complexes is also known.<sup>18,19</sup>

Moreover, on account of the nucleophilic character of the oxime O-atom, the oximes can add, via this atom, to unsaturated species, such as:

- (i) an organonitrile (reaction (4) in [Scheme 3](#)) to produce species **4** or **5** as described in Chapter 1.34;
- (ii) an anhydride,  $(\text{MeCO})_2\text{O}$ , to form an acylated oxime  $\text{Pt}^{\text{II}}$  complex **6**<sup>20</sup> (reaction (5));



**Scheme 3** (1)  $-\text{H}^+$ ; (2) Q; (3)  $\text{X}^-$ ; (4)  $\text{NCR}$ ; (5)  $(\text{MeCO})_2\text{O}$ ,  $-\text{MeCO}_2\text{H}$ ; (6)  $\text{O}=\text{CRR}'$ ; (7)  $\text{R}'\text{CNO}$  or  $\text{R}'\text{COH}$ ; (8)  $\text{CH}_2=\text{CH}-\text{CH}=\text{CH}_2$ ; (9) from  $\text{HON}=\text{C}(\text{R})\text{C}(\text{R}')=\text{C}(\text{R}'')\text{H}$ .

- (iii) a ketone to produce, e.g., the metallacycle **7** ( $\text{M} = \text{Pt}^{\text{IV}}$  center<sup>21</sup> reaction 6 or acetaldiimine at  $\text{Co}^{\text{II}}$  center<sup>22</sup>);
- (iv) an isocyanate  $\text{R}'\text{NCO}$  ( $\text{R}' = \text{alkyl}$  or  $\text{aryl}$ ) or an aldehyde  $\text{R}'\text{C}(\text{O})\text{H}$  ( $\text{R}' = \text{trihalomethyl}$ ) that can insert into the metal–oxygen bond of a trialkyltin oximato complex to afford **8** or **9**, respectively (reactions 7);<sup>8</sup>
- (v) an external olefin, e.g., butadiene to yield, in Pd-catalyzed reactions, the oxime ethers **10** and **11**, and the *N*-alkylated isoxazolidines **12** (reaction (8)),<sup>8</sup> the former conceivably arising from the reactions of oximes with  $\pi$ -allylpalladium intermediates;
- (vi) the olefinic group of an  $\alpha,\beta$ -unsaturated oxime, to form isoxazoles **13**, in  $\text{Pd}^{\text{II}}$ -mediated reactions (reaction (9))<sup>8</sup> which are believed to proceed via intramolecular nucleophilic attack of the oxygen atom of the *N*-coordinated oxime.

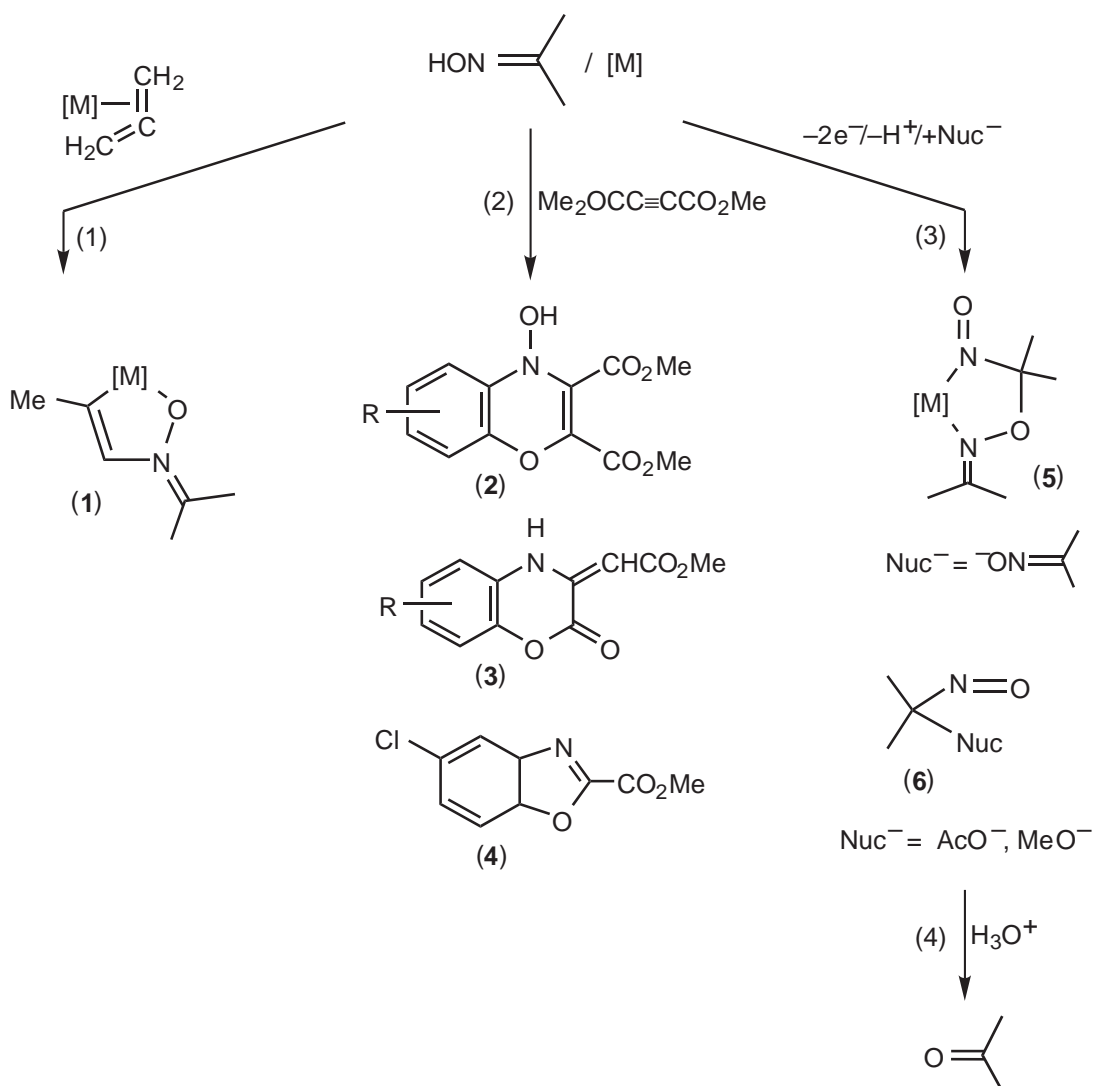
### 1.33.2.2 Reactions Centered at the N- or the C-atom

Rare examples of oxime coupling via the N-atom, acting as the nucleophile, are also known: (i) reaction of an oxime with an allene- $\text{Pt}^{\text{II}}$  complex to produce the metallacycle **1** (reaction (1), Scheme 4);<sup>8</sup> (ii) reactions (2) of *o*-quinone monoxime  $\text{Cu}^{\text{II}}$  or  $\text{Ni}^{\text{II}}$  complexes with an electrophilic acetylene,  $\text{MeO}_2\text{C}-\text{C}\equiv\text{C}-\text{CO}_2\text{Me}$ , in aqueous conditions, to give *N*-containing heterocycles, i.e., the benzoxazines **2** ( $[4+2]$  cycloaddition) and the benzoxazin-2-ones **3**,<sup>23</sup> although the former products are not obtained in anhydrous solvent in which a 1,3-benzoxazole-2-carboxylate, **4**, is formed instead.<sup>24</sup> Cleavage of the N–O bond of the  $\{\text{CNO}\}$  group also occurs in the formation of both **3** and **4**.

The electrophilicity of the C-atom of the NCO group of an oxime is expected to be promoted by oxidation and formal two-electron oxidations promote not only  $\text{H}^+$  loss of the NOH group but also addition of a nucleophile (Nuc) to that C-atom to yield nitrosoalkyl species, such as

- (i) the Pt chelates **5** (see reaction (3) of Scheme 4), in which a  $\text{Pt}^{\text{IV}}$  ion behaves as the oxidant and one oximate ligand as the nucleophile,<sup>25,26</sup> or
- (ii) the liberated nitroso products **6** formed by using  $\text{Pb}^{\text{IV}}$  ( $\text{Nuc} = \text{AcO}^-$ ) or  $\text{Ti}^{\text{III}}$  ( $\text{Nuc} = \text{MeO}^-$ )<sup>7,8</sup> as the oxidants, in the latter case yielding the corresponding aldehydes or ketones.

A variety of metal ion oxidants has been applied<sup>27-35</sup> and different types of mechanisms postulated for these oxidative deoximation reactions.



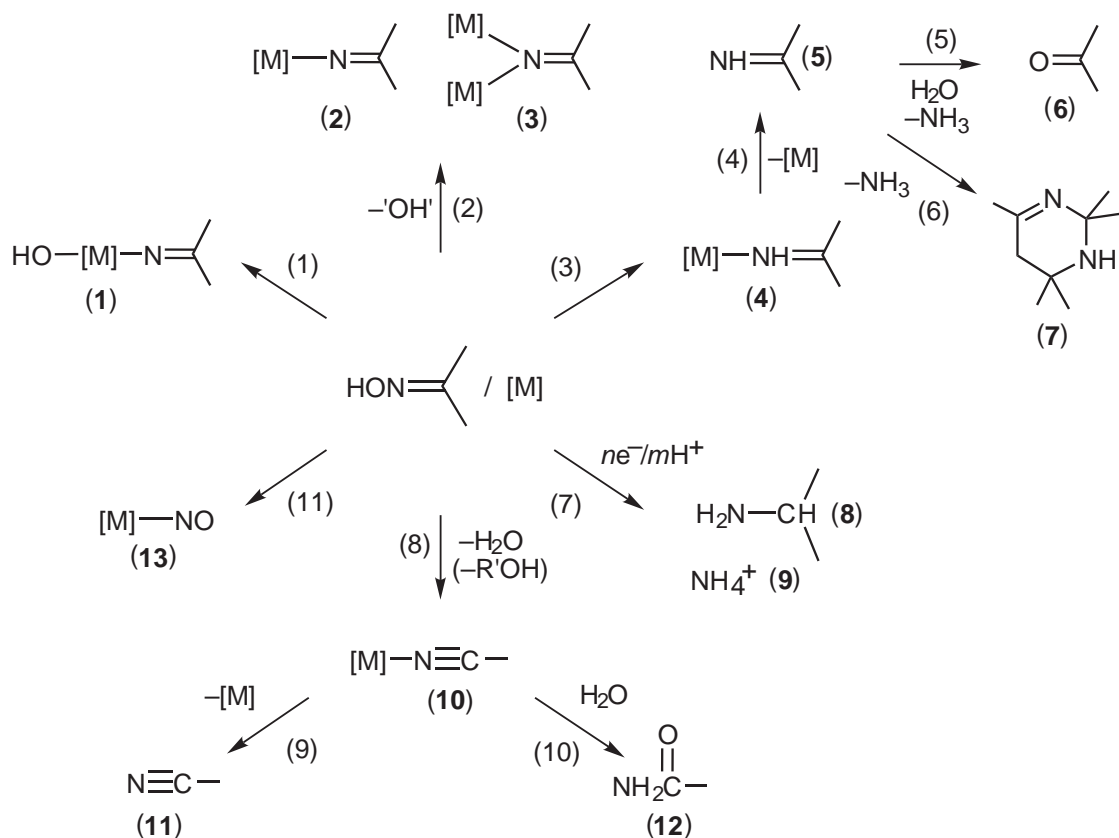
Scheme 4

## 1.33.3 REACTIONS WITH RUPTURE OF THE {CNO} FRAGMENT

## 1.33.3.1 Reactions with N—O Bond Cleavage

Besides rare oxime coupling with an acetylene (formation of **3** and **4**, Scheme 4) or with acetylacetonate in  $[\text{VO}(\text{acac})_2]$ ,<sup>36</sup> other N—O bond rupture reactions are known (see Scheme 5) usually involving the formation of an N—metal bond:

- (i) Oxidative addition (reaction (1)) of  $\text{RR}'\text{C}=\text{NOH}$  to an electron-rich metal center, affording an azavinylidene hydroxo-complex,  $\text{HO}[\text{M}]-\text{N}=\text{CRR}'$  **1**, observed<sup>37</sup> at a  $\text{Re}^{\text{I}}$  center. A related reaction occurs with *O*-silylated oximes,  $\text{RR}'\text{C}=\text{NOSiMe}_3$ , at a  $\text{Ti}^{\text{II}}$  center,<sup>38</sup> and, possibly, in the formation of a bridging azavinylidene from the reaction of an oxime with an  $\text{Os}_3$  cluster.<sup>39</sup> Oxidative addition of oximes to  $\text{Os}_3$  clusters with O—H bond cleavage is also known.<sup>40</sup>
- (ii) Dehydroxygenation (reaction (2) of Scheme 5) of an oxime by an hydride metal center leading, upon dehydration, to an azavinylidene product **2** ( $\text{M} = \text{Ru}^{\text{II}}$  or  $\text{Os}^{\text{II}}$  center).<sup>41–45</sup> A related reaction, although involving O—H oxidative addition of the oxime, yielding a bridging azavinylidene dicobalt product **3**, has been reported.<sup>46</sup>
- (iii) Deoxygenation of an oxime, i.e., its metal-assisted reductive deoxygenation to form an imine complex  $[\text{M}]-\text{NH}=\text{CRR}'$  **4** (reaction (3),  $\text{M} = \text{Cr}^0$  or  $\text{W}^0$  center<sup>8</sup>). The imine  $\text{NH}=\text{CRR}'$  **5** can be liberated from the metal (reaction (4)), e.g., at  $\text{Fe}^0$ -carbonyl centers<sup>8</sup> or in deoxygenation reactions by CO catalyzed by  $\text{Ru}_3(\text{CO})_{12}$ <sup>47,48</sup> (with formation of  $\text{CO}_2$ ), and, upon hydrolysis, can lead to the corresponding ketones or aldehydes  $\text{RR}'\text{C}=\text{O}$  **6** (reaction (5), at  $\text{Ti}^{\text{III}}$ ,  $\text{V}^{\text{III}}$ , and  $\text{V}^{\text{III}}$  centers,<sup>49–53</sup>  $\text{Fe}^{\text{II}}$ <sup>54</sup> or by use of  $\text{Mo}(\text{CO})_6$ <sup>55</sup>) or undergo a Ru-catalyzed trimerization, under CO pressure, to give a pyrimidine derivative **7**<sup>56</sup> (see reaction (6) in Scheme 5), with evolution of  $\text{NH}_3$  and  $\text{CO}_2$ . Other final reduction products can be obtained via deoxygenation of oximes by transition metal systems, namely: amines **8** (by  $\text{SmI}_2$ -base<sup>57,58</sup> or aqueous  $\text{TiCl}_3$  in the



presence of  $[\text{BH}_3\text{CN}]^{-59}$ ; or (also with complete  $\text{N}=\text{C}$  bond cleavage) ammonium **9** (see reaction (7)), either upon treatment of a  $\text{Pt}^{\text{II}}$ -oxime complex with  $\text{HCl}$  (and concomitant oxidation of the metal to  $\text{Pt}^{\text{IV}60}$ ) or by reaction of an oxime with  $\text{RuCl}_3$  (with concomitant nitrosylation of the metal<sup>61,62</sup>); azo compounds can also be obtained.<sup>8</sup> The reduction of oximes can also be achieved by other low or medium oxidation state metal centers<sup>8</sup> and the mechanisms of the processes have mostly not yet been established.

- (iv) Dehydration of an aldoxime ( $\text{RHC}=\text{NOH}$ ) or alcohol elimination ( $\text{R}'\text{OH}$ ) from a ketoxime ( $\text{RR}'\text{C}=\text{NOH}$ ) to give a nitrile complex  $[\text{M}]-\text{N}\equiv\text{CR}$  **10** (see reaction (8),  $\text{M} = \text{Ru}(\text{II or III})^{63,64}$  or  $\text{Os}^{\text{II}65}$ ). The nitriles can be liberated (reaction (9)) and catalytic systems for the conversion of oximes to nitriles **11** have been reported, e.g., based on  $\text{Cu}(\text{OAc})_2$ ,<sup>66</sup>  $\text{AlI}_3$  and  $\text{Rh}_6(\text{CO})_{16}$ <sup>7,8</sup> or other metals.<sup>67-70</sup> In addition, the nitriles can convert into other products such as amides (see v).
- (v) The Beckmann rearrangement of aldoximes into amides **12**, which is believed<sup>7,8</sup> to proceed, at least when catalyzed by some  $\text{Pd}^{\text{II}}$  complexes, via formation of nitriles (see (iv) above) followed by their hydrolysis (see Chapter 1.34), i.e., via consecutive dehydration-hydration paths (reactions (8) and (10)). The rearrangement can also be promoted by other metal centers, e.g.,  $\text{Cu}^{\text{II}}$  or  $\text{Ni}^{\text{II}}$  complexes,  $\text{AlI}_3$ ,  $\text{TaCl}_5$ , or  $\text{ReCl}_5$ ,<sup>7,8</sup> or by  $\text{HReO}_4$ <sup>71,72</sup> which catalyses the rearrangement for ketoximes (a rare reaction for this type of oximes) to produce amides and lactams.

### 1.33.3.2 Reactions with Complete $\text{N}=\text{C}$ Bond Cleavage

The complete  $\text{N}=\text{C}$  bond cleavage of an oxime occurs upon  $\text{Pd}^{\text{II}}$ -,<sup>73</sup>  $\text{Cu}^{\text{II}}$ -, and  $\text{Zn}^{\text{II}}$ -catalyzed<sup>74</sup> hydrolysis or in the final hydrolysis of its nitrosoalkyl (reactions (3) and (4), Scheme 4) or imine (see reactions (3) to (5) of Scheme 5) derivatives, leading, in both cases, to the corresponding ketones or aldehydes. The above mentioned reduction to ammonium (reaction (7), Scheme 5) also involves  $\text{N}=\text{C}$  bond rupture, and in all the cases the  $\text{N}-\text{O}$  bond is also cleaved. A distinct process is followed when the oxime behaves as a nitrosylating agent of the metal to give (reaction (11) of Scheme 5) a nitrosyl complex **13**, as known for some  $\text{Mo}^{75,76}$  or  $\text{Ru}^{61,62}$  complexes, also with formation of ammonium (involving an overall hydrolysis/disproportionation of the oxime) in the latter case.

### 1.33.4 REFERENCES

- Wang, H.-X.; Ding, L.; Wu, Y.-J. *Youji Huaxue* **2000**, *20*, 44–53 [*Chem. Abstr.* **2000**, *132*, 166256].
- Gerasimchuk, N. N.; Bowman-James, K. In *Encyclopedia of Inorganic Chemistry*; King, R. B. Ed.; Wiley: Chichester, 1994; Vol. 5, p 2254.
- Sakharov, S. G. *Zh. Neorg. Khim.* **1999**, *44*, 1783–1791.
- Beirakhov, A. G.; Orlova, I. M.; Mikhailov, Yu. N.; Shchelokov, R. N. *Russ. J. Coord. Chem.* **1998**, *24*, 259–264.
- Sakharov, S. G.; Buslaev, Yu. A. *Koord. Khim.* **1994**, *20*, 3–34.
- Watanabe, Y.; Akazome, M.; Kondo, T. *Yuki Gosei Kagaku Kenkyusho Koenshu* **1994**, *8*, 50–60 [*Chem. Abstr.* **1994**, *121*, 56944].
- Kukushkin, V. Yu.; Pombeiro, A. J. L. *Coord. Chem. Rev.* **1999**, *181*, 147–175 and references therein.
- Kukushkin, V. Yu.; Tudela, D.; Pombeiro, A. J. L. *Coord. Chem. Rev.* **1996**, *156*, 333–362 and references therein.
- Kukushkin, V. Yu.; Nishioka, T.; Tudela, D.; Isobe, K.; Kinoshita, I. *Inorg. Chem.* **1997**, *36*, 6157–6165.
- Kukushkin, V. Yu.; Tudela, D.; Izotova, Yu. A.; Belsky, V. K.; Stash, A. I. *Polyhedron* **1998**, *17*, 2455–2461.
- Aakeroy, C. B.; Beatty, A. M.; Leinen, D. S. *J. Am. Chem. Soc.* **1998**, *120*, 7383–7384.
- Voloshin, Y. Z.; Varzatskii, O. A.; Kron, T. E.; Belsky, V. K.; Zavodnik, V. E.; Strizhakova, N. G.; Nadtochenko, V. A.; Smirnov, V. A. *J. Chem. Soc., Dalton Trans.* **2002**, 1203–1211.
- Voloshin, Y. Z.; Zavodnik, V. E.; Varzatskii, O. A.; Belsky, V. K.; Palchik, A. V.; Strizhakova, N. G.; Vorontsov, I. I.; Antipin, M. Yu. *J. Chem. Soc., Dalton Trans.* **2002**, 1193–1202.
- Voloshin, Y. Z.; Varzatskii, O. A.; Kron, T. E.; Belsky, V. K.; Zavodnik, V. E.; Strizhakova, N. G.; Palchik, A. V. *Inorg. Chem.* **2000**, *39*, 1907–1918.
- Engtrakul, C.; Shoemaker, W. J.; Grzybowski, J. J.; Guzei, I.; Rheingold, A. *Inorg. Chem.* **2000**, *39*, 5161–5163.
- Xie, B.; Elder, T.; Wilson, L. J.; Stanbury, D. M. *Inorg. Chem.* **1999**, *38*, 12–19.
- Burdinski, D.; Birkelbach, F.; Weyhermueller, T.; Floerke, U.; Haupt, H.-J.; Lengen, M.; Trautwein, A. X.; Bill, E.; Wiegardt, K.; Chaudhuri, P. *Inorg. Chem.* **1998**, *37*, 1009–1020.
- Voloshin, Y. Z.; Kostromina, N. A.; Krämer, R. *Clathrochelates: Synthesis, Structure, and Properties*; Elsevier, Amsterdam 2002.
- Harshani de Silva, D. G. A.; Leznoff, D. B.; Impley, G.; Vernik, I.; Jin, Z.; Stynes, D. V. *Inorg. Chem.* **1995**, *34*, 4015–4025.
- Kazankov, G. M.; Dyachenko, O. G.; Nemukhin, A. V.; Ryabov, A. D. *Mendeleev Commun.* **1997**, 159–162.
- Kukushkin, V. Yu.; Belsky, V. K.; Tudela, D. *Inorg. Chem.* **1996**, *35*, 510–513.

22. Hierso, J.-C.; Ellis, D. D.; Spek, A. L.; Bouwman, E.; Reedijk, J. *Eur. J. Inorg. Chem.* **2000**, 2459–2462.
23. Barjesteh, H.; Brain, E. G.; Charalambous, J.; Gaganatsou, P.; Thomas, T. A. *J. Chem. Res., Synopses* **1995**, 454–455.
24. Castellani, C. B.; Millini, R. *J. Chem. Soc., Dalton Trans.* **1984**, 1461–1462.
25. Kukushkin, V. Yu.; Tudela, D.; Izotova, Yu. A.; Belsky, V. K.; Stash, A. I. *Inorg. Chem.* **1996**, *35*, 4926–4931.
26. Kukushkin, V. Yu.; Belsky, V. K.; Aleksandrova, E. A.; Kononov, V. E.; Kirakosyan, G. A. *Inorg. Chem.* **1992**, *31*, 3836–3840.
27. Sankhla, R.; Kothari, S.; Kotai, L.; Banerji, K. K. *J. Chem. Res., Synopses* **2001**, 127–128.
28. Ganguly, N. C.; Sukai, A. K.; De, S.; De, P. *Synth. Commun.* **2001**, *31*, 1607–1612.
29. Bhandari, A.; Sharma, P. K.; Banerji, K. K. *Indian J. Chem., Section A* **2001**, *40A*, 470–473.
30. Bhandari, A.; Mishra, P.; Banerji, K. K. *React. Kinet. Catal. Lett.* **2000**, *71*, 343–347.
31. Heravi, M. M.; Ajami, D.; Tajbakhsh, M.; Ghassemzadeh, M. *Monatsh. Chem.* **2000**, *131*, 1109–1113.
32. Rajkumar, G. A.; Arabindoo, B.; Murugesan, V. *Indian J. Chem., Section B* **2000**, *39B*, 74–75.
33. He, L.; Horiuchi, C. A. *Appl. Organomet. Chem.* **1999**, *13*, 867–869.
34. Zhang, G.-S.; Yang, D.-H.; Chen, M.-F.; Cai, K. *Synth. Commun.* **1998**, *28*, 2221–2225.
35. Tamami, B.; Yeganeh, H. *Tetrahedron* **1997**, *53*, 7889–7896.
36. Zerbib, V.; Robert, F.; Gouzerh, P. *Chem. Commun.* **1994**, 2179–2180.
37. Ferreira, C. M. P.; Guedes da Silva, M. F. C.; Kukushkin, V. Yu.; Fraústo da Silva, J. J. R.; Pompeiro, A. J. L. *J. Chem. Soc., Dalton Trans.* **1998**, 325–326.
38. Tillack, A.; Arndt, P.; Spannenberg, A.; Kempe, R.; Rosenthal, U. *Z. Anorg. Allg. Chem.* **1998**, *624*, 737–740.
39. Deeming, A. J.; Owen, D. W.; Powell, N. I. *J. Organomet. Chem.* **1990**, *398*, 299–310.
40. Wong, J. S.-Y.; Wong, W.-T. *New J. Chem.* **2002**, *26*, 94–104.
41. Castarlenas, R.; Esteruelas, M. A.; Gutierrez-Puebla, E.; Jean, Y.; Lledos, A.; Martin, M.; Onate, E.; Tomas, J. *Organometallics* **2000**, *19*, 3100–3108.
42. Daniel, T.; Knaup, W.; Dziallas, M.; Werner, H. *Chem. Ber.* **1993**, *126*, 1981–1993.
43. Daniel, T.; Müller, M.; Werner, H. *Inorg. Chem.* **1991**, *30*, 3118–3120.
44. Meyer, U.; Werner, H. *Chem. Ber.* **1990**, *123*, 697–702.
45. Werner, H.; Knaup, W.; Dziallas, M. *Angew. Chem.* **1987**, *99*, 277–278.
46. Carofiglio, T.; Stella, S.; Floriani, C.; Chiesi-Villa, A.; Guastini, C. *J. Chem. Soc., Dalton Trans.* **1989**, 1957–1962.
47. Akazome, M.; Tsuji, Y.; Watanabe, Y. *Chem. Lett.* **1990**, 635–638.
48. Lee, K. K.-H.; Wong, W.-T. *J. Chem. Soc., Dalton Trans.* **1997**, 2987–2995.
49. Timms, G. H.; Wildsmith, E. *Tetrahedron Lett.* **1971**, 195–195.
50. Christofis, O.; Habeeb, J. J.; Stevensz, R.; Tuck, D. G. *Can. J. Chem.* **1978**, *56*, 2269–2272.
51. Padmalatha, M.; Sherigara, B. S.; Udupa, H. V. K. *J. Electrochem. Soc. India* **1995**, *44*, 197–199.
52. Pai, K. V.; Nayak, P. V.; Sheregara, B. S. *Asian J. Chem.* **1997**, *9*, 728–733.
53. Chaudhuri, P.; Hess, M.; Weyhermuller, T.; Bill, E.; Haupt, H.-J.; Florke, U. *Inorg. Chem. Commun.* **1998**, *1*, 39–42.
54. Geneste, F.; Racelma, N.; Moradpour, A. *Synth. Commun.* **1997**, *27*, 957–960.
55. Bill, E.; Krebs, C.; Winter, M.; Gerdan, M.; Trautwein, A. X.; Floerke, U.; Haupt, H.-J.; Chaudhuri, P. *Chem. Eur. J.* **1997**, *3*, 193–201.
56. Langenbahn, M.; Stoeckli-Evans, H.; Süß-Fink, G. *Helv. Chim. Acta* **1991**, *74*, 549–553.
57. Soupe, J.; Danon, L.; Namy, J. L.; Kagan, H. B. *J. Organomet. Chem.* **1983**, *250*, 227–236.
58. Kamochi, Y.; Kudo, T. *Nippon Kagaku Kaishi* **1993**, 500 [*Chem. Abstr.* **1993**, *120*, 133244a].
59. Leeds, J. P.; Kirst, H. A. *Synth. Commun.* **1988**, *18*, 777–782.
60. Guedes da Silva, M. F. C.; Izotova, Yu. A.; Pompeiro, A. J. L.; Kukushkin, V. Yu. *Inorg. Chim. Acta* **1998**, *277*, 83–88.
61. Kukushkin, Yu. N.; Bavina, M. V.; Zinchenko, A. V. *Zh. Obshch. Khim.* **1996**, *66*, 1572–1573.
62. Kukushkin, Yu. N.; Bavina, M. V.; Zinchenko, A. V. *Zh. Obshch. Khim.* **1996**, *66*, 1591–1592.
63. Kukushkin, Yu. N.; Bavina, M. V.; Zinchenko, A. V.; Belsky, V. K.; Kukushkin, V. Yu. *Polyhedron* **1997**, *16*, 2429–2433 and references therein.
64. Yang, S. H.; Chang, S. B. *Org. Lett.* **2001**, *3*, 4209–4211.
65. Daniel, T.; Knaup, W.; Dziallas, M.; Werner, H. *Chem. Ber.* **1993**, *126*, 1981–1993.
66. Baruah, J. B.; Sen, K. *Indian J. Chem., Sect. A* **1993**, *32A*, 980–983.
67. Hart-Davis, J.; Battioni, P.; Boucher, J.-L.; Mansuy, D. *J. Am. Chem. Soc.* **1998**, *120*, 12524–12530.
68. Kaneda, K.; Doken, K.; Imanaka, T. *Chem. Lett.* **1988**, 285–286.
69. Kaneda, K.; Fujita, K.; Takemoto, T.; Imanaka, T. *Bull. Chem. Soc. Japan* **1991**, *64*, 602–612.
70. Konwar, D.; Boruah, R. C.; Sandhu, J. S. *Tetrahedron Lett.* **1990**, *31*, 1063–1064.
71. Narasaka, K.; Kusama, H.; Yamashita, Y.; Sato, H. *Chem. Lett.* **1993**, 489–492.
72. Kusama, H.; Yamashita, Y.; Narasaka, K. *Bull. Chem. Soc. Jpn.* **1995**, *68*, 373–377.
73. Kaminskaiia, N. V.; Kostic, N. M. *J. Chem. Soc., Dalton Trans.* **2001**, 1083–1086.
74. Suh, J.; Kwon, B. N.; Lee, W. Y.; Chang, S. H. *Inorg. Chem.* **1987**, *26*, 805–808.
75. Chilou, V.; Gouzerh, P.; Jeannin, Y.; Robert, F. *Inorg. Chim. Acta* **1987**, *133*, 205–206.
76. Chilou, V.; Gouzerh, P.; Jeannin, Y.; Knobler, C. B. *Inorg. Chim. Acta* **1990**, *178*, 23–25.

# 1.34

## Reactivity of Coordinated Nitriles

A. J. L. POMBEIRO

*Instituto Superior Técnico, Lisbon, Portugal*

and

V. YU. KUKUSHKIN

*St. Petersburg State University, St. Petersburg, Russia*

---

1.34.1	INTRODUCTION	639
1.34.2	NUCLEOPHILIC ADDITIONS	640
1.34.2.1	Reactions with Aprotic Nucleophiles and Subsequent Electrophilic Additions	640
1.34.2.2	Reactions with Protic Nucleophiles	643
1.34.2.2.1	Formation of C—O bonds	643
1.34.2.2.1.1	Water and alcohols	643
1.34.2.2.1.2	(NOH) nucleophiles: oximes and hydroxylamines	647
1.34.2.2.2	Formation of C—N bonds	647
1.34.2.2.3	Formation of C—P, C—S, and C—C bonds	651
1.34.3	CYCLOADDITIONS	651
1.34.4	ELECTROPHILIC ADDITIONS	653
1.34.5	FINAL REMARKS	657
1.34.6	REFERENCES	657

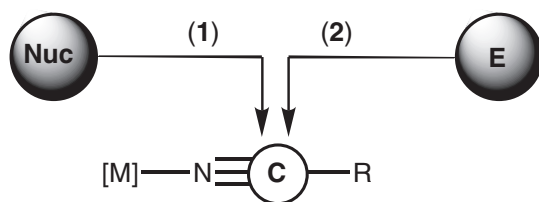
---

### 1.34.1 INTRODUCTION

Organonitrile ligands usually do not behave as either strong  $\sigma$ -donors or effective  $\pi$ -electron acceptors, as shown by their values of the electrochemical  $P_L$  and  $E_L$  parameters (a measure of the net  $\pi$ -electron acceptor minus  $\sigma$ -donor character of a ligand; see Chapter 1.29), which lie between those of more effective electron donors (e.g.,  $\text{OH}^-$ ,  $\text{H}^-$ , halide,  $\text{CN}^-$ , or  $\text{NH}_3$ ) and those of the stronger  $\pi$ -electron acceptors (such as isocyanides,  $\text{N}_2$ , or CO). Hence, they are commonly labile ligands and their complexes have been widely applied as convenient starting materials in coordination chemistry.<sup>1–3</sup> However, in spite of such a moderate coordination ability, they can be effectively activated by ligating to a metal center [M], which commonly results in an enhancement of the electrophilicity of the unsaturated nitrile carbon atom, thus promoting addition of a nucleophile (Nuc, Scheme 1 (1)). This activation has been typically achieved at metal centers in high or medium oxidation states, with a limited  $\pi$ -electron-releasing character. In contrast, the opposite type of nitrile activation, i.e., toward electrophilic attack, is also known (Scheme 1 (2)) although only rarely, when the binding metal site exhibits a high  $\pi$ -electron donor ability. Both types of additions occur, at least formally, at the unsaturated nitrile C atom (i.e., at the  $\beta$ -position) which therefore displays a higher reactivity than the metal-ligated terminal N atom.

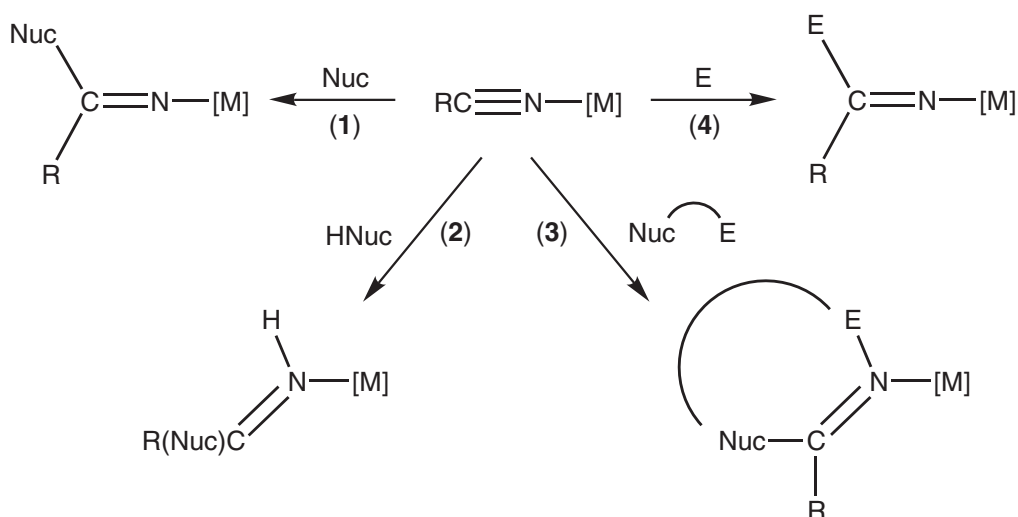
In the former general type of reaction (Scheme 1 (1)), the nucleophile (Nuc) can be (i) aprotic, to give (Scheme 2 (1)) an azavinylidene (or methyleneamide) species,  $[\text{M}]-\text{N}=\text{C}(\text{Nuc})\text{R}$ ; (ii) protic (HNuc), to afford (Scheme 2 (2)) the corresponding imino derivative,  $[\text{M}]-\text{NH}=\text{C}(\text{Nuc})\text{R}$ ; or (iii) aprotic but bearing an electrophilic center that can remain attached to the nucleophilic site

(Nuc<sup>⊖</sup>E), forming a dipole for cycloaddition, to produce (Scheme 2 (3)) a cyclic imino species. The latter general type of reaction (Scheme 1 (2)), involving the addition of an electrophile (E) to the ligated nitrile, yields (Scheme 2 (4)) azavinylidene products, [M]–N=C(E)R. Sequential nucleophilic–electrophilic additions have also been performed (Scheme 3), leading to a stepwise and alternative mode of ligand activation.



Nuc = Nucleophile, E = Electrophile

Scheme 1



Scheme 2

The above types of reaction lead to the creation of new C–X (X = H, C, N, O, S, P, etc.) or N–X bonds; and their variations—sequencing or coupling with other reaction types (such as nitrile insertions), rearrangements, chelation, use of bifunctional reagents or of di- or polynuclear metal centers, ligand bridging ([M] can then denote a dinuclear binding site), etc.—are often encountered, producing numerous types of product. These reactions provide more convenient methods than conventional processes which do not involve metals. Catalytic reactions have scarcely been developed, but the field—of high interest in the early 2000s—is rather promising. The significance of the coordination chemistry of nitriles is substantiated by the increasing number of reviews which have appeared, in particular since the time of publication of *Comprehensive Coordination Chemistry* (CCC, 1987).<sup>4–12</sup> Let us consider now illustrative reaction systems, mostly taken from the recent literature.

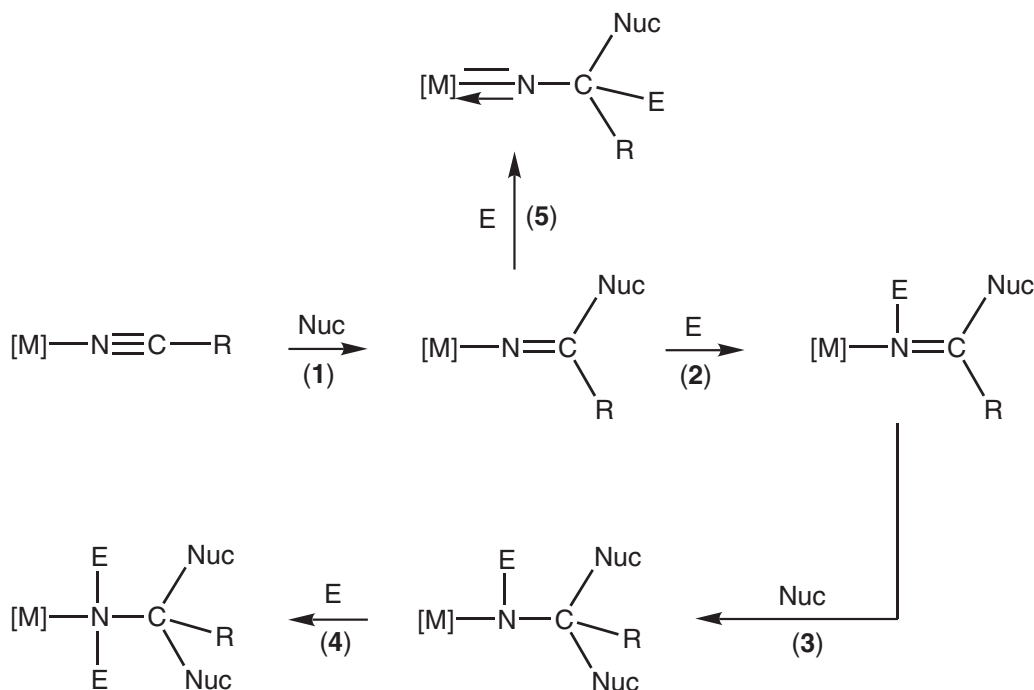
## 1.34.2 NUCLEOPHILIC ADDITIONS

### 1.34.2.1 Reactions with Aprotic Nucleophiles and Subsequent Electrophilic Additions

Addition reactions, to nitrile ligands, of aprotic nucleophiles (Table 1), such as hydride (which can be generated from various sources), a carbanion (R'<sup>⊖</sup>) or an alkoxide (OR'<sup>⊖</sup>), apart from other less common ones, usually give the azavinylidene species [M]–N=CHR (1),<sup>13</sup>



$[M]-N=C(R')R$  (**5**)<sup>14-16</sup> (or in the corresponding bridging dinuclear forms (**3**)<sup>17</sup> or (**6**)<sup>18</sup>), upon C–H or C–C bond formation, or  $[M]-N=C(OR')R$ <sup>14</sup> upon C–O bond formation. A particularly interesting case concerns the stepwise reduction [Scheme 3, Nuc = H<sup>−</sup> or CN<sup>−</sup>, E = H<sup>+</sup>], at a W<sup>II</sup> center, of acetonitrile to amines, which can be liberated (in the form of the ammonium salt (**2**): Nuc = H<sup>−</sup>, CN<sup>−</sup>; R = Me, Table 1) on acidification.<sup>13</sup> This provides a rare isolation and characterization of intermediates in the known overall reduction of nitriles to amines.



Scheme 3

The electrophilic additions occurred at the  $\alpha$ -position (the coordinated N atom), but when the lone pair of the intermediate azavinylidene ligand is involved in a  $\pi$ -bond to the metal the electrophile then adds to the imine C, yielding a nitrene (or imido) product (Scheme 3 (**1**, **5**)) with Nuc = H<sup>−</sup>; E = H<sup>+</sup>, Ph<sub>3</sub>C<sup>+</sup>.<sup>14</sup> Two successive nucleophilic (H<sup>−</sup>) addition steps to a ligated nitrile carbon have been postulated in other W centers, producing, upon subsequent hydrolysis, the corresponding amine complexes. However, for the related reactions with PhLi or MeLi, the above sequential  $\beta$ -nucleophilic and  $\alpha$ -electrophilic addition types (Scheme 3 (**1**, **2**)) are believed<sup>15</sup> to occur as observed<sup>16</sup> for a nitrile Cp\*Ir<sup>III</sup> complex in which one of the methyl groups of the Cp\* ligand is first deprotonated, and the resulting carbanion attacks the nitrile (other examples are known<sup>19</sup>) to form a cyclometalated product that is further protonated.<sup>16</sup>

The N-atom of the azavinylidene species can bridge two other atoms, in particular two metal atoms, as in (**3**) (M = Mo center,<sup>17</sup> Table 1) or in (**6**) (M = Os center<sup>18</sup>), or one metal and one boron atom in the 4-membered chelating ring (**4**) (M = Re,<sup>20,21</sup> Table 1), which represents a trapped intermediate in the reduction of a nitrile ligand by borohydride.

The 7- and 6-membered metallaphosphaheterocycles (**8**)<sup>22</sup> and (**9**)<sup>23</sup> with bridging azavinylidene moieties, were obtained from a rare nitrile–organophosphine coupling in some Mo<sub>2</sub> acetonitrile complexes. The formation of (**9**) involves deprotonation of the phosphine, which behaves as an aprotic nucleophile, but an acidic phosphine can also act as a protic nucleophile (see below).

Carbonyl-stabilized P-ylides Ph<sub>3</sub>P=CHC(O)R' can add to nitrile ligands at Pt<sup>II</sup> to form the iminophosphorane (**10**)<sup>24-26</sup> conceivably via initial nucleophilic attack at the nitrile carbon followed by intramolecular electrophilic addition of the Ph<sub>3</sub>P<sup>+</sup> group. Alternatively, the ylide can behave as a protic nucleophile (see below). The interesting 16-membered ring system (**11**), which is a structural analogue of calix[4]pyrrole, has been prepared<sup>27</sup> from the reaction of acetonitrile with

**Table 1** Reactions of nitrile ligands with aprotic nucleophiles and subsequent electrophilic additions.

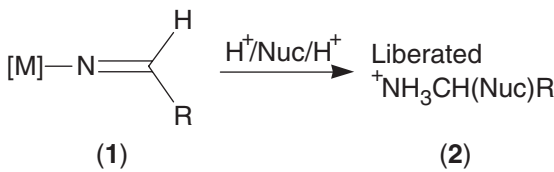
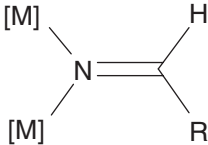
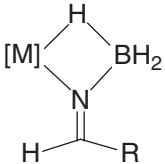
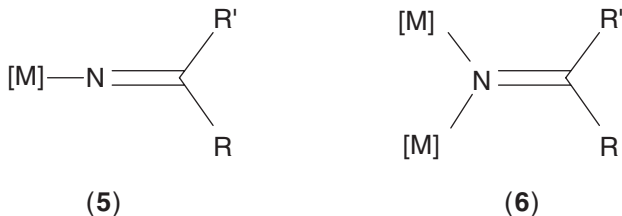
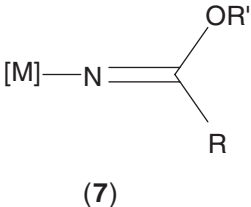
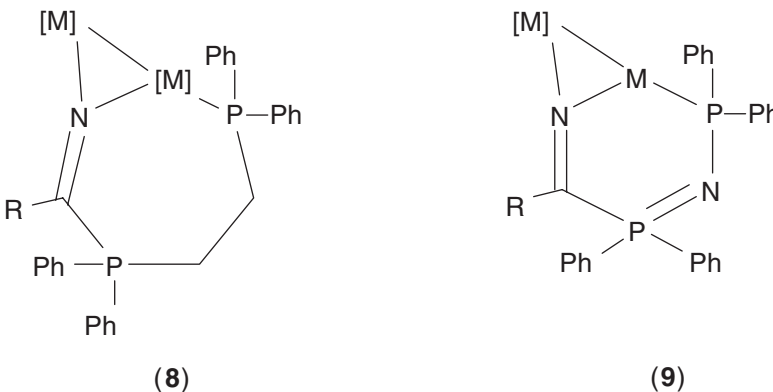
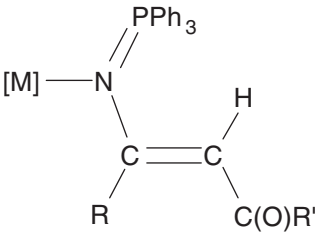
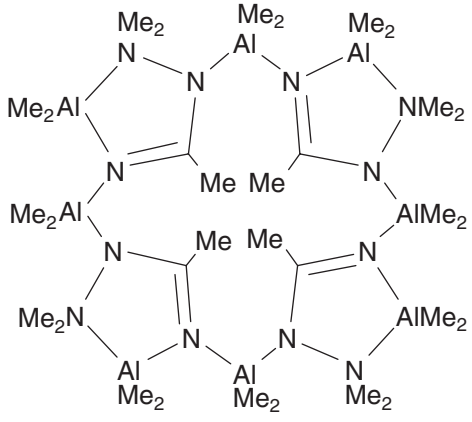
<i>Nucleophile</i>	<i>Main bond formation</i>	<i>Product(s)</i>
H <sup>-</sup>	C—H	 <p>(1) <math>\xrightarrow{H^+/Nuc/H^+}</math> (2) Liberated <math>^+NH_3CH(Nuc)R</math></p>
		 <p>(3)</p>
	C—H, N—B	 <p>(4)</p>
R' <sup>-</sup> (R' = alkyl, aryl, deprotonated methyl of a Cp* ligand, CN)	C—C	 <p>(5) <math>\xrightarrow{R'^-}</math> (6)</p>
R'O <sup>-</sup>	C—O	 <p>(7)</p>
Organophosphine Ph <sub>2</sub> PCH <sub>2</sub> CH <sub>2</sub> - PPh <sub>2</sub> (dppe) Ph <sub>2</sub> PNHPPh <sub>2</sub>	C—P	 <p>(8) <math>\xrightarrow{\text{Ph}_2\text{PCH}_2\text{CH}_2\text{PPh}_2}</math> (9)</p>

Table 1 continued

Nucleophile	Main bond formation	Product(s)
Ph <sub>3</sub> P=CHC(O)R' (R' = alkyl, alkoxy)	C—C N—P	 <p style="text-align: center;">(10)</p>
AlMe <sub>3</sub> / Me <sub>2</sub> N—NH <sub>2</sub> [Me <sub>2</sub> N—N (AlMe <sub>2</sub> ) <sub>2</sub> ]	C—N, N—Al	 <p style="text-align: center;">(11)</p>

[Me<sub>2</sub>N—N(AlMe<sub>2</sub>)<sub>2</sub>], formed *in situ* upon addition of AlMe<sub>3</sub> to 1,1-dimethylhydrazine. The mechanistic details are still unknown.

### 1.34.2.2 Reactions with Protic Nucleophiles

#### 1.34.2.2.1 Formation of C—O bonds

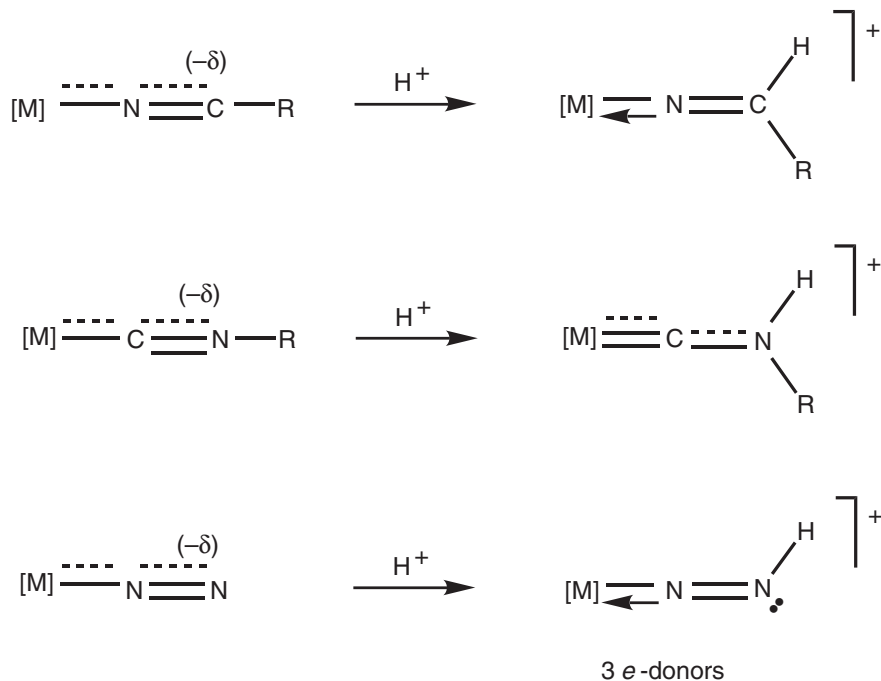
Typical protic nucleophiles, like water or alcohols (R'OH), readily add to nitrile ligands (Table 2), which can also be activated by coordination toward other, less common nucleophilic OH reagents, such as oximes or hydroxylamine, producing imine-type species (Scheme 2 (2)) or, in the case of water, an amidate or derivative.

##### 1.34.2.2.1.1 Water and alcohols

The hydrolysis of nitriles promoted by metal centers is well known, namely toward the synthesis of amides (NH<sub>2</sub>COR), compounds with industrial and pharmacological applications.<sup>5,9–11</sup> The dramatic enhancement of the rate of nitrile hydrolysis to carboxamides can be so great that the reaction becomes faster than the subsequent hydrolysis of the amides to carboxylic acids which, without the presence of the metal, is often faster than the former.<sup>28</sup>

Amidates, [M]—NHCOR, are expected intermediates in the formation of the carboxamide species [M](NH<sub>2</sub>COR) ((1), Table 2) which, in some cases, can be liberated (2) from the metal.<sup>5–11,29–37</sup> However, only a few systems, in homogeneous conditions, present catalytic activity, which is usually low. The most active ones are based on Pt<sup>II</sup> phosphinito-complexes<sup>15,29–32</sup> but a different system of higher simplicity (a zinc salt and an oxime) and lower cost has been

found.<sup>37</sup> Other catalysts are based on nitrile hydratases<sup>38–44</sup> and on mimetic complexes, the latter still showing much lower activity.<sup>45–47</sup> The enzymatic route has found industrial application (production of acrylamide, nicotinic acid *R*-(-)-mandelic acid, and *S*-(+)-ibuprofen) and a number of patents has appeared.<sup>4</sup> The complete hydrolysis of nitriles to carboxylic acids and metal-bound ammonia (**3**) can also be achieved, for example in some Pt<sup>IV</sup><sup>48</sup> Os<sup>IV</sup><sup>49</sup> and Nb<sup>V</sup><sup>50</sup> systems, a reaction with significance toward the investigation of nitrilase, a still little-known enzyme which catalyzes that conversion.



Scheme 4

The carboxamide ligands can react in different ways, e.g., coupling with one or more molecules of the parent nitrile giving the metallacycles (**4**) or (**5**), with a Ru<sup>51</sup> or a Pt<sup>52</sup> center, respectively. The amidate ligands can also react in a different mode from that leading to carboxamides, namely bridging two metals to form bimetallic metallacycles (**6**) in Mo<sub>2</sub>,<sup>53,54</sup> Re<sub>2</sub>,<sup>55</sup> Re<sub>3</sub>,<sup>56–58</sup> Re<sub>4</sub>,<sup>60</sup> Rh<sub>2</sub>,<sup>61</sup> Ni<sub>2</sub>,<sup>62,63</sup> and Ag<sub>2</sub>,<sup>64</sup> systems. The reaction of a Ni<sub>2</sub> complex with dimethylcyanamide, N≡C–NMe<sub>2</sub>, proceeds differently, giving the bridging cyanate metallacycle (**7**) upon possible addition of hydroxide to the cyanamide ligand, followed by loss of dimethylamine.<sup>62,63</sup>

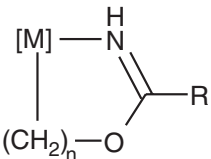
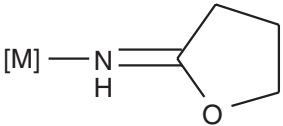
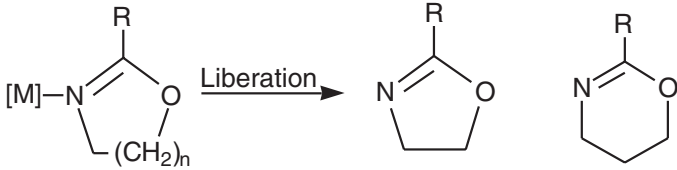
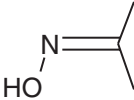
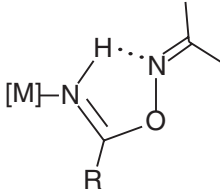
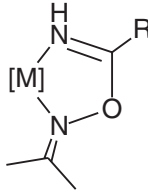
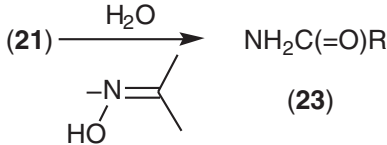
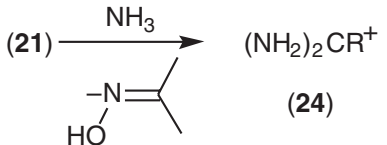
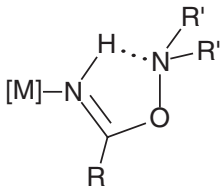
The metal-mediated organonitrile–alcohol (R'OH) coupling leads to imino ester complexes, [M]–NH=C(OR')R (**8**), in which the imino ester is usually stabilized by coordination toward hydrolysis, which nevertheless can occur in some cases, e.g., at some Ni<sup>II</sup> sites<sup>65,66</sup> to produce carboxamide species (**9**). The liberation of the imino ester (**10**) is feasible but has been achieved only rarely, e.g., from some Ir<sup>III</sup><sup>67</sup> or Cu<sup>II</sup><sup>68</sup> centers or in coupling promoted by AuCl<sub>3</sub><sup>69</sup> and therefore the possibility of their use for further organic synthesis has not yet been developed. Nevertheless, in the case of a Cu<sup>II</sup> system, the liberated imino ester (derived from 2-cyanopyridine) undergoes a fast hydrolysis to yield the corresponding ester (**11**).<sup>68</sup> Imino ester complexes have also potential application in pharmacology since antitumor activity was found<sup>70</sup> for some Pt-complexes, which moreover behave in an unconventional manner (higher activity of the *trans*-isomers relative to the *cis* ones).

The alcohol addition to organonitrile ligands was studied at a variety of metal centers;<sup>4</sup> monodentate imino ester ligands (**8**) are more usually obtained with soft (Pt, Pd, Ir, Rh) or borderline (Ni) metal centers but, at harder metal sites (Cu or Zn), metallacycles (**12**; X = pyridyl, imine, amide) are commonly formed, the reaction being particularly effective for cyanoguanidine derivatives.<sup>72</sup> The additional stabilization by chelation was also found for the former type of metal center. For example, 6-membered Pt<sup>II</sup> azametallacycles (**13**) were obtained<sup>73,74</sup> upon methanol reaction with parent cyanoguanidine [N≡C–N=C(NH<sub>2</sub>)<sub>2</sub>] complexes, and 5- and 7-membered bidentate imino ester Pd<sup>II</sup> compounds (**14**) and (**15**) have

**Table 2** Reactions of nitrile ligands with protic nucleophiles: formation of C–O bond.

Nucleophile	Product(s)			
$\text{H}_2\text{O} (\text{OH}^-)$	$\text{M}\{\text{NH}_2\text{C}(=\text{O})\text{R}\} \rightarrow \text{Liberated } \text{NH}_2\text{C}(=\text{O})\text{R} \text{ or } [\text{M}]\text{-NH}_3/\text{RCO}_2\text{H} \text{ from further hydrolysis}$			
	(1)	(2)	(3)	
			(3)	
	(4)	(5)		
	(6)	(7)		
	$\text{R}'\text{OH}$		$\xrightarrow{\text{H}_2\text{O}}$	$[\text{M}]\{\text{NH}_2\text{C}(=\text{O})\text{R}\}$
		(8)		(9)
		$\xrightarrow{\text{Liberation}}$		$\xrightarrow{\text{H}_2\text{O}}$
		(10)		(11)
		$\xrightarrow{\text{e.g.}}$		
	(12)		(13)	(14)
			(15)	

Table 2 continued

Nucleophile	Product(s)	
$-(\text{CH}_2)_n\text{OH}$	<div style="text-align: center;">  </div> <p data-bbox="404 441 451 470">(16)</p> <div style="text-align: center;">  </div> <p data-bbox="411 613 458 641">(17)</p>	
$\text{HO} \curvearrowright \text{X}$ $(\text{X} = \text{Cl}, \text{NH}_2)$	<div style="text-align: center;">  </div> <p data-bbox="446 870 494 899">(18)</p> <p data-bbox="758 870 805 899">(19)</p> <p data-bbox="951 870 998 899">(20)</p>	
	<p data-bbox="339 948 482 977">Coordinated</p> <div style="display: flex; justify-content: space-around;"> <div style="text-align: center;">  </div> <div style="text-align: center;">  </div> </div> <p data-bbox="461 1216 508 1244">(21)</p> <p data-bbox="665 1216 712 1244">(22)</p> <p data-bbox="344 1273 458 1302">Liberated</p> <div style="display: flex; justify-content: space-around;"> <div style="text-align: center;">  <p data-bbox="589 1344 735 1373"><math>\text{NH}_2\text{C}(=\text{O})\text{R}</math></p> <p data-bbox="632 1406 679 1434">(23)</p> </div> <div style="text-align: center;">  <p data-bbox="589 1508 735 1537"><math>(\text{NH}_2)_2\text{CR}^+</math></p> <p data-bbox="632 1569 679 1598">(24)</p> </div> </div>	
$\text{R}'_2\text{NOH}$	<div style="text-align: center;">  </div> <p data-bbox="404 1843 451 1872">(25)</p>	

been derived<sup>75–77</sup> from bifunctional nitriles such as 2-cyanopyridine or succinonitrile, whereas 5- or 6-membered metallacycles (**16**) ( $n = 1$  or  $2$ ) were produced by intramolecular coupling of nitrile and hydroxyalkyl,  $-(\text{CH}_2)_n\text{OH}$ , ligands at  $\text{Ir}^{\text{III}}$ <sup>78</sup> or  $\text{Rh}^{\text{III}}$ <sup>79</sup> centers, respectively.

Intramolecular ligand cyclizations of suitable functionalized nitriles or alcohols can afford rings without the metal, such as the 2-iminotetrahydrofuran  $\text{Pd}^{\text{II}}$  complex (**17**)<sup>80</sup> from  $\text{HO}(\text{CH}_2)_3\text{C}\equiv\text{N}$ , or oxazoline and 1,3-oxazine  $\text{Pt}^{\text{II}}$  species (**18**) ( $n = 1$  or  $2$ ) from haloalcohols  $\text{HO}-\text{CH}_2-(\text{CH}_2)_n-\text{X}$  ( $\text{X} = \text{Cl}$ ,  $n = 1$  or  $2$ )<sup>81–86</sup>. In particular, chiral oxazoline complexes were obtained from chiral haloalcohols, and both oxazoline (**19**) and oxazine (**20**) ligands can be liberated, although catalytic behavior has not yet been achieved.<sup>81–86</sup> Related  $\text{Ni}^{\text{II}}$ - or  $\text{Cu}^{\text{II}}$ -catalyzed reactions of 2-cyanopyridine with amino alcohols,  $\text{HO}-\text{CH}_2\text{C}(\text{R})(\text{R}')\text{NH}_2$ , also lead to oxazolines<sup>87–89</sup> (**19**,  $\text{R} = \text{C}_5\text{H}_4\text{N}$ ), and bis(oxazolines) are obtained<sup>90–94</sup> from  $\text{Zn}^{\text{II}}$ -catalyzed reactions of dinitriles with aminoalcohols. The reactions with the haloalcohols involve intermediate alkoxide  $^-\text{OCH}_2\text{CH}_2\text{Cl}$ , which alternatively can be generated by oxirane ring opening with  $\text{Cl}^-$ .<sup>81–86</sup> The metal-mediated syntheses of oxazolines (and related species) is of particular significance in view of their applications in asymmetric synthesis and their biological and insecticidal properties<sup>4</sup> and their coordination chemistry has also been reviewed.<sup>95</sup>

Electronic and stereochemical factors affecting nitrile–alcohol coupling have also been investigated in a few cases<sup>4,96</sup> whereas mechanistic studies have been reported only rarely, in particular at  $\text{Ni}^{\text{II}}$ <sup>65,66</sup> or  $\text{Pd}^{\text{II}}$ <sup>97</sup> centers. The former indicate<sup>65,66</sup> that, at the  $\text{Ni}^{\text{II}}$  center, the alcohol addition occurs via nucleophilic attack to the nitrile ligand carbon to form a 4-membered (with one alcohol molecule) or 6-membered (with two alcohol molecules) cyclic transition state.

#### 1.34.2.2.1.2 (NOH) nucleophiles: oximes and hydroxylamines

Other hydroxy-functionalized reagents, besides alcohols, have been successfully O-added to nitrile ligands, in particular oximes,  $\text{HON}=\text{CR}'\text{R}''$ , at  $\text{V}^{\text{IV}}$ ,<sup>98,99</sup>  $\text{Pt}^{\text{IV}}$ ,<sup>48,100–102</sup>  $\text{Pt}^{\text{II}}$ ,<sup>103</sup>  $\text{Re}^{\text{IV}}$ ,<sup>104</sup>  $\text{Rh}^{\text{III}}$ ,<sup>105,106</sup> or  $\text{Ni}^{\text{II}}$ ,<sup>107,108</sup> and hydroxylamine,  $\text{R}'_2\text{NOH}$ , although only in a single case, at a  $\text{Pt}^{\text{IV}}$  center.<sup>109</sup> The reactions can be viewed as O-iminoacylations of those reagents, leading to imine derivatives which can ligate the metal, either in a mono-hapto way ((**21**) or (**25**), being further stabilized by hydrogen-bond) or in a di-hapto chelation mode (**22**). Theoretical calculations<sup>48</sup> at  $\text{Pt}^{\text{IV}}$  and  $\text{Pt}^{\text{II}}$  complexes suggest that the addition of the oxime in the undeprotonated form, yielding a transition state with a 4-membered NCOH ring, is energetically favored in comparison with the alternative one involving its prior deprotonation, unless base-catalyzed conditions are used. In the case of organocyanamides,  $\text{N}\equiv\text{CNR}_2$  ( $\text{R} = \text{Me}$ ,  $\text{Et}$ ), at a  $\text{Pt}^{\text{II}}$  center<sup>103</sup> the addition of the oxime requires the presence of a catalytic amount of  $\text{Ag}^+$  or  $\text{Cu}^{2+}$  which, upon binding of the amine group, provides an additional activation of the cyano moiety toward the nucleophile.

Applications in organic synthesis of the iminoacylation reaction of oximes have recently been found at kinetically labile  $\text{Zn}^{\text{II}}$ - or  $\text{Co}^{\text{II}}$ -oxime systems. The former catalyzes the hydrolysis of nitriles to carboxamides (**23**)<sup>37</sup> and the  $\text{Co}^{\text{II}}$  system catalyzes the conversion of nitriles into amidines (**24**) (also involving C–N bond formation upon reaction with ammonia, formed from competitive hydrolysis of the nitrile).<sup>110</sup>

#### 1.34.2.2.2 Formation of C–N bonds

Amidines,  $\text{RC}(=\text{NH})\text{NR}'\text{R}''$ , are compounds of organic synthetic value, with medicinal applications<sup>4</sup> and their coordination chemistry<sup>111</sup> has been reviewed. Their complexes ((**1**), Table 3) can be conveniently prepared by addition, to a nitrile ligand, of (i) ammonia, e.g., at a  $\text{Pt}(\text{II or IV})$ ,<sup>112–116</sup>  $\text{Co}^{\text{III}}$ ,<sup>116,117</sup>  $\text{Rh}^{\text{III}}$ ,<sup>119,120</sup> or  $\text{Os}^{\text{III}}$ ,<sup>116</sup> center; and (ii) of a primary or a secondary amine, e.g., at a  $\text{Pt}^{\text{II}}$ ,<sup>4,8,121–123</sup>  $\text{Ir}^{\text{III}}$ ,<sup>67</sup>  $\text{Re}^{\text{IV}}$ ,<sup>124</sup>  $\text{W}^{\text{II}}$ ,<sup>125,126</sup> or  $\text{Mo}^{\text{IV}}$ <sup>127</sup> center. Ligated amidine derivatives with N-rings, (**9**), can be obtained by similar reactions, for instance with aziridine, e.g., at a  $\text{Pt}^{\text{II}}$  center,<sup>128</sup> to give (**10**) ( $n = 1$ ); with pyrrolidine at a  $\text{Cu}^{\text{I}}$  center<sup>129</sup> to form (**10**) ( $n = 3$ ); or with piperidine at  $\text{Al}^{\text{III}}$ <sup>130</sup> to yield (**10**) ( $n = 4$ ). A variety of metallacycles has been prepared, namely (i) by further intramolecular coupling of amidine intermediates with acetylene or carbonyl ligands at  $\text{W}^{\text{II}}$  sites to yield (**7**)<sup>131</sup> or (**8**);<sup>132</sup> or (ii) upon chelation from HN-heterocycles with imine functions, such as (**11**) ( $\text{M} = \text{Ru}^{\text{II}}$ )<sup>133</sup> or a related one ( $\text{M} = \text{Ir}^{\text{III}}$  /  $\text{Ag}^{\text{I}}$ )<sup>134</sup> from pyrazoles, (**12**) ( $\text{M} = \text{Re}^{\text{IV}}$ )<sup>135</sup> from amino-alkylated adenines, or (**13**) ( $\text{M} = \text{Os}$  in an  $\text{Os}_6$  cluster)<sup>136</sup> from 7-azaindole.

**Table 3** Reactions of nitrile ligands with protic nucleophiles: formation of C–N, C–P, and C–S bonds.

Nucleophile	Main bond formation	Product(s)
HNR'R'' (R', R'' = H, organic)	C–N	Coordinated
		(1)
		Liberated
		(2)
		(3)
(4)		
(5)		
(6)		
(7)		
(8)		



Table 3 continued

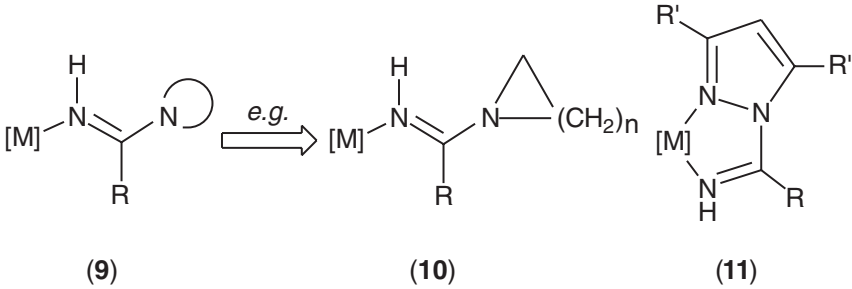
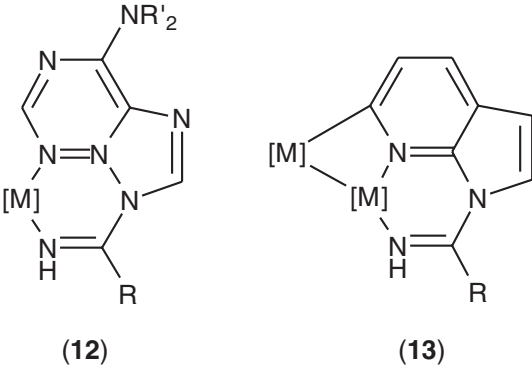
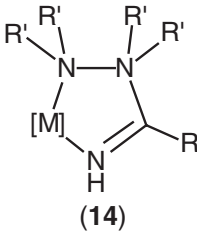
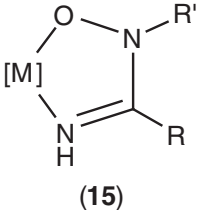
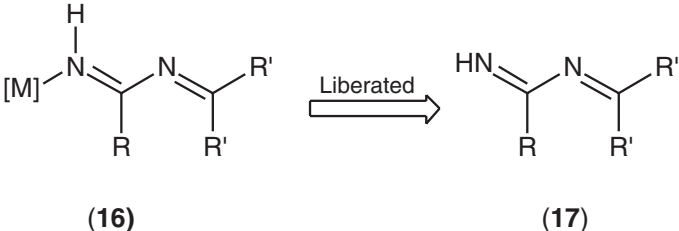
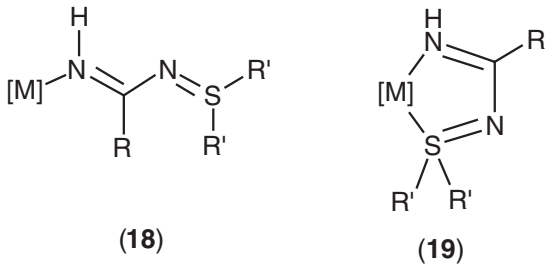
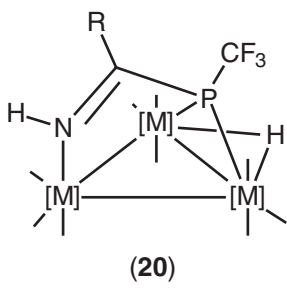
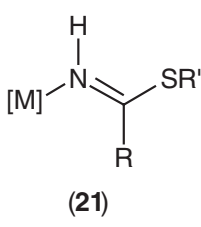
Nucleophile	Main bond formation	Product(s)
$\text{HN} \curvearrowright$	C—N	 <p style="text-align: center;"> <span data-bbox="522 533 554 568">(9)</span> <span data-bbox="843 533 893 568">(10)</span> <span data-bbox="1150 533 1196 568">(11)</span> </p>
		 <p style="text-align: center;"> <span data-bbox="501 932 551 962">(12)</span> <span data-bbox="836 932 886 962">(13)</span> </p>
$\text{R}'\text{HN-NR}'_2$	C—N	 <p style="text-align: center;">(14)</p>
$\text{R}'_2\text{NOH}$	C—N	 <p style="text-align: center;">(15)</p>
$\text{R}'_2\text{C=NH}$	C—N	 <p style="text-align: center;"> <span data-bbox="589 1815 639 1845">(16)</span> <span data-bbox="1043 1815 1093 1845">(17)</span> </p>

Table 3 continued

Nucleophile	Main bond formation	Product(s)
$R'_2S=NH$	C—N	 (18)                      (19)
$HP(CF_3)_2-$ $C(CF_3)_2OH$	C—P	 (20)
$R'SH$	C—S	 (21)

Related metallacycles have also been prepared from diamines at  $Pt^{II}$  centers<sup>137</sup> and from hydrazines which give the amidrazone chelates (**14**) ( $M = Fe$ ,<sup>138</sup>  $Ru$ ,<sup>139</sup>  $Os$ ,<sup>140</sup>  $W$ <sup>141</sup>). In addition O-containing metallacycles, (**15**) ( $M = Mo^{IV}$ <sup>142</sup>  $W^{VI}$ <sup>143</sup>), have been reported from *N*-additions, to nitriles, of hydroxylamines. The O-additions of these ambidentate nucleophiles were discussed above.

Imines,  $R'_2C=NH$ , and sulfimides,  $R'_2S=NH$ , constitute other protic nucleophiles which have been added only very rarely to nitriles, the former yielding the 1,2-diaza-1,3-diene species (**16**) ( $M = Pt^{IV}$  or  $II$ )<sup>144</sup> with synthetic value. Sulfimides can lead to the related monodentate species (**18**) ( $M = Pt^{II}$ <sup>145</sup> or  $Cu^{II}$ <sup>146</sup>), but binding through the other N atom is also possible,<sup>147</sup> as well as *N,S*-chelation as shown in (**19**) ( $M = Pt^{II}$ <sup>145</sup>).

The above nucleophilic addition reactions involve N—C bond formation, a bond that can also be created by insertion (at least formally) of a nitrile into a metal—N bond.<sup>148–150</sup> Stereochemical and kinetic<sup>4,8</sup> studies have been reported, although with few examples, for the addition of amines to nitriles at  $Pt^{II}$  centers, and the latter are indicative of the involvement, similar to the addition of alcohols (see above), of cyclic 4- and 6-center transition states, with one or two amine molecules, respectively, interacting with  $N\equiv C$ .

The products of the above nucleophilic addition reactions, in some cases, can be liberated from the metal center, but catalytic activity has yet to be developed. Examples of amidines (**2**) and derivatives that can be synthesized in this way include the following: (i) amidines from nitrile–amine coupling induced by Lewis acids, such as metal chlorides<sup>151–156</sup> or lanthanide(III) triflates,  $Ln(SO_3CF_3)_3$ ;<sup>157</sup> (ii) cyclic amines (**3**) ( $n = 1–3$ ) from the reactions of nitriles with diamines,  $H_2NCH_2(CH_2)_nNH_2$  ( $n = 1–3$ ), with loss of  $NH_3$ , catalyzed by  $Ln(SO_3CF_3)_3$ <sup>157</sup> or formed ( $n = 1$ ) at  $Pt^{II}$  centers;<sup>128,137</sup> (iii) triazines (**4**) from reactions of nitriles with ammonia (or of nitriles with N-substituted amidines), also catalyzed by  $Ln(SO_3CF_3)_3$ ;<sup>157</sup> (iv) Pyrimidines (**5**) from the reactions of acetonitrile with secondary alicyclic

amines,<sup>157</sup> (v) carboxamides (**6**) from the hydrolytic amidation of nitriles with primary and secondary amines, catalyzed by Pt<sup>II</sup><sup>32</sup> or Ru<sup>II</sup><sup>5-7</sup> complexes (it has not yet been established whether the reaction proceeds via hydrolysis of an amidine intermediate, (**1**), or amidation of RC(=O)NH<sub>2</sub> formed by initial hydrolysis of the nitrile); (vi) the aziridine-derived product liberated from (**10**) ( $n=1$ , [M] = Pt<sup>II</sup> centers);<sup>128</sup> and (vii) 1,2-diaza-1,3-dienes (**17**) liberated from a Pt(II or IV) center.<sup>144</sup>

#### 1.34.2.2.3 Formation of C–P, C–S, and C–C bonds

C–P or C–S bond formation in metal-mediated additions of protic nucleophiles to organonitriles is very rare and involves coupling with an acidic phosphine or a thiol. The former occurs with HP(CF<sub>3</sub>)C(CF<sub>3</sub>)<sub>2</sub>OH and an Os<sub>3</sub> acetonitrile cluster to give (**20**) via a  $\mu$ -PH(CF<sub>3</sub>) species which couples to the nitrile,<sup>158</sup> and the latter produces the thioimine ester complexes (**21**) with a Pt<sup>II</sup><sup>8</sup> or a Rh<sup>III</sup><sup>159</sup> center.

C–C bonds can be formed from the addition of protic nucleophiles leading to imine products such as the ylide imine (**1**) ([M] = Pt<sup>II</sup> center, Table 4)<sup>24-26</sup> derived from a phosphorus ylide (which, alternatively, can behave as an aprotic nucleophile). Of great relevance towards organic synthesis are the reactions with compounds with an activated CH<sub>2</sub> group, i.e., H<sub>2</sub>CXY [X, Y = C(O)R, CN] which exhibit a pronounced C–H acidity. Reactions with  $\beta$ -dicarbonyls,  $\beta$ -ketoamides, or  $\beta$ -ketophosphonates have been reviewed<sup>12</sup> and more recent developments include the formation of the enamino diketones (**2**), from Ni<sup>II</sup><sup>160,161</sup> or Cu<sup>II</sup>-catalyzed<sup>162,163</sup> reactions of acyl nitriles with  $\beta$ -diketones, and of cyano enamines (**3**), from reactions of activated nitriles with N $\equiv$ CCH<sub>2</sub>R' as the nucleophile, catalyzed by low-valent Ir<sup>I</sup> or Rh<sup>I</sup> centers.<sup>164,165</sup> Apart from the electrophilic activation of the nitrile, the metal can also enhance the acidity of H<sub>2</sub>CXY upon its coordination by the X (or Y) functional group, or, in the case of the low-valent Ir<sup>I</sup> or Rh<sup>I</sup> catalysts, it can undergo C–H oxidative addition of such a reagent to form a H–[M]–CHXY intermediate which then couples with the nitrile. Formal insertion reactions of nitriles into M–C bonds leading to the C–C bond formation are well documented.<sup>134</sup>

2- and 4-electron reductive coupling (with C–C bond formation) of two organonitrile molecules, mediated by transition metals, is known to occur, producing bridging diimino (**4**) [M = W<sup>II</sup> center]<sup>166</sup> or enediimino (**5**) [M = Ti<sup>V</sup>]<sup>167</sup> dinuclear species, respectively. Intramolecular coupling of two acetonitrile molecules induced by deprotonation of the CH<sub>3</sub> group of one of them leads to a  $\mu$ - $\eta^1$ -azavinylidene product (**6**) (M = Mo center),<sup>168</sup> whereas the metallacycle (**7**) (M = Al, Ga, or In center)<sup>169-172</sup> from which the ligand can be liberated, is formed by trimerization of acetonitrile, conceivably via deprotonation of one N $\equiv$ CMe. A reductive nitrile–alkyne coupling at a W template to give the intermediate (**8**) has been proposed<sup>173,174</sup> in order to account for the formation of (**9**), (**10**) and (**11**) (R = Me, R' = R'' = H; R = Et, R' = H, R'' = Me) upon further nitrile or acetone coupling (with N–C bond formation) or alcohol addition, respectively.

### 1.34.3 CYCLOADDITIONS

The dipolarophilicity of nitriles can be enhanced by coordination to a metal center, namely toward azides or nitrones, [ $\text{O}^+\text{N}(\text{R}^3)=\text{C}(\text{R}^1)(\text{R}^2)$ ], to yield, via [2 + 3] cycloadditions, the tetrazolate complexes (**1**) and (**2**) (Table 5, the latter derived from the former by sterically promoted linkage isomerization) with a wide variety of metal centers<sup>4</sup> and the  $\Delta^4$ -1,2,4-oxadiazoline complexes (**3**) with Pt centers,<sup>175</sup> respectively. The reactions normally proceed under mild conditions, even for nitriles with electron-donor alkyl groups (R). The tetrazoles<sup>177</sup> and the oxadiazolines<sup>175</sup> were liberated in some cases and the metal-mediated processes constitute promising routes for the synthesis of such heterocycles as exhibit medicinal and other applications.

A concerted mechanism was suggested<sup>178,179</sup> for the cycloaddition of the azides, whereas the promoting effect (on the reactivity) of the increase of the metal oxidation state and of the electron-withdrawal ability of the nitrile R group was investigated<sup>175</sup> for the cycloaddition of nitrones.

Nitriles can also undergo [2 + 2] cycloadditions with metal unsaturated bonds, e.g., at metallocenes with Zr=E (with E = O or S)<sup>180,181</sup> or Ti=CH<sub>2</sub><sup>182-187</sup> moieties, giving unstable 4-membered metallacycles which are intermediates for other products. Other formal cycloadditions involving nitrile insertions into metal–carbon bonds are also known.<sup>182-187</sup> Examples of cycloadditions of nitriles with C–N bond formation to produce metallacycles were presented above ((**11**), Table 1; (**7**) and (**8**), Table 3).

**Table 4** Formation of C—C bonds from reactions of nitrile ligands with protic nucleophiles and other couplings.

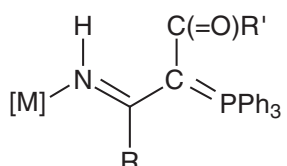
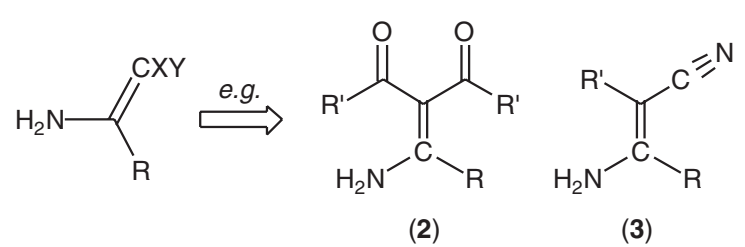
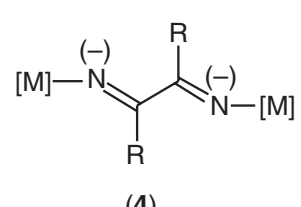
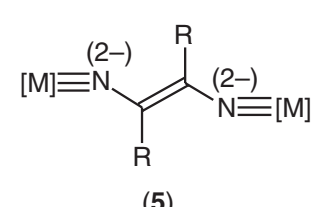
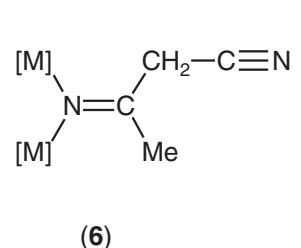
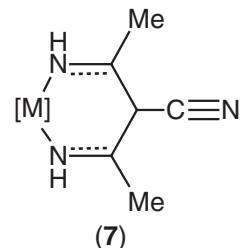
Reaction/Reagent	Product(s)
<b>Addition of protic nucleophiles</b>	
$\text{Ph}_3\text{P}=\text{CHC}(=\text{O})\text{R}'$ ( $\text{R}' = \text{alkyl, alkoxy}$ )	 (1)
$\text{H}_2\text{C} \begin{matrix} \diagup \text{X} \\ \diagdown \text{Y} \end{matrix}$ ( $\text{X, Y} = \text{C}(=\text{O})\text{R}', \text{CN}$ )	 (2)                      (3)
<b>Reductive nitrile couplings</b>	
	 (4)
	 (5)
<b>Other nitrile couplings</b>	
	 (6)
	 (7)

Table 4 continued

Reaction/Reagent	Product(s)
<b>Reductive</b> $N \equiv CR/$ $HC \equiv CPh$ <b>Coupling</b>	<p>The diagram illustrates the reductive coupling of a coordinated nitrile (8) to form three different products (9), (10), and (11). Complex (8) is a five-membered ring with a metal center [M] coordinated to a nitrogen atom with a lone pair and a radical dot. The ring also contains a phenyl group (Ph), a substituent R, and a double bond. Three reaction pathways are shown: 1) Reaction with RCN leads to product (9), an iminoacyl complex where the nitrogen is double-bonded to a carbon atom bonded to an NH group and a substituent R. 2) Reaction with Me<sub>2</sub>C=O leads to product (10), an alkyimido complex where the nitrogen is single-bonded to a carbon atom bonded to two methyl groups and coordinated to the metal. 3) Reaction with R'OH leads to product (11), an imino complex where the nitrogen is double-bonded to a carbon atom bonded to an R'O group and a substituent R.</p>

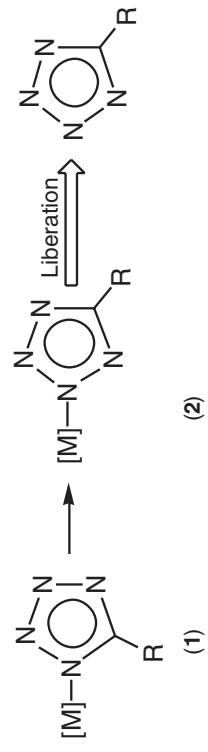
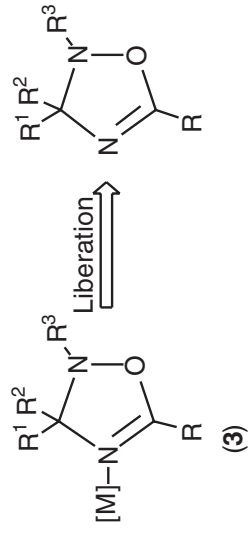
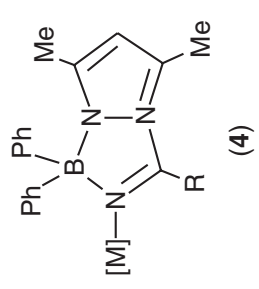
#### 1.34.4 ELECTROPHILIC ADDITIONS

When the organonitrile binds, in the  $\eta^1$ -mode, an electron-rich metal center (with the metal in a low oxidation state and with strong  $\pi$ -electron-releasing ability), it can be activated toward electrophilic attack to produce the azavinylidenes  $[M]=NCHR$  ((1), Table 6)<sup>188–193</sup> or  $[M]=NC(SiMe_3)R$  (5)<sup>190</sup> in the cases of protonation (which is reversible) or silylation, respectively, as observed for typical  $N_2$ -binding  $Re^{1188–190}$   $Mo^0$ , or  $W^{0191–193}$  phosphinic centers. Both *cis*- and *trans*-isomers were obtained for the Re centers and the latter were formerly formulated<sup>189,194</sup> as hydride complexes.

The azavinylidene ligand is linear and behaves both as a three-electron donor and an effective  $\pi$ -electron acceptor,<sup>190</sup> thus being comparable with the aminocarbyne, CNHR, and the diazenide, NNH, ligands derived from protonation of isocyanides (CNR)<sup>195</sup> and of dinitrogen,<sup>196,197</sup> respectively, when activated by the same type of metal centers. Hence, a parallelism of behavior is observed among nitriles, isocyanides, and dinitrogen ligands. Further protonation can occur in some cases, yielding the imide species  $[M] \equiv N-CH_2R$  (2)<sup>191–193,198</sup> and, for  $\beta$ -ketonitriles  $N \equiv CCH_2COR'$ , at a Mo center, the reaction proceeds until complete rupture of the N–C bond, affording the nitride  $[M] \equiv N$  (3) and a vinyl ketone  $CH_2=CHCOR'$  (4).<sup>191,192</sup>

When coordinated in the unusual edge-on mode, nitriles display an enhanced nucleophilicity, on account of the localization at the N atom of the electron lone pair that is then not involved in bonding to the metal. It can undergo alkylation or single protonation to give the iminoacyl species (6) (M = Mo center)<sup>199</sup> or (7) (M = Nb-alkyne center, at which the nitrile behaves as a 3-electron<sup>200</sup>), respectively, or double protonation to yield imino  $NH=CHR$  (8)<sup>14</sup> or, possibly, iminium  $C(R)=N^+H_2$  (9)<sup>201</sup> derivatives. Complex (7) is unstable and converts into a 5-membered azaniobacycle upon C–C coupling of the *NH*-iminoacyl and alkyne ligands.<sup>200</sup> A different electrophilic addition (to the nitrile C atom) occurs on reaction of an  $\eta^2$ -NCR  $W^{II}$  complex (in which the nitrile behaves as a 4-electron donor) with an oxygen transfer agent, pyridine *N*-oxide, to give an alkyimido product (10),<sup>202,203</sup> but neither the direct attack of the reagent to the coordinated nitrile nor the generality of this reaction has been established.

**Table 5** [2 + 3] Cycloadditions of nitrile ligands with dipolar species.

Dipole	Bond formation	Product(s)
Azides, $N_3^-$	C-N N-N	 <p>(1) <math>\xrightarrow{\quad}</math> (2)</p>
Nitrones	C-O N-C	 <p>(3)</p>
Bis(pyrazolyl)borate	C-N N-B	 <p>(4)</p>

**Table 6** Electrophilic additions to nitrile ligands.

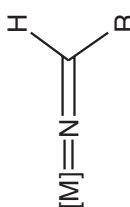
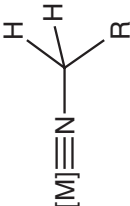
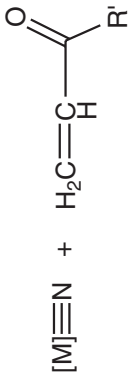

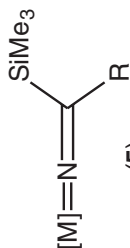
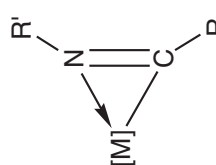
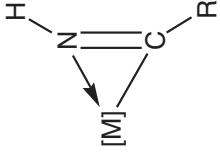

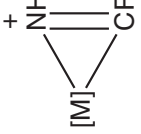

<i>Binding mode/ Electrophile</i>	<i>Bond formation</i>	<i>Product(s)</i>
$\eta^1\text{-NCR}$ , $[\text{M}]\text{-N}\equiv\text{CR}$		
$\text{H}^+$	C-H	  (1)
		  (3)
$\text{SiMe}_3^+$	C-Si	 (5)
$\eta^2\text{-NCR}$ , $[\text{M}]$		 (6)
$\text{R}^{+/+}$	N-C	

Table 6 continued

Binding mode/ Electrophile	Bond formation	Product(s)
$H^+$	$N-H$ $C-H$ $N-H$	 <p>(7)</p>  <p>(8)</p>  <p>(9)</p>
$Py^+-O^-$	$C-O$	 <p>(10)</p>



### 1.34.5 FINAL REMARKS

The above compilation of metal-promoted nitrile (this chapter) and oxime (Chapter 1.33) reactions clearly illustrates the versatility of these reagents in coordination chemistry, and attempts to classify and interpret the known types of reactions have been provided. However, some of the reactions are still rare and not always clearly defined, and systematic studies, as well as mechanistic investigations, are usually still lacking. Nevertheless, their application in metal-mediated syntheses of a variety of valuable N- and/or O-containing products has already been demonstrated. The field is particularly promising and deserves to be further explored.

### 1.34.6 REFERENCES

1. Kukushkin, V. Y.; Tkachuk, V. M.; Vorobiov-Desiatovsky, N. V. *Inorg. Synth.* **1998**, *32*, 144–148.
2. Kukushkin, V. Y.; Oskarsson, Å.; Elding, L. I. *Inorg. Synth.* **1997**, *31*, 279–284.
3. Endres, H. Nitriles. In *Comprehensive Coordination Chemistry*; Pergamon: Oxford, 1987; Vol. 2, Chap. 13.7.
4. Kukushkin, V. Y.; Pombeiro, A. J. L. *Chem. Rev.* **2002**, *102*, 1771–1802.
5. Murahashi, S.-I.; Takaya, H. *Acc. Chem. Res.* **2000**, *33*, 225–233.
6. Murahashi, S.-I.; Naota, T. *Bull. Chem. Soc. Jpn.* **1996**, *69*, 1805–1824.
7. Murahashi, S.-I.; Naota, T. *Chemtracts-Org. Chem.* **1994**, *7*, 281–297.
8. Michelin, R. A.; Mozzon, M.; Bertani, R. *Coord. Chem. Rev.* **1996**, *147*, 299–338.
9. Eglin, J. L. *Comments Inorg. Chem.* **2002**, *23*, 23.
10. da Rocha, Z. N.; Chiericato, G., Jr.; Tfouni, E. *Adv. Chem. Ser.* **1997**, 297–313.
11. Parkins, A. W. *Platinum Metals Rev.* **1996**, *40*, 169–173.
12. Corain, B.; Basato, M.; Veronese, A. C. *J. Mol. Catal.* **1993**, *81*, 133–155.
13. Feng, S. G.; Templeton, J. L. *Organometallics* **1992**, *11*, 1295–1303.
14. Feng, S. G.; White, P. S.; Templeton, J. L. *J. Am. Chem. Soc.* **1994**, *116*, 8613–8620.
15. Yeh, W.-Y.; Ting, C.-S.; Peng, S.-M.; Lee, G.-H. *Organometallics* **1995**, *14*, 1417–1422.
16. Tellers, D. M.; Ritter, J. C. M.; Bergman, R. G. *Inorg. Chem.* **1999**, *38*, 4810–4818.
17. Schollhammer, P.; Cabon, N.; Pétilion, F. Y.; Talarmin, J.; Muir, K. W. *Chem. Commun.* **2000**, 2137–2138.
18. Deeming, A. J.; Donovan-Mtunzi, S.; Kabir, S. E.; Arce, A. J.; De Sanctis, Y. *J. Chem. Soc., Dalton Trans.* **1987**, 1457–1461.
19. Fulton, J. R.; Hanna, T. A.; Bergman, R. G. *Organometallics* **2000**, *19*, 602–614.
20. Hiller, A. C.; Fox, T.; Schmalle, H.; Berke, H. *34th International Conference on Coordination Chemistry*, Edinburgh, Scotland, July 9–14th, 2000; Book of Abstracts, P0383.
21. Hillier, A. C.; Fox, T.; Schmalle, H. W.; Berke, H. *J. Organomet. Chem.* **2003**, *669*, 14–24.
22. Cotton, F. A.; Daniels, L. M.; Murillo, C. A.; Wang, X. *Polyhedron* **1998**, *17*, 2781–2793.
23. Cotton, F. A.; Kühn, F. E. *J. Am. Chem. Soc.* **1996**, *118*, 5826–5827.
24. Vicente, J.; Chicote, M. T.; Beswick, M. A.; Ramirez de Arellano, M. C. *Inorg. Chem.* **1996**, *35*, 6592–6598.
25. Vicente, J.; Chicote, M. T.; Lagunas, M. C.; Jones, P. G. *Inorg. Chem.* **1995**, *34*, 5441–5445.
26. Vicente, J.; Chicote, M. T.; Fernández-Baeza, J.; Lahoz, F. *Inorg. Chem.* **1991**, *30*, 3617–3620.
27. Gibson, V. C.; Redshaw, C.; White, A. J. P.; Williams, D. J. *Angew. Chem. Int. Ed.* **1999**, *38*, 961–963.
28. Brown, B. R. *The Organic Chemistry of Aliphatic Nitrogen Compounds*; Oxford University Press: Oxford, UK, 1994.
29. Ghaffar, T.; Parkins, A. W. *J. Mol. Catal. A: Chem.* **2000**, *160*, 249–261 and references therein.
30. Ghaffar, T.; Parkins, A. W. *Tetrahedron Lett.* **1995**, *36*, 8657–8660.
31. Parkins, A. W.; Ghaffar, T. U.S. Patent 6,133,478, 2000.
32. Coble, C. J.; van den Heuvel, M.; Abbadi, A.; De Vries, J. G. *Tetrahedron Lett.* **2000**, *41*, 2467–2470.
33. Djoman, M. C. K.-B.; Ajjou, A. N. *Tetrahedron Lett.* **2000**, *41*, 4845–4849.
34. Kaminskaja, M. V.; Kostic, N. M. *J. Chem. Soc., Dalton Trans.* **1996**, 3677–3686.
35. Chin, C. S.; Kim, S. Y.; Joo, K.-S.; Won, G.; Chong, D. *Bull. Korean Chem. Soc.* **1999**, *20*, 535–538.
36. Chin, C. S.; Kim, S. Y.; Joo, K.-S.; Won, G.; Chong, D. *Chem. Abstr.* **1999**, *131*, 144179.
37. Kopylovich, M. N.; Kukushkin, V. Yu.; Haukka, M.; Fraústo da Silva, J. J. R.; Pombeiro, A. J. L., *Inorg. Chem.* **2002**, *41*, 4798–4804.
38. Yamada, H.; Shimizu, S.; Kobayashi, M. *Chem. Rec.* **2001**, *1*, 152–161.
39. Endo, I.; Nojiri, M.; Tsujimura, M.; Nakasako, M.; Nagashima, S.; Yohda, M.; Odaka, M. *J. Inorg. Biochem.* **2001**, *83*, 247–253.
40. Endo, I.; Odaka, M. *J. Mol. Catal. B: Enzymatic* **2000**, *10*, 81–86.
41. Bianchi, D.; Bosetti, A.; Battistel, E. *Chim. Ind. (Milan)* **1999**, *81*, 1305–1308.
42. Kobayashi, M.; Shimizu, S. *Curr. Opin. Chem. Biol.* **2000**, *4*, 95–102.
43. Ramakrishna, C.; Dave, H.; Ravindranathan, M. *J. Sci. Ind. Res.* **1999**, *58*, 925–947.
44. Shimizu, S. *Bitamin* **1999**, *73*, 713–720.
45. Mascharak, P. K. *Coord. Chem. Rev.* **2002**, *225*, 201–214.
46. Marlin, D. S.; Mascharak, P. K. *Chem. Soc. Rev.* **2000**, *29*, 69–74.
47. Chin, J. *Acc. Chem. Res.* **1991**, *24*, 145–152.
48. Kuznetsov, M. L.; Bokach, N. A.; Kukushkin, V. Yu.; Pakkanen, T.; Wagner, G.; Pombeiro, A. J. L. *J. Chem. Soc., Dalton Trans.* **2000**, 4683–4693.
49. Bennett, B. K.; Lovell, S.; Mayer, J. M. *J. Am. Chem. Soc.* **2001**, *123*, 4336–4337.
50. Lee, G. R.; Crayston, J. A. *Polyhedron* **1996**, *15*, 1817–1821.
51. Hiraki, K.; Kinoshita, Y.; Kinoshita-Kawashima, J.; Kawano, H. *J. Chem. Soc., Dalton Trans.* **1996**, 291–298.
52. Rochon, F. D.; Kong, P. C.; Melanson, R. *Inorg. Chem.* **1990**, *29*, 2708–2712.

53. Cotton, F. A.; Daniels, L. M.; Haefner, S. C.; Kühn, F. E. *Inorg. Chim. Acta* **1999**, *287*, 159–166.
54. Schollhammer, P.; Le Hénanef, M.; Le Roy-Le Floch, C.; Pétilion, F. Y.; Talarmin, J.; Muir, K. W. *J. Chem. Soc., Dalton Trans.* **2001**, 1573–1577.
55. Nelson, K. J.; McGraff, R. W.; Powell, D. R. *Inorg. Chim. Acta* **2000**, *304*, 130–133.
56. Bauer, C. B.; Concolino, T. E.; Eglin, J. L.; Rogers, R. D.; Staples, R. J. *J. Chem. Soc., Dalton Trans.* **1998**, 2813–2817.
57. McGaff, R. W.; Dopke, N. C.; Hayashi, R. K.; Powell, D. R.; Treichel, P. M. *Polyhedron* **2000**, *19*, 1245–1254.
58. Concolino, T. E.; Eglin, J. L.; Staples, R. J. *Polyhedron* **1999**, *18*, 915–921.
59. Neumann, D.; Paraskevopoulou, P.; Psaroudakis, N.; Mertis, K.; Staples, R. J.; Stavropoulos, P. *Inorg. Chem.* **2000**, *39*, 5530–5537.
60. Mironov, Y. V. *Eur. J. Inorg. Chem.* **1999**, 997–999.
61. Kukushkin, V. Yu.; Nishioka, T.; Nakamura, S.; Kinoshita, I.; Isobe, K. *Chem. Letters* **1997**, 189–190.
62. Meyer, F.; Kaifer, E.; Kircher, P.; Heinze, K.; Pritzkow, H. *Chem. Eur. J.* **1999**, *5*, 1617–1630.
63. Meyer, F.; Hyla-Kryspin, I.; Kaifer, E.; Kircher, P. *Eur. J. Inorg. Chem.* **2000**, 771–781.
64. Luo, R.-S.; Mao, X.-A.; Pan, Z.-Q.; Luo, Q.-H. *Spectrochim. Acta, Part A* **2000**, *56*, 1675–1680.
65. Paul, P.; Nag, K. *Inorg. Chem.* **1987**, *26*, 1586.
66. Paul, P.; Nag, K. *J. Chem. Soc., Dalton Trans.* **1988**, 2373–2383.
67. Chin, C. S.; Chong, D.; Lee, B.; Jeong, H.; Won, G.; Do, Y.; Park, Y. *J. Organometallics* **2000**, *19*, 638–648.
68. Byers, P.; Drew, M. G. B.; Hudson, M. J.; Isaacs, N. S.; Upadhaya, A.; Madic, C. *Polyhedron* **1994**, *13*, 345–347 and references therein.
69. Potts, R. A.; Gaj, D. L.; Schneider, W. F.; Dean, N. S.; Kampf, J. W.; Oliver, J. P. *Polyhedron* **1991**, *10*, 1631–1637.
70. Natile, G.; Coluccia, M. *Coord. Chem. Rev.* **2001**, *216–217*, 383–410 and references therein.
71. Bianucci, A. M.; Demartin, F.; Manassero, M.; Masciocchi, N.; Ganadu, M. L.; Naldini, L.; Panzanelli, A. *Inorg. Chim. Acta* **1991**, *182*, 197–204 and references therein.
72. Blake, A. J.; Hubberstey, P.; Suksangpanya, U.; Wilson, C. L. *J. Chem. Soc., Dalton Trans.* **2000**, 3873–3880.
73. Guedes da Silva, M. F. C.; Ferreira, C. M. P.; Branco, E. M. P. R. P.; Fraústo da Silva, J. J. R.; Pombeiro, A. J. L.; Michelin, R. A.; Belluco, U.; Bertani, R.; Mozzon, M.; Bombieri, G.; Benetollo, F.; Kukushkin, V. Yu. *Inorg. Chim. Acta (Topical Volume on Platinum Chemistry)* **1997**, *265*, 267–270.
74. Ferreira, C. M. P., PhD Thesis, Instituto Superior Técnico, Lisbon, Portugal, 2001.
75. Ruiz, J.; Cutillas, N.; Rodríguez, V.; Sampedro, J.; López, G.; Chaloner, P. A.; Hitchcock, P. B. *J. Chem. Soc., Dalton Trans.* **1999**, 2939–2946.
76. Ruiz, J.; Rodríguez, V.; Lopez, G.; Casabo, J.; Molins, E.; Miravittles, C. *Organometallics* **1999**, *18*, 1177–1184.
77. Sanchez, G.; Serrano, J. L.; Ramirez de Arellano, M. C.; Perez, J.; Lopez, G. *Polyhedron* **2000**, *19*, 1395–1406.
78. Thorn, D. L.; Calabrese, J. C. *J. Organomet. Chem.* **1984**, *272*, 283–293.
79. de Bruin, B.; Boerakker, M. J.; de Gelder, R.; Smits, J. M. M.; Gal, A. W. *Angew. Chem. Int. Ed. Engl.* **1999**, *38*, 219–222.
80. Bertani, R.; Gotti, M.; Michelin, R. A.; Mozzon, M.; Bandoli, G.; Angelici, R. *J. Organometallics* **1996**, *15*, 1236–1241.
81. Michelin, R. A.; Bertani, R.; Mozzon, M.; Bombieri, G.; Benetollo, F.; Angelici, R. *J. Organometallics* **1991**, *10*, 1751–1757.
82. Michelin, R. A.; Bertani, R.; Mozzon, M.; Bombieri, G.; Benetollo, F.; Angelici, R. *J. Chem. Soc., Dalton Trans.* **1993**, 959–966.
83. Michelin, R. A.; Mozzon, M.; Berin, P.; Bertani, R.; Benetollo, F.; Bombieri, G.; Angelici, R. *J. Organometallics* **1994**, *13*, 1341–1350.
84. Campardo, L.; Gobbo, M.; Rocchi, R.; Bertani, R.; Mozzon, M.; Michelin, R. A. *Inorg. Chim. Acta* **1996**, *245*, 269–273.
85. Belucco, U.; Bertani, R.; Meneghetti, F.; Michelin, R. A.; Mozzon, M.; Bandoli, G.; Dolmella, A. *Inorg. Chim. Acta* **2000**, *300*, 912–921.
86. Michelin, R. A.; Belluco, U.; Mozzon, M.; Berin, P.; Bertani, R.; Benetollo, F.; Bombieri, G.; Angelici, R. *J. Inorg. Chim. Acta* **1994**, *220*, 21–33.
87. Miklos, D.; Segl'a, P.; Glowiak, T. *Inorg. Chem. Commun.* **2001**, *4*, 66–71.
88. Segl'a, P.; Koman, M.; Glowiak, T. *J. Coord. Chem.* **2000**, *50*, 105–117.
89. Segl'a, P.; Miklos, D.; Jamnický, M.; Sima, J. *J. Coord. Chem.* **1999**, *48*, 15–31 and references in these works.
90. Stark, M. A.; Jones, G.; Richards, C. J. *Organometallics* **2000**, *19*, 1282–1291.
91. Scaffaro, R.; Carianni, G.; La Mantia, F. P.; Zerroukhi, A.; Mignard, N.; Granger, R.; Arsac, A.; Guillet, J. *J. Polym. Sci., Part A: Polym. Chem.* **2000**, *38*, 1795–1802.
92. Koch, G.; Lloyd-Jones, G. C.; Loiseleur, O.; Pfaltz, A.; Pretot, R.; Schaffner, S.; Schnider, P.; von Matt, P. *Recl. Trav. Chim. Pays-Bas* **1995**, *114*, 206–210.
93. Allen, J. V.; Dawson, G. J.; Frost, C. G.; Williams, J. M. J.; Coot, S. J. *Tetrahedron* **1994**, *50*, 799–808.
94. Bolm, C.; Weickhardt, K.; Zehnder, M.; Ranff, T. *Chem. Ber.* **1991**, *124*, 1173–1180.
95. Gómez, M.; Müller, G.; Rocamora, M. *Coord. Chem. Rev.* **1999**, *193–195*, 769–837.
96. Bokach, N. A.; Kuznetsov, M. L.; Garnovskii, D. A.; Natile, G.; Kukushkin, V. Y.; Pombeiro, A. J. L. *Inorg. Chem.* **2002**, *41*, 2041–2053 and references therein.
97. Kaminskaia, N. V.; Guzei, I. A.; Kostic, N. M. *J. Chem. Soc., Dalton Trans.* **1998**, 3879–3885.
98. Grigg, J.; Collison, D.; Garner, C. D.; Helliwell, M.; Tasker, P. A.; Thorpe, J. M. *Chem. Commun.* **1993**, 1807–1809.
99. Zerbib, V.; Robert, F.; Gouzerh, P. *Chem. Commun.* **1994**, 2179–2180.
100. Kukushkin, V. Y.; Pakhomova, T. B.; Kukushkin, Y. N.; Herrmann, R.; Wagner, G.; Pombeiro, A. J. L. *Inorg. Chem.* **1998**, *37*, 6511–6517.
101. Garnovskii, D. A.; Guedes da Silva, M. F. C.; Pakhomova, T. B.; Wagner, G.; Duarte, M. T.; Fraústo da Silva, J. J. R.; Pombeiro, A. J. L.; Kukushkin, V. Y. *Inorg. Chim. Acta* **2000**, *300–302*, 499–504.
102. Kukushkin, V. Y.; Pakhomova, T. B.; Bokach, N. A.; Wagner, G.; Kuznetsov, M. L.; Galanski, M.; Pombeiro, A. J. L. *Inorg. Chem.* **2000**, *39*, 216–225.

103. Ferreira, C. M. P.; Guedes da Silva, M. F. C.; Fraústo da Silva, J. J. R.; Pombeiro, A. J. L.; Kukushkin, V. Y.; Michelin, R. A. *Inorg. Chem.* **2001**, *40*, 1134–1142.
104. Wagner, G.; Pombeiro, A. J. L.; Bokach, N. A.; Kukushkin, V. Y. *J. Chem. Soc., Dalton Trans.* **1999**, 4083–4086.
105. Kukushkin, V. Y.; Ilichev, I. V.; Wagner, G.; Fraústo da Silva, J. J. R.; Pombeiro, A. J. L. *J. Chem. Soc., Dalton Trans.* **1999**, 3047–3052.
106. Kukushkin, V. Y.; Ilichev, I. V.; Zhdanova, M. A.; Wagner, G.; Pombeiro, A. J. L. *J. Chem. Soc., Dalton Trans.* **2000**, 1567–1572.
107. Pavlishchuk, V. V.; Kolotilov, S. V.; Addison, A. W.; Prushan, M. J.; Butcher, R. J.; Thompson, L. K. *Inorg. Chem.* **1999**, *38*, 1759–1766.
108. Pavlishchuk, V. V.; Kolotilov, S. V.; Addison, A. W.; Prushan, M. J.; Butcher, R. J.; Thompson, L. K. *Chem. Commun.* **2002**, 468–469.
109. Wagner, G.; Pombeiro, A. J. L.; Kukushkin, Y. N.; Pakhomova, T. B.; Ryabov, A. D.; Kukushkin, V. Y. *Inorg. Chim. Acta* **1999**, *292*, 272–275 and references therein.
110. Kopylovich, M. N.; Kukushkin, V. Y.; Guedes da Silva, M. F. C.; Haukka, M.; Fraústo da Silva, J. J. R.; Pombeiro, A. J. L. *J. Chem. Soc., Perkin Trans. 1* **2001**, 1569–1573.
111. Baker, J.; Kilner, M. *Coord. Chem. Rev.* **1994**, *133*, 219–301.
112. Kukushkin, Y. N.; Aleksandrova, E. A.; Pakhomova, T. B. *Zh. Obshch. Khim.* **1994**, *64*, 151–152.
113. Kukushkin, Y. N.; Aleksandrova, E. A.; Pakhomova, T. B.; Vlasova, R. A. *Zh. Obshch. Khim.* **1994**, *64*, 705–707.
114. Kukushkin, Y. N.; Pakhomova, T. B. *Zh. Obshch. Khim.* **1995**, *65*, 330–330.
115. Kukushkin, V. Y.; Aleksandrova, E. A.; Kukushkin, Y. N. *Zh. Obshch. Khim.* **1995**, *65*, 1937–1939.
116. Fairlie, D. P.; Jackson, W. G.; Skelton, B. W.; Wen, H.; White, A. H.; Wickramasinghe, W. A.; Woon, T. C.; Taube, H. *Inorg. Chem.* **1997**, *36*, 1020–1028.
117. Fairlie, D. P.; Jackson, W. G. *Inorg. Chem.* **1990**, *29*, 140–143.
118. Angus, P. M.; Jackson, W. G.; Sargeson, A. M. *Inorg. Chem.* **1993**, *32*, 5285–5290.
119. Kukushkin, V. Y.; Ilichev, I. V.; Wagner, G.; Revenco, M. D.; Kravtsov, V. H.; Suwinska, K. *Eur. J. Inorg. Chem.* **2000**, 1315–1319.
120. Kukushkin, Y. N.; Krylov, V. K.; Larionova, Y. E.; Bavina, M. V. *Zh. Obshch. Khim.* **1994**, *64*, 342–343.
121. Bertani, R.; Catanese, D.; Michelin, R. A.; Mozzon, M.; Bandoli, G.; Dolmella, A. *Inorg. Chem. Commun.* **2000**, *3*, 16–18.
122. Michelin, R. A.; Bertani, R.; Mozzon, M.; Sassi, A.; Benetollo, F.; Bombieri, G.; Pombeiro, A. J. L. *Inorg. Chem. Commun.* **2001**, *4*, 275–280.
123. Kukushkin, Y. N.; Kiseleva, N. P.; Aleksandrova, E. A. *Russ. J. Coord. Chem.* **2000**, *26*, 32–33.
124. Engelhardt, L. M.; Figgis, B. N.; Sobolev, A. N.; Reynolds, P. A. *Aust. J. Chem.* **1996**, *49*, 489–496.
125. Lee, L.; Chen, D.-J.; Lin, Y.-C.; Lo, Y.-H.; Lin, C. H.; Lee, G.-H.; Wang, Y. *Organometallics* **1997**, *16*, 4636–4644.
126. Carrondo, M. A. A. F. de C. T.; Félix, V. *Acta Cryst.* **1991**, *C47*, 2451–2452 and references therein.
127. Redshaw, C.; Elsegood, M. R. *J. Polyhedron* **2000**, *19*, 2657–2659.
128. Michelin, R. A.; Mozzon, M.; Bertani, R.; Benetollo, F.; Bombieri, G.; Angelici, R. J. *Inorg. Chim. Acta* **1994**, *222*, 327–337.
129. Xiaohua, B.; Holt, E. M. *Acta Cryst.* **1992**, *C48*, 1655–1656.
130. Engelhardt, L. M.; Junk, P. C.; Raston, C. L.; Skelton, B. W.; White, A. H. *J. Chem. Soc., Dalton Trans.* **1996**, 3297–3301.
131. Feng, S. G.; White, P. S.; Templeton, J. L. *Organometallics* **1993**, *12*, 1765–1774.
132. Feng, S. G.; White, P. S.; Templeton, J. L. *Organometallics* **1994**, *13*, 1214–1223.
133. Lopez, J.; Santos, A.; Romero, A.; Echavarren, A. M. *J. Organomet. Chem.* **1993**, *443*, 221–228.
134. Stack, J. G.; Doney, J. J.; Bergman, R. G.; Heathcock, C. H. *Organometallics* **1990**, *9*, 453–466.
135. Pearson, C.; Beauchamp, A. L. *Inorg. Chem.* **1998**, *37*, 1242–1248.
136. Leung, K. S., Y.; Wong, W.-T. *J. Chem. Soc., Dalton Trans.* **1998**, 1939–1940.
137. Kukushkin, Y. N.; Kiseleva, N. P.; Zangrando, E.; Kukushkin, V. Y. *Inorg. Chim. Acta* **1999**, *285*, 203–207.
138. Albertin, G.; Antoniutti, S.; Bordignon, E.; Pattaro, S. *J. Chem. Soc., Dalton Trans.* **1997**, 4445–4453.
139. Albertin, G.; Antoniutti, S.; Bacchi, A.; Bordignon, E.; Dolcetti, P. M.; Pelizzi, G. *J. Chem. Soc., Dalton Trans.* **1997**, 4435–4444.
140. Albertin, G.; Antoniutti, S.; Bacchi, A.; Bergamo, M.; Bordignon, E.; Pelizzi, G. *Inorg. Chem.* **1998**, *37*, 479–489.
141. Du, S.; Zhu, N.; Wu, X. *Polyhedron* **1994**, *13*, 301–306.
142. Weighardt, K.; Holzbach, W.; Hoffer, E.; Weiss, J. *Chem. Ber.* **1981**, *114*, 2700–2712.
143. McDonnell, A. C.; Vasudevan, S. G.; O'Connor, M. J.; Wedd, A. G. *Aust. J. Chem.* **1985**, *38*, 1017–1024.
144. Garnovskii, D. A.; Kukushkin, V. Yu.; Haukka, M.; Wagner, G.; Pombeiro, A. J. L. *J. Chem. Soc., Dalton Trans.* **2001**, 560–566.
145. Kelly, P. F.; Slawin, A. M. Z. *Chem. Commun.* **1999**, 1081–1082.
146. Kelly, P. F.; Holmes, K. E., personal communication, 2002.
147. Kelly, P. F.; Slawin, A. M. Z. *Eur. J. Inorg. Chem.* **2001**, 263–265.
148. Mommertz, A.; Leo, R.; Massa, W.; Dehnicke, K. Z. *Naturforsch., Teil B* **1998**, *53*, 887–892.
149. Broder, C. K.; Goeta, A. E.; Howard, J. A. K.; Hughes, A. K.; Johnson, A. L.; Malget, J. M.; Wade, K. *J. Chem. Soc., Dalton Trans.* **2000**, 3526–3533 and references therein.
150. Batsanov, A. S.; Goeta, A. E.; Howard, J. A. K.; Hughes, A. K.; Johnson, A. L.; Wade, K. *J. Chem. Soc., Dalton Trans.* **2001**, 1210–1217.
151. Rousselet, G.; Capdevielle, P.; Maumy, M. *Tetrahedron Lett.* **1993**, *34*, 6395–6398.
152. Garigipati, R. S. *Tetrahedron Lett.* **1990**, *31*, 1969–1972.
153. Kirby, J. P.; van Duntzig, N. A.; Chang, C. K.; Nocera, D. G. *Tetrahedron Lett.* **1995**, *36*, 3477–3480.
154. Moss, R. A.; Ma, W.; Merrer, D. C.; Xue, S. *Tetrahedron Lett.* **1995**, 8761–8764.
155. Towle, M. J.; Lee, A.; Maduakor, E. C.; Swartz, C. E.; Bridges, A. J.; Littlefield, B. A. *Cancer Research* **1993**, *53*, 2553–2559.
156. Singh, S.; Nicholas, K. M. *Synth. Commun.* **1997**, *27*, 4021–4025.
157. Forsberg, J. H.; Spaziano, V. T.; Balasubramanian, T. M.; Liu, G. K.; Kinsley, S. A.; Duckworth, C. A.; Poteruca, J. J.; Brown, P. S.; Miller, J. L. *J. Org. Chem.* **1987**, *52*, 1017–1021.

158. Ang, H.-G.; Koh, C.-H.; Koh, L.-L.; Kwik, W.-L.; Leong, W.-K.; Leong, W.-Y. *J. Chem. Soc., Dalton Trans.* **1993**, 847–855.
159. Kukushkin, Yu. N.; Larionova, Yu. E. *Zh. Obshch. Khim.* **1994**, *64*, 1409–1410.
160. Vasil'ev, L. S.; Sheremetev, A. B.; Khoa, N. K.; Dem'yanets, Z. K.; Dmitriev, D. E.; Dorokhov, V. A. *Russ. Chem. Bull. [Engl. Transl.]* **2001**, *50*, 1280–1286 and references therein.
161. Veronese, A. C.; Callegari, R.; Basato, M.; Valle, G. *J. Chem. Soc., Perkin Trans 1* **1994**, 1779–1785.
162. Veronese, A. C.; Morelli, C. F. *Tetrahedron Lett.* **1998**, *39*, 3853–3856.
163. Morelli, C. F.; Manferdini, M.; Veronese, A. C. *Tetrahedron* **1999**, *55*, 10803–10814.
164. Takaya, H.; Naota, T.; Murahashi, S.-I. *J. Am. Chem. Soc.* **1998**, *120*, 4244–4245.
165. Kujime, M.; Hikichi, S.; Akita, M. *Organometallics* **2001**, *20*, 4049–4060.
166. Young, C. G.; Phillip, C. C.; White, P. S.; Templeton, J. L. *Inorg. Chem.* **1995**, *34*, 6412–6414.
167. Duchateau, R.; Williams, A. J.; Gambarotta, S.; Chiang, M. Y. *Inorg. Chem.* **1991**, *30*, 4863–4866.
168. Schollhammer, P.; Pichon, M.; Muir, K. W.; Pétillon, F. Y.; Pichon, R.; Talarmin, J. *Eur. J. Inorg. Chem.* **1999**, 221–223.
169. Kopp, M. R.; Neumüller, B. Z. *Anorg. Allg. Chem.* **1999**, *625*, 739–745.
170. Kopp, M. R.; Neumüller, B. Z. *Anorg. Allg. Chem.* **1999**, *625*, 1246–1248.
171. Kopp, M. R.; Kraeuter, T.; Dashti-Mommertz, A.; Neumüller, B. *Organometallics* **1998**, *17*, 4226–4231.
172. Neumüller, B., 2001, private communication.
173. Legzdins, P.; Lumb, S. A.; Young, V. G. Jr. *Organometallics* **1998**, *17*, 854–871.
174. Legzdins, P.; Lumb, S. A. *Organometallics* **1997**, *16*, 1825–1827.
175. Wagner, G.; Pombeiro, A. J. L.; Kukushkin, V. Y. *J. Am. Chem. Soc.* **2000**, *122*, 3106–3111.
176. Wagner, G.; Haukka, M.; Fraústo da Silva, J. J. R.; Pombeiro, A. J. L.; Kukushkin, V. Y. *Inorg. Chem.* **2001**, *40*, 264–271.
177. Gyoung, Y. S.; Shim, J.-G.; Yamamoto, Y. *Tetrahedron Lett.* **2000**, *41*, 4193–4196.
178. Paul, P.; Nag, K. *Inorg. Chem.* **1987**, *26*, 2969–2974 and references therein.
179. Hay, R. W.; McLaren, F. M. *Transit. Met. Chem.* **1999**, *24*, 398–402.
180. Carney, M. J.; Walsh, P. J.; Bergman, R. G. *J. Am. Chem. Soc.* **1990**, *112*, 6426–6428.
181. Carney, M. J.; Walsh, P. J.; Hollander, F. J.; Bergman, R. G. *Organometallics* **1992**, *11*, 761–777.
182. Doxsee, K. M.; Farahi, J. B. *Chem. Commun.* **1990**, 1452–1454.
183. Doxsee, K. M.; Farahi, J. B.; Hope, H. *J. Am. Chem. Soc.* **1991**, *113*, 8889–8898.
184. Avarvari, N.; Le Floch, P.; Ricard, L.; Mathey, F. *Organometallics* **1997**, *16*, 4089–4098.
185. Doxsee, K. M.; Farahi, J. B.; Mouser, J. K. M. *Synlett.* **1992**, 13–21.
186. Doxsee, K. M.; Garner, L. C.; Juliette, J. J. J.; Mouser, J. K. M.; Weakly, T. J. R.; Hope, H. *Tetrahedron* **1995**, *51*, 4321–4332.
187. Doxsee, K. M.; Mouser, J. K. M. *Organometallics* **1990**, *9*, 3012–3014.
188. Pombeiro, A. J. L.; Hughes, D. L.; Richards, R. L. *Chem. Commun.* **1988**, 1052–1053.
189. Fraústo da Silva, J. J. R.; Guedes da Silva, M. F. C.; Henderson, R. A.; Pombeiro, A. J. L.; Richards, R. L. *J. Organomet. Chem.* **1993**, *461*, 141–145.
190. Guedes da Silva, M. F. C.; Fraústo da Silva, J. J. R.; Pombeiro, A. J. L. *Inorg. Chem.* **2002**, *41*, 219–228.
191. Seino, H.; Tanabe, Y.; Ishii, Y.; Hidai, M. *Inorg. Chim. Acta* **1998**, *280*, 163–171.
192. Tanabe, Y.; Seino, H.; Ishii, Y.; Hidai, M. *J. Am. Chem. Soc.* **2000**, *122*, 1690–1699.
193. Field, L. D.; Jones, N. G.; Turner, P. *Organometallics* **1998**, *17*, 2394–2398.
194. Amatore, C.; Fraústo da Silva, J. J. R.; Guedes da Silva, M. F. C.; Pombeiro, A. J. L.; Verpeaux, J.-N. *Chem. Commun.* **1992**, 1289–1291.
195. For recent review see: Pombeiro, A. J. L.; Guedes da Silva, M. F. C. *J. Organomet. Chem.* **2001**, *617–618*, 65–69.
196. Richards, R. L. *Coord. Chem. Rev.* **1996**, *154*, 83–99.
197. Hidai, M.; Mizobe, Y. *Chem. Rev.* **1995**, *95*, 1115–1133.
198. Esjornson, D.; Bakir, M.; Fanwick, P. E.; Jones, K. S.; Walton, R. A. *Inorg. Chem.* **1990**, *29*, 2055–2061.
199. Shin, J. H.; Savage, W.; Murphy, V. J.; Bonanno, J. B.; Churchill, D. G.; Parkin, G. *J. Chem. Soc., Dalton Trans.* **2001**, 1732–1753 (and corrigenda **2001**, 2539).
200. Etienne, M.; Carfagna, C.; Lorente, P.; Mathieu, R.; Montauzon, D. *Organometallics* **1999**, *18*, 3075–3086.
201. McGilligan, B. S.; Wright, T. C.; Wilkinson, G.; Motevalli, M.; Hursthouse, M. B. *J. Chem. Soc., Dalton Trans.* **1988**, 1737–1742.
202. Thomas, S.; Young, C. G.; Tiekink, E. R. T. *Organometallics* **1998**, *17*, 182–189.
203. Thomas, S.; Lim, P. J.; Gable, R. W.; Young, C. G. *Inorg. Chem.* **1998**, *37*, 590–593.

# 1.35

## Lone Pair Effects and Stereochemistry

D. REINEN

*Philipps-Universität, Marburg, Germany*

and

M. ATANASOV

*Bulgarian Academy of Sciences, Sofia, Bulgaria*

---

1.35.1	INTRODUCTION	661
1.35.2	THEORETICAL BACKGROUND	661
1.35.3	RESULTS AND APPLICATIONS	664
1.35.3.1	The Hardness Rule	664
1.35.3.2	The Energetic Origin of the Lone-pair Effect	665
1.35.4	CONCLUSIONS AND SUMMARY	667
1.35.5	REFERENCES	667

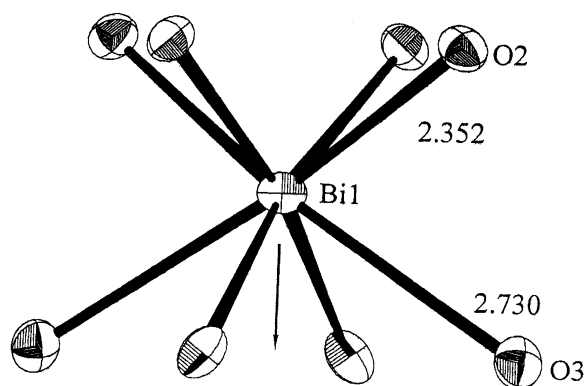
---

### 1.35.1 INTRODUCTION

Electronic instabilities in molecules, complexes, or solids may lead to pronounced steric and energetic effects, and early<sup>1</sup> inorganic coordination and structural chemists developed simple models based on known physical principles to obtain an understanding of such anomalies. One fascinating phenomenon of this kind is the wide variety of distortions which central atoms or ions with lone electron pairs very frequently impose on their environment. It is a great merit of the VSEPR (Valence Shell Electron Pair Repulsion) concept initiated by Gillespie and Nyholm,<sup>2,3</sup> that we have effective rules to hand which correctly describe the observed deformations in most cases, and which belong to the basic knowledge of present-day chemical textbooks. However, these rules are rather crude and lack a sound physical background; moreover, they cannot predict whether a distortion by lone-pair influence occurs or whether the chemical entity remains with the high-symmetry parent geometry. They also run into difficulties if high coordination numbers (CNs) are involved—such as the  $\text{Bi}^{\text{III}}\text{O}_8$  polyhedron in the solid  $\text{Bi}_{14}\text{CrO}_{24}$  (Figure 1) with  $\text{CN} = 8$ , for example—where the lone pair induces a considerable distortion along one  $C_4$  direction of the cubic parent geometry<sup>4</sup> (see Section 1.35.3.1). It is the intention of this chapter to introduce a more sophisticated model, with the potential not only to exactly characterize the displacement paths along which a distortion is activated, but also to elucidate the chemical parameters that finally determine the appearance or absence of lower-symmetry deformations.<sup>5</sup>

### 1.35.2 THEORETICAL BACKGROUND

It is generally accepted, that stereochemical anomalies due to the influence of a lone pair can be analyzed by applying a pseudo-Jahn–Teller (PJT)-type treatment.<sup>6,7</sup> If G and E are the irreducible representations of the ground state and of a low-lying excited state, respectively,



**Figure 1** The Bi(1) coordination in the red pigment  $\text{Bi}_{14}\text{CrO}_{24}$ ; the arrow indicates the lone-pair orientation (after ref. 4).

in the high-symmetry parent geometry, the direct product  $G \otimes v \otimes E$  selects the vibrational modes,  $v$ , along which distortions may occur—utilizing the group theoretical condition that the product must contain the totally symmetric representation. If we restrict ourselves to cations with only one lone pair, which occupies an  $s$  orbital of the undistorted species (totally symmetric ground state), we have the critical condition that  $v$  must possess the same symmetry as  $E$ . In Table 1, a survey of the parent and of the distorted geometries is given for the coordination numbers (CNs) 3 to 6 and 8. They result from ligand displacements according to any linear combination of the components of the active vibrations  $v$  (only the highest symmetry distortions are considered). As an example, we show in (Figure 2) the three distortion alternatives for  $\text{CN} = 6$ , from which two may lead to the complete removal of one ( $C_{4v}$ ) or even two ligands ( $C_{2v}$ ); the geometries of the resulting species with reduced CN are those predicted for  $\text{CN} = 5$  and 4, respectively. This briefly described concept explicitly considers the interaction between the nuclear displacements and the electronic rearrangement motions which accompany the distortion process. Its energetics (see the potential energy diagram for the  $\text{CN} = 3$  in Figure 2) can be followed by the rather simple matrix<sup>5</sup> (1), if the possible interaction with higher excited states of the same symmetry is negligible (two-state approximation).

$$\begin{vmatrix} E_g - E & N \\ N & E_g - E \end{vmatrix} \quad (1)$$

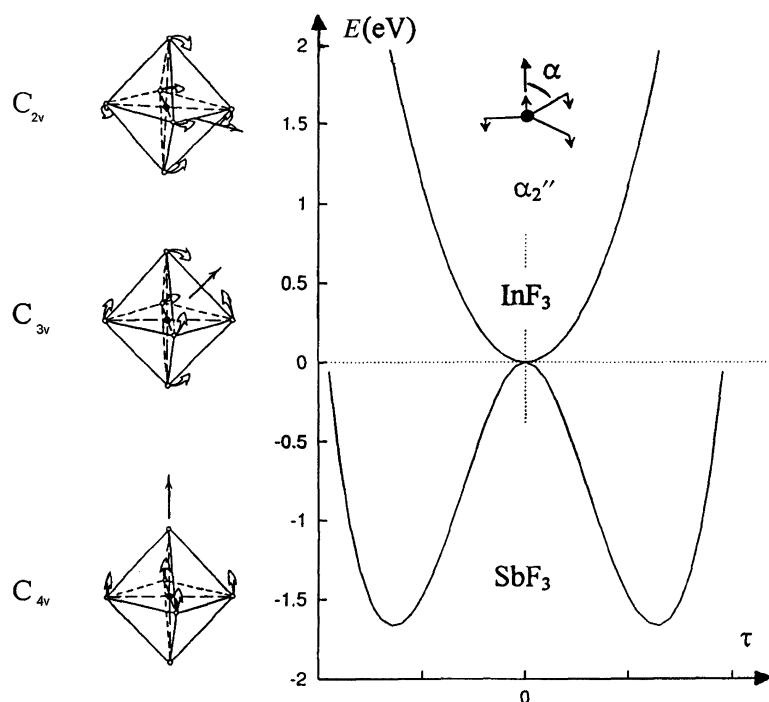
Here,  $E_g$  and  $E_e$  are the initial ground- and excited-state energies, while the off-diagonal term comprises products of the vibronic coupling constants with those ligand displacements that characterize one of the possible distortion paths (Table 1; (Equation 3)). In the general solution (Equation 2) of matrix (1),  $E_-^m$  is the final, optimized ground-state energy,  $E_{\text{rf}}^m$  the restoring energy, and  $E_{\text{vib}}^m$  the vibronic energy, as sketched in Figure 3 for the special case of  $\text{SbF}_3$ .

$$E_-^m = E_{\text{rf}}^m - E_{\text{vib}}^m \quad (2)$$

**Table 1** The parent (pg) and final (fg) geometries of complexes with lone pair properties; the active modes (am) and the excited state symmetries (es) are also specified.

CN	pg	fg <sup>a</sup>	am	es
3	$D_{3h}$ , planar	$C_{3v}$	$\alpha_2''$	$A_2''$
4	$T_d$ , tetrahedral	$C_{2v}$ ( $C_{3v}$ )	$\tau_2$ (2x)	$T_2^b$
5	$D_{3h}$ , trig. bipy.	$C_{2v} \approx C_{4v}$	$\epsilon'$ (3x)	$E'$
6 <sup>c</sup>	$O_h$ , octahedral	$C_{4v}$ , $C_{2v}$ ( $C_{3v}$ )	$\tau_{1u}$ (2x)	$T_{1u}$

<sup>a</sup> Approximately the pseudo tetrahedral ( $\text{CN} = 3$ ), pseudo trigonal-bipyramidal ( $\text{CN} = 4$ : lone pair in equatorial plane ( $C_{2v}$ ) or perpendicular to it ( $C_{3v}$ )), pseudo octahedral ( $\text{CN} = 5$ ) and pseudo "capped octahedral" ( $\text{CN} = 6$ :  $C_{3v}$ ) geometries, according to the VSEPR model; energetically less favored distortions are in parentheses. <sup>b</sup> Presence of first order Jahn-Teller splitting by the  $\epsilon$  mode, with influence on the ground state via  $N$  in matrix (1). <sup>c</sup> The same analysis holds for the  $\text{CN} = 8$  with a cubic  $O_h$  parent geometry.



**Figure 2** The highest symmetry distortions of  $\tau_{1u}$  type in  $O_h$  (CN = 6) (left) and the potential energy diagram of  $SbF_3$  (combined angular and radial displacements  $\tau$ ; minima positions see Figure 3), as compared to that of  $InF_3$  without the lone pair (right).

$E_{rf}^m$  represents the ground-state energy change proceeding from the parent to the distorted geometry, without taking the off-diagonal term into account ( $\equiv E_g^m$ ), and is mostly a positive quantity.  $E_{vib}^m$  is the energy contribution, solely introduced by the vibronic coupling ( $N > 0$ ). In the limits of rather small and of dominating vibronic interactions,  $E_{vib}^m$  adopts the approximate expressions in Equations (2a) and (2b), respectively (for the definitions of  $\delta$  and  $\delta E_{g,c}^m$  see Figure 3).

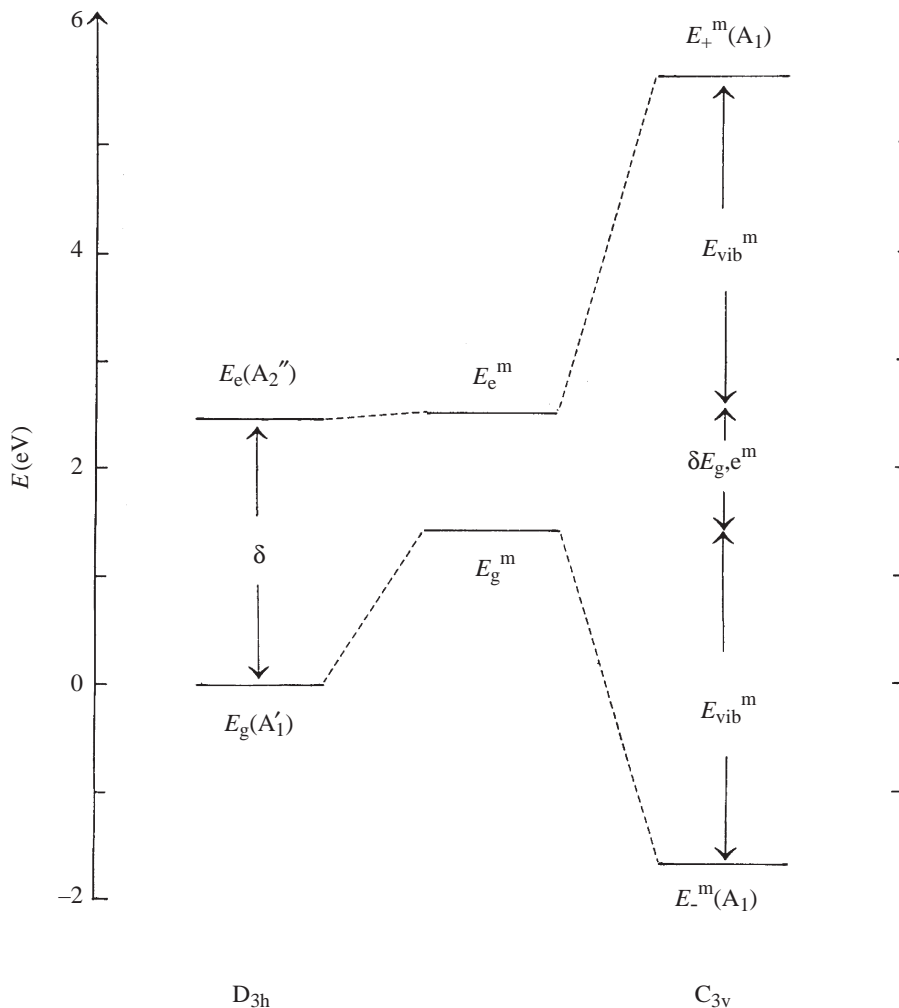
$$E_{vib}^m \approx N^m / \delta \quad (2a)$$

$$E_{vib}^m \approx N^m - \delta E_{g,c}^m / 2 \quad (2b)$$

The latter relationship holds rather well for molecules  $AX_3$  ( $A^{III} = P$  to  $Bi$ ;  $X^{-1} = F$  to  $I$ ). The expression for  $N^m$  is simple for  $CN = 3$ <sup>8</sup> (Equation (3)), but rather complex in the case of higher coordination numbers.<sup>5</sup>

$$CN = 3: N^m = t_\alpha \tau_\alpha^m + t_{\alpha r} \tau_\alpha^m \tau_r^m \quad (3)$$

Because the angular distortion process induces a change of the  $s^2$  ground-state electron configuration by  $p$  admixture toward  $s^{2-\delta} p^\delta$ —thus reducing the  $s$ -electron density in the ligand regions—the average bond length decreases by  $\tau_r$ ; hence a vibronic coupling constant,  $t_{\alpha r}$ , has to be introduced in addition to  $t_\alpha$ , which solely accounts for the angular interaction according to  $\alpha_2''$ -type displacements  $\tau_\alpha$  (Figure 2). If lone-pair configurations different from  $s^2$  are present, as is sometimes observed for the  $CN = 3 - p_z^2$ , for  $AH_3$  ( $A^{III} = N$  to  $Bi$ ) and  $NX_3$  ( $X^{-1} = F$  to  $I$ ) molecules, for example – then a reverse effect (bond-length increases during the distortion) may be seen.<sup>8</sup> The final, optimized  $\tau_r$  and  $\tau_\alpha$  values are  $\tau_r^m$  and  $\tau_\alpha^m$ , respectively. If one utilizes the results of quantum-chemical calculations within density functional theory (DFT), which are usually in fair agreement with published experimental data, all the parameters introduced by the vibronic coupling model can be determined.<sup>8</sup>



**Figure 3** Energy diagram (with  $E_g \equiv 0$ ) of  $\text{SbF}_3$  for the  $D_{3h} \rightarrow C_{3v}$  distortion process ( $a(\text{Sb-F})$ :  $2.02 \rightarrow 1.94 \text{ \AA}$ ;  $\text{F-Sb-F}$ :  $120^\circ \rightarrow 95.8^\circ$ );  $E_g^m$  ( $\equiv E_{\text{rf}}^m$ ),  $E_e^m$  and  $E_-^m$ ,  $E_+^m$  are the ground- and excited-state energies without ( $N=0$ ) and with ( $N^m=0.86$ ,  $E_{\text{vib}}^m=3.60 \text{ eV}$ ) taking the off-diagonal term in matrix (1) into account (minimum positions in Figure 1), respectively.

One remarkable consequence of the concept introduced is that in the case of strong vibronic interaction (Equation (2b)), the off-diagonal vibronic energy  $N^m$  is correlated with the chemical hardness  $\eta$  of the distorted complex or molecule (Equation (4)). This is an *observable quantity*; thus, the vibronic model is directly linked to the experiment.<sup>5</sup>

$$\eta \approx N^m + C \quad \eta = 1/2(I - A) \quad (4)$$

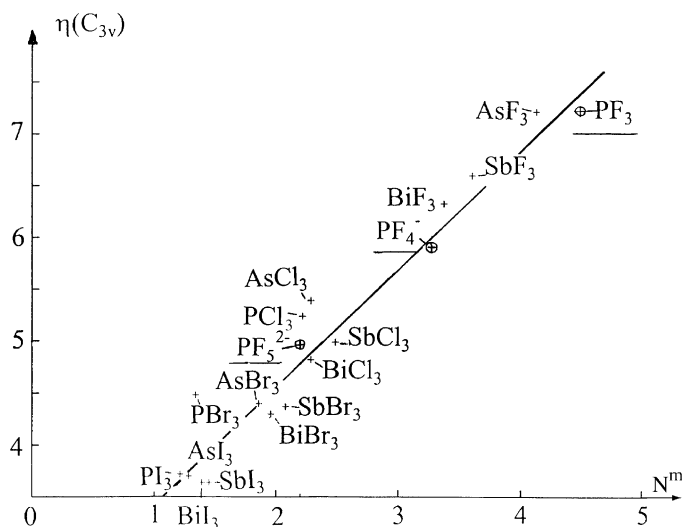
The term  $C$  in Equation (4) is an interelectronic repulsion contribution, while  $I$  and  $A$  are the ionization energy and electron affinity, respectively. We show in the next section that the vibronic coupling strength, imaged by the chemical hardness, may indeed govern the steric and energetic lone-pair effects.

### 1.35.3 RESULTS AND APPLICATIONS

#### 1.35.3.1 The Hardness Rule

The  $\eta(C_{3v}) - N^m$  diagram depicted in (Figure 4) illustrates, that—for the halides of the trivalent fifth group cations  $\text{P}^{\text{III}}$  to  $\text{Bi}^{\text{III}}$  as model compounds, where condition Equation (2b) holds—the sensitivity towards lone-pair distortions (measured by  $N^m$ ) increases from the soft ( $\text{BiI}_3$ ,  $\text{SbI}_3$ ) to the





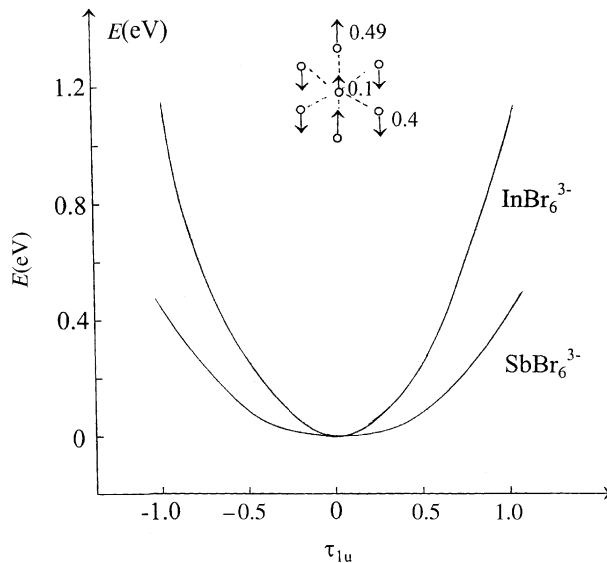
**Figure 4** Chemical hardness vs. vibronic energy diagram for molecules  $AX_3$  ( $X^{-1}$ : F to I;  $A^{III}$ : P to Bi) and the charge-compensated complexes  $PF_4^-$  and  $PF_5^{2-}$  (in eV).

hard ( $PF_3$ ,  $AsF_3$ ) molecules. Including the corresponding halide complexes, one further deduces that the off-diagonal vibronic energy and the hardness decrease with increasing coordination number and negative charge ( $PF_3 \rightarrow PF_4^- \rightarrow PF_5^{2-}$ ), which perfectly matches the experimental observations.<sup>9</sup> (The DFT results refer to the charge-compensated anions by placing the complexes into a polarizable continuum, in order to model the realistic situation as closely as possible.<sup>5</sup>) While all  $AX_3$  molecules adopt the distorted  $C_{3v}$  geometry, only the harder  $AX_4^-$  complexes (i.e.,  $A = P, As$ ;  $X = F, Cl$ ) possess the butterfly-shaped  $C_{2v}$  structure (Table 1), the softer ones remaining in the tetrahedral parent geometry ( $A$ : Sb, Bi;  $X$ : Br, I). With  $CN = 5$ , the number of complexes undergoing a lone-pair distortion to an approximate square pyramid (Table 1) is further reduced, while from the  $AX_6^{3-}$  complexes only those with  $A = P, As, Sb$  and  $X = F$  are vibronically unstable.  $PF_6^{3-}$  and  $SbF_6^{3-}$  distort via  $C_{2v}$  and  $C_{4v}$ , respectively (Figure 2); here a small cation-to-ligand ionic-size ratio seems to support the vibronic instability, such that complete dissociation to the  $CNs$  4 ( $\rightarrow PF_4^-$  ( $C_{2v}$ )) and 5 ( $\rightarrow SbF_5^-$  ( $C_{4v}$ )) occurs.<sup>5</sup> Nicely following the prediction and regarding the complexes  $SbX_6^{3-}$ , only that with  $X = F$  is unknown.<sup>9</sup> Even if the complex or molecule does not distort, a vibronic effect may show up by soft-mode behavior along certain displacement paths (Table 1). An example is the potential energy diagram for  $SbBr_6^{3-}$  compared to the one for the corresponding  $InBr_6^{3-}$  complex without the lone pair (Figure 5). Although the vibronic energy  $E_{vib}$  ( $>0$ ) is finite, it is too small to compensate for the restoring energy (see Equations (2) and (2a)). In such cases small external strains—as are frequently present in solid structures due to lower symmetry second-sphere coordination, for example—may already lead to shallow minima in the flat potential curve at finite distortions. An illustrative example is the  $Bi^{III}O_8$  polyhedron in Figure 1, where ligand displacements according to the highest-symmetry components of the two  $\tau_{1u}$  modes nicely match the distortion path from the cubic parent to the  $C_{4v}$ -distorted geometry (Table 1).

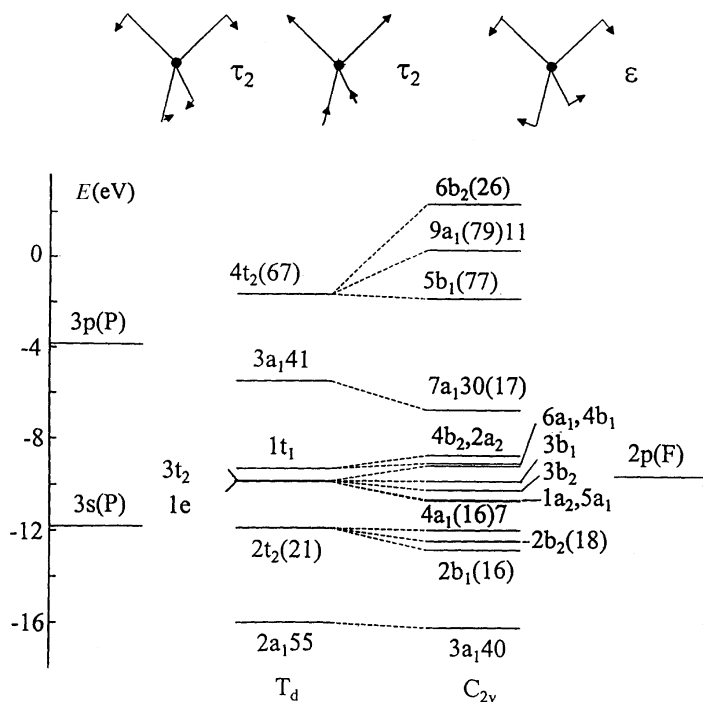
We have already emphasized that the hardness rule is strictly valid only in the case of strong vibronic coupling; it holds rather well for the compounds and complexes considered so far (Figure 4), including also the majority of molecules  $AH_3$  ( $A = N$  to Bi) and  $NX_3$  ( $X = F$  to I) with  $p_z^2$  ground states in  $D_{3h}$ . The serious exceptions are  $NF_3$  and, in particular, ammonia, where the initial splitting  $\delta$  (Figure 2) is very large ( $N^m \cong 2.4$ ;  $\delta \cong 6.5$ ,  $\delta E_{g,e}^m \cong 5.6$  eV) and Equation (2a) holds rather than (2b)—yielding  $E_{vib}^m \cong 0.9$ ,  $E_{rf}^m \cong 0.7$ , and  $E_-^m \cong -0.2$  eV.

### 1.35.3.2 The Energetic Origin of the Lone-pair Effect

As a representative example, we show in (Figure 6) the MO scheme of the charge-compensated  $PF_4^-$  complex. The sum of the electrons in the occupied MOs defines the many-electron ground states  $A_1$  in  $T_d$  and  $C_{2v}$ , and the excited states  $T_2(A_1)$  result from the excitation of one electron from the HOMO  $3a_1$  ( $7a_1$ ) into the LUMO  $4t_2$  ( $9a_1$ ). It is seen that, in spite of small shifts of most of the other MOs, the  $T_d \rightarrow C_{2v}$  transition is energetically dominated by the  $3a_1 - 4t_2$  interaction  $a_1 \otimes \tau_2 \otimes t_2$ , with a lone-



**Figure 5** Potential energy diagram of  $\text{SbBr}_6^{3-}$  in comparison to the one of  $\text{InBr}_6^{3-}$  without the lone pair (unit  $\tau_{1u}$  displacement displayed in insert).



**Figure 6** MO diagram of the charge-compensated  $\text{PF}_4^-$  complex<sup>5</sup> (the low-lying non-bonding MOs from 2s (F) are not shown). The numbers indicate the central ion p- (in parenthesis) and s-participation (%), and the parent AOs are also specified; the vibronically active  $\tau_2$  and  $\epsilon$  vibrations are depicted above.

pair stabilization of about  $-2.5\text{ eV}$  in comparison to the total energy gain  $E_{-}^{\text{m}} \cong -1.7\text{ eV}$ . The electrons in  $3a_1$  are not phosphorus-localized and nonbonding, as is frequently assumed for a lone pair, but antibonding with respect to the parent  $3s(\text{P})$  and  $2p(\text{F})$  electrons, with the density roughly equally distributed between the central ion and the fluoride ligands. The vibronic interaction makes the HOMO less antibonding, induced by an appreciable admixture of  $p$ -character (about  $1/3$ ).

A closer analysis of the DFT results within the vibronic coupling model shows<sup>5</sup> that the lone-pair stabilization—as has been emphasized before<sup>7,10</sup>—is a purely orbital effect. It is caused by the changes in overlap due to the electronic rearrangements, which accompany the nuclear  $T_d \rightarrow C_{2v}$

displacements (for active modes see Figure 6), and is represented by the vibronic energy  $E_{\text{vib}}^{\text{m}}$  (Equation (2)). It is challenging to relate this result to the VSEPR model, which considers the interpair (Pauli) repulsion within the valence shell (including the lone pair)<sup>2</sup> and/or—in its recent modification<sup>11</sup>—the energy connected with the ligand close-packing concept, as the driving force for the distortion process. The consequence of the combined vibronic/DFT study, however, is that both mentioned VSEPR contributions are constituents of the restoring energy  $E_{\text{rf}}^{\text{m}}$ .<sup>5</sup> Because  $E_{\text{rf}}^{\text{m}}$  is mostly a positive quantity, it is the  $s-p_z$  mixing ( $N^{\text{m}} > \text{O}$ ), which dominates the stabilization energy for the lower-symmetry distortion ( $E_{\text{vib}}^{\text{m}} > E_{\text{rf}}^{\text{m}} \rightarrow E_{-}^{\text{m}} < \text{O}$ ; Equation (2)).

### 1.35.4 CONCLUSIONS AND SUMMARY

By combining the vibronic coupling concept with DFT calculations, the lone-pair effect can be rigorously analyzed.<sup>5,8</sup> As shown for the model compounds and complexes  $\text{AX}_n^{-(n-3)}$  ( $\text{A} = \text{P}$  to  $\text{Bi}$ ,  $\text{X} = \text{F}$  to  $\text{I}$ ), the vibronic concept leads to a basic understanding of the steric and energetic phenomena involved and can be linked to chemical parameters. The lone pair becomes less decisive in modifying the stereochemistry of the halides of the fifth main group, trivalent elements, with increasing atomic weight of either central atom or halogen, and with increasing anionic charge and coordination number. These results are in perfect agreement with textbook surveys of experimental data,<sup>9</sup> thus refuting the argument of a theoretical deficiency in this matter. The most significant outcomes are:

1. The lone-pair effect is an orbital overlap phenomenon due to electronic  $s-p$  rearrangements and is not caused by interpair repulsion within the valence shell, in disagreement with the VSEPR model. The lone pair is usually not localized at the central atom, but occupies an antibonding MO with pronounced ligand contributions.
2. The vibronic model provides precise information about the distortion mechanisms and pathways, and explains why certain complexes remain with the high-symmetry parent geometry while others undergo deformation.
3. The harder the  $\text{AX}_3$  molecules and their atomic constituents are, the more susceptible they become towards distortion (hardness rule). With increasing coordination number and negative charge, a complex becomes softer and displays a less pronounced vibronic instability. The hardness rule is able, within certain limits, to predict trends for lone-pair distortions as a function of chemical parameters.
4. Though complexes  $\text{AX}_n^{-(n-3)}$  with large CNs are mostly found with the high-symmetry parent geometry, the potential curves are frequently rather flat along ligand-displacement paths of vibronically active modes and, accordingly, are sensitive towards external strains such as are encountered in solids.

### 1.35.5 REFERENCES

1. Dunitz, J. D.; Orgel, L. E. *Advances Inorg. and Radiochem.* **1960**, *2*, 40–45.
2. Gillespie, R. J.; Nyholm, R. S. *Quart. Rev. (London)* **1957**, *11*, 339–380.
3. Gillespie, R. J.; Robinson, E. A. *Angew. Chem.* **1996**, *108*, 539–560 [Intern Ed. 495].
4. Warda, S. A.; Pietzuch, W.; Massa, W.; Kesper, U.; Reinen, D. *J. Solid State Chem.* **2000**, *149*, 209–217.
5. Atanasov, M.; Reinen, D. *J. Am. Chem. Soc.* **2002**, *124*, 6693–6705 and cited references.
6. Öpik, U.; Price, M. H. L. *Proc.R. Soc. London, Series A* **1957**, *238*, 425–447.
7. Bersuker, I. B. *Electronic Structure and Properties of Transition Metal Compounds*; Wiley: New York, 1996; Chapter 9.
8. Atanasov, M.; Reinen, D. *J. Phys. Chem. A* **2001**, *105*, 5450–5467.
9. Greenwood, N. N.; Earnshaw, A., *Chemistry of the Elements*, 2<sup>nd</sup> ed.; Butterworth Heinemann: Oxford, 1998, pp 558–568.
10. Burdett, J. *Chemical Bonds: A Dialog*; Wiley: Chichester, 1997, pp 155–162.
11. Gillespie, R. J. *Coord. Chem. Rev.* **2000**, *197*, 51–69.

# 1.36

## Outer Sphere Coordination Chemistry

M. ATANASOV

*Bulgarian Academy of Sciences, Sofia, Bulgaria*

and

D. REINEN

*Philipps-Universität, Marburg, Germany*

---

1.36.1	INTRODUCTION	669
1.36.2	SOLUTE–SOLVENT INTERACTIONS (SSI)	669
1.36.3	HIGHER SPHERE LIGAND FIELDS (HSLF)	670
1.36.3.1	Symmetry Effects by the Second Coordination Sphere	670
1.36.3.2	Bond Strength and Covalency Effects Induced by the Second Coordination Sphere	672
1.36.3.3	The Stabilization of High Oxidation States of the Late 3d-Metals by Second Coordination Sphere Effects	674
1.36.3.4	Bonding Anisotropy by Orbital Phase Coupling	677
1.36.4	SUMMARY	677
1.36.5	REFERENCES	677

---

### 1.36.1 INTRODUCTION

Energetic influences from an outer sphere environment may be subdivided into two classes. Interactions occurring between a coordination compound or complex and a surrounding solvent (Section 1.36.2), for example, are usually of predominantly electrostatic character and do not significantly alter the chemical bonding within the solute. In stating this, we exclude chemical reactions between solute and solvent (such as acid–base equilibria). A completely different situation arises if the ligand atoms of a complex are strongly bonded to other cations—this occurs in solids or in the case of extended ligands. Here the central ion–ligand atom bonding may be distinctly affected by the nature of the second (or even higher) coordination sphere. This influence is twofold; on the one hand the  $\sigma$ - and  $\pi$ -bond strength can be modified, and on the other hand a steric factor may additionally be significant. The latter implies that the ligand atomic orbitals are frequently fixed in orientation by strong bonds to the second sphere coordinate frame—this leads to a misdirection of those orbitals, which overlap with the central ion orbitals (*misdirected valence*). We call phenomena of this kind higher sphere ligand field (HSLF) effects (see Section 1.36.3).

### 1.36.2 SOLUTE–SOLVENT INTERACTIONS (SSI)

Outer sphere interactions of this kind are particularly important in the case of strongly polar molecules or charged species. Simulating such effects by a polarizable solvent continuum, DFT

**Table 1** DFT energies (eV), modeling the solvent influence ( $\epsilon = 78.8$ ).

Complex	bare	$E_t$	${}^{\circ}E_t$	$E_{FC}$	solvated	$E_t$	${}^{\circ}E_t$	$E_t'$	${}^{\circ}E_t'$	$E_{FC}'$
$\text{PF}_4^-$		-26.3	-19.9	6.4		-26.2	-19.5	-27.8	-21.5	7.2 eV
$\text{SbF}_5^{2-}$		-27.8	-23.5	4.3		-27.7	-23.2	-36.9	-31.9	5.0 eV

calculations show that the bond energies are usually not significantly affected.<sup>1</sup> Thus the ground state energies  $E_t$  of  $\text{PF}_4^-$  and  $\text{SbF}_5^{2-}$  complexes for example—and the first excited state energies  ${}^{\circ}E_t$  as well—change only slightly (Table 1), though a distinct thermodynamic stabilization occurs via the solute–solvent interaction energy  $E_{\text{solv}}$  ( $E_t' = E_t + E_{\text{solv}}$ ). The Frank–Condon transition energy  $E_{FC}$  ( $\equiv {}^{\circ}E_t' - E_t' = ({}^{\circ}E_t - E_t) + ({}^{\circ}E_{\text{solv}} - E_{\text{solv}})$ ) undergoes a shift of about 15% to higher energy by the solvation, due mostly to the  $\delta E_{\text{solv}}$  contribution. This phenomenon is well known and frequently induces color changes if charge transfer bands in the visible region are shifted through dependence of their energy on the dielectric constant  $\epsilon$  of the solvent (see also Chapter 2.27)<sup>2</sup>. Changing from the polarizable continuum model<sup>3–5</sup> to calculations where the solvent molecules are explicitly modeled, the influence of solvent can be quite large; thus, for example, the metal-to-ligand charge transfer transition of the  $[\text{Ru}(\text{NH}_3)_5\text{py}]^{2+}$  complex was calculated to shift by  $\approx 30\%$  upon hydration, due to the transfer of about one electron from the  $\text{H}_2\text{O}$  molecules to the complex via hydrogen bonding.<sup>6,7</sup>

The tentative conclusion is that solute–solvent interactions can considerably modify the spectroscopic properties while, however, leaving the bonding properties of the solute approximately as in the unsolvated state.

### 1.36.3 HIGHER SPHERE LIGAND FIELDS (HSLF)

#### 1.36.3.1 Symmetry Effects by the Second Coordination Sphere

In Figure 1 we show two  $d-d$  spectra of  $\text{Ni}^{2+}$  in an octahedral oxo-coordination; the host lattice is of the spinel-type with normal ( $[\text{Mg}_{2-x}\text{Ni}_x]^{(6)}[\text{Ge}]^{(4)}\text{O}_4$  mixed crystals) and inverse cation distribution ( $[\text{NiSn}]^{(6)}[\text{Zn}]^{(4)}\text{O}_4$ ), respectively (upper index: coordination number CN). Though the octahedral point symmetry is  $D_{3d}$ , the structural oxygen parameter is very close to the value for an undistorted  $O_h$  coordination in the former case; however, a band assignment and fitting is only possible by the assumption of a considerable trigonal splitting with the sign of an effective *elongation* along an  $S_6$  axis.<sup>8</sup> In contrast, the second spectrum can be fitted on the basis of a small trigonal *compression*, as expected from the structural results in this case. A bonding concept which provides an interpretation of these divergent spectroscopic appearances, and which can be extended to various other model examples, is briefly introduced below.<sup>8</sup> It is based on the AOM parametrization of the *misdirected valence* concept, elaborated by Gerloch *et al.* (see Chapter 2.36).<sup>9,10</sup>

Each oxygen ligand is pseudotetrahedrally surrounded by one  $\text{Ge}^{4+}$  in tetrahedral and three  $\text{Ni}^{2+}$  cations in octahedral coordination:  $\text{Ge}^{(4)}\text{ONi}_3^{(6)}$  ( $C_{3v}$  point symmetry) in the  $\text{Ni}_2\text{GeO}_4$  spinel (Figure 2). Assuming that the high-valent  $\text{Ge}^{\text{IV}}$  center dominates the bonding within the tetrahedron, it may impose an  $sp$  hybridization along the  $\pm z$  directions on the oxygen atom—with a  $sp_z$  hybrid, which is *considerably misaligned* with respect to the three  $\text{Ni}^{2+}$  ions by half the tetrahedral angle ( $54^\circ 44'$ ). The master equations relating the ligand field parameters to the relevant Ni–O orbital overlap energies, expressed in terms of angular overlap model (AOM) parameters, are:

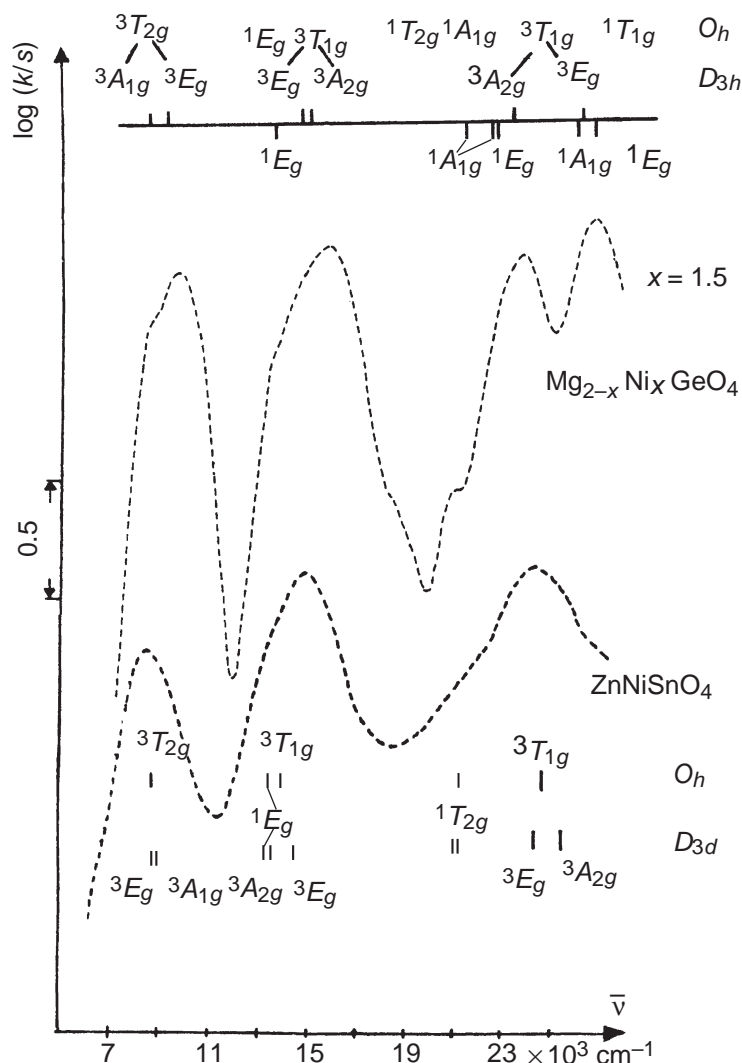
$sp_z$  hybrid,  $p_x, p_y$  ( $O_h$  site symmetry) :

$$e_{\sigma}'[e_{\pi}'] = (1/3)e_{\sigma}(sp_z)[e_{\pi}(sp_z)]$$

$$e_{\sigma}[e_{\pi}] = (2/3)e_{\sigma}(p_x, p_y)[e_{\pi}(p_x, p_y)] \quad (1)$$

$$\Delta = E(e_g) - E(t_{2g}) = 3(e_{\sigma}' + e_{\sigma}) - 4(e_{\pi}' + e_{\pi})$$

$$K = e_{\pi} - 2e_{\pi}'; K' = \sqrt{3}[(e_{\sigma}'e_{\pi}')^{1/2} - (1/2)(e_{\sigma}e_{\pi})^{1/2}]$$



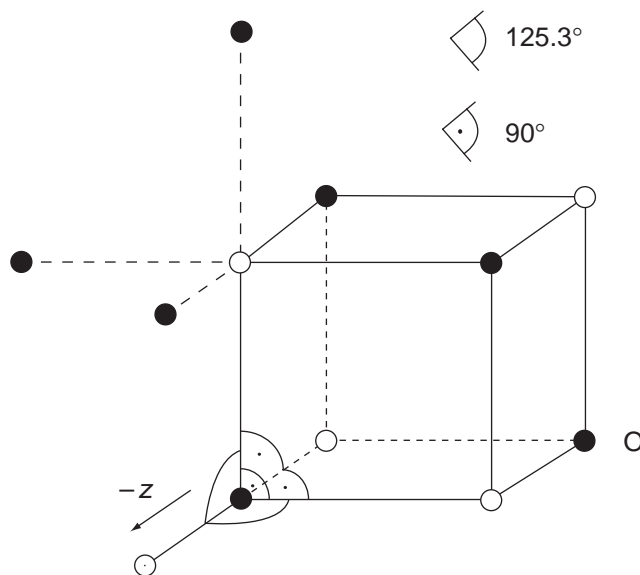
**Figure 1** Diffuse reflectance spectra of octahedral  $\text{Ni}^{2+}$  in the spinels  $\text{Mg}_{0.5}\text{Ni}_{1.5}\text{GeO}_4$  (I) and  $\text{ZnNiSnO}_4$  (II). Band fitting with the parameters given in the text for  $D_{3d}$  and with  $B = 850 \text{ cm}^{-1}$ ,  $C/B = 4.2$ ; the  $\Delta$  value for II ( $O_h$ ) is  $8,700 \text{ cm}^{-1}$ .

Here the  $e_\sigma'$ ,  $e_\pi'$  and  $e_\sigma$ ,  $e_\pi$  AOM parameters refer to  $\sigma$ - and  $\pi$ -overlap between  $\text{Ni}^{2+}$  and oxygen, induced by the oxygen  $sp_z$  hybrid and the  $p_x$ ,  $p_y$  oxygen orbitals perpendicular to it, respectively;  $\Delta$  is the octahedral and  $K$ ,  $K'$  are the trigonal ligand field parameters. With  $e_\sigma[e_\pi](sp_z) = 9,900[870] \text{ cm}^{-1}$  and  $e_\sigma[e_\pi](p_x, p_y) = 2,400[1,750] \text{ cm}^{-1}$  a remarkably good spectroscopic fit is achieved. The critical condition for a vanishing trigonal field component is:

$$e_\sigma(sp_z) = e_\sigma(p_x, p_y); e_\pi(sp_z) = e_\pi(p_x, p_y) \quad (1a)$$

implying, as expected, homogeneous  $\sigma$ - or  $\pi$ - overlap distributions around the oxygen ligator atoms. In the present case the splitting of the  ${}^3A_{2g} \rightarrow {}^3T_{1g}$  transition is approximately  $3K + (9/4)K'$  (Figure 11;  $\Delta = 8,870$ ,  $K = 590$ ,  $K' = 510 \text{ cm}^{-1}$ ). The spectra of  $\text{Mg}_{2-x}\text{Co}_x\text{GeO}_4$  mixed crystals exhibit analogous band splitting, which can be equally traced back to a trigonal distortion with the sign of a trigonal elongation ( $K, K' > 0$ ).

Proceeding to the inverse spinel  $\text{ZnNiSnO}_4$  with a pseudotetrahedral  $\text{Zn}^{(4)}\text{O}(\text{Ni}_{1/2}\text{Sn}_{1/2})_3^{(6)}$  oxygen coordination the charge distribution is totally different. Arguing in a purely ionic model the charge of  $\text{Zn}^{2+}$  acting toward one oxygen is  $+2/(4) = +1/2$  and hence identical with the one from  $\text{Ni}^{2+}_{1/2}\text{Sn}^{4+}_{1/2}$ , namely  $3/(6) = +1/2$  — in contrast to  $\text{Ni}_2\text{GeO}_4$  with  $+4/(4) = +1$  ( $\text{Ge}^{\text{IV}}$ ) and  $+2/(6) = 1/3$  ( $\text{Ni}^{2+}$ ) — the numbers in parentheses denoting the CNs with respect to oxygen.



**Figure 2** The  $B^{(4)}OA_3^{(6)}$  coordination—A, B: open and dotted circles, respectively—in a fragment of the spinel structure ( $A_2^{(6)}B^{(4)}O_4$ , with ideal oxygen parameter; one  $AO_6$  octahedron is indicated).

As expected for such a uniform distribution of charge, an energy calculation assuming  $sp_z$ -hybrids on the oxygen ligator atoms is not feasible, while the hypothesis of a  $sp^3$  hybridization (Equation (2)) leads to a sufficiently good spectroscopic fit (Figure III), in particular in accordance with an apparent trigonal compression ( $K, K' < 0$ ) in this case. The misalignment is rather small, and the  $e_\sigma(sp^3)$ ,  $e_\pi(sp^3)$  and  $\Delta$  parameters deduced are 3,200, 600, and  $8,750 \text{ cm}^{-1}$ , respectively.

$sp^3$  hybrids ( $O_h$  site symmetry):

$$e_\sigma = (25/27)e_\sigma(sp^3); e_\pi = (1/27)e_\pi(sp^3) \quad (2)$$

$$\Delta = 3e_\sigma - 4e_\pi$$

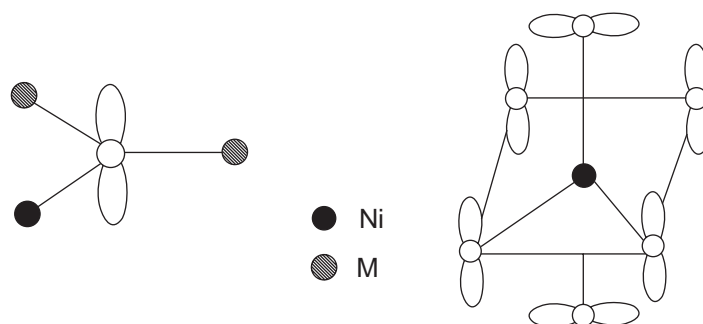
$$K = -2e_\pi; K' = -\sqrt{3}(e_\sigma e_\pi)^{1/2}$$

A further interesting host structure is the rutile lattice, where the oxygen atoms are coordinated by three cations in a roughly trigonal planar environment (Figure 3)—such as  $(Ni)^{(6)}O(Me^V)_2^{(6)}$  in the trirutiles  $NiM_2^VO_4$  ( $M^V = Sb, Nb, Ta$ ). In these cases an  $sp^2$  hybridization is enforced on the oxygen ligator atoms by the cationic second sphere coordination, which in particular imposes a pronounced  $\pi$ -anisotropy on the bonding in the  $NiO_6$  octahedra. It is mainly the latter anisotropy which leads to a distinct band splitting in the spectrum of  $NiSb_2O_6$  ( $e_\sigma = 3485$ ,  $e_\pi = 660 \text{ cm}^{-1}$ ) in comparison to  $NiTa_2O_6$  ( $e_\sigma = 2,900$ ,  $e_\pi = 350 \text{ cm}^{-1}$ ), where  $e_\pi$  is considerably smaller (see Section 1.36.3.2).<sup>8</sup> The  $\pi$ -anisotropy phenomenon, just described, is closely related to that treated in Section 1.36.3.4.

### 1.36.3.2 Bond Strength and Covalency Effects Induced by the Second Coordination Sphere

The second coordination sphere may not only cause anisotropic bonding effects due to the lowering of the *site symmetry* to the *point symmetry*, as from  $O_h$  to  $D_{3d}$  for the spinel  $NiO_6$  octahedra, for example (if site and point symmetry are identical, the influence of the second coordination sphere is frequently such that the spectral lower-symmetry splittings are drastically enhanced), but can also affect the bond *strength* distinctly—reflected by the AOM parameters  $e_\sigma$ ,  $e_\pi$ , and the ligand field strength  $\Delta = 3e_\sigma - 4e_\pi$ , if  $d^n$  cations are involved. It had been suggested earlier, by intuitive arguments, that these quantities are dominated by covalency. However, ionic contributions are usually far from being negligible. In Table 2 we have listed for a selection of



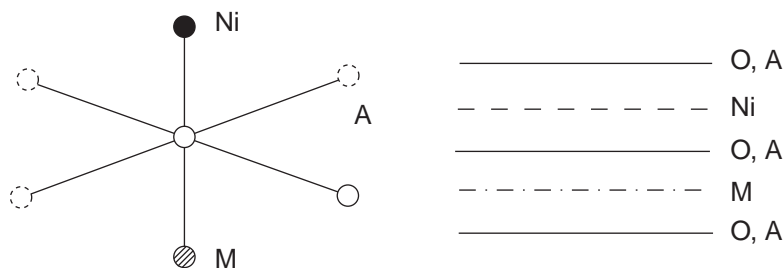


**Figure 3** The  $\text{Ni}^{(6)}\text{OM}^{\text{V}(6)}$  and  $\text{NiO}_6$  coordination in trirutiles  $\text{NiM}^{\text{V}}_2\text{O}_6$  (the orientation of the  $p$  orbitals available for  $\pi$ -overlap is also depicted).

oxide ceramics with  $\text{Ni}^{2+}$  as the color center, the bonding parameters  $\Delta$ ,  $e_\sigma$ ,  $e_\pi$  derived from the  $d-d$  spectra, utilizing calculation methods similar to that described in Section 1.36.3.1.<sup>8</sup> The  $\Delta$  values and—in an even more distinct way—the AOM parameters vary widely, though the Ni—O bond lengths remain constant (2.06(2) Å) within about 1%. It is difficult to systematize these trends in terms of chemical parameters, and we will restrict the discussion here to the striking Ni—O bond energy effects in rutile ( $\text{NiM}_2^{\text{V}}\text{O}_6$ ) and perovskite-type ( $\text{Sr}_2\text{NiM}^{\text{VI}}\text{O}_6$ ) solids, when the  $\text{M}^{\text{V}}$  and  $\text{M}^{\text{VI}}$  electron configurations change from  $d^0$  ( $\text{Ta}^{\text{V}}$ ;  $\text{Nb}^{\text{V}}$ ;  $\text{W}^{\text{VI}}$ ) to  $d^{10}$  ( $\text{Sb}^{\text{V}}$ ;  $\text{Te}^{\text{VI}}$ ). In the trirutile case the  $\text{M}^{\text{V}}$  cations impose their  $\sigma$ - $\text{M}^{\text{V}}$ -O bond properties within the  $sp^2$ -hybrid upon the Ni—O bond (Figure 3), with the more polarizable  $\text{Sb}^{\text{V}}$  center inducing larger  $e_\sigma$  values than  $\text{Ta}^{\text{V}}$  and  $\text{Nb}^{\text{V}}$ . The opposite effect is observed for the elpasolites, where—in contrast to the trirutile lattice—a cation ordering between  $\text{M}^{\text{VI}}$  and  $\text{Ni}^{2+}$  perpendicular to the closed packed oxygen (+A<sup>II</sup>) layers occurs (Figure 4)—giving rise to a pronounced *trans*-effect within the  $sp$  hybrids on the oxygen ligator atoms. The  $\pi$ -type bond properties are also interesting. Only one  $p_z$  orbital of  $\pi$ -symmetry is available for the three cations ( $2\text{M}^{\text{VI}}$ ,  $1\text{Ni}^{2+}$ ), in the trirutiles, but  $\pi$ -overlap will be energetically significant only for  $\text{Ta}^{\text{V}}$  and  $\text{Nb}^{\text{V}}$ , which possess empty  $\pi$ -antibonding  $t_{2g}$  shells; thus  $e_\pi$  is strongly reduced in  $\text{NiTa}(\text{Nb})_2\text{O}_6$  when compared to  $\text{NiSb}_2\text{O}_6$ . In the elpasolites no significant  $e_\pi$  changes are detected when proceeding from  $\text{W}^{\text{VI}}$  to  $\text{Te}^{\text{VI}}$ —presumably because two orbitals perpendicular to the  $sp$  hybrid may overlap with the  $t_{2g}$  orbitals of only two cations ( $\text{M}^{\text{VI}}$ ,  $\text{Ni}^{2+}$ ), assuming the Sr—O bond is mainly ionic. Jørgensen<sup>11</sup> has factorized the ligand field parameters  $\Delta$  of octahedral complexes within the spectrochemical series according to Equation (3), where  $f$  and  $g$  are the anionic and cationic contributions, respectively

$$\Delta \equiv f \cdot g \cdot 10^3 \text{ cm}^{-1}; 1 - \beta \equiv h \cdot k \quad (3)$$

with  $f=1.0$  ( $\text{H}_2\text{O}$ ; the standard) and  $g=8.7$  ( $\text{Ni}^{2+}$ ) for example. Inspecting Table 2 one finds that  $f$  varies between 1.06 and 0.76—all this occurring by the influence of the second coordination sphere of the same oxygen ligator atom. The  $\Delta$  variation is accompanied by spectacular color changes,<sup>12</sup> as is visualized by the  $d-d$  spectra in Figure 5. The color, which is determined by the position of the minimum between the two  ${}^3A_{2g} \rightarrow {}^3T_{1g}$  transitions, shifts from bluish-green (I:  $f=1.09$ ) via yellowish-green (II) to bright yellow (III); the further spectroscopic red shift toward IV ( $f=0.56$ ), implying a color which is determined by an open gap in the violet in



**Figure 4** The cationic coordination of oxygen in the elpasolite structure ( $\text{A}_2^{(12)}\text{M}^{\text{VI}(6)}\text{Ni}^{(6)}\text{O}_6$ , left) and the  $\text{M}^{\text{VI}}/\text{Ni}^{2+}$  ordering perpendicular to close-packed O,A layers (right).



**Table 2** AOM ( $e_\sigma$ ,  $e_\pi$ ) and ligand field ( $\Delta$ ) parameters ( $10^3 \text{ cm}^{-1}$ ) and structural characteristics of selected oxide ceramics with  $\text{Ni}^{2+}$ ; the proposed hybridization at the oxygen ligator atoms is also indicated (adopted from ref. 8).

	$a(\text{\AA})$	$e_\sigma$	$e_\pi$	$\Delta$	Structure		
1. $\text{Ni}_2\text{GeO}_4$	204.5	4.9	1.45	8.9	Spinel	$\text{Ge}^{(4)}\text{ONi}_3^{(6)}$	$sp$
2. $\text{ZnNiSnO}_4$	—	3.0	$\cong 0$	8.9	Spinel	$\text{Zn}^{(4)}\text{O}(\text{Sn}, \text{Ni})_3^{(6)}$	$sp^3$
3. $\text{LiNiPO}_4$	208.5	$\cong 3.95$	$\cong 1.0$	$\cong 7.9$	Olivine	$\text{P}^{(4)}\text{O}(\text{Li}, \text{Ni})_3^{(6)}$	$sp$
4. $\text{NiCO}_3$	207.5	$\cong 3.9$	$\cong 0.6$	9.2	Calcite	$\text{C}^{(3)}\text{ONi}_2^{(6)}$	$sp$
5. $\text{NiSb}_2\text{O}_6$	207	3.5	0.65	9.15	Trirutile	$\text{Sb}_2^{(6)}\text{ONi}^{(6)}$	$sp^2$
6. $\text{NiTa}_2\text{O}_6$	207	$\cong 2.9$	$\cong 0.35$	8.0	Trirutile	$\text{Ta}_2^{(6)}\text{ONi}^{(6)}$	$sp^2$
7. $\text{Sr}_2\text{NiTeO}_6$	204	3.3	0.85	6.6	Elpasolite	$\text{Te}^{(6)}\text{OSr}_4^{(12)}\text{Ni}^{(6)}$	$sp$
8. $\text{Sr}_2\text{NiWO}_6$	204	$\cong 4.0$	$\cong 0.85$	8.5	Elpasolite	$\text{W}^{(6)}\text{OSr}_4^{(12)}\text{Ni}^{(6)}$	$sp$

addition to the minimum in the red region, is caused by a considerable expansion of the Ni-O spacing due to the large  $\text{Ca}^{2+}$  ion on the same site. The decrease of  $\Delta$  from I to IV covers nearly the range which would be predicted if the CN is reduced from  $6(O_h)$  to  $4(T_d)$ . The nephelauxetic ratio  $\beta = B/B_o$  ( $B$ ,  $B_o$  are Racah parameters of interelectronic  $d-d$  repulsion with and without a chemical environment) does not vary significantly in the series from I to IV ( $\beta = 0.83(1)$ ).

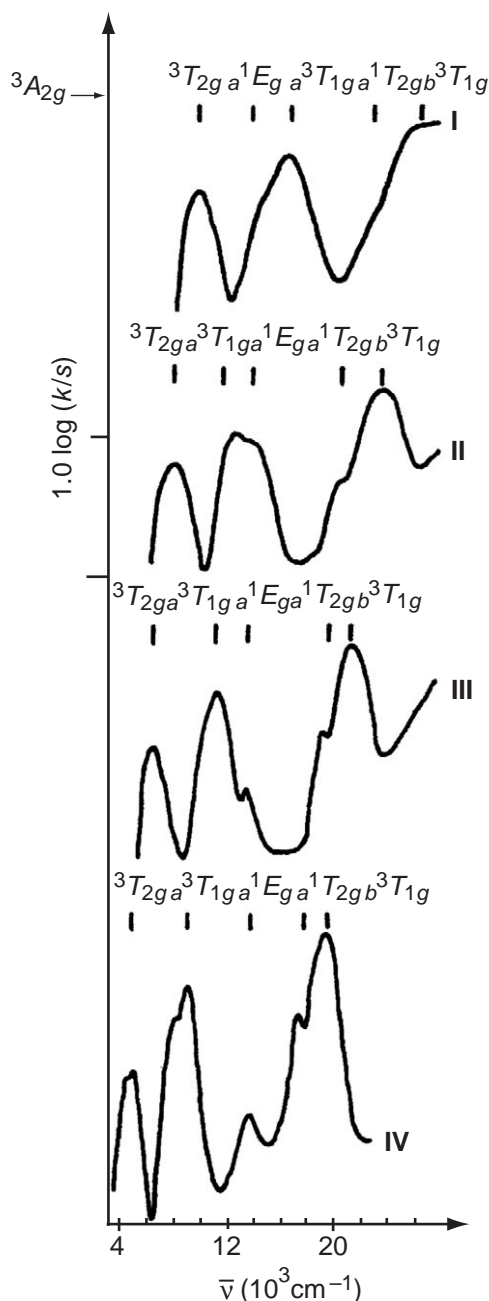
Metal–ligand covalency can be estimated via the nephelauxetic effect,  $1 - \beta$  being the covalency reduction; following again Jørgensen's reasoning,<sup>11</sup> this quantity may be written as the product of a ligand ( $h$ ) and central ion ( $k$ ) factor (Equation (3));  $h = 1.0$ ,  $k = 0.12$  for the  $\text{Ni}(\text{OH}_2)_6^{2+}$  octahedron). Another key quantity, amenable from the hyperfine structure in EPR spectra, is the mixing coefficient  $\alpha$  representing the metal contribution in the  $\sigma$ -antibonding ground state MO of  $\text{Cu}^{2+}$ , for example (Equation (4)), where L denotes the ligand LCAO of proper symmetry.

$$\psi_g = \alpha 3d_\sigma - \alpha L \quad (4)$$

Table 3 comprises a variety of host lattices and covalency parameters  $\beta$  and  $\alpha$ , which have been deduced from the  $d-d$  spectra of the corresponding  $\text{Ni}^{2+}$  doped and from the EPR spectra of the respective  $\text{Cu}^{2+}$ -doped solids and complexes, respectively.<sup>8</sup> Both quantities are very efficient probes for the effective charges on the  $d^n$  cations, which are strongly dependent on the donor properties of the oxygen atoms. The latter are essentially determined by the specific cationic oxygen coordination—*small and high valent second sphere cations with small coordination numbers* are expected to withdraw negative charge from oxygen in a pronounced manner, leaving ligator atoms of *high apparent electronegativity* with respect to the  $\text{Ni}^{2+}$  and  $\text{Cu}^{2+}$  probe cations. Indeed, strongly contrapolarizing centers such as  $\text{S}^{\text{VI}}$  (CN=4) and  $\text{P}^{\text{V}}$  (CN=4) induce highly ionic Ni(Cu)—O bonds (electron density on  $\text{Cu}^{2+}$  in the  $d_{x^2-y^2}$ -type antibonding MO:  $\alpha^2 \approx 0.9$ ), while the Cu—O bond in  $\text{Cu}^{2+}$ -doped  $\text{Y}_2\text{BaZnO}_5$  is rather covalent ( $\alpha^2 \approx 0.7$ ). Interestingly,  $\text{B}^{\text{III}}$  and  $\text{C}^{\text{IV}}$  give rise to less ionic transition metal–oxygen bonds in comparison to  $\text{S}^{\text{VI}}$  and  $\text{P}^{\text{V}}$  in spite of their very small ionic radii; this is possibly caused by the additional  $\pi$ -bond in the  $\text{CO}_3^{2-}$  and  $\text{BO}_3^{3-}$  species, which is less donating in character than the  $\sigma$ -bonds. We may conclude that the second sphere influence on the oxygen ligator atoms is very pronounced (Table 3), inducing electronegativity changes, which cover at least the range between  $\text{F}^-$  as the ligand ( $\alpha \cong 0.92$ ;  $\beta \cong 0.92$ ) and nitrogen donor atoms ( $\alpha \cong 0.87$ ;  $\beta \cong 0.83$ ). The optical basicities towards probe cations such as  $\text{Tl}^{\text{I}}$  and  $\text{Pb}^{\text{II}}$  doped into host compounds  $\text{SO}_3$ ,  $\text{P}_2\text{O}_5$ ,  $\text{B}_2\text{O}_3$ ,  $\text{MgO}$ , etc. show an analogous trend to the one in Table 3,<sup>13</sup> apparently reflecting a general principle. Finer variations of the bonding properties of ligator atoms due to the second sphere coordination also seem to play a crucial role in metalloproteins; apparently, by such effects, the protein frame controls the chemistry occurring at the metal center.<sup>14</sup> A more extended discussion with many more examples is presented elsewhere.<sup>8</sup>

### 1.36.3.3 The Stabilization of High Oxidation States of the Late 3d-Metals by Second Coordination Sphere Effects

Chemical experience shows that transition metal (TM) ions in their higher oxidation states can be stabilized by ionic ligands and ligator atoms with large apparent electronegativities such as



**Figure 5** Diffuse reflectance spectra of octahedral  $\text{Ni}^{2+}$  in various oxide ceramics:  $\text{Zn}^{(4)}(\text{Zn}_{0.75}\text{Ni}_{0.25}\text{Ge})^{(6)}\text{O}_4$  (I:  $\Delta = 9500 \text{ cm}^{-1}$ ,  $\beta \approx 0.83$ ; spinel),  $(\text{NiTa}_2)^{(6)}\text{O}_6$  (II:  $\Delta = 7800 \text{ cm}^{-1}$ ,  $\beta = 0.82$ ; trirutile),  $(\text{Ba}_{0.5}\text{Sr}_{1.5})^{(12)}(\text{NiTe})^{(6)}\text{O}_6$  (III:  $\Delta = 6500 \text{ cm}^{-1}$ ,  $\beta = 0.83$ ; elpasolite) and  $\text{Ba}_2^{(12)}(\text{Ni}_{0.1}\text{Ca}_{0.9}\text{Te})^{(6)}\text{O}_6$  (IV:  $\Delta = 4900 \text{ cm}^{-1}$ ,  $\beta = 0.84$ ; elpasolite).

fluoride but also oxygen under the contrapolarizing influence of high valent cations (i.e.,  $\text{Na}_5[\text{Cu}(\text{HIO}_6)_2] \cdot n\text{H}_2\text{O}$  with a  $\text{Cu}^{\text{III}}\text{OI}^{\text{VII}}$  coordination and  $\text{Cu}^{\text{III}}\text{O}_4$  square planes). Even in solids of the ordered  $\text{K}_2\text{NiF}_4$ -type  $\text{La}_2\text{Li}^{1/2}\text{M}^{\text{III}}_{1/2}\text{O}_4$  ( $\text{M}^{\text{III}}$ :  $\text{Co}, \text{Ni}, \text{Cu}$ )<sup>15</sup> and  $\text{La}_{2-x}\text{Sr}_x\text{Li}^{1/2}\text{Co}_{1/2}\text{O}_4$  ( $0 < x < 0.5$ )<sup>16</sup> oxygen (*trans*- $\text{Li}^{\text{I}}\text{O}(\text{La})_4\text{M}^{\text{III}}$  and elongated octahedral or square planar  $\text{M}^{\text{III(IV)}}\text{O}_4\text{O}_2^{\text{axial}}$  coordinations) is ionic enough still to stabilize the TMs in their +III(+IV) oxidation states, with low-spin  $t_{2g}^5[\text{Co}^{\text{IV}}]$ ,  $t_{2g}^6[\text{Co}^{\text{III}}]$ ,  $t_{2g}^6e_g(d_{z^2})^1[\text{Ni}^{\text{III}}]$ , and  $t_{2g}^6e_g(d_{z^2})^2[\text{Cu}^{\text{III}}]$  configurations. Here the  $\alpha$  coefficients in Equation (4) were estimated on the basis of band fitting procedures to the XANES spectra to have values of about 0.95, 0.9, and 0.8 for the latter three cations (though the absolute values for  $\alpha$  may depend on the chosen theoretical approach, their

**Table 3** Nephelauxetic ratios  $\beta$  for  $\text{Ni}^{2+}$  and mixing coefficients  $\alpha$  in the ground state MO of  $\text{Cu}^{2+}$  for various oxidic solids and complexes with F, N and S ligator atoms (adopted from ref. 8).

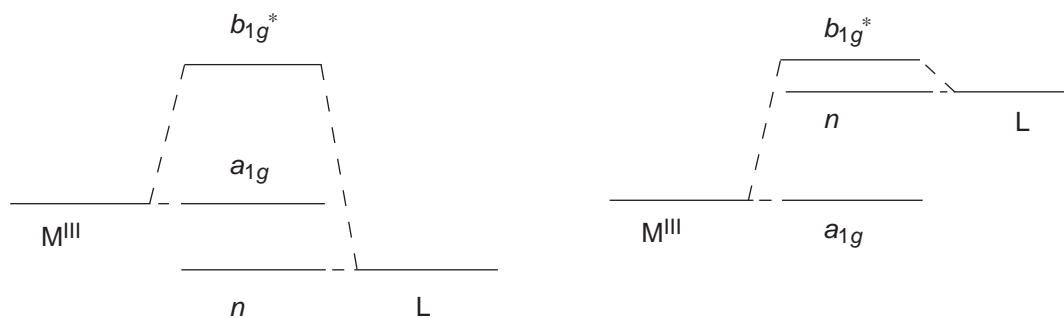
	$\beta$	$\alpha$	Structure	$CA^h$
$\text{Ba}_2\text{ZnF}_6$	0.91 <sub>5</sub>	0.92 <sup>d</sup>	$\text{K}_2\text{NiF}_4$ -related	
$\text{K}_2[\text{Zn}(\text{OH}_2)_6](\text{SO}_4)_2$	$\cong 0.91$	0.91 <sup>d</sup>	Tutton salt	$\text{H}^{\text{I}}(1)$
$\text{Mg}_2\text{SO}_4$	0.88 <sub>5</sub>	0.95	$\alpha$ - $\text{Mg}_2\text{SO}_4$	$\text{S}^{\text{VI}}(4)$
$\text{LiMgPO}_4$	0.88 <sub>5</sub>	0.95	Olivine	$\text{P}^{\text{V}}(4)$
$\text{Mg}_2\text{SiO}_4$ ( $\text{C}_i$ site)	—	$\cong 0.93$	Olivine	$\text{Si}^{\text{IV}}(4)$
$\text{MgCO}_3$	0.85 <sub>5</sub>	0.92	Calcite	$\text{C}^{\text{IV}}(3)$
$\text{Mg}_3(\text{BO}_3)_2^a$	0.84 <sub>4</sub>	0.92	—	$\text{B}^{\text{III}}(3)$
$\text{ZnSb}_2\text{O}_6$	0.83 <sup>b</sup>	0.91	trirutile	$\text{Sb}^{\text{V}}(6)$
$\text{MgWO}_4$	0.83	0.88	wolframite	$\text{W}^{\text{VI}}(6)$
$\text{Sr}_2\text{ZnWO}_6$	0.82 <sub>5</sub>	$\cong 0.88$	elpasolite	$\text{W}^{\text{VI}}(6)$
$\text{La}_2\text{ZnTiO}_4$	<sup>c</sup>	$\cong 0.88$	elpasolite	$\text{Ti}^{\text{IV}}(6)$
$\text{Y}_2\text{BaZnO}_4$	—	0.84	—	$\text{Y}^{\text{III}}(5)$
$\text{M}(\text{TACN})_2^{2+}$	0.82 <sub>5</sub>	0.86 <sub>5</sub>	$\text{NH}^{\text{f}}$	
$\text{M}(\text{TTCN})_2^{2+}$	$\cong 0.77$	0.74	$\text{S}^{\text{f}}$	
$\text{M}(\text{dte})_2$	—	$\cong 0.73^e$	$\text{S}^{\text{g}}$	

<sup>a</sup> For one of the two sites. <sup>b</sup> Value for  $\text{NiTa}_2\text{O}_6$ . <sup>c</sup> B dependent d-d transitions obscured by low-lying charge transfer bands. <sup>d,e</sup> The  $\alpha'$  coefficient in Equation (4) is  $\cong 0.47$  (deduced from the ligand hyperfine structure in the EPR spectrum) and  $\cong 0.8$  (from extended Hückel LCAO calculations on the basis of EPR data), respectively. <sup>f</sup> Triaza(trithia)cyclononane—tridentate. <sup>g</sup> Dithiocarbamate—bidentate.

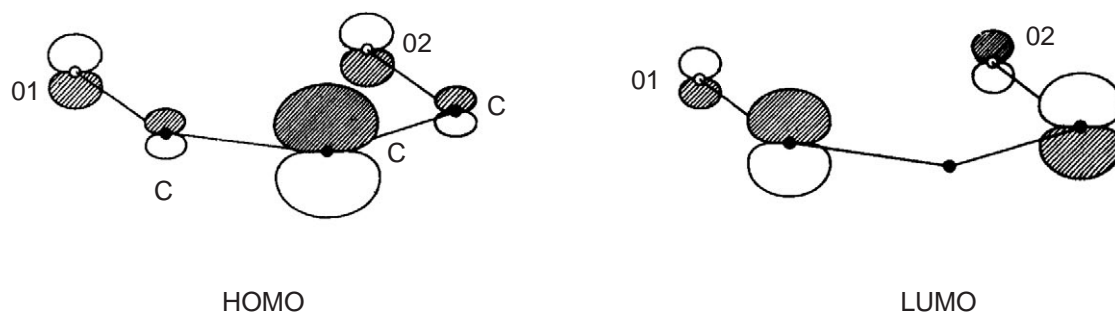
<sup>h</sup> Contrapolarizing atoms and their CNs with respect to oxygen (in parenthesis).

trend can be considered as reliable), while  $\alpha$  for  $\text{Co}^{\text{IV}}$  ranges between the mixing coefficients of  $\text{Ni}^{\text{III}}$  and  $\text{Cu}^{\text{III}}$ .<sup>16</sup> Apparently the M—O bond covalency becomes more pronounced when proceeding to  $d^n$  configurations with larger  $n$  ( $\text{Ni}^{\text{III}} \rightarrow \text{Cu}^{\text{III}}$ ) and when increasing the oxidation state ( $\text{Cu}^{\text{II}}$  ( $\alpha = 0.88(4)$ ; Table 3)  $\rightarrow \text{Cu}^{\text{III}}$  or  $\text{Co}^{\text{III}} \rightarrow \text{Co}^{\text{IV}}$ ). The electron density in the antibonding MOs is mainly TM-centered in all the cases considered which indicates TM parent orbitals of higher energy than those of oxygen (Figure 6, left). If the TM polyhedra do not lie isolated in the structure as in the solids mentioned,<sup>15,16</sup> the bond covalency may change considerably. Thus, electron delocalization by TM—O—TM bridging frequently leads to reduced  $\alpha^2$  values—as in the case of  $\text{Nd}_{0.9}\text{Sr}_{1.1}\text{Ni}^{\text{III}}\text{O}_{3.95}$  with the  $\text{K}_2\text{NiF}_4$  structure and  $\text{Ni}^{\text{III}}\text{—O—Ni}^{\text{III}}$  contacts ( $\alpha^2 \cong 0.81$ )<sup>17</sup> compared to  $\text{La}_2\text{Li}_{1/2}\text{Ni}^{\text{III}}_{1/2}\text{O}_4$  without these contacts ( $\alpha^2 \cong 0.84$ ), for example. Such second-sphere influence by a TM cation of the same kind also induces a drastic lower-energy shift of the charge transfer bands.<sup>18</sup> This shift is particularly pronounced in the case of mixed valence compounds, leading to dark brown or black colors; examples are the  $\text{Cu}^{\text{II}}/\text{Cu}^{\text{III}}$  oxide ceramics with superconducting properties.

We finally mention that soft ligator atoms with pronounced donor properties may also stabilize higher TM oxidation states. Impressive examples are the dithiocarbamate complexes of  $\text{Cu}^{\text{II}}$  (Table 3) and  $\text{Cu}^{\text{III}}$  with square-planar  $\text{CuS}_4$  entities. In the latter case there is pronounced covalency according to  $\alpha^2 \leq 0.5$ , and hence a strongly diminished effective charge on the  $\text{Cu}^{\text{III}}$  center is suggested<sup>19</sup>—with energetically high-lying ligand orbitals (Figure 6 right). In such cases instability with respect to a reduction of the TM cation is frequently observed, either by direct



**Figure 6** Schematic MO diagram for a square planar low-spin  $\text{Cu}^{\text{III}}\text{L}_4$  complex; only sections with the occupied, weakly  $\sigma$ -antibonding or nonbonding  $a_{1g}(d_{z^2})$ -MO, the empty strongly  $\sigma$ -antibonding (with respect to  $\text{Cu}^{\text{III}}$ )  $b_{1g}^*(d_{x^2-y^2})$ -MO and occupied nonbonding, ligand-centered orbitals ( $n$ ) are shown—cases of high (left) and low effective charge (right) on  $\text{Cu}^{\text{III}}$ .



**Figure 7** The HOMO (left) and LUMO (right) of the bidentate acetylacetonate (acac) ligand (adopted from ref. 20); the  $z$ -axis is oriented perpendicular to the molecular plane and the  $x$ -axis bisects the C-C-C angle.

electron flow or by low-energy optical excitation—in the case of a  $n-b_{1g}^*$  near-degeneracy or a very small  $n \rightarrow b_{1g}^*$  transition energy, respectively.

#### 1.36.3.4 Bonding Anisotropy by Orbital Phase Coupling

A higher sphere influence of a special type is encountered in the case of bidentate ligands with a delocalized  $\pi$ -system, such as acetylacetonate, for example (Figure 7).<sup>20</sup> The  $p_z$  orbitals of the oxygen ligand atoms are not independent in their phases, but coupled by specific phase relations. Thus, in a planar  $M(\text{acac})_2$  complex for example, the  $\pi$ -overlap of the ligand HOMO and LUMO—shown in Figure 7—with  $d_{xz}$  and  $d_{yz}$ , respectively, lifts the degeneracy of the latter orbitals. The splittings due to this symmetry reduction are sometimes rather large. The *phase coupling* phenomenon was originally predicted by Orgel<sup>21</sup> and is thoroughly reviewed in Chapters 2.36 and 2.52.

#### 1.36.4 SUMMARY

- (i) If an *outer sphere* disturbance occurs by isotropic electrostatic forces such as *solvent effects* on, for example, a charged species, a distinct thermodynamic stabilization may be observed, without, however, significantly affecting the bonding properties. In contrast, if the *higher sphere* environment is connected to the ligand atoms by strong covalent bonds as in extended solids, the binding properties of these atoms toward any particular coordination center can be significantly modified.
- (ii) In the latter case not only is the  $\sigma$ - and  $\pi$ -bond strength exerted by the ligand atoms influenced, but the higher sphere coordination also frequently imposes directional properties upon the electron density distribution of these atoms such that the donor electron clouds are *misaligned* with respect to the orbitals of the coordination center considered. The symmetry effects originating from this canted overlap, which may be of  $\sigma$ - and/or  $\pi$ -type, can be spectacular (*misdirected valence*).
- (iii) An effective reduction in symmetry due to the higher sphere coordination frequently occurs in extended ligands with a conjugated  $\pi$ -system by *orbital phase coupling*, a singular phenomenon.

#### 1.36.5 REFERENCES

1. Atanasov, M.; Reinen, D. *J. Am. Chem. Soc.* **2002**, *124*, 6693–6705.
2. Hush, N. S.; Reimers, J. R. *Chem. Rev.* **2000**, *100*, 775–786.
3. Karelson, M. M.; Zerner, M. C. *J. Phys. Chem.* **1992**, *96*, 6949–6957.
4. Rösch, N.; Zerner, M. C. *J. Phys. Chem.* **1994**, *98*, 5817–5823.
5. Pye, C. C.; Ziegler, T. *Theor. Chem. Acc.* **1999**, *101*, 396–408.
6. Stavrev, K. K.; Zerner, M. C.; Meyer, T. J. *J. Am. Chem. Soc.* **1995**, *117*, 8684–8685.
7. Pearl, G. M.; Zerner, M. C. *J. Am. Chem. Soc.* **1999**, *121*, 399–404.
8. Reinen, D.; Atanasov, M.; Lee, S.-L. *Coord. Chem. Rev.* **1998**, *175*, 91–158.

9. Deeth, R. J.; Duer, M. J.; Gerloch, M. *Inorg. Chem.* **1987**, *26*, 2573–2582.
10. Deeth, R. J.; Gerloch, M. *Inorg. Chem.* **1987**, *26*, 2582–2585.
11. Jørgensen, C. K. *Oxidation Numbers and Oxidation States*; Springer: Berlin, 1969.
12. Reinen, D. *Theor. Chim. Acta* **1966**, *5*, 312–326.
13. Duffy, J. A. *Bonding, Energy Levels and Bands in Inorganic Solids*; Longman: Harlow, UK and Wiley: New York, chapter 6, 1990.
14. Solomon, E. I.; Brunold, T. C.; Davis, M. I.; Kemsley, J. N.; Lee, S.-K.; Lehnert, N.; Neese, F.; Skulan, A. J.; Yang, Y.-S.; Zhou, J. *Chem. Rev.* **2000**, *100*, 235–350.
15. Warda, S. A.; Pietzuch, W.; Berghöfer, G.; Kesper, U.; Massa, W.; Reinen, D. *J. Solid State Chem.* **1998**, *138*, 18–31.
16. Warda, S. A.; Massa, W.; Reinen, D.; Hu, Z.; Kaindl, G.; deGroot, F. M. F. *J. Solid State Chem.* **1999**, *146*, 79–87.
17. Hu, Z.; Golden, M. S.; Fink, J.; Kaindl, G.; Warda, S. A.; Reinen, D.; Mahadevan, P.; Sarma, D. D. *Phys. Rev. B* **2000**, *61*, 3739–3744.
18. Atanasov, M.; Reinen, D. *J. Electron Spectrosc. Relat. Phenom.* **1977**, *86*, 185–199.
19. Willemse, J.; Cras, J. A.; Steggerda, J. J.; Keijzers, C. P. *Struct. Bonding* **1976**, *28*, 83–126.
20. Atanasov, M.; Schönherr, T. *Inorg. Chem.* **1990**, *29*, 4545–4550.
21. Orgel, L. E. *J. Chem. Soc.* **1961**, 3683–3686.

# 1.37

## Solid State, Crystal Engineering and Hydrogen Bonds

C. B. AAKERÖY

*Kansas State University, Manhattan, KS, USA*

and

A. M. BEATTY

*Mississippi State University, MS, USA*

---

1.37.1	INTRODUCTION AND SCOPE	679
1.37.2	STRATEGIES FOR SUPRAMOLECULAR SYNTHESIS	680
1.37.2.1	Coordination Polymers	680
1.37.2.2	The Hydrogen Bond	680
1.37.3	1D ARCHITECTURES	681
1.37.3.1	1D Assemblies Based on Silver(I) Complexes	681
1.37.3.2	Linear Networks Containing other Transition-metal Ions	682
1.37.3.3	Supramolecular Chains Incorporating Macrocycles	682
1.37.3.4	Halometallates as Hydrogen-bond Acceptors	682
1.37.4	2D ARCHITECTURES	683
1.37.4.1	2D Assemblies Based on Platinum(II) Complexes	683
1.37.4.2	Layered Networks with other Transition-metal Ions	683
1.37.4.3	Metalloporphyrins as Supramolecular Building Blocks	684
1.37.5	3D ARCHITECTURES	685
1.37.6	COMBINING COORDINATION POLYMERS AND HYDROGEN BONDS	685
1.37.7	REFERENCES	687

---

### 1.37.1 INTRODUCTION AND SCOPE

This section outlines some advances that have been made in the use of strong hydrogen-bond interactions<sup>1</sup> for the construction of inorganic–organic hybrid materials with predictable and well-defined supramolecular connectivity.<sup>2,3</sup> The main emphasis is on strategies for connecting coordination complexes into extended networks and infinite architectures via hydrogen-bond interactions between ligand-based substituents, although examples of other hydrogen-bond-based approaches are also described. Coordination complexes that contain hydrogen bonds (e.g., to/from solvent molecules or coordinated aquo- and ammonia ligands) that are not part of an explicit and reproducible assembly strategy are not included in this overview. The results are presented in order of network dimensionality: 1D, 2D, or 3D.

### 1.37.2 STRATEGIES FOR SUPRAMOLECULAR SYNTHESIS

The hydrogen bond has been established as a reliable force for crystal engineering involving organic building blocks and networks,<sup>2,4,5</sup> but it was introduced only relatively recently<sup>6</sup> as a tool for the supramolecular assembly of extended structures containing coordination complexes. Since then several groups have examined the capability and reliability of the hydrogen bond as a supramolecular tool in the directed assembly of inorganic–organic architectures.

#### 1.37.2.1 Coordination Polymers

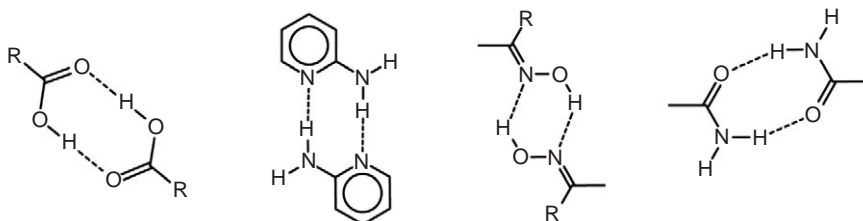
Reasons for incorporating metal ions into supramolecular networks are numerous; metal ions provide access to physical properties that are less common in organic solids, e.g., magnetic properties, conductivity, and catalytic activity. Metal ions also display a variety of coordination geometries, allowing for greater flexibility in constructing materials with specific dimensions and structures. The supramolecular assembly of metal-containing materials has been achieved primarily through the preparation of coordination polymers, typically by attaching bifunctional ligands such as 4,4'-bipyridine to metal ions.<sup>7–13</sup> Other representative examples include a 2D network with rectangular channels composed of pyrazine and Cu<sup>II</sup> ions,<sup>14</sup> Ag<sup>I</sup> helicates,<sup>15</sup> circular double helicates,<sup>16</sup> supramolecular macrocycles,<sup>17</sup> zinc(II) porphyrins assembled into cages,<sup>18</sup> and a large number of interpenetrating diamondoid structures.<sup>19,20</sup>

#### 1.37.2.2 The Hydrogen Bond

The strength and directionality of the hydrogen bond, as compared to other intermolecular forces, account for its structural importance and have made it the most significant interaction in molecular recognition; it is arguably the “master key”<sup>21</sup> to successful supramolecular synthesis.<sup>22–24</sup> Many strategies for supramolecular synthesis have relied on the complementarity of hydrogen-bond interactions, which can involve geometric factors as well as a suitable balance between the number of hydrogen-bond donors and hydrogen-bond acceptors. Self-complementary (or homomeric) interactions have been studied extensively and they include the well-known carboxylic acid dimer, although a variety of other homomeric synthons<sup>25</sup> have also been employed in crystal engineering, Figure 1.

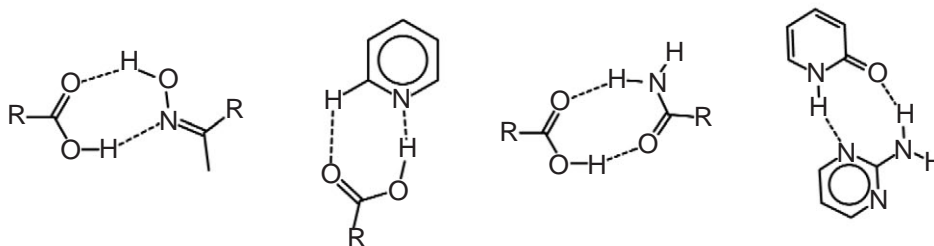
Not only do these supramolecular synthons bring discrete molecules and ions together, they also constrain the relative orientation of those components in much the same way as carbon–carbon double bonds impart specific stereochemistry to individual molecules. More recently, many heteromeric hydrogen-bond interactions have also been employed in supramolecular synthesis, Figure 2.

An increased degree of complementarity (triple,<sup>26</sup> quadruple,<sup>27</sup> or quintuple<sup>28</sup>) dramatically increases selectivity (cf. base-pairing in DNA), but may also lead to considerable covalent synthetic challenges; a balance has to be struck in order to develop cost-effective and versatile supramolecular synthesis.



**Figure 1** Examples of self-complementary (homomeric) hydrogen-bond interactions.





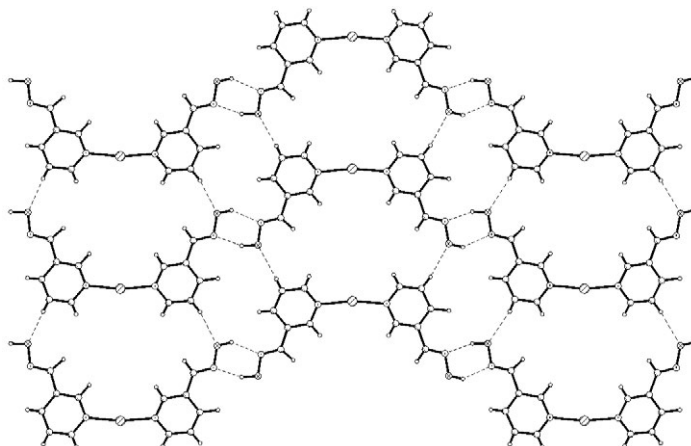
**Figure 2** Examples of complementary (heteromeric) hydrogen-bond interactions.

### 1.37.3 1D ARCHITECTURES

#### 1.37.3.1 1D Assemblies Based on Silver(I) Complexes

A practical and commonly used approach to the design of networks of a desired dimensionality has been to promote the inherent coordination geometry of a suitable metal ion into an infinite assembly. This explains why  $\text{Ag}^{\text{I}}$  ions (which frequently, but not always, adopt linear coordination geometries) have been employed extensively in the construction of 1D networks. Furthermore, much of the work relating to  $\text{Ag}^{\text{I}}$  inorganic–organic hybrid materials has been prompted by the need to test well-known synthons such as carboxylic acid and carboxamide dimers in structurally “uncomplicated” coordination complexes. Synthon reliability has been systematically examined as a function of several variables including the counter-ion (“spherical” counterions vs. asymmetric anions such as  $[\text{O}_3\text{SCF}_3]^-$  and  $[\text{NO}_3]^-$ ) and the location of the hydrogen-bonding substituent on the ligand. Several  $\text{Ag}^{\text{I}}$  oximepyridines<sup>29</sup> and isonicotinamide<sup>30</sup> complexes have produced linear assemblies—two ligands on the  $\text{Ag}^{\text{I}}$  ion create a linear coordination complex, **Figure 3**, and this geometry is propagated into chains through self-complementary oxime–oxime  $\text{R}^2_2(6)$  and amide–amide  $\text{R}^2_2(8)$  interactions, respectively. Alternatively, 1D ladders (from a combination of catemer and head-to-head amide $\cdots$ amide interactions) have been obtained in linear  $\text{Ag}^{\text{I}}$ –nicotinamide complexes when asymmetric anions are present.<sup>31</sup>

Nicotinic acid-based ligands (HL) have been much less consistent as supramolecular connectors in the design of inorganic–organic hybrid materials. For example, reactions between  $\text{Ag}^{\text{I}}$  and carboxylic acid-substituted pyridines have yielded  $\text{AgL}$  coordination polymers,  $\text{Ag}(\text{L})(\text{HL})$  neutral compounds, and  $\text{Ag}(\text{HL})_2^+$  salts. In the latter case, carboxylic acid $\cdots$ counterion hydrogen bonds occur rather than the desired self-complementary interactions. Structures of  $\text{Ag}(\text{L})(\text{HL})$  compounds, which did contain charge-assisted acid $\cdots$ carboxylate hydrogen bonds, were dominated by coordinate-covalent  $\text{Ag}-\text{O}$  interactions, resulting in structurally unpredictable coordination polymers.<sup>32</sup>



**Figure 3** Hydrogen-bonded chain containing  $[\text{Ag}(\text{3-aldoximepyridine})_2]^+$  cations.



### 1.37.3.2 Linear Networks Containing other Transition-metal Ions

The oxime functionality has been used in the assembly of *isocyanide*-based transition-metal complexes.<sup>33</sup> Linear assemblies were generated from OH $\cdots$ N interactions despite the presence of four hydrogen-bonding ligands in FeL<sub>4</sub>I<sub>2</sub>, (L = 4-aldoximephenyl-*isocyanide*). In addition, the related *trans*-PdL<sub>2</sub>I<sub>2</sub> complex also has a chain-like motif built through inter-ligand oxime–oxime hydrogen bonds. Pyridine-based ligands have also been used in the supramolecular assembly of platinum and palladium complexes and bis-nicotinamide and -*isonicotinamide* platinum–phosphine complexes (both *cis*-<sup>34</sup> and *trans*-<sup>35</sup>) containing hydrogen-bonded chains have been reported. Similarly, nicotinic acid, *isonicotinic acid*, and phenylquinoline complexes of PtCl<sub>2</sub> generate infinite chains (in related structures, DMSO and DMF solvent molecules break up the acid $\cdots$ acid acid hydrogen bonds<sup>36</sup>). Self-complementary hydrogen bonds have been used in the assembly of an infinite 1D structure that contain dimeric Cu<sup>II</sup> complex that also present an unusual example of metal–melamine coordination.<sup>37</sup> Catemeric amide $\cdots$ amide interactions have also been used in the 1D assembly of a dinuclear organoplatinum(II) complex of nicotinamide.<sup>35</sup>

### 1.37.3.3 Supramolecular Chains Incorporating Macrocycles

The supramolecular assembly of transition metal–macrocycle complexes via hydrogen bonds has been accomplished in a variety of ways. The axial sites on the metal ion have been used as coordinating sites for hydrogen-bonding ligands (thymine)—zigzag chains appear as a result of self-complementary NH $\cdots$ N hydrogen-bond substituents.<sup>38</sup> The macrocycle itself has also been modified with a hydrogen-bonding moiety (melamine)—the addition of a ligand with a complementary hydrogen-bonding functionality (cyanurate) to the axial metal site produced the desired linear assembly.<sup>39</sup> Alternatively, pyridyl functionalities have been attached to a Ni<sup>II</sup>–hexaaza-macrocycle with pendant pyridine groups. The addition of axial ligands containing non-coordinated carboxylic acid moieties produce robust acid $\cdots$ pyridine hydrogen bonds that result in an infinite assembly of Ni<sup>II</sup>–macrocycles, Figure 4.<sup>40</sup>

### 1.37.3.4 Halometallates as Hydrogen-bond Acceptors

Halometallates are known to accept hydrogen bonds,<sup>41</sup> and complex ions such as [MX<sub>4</sub>]<sup>n-</sup> and [MX<sub>6</sub>]<sup>n-</sup> can give 1D assemblies with di-cations such as 4,4'-bipyridinium, Figure 5.<sup>42,43</sup> This approach is a variation on strategies relying on ligand-based hydrogen-bonding substituents in that the complex ion does not interact directly with itself in a self-complementary fashion; instead, the assembly process relies on hydrogen-bonding through an ionic intermediary. However, extended networks can also be obtained if hydrogen-bonded dimers of protonated *isonicotinamide*

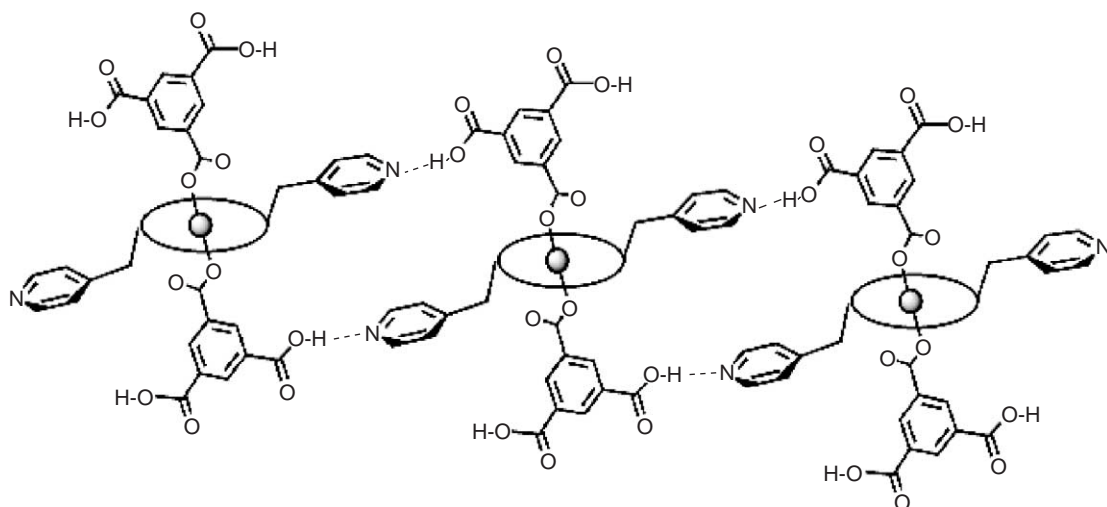
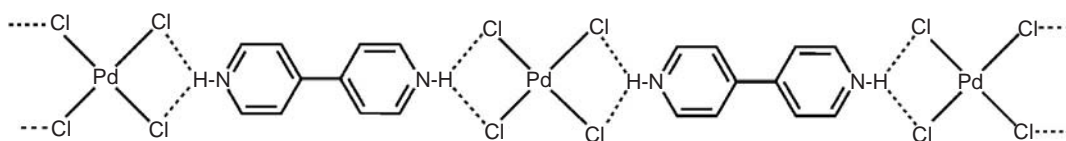


Figure 4 Macrocylic complexes connected via carboxylic acid–pyridine hydrogen bonds.



**Figure 5** Infinite chains of 4,4'-bipyridinium tetrachloropalladate.

are used in place of 4,4'-bipyridinium dications.<sup>44</sup> The amide moiety participates in a classic amide⋯amide dimer motif and also provides a crosslink between adjacent anion⋯cation ribbons to produce a layered structure.

### 1.37.4 2D ARCHITECTURES

Lamellar assemblies have received considerable attention in transition-metal-based crystal engineering—these highly anisotropic structures are of considerable interest due to their potential uses in host–guest chemistry, for applications such as storage,<sup>45,46</sup> separations,<sup>47,48</sup> or catalysis.<sup>49</sup> Extended sheet-like assemblies of coordination complexes tend to be organized through the use of square–planar metal ions such as Pt<sup>II</sup> or Pd<sup>II</sup>,<sup>50</sup> or with the help of *trans*-coordinated hydrogen-bonding ligands in octahedral complexes. However, 2D motifs were also produced via catemeric amide⋯amide interactions in linear Ag<sup>I</sup>nicotinamide salts when “spherical” counterions were used.<sup>18–20</sup>

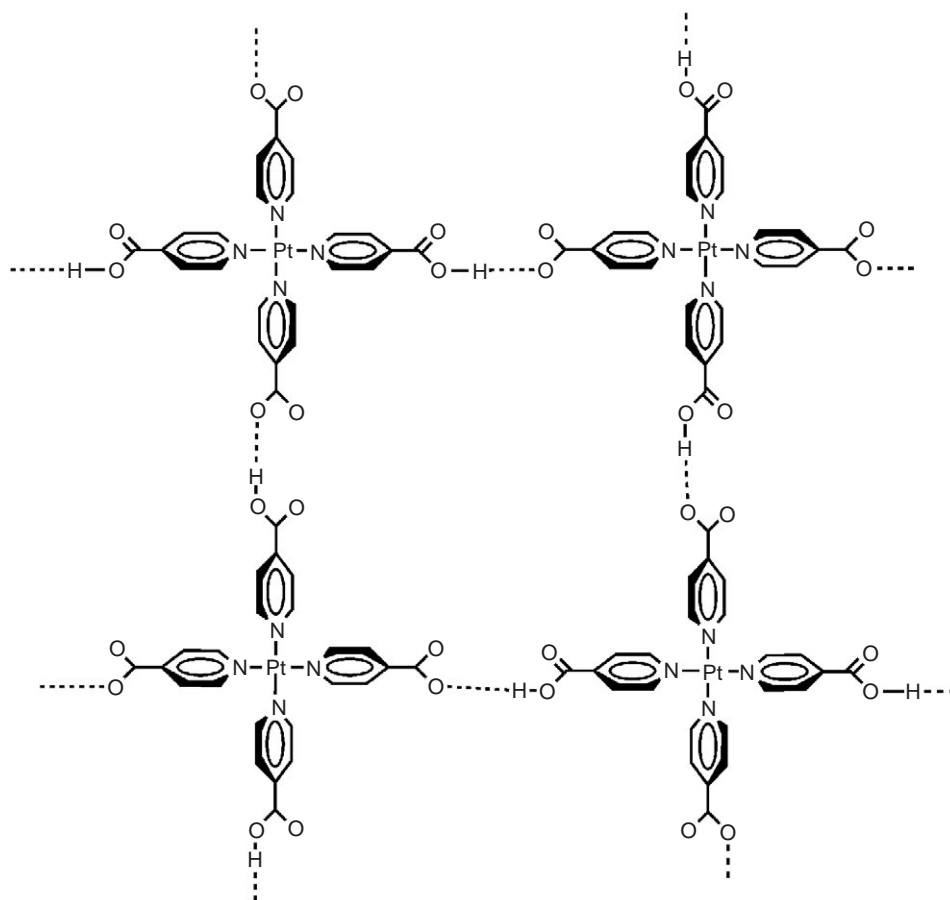
#### 1.37.4.1 2D Assemblies Based on Platinum(II) Complexes

A four-coordinate Pt<sup>II</sup>-*isonicotinamide* complex<sup>51,52</sup> displayed a square, grid-like structure constructed from amide⋯amide hydrogen bonds and a similar grid-like assembly was observed in the structure of [Pt(*isonicotinamide*)<sub>4</sub>]Cl<sub>2</sub>·4*isonicotinamide*.<sup>53</sup> In the latter compound, adjacent Pt<sup>II</sup> complexes were connected through amide⋯amide hydrogen bonds and the resulting square channels host non-coordinated *isonicotinamide* molecules.

An overall neutral complex, obtained from the reaction between *isonicotinic acid* and ammonium tetrachloroplatinate,<sup>53</sup> created a square grid network via charge-assisted OH⋯O hydrogen-bond interactions. The square–planar geometry of Pt(*isonicotinate*)<sub>2</sub>(*isonicotinic acid*)<sub>2</sub> was propagated in two directions, producing two crystallographically unique hydrogen-bonded nets with large square holes, **Figure 6**. The threefold interpenetrated structure contained infinite channels (5–6 Å in diameter) that were occupied by solvent molecules. An advantage of using neutral complexes in the design of porous materials is that the absence of counterions leaves more accessible space for guest molecules (it also limits the possibilities for disruptive and unpredictable hydrogen bonds to the counterions).

#### 1.37.4.2 Layered Networks with other Transition-metal Ions

Lamellar structures based on hydrogen-bonded Ni<sup>II</sup> complexes of *isonicotinamide* and 4-aldoximepyridine respectively have also been reported.<sup>53</sup> The latter contained grid-like sheets (with hourglass-shaped holes) constructed from ligand-based intermolecular OH⋯O interactions between neighboring Ni<sup>II</sup>(4-aldoximepyridine)<sub>4</sub> ions. The holes were partially blocked due to overlap of neighboring sheets, but infinite channels containing uncoordinated 4-aldoximepyridine molecules remained. In another example, anions comprising bidentate 2,2'-biimidazole (HBim) ligands in a trigonal arrangement around Ni<sup>II</sup> create a 2D “honeycomb” (approximately hexagonal) motif with encapsulated potassium counterions, assembled via self-complementary NH⋯N hydrogen bonds. Zigzag chains were obtained with tetrabutylammonium, tetra-*n*-propylammonium, or 1-ethylpyridinium counterions.<sup>54,55</sup> A variety of 1D and 2D structures have also been reported for neutral and cationic Pd<sup>II</sup> complexes where the primary hydrogen-bond interactions take place between ligand-based carboxamide functionalities.<sup>50</sup>



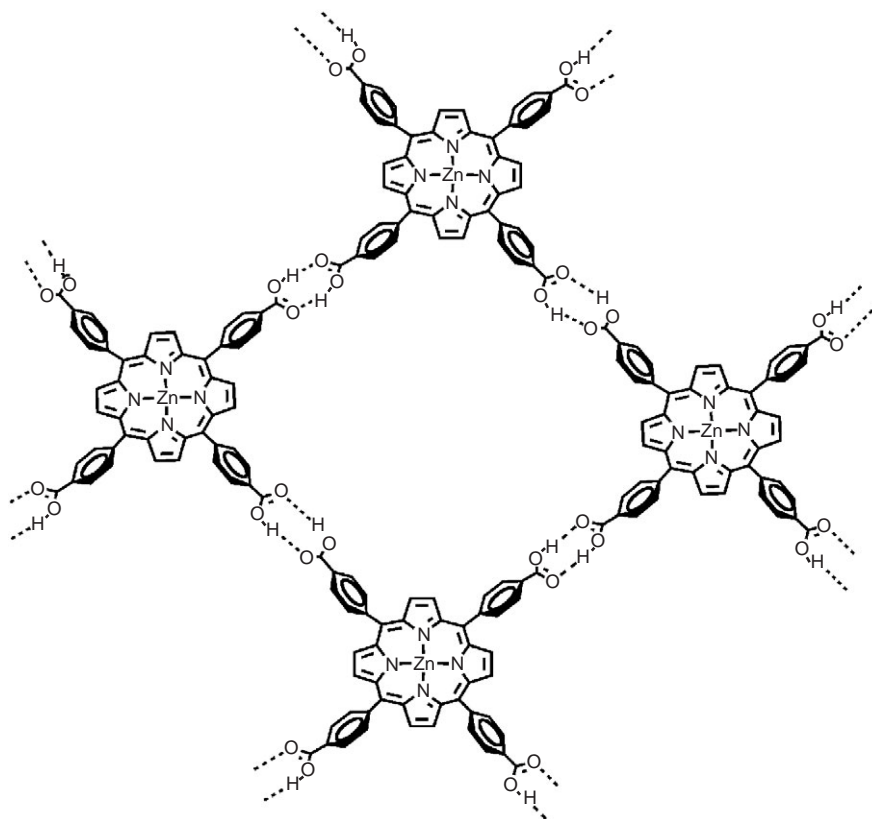
**Figure 6** Hydrogen-bonded grid of  $\text{Pt}(\text{isonicotinic acid})_2(\text{isonicotinate})_2$  complexes.

2D assemblies from propeller-like  $\text{Fe}^{\text{II}}$  complexes with chelating 2,2'-bipyridine ligands (appended with urea-like substituents) and inter-connected through  $\text{NH}\cdots\text{O}$  hydrogen bonds yielded 2D sheets of alternating chirality.<sup>56</sup> Despite the presence of solvent-filled 1 nm cavities, the material maintained crystallinity to 564 K.

Hydrogen-bond-based strategies have also been successfully employed in the supramolecular assembly of metal clusters. The reaction of  $[\text{Mo}_6\text{Cl}_8]^{4+}$  ions with six equivalents of 4-hydroxybenzamide yielded six octahedrally arranged oxobenzamide groups per cluster. Amide $\cdots$ amide hydrogen bonds produced infinite 2D networks separated by counterions.<sup>57</sup>

### 1.37.4.3 Metalloporphyrins as Supramolecular Building Blocks

The versatility of hydrogen-bond-directed supramolecular assembly has been further demonstrated in the design of extended networks containing porphyrin complexes, materials that are of particular interest due to their photoelectronic properties. Crystal structures of porphyrins tend to be governed by  $\pi\cdots\pi$  interactions, but porphyrin complexes that generate flat, grid-like 2D networks through amide $\cdots$ amide<sup>58–60</sup> and acid $\cdots$ acid hydrogen-bond interactions (some with large channels) have also been reported, Figure 7.<sup>61,62</sup> Similarly, 3,5-dihydroxybenzene moieties substituted onto  $\text{Zn}^{\text{II}}$ -porphyrin provided the basis for intermolecular hydrogen bonds that resulted in infinite 2D assemblies.<sup>63</sup> In contrast to such coplanar assemblies, hydrogen-bonded *stacks* of metal-containing porphyrin rings using four 3,5-dihydroxybenzene substituents have also been reported.<sup>64</sup> This demonstrates how it is possible to carefully modulate the distance between the porphyrin units in all three dimensions by modifying the length and nature of the substituents on the ring.<sup>65</sup>



**Figure 7** Small section of an infinite metal–porphyrin 2D grid, constructed via OH $\cdots$ O hydrogen bonds.

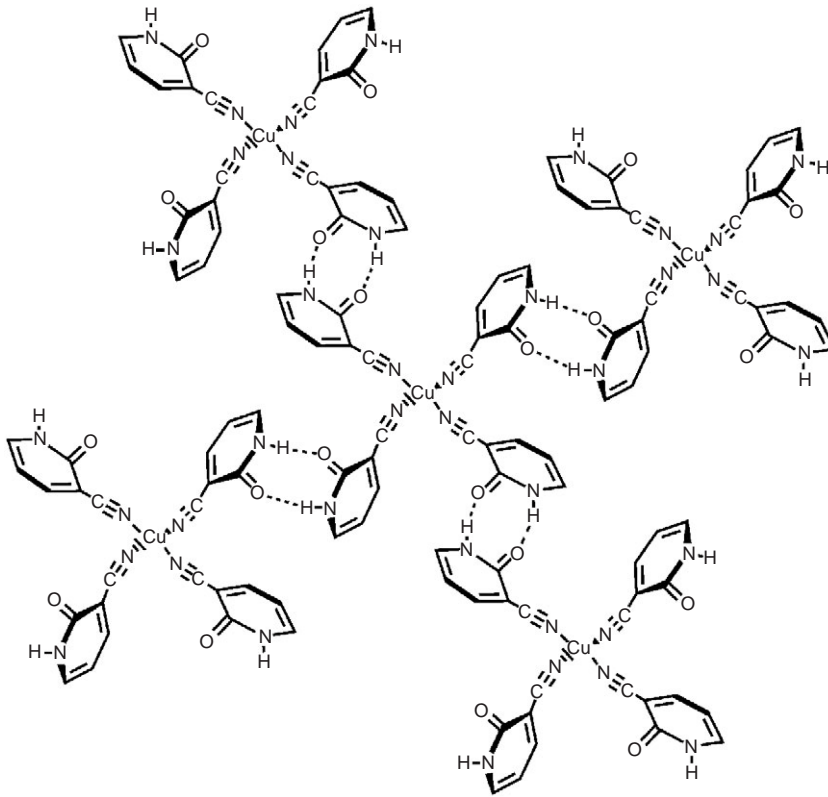
### 1.37.5 3D ARCHITECTURES

In principle, six pyridine-based ligands in an octahedral geometry around a metal ion would be ideal for constructing 3D hydrogen-bonded networks, however, steric constraints usually prevent the formation of hexa-pyridyl complexes. Furthermore, metal ions with three bis-chelating ligands tend to produce propeller-like complexes that generate infinite 2D, not 3D, architectures (e.g., hexagonal sheets). As a consequence, there are relatively few examples of directed 3D assembly using ligand-based hydrogen bonds alone.

One of the earliest reports of predictable 3D networks constructed through ligand $\cdots$ ligand hydrogen bonds relied on tetrahedral Cu<sup>I</sup> complexes of 3-cyano-6-methyl-2-pyridone (coordination to  $-\text{CN}$ ), with a variety of counterions, **Figure 8**.<sup>66</sup> Smaller counterions ( $[\text{ClO}_4]^-$ ,  $[\text{BF}_4]^-$ ), gave structures with catemeric pyridone $\cdots$ pyridone interactions that produced 3D hydrogen-bonded networks. Larger counterions ( $[\text{PF}_6]^-$ ,  $[\text{O}_3\text{SCF}_3]^-$ ) gave structures with self-complementary NH $\cdots$ O hydrogen bonds that resulted in diamondoid-like motifs. Another 3D network (a ThSi<sub>2</sub>-type interpenetrating structure) based on trigonal Ag<sup>I</sup> isonicotinamide complexes inter-linked via catemeric amide $\cdots$ amide interactions, has also been reported.<sup>67</sup>

### 1.37.6 COMBINING COORDINATION POLYMERS AND HYDROGEN BONDS

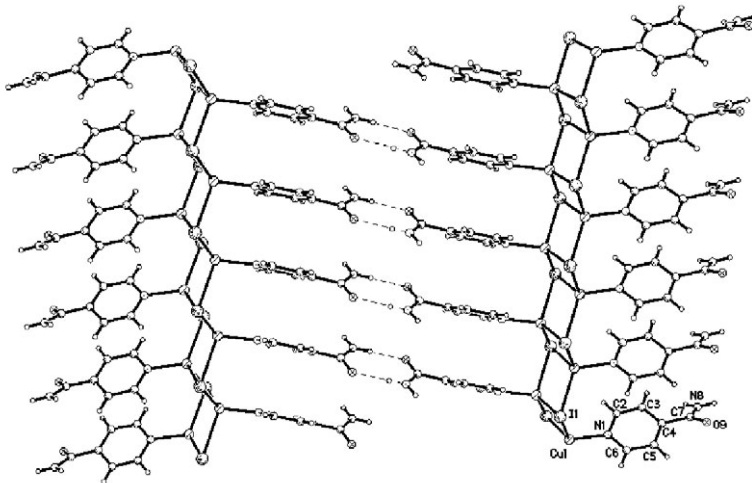
The use of coordination polymers instead of discrete metal–ion complexes as part of the construction materials for extended inorganic–organic assemblies may facilitate structural prediction and control. Early examples of this combination approach (coordination polymers plus hydrogen bonds) utilized Ag<sup>I</sup> ions together with ligands based upon pyridyl-derivatized ureas and oxalamides. The tetrahedral Ag<sup>I</sup> ions are connected into 2D coordination polymers by the bridging bipyridine-like ligands and the complementary ligand-based NH $\cdots$ O hydrogen bonds complete the assembly process, resulting in a 3D network.<sup>68,69</sup> Zn<sup>II</sup>-dicarboxylate coordination polymers



**Figure 8** Part of a 3D cationic  $\text{Cu}^{\text{I}}$  network produced from pyridone...pyridone hydrogen bonds.

can be interconnected through hydrogen bonds between coordinated thiourea ligands and carboxylate moieties on neighboring chains.<sup>70</sup>

A strategy based on additional ligands capable of forming self-complementary hydrogen bonds that are *independent* of the ligands required to assemble the coordination polymer has also been devised.  $\text{Cu}^{\text{I}}$  halides can form linear coordination polymers via bridging halide interactions, and simple pyridine-based ligands with carboxylic acid, carboxamide, and oxime substituents have generated desirable 2D assemblies through expected self-complementary hydrogen bonds, [Figure 9](#).<sup>71,72</sup> Similarly,  $\text{Cd}^{\text{II}}$ -thiocyanate 1D and 2D coordination polymers were connected via



**Figure 9** 2D assembly from a combination of linear  $\text{Cu}^{\text{I}}$  coordination polymers and amide...amide hydrogen bonds.

self-complementary ligand-based hydrogen bonds (using coordinated nicotinic acid, nicotinamide, or isonicotinamide) resulting in 2D and 3D networks.<sup>73</sup> Linear Cu<sup>II</sup>-dicyanamide coordination polymers have been crosslinked via complementary 2-aminopyrimidine hydrogen bonds.<sup>74</sup> Co<sup>II</sup> and Ni<sup>II</sup> complexes of dicyanamide, which create infinite “tubes” through coordinate covalent bonds, have been connected into 3D assemblies through hydrogen bonds between additional 2-aminopyrimidine ligands located on the periphery.<sup>75</sup>

### 1.37.7 REFERENCES

1. An extensive discussion of ‘weaker’ or unconventional hydrogen bonds is provided by Steiner, T.; Desiraju, G. R. in *The Weak Hydrogen Bond in Structural Chemistry and Biology* 1999, Oxford University Press, New York.
2. Beatty, A. M. *Cryst. Eng. Comm.* **2001**, *51*, 1–13.
3. Aakeröy, C. B.; Beatty, A. M. *Aust. J. Chem.* **2001**, *54*, 409–421.
4. Aakeröy, C. B.; Seddon, K. R. *Chem. Soc. Rev.* **1993**, *22*, 397–407.
5. Aakeröy, C. B. *Acta Crystallogr. Sect. B* **1997**, *53*, 569–586.
6. Burrows, A. D.; Chan, C.-W.; Chowdry, M. M.; McGrady, J. E.; Mingos, D. M. P. *Chem. Soc. Rev.* **1995**, 329–339.
7. Copp, S. B.; Subramanian, S.; Zaworotko, M. J. *J. Am. Chem. Soc.* **1992**, *114*, 8719–8720.
8. Subramanian, S.; Zaworotko, M. J. *Angew. Chem. Int. Ed. Engl.* **1995**, *34*, 2127–2129.
9. Zaworotko, M. J. *Chem. Soc. Rev.* **1994**, *23*, 283–288.
10. Yaghi, O. M.; Li, G. *J. Am. Chem. Soc.* **1996**, *118*, 295–296.
11. Yaghi, O. M.; Li, G. *Angew. Chem. Int. Ed. Engl.* **1995**, *34*, 207–209.
12. Fujita, M.; Kwon, Y.-J.; Osamu, S.; Yamaguchi, K.; Ogura, K. *J. Am. Chem. Soc.* **1995**, *117*, 7287–7280.
13. Fujita, M.; Kwon, Y.-J.; Washizu, S.; Ogura, K. *J. Am. Chem. Soc.* **1994**, *116*, 1151–1152.
14. Tong, M.-L.; Chen, X.-M.; Yu, X.-L.; Mak, T. C. W. *J. Chem. Soc. Dalton Trans.* **1998**, 5–6.
15. Garrett, T. M.; Koert, U.; Lehn, J.-M.; Rigault, A.; Meyer, D.; Fischer, J. *J. Chem. Soc., Chem. Commun.* **1990**, 557–558.
16. Hasenknopf, B.; Lehn, J.-M.; Kneisel, B. O.; Baum, G.; Fenske, D. *Angew. Chem. Int. Ed. Engl.* **1996**, *35*, 1838–1840.
17. Drain, C. M.; Russell, K. C.; Lehn, J.-M. *Chem. Commun.* **1996**, 337–338.
18. Drain, C. M.; Fischer, R.; Nolen, E. G.; Lehn, J.-M. *J. Chem. Soc., Chem. Commun.* **1993**, 243–244.
19. Blake, A. J.; Champness, N. R.; Chung, S. S. M.; Li, W.-S.; Schroder, M. *Chem. Commun.* **1997**, 1005–1006.
20. Hirsch, K. A.; Venkataraman, D.; Wilson, S. R.; Moore, J. S.; Lee, S. *J. Chem. Soc., Chem. Commun.* **1995**, 2199–2200.
21. Lehn, J.-M. *Supramolecular Chemistry* 1995, VCH: Weinheim.
22. Seto, C. T.; Whitesides, G. M. *J. Am. Chem. Soc.* **1991**, *113*, 712–713.
23. Zhao, X.; Chang, Y.-L.; Fowler, F. W.; Lauher, J. W. *J. Am. Chem. Soc.* **1990**, *112*, 6627–6637.
24. Lehn, J.-M.; Mascal, M.; DeCian, A.; Fischer, J. *J. Chem. Soc., Perkin Trans.* **1992**, *2*, 461–467.
25. Desiraju, G. R. *Angew. Chem. Int. Ed. Engl.* **1995**, *34*, 2311–2327.
26. Marsh, A.; Silvestri, M.; Lehn, J.-M. *Chem. Commun.* **1996**, 1527–1528.
27. Beijer, F. H.; Kooijman, H.; Spek, A. L.; Sijbesma, R. P.; Mejer, E. W. *Angew. Chem. Int. Ed. Engl.* **1998**, *37*, 75–78.
28. Jaunky, W.; Hosseini, M. W.; Planeix, J.-M.; DeCian, A.; Kyritsakas, N.; Fischer, J. *Chem. Commun.* **1999**, 2313–2314.
29. Aakeröy, C. B.; Beatty, A. M.; Leinen, D. S. *J. Am. Chem. Soc.* **1998**, *120*, 7383–7384.
30. Aakeröy, C. B.; Beatty, A. M. *Cryst. Eng.* **1998**, *1*, 39–49.
31. Aakeröy, C. B.; Beatty, A. M. *Chem. Commun.* **1998**, 1067–1068.
32. Aakeröy, C. B.; Beatty, A. M. *J. Mol. Struct.* **1998**, *474*, 91–101.
33. Lau, K. Y.; Mayr, A.; Cheung, K.-K. *Inorg. Chim. Acta* **1999**, *285*, 223–232.
34. Kuehl, C. J.; Tabellion, F. M.; Arif, A. M.; Stang, P. J. *Organometallics* **2001**, *20*, 1956–1959.
35. Gianneschi, N. C.; Tiekink, E. R. T.; Rendina, L. M. *J. Am. Chem. Soc.* **2000**, *122*, 8474–8479.
36. Qin, Z.; Jenkins, H. A.; Coles, S. J.; Muir, K. W.; Puddephatt, R. J. *Can. J. Chem.* **1999**, *77*, 155–157.
37. Goodgame, D. M. L.; Hussain, I.; White, A. J. P.; Williams, D. J. *J. Chem. Soc., Dalton Trans.* **1999**, 2899–2900.
38. Bazzicalupi, C.; Bencini, A.; Berni, E.; Bianchi, A.; Ciattini, S.; Giorgi, C.; Paoletti, P.; Valtancoli, B. *Eur. J. Inorg. Chem.* **2001**, 629–632.
39. Bernhardt, P. V. *Inorg. Chem.* **1999**, *38*, 3481–3483.
40. Min, K. S.; Suh, M. P. *Chem. Eur. J.* **2001**, *7*, 303–313.
41. Aullón, G.; Bellamy, D.; Brammer, L.; Bruton, E. E.; Orpen, A. G. *Chem. Commun.* **1998**, 653–654.
42. Mareque Rivas, J. C.; Brammer, L. *Inorg. Chem.* **1998**, *37*, 4756–4757.
43. Gillon, A. L.; Lewis, G. R.; Orpen, A. G.; Rotter, S.; Starbuck, J.; Wang, X.-M.; Rodríguez-Martin, Y.; Ruiz-Pérez C. *J. Chem. Soc., Dalton Trans.* **2000**, 3897–3905.
44. Angeloni, A.; Orpen, A. G. *Chem. Commun.* **2001**, 343–344.
45. Liu, C.; Fan, Y.; Liu, M.; Cong, H. T.; Cheng, H. M.; Dresselhaus, M. S. *Science* **1999**, *286*, 1127–1129.
46. Matsumoto, A.; Odani, T.; Sada, K.; Miyata, M.; Tashiro, K. *Nature* **2000**, *405*, 328–330.
47. Swift, J. A.; Ward, M. D. *Chem. Mater.* **2000**, *12*, 1501–1504.
48. Swift, J. A.; Reynolds, A. M.; Ward, M. D. *Chem. Mater.* **1998**, *10*, 4159–4168.
49. Ying, J. Y.; Mehnert, C. P.; Wong, M. S. *Angew. Chem. Int. Ed.* **1999**, *38*, 56–77.
50. Qin, Z.; Jennings, M. C.; Puddephatt, R. J. *Inorg. Chem.* **2001**, *40*, 6220–6228.
51. Mareque Rivas, J. C.; Brammer, L. *New J. Chem.* **1998**, *22*, 1315–1318.
52. Brammer, L.; Mareque Rivas, J. C.; Atencia, R.; Fang, S.; Pigge, F. C. *J. Chem. Soc., Dalton Trans.* **2000**, 3855–3867.
53. Aakeröy, C. B.; Beatty, A. M.; Leinen, D. S. *Angew. Chem. Int. Ed.* **1999**, *38*, 1815–1819.
54. Tadokoro, M.; Nakasuji, K. *Coord. Chem. Rev.* **2000**, *198*, 205–218.



55. Tadokoro, M.; Isobe, K.; Uekusa, H.; Ohashi, Y.; Toyoda, J.; Tashiro, K.; Nakasuji, K. *Ang. Chem. Int. Ed.* **1999**, *38*, 95–98.
56. Kurth, D. G.; Fromm, K. M.; Lehn, J.-M. *Eur. J. Inorg. Chem.* **2001**, 1523–1526.
57. Prokopuk, N.; Weinert, C. S.; Siska, D. P.; Stern, C. L.; Shriver, D. F. *Ang. Chem. Int. Ed.* **2000**, *39*, 3312–3315.
58. Goldberg, I. *Mol. Cryst. Liq. Cryst.* **1996**, *278*, 57–64.
59. Goldberg, I. *Chem. Eur. J.* **2000**, *6*, 3863.
60. Krishna Kumar, R.; Balasubramanian, S.; Goldberg, I. *Chem. Commun.* **1998**, 1435–1436.
61. Dastidar, P.; Stein, Z.; Goldberg, I.; Strouse, C. E. *Supramolecular Chem.* **1996**, *7*, 257–270.
62. Dikin-Posner, Y.; Goldberg, I. *Chem. Commun.* **1999**, 1961–1962.
63. Kobayashi, K.; Koyanagi, M.; Endo, K.; Masuda, H.; Aoyama, Y. *Chem. Eur. J.* **1998**, *4*, 417–424.
64. Bhyrappa, P.; Wilson, S. R.; Suslick, K. S. *J. Am. Chem. Soc.* **1997**, *119*, 8492–8502.
65. Diskin-Posner, Y.; Patra, G. K.; Goldberg, I. *Eur. J. Inorg. Chem.* **2001**, 2515–2523.
66. Munakata, M.; Wu, L. P.; Yamamoto, M.; Kuroda-Sowa, T.; Maekawa, M. *J. Am. Chem. Soc.* **1996**, *118*, 3117–3124.
67. Aakeröy, C. B.; Beatty, A. M.; Helfrich, B. A. *J. Chem. Soc., Dalton Trans.* **1998**, 1943–1946.
68. Schauer, C. L.; Matwey, E.; Fowler, F. W.; Lauher, J. W. *J. Am. Chem. Soc.* **1997**, *119*, 10245–10246.
69. Schauer, C. L.; Matwey, E.; Fowler, F. W.; Lauher, J. W. *Crystal Eng.* **1998**, *1*, 213–223.
70. Burrows, A. D.; Harrington, R. W.; Mahon, M. F.; Price, C. E. *J. Chem. Soc., Dalton Trans.* **2000**, 3845–3845.
71. Aakeröy, C. B.; Beatty, A. M.; Leinen, D. S.; Lorimer, K. R. *Chem. Commun.* **2000**, 935–936.
72. Aakeröy, C. B.; Beatty, A. M.; Lorimer, K. R. *J. Chem. Soc., Dalton Trans.* **2000**, 3869–3872.
73. Yang, G.; Zhu, H.-G.; Liang, B.-H.; Chen, X.-M. *J. Chem. Soc., Dalton Trans.* **2001**, 580–585.
74. van Albada, G. A.; Quiroz-Castro, M. E.; Mutikainen, I.; Turpeinen, U.; Reedijk, J. *Inorg. Chim. Acta* **2000**, *298*, 221–225.
75. Jensen, P.; Batten, S. R.; Moubaraki, B.; Murray, K. S. *Chem. Commun.* **2000**, 793–794.

# 1.38

## Biphasic Synthesis

P. J. DYSON

*École Polytechnique Fédérale de Lausanne, Switzerland*

---

1.38.1	NEW CHEMICAL PROTOCOLS	689
1.38.2	THE APPROACHES TO BIPHASIC SYNTHESIS	689
1.38.2.1	The Traditional Biphasic Approach	690
1.38.2.2	Temperature Dependent Solvent Systems	690
1.38.2.3	Single to Two-phase Systems	690
1.38.2.4	Other Systems	690
1.38.3	SOLVENT COMBINATIONS	690
1.38.3.1	Aqueous–Organic	691
1.38.3.1.1	<i>Phase transfer catalysis</i>	691
1.38.3.1.2	<i>Supported aqueous phase catalysis</i>	691
1.38.3.2	Ionic Liquid–Organic	691
1.38.3.3	Ionic Liquid–Aqueous	693
1.38.3.4	Fluorous–Organic	694
1.38.3.5	Other Solvent Combinations	694
1.38.4	TRIPHASIC SYSTEMS	694
1.38.5	SOLID–LIQUID BIPHASIC CATALYSIS	694
1.38.6	BIOLOGICAL RELEVANCE	694
1.38.7	REFERENCES	695

---

### 1.38.1 NEW CHEMICAL PROTOCOLS

A major challenge for chemists is to develop new products that achieve economic objectives. At one time this was carried out with little or no thought of the impact that production had on the environment, but two of the greatest challenges to chemists today are the replacement of existing technology with cleaner processes and the development of new products that are kinder to the environment.<sup>1</sup> This requires a new approach, which sets out to reduce the materials and energy used in manufacture, minimize or ideally eliminate the dispersion of chemicals in the environment, maximize the use of resources, and extend the durability and recyclability of products.

There are numerous ways by which these goals can be achieved and one that is currently under intensive scrutiny is the development of alternative reaction conditions and solvents or methodologies. Over the years biphasic catalysis has emerged as one of the most effective methods influencing all of the above criteria as volatile organic solvents are reduced or even completely eliminated from the process.<sup>2</sup>

### 1.38.2 THE APPROACHES TO BIPHASIC SYNTHESIS

There are three main types of biphasic processes that may be exploited in synthesis and catalysis and each is described briefly in turn below and expanded upon in [Section 1.38.3](#). The common feature to all three methods is that they overcome the major problem of homogeneous catalysis, notably, catalyst recovery and product separation.



### 1.38.2.1 The Traditional Biphasic Approach

The most widely encountered biphasic method commences with two immiscible phases, one containing the catalyst, the other the substrate or substrates, and was first proposed by Manassen.<sup>3</sup> The two phases are vigorously mixed allowing reaction between the catalyst and substrates to take place. When the reaction is complete the mixing is stopped and the two phases separate (see Figure 1). In the ideal system, the catalyst is retained in one phase ready for reuse and the product is contained in the other phase and can be removed without being contaminated by the catalyst. In certain cases neat substrates can be used without additional solvents. A similar approach can be used in noncatalytic biphasic synthesis if the conversion of a substrate to a product results in it having significantly different solubility properties so that it undergoes a phase transfer.

### 1.38.2.2 Temperature Dependent Solvent Systems

Certain solvents are immiscible at low temperature, but on heating, form a single phase. This allows reactions to be conducted in single phase under homogeneous conditions followed by separation using normal biphasic extraction methods.<sup>4</sup> The technique was first recognized in fluorine-organic biphasic catalysis, and has more recently been applied to ionic liquid-aqueous reactions (see below).

### 1.38.2.3 Single to Two-phase Systems

In some cases the catalyst and substrates are soluble in the same solvent (especially when the substrates are gases), but the products are immiscible with the solvent and form a second phase. If a reaction goes to completion then it is not even necessary for the substrates to dissolve completely in the catalyst phase. This technique is employed commercially for the production of butyraldehyde from propene, carbon monoxide, and hydrogen.<sup>5</sup>

### 1.38.2.4 Other Systems

Various other derivatives/extensions of the biphasic systems mentioned above have been developed. For example, triphasic systems are known (see Section 1.38.4). The third phase is often a built-in wash and in a sense this is similar to many existing industrial processes that use solvent scrubs. It is easy to envisage how the above processes may be put into practice on a large scale using batch reactors. Continuous flow processes have been developed that implement membranes and filters,<sup>6</sup> but these will not be discussed here.

## 1.38.3 SOLVENT COMBINATIONS

There are various combinations of solvents that lead to the different biphasic protocols outlined above. The salient features of principal solvent combinations are described below. Supercritical fluids are covered in Section 1.38.3.5. The essential feature common to all these approaches is that the catalyst and product phases must effectively separate in order to be practical.

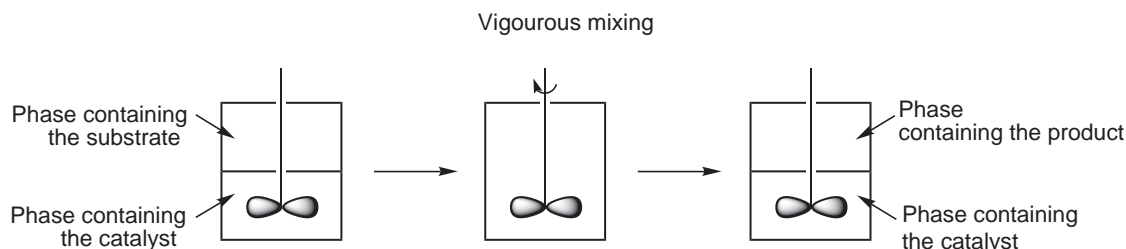


Figure 1 The classical biphasic process.

### 1.38.3.1 Aqueous–Organic

Although the main use of aqueous–organic two-phase systems is in catalysis, they have been used in the synthesis of coordination complexes. For example, reaction of a dichloromethane solution containing the hydrophobic complex  $\text{Ru}(\text{PPh}_3)_3\text{Cl}_2$  with an aqueous solution of the hydrophilic phosphine  $\text{P}(\text{CH}_2\text{OH})_3$  affords  $\text{Ru}\{\text{P}(\text{CH}_2\text{OH})_3\}_2\{\text{P}(\text{CH}_2\text{OH})_2\text{H}\}_2\text{Cl}_2$  in good yield.<sup>7</sup> The product is recovered from the aqueous phase and the  $\text{PPh}_3$  is retained in the organic phase. Although the product is somewhat more complicated than the one expected, the same product is also isolated from the direct reaction of  $\text{RuCl}_3$  with  $\text{P}(\text{CH}_2\text{OH})_3$  in ethanol.

Examples of aqueous–organic catalyzed reactions include oxidations,<sup>8</sup> polymerisations,<sup>9</sup> hydrogenations,<sup>10</sup> hydroformylations,<sup>11</sup> C–C coupling,<sup>12</sup> and olefin metathesis.<sup>13,14</sup> The use of water as a solvent for conducting biphasic catalysis has many advantages; it is cheap, easily purified, readily obtained, and disposed. The main drawback is that trace amounts of organic compounds dissolved in water are difficult to remove, although this does not tend to be a problem when the aqueous–catalyst phase is reused repeatedly for the same reaction.

The area where aqueous–organic biphasic catalysis has had the greatest impact is in oxidation reactions; arguably the most important industrial catalysed reaction. Many oxidation catalysts lend themselves well to the biphasic technique, as they do not require any modification to induce water solubility.<sup>15</sup> Other complexes that are active oxidation catalysts are insoluble in water and in order to induce water solubility hydrophilic groups are attached to the periphery of the ligand. Some examples of such modified ligands are shown in Figure 2.

The limiting factor in aqueous–organic catalysis is often the poor solubility of organic substrates in the aqueous phase, which restricts applications to reactions involving low molecular weight organic substrates and gases. Table 1 lists the solubility of some alkene substrates in water at 298 K, which serves to illustrate the problem.<sup>16</sup> In general, as temperature increases the solubility of organic substrates increases, but other protocols have also been developed to overcome solubility problems including:

- addition of cosolvents in which all the species are partially soluble,
- increasing the interface by rapid stirring, use of ultrasound, etc.,
- use of detergents and surfactants, etc.,
- addition of phase transfer reagents, i.e., phase transfer catalysis.

#### 1.38.3.1.1 Phase transfer catalysis

Phase transfer catalysis uses quaternary ammonium salts, crown ethers, or cryptands to transfer an anionic species from the aqueous phase to the organic phase via extraction as an ion pair—essentially a technique borrowed from nature.<sup>17</sup> Such reagents are widely used in oxidation catalysis with the phase transfer reagent extracting the oxidant, e.g.,  $\text{H}_2\text{O}_2$ , and the catalyst, e.g., polyoxometallate, into the organic phase containing the substrate. Variations of phase transfer catalysis also exist, including counter-phase transfer catalysis<sup>18</sup> and thermoregulated phase transfer catalysis.<sup>19</sup>

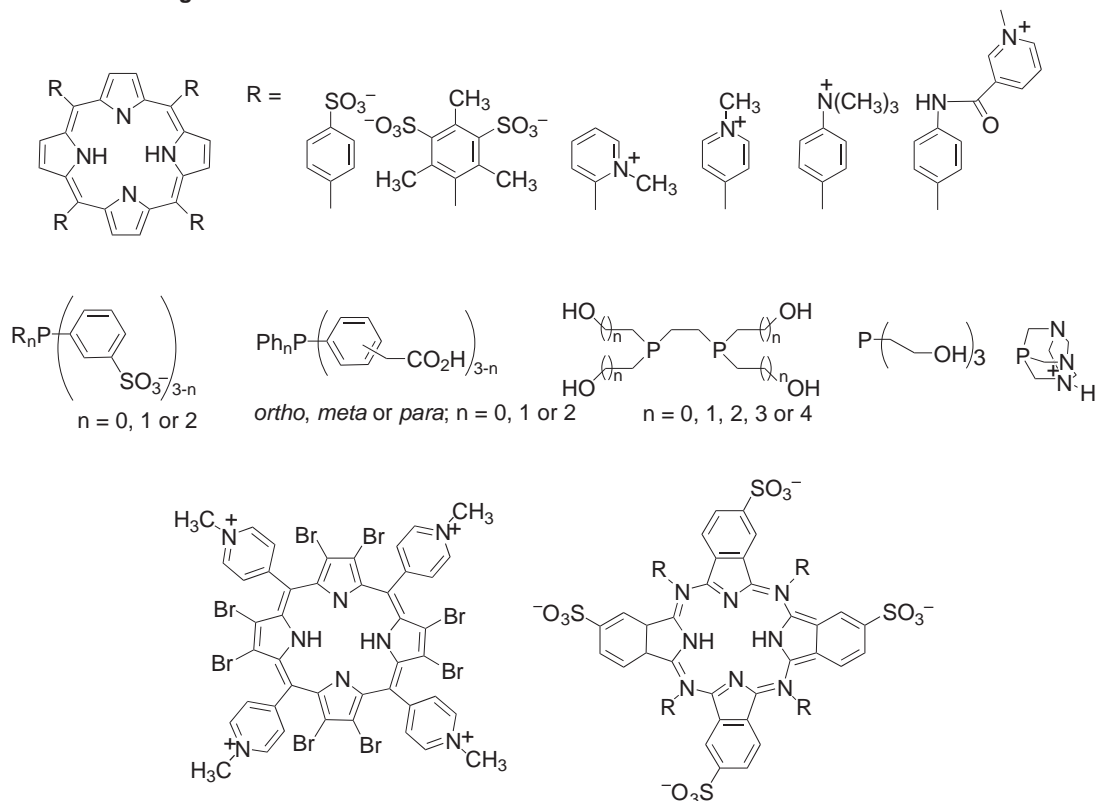
#### 1.38.3.1.2 Supported aqueous phase catalysis

Supported aqueous phase catalyst (SAPC) involves generating a thin water film on a high surface area support surrounded by a bulk organic solvent.<sup>20</sup> SAPC suffers from mass transfer problems despite the sharp increase in interfacial surface area and leaching problems of the water-soluble catalyst. The SAPC method has been effectively applied to cyclohexene oxidations using a simple water-soluble ammonium molybdate catalyst with the aid of supported surfactant molecules.<sup>21</sup>

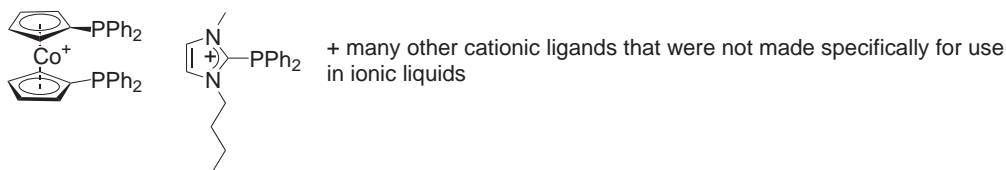
### 1.38.3.2 Ionic Liquid–Organic

Room temperature ionic liquids are composed of ions that have delocalized charges and incompatible shapes preventing the formation of solid-state structures (see Chapter 1.37). In principle, ionic liquids could overcome some of the limitations posed by aqueous–organic biphasic processes, such as poor solubility of substrates as there is essentially no limit to the number of ionic liquids that can be made and they can be tailored to provide specific solubility properties.<sup>22</sup> It should be

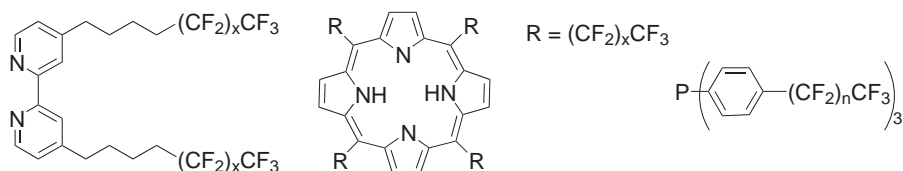
## Water soluble ligands



## Ionic liquid soluble ligands



## Fluorous phase soluble ligands



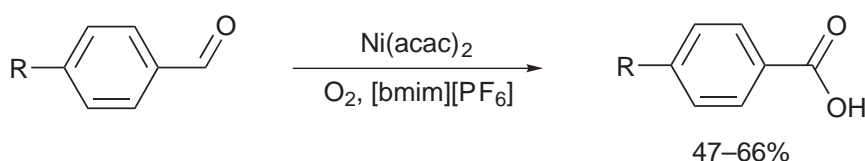
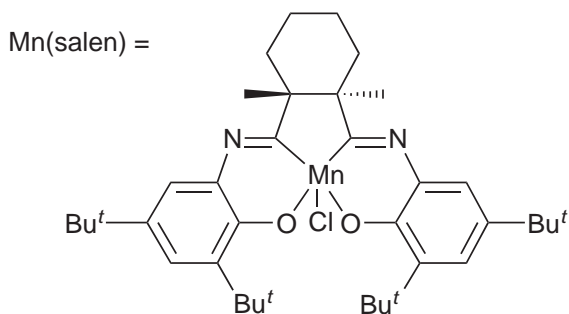
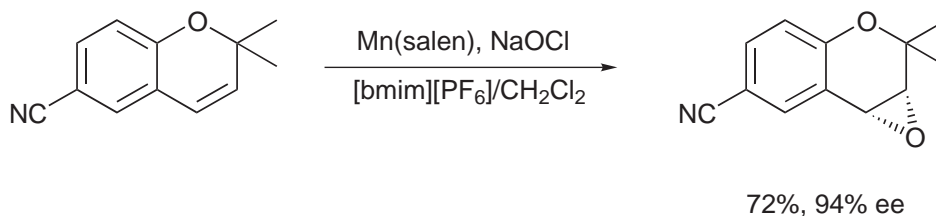
**Figure 2** Examples of water, ionic liquid, and fluorous phase soluble ligands.

stressed, however, that aqueous–organic systems are employed on an industrial scale, and as yet, ionic liquids remain in the developmental stage. Ionic liquids are immiscible with a wide range of organic solvents and water; they are polar (making them good solvents) and the low nucleophilicity of their component ions prevents deactivation of the catalyst. Unlike water, ionic liquids are not environmentally benign, but they do not evaporate and so they do not pose an environmental hazard. Like water, their use reduces the amount of harmful organic solvents required, but unlike water, trace amounts of organic compounds can easily be removed by distillation. Many different reactions have been conducted using ionic liquid supported catalysts mirroring the reactions

**Table 1** Solubility of alkenes in water at 298 K.

Alkene	Solubility (ppm)
Pent-1-ene	148
Hex-1-ene	50
Hep-2-ene	15
Oct-1-ene	2.7
Dec-1-ene	0.6

conducted under aqueous–organic biphasic conditions, e.g., polymerization, hydrogenation, hydroformylation, C–C coupling, etc. although the range of examples studied is considerably more limited (see Dupont *et al.*<sup>22</sup>). Two key oxidation reactions conducted using the ionic liquid–organic approach are illustrated in Schemes 1 and 2. Other reactions more specific to ionic liquids include the lanthanide triflate catalyzed synthesis of  $\alpha$ -amino phosphonates<sup>23</sup> and copper bis-oxazoline catalyzed enantioselective cyclopropanation with ethyldiazoacetate.<sup>24</sup>

**Scheme 1****Scheme 2**

### 1.38.3.3 Ionic Liquid–Aqueous

The miscibility of ionic liquids and water is temperature dependent and combinations are known where the ionic liquid and water form a single phase at higher temperatures and two separate phases at lower temperatures. Two examples that exploit this property in catalysis have been reported. One involves hydrodimerisation<sup>25</sup> and the other hydrogenation<sup>26</sup> and in both cases the reaction is conducted under homogeneous conditions and then the temperature of the system is reduced to bring about phase separation and subsequent product extraction.

### 1.38.3.4 Fluorous–Organic

The miscibility of perfluoroalkanes and other perfluoro solvents is low with corresponding hydrocarbon solvents and is exploited in fluoruous–organic biphasic catalysis.<sup>27</sup> In some cases, apolar reactants may be dissolved in the fluoruous phase and on conversion to higher polarity products a second immiscible phase is formed. Notable examples of catalyzed reactions that are effectively carried out using the fluoruous biphasic approach are hydroformylations<sup>28</sup> and oxidations.<sup>29</sup> It should be noted that fluoruous solvents are damaging to the environment, however, as with other catalyst immobilization solvents, if they are not lost from the system no damage to the environment takes place. Fluoruous biphasic systems have not, as yet, been used on an industrial scale.

### 1.38.3.5 Other Solvent Combinations

In principle many other solvent combinations could be used in biphasic chemistry although the main driving force in this area is to provide environmental benefits. For example, ionic liquids have been combined with supercritical solvents for the hydroformylation of 1-octene.<sup>30</sup> Since ionic liquids have no vapor pressure and are essentially insoluble in supercritical CO<sub>2</sub>, the product can be extracted from the reaction using CO<sub>2</sub> virtually uncontaminated by the rhodium catalyst.

## 1.38.4 TRIPHASIC SYSTEMS

Various triphasic processes have been reported although the area remains under-developed, despite having considerable potential. For example, the epoxidation of *trans*-stilbene has been carried out using a fluoruous–organic–aqueous system.<sup>31</sup> The catalyst is immobilized in the fluoruous phase, the organic product is recovered from the organic phase and waste salt by-products are extracted into the aqueous phase. A triphasic system composed of ionic liquid, water, and organic solvent has been used for Heck coupling reactions.<sup>32</sup> The catalyst is immobilized in the ionic liquid, the product is extracted into the organic phase and the water absorbs the salt byproducts.

## 1.38.5 SOLID–LIQUID BIPHASIC CATALYSIS

This section has focused on “liquid–liquid” biphasic catalysis in which catalysts are supported in different solvents to the substrates and products. Considerable efforts have also been directed to supporting homogeneous catalysts on solid supports including silica, alumina, and zeolites as well as functionalized dendrimers and polymers.<sup>33</sup> It has also been found that synergic effects sometimes prevail between particles embedded in the support and the tethered molecular catalyst, increasing the activity of the catalyst.<sup>34</sup>

## 1.38.6 BIOLOGICAL RELEVANCE

There is a connection between aqueous–organic biphasic chemistry and living systems in that a cell is essentially an aqueous environment whereas the cell membrane is largely hydrophobic. Many of the ligands designed for use in biphasic catalysis are also finding uses in biology, and vice versa. Much work is being conducted at the interface of biphasic catalysis and biology. This includes catalytic transformations of biologically important compounds which are ideally suited to the biphasic method. For example, work has been conducted into the hydrogenation of phospholipid liposomes and other macromolecular biological compounds.<sup>35</sup> Other work includes the clinical evaluation of compounds closely related to those used in biphasic catalysis. For example, manganese derivatives of some of the porphyrin ligands shown in Figure 2 have been identified as superoxide dismutase mimics.<sup>36</sup> A ruthenium complex with a 1,3,5-triaza-7-phosphaadamantane (pta) ligand originally developed for biphasic catalysis exploits the basicity of the pta ligand to target cancer cells.<sup>37</sup> At low pH the ligand is protonated whereas at neutral and higher pH the ligand is deprotonated. In biphasic catalysis this property is used to move a catalyst from an aqueous phase (low pH) to an organic phase (higher pH). In healthy cells

the pta ligand on the complex is deprotonated and does not damage DNA and at the lower pH characteristic of many cancer cells the complex is protonated and damages DNA, thus representing a way of targeting cancer cells.

### 1.38.7 REFERENCES

1. Clark, J. H. *Green Chem.* **1999**, *1*, 1–8.
2. For example see, *Aqueous-phase Organometallic Chemistry*; Cornils, B.; Herrmann, W. A., Eds.; Wiley-VCH: Weinheim, Germany, 1998.
3. Manassen, J. In *Catalysis: Progress in Research*; Bassolo, F.; Burwell, R. L., Eds.; Plenum, London, 1973.
4. Horváth, I. T.; Rábai, J. *Science* **1994**, *266*, 72–75.
5. Cornils, B.; Herrmann, W. A. *J. Mol. Catal.* **1997**, *116*, 27–33.
6. Behr, A. Technical Solutions. In *Aqueous-phase Organometallic Chemistry*; Cornils, B.; Herrmann, W. A., Eds.; Wiley-VCH: Weinheim, Germany, 1998; pp 163–180.
7. Higham, L.; Powell, A. K.; Whittlesey, M. K.; Wocadlo, S.; Wood, P. T. *Chem. Commun.* **1998**, 1107–1108.
8. Arts, S. J. H. F.; Mombarg, E. J. M.; van Bekkum, H.; Sheldon, R. A. *Synthesis* **1997**, *6*, 597.
9. Mecking, S.; Held, A.; Bauers, F. M. *Angew. Chem., Int. Ed. Engl.* **2002**, *41*, 544–561.
10. Joó, F.; Kathó, A. *J. Mol. Catal. A: Chemical* **1997**, *116*, 3–26.
11. Kohlpaintner, C. W.; Fischer, R. W.; Cornils, B. *Appl. Catal. A, Gen.* **2001**, *221*, 219–225.
12. Bhanage, B. M.; Arai, M. *Catal. Rev.* **2001**, *43*, 315–344.
13. Herndon, J. W. *Coord. Chem. Rev.* **1999**, *181*, 177–242.
14. Cornils, B. *J. Mol. Catal. A: Chemical* **1999**, *143*, 1–10.
15. Kozhevnikov, I. V. *Catal. Rev. Sci. Eng.* **1995**, *37*, 311–352.
16. Shaw, D. G.; Haucloit-Pirson, M.-C.; Hefter, G. T.; Maczynski, A., Eds. *Hydrocarbons with Water and Sea Water*, IUPAC Solubility Data Series; Pergamon: New York, 1989, Vols. 37 and 38.
17. Starks, Ch. M.; Liotta, Ch. L.; Halpern, M. *Phase Transfer Catalysis: Fundamentals, Applications, and Industrial Perspectives*; Chapman & Hall: New York, 1994.
18. Okano, T.; Moriyama, Y.; Konishi, Y.; Kiji, J. *Chem. Lett.* **1986**, 1463–1464.
19. Jin, Z.; Zheng, X.; Fell, B. *J. Mol. Catal. A: Chemical* **1997**, *116*, 55–58.
20. Davies, M. E. Transitions to Heterogeneous Techniques. In *Aqueous-phase Organometallic Chemistry*; Cornils, B.; Herrmann, W. A., Eds.; Wiley-VCH: Weinheim, Germany, 1998; pp 241–252.
21. Tsang, S. C.; Zhang, N.; Fellas, L.; Steele, A. M. *Catal. Today* **2000**, *61*, 29–36.
22. Dupont, J.; de Souza, R. F.; Suarez, P. A. *Z. Chem. Rev.* **2002**, *102*, 3667–3692.
23. Lee, S.; Park, J. H.; Kang, J.; Lee, J. K. *Chem. Commun.* **2001**, 1698–1699.
24. Fraile, J. M.; Garcia, J. I.; Herrerias, C. I.; Mayoral, J. A.; Carrie, D.; Vaultier, M. *Tetrahedron: Asymmetry* **2001**, *12*, 1891–1894.
25. Dullius, J. E. L.; Suarez, P. A. Z.; Einloft, S.; de Souza, R. F.; Dupont, J.; Fischer, J.; De Cian, A. *Organometallics* **1998**, *17*, 815–819.
26. Dyson, P. J.; Ellis, D. J.; Welton, T. *Can. J. Chem.* **2001**, *79*, 705–708.
27. Horváth, I. T. *Acc. Chem. Res.* **1998**, *31*, 641–650.
28. Horváth, I. T.; Rábai, J. *Science* **1994**, *266*, 72–75.
29. Li, H. M.; Shu, H. M.; Ye, X. K.; Wu, Y. *Progr. Chem.* **2001**, *13*, 461–471.
30. Sellin, M. F.; Webb, P. B.; Cole-Hamilton, D. J. *Chem. Commun.* **2001**, 781–782.
31. Quici, S.; Cavazzini, M.; Ceragioli, S.; Montanari, F.; Pozzi, G. *Tetrahedron Lett.* **1999**, *40*, 3647–3650.
32. Carmichael, A. J.; Earle, M. J.; Holbrey, J. D.; McCormac, P. B.; Seddon, K. R. *Org. Lett.* **1999**, *1*, 997–1000.
33. Zamaraev, K. I. *Topics in Catalysis* **1996**, *3*, 1–76.
34. Yang, H.; Gao, H. R.; Angelici, R. J. *Organometallics* **2000**, *19*, 622.
35. Nadasdi, L.; Joo, F. *Inorg. Chim. Acta* **1999**, *293*, 218–222.
36. Riley, D. P. *Chem. Rev.* **1999**, *99*, 2573–2587.
37. Allardyce, C. S.; Dyson, P. J.; Ellis, D. J.; Heath, S. L. *Chem. Commun.* **2001**, 1396–1397.

# 1.39

## Solid State Methods, Hydrothermal

J. ZUBIETA

*Syracuse University, NY, USA*

---

1.39.1	INTRODUCTION	697
1.39.2	HYDROTHERMAL SYNTHESIS OF ORGANIC-INORGANIC HYBRID MATERIALS: GENERAL CONSIDERATIONS	697
1.39.2.1	Typical Reaction Conditions	698
1.39.2.2	The Organic Component	698
1.39.3	MOLECULAR CLUSTERS	700
1.39.4	METAL ORGANOPHOSPHONATES	700
1.39.5	INORGANIC OXIDES INCORPORATING ORGANOIMINE LIGANDS	702
1.39.6	BIMETALLIC OXIDE NETWORKS	704
1.39.7	METAL-HALIDE AND -PSEUDOHALIDE MATERIALS	707
1.39.8	CONCLUSIONS	708
1.39.9	REFERENCES	708

---

### 1.39.1 INTRODUCTION

The term “hydrothermal synthesis” is conventionally applied to heterogeneous reactions in aqueous media at temperatures above 100 °C and under autogenous pressures. The method mimics natural conditions for the formation of structurally complex mineral species under relatively mild conditions.<sup>1</sup> Consequently, the technique has been recognized for some time as offering convenient approaches to metastable compounds, low-temperature phases, and materials with elements in unusual oxidation states. Hydrothermal methods have been applied to the preparation of a variety of materials, including microporous phases, chemical sensors, conducting solids, ceramics, magnetic solids, and phosphors.<sup>2</sup> The applications of hydrothermal methods to crystallization processes,<sup>3</sup> zeolite synthesis,<sup>4</sup> the preparation of metastable oxide materials,<sup>5</sup> and general preparative chemistry<sup>1,6</sup> have been reviewed.

### 1.39.2 HYDROTHERMAL SYNTHESIS OF ORGANIC-INORGANIC HYBRID MATERIALS: GENERAL CONSIDERATIONS

One approach to the preparation of novel solid state materials exploits the use of organic molecules which can profoundly alter the inorganic microstructure. Such organic-inorganic hybrid materials combine the unique characteristics of the organic and inorganic components in a complementary fashion to provide novel solid state structures and composite materials with unexpected properties. However, traditional solid state syntheses of thermodynamic products conventionally rely on solid-solid interactions at temperatures of 500–1,000 °C, conditions which will not retain the structural elements of the organic component. On the other hand, hydrothermal synthesis has been found to provide a powerful technique for the preparation of organic-inorganic hybrid materials with retention of the structural elements of the reactants in the final product phase.<sup>7</sup> Hydrothermal reactions, typically carried out in the temperature range 120–260 °C under autogenous pressure, exploit the



self-assembly of the product from soluble precursors. The reduced viscosity of water under these conditions enhances diffusion processes so that solvent extraction of solids and crystal growth from solution are favored. Since differential solubility problems are minimized, a variety of simple precursors may be introduced, as well as a number of organic and/or inorganic structure-directing agents from which those of appropriate size and shape may be selected for efficient crystal packing during the crystallization process. Under such nonequilibrium crystallization conditions, metastable kinetic phases rather than the thermodynamic phase are often isolated. While several pathways, including that resulting in the most stable phase, are available in such nonequilibrium mixtures, the kinetically favored structural evolution results from the smallest perturbations of atomic positions. Consequently, nucleation of a metastable phase may be favored. Thus, one synthetic approach is to employ an organic component at low temperature to modify or control the surface of growing composite crystals in a hydrothermal medium.

### 1.39.2.1 Typical Reaction Conditions

While hydrothermal reactions in the 700 °C and 3 kbar range are not uncommon for some applications, these conditions require specially designed autoclaves.<sup>8</sup> Most syntheses involving organic components are performed in the 100–250 °C temperature range under autogenous pressure and, consequently, may be carried out in more conventional reaction vessels such as acid digestion bombs, thick-walled borosilicate tubes, or even Teflon pouches.<sup>9,10</sup> While the materials described in this chapter were prepared in water, a variety of organic solvents (acetonitrile, ethylene glycol, chloroform) and mixed aqueous–organic solvents have also been exploited in the more generally designated “solvothermal” method.

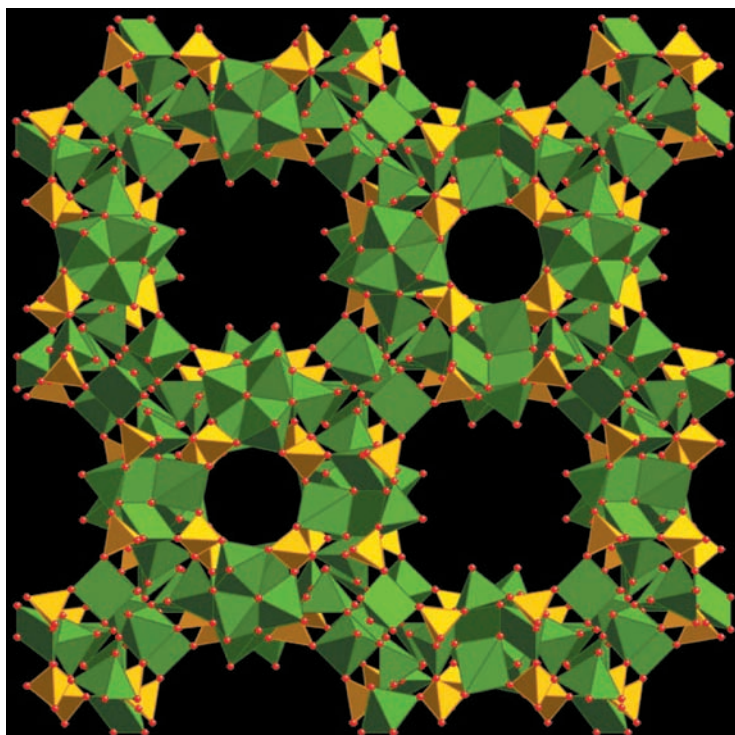
It is noteworthy that, in our experience, the crystals of the hybrid product form at the reaction temperature and pressure. Crystallization of the hybrid material does not occur in most cases during the cooling phase to room temperature or upon standing for various time periods. It is also apparent that the hydrothermal parameter space is extensive, including time, temperature, fill volume, relative stoichiometries of reactants, nucleation and crystal growth rates, pH, and identity of the starting materials. While pH and reaction temperature are critical variables in the syntheses of this study, other parameters have not been systematically investigated. A more complete understanding of the factors influencing the syntheses and properties of such hybrid materials will require a continuing expansion of the structural database. In fact, the solids discussed in this chapter, and the many examples from other investigators, suggest that these materials possess an extensive compositional range and exceptional structural versatility.

### 1.39.2.2 The Organic Component

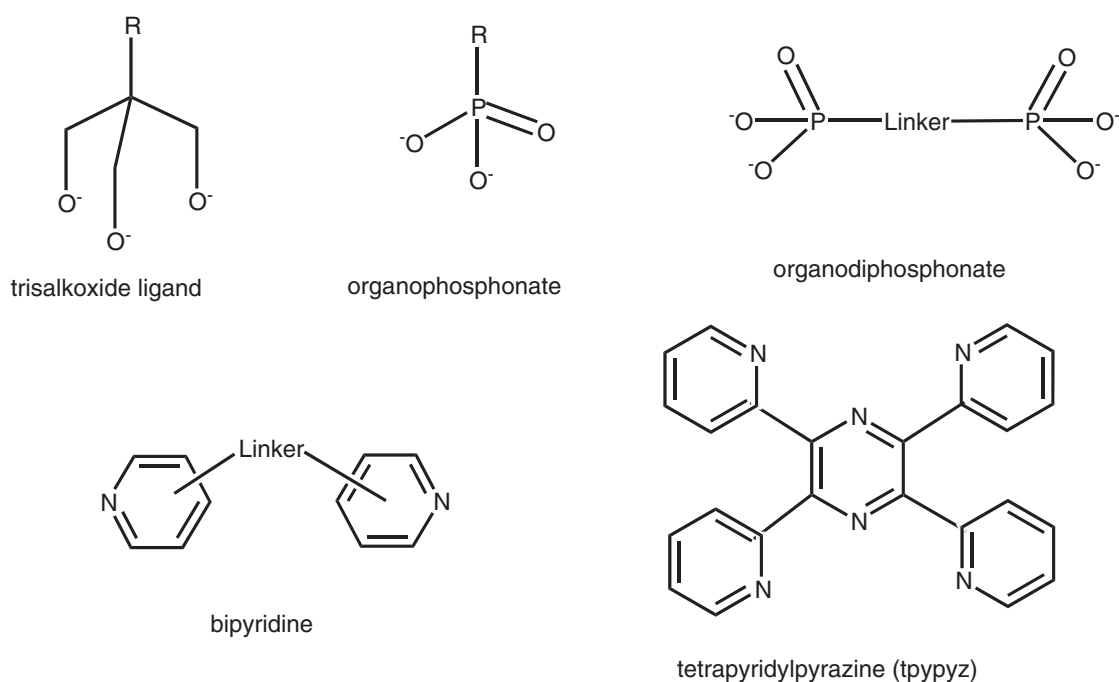
The “classical” role of an organic component in a hybrid material is that of charge compensating cations in the design of microporous materials such as zeolites<sup>4</sup> and aluminosilicates,<sup>11</sup> and mesoporous phases of the MCM-41 class.<sup>12</sup> More recently, organoammonium cations have been exploited in the design of open-framework transition metal phosphates for which  $[\text{HN}(\text{CH}_2\text{CH}_2)_3\text{NH}]\text{K}_{1.35}[\text{V}_5\text{O}_9(\text{PO}_4)_2] \cdot x\text{H}_2\text{O}$ <sup>13</sup> provides a structurally remarkable example.<sup>13,14</sup> This framework material is isolated in 95% yield from the hydrothermal reaction of  $\text{KVO}_3$ , diaminobicyclooctane (DABCO), and phosphoric acid at 200 °C. The complex oxovanadium framework of this material, shown in Figure 1, is constructed from pentanuclear oxovanadium cluster building blocks  $\{(\text{V}_5\text{O}_9)(\text{PO}_4)_2\}^{x-}$  connected in such a fashion as to generate extremely large voids occupied by twelve  $\text{H}_2\text{DABCO}^{2+}$ , 32  $\text{K}^+$ , and about 64  $\text{H}_2\text{O}$  molecules.

However, the organic component of the hybrid material may also be introduced as a ligand, a role in context with the unifying theme of coordination chemistry of solids. While a range of ligand types have been explored in the hydrothermal chemistry of metal cations, this chapter will focus on the oxygen- and nitrogen-donor ligands of Figure 2: the trisalkoxide, organophosphate, and organoimine classes.





**Figure 1** A polyhedral representation of the structure of the  $\{V_5O_9(PO_4)_2\}_n$  anionic framework of  $[HN(CH_2CH_2)_3NH]K_{1.35}[V_5O_9(PO_4)] \cdot xH_2O$ , showing the large cavities occupied by 12  $H_2DACO^{2+}$ , 32  $K^+$ , and 64  $H_2O$  molecules. Color scheme: vanadium polyhedra, green; phosphorus polyhedra, yellow; oxygen, red spheres.



**Figure 2** Representative examples of selected ligand types employed in the fabrication of organic-inorganic hybrid materials.

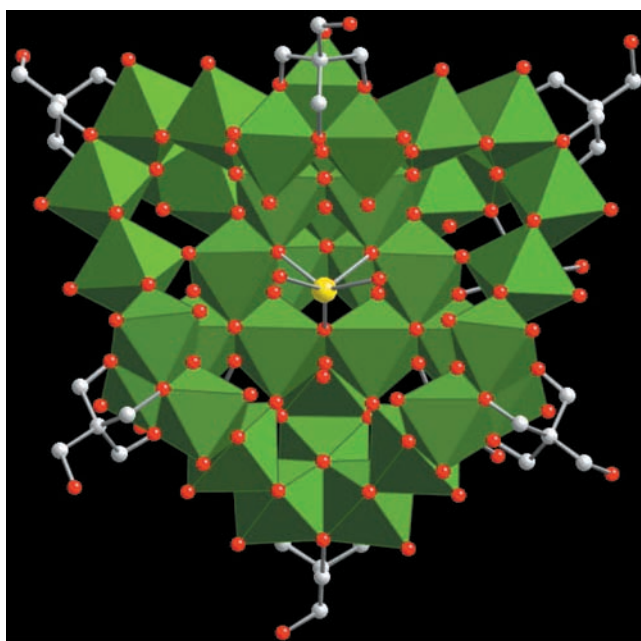
### 1.39.3 MOLECULAR CLUSTERS

While the hydrothermal method is conventionally exploited in the preparation of extended structures, under appropriate conditions and with a judicious choice of ligand, molecular clusters which are not accessible under more conventional conditions may be isolated. In this context, the structural chemistries of a variety of oxometalate–organophosphonate<sup>15</sup> and–trisalkoxide clusters have been developed and reviewed.<sup>16</sup> The remarkable species of the type  $[\text{XH}_n\text{Mo}_{42}\text{O}_{109}\{(\text{OCH}_2)_3\text{CR}\}_7]^{m-}$  ( $\text{X} = \text{Na}(\text{H}_2\text{O})_3^+$ ;  $n = 13, 15$ ;  $\text{X} = \text{MoO}_3$ ;  $n = 13, 14$ ) are representative of the latter series of clusters.<sup>17</sup> The structure of the  $\{\text{Na}(\text{H}_2\text{O})_3\}^+$  supercluster, shown in Figure 3, resembles a bowl consisting of an oxomolybdenum framework, constructed from eighteen pairs of  $\text{Mo}^{\text{V}}-\text{Mo}^{\text{V}}$  dimers and linked through edge-sharing of  $\{\text{MoO}_6\}$  octahedra, with six *cis*-dioxomolybdate(VI) subunits protruding outward to provide the surface of a channel to the cluster molecular cavity which accommodates the  $\{\text{Na}(\text{H}_2\text{O})_3\}^+$  subunit.

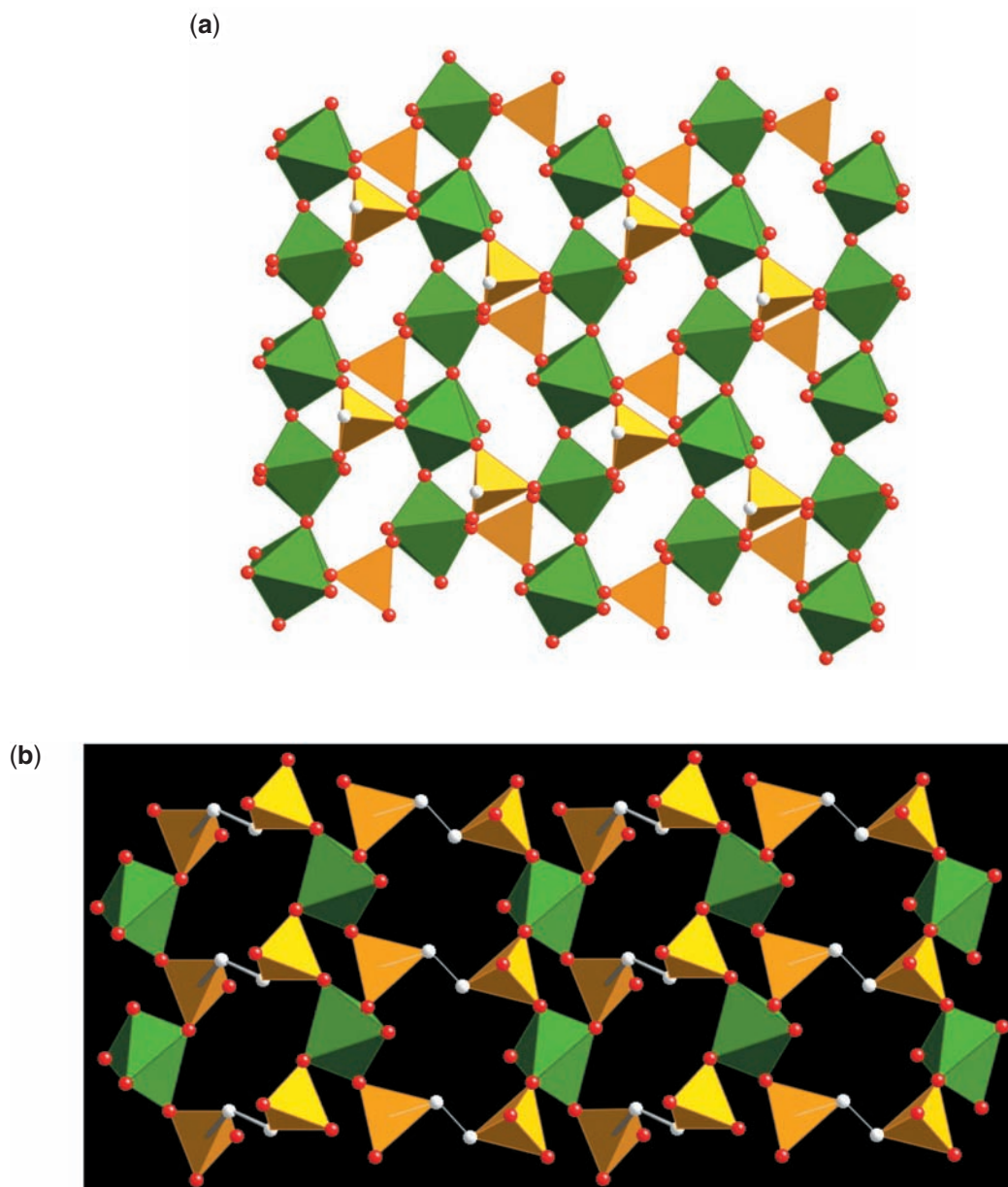
### 1.39.4 METAL ORGANOPHOSPHONATES

Metal organophosphonate phases are prototypical hybrid materials which have been extensively studied with respect to the structural consequences of steric demands of the organic subunit, spacer length modifications, and additional functionality.<sup>18,19</sup> The representative layered<sup>20</sup> and pillared materials,<sup>21</sup>  $[\text{VO}(\text{O}_3\text{PPh})(\text{H}_2\text{O})]$  and  $[\text{VO}(\text{O}_3\text{PCH}_2\text{CH}_2\text{PO}_3)]^{2-}$ , respectively, which are shown in Figure 4, were prepared by conventional hydrothermal methods from mixtures of  $\text{V}_2\text{O}_5$  and the appropriate ligand.

However, the existence of numerous oxometalate–organophosphonate molecular clusters suggested a synthetic design strategy which exploits a building block approach to the construction of metal–phosphonate materials. Thus, the fixed number of directional binding sites on a well-defined cluster will dictate the ultimate connectivity and architecture of a material. In this fashion, one-dimensional materials may be prepared by linking the structurally well-documented polyoxomolybdate cluster type  $[\text{Mo}_5\text{O}_{15}(\text{O}_3\text{PR})_2]^{4-}$  through the simple expedient of tethering the organophosphonate components with appropriate organic linkers. The one-dimensional structure of  $\{[\text{Cu}(\text{bpy})_2]\{\text{Cu}(\text{bpy})(\text{H}_2\text{O})\}(\text{Mo}_5\text{O}_{15})\{\text{O}_3\text{P}(\text{CH}_2)_4\text{PO}_3\}\}^{22}$  shown in Figure 5a, is representative of this approach. However, the structure also illustrates the requirement of



**Figure 3** A view of the structure of  $[\text{Na}(\text{H}_2\text{O})_3\text{Mo}_{42}\text{O}_{109}\{(\text{OCH}_2)_3\text{CR}\}_7]^{-13}$ . Standard color scheme used throughout: molybdenum polyhedra, green; oxygen, red spheres; carbon, light gray spheres; sodium, yellow spheres.

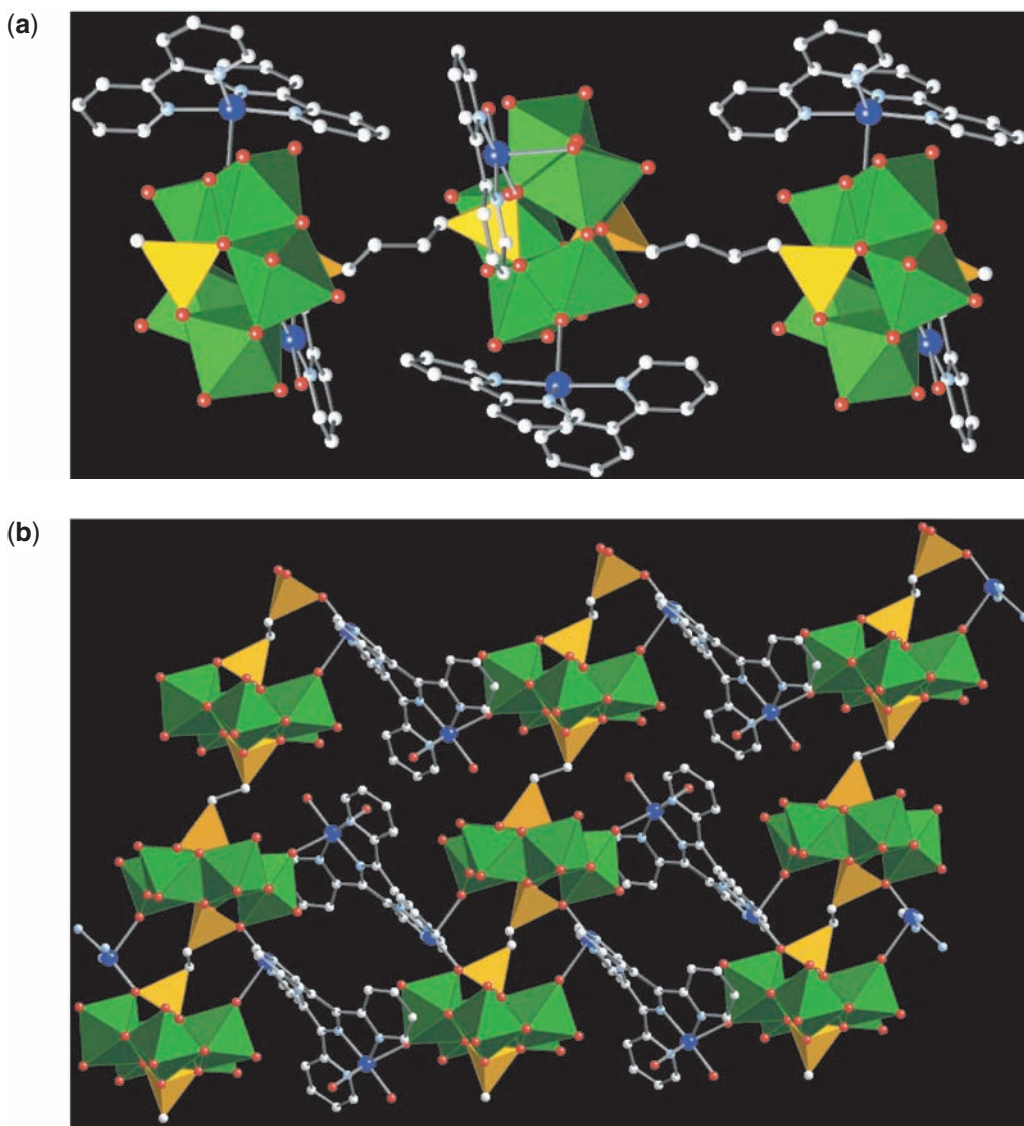


**Figure 4** (a) A polyhedral representation of the layer structure of  $[\text{VO}(\text{O}_3\text{PPh})(\text{H}_2\text{O})]$ ; the phenyl groups are omitted for clarity. (b) A view of the  $[\text{VO}(\text{O}_3\text{PCH}_2\text{CH}_2\text{PO}_3)]^{2-}$  layer of  $(\text{H}_2\text{en})[\text{VO}(\text{O}_3\text{PCH}_2\text{CH}_2\text{PO}_3)]$ . Color scheme as described previously.

a secondary metal–ligand subunit,  $\{\text{Cu}(\text{bpy})_n\}^{+2}$ , to provide charge compensation and to passivate the surface of the cluster to prevent spatial expansion into one- or two-dimensional oxomolybdophosphonate substructures.

Of course, the secondary metal site may also be exploited in structural expansion. Thus, extension into two dimensions may be accomplished by tethering the  $\text{Cu}^{\text{II}}$  sites through a binucleating ligand, such as tetrapyridylpyrazine (tpypy), as illustrated by the structure of  $[\{\text{Cu}_2(\text{tpypy})(\text{H}_2\text{O})_2\}(\text{Mo}_5\text{O}_{15})(\text{O}_3\text{PCH}_2\text{CH}_2\text{PO}_3)]$ , shown in [Figure 5b](#).

These structures illustrate that design concepts are readily incorporated into the hydrothermal preparation of solids. The ligand component may be adapted to provide spatial transmission of structural information. Similarly, the coordination preferences of a secondary metal may also be exploited. These themes will continue to be developed in the following discussion.



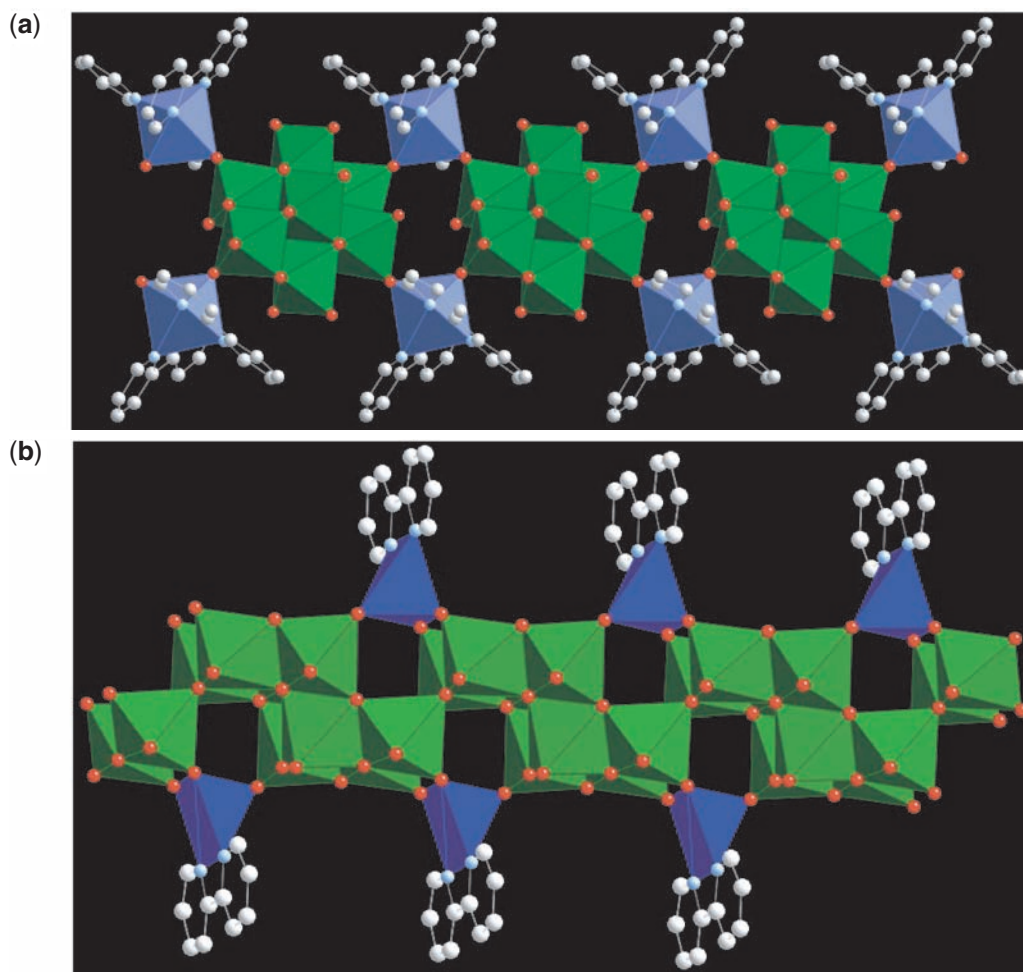
**Figure 5** (a) A view of the one-dimensional structure of  $[\{\text{Cu}(\text{bpy})_2\}\{\text{Cu}(\text{bpy})(\text{H}_2\text{O})\}(\text{Mo}_5\text{O}_{15})\{\text{O}_3\text{P}(\text{CH}_2)_4\text{PO}_3\}]$ . Color scheme as described for Figures 1–4, with Cu polyhedra in blue and nitrogen atoms as light blue spheres. (b) A representation of the layer structure of  $[\{\text{Cu}_2(\text{tpy})_2(\text{H}_2\text{O})_2\}(\text{Mo}_5\text{O}_{15})(\text{O}_3\text{PCH}_2\text{CH}_2\text{PO}_3)]$ .

### 1.39.5 INORGANIC OXIDES INCORPORATING ORGANOIMINE LIGANDS

One approach to the preparation of novel oxide materials proceeds from the self-assembly of three component building blocks: a di- or multi-topic organoimine ligand, a first row transition metal cation (the secondary metal site), and an oxometalate precursor, such as polymolybdates.<sup>23</sup> In this case, the organic component serves as a ligand to the secondary metal site, resulting in the assembly of a coordination complex cation which serves to provide charge-compensation, space-filling, and structure-directing roles. The structure of this organoimine–metal complex reflects the geometrical requirements of the ligand as well as the coordination preferences of the metal. Thus, the ligands may be chelating agents which coordinate to a single metal site or bridging groups of various extensions which may provide polymeric cationic scaffoldings for the entrapment of the metal oxide substructure.

Such coordination chemistry design concepts may be incorporated into a building block approach for the hydrothermal synthesis of novel bimetallic oxides. This strategy reflects the observation that the identity of the molybdenum oxide component can be directed to some degree





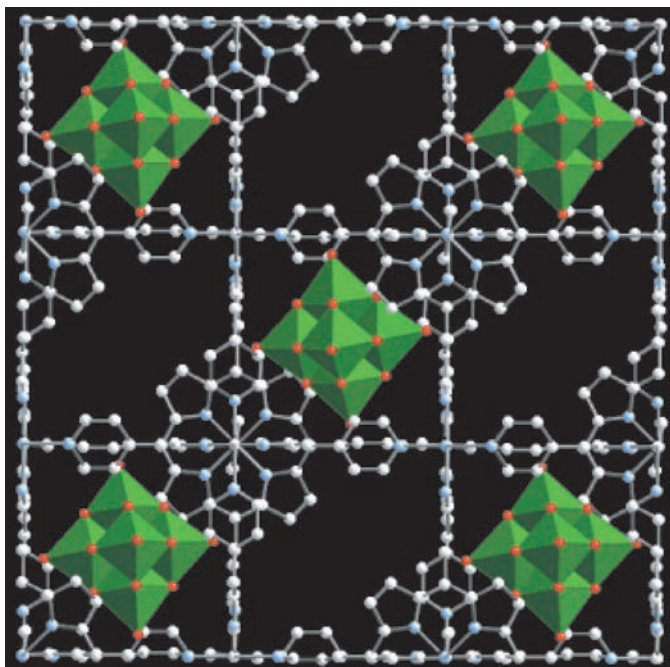
**Figure 6** (a) A polyhedral representation of the structure of  $[\{\text{Ni}(2,2'\text{-bpy})_2\}_2\text{Mo}_8\text{O}_{26}]$ . Ni polyhedra are blue. (b) A polyhedral view of the one-dimensional structure of  $[\{\text{Cu}(2,2'\text{-bpy})_2\}_2\text{Mo}_8\text{O}_{26}]$ .

by the choice of reaction conditions. Thus, low pH (3–5), short reaction times (10–48 h), and lower temperature ranges (110–160 °C) favor the formation of molybdate clusters as structural building blocks. A representative example of this approach is provided by  $[\{\text{Ni}(2,2'\text{-bpy})_2\}_2\text{Mo}_8\text{O}_{26}]$ ,<sup>24</sup> shown in Figure 6a. The structure consists of  $\beta\text{-}[\text{Mo}_8\text{O}_{26}]^{4-}$  clusters linked by  $\{\text{Ni}(2,2'\text{-bpy})_2\}^{2+}$  fragments into a one-dimensional chain.

The influences of the identity of the secondary metal are manifest in the structure of  $[\{\text{Cu}(2,2'\text{-bpy})_2\}_2\text{Mo}_8\text{O}_{26}]$  (Figure 6b). The structure consists of a one-dimensional molybdate chain of edge- and corner-sharing  $\{\text{MoO}_6\}$  octahedra decorated with peripheral  $\{\text{Cu}(\text{bpy})\}^{2+}$  groups. Inspection of the molybdate chain reveals the presence of  $\delta\text{-}[\text{Mo}_8\text{O}_{26}]^{4-}$  fragments fused at four vertices into a chain motif. The structures of these molybdates reflect in part the coordination modes of the  $\text{M}^{\text{II}}$  sites: “4 + 1” distorted square pyramidal for  $\text{Cu}^{\text{II}}$  and more or less regular six coordination for  $\text{Ni}^{\text{II}}$ .

Another strategy for the design of oxide solids exploits coordination complex polymers as the cationic scaffolding, an approach inspired by recent advances in the crystal engineering of coordination polymers.<sup>25</sup> The coordination preferences of appropriate secondary metal centers linked through polydentate ligands of appropriate geometry should result in the self-assembly of extended chains, networks, or frameworks. The structure of the oxide component should then conform to the constraints imposed by the cationic scaffolding.

This expectation is nicely realized in the structure of  $[\{\text{Fe}(\text{tppor})\}_3\text{Fe}(\text{Mo}_6\text{O}_{19})_2] \cdot x\text{H}_2\text{O}$  (tppor = tetra-4-pyridylporphyrin), shown in Figure 7.<sup>26</sup> The structure is constructed from a three-dimensional cationic framework  $\{\text{Fe}_4(\text{tppor})_3\}_n^{4n+}$  and entrained  $\{\text{Mo}_6\text{O}_{19}\}^{2-}$  cluster anions. The cationic matrix consists of cubic building blocks  $\{\text{Fe}_8(\text{tppor})_6\}^{8+}$  with an edge dimension of 9.8 Å. The large cavities generated within these Fe–porphyrin cubes are alternately populated



**Figure 7** A view of the framework structure of  $[\{\text{Fe}(\text{tpypor})_3\}_3\text{Fe}(\text{Mo}_6\text{O}_{19})_2]$ . The  $\{\text{Fe}_4(\text{tpypor})_3\}_n^{4n+}$  scaffolding is presented in ball and stick form while the  $\{\text{Mo}_6\text{O}_{19}\}^{2-}$  clusters are shown as edge-sharing polyhedra.

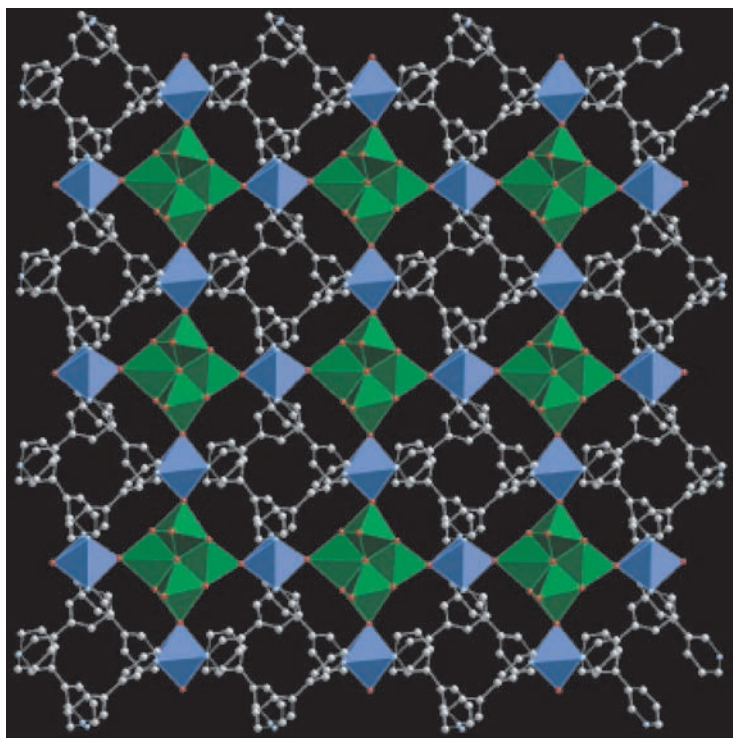
by  $\{\text{Mo}_6\text{O}_{19}\}^{2-}$  clusters and ca. 33 water molecules of crystallization. It is noteworthy that while the reaction conditions are such as to favor the formation of  $\{\text{Mo}_8\text{O}_{26}\}^{4-}$  cluster subunits, the cavity dimensions can only accommodate the hexamolybdate cluster. Furthermore,  $\{\text{Mo}_6\text{O}_{19}\}^{2-}$  exhibits octahedral symmetry, consistent with occupation of the cubic cavity provided by the coordination polymer, suggesting a symmetry-driven entrapment. It is also evident that the cluster is somewhat larger than the cavity, such that the terminal oxo groups “spill over” into the six adjacent cavities. Consequently, each  $\{\text{Mo}_6\text{O}_{19}\}^{2-}$ -containing box is octahedrally surrounded by cavities encapsulating water molecules. Dehydration provides a microporous structure with a Type I isotherm for water sorption.

The incorporation of hexamolybdate, rather than the far more common octamolybdate substructure, in this iron–molybdate suggested that smaller molybdate oligomers would be embedded into the vacancies of appropriately constructed coordination complex polymers. This is indeed the case in  $[\{\text{Ni}(3,3'\text{-bpy})_2\}_2\text{Mo}_4\text{O}_{14}]$ .<sup>27</sup> As shown in [Figure 8](#), the structure consists of a two-dimensional  $\{\text{Ni}(\text{bpy})_2\}_n^{2n+}$  grid with  $\{\text{Mo}_4\text{O}_{14}\}^{4-}$  clusters occupying the intralamellar cavities. Curiously, tetramolybdate has not been isolated as a discrete cluster, nor is the structure of this subunit related to that of  $\{\text{V}_4\text{O}_{12}\}^{4-}$  or to  $\{\text{Mo}_4\text{O}_{14}\}^{4-}$  fragments of the octamolybdate isomers.

### 1.39.6 BIMETALLIC OXIDE NETWORKS

When the three-component system described in [Section 1.39.5](#) is subjected to hydrothermal conditions of higher pH (5 to 8) and more extreme temperatures and reaction times, the resultant oxide materials often exhibit architectures in which the secondary metal is directly incorporated into a bimetallic oxide network and/or in which the molybdate cluster identity is lost upon fusing into one- or two-dimensional molybdenum oxide substructures.

The range of structural chemistry shown by the bimetallic oxide networks is illustrated by the structures of  $[\text{Cu}(3,4'\text{-bpy})\text{MoO}_4]$ ,  $[\text{Cu}(3,3'\text{-bpy})_{0.5}\text{MoO}_4]$ , and  $[\text{Cu}(4,4'\text{-bpy})_{0.5}\text{MoO}_4]$ .<sup>28</sup> The structure of  $[\text{Cu}(3,4'\text{-bpy})\text{MoO}_4]$  consists of bimetallic  $\{\text{CuMoO}_4\}$  oxide layers covalently linked through 3,4'-bpy ligands into a three-dimensional framework. Thus, the structure exhibits the characteristic pattern of alternating organic–inorganic domains previously described for metal–organophosphonate phases. The oxide layer, shown in [Figure 9a](#), is constructed from



**Figure 8** The structure of  $[\{\text{Ni}(3,3'\text{-bpy})_2\}_2\text{Mo}_4\text{O}_{14}]$ .

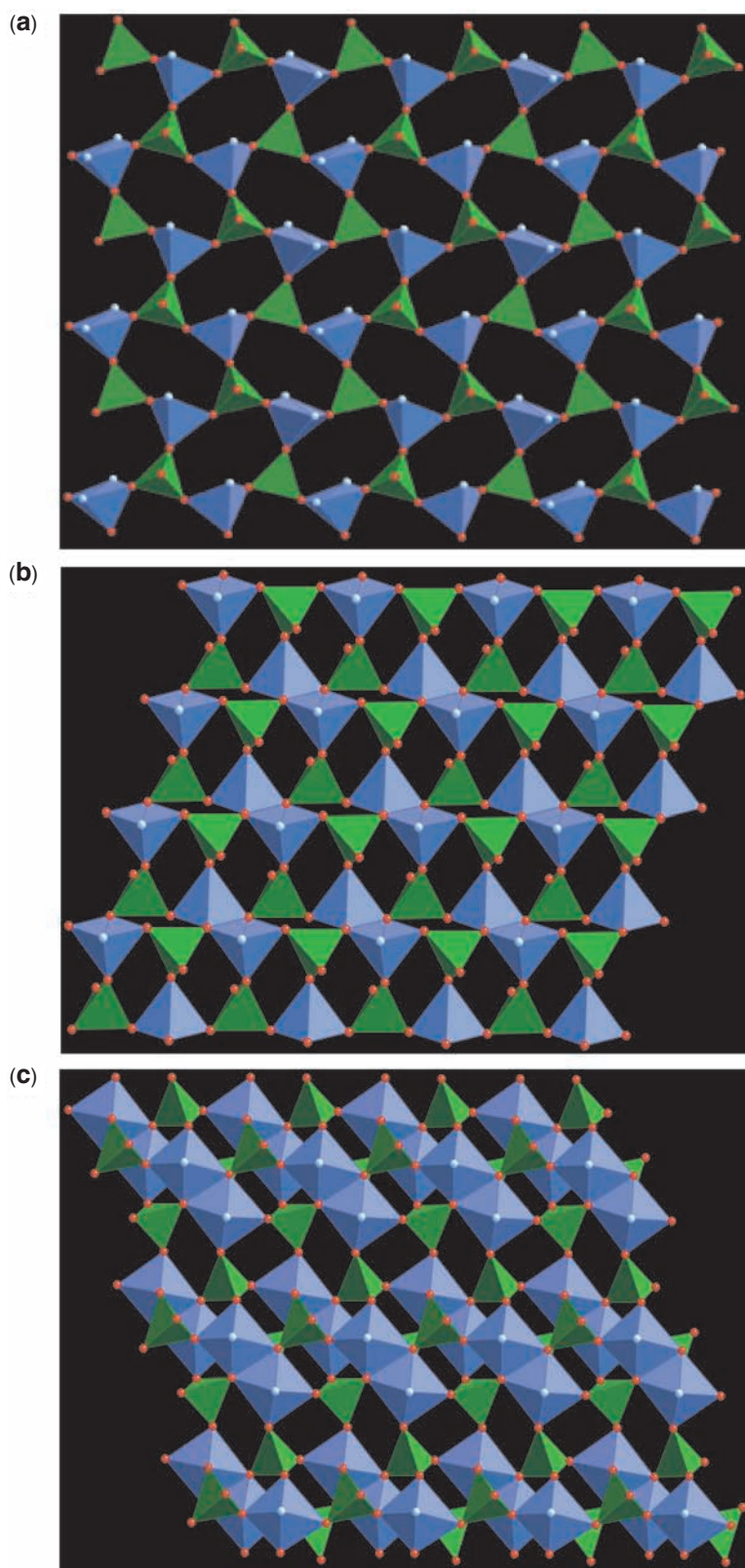
corner-sharing  $\{\text{MoO}_4\}$  tetrahedra and  $\{\text{CuN}_2\text{O}_3\}$  trigonal bipyramids. The coordination geometry at the  $\text{Cu}^{\text{II}}$  sites is defined by two nitrogen donors from two 3,4'-bpy ligands in the axial positions and three oxygen donors from the molybdate tetrahedra in the equatorial plane. Each 3,4'-bpy ligands tethers  $\text{Cu}^{\text{II}}$  sites in adjacent layers to produce a one-dimensional  $\{\text{Cu}(3,4'\text{-bpy})\}_n^{2n+}$  chain as a substructural component. Each  $\{\text{MoO}_4\}^{2-}$  tetrahedron bridges three  $\text{Cu}^{\text{II}}$  sites, leaving one terminal oxo group, which is directed into the interlamellar region. The covalent connectivity in the layer produces twelve-membered  $\{\text{Cu}_3\text{Mo}_3\text{O}_6\}$  rings, which fuse to propagate the network structure.

The structure of  $[\text{Cu}(3,3'\text{-bpy})_{0.5}\text{MoO}_4]$  also exhibits the common pattern of alternating inorganic oxide networks and tethering organic ligand domains. However, in contrast to the  $\{\text{CuMoO}_4\}$  network structure of  $[\text{Cu}(3,4'\text{-bpy})\text{MoO}_4]$ , the  $\{\text{CuMoO}_4\}$  network of  $[\text{Cu}(3,3'\text{-bpy})_{0.5}\text{MoO}_4]$  is constructed from molybdate tetrahedra and binuclear units of  $\text{Cu}^{\text{II}}$  square pyramids, shown in Figure 9b. The geometry at each  $\text{Cu}^{\text{II}}$  center is defined by an apical oxo group and three oxo groups and a nitrogen donor from the 3,3'-bpy ligand in basal plane. Two  $\text{Cu}^{\text{II}}$  sites share a basal edge to form the binuclear unit. Since a given  $\text{Cu}^{\text{II}}$  site coordinates to a single 3,3'-bpy ligand, the  $\text{Cu}^{\text{II}}$  ligand chains propagate as  $\{\text{Cu}_2(3,3'\text{-bpy})\}_n^{4n+}$  chains, rather than the simple  $\{\text{Cu}(3,4'\text{-bpy})\}_n^{2n+}$  chains of  $[\text{Cu}(3,4'\text{-bpy})\text{MoO}_4]$ .

Each binuclear  $\text{Cu}^{\text{II}}$  site is linked to six molybdate sites through corner sharing to bridging oxo groups. Each  $\{\text{MoO}_4\}^{2-}$  tetrahedron in turn bridges three binuclear copper sites, leaving one terminal oxo group to project into the interlamellar region. One consequence of the network connectivity is to generate eight-membered  $\{\text{Cu}_2\text{Mo}_2\text{O}_4\}$  rings. Adjacent "chains" of such fused rings are at right angles to each other to produce a ruffled bimetallic oxide layer.

The structure of  $[\text{Cu}(4,4'\text{-bpy})_{0.5}\text{MoO}_4]$  also exhibits the pattern of inorganic oxide layers alternating with bridging ligand domains. However, in contrast to both  $[\text{Cu}(3,3'\text{-bpy})_{0.5}\text{MoO}_4]$  and  $[\text{Cu}(3,4'\text{-bpy})\text{MoO}_4]$ , the bimetallic oxide network of  $[\text{Cu}(4,4'\text{-bpy})_{0.5}\text{MoO}_4]$ , shown in Figure 9c, is constructed from  $\{\text{MoO}_4\}^{2-}$  tetrahedra and tetranuclear units of edge-sharing  $\{\text{CuNO}_5\}$  octahedra. The coordination geometry at each  $\text{Cu}^{\text{II}}$  site is defined by a nitrogen donor from the 4,4'-bpy ligands and five oxo groups from five corner-sharing molybdate tetrahedra. The 4,4'-bpy ligands bridge adjacent layers and produce  $\{\text{Cu}_4(4,4'\text{-bpy})_2\}_n^{8n+}$  chains as substructural motifs which contrast rather dramatically with the  $\{\text{Cu}(3,4'\text{-bpy})\}_n^{2n+}$  and  $\{\text{Cu}_2(3,3'\text{-bpy})\}_n^{4n+}$  chains of  $[\text{Cu}(3,4'\text{-bpy})\text{MoO}_4]$  and  $[\text{Cu}(3,3'\text{-bpy})_{0.5}\text{MoO}_4]$ . Each tetranuclear  $\text{Cu}^{\text{II}}$  cluster is linked to ten molybdate





**Figure 9** (a) The bimetallic oxide layer of  $[\text{Cu}(3,4'\text{-bpy})\text{MoO}_4]$ . The oxide layers of (b)  $[\text{Cu}(3,3'\text{-bpy})_{0.5}\text{MoO}_4]$  and (c)  $[\text{Cu}(4,4'\text{-bpy})_{0.5}\text{MoO}_4]$ . Color scheme as noted previously.

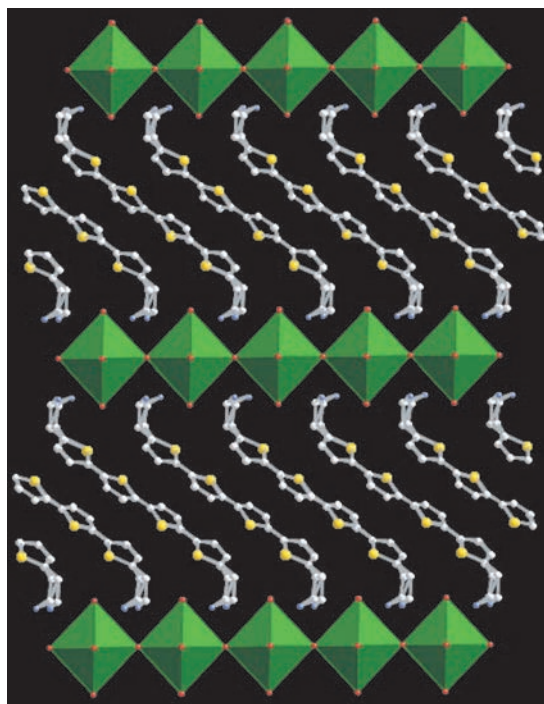


tetrahedra. There are two distinct molybdate sites. One bridges three copper clusters, while the second bridges three copper sites of one cluster and two copper sites of an adjacent cluster. Consequently, in contrast to the structures of  $[\text{Cu}(3,4'\text{-bpy})\text{MoO}_4]$  and  $[\text{Cu}(3,3'\text{-bpy})_{0.5}\text{MoO}_4]$ , which exhibit only doubly bridging oxo groups  $\{\text{Cu}-\text{O}-\text{Mo}\}$ , the structure of  $[\text{Cu}(4,4'\text{-bpy})_{0.5}\text{MoO}_4]$  also possesses triply bridging oxo groups  $\{\text{Cu}_2\text{MoO}\}$ . This more complex connectivity generates six-membered  $\{\text{Cu}_2\text{MoO}_3\}$  rings, as well as eight-membered  $\{\text{Cu}_2\text{Mo}_2\text{O}_4\}$  rings as structural motifs of the oxide networks. The structures of these bimetallic oxide materials provide a dramatic demonstration of the profound structural consequences of minor perturbations of ligand geometry.

### 1.39.7 METAL–HALIDE AND –PSEUDOHALIDE MATERIALS

While the discussion has elaborated on the oxide materials prepared by hydrothermal methods which provide the focus of my interests, there has also been considerable development of the structural chemistry of metal–halide and –pseudohalide materials exploiting hydrothermal methods. Of particular interest in this regard are the organically templated perovskites of which  $(\text{C}_{20}\text{H}_{22}\text{S}_4\text{N}_2)\text{PbBr}_4$  is characteristic (Figure 10).<sup>29,30</sup> The structure may be viewed as a low-dimensional perovskite, conceptually derived from a slice of the three-dimensional perovskite structure. Thus, the metal halide network is constructed of corner-sharing  $\{\text{PbBr}_6\}$  octahedra. The organic cations which occupy the interlamellar regions serve to stabilize the two-dimensional metal halide substructure.

The  $\text{Cu}^{\text{I}}$ -cyanides are representative of the metal pseudohalide phases. In this case, one-, two-, and three-dimensional structures based on the linking of  $\{\text{Cu}(\text{CN})\}$  chains have been constructed by introducing ligands with a variety of steric and geometric constraints.<sup>31,32</sup> Figure 11 shows the structure of a representative material  $[\text{Cu}_2(\text{CN})_2(2,5\text{-dimethylpyrazine})]$ . The framework consists of  $\{\text{Cu}(\text{CN})\}_8$  chains linked through triply bridging cyano groups into copper cyanide networks. These two-dimensional substructures are in turn linked through the ligands into the overall three-dimensional structure.



**Figure 10** A view of the structure of  $(\text{C}_{20}\text{H}_{22}\text{S}_4\text{N}_2)\text{PbBr}_4$ , showing the occupation of the interlamellar region between  $\text{PbBr}_6^{2-}$  networks by the organic cations.

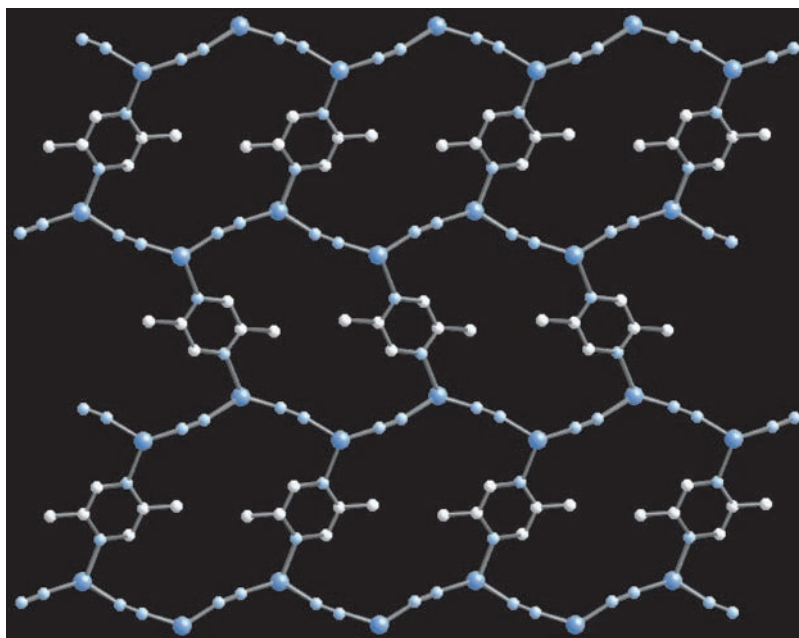


Figure 11 A view of the structure of  $[\text{Cu}_2(\text{CN})_2(2,5\text{-dimethylpyrazine})]$ .

### 1.39.8 CONCLUSIONS

The fundamental principles of coordination chemistry may be adapted to the design of novel solid state materials. Ligand geometry, denticity, steric requirements and functionality may be varied to produce dramatic changes in the microstructures of inorganic solids. By combining this ligand incorporation concept with hydrothermal synthesis, the promise of solid state coordination chemistry may be realized. Hydrothermal synthesis manifestly provides a powerful technique for the preparation of a vast range of organic-inorganic hybrid materials. While much of the work published to date is in the realm of discovery—that is, defining the structural types and compositions which emerge from the hydrothermal mix—elements of design and of understanding of the fundamental chemistry are now emerging.

### 1.39.9 REFERENCES

1. Rabenau, A. *Angew. Chem., Int. Ed. Engl.* **1985**, *24*, 1026–1040.
2. Feng, S.; Xu, R. *Acc. Chem. Res.* **2001**, *34*, 239–247 and references therein.
3. Lobachev, A. N.; Archard, C. D. *Crystallization processes under hydrothermal conditions* **1973**, Consultants Bureau: New York.
4. Barrer, R. M. *Hydrothermal chemistry of zeolites* **1982**, Academic Press: New York.
5. Gopalakrishnan, J. *Chem. Mater.* **1995**, *7*, 1265–1275.
6. Somiya, S. *Hydrothermal reactions for materials science and engineering* **1986**, Elsevier Applied Science: New York.
7. Hagrman, P. J.; Hagrman, D.; Zubieta, J. *Angew. Chem., Int. Ed. Engl.* **1999**, *38*, 2638.
8. Laudise, R. A. *Chem. Eng. News* **1987**, Sept. 28, 30.
9. Halasyamani, P.; Willis, M. J.; Stern, C. L.; Lundquist, P. M.; Wong, G. K.; Poeppelmeier, K. R. *Inorg. Chem.* **1996**, *35*, 1367.
10. Gier, T. E.; Stucky, G. D. *Nature* **1991**, *349*, 508.
11. Szostak, R. *Molecular Sieves: Principles of Synthesis and Identification* **1989**, Van Nostrand Reinhold: New York.
12. Kresge, C. T.; Leonowicz, M. E.; Roth, W. J.; Vartuli, J. C.; Beck, J. S. *Nature* **1992**, *359*, 710–712.
13. Khan, M. I.; Meyer, L. M.; Haushalter, R. C.; Schweitzer, A. L.; Zubieta, J.; Dye, J. L. *Chem. Mater.* **1996**, *8*, 43–53.
14. Cheetham, A. K.; Férey, G.; Loiseau, T. *Angew. Chem., Int. Ed. Engl.* **1999**, *38*, 3268–3292 and references therein.
15. Huan, G.; Jacobson, A. J.; Day, V. W. *Angew. Chem., Int. Ed. Engl.* **1991**, *30*, 422–423.
16. Khan, M. I.; Zubieta, J. *Prog. Inorg. Chem.* **1995**, *43*, 1–149.
17. Khan, M. I.; Chen, Q.; Salta, J.; O'Connor, C. J.; Zubieta, J. *Inorg. Chem.* **1996**, *35*, 1880–1901.
18. Alberti, G., In *Comprehensive Supramolecular Chemistry*, Atwood, J. L.; Davis, J. E. D.; Vogel, F., Eds.; Permagon Press: New York, 1996; Vol. 9, Alberti, G.; Bein, T., Eds., pp 151–187.
19. Clearfield, A. *Prog. Inorg. Chem.* **1998**, *47*, 373–500.
20. Huan, G.; Jacobson, A. J.; Johnson, J. W.; Corcoran, E. W., Jr. *Chem. Mater.* **1990**, *2*, 91–93.

21. Soghomonian, V.; Chen, Q.; Haushalter, R. C.; Zubieta, J. *Angew. Chem., Int. Ed. Engl.* **1995**, *34*, 223–226.
22. Finn, R. C.; Burkholder, E.; Zubieta, J. *Chem. Comm.* **2001**, 1852–1853.
23. Hagrman, D.; Hagrman, P. J.; Zubieta, J. *Comments Inorg. Chem.* **1999**, *21*, 225–261.
24. Zapf, P. J.; Warren, C. J.; Haushalter, R. C.; Zubieta, J. *Chem. Commun.* **1997**, 1543–1544.
25. See for example: Robson, R. *J. Chem. Soc., Dalton Trans.* **2000**, 3735–3744.
26. Hagrman, E.; Hagrman, P. J.; Zubieta, J. *Angew. Chem., Int. Ed. Engl.* **1999**, *38*, 3165–3168.
27. LaDuca, R. L., Jr.; Desciak, M.; Laskowski, M.; Rarig, R. S., Jr.; Zubieta, J. *J. Chem. Soc., Dalton Trans.* **2000**, 2255.
28. Rarig, R. S.; Lam, R.; LaDuca, R. L., Jr.; Greedan, J.; Zubieta, J. *Inorg. Chem.* **2002**, *41*, 0000.
29. Mitzi, D. B. *Inorg. Chem.* **2000**, *39*, 61078–6113.
30. Mitzi, D. B. *J. Chem. Soc., Dalton Trans.* **2001**, 1–12.
31. Chesnut, D. J.; Plewak, D.; Zubieta, J. *J. Chem. Soc., Dalton Trans.* **2001**, 2567–2580.
32. Chesnut, D. J.; Kusnetzow, A.; Birge, R.; Zubieta, J. *J. Chem. Soc., Dalton Trans.* **2001**, 2581–2586.

# 1.40

## Sol–Gel

J. A. CRAYSTON

*University of St. Andrews, Scotland*

---

1.40.1	INTRODUCTION	711
1.40.1.1	Hydrolysis and Condensation	713
1.40.1.2	Control of Morphology	714
1.40.2	METAL ALKOXIDE PRECURSORS	715
1.40.2.1	Modifiers	715
1.40.2.2	Multinuclear Alkoxide Precursors: Homonuclear	716
1.40.2.3	Multinuclear Alkoxide Precursors: Heteronuclear	717
1.40.2.4	Non-hydrolytic Condensation of Alkoxides <sup>3,94</sup>	718
1.40.2.5	Thiols and Non-oxide Gels	718
1.40.3	ORGANIC–INORGANIC HYBRID MATERIALS	718
1.40.3.1	Alkyltrialkoxysilanes and Silasesquioxanes	719
1.40.3.2	Doping with Dyes	720
1.40.3.3	Doping with Biomolecules	720
1.40.3.4	Doping with Polymers	720
1.40.3.5	Templating of Sol–Gel Materials	721
1.40.4	AQUEOUS COLLOIDAL PRECURSORS: CONDENSATION	722
1.40.5	EXAMPLES OF SOL–GEL SYNTHESSES IN CATALYSIS, ELECTROCERAMICS, ELECTROCHROMICS, AND BIOMATERIALS	725
1.40.6	CONCLUSIONS	726
1.40.7	REFERENCES	726

---

### 1.40.1 INTRODUCTION

Sol–gel processing is a relatively new method for the preparation of oxide materials at low temperature. The lower temperatures involved, near room temperature for the formation of the gel precursor to the oxide, are in stark contrast to the traditional method used to prepare oxide materials by mixing fine-grained solid powders of oxides and firing at high temperature: the so-called “grind-and-fire” method. Since the uses of oxide materials are multitudinous—from refractory oxides and the ceramics industry to silica glass to superconductors—the advent of sol–gel processing has had a significant impact over the years.

Sol–gel processing involves the controlled hydrolysis and condensation of a soluble precursor to form a sol, a homogeneous suspension of submicroscopic solid oxide particles in a liquid. In turn, the sol particles can grow and condense to form a continuous network polymer or gel containing trapped solvent particles. The method of drying then determines the nature of the final product: the gel can either be heated to drive off the trapped solvent molecules leading to capillary pressure and a collapse of the gel network; or, alternatively, the gel may be dried supercritically, which allows solvent removal without network collapse (Figure 1). The final product obtained from supercritical drying is called an aerogel, that from heating is called a xerogel. Gels are not the only form for the final product obtainable. Figure 2 shows the various routes to the different product types.

The problems associated with the traditional grind-and-fire method of preparing oxides are well known: high temperatures are required to sinter large particles in order to facilitate diffusion

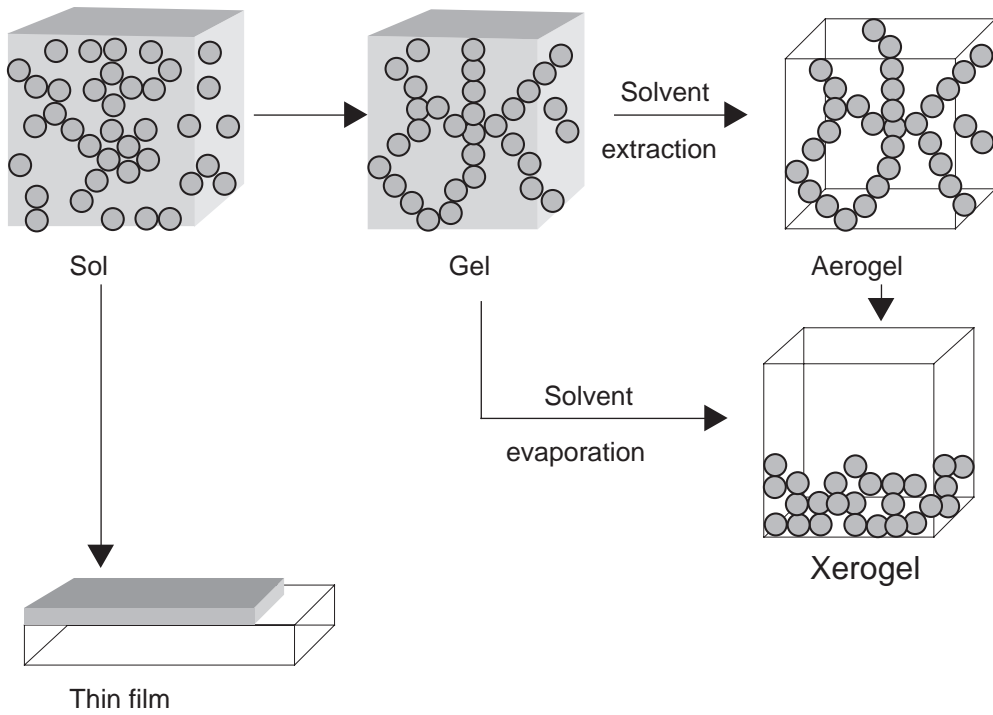


Figure 1 Outline of the sol-gel process.

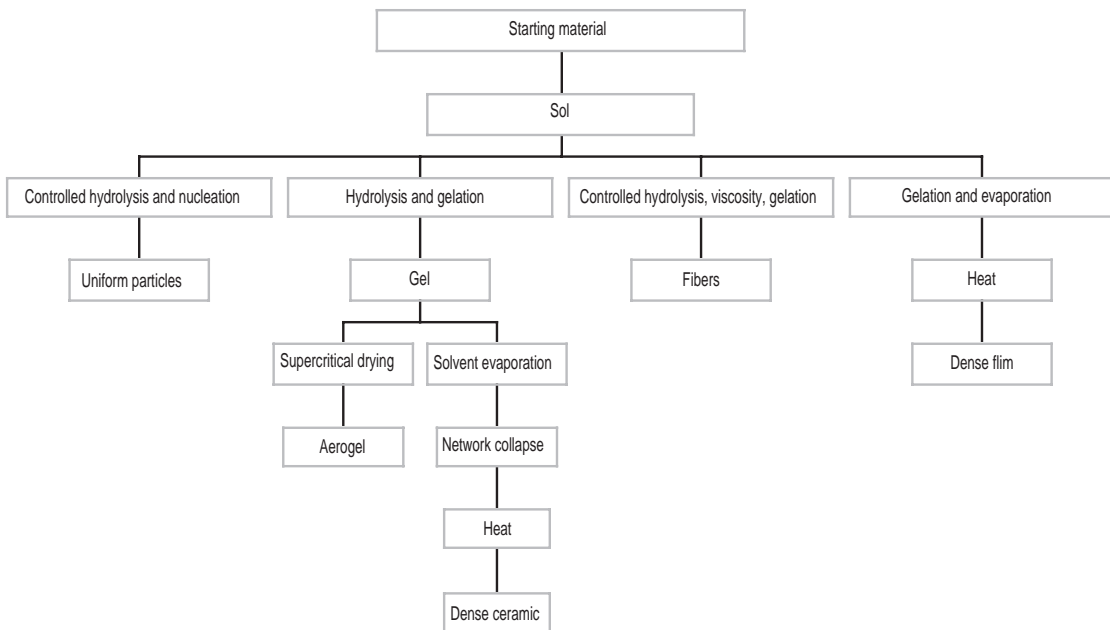


Figure 2 Variation of product type under different sol-gel conditions.

across the large distances between particles; large particles lead to defects and voids which can have a deleterious affect on the properties of the final product; the correct atomic scale stoichiometry and chemical homogeneity is hard to achieve due to the relatively large particle size; and, finally, it is hard to produce some metastable phases due to the high temperatures involved.

There are four principal advantages to using sol-gel processing techniques over traditional methods of preparing ceramic materials:

**Purity of the final product.** As the process uses molecular precursors rather than bulk materials, standard purification techniques such as distillation, sublimation, chromatography, and recrystallization can be applied.

**Greater stoichiometric control.** The use of molecular precursors: sol-gel processing allows precise amounts of starting materials to be mixed together in solution with control of the exact stoichiometry and thus the desired final properties upon calcination. This aspect of the technique is particularly important for the production of complex oxides such as the materials used for high- $T_c$  superconductors.

**Low-temperature synthesis.** Due to the homogeneity of the dried powder/gel product and the smaller particle size when compared to grind-and-fire methods, nucleation and growth of crystalline phases can occur at lower temperatures. This also allows the synthesis of metastable phases and the inclusion of organic or other compounds with low thermal stability into the final product. Volatile materials are no longer lost and amorphous phases can be formed. Lower temperatures avoid the effects of particle sintering.

**Control of ceramic properties through control of parameters.** Variation of the reaction conditions affects product morphologies and bulk properties. Variation of pH, temperature, concentration, and chemical control of the rates of hydrolysis and condensation dramatically affect the final product. The complexity of the reactions involved often precludes a complete mechanistic understanding but the use of computer simulation and mathematical models to predict the behavior of the precursors under different conditions allows an insight into how the reaction might proceed and thus how the nature of the final product can be controlled.

Sol-gel processing holds many of these advantages in common with other so-called “*chimie-douce*” methods such as hydrothermal synthesis. However, we shall focus on sol-gel processing only in this section. The area of sol-gel processing has been extensively reviewed. A key summary of work until 1990 is the comprehensive book by Brinker and Scherer.<sup>1</sup> Since then, more general reviews have appeared,<sup>2,3</sup> as well as reviews specializing in electroceramics,<sup>4,5</sup> electrochromic,<sup>6</sup> and electrode materials,<sup>7-9</sup> optical and electro-optical materials,<sup>10</sup> anti-reflective coatings,<sup>11</sup> and high- $T_c$  superconductors.<sup>12</sup> Reviews have also covered chemical applications in catalysis,<sup>5,13-15</sup> including aerogels<sup>16</sup> and mesoporous solids,<sup>17</sup> and in membranes for gas separations.<sup>18</sup> From the synthesis point of view, reviews have addressed the use of heterometallic alkoxides,<sup>19</sup> lanthanide precursors<sup>20</sup> and the issue of homogeneity of the oxide products.<sup>21</sup>

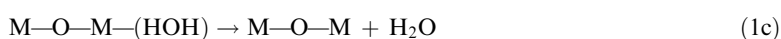
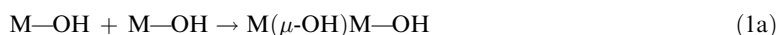
Sol-gel processing can be roughly divided into two areas based on the type of precursor used: the **alkoxide route**, i.e., the controlled hydrolysis and condensation of a hydrolytically unstable precursor (usually based upon a metal alkoxide species) soluble in non-aqueous solvents; and the **colloidal route**, the peptidization of a water-soluble precursor (also known as colloidal processing). Hydrolysis of an aqueous metal precursor occurs on changing the pH of the precursor solution. These types are usually discussed separately.

#### 1.40.1.1 Hydrolysis and Condensation

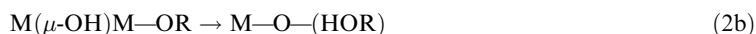
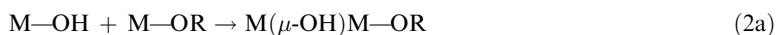
Since most alkoxides are insoluble in, or immiscible with, water, hydrolysis of an alkoxide occurs upon adding water to a non-aqueous solution (e.g., alcohol) of the alkoxide. Hydrolysis is favored when the nucleophilic character of the entering molecule is high (for example, negatively charged, such as hydroxide ion), or when the leaving group has a positive partial charge making it favorable for it to leave the positively charged metal center (e.g.,  $H_2O$  or  $ROH$ ).

After hydrolysis to give reactive monomers, condensation occurs by one of three mechanisms:

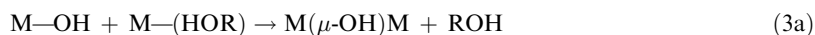
- (i) **Oxolation:** reaction between two  $M-OH$  species to give an oxo bridge and water:



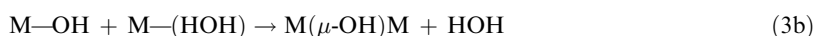
- (ii) **Alcolation:** reaction between M—OH and an alkoxide resulting in an “ol” bridge. This then undergoes a proton transfer step (Equation (2b)) to create a better leaving group (ROH):



- (iii) **Olation:** when the full coordination of the metal is not satisfied (when there is coordinated water or solvent) a hydroxo bridge can be formed.



Or, alternatively:



When the growing particles start to aggregate to form large clusters there will come a point when there is a continuous path from one side of the vessel to the other. The viscosity rises rapidly at this point—the gel point—since flow is no longer possible. The mixture consists of a network of aggregated particles containing trapped solvent within it. On the microscopic scale the solvent molecules move freely, but on the macroscopic scale the gel is solid-like. Such systems are familiar in food science: jellies, set yogurt, cheese, etc. The gel-point is measured by monitoring the viscosity of the solution *in situ* or it may also be detected acoustically.<sup>22</sup> Alternatively, an *induction period* is defined as the time after which precipitates appear. The sol–gel transition has been studied by a variety of physical techniques, including electron microscopy, small-angle X-ray<sup>23,24</sup> and neutron scattering,<sup>25</sup> light scattering,<sup>26,27</sup> and fluorescence anisotropy.<sup>28</sup> These techniques provide strong evidence for the presence of growing nanoparticles during the sol–gel polymerization.

#### 1.40.1.2 Control of Morphology

Monodisperse TiO<sub>2</sub> particles can be prepared through hydrolysis of titanium butoxide in the presence of acac and *p*-toluenesulfonic acid.<sup>29</sup> The methods used to obtain monodisperse metal oxide particles were discussed in classic articles by Matijevic.<sup>30,31</sup>

Due to the constraints of the shrinkage of thin films and the consequent stress-induced cracking, it was originally thought that only film thicknesses of less than 0.1 μm were feasible. However, Dislich discovered<sup>32</sup> that the dip-coating process could produce thick films (0.2–0.3 μm) which were dense and pinhole free. The explanation appears to be based on the forces operating on the leading edge of the film caused by the draining liquid. This process yields dense thin films when dipping from polymeric solution or particulate sols, but is most successful for less cross-linked polymers or easily packed (monodisperse) particle sols.

The thickness (*h*) of a coating obtained by dipping is given by the Landau–Levich equation:

$$h = 0.94 \left( \frac{\eta U}{\gamma} \right)^{1/6} \left( \frac{\eta U}{\rho g} \right)^{1/2} \quad (4)$$

where  $\gamma$  is the surface tension,  $\eta$  is the dynamic viscosity,  $\rho$  is the density,  $g$  is the gravitational acceleration, and  $U$  is the withdrawal rate. This equation only applies for slow withdrawal speeds ( $U < 1 \text{ cm min}^{-1}$ ) where the dependence of viscosity on shear rate is negligible. Examples of dip-coated films include an electrochromic iron oxide<sup>33</sup> and nickel oxide/hydroxide films.<sup>34</sup> A novel method of growing films from aqueous solutions is by heterogeneous nucleation onto substrates.<sup>35</sup>

There has been a good deal of interest in the “2D” nucleation and growth of sol–gels from Langmuir–Blodgett films. The alkoxide is dissolved in CHCl<sub>3</sub> and is spread onto an aqueous sub-phase, whereupon hydrolysis occurs from underneath. The films can be transferred onto substrates such as quartz.<sup>36</sup>

Normally, fibers are spun or drawn from sol–gels; e.g., the production of BaTiO<sub>3</sub> fibers from the alkoxides.<sup>37</sup> However, there has been a considerable amount of work recently on preparing fibers



using membranes as templates.<sup>38,39</sup> Such  $V_2O_5$  fibers were used as a Li insertion electrode.<sup>40</sup> Trapped excitons in 50 nm  $TiO_2$  fibers have been studied.<sup>41</sup> Hollow fibers or nanotubes can be prepared with the aid of a suitable template. For example, silica nanotubes are prepared using the tartrate ion as template.<sup>42</sup> Using a long alkyl chain amine as template, vanadia nanotubes around 50 nm in diameter may be prepared, which consist of rolled up sheets, rather than concentric tubes.<sup>43</sup>

Aerogels are the least dense solids yet known to mankind, and are prepared by supercritical drying of an alcogel or a hydrogel in an autoclave. Far from being new materials, aerogels were in fact discovered back in the early 1930s by Kistler. From the earlier discussion on the dependence of hydrolysis and condensation rates on pH, we see that a low-density gel network can be produced at low pH. However, such gels shrink substantially on drying. To get around this problem Brinker has introduced a two-step process, which produces aerogels with densities approaching  $10^{-3} \text{ g cm}^{-3}$ : (i) hydrolysis at pH 2 with a sub-stoichiometric amount of water leads to  $Si(OH)_3(OR)$ , for example, with minimal condensation; (ii) subsequent addition of base catalyst for rapid condensation gives highly cross-linked, low-density material. The current world record for the lightest aerogel (indeed, the lightest man-made material) was used by NASA on the Mars Pathfinder mission.<sup>44</sup> It will be used to capture particles from comet Wild 2 in 2004. NASA has also used aerogel for thermal insulation on the Mars Pathfinder mission. Aerogels are not limited to silica networks: a porous iron oxide aerogel has been prepared by supercritical drying of ferric solutions treated with propylene oxide.<sup>45</sup>

## 1.40.2 METAL ALKOXIDE PRECURSORS

Sol-gel processing techniques have largely been applied to main group alkoxides, particularly Si and Al, but increasingly studies have dealt with early transition metal elements such as Ti and Zr. The preparation of metal alkoxides has been reviewed extensively.<sup>46-48</sup> Self-condensation of alkoxides can occur, depending on the steric demands of the alkoxide group; for example, Ti methoxide, ethoxide, and isopropoxide are tetrameric, trimeric, and dimeric, respectively,<sup>49</sup> while the zirconium isopropoxide is tetrameric.<sup>50</sup>

The hydrolysis ratio  $h = [H_2O]/[M(OR)_x]$  largely governs the type of condensation reaction that occurs. Three main domains can be said to exist: first, if  $h < 1$  condensation is governed mainly by alcoholation and alkoxolation. Condensation has been shown to occur between well-defined oligomeric units for many transition metal systems with the extent of oligomerization dependent upon the hydrolysis ratio.<sup>46</sup> Gelation and precipitation cannot occur as long as  $h$  is well controlled below unity. The second region  $1 < h < z$  ( $z$  being the charge on the metal atom) is where there is competition between alkoxolation and oxolation. In the third region,  $h > z$ , it is probable that oxolation rather than oxolation dominates. The extent to which hydrolysis occurs is dependent upon the partial charges in the molecule. It is relatively straightforward to hydrolyze the first group, but as the extent of hydrolysis increases so does the positive charge on the OR group, making proton transfer from the attacking water molecule less favorable. Thus, complete hydrolysis to  $TiO_2$  may not occur; instead, only polymer formation is observed.<sup>51,52</sup> Nucleation of nanosized  $TiO_2$  particles occurs instantaneously upon mixing (presumably as all the water is rapidly used up), growth then occurs by nuclei agglomeration, until an explosive precipitation is observed near the end of the induction period.<sup>53</sup>

The relative rates of hydrolysis and condensation help determine the nature of the final product. Use of an acid catalyst allows for the protonation of the OR groups allowing the hydrolysis of all these groups, an outcome which may not be possible in neutral conditions due to the partial charge distribution in partially hydrolyzed alkoxides. Acid catalysis accelerates the rate of hydrolysis but also retards the rate of condensation. It has been shown that by introducing an acid concentration of at least 0.014 mol per mol alkoxide using HCl or  $HNO_3$ , precipitation of titania (caused by fast condensation of hydrolyzed  $Ti(OEt)_4$ ) can be avoided and gels formed. For example, a ratio of 0.075  $HNO_3/Ti$  was used to produce titania gels from  $Ti(O^iPr)_4$ .<sup>54</sup> Finally, it has been discovered that the use of  $Me_4NOH$  as a base leads to control of the phase, size, and shape of  $TiO_2$  nanocrystals.<sup>55</sup>

### 1.40.2.1 Modifiers

Chemical modification of the metal alkoxide precursors can dramatically affect the nature of the final product. Most additives are nucleophilic XOH molecules that react with the alkoxide to give



a different molecular precursor, which will react differently with respect to hydrolysis and condensation by changing the distribution of charge. Modification retards the rate and extent of hydrolysis, reducing the functionality of the hydrolyzed species, thus limiting the degree of condensation. Modification can be performed in several ways. First, mixed alkoxides can be made which have groups which hydrolyze and condense at different rates. Second, metal chloride alkoxides can also be used as gel precursors; for example, it has been shown that niobium chloroalkoxides can lead to gels for niobium whereas the pentachloro and pentaalkoxo species give powders.<sup>56</sup> Third, stable metal alkoxo acetates can be formed by the addition of acetic acid. In general, the coordination number of the metal is increased by nucleophilic addition of the acetate group which is not immediately removed during hydrolysis or condensation.

Diketones such as acetylacetone are also known to stabilize the precursor and increase gelation times for transition metal alkoxides. From light-scattering measurements of the induction time, as little as one in eighty Zr—OR bonds need to react with acac to dramatically reduce the gelation time. It is suggested that the acac ligands segregate to the surface of growing particles.<sup>57</sup> Various carboxylate<sup>58,59</sup> and hydroxyketone<sup>60</sup> adducts of titanium oxo clusters have been reported. Acetate was reported to be useful in preventing metals from segregating when using multinuclear heterometallic alkoxide precursors.<sup>61</sup> Carboxylate ligands do not react completely innocently with alkoxides: they may react with alkoxide to give ester and water, which can lead to hydrolysis and condensation of the original alkoxide.<sup>62</sup> Amino acids can chelate to titanium alkoxide; the glycine derivative is dimeric.<sup>63</sup> Acetonitrile, as a good  $\sigma$ -electron-donating ligand, was used to promote the cross-linking of MoO<sub>3</sub> gels by discouraging the formation of terminal, unreactive Mo=O groups.<sup>64</sup> Besides being excellent colloid stabilizers,<sup>65</sup> diols and polyols have an interesting effect on the products. Polyol iron complexes are “one-pot” precursors to disc-shaped hematite crystals.<sup>66</sup> A diolate complex was prepared as a potential precursor for SrCuO<sub>2</sub>.<sup>67</sup> Use of a tripodal polyol modifier, tris(hydroxymethyl)nitromethane, leads to the isolation of titanium oligomers containing common tetrameric units.<sup>68</sup> Hydrogen peroxide has been used as a chemical modifier to give gels. Peroxide ions are strongly chelating and increase the coordination number of the metal. As the peroxy groups are not removed the functionality of the precursor is somewhat reduced.<sup>69</sup> Modifiers such as peroxide and citrate may lead to the isolation of complexes which are hydrolytically stable.<sup>70</sup> Triethyleneglycol was found to improve the morphology of BaPbO<sub>3</sub> films.<sup>71</sup>

#### 1.40.2.2 Multinuclear Alkoxide Precursors: Homonuclear

There is much interest in the mechanism of hydrolysis in sol–gel reactions and it has long been known that hydrolysis and condensation are not the only reactions that can occur, and that metal alkoxides can be converted to oxo alkoxides by a number of alternative pathways; for example, by the elimination of ether:



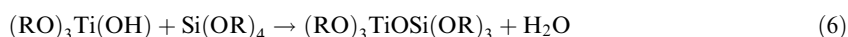
Oxo-alkoxides are partially condensed species and represent a new class of sol–gel precursors. These species are oligomeric and can be either homometallic or heterometallic. In many cases the oxo bridges produced in these compounds are multiply bridging, in order to achieve the most favored coordination number of six for metal atoms in alkoxide species. Isolation of compounds with similar multiply bridging oxygen atoms has been observed by the reaction of metals with the appropriate phenol or alcohol, with, in some cases, reaction with solvent molecules producing compounds quite different from the simple binary alkoxides expected.<sup>72</sup> Besides isolation of intermediates, it is also possible to monitor the reactions by NMR and mass spectrometry.<sup>73</sup>

As observed for the simple alkoxide system, the nature of the solvent used has consequences for the final product obtained. It was found that in reactions between Sn(O-<sup>t</sup>Bu)<sub>4</sub> and Sn(OAc)<sub>4</sub> (or Me<sub>3</sub>SiOAc) in a refluxing hydrocarbon solvent, elimination of tert-butyl acetate occurs resulting in Sn—O—Sn and Sn—O—Si derivatives. This ester elimination is thought to arise from a mechanism similar to acid-catalyzed esterification in which the coordinatively unsaturated tin atom acts as a Lewis acid facilitating transfer of an alkoxide group onto an acetate carbonyl carbon.<sup>74</sup> The kinetics of alcohol interchange have also been measured for tin butoxide by magnetization transfer experiments.<sup>75</sup> If a coordinating solvent such as pyridine or the parent alcohol is used, the rate of ester formation is reduced dramatically and it was found that with no vacant coordination sites precursors remain monomeric, ligand exchange being the only process observed.

Both homometallic and heterometallic oxo-alkoxides can be produced by partial hydrolysis of metal alkoxide precursors via dehydroxylation and dealkoxolation of metal hydroxo alkoxides. The crystal structures of a number of polynuclear titanium oxo alkoxides have been elucidated, these structures having evolved during the slow addition of small amounts of water to  $\text{Ti}(\text{OEt})_4$ .<sup>47,48,76-79</sup>

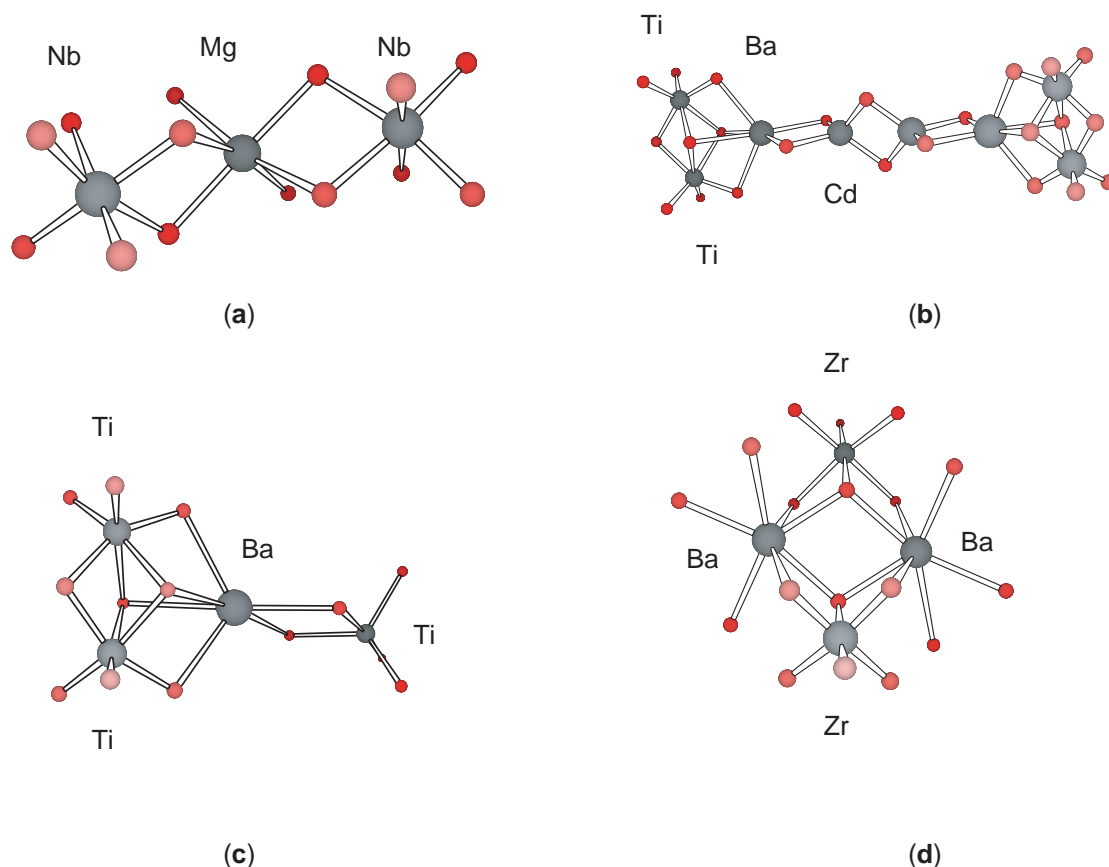
### 1.40.2.3 Multinuclear Alkoxide Precursors: Heteronuclear

One major problem in producing gels containing homogeneous mixtures of a variety of oxides is that the precursors may not all hydrolyze at the same rate. In particular, transition metal alkoxides hydrolyze much more rapidly than silicon alkoxides. The controlled hydrolysis of low-molecular-weight homometallic species described in the previous section can be adapted to prepare mixed alkoxides. For example, pre-hydrolysis of metal alkoxide followed by reaction with the silicon alkoxide gives a mixed dimeric species such as:



A variety of related compounds, such as  $\text{M}(\text{OSi}(\text{OR})_3)_4$  ( $\text{M} = \text{Hf}$  and  $\text{Zr}$ ) species has recently been studied, and some have been found to form stable aqua adducts below  $10^\circ\text{C}$ .<sup>80-82</sup> Another example is the barium titanate precursor,  $\text{Ba}_2\text{Ti}_2(\text{acac})_4(\text{OEt})_8$ .<sup>83</sup>

Single metal and mixed metal oxo alkoxides can also be prepared by reaction between metal halides, oxy halides, and alkali metal alkoxides.<sup>47,48</sup> One of the first to be structurally characterized was a series of mixed Cd or Sn containing zirconium, tin, and titanium alkoxides.<sup>84,85</sup> These and other examples are shown in skeletal form in Figure 3.



**Figure 3** Skeletal structures (only metal and oxygen atoms shown) of some heteronuclear metal alkoxides: (a)  $\text{MgNb}_2(\mu\text{-OAc})_2(\mu\text{-OPr}^i)_4(\text{OPr}^i)_6$ ; (b)  $[\{\text{Cd}(\text{OPr}^i)_3\}\text{Ba}\{\text{Ti}_2(\text{OPr}^i)_9\}]_2$ ; (c)  $\{\text{Ti}_2(\text{OPr}^i)_9\}\text{Ba}\{\text{Ti}_2(\text{OPr}^i)_5\}$ ; (d)  $[\text{BaZr}(\text{OH})(\text{OPr}^i)_5(\text{Pr}^i\text{OH})_3]_2$ .

Another example is the mixed sodium/iron oxoalkoxide  $\text{Na}_2\text{Fe}_6\text{O}(\text{OMe})_{18}$ , which is prepared by reaction of a suspension of anhydrous  $\text{FeCl}_3$  in methanol with an excess of  $2\text{M NaOMe}$ .<sup>89</sup> Complexes of formula  $\text{MNb}_2(\mu\text{OAc})_2(\mu\text{OPr}^i)_4(\text{OPr}^i)_6$  ( $\text{M} = \text{Mg, Ba, Pb, Zn, Cd}$ ) were isolated from solutions of niobium alkoxide and the acetates.<sup>54</sup> Hydrolysis pathways of  $\text{MSb}_4(\text{OEt})_{16}$  ( $\text{M} = \text{Mn, Ni}$ ) have been compared.<sup>90</sup> Various mixed Ba/Mg/Ta mixed alkoxides were identified using NMR and MS techniques.<sup>91</sup>

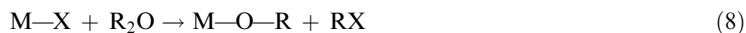
It is also possible to incorporate fluoride dopant atoms into the precursor. Specially synthesized trialkynyl(fluoroorgano)tin compounds were hydrolyzed to soluble oligomers, which were thermally decomposed to fluoride-doped  $\text{SnO}_2$  for use as optically transparent conducting films.<sup>92,93</sup>

#### 1.40.2.4 Non-hydrolytic Condensation of Alkoxides<sup>3,94</sup>

Silica can also be obtained by reaction of silicon tetrachloride and some tetraalkoxysilanes in sealed vials:



The mechanism is thought to involve coordination of the oxygen atom of an alkoxy group to silicon tetrachloride followed by nucleophilic attack of a halogen at the carbon center of the alkoxy group, resulting in a monolithic gel. The process depends on the ability of the O—R bond to split and is hence governed by the nature of the carbon group and the halide involved. Likewise, condensation between metal acetates and alkoxides and even metal halides themselves, via etherolysis (Equation (8)) and non-hydrolytic condensation, also allows the formation of gels. Corriu *et al.* applied these techniques to producing gels of  $\text{Al}_2\text{O}_3$  and  $\text{TiO}_2$  with gels times ranging from twenty hours for the former to eight days for the latter.<sup>95,96</sup>



It is in the production of mixed metal oxides that non-hydrolytic techniques are most useful. In ordinary hydrolytic sol-gel processing of mixed metal oxides the different reactivities of the precursors involved can lead to homocondensation and thus problems in obtaining homogenous gels. This problem is generally overcome by synthesizing mixed alkoxide precursors or by prehydrolyzing the less reactive precursor to make it more reactive, but in many cases the hydrolytic reactions are in part reversible and homocondensation can still occur. In the case of non-hydrolytic processing, the by-product of a reaction is an alkyl halide or an ester, the nucleophilic character of which is virtually non-existent. Reactions are not reversible, and even if they were the by-product is often volatile enough to be removed during the reaction. Work on production of mixed oxides has not yet been widely reported, as the field is relatively new, but to date zirconium titanate gels have been synthesized.<sup>97</sup>

#### 1.40.2.5 Thiols and Non-oxide Gels

“Thiol” sol-gel processes are known.<sup>98–100</sup> Titanium thiolate complexes react with  $\text{H}_2\text{S}$  at room temperature to form a precipitate which on annealing at  $800^\circ\text{C}$  yields  $\text{TiS}_2$ .<sup>101</sup> It is also possible to prepare gels from purely organic materials and from coordination complexes such as cyanide. Chiral organic gelator molecules can give rise to helical tubular structures.<sup>102</sup> As an example of the cyanide gels, the reaction of  $\text{K}_2\text{PdCl}_4$  and  $\text{K}_3[\text{Co}(\text{CN})_6]$  results in gels containing 95% water by weight. Sintering in the absence of oxygen gives PdCo ferromagnetic alloys, while under oxygen the oxide  $\text{PbCoO}_2$  is produced.<sup>103</sup>

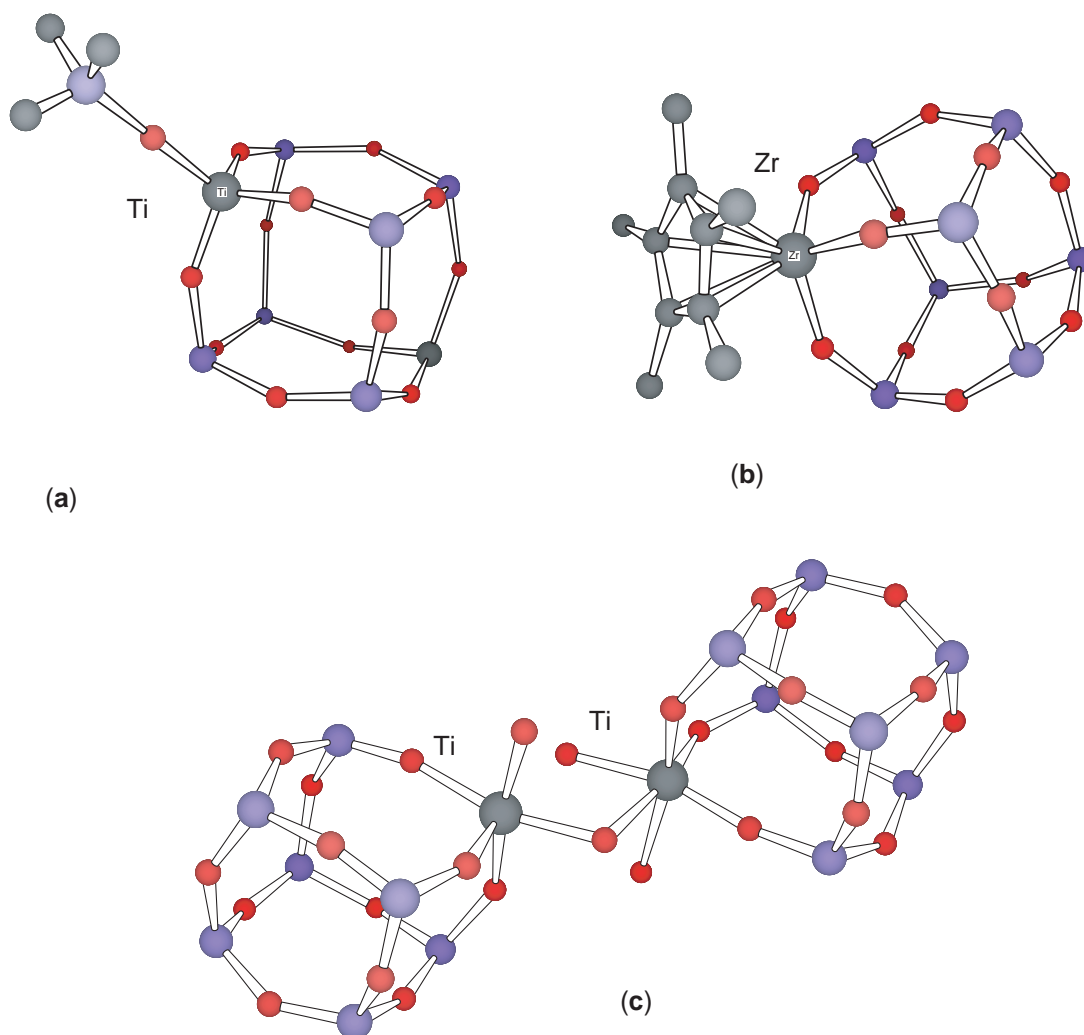
### 1.40.3 ORGANIC-INORGANIC HYBRID MATERIALS

The low-temperature nature of the sol-gel process lends itself well to the entrapment of organic materials (dyes, polymers, redox reagents) and biomolecules (enzymes, proteins, antibodies, whole cells) which are immobilized inside an inorganic matrix. This opens up a whole new class of materials with unique properties. This rapidly growing topic has been extensively reviewed in the

past,<sup>104–111</sup> and, in addition, a specialized review has appeared on the applications of these materials in electrochemistry.<sup>112</sup>

#### 1.40.3.1 Alkyltrialkoxysilanes and Silasesquioxanes

The hydrolysis of trialkoxysilanes has been reviewed by Corriu *et al.*<sup>113,114</sup> A study of substituent effects on the polymerization of these monomers concluded that phase separation was a major problem even with short-chain alkyl groups.<sup>115</sup> The polymerization of alkyltrialkoxysilanes with rigid linking groups, e.g.,  $(OR)_3Si-C_6H_4-Si(OR)_3$  has been investigated, particularly the effects of aging of the cross-linked polymer gels.<sup>116</sup> Coatings were prepared from TMOS and *N*-(3-triethoxysilylpropyl)-2,4-dinitrophenylamine, and tested for second-harmonic generation.<sup>117</sup> Hydrophobic aerogels have been prepared as oil-spill clean-up materials.<sup>118</sup> Trialkoxysilanes can be hydrolyzed to monomeric, dimeric, or cyclotrimeric silanols within Pd coordination cages of increasing size.<sup>119</sup> There is also a great deal of interest in the so-called polyhedral oligosilasesquioxanes (POSS) molecules which can be generated in high yield from the hydrolysis of alkyltrialkoxysilanes.<sup>120,121</sup> For example, the corner may be removed from one or more of the corners of the octameric cubic POSS in order to coordinate to metals (Figure 4).



**Figure 4** Transition metal polyhedral oligosilasesquioxane (POSS) derivatives (skeletal bonds only shown): (a)  $[(c\text{-hexyl})_7Si_8O_{12}]TiOSiMe_3$ ,<sup>122</sup> (b)  $[(c\text{-hexyl})_7Si_8O_{12}]Zr(C_5Me_5)$ ,<sup>123</sup> (c)  $[(c\text{-hexyl})_7Si_8O_{12}]_2Ti_2(OPr^i)_2(MeOH)_2$ .<sup>124</sup>

### 1.40.3.2 Doping with Dyes

Work on using entrapped dyes as sensors or nonlinear optical devices has been reviewed according to whether the sensing elements were films<sup>125</sup> or optical fibers.<sup>126</sup> Sol-gel matrices offer the advantages of being optically transparent with good thermal and mechanical stability, and the isolation of the dye prevents aggregation which can quench the fluorescence. Sol-gel-prepared TiO<sub>2</sub> was used as a host for iron porphyrin probe molecules to detect cyanide.<sup>127</sup> Porphyrins have also been doped into vanadia xerogels.<sup>128</sup>

Dyes can also act as optical probes of the nature of the environment within the sol-gel material, for example, as a pH indicator.<sup>129</sup> In a review of fluorescence probe spectroscopy techniques, four types of environment were identified: solvent inside the pores; the interface region between the solvent and the pore wall; the pore wall; and the constraining region, i.e., pockets in the pore wall of molecular dimension.<sup>130</sup> Perhaps the most informative technique is fluorescence depolarization due to Brownian rotation of the molecular probe.<sup>28</sup> The amount of depolarization is related to the local mobility of the probe. The intensity of the emission from Eu<sup>3+</sup> in TiO<sub>2</sub> gels is extremely sensitive to the number of water molecules present in the local environment.<sup>131</sup> Emission from a Tb<sup>3+</sup>-cyclodextrin complex immobilized in a sol-gel matrix was triggered by the sensing of a biphenyl guest within the cyclodextrin.<sup>132</sup>

Ferrocene doping provides an electrochemical probe of the material during gelation, reporting in particular on the mobility of the probe as measured by the diffusion coefficient.<sup>133,134</sup> If necessary the sol-gel material can be loaded with carbon powder to confer electrical conductivity (composite ceramic carbon electrodes, CCEs).<sup>135</sup> Single-walled nanotubes in vanadia aerogels exhibit high capacities for lithium intercalation.<sup>136</sup>

### 1.40.3.3 Doping with Biomolecules

There are many examples of the immobilization of biomolecules within sol-gels, including active enzymes such as yeast alcohol dehydrogenase,<sup>137</sup> and even whole cells.<sup>138</sup> A fuller discussion of this topic lies outside the scope of this review and readers are referred to recent reviews on this topic.<sup>139,140</sup> Sol-gel-derived silica as an alternative to the usual polymer encapsulation has the following advantages that help to maintain the activity of the biomolecule: improved mechanical strength; resistant to swelling in solvents, preventing leaching; non-toxic and biologically inert; chemical modification of the biomolecule is not necessary. The two-step sol-gel process is usually used to prevent exposure of the biomolecules to acid and alcohol: pre-hydrolysis of the alkoxide in acidic alcohol is followed by condensation in pH 7 buffer in the presence of the biomolecule. A popular, cheap, and robust enzyme for study is glucose oxidase, with the aim of preparing glucose sensors. The glucose concentration is measured indirectly through the consumption of oxygen (as measured by a silver anode,<sup>141</sup> or by the quenching of Ru complex fluorescence<sup>142</sup>), or by the optical detection of dye which is oxidized by hydrogen peroxide, the product of the glucose oxidase reaction.<sup>143</sup> Alternatively, the oxygen substrate for the enzyme is replaced by a direct ferrocene mediator which is electrochemically detected.<sup>144</sup>

Immunoassay sensors may be prepared by encapsulating antibodies into the sol-gel matrix. The antibodies must first be produced by mice in response to a protein derivatized with the target analyte, such as pesticide or nitroaromatic compounds.<sup>145</sup> The binding of the analyte is usually quantified using the standard enzyme-linked immunosorbent assay (ELISA), but sometimes direct optical or electrochemical detection is possible. Conversely, antibodies present in human blood may be detected by immobilizing pathogen whole cells which produce antigens.<sup>146</sup> The enormous binding constants of antibodies to antigens are exploited in affinity chromatography. Where the confines of the sol-gel matrix are too constrictive for accessibility to the entrapped biomolecules, the sol-gel is deposited as a layer on top of glass fibers.<sup>147,148</sup>

### 1.40.3.4 Doping with Polymers

Polydimethylsiloxane and Zr oxo species have been reacted to give hybrid materials which were characterized by solid-state NMR.<sup>149</sup> TEOS/PEG (polyethylene glycol) materials are biphasic systems. The materials were studied by <sup>13</sup>C NMR, EPR, and thermal analysis.<sup>150</sup> Other systems studied include titania/polyvinylacetate,<sup>151</sup> titania/PEG,<sup>152</sup> silica/polyacrylates,<sup>153</sup> polyimide/silica,<sup>154-156</sup> linseed oil alkyds/titania,<sup>157</sup> and PVC/titania and vanadia/sulfonated polyaniline



for batteries.<sup>158</sup> Polymers may be involved in the nucleation process and may emerge as intercalates in the final inorganic layered material. Polymers may also influence the final structure in a way similar to surfactants template materials through ionic, hydrophobic/hydrophilic, or other interactions (see next section).

It is hoped that polymerizable titanium acrylate-alkoxide monomers may lead to self-cleaning coatings.<sup>159</sup> Entrapped pyrrole groups have been electropolymerized within sol-gel electrode coatings.<sup>160</sup> Solid-state NMR is a good technique for characterizing these hybrid materials.<sup>161</sup> Alternatively, the alkoxide may be modified with a polymerizable ligand. Examples include methacrylate,<sup>162</sup> acrylamide and acid anhydride<sup>163</sup> derivatives. The polymerization of citrate complexes with diols to give a polyester—the Pecchini route—is a well-known method for isolating metal centers.<sup>164</sup>

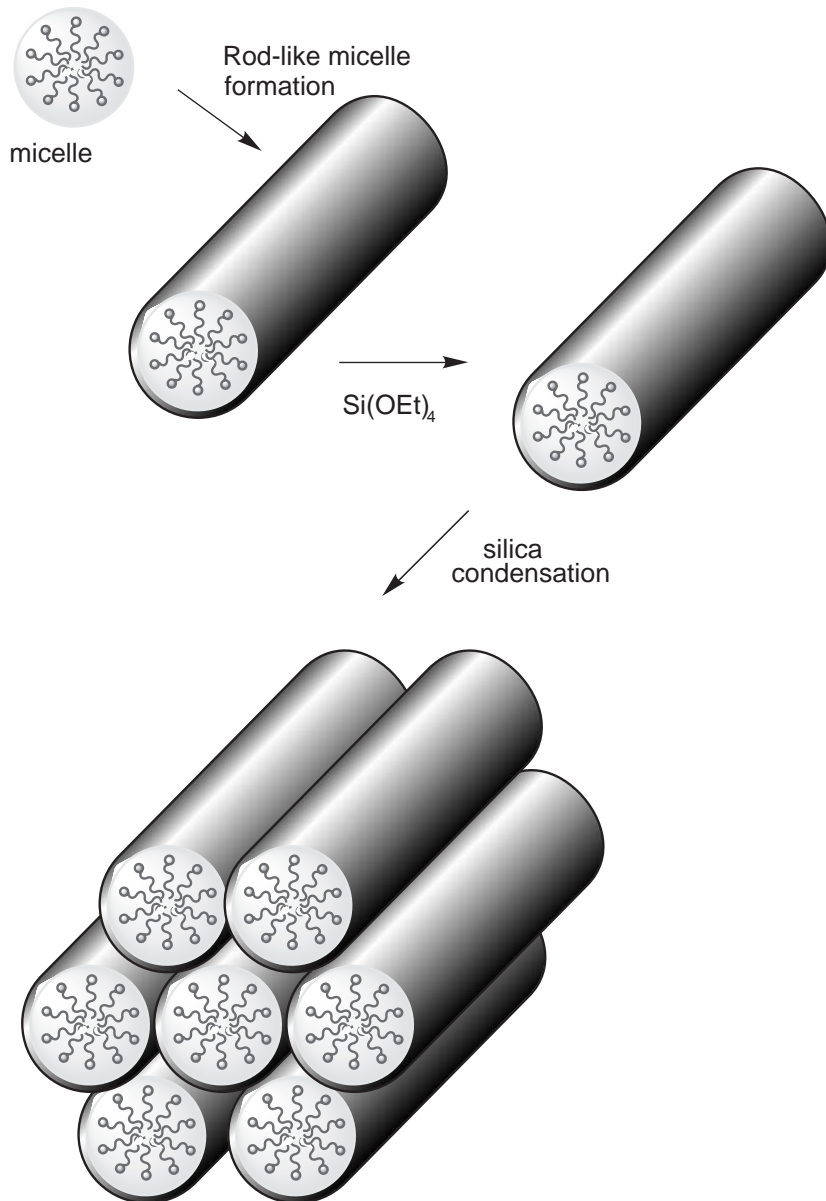
#### 1.40.3.5 Templating of Sol-Gel Materials

Perhaps the most significant development in sol-gel processing in recent years has been the exploration of the use of organic templates to influence the final morphology and, in particular, porosity, of the final oxide material. The motivation here is to prepare mesoporous materials for applications in catalysis, separations, and sensors. In addition, the field has been influenced by the desire to reproduce the extraordinarily varied and fascinating silicate and other structures observed in natural objects, memorably catalogued by Darcy Wentworth Thompson of your reviewer's university.<sup>165</sup> More recently, several inspirational reviews on the possibilities of biomimetic synthesis have appeared.<sup>166–170</sup> The role of sol-gel chemistry in this area has been reviewed.<sup>171,172</sup> Many of the advances have been made using the micellar or lyotropic liquid crystalline phases of surfactants to template the growing sol-gel structure (Figure 5).<sup>173</sup>

This idea arose out of the well-known work on the templating of mesoporous inorganic solids such as zeolites using hydrothermal synthesis techniques.<sup>174,175</sup> However, in certain cases the growing oxide network perturbs the surfactant template resulting in orderings of much longer length scales than expected.<sup>166</sup> Nevertheless, some spectacular molecular templated structures have been observed, such as spiral structures using chiral surfactant templates,<sup>171</sup> cratered spherical particles from aluminum phosphonate surfactant templates,<sup>170</sup> and Archimedean screws, from silica templated with CTACl (cetyltrimethylammonium chloride).<sup>170</sup> Some applications of these materials are being tested, for example, the templating of silica with oligoethyleneoxide surfactant complexed with lithium triflate produces a lithium ion conducting material.<sup>176</sup> Polymer fibers may be grown in the pores, then released by dissolving away the silica with HF.<sup>177</sup> The surfactant may be covalently attached to the sol-gel monomer, as in a stearate complex of titanium alkoxide.<sup>178</sup> Alternatively, the association with the surfactant may simply be ionic. Thus, the glycolate anions of silicon<sup>179</sup> and titanium<sup>180</sup> have been hydrolyzed in the presence of cationic surfactants to give lamellar structures. Block copolymers, which are the macromolecular equivalents of surfactants, possessing both hydrophobic and hydrophilic regions, may be used as an alternative to surfactants.<sup>181–183</sup>

It might be desirable to include organic groups into the walls of the templated silicate materials for various sensor and catalytic applications.<sup>184</sup> Although no reports have emerged using trialkoxysilanes, perhaps because these networks collapse, several groups have reported on the use of bridged bis(trialkoxo)silanes, perhaps because these monomers form more highly cross-linked products after hydrolysis. Thus a two-step acid-catalyzed hydrolysis followed by the base-catalyzed condensation of an ethene-bridged monomer in the presence of the surfactant CTAB, followed by solvent extraction of the surfactant, leads to microporous materials with XRD evidence for pores arising from the hexagonal structure of the surfactant mesophase. Interestingly, the ethene groups embedded in the structure were reactive towards bromine addition.<sup>185</sup> Dyes have been placed deliberately in the framework and at the interfaces of these microporous materials.<sup>186</sup>

One of the most recent trends is to use “nanobuilding blocks,” or “crystal tectonics.”<sup>106,187,188</sup> The idea is to use a pre-formed inorganic fragment with the desired porous or catalytic properties which is then simply immobilized into a matrix, as, for example, in POSS or titanium alkoxide fragments.<sup>189</sup> Alternatively, the fragment may be coordinated to the surfactant template.<sup>189,190</sup> Incorporation of metallocene catalyst-terminated silanol dendrimers into silica was achieved through sol-gel processing methods.<sup>191</sup>



**Figure 5** Templating of sol-gel silicate materials using surfactants.

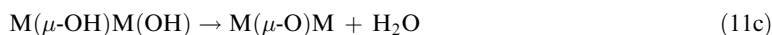
#### 1.40.4 AQUEOUS COLLOIDAL PRECURSORS: CONDENSATION

The formation of gels of metal oxides from aqueous solutions is less straightforward than for metal alkoxides but the relative ease and low cost of the process has sustained interest in these routes. As shown earlier the nature of the metal and the pH of the solution affect the nature of the ligand bound to a metal center and this will affect the condensation pathway. For low valent metals at low or intermediate pH the aqua ion tends to be a mixed hydroxo-aquo species with the principal method of condensation being olation (Equation (3b)). The mechanism is fundamentally nucleophilic substitution, in which  $M-OH$  is the nucleophile and  $H_2O$  the leaving group. Doubly or triply bridging OH bridges, as well as  $M(\mu-OH)_2M$  and  $M(\mu-OH)_3M$  bridges can be formed after condensation. In all cases an aquo ligand must be removed and the rate of reaction thus depends upon the charge, size, electronegativity, and electronic configuration of the  $M-OH_2$  bond.

Oxolation occurs in aqueous solutions when there is no coordinated aquo group; i.e., either in higher valent metals or in solutions at higher pH. Two basic oxolation mechanisms exist. First, if the metal coordination is not fully satisfied then rapid nucleophilic addition can occur in order to achieve saturation (Equation (11a)).



If the metal coordination is fully satisfied a two-step mechanism involving nucleophilic addition of an OH group leading to an unstable M—OH—M bond followed by  $\beta$ -elimination of a water molecule (Equations (11b) and (11c)).



The first step in this mechanism is catalyzed by base which can remove a proton from the attacking M—OH group to give a highly nucleophilic M—O<sup>-</sup> group. Conversely, the second step can be acid catalyzed since OH groups bound to the unstable intermediate can be protonated, facilitating the elimination of the leaving group.

Livage and co-workers attempted to explain the nature of precursors in aqueous solution.<sup>192</sup> The number of each hydroxo, oxo, or aqua ligands attached to the metal center is obviously dependent upon both the charge on the metal and on the pH of the solution (Figure 6).

The relative ratios of these different ligands affects the reactivity of the precursor; for example, the condensation mechanisms require the presence of at least one M—OH group. The partial charge model (PCM) allows calculation of the partial charge distribution within a complex and thus a measure of its propensity to hydrolysis and condensation can be determined. Thus, a high partial charge on the metal coupled with a high positive partial charge on a water ligand leads to hydrolysis to MOH groups. If the partial charge on a coordinated OH group is negative then it will participate in condensation reactions. The PCM model has been used recently to rationalize the condensation of vanadium phosphate species.<sup>193,194</sup>

Livage has also shown that it is possible to construct plausible and interesting speculations on the occurrence of different species in solution.<sup>195</sup> For example, a trivalent metal condensation of a fourth octahedron to a trimeric species may occur in one of two ways (Figure 7). It may add to give a “closed” tetramer  $[\text{M}_4\text{O}(\text{OH})_5(\text{OH}_2)_{10}]^{5+}$  containing four  $\mu_2$ -OH species and one  $\mu_4$ -O or the “open” tetramer  $[\text{M}_4(\text{OH})_6(\text{OH}_2)_{10}]^{6+}$  containing two  $\mu_3$ -OH species (one above and one below the plane) and four  $\mu_2$ -OH groups. The former is dominant if O  $p\pi$ -M $p\pi$  donation is favored as in Al<sup>3+</sup>, leading to puckered oxide sheets in boehmite ( $\gamma$ -AlO(OH)). In contrast, high-spin iron(III) does not favor O  $p\pi$ -M $p\pi$  donation and leads to the open tetramer and planar sheets in goethite ( $\alpha$ -FeO(OH)).

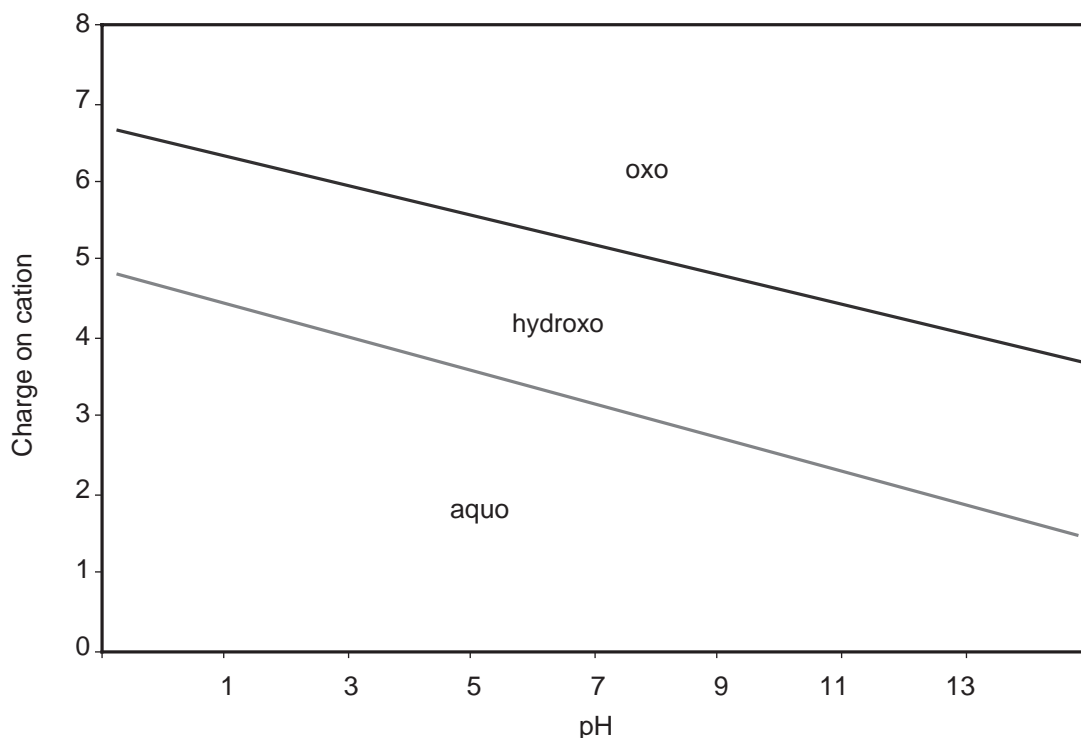
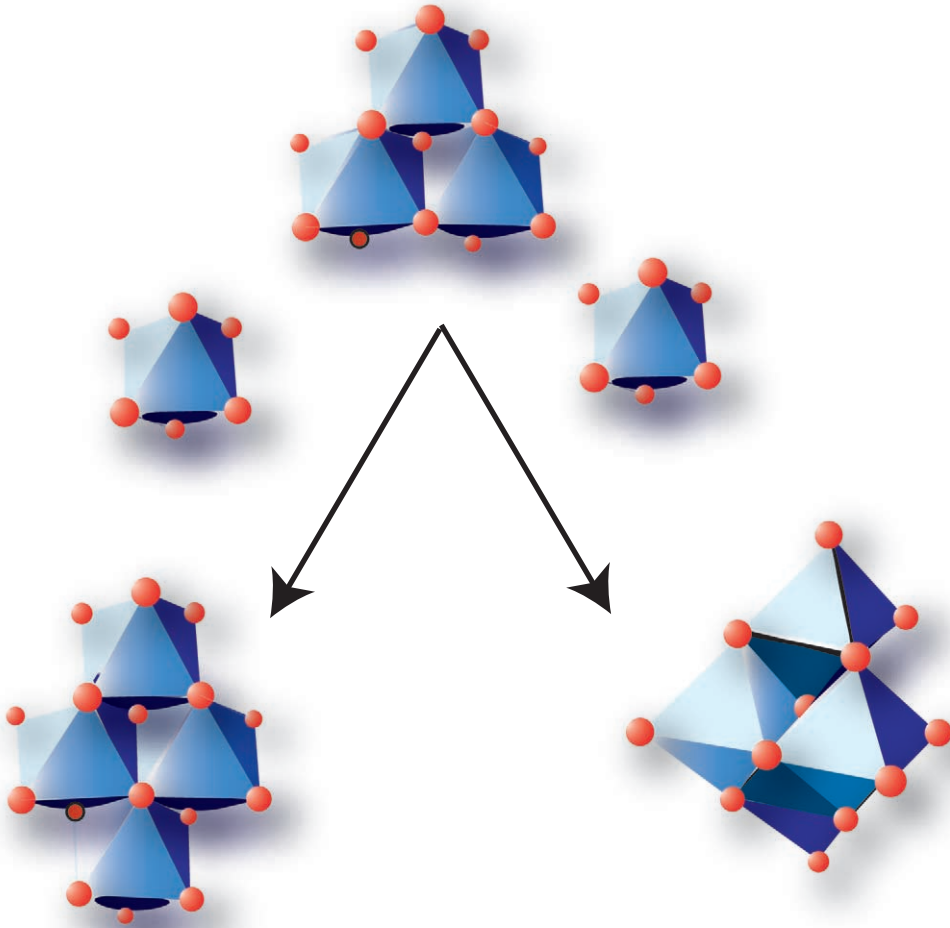


Figure 6 Charge vs. pH diagram indicating the aqua, hydroxo, and oxo domains.





**Figure 7** Schematic diagram showing two possible ways of condensing four octahedra.

It has been shown from PCM calculations that the nature of the counterion is of importance, since, at certain pH values, these counterions will become bound to the metal, affecting its reactivity. For example, tantalum oxide is stabilized in the presence of oxalate.<sup>196,197</sup> The counterion can also compete for protons with the metal aqua species and thus affect whether the metal has bound aquo, hydroxo, or oxo ligands.

Crystal field effects must also be considered in colloidal sol-gel processing: gels of cobalt(III), a  $d^6$  low-spin species, can be made easily from cobalt sulfate, chloride, nitrate, or acetate whereas iron(III) tends to give gelatinous precipitates due to rapid olation arising from the labile  $d^5$  high-spin electron configuration. Gels of tetravalent metals are also hard to obtain due to rapid olation. This problem has been overcome for manganese(IV) oxides by using reduction routes from  $\text{KMnO}_4$ . Thus, gels of birnessite<sup>198</sup> ( $\text{K}_{0.28}\text{MnO}_{1.96}$ ) and cryptomelane ( $\text{K}_{0.125}\text{MnO}_2(\text{H}_2\text{O})_{0.09}$ )<sup>199</sup> are obtained by addition of solutions of  $\text{KMnO}_4$  to concentrated solutions of glucose or sucrose and fumaric acid, respectively. Extraction of potassium ions can be achieved by soaking the gels in solutions of potassium nitrate to leave gels of manganese dioxide. Birnessite has potential catalytic applications and has been produced cheaply by reduction of  $\text{KMnO}_4$  with solutions of sucrose, gelation occurring within thirty seconds.<sup>200–202</sup> Reduced oxides of V, Cr, Fe, Mo, and W have been prepared from the ammonium  $\text{MO}_4^-$  salts in the presence of aqueous hydroxylamine hydrochloride.<sup>203</sup>

For higher valent oxides such as vanadium and tungsten, the charge on the compact polyanions can prevent condensation. Acidification via ion-exchange chromatography is then required to sufficiently neutralize the species involved to allow the formation of a solid phase. Vanadium precursors possess bound water molecules allowing condensation by both olation and

oxolation.<sup>204,205</sup> Tungsten, on the other hand, can only condense via oxolation as the high charge on the metal center allows only the formation of hydroxo groups.<sup>206</sup>

#### 1.40.5 EXAMPLES OF SOL-GEL SYNTHESSES IN CATALYSIS, ELECTROCERAMICS, ELECTROCHROMICS, AND BIOMATERIALS

The use of sol-gel processing techniques has become extremely important in the production of advanced oxide materials with desirable catalytic, electrical, or optical properties. The variety and flexibility of the sol-gel techniques available allows for tailoring of materials with very specific properties. For example, high-surface-area nanocrystalline oxide powders are important in catalysis. The production of vanadia-silica aerogels by sol-gel processing followed by supercritical drying gives a high-surface-area material highly desired for its use as a heterogeneous catalyst.<sup>207</sup> Nanocrystalline titania supports are used in dye-sensitized solar cells.<sup>208-210</sup> Titania containing iron gives nanocrystalline ilmenite ( $\text{FeTiO}_3$ ) which is used in the photomineralization of waste.<sup>211</sup> Chromium oxide gels are effective catalysts for the high-temperature shift reactions.<sup>212</sup> The preparation of vanadium oxidation catalysts has been extensively studied by techniques including  $^{51}\text{V}$  NMR.<sup>213-215</sup> There is  $^{17}\text{O}$  NMR evidence for the presence in these gels of a chain polymer of repeat unit  $\text{VO}_2(\text{OH})(\text{OH}_2)_2$ .<sup>216</sup> Otherwise, there are few examples of the use of  $^{17}\text{O}$  NMR for structural investigations, which is surprising as doubly and triply bridging oxygens are readily identified, as in studies of titanium alkoxide hydrolysis.<sup>52,217,218</sup> FT-Raman is also an excellent technique for studying colloids, such as titania,<sup>59</sup> and has also been applied to the study of aging of aluminum alkoxide gels.<sup>219</sup> Steam-reforming  $\text{CuH}$  and  $\text{Mn}$ -substituted barium hexaaluminate catalysts may be prepared by sol-gel processing of the alkoxides.<sup>220</sup> Lanthanum oxide is a good catalyst for methane coupling and can be prepared by hydrolysis and condensation of lanthanum isopropoxide.<sup>54</sup> A variety of mixed samarium-zirconium/niobium isopropoxide precursors has been prepared.<sup>221</sup>

The discovery of high- $T_c$  superconductors in the late 1980s led to the need to produce homogeneous and high-purity complex metal oxide species, a need that could be met by the use of sol-gel techniques. The first sol-gel routes to yttrium barium copper oxide (YBCO) involved coprecipitation,<sup>222</sup> but latterly, routes based on the hydrolysis and condensation of yttrium and barium alkoxides with copper methoxyethoxide have been developed. It is found that the hydrolysis ratio used in the production of the gel can affect the temperature of the onset of  $T_c$  and the sharpness of the transition to superconductivity.<sup>223</sup>

Titanate materials, important as sensors, capacitors, and ferroelectric materials, once required the use of very high temperatures, leading to coarse, inhomogeneous materials with poor electrical properties due to impurities. Nowadays, lead titanate can be simply prepared from mixtures of lead acetate and titanium alkoxides by sol-gel processing,<sup>37</sup> and a simple mixed alkoxide of barium and titanium has been reported allowing the preparation of homogeneous gels with the correct stoichiometry.<sup>224,225</sup> The so-called "oxide one-pot synthesis" (OOPS) method for producing a multi-metal precursor is popular for titanates and related materials.<sup>226-228</sup> Lithium niobates are also used as ferroelectric materials and are prepared from  $\text{Li}(\text{Nb}(\text{OC}_2\text{H}_5)_6)$  or from niobium ethoxide and lithium nitrate.<sup>229</sup> The sol-gel process does not always lead to a homogeneously mixed product, as found in the preparation of  $\text{Pb}(\text{Zr}_{0.5}\text{Ti}_{0.5})\text{O}_3$  samples.<sup>230</sup> Deposition of metallic lead occurred before the desired  $\text{PbMgNbO}_3$  phase formation using a sol-gel precursor.<sup>231</sup>

There is much interest in electrochromic materials for use in smart windows, mirrors, or even sunglasses. Such materials are generally amorphous, to allow for good ionic conductivity, and so low-temperature routes such as sol-gel processing are inexpensive and effective. Vanadium and tungsten oxides are potential electrochromic materials; sol-gel routes to these materials have been extensively explored. Different vanadium oxide materials are produced from vanadium alkoxides depending on the hydrolysis ratio.<sup>205,232</sup> Electrochromic films of  $\text{Nb}_2\text{O}_5$  may be prepared using sol-gel techniques.<sup>56</sup> A comparison of classical and sol-gel routes to layered  $\text{MnO}_2$  electrodes has shown that the sol-gel materials have superior electrochemical characteristics.<sup>233,234</sup> The properties of aerogel transition metal oxides for electrochemical reactions has been highlighted, in particular for capacitors and fuel cell electrodes.<sup>7</sup> Very high Li capacities have been observed for sol-gel-derived pure vanadia<sup>235</sup> and iron/vanadia electrodes.<sup>236</sup>

Finally, sol-gel processing is widely used in the exploration of methods to prepare biomaterials; for example, hydroxyapatite prepared from triethyl phosphite and calcium salts.<sup>237,238</sup> Phosphate sol-gel synthesis is more difficult than for silicates since phosphoric esters are very difficult to hydrolyze.<sup>239</sup>

The low temperatures used in sol-gel synthesis open up the possibility of preparing hydroxyapatite/polymer biomaterials with the combination of high-mechanical strength and light weight.

### 1.40.6 CONCLUSIONS

Sol-gel chemistry has matured into a highly diverse and active field. Due to the high cost of the precursor alkoxides it is not the technique of choice for preparing bulk quantities of single-component oxide unless very high purity or amorphous oxide is required. However, it is ideally suited to preparing multi-element, or multi-component specialist oxides. Catalysis and membrane separations make use of the high-surface areas and controlled porosity of sol-gel catalysts and supports. Aerogels prepared by sol-gel processing are the least dense solid materials known to man and find applications in thermal and sound insulation, as well as space exploration. Advanced multimetallic oxide electroceramics, such as high- $T_c$  superconductors, critically demand high purity and phase homogeneity. The electronic properties of sol-gel-processed electroceramics seem to be superior to those prepared by other methods. In the area of coatings, including electroactive coatings, the convenience of the sol-gel method for application of the coating is attractive. The amorphous nature of the sol-gel coating is also desirable where ionic transport is required. In the face of all these practical applications, there is still plenty of scope for further study of the reaction mechanisms, and the development of new precursors, particularly for multi-component oxides.

However, the main growth areas appear to be in preparing organic/inorganic hybrid materials in which an organic or biological species is entrapped in an oxide matrix. Here, the low-temperature nature of sol-gel processing is exploited in the most imaginative ways. The excellent optical and isolating properties of the sol-gel matrix are useful in the entrapment of dyes for laser applications and enzymes for sensor applications. Biomolecules such as enzymes and antibodies are immobilized for synthetic and sensor applications. And, most excitingly, templated sol-gel materials offer the sort of control of morphology and pore structure of amorphous oxides that until now has only been observed in the biological world.

### 1.40.7 REFERENCES

1. Brinker, C. J.; Scherer, G. W. *Sol-Gel Science: The Physics and Chemistry of Sol-Gel Processing*; Academic Press: London, 1990.
2. Gopalakrishnan, J. *Chem. Mater.* **1995**, *7*, 1265–1275.
3. Corriu, R. J. P.; Leclercq, D. *Comments Inorg. Chem.* **1997**, *19*, 245–262.
4. Lee, G. R.; Crayston, J. A. *Adv. Mater.* **1993**, *5*, 434–442.
5. Ying, J. Y.; Sun, T. J. *Electroceram.* **1997**, *1*, 219–238.
6. Livage, J.; Ganguli, D. *Sol. Energy Mater. Sol. Cells* **2001**, *68*, 365–381.
7. Rolison, D. R.; Dunn, B. J. *Mater. Chem.* **2001**, *11*, 963–980.
8. Manthiram, A.; Kim, J. *Chem. Mater.* **1998**, *10*, 2895–2909.
9. Dunn, B.; Farrington, G. C.; Katz, B. *Solid State Ion.* **1994**, *70*, 3–10.
10. Levy, D.; Esquivias, L. *Adv. Mater.* **1995**, *7*, 120–129.
11. Chen, D. G. *Sol. Energy Mater. Sol. Cells*, **2001**, *68*, 313–336.
12. Bendor, L. *Heterogeneous Chem. Rev.* **1995**, *2*, 41–50.
13. Miller, J. B.; Ko, E. I. *Catal. Today* **1997**, *35*, 269–292.
14. Narendar, Y.; Messing, G. L. *Catal. Today* **1997**, *35*, 247–268.
15. Ward, D. I.; Ho, E. I. *Ind. Eng. Chem. Res.* **1995**, *34*, 421–433.
16. Schneider, M.; Baiker, A. *Catal. Rev. Sci. Eng.* **1995**, *37*, 515–556.
17. Ciesla, U.; Schuth, F. *Microporous Mesoporous Mater.* **1999**, *27*, 131–149.
18. Brinker, C. J.; Sehgal, R.; Hietala, S. L.; Deshpande, R.; Smith, D. M.; Loy, D.; Ashley, C. S. *J. Membr. Sci.* **1994**, *94*, 85–102.
19. Hubertpalfzgraf, L. G. *Polyhedron*, **1994**, *13*, 1181–1195.
20. Hubertpalfzgraf, L. G. *New J. Chem.* **1995**, *19*, 727–750.
21. Barboux, P.; Griesmar, P.; Ribot, F.; Mazerolles, L. *J. Solid State Chem.* **1995**, *117*, 343–350.
22. Serfaty, S.; Griesmar, P.; Gindre, M.; Gouedard, G.; Figuiere, P. *J. Mater. Chem.* **1998**, *8*, 2229–2231.
23. Himmel, B.; Gerber, T.; Burger, H. *J. Non-Cryst. Solids*, **1987**, *91*, 122–136.
24. Himmel, B.; Burger, H.; Gerber, T.; Olbertz, A. *J. Non-Cryst. Solids*, **1995**, *185*, 56–66.
25. Winter, R.; Hua, D. W.; Thiyagarajan, P.; Jonas, J. *J. Non-Cryst. Solids*, **1989**, *108*, 137–142.
26. Byers, C. H.; Harris, M. T.; Williams, D. F. *Ind. Eng. Chem. Res.* **1987**, *26*, 1916–1923.
27. Boonstra, A. H.; Meeuwsen, T. P. M.; Baken, J. M. E.; Aben, G. V. A. *J. Non-Cryst. Solids*, **1989**, *109*, 153–163.
28. Geddes, C. D.; Karolin, J.; Birch, D. J. S. *J. Phys. Chem. B*, **2002**, *106*, 3835–3841.
29. Scolan, E.; Sanchez, C. *Chem. Mater.* **1998**, *10*, 3217–3223.
30. Matijevic, E. *Chem. Mater.* **1993**, *5*, 412–426.

31. Matijevic, E. *Langmuir*, **1994**, *10*, 8–16.
32. Dislich, H. *Angew. Chem.* **1971**, *83*, 428.
33. Orel, B.; Macek, M.; Svegl, F.; Kalcher, K. *Thin Solid Films* **1994**, *246*, 131–142.
34. Sharma, P. K.; Fantini, M. C. A.; Gorenstein, A. *Solid State Ion.* **1998**, *115*, 457–463.
35. Yamabi, S.; Imai, H. *Chem. Mater.* **2002**, *14*, 609–614.
36. Moriguchi, I.; Maeda, H.; Teraoka, Y.; Kagawa, S. *J. Am. Chem. Soc.* **1995**, *117*, 1139–1140.
37. Toyoda, M.; Hamaji, Y.; Tomono, K. *J. Sol-Gel Sci. Technol.* **1997**, *9*, 71–84.
38. Lakshmi, B. B.; Patrissi, C. J.; Martin, C. R. *Chem. Mater.* **1997**, *9*, 2544–2550.
39. Lakshmi, B. B.; Dorhout, P. K.; Martin, C. R. *Chem. Mater.* **1997**, *9*, 857–862.
40. Patrissi, C. J.; Martin, C. R. *J. Electrochem. Soc.* **1999**, *146*, 3176–3180.
41. Lei, Y.; Zhang, L. D. *J. Mater. Res.* **2001**, *16*, 1138–1144.
42. Nakamura, H.; Matsui, Y. *J. Am. Chem. Soc.* **1995**, *117*, 2651–2652.
43. Krumeich, F.; Muhr, H. J.; Niederberger, M.; Bieri, F.; Schnyder, B.; Nesper, R. *J. Am. Chem. Soc.* **1999**, *121*, 8324–8331.
44. ([http://www.jpl.nasa.gov/releases/2002/release\\_2002\\_108.html](http://www.jpl.nasa.gov/releases/2002/release_2002_108.html))
45. Gash, A. E.; Tillotson, T. M.; Satcher, J. H.; Poco, J. F.; Hrubesh, L. W.; Simpson, R. L. *Chem. Mater.* **2001**, *13*, 999–1007.
46. Bradley, D. C. *Coord. Chem. Rev.* **1967**, *2*, 299.
47. Mehrotra, R. C.; Singh, A.; Sogani, S. *Chem. Rev.* **1994**, *94*, 1643–1660.
48. Mehrotra, R. C.; Singh, A. In *Progress in Inorganic Chemistry* 1997, Vol. 46, pp 239–454.
49. Damo, S. M.; Lam, K. C.; Rheingold, A.; Walters, M. A. *Inorg. Chem.* **2000**, *39*, 1635–1638.
50. Day, V. W.; Klemperer, W. G.; Pafford, M. M. *Inorg. Chem.* **2001**, *40*, 5738–5746.
51. Blanchard, J.; In, M.; Schaudel, B.; Sanchez, C. *Eur. J. Inorg. Chem.* **1998**, 1115–1127.
52. Blanchard, J.; Bonhomme, C.; Maquet, J.; Sanchez, C. *J. Mater. Chem.* **1998**, *8*, 985–989.
53. Soloviev, A.; Tufeu, R.; Sanchez, C.; Kanaev, A. V. *J. Phys. Chem. B*, **2001**, *105*, 4175–4180.
54. Bartlett, J. R.; Woolfrey, J. L. *Chem. Mater.* **1996**, *8*, 1167–1174.
55. Chemseddine, A.; Moritz, T. *Eur. J. Inorg. Chem.* **1999**, 235–245.
56. Lee, G. R.; Crayston, J. A. *J. Mater. Chem.* **1994**, *4*, 1093–1100.
57. Percy, M. J.; Bartlett, J. R.; Woolfrey, J. L.; Spiccia, L.; West, B. O. *J. Mater. Chem.* **1999**, *9*, 499–505.
58. Steunou, N.; Ribot, F.; Boubekeur, K.; Maquet, J.; Sanchez, C. *New J. Chem.* **1999**, *23*, 1079–1086.
59. Venz, P. A.; Klopogge, J. T.; Frost, R. L. *Langmuir*, **2000**, *16*, 4962–4968.
60. Takahashi, Y.; Ohsugi, A.; Arafuka, T.; Ohya, T.; Ban, T.; Ohya, Y. *J. Sol-Gel Sci. Technol.* **2000**, *17*, 227–238.
61. Boulmaaz, S.; Papiernik, R.; HubertPfalzgraf, L. G.; Septe, B.; Vaissermann, J. *J. Mater. Chem.* **1997**, *7*, 2053–2061.
62. Steunou, N.; Robert, F.; Boubekeur, K.; Ribot, F.; Sanchez, C. *Inorg. Chem. Acta*, **1998**, *279*, 144–151.
63. Schubert, U.; Tewinkel, S.; Moller, F. *Inorg. Chem.* **1995**, *34*, 995–997.
64. Dong, W.; Dunn, B. *J. Mater. Chem.* **1998**, *8*, 665–670.
65. Feldmann, C.; Jungk, H. O. *Angew. Chem. Int. Ed. Engl.* **2001**, *40*, 359–362.
66. Niederberger, M.; Krumeich, F.; Hegetschweiler, K.; Nesper, R. *Chem. Mater.* **2002**, *14*, 78–82.
67. Pico, A. R.; Houk, C. S.; Weakley, T. J. R.; Page, C. J. *Inorg. Chem. Acta*, **1997**, *258*, 155–160.
68. Weymann-Schildknecht, S.; Henry, M. *J. Chem. Soc. Dalton Trans.* **2001**, 2425–2428.
69. Fontenot, C. J.; Wiench, J. W.; Pruski, M.; Schrader, G. L. *J. Phys. Chem. B*, **2000**, *104*, 11622–11631.
70. Kakihana, M.; Tada, M.; Shiro, M.; Petrykin, V.; Osada, M.; Nakamura, Y. *Inorg. Chem.* **2001**, *40*, 891–894.
71. Azuma, T.; Sakamoto, Y.; Mitani, K.; Takahashi, S.; Kuwabara, M. *J. Ceram. Soc. Jpn.* **1995**, *103*, 822–827.
72. Caulton, K. G.; HubertPfalzgraf, L. G. *Chem. Rev.* **1990**, *90*, 969–995.
73. Sobott, F.; Schunk, S. A.; Schuth, F.; Brutschy, B. *Chem. Eur. J.* **1998**, *4*, 2353–2359.
74. Caruso, J.; Roger, C.; Schwertfeger, F.; Hampdensmith, M. J.; Rheingold, A. L.; Yap, G. *Inorg. Chem.* **1995**, *34*, 449–453.
75. Caruso, J.; Alam, T. M.; HampdenSmith, M. J.; Rheingold, A. L.; Yap, G. A. P. *J. Chem. Soc. Dalton Trans.* **1996**, 2659–2664.
76. Schmid, R.; Mosset, A.; Galy, J. *J. Chem. Soc. Dalton Trans.* **1991**, 1999–2005.
77. Day, V. W.; Eberspacher, T. A.; Chen, Y. W.; Hao, J. L.; Klemperer, W. G. *Inorg. Chem. Acta*, **1995**, *229*, 391–405.
78. Day, V. W.; Eberspacher, T. A.; Klemperer, W. G.; Park, C. W. *J. Am. Chem. Soc.* **1993**, *115*, 8469–8470.
79. Day, V. W.; Eberspacher, T. A.; Klemperer, W. G.; Park, C. W.; Rosenberg, F. S. *J. Am. Chem. Soc.* **1991**, *113*, 8190–8192.
80. Lugmair, C. G.; Furdala, K. L.; Tilley, T. D. *Chem. Mater.* **2002**, *14*, 888–898.
81. Lugmair, C. G.; Tilley, T. D. *Inorg. Chem.* **1998**, *37*, 764–769.
82. Lugmair, C. G.; Tilley, T. D.; Rheingold, A. L. *Chem. Mater.* **1997**, *9*, 339–348.
83. Kessler, V. G.; HubertPfalzgraf, L. G.; Daniele, S.; Gleizes, A. *Chem. Mater.* **1994**, *6*, 2336–2342.
84. Veith, M.; Mathur, S.; Huch, V. *J. Am. Chem. Soc.* **1996**, *118*, 903–904.
85. Veith, M.; Mathur, S.; Huch, V. *J. Chem. Soc. Dalton Trans.* **1996**, 2485–2490.
86. Veith, M.; Mathur, S.; Huch, V. *Inorg. Chem.* **1996**, *35*, 7295–7303.
87. Veith, M.; Mathur, S.; Huch, V. *Inorg. Chem.* **1997**, *36*, 2391–2399.
88. Veith, M.; Mathur, S.; Huch, V.; Decker, T. *Eur. J. Inorg. Chem.* **1998**, 1327–1332.
89. Hegetschweiler, K.; Schmalte, H. W.; Streit, H. M.; Gramlich, V.; Hund, H. U.; Erni, I. *Inorg. Chem.* **1992**, *31*, 1299–1302.
90. Westin, G. *J. Sol-Gel Sci. Technol.* **1998**, *12*, 203–212.
91. Jun, D. Y.; Kim, E. S.; Jo, K. H.; Payne, D. A. *Mol. Cryst. Liquid Cryst.* **2000**, *339*, 11–29.
92. Franc, C.; Jousseume, B.; Linker, M.; Toupance, T. *Chem. Mater.* **2000**, *12*, 3100–3107.
93. Gamard, A.; Jousseume, B.; Toupance, T.; Campet, G. *Inorg. Chem.* **1999**, *38*, 4671–4679.
94. Bourget, L.; Corriu, R. J. P.; Leclercq, D.; Mutin, P. H.; Vioux, A. *J. Non-Cryst. Solids*, **1998**, *242*, 81–91.
95. Arnal, P.; Corriu, R. J. P.; Leclercq, D.; Mutin, P. H.; Vioux, A. *J. Mater. Chem.* **1996**, *6*, 1925–1932.
96. Corriu, R. J. P.; Leclercq, D.; Lefevre, P.; Mutin, P. H.; Vioux, A. *J. Mater. Chem.* **1992**, *2*, 673–674.
97. Andrianainarivelo, M.; Corriu, R. J. P.; Leclercq, D.; Mutin, P. H.; Vioux, A. *J. Mater. Chem.* **1997**, *7*, 279–284.

98. Sriram, M. A.; Kumta, P. N. *J. Am. Ceram. Soc.* **1994**, *77*, 1381–1384.
99. Sriram, M. A.; Weil, K. S.; Kumta, P. N. *Appl. Organomet. Chem.* **1997**, *11*, 163–179.
100. Sriram, M. A.; Kumta, P. N. *J. Mater. Chem.* **1998**, *8*, 2441–2451.
101. Carmalt, C. J.; Dinnage, C. W.; Parkin, I. P. *J. Mater. Chem.* **2000**, *10*, 2823–2826.
102. Jung, J. H.; Kobayashi, H.; Masuda, M.; Shimizu, T.; Shinkai, S. *J. Am. Chem. Soc.* **2001**, *123*, 8785–8789.
103. Heibel, M.; Bocarsly, A. B. In *Metastable, Mechanically Alloyed and Nanocrystalline Materials*, Parts 1 & 2, 1996, pp 941–945.
104. Schottner, G. *Chem. Mater.* **2001**, *13*, 3422–3435.
105. Avnir, D. *Accounts Chem. Res.* **1995**, *28*, 328–334.
106. Ribot, F.; Sanchez, C. *Comments Inorg. Chem.* **1999**, *20*, 327–371.
107. Judeinstein, P.; Sanchez, C. *J. Mater. Chem.* **1996**, *6*, 511–525.
108. Sanchez, C.; Ribot, F.; Lebeau, B. *J. Mater. Chem.* **1999**, *9*, 35–44.
109. Novak, B. M. *Adv. Mater.* **1993**, *5*, 422–433.
110. Schubert, U.; Husing, N.; Lorenz, A. *Chem. Mater.* **1995**, *7*, 2010–2027.
111. Cerveau, G.; Corriu, R. J. P.; Framery, E. *Chem. Mater.* **2001**, *13*, 3373–3388.
112. Walcarius, A. *Chem. Mater.* **2001**, *13*, 3351–3372.
113. Cerveau, G.; Corriu, R. J. P. *Coord. Chem. Rev.* **1998**, *180*, 1051–1071.
114. Corriu, R. J. P. *Polyhedron*, **1998**, *17*, 925–934.
115. Loy, D. A.; Baugher, B. M.; Baugher, C. R.; Schneider, D. A.; Rahimian, K. *Chem. Mater.* **2000**, *12*, 3624–3632.
116. Cerveau, G.; Corriu, R. J. P.; Framery, E. *J. Mater. Chem.* **2001**, *11*, 713–717.
117. Lebeau, B.; Maquet, J.; Sanchez, C.; Toussaere, E.; Hierle, R.; Zyss, J. *J. Mater. Chem.* **1994**, *4*, 1855–1860.
118. Reynold, J. G.; Coronado, P. R.; Hrubesh, L. W. *J. Non-Cryst. Solids* **2001**, *292*, 127–137.
119. Yoshizawa, M.; Kusakawa, T.; Fujita, M.; Sakamoto, S.; Yamaguchi, K. *J. Am. Chem. Soc.* **2001**, *123*, 10454–10459.
120. Abbenhuis, H. C. L. *Chem. Eur. J.* **2000**, *6*, 25–32.
121. Feher, F. J.; Budzichowski, T. A. *Polyhedron*, **1995**, *14*, 3239–3253.
122. Crocker, M.; Herold, R. H. M.; Orpen, A. G. *Chem. Commun.* **1997**, 2411–2412.
123. Feher, F. J. *J. Am. Chem. Soc.* **1986**, *108*, 3850–3852.
124. Maschmeyer, T.; Klunduk, M. C.; Martin, C. M.; Shephard, D. S.; Thomas, J. M.; Johnson, B. F. G. *Chem. Commun.* **1997**, 1847–1848.
125. Prasad, P. N.; Bright, F. V.; Narang, U.; Wang, R.; Dunbar, R. A.; Jordan, J. D.; Gvishi, R. In *Hybrid Organic-Inorganic Composites* 1995, pp 317–330.
126. Gvishi, R.; Narang, U.; Ruland, G.; Kumar, D. N.; Prasad, P. N. *Appl. Organomet. Chem.* **1997**, *11*, 107–127.
127. Dunuwila, D. D.; Torgerson, B. A.; Chang, C. K.; Berglund, K. A. *Anal. Chem.* **1994**, *66*, 2739–2744.
128. Oliveira, H. P.; Graeff, C. F. O.; Rosolen, J. M. *Mater. Res. Bull.* **1999**, *34*, 1891–1903.
129. Rottman, C.; Avnir, D. *J. Am. Chem. Soc.* **2001**, *123*, 5730–5734.
130. Dunn, B.; Zink, J. I. *Chem. Mater.* **1997**, *9*, 2280–2291.
131. Meng, Q. G.; Zhang, H. J.; Fu, L. S.; Yang, K. Y. *J. Inorg. Mater.* **1999**, *14*, 630–634.
132. Rudzinski, C. M.; Young, A. M.; Nocera, D. G. *J. Am. Chem. Soc.* **2002**, *124*, 1723–1727.
133. Cattet, H.; Audebert, P.; Sanchez, C.; Hapiot, P. *J. Phys. Chem. B*, **1998**, *102*, 1193–1202.
134. Cattet, H.; Audebert, P.; Sanchez, C.; Hapiot, P. *J. Mater. Chem.* **1997**, *7*, 1461–1466.
135. Lev, O.; Wu, Z.; Bharathi, S.; Glezer, V.; Modestov, A.; Gun, J.; Rabinovich, L.; Sampath, S. *Chem. Mater.* **1997**, *9*, 2354–2375.
136. Sakamoto, J. S.; Dunn, B. *J. Electrochem. Soc.* **2002**, *149*, A26–A30.
137. Williams, A. K.; Hupp, J. T. *J. Am. Chem. Soc.* **1998**, *120*, 4366–4371.
138. Chia, S. Y.; Urano, J.; Tamanoi, F.; Dunn, B.; Zink, J. I. *J. Am. Chem. Soc.* **2000**, *122*, 6488–6489.
139. Livage, J.; Coradin, T.; Roux, C. *J. Phys. Condens. Matter*, **2001**, *13*, R673–R691.
140. Bottcher, H. *J. Prakt. Chem.* **2000**, *342*, 427–436.
141. Tatsu, Y.; Yamashita, K.; Yamaguchi, M.; Yamamura, S.; Yamamoto, H.; Yoshikawa, S. *Chem. Lett.* **1992**, 1615–1618.
142. Wolfbeis, O. S.; Oehme, I.; Papkovskaya, N.; Klimant, I. *Biosens. Bioelectron.* **2000**, *15*, 69–76.
143. Yamanaka, S. A.; Nishida, F.; Ellerby, L. M.; Nishida, C. R.; Dunn, B.; Valentine, J. S.; Zink, J. I. *Chem. Mater.* **1992**, *4*, 495–497.
144. Gun, J.; Lev, O. *Anal. Chem. Acta* **1996**, *336*, 95–106.
145. Bronshtein, A.; Aharonson, N.; Turniansky, A.; Altstein, M. *Chem. Mater.* **2000**, *12*, 2050–2058.
146. Livage, J.; Roux, C.; DaCosta, K. M.; Desportes, I.; Quinson, J. F. *J. Sol-Gel Sci. Technol.* **1996**, *7*, 45–51.
147. Zusman, R.; Zusman, I. *J. Biochem. Biophys. Methods*, **2001**, *49*, 175–187.
148. Hayes, J. D.; Malik, A. *J. Chromatogr. B* **1997**, *695*, 3–13.
149. Guermeur, C.; Lambard, J.; Gerard, J. F.; Sanchez, C. *J. Mater. Chem.* **1999**, *9*, 769–778.
150. Lesot, P.; Chapuis, S.; Bayle, J. P.; Rault, J.; Lafontaine, E.; Campero, A.; Judeinstein, P. *J. Mater. Chem.* **1998**, *8*, 147–151.
151. Lantelme, B.; Dumon, M.; Mai, C.; Pascault, J. P. *J. Non-Cryst. Solids*, **1996**, *194*, 63–71.
152. Kajihara, K.; Yao, T. *J. Sol-Gel Sci. Technol.* **2000**, *17*, 239–245.
153. Wei, Y.; Jin, D. L.; Yang, C. C.; Wei, G. *J. Sol-Gel Sci. Technol.* **1996**, *7*, 191–201.
154. Cornelius, C. J.; Marand, E. *Polymer*, **2002**, *43*, 2385–2400.
155. Hu, Q.; Marand, E.; Dhingra, S.; Fritsch, D.; Wen, J.; Wilkes, G. *J. Membr. Sci.* **1997**, *135*, 65–79.
156. Asif, K. M.; Sarwar, M. I.; Rafiq, S.; Ahmad, Z. *Polym. Bull.* **1998**, *40*, 583–590.
157. Sailer, R. A.; Wegner, J. R.; Hurr, G. J.; Janson, J. E. Soucek, M. D. *Prog. Org. Coat.* **1998**, *33*, 117–125.
158. Huguenin, F.; Giz, M. J.; Ticianelli, E. A.; Torresi, R. M. *J. Power Sources*, **2001**, *103*, 113–119.
159. Camail, M.; Humbert, M.; Margailan, A.; Riandel, A.; Vernet, J. L. *Polymer*, **1998**, *39*, 6525–6531.
160. Roux, S.; Audebert, P.; Pagetti, J.; Roche, M. *New J. Chem.* **2002**, *26*, 298–304.
161. De Paul, S. M.; Zwanziger, J. W.; Ulrich, R.; Wiesner, U.; Spiess, H. W. *J. Am. Chem. Soc.* **1999**, *121*, 5727–5736.
162. In, M.; Gerardin, C.; Lambard, J.; Sanchez, C. *J. Sol-Gel Sci. Technol.* **1995**, *5*, 101–114.
163. BarglikChory, C.; Schubert, U. *J. Sol-Gel Sci. Technol.* **1995**, *5*, 135–142.

164. Kakihana, M.; Yoshimura, M. *Bull. Chem. Soc. Jpn.* **1999**, *72*, 1427–1443.
165. Thompson, D. W., *On Growth and Form*; Cambridge: Cambridge University Press, 1917.
166. Mann, S. *Angew. Chem. Int. Ed. Engl.* **2000**, *39*, 3393–3406.
167. Ozin, G. A. *Can. J. Chem. Rev. Can. Chim.* **1999**, *77*, 2001–2014.
168. Ozin, G. A. *Acc. Chem. Res.* **1997**, *30*, 17–27.
169. Davis, S. A.; Breulmann, M.; Rhodes, K. H.; Zhang, B.; Mann, S. *Chem. Mater.* **2001**, *13*, 3218–3226.
170. Ozin G. A. *Chem. Commun.* **2000**, 419–432.
171. Mann, S.; Burkett, S. L.; Davis, S. A.; Fowler, C. E.; Mendelson, N. H.; Sims, S. D.; Walsh, D.; Whilton, N. T. *Chem. Mater.* **1997**, *9*, 2300–2310.
172. Auvray, L.; Ayrat, A.; Dabadie, T.; Cot, L.; Guizard, C.; Ramsay, J. D. F. *Faraday Discuss.* **1995**, 235–247.
173. Kresge, C. T.; Leonowicz, M. E.; Roth, W. J.; Vartuli, J. C.; Beck, J. S. *Nature* **1992**, *359*, 710–712.
174. Ying, J. Y.; Mehnert, C. P.; Wong, M. S. *Angew. Chem. Int. Ed. Engl.* **1999**, *38*, 56–77.
175. Barton, T. J.; Bull, L. M.; Klemperer, W. G.; Loy, D. A.; McEnaney, B.; Misono, M.; Monson, P. A.; Pez, G.; Scherer, G. W.; Vartuli, J. C.; Yaghi, O. M. *Chem. Mater.* **1999**, *11*, 2633–2656.
176. Dag, O.; Verma, A.; Ozin, G. A.; Kresge, C. T. *J. Mater. Chem.* **1999**, *9*, 1475–1482.
177. Johnson, S. A.; Khushalani, D.; Coombs, N.; Mallouk, T. E.; Ozin, G. A. *J. Mater. Chem.* **1998**, *8*, 13–14.
178. Takahashi, R.; Takenaka, S.; Sato, S.; Sodesawa, T.; Ogura, K.; Nakanishi, K. *J. Chem. Soc. Faraday Trans.* **1998**, *94*, 3161–3168.
179. Khushalani, D.; Ozin, G. A.; Kuperman, A. *J. Mater. Chem.* **1999**, *9*, 1483–1489.
180. Khushalani, D.; Ozin, G. A.; Kuperman, A. *J. Mater. Chem.* **1999**, *9*, 1491–1500.
181. Yang, P. D.; Zhao, D. Y.; Margolese, D. I.; Chmelka, B. F.; Stucky, G. D. *Chem. Mater.* **1999**, *11*, 2813–2826.
182. Antonietti, M.; Breulmann, M.; Goltner, C. G.; Colfen, H.; Wong, K. K. W.; Walsh, D.; Mann, S. *Chem. Eur. J.* **1998**, *4*, 2493–2500.
183. Khushalani, D.; Hasenzahl, S.; Mann, S. *J. Nanosci. Nanotechnol.* **2001**, *1*, 129–132.
184. Wen, J. Y.; Wilkes, G. L. *Chem. Mater.* **1996**, *8*, 1667–1681.
185. Melde, B. J.; Holland, B. T.; Blanford, C. F.; Stein, A. *Chem. Mater.* **1999**, *11*, 3302–3308.
186. Hernandez, R.; Franville, A. C.; Minoofar, P.; Dunn, B.; Zink, J. I. *J. Am. Chem. Soc.* **2001**, *123*, 1248–1249.
187. Cabrera, S.; El Haskouri, J.; Guillem, C.; Latorre, J.; Beltran-Porter, A.; Beltran-Porter, D.; Marcos, M. D.; Amoros, P. *Solid State Sci.* **2000**, *2*, 405–420.
188. Sanchez, C.; Soler-Illia, G.; Ribot, F.; Lalot, T.; Mayer, C. R.; Cabuil, V. *Chem. Mater.* **2001**, *13*, 3061–3083.
189. Soler-Illia, G.; Socolan, E.; Louis, A.; Albouy, P. A.; Sanchez, C. *New J. Chem.* **2001**, *25*, 156–165.
190. Ribot, F. O.; Eychenne-Baron, C.; Sanchez, C. *Phosphorus Sulfur Silicon Relat. Elem.* **1999**, *151*, 41–58.
191. Juwiler, D.; Neumann, R. *Catal. Lett.* **2001**, *72*, 241–243.
192. Livage, J.; Henry, M.; Sanchez, C. *Prog. Solid State Chem.* **1988**, *18*, 259–341.
193. Roca, M.; Marcos, M. D.; Amoros, P.; Beltran-Porter, A.; Edwards, A. J.; Beltran-Porter, D. *Inorg. Chem.* **1996**, *35*, 5613–5621.
194. Roca, M.; Marcos, M. D.; Amoros, P.; Alamo, J.; Beltran-Porter, A.; Beltran-Porter, D. *Inorg. Chem.* **1997**, *36*, 3414–3421.
195. Livage, J. In *Encyclopedia of Inorganic Chemistry*, ed., King, R. B. Wiley: Chichester, **1994**, pp 3836–3851.
196. Szanics, J.; Kakihana, M. *Chem. Mater.* **1999**, *11*, 2760–2763.
197. Nelis, D.; Van Werde, K.; Mondelaers, D.; Vanhoyland, G.; Van Bael, M. K.; Mullens, J.; Van Poucke, L. C. *J. Eur. Ceram. Soc.* **2001**, *21*, 2047–2049.
198. Ching, S.; Landrigan, J. A.; Jorgensen, M. L.; Duan, N. G.; Suib, S. L.; Oyoung, C. L. *Chem. Mater.* **1995**, *7*, 1604–1606.
199. Ching, S.; Roark, J. L.; Duan, N.; Suib, S. L. *Chem. Mater.* **1997**, *9*, 750–754.
200. Ching, S.; Petrovay, D. J.; Jorgensen, M. L.; Suib, S. L. *Inorg. Chem.* **1997**, *36*, 883–890.
201. Ching, S.; Welch, E. J.; Hughes, S. M.; Bahadoor, A. B. F.; Suib, S. L. *Chem. Mater.* **2002**, *14*, 1292–1299.
202. Luo, J. A.; Zhang, Q. H.; Suib, S. L. *Inorg. Chem.* **2000**, *39*, 741–747.
203. Manivannan, V.; Goodenough, J. B. *Inorg. Chem.* **1998**, *37*, 3448.
204. Livage, J. *Solid State Ion.* **1996**, *86–8*, 935–942.
205. Livage, J. *Coord. Chem. Rev.* **1999**, *192*, 391–403.
206. Judeinstein, P.; Livage, J. *J. Mater. Chem.* **1991**, *1*, 621–627.
207. Caraba, R. M.; Masters, S. G.; Eriksen, K. M.; Parvulescu, V. I.; Fehrmann, R. *Appl. Catal. B Environ.* **2001**, *34*, 191–200.
208. Castellano, F. N.; Heimer, T. A.; Tandhasetti, M. T.; Meyer, G. J. *Chem. Mater.* **1994**, *6*, 1041–1048.
209. Castellano, F. N.; Stipkala, J. M.; Friedman, L. A.; Meyer, G. J. *Chem. Mater.* **1994**, *6*, 2123–2129.
210. Stipkala, J. M.; Castellano, F. N.; Heimer, T. A.; Kelly, C. A.; Livi, K. J. T.; Meyer, G. J. *Chem. Mater.* **1997**, *9*, 2341–2353.
211. Smirnova, N.; Eremenko, A.; Rusina, O.; Hopp, W.; Spanhel, L. *J. Sol-Gel Sci. Technol.* **2001**, *22*, 109–113.
212. Rangel, M. D.; Sasaki, R. M.; Galembeck, F. *Catal. Lett.* **1995**, *33*, 237–254.
213. Lee, K. T.; Pozarnsky, G.; Zarembowitch, O.; McCormick, A. *Chem. Eng. J.* **1996**, *64*, 215–223.
214. Dutoit, D. C. M.; Schneider, M.; Fabrizioli, P.; Baiker, A. *Chem. Mater.* **1996**, *8*, 734–743.
215. Pozarnsky, G. A.; McCormick, A. V. *Chem. Mater.* **1994**, *6*, 380–385.
216. Pozarnsky, G. A.; McCormick, A. V. *J. Mater. Chem.* **1994**, *4*, 1749–1753.
217. Blanchard, J.; Ribot, F.; Sanchez, C.; Bellot, P. V.; Trokner, A. *J. Non-Cryst. Solids* **2000**, *265*, 83–97.
218. Blanchard, J.; Barbouxdoeuff, S.; Maquet, J.; Sanchez, C. *New J. Chem.* **1995**, *19*, 929–941.
219. Martens, W. N.; Frost, R. L.; Bartlett, J.; Klopogge, J. T. *J. Mater. Chem.* **2001**, *11*, 1681–1686.
220. Artizzu-Duart, P.; Brulle, Y.; Gaillard, F.; Guilhaume, N.; Primet, M. *Catal. Today* **1999**, *54*, 181–190.
221. Garg, G.; Singh, A.; Mehrotra, R. C. *Indian J. Chem. Sect A Inorg. Phys. Theor. Anal. Chem.* **1995**, *34*, 484–486.
222. Kareiva, A.; Karppinen, M.; Niinisto, L. *J. Mater. Chem.* **1994**, *4*, 1267–1270.
223. Lakeman, C. D. E.; Payne, D. A. *Mater. Chem. Phys.* **1994**, *38*, 305–324.
224. Frey, M. H.; Payne, D. A. *Chem. Mater.* **1995**, *7*, 123–129.
225. Zeng, H. C.; Tung, S. K. *Chem. Mater.* **1996**, *8*, 2667–2672.

226. Cho, C. R.; Lee, W. J.; Yu, B. G.; Kim, B. W. *J. Appl. Phys.* **1999**, *86*, 2700–2711.
227. Kighelman, Z.; Damjanovic, D.; Cantoni, M.; Setter, N. *J. Appl. Phys.* **2002**, *91*, 1495–1501.
228. Yoshikawa, Y.; Tsuzuki, K. *J. Am. Ceram. Soc.* **1992**, *75*, 2520–2528.
229. Eichorst, D. J.; Payne, D. A.; Wilson, S. R.; Howard, K. E. *Inorg. Chem.* **1990**, *29*, 1458–1459.
230. Wilkinson, A. P.; Xu, J.; Pattanaik, S.; Billinge, S. J. I. *Chem. Mater.* **1998**, *10*, 3611–3619.
231. Beltran, S.; Cordocillo, E.; Escribano, P.; Carda, J. B.; Coats, A.; West, A. R. *Chem. Mater.* **2000**, *12*, 400–405.
232. Anaissi, F. J.; Demets, G. J. F.; Alvarez, E. B.; Politi, M. J.; Toma, H. E. *Electrochim. Acta*, **2001**, *47*, 441–450.
233. Legoff, P.; Baffier, N.; Bach, S.; Pereiramos, J. P. *J. Mater. Chem.* **1994**, *4*, 875–881.
234. Stadniychuk, H. P.; Anderson, M. A.; Chapman, T. W. *J. Electrochem. Soc.* **1996**, *143*, 1629–1632.
235. Denis, S.; Baudrin, E.; Orsini, F.; Ouvrard, G.; Touboul, M.; Tarascon, J. M. *J. Power Sources* **1999**, *82*, 79–84.
236. Surca, A.; Orel, B.; Krasovec, U. O.; Stangar, U. L.; Drazic, G. *J. Electrochem. Soc.* **2000**, *147*, 2358–2370.
237. Liu, D. M.; Troczynski, T.; Tseng, W. J. *Biomaterials*, **2001**, *22*, 1721–1730.
238. Weng, L.; Hodgson, S. N. B. *J. Non-Cryst. Solids* **2002**, *297*, 18–25.
239. Vandenborre, M. T.; Maquet, J.; Livage, J. *J. Chim. Phys. Chim. Biol.* **1994**, *91*, 329–339.



# 1.41

## Sonochemistry

K. S. SUSLICK

*University of Illinois at Urbana-Champaign, Urbana, IL, USA*

---

1.41.1	INTRODUCTION	731
1.41.1.1	Acoustic Cavitation	732
1.41.1.2	Microjet Formation During Cavitation at Liquid–Solid Interfaces	733
1.41.2	SONOLUMINESCENCE	734
1.41.2.1	Types of Sonoluminescence	734
1.41.2.2	Spectroscopic Probes of Cavitation Conditions	734
1.41.3	SONOCHEMISTRY	735
1.41.3.1	Homogeneous Sonochemistry: Bond Breaking and Radical Formation	735
1.41.3.2	Applications of Sonochemistry to Materials Synthesis	736
1.41.3.3	Heterogeneous Sonochemistry: Reactions of Solids with Liquids	737
1.41.4	CONCLUSIONS	738
1.41.5	REFERENCES	739

---

### 1.41.1 INTRODUCTION

Ultrasonic irradiation of liquids causes high-energy chemical reactions to occur, often with the emission of light.<sup>1–3</sup> The origin of sonochemistry and sonoluminescence is acoustic cavitation: the formation, growth, and implosive collapse of bubbles in liquids irradiated with high-intensity sound. The collapse of bubbles caused by cavitation produces intense local heating and high pressures, with very short lifetimes. In clouds of cavitating bubbles, these hot-spots<sup>4–6</sup> have equivalent temperatures of roughly 5,000 K, pressures of about 1,000 atm, and heating and cooling rates above  $10^{10} \text{ K s}^{-1}$ . In single bubble cavitation, conditions may be even more extreme. Thus, cavitation can create extraordinary physical and chemical conditions in otherwise cold liquids.

When liquids that contain solids are irradiated with ultrasound, related phenomena can occur. When cavitation occurs near an extended solid surface, cavity collapse is non-spherical and drives high-speed jets of liquid into the surface.<sup>7</sup> These jets and associated shock waves can cause substantial surface damage and expose fresh, highly heated surfaces. Ultrasonic irradiation of liquid–powder suspensions produces another effect: high-velocity inter-particle collisions. Cavitation and the shock-waves it creates in a slurry can accelerate solid particles to high velocities.<sup>8</sup> The resultant collisions are capable of inducing dramatic changes in surface morphology, composition, and reactivity.<sup>9</sup>

Sonochemistry can be roughly divided into categories based on the nature of the cavitation event: homogeneous sonochemistry of liquids, heterogeneous sonochemistry of liquid–liquid or liquid–solid systems, and sonocatalysis (which overlaps the first two). In some cases, ultrasonic irradiation can increase reactivity by nearly a million-fold.<sup>10</sup> Because cavitation can only occur in liquids, chemical reactions are not generally seen in the ultrasonic irradiation of solids or solid–gas systems.

Sonoluminescence in general may be considered a special case of homogeneous sonochemistry; however, recent discoveries in this field have heightened interest in the phenomenon in and by itself.<sup>11,12</sup> Under conditions where an isolated, single bubble undergoes cavitation, recent studies on the duration of the sonoluminescence flash suggest that a shock wave may be created within



the collapsing bubble, with the capacity to generate truly enormous temperatures and pressures within the gas.

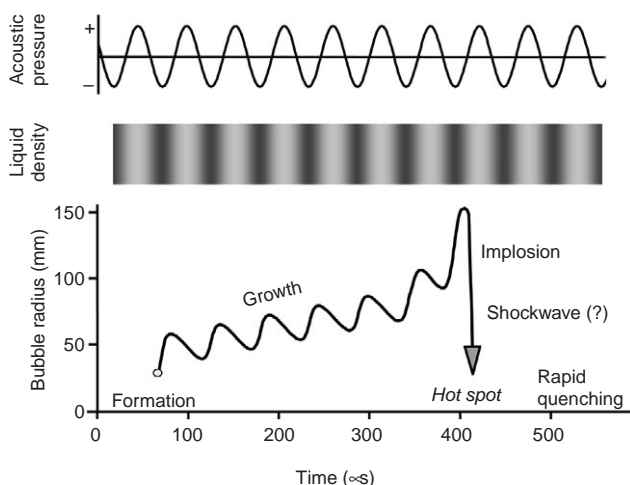
### 1.41.1.1 Acoustic Cavitation

The chemical effects of ultrasound do not arise from a direct interaction with molecular species. Ultrasound spans the frequencies of roughly 15 kHz to 1 GHz. With sound velocities in liquids typically about  $1,500 \text{ m s}^{-1}$ , acoustic wavelengths range from roughly 10 cm to  $10^{-4} \text{ cm}$ . These are not molecular dimensions. Consequently, no direct coupling of the acoustic field with chemical species on a molecular level can account for sonochemistry or sonoluminescence.

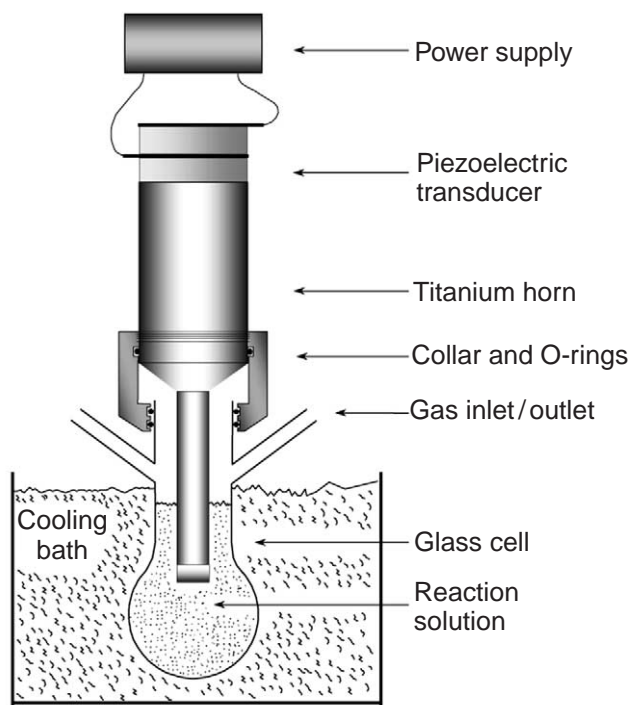
Instead, sonochemistry and sonoluminescence derive principally from acoustic cavitation, which serves as an effective means of concentrating the diffuse energy of sound. Compression of a gas generates heat. When the compression of bubbles occurs during cavitation, it is more rapid than thermal transport, which generates a short-lived, localized hot-spot. Rayleigh's early descriptions of a mathematical model for the collapse of cavities in incompressible liquids predicted enormous local temperatures and pressures.<sup>13</sup> Ten years later, Richards and Loomis reported the first chemical and biological effects of ultrasound.<sup>14</sup>

If the acoustic pressure amplitude of a propagating acoustic wave is relatively large (greater than  $\approx 0.5 \text{ MPa}$ ), local inhomogeneities in the liquid can give rise to the rapid growth of a nucleation site into a cavity of macroscopic dimensions, primarily filled with vapor. Such a bubble is inherently unstable, and its subsequent collapse can result in an enormous concentration of energy (Figure 1). This violent cavitation event is generally termed "transient cavitation." A normal consequence of this unstable growth and subsequent collapse is that the cavitation bubble itself is destroyed. Gas-filled remnants from the collapse, however, may give rise to reinitiation of the process.

A variety of devices have been used for ultrasonic irradiation of solutions. There are three general designs in use presently: the ultrasonic cleaning bath, the direct immersion ultrasonic horn, and flow reactors. The originating source of the ultrasound is generally a piezoceramic material that is subjected to a high AC voltage with an ultrasonic frequency (typically 15–50 kHz). The vibrating source is attached to the wall of a cleaning bath, to an amplifying horn, or to the outer surfaces of a flow-through tube or diaphragm. The ultrasonic cleaning bath is clearly the most accessible source of laboratory ultrasound and has been used successfully for a variety of liquid–solid heterogeneous sonochemical studies. The low intensity available in these devices ( $\approx 1 \text{ W cm}^{-2}$ ), however, means that even in the case of heterogeneous sonochemistry, an ultrasonic cleaning bath must be viewed as an apparatus of limited capability. The most intense and reliable source of ultrasound generally used in the chemical laboratory is the direct immersion ultrasonic horn ( $50 \text{ to } 500 \text{ W cm}^{-2}$ ), as shown in Figure 2, which can be used for work under either inert or reactive atmospheres or at moderate pressures ( $< 10 \text{ atm}$ ). These devices are available from several manufacturers at modest cost.



**Figure 1** Transient acoustic cavitation: the origin of sonochemistry and sonoluminescence.



**Figure 2** A typical sonochemical apparatus with direct immersion ultrasonic horn. Ultrasound can be easily introduced into a chemical reaction with good control of temperature and ambient atmosphere.

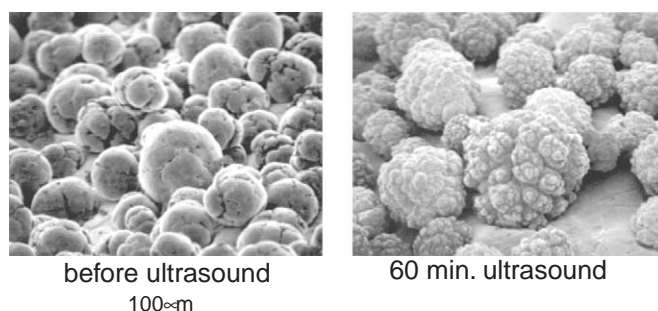
The generally accepted explanation for the origin of sonochemistry and sonoluminescence is the hot-spot theory, in which the potential energy given to the bubble as it expands to maximum size is concentrated into a heated gas core as the bubble implodes. The oscillations of a gas bubble driven by an acoustic field are well described by the “Rayleigh–Plesset” equation.<sup>7</sup>

The transient nature of the cavitation event precludes conventional examination of the conditions generated during bubble collapse. Chemical reactions themselves, however, can be used to probe reaction conditions through the use of “comparative-rate chemical thermometry.”<sup>4</sup> These kinetic studies revealed that there were in fact *two* sonochemical reaction sites: the first (and dominant site) is the bubble’s interior gas phase while the second is an *initially* liquid phase. The latter corresponds either to heating of a shell of liquid around the collapsing bubble or to droplets of liquid ejected into the hot-spot by surface wave distortions of the collapsing bubble.

#### 1.41.1.2 Microjet Formation During Cavitation at Liquid–Solid Interfaces

A very different phenomenon arises when cavitation occurs near extended liquid–solid interfaces. There are two proposed mechanisms for the effects of cavitation near surfaces: microjet impact and shockwave damage. Whenever a cavitation bubble is produced near a boundary, the asymmetry of the liquid particle motion during cavity collapse induces a deformation in the cavity.<sup>7</sup> The potential energy of the expanded bubble is converted into kinetic energy of a liquid jet that extends through the bubble’s interior and penetrates the opposite bubble wall. Because most of the available energy is transferred to the accelerating jet, rather than the bubble wall itself, this jet can reach velocities of hundreds of meters per second. Because of the induced asymmetry, the jet often impacts the local boundary and can deposit enormous energy densities at the site of impact. Such energy concentration can result in severe damage to the boundary surface. The second mechanism of cavitation-induced surface damage invokes shockwaves created by cavity collapse in the liquid. The impingement of microjets and shockwaves on the surface creates the localized erosion responsible for ultrasonic cleaning and many of the sonochemical effects on heterogeneous reactions. The erosion of metals by cavitation generates newly exposed, highly heated surfaces.

A solid surface several times larger than the resonance bubble size is necessary to induce distortions during bubble collapse. For ultrasound of  $\approx 20$  kHz, damage associated with jet formation cannot occur if the solid particles are smaller than  $\approx 200$   $\mu\text{m}$ . In these cases, however,



**Figure 3** The effect of ultrasonic irradiation on the surface morphology and particle size of Ni powder. High-velocity interparticle collisions caused by ultrasonic irradiation of slurries are responsible for the smoothing and removal of passivating oxide coating. (reproduced with permission.<sup>9</sup>)

the shockwaves created by homogeneous cavitation can create high-velocity interparticle collisions.<sup>8,9</sup> Suslick and co-workers have found that the turbulent flow and shockwaves produced by intense ultrasound can drive metal particles together at sufficiently high speeds to induce effective melting in direct collisions and the abrasion of surface crystallites in glancing impacts (Figure 3). A series of transition metal powders were used to probe the maximum temperatures and speeds reached during interparticle collisions. Using the irradiation of Cr, Mo, and W powders in decane at 20 kHz and  $50 \text{ W cm}^{-2}$ , agglomeration and essentially a localized melting occurs for the first two metals, but not the third. On the basis of the melting points of these metals, the effective transient temperature reached at the point of impact during interparticle collisions is roughly  $3,000^\circ\text{C}$  (which is unrelated to the temperature inside the hot-spot of a collapsing bubble). From the volume of the melted region of impact, the amount of energy generated during collision was determined. From this, a lower estimate of the velocity of impact is roughly one half the speed of sound.<sup>8</sup> These are precisely the effects expected on suspended particulates from cavitation-induced shockwaves in the liquid.

## 1.41.2 SONOLUMINESCENCE

### 1.41.2.1 Types of Sonoluminescence

In addition to driving chemical reactions, ultrasonic irradiation of liquids can also produce light. Sonoluminescence was first observed from water in 1934 by Frenzel and Schultes.<sup>15</sup> As with sonochemistry, sonoluminescence derives from acoustic cavitation. It is now generally thought that there are two separate forms of sonoluminescence: multiple-bubble sonoluminescence (MBSL) and single-bubble sonoluminescence (SBSL).<sup>11,12</sup> Since cavitation is a nucleated process and liquids generally contain large numbers of particulates that serve as nuclei, the “cavitation field” generated by a propagating or standing acoustic wave typically consists of very large numbers of interacting bubbles, distributed over an extended region of the liquid. If this cavitation is sufficiently intense to produce sonoluminescence, then the phenomenon is MBSL.<sup>1,16</sup>

Under the appropriate conditions, the acoustic force on a bubble can be used to balance against its buoyancy, holding the bubble stable in the liquid by acoustic levitation. This permits examination of the dynamic characteristics of the bubble in considerable detail, from both a theoretical and an experimental perspective. Such a bubble is typically quite small compared to an acoustic wavelength (e.g., at 20 kHz, the resonance size is approximately  $150 \mu\text{m}$ ). For rather specialized but easily obtainable conditions, a single, stable, oscillating gas bubble can be forced into such large-amplitude pulsations that it produces sonoluminescence emissions on each (and every) acoustic cycle. Such SBSL is outside the scope of this chapter.

### 1.41.2.2 Spectroscopic Probes of Cavitation Conditions

The MBSL of both aqueous and non-aqueous solutions is similar to the emission expected from high-temperature flames; e.g., excited-state  $\text{OH}^*$  from water, excited states of  $\text{C}_2$  ( $d^3\Pi_g - a^3\Pi_u$ ) from hydrocarbons (these lines also give hydrocarbon flames their blue color), and CN excited

states in the presence of a nitrogen source. For both aqueous and non-aqueous liquids, MBSL is caused by chemical reactions of high-energy species formed during cavitation by bubble collapse. Its principal source is most probably not blackbody radiation or electrical discharge. MBSL is a form of chemiluminescence.<sup>16</sup>

Determination of the temperatures reached in a cavitating bubble has remained a difficult experimental problem. As a spectroscopic probe of the cavitation event, MBSL provides a solution. High-resolution MBSL spectra from silicone oil under Ar have been reported and analyzed.<sup>5</sup> The observed emission comes from excited-state  $C_2$  and has been modeled with synthetic spectra as a function of rotational and vibrational temperatures. From comparison of synthetic to observed spectra, the effective cavitation temperature is  $5,050 \pm 150$  K.

A second spectroscopic thermometer comes from the relative intensities of atomic emission lines in the sonoluminescence spectra of excited-state metal atoms produced by sonolysis of volatile Fe, Cr, and Mo carbonyls. Sufficient spectral information about emissivities of many metal atom excited states are available to readily calculate emission spectra as a function of temperature. Because of this, the emission spectra of metal atoms are extensively used by astronomers to monitor the surface temperature of stars. From comparison of calculated spectra and the observed MBSL spectra from metal carbonyls, another measurement of the cavitation temperature was obtained.<sup>6</sup> The effective emission temperature from metal atom emission during cavitation under argon at 20 kHz is  $4,900 \pm 250$  K.

The excellence of the match between the observed MBSL and the synthetic spectra provides definitive proof that the sonoluminescence event is a thermal, chemiluminescence process. The agreement among these spectroscopic determinations<sup>5,6</sup> of the cavitation temperature and to that made by comparative rate thermometry of sonochemical reactions<sup>4</sup> is extremely good.

### 1.41.3 SONOCHEMISTRY

In a fundamental sense, chemistry is the interaction of energy and matter. Chemical reactions require energy in one form or another to proceed: chemistry stops as the temperature approaches absolute zero. One has only limited control, however, over the nature of this interaction. In large part, the properties of a specific energy source determine the course of a chemical reaction. Ultrasonic irradiation differs from traditional energy sources (such as heat, light, or ionizing radiation) in duration, pressure, and energy per molecule. The immense local temperatures and pressures and the extraordinary heating and cooling rates generated by cavitation bubble collapse mean that ultrasound provides an unusual mechanism for generating high-energy chemistry. Like photochemistry, very large amounts of energy are introduced in a short period of time, but it is thermal, not electronic, excitation. As in flash pyrolysis, high thermal temperatures are reached, but the duration is very much shorter (by  $>10^4$ ) and the temperatures are even higher (by five- to tenfold). Similar to shock-tube chemistry or multiphoton infrared laser photolysis, cavitation heating is very short lived, but occurs within condensed phases. Furthermore, sonochemistry has a high-pressure component, which suggests that one might be able to produce on a microscopic scale the same macroscopic conditions of high-temperature pressure “bomb” reactions or explosive shockwave synthesis in solids. Control of sonochemical reactions is subject to the same limitation that any thermal process has: the Boltzmann energy distribution means that the energy per individual molecule will vary widely. One does have easy control, however, over the intensity of heating generated by acoustic cavitation using various physical parameters (including thermal conductivity of dissolved gases, solvent vapor pressure inside the bubble, and ambient pressure). In contrast, frequency appears to be less important, at least within the range where cavitation can occur (a few hertz to a few megahertz), although there have been few detailed studies of its role.

#### 1.41.3.1 Homogeneous Sonochemistry: Bond Breaking and Radical Formation

The chemical effects of ultrasound on aqueous solutions have been studied for many years. The primary products are  $H_2$  and  $H_2O_2$ ; there is strong evidence for various high-energy intermediates, including  $HO_2$ ,  $H^\cdot$ ,  $OH^\cdot$ .<sup>17</sup> As one would expect, the sonolysis of water, which produces both strong reductants and oxidants, is capable of causing secondary oxidation and reduction reactions, as often observed by Margulis and co-workers.<sup>18</sup> Most recently there has been strong interest shown in the use of ultrasound for remediation of low levels of organic contamination

of water.<sup>19</sup> The OH<sup>·</sup> radicals produced from the sonolysis of water are able to attack essentially all organic compounds (including halocarbons, pesticides, and nitroaromatics) and through a series of reactions oxidize them fully. The ultrasonic irradiation of organic liquids creates the same kinds of products associated with very-high-temperature pyrolysis.<sup>20</sup> The sonochemistry of solutes dissolved in organic liquids also remains largely unexplored. The sonochemistry of metal carbonyl compounds is an exception.<sup>21</sup> Detailed studies of these systems led to important mechanistic understandings of the nature of sonochemistry. A variety of unusual reactivity patterns have been observed during ultrasonic irradiation, including multiple ligand dissociation, novel metal cluster formation, and the initiation of homogeneous catalysis at low ambient temperature.<sup>21</sup>

### 1.41.3.2 Applications of Sonochemistry to Materials Synthesis

Of special interest is the recent development of sonochemistry as a synthetic tool for the creation of unusual inorganic materials.<sup>22</sup> As one example, the recent discovery of a simple sonochemical synthesis of amorphous iron helped settle the long-standing controversy over its magnetic properties.<sup>23,24</sup> More generally, ultrasound has proved extremely useful in the synthesis of a wide range of nanostructured materials, including high-surface-area transition metals, alloys, carbides, oxides, and colloids.<sup>22,25–27</sup> Sonochemical decomposition of volatile organometallic precursors in high-boiling solvents produces nanostructured materials in various forms with high catalytic activities. Nanometer colloids; nanoporous high-surface-area aggregates; nanostructured carbides, sulfides, and oxides; and supported heterogeneous catalysts can all be prepared by this general route, as shown schematically in Figure 4. As an example, ultrasonic irradiation of Mo(CO)<sub>6</sub> produces aggregates of nanometer-sized clusters of face-centered cubic molybdenum carbide, with high porosity and very large surface area. The catalytic properties showed that the molybdenum carbide generated by ultrasound is an active and highly selective dehydrogenation catalyst comparable to commercial ultrafine platinum powder.<sup>25</sup> In related work, Gedanken and co-workers have extended the sonochemical synthesis of amorphous transition metals to the production of nanostructured metal oxides simply by sonication in the presence of air.<sup>26–28</sup>

The sonochemical synthesis of nanostructured molybdenum sulfide<sup>29</sup> provides another example of the utility of sonochemistry to the production of active catalysts. MoS<sub>2</sub> is the predominant hydrodesulfurization catalyst heavily used by the petroleum industry to remove sulfur from fossil fuels before combustion. The sonochemical synthesis of MoS<sub>2</sub> by the irradiation of solutions of molybdenum hexacarbonyl generates a most unusual morphology. As shown in Figure 5, conventional MoS<sub>2</sub> shows a plate-like morphology typical for such layered materials, whereas the sonochemical MoS<sub>2</sub> exists as a porous agglomeration of clusters of spherical particles with an average diameter of 15 nm. Despite the morphological difference between the sonochemical and conventional MoS<sub>2</sub>, TEM images of both sulfides show lattice fringes with interlayer spacings of 0.62 ± 0.01 nm. The sonochemically prepared MoS<sub>2</sub>, however, shows much greater edge and

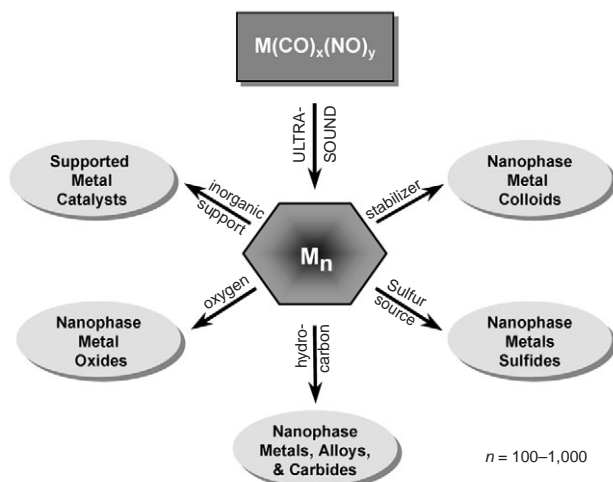
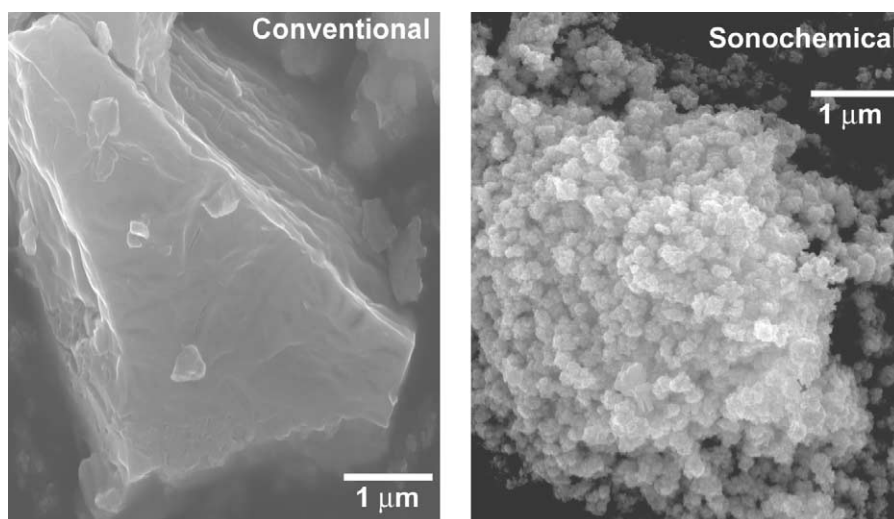


Figure 4 Sonochemical synthesis of nanostructured inorganic materials.





**Figure 5** Morphology of conventional and sonochemically prepared MoS<sub>2</sub>.

defect content, as the layers must bend, break, or otherwise distort to form the outer surface. It is well established that the activity of MoS<sub>2</sub> is localized at the edges and not on the flat basal planes. Given the inherently higher edge concentrations in nanostructured materials, the catalytic properties of sonochemically prepared MoS<sub>2</sub> shows substantially increased activity for hydrodesulfurization.

Using a very different route, Grieser and co-workers have sonochemically produced nanocrystalline CdS colloids.<sup>30</sup> *In situ*-generated hydrogen sulfide from the sonication of 2-mercaptoacetic acid acted as the sulfiding agent. Spectroscopic studies revealed that sonication produces CdS particles in the quantum dot range (“Q-state”, ~3 nm diameter in this study) and the sonication time and the thiol type determine the particle size distribution.

#### 1.41.3.3 Heterogeneous Sonochemistry: Reactions of Solids with Liquids

The use of ultrasound to accelerate chemical reactions in heterogeneous systems has become increasingly widespread. The physical phenomena that are responsible include the creation of emulsions at liquid–liquid interfaces, the generation of cavitation erosion and cleaning at liquid–solid interfaces, the production of shockwave damage and deformation of solid surfaces, the enhancement in surface area from fragmentation of friable solids, and the improvement of mass transport from turbulent mixing and acoustic streaming.

The use of high-intensity ultrasound to enhance the reactivity of metal powders and surfaces as stoichiometric reagents has become an especially routine synthetic technique for many heterogeneous organic and organometallic reactions,<sup>1–3</sup> particularly those involving reactive metals such as Mg, Li, or Zn. This development originated from the early work of Renaud and the more recent breakthroughs of Luche.<sup>3</sup> The effects are quite general and apply to reactive inorganic salts and to main group reagents as well. Less work has been done with unreactive metals (e.g., V, Nb, Mo, W), but results here are promising as well. Rate enhancements of more than 10-fold are common, yields are often substantially improved, and by-products avoided. A range of synthetically useful examples of heterogeneous sonochemical reactions are listed in Table 1.

The mechanism of the sonochemical rate enhancements in both stoichiometric and catalytic reactions of metals is associated with dramatic changes in morphology of both large extended surfaces and of powders. As discussed earlier, these changes originate from microjet impact on large surfaces and high-velocity interparticle collisions in slurries. Surface composition studies by Auger electron spectroscopy and sputtered neutral mass spectrometry reveal that ultrasonic irradiation effectively removes surface oxide and other contaminating coatings.<sup>9</sup> The removal of such passivating coatings can dramatically improve reaction rates. The reactivity of clean metal surfaces also appears to be responsible for the greater tendency for heterogeneous sonochemical reactions to involve single electron transfer rather than acid-base chemistry.<sup>31</sup>

Significant applications of sonochemistry to heterogeneous catalysis have also been noted.<sup>32</sup> Among the more impressive results are hydrogenations and hydrosilations by Ni powder, Raney

**Table 1** Some representative examples of heterogeneous sonochemistry.

<i>Heterogeneous reagent</i>	<i>Reactant</i>	<i>Products</i>
<b>Compounds of metals</b>		
LiAlH <sub>4</sub>	Ar-X	ArH
LiAlH <sub>4</sub>	R <sub>3</sub> M-X (X = Cl, NR <sub>2</sub> , OR)	R <sub>3</sub> M-H (M = Si, Ge, Sn)
Al <sub>2</sub> O <sub>3</sub>	C <sub>6</sub> H <sub>5</sub> CH <sub>2</sub> Br + KCN	C <sub>6</sub> H <sub>5</sub> CH <sub>2</sub> CN
KMnO <sub>4</sub>	RR'HCOH	RR'CO
CrO <sub>2</sub> Cl <sub>2</sub>	RR'HCOH	RR'CO
HBR <sub>2</sub>	R' <sub>2</sub> C=CR' <sub>2</sub>	HR' <sub>2</sub> C-CR' <sub>2</sub> (BR <sub>2</sub> )
MS <sub>2</sub> , V <sub>2</sub> O <sub>5</sub>	NR <sub>3</sub> , py, Cp <sub>2</sub> Co	Intercalates
<b>Hg</b>	(HR <sub>2</sub> BrC) <sub>2</sub> CO + R'CO <sub>2</sub> H (HR <sub>2</sub> BrC) <sub>2</sub> CO + R'OH	(HR <sub>2</sub> C)CO(C(O <sub>2</sub> CR')R <sub>2</sub> ) (HR <sub>2</sub> C)CO(C(OR')R <sub>2</sub> )
<b>Mg</b>	R-Br R <sub>2</sub> C=CHCH <sub>2</sub> Cl + Mg/C <sub>14</sub> H <sub>14</sub>	R-MgBr R <sub>2</sub> C=CHCH <sub>2</sub> MgCl
<b>Li</b>	R-Br (R = Pr, n-Bu, Ph) R-Br + R'R''CO R-Br + (H <sub>3</sub> C) <sub>2</sub> NCHO R <sub>3</sub> M-Cl (M = C, Si, Sn) R <sub>2</sub> SiCl <sub>2</sub> (R = arenes) R <sub>2</sub> MCl <sub>2</sub> + Na + Se (M = Si, Sn)	R-Li RR'R''COH RCHO R <sub>3</sub> MMR <sub>3</sub> cyclo-(R <sub>2</sub> Si) <sub>3</sub> (R <sub>2</sub> MSe) <sub>3</sub>
<b>Zn</b>	CF <sub>3</sub> I + RR'C=O C <sub>n</sub> F <sub>2n+1</sub> I + CO <sub>2</sub> RR'C=O + BrCH <sub>2</sub> CO <sub>2</sub> R'' PhBr + RCOCH=CHR' + Ni(acac) <sub>2</sub> RR'C=O + R'' <sub>2</sub> C=CHCH <sub>2</sub> Br	RR'C(OH)CF <sub>3</sub> C <sub>n</sub> F <sub>2n+1</sub> CO <sub>2</sub> H RR'C(OH)CH <sub>2</sub> CO <sub>2</sub> R'' RCOCH <sub>2</sub> CHR'Ph (R = H, alkyl) RR'(HO)CCR'' <sub>2</sub> CH=CH <sub>2</sub>
<b>Transition metals</b>	MCl <sub>5</sub> + Na + CO (M = V, Nb, Ta) MCl <sub>6</sub> + Na + CO (M = Cr, Mo, W) MnCl <sub>3</sub> + Na + CO FeCl <sub>3</sub> + Na + CO Fe <sub>2</sub> (CO) <sub>9</sub> + alkenylepoxide Fe <sub>2</sub> (CO) <sub>9</sub> + RHC=CR'-CH=CHR' NiCl <sub>2</sub> + Na + CO NiCl <sub>2</sub> + Na + bipy + COD/CDT Co(acac) <sub>3</sub> + C <sub>5</sub> H <sub>6</sub> + COD + Mg/C <sub>14</sub> H <sub>10</sub> RuCl <sub>3</sub> + Li + 1,5-cyclooctadiene [Fe(C <sub>5</sub> R <sub>5</sub> )(CO) <sub>2</sub> ] <sub>2</sub> + K + Ph <sub>3</sub> C <sup>+</sup> [M(C <sub>5</sub> R <sub>5</sub> )(CO) <sub>n</sub> ] <sub>2</sub> + K (M = Fe, Ru, Mo) Pd + CH <sub>2</sub> =CHCH <sub>2</sub> X La + NH <sub>4</sub> SCN in HMPA Cu + <i>o</i> -C <sub>6</sub> H <sub>4</sub> (NO <sub>2</sub> )I	M(CO) <sub>6</sub> <sup>-</sup> M <sub>2</sub> (CO) <sub>10</sub> <sup>-2</sup> Mn(CO) <sub>5</sub> <sup>-</sup> Fe(CO) <sub>4</sub> <sup>-2</sup> + Fe <sub>2</sub> (CO) <sub>8</sub> <sup>-2</sup> Fe(CO) <sub>3</sub> (π-allyllactone) Fe(CO) <sub>3</sub> (η <sup>4</sup> -diene) Ni <sub>6</sub> (CO) <sub>12</sub> <sup>-2</sup> Ni(bipy)(COD/CDT) Co(Cp)(COD) (η <sup>6</sup> -1,3,5-COT)(η <sup>4</sup> -1,5-COD)Ru(0) Fe(C <sub>5</sub> R <sub>5</sub> )(CO) <sub>2</sub> (C <sub>2</sub> H <sub>4</sub> ) <sup>+</sup> [M(C <sub>5</sub> R <sub>5</sub> )(CO) <sub>n</sub> ] <sup>-</sup> [(η <sup>3</sup> -H <sub>2</sub> C-CH-CH <sub>2</sub> )Pd(X)] <sub>2</sub> La(NCS) <sub>3</sub> ·4HMPA <i>o</i> -(O <sub>2</sub> N)H <sub>4</sub> C <sub>6</sub> -C <sub>6</sub> H <sub>4</sub> (NO <sub>2</sub> )

Ni, and Pd or Pt on carbon. For example, the hydrogenation of alkenes by Ni powder is enormously enhanced (>10<sup>5</sup>-fold) by ultrasonic irradiation.<sup>10</sup> This dramatic increase in catalytic activity is due to the formation of uncontaminated metal surfaces from interparticle collisions caused by cavitation-induced shockwaves.

#### 1.41.4 CONCLUSIONS

Since the early 1980s, sonochemistry has become a well-defined technique for both mechanistic and synthetic studies. The general details of the process of acoustic cavitation and the high-energy

chemistry generated during such bubble collapse are now reasonably well understood. The major challenges that face a wider application of this technology include issues of scale-up and energy efficiency. While laboratory equipment for sonochemical reactors are readily available commercially, larger-scale apparatus is only now becoming commercially available. Perhaps more importantly, sonochemistry shares with photochemistry an energy inefficiency that remains problematic: while the production of ultrasound from electrical power can be extremely efficient, the coupling of ultrasound into chemically useful cavitation events remains a low-yield event. As we begin to understand the physics of cavitation clouds and dense multiphase acoustics, more effective means of inducing cavitation in liquids may alleviate this current limitation.

## 1.41.5 REFERENCES

1. Crum, L. A.; Mason, T. J.; Reisse, J.; Suslick, K. S., Eds. *Sonochemistry and Sonoluminescence*, NATO ASI Series C, v. 524; Kluwer: Dordrecht, The Netherlands, 1999.
2. Mason, T. J.; Lorimer, J. P. *Sonochemistry: Theory, Applications and Uses of Ultrasound in Chemistry* **1988**, Ellis Horwood: Chichester, UK.
3. Luche, J.-L. *Synthetic Organic Sonochemistry* **1998**, New York: Plenum.
4. Suslick, K. S.; Cline, Jr., R. E.; Hammerton, D. A. *J. Am. Chem. Soc.* **1986**, *108*, 5641–5642.
5. Flint, E. B.; Suslick, K. S. *Science* **1991**, *253*, 1397–1399.
6. McNamara III, W. B.; Didenko, Y.; Suslick, K. S. *Nature* **1999**, *401*, 772–775.
7. Leighton, T. G. *The Acoustic Bubble* **1994**, Academic Press: London.
8. Suslick, K. S.; Doktycz, S. J. *Science* **1990**, *247*, 1067–1069.
9. Suslick, K. S.; Doktycz, S. J. *Adv. Sonochem.* **1990**, *1*, 197–230.
10. Suslick, K. S.; Casadonte, D. J. *J. Am. Chem. Soc.* **1987**, *109*, 3459–3461.
11. Crum, L. A. *Phys. Today* **1994**, *47*, 22–29.
12. S. J. Putterman, *Sci. Am.* **1995**, (Feb.), 46–52.
13. Lord Rayleigh, *Philos. Mag. Ser. 6* **1917**, *34*, 94–98.
14. Richards, W. T.; Loomis, A. L. *J. Am. Chem. Soc.* **1927**, *49*, 3086–3100.
15. Frenzel, H.; Schultes, H. Z. *Phys. Chem.* **1934**, *27b*, 421–424.
16. Suslick, K. S.; Crum, L. A. Sonochemistry and Sonoluminescence. In *Encyclopedia of Acoustics*; Crocker, M. J., Ed., Wiley-Interscience: New York, 1997; Vol. 1, pp 271–282.
17. Riesz, P. *Adv. Sonochem.* **1991**, *2*, 23–64.
18. Margulis, M. A.; Maximenko, N. A. *Adv. Sonochem.* **1991**, *2*, 253–292.
19. Destailhats, H.; Lesko, T. M.; Knowlton, M.; Wallace, H.; Hoffmann, M. R. *Ind. Eng. Chem. Res.* **2001**, *40*, 3855–3860.
20. Suslick, K. S.; Gawienowski, J. W.; Schubert, P. F.; Wang, H. H. *J. Phys. Chem.* **1983**, *87*, 2299–2301.
21. Suslick, K. S. *Adv. Organomet. Chem.* **1986**, *25*, 73–119.
22. Suslick, K. S.; Price, G. *Annu. Rev. Mater. Sci.* **1999**, *29*, 295–326.
23. Suslick, K. S.; Choe, S. B.; Cichowlas, A. A.; Grinstaff, M. W. *Nature* **1991**, *353*, 414–416.
24. Grinstaff, M. W.; Salamon, M. B.; Suslick, K. S. *Phys. Rev. B* **1993**, *48*, 269–273.
25. Hyeon, T.; Fang, M.; Suslick, K. S. *J. Am. Chem. Soc.* **1996**, *118*, 5492–5493.
26. Cao, X.; Prozorov, R.; Koltypin, Y.; Kataby, G.; Felner, I.; Gedanken, A. *J. Mater. Res.* **1997**, *122*, 402–406.
27. Shafi, K. V. P. M.; Koltypin, Y.; Gedanken, A.; Prozorov, R.; Balogh, J.; Lendvai, J.; Felner, I. *J. Phys. Chem. B.* **1997**, *101*, 6409–6414.
28. Kataby, G.; Prozorov, T.; Koltypin, Y.; Cohen, H.; Sukenik, C. N.; Ulman, A.; Gedanken, A. *Langmuir* **1997**, *13*, 6151–6158.
29. Mdeleleni, M. M.; Hyeon, T.; Suslick, K. S. *J. Am. Chem. Soc.* **1998**, *120*, 6189–6190.
30. Sostaric, J. Z.; Carusohobson, R. A.; Mulvaney, P.; Grieser, F. *J. Chem. Soc. Faraday Trans.* **1997**, *93*, 1791–1795.
31. Luche, J.-L. *Ultrasonics Sonochem.* **1994**, *1*, S111.
32. Suslick, K. S. In *Handbook of Heterogeneous Catalysis*; Ertl, G.; Knozinger, H.; Weitkamp, J., Eds.; Wiley-VCH: Weinheim, 1997; Vol. 3, pp 1350–1357.



# 1.42

## Microwave Heating

A. HARRISON and A. G. WHITTAKER  
*University of Edinburgh, UK*

---

1.42.1	INTRODUCTION: MICROWAVES IN CONDENSED PHASE CHEMISTRY	741
1.42.2	MECHANISMS OF MICROWAVE HEATING IN CONDENSED MATTER	741
1.42.3	COMPARISON OF MICROWAVE AND CONVENTIONAL HEATING	742
1.42.3.1	Microwave-specific Effects	743
1.42.3.2	Nonthermal Effects	743
1.42.4	MICROWAVE EQUIPMENT	743
1.42.4.1	Microwave Applicators	743
1.42.4.2	Reaction Vessels	744
1.42.4.3	Temperature Measurement	744
1.42.5	SPECIFIC APPLICATIONS TO COORDINATION CHEMISTRY	744
1.42.6	CONCLUSIONS	744
1.42.7	REFERENCES	745

---

### 1.42.1 INTRODUCTION: MICROWAVES IN CONDENSED PHASE CHEMISTRY

The potential for microwave radiation to stimulate reactions in ceramics was recognized as early as the 1960s,<sup>1</sup> but it was only applied to liquid-phase syntheses in the mid-1980s.<sup>2,3</sup> The technique is now widely accepted in many areas of chemical synthesis,<sup>4-10</sup> as well as materials preparation and processing,<sup>11</sup> medicinal<sup>12</sup> and environmental chemistry,<sup>13,14</sup> and chemical analysis.<sup>13</sup> It may, therefore, also offer advantages in coordination chemistry, in the synthesis of ligands, assembly or modification of complexes, and in chemical applications of such species.<sup>15,16</sup> In particular, microwave heating may increase reaction rates, improve yields, and produce different product distributions, all of which have contributed to a dramatic rise in its popularity since the late 1980s. A contributing factor to this trend has been the easy access to inexpensive equipment for microwave chemistry, and in particular to domestic microwave ovens. However, this has proved a mixed blessing, because such equipment is not ideal for controlled and predictable application of the technique, and has perhaps contributed to its reputation for poor reproducibility.

This chapter describes the basic mechanisms of microwave heating of condensed phases, and by contrasting these with conventional methods, illustrates the advantages that microwave heating may offer synthetic chemists. The basic practices of microwave chemistry are discussed, and key applications in coordination chemistry are briefly reviewed.

### 1.42.2 MECHANISMS OF MICROWAVE HEATING IN CONDENSED MATTER

Microwaves are electromagnetic waves with frequencies between 30 GHz and 0.3 GHz, corresponding to wavelengths from 1 cm to 1 m. To avoid interference with radar and telecommunications, industrial and domestic microwave apparatus may only operate at wavelengths regulated at both national and international levels. In the majority of countries,

2.45 ( $\pm 0.05$ ) GHz is the major operating frequency for such purposes, and is used in all domestic ovens.

Microwave heating effects result primarily from the interaction of the electric component of the microwave with dipoles or charged particles in a material. The response of the system to such fluctuating fields is described by the complex *dielectric constant*,  $\epsilon^*$ .<sup>17</sup> This may be expressed as the sum of real ( $\epsilon'$ ) and imaginary ( $\epsilon''$ ) dielectric constants:

$$\epsilon^* = \epsilon' + i\epsilon''$$

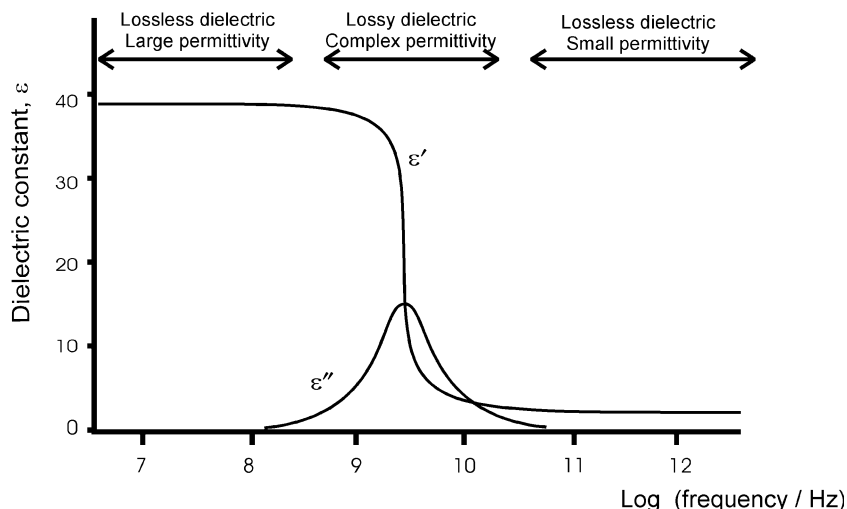
where  $\epsilon'$  represents the substance's *polarizability* in phase with an external electric field, and  $\epsilon''$  represents the out of phase polarizability. To gain further insight into  $\epsilon^*$ , consider the case of a liquid containing dipolar molecules, which is the most common system in which microwave chemistry is performed.  $\epsilon^*$  depends on the extent to which dipoles align with the field, and it will clearly also depend on the frequency of the radiation in relation to the *relaxation time*,  $\tau$ , of the dipoles (Figure 1). At field frequencies much lower than  $1/\tau$ , all dipole reorientation takes place in phase with the electric field and the energy transfer from the field to the liquid is negligible. At frequencies much higher than  $1/\tau$ , dipole reorientation is too slow to contribute to the polarization. At frequencies comparable to  $1/\tau$ , dipolar polarization takes place, but with a phase lag of  $\delta$  radians between the dipole and the field. This phase difference causes random collisions, giving rise to dielectric heating. The efficiency of the heating is proportional to the "loss tangent,"  $\tan(\delta)$ , which may be calculated from:

$$\tan \delta = \epsilon''/\epsilon'$$

In addition to the dipolar polarization term, a significant heating effect may also result from resistive heating, as charge carriers are displaced under the influence of the field. This term is significant in solid conductors such as some forms of carbon, and aqueous electrolyte solutions where ionic conduction gives rise to a heating effect comparable to that from dipolar loss terms.

### 1.42.3 COMPARISON OF MICROWAVE AND CONVENTIONAL HEATING

Microwave heating differs from conventional heating in several respects. First, energy is only transferred directly to those reaction components that are susceptible to microwave polarization. This may improve energy efficiency, reducing the need to heat vessels or the heating apparatus itself; it may allow energy to be directed into specific parts of the reactive system such as metal particles,<sup>18</sup> or susceptible solid supports.<sup>19,20</sup> In some cases, this reduces or eliminates the need for solvents, with obvious economic and environmental benefits.<sup>21</sup> A second consequence of this



**Figure 1** Variation of  $\epsilon'$  and  $\epsilon''$  with frequency for methanol. The maximum in  $\epsilon''$  occurs at a frequency  $1/2\pi\tau$ .

direct heating is that it is possible to raise the temperature of a sample much faster than with conventional methods, frequently leading to quite different kinetics.<sup>22</sup> Finally, microwave heating may be applied to a sample from a remote source via a waveguide enabling processing in hazardous environments.

Differences between chemistry observed with microwave and conventional heating can often be attributed to the different transfer rate or spatial distribution of heat. Once appropriate temperatures are known in various parts of the system, conventional laws of thermodynamics or kinetics commonly apply. Such cases may be called *microwave specific effects*. However, there are also cases where it is proposed that an additional effect operates, perhaps through the action of the electric field,<sup>23</sup> such effects are commonly called *nonthermal* or *athermal* microwave effects. Although their existence is controversial in fluid phases,<sup>6,24–26</sup> there is a strong body of evidence supporting such effects in solid phases.<sup>27–29</sup>

#### 1.42.3.1 Microwave-specific Effects

The most common microwave-specific effect in liquids is superheating, whereby microwave-heated solvents boil at up to 30 °C above their thermodynamic boiling point. This is widely believed to be responsible for the rate and yield increases that accompany many liquid phase reactions.<sup>4</sup> To take full advantage of this effect, reagents should be sealed in vessels made of microwave transparent materials, allowing yet higher temperatures to be reached. A particularly important application of the decreased reaction times that result from microwave processing is in the *synthesis of radiolabeled chemicals*. The location of pharmaceutical products using positron emission tomography during preclinical trials relies on the use of a number of nuclides with very short half-lives.<sup>30</sup> The most commonly used isotopes for this work include <sup>122</sup>I( $t_{1/2}$  = 3.6 min), <sup>11</sup>C( $t_{1/2}$  = 20 min), and <sup>18</sup>F( $t_{1/2}$  = 110 min), and savings of even a few minutes may dramatically affect the purity of the radioisotopes in their compounds.

The dramatic acceleration of heating rate that may be achieved with microwaves may be exploited in kinetic control of reactions, favoring products that are formed more quickly, rather than products that might be selected thermodynamically.<sup>22</sup> Rapid heating may also minimize the time during which unwanted by-products or degradation may occur.<sup>31</sup> However, this phenomenon has serious implications for safety,<sup>6</sup> with rapid buildup of pressure when sealed vessels are used. Care should also be taken to avoid decomposition of reactants and products through overheating.<sup>32,33</sup> Thus, there are also drawbacks to microwave heating, most of which stem from poor knowledge and control of the temperature of the system when nonspecialized equipment is used.

#### 1.42.3.2 Nonthermal Effects

The question of whether microwaves may induce nonthermal effects is still open to debate.<sup>23,25,26,34</sup> Some earlier claims for specific activation have been shown to arise from incomplete knowledge of temperature and temperature gradients, and often result from microwave-induced superheating of solvents. However, there are cases where the data appear to be reliable, and where activation of a chemical reaction is greater than expected for the particular thermal conditions. The rationale for such effects may be discussed with reference to the Arrhenius law for the rate constant  $k$ :<sup>23</sup>  $k = A \exp(-\Delta G'/RT)$ , where the pre-exponential factor  $A$  may represent the rate of encounter between reacting molecules, and  $\Delta G'$  is the free energy of activation. It has been postulated that electric field component of the microwave radiation may enhance  $A$  through either increased diffusion rates, or enhanced polarization of polar reactants;  $\Delta G'$  may be reduced by the microwave field if there is a significant increase in polarity between the ground and transition state.

### 1.42.4 MICROWAVE EQUIPMENT

#### 1.42.4.1 Microwave Applicators

In a chemical synthesis, microwaves are conveyed from a generator to the sample via an applicator. This is generally a metal enclosure that contains the radiation as standing waves

and is designed to contain either a single standing wave pattern (a monomode or single-mode cavity) or a range of modes (a multimode applicator). Multimode applicators that are suitable for synthetic chemistry are easily constructed from modified domestic ovens, but are also commercially available. They are generally cheaper and simpler to use than monomode cavities, but the positions of wave maxima are difficult to determine and energy transfer to the sample is much less efficient than is possible in a monomode cavity. Monomode cavities are more difficult to set up and maintain, but have a well-defined position of maximum field intensity, and are particularly useful where the sample has poor microwave characteristics, or where energy-transfer studies are of interest. Within any microwave applicator, ports for apparatus are permissible, providing that they are suitably shielded, and ideally with a diameter of less than half the wavelength of the microwaves.<sup>35,36</sup>

#### 1.42.4.2 Reaction Vessels

Reaction containment during microwave syntheses is relatively straightforward, but some limitations are imposed, as vessel materials must be both mechanically robust and microwave transparent. Ambient and elevated pressure vessels may be constructed from standard laboratory glassware, polytetrafluoro-ethylene (PTFE), or other microwave-transparent polymers, although vessels specifically tailored for microwave synthesis are commercially available.

#### 1.42.4.3 Temperature Measurement

Reliable temperature measurement in a microwave reaction presents a considerable challenge to the experimentalist, as the microwave field directly affects conventional instruments such as thermometers and thermocouples. Although thermocouples *may* be used if they are suitably shielded and earthed, there is an inevitable perturbation to the microwave field pattern. A number of other methods are available that are appropriate to use at moderate temperatures. A gas pressure thermometer, or a microwave-transparent liquid thermometer, may be used as inexpensive options, whilst thermal imaging and fluoro-optic thermometry, although expensive, provide more reliable, higher precision information.

### 1.42.5 SPECIFIC APPLICATIONS TO COORDINATION CHEMISTRY

The routine application of microwave heating to small-molecule organic syntheses clearly has important implications for coordination chemistry, and there are extensive reviews<sup>4-7,9,10</sup> of a great number of reactions that are accelerated in this manner to produce potential ligands. Microwave heating may also speed the assembly<sup>37</sup> or modification<sup>9</sup> of complexed metal centers, particularly where more conventional methods are greatly slowed by steric hindrance<sup>38</sup> or electronic factors.<sup>39</sup> Provided care is taken not to overheat the system, which frequently leads to degradation of reactants or products, selectivity may be comparable to that achieved with conventional methods; high stereoselectivity may be found in microwave-driven preparations of both optically active ligands<sup>40</sup> and complexes.<sup>41</sup>

Microwave irradiation is also used extensively to hasten reactions in which coordination compounds act as catalysts. The extent to which microwave methods are currently exploited in this area of synthesis reflects the more general level of interest in the development of synthetic methodology. There is vigorous activity in cross-coupling methods of C—C bond formation, such as the Pd-catalyzed Heck,<sup>42</sup> Suzuki,<sup>43</sup> and Stille<sup>44</sup> reactions to link *sp*<sup>2</sup>-hybridized carbon atoms<sup>45,46</sup> with dramatic rate enhancement over conventional methods through microwave heating. Asymmetric reactions may also be greatly accelerated under microwave irradiation,<sup>47</sup> though enantioselectivity may suffer.<sup>32</sup>

#### 1.42.6 CONCLUSIONS

Microwave radiation is a widely used tool in the synthesis and chemical application of coordination compounds. Problems of control and reproducibility encountered when using domestic

microwave equipment may be avoided through the use of purpose-built, single-mode ovens with accurate temperature monitoring and power control. Applied well, the technique may accelerate many reactions greatly, and may also provide ways of reducing or eliminating solvents, of taking greater advantage of water as a reaction medium, and accelerating a wide range of reactions on solid supports, including combinatorial processes.<sup>19,20</sup>

### 1.42.7 REFERENCES

1. Booske, J. H.; Cooper, R. F. *Mat. Res. Innovat.* **1997**, *1*, 77–84.
2. Gedye, R.; Smith, F.; Westaway, K.; Ali, H.; Baldisera, L.; Lanerge, L.; Rousell, J. *Tetrahedron Lett.* **1986**, *27*, 279–282.
3. Giguere, R. J.; Bray, T. L.; Duncan, S. M.; Majitech, G. *Tetrahedron Lett.* **1986**, *27*, 4945–4948.
4. Mingos, D. M. P.; Baghurst, D. R. *Chem. Soc. Rev.* **1991**, *20*, 1–47.
5. Caddick, S. *Tetrahedron* **1995**, *51*, 10403–10432.
6. Strauss, C. R.; Trainor, R. W. *Aust. J. Chem.* **1995**, *48*, 1665–1692.
7. Galema, S. A. *Chem. Soc. Rev.* **1997**, *26*, 233–238.
8. Strauss, C. R. *Aust. J. Chem.* **1999**, *52*, 83–96.
9. Lidstrom, P.; Tierney, J.; Wathey, B.; Westman, J. *Tetrahedron* **2001**, *57*, 9225–9283.
10. Anderson, N. G. *Org. Proc. Res. Devel.* **2001**, *5*, 613–621.
11. Rao, K. J.; Vaidhyanathan, B.; Ganguli, M.; Ramakrishnan, P. A. *Chem. Mat.* **1999**, *11*, 882–895.
12. Larhed, M.; Hallberg, A. *Drug Discov. Today* **2001**, *6*, 406–416.
13. Zlotorzynski, A. *Crit. Rev. Anal. Chem.* **1995**, *25*, 43–76.
14. Letellier, M.; Budzinski, H. *Analysis* **1999**, *27*, 259–271.
15. Baghurst, D. R.; Mingos, D. M. P.; Watson, M. J. *J. Organomet. Chem.* **1989**, *368*, C43–C45.
16. Whittaker, A. G.; Mingos, D. M. P. In *Chemistry under Extreme or Non-classical Conditions*; van Eldik, R., Hubbard, C. Eds.; Wiley: New York, 1996; pp 479–514.
17. Fröhlich, H. *Theory of Dielectrics*; Oxford University Press, Oxford, U.K., 1958.
18. Whittaker, A. G.; Mingos, D. *J. Chem. Soc., Dalton Trans* **1995**, 2073–2079.
19. Cotterill, I. C.; Usyatinsky, A. Y.; Arnold, J. M.; Clark, D. S.; Dordick, J. S.; Michels, P. C.; Khmelnistky, Y. L. *Tetrahedron Lett.* **1998**, *39*, 1117–1120.
20. Usyatinsky, A. Y.; Khmelnistky, Y. L. *Tetrahedron Lett.* **2000**, *41*, 5031–5034.
21. Jun, C. H.; Chung, J. H.; Lee, D. Y.; Loupy, A.; Chatti, S. *Tetrahedron Lett.* **2001**, *42*, 4803–4805.
22. Stuerge, D.; Gonon, K.; Lallemand, M. *Tetrahedron* **1993**, *49*, 6229–6234.
23. Perreux, L.; Loupy, A. *Tetrahedron* **2001**, *57*, 9199–9223.
24. Jacob, J.; Chia, L. H. L.; Boey, F. Y. C. *J. Mater. Sci.* **1995**, *30*, 5321–5327.
25. Stuerge, D. A. C.; Gaillard, P. *J. Microw. Power Electromagn. Energy* **1996**, *31*, 87–100.
26. Stuerge, D. A. C.; Gaillard, P. *J. Microw. Power Electromagn. Energy* **1996**, *31*, 101–113.
27. Booske, J. H.; Cooper, R. F.; Dobson, I. *J. Mat. Res.* **1992**, *7*, 495–501.
28. Freeman, S. A.; Booske, J. H.; Cooper, R. F. *J. Appl. Phys.* **1998**, *83*, 5761.
29. Booske, J. H.; Cooper, R. F. In *8th International AMPERE Conference on Microwave Heating*; Bayreuth, Germany, Sept 3–7, 2001; Willert-Porada, M. Ed.; AMPERE, Cambridge, U.K., 2001.
30. Sasaki, S.; Ishibashi, N.; Kuwamura, T.; Sano, H.; Matoba, M.; Nisikawa, T.; Maeda, M. *Bioorg. Med. Chem. Lett.* **1998**, *8*, 2983–2986.
31. Nilsson, P.; Larhed, M.; Hallberg, A. *J. Am. Chem. Soc.* **2001**, *123*, 8217–8225.
32. Lutsenko, S.; Moberg, C. *Tetrahedron-Asymmetry* **2001**, *12*, 2529–2532.
33. Olofsson, K.; Sahlin, H.; Larhed, M.; Hallberg, A. *J. Org. Chem.* **2001**, *66*, 544–549.
34. Abramovich, R. A. *Org. Prep. Proc. Int.* **1991**, *23*, 683–711.
35. Kingston, H. M.; Haswell, S. J., Eds. *Microwave-Enhanced Chemistry: Fundamentals, Sample Preparation, and Applications*; American Chemical Society: Washington, DC, 1997.
36. Kraus, J. D.; Fleisch, D. A. *Electromagnetics with Applications*; McGraw-Hill: Singapore, 1999.
37. Baghurst, D. R.; Cooper, S. R.; Greene, D. L.; Mingos, D. M. P.; Reynolds, S. M. *Polyhedron* **1990**, *9*, 893–895.
38. Dabirmanesh, Q.; Roberts, R. M. G. *J. Organomet. Chem.* **1997**, *542*, 99–103.
39. Liao, J. H.; Chen, P. L.; Hsu, C. C. *J. Phys. Chem. Solids* **2001**, *62*, 1629–1642.
40. Pezet, F.; Sasaki, I.; Daran, J. C.; Hydrio, J.; Ait-Haddou, H.; Balavoine, G. *Eur. J. Inorg. Chem.* **2001**, 2669–2674.
41. Pezet, F.; Daran, J. C.; Sasaki, I.; Ait-Haddou, H.; Balavoine, G. G. A. *Organometallics* **2000**, *19*, 4008–4015.
42. Olofsson, K.; Larhed, M.; Hallberg, A. *J. Org. Chem.* **1998**, *63*, 5076–5079.
43. Larhed, M.; Lindeberg, G.; Hallberg, A. *Tetrahedron Lett.* **1996**, *37*, 8219–8222.
44. Larhed, M.; Hoshino, M.; Hadida, S.; Curran, D. P.; Hallberg, A. *J. Org. Chem.* **1997**, *62*, 5583–5587.
45. Bremberg, U.; Larhed, M.; Moberg, C.; Hallberg, A. *J. Org. Chem.* **1999**, *64*, 1082–1083.
46. Vallin, K. S. A.; Larhed, M.; Johansson, K.; Hallberg, A. *J. Org. Chem.* **2000**, *65*, 4537–4542.
47. Banik, B. K.; Manhas, M. S.; Robb, E. W.; Bose, A. K. *Heterocycles* **1997**, *44*, 405–415.

# 1.43

## Assemblies and Self-assembly

G. F. SWIEGERS

*Commonwealth Scientific and Industrial Research Organisation  
(CSIRO), Melbourne, Vic., Australia*

---

1.43.1	INTRODUCTION	747
1.43.2	TYPES OF SELF-ASSEMBLY AND THEIR UTILITY IN DESIGNED SYNTHESIS	747
1.43.3	THERMODYNAMIC SELF-ASSEMBLY	748
1.43.4	COMMON SYNTHETIC SELF-ASSEMBLY STRATEGIES	749
1.43.4.1	Mismatching Ligand and Metal Preferences	749
1.43.4.2	Entropy-driven Self-assembly	750
1.43.4.3	Self-assembly Involving Geometric Complementarity	751
1.43.4.4	Symmetry-driven Self-assembly	752
1.43.4.5	Stoichiometry-driven Self-assembly	752
1.43.4.6	“Rings-and-strings” Self-assembly	754
1.43.4.7	Multiple-interaction Self-assembly	757
1.43.5	CONCLUSION	758
1.43.6	REFERENCES	758

---

### 1.43.1 INTRODUCTION

The study of self-assembling systems in coordination chemistry has delivered a wide variety of discrete, hierarchical molecular architectures in recent years, including twisted structures (e.g., helicates); latticed structures (e.g., grids, racks, arrays); filamentous structures (e.g., rods, metallo dendrimers); closed structures (e.g., 2-D and 3-D geometric metallocycles); and interlaced structures (e.g., rotaxanes, catenanes, knots).<sup>1-4</sup> The formation of these materials has been achieved largely because of an improved understanding of the self-assembly process, particularly in regard to its manipulation for synthetic ends. A number of strategies have been developed to allow the assembly of coordination compounds by rational design. The ability to deliberately synthesize complexes having particular shapes is a crucial step in discovering novel physico-chemical properties associated with new architectures. Just as the shape of bio-molecules such as folded proteins or helically twisted nucleic acids endows them with some remarkable physical and chemical properties, so those of coordination compounds prospectively offer a vista of novel properties and applications (some of which are already under investigation<sup>5</sup>).

This section briefly discusses the use of self-assembly in the designed synthesis of coordination compounds having higher structures. The different types of self-assembly are reviewed, along with factors which influence them. Certain well-known synthetic strategies are also described.

### 1.43.2 TYPES OF SELF-ASSEMBLY AND THEIR UTILITY IN DESIGNED SYNTHESIS

Self-assembly involves the spontaneous aggregation of molecules into stable, noncovalently joined ensembles displaying 3-D order. Coordinate bonds are noncovalent interactions that have greater



directionality and higher bond energy (ca. 40–120 kJ mol<sup>-1</sup>)<sup>4</sup> than other such interactions; cf. van der Waals attractions (bond energy ca. 1–5 kJ mol<sup>-1</sup>),<sup>6</sup> ion-pairing interactions (ca. 12–20 kJ mol<sup>-1</sup>),<sup>6</sup> hydrophobic/hydrophilic interactions (ca. 12–15 kJ mol<sup>-1</sup>),<sup>1</sup> hydrogen bonding (ca. 10–20 kJ mol<sup>-1</sup>),<sup>6</sup> and  $\pi\pi$  donor–acceptor interactions (free energy of complexation ca. 7–20 kJ mol<sup>-1</sup>).<sup>4</sup> The availability of self-assembly for the formation of coordination compounds therefore offers an important avenue to generate securely fastened and well-defined metal-containing compounds having complicated and hierarchical structures.

Several types of self-assembly have been identified from the biological literature:<sup>7</sup> (i) thermodynamic self-assembly; (ii) irreversible self-assembly; (iii) assisted and directed self-assembly; and (iv) self-assembly with pre-, post-, or intermittent modification.

Thermodynamic self-assembly has been most widely used as a synthetic technique in coordination chemistry. It involves the establishment of a kinetically rapid, reversible, thermodynamic equilibrium in solution which results in the energetically most stable product being formed in the greatest proportions. Because the equilibrium is reversible, the individual coordinate bonds need not form in the desired manner each and every time. Instead, the constant forming and reforming of bonds in the solution results in “incorrect” bonds being undone and associating “correctly” under a thermodynamic impetus. Thermodynamic self-assembly therefore has the unique property of being “self-correcting.”

Irreversible self-assembly involves a series of steps which cascade down a particular pathway, guided by kinetic influences. The products of each step in the assembly are kinetically stable, so that each coordinate bond must be formed correctly the first time for the assembly to proceed successfully. While several designed self-assembly processes appear to occur irreversibly, the generality of such procedures must be considered uncertain.

Assisted and directed self-assembly are derivatives of thermodynamic and irreversible self-assembly in which an external agent or template either prevents the formation of non-functional intermediates (assisted self-assembly), or stabilizes key intermediates or products (directed self-assembly). The external agent need not appear in the final product. Numerous examples of directed self-assembly, in particular, have been described. Such systems provide important new pathways to novel structures. However, the factors controlling such processes are often not easily rationalized.

Self-assembly processes involving covalent modifications typically comprise one of the earlier classes of self-assembly followed by, preceded by, or intermixed with conventional covalent bond formation. In coordination chemistry, for example, self-assembly with precursor modification means synthesizing the component ligands and metal complexes before carrying out the reaction. Post-modification involves locking a self-assembled structure into a kinetically stable state. Self-assembly with intermittent processing involves combinations of both of these.

### 1.43.3 THERMODYNAMIC SELF-ASSEMBLY

The most important and widely used assembly technique in designed synthesis is thermodynamic self-assembly. Because product selection in such processes is dependent on thermodynamic stability, the key to using this class of self-assembly as a synthetic tool is to ensure that the desired product will be more stable than any possible competing product. This is achieved by reverse engineering the assembly components so that the desired structure is selectively favored. The greater its stability relative to its competitors, the greater will be its proportion in solution.

The easiest way to engineer components in this way is by an astute and discriminating use of rigidity. Rigid or semi-rigid assembly components drastically reduce the binding possibilities available during the self-assembly, and thereby limit competing structures. They also amplify stability differences by reducing the range of possible products. This approach has been widely used. For example, virtually all known geometrically shaped 2-D and 3-D metallocycles employ rigid components,<sup>3</sup> most helicates employ semi-flexible ligands.<sup>2</sup>

Fully flexible components can be used in designed self-assembly, of course, but only when the desired assembly can be selectively stabilized by, for example, steric hindrance in competing structures, or the formation of stable donor-atom bridges, chelate rings, diastereomers, or noncoordinate, noncovalent interactions.<sup>4,8,9</sup> Because such inputs may not be intuitively obvious, designed synthesis using flexible ligands requires a more rigorous and often a computational approach (e.g., in the use of semi-empirical molecular mechanics programs).

Another important characteristic of thermodynamic self-assembly is the relative influence of enthalpy and entropy. Because of the large bond energy involved in coordination, enthalpy constitutes the main driving force for all thermodynamic self-assembly involving coordination

chemistry. Coordinative assemblies always favor the formation of the maximum number of coordinate bonds per assembly component. This has important ramifications. For example, it causes 2-D and 3-D metallocycles to be more stable than their corresponding linear oligomers when ditopic assembly components are employed.<sup>10</sup> It also induces the formation of product mixtures in which the sum of the compound stabilities is greatest. Indeed, this is the only way to obtain many threaded compounds which may be less stable than complexes of their separate components (*vide infra*, Section 1.43.4.6). To avoid complications arising from enthalpic driving forces, most designed self-assembly employs stoichiometric reagent mixtures.

Entropic influences are less significant. However they can be used to selectively stabilize one product over others that have equal enthalpic stability. For example, at high solution concentrations entropy favors the formation of large structures over small ones. Thus, certain binuclear helicates can be transformed into their corresponding tri- or higher multinuclear circular helicates, simply by concentrating the reaction solution; some metallocycles can be transformed into catenanes in the same way (*vide infra*, Sections 1.43.4.2 and 1.43.4.7).

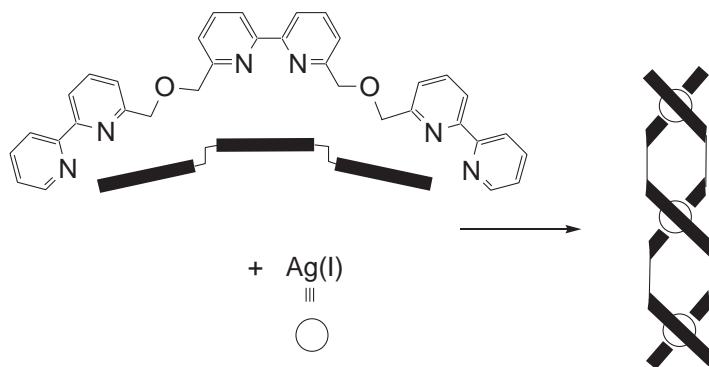
Finally, it should be noted that the compounds assembled in solution during a thermodynamic self-assembly are not necessarily readily obtained in the solid state. Crystal packing forces during the crystallization of such a mixture do, on occasion, favor a minor species in the equilibrium; this is then selectively isolated in the solid state with an accompanying transformation of the mixture. This disadvantage of thermodynamic self-assembly is not unique to coordination chemistry, being experienced also in biological fields such as protein crystallography. The best way to overcome the problem is to ensure that the desired structure is assembled in overwhelming excess, thereby kinetically hindering competitive crystallization by minor species. Alternatively, crystallization can be carried out at different temperatures in a range of solvents. It also seems sensible to design assemblies for maximum physical compactness, because compact molecules appear often to crystallize more readily than expansive ones.<sup>11</sup> If isolation in the solid state is problematic, product solutions can usually be transformed *in situ* into a kinetically stable state.

## 1.43.4 COMMON SYNTHETIC SELF-ASSEMBLY STRATEGIES

### 1.43.4.1 Mismatching Ligand and Metal Preferences

Helicates are multistranded, oligonuclear coordination compounds which are twisted into helical arrangements. Thermodynamic self-assembly of helicates is generally brought about by treating a semiflexible linear polydentate ligand with a kinetically labile metal ion which is too small for the binding cavity that would exist if the ligand was in a planar conformation.<sup>2,12</sup> This mismatch of the ligand binding geometry and the preferred geometry of the metal ion destabilizes the monomeric complex which is often the only competing product in the assembly. The bi- or oligonuclear helicate is then selectively formed.

Mismatches of the topicity of the ligand and metal can also be used to favor helicate formation. (Figure 1) illustrates an example of such a reaction in which the poor flexibility of the ligand and mismatched topicity prevent it from wrapping itself around a single metal ion.<sup>13</sup>



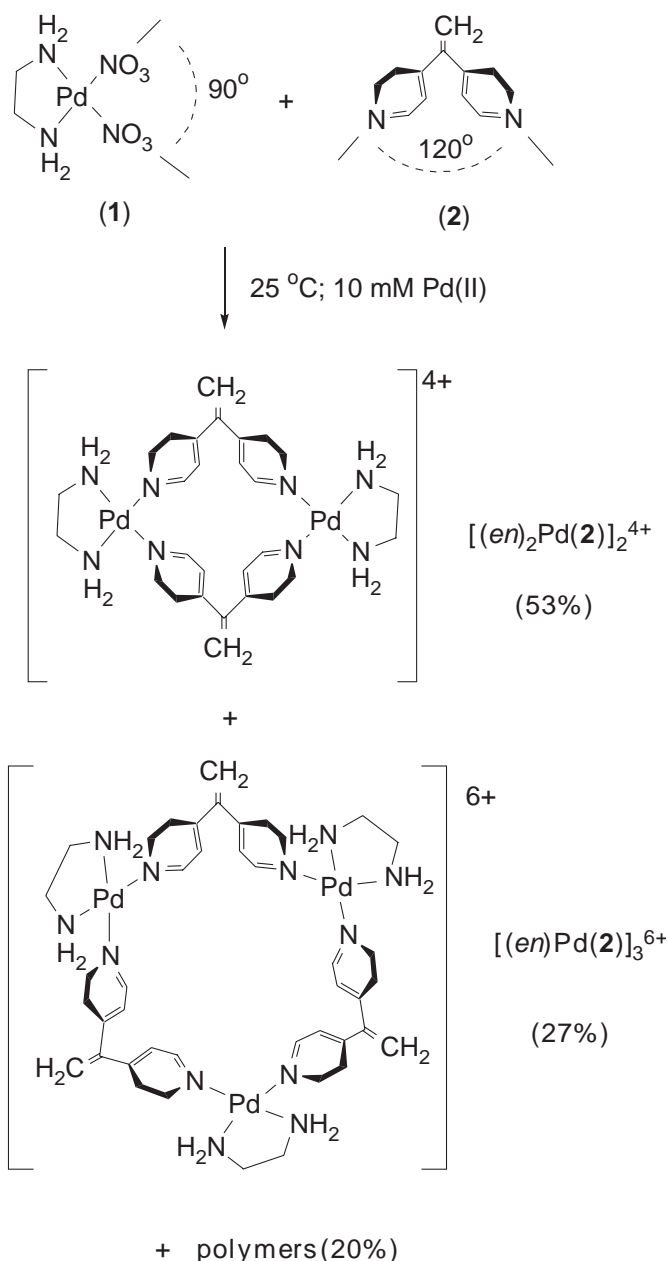
**Figure 1** Mismatching ligand and metal preferences. combining a semi-flexible tris(bipyridine) ligand with a tetrahedral silver(I) ion produces a helicate.



The flexibility and the length of the linkers between the ligand binding sites are crucial in this strategy. Linkers which are too flexible or too long may result in the formation of nonhelical species such as meso-helicates or double-stranded “side-by-side” complexes.<sup>2</sup> On the other hand, linkers which are too rigid may cause competitive formation of metallocycles or, in extreme cases, grid structures.<sup>1,4</sup> Other impediments to this strategy include:<sup>1,2,4</sup> (i) the formation of kinetic products (usually in the form of precipitating polymers); (ii) the presence of sterically bulky groups on the ligand, which are remote from the interacting sites (this usually results in polymerization); (iii) competitive solvent–metal interactions; and (iv) concentration effects (*vide infra*).

#### 1.43.4.2 Entropy-driven Self-assembly

As noted earlier, entropy can play a useful, if minor role in product selection. (Figure 2) illustrates how entropy can alter the favorability of one product over another. The reaction at 25 °C and



**Figure 2** Entropy influences the product proportions in a mismatched self-assembled system.

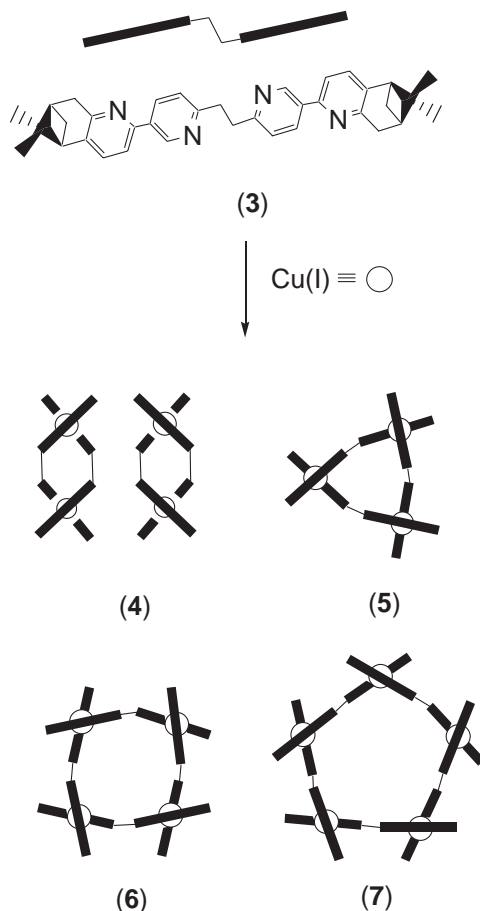
10 mM of (2) with *cis-(en)Pd<sup>II</sup>* (1) in water produces a mixture which includes the molecular square [(*en*)Pd(2)]<sub>2</sub><sup>4+</sup> and the hexagon [(*en*)Pd(2)]<sub>3</sub><sup>6+</sup> (*en* = 1,2-ethylenediamine).<sup>14</sup> These products have similar stabilities because of a mismatch in the binding preferences of the ligand and the metal. The ligand subtends an angle of 120° between its binding sites; this is ideal for hexagon formation. The metal encloses a binding angle of 90°, which is ideal for square formation. At ambient temperature and low concentration, the square (53%) exists in greater proportions in solution than the hexagon (27%). However the relative amount of the hexagon was substantially increased by concentrating the mixture and decreasing its temperature. Complete transformation of the mixture to one or the other product was impossible because the mismatch was so fundamental.

Another example involves the reaction of Cu<sup>I</sup> with the 2,2':2'',6'':6'',2'''-quaterpyridine ligand (3) (Figure 3).<sup>15</sup> A stoichiometric mixture of these molecules at ambient temperature and moderate concentration was found by ES-MS to contain a library of compounds which included the diastereomeric binuclear helicates, (4), and the oligonuclear circular helicates (5), (6), and (7). Concentration of the mixture resulted in an increase in the higher nuclearity species. At concentrations below 10<sup>-4</sup> M, however, only the helicates were present. Crystallization transformed the mixture into (6) in the solid state.

#### 1.43.4.3 Self-assembly Involving Geometric Complementarity

Self-assembly methodologies have been used for the designed synthesis of a range of discrete, metalcyclic 2-D and 3-D coordination compounds. The topologies of many such compounds resemble well-known geometric shapes, so that they are widely referred to as “molecular polygons” (2-D) or “molecular polyhedra” (3-D).

One technique used in their synthesis is the “Molecular Library” method devised by Stang.<sup>3</sup> It employs rigid ligand and metal building blocks which are geometrically and architecturally complementary. When combined in solution, the rigidity of the binding angles in concert with those of the



**Figure 3** Entropy-driven self-assembly: only the helicates (4) are present at concentrations below 10<sup>-4</sup> M.

ligands precludes the formation of any structure other than the one intended. The effect of the binding angles can be transmitted over distances of up to 3.4 nm if suitably rigid ligands are employed.<sup>16</sup> (Figure 4) illustrates the formation of a selection of molecular polygons using this approach.<sup>3</sup>

The Molecular Library method has been extraordinarily successful for the formation of small polygons and symmetrical polyhedra using highly labile metal–ligand systems. However it is more prone to failure when less labile systems are used in concert with poor ligands;<sup>17</sup> in such cases polymers typically precipitate. Controversy has also accompanied claims of the formation of multicomponent molecular polygons like hexagon (11);<sup>18</sup> the likely instability of large planar structures to even small distortions in the bond angles suggests that structures of this and greater size are likely to be only one part of a more complex mixture in solution.

#### 1.43.4.4 Symmetry-driven Self-assembly

Another technique which has been used to prepare 3-D polyhedra is Raymond's "symmetry-interaction" method.<sup>19</sup> This strategy derives from the realization that many natural supramolecular assemblies are formed in a symmetry-driven process which relies on incommensurate lock-and-key interactions. By closely examining a desired polyhedral structure, one may establish the relevant symmetry interactions and their associated geometric relationships, and then design metal–ligand systems capable of fulfilling them.

To describe the geometric relationships, several new concepts have been defined.<sup>19</sup> The plane in which a chelating ligand binds to a metal ion in a geometric cluster is termed the "chelate plane." The "coordinate vector" of the chelating group lies in the chelate plane where it bisects the chelate in the direction of the metal ion. The "approach angle" is defined as the angle between the plane which contains all of the coordinating atoms of the chelate, and the major symmetry axis of the metal center. Different polyhedra have different relationships between these variables.

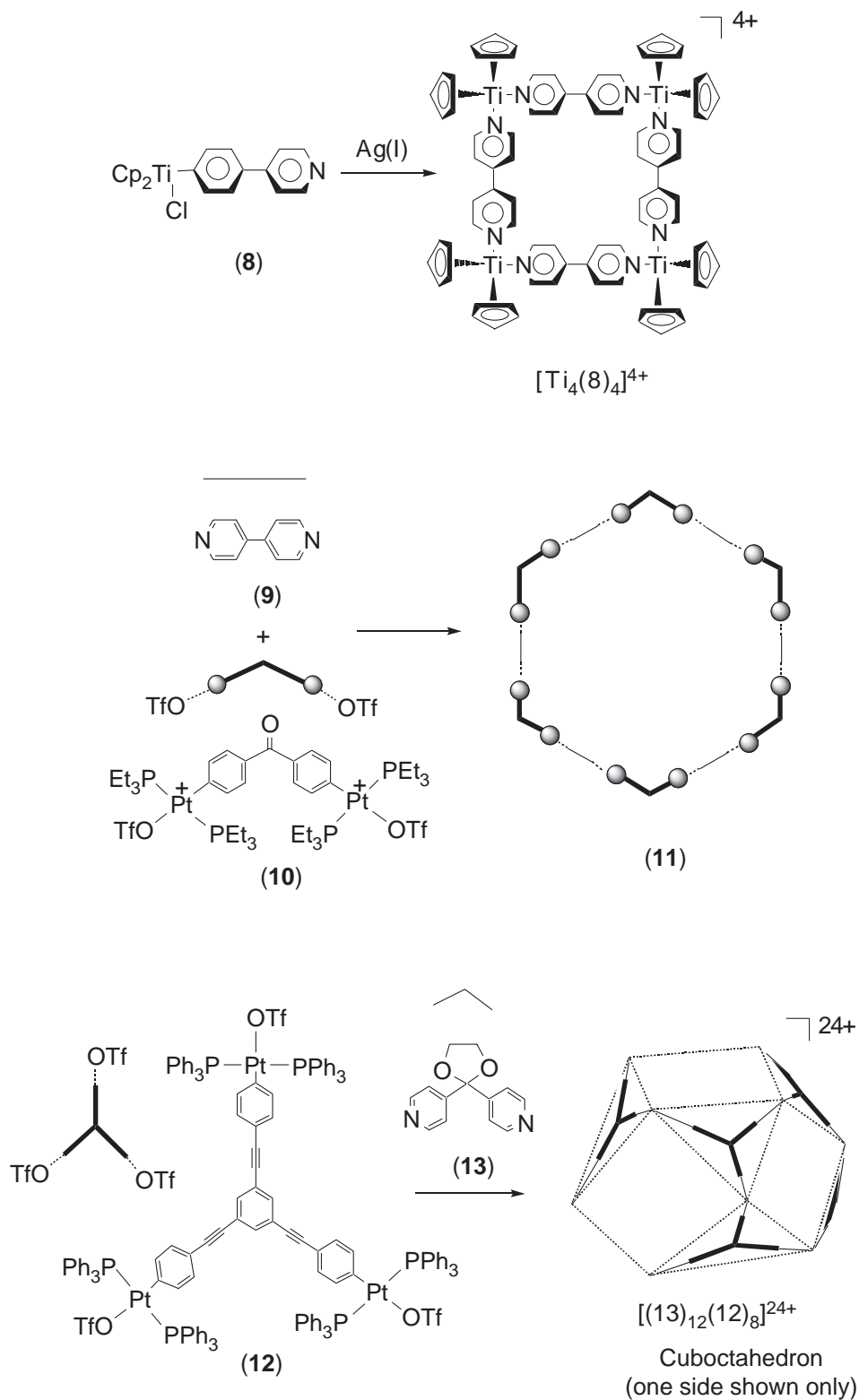
A series of  $M_4L_6$  molecular tetrahedra ( $M$  = metal ion,  $L$  = ligand) have been prepared using the symmetry-interaction strategy. For example, the reaction of octahedral, threefold symmetric  $Ga^{3+}$  with the twofold symmetric bis(hydroxamate) ligand ( $14$ )<sup>2-</sup>·2H<sup>+</sup> generates the  $T$ -symmetric tetrahedron  $[Ga_4(14)_6]$  (Figure 5).<sup>20</sup> In solution, exchange could not be detected on the NMR timescale between cluster ligands and unbound, solution ligands. This suggests exceedingly slow or perhaps even nonexistent kinetics. It is possible that these species may have been formed in an irreversible, kinetically guided process.

#### 1.43.4.5 Stoichiometry-driven Self-assembly

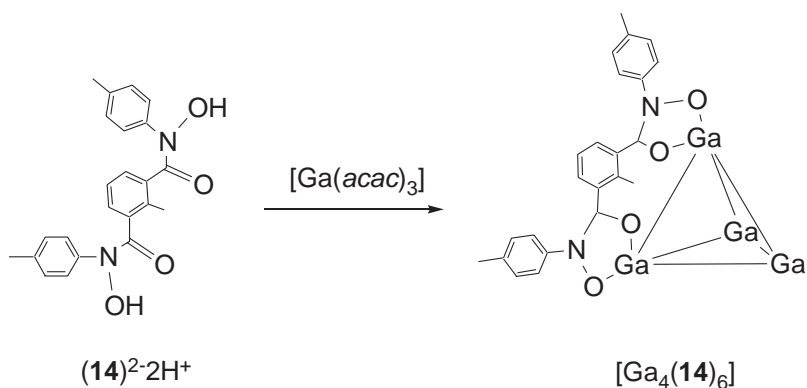
The stoichiometry of a reagent mixture can significantly influence the net thermodynamic stability of its product mixture, leading to one structure being favored over another. However, stoichiometry is seldom considered the sole determinant of product selection. One system in which it unequivocally plays the central role involves the formation of coordination oligomers from combinations of linear ditopic ligands and linear ditopic metal ions, as depicted in (Figure 6). In such self-assemblies, the first complexes formed are unsaturated. Oligomerization therefore occurs in solution until it is either terminated by precipitation of the polymer as a kinetic product, or by coordination of a monotopic "terminator" ligand or metal ion which prevents further chain growth.<sup>21</sup> Because the terminator is the only species able to halt enthalpy-driven polymerization, its relative proportion in a thermodynamic self-assembling mixture of this type determines the average length of the coordination oligomer generated. The greater the proportion of the terminator present, the shorter the average oligomer, and vice versa. Thus, oligonuclear coordination oligomers containing a particular average number of constituent metals and ligands in solution can be selectively self-assembled, and this can be varied by simply altering the relative proportion of the terminator present.

This strategy assumes, of course, that a perfect thermodynamic equilibrium exists at all stages in the process and that other influences, such as steric congestion, solvent interactions, and slow kinetics, *inter alia*, do not affect the self-assembly reaction. Moreover, like conventional polymer chemistry, this approach delivers a statistical distribution of product chain lengths rather than one discrete product.

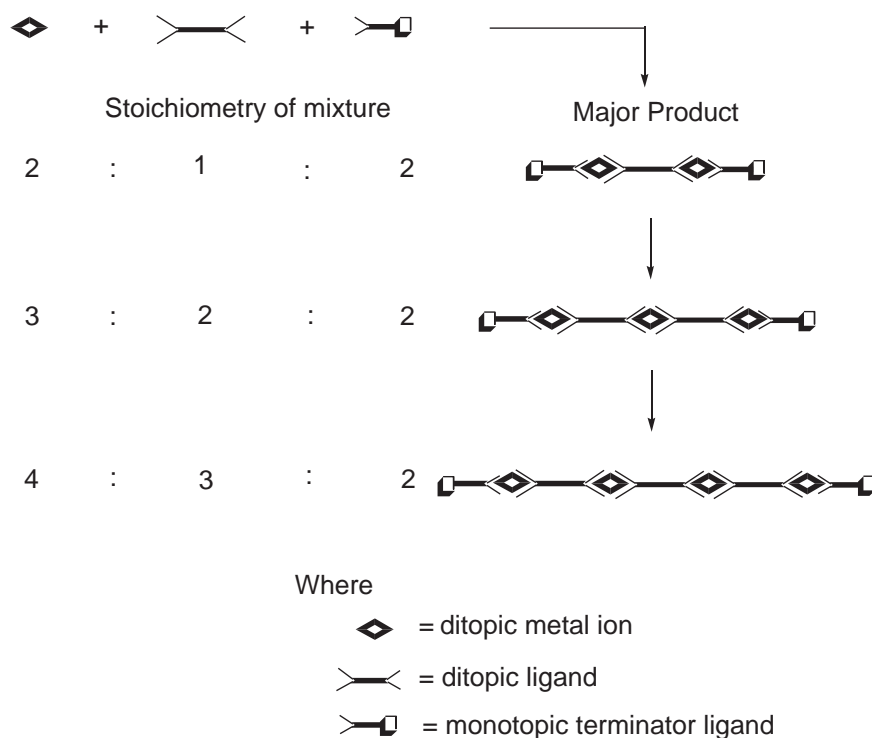
An example of a stoichiometrically-driven self-assembly is depicted in (Figure 7).<sup>22</sup> The  $AB_2$  monomer (15) contains an acetonitrile co-ligand. When a solution of (15) is heated under vacuum, dendritic aggregates (16) spontaneously form by a convergent self-assembly process, in which the labile acetonitrile co-ligands are replaced with pendant cyanomethyl groups from other molecules. The



**Figure 4** Self-assembly involving geometric complementarity: examples of 2-D and 3-D metallocycles prepared using the Molecular Library method.



**Figure 5** Symmetry-driven self-assembly: a truncated tetrahedral cluster prepared using the Symmetry-Interaction approach (*acac* = acetylacetonate).

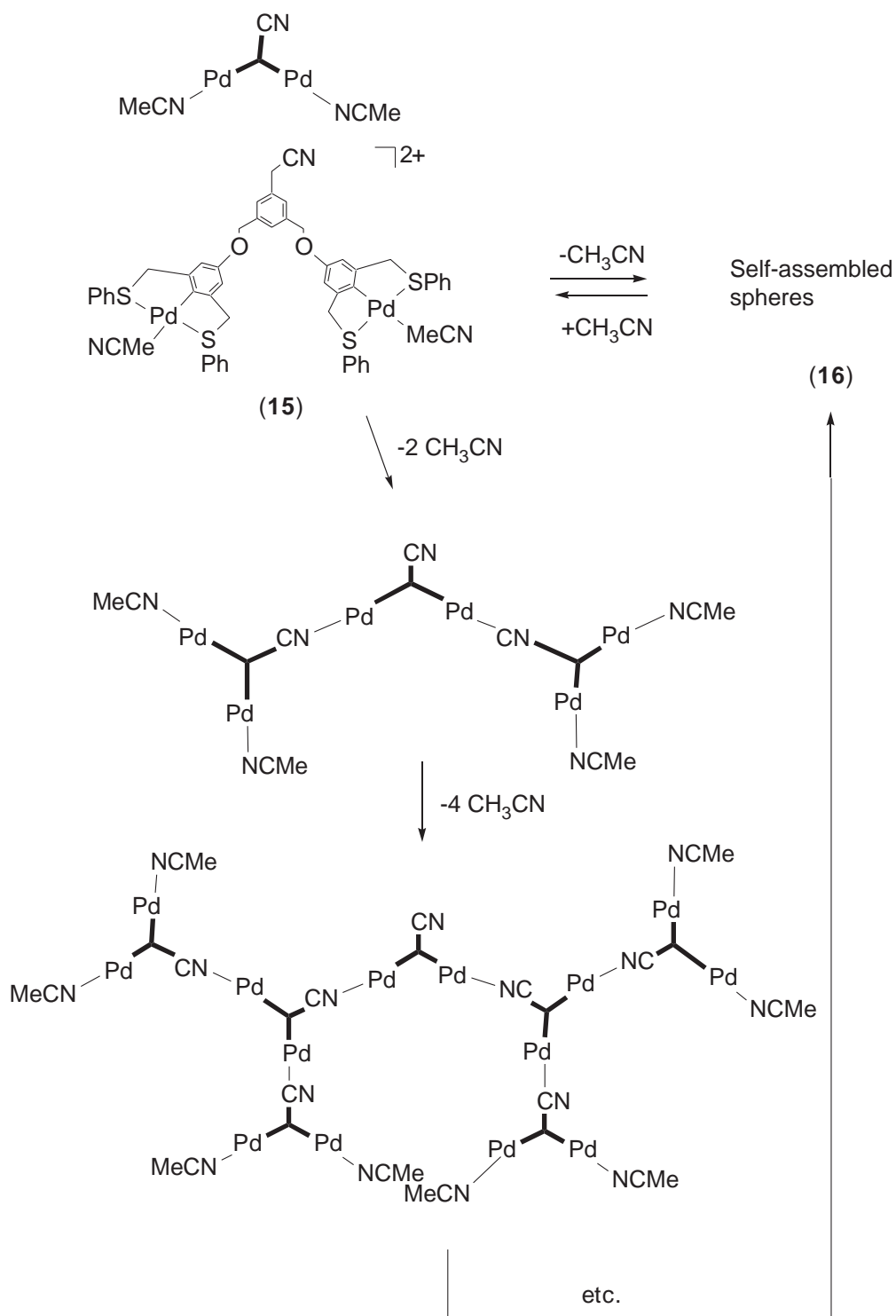


**Figure 6** Stoichiometry-driven self-assembly: reagent stoichiometry determines the average length of the coordination oligomer present.

aggregates grow until they reach a diameter of 200 nm ( $\pm 30$  nm), after which growth stops. The addition, at this stage, of acetonitrile to the system induces spontaneous de-assembly of the aggregates, regenerating monomer (**15**). Acetonitrile therefore acts as the terminator species. When present in large proportion, the system exists purely as monomers. When the proportion of acetonitrile is reduced, aggregation occurs and the average molecular weight of the species present increases. If a true thermodynamic equilibrium existed at all stages in this process, the entire mixture would ultimately form a single molecule when the acetonitrile concentration was zero. However, the assembly appears instead to stop when steric hindrance at the dendrimer surface becomes too great.

#### 1.43.4.6 “Rings-and-strings” Self-assembly

Pseudorotaxanes are interlaced compounds in which a filamentous ligand is threaded through a cyclic one. Their one-step synthesis by self-assembly generally involves a “rings-and-strings”



**Figure 7** Stoichiometry-driven self-assembly: metallo-dendrimer aggregates (16) (diameter  $200 \pm 30$  nm) self-assemble upon removal of acetonitrile under vacuum. The addition of acetonitrile regenerates the monomers.

strategy<sup>23</sup> in which the interlaced product is not necessarily the most stable possible product of the assembly. However, the stability of the product mixture is greater than the sum of the stabilities of any other possible product mixture. Because reagent stoichiometry plays a significant role in the net thermodynamic stability of these systems, rings-and-strings self-assembly can be considered a special class of stoichiometry-driven self-assembly.

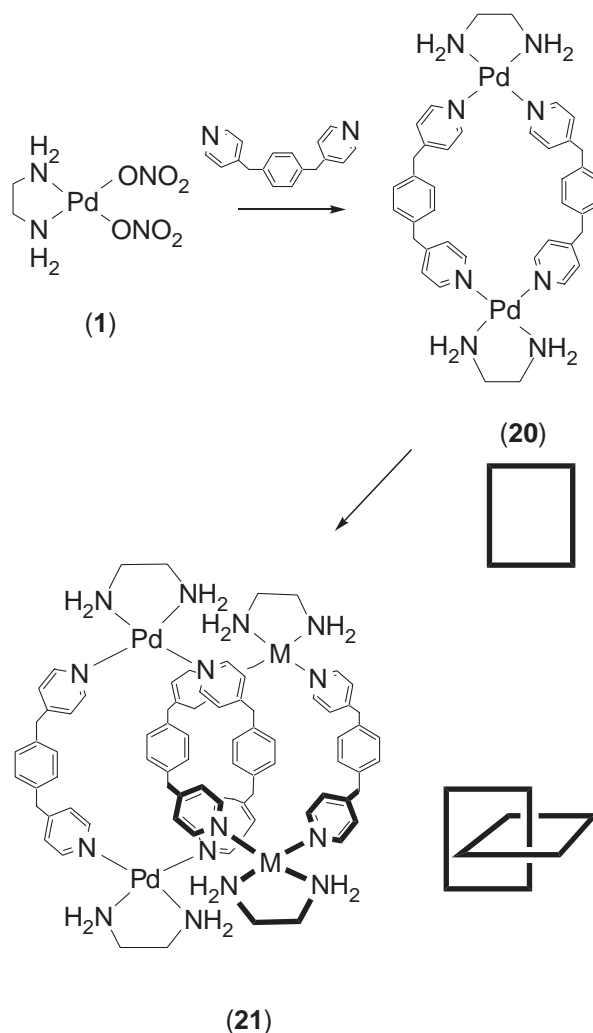


between the binding sites on the filamentous ligand to prevent multiple chelation to a single metal ion. Interestingly, the use of longer and more flexible spacers need not obstruct rotaxane formation. Nonstoichiometric mixtures, in which the absolute numbers of metal and ligand binding sites in the solution are equal, can still produce pseudorotaxanes under suitable conditions.<sup>23</sup>

#### 1.43.4.7 Multiple-interaction Self-assembly

All of the strategies for self-assembly described in this section up to this point have involved only one type of coordinate bond formation and are therefore classified as “single-interaction” self-assembly processes. However, more than one type of interaction can also be used in designed self-assembly. Such procedures are known as “multiple-interaction” processes.<sup>25</sup> Multiple-interaction self-assembly effectively involves the self-assembly of a reagent which has itself been self-assembled. Therefore two or more separate self-assembly processes occur *in situ*. They may enhance or interfere with each other, or they may operate totally independently of each other (so-called “orthogonal” self-assembly processes<sup>26</sup>). The rationale for using such processes is typically to drive the formation of intricate structures which are not accessible using single-interaction self-assembly.

Two main types of multiple-interaction self-assembly have been demonstrated:<sup>25</sup> (i) those involving the formation of two or more different types of coordinate bonds (metal-mediated or



**Figure 9** Multiple-interaction self-assembly (multi-mediated): coordinate bond formation induces assembly of the metalocycle (20). Hydrophobic- and  $\pi$ -interactions, along with an entropy contribution, produce the interlocked catenane (21).



uni-mediated processes); and (ii) those involving both coordinate and other noncovalent interactions (multimediated processes).

Perhaps the best examples of multiple-interaction self-assembly involve the one-step formation of catenanes. Catenanes are species in which two ring molecules are interlocked with each other, i.e., each ring passes through the center of the other ring. The self assembly of a catenane from its constituent ligands and metals requires two steps: (i) formation of the rings; and (ii) interlocking of the rings. In conventional systems each of these steps represents a major synthetic challenge, so that organic catenanes are exceedingly rare. However, in self-assembled systems, the steps can be readily achieved and this can be done *in situ*.

Formation of catenane (**19**) (Figure 8) involves a self-assembly process driven entirely by the formation of two different types of coordinate bond (i.e., metal-mediated, multiple-interaction self-assembly).<sup>24</sup> The tri-segmented ligand strand (**17**) contains tridentate binding sites at its termini, and a bidentate binding site at its centre. When treated with (**18**), Cu<sup>I</sup>, and Ru<sup>II</sup> in the correct stoichiometry, the [2]metallocatenate (**19**) is spontaneously assembled. This occurs because of selective binding by the metal ions; Ru<sup>II</sup> favors six-coordination, while Cu<sup>I</sup> prefers four-coordination. Neither metal interferes with the binding site/s preferred by the other during bond formation.

In Fujita's system depicted in (Figure 9),<sup>27</sup> enthalpy is harnessed to induce formation of the free metal cycle (**20**), and hydrophobic- and  $\pi$ -aromatic interactions along with entropic influences are used to induce interlocking, giving catenane (**21**). This assembly is therefore a multimediated, multiple-interaction process. The role of the noncoordinate interactions in the interlocking step was estimated to double the free energy change due to entropy alone, making the metalcatenate stable enough to be quantitatively self-assembled at high concentrations.

### 1.43.5 CONCLUSION

Synthesis by self-assembly is proving to be an important new field in coordination chemistry. Not only does it provide the capacity to produce compounds with elaborate higher structures, but it can also be manipulated for the designed synthesis of such structures. This can, moreover, be done for virtually any molecular architecture known to date. The clear challenge for the future is to harness the power of self-assembly in the designed synthesis of compounds displaying novel physical and chemical properties.

### 1.43.6 REFERENCES

- Muchado, V. G.; Baxter, P. N.; Lehn, J. M. *J. Braz. Chem. Soc.* **2001**, *12*, 431–462 and references therein.
- Piguet, C.; Bernardinelli, G.; Hopfgartner, G. *Chem. Rev.* **1997**, *97*, 2005–2062 and references therein.
- Leininger, S.; Olenyuk, B.; Stang, P. J. *Chem. Rev.* **2000**, *100*, 853–908 and references therein.
- Swiegers, G. F.; Malefetse, T. J. *Chem. Rev.* **2000**, *100*, 3483–3537 and references therein.
- For example: Weissbuch, I.; Baxter, P. N. W.; Cohen, S.; Cohen, H.; Kjaer, K.; Howes, P. B.; Als-Nielsen, J.; Hanan, G. S.; Schubert, U. S.; Lehn, J.-M.; Leiserowitz, L.; Lahav, M. *J. Am. Chem. Soc.* **1998**, *120*, 4850–4860.
- Kuchel, P. W.; Ralston, G. B. *Biochemistry*; McGraw-Hill: New York, 1988; Schaum's Outline Series; p 91.
- Lindsey, J. S. *New J. Chem.* **1991**, *15*, 153–180.
- Airey, A. L.; Swiegers, G. F.; Willis, A. C.; Wild, S. B. *Inorg. Chem.* **1997**, *36*, 1588–1597.
- Bowyer, P. K.; Cook, V. C.; Gharib-Naseri, N.; Guggen, P. A.; Rae, A. D.; Swiegers, G. F.; Willis, A. C.; Zank, J.; Wild, S. B. *Proc. Nat. Acad. Sci. USA.* **2002**, *99*, 4877–4882.
- Chi, X.; Guerin, A. J.; Haycock, R. A.; Hunter, C. A.; Sarson, L. D. *J. Chem. Soc. Chem. Commun.* **1995**, 2563–2564.
- Rae, A. D. Private communication.
- Constable, E. C.; Ward, M. D.; Tocher, D. A. *J. Chem. Soc., Dalton Trans.* **1991**, 1675–1683.
- Garret, T. M.; Koert, U.; Lehn, J.-M.; Rigault, A.; Meyer, D.; Fischer, J. *J. Chem. Soc. Chem. Commun.* **1990**, 557–558.
- Fujita, M.; Aoyagi, M.; Ogura, K. *Inorg. Chim. Acta* **1996**, *246*, 5357.
- Baum, G.; Constable, E. C.; Fenske, D.; Housecroft, C. E.; Kulke, T. *Chem. Commun.* **1999**, 195–196.
- Manna, J.; Kuehl, C. J.; Whitford, J. A.; Stang, P. J.; Muddiman, D. C.; Hofstadler, C. D.; Smith, R. D. *J. Am. Chem. Soc.* **1997**, *119*, 11611–11619.
- Pt<sup>II</sup> forms polymers with weak donors, such as cyano-based ligands: Stang, P. J.; Cao, D. H.; Saito, S.; Arif, A. M. *J. Am. Chem. Soc.* **1995**, *117*, 6273–6283.
- Stang, P. J.; Persky, N. E.; Manna, J. *J. Am. Chem. Soc.* **1997**, *119*, 4777–4778.
- Caulder, D. L.; Raymond, K. N. *Dalton Trans.* **1999**, 1185–1200 and references therein.
- Beissel, T.; Powers, R. E.; Raymond, K. N. *Angew. Chem. Int. Ed. Engl.* **1996**, *35*, 1084–1086.
- Constable, E. C. *Macromol. Symp.* **1995**, *98*, 503–524.
- Huck, W. T. S.; van Veggel, F. C. J. M.; Kropman, B. L.; Blank, D. H. A.; Keim, E. G.; Smithers, M. M. A.; Reinhoudt, D. N. *J. Am. Chem. Soc.* **1995**, *117*, 8293–8294.
- Chambon, J.-C.; Dietrich-Buchecker, C. O.; Nierengarten, J.-F.; Sauvage, J.-P. *J. Chem. Soc. Chem. Commun.* **1993**, 801–804.
- Cárdenas, D. J.; Gaviña, P.; Sauvage, J.-P. *J. Am. Chem. Soc.* **1997**, *119*, 2656–2664.

25. Swiegers, G. F.; Malefetse, T. J. *J. Incl. Phen. Mol. Recogn. Chem.* **2001**, *40*, 253–264.
26. Goral, V.; Nelen, M. I.; Eliseev, A. V.; Lehn, J.-M. *Proc. Nat. Acad. Sci. USA* **2001**, *98*, 1347–1352.
27. Fujita, M.; Ibukuro, F.; Hagihara, H.; Ogura, K. *Nature* **1994**, *367*, 720–723.

# 1.44

## Electrochemical Methods, Electrocrystallization

P. CASSOUX and L. VALADE

*CNRS, Toulouse, France*

and

P.-L. FABRE

*Université Paul Sabatier, Toulouse, France*

---

1.44.1	BASIC PRINCIPLES	761
1.44.2	EXPERIMENTAL CONDITIONS	762
1.44.2.1	Reference Electrode	762
1.44.2.2	Working Electrode	763
1.44.2.3	Electrolytes	763
1.44.2.4	Electrochemical Cells	764
1.44.2.5	Electrocrystallization Conditions	764
1.44.2.6	Additional Parameters	766
1.44.3	ELECTROSYNTHESIS OF COORDINATION COMPOUNDS	767
1.44.3.1	Electrolysis at Inert Electrodes	767
1.44.3.2	Electrolysis at Sacrificial Electrodes	767
1.44.3.2.1	<i>Inorganic metal salts and their derivatives</i>	768
1.44.3.2.2	<i>Organometallic complexes</i>	768
1.44.3.3	Electrocrystallization	769
1.44.3.3.1	<i>Electrochemical oxidation of a complex</i>	769
1.44.3.3.2	<i>Concomitant formation of complex and material</i>	770
1.44.3.3.3	<i>Competing electrochemical reactions</i>	771
1.44.4	DEDICATION	771
1.44.5	REFERENCES	772

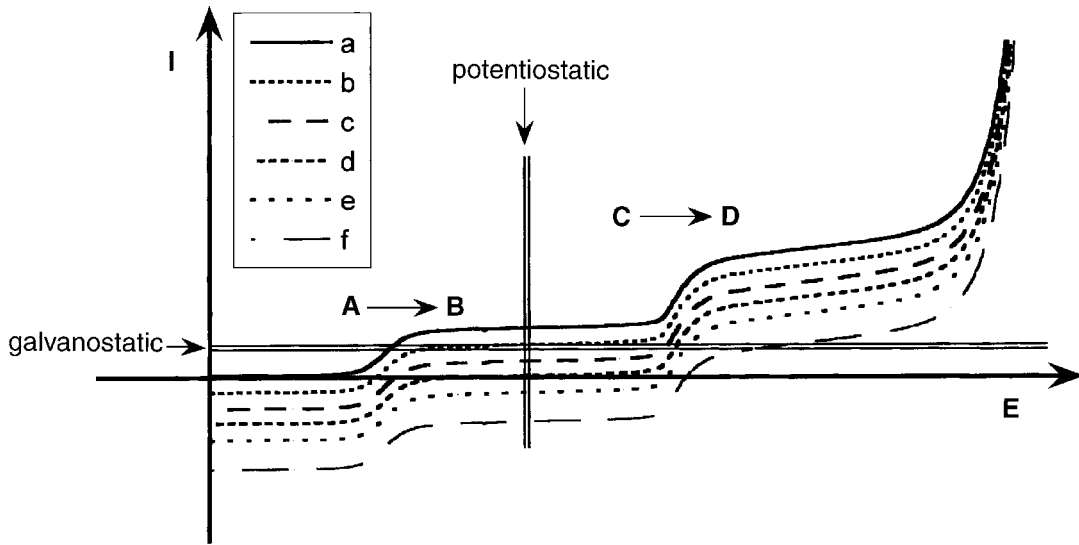
---

### 1.44.1 BASIC PRINCIPLES

Electrosynthesis is an alternative procedure for the synthesis of new complexes; it offers control of reagent activity by varying the electrode potential. The successful application of an electrochemical synthesis requires a detailed understanding of the phenomena leading to an appropriate choice of parameters, such as the nature of the electrochemical cell, the electrodes, and the media, etc.

Electrochemical methods for the elucidation of electrode processes are described in Chapter 2.15. In this section, we will restrict ourselves to the electrosynthesis of coordination compounds on the laboratory scale, from a few milligrams up to gram levels. The problems associated with scale-up have been reviewed.<sup>1-3</sup>

An electrochemical process can be controlled in two different ways which are illustrated in Figure 1: potentiostatic (thermodynamic control) or galvanostatic (kinetic control). Figure 1 repre-



**Figure 1** Current—potential ( $i/E$ ) curves during the electrolysis of oxidizable compounds: Curve a, before electrolysis; Curves b–c, during the electrolysis; Curve d, end of the electrolysis of A into B; Curves e–f, further oxidation of C.

sents the voltammograms of two oxidizable compounds, A and C, showing the limits of the electroactivity. The appearance of the voltammograms at different stages during an electrolysis are shown.

Under potentiostatic conditions, the electrode potential is set on the plateau of the  $A \rightarrow B$  transition. During the electrolysis, the current will decrease with the concentration of A and reach zero (curve d). The process is quite selective, as the other electrode process cannot take place. Note that this electrosynthetic procedure requires the use of a potentiostat with three electrodes (working, reference, and auxiliary).

Under galvanostatic conditions, the oxidation current is set below the current plateau of the  $A \rightarrow B$  transition: the electrode potential is suitable for the required oxidation. During the electrolysis, the concentration of A, and thus its limiting current, decreases. When the electrolysis current becomes higher than the limiting current, the electrode potential shifts to a value suitable for the oxidation of  $C \rightarrow D$  (curves c, d, e, and f) or the limit of the electroactivity domain. The electrolysis is no longer selective but galvanostatic conditions only require a simple current generator and two electrodes (an anode and a cathode). The galvanostatic method is preferred in industrial electrochemistry.<sup>2</sup>

On the laboratory scale, potentiostatic conditions are generally favored in order to obtain high selectivity. Galvanostatic conditions may also be used to directly obtain crystals at the electrode when the selected current remains lower than the limiting one as in electrocrystallization. In either case, one should recognize that an electrochemical cell presents two electrode reactions: reduction at the cathode and oxidation at the anode. Generally, only one side is of interest but the product at the other side may react with the target product. In this case, the choice of the experimental conditions might be important.

## 1.44.2 EXPERIMENTAL CONDITIONS

To perform an electrolysis, the experimental conditions are chosen according to the physicochemical properties of the compounds and the results of prior electrochemical analysis (see Chapter 2.15).

### 1.44.2.1 Reference Electrode

Under potentiostatic conditions, the working electrode potential is monitored by a potentiostat versus a reference electrode. This reference electrode is a half-cell, which must be stable, unpolar-

izable with a low resistance, easy to use, and must not contaminate the working solution.<sup>4</sup> The standard hydrogen electrode (SHE) is the thermodynamic electrode of choice but is inconvenient to handle.

Among the various reference electrodes, the most popular is the saturated calomel electrode (SCE) working in aqueous saturated KCl solution,  $E = 0.242$  V vs. SHE at 25 °C. The silver/silver chloride electrode is also widely used and consists of a silver wire in an aqueous KCl solution. It has the advantage of being less cumbersome than the SCE. At 25 °C, in saturated KCl,  $E = 0.197$  V vs. SHE. These reference electrodes are separated from the working solution by a glass frit or an agar bridge. In nonaqueous solvents, double junctions (solvent plus supporting electrolyte) are used. Special attention must be paid to the potential junction which may cause the reference electrode potential to drift (refer to Chapter 2.15).

Other reference electrodes have been proposed for use in the nonaqueous solvents that are widely used in coordination chemistry. Their main advantage is that they allow one to work with a single solvent. Among these electrodes, the  $\text{Ag}^+/\text{Ag}$  electrode is reversible in many solvents.<sup>4</sup>  $\text{Ag}^+$  ions are introduced as salts, such as  $\text{AgCl}$  or  $\text{AgBF}_4$ . However, the inner solution has to be refreshed due to the reactivity of  $\text{Ag}^+$ . Another class consists of redox electrodes in which the two components are in solution, such as ferrocenium ion/ferrocene  $\text{Fc}^+/\text{Fc}$ .<sup>5</sup> Since the potential is dependent on the concentration ratio of the redox couple, this ratio must be kept constant. An attractive solution to prevent the use of a junction lies in the preparation of a functionalized-polymer coated electrode such as poly(vinylferrocene).<sup>6</sup> The polymer is deposited by electro-oxidation in its oxidized form,  $\text{polyFc}^+$ , and then partially reduced to yield  $\text{poly Fc}^+/\text{Fc}$ . Their use is limited by their relative stability in the different solvents.

#### 1.44.2.2 Working Electrode

The working electrode is a key factor in the process, directing the course of the electrochemical reaction according to its properties: material, adsorbent surface, etc. The working electrode must be stable towards corrosion and may be improved by additives or surface treatments. For bulk electrolysis, a high surface to volume ratio is chosen in order to reduce the electrolysis time. The electrodes may be constructed of grids, foams, expanded metals, liquid mercury, porous material, wool, etc. For electrocrystallization experiments, the size is less important and generally platinum wires are used.

The most popular electrode materials for reduction are mercury, lead, titanium, and platinum. The choice of anode is limited because most metals are anodically corroded. In the laboratory, most of the electrodes are made of platinum, gold, or carbon. Exotic anodes such as lead dioxide or DSA (Dimensionally Stable Anode such as  $\text{Ti}/\text{RuO}_2$ ) have been developed for organic or chlorine electrochemistry.

Sacrificial anodes ( $\text{Al}$ ,<sup>7,8</sup>  $\text{Mg}$ <sup>9,10</sup>) have been proposed for electro-organic processes as they allow one to use simple undivided electrochemical cells. In coordination electrosynthesis, they may provide a means to obtain complexes containing the metal of the sacrificial electrode (see Section 1.44.3.2).

#### 1.44.2.3 Electrolytes

Electrolysis is carried out in a conductive medium that comprises a solvent and a supporting electrolyte. The supporting electrolyte is a salt that ensures ionic conduction in the cell. Its choice depends on various properties: solubility (high), conductivity, dissociation (complete), inertness towards the substrate, high purity, proton activity, and redox properties (high oxidation potential for anions and low reduction potentials for cations).

In aqueous solution, various salts can be employed for the supporting electrolyte but may also be used for pH buffers. Generally, alkali sulfates, nitrates, or phosphates are used at concentrations around 0.1 M. In organic solvents, the most common electrolytes are tetraalkylammonium salts such as  $\text{Bu}_4\text{NPF}_6$ ,  $\text{Bu}_4\text{NBF}_4$ ,  $\text{Et}_4\text{NBF}_4$ , etc. They may be recrystallized before use.<sup>12</sup>

The solvent must dissolve the supporting electrolyte and the substrate, while a high dielectric constant suppresses ion-pair formation. In protic solvents, special attention has to be taken about pH control because of possible proton exchange with the analyte. Solvents with high boiling points may be difficult to separate from the product while low boiling point solvents will require

**Table 1** Main characteristics of selected media for electrosynthesis. Approximate limits of the electroactivity domain at a platinum electrode versus SCE.

Solvent	Melting point $T_{mp}$ (°C)	Boiling point $T_{bp}$ (°C)	Dielectric constant $\epsilon$ (25 °C)	Cathodic limit (V)	Anodic limit (V)
Water	0	100	78.3	-0.4 <sup>a</sup>	1.3 <sup>a</sup>
Acetonitrile, CH <sub>3</sub> CN	-43.8	81.6	36	-2.5	2.5
Dichloromethane, CH <sub>2</sub> Cl <sub>2</sub>	-94.9	39.6	8.9	-2.0	1.9
N,N-dimethylformamide (DMF)	-60.4	153	36.7	-2.4	1.9
Dimethylsulfoxide (DMSO)	18.5	189	46.5	-2.2	2.0
Tetrahydrofuran (THF)	-108.4	66.0	7.6	-3.0	1.8

Source: Bard and Faulkner<sup>11</sup><sup>a</sup> At pH=0

air-tight cells. The solvent must exhibit both electrochemical and chemical inertness; the donor number may be taken into consideration for avoiding, for example, solvent coordination.<sup>13,14</sup> The medium and the working electrode define the electroactivity domain, that is the accessible potential window between the anodic and cathodic limits. Wide electroactivity domains are suitable (Table 1) for the preparation of various redox states of the analyte. A mercury electrode, which offers a large cathodic domain versus a small anodic one, can be used for reduction at more negative potentials. One should preferably use HPLC grade organic solvents stored over activated molecular sieves (3 Å) under an argon or nitrogen atmosphere. Methods for purification have been published.<sup>15</sup>

Among the various solvents, acetonitrile is the most popular because it presents a wide electroactivity domain, dissociative properties, and easy removal. However, it may be also involved as an extra ligand.

#### 1.44.2.4 Electrochemical Cells

The simplest cell consists of a beaker with two electrodes (cathode and anode) connected to a direct current (DC) source. This undivided cell may be used when the cathodic and anodic products do not interact. In elaborate experiments, a closed cell under an inert atmosphere may be convenient (Figure 2). For potential-controlled electrolysis, the use of a reference electrode is needed and its location is important for the potential distribution.

The U-cell and H-cell are most commonly used in the laboratory (Figure 2). The electrolytes are separated by a diaphragm consisting of porous materials (fritted glass, alumina, nylon cloth, porous plastic, etc.) or ion-exchange membranes (anionic, cationic, Nafion, etc.). This type of cell is particularly useful in electrocrystallization experiments under galvanostatic conditions.

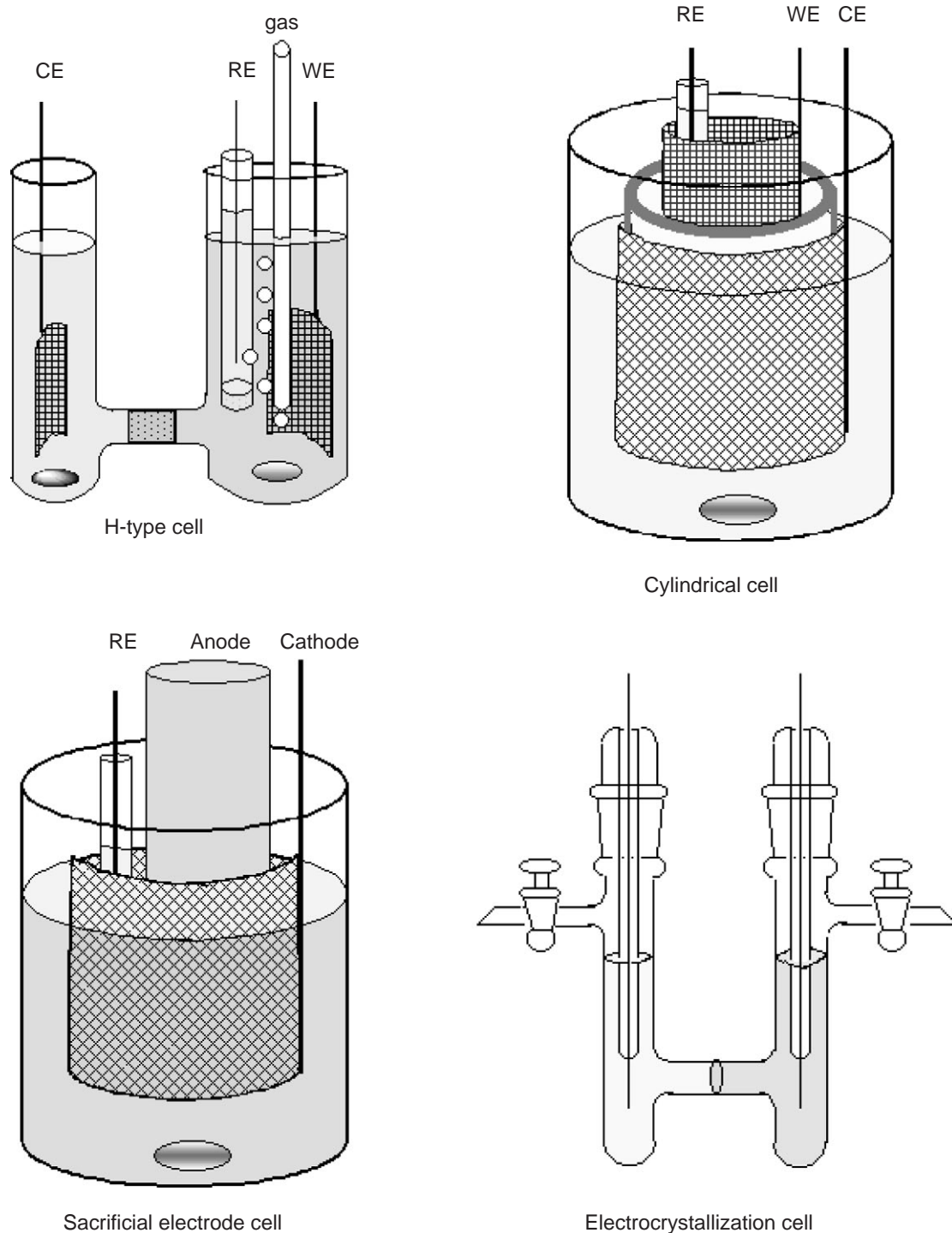
The cylindrical cell is a more convenient cell because the potential or current distribution is nearly perfect. It can be used undivided or divided with a cylindrical diaphragm. This cell type is used with a sacrificial electrode cell, generally with the undivided configuration.

In order to accelerate the electrolysis, mass transfer is enhanced by means of stirring the solution, rotating or vibrating the electrode, sonication, etc. With a mercury pool electrode, the magnetic stirrer ensures both the cleaning of the electrode surface and stirring of the electrolyte.

Among the exotic cells for the laboratory, flow cells (filter press cells) require an external loop with a pump to recirculate the electrolyte. Also, solid polymer electrode (SPE) cells have been described.<sup>16-19</sup> The electrode material is deposited on both sides of a membrane (Nafion) or pressed against the membrane. An advantage is that the ionic conduction takes place in the membrane so that no supporting electrolyte is required. Moreover, this cell can work with gaseous reactants.

#### 1.44.2.5 Electrocrystallization Conditions

During electrocrystallization, it is the intention to deposit compounds as crystals attached to the electrode surface. These crystals must be conductive, as an electrode covered with crystals should retain enough conductivity to continue the process of deposition. Within the field of molecule-



**Figure 2** Typical electrochemical cells.

based species, neglecting the electrodeposition of metals, electrocrystallization is usually encountered for the growth of molecular conductors or superconductors.<sup>20–23</sup>

Potentiostatic or galvanostatic conditions may be applied. Even though the potentiostatic mode was successful to discriminate between different crystalline phases that may result from a given electrochemical reaction,<sup>24,25</sup> the galvanostatic mode is preferred for growing large and high quality crystals. A constant voltage implies high current densities, i.e., a high growth rate at the



beginning of the process leading to a large number of crystal nuclei. In this case, quantity is favored versus size and quality. On the other hand, applying a constant current of low intensity imposes a low growth rate at a constant speed. This leads to fewer nuclei which grow slowly. The result is concomitantly small yields but high quality crystals.

Some “tricks” have been reported to avoid multiplication of nuclei, such as a low temperature electrolysis, a low concentration of the solutions, aspects of the nature and preparation of the electrode surface. The fewer defects on the electrode surface, the fewer are the nucleation sites.<sup>26,27</sup> As a first step, the electrodes are mechanically polished using abrasive paper. In a second step, the surface is electrochemically polished by successively generating hydrogen and oxygen on the electrode while immersed in a sulfuric acid bath. Electrodes intended for use as anodes are cathodically polarized in a final step. They are then washed and dried before use. The more commonly used electrodes are Pt wires (typically 1 cm long and 1 mm diameter). Other types have been studied.<sup>28</sup>

The quality of the crystals also depends on the nature and purity of the solvent.<sup>29,30</sup> Acetonitrile (MeCN), tetrachloroethylene (TCE),  $\text{CH}_2\text{Cl}_2$ , benzonitrile, nitromethane, nitrobenzene, THF, and chlorobenzene are the more commonly used solvents. The addition of 10% v/v of ethanol or methanol is sometimes made either for solubility purposes or crystal growth amelioration. The solvents should be distilled before use. Halogen containing solvents are further passed over basic alumina in order to eliminate traces of acid. Solid starting compounds are either recrystallized or sublimed. Inert conditions are maintained during electrocrystal growth.

Typical current intensities for crystal growth are low and range from  $0.1 \mu\text{A}$  to  $5 \mu\text{A}$  for a classical electrode ( $L = 1 \text{ cm}$ ,  $d = 1 \text{ mm}$ ). In some cases, the current may be varied stepwise from low to higher to control the nucleation step and then increase the rate of growth of the nuclei. Concentrations of the starting species are in the millimolar range. The supporting electrolyte is added for supporting migration currents but also as an ion source (see Section 1.44.3.3.2). Its concentration ratio is often reduced from that applied in constant voltage processes (1:10 vs. 1:100), mostly to allow the electroactive compound to dissolve at a high enough concentration.

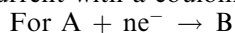
Galvanostatic growth is likely conducted in two-compartment cells (Figure 2).<sup>20,22,29,31–33</sup> An electrode configuration as shown in Figure 2 is often used because crystals tend to grow along the lines of current. The cell is kept in a vibration-free room at constant temperature. The temperature might range from 283 K to 323 K depending on the solubility of the initial reagents, or to control growth rate. The solution is not stirred in order to avoid negative effect of convection on crystal growth.

The electrolysis is usually conducted for periods of one to three weeks. The end of the electrolysis is not easy to evaluate, although the color of the solution may be an indication. The crystals are recovered by filtration of the solution.

#### 1.44.2.6 Additional Parameters

Additional parameters should be mentioned including ohmic drop, counter electrode reaction, removal of oxygen, integration of the current, and finally work-up of the solution.

In organic solvents and according to the cell configuration, the ohmic drop may be prohibitive and the potentiostat must have a high output voltage (50 V or more). The integration of the current with a coulometer enables one to verify Faraday's law and to calculate the electric yield:



$$Q = \int i dt = nFN_{\text{A}}$$

Where  $N_{\text{A}}$  is number of moles of A transformed. The counter electrode reaction must be chosen carefully in undivided cells to prevent reaction with the target product. The use of a sacrificial counter electrode may be satisfactory. The ideal solution is a “paired” electrosynthesis, i.e., when both cathodic and anodic processes are of interest. In most electrolyses, oxygen, which is electroactive, is a poison and must be removed by bubbling an inert gas through the solution or by vacuum techniques. When the electrolysis is complete, the product must be recovered. Obviously, there is no problem when the product precipitates or electrocrystallizes. The work-up of the solution may be facilitated by an appropriate choice of the experimental conditions. In



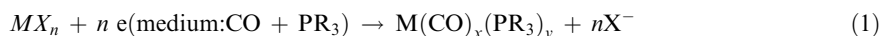
most cases, the product must be separated from the supporting electrolyte. Say for example that an electrolysis is carried out in MeCN/Et<sub>4</sub>NBF<sub>4</sub>: at the conclusion of the experiment, the solvent is easily evaporated and the residue is extracted by CH<sub>2</sub>Cl<sub>2</sub> since Et<sub>4</sub>NBF<sub>4</sub> is insoluble in CH<sub>2</sub>Cl<sub>2</sub>, the product is easily recovered.

### 1.44.3 ELECTROSYNTHESIS OF COORDINATION COMPOUNDS

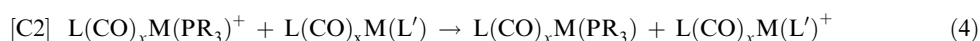
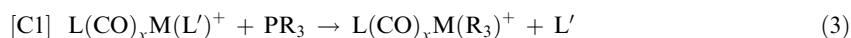
There is an extensive literature on the electrosynthesis of coordination compounds, which has been periodically reviewed.<sup>34–38</sup> In the last 10 years, significant progress has been made in electrocrystallization and in the use of sacrificial anodes.

#### 1.44.3.1 Electrolysis at Inert Electrodes

Electrosynthesis is widely used in order to provide evidence for the various redox states of a compound. Very often, the product is not isolated but only characterized *in situ* by spectrometric methods (see Chapters 1.45 and 2.15). Some examples of successful electrosynthetic procedures are presented. In the course of studies on sandwich complexes, electrosyntheses of metal (Z-cyclopentadienyl) or (Z-arene) complexes have been described, for example Fe complexes<sup>39</sup> or Nb complexes.<sup>40</sup> Among the classical complexes largely studied by electrochemistry, organocobalt Costa-type complexes are excellent case studies.<sup>41,42</sup> Electrochemistry was found to be the only synthetic route.<sup>42</sup> Starting with mononuclear complexes [RuCl<sub>3</sub>(dppb)(L)] (where L = pyridine, 4-methylpyridine, or DMSO, and dppb = 1,4-bis(diphenylphosphino)butane), electroreduction yields dimers [Ru<sub>2</sub>Cl<sub>4</sub>(dppb)<sub>2</sub>(L)].<sup>43</sup> Extensive electrochemical studies on metal carbonyl complexes have been carried out. Since the pioneering work of Grobe *et al.*<sup>44–46</sup> electrosyntheses have been explored to prepare substituted metal (Fe, Co, Ni) carbonyl complexes, for example:



The mixed-ligand complexes [M(CO)<sub>x</sub>(PR<sub>3</sub>)<sub>y</sub>] with M = Cr, Mn, Mo, W were prepared by CO or ligand substitution by electron transfer chain catalysis (ETC catalysis),<sup>47–49</sup> such as:



Once [L(CO)<sub>x</sub>M(L')<sup>+</sup>] is formed, reactions C1 and C2 cycle (ligand exchange and redox reactions, respectively) and yield the [L(CO)<sub>x</sub>M(PR<sub>3</sub>)] complex. The process functions approximately, with one electron for every 1,000 molecules.

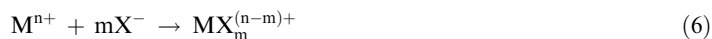
The principal difficulty of such electrolyses usually is the recovery of the product from the bulk solution (solvent, supporting electrolyte, reactant, by-products). This may explain the under-development of this technique in coordination chemistry with respect to classical synthetic procedures.

#### 1.44.3.2 Electrolysis at Sacrificial Electrodes

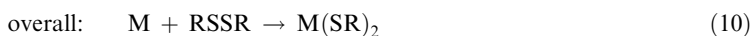
Electrolyses at sacrificial electrodes allow direct synthesis of metal complexes from bare metal electrodes. Systematic studies have been reported and periodically reviewed.<sup>22–24</sup> The sacrificial electrode may either be a cathode (Pb, Sn, Hg), or an anode (metals) which is the most usual configuration. The experiments are generally carried out under galvanostatic conditions (10–30 mA cm<sup>-2</sup>) and so a reference electrode and a potentiostat are not required. Different types of products have been obtained from the simplest complexes to clusters.

### 1.44.3.2.1 Inorganic metal salts and their derivatives

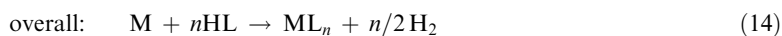
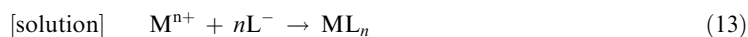
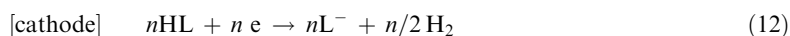
By oxidation in the presence of anions (halide  $X^-$ ,  $SCN^-$ ,  $NCO^-$ ,  $NO_3^-$ , etc.), inorganic metal salts are obtained with high purity and low water content:<sup>50</sup>



In the presence of a ligand L (L = N, P, O donor), co-adducts  $MLX_m^{(n-m)+}$  are obtained by simple electrooxidation of the metal M. To prevent side reactions at the anode, a divided cell is recommended. On the contrary, an undivided cell is used to obtain metal thiolates or selenolates through the cathodic cleavage of S—S or Se—Se bonds:<sup>51,52</sup>



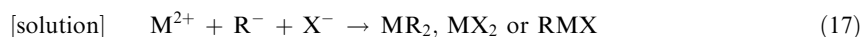
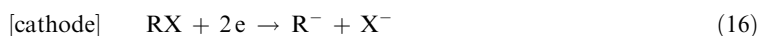
According to the above scheme, complexes derived from organic weak acids (labile H) can be prepared in an undivided cell:<sup>38</sup>



In this way, alkoxides, glycolates, catecholates, carboxylates, or Schiff base complexes have been obtained.<sup>37,38</sup> Other metal chelates have been synthesized by electro-oxidation of the bare metal electrode: phosphido, azolates, phthalocyanines, semicarbazides, Schiff bases, etc.<sup>37</sup> In addition to the syntheses of monometallic complexes, electrochemistry has been proven to yield polynuclear complexes by using assembling or multidentate ligands.<sup>37</sup>

### 1.44.3.2.2 Organometallic complexes

Electrosynthetic methods have been successfully exploited on an industrial scale for the production of tetraethyl lead. Using a range of sacrificial anodes (Cu, Cd, Ti, Zr, Hf, etc.), different products may be obtained, alkyl metal  $MR_x$  or alkylmetal halide  $R_xMX_x$ .<sup>38,53</sup>



Metallocenes and their derivatives are another large class of organometallic compounds, such as the well-known ferrocene. Typically, they are chemically synthesized by reacting the metal ion with a cycloolefin activated by a very strong base. The electrochemical process works under milder conditions in an undivided cell. The chosen metal is oxidized at the anode, and at the cathode the olefin is reduced.<sup>53</sup>



Various metal (Fe, Co, Ni, etc.) cycloolefin complexes have been obtained using this procedure. They are formed in very high purity.

Electrosynthetic methods using sacrificial anodes are very promising. In particular, when both cathode and anode participate in the synthetic product, the process is quite clean or a “green process.” Moreover, it is very simple to manage: a simple DC source connected to an undivided cell is sufficient.

### 1.44.3.3 Electrocrystallization

As mentioned above, electrocrystallization is usually used for the growth of conductive molecular materials. These materials arise from the combination of organic, metallo-organic and/or inorganic building blocks and belong to two main classes of compounds, so-called donor–acceptor (DA) and fractional oxidation state (FOSC) compounds. Since the early 1970s, several hundred conductive and superconductive molecular systems have been isolated.<sup>20–23,54</sup> A large majority of them arise from organic molecules combined together or associated with inorganic species, while a smaller number derive from coordination compounds being associated with organic or inorganic counter species (Figure 3).<sup>23,54–58</sup> We will only focus on the last group of materials.

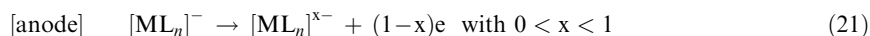
Among other features, the conductive properties of DA and FOSC compounds originate from the partial oxidation state of the constitutive molecules or building blocks. Where coordination complexes are concerned, two synthetic routes appear to achieve this feature:

- (i) electrochemical oxidation of a complex, i.e., changes in its oxidation state, and
- (ii) concomitant formation of complex and material.

#### 1.44.3.3.1 Electrochemical oxidation of a complex

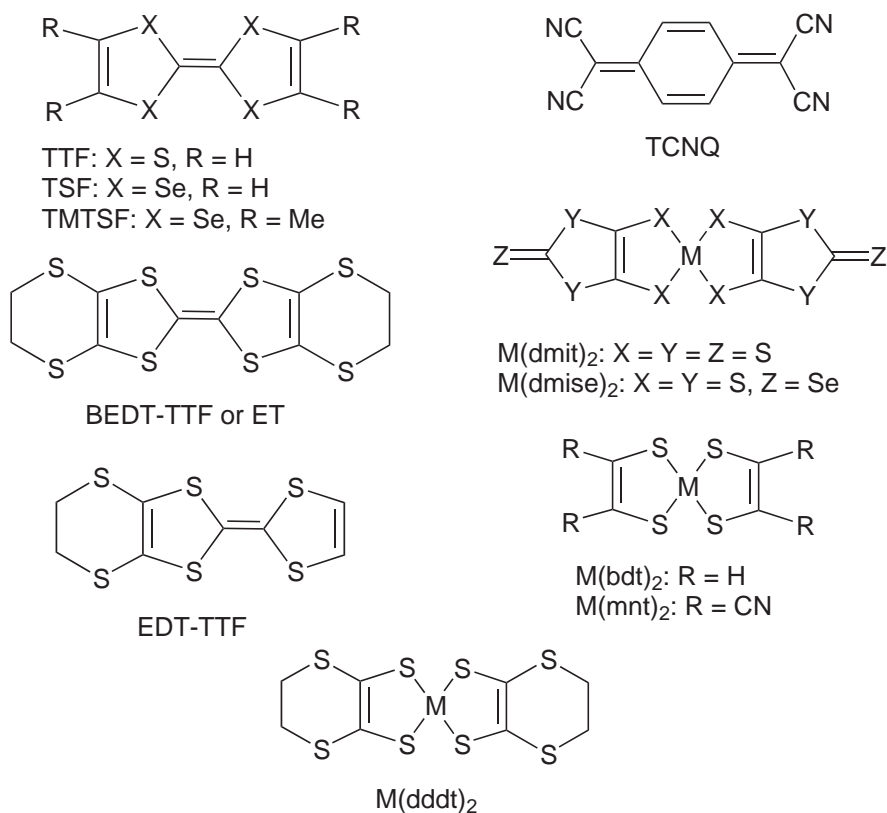
FOSC are grown following electrochemical oxidation of a complex. Many examples are found with metal bis-dithiolene species associated with closed-shell cations (Table 2).<sup>55–58</sup> Either the cation is already part of the starting complex, or it is supplied by the supporting electrolyte. In the latter, incorporation of the cation is governed by the respective solubility constants of the competing species.

The electrochemical reaction leading to a FOSC species may be summarized as:



A mechanism was proposed in the case of Ni(dmit)<sub>2</sub> complexes (refer to figure 3).<sup>68</sup>

Bisdithiolene complexes bearing the dddt ligand exhibit (refer to figure 3) different electrochemical behavior, e.g., these complexes may appear as anionic,<sup>66</sup> neutral, and cationic species.<sup>69</sup> Therefore, they are the only known dithiolene compounds that may act both as donor<sup>69</sup> or acceptor<sup>70</sup> systems. FOSC, i.e., dddt containing cationic species, originates from the oxidation of neutral species in the presence of various anions (Table 2). Anionic species containing dddt associated with cations or donor molecules were also reported.<sup>57</sup>



**Figure 3** Examples of molecular conductor building blocks. TTF, tetrathiofulvalene; TSF, tetraselenafulvalene; TMTSF, tetramethyltetraselenafulvalene; TCNQ, tetracyanoquinodimethane; BEDT-TTF, bis-ethylene-dithio-tetrathiofulvalene; EDT-TTF, ethylene-dithio-tetrathiofulvalene; dmit, dimercaptoisotri-thione or 2-thioxo-1,3-dithiole-4,5-dithiolato; dmise, 2-selenoxo-1,3-dithiole-4,5-dithiolato; dddt, 5,6-dihydro-1, 4-dithiin-2,3-dithiolato.

#### 1.44.3.3.2 Concomitant formation of complex and material

Many examples are given within the electron transfer (ET)-based series involving copper complexes (Table 3). In some cases (see for example entry 3 in Table 3), the supporting electrolyte consists of a mixture of a copper salt and of a salt containing the ligand concerned. In that case, the  $[\text{Cu}(\text{L}_2)]^-$  anions only form within the solution and react with oxidized ET on the electrode. Moreover, note (see Table 3) that different modifications of the same compound may be obtained depending on the electrochemical conditions.

**Table 2** Selection of FO SC grown by electrocrystallization.

Starting complex	Ionic species in the electrolyte	FO SC formula	References
$(\text{Bu}^n)_4\text{N} [\text{Ni}(\text{dmit})_2]$	$(\text{Bu}^n)_4\text{N}^+$	$((\text{Bu}^n)_4\text{N})_{0.29} [\text{Ni}(\text{dmit})_2]$	59
$(\text{Bu}^n)_4\text{N} [\text{Ni}(\text{dmit})_2]$	$\text{Na}^+$	$\text{Na} [\text{Ni}(\text{dmit})_2]_2$	55
$(\text{Bu}^n)_4\text{N} [\text{Pd}(\text{dmit})_2]$	$(\text{Bu}^n)_4\text{N}^+$	$((\text{Bu}^n)_4\text{N}) [\text{Pd}(\text{dmit})_2]_2((\text{Bu}^n)_4\text{N}) [\text{Pd}(\text{dmit})_2]_3$	60
$(\text{MeEt}_2\text{S}) [\text{Pd}(\text{dmit})_2]$	$(\text{MeEt}_2\text{S})^+$	$(\text{MeEt}_2\text{S}) [\text{Pd}(\text{dmit})_2]_2$	61
$(\text{HMe}_3\text{N}) [\text{Pt}(\text{dmit})_2]$	$(\text{HMe}_3\text{N})^+$	$(\text{HMe}_3\text{N}) [\text{Pt}(\text{dmit})_2]_3 \cdot \text{MeCN}$	62
$(\text{Et}_4\text{N}) [\text{Au}(\text{dmit})_2]$	$(\text{Et}_4\text{N})^+$	$\alpha\text{-}(\text{Et}_4\text{N}) [\text{Au}(\text{dmit})_2]_2$	63
$\text{Cs}_2 [\text{Pd}(\text{mnt})_2]$	$\text{Cs}^+$	$\text{Cs}_{0.83} [\text{Pd}(\text{mnt})_2] \cdot 0.5 \text{H}_2\text{O}$	64
$[\text{Pd}(\text{dddt})_2]$	$\text{PF}_6^-$	$(\text{PF}_6) [\text{Pd}(\text{dddt})_2]_2$	65
$[\text{Ni}(\text{dddt})_2]$	$(\text{HSO}_4)^-$	$(\text{HSO}_4)_2 [\text{Ni}(\text{dddt})_2]_3$	65
$[(\text{Bu}^n)_4\text{N}]_2 [\text{Co}(\text{dddt})_2]_2$	$(\text{Bu}^n)_4\text{N}^+$	$((\text{Bu}^n)_4\text{N})_2 [\text{Co}(\text{dddt})_2]$	66
$(\text{NH}_2\text{Me}_2) [\text{Ni}(\text{dmise})_2]$	$(\text{NH}_2\text{Me}_2)^+$	$(\text{NH}_2\text{Me}_2) [\text{Ni}(\text{dmise})_2]_2$	67

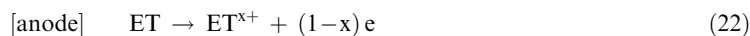
(refer to Figure 3)

**Table 3** Electrocrystallized ET phases with concomitant formation of Cu complexes.

Composition of the supporting electrolyte	ET phases	References
1. KSCN + CuSCN + 18-crown-6-ether 2. (TBA)SCN <sup>a</sup> + CuSCN	$\kappa$ -(ET) <sub>2</sub> Cu(NCS) <sub>2</sub> also $\alpha$ -(ET) <sub>2</sub> Cu(NCS) <sub>2</sub>	72
1. CuBr + Na[N(CN) <sub>2</sub> ] + 18-crown-6-ether 2. CuBr + TPP[N(CN) <sub>2</sub> ] <sup>b</sup> 3. Cu[N(CN) <sub>2</sub> ] + (TBA)Br 4. TPP <sub>4</sub> Cu[N(CN) <sub>2</sub> ] <sub>2</sub> <sup>b</sup> + (TBA)Br	$\kappa$ -(ET) <sub>2</sub> Cu[N(CN) <sub>2</sub> ]Br	73
1. CuCl + Na[N(CN) <sub>2</sub> ] + 18-crown-6-ether 2. Cu[N(CN) <sub>2</sub> ] + KCl + 18-crown-6-ether 3. CuCl + TPP[N(CN) <sub>2</sub> ] <sup>b</sup> 4. CuCl + KCl + TPP[N(CN) <sub>2</sub> ] <sup>b</sup> 5. TPP[N(CN) <sub>2</sub> ] <sup>b</sup> + CuCl + (THA)Cl <sup>c</sup> 6. TPP[N(CN) <sub>2</sub> ] <sup>b</sup> + CuCl + (TPP)Cl <sup>b</sup>	$\kappa$ -(ET) <sub>2</sub> Cu[N(CN) <sub>2</sub> ]Cl also $\alpha$ -(ET) <sub>2</sub> Cu[N(CN) <sub>2</sub> ]Cl and $\alpha$ -(ET) <sub>2</sub> CuCl <sub>2</sub>	74
1. CuCN + KCN + 18-crown-6-ether 2. Cu[N(CN) <sub>2</sub> ] + KCN + 18-crown-6-ether 3. CuCN + TPP[N(CN) <sub>2</sub> ] <sup>b</sup> + KCN 4. Na[N(CN) <sub>2</sub> ] + CuCN + 18-crown-6-ether 5. CuCN + TPP[N(CN) <sub>2</sub> ]	$\kappa$ -, $\kappa'$ or $\theta$ phases of (ET) <sub>2</sub> Cu(CN)[N(CN) <sub>2</sub> ] (ET) <sub>2</sub> Cu <sub>2</sub> (CN) <sub>3</sub>	75

<sup>a</sup> TBA = tetrabutylammonium. <sup>b</sup> TPP = tetraphenylphosphonium. <sup>c</sup> THA = tetrahexylammonium.

The electrochemical reaction involves the oxidation of the ET molecule summarized as:



It was shown in the case of EDT-TTF that this oxidation step follows an EC mechanism.<sup>71</sup>

#### 1.44.3.3 Competing electrochemical reactions

In the case of DA compounds, both donor and acceptor molecules may undergo oxidation towards fractional oxidation states. In general, their half wave potentials are similar and formation of the DA compound may compete with crystal growth of FOSSC phases. This feature was illustrated in the case of TTF[Ni(dmit)<sub>2</sub>]<sub>2</sub>. Single crystals of this phase were electrocrystallized using TTF and TBA[Ni(dmit)<sub>2</sub>]. The cyclic voltammogram of each compound shows that [Ni(dmit)<sub>2</sub>]<sup>-</sup> is oxidized at a potential 120 mV lower than that of TTF. However, addition of TTF to a solution of (Bu<sup>n</sup>)<sub>4</sub>[Ni(dmit)<sub>2</sub>] inhibits the formation of the (Bu<sup>n</sup>)<sub>4</sub> 0.29[Ni(dmit)<sub>2</sub>] FOSSC phase in favor of the TTF[Ni(dmit)<sub>2</sub>]<sub>2</sub> one.<sup>76</sup>

So far, we have only reported oxidation type reactions. However, reduction type reactions have also been reported in the case of TCNQ-based materials associated with organometallic species.<sup>24,25</sup> Moreover, in these examples, it was shown that different stoichiometries were reached and were controlled by the electrochemical conditions.

#### 1.44.4 DEDICATION

This section is dedicated to our common dear friend, the late Dominique de Montauzon (†August 2001). He was the one who introduced one of us (PC) to the fascinating world of Electrochemistry. His enthusiasm and dedication have been almost solely responsible for the development of this technique in our Institute. Should he be still with us, then he would have been the most appropriate author of this section.

## 1.44.5 REFERENCES

1. Pletcher, D. *Industrial Electrochemistry*; Chapman & Hall: London, 1982.
2. Pickett, D. J. *Electrochemical Reactor Designs*; Elsevier: New York, 1977.
3. Coeuret, F.; Storck, A. *Eléments de Génie Electrochimique*; Lavoisier: Paris, 1984.
4. Ives, D. J. G.; Janz, G. J. *Reference Electrodes*; Academic Press: New York, 1961.
5. Gritzner, G.; Kuta, J. *Electrochim. Acta* **1984**, *29*, 869–873.
6. Pearce, P. J.; Bard, A. J. *J. Electroanal. Chem.* **1980**, *108*, 121–125.
7. Gambino, S.; Filardo, G.; Silvestri, G. *J. Appl. Electrochem.* **1982**, *12*, 549–555.
8. Silvestri, G.; Gambino, S.; Filardo, G. *Tetrahedron Lett.* **1986**, *27*, 3429–3430.
9. Sock, O.; Troupel, M.; Pèrichon, J. *Tetrahedron Lett.* **1985**, *26*, 1509–1512.
10. Folest, J. C.; Nédélec, J. Y.; Pèrichon, J. *Tetrahedron Lett.* **1987**, *28*, 1885–1886.
11. Bard, A. J.; Faulkner, L. R. *Electrochemical Methods. Fundamentals and Applications*; Wiley: New York, 1980.
12. Perrin, D. D.; Armarego, W. L. F. *Purification of Laboratory Chemicals*; 3rd ed.; Pergamon: New York, 1993.
13. Gutmann, V. *Electrochim. Acta* **1976**, *21*, 661–670.
14. Gutmann, V. *The Donor–Acceptor Approach to Molecular Interactions*; Plenum: New York, 1978.
15. Coetzee, J. F. *Recommended Methods for Purification of Solvents and Tests for Impurities*; Pergamon: Oxford, UK, 1982.
16. Ogumi, Z.; Nishio, K.; Yoshizawa, S. *Electrochim. Acta* **1981**, *26*, 1779–1782.
17. Ogumi, Z.; Yamashita, H.; Nishio, K. *Electrochim. Acta* **1983**, *28*, 1687–1693.
18. Sarrazin, J.; Tallec, A. *J. Electroanal. Chem.* **1982**, *137*, 183–188.
19. Raoult, E.; Sarrazin, J.; Tallec, A. *J. Appl. Electrochem.* **1984**, *14*, 639–643.
20. Ishiguro, T.; Yamaji, K.; Saito, G. Design, Synthesis, and Crystal Growth of Organic Metals and Superconductors. In *Organic Superconductors*; Fulde, P., Ed.; Springer-Verlag: Berlin, 1998; Vol. 88, pp 393–454, 504–513.
21. Farges, J.-P. *Organic Conductors: Fundamentals and Applications*; Marcel Dekker: New-York, 1994; Vol. 4.
22. Williams, J. M.; Ferraro, J. R.; Thorn, R. J.; Carlson, K. D.; Geiser, U.; Wang, H. H.; Kini, A. M.; Whangbo, M.-H. Synthesis of organic-donor molecules and conducting salts. In *Organic Superconductors (Including Fullerenes): Synthesis, Structure, Properties, and Theory*; Prentice Hall: Englewood Cliffs, NJ, 1992; pp 11–64.
23. Cassoux, P.; Valade, L. Molecular Inorganic Superconductors. In *Inorganic Materials*; Bruce, D. W.; O'Hare, D., Eds.; Wiley: Chichester, U. K. 1996; pp 1–64.
24. Ward, M. D.; Johnson, D. C. *Inorg. Chem.* **1987**, *26*, 4213–4227.
25. Ward, M. D.; Fagan, P. J.; Calabrese, J. C.; Johnson, D. C. *J. Am. Chem. Soc.* **1989**, *111*, 1719–1732.
26. Emge, T. J.; Wang, H. H.; Beno, M. A.; Williams, J. M.; Whangbo, M.-H.; Evain, M. *J. Am. Chem. Soc.* **1986**, *108*, 8215–8223.
27. Williams, J. M.; Wang, H. H.; Emge, T. J.; Geiser, U.; Beno, M. A.; Leung, P. C. W.; Carlson, K. D.; Thorn, R. J.; Schultz, A. J.; Whangbo, M.-H. *Prog. Inorg. Chem.* **1987**, *35*, 51–218.
28. Anzai, H.; Maki, S.; Takasaki, S.; Tanaka, S.; Nakatsuji, S. I.; Yamada, J.-I.; Nozaki, K.; Negishi, A.; Harusawa, M. *J. Cryst. Growth* **1998**, *191*, 148–152.
29. Anzai, H.; Tokumoto, M.; Saito, G. *Mol. Cryst. Liq. Cryst.* **1985**, *125*, 385–392.
30. Anzai, H.; Tokumoto, M.; Takahashi, K.; Ishiguro, T. *J. Cryst. Growth* **1988**, *91*, 225–228.
31. Montgomery, L. K. Chemical Synthesis and Crystal Growth Techniques. In *Organic Conductors: Fundamentals and Applications*; Farges, J.-P., Ed.; Marcel Dekker: New York, 1994; Vol. 4, pp 115–145.
32. Saito, G.; Inukai, T. *J. Jpn. Assoc. Cryst. Growth* **1989**, *16*, 2–16.
33. Stephens, D. A.; Rehan, A. E.; Compton, S. J.; Barkhau, R. A.; Williams, J. M. *Inorg. Synth.* **1986**, *24*, 135–137.
34. Chakravorty, M. C.; Subrahmanyam, G. V. B. *Coord. Chem. Rev.* **1994**, *135/136*, 65–92.
35. Garnovskii, A. D.; Kharisov, B. I.; Gojon-Zorrilla, G.; Garnovskii, D. A. *Russ. Chem. Rev.* **1995**, *64*, 201–221.
36. Garcia-Vasquez, J. A.; Romero, J.; Sousa, A. *Coord. Chem. Rev.* **1999**, *193/195*, 691–745.
37. Garnovskii, A. D.; Blanco, L. M.; Kharisov, B. I.; Garnovskii, D. A.; Burlov, A. S. *J. Coord. Chem.* **1999**, *48*, 219–263.
38. Vecchio-Sadus, A. M. *J. Appl. Electrochem.* **1993**, *23*, 401–416.
39. Pierre, F.; Stricker, A.; Moinet, C.; Sinbandhit, S.; Toupet, L. *J. Organomet. Chem.* **1998**, *553*, 253–268.
40. Antinolo, A.; Fajardo, M.; Otero, A.; Mugnier, Y.; Nabaoui, H.; Mourad, H. *J. Organomet. Chem.* **1991**, *414*, 155–164.
41. Gollas, B.; Speiser, B.; Stahl, H.; Sieglén, J.; Straöhle, J. *Z. Naturforsch. B* **1996**, *51*, 388–398.
42. Seeber, R.; Parker, J. W. O.; Marzilli, P. A.; Marzilli, L. G. *Organometallics* **1989**, *8*, 2377–2381.
43. Wohnrath, K.; Peres de Araujo, M.; Dinelli, L. R.; Batista, A. A.; de Sousa Moreira, I.; Castellano, E. E.; Ellena, J. *J. Chem. Soc., Dalton Trans.* **2000**, 3383–3386.
44. Grobe, J.; Keil, M.; Schneider, B. H.; Zimmermann, H. *Z. Naturforsch. B Anorg. Chem. Org. Chem.* **1980**, *35*, 428–432.
45. Grobe, J.; Schneider, B. H. *Z. Naturforsch. B Anorg. Chem. Org. Chem.* **1981**, *36*, 1–7.
46. Grobe, J.; Schneider, B. H. *Z. Naturforsch. B Anorg. Chem. Org. Chem.* **1981**, *36*, 8–13.
47. Hershberger, J. W.; Amatore, C.; Kochi, J. K. *J. Organomet. Chem.* **1983**, *250*, 345–372.
48. Hershberger, J. W.; Klinger, R. J.; Kochi, J. K. *J. Am. Chem. Soc.* **1983**, *105*, 61–73.
49. Narayanan, B. A.; Amatore, C.; Kochi, J. K. *J. Chem. Soc., Chem. Commun.* **1983**, 397–399.
50. Tuck, D. G. *Molecular Electrochemistry of Inorganic, Bioinorganic, and Organometallic Compounds*; Kluwer: New York, 1993.
51. Kumar, R.; Mabrouk, H. E.; Tuck, D. G. *J. Chem. Soc., Dalton Trans.* **1988**, 1045–1048.
52. Kumar, R.; Tuck, D. G. *Can. J. Chem.* **1989**, *67*, 127–129.
53. Grobe, J.; Schneider, B. H.; Zimmermann, H. *Z. Anorg. Allg. Chem.* **1981**, *481*, 107–112.
54. Cassoux, P.; Miller, J. S. Electron-transfer Salt Based Conductors, Superconductors, and Magnets. In *Chemistry of Advanced Materials*; Interrante, L. V.; Hampden-Smith, M. J., Eds.; Wiley-VCH: New York, 1998; pp 19–71.
55. Cassoux, P.; Valade, L.; Kobayashi, H.; Kobayashi, A.; Clark, R. A.; Underhill, A. E. *Coord. Chem. Rev.* **1991**, *110*, 115–160.
56. Cassoux, P. *Coord. Chem. Rev.* **1999**, *185–186*, 213–232.

57. Robertson, N.; Cronin, L. *Coord. Chem. Rev.* **2002**, *227*, 93–127.
58. Faulmann, C.; Cassoux, P. *Prog. Inorg. Chem.* **2003**, *52*, in press.
59. Valade, L.; Legros, J.-P.; Bousseau, M.; Cassoux, P.; Garbauskas, M.; Interrante, L. V. *J. Chem. Soc., Dalton Trans.* **1985**, 783–794.
60. Legros, J.-P.; Valade, L.; Cassoux, P. *Synth. Met.* **1988**, *27*, B347–B352.
61. Faulmann, C.; Errami, A.; Donnadiou, B.; Malfant, I.; Legros, J.-P.; Cassoux, P.; Rovira, C.; Canadell, E. *Inorg. Chem.* **1996**, *35*, 3856–3873.
62. Pomarède, B.; Garreau, B.; Malfant, I.; Valade, L.; Cassoux, P.; Legros, J.-P.; Audouard, A.; Brossard, L.; Ulmet, J.-P.; Doublet, M.-L.; Canadell, E. *Inorg. Chem.* **1994**, *33*, 3401–3414.
63. Kotov, A. I.; Kusch, L. A.; Laukhina, E. E.; Khomenko, A. G.; Zvarykina, A. V.; Shibaeva, R. P.; Yagubskii, E. B.; Nagapetyan, S. S.; Struchkov, Y. T. *Synth. Met.* **1991**, *42*, 2355–2358.
64. Clemenson, P. I.; Underhill, A. E.; Hursthouse, M. B.; Short, R. L.; Ashwell, G. J.; Sandy, I. M.; Jones, M. T.; Jacobsen, C.; Carneiro, K. *Synth. Met.* **1987**, *19*, 579–584.
65. Yagubskii, E. B.; Kusch, L. A.; Gritsenko, V. V.; Dyachenko, O. A.; Buravov, L. I.; Khomenko, A. G. *Synth. Met.* **1995**, *70*, 1039–1041.
66. Welch, J. H.; Bereman, R. D.; Singh, P.; Moreland, C. *Inorg. Chim. Acta* **1989**, *158*, 17–25.
67. Sato, A.; Kobayashi, H.; Naito, T.; Sakai, F.; Kobayashi, A. *Inorg. Chem.* **1997**, *36*, 5262–5269.
68. Tommasino, J.-B.; Pomarède, B.; Médus, D.; de Montauzon, D.; Cassoux, P. *Mol. Cryst. Liq. Cryst.* **1993**, *237*, 445–456.
69. Faulmann, C.; Errami, A.; Legros, J.-P.; Cassoux, P.; Yagubskii, E. B.; Kotov, A. I. *Synth. Met.* **1993**, *56*, 2057–2062.
70. Geiser, U.; Schultz, A. J.; Wang, H. H.; Beno, M. A.; Williams, J. M. *Acta Cryst. C* **1988**, *44*, 259–262.
71. Garreau, B.; de Montauzon, D.; Cassoux, P.; Legros, J.-P.; Fabre, J.-M.; Saoud, K.; Chakroune, S. *New J. Chem.* **1995**, *19*, 161–171.
72. Urayama, H.; Yamochi, H.; Saito, G.; Nozawa, K.; Sugano, T.; Kinoshita, M.; Sato, S.; Oshima, K.; Kawamoto, A.; Tanaka, J. *Chem. Lett.* **1988**, 55–58.
73. Wang, H. H.; Kini, A. M.; Montgomery, L. K.; Geiser, U.; Carlson, K. D.; Williams, J. M.; Thompson, J. E.; Watkins, D. M.; Kwok, W. K.; Welp, U.; Vandervoort, K. G. *Chem. Mater.* **1990**, *2*, 482–484.
74. Mori, H. *Intl. J. Mod. Phys. B* **1994**, *8*, 1–45.
75. Komatsu, T.; Matsukawa, M.; Inoue, T.; Saito, G. *J. Phys. Soc. Jpn* **1996**, *65*, 1340–1354.
76. Valade, L.; Legros, J.-P.; de Montauzon, D.; Cassoux, P.; Interrante, L. V. *Israel J. Chem.* **1986**, *27*, 353–362.

# 1.45

## Spectroelectrochemistry

J. A. CRAYSTON

*University of St. Andrews, UK*

---

1.45.1	INTRODUCTION	775
1.45.2	UV-VIS SPECTROELECTROCHEMISTRY	777
1.45.2.1	One-electron Transfer	777
1.45.2.2	Multi-electron Transfer and Noninnocent Ligands	777
1.45.2.3	ECE Reactions and Catalysis	779
1.45.2.4	Dimers and Higher Nuclearity Complexes	780
1.45.2.5	Porphyryns, Phthalocyanines, and Macrocyclic Complexes	781
1.45.2.6	Organometallic Chemistry	782
1.45.3	RAMAN SPECTROELECTROCHEMISTRY	782
1.45.4	FTIR SPECTROELECTROCHEMISTRY	783
1.45.4.1	Carbonyls	783
1.45.4.2	Non-carbonyl Ligands with Multiple Bonds: Nitrosyls, Cyanides, Nitriles, Isonitriles, Thiocyanates	784
1.45.4.3	Other Ligands	785
1.45.5	EPR SPECTROELECTROCHEMISTRY	785
1.45.6	CONCLUSIONS	786
1.45.7	REFERENCES	786

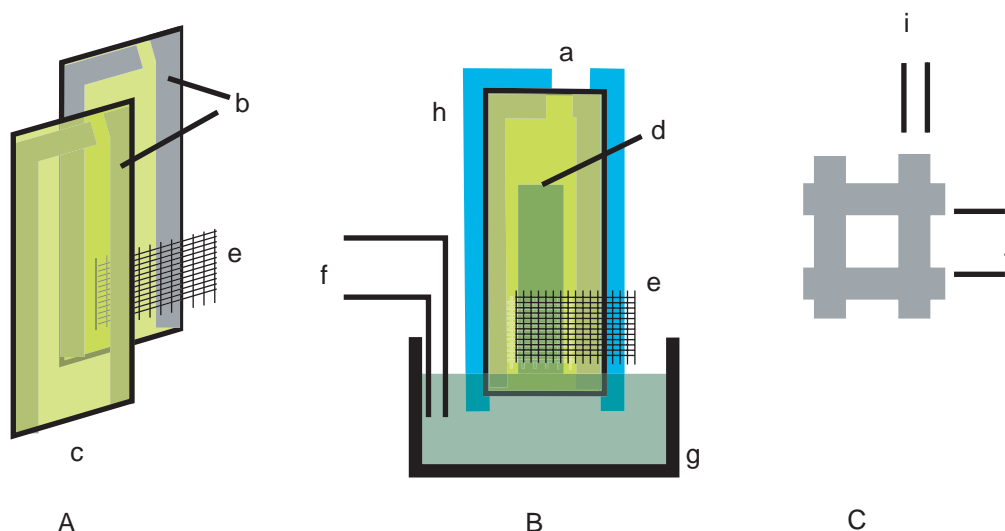
---

### 1.45.1 INTRODUCTION

The term spectroelectrochemistry generally refers to an *in situ* method for monitoring electrochemical redox processes and subsequent follow-up reactions. The basic theory and techniques are well-established for processes based in solution,<sup>1-3</sup> dominated by UV-vis, FTIR, Raman, and EPR spectroscopy. While other techniques such as Mössbauer and NMR spectroscopy are very useful for characterizing the products of electrochemical reactions, often by freezing electrolyzed solutions, they are not strictly *in situ* techniques. That is not to say that other techniques are not being developed—there is ever-growing interest in applying many specialist surface spectroscopies<sup>4-7</sup>—but these are not yet in routine use for the study of solution processes. Even the most popular technique today, UV-vis spectroelectrochemistry, took some time to catch on in the inorganic world but is now seen as an extremely useful tool. One of the main reasons for the growth in popularity of spectroelectrochemistry is its use as an aid in characterizing a redox process as either largely metal or largely ligand based, in those complexes where it is meaningful or appropriate to do so. To some extent the inorganic electrochemist can guess at these assignments (based on previous work or the CV of the ligand alone) but the UV-vis spectroelectrochemistry experiment serves as valuable confirmation. For this purpose, when paramagnetic ligand or metallic species are suspected, additional EPR spectroelectrochemistry experiments (using a different, specialized cell design) are recommended. The EPR spectroelectrochemical cell design is demanding to implement successfully and the presence of the metal electrodes within the cell reduces sensitivity considerably.

The optically transparent thin-layer electrochemical (or OTTLE) cell has caught on to the greatest extent for UV-vis spectroelectrochemistry (Figure 1).<sup>1-3</sup> The OTTLE also offers a way to measure both the redox potential and the *n*-value without requiring knowledge of the electron

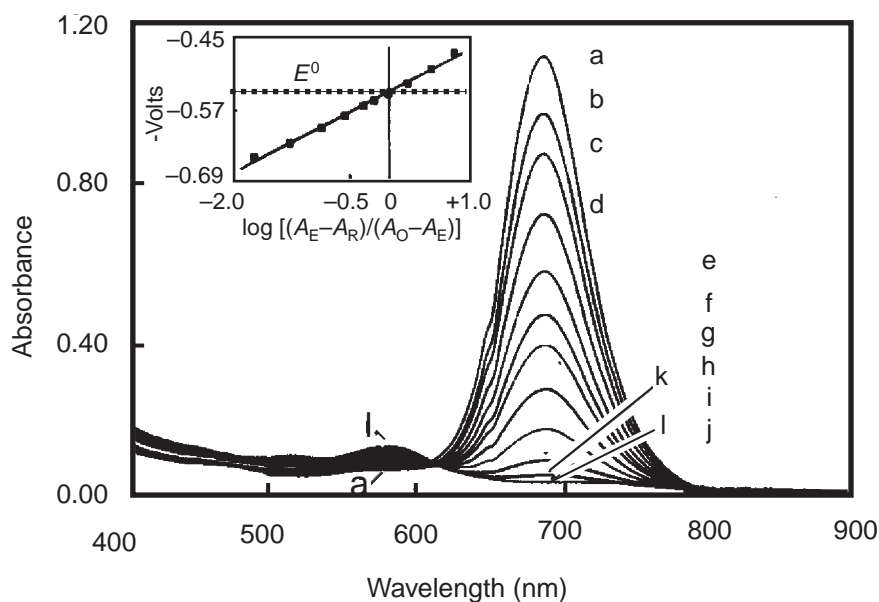




**Figure 1** Mini-grid OTTLE cell. (A) Assembly of the cell, (B) front view, (C) dimensions of 100 wires per inch gold minigrad. (a) Point of suction application to change solution, (b) teflon tape spacers, (c) microscope slides (1 × 3 inches), (d) transparent gold minigrad electrode, (f) reference and auxiliary electrodes, (g) solution cup, (h) epoxy holding cell together. Typical measurements: (i) 0.0027 cm, (j) 0.023 cm.

transfer kinetics, the diffusion coefficient or, indeed, the concentration (Figure 2).<sup>1,2</sup> The use of OTTLEs in determining an accurate value for the redox potential,  $E^{0'}$ , of biological molecules with slow heterogeneous electron transfer rates can also be profitably applied to inorganic complexes. For example, many  $\text{Cu}^{\text{II/I}}$  waves are very broad due to the very different preferred coordination geometries for the two halves of the redox couple.<sup>8</sup>

Less common than UV-vis spectroelectrochemistry, but potentially very informative, are Raman and FTIR spectroelectrochemistry techniques. This is a pity, since both UV-vis and



**Figure 2** Absorption spectra of a 6.08 mM solution of  $\text{Re}_3\text{Cl}_9$  in the 49 mol.%  $\text{AlCl}_3\text{-MeEtImCl}$  salt at  $40^\circ\text{C}$  in at various applied potentials (V): (a) open-circuit; (b)  $-0.266$ ; (c)  $-0.303$ ; (d)  $-0.325$ ; (e)  $-0.340$ ; (f)  $-0.352$ ; (g)  $-0.364$ ; (h)  $-0.383$ ; (i)  $-0.405$ ; (j)  $-0.550$ . Inset: Nernst plot constructed from the spectra (redrawn with permission from S. K. D. Strubinger, I. W. Sun, W. E. Cleland, C. L. Hussey, *Inorg. Chem.*, **1990**, 29, 993–999; © 1990, American Chemical Society).

Raman regions may be examined relatively easily using the same OTTLE cell. FTIR spectroelectrochemical cells are often based on OTTLEs fitted with IR-transparent windows, as, for example, in the design of Krejčík *et al.*<sup>9</sup> Another popular configuration for FTIR is reflectance. The various types of spectroelectrochemical cell are shown compared schematically in Figure 3.

## 1.45.2 UV-VIS SPECTROELECTROCHEMISTRY

### 1.45.2.1 One-electron Transfer

Technetium(III/II) electrochemistry features in the original Heineman reviews.<sup>2,10</sup> A similar but more recent example concerns *cis*-[Tc<sup>III</sup>(*p*-SC<sub>6</sub>H<sub>4</sub>X)<sub>2</sub>(DMPE)<sub>2</sub>] (DMPE = 1,2-bis(dimethylphosphinoethane)). Spectroelectrochemical monitoring of the reversible Tc<sup>III/II</sup> and irreversible Tc<sup>IV/III</sup> couples was reported.<sup>11</sup> Studies of mixed ligand Ru complexes<sup>12</sup> using the McQuillan cell,<sup>13</sup> allowed the authors to determine the site of reduction, a very common use of UV-vis spectroelectrochemistry.<sup>14</sup> This was confirmed by resonance Raman spectroscopy of the reduced species. The reduction of unusual 17-electron Mo compounds [Mo(Tp)(NO)ClPy] (Tp = tripyrazolylborate and py = pyridine) by one electron gives species with MLCT transitions in the near-IR.<sup>15</sup> A long-optical-path-length thin-layer cell was used in the study of the iron(III) complex of a pentadentate ligand derived from diazoxacyclononane,<sup>16</sup> showing that the complex is oxidized by one electron from [FeL]<sup>2+</sup> to [FeLCl]<sup>2+</sup>.

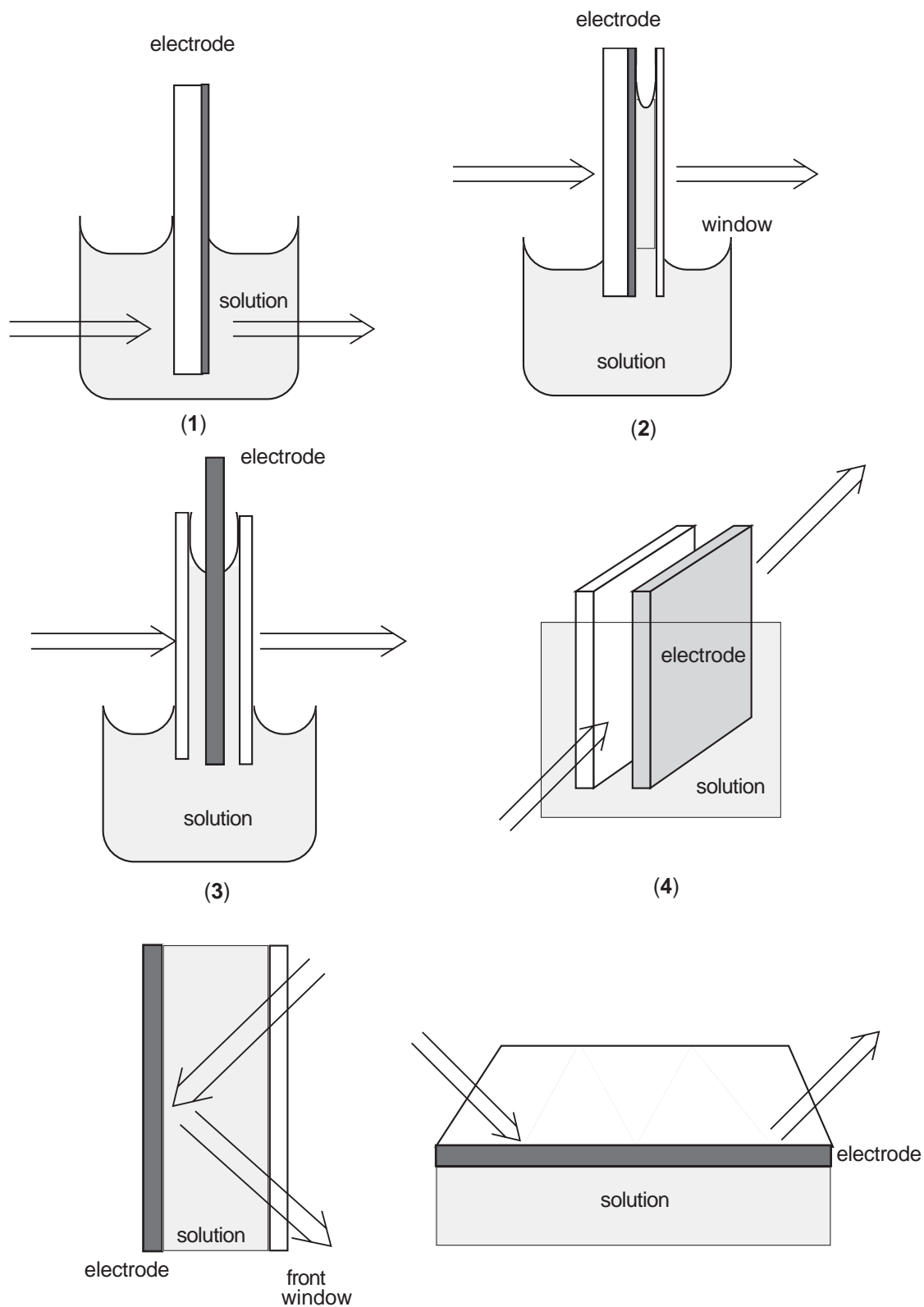
Chlistunoff and Bard have reported the oxidation of [M(bpy)<sub>3</sub>]<sup>3+</sup> where M = Zn, Cd,<sup>17</sup> and Ni<sup>18</sup> in liquid SO<sub>2</sub>. The shifts in the LMCT bands were consistent with the bpy ligand being oxidized successively by one electron. Switching off the potentiostat after producing [Zn(bpy)<sub>3</sub>]<sup>3+</sup> allowed its decay by second-order kinetics to be monitored. [Ir(bpy)<sub>3</sub>]<sup>3+</sup> can be reduced by successive electrons to the Ir<sup>0</sup> state.<sup>19</sup> The application of bis(4,4'-dicarboxylatebipyridine)ruthenium(II) complexes in dye-sensitized solar cells has inspired a detailed study of the electrochemistry and UV-vis spectroelectrochemistry of both the reduction<sup>20</sup> and oxidation<sup>21</sup> of the ester derivatives. The site of the redox reactions is clearly indicated by the characteristic spectra. For the dicarboxylic acid, blue shifts in the MLCT bands were noted during electrolysis, indicating deprotonation and hydrogen evolution, rather than reduction at the bpy ligand (which was only observed at low temperature). The deprotonated complexes were then reducible at more negative potentials.<sup>22</sup>

### 1.45.2.2 Multi-electron Transfer and Noninnocent Ligands

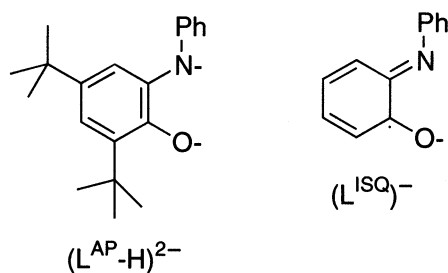
A recent recognition of their role in biological redox processes has sparked a resurgence of interest in the electrochemistry of complexes of so-called “noninnocent” ligands, i.e., ligands which themselves can undergo facile redox reactions. For example, catecholate can be oxidized in two steps to the semiquinone and the quinone. More complex still are those analogous ligands which involve proton, as well as electron transfer. UV-vis spectroelectrochemistry played an important role in unraveling the complexities of the oxidation of the 2-aminothiophenolato complex of Ru<sup>II</sup>. The oxidation is shown to follow an ECE pathway, giving the appearance of “hysteresis” in the cyclic voltammogram.<sup>23</sup> Another example of the use of spectroelectrochemical methods to help to unravel the complexities of a proton-dependent inorganic system is the study of the complexes of 1,10-phenanthroline-5,6-dione. The compounds are efficient catalysts for the indirect oxidation of the enzymatic cofactor NADP(H).<sup>24</sup> The aquo ligand could also be regarded as “non-innocent.” The complexes [LL'Ru(H<sub>2</sub>O)]<sup>2+</sup> (L = bidentate amine, L' = tridentate amine) are oxidized cleanly by 2e to give [LL'Ru<sup>IV</sup>=O].<sup>25</sup>

Recent work by Wieghardt *et al.* on complexes of the aminophenolate ligand (L<sup>AP</sup>-H)<sup>2-</sup> (Scheme 1) previously thought to be innocent, showed that the compound [V<sup>V</sup>(L<sup>AP</sup>-H)<sub>2</sub>(L<sup>ISQ</sup>)] may be oxidized by one electron to [V<sup>V</sup>(L<sup>AP</sup>-H)(L<sup>ISQ</sup>)<sub>2</sub>]<sup>+</sup> and reduced by three electrons, first at the ligand, then at the metal, as confirmed by EPR on the V<sup>IV</sup> species.<sup>26</sup> Studies have also been carried out on the related Ni, Pd, and Pt complexes.<sup>27</sup>

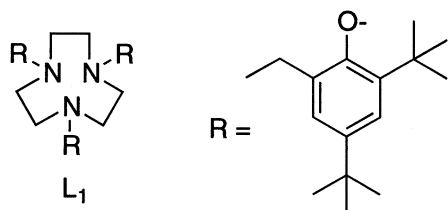
Coordinated tyrosyl radicals have been discovered in the active form of the Cu<sup>II</sup>-containing fungal enzyme, galactose oxidase. The unpaired electron on the ligand is strongly anti-ferromagnetically coupled to the unpaired *d* electron. Phenoxy radical ligands have been confirmed in the successive one-electron oxidation of [Ga(L<sub>1</sub>)<sub>3</sub>] by spectroelectrochemistry of the Ga model complex (L<sub>1</sub> shown in Scheme 2).



**Figure 3** Spectroelectrochemical cell configurations: (1) transmission cell with optically transparent electrode (OTE); (2) transmission optically transparent thin layer electrode cell (OTTLE) with OTE; (3) sandwich OTTLE cell with minigrad or reticulated carbon (RVC) electrode; (4) long optical path-length cell (LOPTC) with light parallel to electrode surface; (5) double transmission reflection cell; (6) internal reflection cell.

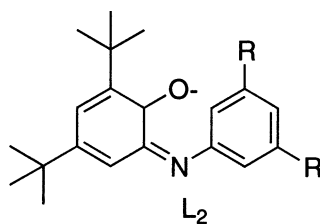


Scheme 1



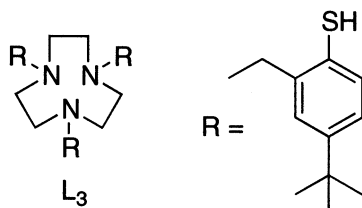
Scheme 2

This work helped to establish unambiguously the ligand-based oxidations of the Fe and Mn complexes of this ligand.<sup>28</sup> The Zn,<sup>29</sup> Ni, and Cu complexes of the related ligand L<sub>2</sub> (Scheme 3) have also been studied.<sup>30</sup> Interestingly, the Ni<sup>II</sup> complex contains two coordinated radical anions which couple together antiferromagnetically.



Scheme 3

The related phenylthiyl radical complexes are also known.<sup>31</sup> The Ru complex of L<sub>3</sub> (Scheme 4) is oxidized by four electrons in an unusual reaction to give the dimeric macrocyclic complex.<sup>32</sup>



Scheme 4

### 1.45.2.3 ECE Reactions and Catalysis

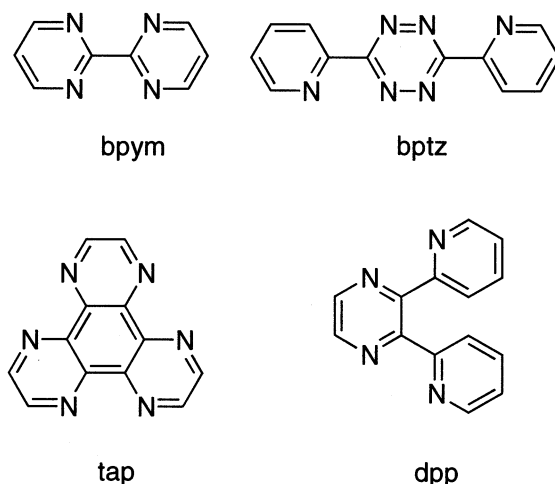
Loss of halide followed by substitution is quite common in the reduction of some complexes. Such reactions can be monitored by IR and UV-vis spectroelectrochemistry, e.g., halide loss from [RuX<sub>4</sub>(CNBu<sup>t</sup>)<sub>2</sub>]<sup>-</sup>.<sup>33</sup> Similar chemistry is a feature of the reduction of some complexes, [Cp\*ClRh(L)Cl]<sup>+</sup> (Cp\* = C<sub>5</sub>Me<sub>5</sub>, M = Rh<sup>34</sup> and Ir<sup>35</sup>) but not for the corresponding Co<sup>36</sup> complex. These complexes are normally regarded as non-labile in their M<sup>III</sup> oxidation states. However, on reduction, provided that L does not delocalize the extra charge away from the metal too

much, the chloride is rapidly released and a further reduction occurs in an overall two-electron (ECE) process. Evidence for the loss of chloride is obtained from the UV-vis spectra, e.g., chloride-free  $\text{Rh}^{\text{I}}$  has intense long-wavelength absorptions in the spectrum, or monitored using Hg polarography.<sup>37</sup> In the case of  $[\text{Cp}^*\text{ClRh}(\text{bpy})]^+$  the coordinatively unsaturated product of the reduction is highly reactive in the catalysis of hydride transfer to  $\text{H}^+\text{NAD}^+$ , or formate.<sup>38,39</sup> Coupling two of these centers together with a bridging ligand dramatically delays the chloride dissociation until two electrons are added to the complex.<sup>40</sup> The first electron resides on the ligand (EPR evidence) and it is only when the second electron is added that chloride loss is triggered. The released chloride is detected by the methods already mentioned, from conductivity, or from the concentration dependence of the electrode potential.

#### 1.45.2.4 Dimers and Higher Nuclearity Complexes

Studies of analogs of the famous Creutz-Taube dimer are attractive subjects for spectroelectrochemical study.<sup>41</sup> In the two complexes,  $[(\text{CN})_4\text{FeLFe}(\text{CN})_4]$   $\text{L} = \text{bpym}$  and  $\text{bptz}$ ,<sup>42</sup> it is the one with the longer bridging ligand (bmtz) that gives evidence for the greatest delocalization of metal charge (IVCT band at  $2,230\text{ cm}^{-1}$ ) whereas the localized formulation  $\text{Fe}^{\text{II}}\text{Fe}^{\text{III}}$  is more appropriate for the bpym complex (no IVCT band observed). This is a consequence of very low-lying  $\pi^*$  LUMO in the bptz ligand.

The reduction of hexaazatriphenylene (tap) bridged Ru dimers, photosensitizers of DNA photo-oxidation, leads to electron localization on the bridging ligand. The MLCT band disappears as the  $\pi^*$ -orbital of the bridge becomes occupied.<sup>43</sup> Similarly, heterobimetallic  $\text{Os}^{\text{II}}, \text{Ru}^{\text{II}}$  dimers bridged by dipyridylpyrazine (dpp) are oxidized sequentially at the Os center, removing the Os MLCT bands, leaving behind those due to the  $\text{Ru}^{\text{II}}$  chromophore (Scheme 5).<sup>44</sup>



Scheme 5

Finally, the cation of a fascinating  $\mu\text{-C}\equiv\text{C}-\text{C}\equiv\text{C}$ -bridged diruthenium complex shows IVCT bands characteristic of a class-III Robin-Day system.<sup>45</sup> The FTIR spectroelectrochemistry also showed a  $100\text{ cm}^{-1}$  shift in  $\nu(\text{C}\equiv\text{C})$  to lower frequencies, characteristic of cumulene-type chains. Data were also gathered for the complex after further oxidation.

Multi-electron processes in complexes, including dimeric complexes, continue to fascinate electrochemists as they may give clues as to how nature organizes multi-electron processes in redox enzymes. The spectra (including that of the one-electron oxidized species) obtained in the two-electron oxidation of two diverse dimer systems, A-frame Rh dimers<sup>46</sup> and a tungsten carbonyl dimer<sup>47</sup> were used to obtain disproportionation constants. These constants were then used to calculate the peak separation of the two one-electron redox potentials. Slow two-electron transfer in dirhodium complexes<sup>48</sup> give peculiar, yet characteristic, CV shapes.<sup>49</sup>

Other studies include the oxidation of  $[\text{Rh}_2(\text{CO})_2(\text{PPh}_3)_2(\mu\text{-}3,5\text{-Me}_2\text{pz})_2]$  (pz = pyrazine)<sup>50</sup> and the redox reactions of  $\mu_3\text{-O}$  bridged trinuclear  $\text{Rh}^{\text{III}}$  and  $\text{Ir}^{\text{III}}$  complexes.<sup>51</sup> Tetrameric molecular

rectangular complexes can be reduced by up to 8 electrons. The *in situ* spectroelectrochemistry (UV-vis and IR) indicates that the metal remains as  $\text{Re}^{\text{I}}$  throughout but indicates clearly the site of electron transfer.<sup>52</sup> Some remarkable polyoxometallates,  $[\text{ZnW}_{11}\text{M}(\text{H}_2\text{O})\text{O}_3]^{n-}$  ( $\text{M} = 3d$  metal), with many reversible redox processes have been observed.<sup>53</sup> A special UV-vis FTIR cell<sup>54</sup> was used to investigate nickel trimers for  $\text{CO}_2$  reduction.<sup>55</sup>

#### 1.45.2.5 Porphyrins, Phthalocyanines, and Macrocyclic Complexes

The accessible ligand orbitals of porphyrins and phthalocyanines inevitably lead to ambiguity about the site of electron transfer, and here again spectroelectrochemistry has played an important role in addressing this issue. In recent years spectroelectrochemistry has been used not only to distinguish between metal and ring oxidation of complexes, as in binuclear Fe and Co phthalocyanines,<sup>56</sup> but also whether nucleophilic attack on the ring cation radical species has occurred—for example, whether attack of the porphyrin cation radical to give isoporphyrin has occurred.<sup>57</sup> Three excellent studies on the solvent and ligand dependence of the electrochemistry of diverse  $[\text{PorMn}^{\text{III}}\text{Cl}]$  complexes have been published,<sup>58–60</sup> the latter study including surface-enhanced Raman spectroscopy (SERS). For example, in the case of tetra-*N*-methylpyridylporphyrins, the reduction processes were characterized as either metal-based, porphyrin-based, or pyridyl-based, the former coupled with chloride release.<sup>58</sup>

The one-electron oxidation of hydroxy(tetramesitylporphyrinato)iron(III) in  $\text{CH}_2\text{Cl}_2$  is reversible on the cyclic voltametric timescale and its spectrum, obtained by double potential step chronoabsorptometry, indicates ring-based oxidation. However, at longer times, loss of hydroxide ion occurs, followed by reduction of the dication in an  $\bar{E}CE$  process.<sup>61</sup> Loss of axial ligand also was shown to occur for indium porphyrin during both oxidation and reduction.<sup>62</sup>

Of course, assignment of an absorption band to purely *d*-orbital character or purely ligand character is a gross simplification. It is interesting to note the use of popular programs such as Cache and Hyperchem in calculating the absorption spectra of electrogenerated intermediates using the reliable ZINDO method. For example, in the case of the oxidation of tetraoxolene-bridged dinuclear Ru complexes, the ZINDO calculations showed strong mixing between metal and bridging-ligand orbitals.<sup>63</sup> In some cases the band assignments can be backed up by *in situ* EPR spectroelectrochemistry, and, more rarely, Raman excitation profile analysis.<sup>64–67</sup>

A very thorough study of  $\text{Mg}^{\text{II}}$  porphyrins was undertaken in order to correlate the oxidized intermediates observed during photoinduced electron transfer in the presence of a donor (viologen) with those observed in spectroelectrochemistry.<sup>68</sup> This approach to interpret excited-state spectroscopy with ground-state redox data is now quite common.<sup>69,70</sup> The redox states of a series of face-to-face dimeric and trimeric manganese porphyrins held together by Coulombic interactions were characterized by spectroelectrochemistry.<sup>71</sup> Double-decker porphyrins and phthalocyanines also received a thorough study.<sup>72</sup> Spectroelectrochemistry was used to study dioxygen reduction in  $\text{Co}^{\text{II}}$  porphyrin monolayers<sup>73</sup> and the binding of chloride ion to cobalt phthalocyanines in the +I, +II, and +III oxidation states.<sup>74</sup> The dioxygen adducts of  $[\text{Co}(\text{salen})]$  complexes show features very similar to  $\text{Co}^{\text{III}}$ , suggesting the formulation  $[\text{Co}^{\text{III}}(\text{O}_2^-)\text{salen}]$ .<sup>75</sup> Oxidation of these adducts releases  $\text{O}_2$ , a property which may find application in oxygen-carrier systems.<sup>76</sup>

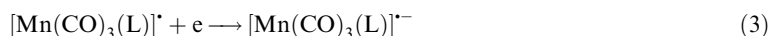
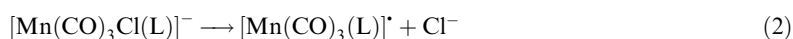
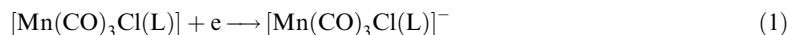
In solutions of  $\text{Co}^{\text{II}}$  imine complexes evidence was presented for a dioxygen adduct as an unstable intermediate.<sup>77</sup> The same imine complexes have also been studied in the context of organocobalt coenzyme  $\text{B}_{12}$  models, using a technique which plots the derivative of the absorbance with respect to potential (also known as derivative cyclic voltabsorptometry (DCVA)). The derivative absorbance recorded at  $0.2\text{--}0.3\text{ mV s}^{-1}$  (or 1 spectrum every 10 mV) shows that the  $\text{Co}^{\text{III}}$  and  $\text{Co}^{\text{I}}$  species have identical DVCA traces, strongly supporting the proposed mechanism involving rapid disproportionation of the intermediate  $\text{Co}^{\text{II}}$  species.<sup>78</sup>

The rich low-valent chemistry of iron porphyrins has been studied over many years. For example,  $[\text{Fe}^{\text{0}}\text{TPP}]^{2-}$  generated electrochemically reacts with  $\text{R}_4\text{N}^+$  electrolyte cation to give  $[\text{RFe}^{\text{I}}\text{TPP}]^-$ .<sup>79</sup> The reactions of reduced porphyrins have also been studied by DVCA.<sup>80</sup> The oxidation of iron(III) complexes of novel pentadentate pendant macrocyclic ligands were investigated and shown to polymerize in the presence of superoxide ( $\text{O}_2^-$ ).<sup>81</sup>

Recent attention has turned to novel, porphyrin-related macrocycles such as the porphyrines<sup>82–85</sup> and the nitrite reductase model iron complexes of porphyrone, porphindione, and isobacteriochlorin.<sup>86</sup>

### 1.45.2.6 Organometallic Chemistry

Using a specially designed variable-temperature OTTLE cell for both FTIR and UV–vis spectroelectrochemistry, Hartl and co-workers have examined many challenging problems in organometallic electrochemistry, particularly where fast follow-up reactions can be slowed using the low-temperature facility. For example,  $[\text{Mn}(\text{CO})_3\text{Cl}(\text{L})]$  ( $\text{L} = \text{bpy}, \text{Pr}^1\text{-DAB}, 1,4\text{-diisopropyl-1,4-diaza-1,3-butadiene}$ ) is reduced by one electron and this is followed by rapid chloride dissociation at room temperature to give the five-coordinate intermediate  $[\text{Mn}(\text{CO})_3(\text{L})]^\cdot$ .<sup>87</sup> This species was originally thought to dimerize to give  $[\text{Mn}(\text{CO})_3\text{L}]_2$  but it is now believed that the dimer arises from reduction of  $[\text{Mn}(\text{CO})_3(\text{L})]^\cdot$  to the anion  $[\text{Mn}(\text{CO})_3\text{L}]^-$  which reacts with the starting material to give the dimer  $[\text{Mn}(\text{CO})_3\text{L}]_2$  accompanied by loss of  $\text{Cl}^-$ . The reaction is an ECE reaction overall:



The corresponding Re system, however, differs in that the five-coordinate intermediate is rather reactive towards basic coordinating ligands. If these are absent then the intermediate will coordinate to, and reduce,  $\text{CO}_2$  in an electrocatalytic cycle.<sup>88</sup>

### 1.45.3 RAMAN SPECTROELECTROCHEMISTRY

We limit the discussion to *in situ* studies using a specially designed cell. Often, an OTTLE designed for UV–vis studies is used virtually without modification, although special reflectance cell designs are also available.<sup>89</sup> With photosensitive or strongly absorbing systems it is possible to construct a rotating bulk electrolysis cell,<sup>90</sup> or to use a flow cell.<sup>91</sup> Raman spectroscopy is particularly useful for aqueous systems, since water scattering is very weak. For example, biological molecules in aqueous media are frequently studied, particularly when Resonance Raman (RR) provides a form of selectivity for the vibrations around the metal center. Nevertheless, for solubility or redox stability reasons most studies of inorganic systems use nonaqueous solvents. Popular systems for investigation include mononuclear and binuclear complexes of easily reduced ligands, which present some ambiguity about whether the reduction is ligand or metal based. Dinuclear 4,4'-bipyridine tungsten carbonyl complexes  $[\text{W}(\text{CO})_5]_2\text{L}$  are generally reduced at the ligand.<sup>92</sup> This localized reduction nevertheless causes a shift in the carbonyl band positions. This was consistent with observations made in the excited-state IR, providing evidence for a localized  $\text{W}^0(\text{L}^-)\text{W}^+$  excited state. Similar RR spectroelectrochemical analysis of Mo and W dimers has been presented.<sup>93</sup> The site of reduction may also be determined in this way for mixed-ligand Ru dimers.<sup>12</sup>

The RR spectra of the reduced forms of mononuclear Cu complexes of polypyridyl ligands show ligand-based reduction (with decomposition in some cases<sup>94</sup>) and for 2,2'-biquinoline ligands the spectra compare favorably with the time-resolved RR spectra, confirming the MLCT character of the excited state.<sup>95</sup> A similar comparison carried out with dinuclear Cu complexes of binucleating ligands indicates a mixed-valence,  $\text{Cu}^{\text{I}}\text{Cu}^{\text{II}}$  excited state.<sup>65,66,70</sup> In the fast-moving field of self-assembled monolayers, RR spectroelectrochemistry has been used to verify the complexation of Cu ions to thiol-tethered dithizone ligands.<sup>96</sup>

Increasing the level of complexity, the non-innocent catecholate complexes of Mn<sup>97</sup> and Re<sup>98</sup> may be studied effectively by RR spectroscopy since it provides valuable assignment of the UV–vis bands. The nature of these bands was found to change dramatically depending on the redox state of the ligand, from LMCT in the Cat form to  $\text{ReO } \pi\text{-}\pi^*$  in the quinone form. RR spectroelectrochemistry<sup>99</sup> on binuclear Ru complexes of a bridging bis(*o*-quinone) ligand correlated well with the UV–vis assignments. Bond and co-workers have recently shown that proton-dependent process involving such bridging ligands are facile even in the solid state when the complexes are immobilized as microcrystals on the surface of an electrode.<sup>100</sup> Ru and Os complexes of other proton-dependent bridging ligands have been the subject of thorough studies.<sup>64,101</sup>



Complexes of porphyrins<sup>90,102–108</sup> and related macrocycles, such as phthalocyanines,<sup>109</sup> chlorins,<sup>103</sup> and tetraazaannulenes<sup>110,111</sup> are popular candidates for study, in part due to their intense Raman bands. Typically, the ligand spectra change dramatically if the redox process is centered on the ligand, whereas metal-centered redox processes cause shifts in a limited number of characteristic “marker” bands.

SERS studies of ligand interactions with complexing agents are extremely important in understanding the mechanism of the corrosion protection of metals such as copper. But SERS is also useful in studying the interactions of adsorbed,<sup>112–114</sup> or polymer-bound complexes.<sup>105,115–118</sup> It is also an extremely useful technique in studying the electrodeposition of polymeric complexes, e.g., Pt cyano complexes,<sup>119,120</sup> Magnus green salts,<sup>121</sup> nickel macrocycles,<sup>122</sup> and conducting salts.<sup>123</sup> SERS has been used to probe the binding of  $\text{Mg}^{2+}$  to crown-ether modified dyes,<sup>124</sup> cyclodextrin–nickel complex binding,<sup>125</sup> and Langmuir–Blodgett films of bisphthalocyanines.<sup>126–128</sup> Recently, the SERS charge-transfer mechanism has found favor with some inorganic spectroscopists. The analysis has been successfully applied to determine the direction of charge transfer between electrode and complex.<sup>125,129–134</sup>

A plot of the potential-dependence of the Raman intensities of a Ru binuclear  $\mu$ -oxo water oxidation catalyst showed evidence for one-, two-, and four-electron oxidized species. Oxygen isotopic labeling was used to characterize the catalytically active fully oxidized state.<sup>91</sup>

#### 1.45.4 FTIR SPECTROELECTROCHEMISTRY

Several cell designs are available in the literature, ranging from simply placing a Pt gauze inside a commercial demountable liquid cell to more sophisticated transmission FTIR OTTLs for room-temperature<sup>9</sup> and low-temperature<sup>135</sup> operation. Application of this cell to Mn and Re carbonyl anions was mentioned in the UV–vis section above. Another popular cell design is based on reflection of the beam from a planar electrode.<sup>54,136–138</sup> The following survey highlights studies in which the FTIR spectroelectrochemistry was crucial in the characterization of the redox processes.

##### 1.45.4.1 Carbonyls

There are several classic examples of the use of FTIR spectroelectrochemistry in elucidating the EC reactions of oxidized carbonyl complexes. These include the isomerization of 17e complexes; for example, the isomerization of *cis*-[Mo(CO)<sub>2</sub>(P–P)<sub>2</sub>]<sup>+</sup> to the *trans*-isomer.<sup>139</sup> Similarly, the *cis*-isomer of [Re(CO)<sub>2</sub>(P–P)<sub>2</sub>]<sup>+</sup> or [Re(CO)(P–P)<sub>2</sub>X] will isomerize on oxidation as monitored in a reflection IR cell.<sup>140</sup> One-electron oxidation of [IrH(CO)(PPh<sub>3</sub>)<sub>3</sub>] is reversible, but further oxidation to the dication induces hydride oxidation and the appearance of bands due to the 16e complex [Ir(CO)(PPh<sub>3</sub>)<sub>3</sub>]<sup>+</sup>.<sup>141</sup> Oxidation of arene tricarbonyls of Group 6 metals is frequently irreversible, especially in coordinating solvents at ambient temperature. However, the mesitylene tungsten tricarbonyl complex is oxidized by two electrons with the reversible take up of MeCN.<sup>142</sup>

Regarding reductions, ligand dissociation is sometimes observed, as in the loss of halide from the [M(CO)<sub>3</sub>(NN)X]<sup>+</sup> (M = Mn, Re; NN = bidentate ligand, e.g., bpy) system discussed above in Section 1.45.2.6. In an extensive study, the catalytic activity of the Re complex towards the reduction of CO<sub>2</sub> was shown to involve the reductive loss of halide ligand to give the catalytically active five-coordinate intermediate radical [Re(CO)<sub>3</sub>(bpy)]<sup>•</sup> and anion [Re(CO)<sub>3</sub>(bpy)]<sup>–</sup>. Product bands due to CO, CO<sub>3</sub><sup>2–</sup>, and free CO<sub>2</sub>H<sup>–</sup> were detected, the latter product released on reduction of [Re(CO)<sub>3</sub>(bpy)(CO<sub>2</sub>H)]<sup>–</sup>, a by-product of the catalytic cycle.<sup>88</sup> Another example of reductive dissociation of ligands is the 2e reduction of [XTa(CO)<sub>4</sub>(dppe)] to give [Ta(CO)<sub>4</sub>(dppe)]<sup>–</sup> which will recombine with X<sup>–</sup> when oxidized.<sup>143</sup> Reduction of [Mo(CO)<sub>2</sub>(dppe)<sub>2</sub>F]<sup>+</sup> by two electrons yields an observable anionic intermediate which decomposes with the loss of fluoride.<sup>144</sup> The spectra were concentration-dependent, explained by the formation of fluoride-bridged dimeric species. On the other hand, phosphine release is observed on reduction of [PR<sub>3</sub>(CO)<sub>3</sub>(Rpz)M]<sup>+</sup> (M = Mo, W; P = PCy<sub>3</sub>; Rpz = *N*-alkylpyrazine).<sup>145</sup>

It was once thought that the magnitude of the carbonyl shift could reveal the site of reduction, since, in principle, a metal-based reduction would lead to greater back-donation to the CO, and hence a greater lowering in the stretching frequency. However, non-carbonyl ligand-based reduction can also transmit electron density to the carbonyl through  $\pi$  interactions. This depends on the nature of the ligand. For example, in the stepwise reduction of [(NN)Re(CO)<sub>3</sub>(MQ)]<sup>+</sup>, first at



the MQ ligand, then at the NN ligand, a much smaller shift in  $\nu(\text{CO})$  is seen for the first reduction. DFT calculations of the expected changes in force constants in the reduced anion  $[\text{Cr}(\text{CO})_4(\text{bpy}^{\cdot-})]$  gave excellent agreement with experiment, so this application of theory might be a good method for predicting and interpreting the IR spectra of electrogenerated carbonyl complexes.<sup>146</sup>

Manganese and rhenium carbonyl complexes of non-innocent catechol complexes have been thoroughly investigated, as mentioned earlier. The CO ligands are sensitive to the drastic changes in the donor/acceptor properties of the noninnocent ligand's various redox levels.<sup>97,98,147</sup> Manganese carbonyl monomers and dimers have received a great deal of attention.<sup>54,148</sup>  $[(\text{CO})\text{bpymRe}(\text{CO})_3\text{Br}]$  is reduced to an anion which dissociates to  $[\text{Re}(\text{CO})_3\text{bpym}]$  and  $[\text{Mn}(\text{CO})_5]^-$ .<sup>149</sup>

Oxidation of the  $[\text{CpFe}(\text{CO})_2]_2$  dimer leads to a cation which retains one or more bridging carbonyl groups, but in the presence of coordinating ligands this dissociates into the mononuclear  $17e$   $\text{CpFe}(\text{CO})_2^{\cdot+}$  radical and  $\text{CpFe}(\text{CO})_2\text{L}^+$ .<sup>150</sup> For details on mixed-valent carbonyl dimers, please refer to the following section.

Trinuclear cobalt  $48e$  carbonyl cluster complexes have been shown to undergo redox-induced isomerization with changes in the number of bridging CO ligands.<sup>151,152</sup> The reporter carbonyl group in  $[\text{Ru}^{\text{II}}_3(\mu_3\text{-O})(\mu_2\text{-OAc})_6(\text{CO})\text{py}_2]$  shifts by unequal amounts as the Ru groups are oxidized, clearly indicating the step corresponding to the oxidation of the carbonyl-bearing Ru<sup>153</sup> (see also Chapter 2.60). CO is also used as a probe in studies of hydrogenases. The FTIR OTTL spectroelectrochemistry on the hydrogenase from *Desulfovibrio gigas* suggests that the Fe and Ni sites are strongly coupled.<sup>154</sup> Finally, 24- and 26-atom platinum carbonyl clusters have been studied as models for the exchange of  $^{13}\text{CO}$  with Pt electrode surface-bound CO.<sup>155</sup>

#### 1.45.4.2 Non-carbonyl Ligands with Multiple Bonds: Nitrosyls, Cyanides, Nitriles, Isonitriles, Thiocyanates

These ligands present strong and characteristic redox-sensitive IR bands, usually in an uncluttered region of the IR spectrum. For example, reduction centered on the nitrosyl ligand is obvious, causing a huge shift to lower frequency (ca.  $300\text{ cm}^{-1}$ );<sup>156</sup> otherwise, for reductions at the metal center, smaller shifts of ca.  $70\text{ cm}^{-1}$  are observed.<sup>157</sup> The FTIR spectroelectrochemistry of the cyanide stretching region of electrogenerated, potentially mixed-valence  $[\text{M}(\text{CN})_5]_2\text{L}^{n-}$  (L bidentate) or  $[\text{M}(\text{CN})_4]_2\text{L}^{n-}$  (L tetradentate) dimers with various bridging ligands can reveal a great deal about the nature of the mixed-valent state. For example,  $[\text{M}(\text{CN})_4]_2\text{L}^{4-}$  with L = bptz is oxidized to give a species with only one band, at a frequency intermediate between the monomer frequencies in the Fe<sup>II</sup> and Fe<sup>III</sup> states, indicating delocalized Fe<sup>2.5+</sup> centers on the IR timescale ( $10^{-12}$  s).<sup>42</sup> In contrast, when L = bpym several new bands are observed. The greater interaction between iron centers in the former case, despite the ligand being longer, is due to a low-lying  $\pi^*$  orbital. The IR spectrum of the electrogenerated classic Creutz-Taube ion also shows delocalization on the IR timescale.<sup>158</sup> Carbonyl dimers exist which are delocalized on the EPR timescale but valence-localized on the IR timescale,<sup>159,160</sup> while others are completely delocalized on the IR timescale, for example  $(\text{bpym})[\text{Mo}(\text{CO})_2(\text{PBU}^n_3)_2]^{+93}$  and  $[\text{L}_2(\text{CO})_3\text{W}]_2\mu\text{-pz}^+$  both of which also display an inter-valent charge-transfer (IVCT) band in the IR.<sup>161</sup> The IR averaging effect may be observed with any convenient, oxidation-state-sensitive band, such as the BH stretching frequency.<sup>162</sup> In certain cases, ambiguous results, showing evidence for partial delocalization, have been observed, as, for example, in the spectra obtained after one-electron oxidation of  $[\text{Fe}(\text{CN})_5]_2\text{pz}^{6-}$ .<sup>163</sup> Of course, in some systems there may be ambiguity over the site of oxidation or reduction in the dimer. The size of the shift in itself is not a reliable indicator that the metal center has been targeted in the redox reaction. Nevertheless, the complete replacement of starting material bands on oxidation is a good sign that a delocalized mixed-valent state has been formed. Conversely, the appearance of new symmetric bridging ligand bands in the spectrum reflects a loss of symmetry due to localized states.

The CN bands of tetranuclear Ru complexes bridged by  $\mu_4$ -TCNE (tetracyanoethene) and related ligands were used to characterize oxidized species.<sup>164</sup> Electrocatalytic reduction of  $\text{CO}_2$  at  $-1.9\text{ V}$  by  $[\text{Ir}_2(\text{dimen})_4]^{2+}$  causes bands due to bicarbonate and formate to appear in the IR spectrum.<sup>165</sup> Oxidation of the corresponding Rh dimers can occur by one or two electrons depending on the presence of axial ligands.<sup>166</sup> If the axial groups are  $\text{Re}(\text{CO})_5$  groups then  $2e$  oxidation causes dissociation of  $[\text{Re}(\text{CO})_5(\text{CH}_3\text{CN})]^+$ .<sup>167</sup>  $[\text{Re}_2(\mu\text{-NCS})_2(\text{NCS})_8]^{3-}$  is reversibly reduced and oxidized by one electron. Note that the shifts in  $\nu(\text{CN})$  are in the opposite direction to those found in carbonyl complexes.<sup>168</sup>

#### 1.45.4.3 Other Ligands

By following the strong IR bands due to the bound oxalate, it was shown that  $[\text{Rh}(\text{ox})(\text{CO})_2]^-$  decomposes with release of  $\text{CO}_2$  on oxidation, whereas the dimer  $[\text{Rh}(\text{ox})(\text{CO})_2]^-$  is stable to oxidation.<sup>169</sup> The amide region of the spectrum was monitored in the reduction of  $[\text{Cp}^*\text{IrCl}]^+$  (L = flavin model, 3-dimethylalloxazine). Both the metal-coordinated and uncoordinated CO bands shift by similar amounts, indicating that the reduction is ligand-based.<sup>37</sup>

The catalytic carboxylation and reduction of an organic halide by  $\text{Co}^{\text{I}}\text{TPP}^-$  showed that the initially formed  $\text{RCo}^{\text{III}}(\text{TPP})$  is reduced by one electron to the anion which dissociates by homolytic cleavage to reform  $\text{Co}^{\text{I}}\text{TPP}^-$ . Decomposition of the complex was thought to proceed as a result of attack of the cleaved organic radical on the porphyrin ring, at the pyrrole nitrogen.<sup>170</sup> Porphyrin oxidation-state marker bands have been used to monitor the  $[\text{U}(\text{OEP})_2]^{+/2+}$  redox process.<sup>72</sup>

The IR spectroelectrochemistry of the mixed-valent heteropolyanions  $[\text{PMo}_{12}\text{O}_{40}]^{n-}$  (where  $n = 4, 5, 6, 7$ ) suggests that these anions belong to the class II system in Robin and Day's classification of mixed-valence compounds. The spectra also showed evidence for decreased Mo=O bond strength after reduction.<sup>171</sup>

#### 1.45.5 EPR SPECTROELECTROCHEMISTRY

Only a handful of research groups regularly carry out *in situ* EPR spectroelectrochemistry, despite the potentially high quality of structural and electronic information provided by the spectra. In addition, EPR spectroelectrochemistry offers greater discrimination between species generated at similar potentials and, thanks to modern pulsed-EPR instruments, the potential for greater sensitivity to detect weak coupling. There are several reasons for the relative neglect of *in situ* EPR spectroelectrochemistry. The presence of metal electrodes strongly absorb the microwaves, preventing tuning, and degrading the signal from the cell. The cell design for minimizing this problem is demanding.<sup>172–176</sup> Not only that, but the designs often lead to a high resistance inside the cell due to the small volume and/or the poor reference electrode placement, although a new design claims to overcome the latter problem.<sup>177</sup> Further, it is very difficult to arrange for convenient low-temperature operation in the cavity using typical electrochemical cell designs, and cell operation is worsened when the resistivity of the electrolyte decreases at low temperatures. Many *in situ* cells only perform at or near to room temperature.<sup>178–180</sup> All of these difficulties cause many workers to electrogenerate the paramagnetic intermediate outside the spectrometer and then transfer it to a conventional tube, which may be frozen or cooled as desired.<sup>82,181</sup> Special "titration" cells with an attached EPR tube are available for metalloenzyme studies.<sup>182</sup> Partial loss of radical species in this process is not a problem since EPR is very sensitive. Nevertheless, at least one example has been provided of an organometallic Cr species which could only be generated *in situ* at low temperature.<sup>183</sup>

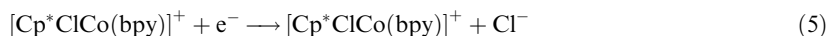
In favorable cases, the hyperfine splitting (hfs) pattern can distinguish between two different redox orbitals as in the case of the anion of  $[\text{M}(\text{CO})_4(\text{phen})]$  complexes<sup>184</sup> and in anionic bridging ligands.<sup>185</sup>

One of the most active research groups in this area has used *in situ* EPR spectroelectrochemistry in the study of potentially mixed-valent dimeric complexes.<sup>41</sup> In the reduction of  $\text{Re}^{\text{I}}$  2,2'-azobispyridine complexes, for example, comparison between the monomer and dimer spectra indicated a localized rather than a mixed-valence reduced species.<sup>186</sup> A similar analysis was applied to iron complexes of bpym and bptz, the latter showing delocalized, mixed-valent  $\text{Fe}^{2.5+}$ .<sup>42</sup> (See Section 1.45.2.4 for the earlier discussion of the UV-vis spectroelectrochemistry of these complexes.) When the bptz ligand bridges  $[\text{Cp}^*\text{CIM}]^{+/0}$  (M = Rh and Ir) centers, on the other hand, EPR data suggest a ligand-localized electron in the reduced form, with the Ir complex showing greater evidence for involvement of the *d*-orbitals through greater broadening and *g* anisotropy.<sup>40</sup> Strongly coupled Ru and Os dimers tend to show broad, anisotropic EPR signals or are silent.<sup>187,188</sup> Recently, Pt dimers have attracted some attention from various groups.<sup>189</sup> In these dimers no hyperfine splitting (hfs) to Pt is observed in the reduced form, but the small amount of *g* anisotropy indicates a small (<5%) mixing of *d*-orbital character similar to the monomeric complexes.<sup>190–192</sup> Similar experiments have been carried out on cyclometallated mononuclear<sup>193</sup> and dinuclear<sup>194</sup> Pt complexes.

EPR is often an unambiguous method used for establishing the site of the redox process. Examples studied by Kaim's group include:  $[\text{M}^{\text{II}}(\text{CN})_5\text{L}]^{n-}$  (M = Os, L =  $\text{NO}^+$ <sup>156</sup> or

*N*-methylpyrazine<sup>195</sup>),  $[M^{II}(\text{CN})_4\text{L}]^{2-}$  ( $M = \text{Os}$ ,  $L = \text{bidentate ligand}$ ),<sup>196</sup> heteroleptic Ru polypyridine complexes,<sup>179,197</sup> and dimers of Mo<sup>93</sup> and Al.<sup>198</sup> In some complexes with two reducible ligands the assignment is more doubtful, as in, for example,  $[(\text{NN})\text{Re}(\text{CO})_3\text{L}]$ , where NN is bpy and L is an *N*-alkyl-4,4'-bipyridine.<sup>199</sup> Higher nuclearity species studied include dimers bridged by tetrathiometalate groups<sup>200,201</sup> and the extent of metal mixed-valency in tetranuclear TCNQ complexes of Ru and Os.<sup>164,202</sup>

Another aspect of EPR is its role in identifying short-lived intermediates, for example, the product of the reduction:<sup>36</sup>



or the dissociation of phosphine on reduction of a tungsten complex which is indicated by a simplification of the <sup>31</sup>P hfs in the EPR spectrum.<sup>145</sup> More unusual applications of EPR include the study of the deposition of metal salts of TCNQ<sup>203</sup> and the generation of Ni<sup>III</sup> species from  $[\text{Ni}(\text{bpy})_3]^{2+}$  in liquid SO<sub>2</sub>.<sup>18</sup>

### 1.45.6 CONCLUSIONS

Spectroelectrochemistry is used enthusiastically by a number of research groups who have the expertise to set up the experiments. UV–vis spectroelectrochemistry should certainly be given pride of place in any serious electrochemical investigation of coordination compounds with strong chromophores. The cells, especially OTTLE UV–vis and IR cells, are not difficult to construct. UV–vis spectroelectrochemistry on its own can sometimes be ambiguous, and *ex situ* or *in situ* EPR spectroelectrochemistry is recommended as a powerful confirmation of the site of the redox process, especially for ligand-based processes. IR spectroelectrochemistry is particularly attractive for relatively simple systems with strongly absorbing groups such as carbonyls and cyanides, and has found widespread application in the area of dimers. Raman spectroelectrochemistry finds favor as a tool for the study of the electrochemistry of complexes with strong resonance Raman enhancement such as porphyrins. In the future, all these techniques are set to grow and to become more routine. In addition, many other techniques from the realm of surface science research are likely to become available to coordination chemists.

### 1.45.7 REFERENCES

1. Kuwana, T.; Winograd, N. *Electroanal. Chem.* **1974**, *7*, 1.
2. Heineman, W. R.; Hawkrigide, F. M.; Blount, H. N. *Electroanal. Chem.* **1984**, *13*, 1–113.
3. Niu, J. J.; Dong, S. J. *Rev. Anal. Chem.* **1996**, *15*, 1–171.
4. Abruna, H. D., Ed. *Electrochemical Interfaces: Modern Techniques for In Situ Interface Characterization*, VCH: New York, 1991.
5. Gutierrez, C.; Melendres, C. A., Eds. *Spectroscopic and Diffraction Techniques in Interfacial Electrochemistry*, Kluwer: Amsterdam, 1990.
6. Varma, R.; Selman, J. R., Eds. *Techniques for Characterization of Electrodes and Electrochemical Processes*, Wiley: New York, 1991.
7. Gale, R. J., Ed. *Spectroelectrochemistry*, Plenum: New York, 1998.
8. Sanna, G.; Pilo, M. I.; Zoroddu, M. A.; Seeber, R.; Mosca, S. *Inorg. Chim. Acta* **1993**, *208*, 153–158.
9. Krejci, M.; Danek, M.; Hartl, F. *J. Electroanal. Chem.* **1991**, *317*, 179–187.
10. Hurst, R. W.; Heineman, W. R.; Deutsch, E. *Inorg. Chem.* **1981**, *20*, 3298–3303.
11. Konno, T.; Seeber, R.; Kirchhoff, J. R.; Heineman, W. R.; Deutsch, E.; Heeg, M. J. *Transit. Met. Chem.* **1993**, *18*, 209–217.
12. Scott, S. M.; Burrell, A. K.; Cocks, P. A.; Gordon, K. C. *J. Chem. Soc.-Dalton Trans.* **1998**, 3679–3684.
13. Babaei, A.; Connor, P. A.; McQuillan, A. J.; Umaphathy, S. *J. Chem. Educ.* **1997**, *74*, 1200–1204.
14. Jones, S. W.; Vrana, L. N.; Brewer, K. J. *J. Organomet. Chem.* **1998**, *554*, 29–40.
15. Kowallick, R.; Jones, A. N.; Reeves, Z. R.; Jeffery, J. C.; McCleverty, J. A.; Ward, M. D. *New J. Chem.* **1999**, *23*, 915–921.
16. Szulbinski, W. S.; Warburton, P. R.; Busch, D. H.; Alcock, N. W. *Inorg. Chem.* **1993**, *32*, 297–302.
17. Chlistunoff, J. B.; Bard, A. J. *Inorg. Chem.* **1993**, *32*, 3521–3527.
18. Chlistunoff, J. B.; Bard, A. J. *Inorg. Chem.* **1992**, *31*, 4582–4587.
19. Coombe, V. T.; Heath, G. A.; Mackenzie, A. J.; Yellowlees, L. J. *Inorg. Chem.* **1984**, *23*, 3423–3425.
20. Wolfbauer, G.; Bond, A. M.; MacFarlane, D. R. *J. Chem. Soc.-Dalton Trans.* **1999**, 4363–4372.
21. Wolfbauer, G.; Bond, A. M.; MacFarlane, D. R. *Inorg. Chem.* **1999**, *38*, 3836–3846.
22. Wolfbauer, G.; Bond, A. M.; Deacon, G. B.; MacFarlane, D. R.; Spiccia, L. *J. Am. Chem. Soc.* **2000**, *122*, 130–142.
23. Ebadi, M.; Lever, A. B. P. *Inorg. Chem.* **1999**, *38*, 467–474.

24. Hilt, G.; Jarbawi, T.; Heineman, W. R.; Steckhan, E. *Chem.-Eur. J.* **1997**, *3*, 79–88.
25. Catalano, V. J.; Heck, R. A.; Immoos, C. E.; Ohman, A.; Hill, M. G. *Inorg. Chem.* **1998**, *37*, 2150–2157.
26. Chun, H.; Verani, C. N.; Chaudhuri, P.; Bothe, E.; Bill, E.; Weyhermuller, T.; Wieghardt, K. *Inorg. Chem.* **2001**, *40*, 4157–4166.
27. Herebian, D.; Bothe, E.; Bill, E.; Weyhermuller, T.; Wieghardt, K. *J. Am. Chem. Soc.* **2001**, *123*, 10012–10023.
28. Adam, A.; Bill, E.; Bothe, E.; Goerdts, B.; Haselhorst, G.; Hildenbrand, K.; Sokolowski, A.; Steenken, S.; Weyhermuller, T.; Wieghardt, K. *Chem.-Eur. J.* **1997**, *3*, 308–319.
29. Chaudhuri, P.; Hess, M.; Hildenbrand, K.; Bill, E.; Weyhermuller, T.; Wieghardt, K. *Inorg. Chem.* **1999**, *38*, 2781–2790.
30. Chaudhuri, P.; Verani, C. N.; Bill, E.; Bothe, E.; Weyhermuller, T.; Wieghardt, K. *J. Am. Chem. Soc.* **2001**, *123*, 2213–2223.
31. Kimura, S.; Bill, E.; Bothe, E.; Weyhermuller, T.; Wieghardt, K. *J. Am. Chem. Soc.* **2001**, *123*, 6025–6039.
32. Albela, B.; Bothe, E.; Brosch, O.; Mochizuki, K.; Weyhermuller, T.; Wieghardt, K. *Inorg. Chem.* **1999**, *38*, 5131–5138.
33. al Dulaimi, J. P.; Clark, R. J. H.; Saavedra, S. M.; Salam, M. A. *Inorg. Chim. Acta* **2000**, *300*, 525–530.
34. Ladwig, M.; Kaim, W. *J. Organomet. Chem.* **1991**, *419*, 233–243.
35. Ladwig, M.; Kaim, W. *J. Organomet. Chem.* **1992**, *439*, 79–90.
36. Kaim, W.; Reinhardt, R.; Waldhor, E.; Fiedler, J. *J. Organomet. Chem.* **1996**, *524*, 195–202.
37. Heilmann, O.; Hornung, F. M.; Kaim, W.; Fiedler, J. *J. Chem. Soc.-Faraday Trans.* **1996**, *92*, 4233–4238.
38. Kolle, U.; Grutzel, M. *Angew. Chem.-Int. Edit. Engl.* **1987**, *26*, 567–570.
39. Caix, C.; ChardonNoblat, S.; Deronzier, A.; Moutet, J. C.; Tingry, S. *J. Organomet. Chem.* **1997**, *540*, 105–111.
40. Kaim, W.; Berger, S.; Greulich, S.; Reinhardt, R.; Fiedler, J. *J. Organomet. Chem.* **1999**, *582*, 153–159.
41. Kaim, W.; Klein, A.; Glockle, M. *Accounts of Chemical Research*, **2000**, *33*, 755–763.
42. Glockle, M.; Kaim, W.; Katz, N. E.; Posse, M. G.; Cutin, E. H.; Fiedler, J. *Inorg. Chem.* **1999**, *38*, 3270–3274.
43. Tan-Sien-Hee, L.; Kirschdemesmaeker, A. *J. Chem. Soc.-Dalton Trans.* **1994**, 3651–3658.
44. Richter, M. M.; Jensen, G. E.; Brewer, K. J. *Inorg. Chim. Acta* **1995**, *230*, 35–40.
45. Bruce, M. I.; Low, P. J.; Costuas, K.; Halet, J. F.; Best, S. P.; Heath, G. A. *J. Am. Chem. Soc.* **2000**, *122*, 1949–1962.
46. Hill, M. G.; Mann, K. R. *Inorg. Chem.* **1991**, *30*, 1429–1431.
47. Hill, M. G.; Rosenhein, L. D.; Mann, K. R.; Mu, X. H.; Schultz, F. A. *Inorg. Chem.* **1992**, *31*, 4108–4111.
48. Chin, T. T.; Geiger, W. E.; Rheingold, A. L. *J. Am. Chem. Soc.* **1996**, *118*, 5002–5010.
49. Ryan, M. D. *J. Electrochem. Soc.* **1978**, *125*, 547.
50. Seeber, R.; Minghetti, G.; Pilo, M. I.; Banditelli, G.; Zamponi, S. *J. Organomet. Chem.* **1991**, *402*, 413–420.
51. Takahashi, K.; Umakoshi, K.; Kikuchi, A.; Sasaki, Y.; Tominaga, M.; Taniguchi, I. *Z.Naturforsch.(B)* **1995**, *50*, 551–557.
52. Hartmann, H.; Berger, S.; Winter, R.; Fiedler, J.; Kaim, W. *Inorg. Chem.* **2000**, *39*, 4977.
53. Cheng, L.; Sun, H.; Liu, B. F.; Liu, J. F.; Dong, S. J. *J. Chem. Soc.-Dalton Trans.* **1999**, 2619–2625.
54. Wittig, R. E.; Kubiak, C. P. *J. Electroanal. Chem.* **1995**, *393*, 75–86.
55. Washington, J.; Kubiak, C. P. *Can. J. Chem.-Rev. Can. Chim.* **1996**, *74*, 2503–2508.
56. Kobayashi, N.; Lam, H.; Nevin, W. A.; Janda, P.; Leznoff, C. C.; Koyama, T.; Monden, A.; Shirai, H. *J. Am. Chem. Soc.* **1994**, *116*, 879–890.
57. Elkasmi, A.; Lexa, D.; Maillard, P.; Momenteau, M.; Saveant, J. M. *J. Am. Chem. Soc.* **1991**, *113*, 1586–1595.
58. Vancaemelbecke, E.; Kutner, W.; Kadish, K. M. *Inorg. Chem.* **1993**, *32*, 438–444.
59. Mu, X. H.; Schultz, F. A. *Inorg. Chem.* **1992**, *31*, 3351–3357.
60. Chen, S. P.; Williams, A.; Ejeh, D.; Hambright, P.; Hosten, C. M. *Langmuir* **1999**, *15*, 3998–4004.
61. Jones, D. H.; Hinman, A. S. *Can. J. Chem.-Rev. Can. Chim.* **2000**, *78*, 1318–1324.
62. Guillard, R.; Jagerovic, N.; Tabard, A.; Naillon, C.; Kadish, K. M. *J. Chem. Soc.-Dalton Trans.* **1992**, 1957–1966.
63. Barthram, A. M.; Ward, M. D. *New J. Chem.* **2000**, *24*, 501–504.
64. Keyes, T. E.; Forster, R. J.; Jayaweera, P. M.; Coates, C. G.; McGarvey, J. J.; Vos, J. G. *Inorg. Chem.* **1998**, *37*, 5925–5932.
65. Waterland, M. R.; Gordon, K. C.; McGarvey, J. J.; Jayaweera, P. M. *J. Chem. Soc.-Dalton Trans.* **1998**, 609–616.
66. Gordon, K. C.; Alobaidi, A. H. R.; Jayaweera, P. M.; McGarvey, J. J.; Malone, J. F.; Bell, S. E. *J. Chem. Soc.-Dalton Trans.* **1996**, 1591–1596.
67. Mack, J.; Stillman, M. J. *Inorg. Chem.* **1997**, *36*, 413–425.
68. Szulbinski, W. S. *Inorg. Chim. Acta* **1995**, *228*, 243–250.
69. Damrauer, N. H.; McCusker, J. K. *J. Phys. Chem. A* **1999**, *103*, 8440–8446.
70. Waterland, M. R.; Gordon, K. C. *J. Raman Spectrosc.* **2000**, *31*, 243–253.
71. Ruhlmann, L.; Nakamura, A.; Vos, J. G.; Fuhrhop, J. H. *Inorg. Chem.* **1998**, *37*, 6052–6059.
72. Kadish, K. M.; Moninot, G.; Hu, Y.; Dubois, D.; Ibnlfassi, A.; Barbe, J. M.; Guillard, R. *J. Am. Chem. Soc.* **1993**, *115*, 8153–8166.
73. Postlethwaite, T. A.; Hutchison, J. E.; Hathcock, K. W.; Murray, R. W. *Langmuir* **1995**, *11*, 4109–4116.
74. Ozkaya, A. R.; Hamuryudan, E.; Bayir, Z. A.; Bekaroglu, O. *J. Porphy. Phthalocyanine* **2000**, *4*, 689–697.
75. Ortiz, B.; Park, S. M. *Bull. Korean Chem. Soc.* **2000**, *21*, 405–411.
76. Cameron, J. H.; Turner, S. C. *J. Chem. Soc.-Dalton Trans.* **1993**, 1941–1945.
77. Costa, G.; Tavagnacco, C.; Balducci, G. *J. Electroanal. Chem.* **1991**, *318*, 183–206.
78. Seeber, R.; Marassi, R.; Parker, W. O.; Kelly, G. *Inorg. Chim. Acta* **1990**, *168*, 127–138.
79. Desilva, C.; Czarnecki, K.; Ryan, M. D. *Inorg. Chim. Acta* **1994**, *226*, 195–201.
80. De Silva, C.; Czarnecki, K.; Ryan, M. D. *Inorg. Chim. Acta* **1999**, *287*, 21–26.
81. Szulbinski, W. S.; Warburton, P. R.; Busch, D. H. *Inorg. Chem.* **1993**, *32*, 5368–5376.
82. Dsouza, F.; Boulas, P.; Aukauloo, A. M.; Guillard, R.; Kisters, M.; Vogel, E.; Kadish, K. M. *J. Phys. Chem.* **1994**, *98*, 11885–11891.
83. Kadish, K. M.; Dsouza, F.; Vancaemelbecke, E.; Boulas, P.; Vogel, E.; Aukauloo, A. M.; Guillard, R. *Inorg. Chem.* **1994**, *33*, 4474–4479.
84. Kadish, K. M.; Boulas, P.; Dsouza, F.; Aukauloo, M. A.; Guillard, R.; Lausmann, M.; Vogel, E. *Inorg. Chem.* **1994**, *33*, 471–476.

85. Bernard, C.; Gisselbrecht, J. P.; Gross, M.; Vogel, E.; Lausmann, M. *Inorg. Chem.* **1994**, *33*, 2393–2401.
86. Liu, Y. H.; Benassy, M. F.; Chojnacki, S.; Dsouza, F.; Barbour, T.; Belcher, W. J.; Brothers, P. J.; Kadish, K. M. *Inorg. Chem.* **1994**, *33*, 4480–4484.
87. Rossenaar, B. D.; Hartl, F.; Stufkens, D. J.; Amatore, C.; Maisonhaute, E.; Verpeaux, J. N. *Organometallics* **1997**, *16*, 4675–4685.
88. Johnson, F. P. A.; George, M. W.; Hartl, F.; Turner, J. J. *Organometallics* **1996**, *15*, 3374–3387.
89. Son, Y.; Rajeshwar, K. *J. Chem. Soc.-Faraday Trans.* **1992**, *88*, 605–610.
90. Hu, W.; Hinman, A. S. *Anal. Chem.* **2000**, *72*, 3233–3235.
91. Yamada, H.; Hurst, J. K. *J. Am. Chem. Soc.* **2000**, *122*, 5303–5311.
92. McNicholl, R. A.; McGarvey, J. J.; Alobaidi, A. H. R.; Bell, S. E. J.; Jayaweera, P. M.; Coates, C. G. *J. Phys. Chem.* **1995**, *99*, 12268–12273.
93. Kaim, W.; Bruns, W.; Kohlmann, S.; Krejčík, M. *Inorg. Chim. Acta* **1995**, *229*, 143–151.
94. Page, S. E.; Gordon, K. C.; Burrell, A. K. *Inorg. Chem.* **1998**, *37*, 4452–4459.
95. Alobaidi, A. H. R.; Gordon, K. C.; McGarvey, J. J.; Bell, S. E. J.; Grimshaw, J. J. *J. Phys. Chem.* **1993**, *97*, 10942–10947.
96. Mirkhalaf, F.; Schiffrin, D. J. *J. Chem. Soc.-Faraday Trans.* **1998**, *94*, 1321–1327.
97. Hartl, F.; Stufkens, D. J.; Vlcek, A. *Inorg. Chem.* **1992**, *31*, 1687–1695.
98. Hartl, F.; Vlcek, A. *Inorg. Chem.* **1992**, *31*, 2869–2876.
99. Hartl, F.; Snoeck, T. L.; Stufkens, D. J.; Lever, A. B. P. *Inorg. Chem.* **1995**, *34*, 3887–3894.
100. Bond, A. M.; Marken, F.; Williams, C. T.; Beattie, D. A.; Keyes, T. E.; Forster, R. J.; Vos, J. G. *J. Phys. Chem. B* **2000**, *104*, 1977–1983.
101. Coates, C. G.; Keyes, T. E.; Hughes, H. P.; Jayaweera, P. M.; McGarvey, J. J.; Vos, J. G. *J. Phys. Chem. A* **1998**, *102*, 5013–5018.
102. Axolabehere, E.; Chottard, G.; Lexa, D. *New J. Chem.* **1994**, *18*, 889–899.
103. Blackwood, M. E.; Lin, C. Y.; Cleary, S. R.; McGlashen, M. M. Spiro, T. G. *J. Phys. Chem. A* **1997**, *101*, 255–258.
104. Hosten, C. M.; Birke, R. L.; Lombardi, J. R. *J. Phys. Chem.* **1992**, *96*, 6585–6592.
105. Bell, S. E. J.; Devenney, M.; Grimshaw, J.; Trochagrimshaw, J.; McGarvey, J. J. *J. Chem. Soc.-Chem. Commun.* **1992**, 221–222.
106. Popovici, S.; Leyffer, W.; Holze, R. *J. Porphyr. Phthalocyanines* **1998**, *2*, 249–260.
107. Popovici, S.; Leyffer, W.; Holze, R. *J. Porphyr. Phthalocyanines* **1999**, *3*, 265–282.
108. Alobaidi, A. H. R.; Rigby, S. J.; Bell, S. E. J.; McGarvey, J. J. *J. Phys. Chem.* **1992**, *96*, 10960–10963.
109. Bovill, A. J.; McConnell, A. A.; Rospadowski, B. N.; Smith, W. E. *J. Chem. Soc.-Faraday Trans.* **1992**, *88*, 455–459.
110. Holze, R. *Z. Phys. Chemie-Int. J. Res. Phys. Chem. Chem. Phys.* **1994**, *185*, 1–15.
111. Bell, S.; Crayston, J.; Dines, T. J.; Ellahi, S. B. *J. Phys. Chem.* **1996**, *100*, 5252–5260.
112. Janikczachor, M.; Jasny, J. *Electrochim. Acta* **1992**, *37*, 2347–2352.
113. Joy, V. T.; Srinivasan, T. K. *J. Phys. Chem. B* **1999**, *103*, 6509–6514.
114. Temperini, M. L. A.; Rubim, J. C.; Sala, O.; Jubert, A. H.; Villalba, M. E. C.; Aymonino, P. J. *J. Raman Spectrosc.* **1991**, *22*, 301–305.
115. Taylor, A. P.; Crayston, J. A.; Dines, T. J. *Analyst* **1998**, *123*, 1913–1921.
116. Maclean, A. L.; Armstrong, R. S.; Kennedy, B. J. *J. Raman Spectrosc.* **1995**, *26*, 981–989.
117. Bell, S. E. J.; Devenney, M. D.; Grimshaw, J.; Hara, S.; Rice, J. H.; Trocha-Grimshaw, J. *J. Chem. Soc.-Faraday Trans.* **1998**, *94*, 2955–2960.
118. Bell, S. E. J.; Devenney, M.; Grimshaw, J.; Trochagrimshaw, J. *J. Phys. IV* **1994**, *4*, 157–161.
119. Pei, J. H.; Weng, L. T.; Li, X. Y. *J. Electroanal. Chem.* **2000**, *480*, 74–83.
120. Cooper, J. B.; Rhodes, S. M.; Wertz, D. W. *J. Phys. Chem.* **1991**, *95*, 4800–4803.
121. Pei, J. H.; Li, X. Y. *J. Solid State Electrochem.* **2000**, *4*, 131–140.
122. Bukowska, J.; Roslonek, G.; Taraszewska, J. *J. Electroanal. Chem.* **1996**, *403*, 47–52.
123. Shelton, R. D.; Chambers, J. Q.; Schneider, W. *J. Electroanal. Chem.* **1991**, *305*, 217–228.
124. Feofanov, A.; Ianoul, A.; Oleinikov, V.; Gromov, S.; Fedorova, O.; Alfimov, M.; Nabiev, I. *J. Phys. Chem.* **1996**, *100*, 2154–2160.
125. Barreto, W. J.; Santos, P. S.; Rubim, J. C. *Vib. Spectrosc.* **1993**, *6*, 87–93.
126. Gorbunova, Y.; Rodriguezmendez, M. L.; Souto, J.; Tomilova, L.; Desaja, J. A. *Chem. Mat.* **1995**, *7*, 1443–1447.
127. Rodriguezmendez, M. L.; Aroca, R.; Desaja, J. A. *Chem. Mat.* **1993**, *5*, 933–937.
128. Aroca, R.; Bolourchi, H.; Battisti, D.; Najafi, K. *Langmuir* **1993**, *9*, 3138–3141.
129. Rubim, J. C.; Temperini, M. L. A.; Corio, P.; Sala, O.; Jubert, A. H.; Chaconvillalba, M. E.; Aymonino, P. J. *J. Phys. Chem.* **1995**, *99*, 345–355.
130. Corio, P.; Rubim, J. C. *J. Raman Spectrosc.* **1997**, *28*, 235–241.
131. Corio, P.; Rubim, J. C. *J. Phys. Chem.* **1995**, *99*, 13217–13223.
132. Corio, P.; Temperini, M. L. A.; Rubim, J. C.; Santos, P. S. *Spectrosc. Acta Pt. A-Molec. Biomolec. Spectr.* **1999**, *55*, 2411–2421.
133. Corio, P.; Temperini, M. L. A.; Santos, P. S.; Rubim, J. C. *Langmuir* **1999**, *15*, 2500–2507.
134. Rubim, J. C.; Corio, P.; Ribeiro, M. C. C.; Matz, M. *J. Phys. Chem.* **1995**, *99*, 15765–15774.
135. Hartl, F.; Luyten, H.; Nieuwenhuis, H. A.; Schoemaker, G. C. *Appl. Spectrosc.* **1994**, *48*, 1522–1528.
136. Best, S. P.; Clark, R. J. H.; McQueen, R. C. S.; Cooney, R. P. *Rev. Sci. Instrum.* **1987**, *58*, 2071–2074.
137. Best, S. P.; Ciniawsky, S. A.; Humphrey, D. G. *J. Chem. Soc.-Dalton Trans.* **1996**, 2945–2949.
138. Hinman, A. S.; Olorunyolemi, T. *Can. J. Chem.-Rev. Can. Chim.* **1993**, *71*, 1975–1982.
139. Lyons, L. J.; Pitz, S. L.; Boyd, D. C. *Inorg. Chem.* **1995**, *34*, 316–322.
140. Bond, A. M.; Colton, R.; Humphrey, D. G.; Mahon, P. J.; Snook, G. A.; Tedesco, V.; Walter, J. N. *Organometallics* **1998**, *17*, 2977–2985.
141. Bond, A. M.; Humphrey, D. G.; Menglet, D.; Lazarev, G. G.; Dickson, R. S.; Vu, T. *Inorg. Chim. Acta* **2000**, *300*, 565–571.
142. Zhang, Y.; Gosser, D. K.; Rieger, P. H.; Sweigart, D. A. *J. Am. Chem. Soc.* **1991**, *113*, 4062–4068.
143. Blaine, C. A.; Ellis, J. E.; Mann, K. R. *Inorg. Chem.* **1995**, *34*, 1552–1561.

144. Bond, A. M.; Colton, R.; Humphrey, D. G.; Tedesco, V.; van den Bergen, A. *Organometallics* **1998**, *17*, 3908–3915.
145. Hilgers, F.; Bruns, W.; Fiedler, J.; Kaim, W. *J. Organomet. Chem.* **1996**, *511*, 273–280.
146. Zalis, S.; Daniel, C.; Vlcek, A. *J. Chem. Soc.-Dalton Trans.* **1999**, 3081–3086.
147. Hartl, F. *Inorg. Chim. Acta* **1998**, *268*, 1–11.
148. Atwood, C. G.; Geiger, W. E.; Bitterwolf, T. E. *J. Electroanal. Chem.* **1995**, *397*, 279–285.
149. Vanoutersterp, J. W. M.; Hartl, F.; Stufkens, D. *J. Organometallics* **1995**, *14*, 3303–3310.
150. Bullock, J. P.; Palazotto, M. C.; Mann, K. R. *Inorg. Chem.* **1991**, *30*, 1284–1293.
151. Robben, M. P.; Rieger, P. H.; Geiger, W. E. *J. Am. Chem. Soc.* **1999**, *121*, 367–375.
152. Brooksby, P. A.; Duffy, N. W.; McQuillan, A. J.; Robinson, B. H.; Simpson, J. *J. Chem. Soc.-Dalton Trans.* **1998**, 2855–2860.
153. Ye, S.; Akutagawa, H.; Uosaki, K.; Sasaki, Y. *Inorg. Chem.* **1995**, *34*, 4527–4528.
154. DeLacey, A. L.; Stadler, C.; Fernandez, V. N.; Hatchikian, E. C.; Fan, H. J.; Li, S. H.; Hall, M. B. *J. Biol. Inorg. Chem.* **2002**, *7*, 318–326.
155. Roth, J. D.; Lewis, G. J.; Jiang, X. D.; Dahl, L. F.; Weaver, M. J. *J. Phys. Chem.* **1992**, *96*, 7219–7225.
156. Baumann, F.; Kaim, W.; Baraldo, L. M.; Slep, L. D.; Olabe, J. A.; Fiedler, J. *Inorg. Chim. Acta* **1999**, *285*, 129–133.
157. Bear, J. L.; Wellhoff, J.; Royal, G.; Van Caemelbecke, E.; Eapen, S.; Kadish, K. M. *Inorg. Chem.* **2001**, *40*, 2282–2286.
158. Best, S. P.; Clark, R. J. H.; McQueen, R. C. S.; Joss, S. *J. Am. Chem. Soc.* **1989**, *111*, 548–550.
159. Atwood, C. G.; Geiger, W. E.; Rheingold, A. L. *J. Am. Chem. Soc.* **1993**, *115*, 5310–5311.
160. Pierce, D. T.; Geiger, W. E. *Inorg. Chem.* **1994**, *33*, 373–381.
161. Bruns, W.; Kaim, W.; Waldhor, E.; Krejčík, M. *Inorg. Chem.* **1995**, *34*, 663–672.
162. Chin, T. T.; Lovelace, S. R.; Geiger, W. E.; Davis, C. M.; Grimes, R. N. *J. Am. Chem. Soc.* **1994**, *116*, 9359–9360.
163. Ketterle, M.; Kaim, W.; Olabe, J. A.; Parise, A. R.; Fiedler, J. *Inorg. Chim. Acta* **1999**, *291*, 66–73.
164. Moscherosch, M.; Waldhor, E.; Binder, H.; Kaim, W.; Fiedler, J. *Inorg. Chem.* **1995**, *34*, 4326–4335.
165. Cheng, S. C.; Blaine, C. A.; Hill, M. G.; Mann, K. R. *Inorg. Chem.* **1996**, *35*, 7704–7708.
166. Hill, M. G.; Mann, K. R. *Inorg. Chim. Acta* **1996**, *243*, 219–228.
167. Hill, M. G.; Bullock, J. P.; Wilson, T.; Bacon, P.; Blaine, C. A.; Mann, L. R. *Inorg. Chim. Acta* **1994**, *226*, 61–68.
168. Clark, R. J. H.; Humphrey, D. G. *Inorg. Chem.* **1996**, *35*, 2053–2061.
169. Dodson, E. D.; Zhao, X.; Anderson, O. P.; Caughey, W. S.; Elliott, C. M. *Abstr. Pap. Am. Chem. Soc.* **1993**, *205*, 508–INOR.
170. Zheng, G. D.; Stradiotto, M.; Li, L. J. *J. Electroanal. Chem.* **1998**, *453*, 79–88.
171. Sun, H. R.; Zhang, S. Y.; Xu, J. Q.; Yang, G. Y.; Shi, T. S. *J. Electroanal. Chem.* **1998**, *455*, 57–68.
172. Webster, R. D.; Bond, A. M.; Coles, B. A.; Compton, R. G. *J. Electroanal. Chem.* **1996**, *404*, 303–308.
173. Fiedler, D. A.; Koppenol, M.; Bond, A. M. *J. Electrochem. Soc.* **1995**, *142*, 862–867.
174. Bagchi, R. N.; Bond, A. M.; Scholz, F. *Electroanalysis* **1989**, *1*, 1–11.
175. Mu, X. H.; Kadish, K. M. *Electroanalysis* **1990**, *2*, 15–20.
176. Pilo, M. I.; Manca, G.; Zoroddu, M. A.; Seeber, R. *Inorg. Chim. Acta* **1991**, *180*, 225–230.
177. Hartl, F.; Groenestein, R. P.; Mahabiersing, T. *Collect. Czech. Chem. Commun.* **2001**, *66*, 52–66.
178. Lexa, D.; Momeuteau, M.; Mispelter, J.; Saveant, J. M. *Inorg. Chem.* **1989**, *28*, 30–35.
179. Kaim, W.; Ernst, S.; Kasack, V. *J. Am. Chem. Soc.* **1990**, *112*, 173–178.
180. Barton, M. T.; Rowley, N. M.; Ashton, P. R.; Jones, C. J.; Spencer, N.; Tolley, M. S.; Yellowlees, L. J. *J. Chem. Soc.-Dalton Trans.* **2000**, 3170–3175.
181. Holliger, C.; Pierik, A. J.; Reijerse, E. J.; Hagen, W. R. *J. Am. Chem. Soc.* **1993**, *115*, 5651–5656.
182. Harder, S. R.; Feinberg, B. A.; Ragsdale, S. W. *Anal. Biochem.* **1989**, *181*, 283–287.
183. Bond, A. M.; Dyson, P. J.; Humphrey, D. G.; Lazarev, G.; Suman, P. *J. Chem. Soc.-Dalton Trans.* **1999**, 443–447.
184. Farrell, I. R.; Hartl, F.; Zalis, S.; Mahabiersing, T.; Vlcek, A. *J. Chem. Soc.-Dalton Trans.* **2000**, 4323–4331.
185. Waldhor, E.; Zulu, M. M.; Zalis, S.; Kaim, W. *J. Chem. Soc.-Perkin Trans. 2* **1996**, 1197–1204.
186. Hartmann, H.; Scheiring, T.; Fiedler, J.; Kaim, W. *J. Organomet. Chem.* **2000**, *604*, 267–272.
187. Hornung, F. M.; Baumann, F.; Kaim, W.; Olabe, J. A.; Slep, L. D.; Fiedler, J. *Inorg. Chem.* **1998**, *37*, 311–316.
188. Poppe, J.; Moscherosch, M.; Kaim, W. *Inorg. Chem.* **1993**, *32*, 2640–2643.
189. Klein, A.; Kaim, W.; Hornung, F. M.; Fiedler, J.; Zalis, S. *Inorg. Chim. Acta* **1997**, *264*, 269–278.
190. Klein, A.; Kaim, W. *Organometallics* **1995**, *14*, 1176–1186.
191. Braterman, P. S.; Song, J. I.; Wimmer, F. M.; Wimmer, S.; Kaim, W.; Klein, A.; Peacock, R. D. *Inorg. Chem.* **1992**, *31*, 5084–5088.
192. Collison, D.; Mabbs, F. E.; McInnes, J. L.; Taylor, K. J.; Welch, A. J.; Yellowlees, L. J. *J. Chem. Soc.-Dalton Trans.* **1996**, 329–334.
193. Minghetti, G.; Pilo, M. I.; Sanna, G.; Seeber, R.; Stoccoro, S.; Laschi, F. *J. Organomet. Chem.* **1993**, *452*, 257–261.
194. Crespo, M.; Grande, C.; Klein, A. *J. Chem. Soc.-Dalton Trans.* **1999**, 1629–1637.
195. Waldhor, E.; Kaim, W.; Olabe, J. A.; Slep, L. D.; Fiedler, J. *Inorg. Chem.* **1997**, *36*, 2969–2974.
196. Waldhor, E.; Poppe, J.; Kaim, W.; Cutin, E. H.; Posse, M. E. G.; Katz, N. E. *Inorg. Chem.* **1995**, *34*, 3093–3096.
197. Krejčík, M.; Zalis, S.; Klima, J.; Sykora, D.; Matheis, W.; Klein, A.; Kaim, W. *Inorg. Chem.* **1993**, *32*, 3362–3368.
198. Hasenzahl, S.; Kaim, W.; Stahl, T. *Inorg. Chim. Acta* **1994**, *225*, 23–34.
199. Berger, S.; Klein, A.; Kaim, W. *Inorg. Chem.* **1998**, *37*, 5664–5671.
200. Schafer, R.; Kaim, W.; Moscherosch, M.; Krejčík, M. *J. Chem. Soc.-Chem. Commun.* **1992**, 834–835.
201. Schafer, R.; Fiedler, J.; Moscherosch, M.; Kaim, W. *J. Chem. Soc.-Chem. Commun.* **1993**, 896–897.
202. Baumann, F.; Kaim, W.; Olabe, J. A.; Parise, A. R.; Jordanov, J. *J. Chem. Soc.-Dalton Trans.* **1997**, 4455–4459.
203. Oyama, M.; Webster, R. D.; Suarez, M.; Marken, F.; Compton, R. G.; Okazaki, S. *J. Phys. Chem. B* **1998**, *102*, 6588–6595.



# 1.46

## Applications of Genetic Engineering

D. BARRICK

*Johns Hopkins University, Baltimore, MD, USA*

---

1.46.1	INTRODUCTION	791
1.46.2	PROTEINS, THE GENETIC CODE, AND THE METAL LIGANDS OF PROTEINS	792
1.46.3	METHODS FOR INTRODUCTION AND REPLACEMENT OF METAL LIGANDS IN PROTEINS	792
1.46.4	LIGAND REPLACEMENT WITHIN THE BOUNDS OF THE GENETIC CODE	795
1.46.4.1	Identification of Protein-derived Metal Ligands in the Absence of Structural Information	795
1.46.4.2	Structure–Function Studies Targeting Known Ligands	796
1.46.4.2.1	<i>Ligands in the first coordination shell</i>	796
1.46.4.2.2	<i>Residues in the second coordination shell</i>	796
1.46.5	LIGAND REPLACEMENT OUTSIDE THE BOUNDS OF THE GENETIC CODE	797
1.46.5.1	Trans-substitution as a Means to Modify Ligand Chemistry	797
1.46.5.2	Identification of Protein Ligands in the Absence of Structure Using <i>trans</i> -Substitution	798
1.46.5.3	Structure–Energy–Function Studies of Known Ligands using <i>trans</i> -Substitution	800
1.46.6	<i>DE NOVO</i> DESIGN OF METAL SITES IN PROTEINS	802
1.46.6.1	Mimicking Naturally Occurring Metal Sites	802
1.46.6.2	Designing Novel Metal Sites with New Functions	803
1.46.7	GLOSSARY	803
1.46.8	REFERENCES	804

---

### 1.46.1 INTRODUCTION

Since the early 1970s, methods have been developed to produce complex biological macromolecules that do not rely on purification of the molecule from its native biological source. One avenue that has opened up is chemical synthesis of linear biopolymers, including both peptides<sup>1,2</sup> and proteins.<sup>3,4</sup> Another avenue for producing large biological molecules, in particular, proteins, involves the use of living cells. In this method, a gene encoding a protein of interest is introduced into the appropriate host cells, the cells are grown under conditions that promote synthesis of the protein encoded by the foreign gene, and the protein is recovered from the cells and is purified from the other cellular proteins.

All of these methods permit chemical changes to be made to the protein sequence. For the bioinorganic chemist, this allows modifications to be made to protein ligands that coordinate metals, as well as second-sphere groups. Alternatively, new metal sites can be introduced into proteins of known structure by introducing ligands in carefully selected sites. At the extreme, the methods described above can be used to design new proteins of entirely novel sequence (termed “*de novo* design”) that can incorporate metal sites into their folded structures.

In this chapter, I will focus on the use of genetic methods (that is, the modification and expression of foreign genes in cells to produce targeted changes in the protein sequence) to obtain metalloproteins with altered or novel metal sites. First, the genetic code will be discussed from a perspective of the ligand properties of different residues. Next, methods will be described for modification of genes to alter ligands and other residues that influence the structure and function of metal sites.

In the section that follows, specific examples will be given of the use of genetic methods to modify protein-derived metal ligands. Ligand modification can provide two different types of

information. First, substitutions in metalloproteins of known sequence but unknown structure can reveal ligand identity. Second, substitution of ligands in metalloproteins of known structure can reveal how particular metal–ligand interactions contribute to structure, function, spectroscopic features, and energetics. In both types of experiments, ligand substitution can be either to another residue that retains metal ligation capability, or it can be to a non-ligating (usually aliphatic) residue. In a variant form of ligand substitution, a ligating residue is effectively deleted (by replacement with a small residue such as alanine or glycine) and ligand function is provided *in trans*, by addition of an exogenous small basic molecule to the modified protein in solution. This method, which has been referred to as “chemical rescue” in analogy with similar experiments in enzyme active sites, provides a high level of chemical flexibility that is not permitted within the confines of the genetic code. Examples of ligand substitution *in trans* will be used to illustrate the method, its ability to identify ligands in the absence of structural information, and insights that can be gained from applying this method to metalloproteins of known structure. The last section will provide examples of design of novel metal sites in proteins using genetic methods.

### 1.46.2 PROTEINS, THE GENETIC CODE, AND THE METAL LIGANDS OF PROTEINS

Proteins consist of amino acids that are strung together into a linear polymer through amide, or “peptide” linkages. The chemical features and structures of proteins are determined by their amino acid sequences. With a few exceptions, proteins produced by living organisms contain just twenty amino acids. This restriction is imposed by the genetic code, the code by which the cellular translation machinery converts nucleic acid sequences of genes into protein sequences (Figure 1(a)).

The set of twenty amino acids specified by the genetic code contain both polar and nonpolar side chains. Amino acids with nonpolar side chains are typically found in the interior of proteins, where they are shielded from aqueous solvent. This arrangement lends stability to the native form of proteins; thus these structure-determining residues show a high degree of conservation when protein sequences from different organisms are compared. Polar residues are typically found on the surface of proteins. Typically, these residues are not critical for the stability of native proteins, and can often be substituted;<sup>5,6</sup> as a consequence, polar surface residues are weakly conserved.<sup>7</sup> In exception to this, the polar residues that coordinate metal ions are very highly conserved. For example, in myoglobin and hemoglobin sequence compilations, the axial histidine ligand is invariant.<sup>8</sup> Thus, it is not possible to study ligand variations in metal sites by comparing sequences of the same protein from different organisms. Instead, methods must be used that can replace specific side chains at metal sites.

There are twelve polar amino acids within the genetic code that can, in principle, act as metal ligands (Figure 1).<sup>9</sup> Although restriction to twelve ligands is severe compared to the broad range of ligands available to the synthetic bioinorganic chemist, these twelve ligands present a broad range of functionality and reactivity (Figure 1b). Within this group of twelve ligands are hard oxygen ligands (shaded dark gray in Figure 1a), including the hydroxyls of serine and threonine, the phenolic oxygen of tyrosine, and the carboxylates of aspartic and glutamic acids. Also included are intermediate and soft nitrogen and sulfur ligands (shaded medium gray and light gray, respectively, in Figure 1a). Nitrogen ligands include the heterocyclic imidazole of histidine, and the primary amine side chain of lysine. Sulfur ligands include the thiol of cysteine and the thioether (or sulfide) of methionine. In addition, the amide side chains of asparagine and glutamine (and in some cases, the polypeptide backbone) can coordinate metals, typically using carbonyl oxygens.

### 1.46.3 METHODS FOR INTRODUCTION AND REPLACEMENT OF METAL LIGANDS IN PROTEINS

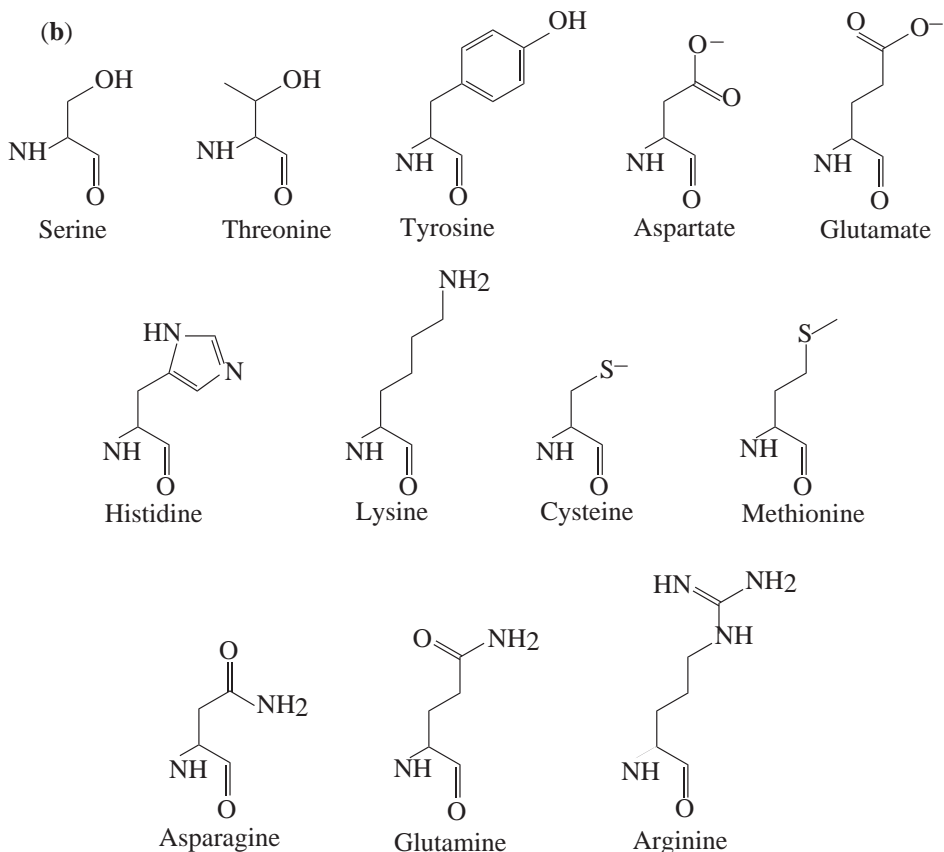
By far the most common means to substitute a side chains in a protein involves using short synthetic DNA oligonucleotides to direct enzyme-mediated modification of the gene encoding the protein at a specific site. The modified gene, which directs production of a protein containing the desired amino acid substitution, is then placed in an appropriate host cell where it directs the synthesis of the substituted protein. Collectively, the molecular biology methods used to make the desired gene modification are referred to as “site-directed mutagenesis” techniques.



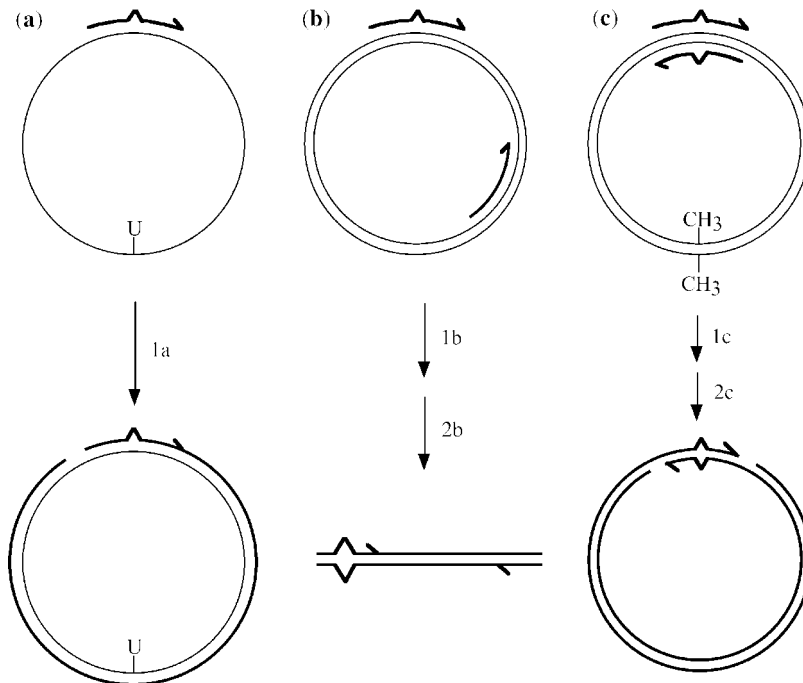
(a)

		Second base				
		T	C	A	G	
First base	T	Phe	Ser	Tyr	Cys	T
		Phe	Ser	Tyr	Cys	C
		Leu	Ser	Stop	Stop	A
		Leu	Ser	Stop	Trp	G
	C	Leu	Pro	His	Arg	T
		Leu	Pro	His	Arg	C
		Leu	Pro	Gln	Arg	A
		Leu	Pro	Gln	Arg	G
	A	Ile	Thr	Asn	Ser	T
		Ile	Thr	Asn	Ser	C
		Ile	Thr	Lys	Arg	A
		Met	Thr	Lys	Arg	G
	G	Val	Ala	Asp	Gly	T
		Val	Ala	Asp	Gly	C
		Val	Ala	Glu	Gly	A
		Val	Ala	Glu	Gly	G

Third base



**Figure 1** The genetic code and metal ligands in proteins. (a) The genetic code; residues with side chains containing hard ligands are shaded dark gray, whereas those with softer ligand groups are shaded medium gray. Residues that contain weak ligand groups are shaded light gray. (b) The covalent structure of amino acids with side chains that can ligate metal ions. The top row contains hard side-chain ligands (shaded dark gray in (a)), the middle row contains softer side-chain ligands (shaded medium gray in (a)); the cysteine is represented as a thiolate, which is the predominant ionization state for metal ligation), and the bottom row contains weak side-chain ligands (shaded light gray in (a)); although the side chain of arginine is shown in its neutral ionization state, its affinity for hydrogen ions is so high that it is not typically available for metal ligation at neutral pH).



**Figure 2** Different schemes for site-directed mutagenesis. Specific residues, such as ligands to metals, can be substituted by using synthetic DNA oligonucleotides (thick lines) that anneal at the desired ligand substitution site in a gene encoding a metalloprotein. (a) The Kunkel method,<sup>10,11</sup> in which a single mutagenic oligonucleotide is extended on a single-stranded DNA template. The mutated strand is selected for in the cell because the template strand contains uracil (U) bases, and is degraded. (b) PCR-based methods, in which one oligonucleotide directs the mutation, and a second oligonucleotide anneals at a site distal to the mutation on the opposite strand. Following PCR (step 1b), the mutated PCR product must be purified (step 2b) and subcloned into an appropriate plasmid. (c) The “QuikChange<sup>TM</sup>” method (see text), in which both complementary oligonucleotide primers direct the mutation. The mutated DNA is selected for by digestion of the template plasmid with an enzyme (*Dpn* I, step 2c) that digests only methylated DNA.

Several schemes for site-directed mutagenesis are shown in [Figure 2](#). In all of these schemes, the gene that is being modified is contained within a circular DNA molecule, or plasmid, that can be propagated in bacterial cells. In each method, the original, unmodified gene acts as a template from which the sequence of the gene is copied to the synthetic oligonucleotide. Since the oligonucleotide bears the desired sequence change, the copied DNA molecule contains the desired mutation. However, before production of the variant protein can be directed from the mutant gene, the gene must be separated from the original unmodified DNA. In scheme A, devised by Kunkel, separation is facilitated by incorporation of uracil bases into the original, unmodified DNA sequence.<sup>10,11</sup> When the resulting DNA is introduced into cells, the template DNA is destroyed because it contains uracil, leaving only the copied DNA containing the desired mutation. This scheme requires the DNA to be in a single-stranded form, which is obtained with the help of a bacteriophage. While this method for making site-directed mutations can be quite reliable, several steps are involved to prepare single-stranded template, and the plasmid must carry additional sequences that are recognized by the bacteriophage.

The invention of the polymerase chain reaction (PCR) provided the ability to isolate large amounts of double-stranded DNA from any template DNA sequence.<sup>12–14</sup> By encoding the desired sequence substitution in one of the two synthetic PCR oligonucleotide primers, a mutation can readily be incorporated into the PCR product ([Figure 2b](#)). If the mutation can be made in close proximity to a restriction site, the PCR product can be digested and cloned directly into the appropriately digested plasmid, such that the mutated gene directs expression of the substituted protein. In cases where the desired mutation site is not near to a restriction site, the PCR product can be used as a large primer on the original template gene to connect to a restriction site.<sup>15,16</sup> Although PCR-based site-directed mutagenesis does not require single-stranded DNA ([Figure 2b](#)), cloning the PCR product involves extensive manipulation of both the PCR DNA

(including a step to physically separate the PCR DNA from the unmodified parent DNA) and the plasmid DNA into which the mutated PCR DNA will be cloned.

Recently, a very simple and reliable method for introducing site-specific mutations has gained widespread popularity (Figure 2c). This method (used in the Stratagene “QuikChange™” kit,<sup>17</sup> US Patent numbers 5,789,166 and 5,923,419) takes advantage of the best features of both the Kunkel and PCR methods (Figures 2a and 2b respectively). Like the Kunkel method, the template DNA is chemically tagged for degradation, and the entire plasmid is copied, eliminating subsequent cloning steps. Like the PCR method, the template is double-stranded DNA, eliminating the need to isolated single-stranded template. With this method, specific substitutions can easily be generated and introduced to cells in one day or less.

#### 1.46.4 LIGAND REPLACEMENT WITHIN THE BOUNDS OF THE GENETIC CODE

The genetic code permits a variety of potential substitutions to be made to known or candidate metal ligands that either alter or eliminate metal ligation. Ligand alteration is often most appropriate for probing structure–function at a metal site of known structure because subtle effects on structure and function can be examined, whereas ligand elimination may be better suited for ligand identification because the severe effects of ligand elimination are often unambiguous. Substitutions of protein-derived metal ligands within the bounds of the genetic code have been used in a very large number of studies. As space limitations preclude listing each and every example, I will attempt to list some important examples that illustrate the utility of such substitutions, and the types of results that are obtained.

##### 1.46.4.1 Identification of Protein-derived Metal Ligands in the Absence of Structural Information

With the speed of gene sequencing far exceeding that of high-resolution structure determination of proteins, it is often the case that researchers have the sequence of a protein of interest in hand, and have some knowledge that the protein binds a particular metal (or group of metals), but little else is known about the structure. In such cases, determination of ligand identity would provide insight into the structure of the protein and the reactivity of its metal center(s). In such cases, educated guesses can be made as to which residues (see the shaded residues in Figure 1) are likely to be metal ligands. Obviously, the approximately fifty to hundreds of candidate ligands can be narrowed in some cases, by knowing the ligand preference of the metal(s) involved—a calcium will not likely bind cysteine thiols, and a copper will not likely bind carboxylates. The field can often be narrowed further to one or two types of residues by considering spectroscopic data. A further restriction can be obtained by phylogenetic comparisons—by comparing protein sequences from different organisms, candidate ligands can often (but not always, see Baker *et al.*<sup>18</sup>) be rejected if they are not conserved in across species. However, even with strong spectroscopic, biochemical, and phylogenetic indications of ligand identity, substitution experiments must be done to verify (or disprove) ligand identity.

In an example of determination of ligand identity using site-directed mutagenesis, a pair of histidine substitutions were made in the gene 32 protein from the *E. coli* bacteriophage T4.<sup>19</sup> Spectroscopic studies had previously indicated zinc coordination by three cysteine and one non-cysteine ligand, and sequence comparisons had suggested one of two histidines. Substitution of histidine 64 with weakly (glutamine, asparagine) or nonligating (leucine) residues disrupted zinc binding, and diminished DNA binding activity, whereas replacement of histidine 81 had no effect on either property. Similarly, in a copper-responsive transcription factor from yeast,<sup>20</sup> biochemical, spectroscopic, and phylogenetic studies were used to guide substitutions that identified zinc and copper ligands. Ligand substitution has also been used to identify copper ligands in coagulation factor VIII<sup>21</sup> and in tyrosinase,<sup>22</sup> nickel ligands in a urease metallochaperone,<sup>23</sup> and manganese ligands in manganese peroxidase.<sup>24</sup>

Site-directed mutagenesis has also been used to identify axial ligands to heme irons. In heme oxygenase, substitution of histidine 25 with alanine greatly altered the ligation and functional properties of the enzyme,<sup>25,26</sup> and eliminated a vibrational feature from the resonance Raman spectrum attributed to an iron–histidine nitrogen stretch [ $\nu(\text{Fe}-\text{N}_{\text{im}})$ ].<sup>26</sup> Ligand substitution has also been used to identify heme ligands in cytochrome *bo*,<sup>27,28</sup> cytochrome *c* oxidase,<sup>29</sup> cytochrome *bd* ubiquinol oxidase,<sup>30</sup> and cytochrome *d* oxidase,<sup>31</sup> all integral membranes involved in electron transport.

#### 1.46.4.2 Structure–Function Studies Targeting Known Ligands

When the structure of a metalloprotein is known, the identities of its metal ligands are clear. In such cases, ligand substitution of metal ligands can often provide insight into the role of the metals in determining structure and function. In addition, substitution allows ligands and residues in the second coordination shell to be changed to match residues found in other metalloproteins with different function, creating “hybrid” metalloproteins. The resulting hybrids can provide an understanding of reactivity.

##### 1.46.4.2.1 Ligands in the first coordination shell

One of the first examples of substitution of a known metalloprotein ligand was the substitution of the proximal histidine with tyrosine and cysteine in sperm whale myoglobin.<sup>32–34</sup> Spectroscopic studies confirmed coordination of the heme iron by tyrosine and cysteine, and revealed similarities between the tyrosine-substituted myoglobin and several other tyrosine-ligated hemoprotein.<sup>32,33</sup> Furthermore, similarities were seen between the cysteine-substituted protein and cytochrome P450, a cysteine-ligated hemoprotein.<sup>34</sup> Substitution of the proximal histidine of prostaglandin endoperoxide synthase with tyrosine was used to discriminate among possible mechanisms of cyclooxygenase activation.<sup>35</sup> In heme oxygenase, substitutions of the proximal histidine with tyrosine and cysteine disrupted oxygenase activity but enabled oxidase activity.<sup>36</sup> In cytochrome c peroxidase, substitution of the proximal histidine to the heme with glutamine resulted in coordination of the glutamine side-chain oxygen to the heme iron; surprisingly, this substituted enzyme retains nearly full catalytic activity.<sup>37</sup> Ligand substitution was also used to examine the role of protein ligands on iron binding and release from lactoferrin<sup>38</sup> and transferrin;<sup>39</sup> in a related study, structural consequences of ligand-substitution in transferrin were determined crystallographically, and were related to naturally occurring sequence differences at the iron site.<sup>18</sup>

Ligand substitution has also been applied to zinc sites in proteins of known structure. In carbonic anhydrase II (CAII), where a single  $Zn^{2+}$  is coordinated by three histidines and a single reactive water, substitution of the histidine ligands decreased zinc affinity and activity.<sup>40–42</sup> Substitution of a nearby threonine to a cysteine converted the CAII zinc site to a closed tetrahedral  $His_3/Cys$  configuration with decreased activity.<sup>41</sup> Substitutions of the zinc ligands of the gene 32 protein decreased metal affinity, and in some cases resulted in a dimeric protein complex linked through a single zinc ion.<sup>43</sup> Ligand substitutions at other metal sites include the manganese site of arginase,<sup>44</sup> and the calcium sites of calmodulin.<sup>45</sup>

##### 1.46.4.2.2 Residues in the second coordination shell

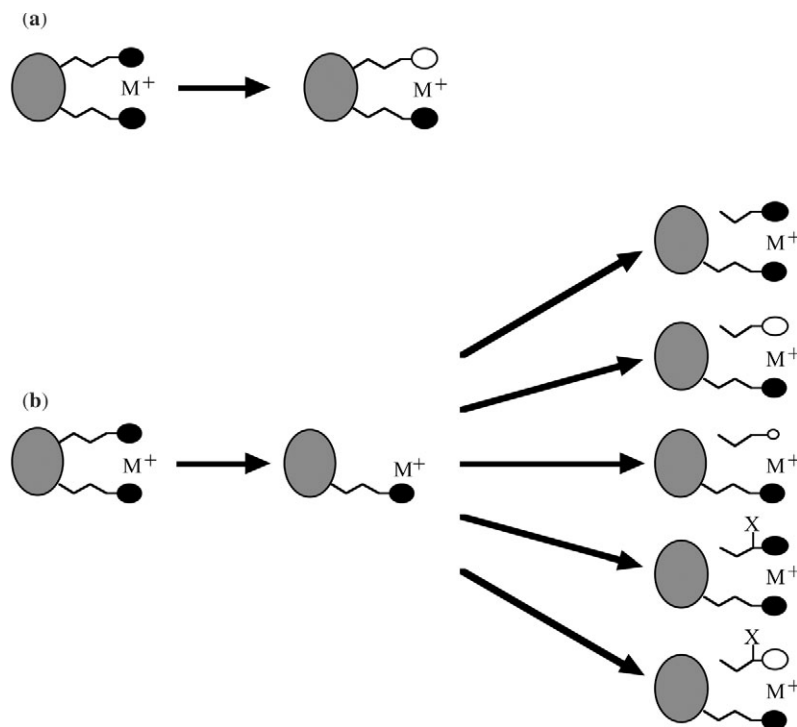
In addition to substitution of coordinating ligands in metalloproteins, substitution of residues in the second coordination shell can provide critical information on structure, function, and specificity. A dramatic illustration is provided in mutational studies of *E. coli* iron and manganese superoxide dismutases (SODs). Although these two enzymes have very similar first coordination shells involving the same protein-derived metal ligands, enzymes substituted with their non-native metal are inactive, in part because their redox potentials are offset from that of their substrate-product chemical transformations.<sup>46</sup> A glutamine substitution in the second coordination shell restored activity in the iron-containing manganese SOD.<sup>47</sup> In another example of second-sphere effects, substitutions in a set of aromatic residues near the ligating histidines of CAII revealed the importance of these residues in maintaining high zinc affinity and specificity for cobalt and copper.<sup>48</sup> Likewise, substitutions of the second coordination shell of a designed zinc site increased metal affinity.<sup>49</sup> In cytochrome b5, a heme protein, substitution of a valine for an alanine near the proximal histidine produced a reorientation of the proximal histidine ligand, resulting in a change in reduction potential.<sup>50</sup> In myoglobin, substitution of a distal, non-coordinating histidine with tyrosine resulted in iron coordination by the substituting tyrosine.<sup>32</sup> In a proximal cysteine-substituted myoglobin, mutations of non-ligating distal residues were found to enhance the efficiency of cytochrome P450-like catalysis.<sup>51</sup>

## 1.46.5 LIGAND REPLACEMENT OUTSIDE THE BOUNDS OF THE GENETIC CODE

### 1.46.5.1 Trans-substitution as a Means to Modify Ligand Chemistry

Although in principal, a variety of ligand substitutions are accessible within the bounds of the genetic code, producing variation in ligating atom type, and variation in ligand character, in practice, the twelve choices for substitution (see Figure 1) often impose a fairly severe restriction on the chemistry that can be brought to bear on the metal site. In addition to the limited set of available ligands specified by the genetic code compared to that available to the synthetic inorganic chemist, the variation in the number of bonds between the ligating atom(s) and point of attachment to the polypeptide main-chain for different side chains (two for serine, threonine, and cysteine to six for tyrosine) provides a steric restriction on potential ligand substitutions. Assuming that upon substitution, the polypeptide chain is unable to undergo major conformational rearrangements, a small ligand (like serine) may be unable to substitute for a large naturally occurring ligand (like tyrosine) because it may be unable to position close enough to coordinate the metal. Even if coordination is possible, the covalent restrictions on ligand orientation imposed by the polypeptide may strain or distort the resulting ligand–metal interaction.

To avoid restrictions on ligand chemistry imposed by the genetic code, site-directed mutagenesis can be used to convert endogenous, protein-derived ligands to exogenous ligands that can be supplied “*in trans*” (Figure 3). In this scheme, a protein-derived ligand is effectively deleted by substitution with a residue containing a small (non-ligating) side chain such as alanine or glycine. In principle, this substitution should create a cavity at the position formerly occupied by the ligand under study. The ligand is then provided by adding a small molecule to solution that has similar coordination characteristics and that possesses some degree of shape complementarity to the cavity resulting from deletion of the original ligand. In many cases, the exogenous, substituting ligand can be added directly to the bacterial culture at the time of expression;<sup>52</sup> alternatively, the ligand can be added to the substituted protein once it is purified.



**Figure 3** *Trans*-substitution of endogenous ligands in a metalloprotein. (a) Schematic representation of a simple genetically encoded substitution of a protein-derived metal ligand (upper black oval) with another residue (white) that maintains binding with the metal (M<sup>+</sup>). (b) Using *trans*-substitution, the ligating residue is removed, and an exogenous, “surrogate” ligand is added to the solution. These exogenous ligands can closely mimic the molecular features of the original ligand, or can introduce new chemical features to the metalloprotein site.

The *trans*-substitution method outlined in Figure 3 was first used by Toney and Kirsch to gain insight into the relationship between structure and mechanism at the active site of the enzyme aspartate aminotransferase.<sup>53</sup> These authors adopted the term “chemical rescue” to describe the ability of small molecules to restore activity to a variant enzyme containing a cavity-forming substitution. Although the substituted residue was not a metal ligand in the aspartate aminotransferase study,<sup>53</sup> the success of the study made clear the potential of this method to study structure–function relationships of metal ligands as well as non-ligating groups. The method applied by Toney and Kirsch has subsequently been applied to a large number of protein metal ligands. In some cases, addition of a surrogate ligand restores activity, structural, and spectroscopic features, consistent with the idea of “rescue” by the added ligand. In other cases, however, these properties are significantly altered in the *trans*-substituted complex. In such cases, there is much to be learned about how the subtle changes in bonding, stereochemistry, and electronic structure of the resulting metal–surrogate ligand complex influences structure and function; however, the term “rescue” seems inappropriate given the structural and functional deficiencies resulting from the substitution procedure. Thus, although the use of the term “chemical rescue” is widespread, the term “*trans*-substitution” will be used here to avoid functional implications.

One of the advantages of *trans*-substitution is that it provides high chemical flexibility. Unlike the restrictions imposed by the genetic code, the main restriction in the *trans*-substitution method is that affinity of the ligand must be reasonably high. Quantitatively, if affinity is represented using a dissociation constant ( $K_d$ ) for the reaction



where P and L represent protein and ligand respectively, the solution ligand concentration must be above the  $K_d$ , so that the ligand cavity is saturated with the ligand. At non-metal sites, this condition may be difficult to meet: indeed, in the aspartate aminotransferase study, binding of side-chain surrogates to the enzyme showed no sign of saturation even at 250 mM. At metal sites, however, this condition can often be met quite readily, since metal ligands tend to be polar and thus have high solubility, and since the metal–ligand interaction provides added stability, decreasing  $K_d$ . If saturation can be achieved for a variety of exogenous ligands, the effects of subtle variations in ligand properties such as basicity,  $\pi$ -bonding ability, and steric features on metalloprotein structure and function can be dissected. In addition, through introduction of ligands that are very different from those of the genetic code, the effects of drastic variation in ligand properties can be examined, and metalloproteins with novel and otherwise inaccessible properties can be prepared. The *trans*-substitution method also allows the structural and functional role of the covalent linkage between a metal ligand and the protein to be assessed, especially when the exogenous ligand is chemically similar to the substituted side chain.<sup>54</sup> In some cases, these linkages are proposed to play critical roles in determining the structural, functional, and/or spectroscopic properties of metalloproteins.

#### 1.46.5.2 Identification of Protein Ligands in the Absence of Structure Using *trans*-Substitution

As described above, site-directed mutagenesis can be used to help determine the identity of ligands to metal sites in proteins for which high-resolution structural information is lacking. A potential ligand residue can be replaced by a residue that is either unable to coordinate metal, or has altered coordination properties, and the spectroscopic, biochemical, and/or functional properties of the protein are examined. If these properties are altered (the variant protein may fail to interact with the metal, have very different spectroscopic features, or may lack enzymatic activities attributed to the metal site), it is reasonably likely that the substituted residue may indeed act as a metal ligand. However, such defects may also result from substitution of a residue that plays a critical role in stabilizing the overall structure of the metalloprotein, without directly bonding to the metal.

The *trans*-substitution method outlined in Figure 3 provides a stringent test of ligand identity that avoids misassigning structurally critical non-ligating residues as ligands. In cases where substitutions of non-ligating residues alter the properties of a metalloprotein by overall disruption of structure, it is unlikely that structure can be restored by addition of an exogenous surrogate



ligand. In the absence of metal–ligand interactions, the affinity of small molecules for preformed cavities in proteins is fairly low.<sup>54–57</sup> If deletion of a side chain disrupts structure, then the cavity to which the side-chain surrogate might bind would not be preformed, and the energy penalty to restructure the cavity (and the surrounding protein) would further decrease affinity. Thus, recovery of metal binding, wild-type spectroscopic features, and/or reactivity towards substrates as a result of adding an exogenous mimic of the deleted side chain is a strong indication that the side chain is in fact a metal ligand.

The chemical flexibility of the *trans*-substitution method can also enhance ligand identification. The addition of exogenous ligands that have predictable effects on spectroscopic features associated with a metal center can provide direct evidence of coordination. For instance, addition of exogenous ligands with different coordination properties may produce characteristic changes in electronic absorbance spectra.<sup>58</sup> Alternatively, addition of deuterated exogenous ligand to a paramagnetic metalloprotein may result in the loss of one or more hyperfine-shifted resonances in an <sup>1</sup>H-NMR spectrum.<sup>59–61</sup> Likewise, the addition of conservatively modified or isotopically substituted exogenous ligands may alter ligand–metal vibrational features in resonance Raman spectra through a mass effect, demonstrating direct bonding between the exogenous ligands and metal.

One of the first examples of the use of *trans*-substitution to determine protein ligand identity is the *trans*-substitution of an axial heme ligand in heme oxygenase (HO). Heme oxygenase is an enzyme that catalyzes the conversion of its own heme to biliverdin. As described above, site-directed mutagenesis had implicated His25 as an axial ligand to the heme substrate, as replacement with alanine produced a hemoprotein with very different spectroscopic features, and no catalytic activity.<sup>26</sup> However, addition of imidazole (imd) to H25A HO restored both the spectroscopic and catalytic properties of the unsubstituted enzyme.<sup>62</sup> Notably, the band associated with the heme iron–histidine nitrogen vibration [ $\nu(\text{Fe}-\text{N}_{\text{im}})$ ] that was missing from the resonance Raman spectrum of H25A HO was restored upon addition of imd. Furthermore, by addition of *N*-methylimidazole (*N*-meimd), the frequency of the  $\nu(\text{Fe}-\text{N}_{\text{N-meim}})$  band was shifted in a way that is consistent, both in direction and in magnitude, with the expected mass effect on a diatomic oscillator.<sup>62</sup> These *trans*-substitution results strongly support the assignment of His25 as the axial ligand to the heme in this enzyme.

*Trans*-substitution has also been used to identify the metal ligands in the  $\beta$ 1-subunit of soluble guanylate cyclase (sGC). This enzyme catalyzes the nitric oxide-dependent conversion of GTP to cGMP.<sup>63</sup> Soluble guanylate cyclase had previously been shown to bind a heme<sup>64</sup> through a single axial histidine;<sup>65</sup> further studies had localized the heme-binding region to an *N*-terminal 385 residue region of the  $\beta$ 1-subunit.<sup>66</sup> A sequence alignment of  $\beta$ 1 subunits shows four conserved histidines in the heme binding region of sGC. Substitution of three of the four conserved histidines has no effect on the heme content of this fragment, whereas a fourth histidine substitution, H105A, prevented heme from combining with protein expressed in *E. coli*.<sup>67</sup> Although these results are consistent with histidine 105 serving as axial ligand, it is also possible that the loss of heme binding in the H105A variant results from misfolding. However, by adding imidazole to the growth media, the H105A polypeptide was recovered with a stoichiometric equivalent of heme.<sup>67</sup> The *trans*-substituted complex could be prepared in states with similar electronic absorbance spectra to the wild-type complex.<sup>67</sup> Again, resonance Raman spectroscopy was used to confirm that exogenous imidazole was acting as an axial ligand.<sup>67</sup>

*Trans*-substitution has also been used to identify ligands and gain structural and functional insight in a transmembrane hemoprotein, the cytochrome *b* subunit of *Azobacter vinelandii* hydrogenase.<sup>68</sup> Eight histidines were replaced by various residues in this study, including four conserved histidines in the putative transmembrane helices. Substitution of the four transmembrane histidines with alanine resulted in proteins that were unable to catalyze O<sub>2</sub>-dependent H<sub>2</sub> oxidation, suggesting that these histidines act as ligands to two transmembrane hemes. When imidazole was added to H194A, one of the transmembrane variants, O<sub>2</sub>-dependent H<sub>2</sub> oxidation activity was restored, supporting the assignment of histidine 194 as a heme ligand.<sup>68</sup> In a second assay of activity, imidazole restored activity of both the H194A and the H208 variants. Interestingly, imidazole also restored catalytic activity in proteins with tyrosines at positions 194 and 208. The recovery of activity with addition of imidazole to the H194 and H208 variants supports the idea that these histidines act as heme ligands. The success of the *trans*-substitution method in heme oxygenase suggests that this method may have general applicability for ligand identification and characterization in integral membrane metalloproteins such as those involved in electron transport, where structural data is difficult to obtain.

### 1.46.5.3 Structure–Energy–Function Studies of Known Ligands using *trans*-Substitution

The *trans*-substitution method can be applied to metalloproteins of known structure to gain insight into how covalently attached endogenous ligands influence structure and function. In addition, the chemical flexibility associated with the *trans*-substitution allows the chemical and structural properties of the ligand to be correlated with structural and functional properties, and permits the energetics of ligand–polypeptide and ligand–metal interactions to be carefully dissected. Table 1 lists metalloproteins for which *trans*-substitution of one or more metal ligands has been successful. All of the *trans*-substitutions on the list except for three (heme oxygenase, guanylate cyclase, and the cytochrome *b* from hydrogenase complex, see above) targeted ligands from proteins of known structure.

Although Table 1 includes metalloproteins containing a variety of metals (copper, zinc, nickel, and iron), the abundance of *trans*-substitutions to axial heme ligands is striking. There are several possible reasons for this apparent bias. It is possible that heme proteins may be easier to express and reconstitute than other metalloproteins: they tend to be small, single-domain proteins, and their metal is contained within a prosthetic group that is available at high levels in *E. coli*. Alternatively, exogenous ligands (in particular, imidazoles, which dominate the list of substituted heme ligands) may have higher affinities for vacant heme ligand cavities than to cavities at other metal sites. Achieving a high level of expression of variant protein, reconstitution with metal, and subsequent binding of exogenous ligands are all necessary steps in the *trans*-substitution method, thus the bias toward heme proteins in Table 1 may result from the filter of success that keeps negative results out of the literature. Another possibility is that the bias reflects a bias in the focus of biophysicists and biochemists since the early 1970s towards heme proteins. Whatever the bias, the appearance of both heme and non-heme metalloproteins in Table 1 demonstrates that the *trans*-substitution method is a generally applicable route to metal ligand modification in proteins.

**Table 1** *Trans*-substitution of metal ligands in metalloproteins.

<i>Protein</i>	<i>Metal</i>	<i>Substituted ligand</i>	<i>Exogenous ligand</i> <sup>a</sup>	<i>K<sub>d</sub></i> (M) <sup>b</sup>	<i>References</i>
<i>Heme proteins</i>					
iso-1-cyt <i>c</i>	iron	Met80 → Ala	thiomethoxide (CH <sub>3</sub> S <sup>-</sup> )	N.D.	112
Myoglobin	iron	His93 → Gly	imd and substituted imds, pyr and substituted pyr.	<5 × 10 <sup>-7</sup> 6 × 10 <sup>-4</sup>	52,58,61,69,72
Hemoglobin	iron	αHis87 → Gly, βHis91 → Gly	imd	N.D.	60,86
Cyt <i>c</i> peroxidase (CCP)	iron	His175 → Gly	imd, <i>N</i> -meimd	2.7 × 10 <sup>-3</sup>	77
Heme oxygenase	iron	His25 → Ala	imd, various meimds	N.D.	62
Horseradish peroxidase (HRP)	iron	His170 → Ala	imd	2.2 × 10 <sup>-2</sup>	76
Guanylate cyclase	iron	His105 → Gly	imd, <i>N</i> -meimd	N.D.	67
Hydrogenase cyt <i>b</i>	iron	His194 → Ala, Tyr His208 → Ala, Tyr	imd	N.D.	68
<i>Nonheme proteins</i>					
Urease	dinickel	carbamyl-lys217 → Glu, Cys,Ala	formate	~0.2	75
Azurin	copper	His117 → Gly	imds, thiazole	N.D.	113
Zinc finger peptide	cobalt	ΔHis4 <sup>c</sup>	meimd β-mercaptoethanol (SH)	8 × 10 <sup>-4</sup> 2 × 10 <sup>-4</sup>	114
Photosystem 1	4Fe–4S	Cys14 → Ala, GlyCys51 → Ala, Gly	β-mercaptoethanol, dithiothreitol	N.D.	74

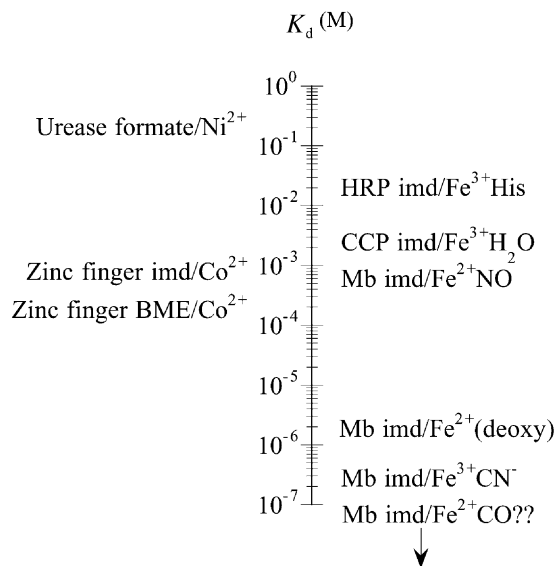
<sup>a</sup> Imd, imidazole, meimd, methylimidazole; pyr, pyridine. <sup>b</sup> N.D., not determined; for urease, the *K<sub>d</sub>* was estimated as the midpoint in a plot of enzyme activity versus formate concentration. <sup>c</sup> The substituted cysteine in the CPI designed zinc finger is the fourth histidine in the Cys<sub>2</sub>/His<sub>2</sub> tetrahedral coordination sphere.



The affinities of exogenous, *trans*-substituted ligands for their metalloprotein sites vary over a broad range (Table 1, Figure 4). Variation in affinity is seen both for different metals, and for different sites containing the same metal. For example, imidazole ligands vary in their affinity towards hemoproteins over five orders of magnitude. Clearly, some of this variation comes from differences in iron oxidation state and identity of the other (distal) ligand: addition of CO to H93G deoxymyoglobin (deoxyMb) increases proximal imidazole affinity,<sup>61</sup> whereas addition of NO decreases imd affinity.<sup>69,70</sup> These affinity changes are consistent with well-known antagonistic effects between these ligands interacting with free heme models.<sup>71</sup> Although indirect evidence for analogous antagonistic effects in hemoproteins has been obtained through studies of the NO dependence of the  $\nu(\text{Fe}-\text{N}_{\text{imd}})$  vibration and through changes in crystallographically derived structural parameters, the *trans*-substitution method permits such antagonistic effects to be directly quantified *in situ*, in the protein itself.

In addition to the metal oxidation state and distal ligand identity, the protein matrix surrounding the *trans*-substituted ligand can modulate affinity significantly. Such interactions may contribute to the ten-fold difference in proximal imidazole affinity in the proximal histidine mutants of cytochrome *c* peroxidase (H175G CCP) and horseradish peroxidase (H25A HRP), which are both in the ferric form. Likewise, protein matrix interactions are likely to give rise to differences in proximal imidazole affinity to the  $\text{Fe}^{3+}/\text{H}_2\text{O}$  complex of the H93G myoglobin variant, compared with H175G CCP. Although the  $K_{\text{d}}$  of the ferric H93G Mb·imd complex is difficult to precisely quantify, since at high concentrations imidazole appears to ligate the heme on the distal side, the first binding reaction (presumably describing the formation of the H93G Mb·imd complex) is half-saturated around 50–100  $\mu\text{M}$  imd (D. Barrick, unpublished), a factor of around fifty lower (tighter) than the H175G CCP imidazole  $K_{\text{d}}$ .

The chemical flexibility of *trans*-substitution permits an energetic dissection of these exogenous ligand–protein interactions. In H93G Mb, the structural and energetic consequences of hydrogen bonding between the proximal imidazole ligand and an adjacent serine residue (S92) were examined by determining binding constants and crystal structures of H93G Mb complexed with isosteric methylimidazoles that differ in their ability to hydrogen bond.<sup>59,61,69,72,73</sup> Indeed, this



**Figure 4** Dissociation constants of exogenous *trans*-substituted ligand-metalloprotein complexes. Nonheme proteins are on the left, hemoproteins are on the right. Proteins are listed at their measured  $K_{\text{d}}$  values (log scale), followed by the exogenous ligand. The metal and oxidation state is given to the right of the forward slash. For hemoproteins, the distal ligand (on the opposite face of the heme from the *trans*-substituted imidazole) is given following the metal. For Mb imd/ $\text{Fe}^{2+}$ CO, only an approximate upper limit on  $K_{\text{d}}$  is given, since stoichiometric imd binding was observed at micromolar concentrations.<sup>61</sup> For urease, the  $K_{\text{d}}$  was estimated as described in the legend to Table 1. For cytochrome *c* peroxidase (CCP), the identity and occupancy of the distal ligand is somewhat uncertain, since crystallographic studies indicate that the water may be bound loosely, dissociated, or replaced with a phosphate anion depending on conditions.<sup>78,79</sup> Likewise, horseradish peroxidase (HRP) may exist in a mixed distal ligation state involving a distal histidine and exogenous water.<sup>57</sup>

hydrogen bond was found to stabilize the bound ligand by up to  $4 \text{ kcal mol}^{-1}$ ; furthermore, the magnitude of this stabilizing effect was found to be strongly coupled to the oxidation state of the iron, distal ligand identity, and steric interactions with the heme.<sup>61</sup>

Another advantage of *trans*-substitution is that it can provide an assessment of the role of the covalent linkage between the polypeptide and metal ligand in determining structure and function. For some metalloproteins, *trans*-substitution using a close mimic of the original ligand (imidazole for histidine, for instance) reconstitutes partial or complete enzymatic function. Functional reconstitution is achieved for the thiol-substituted cysteine variants of photosystem 1,<sup>74</sup> and for a formate-substituted carbamyl-lysine variant of *K. aerogenes* urease.<sup>75</sup> In other cases, *trans*-substitution fails to reconstitute full activity. For the H170A variant of horseradish peroxidase (HRP), imidazole increases rate constants for the various catalytic steps in  $\text{H}_2\text{O}_2$ -based substrate oxidation by several orders of magnitude, but these constants fall about two orders of magnitude short of values for the wild-type protein.<sup>76</sup> Based on UV-vis and resonance Raman spectroscopy, the authors suggest that the limited reactivity of the H170A HRP·imd complex may result from the increase in ligation of the heme by a distal histidine. Thus, one role of the covalently linked proximal histidine in HRP might be to constrain the iron to a more proximal position, preventing distal ligation. This is similar to an interpretation of the partial recovery of activity upon *trans*-substitution of cytochrome *c* peroxidase,<sup>77-79</sup> where the loss of covalent connection between the proximal histidine and the polypeptide allows the heme, iron, and proximal imidazole to occupy a more distal position. In turn, this repositioning alters a critical proximal hydrogen bond, affecting the structure and, perhaps, the reactivity of the proximal pocket.

*Trans*-substitution has also been used to evaluate the role of the covalent linkages between the proximal histidines and the polypeptide backbones in the  $\alpha$ - and  $\beta$ -subunits of human hemoglobin. In his classic paper on the structural basis of hemoglobin cooperativity, Perutz proposed that these linkages relay information on oxygen binding to and from the four oxygen-binding sites of the hemoglobin tetramer.<sup>80</sup> In the proposal, this linkage restricts the heme iron from moving into a distal, reactive position, thus lowering oxygen affinity in the deoxy quaternary structure. However, when oxygen does bind, the same proximal linkages are proposed to reposition the polypeptide, triggering a quaternary structure transition that increases oxygen affinity. Subsequent structural analysis<sup>81,82</sup> and model compound studies<sup>83-85</sup> have provided indirect support for the Perutz proposal, although experimental perturbation of the proximal linkage was required to directly test the role of these linkages in hemoglobin cooperativity. *Trans*-substitution of the proximal histidine residues with imidazole provides the needed test, as it disrupts the covalent linkage while conserving the local chemistry of the heme within the context of the hemoglobin tetramer.<sup>86</sup> As predicted from the Perutz model, *trans*-substitution of the proximal histidines of hemoglobin greatly increases distal oxygen and alkyl-isocyanide affinity, and decreases cooperativity.<sup>60,86</sup> Furthermore, deletion of the proximal histidine linkages appears to prevent quaternary structure switching in response to distal ligand binding, indicating that these linkages not only couple the oxygen-binding sites to each other, they couple the oxygen-binding sites to the subunit interfaces where quaternary rearrangements take place.<sup>60</sup> However, despite a significant decrease in heme-heme communication in *trans*-substituted hemoglobin, there appears to be a low level of residual cooperativity that does not rely on the proximal linkages of the Perutz mechanism.

### 1.46.6 DE NOVO DESIGN OF METAL SITES IN PROTEINS

In addition to providing a means to modify naturally occurring metal sites in proteins, the ligand substitution can be used to introduce new metal-binding sites into regions of proteins where no such sites existed. Such design goals provide useful targets to test and refine protein design capability, and can provide insight into the sensitivity of catalytic metal sites to their environments. Metal sites can be introduced to provide control of protein stability, or to modulate existing protein functions, such as ion transport, molecular recognition, and catalysis. While important advances have been made in designing synthetic peptides that specifically interact with metals,<sup>87-93</sup> the current discussion will be restricted to designed proteins produced from genetic engineering techniques.

#### 1.46.6.1 Mimicking Naturally Occurring Metal Sites

Since the early 1990s, several metal sites analogous to known metalloenzyme sites have been grafted onto new locations on proteins of known structure. Success in this endeavor requires

selection of a site where three or more protein ligands can be introduced that will have orientations suitable for coordinating a metal, but will not disrupt the structure of the protein. As many of the sites in a protein would be unlikely to satisfy these criteria, identifying such a site by visual inspection would be a long and arduous process. To avoid this, Hellinga and co-workers wrote a program, which they named “DEZYMER,” to exhaustively search for such sites.<sup>94</sup> A similar program has been written by Clarke and Yuan.<sup>95</sup> Using DEZYMER, Hellinga and co-workers have constructed a variety of different metal sites into a single protein scaffold, *E. coli* thioredoxin. Examples include a copper-binding site,<sup>96</sup> an 4Fe–4S cluster,<sup>97</sup> a mononuclear iron superoxide dismutase site,<sup>98</sup> a mononuclear, rubredoxin-like iron–sulfur center,<sup>99</sup> and several Cys<sub>2</sub>/His<sub>2</sub> zinc fingers.<sup>100</sup> Several of these designed sites are active in redox chemistry and catalysis. Using *E. coli* maltose binding protein, the maltose binding site was redesigned to bind zinc, and the resulting protein could be used as a fluorescent zinc sensor.<sup>101</sup> Working with the B1 domain of Streptococcal protein G, Regan and co-workers designed a high-affinity tetrahedral His<sub>3</sub>/Cys zinc-binding site.<sup>102</sup> Metal sites analogous to that found in carbonic anhydrase B have been designed into single-chain antibodies, and these antibodies appear to bind divalent copper and zinc.<sup>103,104</sup> A goal of these “metalloantibody” studies is to combine hydrolase activity from the designed metal site with the high-specificity binding reactions intrinsic to antibodies, enabling chemical reactivity to be directed with high selectivity towards particular substrates.

#### 1.46.6.2 Designing Novel Metal Sites with New Functions

One important goal of designing metal sites into proteins is to regulate already existing functions. Several studies have appeared in which a designed metal site interferes with enzymatic catalysis, ion conductance, or molecular recognition. In serine proteases, metal binding sites have been introduced that coordinate a catalytically important histidine as a metal ligand.<sup>105–107</sup> Acting as a ligand, the histidine is unable to participate in the proton transfer reactions required for protease activity. As designed, divalent metal ions (especially copper) decreased activity by decreasing  $k_{\text{cat}}$ , while leaving substrate binding ( $K_{\text{m}}$ ) unchanged. Alternatively, when a metal site was designed in the substrate binding pocket, addition of divalent copper ions decreased the activity by lowering  $K_{\text{m}}$ , leaving  $k_{\text{cat}}$  unchanged.<sup>108</sup> In  $\alpha$ -hemolysin, a heptameric transmembrane channel, substitution of histidines in the interior of the channel imparted zinc sensitivity to channel conductance.<sup>109</sup> Zinc has also been used to regulate activity in the kappa-opioid receptor,<sup>110</sup> and in rhodopsin.<sup>111</sup> As design methods improve, regulation of protein activity via designed metal sites is likely to take on a prominent role both *in vivo* and *in vitro*.

#### 1.46.7 GLOSSARY

**Bacteriophage.** A small particle, composed of protein and RNA or DNA, that can infect, replicate in, and release from bacterial cells. Bacteriophage particles can be used to package DNA molecules into single-stranded forms for further manipulation and modification.

**Chemical rescue.** Restoration of structure and/or activity to a macromolecule (usually a protein) that has had a side chain critical for structure/activity deleted, by the addition of a small molecule that mimics the deleted side chain.

**Clone.** In the context used here, refers to inserting a segment of duplex DNA, usually encoding a protein of interest, into a larger DNA molecule (typically a plasmid; see below) that has the ability to propagate in a bacterial cell. Likewise, the movement of a cloned DNA fragment from one plasmid to another is often referred to as “subcloning.”

**Endogenous ligand.** A metal ligand (typically a protein side chain) that is covalently attached to the macromolecule (i.e., metalloprotein) to which the metal binds.

**Exogenous ligand.** A metal ligand that is not covalently attached to the macromolecule. In the studies described here, exogenous ligands are often added to solution to substitute for deleted endogenous ligands (protein side chains) *in trans*.

**Expression.** The production of a particular protein in a culture of bacterial cells. The production of such a protein is controlled by placing a gene encoding the protein of interest into a plasmid capable of directing protein synthesis.

**PCR.** The polymerase chain reaction, an enzymatic reaction capable of amplifying specific DNA sequences by many orders of magnitude. In the studies described above, PCR is used to modify gene sequences, and to obtain large quantities of these gene sequences for subcloning purposes.

**Phylogenetic comparison.** Comparison of one or more attributes in related and distant species. In the studies described above, phylogenetic comparisons are used to help identify metal ligands in metalloproteins of unknown structure, by identifying suitable residues that are invariant among distant protein sequences.

**Plasmid.** A circular DNA molecule that is capable of propagating in bacteria. By inserting a gene of interest into the plasmid, the gene is also propagated, and can be used to direct protein expression.

**Restriction site.** A DNA sequence that can be recognized and cut by a restriction enzyme. Cutting, or digestion, of DNA sequences at specific restriction sites allows different DNA fragments to be rearranged, and forms the basis of cloning and subcloning of DNA.

**Site-directed mutagenesis.** A procedure used to change a particular DNA sequence. Site-directed mutagenesis provides a means to substitute individual residues within proteins, by modifying the corresponding codon within the gene encoding the protein. Several methods have been developed for site-directed mutagenesis, as shown in Figure 2.

**Template.** In the context used here, template refers to a piece of DNA (either single- or double-stranded) that is enzymatically replicated. This process is directed by complementary single-stranded DNA oligonucleotides, or “primers.” If these primers have one or more base substitutions compared to the template, the replicated strands will bear those substitutions.

**Trans-substitution.** Replacement of an endogenous protein ligand with an exogenous ligand, by deletion of the endogenous ligand side chain using site-directed mutagenesis techniques, and subsequent addition of a small-molecule side-chain mimic (see Figure 3).

## 1.46.8 REFERENCES

- Merrifield, B. *Science* **1986**, *232*, 341–347.
- Merrifield, B. *Methods Enzymol.* **1997**, *289*, 3–13.
- Dawson, P. E.; Kent, S. B. *Annu. Rev. Biochem.* **2000**, *69*, 923–960.
- Kent, S. B. *Annu. Rev. Biochem.* **1988**, *57*, 957–989.
- Bowie, J. U.; Reidhaar-Olson, J. F.; Lim, W. A.; Sauer, R. T. *Science* **1990**, *247*, 1306–1310.
- Reidhaar-Olson, J. F.; Sauer, R. T. *Science* **1988**, *241*, 53–57.
- Dayhoff, M. O. *Atlas of Protein Sequence and Structure*; National Biomedical Research Foundation: Washington, DC, 1972.
- Bashford, D.; Chothia, C.; Lesk, A. M. *J. Mol. Biol.* **1987**, *196*, 199–216.
- Holm, R. H.; Kennepohl, P.; Solomon, E. I. *Chem. Rev.* **1996**, *96*, 2239–2314.
- Kunkel, T. A. *Proc. Natl. Acad. Sci. USA* **1985**, *82*, 488–492.
- Kunkel, T. A.; Roberts, J. D.; Zakour, R. A. *Methods Enzymol.* **1987**, *154*, 367–382.
- Saiki, R. K.; Gelfand, D. H.; Stoffel, S.; Scharf, S. J.; Higuchi, R.; Horn, G. T.; Mullis, K. B.; Erlich, H. A. *Science* **1988**, *239*, 487–491.
- Saiki, R. K.; Bugawan, T. L.; Horn, G. T.; Mullis, K. B.; Erlich, H. A. *Nature* **1986**, *324*, 163–166.
- Mullis, K.; Faloona, F.; Scharf, S.; Saiki, R.; Horn, G.; Erlich, H. *Cold Spring Harb. Symp. Quant. Biol.* **1986**, *51*, 263–273.
- Merino, F.; Osuna, J.; Bolivar, F.; Soberon, X. *Biotechniques* **1992**, *12*, 508–509.
- Barrick, D.; Hughson, F. M.; Baldwin, R. L. *J. Mol. Biol.* **1994**, *237*, 588–601.
- Papworth, C.; Bauer, J. C.; Braman, J.; Wright, D. A. *Strategies* **1996**, *9*, 3–4.
- Baker, H. M.; Mason, A. B.; He, Q. Y.; MacGillivray, R. T.; Baker, E. N. *Biochemistry* **2001**, *40*, 11670–11675.
- Giedroc, D. P.; Giu, H. W.; Khan, R.; King, G. C.; Chen, K. *Biochemistry* **1992**, *31*, 765–774.
- Farrell, R. A.; Thorvaldsen, J. L.; Winge, D. R. *Biochemistry* **1996**, *35*, 1571–1580.
- Tagliavacca, L.; Moon, N.; Dunham, W. R.; Kaufman, R. J. *J. Biol. Chem.* **1997**, *272*, 27428–27434.
- Nakamura, M.; Nakajima, T.; Ohba, Y.; Yamauchi, S.; Lee, B. R.; Ichishima, E. *Biochem. J.* **2000**, *350 Pt 2*, 537–545.
- Colpas, G. J.; Brayman, T. G.; Ming, L. J.; Hausinger, R. P. *Biochemistry* **1999**, *38*, 4078–4088.
- Youngs, H. L.; Sollewijn Gelpke, M. D.; Li, D.; Sundaramoorthy, M.; Gold, M. H. *Biochemistry* **2001**, *40*, 2243–2250.
- Ito-Maki, M.; Ishikawa, K.; Matera, K. M.; Sato, M.; Ikeda-Saito, M.; Yoshida, T. *Arch. Biochem. Biophys.* **1995**, *317*, 253–258.
- Sun, J.; Loehr, T. M.; Wilks, A.; Ortiz de Montellano, P. R. *Biochemistry* **1994**, *33*, 13734–13740.
- Minagawa, J.; Mogi, T.; Gennis, R. B.; Anraku, Y. *J. Biol. Chem.* **1992**, *267*, 2096–2104.
- Tsubaki, M.; Mogi, T.; Hori, H.; Hirota, S.; Ogura, T.; Kitagawa, T.; Anraku, Y. *J. Biol. Chem.* **1994**, *269*, 30861–30868.
- Mitchell, D. M.; Aasa, R.; Adelroth, P.; Brzezinski, P.; Gennis, R. B.; Malmstrom, B. G. *FEBS Lett.* **1995**, *374*, 371–374.
- Kaysser, T. M.; Ghaim, J. B.; Georgiou, C.; Gennis, R. B. *Biochemistry* **1995**, *34*, 13491–13501.
- Fang, H.; Lin, R. J.; Gennis, R. B. *J. Biol. Chem.* **1989**, *264*, 8026–8032.

32. Egeberg, K. D.; Springer, B. A.; Martinis, S. A.; Sligar, S. G.; Morikis, D.; Champion, P. M. *Biochemistry* **1990**, *29*, 9783–9791.
33. Adachi, S.; Nagano, S.; Watanabe, Y.; Ishimori, K.; Morishima, I. *Biochem. Biophys. Res. Comm.* **1991**, *180*, 138–145.
34. Adachi, S.; Nagano, S.; Ishimori, K.; Watanabe, Y.; Morishima, I.; Egawa, T.; Kitagawa, T.; Makino, R. *Biochemistry* **1993**, *32*, 241–252.
35. Goodwin, D. C.; Rowlinson, S. W.; Marnett, L. J. *Biochemistry* **2000**, *39*, 5422–5432.
36. Liu, Y.; Moenne-Loccoz, P.; Hildebrand, D. P.; Wilks, A.; Loehr, T. M.; Mauk, A. G.; Ortiz de Montellano, P. R. *Biochemistry* **1999**, *38*, 3733–3743.
37. Sundaramoorthy, M.; Choudhury, K.; Edwards, S.; Poulos, T. L. *J. Am. Chem. Soc.* **1991**, *113*, 7755–7757.
38. Nicholson, H.; Anderson, B. F.; Bland, T.; Shewry, S. C.; Tweedie, J. W.; Baker, E. N. *Biochemistry* **1997**, *36*, 341–346.
39. He, Q. Y.; Mason, A. B.; Pakdaman, R.; Chasteen, N. D.; Dixon, B. K.; Tam, B. M.; Nguyen, V.; MacGillivray, R. T.; Woodworth, R. C. *Biochemistry* **2000**, *39*, 1205–1210.
40. Ippolito, J. A.; Christianson, D. W. *Biochemistry* **1994**, *33*, 15241–15249.
41. Kiefer, L. L.; Krebs, J. F.; Paterno, S. A.; Fierke, C. A. *Biochemistry* **1993**, *32*, 9896–9900.
42. Xue, Y.; Jonsson, B. H.; Liljas, A.; Lindskog, S. *FEBS Lett.* **1994**, *352*, 137–140.
43. Guo, J.; Giedroc, D. P. *Biochemistry* **1997**, *36*, 730–742.
44. Scolnick, L. R.; Kanyo, Z. F.; Cavalli, R. C.; Ash, D. E.; Christianson, D. W. *Biochemistry* **1997**, *36*, 10558–10565.
45. Waltersson, Y.; Linse, S.; Brodin, P.; Grundstrom, T. *Biochemistry* **1993**, *32*, 7866–7871.
46. Vance, C. K.; Miller, A. F. *Biochemistry* **2001**, *40*, 13079–13087.
47. Schwartz, A. L.; Yikilmaz, E.; Vance, C. K.; Vathyam, S.; Koder, R. L.; Miller, A. F. *J. Inorg. Biochem.* **2000**, *80*, 247–256.
48. Hunt, J. A.; Ahmed, M.; Fierke, C. A. *Biochemistry* **1999**, *38*, 9054–9062.
49. Marino, S. F.; Regan, L. *Chem. Biol.* **1999**, *6*, 649–655.
50. Sarma, S.; DiGate, R. J.; Goodin, D. B.; Miller, C. J.; Guiles, R. D. *Biochemistry* **1997**, *36*, 5658–5668.
51. Matsui, T.; Nagano, S.; Ishimori, K.; Watanabe, Y.; Morishima, I. *Biochemistry* **1996**, *35*, 13118–13124.
52. Barrick, D. *Biochemistry* **1994**, *33*, 6546–6554.
53. Toney, M. D.; Kirsch, J. F. *Science* **1989**, *243*, 1485–1488.
54. Barrick, D. *Curr. Opin. Struct. Biol.* **1995**, *6*, 411–418.
55. Morton, A.; Baase, W. A.; Matthews, B. W. *Biochemistry* **1995**, *34*, 8564–8575.
56. Fitzgerald, M. M.; Churchill, M. J.; McRee, D. E.; Goodin, D. B. *Biochemistry* **1994**, *33*, 3807–3818.
57. Newmyer, S. L.; de Montellano, P. R. *J. Biol. Chem.* **1996**, *271*, 14891–14896.
58. De Pillis, G. D.; Decatur, S. M.; Barrick, D.; Boxer, S. G. *J. Am. Chem. Soc.* **1994**, *116*, 6981–6982.
59. Decatur, S. M.; Boxer, S. G. *Biochemistry* **1995**, *34*, 2122–2129.
60. Barrick, D.; Ho, N. T.; Simplaceanu, V.; Ho, C. *Biochemistry* **2001**, *40*, 3780–3795.
61. Barrick, D. *Proteins* **2000**, *39*, 291–308.
62. Wilks, A.; Sun, J.; Loehr, T. M.; Ortiz de Montellano, P. R. *J. Am. Chem. Soc.* **1995**, *117*, 2925–2926.
63. Garbers, D. L.; Lowe, D. G. *J. Biol. Chem.* **1994**, *269*, 30741–30744.
64. Gerzer, R.; Bohme, E.; Hofmann, F.; Schultz, G. *FEBS Lett.* **1981**, *132*, 71–74.
65. Deinum, G.; Stone, J. R.; Babcock, G. T.; Marletta, M. A. *Biochemistry* **1996**, *35*, 1540–1547.
66. Zhao, Y.; Marletta, M. A. *Biochemistry* **1997**, *36*, 15959–15964.
67. Zhao, Y.; Schelvis, J. P.; Babcock, G. T.; Marletta, M. A. *Biochemistry* **1998**, *37*, 4502–4509.
68. Meek, L.; Arp, D. J. *J. Bacteriol.* **2000**, *182*, 3429–3436.
69. Decatur, S. M.; Franzen, S.; DePillis, G. D.; Dyer, R. B.; Woodruff, W. H.; Boxer, S. G. *Biochemistry* **1996**, *35*, 4939–4944.
70. Thomas, M. R.; Brown, D.; Franzen, S.; Boxer, S. G. *Biochemistry* **2001**, *40*, 15047–15056.
71. Traylor, T. G.; Sharma, V. S. *Biochemistry* **1992**, *31*, 2847–2849.
72. Barrick, D.; Dahlquist, F. W. *Proteins* **2000**, *39*, 278–290.
73. Decatur, S. M.; Belcher, K. L.; Rickert, P. K.; Franzen, S.; Boxer, S. G. *Biochemistry* **1999**, *38*, 11086–11092.
74. Jung, Y. S.; Vassiliev, I. R.; Qiao, F.; Yang, F.; Bryant, D. A.; Golbeck, J. H. *J. Biol. Chem.* **1996**, *271*, 31135–31144.
75. Pearson, M. A.; Schaller, R. A.; Michel, L. O.; Karplus, P. A.; Hausinger, R. P. *Biochemistry* **1998**, *37*, 6214–6220.
76. Newmyer, S. L.; Sun, J.; Loehr, T. M.; Ortiz de Montellano, P. R. *Biochemistry* **1996**, *35*, 12788–12795.
77. McRee, D. E.; Jensen, G. M.; Fitzgerald, M. M.; Siegel, H. A.; Goodin, D. B. *Proc. Natl. Acad. Sci. USA* **1994**, *91*, 12847–12851.
78. Hirst, J.; Wilcox, S. K.; Ai, J.; Moenne-Loccoz, P.; Loehr, T. M.; Goodin, D. B. *Biochemistry* **2001**, *40*, 1274–1283.
79. Hirst, J.; Wilcox, S. K.; Williams, P. A.; Blankenship, J.; McRee, D. E.; Goodin, D. B. *Biochemistry* **2001**, *40*, 1265–1273.
80. Perutz, M. F. *Nature* **1970**, *228*, 726–739.
81. Baldwin, J.; Chothia, C. *J. Mol. Biol.* **1979**, *129*, 175–220.
82. Warshel, A. *Proc. Natl. Acad. Sci. USA* **1977**, *74*, 1789–1793.
83. Collman, J. P.; Brauman, J. I.; Doxsee, K. M.; Halbert, T. R.; Suslick, K. S. *Proc. Natl. Acad. Sci. USA* **1978**, *75*, 564–568.
84. Rougee, M.; Brault, D. *Biochemistry* **1975**, *14*, 4100–4106.
85. White, D. K.; Cannon, J. B.; Traylor, T. G. *J. Am. Chem. Soc.* **1979**, *101*, 2443–2454.
86. Barrick, D.; Ho, N. T.; Simplaceanu, V.; Dahlquist, F. W.; Ho, C. *Nat. Struct. Biol.* **1997**, *4*, 78–83.
87. Regan, L.; Clarke, N. D. *Biochemistry* **1990**, *29*, 10878–10883.
88. Arnold, P. A.; Shelton, W. R.; Benson, D. R. *J. Am. Chem. Soc.* **1997**, *119*, 3181–3182.
89. Berg, J. M. *Acc. Chem. Res.* **1995**, *28*, 14–19.
90. Gibney, B. R.; Mulholland, S. E.; Rabanal, F.; Dutton, P. L. *Proc. Natl. Acad. Sci. USA* **1996**, *93*, 15041–15046.
91. Rau, H. K.; DeJonge, N.; Haehnel, W. *Proc. Natl. Acad. Sci. USA* **1998**, *95*, 11526–11531.
92. Lombardi, A.; Summa, C. M.; Geremia, S.; Randaccio, L.; Pavone, V.; DeGrado, W. F. *Proc. Natl. Acad. Sci. USA* **2000**, *97*, 6298–6305.
93. Schnepf, R.; Horth, P.; Bill, E.; Wieghardt, K.; Hildebrandt, P.; Haehnel, W. *J. Am. Chem. Soc.* **2001**, *123*, 2186–2195.

94. Hellinga, H. W.; Richards, F. M. *J. Mol. Biol.* **1991**, *222*, 763–785.
95. Clarke, N. D.; Yuan, S. M. *Nat. Struct. Biol.* **1995**, *1995*, 256–263.
96. Hellinga, H. W.; Caradonna, J. P.; Richards, F. M. *J. Mol. Biol.* **1991**, *222*, 787–803.
97. Coldren, C. D.; Hellinga, H. W.; Caradonna, J. P. *Proc. Natl. Acad. Sci. USA* **1997**, *94*, 6635–6640.
98. Pinto, A. L.; Hellinga, H. W.; Caradonna, J. P. *Proc. Natl. Acad. Sci. USA* **1997**, *94*, 5562–5567.
99. Benson, D. E.; Wisz, M. S.; Liu, W.; Hellinga, H. W. *Biochemistry* **1998**, *37*, 7070–7076.
100. Wisz, M. S.; Garrett, C. Z.; Hellinga, H. W. *Biochemistry* **1998**, *37*, 8269–8277.
101. Marvin, J. S.; Hellinga, H. W. *Proc. Natl. Acad. Sci. USA* **2001**, *98*, 4955–4960.
102. Klemba, M.; Gardner, K. H.; Marino, S.; Clarke, N. D.; Regan, L. *Nat. Struct. Biol.* **1995**, *2*, 368–373.
103. Iverson, B. L.; Iverson, S. A.; Roberts, V. A.; Getzoff, E. D.; Tainer, J. A.; Benkovic, S. J.; Lerner, R. A. *Science* **1990**, *249*, 659–662.
104. Roberts, V. A.; Iverson, B. L.; Iverson, S. A.; Benkovic, S. J.; Lerner, R. A.; Getzoff, E. D.; Tainer, J. A. *Proc. Natl. Acad. Sci. USA* **1990**, *87*, 6654–6658.
105. Halfon, S.; Craik, C. S. *J. Am. Chem. Soc.* **1996**, *118*, 1227–1228.
106. Higaki, J. N.; Fletterick, R. J.; Craik, C. S. *Trends Biochem. Sci.* **1992**, *17*, 100–104.
107. Higaki, J. N.; Haymore, B. L.; Chen, S.; Fletterick, R. J.; Craik, C. S. *Biochemistry* **1990**, *29*, 8582–8586.
108. Briand, L.; Chobert, J. M.; Tauzin, J.; Declerck, N.; Leonil, J.; Molle, D.; Tran, V.; Haertle, T. *Protein Eng.* **1997**, *10*, 551–560.
109. Braha, O.; Walker, B.; Cheley, S.; Kasianowicz, J. J.; Song, L.; Gouaux, J. E.; Bayley, H. *Chem. Biol.* **1997**, *4*, 497–505.
110. Thirstrup, K.; Elling, C. E.; Hjorth, S. A.; Schwartz, T. W. *J. Biol. Chem.* **1996**, *271*, 7875–7878.
111. Sheikh, S. P.; Zvyaga, T. A.; Lichtarge, O.; Sakmar, T. P.; Bourne, H. R. *Nature* **1996**, *383*, 347–350.
112. Lu, Y.; Casimiro, D. R.; Bren, K. L.; Richards, J. H.; Gray, H. B. *Proc. Natl. Acad. Sci. USA* **1993**, *90*, 11456–11459.
113. den Blaauwen, T.; Canters, G. W. *J. Am. Chem. Soc.* **1993**, *115*, 1121–1129.
114. Merkle, D. L.; Schmidt, M. H.; Berg, J. M. *J. Am. Chem. Soc.* **1991**, *113*, 5450–5451.

# 1.47

## Appendix to Volume 1

JON A. McCLEVERTY

*University of Bristol, Bristol, UK*

and

THOMAS J. MEYER

*Los Alamos National University, Los Alamos, New Mexico, USA*

---

This appendix provides access to original chapters from Comprehensive Coordination Chemistry (published in 1987) that are relevant to this volume of Comprehensive Coordination Chemistry II (CCC2) but that are not cited by a specific chapter in CCC2.

For further details please see the end of the Preface under the General Information tab.

- PDF 1. Chapter 1.1 General Historical Survey to 1930
- PDF 2. Chapter 2 Coordination Numbers and Geometries
- PDF 3. Chapter 3 Nomenclature of Coordination Compounds
- PDF 4. Chapter 4 Clusters and Cages
- PDF 5. Chapter 7.1 Substitution Reactions
- PDF 6. Chapter 11 Mercury as a Ligand
- PDF 7. Chapter 12.1 Cypimis and Fulminates
- PDF 8. Chapter 13.1 Ammonia and Amines
- PDF 9. Chapter 13.4 Amido and Imido Metal Complexes
- PDF 10. Chapter 13.5 Sulfurdiimine, Triazenido, Azabutadiene and Triatomic Hetero Anion Ligands
- PDF 11. Chapter 16.1 Sulfides
- PDF 12. Chapter 18 Halogens as Ligands
- PDF 13. Chapter 19 Hydrogen and Hydrides as Ligands
- PDF 14. Chapter 20.3 Complexones
- PDF 15. Chapter 21.3 Macropolycyclic Ligands
- PDF 16. Chapter 22 Naturally Occurring Ligands
- PDF 17. Chapter 61.5 Decomposition of Water into its Elements