



Soil Carbon Dynamics

An Integrated Methodology

EDITED BY

Werner L. Kutsch, Michael Bahn and Andreas Heinemeyer

CAMBRIDGE

CAMBRIDGE

www.cambridge.org/9780521865616

This page intentionally left blank

Soil Carbon Dynamics

An Integrated Methodology

Carbon stored in soils represents the largest terrestrial carbon pool and factors affecting this will be vital in the understanding of future atmospheric CO₂ concentrations. Through the understanding of the dynamics of this pool and its component fluxes, accurate model predictions of future climate changes will be possible. This book provides an integrated view on measuring and modeling soil carbon dynamics. Based on a broad range of in-depth contributions by leading scientists it gives an overview of current research concepts, developments and outlooks and introduces cutting-edge methodologies, ranging from questions of appropriate measurement design to the potential application of stable isotopes and molecular tools. In also includes a standardized soil CO₂ efflux protocol, aimed at data consistency and inter-site comparability and thus underpins a regional and global understanding of soil carbon dynamics. This book provides an important reference work for students and scientists interested in many aspects of soil ecology, and biogeochemical cycles, but also for policy makers, carbon traders and others concerned with the global carbon cycle.

WERNER L. KUTSCH coordinates the ecosystem fluxes group at the Max-Planck-Institute for Biogeochemistry, Jena, Germany. Previously, he worked at the University of Kiel, Germany and the Kruger National Park, South Africa. His research interests lie in dynamics of ecosystem fluxes, soil and ecosystem carbon balances, soil respiration and plant and microbial eco-physiology in temperate and tropical ecosystems. He has been awarded the Horst Wiehe Award 1994 by the Ecological Society of Germany, Austria, and Switzerland (GfÖ) for an 'outstanding scientific work in the field of Ecology'.

MICHAEL BAHN is senior scientist at the Institute of Ecology, University of Innsbruck, where he teaches ecosystem and plant ecology and ecophysiology. He has carried out research on plant resource utilization, functional biodiversity and ecosystem processes in numerous mountain ecosystems across Europe. For several years he has been particularly concerned with understanding abiotic and biotic controls on ecosystem and soil C fluxes and their components across a range of spatial and temporal scales, with a focus on global change and the plant - soil interface.

ANDREAS HEINEMEYER has been a soil scientist for more than 10 years, first at the University of Göttingen, Germany, and then at the University of York in 2002, where he continued to work as a research associate within the UK Centre for Terrestrial Carbon Dynamics. His research focus is on relating soil carbon stocks and fluxes to climate with a particular focus on the mycorrhizal symbioses, linking plant carbon supply to soil respiration. He was the first to have continuously measured mycorrhizal soil carbon fluxes in the field and is increasingly involved in plant-soil carbon flux model developments.

Soil Carbon Dynamics

An Integrated Methodology

Edited by

Werner L. Kutsch

Max-Planck-Institute for Biogeochemistry, Jena

Michael Bahn

Leopold-Franzens Universität Innsbruck, Austria

Andreas Heinemeyer

Stockholm Environmental Institute, University of York



CAMBRIDGE
UNIVERSITY PRESS

CAMBRIDGE UNIVERSITY PRESS
Cambridge, New York, Melbourne, Madrid, Cape Town, Singapore,
São Paulo, Delhi, Dubai, Tokyo

Cambridge University Press
The Edinburgh Building, Cambridge CB2 8RU, UK

Published in the United States of America by Cambridge University Press, New York

www.cambridge.org

Information on this title: www.cambridge.org/9780521865616

© Cambridge University Press 2009

This publication is in copyright. Subject to statutory exception and to the provision of relevant collective licensing agreements, no reproduction of any part may take place without the written permission of Cambridge University Press.

First published in print format 2010

ISBN-13 978-0-511-71232-6 eBook (NetLibrary)

ISBN-13 978-0-521-86561-6 Hardback

Cambridge University Press has no responsibility for the persistence or accuracy of urls for external or third-party internet websites referred to in this publication, and does not guarantee that any content on such websites is, or will remain, accurate or appropriate.

Contents

List of Contributors	page vi		
Preface	ix		
1 Soil carbon relations: an overview WERNER L. KUTSCH, MICHAEL BAHN AND ANDREAS HEINEMEYER	1		
2 Field measurements of soil respiration: principles and constraints, potentials and limitations of different methods JUKKA PUMPANEN, BERNARD LONGDOZ AND WERNER L. KUTSCH	16		
3 Experimental design: scaling up in time and space, and its statistical considerations JENS-ARNE SUBKE, ANDREAS HEINEMEYER AND M. REICHSTEIN	34		
4 Determination of soil carbon stocks and changes MIRCO RODEGHIERO, ANDREAS HEINEMEYER, MARION SCHRUMPF AND PAT BELLAMY	49		
5 Litter decomposition: concepts, methods and future perspectives MIRCO FRANCESCA COTRUFO, ILARIA DEL GALDO AND DANIELA PIERMATTEO	76		
6 Characterization of soil organic matter KAROLIEN DENEFF, ALAIN F. PLANTE AND JOHAN SIX	91		
7 Respiration from roots and the mycorrhizosphere FERNANDO E. MOYANO, OWEN K. ATKIN, MICHAEL BAHN, DAN BRUHN, ANDREW J. BURTON, ANDREAS HEINEMEYER, WERNER L. KUTSCH AND GERHARD WIESER	127		
8 Separating autotrophic and heterotrophic components of soil			
		respiration: lessons learned from trenching and related root-exclusion experiments	157
		DANIEL EPRON	
		9 Measuring soil microbial parameters relevant for soil carbon fluxes	169
		WERNER L. KUTSCH, JOSHUA SCHIMEL AND KAROLIEN DENEFF	
		10 Trophic interactions and their implications for soil carbon fluxes	187
		EDWARD AYRES, DIANA H. WALL AND RICHARD D. BARDGETT	
		11 Semi-empirical modelling of the response of soil respiration to environmental factors in laboratory and field conditions	207
		MARKUS REICHSTEIN AND IVAN A. JANSSENS	
		12 Modelling soil carbon dynamics	221
		PETE FALLOON AND PETE SMITH	
		13 The role of soils in the Kyoto Protocol	245
		PETE SMITH, PETE FALLOON AND WERNER L. KUTSCH	
		14 Synthesis: emerging issues and challenges for an integrated understanding of soil carbon fluxes	257
		MICHAEL BAHN, WERNER L. KUTSCH AND ANDREAS HEINEMEYER	
		15 Appendix: Towards a standardized protocol for the measurement of soil CO₂ efflux	272
		MICHAEL BAHN, WERNER L. KUTSCH, ANDREAS HEINEMEYER AND IVAN A. JANSSENS	
		Index	281

Contributors

OWEN ATKIN

Functional Ecology Group,
Research School of Biological Sciences,
The Australian National University, Canberra,
ACT 0200, Australia
Email: Owen.Atkin@anu.edu.au

EDWARD AYRES

Natural Resource Ecology Laboratory and
Department of Biology, Colorado State University,
Fort Collins, CO 80523, USA
Email: edayres@nrel.colostate.edu

MICHAEL BAHN

Institut für Ökologie, Universität Innsbruck,
Sternwartestraße 15, 6020 Innsbruck, Austria
Email: Michael.Bahn@uibk.ac.at

RICHARD BARDGETT

Soil and Ecosystem Ecology Laboratory,
Institute of Environmental and Natural Sciences,
Lancaster University, Lancaster, LA1 4YQ, UK
Email: r.bardgett@lancaster.ac.uk

PATRICIA BELLAMY

Natural Resources, Building 53, Cranfield
University, College Road, Cranfield, Bedfordshire,
MK43 0AL, UK
Email: p.bellamy@cranfield.ac.uk

DAN BRUHN

Biosystems Department,
Risø National Laboratory for Sustainable Energy,
Technical University of Denmark – DTU,
Building 309, P.O. Box 49,
DK-4000 Roskilde, Denmark
Email: dan.bruhn@risoe.dk

ANDREW BURTON

School of Forest Resources & Environmental
Science, Michigan Technological University, 1400

Townsend Drive, Houghton, MI 49931, USA
Email: ajburton@mtu.edu

M. FRANCESCA COTRUFO

Dept. Soil and Crop Sciences, Colorado
State University, Fort Collins, CO 80523, USA
Email: francesca.cotrufo@colostate.edu

ILARIA DEL GALDO

Environmental Science Department, Seconda
Università di Napoli, Via Vivaldi 43,
81100 Caserta, Italy
Email: ilaria.delgaldo@unina2.it

KAROLIEN DENEFF

Laboratory of Applied Physical Chemistry –
ISOFYS, Faculty of Bioscience Engineering,
Ghent University, Coupure 653, B-9000 Gent, Belgium;
Current address: Consultant – Energy & Climate Change
team, Environmental Resources Management – ERM nv,
Meersstraat 138D, 9000 Gent, Belgium
E-mail: Karolien.Denef@erm.com

DANIEL EPRON

Ecologie et Ecophysiologie forestières, Faculté des
Sciences, Université Henri Poincaré - Nancy 1, UMR
1137 INRA
UHP, BP 239, 54506 Vandoeuvre, France
Email: Daniel.Epron@scbiol.uhp-nancy.fr

PETE FALLOON

Impacts Model Development, Met Office Hadley
Centre, Fitzroy Road, Exeter EX1 3PB, UK
Email: pete.falloon@metoffice.gov.uk

ANDREAS HEINEMEYER

Stockholm Environment Institute (SEI-York),
Biology Department, Grimston House,
University of York, PO Box 373,
York YO10 5YW, England, UK
Email: ah126@york.ac.uk

IVAN A. JANSSENS

Plant and Vegetation Ecology, Department of Biology,
University of Antwerp, Campus Drie Eiken, D.C16,
Universiteitsplein 1, 2610 Wilrijk, Belgium
Email: ivan.janssens@ua.ac.be

WERNER L. KUTSCH

Department of Biogeochemical Processes,
Max-Planck-Institute for Biogeochemistry,
P.O. Box 10 01 64, 07701 Jena, Germany
Email: wkutsch@bgc-jena.mpg.de

BERNARD LONGDOZ

UMR Ecologie et Ecophysiologie Forestières,
Centre INRA de Nancy, Rue d'Amance,
54280 Champenoux, France
Email: longdoz@nancy.inra.fr

FERNANDO MOYANO

Department of Biogeochemical Processes,
Max-Planck-Institute for Biogeochemistry,
P.O. Box 10 01 64, 07701
Jena, Germany
Email: nanomoyano@gmail.com

DANIELA PIERMATTEO

Environmental Science Department, Seconda
Università di Napoli, Via Vivaldi 43,
81100 Caserta, Italia
Email: daniela.piermatteo@unina2.it

ALAIN F. PLANTE

Dept. Earth and Environmental Science,
University of Pennsylvania,
Rm 162, Hayden Hall, 240 South 33rd Street,
Philadelphia, PA 19104-6316, USA
Email: aplante@sas.upenn.edu

JUKKA PUMPANEN

Department of Forest Ecology,
University of Helsinki,
Latokartanonkaari 7 (P.O. BOX 27) FI-00014,
Finland
Email: jukka.pumpanen@helsinki.fi

MARKUS REICHSTEIN

Biogeochemical Model-Data Integration Group,
Max-Planck Institute for Biogeochemistry,
Hans-Knoell-Str. 10, 07745 Jena,
Germany
Email: markus.reichstein@bgc-jena.mpg.de

MIRCO RODEGHIERO

Fondazione Edmund Mach,
Research and Innovation Centre,
Environment and Natural Resources Area Viote del
Monte Bondone, 38040 Trento, Italy
Email: rodegghiero@cealp.it

JOSHUA SCHIMEL

Ecology, Evolution & Marine Biology,
University of California, Santa Barbara,
CA 93106-9610, USA
Email: schimel@lifesci.ucsb.edu

MARION SCHRUMPF

Department of Biogeochemical Processes,
Max-Planck-Institute for Biogeochemistry,
Hans-Knoell-Str. 10, 07745 Jena, Germany
Email: mschrumpf@bgc-jena.mpg.de

JOHAN SIX

Department of Plant Sciences,
University of California,
Davis, CA 95616, USA
Email: jwsix@ucdavis.edu

PETE SMITH

Soils & Global Change, School of Biological, Sciences,
University of Aberdeen, Cruickshank Building,
St Machar Drive, Aberdeen, AB24 3UU, Scotland, UK
Email: pete.smith@abdn.ac.uk

JENS-ARNE SUBKE

Stockholm Environment Institute (SEI),
Department of Biology, Grimston House,
University of York,
York, YO10 5DD, UK
Email: js51@york.ac.uk

DIANA H. WALL

School of Global Environmental Sustainability,
Natural Resource Ecology Laboratory, NESB B244,
Colorado State University, Fort Collins, CO 80523-1499,
USA
Email: Diana@nrel.colostate.edu

GERHARD WIESER

Federal Research and Training Centre for Forest,
Natural Hazards and Landscape (BFW), Unit of Alpine
Timberline Ecophysiology, Rennweg 1, 6020 Innsbruck,
Austria
Email: Gerhard.Wieser@uibk.ac.at

Preface

Soil has played a major role in human history. The literature of ancient Middle Eastern, Mediterranean, Chinese and Indian civilizations highlight the importance given to soil management and soil fertility. John Steinbeck's famous novel, *Grapes of Wrath* (1939), is one of numerous literary examples describing the dependency of human welfare on soil fertility. Set during the Great Depression Steinbeck focuses on a poor family of tenant farmers driven from their home by the Dust Bowl, droughts, economic turmoil and changes in agriculture practices. Despite this historical and literary context, our scientific understanding of soil and soil-associated processes, particularly the more biotic components, has remained limited. It is only in the last few decades that we have started to understand, in detail, the complex nature of soil biological communities and their environment, and soil biota's functional significance for ecosystem processes. We are now also considerably more aware of the role of soils, and soil biota, in regulating and determining the response of ecosystems to global environmental change.

Excluding carbonate rocks, soils represent the largest terrestrial stock of carbon, holding approximately 1,500 Pg (10^{15} g) C in the top metre. This is approximately twice the amount held in the atmosphere and thrice the amount held in terrestrial vegetation. Soils, and soil organic carbon in particular, currently receive much attention in terms of the role they can play in mitigating the effects of elevated atmospheric carbon dioxide (CO₂) and associated global warming. Protecting soil carbon stocks and the process of soil carbon sequestration, or flux of carbon into the soil, have become integral parts of managing the global carbon balance. This has been mainly because many of the factors affecting the flow of carbon into and out of the soil are affected directly by land-management practices.

In his book, *Communities and Ecosystems. Linking the Aboveground and Belowground Components*, Wardle (2002) comments on how the majority of environmental

theory appears to be based on synthesizing what above-ground and aquatic biologists have found, with soil biology seemingly having a negligible effect on the development of this theory. This could be extended from the more biotic components highlighted by Wardle to carbon balance studies that have, for various reasons, been focused on studies based around the above-ground parts of ecosystems. It is not hard to see why! Whereas the carbon stocks and fluxes of the above-ground components can be quantified with relative ease, those of the below-ground parts cannot. That is not to say, however, that little is known quantitatively about the processes taking place within the soil. There is a significant body of work published by soil scientists over the past several decades precisely on this topic. Unfortunately, as so frequently has happened in biology, this work has been very much seen as the remit of the more 'traditional' soil scientists and little has been done to integrate the findings within the broader realms of ecosystem and general carbon balance studies.

Understanding the global circulation of carbon in the context of climate change is at the vanguard of European Science Foundation (ESF)'s Strategic Plan for 2006–2010. In identifying such an aim it was also recognized that there existed an urgent need to develop methods of studying and describing soil carbon balance that are not only empirically robust, but are recognized as being so. As highlighted in the 2007 *Intergovernmental Panel for Climate Change* (IPCC) report, achieving an international consensus on carbon balances and how to include soil carbon in carbon accounting procedures demands that methods of determining, reporting and verifying changes in soil carbon stocks are scientifically valid. To do this, soil carbon research must become more coherent, and develop greater linkages between pure and applied scientists, between mathematical modellers and experimentalists, and between scientists, economists and policy makers. It was for this reason that the Standing Committee for Life, Earth and

Environmental Sciences (LESC) of ESF established the Role of Soil in the Terrestrial Carbon Balance (RSTCB) Programme, and from whose activities and deliberations this book has arisen. The RSTCB Programme was specifically set up to increase confidence in soil carbon flux and stock change estimates with the aim to generate reliable and consistent datasets; to develop a new generation of models describing soil carbon dynamics; and, finally, to investigate the effects of perturbation on soil carbon balance and the potential for mitigation of carbon emissions.

The increased importance of the issue has led to an increased number of Ph.D. studies in that area. The idea to write this book arose while the editors and most of the authors taught in a Summer School organized within the RSTCB Programme framework in September 2004, where 28 students, over a period of two weeks, were trained both theoretically and practically in soil carbon flux measurements. All students agreed that the course provided an extremely valuable overview and stressed the need of an integrated book on methodology. Since this need was felt across the whole scientific community, encouraging North American colleagues to contribute proved an easy task! Edited by the RSTCB Programme's Steering Committee Chair and two colleagues very much involved with the Programme, many of the volume's authors are internationally recognized in their respective fields of research. Indeed, many have been involved in one or more of the recent European and American networks established on the carbon relations of terrestrial ecosystems (e.g. Fluxnet, CarboEurope, Ameriflux, CarboMont).

Soils vary, spanning the range from the carbon storehouses of the polar and boreal regions to the

arid and semi-arid, desertification-prone soils of the Mediterranean and tropical zones and from the rich, intensively farmed soils of the low-countries to the thin, erosion-prone soil cover of more mountainous regions. The RSTCB Programme managed to bring together soil carbon researchers from all these regions to create a global perspective on the role of soils in the terrestrial carbon balance; the book highlights the value of such collaboration providing, for the first time, the essential standardized protocol for the assessment of soil CO₂ fluxes. Signatories to the Kyoto Protocol, many of which are economically developing nations, will be requested to submit national carbon budgets and/or review their Clean Development Mechanism (CDM) Sink Projects. Many of the authors whose work is presented in this volume have direct experience of working in these countries. It is very much hoped that the volume and its contents will contribute directly to capacity building in this field.

Hefin Jones, Member of the Standing Committee for Life, Earth and Environmental Sciences of the European Science Foundation

REFERENCES

- Wardle, D. A. (2002) *Communities and Ecosystems. Linking the Aboveground and Belowground components*. Monographs in Population Biology 34. Princeton University Press.
- IPCC (2007) *Climate Change 2007: The Physical Science Basis*. Contribution of Working Group I to the Fourth Assessment Report of the Intergovernmental Panel on Climate Change, S. Solomon, D. Qin, M. Manning *et al.* (eds). Cambridge: Cambridge University Press.

1 • Soil carbon relations: an overview

Werner L. Kutsch, Michael Bahn and Andreas Heinemeyer

1.1 INTRODUCTION

Soils are localized between base rock, atmosphere and vegetation, and represent a home for numerous organisms and the place of countless biogeochemical transformation and transfer processes. In addition, soils store many substances that are essential to maintain human life and ecosystem processes. Therefore, soils have been a research focus for more than a century and soil science has deep connections to ecology, agriculture and nature conservation.

The most important practical applications of soil science are diagnostics and maintenance of soil fertility and, more recently, definition of the role of soils in the terrestrial carbon balance in the context of increasing atmospheric CO₂ concentration and the resulting greenhouse effect. Carbon stored in soils represents the largest carbon pool in nearly all terrestrial biomes (Bolin *et al.*, 2001) and thus it has a huge potential for either sequestering or releasing carbon into the atmosphere. Consequently, knowledge of the dynamics of soil carbon is essential for a better understanding of the terrestrial carbon balance. However, inter-annual changes in soil carbon stocks are small compared to the total carbon stored in soils, and thus determining any changes in soil carbon stocks by repeated inventories is difficult. On the other hand, flux measurements also bear inaccuracies and uncertainties, confounding attempts to directly measure and model the CO₂ flux from the soil and linking this flux to the underlying processes. There are considerable challenges in monitoring soil fluxes without disturbing the plant–soil carbon flow. Furthermore, we must also deal with considerable spatial and temporal variability inherent to nearly all ecosystems.

The above challenges imply some conceptual and technical consequences in the methodology of soil

carbon studies. It is the intention of this book to summarize the actual state-of-the-art methods on soil carbon stock and flux measurements and modelling approaches. However, the authors intend to provide more than a ‘manual’ for several methods. The goal is a critical review on the potentials and limitations of different concepts and underlying methodological approaches as well as giving guidance on their informational value and their possible integration. The main aim is, firstly, to provide a more integrated methodology on soil carbon stock and flux measurements at different scales and, secondly, to discuss the relevance of such measurements within the terrestrial carbon cycle and climate system.

1.2 SOIL CARBON RELATIONS: A BASIC CONCEPT

In terrestrial ecosystems the source of soil organic carbon input is from photosynthesis or net primary productivity. Assimilates can be transferred directly to the roots via the phloem or can be converted to biomass that might be transferred to the soil via litter (Fig. 1.1). The ‘assimilate-fed’ and the ‘litter-fed’ pathways have also been named ‘autotrophic’ and ‘heterotrophic’ components of soil respiration in many studies. For many concepts and methods related to soil carbon dynamics it is a prerequisite to distinguish between these components of soil respiration because they depend on very different mechanisms determining their response to environmental conditions.

The autotrophic component can be further separated into respiration of the roots *sensu stricto* and their mycorrhizal symbionts and the microbiota of the rhizosphere, which depend directly or indirectly on carbohydrate sources from roots or mycorrhiza.

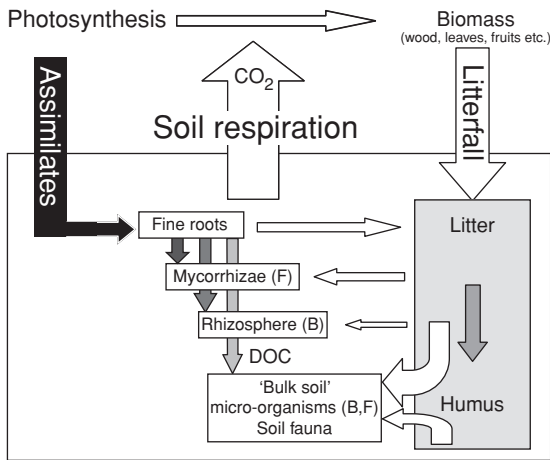

Figure 1.1 Basic concept model of soil carbon dynamics.

In many conceptual (i.e. modelling) approaches three pools of organic matter are distinguished. The easily decomposable active soil organic matter and the more stable slow and passive humic substances, also often called the recalcitrant pool. These pools receive fresh organic matter via litter input but also from microbial turnover and other events such as fire. Litter and the resulting humic substances are decomposed, mainly by the bulk soil micro-organisms that comprise bacteria, fungi and the soil meso- and macro-fauna, resulting in respiration and subsequent soil CO₂ efflux and changes in the chemical composition of soil organic matter (SOM). This biological activity is the driving force for the conversion of litter into stable humus and is also related to bioturbation (e.g. earthworm activity), which causes both aeration and SOM incorporation into clay minerals or deeper soil layers. Importantly, this biological activity, although crucial in determining SOM turnover and soil carbon storage capacity, is not yet adequately included in most modelling frameworks.

The above conceptual framework has at least three weak points: (1) rhizosphere micro-organisms as well as mycorrhizas do not solely depend on root exudates as they also break down soil organic matter, even though most of the energy required for this process is received via fresh root-derived carbon; (2) the fine-root and mycorrhizal compartments are not only respiratory components but also feed into the litter pool themselves; and (3) soil organic matter is a complex mixture of thousands of chemical compounds, each with its own rate

of decomposition depending on the soil microbial and faunal community, their activity and their potential to access compounds adhered to or occluded by mineral surfaces.

Nevertheless, it will be shown later that – despite these limitations – the two-pathway conceptual model is a useful tool for many methods and for their integration.

1.3 RESEARCH LINES

Four different lines of research concerning soil carbon relations have been distinguished in the past: a chemical, physical, physiological and an ecological line. This fragmentation had some fatal consequences: in 1961 Domsch remarked that the research on soil respiration had a ‘borderland character’ being located between soil science, hygiene, meteorology, microbiology, agricultural chemistry, ecology, horticulture, forestry, biochemistry and phytopathology. He concluded that this led (and still leads) to the consequence that new information was often isolated in one scientific community and did not spread through the whole facet of disciplines. The result was a number of ‘quaint rediscoveries’ throughout the years that can still be found even in very recent publications.

1.3.1 Soil chemistry

The *chemical line* concentrates on the chemical characterization of soil organic matter and the resulting decomposition rates. Chemical properties and the amount of soil organic matter determine the basic structure and function of an ecosystem.

The chemical properties, often called the ‘quality’ of SOM, play an important role in the regulation of microbial activity. In addition to basic chemical properties such as pH values, element concentrations as well as element ratios (e.g. C/N), ratios of substrate groups (e.g. cellulose to lignin), or between substrate groups and elements (e.g. lignin to N) are usually used to determine organic matter quality (e.g. Vance and Chapin, 2001). Ågren and Bosatta (1996) called the litter quality ‘the bridge between plant and soil’. Numerous techniques that have been developed during the past decades promise deeper insights into the chemistry and dynamics of soil organic matter (Kögel-Knabner *et al.*, 2008).

However, determining changes in the amount of soil organic matter over time is challenging because

it means detecting a small change in a large number. Therefore, most of the studies using this method have been, and indeed should be, conducted at long-term experimental sites (Jenkinson and Johnston, 1977; Körschgens, 1996; Huggins *et al.*, 1998) that are merged in regional or global networks (Smith *et al.*, 1996; Powlson *et al.*, 1998; www.rothamsted.bbsrc.ac.uk/aen/somnet).

The potential for directly detecting short-term changes through repeated soil sampling was recently examined in several studies (Conant *et al.*, 2003; Conen *et al.*, 2003; Smith, 2004). The minimum time resolution of this approach depends on the spatial heterogeneity of a system in relation to the number of samples and the magnitude of change. Most of the studies conclude that changes in the amount of soil organic matter expected as a result of climate or land-use change cannot be detected statistically significantly within less than a decade.

1.3.2 Physical mechanisms

The second line centres on the *physical* mechanisms that drive the mass flow of CO₂ from the soil to its boundary layer with the atmosphere. It is affected by an old dispute about the driving force of this mass flow. From the first systematic measurements, Romell (1922) drew the conclusion that the diffusion along a CO₂ gradient was the main driving force of soil CO₂ efflux. Nevertheless, other authors suggested additional meteorological and hydrological factors that were summarized by Albertsen (1977):

- temperature-induced differences in density and diffusivity between ground air and atmosphere
- barometric pressure changes
- displacement of ground air by the percolation of water (rain, irrigation)
- changes in the groundwater table
- solution and transport of gases in the sewage water
- pressure changes induced by vertical wind.

Although these factors can play a distinct role in certain situations, most authors rate diffusion as the most relevant factor (van Bavel, 1951, 1952). Therefore, many studies have focused on the physical parameters that influence the diffusivity of CO₂ through soils, such as porosity, texture and water content.

Nevertheless, the additional factors and their contribution to driving soil CO₂ efflux have been re-analyzed several times since new and more accurate measuring instruments for pressure and wind speed became available. From several studies it became evident that turbulent transport can indeed play an important role (Kimball and Lemon, 1971; Kutsch, 1996; Fang and Moncrieff, 1999; Moncrieff and Fang, 1999; Kutsch *et al.*, 2001a; Takle *et al.*, 2004; Flechard *et al.*, 2007). However, a systematic study about the influence of wind-induced turbulence on soil CO₂ efflux is still missing.

1.3.3 The physiological research line

Beyond flux component analysis as depicted in Fig. 1.1 and discussed above, the basic goal of the physiological research line is to understand the eco-physiological performance of soil biota. Since most of the soil CO₂ originates from respiratory processes by plant roots and soil organisms, the *physiological research line* analyzes how these processes are influenced by climate, structure and activity of the microbial biomass, roots and mycorrhiza, as well as trophic interactions in the soil food web and the physico-chemical properties of the soil. This research comprises soil microbiology, zoology, the physiology of roots and mycorrhizae, and rhizosphere processes.

The physiological work on bulk soil micro-organisms is usually done with soil samples in the laboratory. This enables researchers to isolate single processes or factors, e.g. by keeping all other factors constant. The basic information about the reaction of soil biota to short-term changes in temperature and moisture as well as the influence of pH, oxygen and nutrients were obtained as early as the second half of the nineteenth century (Wollny, 1880; van Suchtelen, 1910; Stoklasa and Ernest, 1922). In later studies the properties of the micro-biota in soils were also used as a measure of soil quality or soil integrity when environmental problems had to be evaluated, such as acidification (Bewley and Stotzky, 1983; Lohm *et al.*, 1984; Mai and Fiedler, 1988), pesticides (Chopra and Magu, 1985), heavy metals (Wilke, 1988) or dioxins and polychlorinated biphenyls (PCBs) (Arthur and Frea, 1988).

Another branch of the physiological line specifically analyzes the regulation of 'autotrophic respiration',

going back at least to the third decade of the twentieth century (Eidmann, 1943). Estimates of autotrophic respiration have been reported to comprise between 5% and 90% of total soil respiration, most studies give values between 40% and 70% (Hanson *et al.*, 2000; Bond-Lamberty *et al.*, 2004; Subke *et al.*, 2006). Two groups of approaches have been used to determine the proportion of autotrophic respiration. The first group consists of approaches that work with exclusion or down-regulation of root respiration and comparing soil respiration in areas with and without root activity. In agricultural ecosystems this can be done easily by keeping parts of a crop field bare. In forest ecosystems roots can be excluded by ‘trenching’ small soil areas (Epron *et al.*, 1999) or root activity can be ceased by ‘girdling’ groups of trees (Högberg *et al.*, 2001). Grasslands may be the most difficult systems to apply trenching methods to as the disturbance induced by the use of chamber techniques in the dense canopy is high and the required clipping can considerably change the soil environment.

The other (far less intrusive) group of approaches uses isotopes of the element carbon – either in the form of the radioactive ^{14}C or the stable ^{13}C . Isotopic approaches rely on artificial enrichment or natural biochemical fractionation that occurs in the pathway from air to plant and soil, and can apply mixing models for separating source components.

Like all respiration processes autotrophic respiration is influenced by temperature and moisture. However, because it utilizes plant assimilates as substrate, it also depends on net primary productivity and carbon partitioning in the plants and as such might be less temperature dependent than soil microbial respiration. In addition, root respiration *sensu stricto* is affected by root nitrogen concentration (Burton *et al.*, 1998; Bahn *et al.*, 2006). Also species, root diameter and seasonal dynamics play a distinct role. Lambers *et al.* (1991) related root respiration to the three basic functions: growth, maintenance and ion uptake. The latter can account for up to one quarter of root respiration.

More recently, new approaches have drawn attention to the regulation of mycorrhizal respiration (Heinemeyer *et al.*, 2006, 2007; Moyano *et al.*, 2007), since more than one third of the respiratory energy requirement of roots can be due to mycorrhizas (Lambers *et al.*, 1998). These studies, using mesh bags that enable the mycelium to grow into a soil column

but exclude roots, showed that mycorrhizal respiration depends more on the supply of photosynthates than on temperature. However, more data and improved techniques are needed, avoiding artefacts such as soil moisture changes and the need to assess the potential of any changes in heterotrophic respiration due to the exclusion of roots and mycorrhizae (e.g. ‘Gadgil effect’, Gadgil and Gadgil, 1971), and the decomposition of cut root fragments.

In the *ecological* research line the soil carbon relations are understood as a part of the ecosystem matter cycling. Soil organic matter plays an important role in determining the structure and function of ecosystems, e.g. by storage as well as the interaction of carbon and nutrient cycles (Odum, 1969).

1.3.4 The ecological research line

In this context a flux-based approach has become widely adopted, focusing on field measurements of soil CO_2 efflux. The definition of the term ‘soil respiration’ as CO_2 evolution from the soil surface, and the beginning of field studies, dates back more than 80 years. It was the Swedish scientist Henrik Lundegårdh (1924, 1927) who started first measurements with a method that we would call ‘static closed chamber’ today. It is remarkable that Lundegårdh’s work on soil respiration was part of his more integrative studies on carbon cycling in agricultural ecosystems that he summarized 1924 in a book called *Der Kreislauf der Kohlensäure in der Natur* (the cycling of carbonic acid in nature). This tells us that field measurements of soil respiration were part of an ecosystem approach from their early beginnings, about a decade before the term ‘ecosystem’ itself was defined by Tansley in 1935. A lot of later studies combined basic and applied aspects: focusing on either the analysis of the major factors driving soil respiration and the accumulation or loss of soil organic matter, or on defining indicators of soil fertility, health, integrity or sustainability (Haber, 1958; Walterscheidt, 1960; Edwards and Sollins, 1973; Singh and Gupta, 1977; Trumbore, 2006).

More recently soil carbon relations became a central part of the research on climate change. Since the 1970s it became more and more evident that anthropogenic emissions of CO_2 result in an increase of the natural greenhouse effect of atmospheric trace gases and hence to an increase of the earth’s surface temperature

(IPCC, 2001). In view of the large size of global terrestrial soil carbon stocks and a general temperature sensitivity of biological and biochemical processes, there has been increasing recognition of the potential role of soils for the terrestrial carbon cycle in a globally changing environment. In this context, a number of important questions have recently become issues of debate.

- How do temperature and precipitation changes affect the mineralization of soil organic matter? Will soil respiration increase significantly with rising temperatures or will acclimation processes occur?
- How much atmospheric CO₂ can be sequestered for how long in soil organic matter and in which ecosystems? Conversely, which ecosystems might potentially release large amounts of soil carbon?
- Will increased net primary production, due to anthropogenic CO₂ and nitrogen fertilization effects, lead to increased litter production and hence increased soil carbon storage?

The answers to these questions require a deep knowledge on the regulation of soil carbon fluxes and its underlying processes. Soil temperature and soil moisture were often defined as primary factors driving the mineralization of soil organic matter. In most cases they explain a high proportion of (short-term) temporal variations in soil respiration at one distinct site. However, the individual components of the measured soil CO₂ efflux (e.g. root-derived respiration) might respond differently to environmental change (Staddon *et al.*, 2002).

1.4 CURRENT CHALLENGES

As simple as measuring soil CO₂ efflux or determining the soil carbon stocks of a site might appear, this basic research on soil carbon dynamics provides many challenges. In contrast to above-ground carbon relations, the world of soil carbon turnover and decomposition is covered within the ‘hidden half’ of terrestrial ecosystems. It involves literally thousands of species of soil organisms, ranging from the metre or centimetre to less than micrometre scale.

It is surprising how little we know globally about those biological components that drive turnover rates of litter and organic matter. Many of the decomposer bacteria, for example, are still unknown, but their role is important in aerobic, and even more so in anaerobic, decomposition. We are not yet able to name most of

them at species level or to group them into functional types as is commonly done when modelling plant carbon dynamics at the larger scales. About another important group, the soil fungi, we do not yet fully understand their life cycles, environmental responses or specific role in the carbon cycle. Only recently, the advance of molecular techniques enabled us to realize the level of complexity of processes involved in the decomposition of organic matter, and the combination of these novel molecular techniques with stable isotope probing will hopefully improve our understanding in the near future.

In addition, the activity of below-ground decomposer organisms is influenced by many factors such as the amount and chemical quality of litter and soil organic matter, soil texture and porosity, pH value, input via litterfall and root turnover, root biomass and root activity. Also past and recent disturbances, such as fire or erosion as well as ploughing, agro chemicals or acid deposition, can affect the soil carbon turnover substantially. Therefore, site inter-comparisons even for the same soil type are difficult to interpret.

Moreover, our basic ability to adequately separate autotrophic and heterotrophic flux components (see Fig. 1.1) and their respective responses to environmental changes is still limited. However, the proper link between above- and below-ground carbon flow in the plant–soil carbon flux continuum needs to be established, as can be seen in the continued debate on the existence and role of soil priming, which may alter turnover of older organic matter as a result of fresh plant-derived soil carbon input. Finally, all these novel aspects need to be considered by the modelling community, for which the incorporation of basic soil biology still seems a major obstacle.

In the following description of the main book sections we will try to highlight the most important issues regarding soil carbon fluxes. The book chapters aim not only to outline the most important approaches but also to highlight cutting-edge methodologies and future directions of research.

1.4.1 Experimental design of flux measurements and stock taking: limitations at the plot scale

Soil respiration measurements in the field are one of the most difficult among the ecosystem flux measurements. So far, no single method has been established as

standard but comparisons, which give important indications on their accuracy, have been performed (Janssens *et al.*, 2000; Pumpanen *et al.*, 2004; Butnor *et al.*, 2005). Notably, all methods can affect the object being measured by disturbing the biochemical processes involved in CO₂ production, the physical properties influencing CO₂ movement towards the soil surface or by changing the environmental conditions in the soil. In addition, although collar insertion assures a good chamber-to-soil seal, at the same time it cuts through parts of the surface rooting zone, causing in effect a miniature trenching effect.

Furthermore, it is important to unravel the sources of variability observed in soil CO₂ efflux and to distinguish spatial and temporal variations for both biotic and abiotic factors (e.g. ‘hot spots’ of decomposition). Whereas biotic variations can occur at micrometre scales, abiotic variability is predominantly at much larger scales (e.g. throughfall patterns). In this context, the relation of high frequency (i.e. capturing diurnal response times and correlations) versus infrequent measurements (capturing spatial resolution) might specifically need to be addressed.

Chapters 2 (Pumpanen *et al.*) and 3 (Subke *et al.*) of this book summarize the challenges in chamber design, experimental setup and scaling up from sparse and infrequent measurements to the level of, for example, catchment, region, or even continental or global scales bearing a considerable degree of uncertainty. The two chapters conclude with a step-wise guide to experimental planning and hypotheses testing with a particular emphasis on including consideration of pre-treatment periods and how to adequately address spatial variability and to up-scale point results within a geographical information systems (GIS) framework. Chapter 3 also includes a specific introduction to addressing sampling strategies and spatial autocorrelation with the use of a simple semivariogram as part of an initial site survey with consideration of budget and manpower constraints. This chapter aims to offer the basis for sound statistical design leading to meaningful data and their adequate interpretation.

International environmental policy programmes (e.g. the United Nations Framework Convention on Climate Change; http://unfccc.int/kyoto_protocol/items/2830.php) are increasingly requiring assessment of the soil carbon sink or source potential, and more accurate net soil carbon balance measurements. As such, a full carbon balance often also needs to consider many

rather difficult components such as dissolved organic carbon (DOC) fluxes or effects of fire.

Chapter 4 (Rodeghiero *et al.*) focuses on organic soil carbon stocks and the associated measurement techniques and starts with an overview of global datasets on soil carbon stocks across biomes and a schematic soil carbon cycle also considering hypothetical relationships between soil carbon stocks and environmental change (i.e. temperature, elevated CO₂ and nitrogen). Like flux measurements, the repeated inventory approach to determine soil carbon changes over time has considerable simplifications and uncertainties. Notably, it requires a consistent sampling design and analytical approach between inventories to allow meaningful comparison and detect changes in soil carbon stocks with sufficient precision. In particular, soil sampling procedure, measurements of soil bulk density and conversion factors of soil organic matter (SOM) to soil organic carbon (SOC) are highlighted as a source of significant error in SOC stocks and their estimated changes, in particular in organic soils. Issues of a strict protocol, soil sampling by horizon or depth increments, excavation pits, required sample number and sampling time interval in relation to the minimum detectable difference are all discussed in Chapter 4. The chapter considers and compares all of the major methods of analyzing soil for organic carbon and points out their individual advantages and shortfalls (e.g. SOM conversion factors). Importantly, this chapter also offers a simple flow chart for soil analysis for selecting an appropriate soil carbon analysis.

1.4.2 Litter and soil organic matter: a meaningful separation and characterization of carbon pools

The second section (Chapters 5, Cotrufo *et al.*, and 6, Deneff *et al.*) discusses a large number of techniques that have been developed for the characterization of litter and SOM, the non-living organic material within the soil matrix, and cautiously addresses how to interpret the results in a meaningful way, also using stable isotope techniques. This work is intended to gain insight in the stabilization and destabilization mechanisms that underlie SOM dynamics in the short and long term.

Chapter 6 (Deneff *et al.*) shows that a suite of techniques combining physical or chemical fractionation, analytical pyrolysis or nuclear magnetic resonance

(NMR) for biochemical characterization, and isotopic analysis techniques for an assessment of dynamics, is necessary for an exhaustive examination of the nature and dynamics of SOM. These developing techniques will hopefully deliver some of the data needed for an increased process understanding of long-term soil carbon storage and the evaluation of the commonly used model parameters of SOM decomposition. However, there are some clear limitations in most studies in understanding long-term carbon storage as the nature of sampling destroys, to some degree, the structures to be investigated.

Soil organic matter fractionation approaches generally provide useful measures of SOM stability (e.g. age and turnover times) and microbial functioning, yet methodologies and protocols need to be developed further. For example, in contrast to the common assumption that clay content is the most important determinant of SOC storage, in many soils, the type of organo-mineral complex appears to be even more important (Koch *et al.*, 1988; Bardgett and Saggarr, 1994; Torn *et al.*, 2002). There is a clear mandate for studying the composition and stability of physical SOM fractions in different soil types and environments following recently standardized fractionation procedures.

Litter decomposition is a crucial step in determining SOC accumulation and changes over time. Overall litter chemistry and nutrient levels, climate and soil biology control the processes involved in litter incorporation into SOM and eventually its turnover into CO₂, H₂O or CH₄ and other fermentation products (Kögel-Knabner *et al.*, 2008). However, despite a large number of studies, general conclusions are still difficult to draw and, as recently underlined by Prescott *et al.* (2004), ‘many of the well-known facts about litter decomposition need to be revised’. Chapter 5 (Cotrufo *et al.*) outlines the current state of knowledge on litter decomposition processes and identifies avenues of future research. Future research is needed where theoretical and experimental work are designed and executed in coordination, to measure ‘true’ processes and to model measurable pools and fluxes.

Litter quality cannot be described by a universally accepted index and is mainly based on defining known recalcitrant litter fractions (e.g. lignin, tannins, phenolic compounds etc.). There are novel and promising non-destructive techniques (such as mid-infrared (MIR), near-infrared (NIR) and diffuse reflectance

infrared Fourier-transform (DRIFT) spectroscopy), which could make important contributions to rapidly assess litter or SOM quantity and quality and directly relate quality to dynamics and microbial functioning. Although microbes are able to degrade virtually all biological compounds, differences exist between fungal and bacterial communities and their decomposition potential, mostly relating to litter type and soil chemistry.

A good understanding of the feedback and interactions between the characteristics of litter and SOM and the biological activity is still limited. Therefore, the next two sections focus on biotic soil activities, starting with two chapters on methods for partitioning autotrophic versus heterotrophic respiration and two further chapters focusing in more detail on microbial communities and soil food webs, respectively.

1.4.3 Measuring autotrophic versus heterotrophic fluxes: available methods and their meaning

It has been widely acknowledged that we need an increased understanding of how autotrophic and heterotrophic flux components vary over time and with climate. In particular, as root-derived carbon fluxes might lead to additional SOM turnover or ‘soil priming’. The research focus has recently shifted to the role of mycorrhizal fungi in plant–soil carbon supply and implications for SOM turnover.

Chapters 7 (Moyano *et al.*) and 8 (Epron) provide an in-depth overview of the current understanding and the available techniques for partitioning autotrophic and heterotrophic respiration. Chapter 7 describes in detail physiological approaches to assessing the respiration of roots and the mycorrhizosphere, whereas Chapter 8 focuses on gap, trenching, girdling and clipping techniques in order to assess root-derived respiration.

Integrating the results of these different approaches is difficult. One reason is that mycorrhizal fungi are usually included in the autotrophic flux component. Consequently, root respiration *sensu stricto* has been overestimated when derived from girdling or trenching without further partitioning (Pendall *et al.*, 2004). When using lab-based respiration rates of excised (mycorrhizal-deprived) roots, the ignored extra-radical mycelium (ERM) respiration component might explain why scaled-up respiration measurements show low estimates of autotrophic respiration when compared to

girdling (Högberg *et al.*, 2001) or trenching experiments, which include the ERM component (Simard *et al.*, 1997; Högberg *et al.*, 2002). In addition, it is important to note that trenching and girdling changes the presence and activity of biota in soils (Schulze *et al.*, 2005).

A major demand for the field ecologist is to enable continuous and high-frequency measurements of soil or soil-component respiration in order to capture the highly variable contribution of the autotrophic carbon flux components. A combination of mesh collars with isotope tracer studies within the footprint of an eddy covariance system will deliver simultaneous data of canopy photosynthesis and plant carbon allocation to the rhizosphere, and seems a most promising way forward to increase our understanding of the soil CO₂ flux components, the contribution changes over time, their environmental responses and impacts on SOM decomposition.

1.4.4 Soil microbes, soil fauna and trophic interactions: describing communities, their functions and activity

In general, the knowledge about microbial activity in soils under field conditions and its adjustment to changing environmental constraints is small (Vance and Chapin, 2001; Kögel-Knabner *et al.*, 2008). This has methodological reasons, because many microbiological analyses cannot be conducted *in situ* and field measurements of soil respiration are very seldom directly connected with microbiological analyses in the laboratory. In addition, it has been impossible until recently to analyze the species spectra of soil microbial communities, their micro-habitats and their position in the soil carbon cycle (Ekschmitt *et al.*, 2008). Microbial eco-physiology preferred to work with functional groups or with the characterization of whole soil microbial biomass by applying metabolic quotients (Paul and Clark, 1989; Anderson and Domsch, 1990; Ritz *et al.*, 1994; Alef and Nannipieri, 1995). Measurements such as microbial biomass, basal respiration or the metabolic quotient ($q\text{CO}_2$) can reveal valuable information about the capacity of a microbial community to mineralize soil organic matter, but they can never be used directly for estimating carbon fluxes in the field because this capacity is mediated by the variations of environmental factors, such as soil temperature or moisture and

changes in soil chemical properties, but also by temporal changes in root-derived carbon supply, in effect 'fuelling' decomposition.

An exciting new branch of microbiological research has developed very rapidly during the past years. New molecular technologies reveal deeper insights into microbial community dynamics and the way they interact with element cycles for the first time (Nannipieri *et al.*, 2003). It will be interesting to see how these novel approaches can be integrated into quantitative soil carbon studies. In particular, evolving stable-isotope probing (SIP) techniques (Manfield *et al.*, 2002) will enable fast insights in this area. Chapter 9 (Kutsch *et al.*) introduces traditional and novel approaches in soil microbiology.

Trophic interactions and the principal ways by which they influence soil carbon fluxes are a frequently overlooked issue. Above- and below-ground herbivory has various impacts on soil carbon dynamics while soil fauna plays a key role in organic matter decomposition, either directly via the consumption of litter, or indirectly via feeding on saprotrophs or the movement of organic matter. Numerous experiments have shown that the presence of a range of different soil fauna, including collembolas, mites, enchytraeids, isopods and earthworms, typically increase rates of mass loss and carbon mineralization. However, as often as the mediation of decomposition by animals has been shown qualitatively, it is extremely difficult to determine its relative importance because many mechanisms typically occur simultaneously. Notably, Chapter 10 (Ayres *et al.*) gives an introduction to the main trophic interactions in soils and emphasizes important relationships between biodiversity and ecosystem function, particularly in relation to soil carbon cycling.

1.4.5 Temperature sensitivity and acclimation: application and shortfalls of different concepts

The influence of soil temperature on soil respiration or decomposition is a cross-section topic that is related to almost every chapter in this book. It is an actual challenge because our understanding of temperature effects on soil carbon turnover has a huge impact on the prediction of the global carbon cycle under future climate (Cox *et al.*, 2000). Early studies predicted a feedback cycle where increasing CO₂ concentration in the atmosphere caused increasing temperature, which itself led

to higher soil respiration rates and, consequently, an accelerated increase in atmospheric CO₂. Later studies doubted the realism of such a positive 'runaway' feedback cycle for three reasons: (1) physiological acclimation and community adjustment decrease carbon mineralization rates; (2) in the long run the mineralization of soil organic matter is driven by substrate input and should develop a relatively temperature-independent equilibrium; (3) parts of the new input via the litter pathway are stable and, thus, are transferred to the 'protected', more stable, soil carbon pools (Liski and Westman, 1997; Liski *et al.*, 1999; Thornley and Cannell, 2001). The third reason could even result in an increase of soil organic matter, when litter production is increased due to higher atmospheric CO₂.

One crucial question in the current debate in this field is: how does the older and chemically more resistant SOM pool (or recalcitrant SOM) behave under the conditions of climate change? The answer is important to interpret recent findings from soil-warming experiments, which often show a transient response of soil respiration to a temperature increase (McHale *et al.*, 1998; Luo *et al.*, 2001; Melillo *et al.*, 2002; Eliasson *et al.*, 2005). Using another approach, Christensen *et al.* (1996) found that the response of soil respiration to temperature decreases with increasing soil depth. All these findings lead to the hypothesis that the recalcitrant SOM mineralization either adjusts to the temperature or is generally less temperature sensitive. In contrast, an alternative interpretation suggests that the observed, apparent adjustment is in fact the result of a depletion of the labile carbon pools following a transient stimulation of mineralization rates by increasing temperature (Kirschbaum, 2004; Eliasson *et al.*, 2005). This was confirmed by recent laboratory incubations of soil samples indicating that the decomposition of the recalcitrant SOM pool may be as sensitive to temperature as that of the labile one (Fang *et al.*, 2005b). From a model study Knorr *et al.* (2005a) concluded that it is even more temperature sensitive, a conclusion that caused an intense debate (Fang *et al.*, 2005a; Knorr *et al.*, 2005b; Reichstein *et al.*, 2005). Davidson and Janssens (2006) and Davidson *et al.* (2006) have shown theoretically that substrate quality and temporal and spatial differences in substrate availability contribute to the large variability in Q_{10} observed in nature. Q_{10} is the factor by which respiration is multiplied when temperature increases by 10°C (van 't Hoff, 1898).

Davidson *et al.* (2006) suggest including substrate turnover via Michaelis–Menten kinetics into the mathematical description of decomposition and heterotrophic soil respiration. A more recent concept is the Q_{10-q} in which Contant *et al.* (2008) derived a novel approach that accounts for changes in soil organic matter quality during decomposition as more resistant soil carbon seem to have a higher Q_{10} than labile compounds.

As interesting and straightforward this debate has been, it is characterized by a complete lack of a biological component. Kutsch and Kappen (1997) and Luo *et al.* (2001) already proposed that the seasonal differences in short-term temperature sensitivity reflect an adjustment of the soil microflora to temperature and moisture history. This can be the result of both: changes in the physiology of particular species and of changes of species composition. Temperature adjustment of the biotic components is discussed in Chapters 7 (Moyano *et al.*) and 9 (Kutsch *et al.*).

The current debate around temperature sensitivity of soil respiration shows that the drivers of soil carbon fluxes are still not completely unravelled. Since there is evidence that soil temperature and moisture as primary factors cannot explain most differences between sites (Raich and Schlesinger, 1992; Giardina and Ryan, 2000; Janssens *et al.*, 2001), it remains a challenge to integrate soil chemical and biological methods because the linkage between the bio-physico-chemical quality of SOM and the temperature response of SOM turnover remains poorly understood, or even elusive, especially as fractionation methods have seldom been directly linked to microbial functioning and resulting SOM dynamics. The combination of stable-isotope probing (SIP) of nucleic acids (DNA and rRNA) with promising non-destructive techniques (such as MIR, NIR and DRIFT spectroscopy) could make important contributions to rapidly assess SOM quantity and quality, and directly relate SOM quality to SOM dynamics and microbial functioning.

1.4.6 Modelling soil carbon dynamics: current and future model validation and structures

Chapters 11 (Reichstein and Janssens) and 12 (Fallon and Smith) give an overview over the current state of modelling soil carbon cycling. Whereas Chapter 11 focuses on carbon fluxes, Chapter 12 considers the

long-term SOM turnover. Ultimately the two are inter-linked but each deserves its own consideration.

Modelling soil respiration in contrast to above-ground processes has certain key challenges:

- what is the functional unit?
- what are the biochemical processes involved?
- what do we know about the key contributing species?

The answers to all of those are clearly ‘very much unknown at present’, mainly as soil is very heterogeneous without a single functional unit. Instead a largely unknown number of organisms and enzymes are decomposing a large variety of chemical substances. Consequently, modelling approaches are mostly substrate orientated (Wallman *et al.*, 2004).

A major drawback of most soil respiration models is that they see the soil as a homogeneous structure, whereas in fact the soil is a horizontally and vertically very heterogeneous system. For example, animal activity concentrates in the most suitable areas and as such the average soil environment might not reflect the overall activity. Also ‘memory effects’ are commonly overlooked as site history might explain soil respiration rates over many decades or even centuries. Chapter 11 outlines several dominant temporal scales of factors and processes influencing soil respiration, and points out several issues with comparing laboratory versus field studies (e.g. disturbance effect and limited root-derived carbon supply). Another major issue is the influence of net primary productivity (NPP) on soil respiration (Nadelhoffer and Raich, 1992; Raich and Tufekciogul, 2000; Janssens *et al.*, 2001). To include NPP into algorithms modelling soil respiration will be a key future challenge and, as shown by Reichstein *et al.* (2003), it is possible and necessary to separate climatic and biological effects on soil respiration. However, other factors, such as soil acidity, oxygen and nutrient availability, have also received inadequate attention although they seem to be crucial in determining long-term carbon accumulation, particularly in peatlands.

Mechanistic models tend to also include specific decomposition rates of assumed SOM fractions, which are then modified based on environmental factors such as temperature and moisture leading to humification and formation of recalcitrant SOM according to Akselsson *et al.* (2005). However, a major shortfall of these models is that crucial biological processes (e.g. priming or

microbial growth dynamics) are not explicitly considered, and no direct link (other than litter fall) from assimilation to below-ground processes is provided. As such the models reflect the state-of-the-art in science as discussed in the former section. Consequently the parameterization is very uncertain and the ‘right number’ might be a result for ‘the wrong reasons’. The chapter finishes with an overview of how to address the problem of different scales and emphasizes that any direct comparisons should only be performed at corresponding levels.

Modelling frameworks of decomposition have similar aims to the above, they are used to better understand processes, extrapolate or interpolate experimental results in time, space and to different environmental conditions or to investigate scenarios that are beyond the realm of experimental work; this resulted in many different SOM modelling approaches. SOMNET contains over 30 current operational multi-compartment, process-based SOM models (<http://www.rothamsted.bbsrc.ac.uk/aen/somnet/>). Chapter 12 focuses on two of the most widely used SOM models, RothC and CENTURY, and provides detailed case studies of model formulation, development and application. However, in so far as these models only model SOM turnover, it does not include root-derived respiration and as such makes comparison to, or model validation with, field flux data impossible (Luckai and Larocque, 2002).

So far, the differences between the central SOM decomposition modules in compartmental SOM models are generally small and may give similar results when driven with equivalent input data (Smith *et al.*, 1997; Falloon and Smith, 2002). Another challenge is that in nature soils grow as cohorts (see McGill, 1996; i.e. new leaf litter fall). This characterizes peatlands, containing the largest global soil carbon stocks, and a major question remains how non-cohort-based models can actually be used to model peatland SOM dynamics. This also includes model descriptions of the soil water balance, which mostly does not allow for water table movement up to the surface but rather allocating surplus water to runoff. However, these still in many ways limited SOM models are increasingly being used by policy makers at the national, regional or global scale, for example in the post-Kyoto Protocol. Consequently, the chapter also provides an overview of related model weaknesses, including root distribution, soil layering,

bioturbation by meso-fauna and macroorganisms (i.e. earthworms), dissolved organic carbon and deep soil processes. Overall, there is also a clear need to pay more attention to chemical effects (e.g. pH effects on soil carbon turnover in CENTURY) and to further develop biologically focused, food web-based models of soil respiration (Hunt, 1977; Hunt *et al.*, 1977).

1.4.7 The role of soils in a changing climate: towards a better understanding of the role of soils in the greenhouse gas budget

Chapter 13 (Smith *et al.*) places the role of soil carbon research and modelling in the broader context of the Kyoto framework. The Kyoto Protocol allows carbon emissions to be offset by demonstrable removal of carbon from the atmosphere. Thus, land-use or land-management change including improved management of agricultural soils and forestry activities that are shown to reduce atmospheric CO₂ levels can be included in the Kyoto emission reduction targets. For soil carbon sinks, the best options are to increase carbon stocks in soils that have been depleted in carbon in the past, i.e. agricultural soils and degraded soils.

1.5 SUMMARY

The book is concluded by a synthesis (Chapter 14, Bahn *et al.*) and a common protocol (Chapter 15, Bahn *et al.*) that aims to reduce the uncertainty within and across sites by measuring in a comparable way, avoiding measurement bias or artefacts and covering the annual range of environmental conditions prevailing at a site. The protocol lists the minimum requirements of supplemental parameters to be measured, which are necessary to ensure a proper inter-comparison of sites and an up-scaling of the data.

Soil carbon relations have become an issue of increasing importance for the interpretation of monitored ecosystem fluxes and the prediction of future developments, and no integrated publication on the state of the art of this rapidly developing field is currently available. In this context, the editors and the authors hope to provide a useful book to their readership that compiles both actual concepts and state-of-the-art method descriptions.

The increased importance of the issue, which has led to an increased number of Ph.D. studies in the

area, and the fact that some of us have worked and taught in developing countries motivated us to write this book. Many of the countries that have signed the Kyoto Protocol and have to submit national carbon budgets or to review clean development mechanism (CDM) sink projects in future do not have the local capacity to conduct in-depth studies on soil carbon dynamics. We believe that our book can contribute to capacity building in this field, which we feel will be an ongoing process over many decades to come.

REFERENCES

- Ågren, G. I. and Bosatta, E. (1996) *Theoretical Ecosystem Ecology: Understanding Element Cycles*. Cambridge: Cambridge University Press.
- Akselsson, C., Berg, B., Meentemeyer, V. and Westling, O. (2005) Carbon sequestration rates in organic layers of boreal and temperate forest soils: Sweden as a case study. *Global Ecology and Biogeography*, **14**, 77–84.
- Albertsen, M. (1977) Labor- und Felduntersuchungen zum Gasaustausch zwischen Grundwasser und Atmosphäre über natürlichen und verunreinigten Grundwassern. Christian-Albrechts-Universität, Kiel.
- Alef, K. and Nannipieri, P. (1995) *Methods in Applied Soil Microbiology and Biochemistry*. San Diego, CA: Academic Press.
- Anderson, T. H. and Domsch, K. H. (1990) Application of eco-physiological quotients ($q\text{CO}_2$ and $q\text{D}$) on microbial biomasses from soils of different cropping histories. *Soil Biology and Biochemistry*, **22**, 251–5.
- Arthur, M. F. and Frea, J. I. (1988) Microbial activity in soils contaminated with 2,3,7,8-TCDD. *Environmental Toxicology and Chemistry*, **7**, 5–14.
- Bahn, M., Knapp, M., Garajova, Z., Pfahringer, N. and Cernusca, A. (2006) Root respiration in temperate mountain grasslands differing in land use. *Global Change Biology*, **12**, 995–1006.
- Bardgett, R. D. and Saggart, S. (1994) Effects of heavy metal contamination on the short-term decomposition of labelled ¹⁴C-glucose in a pasture soil. *Soil Biology and Biochemistry*, **26**, 727–33.
- Bewley, R. J. and Stotzky, G. (1983) Simulated acid rain (H₂SO₄) and microbial activity in soil. *Soil Biology and Biochemistry*, **15**, 425–9.
- Bolin, B., Sukumar, R., Ciais, P. *et al.* (2001) The global perspective. In *IPCC Special Report on Land Use, Land-use Change and Forestry*, ed. R. T. Watson, I. R.

- Noble, B. Bolin *et al.* Cambridge: Cambridge University Press, pp. 23–51.
- Bond-Lamberty, B., Wang, C. K. and Gower, S. T. (2004) A global relationship between the heterotrophic and autotrophic components of soil respiration? *Global Change Biology*, **10**, 1756–66.
- Burton, A. J., Pregitzer, K. S., Zogg, G. P. and Zak, D. R. (1998) Drought reduces root respiration in sugar maple forests. *Ecological Applications*, **8**, 771–8.
- Butnor, J. R., Johnsen, K. H. and Maier, C. A. (2005) Soil properties differently influence estimates of soil CO₂ efflux from three chamber-based measurement systems. *Biogeochemistry*, **73**, 283–301.
- Chopra, P. and Magu, S. P. (1985) Effect of selected herbicides and city compost on the rhizospheric microflora of wheat and maize. *Indian Journal of Agronomy*, **30**, 5–9.
- Christensen, S., Ronn, R., Ekelund, F. *et al.* (1996) Soil respiration profiles and protozoan enumeration agree as microbial growth indicators. *Soil Biology and Biochemistry*, **28**, 865–8.
- Conant, R. T., Smith, G. R. and Paustian, K. (2003) Spatial variability of soil carbon in forested and cultivated sites: implications for change detection. *Journal of Environmental Quality*, **32**, 278–86.
- Conant, R. T., Drijber, R. A., Haddix, M. L. *et al.* (2008) Sensitivity of organic matter decomposition to warming varies with its quality. *Global Change Biology*, **14**, 868–77.
- Conen, F., Yakutin, M. V. and Sambuu, A. D. (2003) Potential for detecting changes in soil organic carbon concentrations resulting from climate change. *Global Change Biology*, **9**, 1515–20.
- Cox, P. M., Betts, R. A., Jones, C. D., Spall, S. A. and Totterdell, I. J. (2000) Acceleration of global warming due to carbon-cycle feedbacks in a coupled climate model. *Nature*, **408**, 184–7.
- Davidson, E. A. and Janssens, I. A. (2006) Temperature sensitivity of soil carbon decomposition and feedbacks to climate change. *Nature*, **440**, 165–73.
- Davidson, E. A., Janssens, I. A. and Luo, Y. Q. (2006) On the variability of respiration in terrestrial ecosystems: moving beyond Q₁₀. *Global Change Biology*, **12**, 154–64.
- Domsch, K. H. (1961) Bodenatmung – Sammelbericht über Methoden und Ergebnisse. *Zentralblatt fuer Bakteriologie, Mikrobiologie und Parasitenkunde Abt II*, **116**, 33–78.
- Edwards, N. T. and Sollins, P. (1973) Continuous measurements of carbon dioxide evolution from partitioned forest floor components. *Ecology*, **54**, 406–12.
- Eidmann, F. E. (ed) (1943) *Untersuchungen über die Wurzelatmung und Transpiration unserer Hauptholzarten*. Frankfurt am Main: J. D. Sauerländer's Verlag.
- Ekschmitt, K., Kandeler, E., Poll, C. *et al.* (2008) Soil-carbon preservation through habitat constraints and biological limitations on decomposer activity. *Journal of Plant Nutrition and Soil Science*, **171**, 27–35.
- Eliasson, P. E., McMurtrie, R. E., Pepper, D. A. *et al.* (2005) The response of heterotrophic CO₂ flux to soil warming. *Global Change Biology*, **11**, 167–81.
- Epron, D., Farque, L., Lucot, E. and Badot, P. M. (1999) Soil CO₂ efflux in a beech forest: dependence on soil temperature and soil water content. *Annals of Forest Science*, **56**, 221–6.
- Falloon, P. and Smith, P. (2002) Simulating SOC changes in long-term experiments with RothC and CENTURY: model evaluation for a regional scale application. *Soil Use and Management*, **18**, 101–11.
- Fang, C. and Moncrieff, J. B. (1999) A model for soil CO₂ production and transport 1: model development. *Agricultural and Forest Meteorology*, **95**, 225–36.
- Fang, C., Smith, P. and Smith, J. U. (2005a) Is resistant soil organic matter more sensitive to temperature than the labile organic matter? *Biogeosciences*, **3**, 65–8.
- Fang, C., Smith, P., Moncrieff, J. B. and Smith, J. U. (2005b) Similar response of labile and resistant soil organic matter pools to changes in temperature. *Nature*, **433**, 57–9.
- Flechard, C. R., Neftel, A., Jocher, M. *et al.* (2007) Temporal changes in soil pore space CO₂ concentration and storage under permanent grassland. *Agricultural and Forest Meteorology*, **142**, 66–84.
- Gadgil, R. L. and Gadgil, P. D. (1971) Mycorrhiza and litter decomposition. *Nature*, **233**, 133.
- Giardina, C. P. and Ryan, M. G. (2000) Evidence that decomposition rates of organic carbon in mineral soil do not vary with temperature. *Nature*, **404**, 858–61.
- Haber, W. (1958) Ökologische Untersuchung der Bodenatmung. Mit einer Übersicht über frühere Bearbeitungen, insbesondere deren Methoden. *Flora*, **146**, 109–57.
- Hanson, P. J., Edwards, N. T., Garten, C. T. and Andrews, J. A. (2000) Separating root and soil microbial

- contributions to soil respiration: a review of methods and observations. *Biogeochemistry*, **48**, 115–46.
- Heinemeyer, A., Ineson, P., Ostle, N. and Fitter, A. H. (2006) Respiration of the external mycelium in the arbuscular mycorrhizal symbiosis shows strong dependence on recent photosynthates and acclimation to temperature. *New Phytologist*, **171**, 159–70.
- Heinemeyer, A., Hartley, I. P., Evans, S. P., De la Fuente, J. A. C. and Ineson, P. (2007) Forest soil CO₂ flux: uncovering the contribution and environmental responses of ectomycorrhizas. *Global Change Biology*, **13**, 1786–97.
- Högberg, P., Nordgren, A., Buchmann, N. *et al.* (2001) Large-scale forest girdling shows that current photosynthesis drives soil respiration. *Nature*, **411**, 789–92.
- Högberg, P., Nordgren, A. and Agren, G. I. (2002) Carbon allocation between tree root growth and root respiration in boreal pine forest. *Oecologia*, **132**, 579–81.
- Huggins, D. R., Buyanovsky, G. A., Wagner, G. H. *et al.* (1998) Soil organic C in the tallgrass prairie-derived region of the corn belt: effects of long-term crop management. *Soil and Tillage Research*, **47**, 219–34.
- Hunt, H. W. (1977) A simulation model for decomposition in grasslands. *Ecology*, **58**, 469–84.
- Hunt, H. W., Cole, C. V., Klein, D. A. and Coleman, D. C. (1977) A simulation model for the effect of predation on bacteria in continuous culture. *Microbial Ecology*, **3**, 259–78.
- IPCC (2001) *Climate Change 2001: The Scientific Basis*. Contribution of Working Group I to the Third Assessment Report of the Intergovernmental Panel on Climate Change. Cambridge: Cambridge University Press.
- Janssens, I. A., Kowalski, A. S., Longdoz, B. and Ceulemans, R. (2000) Assessing forest soil CO₂ efflux: an *in situ* comparison of four techniques. *Tree Physiology*, **20**, 23–32.
- Janssens, I. A., Lankreijer, H., Matteucci, G. *et al.* (2001) Productivity overshadows temperature in determining soil and ecosystem respiration across European forests. *Global Change Biology*, **7**, 269–78.
- Jenkinson, D. S. and Johnston, A. E. (1977) *Soil Organic Matter in the Hoosfield Continuous Barley Experiment*. Rothamsted Experimental station. Report no. part 2.
- Kimball, B. A. and Lemon, E. R. (1971) Air turbulence effects upon soil gas exchange. *Soil Science Society of America Proceedings*, **35**, 16–21.
- Kirschbaum, M. U. F. (2004) Soil respiration under prolonged soil warming: are rate reductions caused by acclimation or substrate loss? *Global Change Biology*, **10**, 1870–7.
- Knorr, W., Prentice, I. C., House, J. I. and Holland, E. A. (2005a) Long-term sensitivity of soil carbon turnover to warming. *Nature*, **433**, 298–433.
- Knorr, W., Prentice, I. C., House, J. I. and Holland, E. A. (2005b) On the available evidence for the temperature dependence of soil organic carbon. *Biogeosciences Discussions*, **2**, 749–55.
- Koch, G. W., Schulze, E. D., Percival, F., Mooney, H. A. and Chu, C. (1988) The nitrogen balance of *Raphanus sativus x raphanistrum* plants. II. Growth, nitrogen redistribution and photosynthesis under NO₃ deprivation. *Plant Cell and Environment*, **11**, 55.
- Kögel-Knabner, I., Guggenberger, G., Kleber, M. *et al.* (2008) Organo-mineral associations in temperate soils: integrating biology, mineralogy, and organic matter chemistry. *Journal of Plant Nutrition and Soil Science*, **171**, 61–82.
- Körschgens, M. (1996) Long-term datasets from Germany and Eastern Europe. In *Evaluation of Soil Organic Matter Models Using Existing, Long-term Datasets*, ed. D. S. Powlson, P. Smith and J. U. Smith. Vol. 38. NATO ASI Series I. Berlin: Springer, pp. 69–80.
- Kutsch, W. L. (1996) Untersuchung zur Bodenatmung zweier Ackerstandorte im Bereich der Bornhöveder Seenkette. *EcoSys, Beiträge zur Ökosystemforschung, Suppl.* **16**, 125.
- Kutsch, W. L. and Kappen, L. (1997) Aspects of carbon and nitrogen cycling in soils of the Bornhöved lake district. 2. Modelling the influence of temperature increase on soil respiration and organic carbon content in arable soils under different managements. *Biogeochemistry*, **39**, 207–24.
- Kutsch, W. L., Staack, A., Wötzel, J., Middelhoff, U. and Kappen, L. (2001) Field measurements of root respiration and total soil respiration in an alder forest. *New Phytologist*, **150**, 157–68.
- Lambers, H., Van Der Werf, A. and Konings, H. (1991) Respiratory patterns in roots in relation to their functioning. In *Plant Roots: The Hidden Half*, ed. Y. Waisel, A. Eshel and U. Kafkafi. New York: Marcel Dekker, pp. 229–64.
- Lambers, H., Chapin, F. S. I. and Pons, T. L. (1998) *Plant Physiological Ecology*. New York: Springer.

- Liski, J. and Westman, C. J. (1997) Carbon storage in forest soil of Finland I. Effect of thermoclimate. *Biogeochemistry*, **36**, 239–60.
- Liski, J., Ilvesniemi, H., Mäkelä, A. and Westman, K. J. (1999) CO₂ emissions from soil in response to climatic warming are overestimated: the decomposition of old soil organic matter is tolerant of temperature. *Ambio*, **28**, 171–4.
- Lohm, U., Larsson, K. and Nommik, H. (1984) Acidification and liming of coniferous forest soil: long-term effects on turnover rates of carbon and nitrogen during an incubation experiment. *Soil Biology and Biochemistry*, **16**, 343–6.
- Luckai, N. and Larocque, G. R. (2002) Challenges in the application of existing process-based models to predict the effect of climate change on C pools in forest ecosystems. *Climatic Change*, **55**, 39–60.
- Lundegårdh, H. (1924) *Der Kreislauf der Kohlensäure in der Natur. Ein Beitrag zur Pflanzenökologie und zur Landwirtschaftlichen Düngungslehre*. Jena: Gustav Fischer Verlag.
- Lundegårdh, H. (1927) Carbon dioxide evolution of soil and crop growth. *Soil Science*, **23**, 417–53.
- Luo, Y. Q., Wan, S. Q., Hui, D. F. and Wallace, L. L. (2001) Acclimatization of soil respiration to warming in a tall grass prairie. *Nature*, **413**, 622–5.
- Mai, H. and Fiedler, H. J. (1988) Microbiological characterization of different soil forms of a Gneiss Catena under deciduous forests. *Zentralblatt Für Mikrobiologie*, **143**, 73–82.
- Manfield, M., Whiteley, A. S., Griffiths, R. I. and Bailey, M. J. (2002) RNA stable isotope probing, a novel means of linking microbial community function to phylogeny. *Applied Environmental Microbiology*, **68**, 5367–73.
- McGill, W. B. (1996) Review and classification of ten soil organic matter (SOM) models. In *Evaluation of Soil Organic Matter Models Using Existing, Long-term Data-sets*, ed. D. S. Powlson, P. Smith and J. U. Smith. NATO ASI I38. Berlin: Springer-Verlag, pp. 111–33.
- McHale, P. J., Mitchell, M. J. and Bowles, F. P. (1998) Soil warming in a northern hardwood forest: trace gas fluxes and leaf litter decomposition. *Canadian Journal of Forest Research*, **28**, 1365–72.
- Melillo, J. M., Steudler, P. A., Aber, J. D. *et al.* (2002) Soil warming and carbon-cycle feedbacks to the climate system. *Science*, **298**, 2173–6.
- Moncrieff, J. B. and Fang, C. (1999) A model for soil CO₂ production and transport 2: application to a Florida *Pinus elliotte* plantation. *Agricultural and Forest Meteorology*, **95**, 237–56.
- Moyano, F. E., Kutsch, W. L. and Schulze, E.-D. (2007) Response of mycorrhizal, rhizosphere and soil basal respiration to temperature and photosynthesis in a barley field. *Soil Biology and Biochemistry*, **39**, 843–53.
- Nadelhoffer, K. J. and Raich, J. W. (1992) Fine root production estimates and belowground carbon allocation in forest ecosystems. *Ecology*, **73**, 1139–47.
- Nannipieri, P., Ascher, J., Ceccherini, M. T. *et al.* (2003) Microbial diversity and soil functions. *European Journal of Soil Science*, **54**, 655–70.
- Odum, E. P. (1969) The strategy of ecosystem development. *Science*, **164**, 262–70.
- Paul, E. A. and Clark, F. E. (1989) *Soil Microbiology and Biochemistry*. New York: Academic Press.
- Pendall, E., Bridgham, S., Hanson, P. J. *et al.* (2004) Below-ground process responses to elevated CO₂ and temperature: a discussion of observations, measurement methods, and models. *New Phytologist*, **162**, 311–22.
- Powlson, D. S., Smith, P., Coleman, K. *et al.* (1998) A European network of long-term sites for studies on soil organic matter. *Soil and Tillage Research*, **47**, 263–74.
- Prescott, C. E., Blevins, L. L. and Staley, C. (2004) Litter decomposition in British Columbia forests: controlling factors and influences of forestry activities. *Journal of Ecosystems and Management*, **5**, 45–57.
- Pumpanen, J., Kolari, P., Ilvesniemi, H. *et al.* (2004) Comparison of different chamber techniques for measuring soil CO₂ efflux. *Agricultural and Forest Meteorology*, **123**, 159–76.
- Raich, J. W. and Schlesinger, W. H. (1992) The global carbon-dioxide flux in soil respiration and its relationship to vegetation and climate. *Tellus Series B – Chemical and Physical Meteorology*, **44**, 81–99.
- Raich, J. W. and Tufekcioglu, A. (2000) Vegetation and soil respiration: correlations and controls. *Biogeochemistry*, **48**, 71–90.
- Reichstein, M., Rey, A., Freibauer, A. *et al.* (2003) Modeling temporal and large-scale spatial variability of soil respiration from soil water availability, temperature and vegetation productivity indices. *Global Biogeochemical Cycles*, **17**, 1104.
- Reichstein, M., Katterer, T., Andren, O. *et al.* (2005) Temperature sensitivity of decomposition in relation to soil organic matter pools: critique and outlook. *Biogeosciences*, **2**, 317–21.

- Ritz, K., Dighton, J. and Giller, K. (1994) *Beyond the Biomass*. Chichester: Wiley.
- Romell, L. G. (1922) Luftväxlingen i marken som ekologisk faktor. *Medd Seadens Shogsfarsösanstalt*, **19**.
- Schulze, W. X., Gleixner, G., Kaiser, K. *et al.* (2005) A proteomic fingerprint of dissolved organic carbon and of soil particles. *Oecologia*, **142**, 335–43.
- Simard, S. W., Perry, D. A., Jones, M. D. *et al.* (1997) Net transfer of carbon between ectomycorrhizal tree species in the field. *Nature*, **388**, 579–82.
- Singh, J. S. and Gupta, S. R. (1977) Plant decomposition and soil respiration in terrestrial ecosystems. *Botanical Review*, **43**, 449–528.
- Smith, P. (2004) How long before a change in soil organic carbon can be detected? *Global Change Biology*, **10**, 1878–83.
- Smith, P., Powlson, D. S., Smith, J. U. and Glendining, M. J. (1996) The GCTE SOMNET: a global network and database of soil organic matter models and long-term datasets. *Soil Use and Management*, **12**, 104.
- Smith, P., Powlson, D. S., Smith, J. U. and Elliott, E. T. (1997) Special issue: evaluation and comparison of soil organic matter models using datasets from seven long-term experiments – preface. *Geoderma*, **81**, 1–3.
- Staddon, P. L., Heinemeyer, A. and Fitter, A. H. (2002) Mycorrhizas and global environmental change: research at different scales. *Plant Soil*, **244**, 253–61.
- Stoklasa, J. and Ernest, A. (1922) Über den Ursprung, die Menge und die Bedeutung des Kohlendioxids im Boden. *Zentralblatt fuer Bakteriologie, Mikrobiologie und Parasitenkunde Abt II*, **14**, 732–6.
- Subke, J. A., Inglima, I. and Cotrufo, M. F. (2006) Trends and methodological impacts in soil CO₂ efflux partitioning: a meta-analytical review. *Global Change Biology*, **12**, 921–43.
- Takle, E. S., Massman, W. J., Brandle, J. R. *et al.* (2004) Influence of high-frequency ambient pressure pumping on carbon dioxide efflux from soil. *Agricultural and Forest Meteorology*, **124**, 193–206.
- Tansley, A. G. (1935) The use and abuse of vegetational concepts and terms. *Ecology*, **16**, 284–307.
- Thornley, J. H. M. and Cannell, M. G. R. (2001) Soil carbon storage response to temperature: an hypothesis. *Annals of Botany*, **87**, 591–8.
- Torn, M. S., Lapenis, A. G., Timofeev, A. *et al.* (2002) Organic carbon and carbon isotopes in modern and 100-year-old-soil archives of the Russian steppe. *Global Change Biology*, **8**, 941–53.
- Trumbore, S. (2006) Carbon respired by terrestrial ecosystems: recent progress and challenges. *Global Change Biology*, **12**, 141–53.
- van 't Hoff, J. H. (1898) *Lectures on Theoretical and Physical Chemistry. Part I. Chemical Dynamics*. London: Edward Arnold.
- van Bavel, C. H. M. (1951) A soil aeration theory based on diffusion. *Soil Science*, **72**, 33–46.
- van Bavel, C. H. M. (1952) Gaseous diffusion and porosity in porous media. *Soil Science*, **73**, 91–104.
- van Suchtelen, F. H. H. (1910) Über die Messung der Lebenstätigkeit der aerobiotischen Bakterien im Boden durch Kohlensäureproduktion. *Zentralblatt fuer Bakteriologie, Mikrobiologie und Parasitenkunde Abt II*, **28**, 45–89.
- Vance, E. D. and Chapin, F. S. (2001) Substrate limitations to microbial activity in taiga forest floors. *Soil Biology and Biochemistry*, **33**, 173–88.
- Wallman, P., Belyazid, S., Svensson, M. G. E. and Svedrup, H. (2004) DECOMP: a semi-mechanistic model of litter decomposition. *Environmental Modelling and Software*, **21**, 33–44.
- Walterscheidt, W. (1960) Die Bedeutung des Blasius-Segens für die Bodenfruchtbarkeit, dargestellt am Beispiel der Bodenatmung gesegneter und ungesegneter Äcker im Hochsauerland. *Schriftenreihe der Kath Landbewegung im Erzbistum Köln*, **52**, 132–8.
- Wilke, B. M. (1988) Effects of sodium selenite on microbial activity of mull, moder and mor soils. *Biology and Fertility of Soils*, **6**, 148–52.
- Wollny, E. (1880) Untersuchungen über den Kohlensäuregehalt der Bodenluft. *Die landwirtschaftlichen Versuchs-Stationen*, **25**, 373–93.

2 • Field measurements of soil respiration: principles and constraints, potentials and limitations of different methods

Jukka Pumpanen, Bernard Longdoz and Werner L. Kutsch

2.1 INTRODUCTION

Soil respiration is a major component in the carbon balance of terrestrial ecosystems and has been measured in the field for more than eight decades. In this chapter, we will describe the measurement of soil CO₂ efflux at the soil surface that can be considered as equivalent to soil CO₂ production when integrated over long time periods (week, month or season). At shorter time scales the transport of CO₂ may uncouple the soil CO₂ efflux from its production inside the soil. Different methods have been developed to measure this efflux. These methods can affect the object being measured by disturbing the biochemical processes involved in CO₂ production, the physical properties influencing CO₂ movement towards the soil surface, or by changing the environmental conditions in the soil. Therefore, soil respiration measurements in the field are one of the most difficult among the ecosystem flux measurements. So far, no single method has been established as the standard but comparisons, which give important indications on their accuracy, have been performed. The choice of the measurement methodology is not limited to that of a measurement system. The experimenter has to elaborate a protocol depending on the temporal and spatial scales studied. In this chapter, we will describe the most commonly used methodologies for measuring soil CO₂ efflux and present their history, principles and constraints (Section 2.2). In addition, we will present a number of major error sources associated with the different methods and the ways to avoid them (Section 2.3), describe a comparison between different systems (Section 2.4) and give recommendations for the measurement protocol (Section 2.5).

2.2 MEASUREMENT PRINCIPLES AND HISTORY OF TECHNICAL DEVELOPMENTS

Soil respiration chambers can be grouped in three categories based on their working principle. A schematic presentation of the working principle and flux calculation of different chamber types is presented in Fig. 2.1. In *closed chambers*, the CO₂ flux is determined from the concentration increase within the chamber's headspace during a known period of time (Fig. 2.1, upper part). Closed chambers can further be divided into two major categories: *closed dynamic chambers* (also known as non-steady-state flow-through chambers) and *closed static chambers* also known as non-steady-state non-flow-through chambers). In *open chambers* (also known as steady-state flow-through chambers) the CO₂ efflux is determined from the difference between CO₂ concentration at the inlet and outlet of the chamber (Fig. 2.1, lower panel).

The Swedish scientist Henrik Lundegårdh (1922; 1924; 1927) was the first to start with measurements of soil respiration in the field. Lundegårdh used a chamber ('respiration bell', Fig. 2.2) with a collar that was driven into the soil. Since there was no exchange with the surrounding air the system was coined a 'closed static' in the later systematic of the methods. The CO₂ concentration inside the respiration bell increased proportionally to the soil respiration. After 10 to 20 minutes Lundegårdh took small samples of air from the chamber, which were analyzed in a self-constructed 'apparatus for accurate analysis of the CO₂ concentration in the air'. This apparatus was based on the absorption of CO₂ by a mixture of KOH and Ba(OH)₂ and the

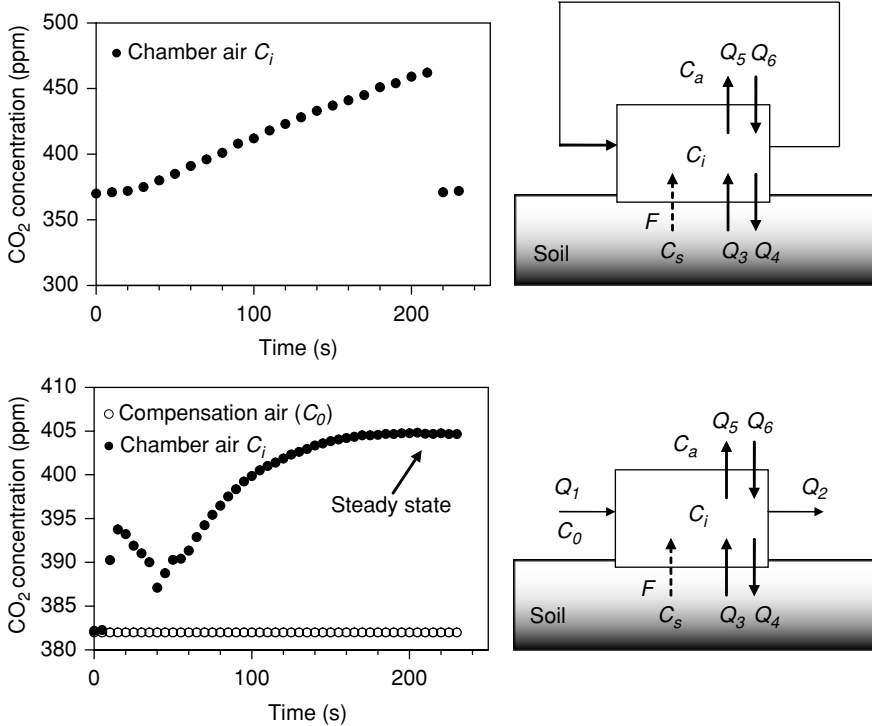

Figure 2.1 (Upper panel) In a closed chamber (dynamic or static) the CO_2 efflux rate can be calculated from the slope of the CO_2 concentration increase within the chamber (C_i). Similarly, possible air flows between the soil air space and the chamber (Q_3 and Q_4) as well as between the ambient air and the chamber (Q_5 and Q_6) can generate additional mass flow of CO_2 in and out of the chamber. When designing both chamber types, air flows of type Q_3 , Q_5 or Q_6 should be avoided. The CO_2 efflux from soil (F) can be determined using Eq. (2.1).

(Lower panel) The CO_2 concentration in an open chamber depends on CO_2 concentrations (C_0 and C_i) and flow rates of the incoming and outgoing air flows (Q_1 and Q_2), which should be equal to avoid pressure differences). In addition, possible air flows (Q_3 and Q_4) between the soil air space and the chamber as well as between the ambient air and the chamber (Q_5 and Q_6) can generate additional mass flow of CO_2 in and out of the chamber and should also be avoided. When a steady-state concentration in the chamber has been reached, the CO_2 efflux from soil (F) can be determined from the mass balance shown in Eq. (2.2).

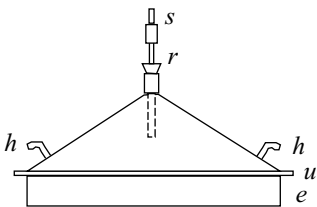

Figure 2.2 Lundegårdh's respiration bell.

measurement of the induced volume change. Between 1921 and 1925 Lundegårdh made a large number of soil respiration measurements combined with measurements of soil temperature, moisture, soil properties, manure and even CO_2 profiles in the soil as well as in

the lowest parts of the atmosphere. Thus, he was able to make a first analysis of the regulation of soil respiration by climatic and edaphic factors.

The introduction of the first 'open dynamic chamber' by Porkka (1931) was motivated by the observation that the increasing CO_2 concentration in the closed chamber could reduce the gradient that is driving the diffusive transport. He used a round chamber with an inlet at its top and analyzed the air sucked through this chamber by absorbing the CO_2 in $\text{Ba}(\text{OH})_2$ and titration thereafter. In parallel, he analyzed the air at 5 cm above the soil surface and calculated the soil respiration from the difference in the measured CO_2 concentration.

With Porkka's publication the never ending competition between open and closed systems was opened, and it is interesting to read that most of the important arguments were exchanged even during this early stage of the discussion and eternally repeated thereafter.

Closed chambers seal a certain area of the soil surface completely from the ambient air. They can be further distinguished after the way the CO₂ efflux is determined. In *closed static accumulation chambers*, the CO₂ coming from the soil accumulates inside. The CO₂ concentration increase is determined from air sampled with a syringe and analyzed separately with a CO₂ analyzer (in former times, as Lundegårdh (1927) did, by titration, or as nowadays with either an infrared gas analyzer or a gas chromatograph). Then, the soil efflux (F) in $\mu\text{mol m}^{-2}$ per unit of time (t) can be calculated from the increase of the CO₂ concentration within the chamber $\frac{\Delta C_i}{\Delta t}$, the chamber volume (V_c), the molar volume (V_{mol}) and the covered soil area (A):

$$F = \frac{\Delta C_i}{\Delta t} \cdot \frac{V_c}{V_{mol} \cdot A} \quad \text{Eq. (2.1)}$$

The V_{mol} corresponds to the molar volume $\text{m}^3 \text{mol}^{-1}$ (approx $22.4 \cdot 10^{-3} \text{ m}^3 \text{mol}^{-1}$ for ideal gas) and is thus equal to $8.314 \text{ J K}^{-1} \text{mol}^{-1} \cdot T_{\text{air}}/P_{\text{atm}}$.

Another application of the closed static system is the closed static *absorption method* that was introduced by Lundegårdh (1922). The CO₂ coming from the soil is usually trapped with chemicals such as NaOH or soda lime placed within the chamber. They can be used either as solutions, which are titrated thereafter, or as grains that are dried and weighed. Thus, the CO₂ concentration within the chamber remains relatively stable. The CO₂ efflux can be calculated from the amount of CO₂ bound in the trapping chemical. When soda lime is used for the trapping, the soil efflux measured has also to be corrected to account for the water release during the chemical reaction between CO₂ and soda lime (Edwards, 1982; Grogan, 1998; Janssens *et al.*, 2000). The advantage of the adsorption method over the accumulation method is that it can integrate over periods up to 24 hours and can easily be applied simultaneously at tens or hundreds of soil chambers (Haber, 1958; Janssens and Ceulemans, 1998). The last kind of closed system is the *dynamic* one, where the air circulates between the CO₂ analyzer and the chamber. At each passage through the chamber the soil efflux adds some CO₂ to the air and the CO₂ concentration increases

regularly. The soil efflux is then calculated using Eq. (2.1).

In *open* systems, ambient air is continuously sucked through the chamber. The CO₂ concentration within the chamber (Fig. 2.1) reaches steady-state (equilibrium) after a period of time. Then, the CO₂ flux from the soil into the chamber is balanced by the transport of CO₂ by the air stream through the chamber, and the soil respiration rate (F) is determined from the difference between the CO₂ concentration at the inlet and the outlet of the chamber ($\Delta\text{CO}_2 = C_i - C_o$ in Fig. 2.1, lower panel), the through-flow rate (Φ , $Q_i = Q_o$ in Fig. 2.1, lower panel) and the soil covered area (A):

$$F = \Delta\text{CO}_2 \cdot \frac{\Phi}{A} \quad \text{Eq. (2.2)}$$

However, open systems were not used very often, because they required a higher amount of samples to analyze and a facility to pump the air through the chamber (Porkka used a 12.6 L bottle of water that he slowly emptied). Therefore, the time of open systems did not dawn until about 20 years later when infrared gas analyzers (IRGA) and electrical membrane pumps became available. The first soil respiration system using an IRGA was an open system developed by H. Koepf (1953a). This first open dynamic system gave promising results (Koepf, 1953b, 1954), but was only useful for stationary measurements close to the laboratory, because the IRGA alone was 115 cm high and weighed about 50 kg. In addition, the system needed grid power.

Consequently, the closed 'Lundegårdh bell' remained the standard method for another 20 years, either in the original way with the extraction of an air sample after 10 to 20 minutes or with an amount of absorbent placed inside the chamber.

With the further development of electronics smaller IRGAs became available and more open systems were developed for field measurements (Witkamp, 1969; Witkamp and Frank, 1969; Edwards and Sollins, 1973; Edwards, 1974; Kanemasu *et al.*, 1974; Schwartzkopf, 1978). They enabled much more accurate and continuous measurements as close as possible to the natural conditions. A large variety of systems developed at different research institutions are based on the open chamber technique (Fang and Moncrieff, 1996; Kutsch, 1996; Iritz *et al.*, 1997; Kutsch and Kappen, 1997; Rayment and Jarvis, 1997; Fang and Moncrieff,



Figure 2.3 Open dynamic chamber systems from different manufacturers. PP-Systems CFX-1 at the back and ADC SRS-1000 in the small figure. Automatic closed dynamic system Li-Cor Li-8100 chamber at the front is based on closed dynamic technique.

1998; Longdoz *et al.*, 2000; Rayment, 2000; Kutsch *et al.*, 2001; Pumpanen *et al.*, 2001, 2004) Recently, commercial open systems have also become available (Fig. 2.3).

Closed systems were also further developed with the technical development in electronics that provided smaller and much better portable IRGAs. Modern ‘closed dynamic’ systems recycle the air from the chamber to the analyzer and back, and can monitor the increase in concentration continuously (Fig. 2.1, upper panel, right). In addition, they may scrub the increased CO₂ at the end of a measurement cycle by means of a soda lime column to start a new measurement automatically. Portability and short measuring times in closed dynamic chambers allow the measurement of a high number of frames or collars within a big area, and therefore the estimation of the heterogeneity of soil respiration. Most of the commercial systems are based on the closed dynamic chamber technique (LiCor, PP-systems, ADC, Figs. 2.3, 2.4 and 2.5) but also a lot of researchers went this way (Rochette *et al.*, 1992;

Goulden and Crill, 1997; Rochette *et al.*, 1997; Davidson *et al.*, 2002; Savage and Davidson, 2003).

Two more techniques are commonly used to determine soil respiration in the field: ground level eddy covariance (Norman *et al.*, 1992) and concentration gradients (Albertsen, 1979). The eddy covariance (EC) system is composed of a sonic anemometer and an infrared gas analyzer measuring respectively at the same point the three components of the wind speed and the CO₂ concentration at high frequency (10 Hz or more). With these measurements, it is possible to deduce the CO₂ vertical turbulent flux equal to the mean product of the fluctuations of the vertical wind speed and the CO₂ concentration. It can be demonstrated with fluid mechanic equations (Aubinet *et al.*, 2000) that, according to few assumptions, this vertical turbulent flux at any point above an ecosystem can be equal to the net quantity of CO₂ produced or absorbed by this ecosystem. The principal assumptions are the horizontal homogeneity of the ecosystem and a relatively high level of turbulence (high enough to neglect the transport of CO₂ by



Figure 2.4 Closed chamber systems from different manufacturers (a) PP-Systems SRC-1 closed dynamic chamber, (b) Vaisala GMP-343 CO₂ probe connected to a closed chamber made by Tunkua Oy, Finland. In the figure, a transparent chamber is being used for measuring photosynthesis of ground vegetation.

advection and the CO₂ storage between the measurement point and the soil). Eddy covariance systems are now frequently installed on towers above forests, grasslands and crops (Law *et al.*, 1999) to measure their net ecosystem exchange.

In several studies EC systems were mounted within the trunk space of forests to quantify the soil CO₂ efflux (Norman *et al.*, 1997; Kelliher *et al.*, 1999; Janssens *et al.*, 2001; Shibistova *et al.*, 2002). This is problematic because the presence of tree crowns prevents eddy penetration below the canopy to the measurement level. Thus, the turbulence characteristics close to the forest floor may lead to a bias in the measurements or can induce large time periods with turbulence being too low for a good functioning of the EC system. However, using data coming from forests with a relatively open canopy and, more particularly, selecting measurements performed during a windy period (data quality control routines exist), it might be possible to obtain interesting quantitative information on forest soil CO₂ efflux. The other difficulties introduced by the EC method are the determination of the footprint area and the impossibility to separate vegetation and soil signals, which implies that EC is not really applicable for soil CO₂ efflux measurements on vegetated surfaces. The most important

problem in forests with relatively open canopies, in crop lands and in grasslands is the presence of understorey and ground vegetation. An EC system installed at one or few metres height is then unable to separate the soil and ground vegetation contribution to the net flux. These restrictions reduce the possibilities of using ground level EC systems to measure soil CO₂ efflux, even if it minimizes disturbance at the soil surface and covers a larger area than chambers do.

Soil CO₂ effluxes can also be derived from CO₂ concentration gradients between soil and the atmosphere, and between different soil layers. Carbon dioxide concentration in the soil air space between soil particles is often an order of magnitude higher than in the atmosphere (Fernandez and Kosian, 1987; Suarez and Šimuněk, 1993), resulting in a large concentration gradient between the soil and the atmosphere. The primary mechanism for transporting CO₂ from the soil to the atmosphere is molecular diffusion (Freijer and Leffelaar, 1996). According to Fick's first law, the gas flux is dependent on the concentration gradient and the diffusivity of the soil. Thus the CO₂ flux in the soil is usually upwards, resulting in a CO₂ efflux out of the soil (Fig. 2.6). The diffusion of CO₂ depends essentially on the total porosity of soil layers, soil water

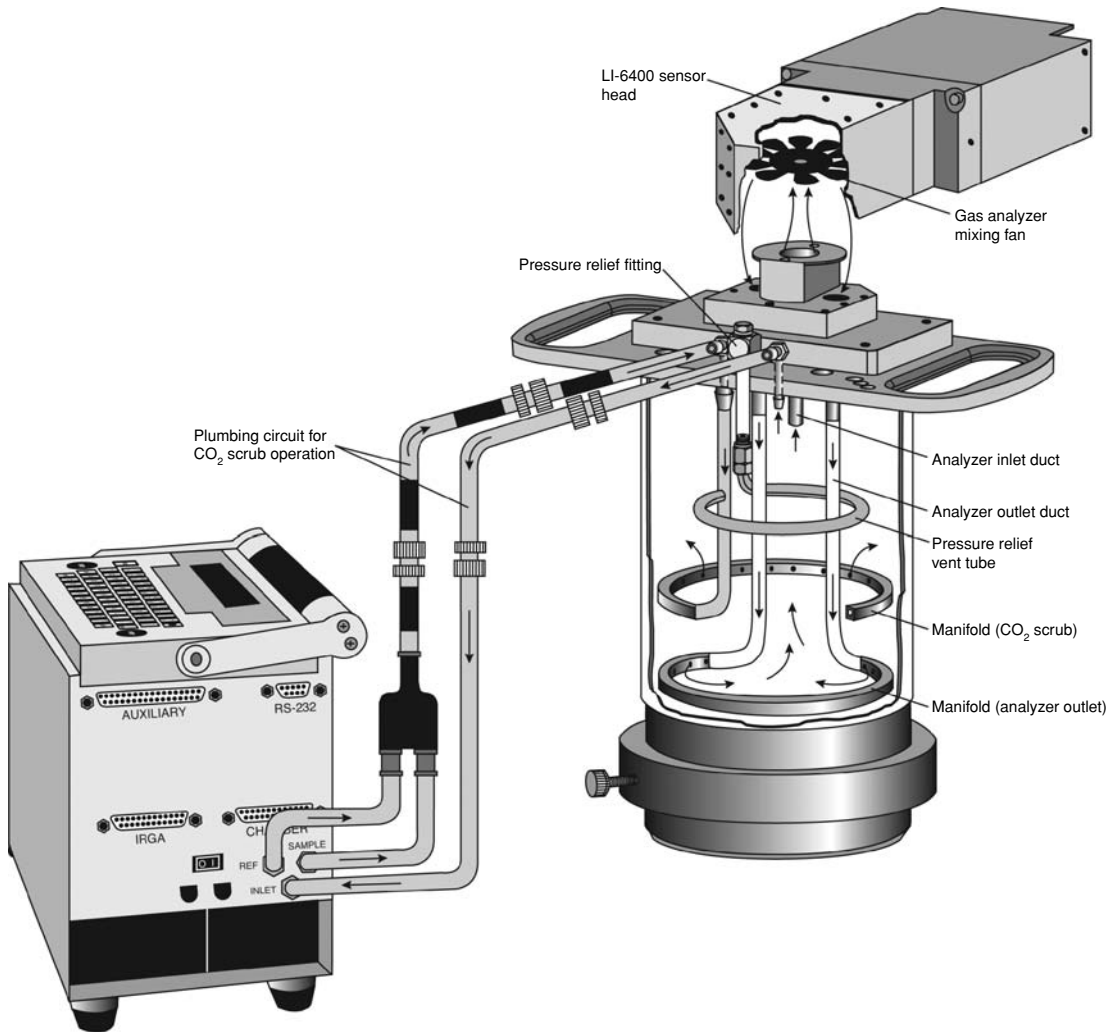

Figure 2.5 An example of the air circulation in a closed dynamic chamber (Li-Cor 6400–09). The air is pumped from the chamber to the IRGA and returned back to the chamber through a perforated manifold. The pressure equilibrium tube is located on top of the chamber (extract from Li-Cor 6400–09 Soil CO₂ flux chamber instruction manual, with the kind permission of Li-Cor Inc., Nebraska USA). In the PP-Systems chamber, the air is mixed by a fan installed in the upper part of the chamber.

content, layer thickness and the concentration gradient between the layers. Gradients of CO₂ concentration are difficult to convert into fluxes because the diffusivity of the soil is heterogeneous and also changes with soil moisture. Despite these difficulties, some studies have been conducted with this technique during recent years (Tang *et al.*, 2003; Pumpanen *et al.*, 2003a, 2003b; Jassal *et al.*, 2004; Tang *et al.*, 2005; Pihlatie *et al.*, 2007, Mykeebust *et al.*, 2008).

The next sections will provide more detailed information on the possible disturbances involved in the measurement systems and the ways to avoid them.

2.3 DISTURBANCES INTRODUCED BY THE MEASUREMENT SYSTEM

Systematic errors can be introduced into the flux measurement by disturbing the physical processes involved

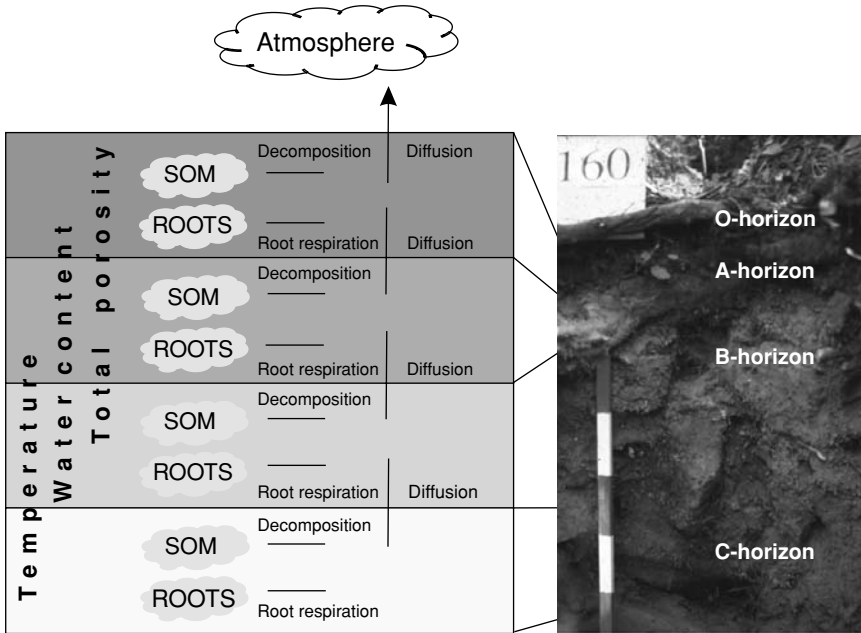

Figure 2.6 Schematic presentation of the soil profile and processes underlying soil CO₂ efflux.

in CO₂ movement within the soil or by modifying the biochemical processes involved in soil CO₂ production. This last disturbance can be induced directly or indirectly by changes in the soil environmental conditions. This section presents these disturbances and the ways to overcome them.

A chamber measurement system does not determine directly the soil CO₂ production but the soil CO₂ efflux. For long-term integration (month or season) these two fluxes can be considered as equivalent. The CO₂ is transported through the soil surface mainly by molecular diffusion but can also be driven by wind (advection or turbulence). Fang and Moncrieff (1999) as well as Lund *et al.* (1999) provide theoretical derivations and model formulations for these two ways of transport.

2.3.1 Vertical pressure gradient

In open and closed dynamic chamber systems the artificial air circulation generated by the pump can modify the air pressure just above the soil and thus perturb the vertical pressure gradient. Even a small pressure difference between the inside of the chamber and the atmosphere (PDC), as low as 1 Pa, has been shown to cause significant errors to the measured CO₂ efflux

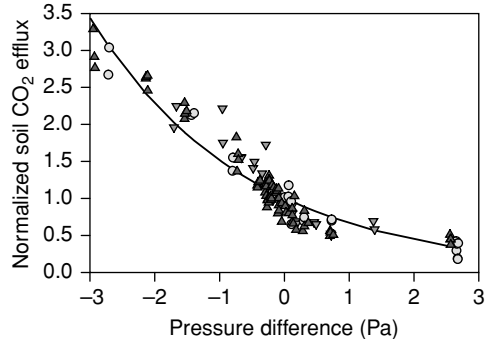

Figure 2.7 Effect of a constant pressure difference between the inside and the outside of the chamber (PDC) on soil CO₂ efflux in the forest of Vielsalm (Belgium). The flux is normalized by its value at PDC = 0 and negative PDC corresponds to a pressure in the chamber being lower than the atmospheric pressure.

(Kanemasu *et al.*, 1974; De Jong *et al.*, 1979; Fang and Moncrieff, 1996; Kutsch, 1996; Fang and Moncrieff, 1998; Lund *et al.*, 1999; Longdoz *et al.*, 2000; Kutsch *et al.*, 2001). Figure 2.7 shows an example of the dependence of soil CO₂ efflux on the PDC for the forest soil of Vielsalm in Belgium.

In a closed dynamic chamber, the reproduction of the natural vertical pressure gradient near the soil

surface is the main problem (Kanemasu *et al.*, 1974; De Jong *et al.*, 1979; Fang and Moncrieff, 1998). In these systems, pumps may create an overpressure or underpressure at its two faces. The air circulates from the overpressure face to the underpressure face along a pressure gradient. The pressure at any point is constant and depends only on its position in the circuit. Thus, the pressure in the chamber can be lower or higher than in the atmosphere. Underpressure generates an artificial mass flow of CO₂ from the soil into the chamber and leads to an overestimation of the efflux, whereas overpressure can block the natural CO₂ efflux from the soil leading to an underestimation (Norman *et al.*, 1992; Striegl *et al.*, 1992).

The CO₂ efflux is more sensitive to the suction of air than to a slight overpressure especially in a porous soil (Longdoz *et al.*, 2000; Pumpanen *et al.*, 2001). The mass flow of CO₂ from soil pores also increases with increasing pore space CO₂ concentration. Thus the impact of the PDC increases with the permeability and CO₂ productivity of the soil. To reduce the PDC, some chambers have a small hole with a tube connecting the inside and outside of the chamber and maintaining the pressure equilibrium. Unfortunately, this tube is not always sufficient to transmit the high-frequency atmospheric pressure fluctuations into the chamber, which can have a significant impact on the soil efflux measurement (Longdoz *et al.*, 2000; Pumpanen *et al.*, 2001; Takle *et al.*, 2004).

Another possible origin of PDC in closed dynamic chambers is the effect of the air mixing inside the chamber. In closed chambers, the determination of CO₂ efflux is based on the assumption that the concentration is homogeneous within the chamber's headspace (Fig. 2.1). In some commercial systems (e.g. Li-Cor), the air mixing is assured by extracting the sample air from the upper part of the chamber and by pushing air from the analyzer back into the chamber through a perforated manifold circulating around the chamber. In PP-systems SRC-1 chamber, the air is mixed by a fan installed on top of the chamber and inducing a vertical air flow in the chamber's headspace. Inevitably, the air mixing changes the natural turbulent conditions in the chamber. The perturbation provoked can be significantly reduced when small airflow is used or when the turbulence generated by the fan is reduced by placing a metal mesh between the fan and the soil surface. This latter option is used in the latest version of the

PP-systems soil respiration chamber. For all the closed chambers a measurement of the PDC value is recommended before starting measurements.

In open systems, pressure problems arise if the inlet size and through-flow are not balanced such that pressure differences occur, or if an open system does not only transmit but also modifies the natural pressure fluctuations due to an inappropriate design of the chamber inlet. For example, Kutsch *et al.* (2001) placed the inlet at one side of the chamber and thus caused an overpressure inside the chamber when the wind blew directly towards the inlet and an underpressure with all other wind directions. Therefore, the open chamber system has to be designed very carefully to avoid artificial underpressure or overpressure during the measurements.

Pump(s) can also induce PDC in open chamber systems (Rayment and Jarvis, 1997; Fang and Moncrieff, 1998) if the inlet and outlet airflow are not the same. Flow rate differences can be induced by the resistance at the inlet or outlet of the chamber. It may not be enough just to let the air be drawn into or out of the chamber. Even if the inlet and the outlet are large in diameter, there is always a small PDC as long as the air is only sucked into or out of the chamber. Preferably, an equal amount of compensating air should be fed into the chamber as is drawn out of the chamber. Separate pumps and mass flow controllers can be used to control the flow rates of air in and out of the chamber. Basically, this is the only way to avoid the pressure effect. However, in practice mass flow controllers can not reproduce the natural pressure fluctuation induced by the wind just above the soil surface. Nevertheless, at least systematic PDC caused by suction of air can be avoided by using separate pumps and mass flow controllers on both sides of the chamber. If it is not possible to organize separate pumps and mass flow controllers, it is of utmost importance to monitor the PDC to detect the possible pressure differences.

2.3.2 Vertical CO₂ concentration gradient

By contrast to the EC and gradient systems, all of the chamber systems can disturb the vertical CO₂ concentration gradient in different ways. They may modify the air CO₂ concentration in the chamber or disturb the soil CO₂ concentration by perturbing soil production directly or by changing the soil temperature or water

content (Healy *et al.*, 1996; Lund *et al.*, 1999). In absorption-based closed static chamber techniques, the CO₂ efflux is affected by two different mechanisms: by altered CO₂ concentration inside the chamber and by lack of turbulence. When soil respiration is high the CO₂ concentration inside the chamber and in the soil is high. At the same time, the lack of turbulence will have a large effect on the CO₂ efflux, because the only mechanism of CO₂ transport is then diffusion. This will create a severe underestimation. When the soil respiration is low, soda lime reduces CO₂ concentration inside chamber headspace, typically below ambient, and the resulting larger concentration gradient causes overestimation of fluxes. This overestimation is partly offset by the reduced turbulence, but this is much less important when soil respiration is low because soil CO₂ concentration is lower. These mechanisms can cause overestimation of low fluxes and underestimation of high fluxes (Janssens and Ceulemans, 1998).

In the closed static accumulation chamber, the CO₂ concentration can exceed that of the ambient air. This saturation effect changes the natural concentration gradient within the soil surface and may reduce significantly the CO₂ efflux (Nay *et al.*, 1994; Livingston and Hutchinson, 1995; Davidson *et al.*, 2002). So, this technique is known to underestimate the soil efflux (Janssens and Ceulemans, 1998).

In the closed dynamic system, the CO₂ concentration in the chamber rises by a few tens of ppm above atmospheric value during the measurement (over a few minutes). The saturation effect generated is smaller than that in the static accumulation system and can be further reduced by passing the chamber air through a CO₂ scrubber before the measurement record period. The perturbations of the concentration gradient can be minimized by starting the measurement just below and finishing just above the ambient CO₂ concentration. This CO₂ scrubbing technique is used, for example, in some Li-Cor chambers. The CO₂ concentration in the chamber's headspace is scrubbed down by a few tens of ppm below the ambient target concentration by pumping the air in the chamber through an absorber column. Then the CO₂ concentration is monitored as it rises above the target, and the CO₂ efflux is calculated from the rate of increase of CO₂ concentration at around the ambient concentration. With this technique, it is possible to avoid the effects of saturation on CO₂ diffusion from the soil to the chamber. A good

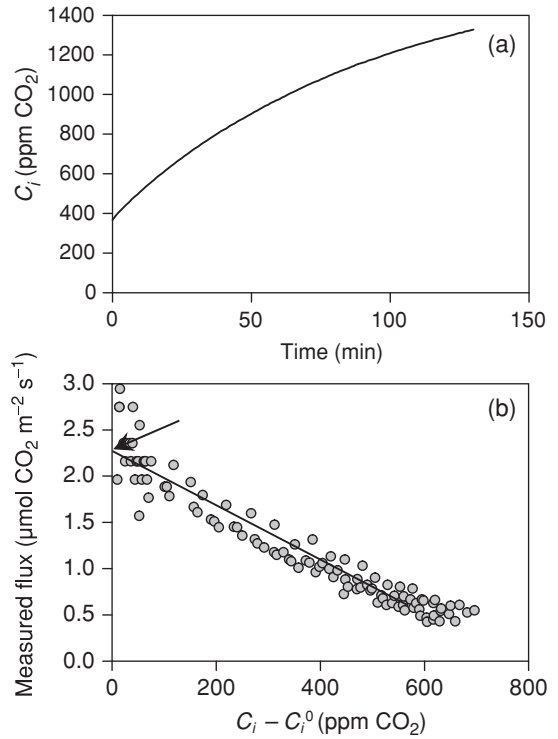

Figure 2.8 An example of the concentration development in a closed dynamic chamber (a) and the respective CO₂ efflux plotted against the CO₂ build-up within the chamber's headspace (b). The measured CO₂ efflux decreases along with increasing CO₂ concentration in the chamber due to the slow down in diffusion rate. The CO₂ efflux decreases rapidly at the beginning of the measurement period. A peak in the CO₂ efflux during the first minute or two of the measurement period may be due to pressure perturbations induced by the chamber or by the fan. After 1–2 minutes the CO₂ efflux decreases linearly in relation to the concentration change in the chamber. In this case, the disturbance at the beginning of the measurement period could be corrected by interpolating linearly to zero in Fig. (b). The actual CO₂ efflux from soil driven by diffusion is marked with an arrow.

indicator to see if saturation has a significant impact on the efflux is to detect the decrease in the slope of the time evolution of CO₂ concentration or a low r^2 -value in the linear fit on $\Delta C/\Delta t$ (Fig. 2.1). The decrease in time evolution of CO₂ concentration and soil CO₂ efflux is illustrated in Fig. 2.8. The saturation effect should be taken into account when designing the dimensions of a closed chamber and the length of the measurement period. The volume vs. surface-area ratio of the chamber determines its sensitivity. For example, if the

volume vs. surface-area ratio is low the system will detect even a small concentration increase and is thus applicable to measure small fluxes. However, in this case, the saturation of CO₂ concentration will take place faster, which is a problem at high CO₂ effluxes. Thus the volume vs. surface-area ratio should be designed bearing in mind the efflux range to be measured.

In the open dynamic system, the CO₂ concentration in the chamber is constant but slightly above the ambient one. To make sure that the impact of this on the efflux is negligible, a closed dynamic chamber can be used for comparison. The slope of the time evolution of CO₂ at the concentration recorded in the open system should be equal (very close) to the slope obtained at the ambient concentration (Longdoz *et al.*, 2000).

2.3.3 Horizontal wind

The EC and gradient methods are the only ones that do not disturb the natural horizontal wind. Chambers are unable to reproduce natural wind conditions. In closed-static chambers (Edwards, 1982; Crill, 1991) wind velocity is zero. The only mechanism of CO₂ transport is then diffusion. In dynamic-closed chambers and in open chambers wind velocity is determined by the airflow rate and by the chamber's design. Thus the boundary layer thickness and consequently the soil CO₂ efflux will be altered. To our knowledge, the separate effect of this perturbation has not been studied systematically to date (this effect is difficult to distinguish from the PDC perturbation). Recently, Bain *et al.* (2005) studied the effect of horizontal wind speed on the PDC and found that horizontal wind induced substantial error in the CO₂ efflux measurements also in closed dynamic chambers through the so-called 'Venturi effect', which was first reported by Conen and Smith (1998). In the Venturi effect, the wind movement around the vent of a closed chamber depressurizes the chamber by pulling air out of the chamber headspace resulting in a mass flow of soil gases from the porous soil into the chamber interior (Bain *et al.*, 2005). This effect was shown to be very significant. According to Conen and Smith (1998), a steady wind speed of 2 m s⁻¹ resulted in a 233% increase in measured soil emissions, and even in very calm conditions, with wind speed less than 1 m s⁻¹, systematic errors of 10 to 50% were discovered. Similar results were later confirmed by Bain *et al.* (2005). The wind direction and speed on the

soil surface usually fluctuates leading to unpredictable pressure variations inside the chamber. The Venturi effect and other anomalous pressure effects resulting from wind turbulence can be studied by testing the chamber vent and possible PDC by fast-response differential pressure sensor on a non-permeable plate and on different soil types and wind conditions. The pressure differences resulting from the Venturi effect may not be seen if the tests are conducted on a porous soil only, because the air flow through the porous soil into the chamber may compensate for the pressure loss in the chamber induced by the Venturi effect. Recently, Xu *et al.* (2006) suggested a new vent type for decreasing the Venturi effect in the chambers. The vent allows pressure inside the chamber to track pressure at the soil surface outside the chamber. The vent is designed so that it slows down the wind velocity within the vent such that the dynamic pressure changes induced by the wind are converted to static pressure, which the chamber equilibrates. They have tested this new vent design in field conditions with promising results.

2.3.4 Other effects

Usually chambers seal the soil surface either by pushing the chamber on or into the bare ground ('insertion method') or by placing the chamber on a collar penetrating the soil surface ('collar method'). This latter mode of chamber-soil contact assures airtight connection between the chamber and the soil, which is of advantage especially if the soil is porous and the measurement place is subjected to winds. Compared to the insertion of the chamber on the soil only, the collar has the advantage of reducing the risk of CO₂ leakage out of the chamber and facilitates repeated measurements on the same spot. However, the drawback of collars is that roots are cut during insertion into the soil (the trenching effect). Consequently, because roots contribute significantly to soil respiration (Hanson *et al.*, 2000), the soil CO₂ concentration and the efflux will be affected. To reduce the trenching effect, the collars should not be pushed down into the rooting zone. If this cannot be avoided, the collars should be left in place until the roots have re-grown inside the collar. The recovery of fine roots may take several years. Makkonen and Helmisaari (1999) studied fine-root biomass growth with root ingrowth core method in a boreal forest. The ingrowth cores were initially without root biomass and

no levelling off in the biomass growth was found during the first three growing seasons. If installed very deeply in the soil, the collars may produce a similar effect. However, most of the damage may be mitigated by flat collars that have spikes to keep the collar grounded but do not trench the whole root system.

Recent studies confirmed that the chamber–soil contact mode has a significant impact on the apparent soil respiration rates (Ngao *et al.*, 2006) with generally higher values obtained for the ‘insertion’ mode. Even if both chamber–soil contact modes have advantages and disadvantages, it can be concluded that the advantages of using a collar prevail. Therefore, the use of collars is recommended.

The heating of the chambers in the sun when the measurement time is long and the chamber is transparent can affect the temperature and water status of the ground vegetation and soil surface inside the chamber. The temperature can increase by up to 10 to 15 °C during chamber closure on a warm, sunny day. This may disturb the respiration rate and results in changes in the CO₂ concentration gradient. Therefore, a thermostatically controlled cooling system would be recommended, especially if the chamber is transparent and closed. Heating of the chambers in the sun should also be taken into consideration as a possible cause of pressure–gradient perturbation, especially when the measurement time is long and the chamber is transparent. The temperature increase results in a physical expansion of air inside the chamber, which may result in an overpressure blocking soil efflux and creating a mass flow of CO₂ out of the chamber through the equilibrium tube or through the soil.

2.4 COMPARISON OF THE EXISTING SYSTEMS AND RECOMMENDATIONS

Several recent studies compared the accuracy of different systems. Janssens *et al.* (2000) as well as Shibistova *et al.* (2002) found systematically lower values of soil respiration measured by ground level EC compared to chamber measurements. In the study by Janssens *et al.* (2000) this underestimation was correlated with photosynthetically active radiation (PAR), suggesting a confounding effect of the ground vegetation. Chamber comparisons were either conducted in the field by comparing the apparent fluxes at the same collars (Janssens *et al.*, 2000), by artificial systems with known fluxes

(Pumpanen *et al.*, 2004) or by a combination of both (Butnor *et al.*, 2005). The comparisons have indicated relative differences between chamber types (Raich *et al.*, 1990; Norman *et al.*, 1997; Janssens *et al.*, 2000; Pumpanen *et al.*, 2004) or showed chamber-specific limitations (Nay *et al.*, 1994; Fang and Moncrieff, 1998; Gao and Yates, 1998).

In most cases, closed dynamic and static chambers have been shown to give systematically lower values than open dynamic chambers – the difference ranging from 10% (Rayment, 2000) to 40–50% (Norman *et al.*, 1997; Pumpanen *et al.*, 2003a). However, in a recent study (Pumpanen *et al.*, 2004), the differences between chambers using different measurement principles seemed not to be consistent. When most of the currently available chamber systems were compared against known CO₂ effluxes generated by a calibration chamber in laboratory conditions, their reliability appeared to be independent of the measurement principle as such (Pumpanen *et al.*, 2004). Instead, the geometrical design of the chamber, the mixing of air inside the chamber and the collar model seemed to affect the measured CO₂ efflux more than the measurement principle. Even identical chambers with different collar designs showed highly variable results. However, the general trend seemed to be that closed static chambers underestimated CO₂ effluxes by 4 to 14%. No systematic differences were found between open dynamic chambers and closed dynamic chambers (Pumpanen *et al.*, 2004). An extract from the recent paper by Pumpanen *et al.* (2004) is presented in Table 2.1. In Table 2.2, we have listed the advantages and disadvantages of the major chamber systems. A standard chamber will hardly be available, because different ecosystems require different chamber designs. One technical solution may not be the best for all purposes. For example, a small chamber suitable for forest with abundance of stones and small shrub vegetation is probably not suitable for measuring grasslands. The only reasonable way to standardize various chamber systems is to compare them against known CO₂ effluxes.

In conclusion, the method used for measuring soil CO₂ efflux should be chosen based on the research conducted and the type of ecosystem (see Section 2.5). The chamber methods affect the flux being measured, but this error can be detected and corrected if the chambers are tested against known CO₂ effluxes. Reliable CO₂ efflux measurements can be carried out with open as

Table 2.1 (Extract from Pumpanen et al. (2004)). Correction factors for different chambers. Each chamber can be scaled to the reference flux obtained from the calibration tank by dividing the measured flux by the correction factor of a specific soil type.

Chamber type ^a	Coarse sand	95% confidence interval	Dry fine sand	95% confidence interval	Wet fine sand	95% confidence interval
NSF-1 (Licor 6400-09)	1.01	0.99–1.03	1.01	0.98–1.04	1.05	1.01–1.09
NSF-1b (Licor 6400-09)	1.13	1.07–1.18	1.09	0.98–1.19	1.09	1.04–1.14
NSF-2 (EGM-3 + SRC-1)	1.21	1.17–1.26	1.27	1.15–1.39	1.05	0.97–1.13
NSF-3 (EGM-3 + SRC-1 widened collar)	0.86	0.82–0.89	1.00	0.94–1.05	–	–
NSF-4 (EGM-1 + SRC-1 no collar)	1.03	1.01–1.06	1.19	1.14–1.24	0.94	0.86–1.03
NSF-5 (EGM-4 + SRC-1 mesh)	1.16	1.12–1.19	1.19	1.11–1.27	1.33	1.20–1.47
NSF-6 (University of Bayreuth)	0.96	0.91–1.02	0.89	0.86–0.92	0.96	0.87–1.06
NSF-7 (Finnish Meteorological Institute)	1.03	1.01–1.05	1.07	0.99–1.15	1.00	0.92–1.08
NSF-8 (Woodshole Research Center)	0.83	0.79–0.86	0.91	0.86–0.96	0.83	0.80–0.85
NSF-9 (Max Planck Institute)	0.81	0.79–0.83	0.80	0.79–0.82	0.79	0.77–0.80
NSF-10 (University of Helsinki)	1.01	0.96–1.05	1.19	1.14–1.23	1.04	0.96–1.13
NSF-11 (University of Helsinki)	1.00	0.96–1.03	0.85	0.81–0.87	0.87	0.84–0.89
NSF-12 (University of Helsinki)	–	–	1.13	1.08–1.18	0.93	0.87–0.99
NSF-Average	1.00	–	1.04	–	0.99	–
NSNF-1 (University of Joensuu)	0.98	0.95–1.01	0.94	0.89–0.98	0.85	0.81–0.88
NSNF-1 (University of Joensuu with extension)	0.95	0.86–1.05	0.98	0.92–1.03	0.85	0.75–0.94
NSNF-2 (Agrifood Research Finland, 10 min.)	0.96	0.91–1.01	0.96	0.76–1.15	0.95	0.84–1.06
NSNF-2 (Agrifood Research Finland, 30 min.)	0.85	0.79–0.90	0.85	0.71–0.98	0.90	0.80–1.00
NSNF-3 (University of Helsinki)	1.06	0.96–1.17	0.82	0.63–1.01	0.85	0.78–0.93
NSNF-4 (University of Helsinki)	–	–	0.65	0.56–0.74	0.84	0.81–0.87
NSNF-Average	0.96	–	0.86	–	0.87	–
SSFL-1 (University of Bayreuth)	1.03	1.01–1.05	0.96	0.92–1.01	1.09	1.02–1.15
SSFL-2 (University of Kiel)	1.05	0.99–1.11	1.08	1.01–1.15	0.95	0.80–1.09
SSFL-Average	1.04	–	1.02	–	1.02	–

^a NSF = non-steady-state flow-through chamber (closed dynamic chamber); NSNF = non-steady-state non-flow-through chamber (closed static accumulation chamber); SSFL = steady-state flow-through chamber (open dynamic chamber).

Table 2.2 *Benefits and drawbacks of different techniques.*

	Open dynamic	Closed dynamic	Closed static	Gradient	Eddy covariance
+	No build up of CO ₂ in the chamber	Easily commercially available	Easy to construct	Does not disturb the CO ₂ efflux	Does not disturb the CO ₂ efflux
+	Can be used for measuring photosynthesis	Small and practical to carry in the field	Low costs	Suits well for long-term monitoring	Suits well for long-term monitoring
+	No need for tall collars and therefore no trenching effect	Fast measurements	Can be used for spatial sampling	Maintenance free	
+		Can be used for measuring photosynthesis		Monitoring of below-ground dynamics of CO ₂	
-	Sensitive to pressure differences between the inside and outside of the chamber	Build up of CO ₂ in the chamber	Build up of CO ₂ in the chamber	Expensive, because it requires several CO ₂ sensors and water content measurements	Problems associated with the footprint area
-	Low mobility	Sensitive to turbulence inside the chamber	Long measurement time	Turbulent transport close to the soil surface is difficult to measure	Low accuracy in non-turbulent conditions under the tree canopy
-	Requires mass flow controllers (expensive)	Temperature warms up in the chamber if transparent	Low time resolution if used with CO ₂ trapping chemical	Sensitive to the concentration measurements	Advection problems on hill slope sites
-	Not easily available commercially	Trenching effect associated with the collars	Temperature dependency of trapping chemicals	Needs additional information on soil for determining the soil CO ₂	Cannot separate respiration and photosynthesis
-	May change the moisture conditions if the chamber persistently in the same location		Trenching effect associated with the collars	Diffusion coefficient in the soil is difficult to determine	Expensive and complicated technology
-				Disturbs the soil when installing the equipment	Low mobility

well as with closed dynamic chambers if the chamber is designed taking into account the following issues.

- Special attention should be paid to the mixing of air within the chamber, because it can be a major source of error. Excessive turbulence inside the chamber can cause over- or underpressure compared to natural ambient conditions, which can lead to artificial mass flow of CO₂ between soil and the chamber. This is particularly important when using closed dynamic chambers where the CO₂ concentration has to be evenly distributed within the chamber in order to calculate the flux correctly. The air mixing should be efficient enough to provide homogeneous CO₂ concentration within the chamber's headspace, but weak enough not to cause pressure anomalies.
- The headspace concentration inside the chamber affects the flux by altering the concentration gradient between the soil and the chamber, and therefore the chamber should be designed so that the increase in CO₂ concentration of the chamber headspace is as small as possible.
- Collars, which are the recommended chamber–soil contact method, should be designed for minimum disturbance of the root system. This can be solved in different ways either by using spikes or by a sufficient delay between collar insertion and measurement.

2.5 EXPERIMENTAL DESIGN

The experimental design of a measurement campaign depends on the space and time scales studied. The measurement system and protocol have to be adapted to the type of ecosystems in which the soil CO₂ efflux measurements are performed. In studies requiring continuous monitoring of soil CO₂ efflux over a long time period, the measurement technique should cause minimum disturbance on the soil. Unfortunately, most of the chamber techniques cannot fulfil this requirement. The eddy covariance technique would be an ideal method for long-term monitoring, because, unlike the chamber methods, it does not affect the processes underlying soil CO₂ effluxes. It is efficient for analyzing the time evolution with small time steps (half-hour) even over a long time period but only in open forests (Baldocchi and Vogel, 1996; Black *et al.*, 1996; Law *et al.*, 1999) and for an area of several square metres.

Another method causing relatively small disturbance of the measurement object is the gradient method. However, the use of this method is rather uncommon because the flux data are very sensitive to the soil diffusivity, a parameter that is difficult to determine, and to the accuracy of the CO₂ concentration measurements. The accuracy of this method is still debatable. However, on grasslands and in forests with dense ground vegetation it could be a good alternative, because EC and chambers do not dissociate ground vegetation exchange and soil CO₂ efflux. The gradient method is better suited for long-term monitoring of CO₂ effluxes from a relatively small surface area rather than for determining statistically representative flux estimates over a large area. This is because the soil diffusivity and soil air CO₂ concentration often vary at the small spatial scale and the equipment needed to capture this spatial variability would be rather expensive, especially if the area to be measured were heterogeneous. The gradient method is at its best when studying the CO₂ effluxes on a process level. The gradient measurement itself does not disturb the CO₂ efflux after the initial disturbance from the installation of the measurement devices. The devices should be installed in an undisturbed soil, by soil core removing, and should avoid as much as possible root cutting and modifications in the diffusion properties of the soil. However, at the same time, continuous vertical pathways from the CO₂ sensors to the soil surface should be avoided, because they change the hydraulic properties of the soil by providing a water passage from the soil surface to the sensor. In addition, the CO₂ diffusion along these vertical pathways may be faster than in the natural soil. This can result in erroneous CO₂ concentration measurements and consequently lead to biased CO₂ efflux estimates.

In view of the difficulties met by the gradient method (see above), the dynamic chamber systems (open or closed) appear to be the most adequate on vegetated soil. The open chamber measures with a high temporal resolution but has to fulfil some requirements before being applicable for long-term measurements. After a few days the soil conditions (temperature and water content) can be significantly affected by the perpetual presence of the chamber if the chamber top is not opened in between the measurements. If opened between the measurements, the open dynamic chamber needs some time to reach steady-state conditions. This equilibrium time depends on the flow rate and on

the CO₂ efflux. In addition, the surface area that can be sampled by the open chamber is small because one chamber covers only a few tens to hundreds of square centimetres and the scaling-up of the system is often expensive. Therefore, open chambers may not be the best in studies requiring good spatial coverage.

Spatial sampling is often carried out with portable chambers. The closed static chamber systems have largely been abandoned because of the systematic errors in this technique (the tendency to underestimate the efflux). For spatial sampling, manual or automated closed dynamic chambers may be a better option. Manual chambers can be moved from one collar to another by the experimenter. Because the measurement time is relatively short, he or she is able to collect data representing the efflux of up to one or more hectares in one day. In this condition, it is possible to integrate the spatial variability of an entire plot. However, this integration is done to the detriment of the temporal resolution of the measurement on the same spot. Temporal changes in soil respiration have to be taken into consideration when studying the spatial variation with manual chambers. Ideally, the temperature fluctuation during the spatial sampling should be as small as possible. The measurements carried out at different temperature conditions on different measurement collars cannot be used for averaging the efflux over the whole measurement plot, or at least the CO₂ efflux values measured from individual collars should be corrected for the difference in temperature. This in turn requires information on the temperature response of the individual collars.

Best results can probably be obtained by combining continuous monitoring of CO₂ efflux with automated chambers and spatial measurements with manual chambers. This way, it is possible to obtain both good temporal resolution and spatial representativeness. There are already automatic closed chambers available, which are attached to one collar at a time and measured at a chosen frequency. Then the short-term CO₂ evolution (half-hour) can be obtained over a long time period (season or even year) from a number of points depending on the financial resources. However, the representative area sampled cannot be as large as with a manual system.

The experimental design and the measurement protocol applied in individual studies is usually a trade-off between the technical and human resources available. It is the experimenter's task to plan the

measurements so that they, on the one hand, provide enough information on spatial variation for sound statistical analysis and, on the other hand, provide data with high enough temporal resolution for studying the processes underlying soil CO₂ efflux and all this with feasible costs. We hope that the issues discussed in this chapter will help the reader to solve this equation.

REFERENCES

- Albertsen, M. (1979) Carbon dioxide balance in the gas-filled part of the unsaturated zone, demonstrated at a Podzol. *Z Pflanz Bodenk*, **142**, 39–56.
- Aubinet, M., Grelle, A., Ibrom, A. *et al.* (2000) Estimates of the annual net carbon and water exchange of forests: the EUROFLUX methodology. *Advances in Ecological Research*, **30**, 113–75.
- Bain, W. G., Hutrya, L., Patterson, D. C. *et al.* (2005) Wind-induced error in the measurement of soil respiration using closed dynamic chambers. *Agricultural and Forest Meteorology*, **131**, 225–32.
- Baldocchi, D. D. and Vogel, C. A. (1996) Energy and CO₂ flux densities above and below a temperate broad-leaved forest and boreal pine forest. *Tree Physiology*, **16**, 5–16.
- Black, T. A., den Hartog, G., Neumann, H. H. *et al.* (1996) Annual cycles of water vapour and carbon dioxide fluxes in and above a boreal aspen forest. *Global Change Biology*, **2**, 219–29.
- Butnor, J. R., Johnsen, K. H. and Maier, C. A. (2005) Soil properties differently influence estimates of soil CO₂ efflux from three chamber-based measurement systems. *Biogeochemistry*, **73**, 283–301.
- Conen, F. and Smith, K. A. (1998) A re-examination of closed flux chamber methods for the measurement of trace gas emissions from soils to the atmosphere. *European Journal of Soil Science*, **49**, 701–7.
- Crill, P. M. (1991) Seasonal pattern cycles of methane uptake and carbon dioxide release by a temperate woodland soil. *Global Biogeochemistry*, **5**, 319–34.
- Davidson, E. A., Savage, K., Verchot, L. V. and Navarro, R. (2002) Minimizing artifacts and biases in chamber-based measurements of soil respiration. *Agricultural and Forest Meteorology*, **113**, 21–37.
- De Jong, E., Redmann, R. E. and Ripley, E. A. (1979) A comparison of methods to measure soil respiration. *Soil Science*, **127**, 300–6.
- Edwards, N. T. (1974) A moving chamber design for measuring soil respiration rates. *Oikos*, **25**, 97–101.

- Edwards, N. T. (1982) The use of soda-lime for measuring respiration rates in terrestrial ecosystems. *Pedobiologia*, **23**, 321–30.
- Edwards, N. T. and Sollins, P. (1973) Continuous measurements of carbon dioxide evolution from partitioned forest floor components. *Ecology*, **54**, 406–12.
- Fang, C. and Moncrieff, J. B. (1996) An improved dynamic chamber technique for measuring CO₂ efflux from the surface of soil. *Functional Ecology*, **10**, 297–305.
- Fang, C. and Moncrieff, J. B. (1998) An open-top chamber for measuring soil respiration and the influence of pressure difference on CO₂ efflux measurement. *Functional Ecology*, **12**, 319–25.
- Fang, C. and Moncrieff, J. B. (1999) A model for soil CO₂ production and transport I: Model development. *Agricultural and Forest Meteorology*, **95**, 225–36.
- Fernandez, I. J. and Kosian, P. A. (1987) Soil air carbon dioxide concentrations in a New England spruce-fir forest. *Soil Science Society of America Journal*, **51**, 261–3.
- Freijer, J. I. and Leffelaar, P. A. (1996) Adapted Fick's law applied to soil respiration. *Water Resources Research*, **32**, 791–800.
- Gao, F. and Yates, S. R. (1998) Laboratory study of closed and dynamic flux chambers: experimental results and implications for field application. *Journal of Geophysical Research*, **103**, 26115–25.
- Goulden, M. L. and Crill, P. M. (1997) Automated measurements of CO₂ exchange at the moss surface of a black spruce forest. *Tree Physiology*, **17**, 537–42.
- Grogan, P. (1998) CO₂ flux measurement using soda lime: correction for water formed during CO₂ adsorption. *Ecology*, **79**, 1467–8.
- Haber, W. (1958) Ökologische Untersuchung der Bodenatmung. Mit einer Übersicht über frühere Bearbeitungen, insbesondere deren Methoden. *Flora*, **146**, 109–57.
- Hanson, P. J., Edwards, N. T., Garten, C. T. and Andrews, J. A. (2000) Separating root and soil microbial contributions to soil respiration: a review of methods and observations. *Biogeochemistry*, **48**, 115–46.
- Healy, R. W., Striegl, R. G., Russell, T. F., Hutchinson, G. L. and Livingston, G. P. (1996) Numerical evaluation of static-chamber measurements of soil-atmosphere gas exchange: identification of physical processes. *Soil Science Society of America Journal*, **60**, 740–7.
- Iritz, Z., Lindroth, A. and Gärdenäs, A. (1997) Open ventilated chamber system for measurements of H₂O and CO₂ fluxes from the soil surface. *Soil Technology*, **10**, 169–84.
- Janssens, I. A. and Ceulemans, R. (1998) Spatial variability in forest soil CO₂ efflux assessed with a calibrated soda lime technique. *Ecology Letters*, **1**, 95–8.
- Janssens, I. A., Kowalski, A. S., Longdoz B. and Ceulemans, R. (2000) Assessing forest soil CO₂ efflux: an in situ comparison of four techniques. *Tree Physiology*, **20**, 23–32.
- Janssens, I. A., Kowalski, A. S. and Ceulemans, R. (2001) Forest floor CO₂ fluxes estimated by eddy covariance and chamber-based model. *Agricultural and Forest Meteorology*, **106**, 61–9.
- Jassal, R. S., Black, T. A., Drewitt, G. B. *et al.* (2004) A model of the production and transport of CO₂ in soil: predicting soil CO₂ concentrations and CO₂ efflux from a forest floor. *Agricultural and Forest Meteorology*, **124**, 219–36.
- Kanemasu, E. T., Powers, W. L. and Sij, J. W. (1974) Field chamber measurements of CO₂ efflux from soil surface. *Soil Science*, **118**, 233–7.
- Kelliher, F. M., Lloyd, J., Arneth, A. *et al.* (1999) Carbon dioxide efflux density from the floor of a central Siberian pine forest. *Agricultural and Forest Meteorology*, **94**, 217–32.
- Koepf, H. (1953a) Die Verwendung eines Ultrarotabsorptionsschreibers (URAS) für die kontinuierliche Registrierung der Bodenatmung im Freiland. *Landwirtschaftliche Forschung*, **5**, 54–62.
- Koepf, H. (1953b) Die Temperatur/Zeit – Abhängigkeit der Bodenatmung. Experimentelle Untersuchung unter Verwendung des Ultrarotabsorptionsschreibers (URAS). *Zeitung für Pflanzenernährung, Düngung, Bodenkunde*, **61**, 29–47.
- Koepf, H. (1954) Die biologische Aktivität des Bodens und ihre experimentelle Kennzeichnung. *Zeitung für Pflanzenernährung, Düngung, Bodenkunde*, **64**, 138–46.
- Kutsch, W. L. (1996) *Untersuchung zur Bodenatmung zweier Ackerstandorte im Bereich der Bornhöveder Seenkette*. EcoSys. Beiträge zur Ökosystemforschung, Vol. Suppl. 16. Kiel: Verein zur Förderung der Ökosystemforschung.
- Kutsch, W. L. and Kappen, L. (1997) Aspects of carbon and nitrogen cycling in soils of the Bornhöved lake district. 2. Modelling the influence of temperature increase on soil respiration and organic carbon content in arable soils under different managements. *Biogeochemistry*, **39**, 207–24.

- Kutsch, W. L., Staack, A., Wötzel, J., Middelhoff, U. and Kapfen, L. (2001) Field measurements of root respiration and total soil respiration in an alder forest. *New Phytologist*, **150**, 157–68.
- Law, B. E., Baldocchi, D. D. and Anthoni, P. M. (1999) Below-canopy and soil CO₂ fluxes in a ponderosa pine forest. *Agricultural and Forest Meteorology*, **94**, 171–88.
- Livingston, G. P. and Hutchinson, G. L. (1995) Enclosure-based measurement of trace gas exchange: applications and sources of error. In *Methods in Ecology, Biogenic Trace Gases: Measuring Emissions from Soil and Water*, ed. P. A. Matson and R. C. Harris. Cambridge: Blackwell Science, pp. 14–50.
- Longdoz, B., Yernaux, M. and Aubinet, M. (2000) Soil CO₂ efflux measurements in a mixed forest: impact of chamber disturbances, spatial variability and seasonal evolution. *Global Change Biology*, **6**, 907–17.
- Lund, C. P., Riley, W. J., Pierce, L. L. and Field, C. B. (1999) The effects of chamber pressurization on soil-surface CO₂ flux and the implications for NEE measurements under elevated CO₂. *Global Change Biology*, **5**, 269–81.
- Lundegårdh, H. (1922) Neue Apparate zur Analyse des Kohlensäuregehalts der Luft. *Biochem Z*, **131**, 109.
- Lundegårdh, H. (1924) *Der Kreislauf der Kohlensäure in der Natur. Ein Beitrag zur Pflanzenökologie und zur Landwirtschaftlichen Düngungslehre*. Jena: Verlag von Gustav Fischer.
- Lundegårdh, H. (1927) Carbon dioxide evolution of soil and crop growth. *Soil Science*, **23**, 417–53.
- Makkonen, K. and Helmisaari, H. S. (1999) Assessing fine-root biomass and production in a Scots pine stand: comparison of soil core and root ingrowth core methods. *Plant Soil*, **210**, 43–50.
- Mykeebust, M. C., Hippias, L. E. and Ryel, R. J. (2008) Comparison of eddy covariance, chamber, and gradient methods of measuring soil CO₂ efflux in an annual semi-arid grass, *Bromus tectorum*. *Agricultural and Forest Meteorology*, **148**, 1894–907.
- Nay, M. S., Mattson, K. G. and Bormann, B. T. (1994) Biases of chamber methods for measuring soil CO₂ efflux demonstrated with a laboratory apparatus. *Ecology*, **75**, 2460–3.
- Ngao, J., Longdoz, B., Perrin, D. *et al.* (2006) Cross-calibration functions for soil CO₂ efflux measurement systems. *Annals of Forest Science*, **63**, 477–84.
- Norman, J. M., Garcia, R. and Verma, S. B. (1992) Soil surface CO₂ fluxes and the carbon budget of a grassland. *Journal of Geophysical Research*, **97**, 18845–53.
- Norman, J. M., Kucharik, C. J., Gower, S. T. *et al.* (1997) A comparison of six methods for measuring soil-surface carbon dioxide fluxes. *Journal of Geophysical Research – Atmospheres*, **102**, 28771–7.
- Pihlatie, M., Pumpanen, J., Rinne, J. *et al.* (2007) Gas concentration driven fluxes of nitrous oxide and carbon dioxide in boreal forest soil. *Tellus Series B – Chemical and Physical Meteorology*, **59**, 458–69.
- Porkka, O. H. (1931) Über eine neue Methode zur Bestimmung der Bodenatmung. *Ann Soc Zool-Bot Fenn Yanamo*, **15**, 101–18.
- Pumpanen, J., Ilvesniemi, H., Keronen, P. *et al.* (2001) An open chamber system for measuring soil surface CO₂ efflux: analysis of error sources related to the chamber system. *Journal of Geophysical Research*, **106**, 7985–92.
- Pumpanen, J., Ilvesniemi, H., Peramaki, M. and Hari, P. (2003a) Seasonal patterns of soil CO₂ efflux and soil air CO₂ concentration in a Scots pine forest: comparison of two chamber techniques. *Global Change Biology*, **9**, 371–82.
- Pumpanen, J., Ilvesniemi, H. and Hari, P. (2003b) A process-based model for predicting soil carbon dioxide efflux and concentration. *Soil Science Society of America Journal*, **67**, 402–13.
- Pumpanen, J., Kolari, P., Ilvesniemi, H. *et al.* (2004) Comparison of different chamber techniques for measuring soil CO₂ efflux. *Agricultural and Forest Meteorology*, **123**, 159–76.
- Raich, J. W., Bowden, R. D. and Steudler, P. A. (1990) Comparison of two static chamber techniques for determining carbon dioxide efflux from forest soils. *Soil Science Society of America Journal*, **54**, 1754–7.
- Rayment, M. B. (2000) Closed chamber systems underestimate soil CO₂ efflux. *European Journal of Soil Science*, **51**, 107–10.
- Rayment, M. B. and Jarvis, P. G. (1997) An improved open chamber system for measuring soil CO₂ effluxes in the field. *Journal of Geophysical Research*, **102**, 28779–84.
- Rochette, P., Gregorich, E. G. and Desjardins, R. L. (1992) Comparison of static and dynamic closed chambers for measurement of soil respiration under field conditions. *Canadian Journal of Soil Science*, **72**, 605–9.

- Rochette, P., Ellert, B., Gregorich, E. G. *et al.* (1997) Description of a dynamic closed chamber for measuring soil respiration and its comparison with other techniques. *Canadian Journal of Soil Science*, **77**, 195–203.
- Savage, K. E. and Davidson, E. A. (2003) A comparison of manual and automated systems for soil CO₂ flux measurements: trade-offs between spatial and temporal resolution. *Journal of Experimental Botany*, **54**, 891–9.
- Schwartzkopf, S. H. (1978) An open chamber technique for the measurement of carbon dioxide evolution from soils. *Ecology*, **59**, 1062–8.
- Shibistova, O., Lloyd, J., Zrazhevskaya, G. *et al.* (2002) Annual ecosystem respiration budget for a *Pinus sylvestris* stand in central Siberia. *Tellus Series B*, **54**, 568–89.
- Striegl, R. G., McConnaughey, T. A., Thorstenson, D. C., Weeks, E. P. and Woodward, J. C. (1992) Consumption of atmospheric methane by desert soils. *Nature*, **337**, 145–7.
- Suarez, D. L. and Šimunek, J. (1993) Modeling of carbon dioxide transport and production in soil 2. Parameter selection, sensitivity analysis and comparison of model predictions to field data. *Water Resources Research*, **29**, 499–513.
- Take, E. S., Massman, W. J., Brandle, J. R. *et al.* (2004) Influence of high-frequency ambient pressure pumping on carbon dioxide efflux from soil. *Agricultural and Forest Meteorology*, **124**, 193–206.
- Tang, J., Misson, L., Gershenson, A., Cheng, W. and Goldstein, A. H. (2005) Continuous measurements of soil respiration with and without roots in a ponderosa pine plantation in the Sierra Nevada Mountains. *Agricultural and Forest Meteorology*, **132**, 212–27.
- Tang, J. W., Baldocchi, D. D., Qi, Y. and Xu, L. K. (2003) Assessing soil CO₂ efflux using continuous measurements of CO₂ profiles in soils with small solid-state sensors. *Agricultural and Forest Meteorology*, **118**, 207–20.
- Witkamp, M. (1969) Cycles of temperature and carbon dioxide evolution from litter and soil. *Ecology*, **50**, 922–4.
- Witkamp, M. and Frank, M. L. (1969) Evolution of CO₂ from litter, humus, and subsoil of a pine stand. *Pedobiologia*, **9**, 358–65.
- Xu, L., Furtaw, M. D., Madsen, R. A. *et al.* (2006) On maintaining pressure equilibrium between a soil CO₂ flux chamber and the ambient air. *Journal of Geophysical Research*, **111**, D08S10, doi:10.1029/2005JD006435.

3 • Experimental design: scaling up in time and space, and its statistical considerations

Jens-Arne Subke, Andreas Heinemeyer and Markus Reichstein

3.1 INTRODUCTION

Accurate measurement of the soil CO₂ efflux is critical for the assessment of the carbon budget of terrestrial ecosystems, since it is the main pathway for assimilated carbon to return to the atmosphere, and only small changes in the soil CO₂ efflux rate might have important implications on the net ecosystem carbon balance. Due to this central role in the terrestrial carbon cycle, soil CO₂ efflux has been measured throughout all biomes, and covering all principal vegetation types. Using simplified regressions of soil CO₂ efflux measurements reported in the scientific literature, the total amount of carbon emitted as CO₂ by soils worldwide has been estimated at approximately 68–80 Pg (1995; Raich *et al.*, 2002), representing the second largest carbon flux between ecosystems and the atmosphere. This amount is more than ten times the current rate of fossil fuel combustion and indicates that each year around 10% of the atmosphere's CO₂ cycles through the soil (Prentice *et al.*, 2001). Thus, even a small change in soil respiration could significantly intensify, or mitigate, current atmospheric increases of CO₂, with potential feedbacks to climate change. In fact, soils store more than twice as much carbon globally than the atmosphere (Bolin, 2000) and consequently contain a large long-term potential for the carbon cycle climate feedback. Applying results from small-scale experiments to larger areas is necessary in order to understand the potential role of soils in sequestering or releasing carbon under changed climatic conditions, and to inform management and policy makers about likely consequences of land-use changes on carbon fluxes and stocks in specific regions. As in the example of the global estimate mentioned above, there is inevitably a need to estimate the soil CO₂ efflux over vast areas that it is impossible to cover appropriately by actual measurements, and for time scales beyond

the scope of measured data, particularly where future predictions are required.

Scaling up from sparse and infrequent measurements to the level of, for example, catchment, region or even continental or global scales, bears a considerable degree of uncertainty, making such extrapolations difficult. The scope of this chapter is to introduce a range of requirements that are critical to facilitate meaningful extrapolation of results observed on small scales to allow making estimates of soil CO₂ efflux over larger areas and longer time scales. The aim is to provide a general overview in order to enable the reader to design a suitable measuring strategy towards such extrapolations, mainly at the plot and landscape scale.

Measuring techniques can be broadly divided into (1) chamber-based, (2) soil profile and (3) eddy covariance approaches. Chamber-based measurements provide by far the majority of published results, and the general considerations of heterogeneity are valid for all measuring approaches. We therefore concentrate on chamber-based measurements to illustrate experimental designs for dealing with natural variations in soil CO₂ efflux. Soil profile methods allow a vertical resolution of the origin of surface flux contributions, thus providing critical insight into carbon allocation within soils by roots and contributions to the heterotrophic flux component for different soil depths. However, soil profiles inherently create considerable disturbance both during installation and sampling (Fang and Moncrieff, 1998) and are difficult to replicate within plots. For successful applications of this technique, please refer to Tang *et al.* (2003), Liang *et al.* (2004) and Davidson *et al.* (2006). Eddy covariance has been applied to measure soil surface CO₂ flux with some success (see e.g. Law *et al.*, 1999; Janssens *et al.*, 2000; Wilson and Meyers, 2001; Subke and Tenhunen, 2004). This technique has the

advantage of causing no disturbance to the soil, but it is restricted to conditions of sufficient atmospheric turbulence, and homogeneity of the surface in the up-wind fetch. However, eddy covariance is much less suited for measuring under a closed forest canopy or in complex terrains.

Although laboratory incubations are important in addressing certain hypotheses (e.g. temperature sensitivity of the heterotrophic component), this chapter does not provide in-depth detail on this topic but concentrates on the relative strengths and limitations of some laboratory-based approaches in the context of flux measurements. References given in that section (and those by Reichstein and Janssens in [Chapter 11](#) of this book) are intended to guide the reader to look up individual studies on technical issues. Soil CO₂ efflux measuring equipment and auxiliary measurements at experimental sites have been addressed in the previous chapter, and the actual methods of scaling and interpreting soil efflux observations with models from laboratory to global scales are covered in [Chapter 11](#). Here we point out some further measurement considerations in relation to capturing temporal variability accurately. Finally, we provide a logical framework of how to design and perform statistically sound experiments for testing hypotheses.

3.2 SPATIAL AND TEMPORAL VARIABILITY

3.2.1 Sources of variability

Soil CO₂ efflux is the sum of respiratory activity from a variety of sources. Mineralization of carbon from both fresh litter and older soil organic matter (SOM) through soil-dwelling animals, fungi and bacteria comprise the heterotrophic flux contributions. The separation of this flux from autotrophic sources is ambiguous (see Moyano *et al.*, [Chapter 7](#)), as definitions in the literature differ according to a classification by the source of carbon being respired and the fraction of soil biota in which respiration actually occurs. Growth and maintenance respiration by plant roots represents the true respiration by autotrophs, but mineralization of carbon contained in compounds secreted by living roots (exudations, mucilage or sloughed root cap cells) by soil bacteria or fungi form a grey area in the categorization of flux origin (see e.g. Kuzyakov, 2006a, b and

Högberg *et al.*, 2006 for a recent debate on the issue of separating these flux contributions). For the purpose of this chapter, we consider the portion of soil CO₂ efflux caused by the input of carbon from roots as autotrophic respiration. It therefore includes respiration by mycorrhizal fungi, which obtain substrate for their metabolism nearly exclusively from their hosts' roots, and that of all other soil microbes metabolizing recent plant-derived carbon (such as usage of root exudates). In addition to these biotic flux sources, soils may have a varying degree of inorganic fluxes through the weathering of carbonates contained in soil and underlying geology.

Soils form over periods of hundreds to thousands of years, and their structure and carbon content is mainly a result of the geologic parent material (e.g. bed-rock of varying weatherability, or mineral deposits such as sands or clays), geomorphological conditions (e.g. slope and aspect of the soil surface), local climate and vegetation cover (Jenny, 1980). It is important to note that in particular climate and vegetation cover are not constant site factors but may vary considerably during pedogenesis. Thus organic carbon within the soil represents a mixture of ages, ranging from very recently fixed litter carbon to humified materials literally thousands of years old. This mixture represents not only present site conditions but also a long legacy of previous biotic and abiotic influences. Physical structure and chemical composition of the soil is therefore also linked to the diversity of organisms to which the soil has been a habitat over these periods, with significant implications for the physical distribution of organic matter and cycling of nutrients, which in turn impacts on the vegetation cover above ground (see Chapters 9 and 10).

Consequently, in a physically complex structure such as soil, sources of carbon substrates (for all types of respiration) are not distributed homogeneously, and their availability at any given place may also change with time. Nunan *et al.* (2002) observed different spatial structures in the distribution of soil microbes, which were closely linked to pore space within the soil. While topsoil distributions showed a pattern on the micrometre scale, in the subsoil an additional but separate centimetre to metre scale could be observed.

The abiotic soil environment (e.g. soil temperature, water content, CO₂ and O₂ concentrations) strongly influences the rate at which CO₂ mineralization from different sources occurs. In the literature most attention has been attributed towards soil temperature and

moisture as they impact strongly on both autotrophic and heterotrophic activity. For example, soil temperature fluctuation at the soil surface propagates into soil depths both with dampened amplitude and increasing time lag, which has to be considered if a significant portion of the surface CO₂ efflux originates from a lower soil depth (see also Chapter 11). Soil surface temperature fluctuations are, in turn, strongly dependent on vegetation cover and its exposure throughout daily and seasonal cycles. Irregular canopies, for example, result in considerable differences of incident light at ground level with potentially significant consequences for soil temperatures. Soil moisture conditions may also differ at a small scale, as canopy throughfall often consistently differs in space due to canopy structure or patchiness of ground vegetation cover. Under well developed regular canopies with high leaf area index (LAI) values, by contrast, soil temperature and moisture are likely to be more homogeneous, so that differences in soil CO₂ efflux are likely to be smaller.

There are, however, other important biotic factors, which, although mostly overlooked, should be considered when measuring and modelling soil CO₂ efflux, such as the distribution of live roots and soil fungi, both showing considerable spatial and temporal variations at the plot scale. Root density is affected by soil structure (e.g. bulk density and rock content) and soil depth, and the distribution of nutrients and water availability at the site. Furthermore, mycorrhizal fungal hyphae are important structures for the bidirectional translocation of nutrients from local patches ('hot spots') to roots, and of carbon from the host plant to the fungus for its growth and metabolic requirements (Smith and Read, 1997). Naturally, this flow of carbon from plants to symbiotic fungi is directly linked to the rate of assimilation by the canopy, and as such will show seasonality due to canopy phenological changes. Therefore, the degree to which biotic conditions differ within a site is strongly dependent on local abiotic conditions, small-scale topography and site management history. It is also important to consider the degree of heterogeneity throughout the phenological cycle, as a single area survey may not capture the variation of this biotic flux contribution accurately. As the autotrophic flux component of the biotic flux might be largely independent of the commonly observed changes in soil temperature, due to temperature acclimation of root respiration (Atkin *et al.*, 2000) or mycorrhizal hyphae (Heinemeyer

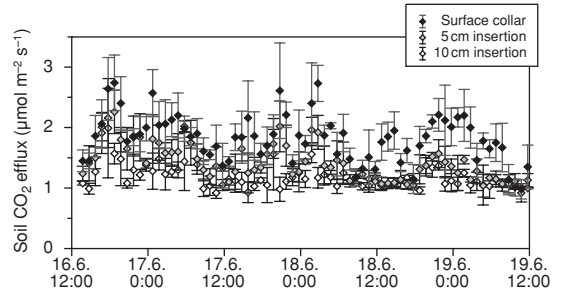

Figure 3.1 Diurnal variation in mean hourly soil CO₂ efflux measured in a 15-year-old temperate pine forest (Heinemeyer *et al.*, unpublished) using different collar insertion depths of 0 cm (surface collar, black), 5 cm (grey) and 12 cm (white). Soil respiration was measured with a multiplexed long-term monitoring system (Li-Cor 8100, Li-Cor, Nebraska). Collar insertion depth is measured from the litter surface and therefore includes the O₁, O_f layer of about 2 cm. Symbols indicate hourly mean fluxes with error bars of 1 SE (n = 3) over the period of four consecutive days during summer 2006, one week after collar insertion.

et al., 2006, 2007), it might be necessary to monitor additional factors such as plant phenology and root activity for accurate up-scaling procedures. In fact, the role of the autotrophic flux component may have been largely underestimated in the past as soil collar insertion even of only a few centimetres might have cut off a large fraction of the autotrophic carbon supply to fine roots (as shown by Wang *et al.*, 2005) and their associated mycorrhizal hyphae, predominantly living in the top organic rich soil layers. Figure 3.1 shows a reduction in measured surface CO₂ flux with increasing soil collar insertion depth in a 15-year-old pine plantation without any ground vegetation. A considerable loss of respired CO₂ could be observed for the relatively shallow depth of 5 cm (which includes 2 cm of the surface litter layer), and also appears to reduce diurnal variations and overall variation between replicates (i.e. standard error). The shown flux reductions were still maintained six months after the collar insertion (data not shown). Figure 3.1 therefore clearly shows that where soil CO₂ efflux is measured from soil collars, these should be as shallow as possible. It also indicates that the commonly employed 'good practice' of measuring fluxes from collars installed at least 24 hours before measurements is not sufficient to allow natural efflux conditions to re-establish. Good seals with the soil surface can generally be achieved with

Table 3.1 Coefficients of variation (CV) for spatial variation within forested sites reported for different ecosystems.

	CV	Reference	Comments
Boreal forest	18–45%	Pumpanen <i>et al.</i> (2003)	CV found to increase with magnitude of CO ₂ efflux
Boreal forest	87%	Rayment and Jarvis (2000)	
Temperate hardwood	30%	Davidson <i>et al.</i> (2002)	
Temperate coniferous	28%	Yim <i>et al.</i> (2003)	<i>Larix</i> plantation
Temperate coniferous	40%	Buchmann (2000)	CV of peak rates in four <i>Picea</i> stands of different ages
Temperate coniferous	42%	Subke <i>et al.</i> (2003)	Measured in one of the stands covered by Buchmann (2000)
Mediterranean deciduous	40%	Tedeschi <i>et al.</i> (2006)	Oak coppice
Tropical forest	30%	Davidson <i>et al.</i> (2002)	
Tropical pasture	30%	Davidson <i>et al.</i> (2002)	

quite shallow collar insertions. Where this is not possible (e.g. in the absence of a humus layer with relatively brittle mineral soil exposed at the surface), fine roots are likely to be less concentrated in the top soil layer.

3.2.2 Coping with variability

3.2.2.1 Spatial variability

The previously described sources of biotic and abiotic drivers of soil CO₂ efflux result in the naturally observed spatial soil CO₂ efflux variations. Sites that have experienced recent physical disturbance and have a poorly developed canopy are likely to have significantly more variability than mature stands, while agricultural sites where soils have been homogenized, for example by ploughing, will show a lesser extent of variability. Table 3.1 lists the coefficient of variation (CV = standard deviation/mean soil CO₂ efflux) as a measure of the variability between sampling points in a range of ecosystem types reported in the literature.

Values for the CV of around 40% are commonly observed, and the number of sampling locations required to produce a reliable estimate of the actual soil CO₂ efflux value is directly dependent on the degree of variability at a given site. Once the degree of variability within a stand has been established, the number of sampling points (n) that will produce an estimate within a desired range of the true value for a given probability level is $n = \left[\frac{z_{\alpha/2} \sigma}{D} \right]^2$, where $z_{\alpha/2}$ is the critical z-value that is at the vertical boundary for the area of $\alpha/2$ in the

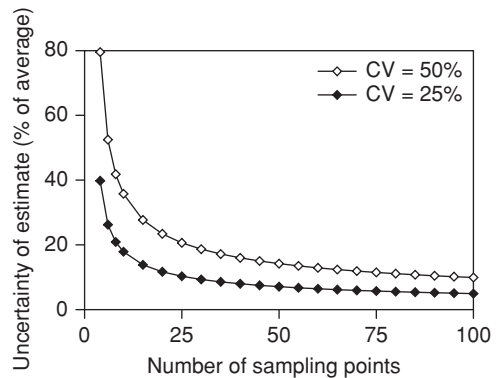

Figure 3.2 Effect of the number of sampling points within a stand on the uncertainty of a spatially averaged soil CO₂ efflux for a confidence level of 0.05. The degree of uncertainty shows a steep decline as the number of sampling points increases to about 20, and increases directly with the magnitude of the coefficient of variation (CV).

right tail of the standard normal distribution, σ is the standard deviation and D is the desired range of the true efflux value (e.g. 20%). Figure 3.2 illustrates the effect of both the number of sampling points and CV on the degree of uncertainty in a spatially averaged flux, based on this relationship.

Two studies applying this analysis to extensive datasets (mixed temperate hardwood forest by Davidson *et al.* (2002), and *Larix* plantation by Yim *et al.* (2003)) showed that for a CV of *c.* 30%, 8 to 10 sampling points are required to reach 20% of the true site CO₂

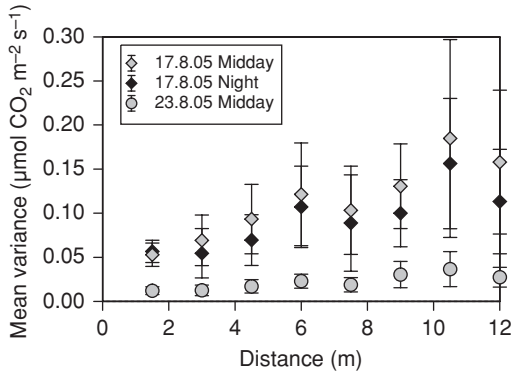

Figure 3.3 Effect of sampling distance on mean soil CO₂ efflux ($\mu\text{mol m}^{-2} \text{s}^{-1}$) at a UK heather moorland site (Heinemeyer *et al.*, unpublished). Mean variances are based on soil respiration measured from eight locations with 1.5 m spacing using a Li-Cor 8100 system (measured on 20 cm deep PVC collars; error bars indicate standard errors for the calculated variances). The three symbols reflect three different measurement periods in August 2005: two during the 17th (dry and warm) and one on the 23rd (wet and cold). Note the reduced variance due to very low fluxes after waterlogging on the 23 August.

efflux at a 95% confidence level, while 30 to 40 sampling points are required for estimates to be within 10% of the site mean at the same level of confidence. Another commonly overlooked issue is the spatial autocorrelation, i.e. the closer the flux sampling points to each other, the more similar are the expected soil CO₂ effluxes. This behaviour can be analyzed by geostatistical variogram analysis (Cressie, 1993) and should be accounted for in the sampling design by placing sampling points far enough from each other to guarantee statistical independence and to avoid pseudo-replication (Hurlbert, 1984). Figure 3.3 illustrates the degree of spatial heterogeneity at a moorland flux site in England (Malham Tarn) where soil CO₂ efflux has been measured along a transect with regular collar spacing of 1.5 m. The mean variance for a given collar distance (i.e. multiples of 1.5 m in this case) can be calculated according to: $\gamma(d) = \frac{1}{2n} \sum (R_x - R_y)^2$, where γ is the mean variance (i.e. a measure of the similarity) between collars, d is the distance between collars, n is the number of pairs of observations in any of the distance classes and R is the soil CO₂ efflux measured on any two collars (x and y).

3.2.2.2 Temporal variability

Owing to the natural fluctuations in biotic and abiotic drivers of soil CO₂ efflux, observed rates commonly show a pronounced seasonal and diurnal variability. Studies aiming to quantify soil CO₂ efflux over longer periods have to ensure that all key efflux situations (e.g. summer drought, rewetting, budburst etc.) are well represented by the sampling strategy. Thus the sampling frequency needs to allow a meaningful interpolation of measurements in order to adequately describe the total integrated soil CO₂ efflux. However, as with capturing the spatial variability, this requirement is most commonly limited by the cost of materials or labour involved. Additional bias may be introduced if soil CO₂ efflux is always sampled at the same time of day, missing out key biotic (e.g. diurnal changes in autotrophic activity) and abiotic (e.g. lag in soil temperature changes with depth) components.

Soil CO₂ efflux is strongly correlated over time, and while there is usually a pronounced diurnal variability in surface fluxes, these tend to show relatively small changes between successive days. Fluxes measured from the same location after only a short time interval are therefore not independent observations and may confound the statistical analysis in an experiment. Semivariance analysis is a useful tool to analyze the degree of autocorrelation over time and helps to determine the adequate sampling interval in order to avoid oversampling. Figure 3.4 illustrates the degree of correlation between soil surface CO₂ fluxes with an increasing time lag. The graph shows local minima between fluxes at the same time of day (i.e. time lag of multiples of 1 day), with a general increase in variance over the first 5 days. Thereafter, variances between efflux measurements are relatively constant while still retaining the lowest variance for measurements made at the same time of day. For this particular site, it can therefore be concluded that a periodic sampling strategy with measurements taken at a minimum of 5-day intervals would not oversample and thus prevent autocorrelated results.

To further assess both the impact of sampling interval and potential biases resulting from selective sampling at specific times of the day, soil CO₂ efflux from the same dataset of continuous hourly soil CO₂ efflux data was 're-sampled'. To simulate periodic sampling, fluxes were averaged either for the morning hours

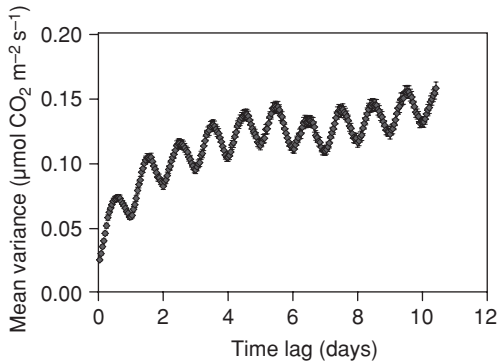

Figure 3.4 Mean variance of hourly soil CO₂ efflux values with fluxes measured from the same locations, but with increasing time lags. Variances were computed for a dataset with hourly flux measurements (disregarding data gaps) over three periods of the growing season (29 April 1999–4 July 1999, 28 July 1999–7 September 1999 and 29 October 1999–2 December 1999) in a mature temperate spruce forest (see Subke *et al.*, 2003). The complete dataset includes 3476 hourly flux measurements, allowing variances to be calculated for between 3344 (interval = 1 hour) and 2324 (interval = 10 days) pairs of flux values. Error bars indicate standard errors for the calculated variances.

(9 a.m.–1 p.m.), or for daytime measurements (9 a.m.–6 p.m.), for 1 day, 2 days, bi-weekly, weekly or fortnightly sampling intervals. The analysis shows that increasing the sampling interval results in increasing deviations from the continuously measured average (which for the purpose of this analysis is assumed to represent the true site efflux), reaching values of up to 10% (Fig. 3.5). The error bars in Fig. 3.5 indicate the lower degree of certainty of low frequency measurements owing to the smaller number of sampling dates. Parkin and Kaspar (2004) report a similar increase in cumulative CO₂ flux estimate with increasing lengths of sampling intervals.

Figure 3.5 further shows a small but consistent bias resulting from the different periods within a day over which samples were collected. At this particular site, soil CO₂ efflux showed a slow increase after sunrise, following the temperature increase in the soil. Peak values were commonly observed in the early afternoon and fluxes declined slowly before dropping after sunset. In this example, fluxes measured between 9 a.m. and 1 p.m. were a better representation of the actual site mean efflux than those collected between 9 a.m.

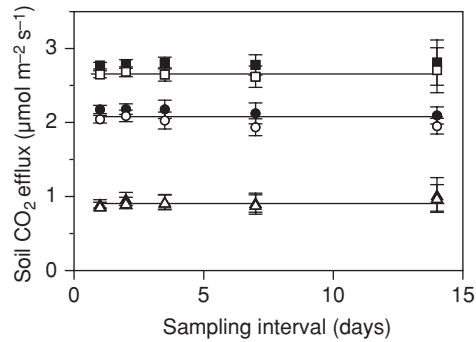

Figure 3.5 Effect of re-sampling a continuous dataset of soil CO₂ efflux measured in a mature temperate spruce forest (see Subke *et al.*, 2003) using different sampling frequencies. Symbols indicate mean fluxes with error bars of 1 SE, while horizontal lines indicate the mean flux obtained from the continuous dataset. Circles: 29 April 1999–4 July 1999; squares: 28 July 1999–7 September 1999; triangles: 29 October 1999–2 December 1999. For each period, open symbols are average fluxes measured between 9 a.m. and 1 p.m., while solid symbols are fluxes measured between 9 a.m. and 6 p.m.

and 6 p.m. Pair-wise comparison of fluxes in the first sampling period of Fig. 3.5 showed a significant difference between fluxes obtained during the morning and those obtained throughout the daytime hours ($t = 7.21$, $p < 0.001$), while neither of the estimates differed significantly from the true 24-hour mean of corresponding sampling days. On average, morning fluxes underestimated 24-hour means by 3%, while daytime hour flux estimates overestimated the true diurnal mean by the same margin. Notably the time lags in the diurnal soil CO₂ efflux dynamics differ according to site conditions and the relatively small error introduced by either morning or daytime sampling in this example cannot be automatically assumed to hold for different sites. Data in Fig. 3.1, for example, show peak values at around midnight, which is likely to be due to the time lag for assimilation products fixed throughout the day to reach the roots and rhizosphere.

Correcting any possible bias resulting from the time of day during which sampling took place may be possible if the diurnal variation of soil CO₂ efflux (meaning day- and night-time fluxes) is measured repeatedly throughout the measuring period. If the bias is constant throughout the period, a simple multiplicative correction may suffice; alternatively, a simple soil temperature model may be necessary to correct fluxes.

Table 3.2 Comparison of attributes for automated and manually operated soil CO₂ efflux measuring systems. Please note that there is a considerable variety of measuring principles, so that within each of the two categories individual aspects may vary.

	Automated system	Manual system
Measuring frequency	continuous	periodic
Number of sampling points	small	high
Technical requirements	high	low
Labour intensity	low	high
Capture of spatial heterogeneity	low	high
Capture of temporal heterogeneity	high	low
Suited for	Time series analysis Capture of 'events'	Areal survey

3.2.2.3 Implications for soil CO₂ efflux sampling strategies

Soil CO₂ efflux measurements using chambers in the field are commonly done by either continuous automated systems or manually operated chambers with measurements carried out in periodic campaigns (see Chapter 2 Pumpanen *et al.* for a more detailed description of measuring methods). The choice of a measuring system depends principally on the objective of an experiment. Table 3.2 provides a general overview of the attributes of automated continuously measuring systems and those of manually operated systems. However, while these attributes are generally correct, there is considerable variability within each category. A further constraint is commonly posed by the availability of resources to invest in either materials or labour, which are assumed to be restrictive for this comparison. Given a big enough budget, it is feasible to either measure with a continuous system from a high number of sampling points or to measure fluxes manually at high frequency, thus compensating for some of the aspects highlighted in Table 3.2.

In their investigation into trade-offs between the resolutions of either measuring mode, Savage and Davidson (2003) conclude that the manual mode is beneficial for investigations where the mean soil CO₂ efflux of a site is under investigation, with significant reductions in the 95% confidence intervals owing to the better capture of spatial heterogeneity. However, this sampling mode was not well suited for capturing

short-term changes in soil CO₂ efflux, for example following wetting events or changes in temperature. Studies interested in empirical modelling of soil CO₂ efflux to environmental factors would therefore benefit from data obtained from automated continuous measurements. A combination of both approaches is advisable in order to avoid bias due to the shortcomings of either temporal or spatial representation.

Experimenters operating continuous systems with low spatial replication are well advised to first assess spatial heterogeneity with a survey chamber in order to test how representative the continuous sampling locations are. Again, this survey should ideally be repeated throughout the annual cycle if measurements are to be used for extrapolation of annual fluxes.

3.2.3 Laboratory measurements

Laboratory incubations of soils allow a close investigation of the respiratory response to specific environmental parameters (most commonly temperature and soil moisture), or soil amendments with respiration substrates, nutrient solutions or pollutants (Dilly and Nannipieri, 2001; Allen and Schlesinger, 2004; Miller *et al.*, 2005; Smith, 2005; Shaver *et al.*, 2006). The obvious advantage is the level of control over a range of parameters (both biotic and abiotic) influencing soil CO₂ efflux under field conditions, allowing a clearer interpretation of results from experimental treatments. Depending on the experimental aims, soil samples from the field may

be left intact as complete monoliths or separated into different soil components (surface litter, organic horizon(s), mineral soil and roots). Soil extraction from the field and incubation in the laboratory by its very nature represents a major disturbance. Even if soil cores are left intact, biological processes within this portion of soil are significantly affected by the physical disturbance during extraction and interruption of the autotrophic connections (i.e. roots and mycorrhizal hyphae). Depending on the mode of soil sampling, local compaction or loosening of the soil matrix is possible, with considerable influence on soil diffusivity due to artificial changes in soil pore space volumes. Roots that were severed are likely to lose labile organic compounds ('wound respiration') in the short term (Cabrera and Saltveit, 2003), while the obvious lack of carbon input from the plants and subsequent loss of exudations from roots within the soil core means that substrate supply to a host of microbial organisms have been removed. The result is a rapid decline in soil CO₂ efflux in the initial period (on the time scale of hours to a few days) following soil extraction in the field (Reichstein *et al.*, 2005). Ultimately, roots (and any other directly dependent organisms such as the mycorrhizal mycelium) within the core will die, so that the amount of dead biomass is artificially increased with respect to soil conditions at the site the sample was taken from.

Laboratory incubations of root-free soil, on the other hand, can be used to estimate the carbon mineralization potential of different soil parts or the microbial heterotrophic response to temperature and soil moisture conditions. Due, again, to the inherent disturbance by the sampling process and subsequent separation of soil components, there is a clear limitation to the possibility of extrapolating soil CO₂ efflux obtained in laboratory incubations to field conditions. For investigations aiming at quantifying the soil CO₂ efflux under field conditions or addressing any hypotheses involving an intact autotrophic flux component, measurements made on laboratory incubated soil samples alone are not suitable as an experimental approach. However, soil CO₂ efflux studies based on laboratory incubations have been instrumental in supplementing field-based measurements by separating out individual aspects of soil CO₂ efflux responses to environmental conditions (Fang *et al.*, 2005; Miller *et al.*, 2005; Reichstein *et al.*, 2005), the potential of CO₂ being mineralized from different forest sites (Person, 2000; Sjöberg *et al.*, 2004),

as well as investigations of the stability of soil organic matter fractions (Franzluebbers *et al.*, 2001; Ladegaard-Pedersen *et al.*, 2005; Leifeld and Fuhrer, 2005) or effects of pollution and soil amendments on soil microbiota (Rajapaksha *et al.*, 2004; Fuentes *et al.*, 2006; Oorts *et al.*, 2006).

3.2.4 Scaling up

Scaling up in space and time is always based on the generalization of the data with respect to factors controlling the variation. Day-to-day and seasonal variation in time is often largely dependent on temperature, soil moisture and simple measures of vegetation activity (such as leaf area index) and can be modelled relatively easily. The longer the time scale, however, the more interacting factors come into play (e.g. carbon pool dynamics, disturbances – including small non-visible ones – and population dynamics), reducing our ability to predict longer term cycles and trends in soil efflux. Similarly, spatial variation can be modelled quite well along gradients where temperature, soil moisture regimes and vegetation productivity are the dominating factors (e.g. along continental gradients) (Reichstein *et al.*, 2003). As soon as those factors are less dominant, subtler but important factors might come into play: prominently soil chemical status (e.g. pH, nutrients), vegetation cover and site history (Reth *et al.*, 2005). There is still no general picture of how these factors co-determine the between-site variation of soil respiration. Consequently, scaling up is difficult and depends largely on well stratified sample databases. Typical models addressing temporal and spatial variation at different scales are discussed in Chapters 11 and 12.

3.2.5 Site variation: random, stratified or systematic design, and avoiding bias

Apart from sampling soil CO₂ efflux from a sufficient number of locations according to a site's heterogeneity, the allocation of adequately spaced sampling points (see Section 3.2.1 for autocorrelation issues) is equally important in order to achieve a representative estimate of the true soil CO₂ efflux value. An appropriate design will vary according to the site conditions and depends on the question to be answered. Mainly there are three types of sample design: (1) random, (2) stratified or (3) systematic. Whereas (1) assumes fairly uniform site

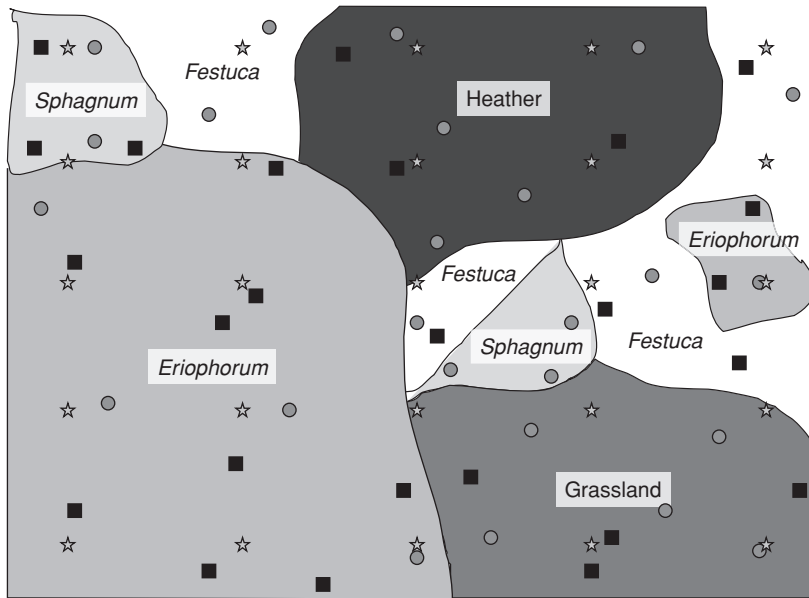

Figure 3.6 Example of three different sample designs for assessing CO₂ efflux site variability in a heather moorland with a patchwork, dominant vegetation cover. Symbols indicate the three sets of 25 measurement locations each: squares and circles represent the random and stratified design, respectively, whereas a systematic approach would cover the area in 25 equally spaced points (stars).

conditions (e.g. old beech forest on brown earth), (2) is more suitable for sites with known spatial variability (e.g. heathland covering a patchwork of soil types with differences in dominant vegetation types and slope variation). Systematic sampling (3) might be considered as straightforward but ignores underlying site variability. However, it is suitable to answer questions such as variance distance relationships (see Section 3.2.1 for semivariogram-based analysis). More information on sampling approaches is given in Hurlbert (1984).

From Fig. 3.6 it is clear that using different sample strategies will lead to different results. In a first approach we will only consider one environmental factor, vegetation cover, in order to obtain an ‘overall site soil flux’ estimate. In our case (Fig. 3.6), the random design will not only misrepresent the patchwork of dominant vegetation types, it will also lead to a bias towards *Eriophorum* coverage (11 sample points vs. only 3 for *Sphagnum*). Both would be much better accounted for by a stratified design (5 sample points for each vegetation zone). To make sure there is no further bias introduced, the stratified design needs to be allocated in a randomized way, i.e. sample points should be given coordinates based on a random number approach within each stratified

zone (e.g. five random coordinates for each vegetation type). However, in another approach one might want to focus on assessing the ‘dominant site soil flux’ allocating more measurements to the dominant vegetation type, thus the stratification must be weighted according to the proportion of the total area occupied by each vegetation type.

A different approach altogether would be to include many more environmental variables, which would demand more sophisticated geostatistical methodology such as sampling of assembled data, for which examples are given in McBratney *et al.* (2003). For example, a constrained Monte Carlo sampling scheme selects μ different values from each of the different variables by dividing them into several non-overlapping intervals on the basis of equal probability. One value from each interval is selected at random with respect to the probability density in the interval. The obtained μ values are then paired in a random manner between the many environmental variables until μ -duplets are formed; searching through the data can then find the locations that are taxonomically most similar to the combination of values chosen (e.g. heather on deep peat), or find locations that match the intervals in the various variables (e.g.

pH ranges). In either case, this will result in a set of μ spatial coordinates (locations) for observation (see McBratney *et al.*, 2003). There are many other sophisticated geostatistical procedures and practical considerations, and the reader may want to consult McBratney *et al.* (2003) for useful examples on related geostatistical methods such as Kriging and co-Kriging. Kriging is a process by which values are estimated at those locations that have not been sampled. The technique uses a weighted average of neighbouring samples to estimate the 'unknown' value at a given location, which can be optimized using the semivariogram model. The technique also provides a 'standard error', which may be used to quantify confidence levels. Co-Kriging uses a similar interpolation technique but estimates map values if the distribution of a secondary variable can easily be sampled more intensely than the primary variable.

3.2.6 Using geographical information systems (mapping and querying)

An alternative to the complex geostatistical procedures mentioned above is the use of a geographical information system (GIS), which can help considerably with the development of field sample strategies. In our example, the stratified sample design locations shown in Fig. 3.6 might change considerably if sample point allocation is weighted on a vegetation type area basis as done by Garnett *et al.* (2001) for soil sampling. This weighted allocation will reflect the soil fluxes under different vegetation covers in proportion to their area, thus providing an undistorted mean flux estimate for the entire site. There are many GIS software packages available offering different levels of complexity and user knowledge, and the reader may wish to consult specific literature. In many cases a wide variety of plot or landscape information (e.g. soil and vegetation types, soil pH, organic carbon content, slope and soil depth) is available about a given area on which sample strategy can be based. However, it will become increasingly difficult to display and query those data in conventional software in order to assist with sample design. In a GIS such digitized data are then imported as either polygons (areas) or point information that can then be used to draw map layers and to query any combination of layers. For example, the soil type in Fig. 3.6 might actually not overlap with the dominant vegetation or there might be steep slopes across the heather and grassland communities,

both might strongly impact on the measured soil CO₂ efflux. In a GIS a query can be done, outlining different zones based on all the information available (e.g. including slope grades), on which a more accurate stratified design can be based. The intention would be to sample the reference area as outlined above in order to fit a model and extrapolate to the rest of the area. This might give a better chance of fitting local relationships with a given sampling effort, and should be more efficient in required field time.

The GIS approach may also help with the spatial display of soil fluxes and to model point measurement integration (e.g. plot interpolation, see Kaye and Hart, 1998), which can be done using quite a diverse set of procedures (e.g. surface or grid interpolation making different assumptions about spatial relation). Further, if larger than plot scale information is available, such as land use, vegetation or soil maps, then scaling up the integrated plot results to the landscape is achievable in a GIS using spatial information, as done by McBratney *et al.* (2000) for soil mapping.

3.3 FORMULATING AND TESTING HYPOTHESES

Whereas the previous part of this chapter provides critical knowledge for observation-based science (e.g. obtaining meaningful spatial and temporal site flux variations) the following also considers theoretical and practical issues related to experimental manipulation (e.g. hypothesis testing). The basis of science is the formulation and testing of hypotheses by applying experimental treatments, which distinguishes it from purely observational disciplines such as natural history or even assessing temporal and spatial flux variability as outlined previously. It is assumed that the null hypothesis is true and the scientist will look for evidence in the data to either support or reject the null hypothesis. A fundamental concept of the method is to assume that the null hypothesis is true until there is overwhelming evidence against it (typically, less than a 1% or 5% chance of obtaining the observed value or one more extreme if, in fact, the null hypothesis were true).

However, it is not always easy to formulate clear and testable hypotheses or design a balanced experiment with appropriate controls. Therefore, care should be taken to follow certain guidelines, which will lead to successful experimental testing of hypotheses and thus

provide meaningful answers. In the following section we suggest an experimental step-by-step approach as a basis for scientific hypotheses testing, which can be summarized in five steps.

1. Make the **observation**.
2. Formulate the **hypothesis**.
3. Draw the **graph**.
4. Design and perform the **experiment**.
5. Evaluate data with the appropriate **statistical design**.

Although the following section will be sufficient in a soil respiration context, there might be additional precautions needed to ensure successful hypothesis testing under special circumstances (e.g. when measuring in unusual environments). The most common mistakes are made by having (1) an inappropriate or no control treatment at all or (2) no pre-treatment data; this five-step approach is intended to prevent such mistakes.

3.3.1 Make the observation

Soil respiration data are used to inform models about site-specific soil CO₂ efflux behaviour throughout the year in order to improve model performance (see Chapter 11 Reichstein and Janssens). As explained above, the annual cycle might be divided into several key soil respiration process stages (e.g. snow cover, thawing, bud burst etc.). Thus different observations throughout the year might lead to addressing different hypotheses. For example, the observation might be that winters with less snow cover result in comparatively low soil respiration flux as observed by Monson *et al.* (2006). One might link this to better soil insulation under snow cover, leading to warmer soil temperatures and thus higher microbial activity, or protecting roots from frost damage. However, the observation needs to be tested scientifically; it is not enough to compare one year with another as other factors leading to higher soil respiration fluxes might have changed as well, which crucially remained unobserved.

3.3.2 Formulate the hypothesis

The hypothesis based on the above observation can be phrased as: ‘Soil CO₂ efflux increases with depth of snow cover’. The null hypothesis that is going to be tested statistically therefore states: ‘Higher snow cover depth does not result in higher soil CO₂ efflux’.

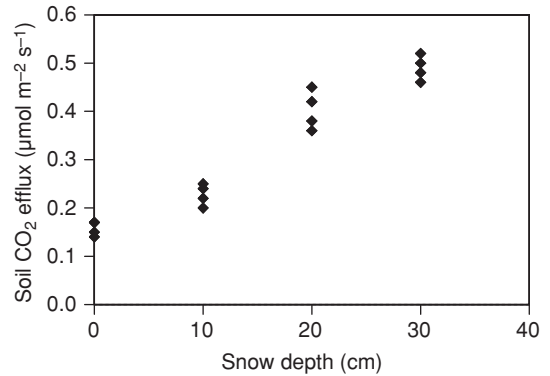

Figure 3.7 Hypothetical graph illustrating the expected correlation between soil respiration (y -axis) measured under snow depths treatments (x -axis) on which the hypothesis is based ($n = 4$). Note that the correlation is expected to be non-linear; consequently flux measurements at more than two snow depths treatments are needed. Further, the dependent variable is placed on the y -axis, indicating that soil respiration depends on snow depth and not the other way round.

3.3.3 Draw the graph

A first graph (Fig. 3.7) aims at illustrating the hypothesis – in this case a correlation. It is important to note that drawing the graph at this stage does not reflect a foregone conclusion of the outcome of the experiment. The graph reflects one possible outcome (based on the observations that led to the hypothesis), it is intended as a guide towards the most adequate statistical test.

In this graph we already include a critical aspect for the sampling strategy: as we do not know whether there is a critical snow depth from which the hypothesized insulating effect becomes effective (i.e. a likely non-linear relationship between snow depth and soil respiration rates), we will impose four different snow depth treatments. However, as it is possible that there is a minimum time to produce a reduction in flux activity by frost penetration into the soil, we will have to extend the previous plan (Fig. 3.7) and add repeated flux measurements. Based on this, we may proceed with a second hypothetical graph, which sets out the logistics of the experiments; showing extended fortnightly sampling over 15 weeks (Fig. 3.8). Please note that this example is intended to give a guide to the planning of an experiment; measuring CO₂ efflux from soil snow is a considerable technical challenge (Hirano, 2005; Suzuki *et al.*, 2006) and is not part of this exercise. Given that we

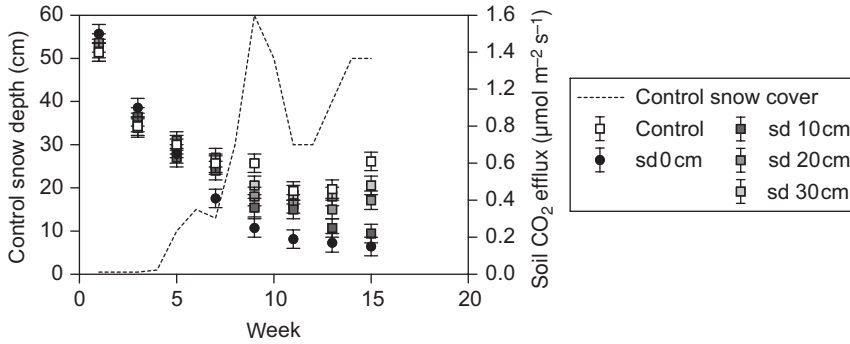

Figure 3.8 A hypothetical graph for the experimental testing of the hypothesis that snow depth is positively related to soil CO₂ efflux. Symbols indicate predicted fortnightly soil respiration fluxes (± 1 SE is an indication that we need more than three replicates!) on the right y-axis for the four snow depth (sd) treatments (i.e. snow depth limited to a maximum depth of either 0, 10, 20 or 30 cm by regular sweeping). A hypothetical natural snow cover depth for the unswept control (natural snow cover) is indicated on the left y-axis (broken line). Note that the final data (week 15) correspond to the hypothetical data presented in Fig. 3.7.

want to repeat measurements from the same locations, and compare the fluxes from different snow depths, the appropriate statistical test is an analysis of variance (ANOVA) with repeated measures. This also has implications for the sampling strategy as the number of replicates required for each treatment has to be sufficient to yield the statistical power to resolve possible differences. Further, the practical guidance for semi-variogram assessment for spatial and temporal flux measurements in order to avoid pseudo-replication should be considered (see Section 3.2.2.1).

By drawing this second graph (Fig. 3.8), and including hypothetical error bars, we are automatically guided to the material requirements of the measuring process and we can instantly recognize if this will, for example, conflict with the capabilities of the measuring system (number of collars available, time required to complete measurements from all locations etc.) or time issues (e.g. holidays). Also note the pre-snow measurements indicated in Fig. 3.8, which are critical to reveal any possible difference in location that is independent of the snow depths. Details such as pre-treatment fluxes, controls and time issues are easily overlooked, and the graph is intended to avoid such mistakes.

3.3.4 Design and perform the experiment

Based on this example, we would plan to measure soil CO₂ efflux from 15 locations beginning well before the first snowfall at fortnightly intervals. These 15 collars

are divided into five different experimental groups (four imposed snow depths and one ‘control’ of natural snow height), using a randomized block design (see Hurlbert, 1984) to ensure that the variances of all groups are identical. In the blocked treatment design, the selected measurement locations are spatially allocated within a block containing a full set of treatments, and blocks are spaced widely enough to avoid pseudo-replication. Blocking can also be used to create a more homogeneous experimental test bed according to similarity criteria, which are ideally based on a pre-treatment ranking (e.g. three blocks with each containing the three plots with highest, medium and lowest soil CO₂ efflux rates). Experimental blocking has two major advantages, both of which increase the statistical power as the block effect can be ‘deducted’ from the data: (1) it will reduce within-block variability and (2) it can take into account potential environmental gradients (e.g. of soil moisture or pH). As snow depth increases with time, regular sweeping achieves the imposed snow depth of each treatment, and we would plan to continue measurements of CO₂ efflux at fortnightly intervals.

3.3.5 Evaluate the data with the appropriate statistical design

For the statistical analysis, all flux data collected from the time when the snow cover exceeds 30 cm (i.e. after week 8 in Fig. 3.8, in this example) would be considered. Other tests may be considered to look, for example, at

the variation of temperature (in air) and below the different snow depth treatments (in the soil) during the experiment. These factors may be included in the statistics by means of an analysis of covariance (ANCOVA). For more detailed advice on choosing appropriate statistical tests the reader may wish to consider special literature such as Dytham (2003).

3.4 CONCLUSION

Capturing the spatial and temporal heterogeneity of soil CO₂ efflux is one of the biggest challenges to obtaining flux estimates that allow scaling up to larger scales. The aim of this chapter was to introduce the reader to the sources of variability, and to illustrate possible theoretical and practical approaches in order to allow meaningful measurements of complete flux sums. As we have pointed out throughout this chapter, variability of fluxes in time and space is strongly influenced by site-specific conditions and the methodology used. For the purpose of scaling up, it would be desirable to separate individual influences on soil CO₂ efflux, since simplistic parameterizations hold the risk of confounding different sources of variability. While the dynamics of soil CO₂ efflux through the growing season are likely to correlate reasonably well with temperature (and possibly soil moisture), a simple parameterization on these factors alone will likely mask their indirect influence on plant activity, which in turn affects soil CO₂ efflux. A good spatial coverage including the experimental separation of autotrophic and heterotrophic fluxes in the field, and independent parameterization is likely to provide a more meaningful basis for larger scale modelling, where plant activity can be modelled independently, and thus providing a possible input parameter for autotrophic flux contributions. However, any such experimental work needs to be based on a sound statistical design and we hope that our experimental step-by-step approach will be useful to the field scientist responsible for obtaining 'meaningful numbers' on soil carbon turnover processes.

REFERENCES

- Allen, A. S. and Schlesinger, W. H. (2004) Nutrient limitations to soil microbial biomass and activity in loblolly pine forests. *Soil Biology and Biochemistry*, **36**, 581–9.
- Atkin, O. K., Edwards, E. J. and Loveys, B. R. (2000) Response of root respiration to changes in temperature and its relevance to global warming. *New Phytologist*, **147**, 141–54.
- Bolin, B. (2000) Global perspective. In *Land Use, Land Use Change, and Forestry. A Special Report of the Intergovernmental Panel on Climate Change (IPCC)*, ed. R. T. Watson, I. R. Noble, B. Bolin, N. H. Ravindranath, D. J. Verardo and D. J. Dokken. Cambridge: Cambridge University Press, pp. 23–51.
- Buchmann, N. (2000) Biotic and abiotic factors controlling soil respiration rates in *Picea abies* stands. *Soil Biology and Biochemistry*, **32**, 1625–35.
- Cabrera, R. M. and Saltveit, M. E. (2003) Survey of wound-induced ethylene production by excised root segments. *Physiologia Plantarum*, **119**, 203–11.
- Cressie, N. A. C. (1993) *Statistics for Spatial Data*. Wiley Series in Probability and Mathematical Statistics, Rev. edn. New York: Wiley.
- Davidson, E. A., Savage, K., Verchot, L. V. and Navarro, R. (2002) Minimizing artifacts and biases in chamber-based measurements of soil respiration. *Agricultural and Forest Meteorology*, **113**, 21–37.
- Davidson, E. A., Savage, K. E., Trumbore, S. E. and Boroken, W. (2006) Vertical partitioning of CO₂ production within a temperate forest soil. *Global Change Biology*, **12**, 944–56.
- Dilly, O. and Nannipieri, P. (2001) Response of ATP content, respiration rate and enzyme activities in an arable and a forest soil to nutrient additions. *Biology and Fertility of Soils*, **34**, 64–72.
- Dytham, C. (2003) *Choosing and Using Statistics: A Biologist's Guide*. Oxford: Blackwell Science.
- Fang, C. and Moncrieff, J. B. (1998) Simple and fast technique to measure CO₂ profiles in soil. *Soil Biology and Biochemistry*, **30**, 2107–12.
- Fang, C., Smith, P., Moncrieff, J. B. and Smith, J. U. (2005) Similar response of labile and resistant soil organic matter pools to changes in temperature. *Nature*, **433**, 57–9.
- Franzluebbers, A. J., Haney, R. L., Honeycutt, C. W. *et al.* (2001) Climatic influences on active fractions of soil organic matter. *Soil Biology and Biochemistry*, **33**, 1103–11.
- Fuentes, J. P., Bezdicsek, D. F., Flury, M., Albrecht, S. and Smith, J. L. (2006) Microbial activity affected by lime in a long-term no-till soil. *Soil and Tillage Research*, **88**, 123–31.

- Garnett, M. H., Ineson, P., Stevenson, A. C. and Howard, D. C. (2001) Terrestrial organic carbon storage in a British moorland. *Global Change Biology*, **7**, 375–88.
- Heinemeyer, A., Ineson, P., Ostle, N. and Fitter, A. H. (2006) Respiration of the external mycelium in the arbuscular mycorrhizal symbiosis shows strong dependence on recent photosynthates and acclimation to temperature. *New Phytologist*, **171**, 159–70.
- Heinemeyer, A., Hartley, I. P., Evans, S. P., De la Fuente, J. A. C. and Ineson, P. (2007) Forest soil CO₂ flux: uncovering the contribution and environmental responses of ectomycorrhizas. *Global Change Biology*, **13**, 1786–97.
- Hirano, T. (2005) Seasonal and diurnal variations in topsoil and subsoil respiration under snowpack in a temperate deciduous forest – art. no. GB2011. *Global Biogeochemical Cycles*, **19**, B2011.
- Högberg, P., Buchmann, N. and Read, D. J. (2006) Comments on Yakov Kuzyakov's review 'Sources of CO₂ efflux from soil and review of partitioning methods' (*Soil Biology and Biochemistry*, **38**, 425–48). *Soil Biology and Biochemistry*, **38**, 2997–8.
- Hurlbert, S. H. (1984) Pseudoreplication and the design of ecological field experiments. *Ecological Monographs*, **54**, 187–211.
- Janssens, I. A., Kowalski, A. S., Longdoz, B. and Ceulemans, R. (2000) Assessing forest soil CO₂ efflux: an in situ comparison of four techniques. *Tree Physiology*, **20**, 23–32.
- Jenny, H. (1980) *The soil resource: origin and behaviour*. New York: Springer-Verlag.
- Kaye, J. P. and Hart, S. C. (1998) Restoration and canopy-type effects on soil respiration in a ponderosa pine–bunchgrass ecosystem. *Soil Science Society of America Journal*, **62**, 1062–72.
- Kuzyakov, Y. (2006a) Sources of CO₂ efflux from soil and review of partitioning methods. *Soil Biology and Biochemistry*, **38**, 425–48.
- Kuzyakov, Y. (2006b) Response to the comments by Peter Högberg, Nina Buchmann and David J. Read on the review 'Sources of CO₂ efflux from soil and review of partitioning methods' (*Soil Biology and Biochemistry*, **38**, 425–48). *Soil Biology and Biochemistry*, **38**, 2999–3000.
- Ladegaard-Pedersen, P., Elberling, B. and Vesterdal, L. (2005) Soil carbon stocks, mineralization rates, and CO₂ effluxes under 10 tree species on contrasting soil types. *Canadian Journal of Forest Research*, **35**, 1277–84.
- Law, B. E., Baldocchi, D. D. and Anthoni, P. M. (1999) Below-canopy and soil CO₂ fluxes in a ponderosa pine forest. *Agricultural and Forest Meteorology*, **94**, 171–88.
- Leifeld, J. and Fuhrer, J. (2005) The temperature response of CO₂ production from bulk soils and soil fractions is related to soil organic matter quality. *Biogeochemistry*, **75**, 433–53.
- Liang, N. S., Nakadai, T., Hirano, T. *et al.* (2004) In situ comparison of four approaches to estimating soil CO₂ efflux in a northern larch (*Larix kaempferi* Sarg.) forest. *Agricultural and Forest Meteorology*, **123**, 97–117.
- McBratney, A. B., Odeh, I. O. A., Bishop, T. F. A., Dunbar, M. S. and Shatar, T. M. (2000) An overview of pedometric techniques for use in soil survey. *Geoderma*, **97**, 293–327.
- McBratney, A. B., Santos, M. L. M. and Minasny, B. (2003) On digital soil mapping. *Geoderma*, **117**, 3–52.
- Miller, A. E., Schimel, J. P., Meixner, T., Sickman, J. O. and Melack, J. M. (2005) Episodic rewetting enhances carbon and nitrogen release from chaparral soils. *Soil Biology and Biochemistry*, **37**, 2195–204.
- Monson, R. K., Lipson, D. L., Burns, S. P. *et al.* (2006) Winter forest soil respiration controlled by climate and microbial community composition. *Nature*, **439**, 711–14.
- Nunan, N., Wu, K., Young, I. M., Crawford, J. W. and Ritz, K. (2002) In situ spatial patterns of soil bacterial populations, mapped at multiple scales, in an arable soil. *Microbial Ecology*, **44**, 296–305.
- Oorts, K., Bronckaers, H. and Smolders, E. (2006) Discrepancy of the microbial response to elevated copper between freshly spiked and long-term contaminated soils. *Environmental Toxicology and Chemistry*, **25**, 845–53.
- Parkin, T. B. and Kaspar, T. C. (2004) Temporal variability of soil carbon dioxide flux: effect of sampling frequency on cumulative carbon loss estimation. *Soil Science Society of America Journal*, **68**, 1234–41.
- Person, T., Karlsson, P. S., Sjöberg, R. M. and Rudebeck, A. (2000) Carbon mineralization in European forest soils. *Ecological Studies*, **142**, 257–75.
- Prentice, I. C., Farquar, G. D. and Fasham, M. J. R. (2001) The carbon cycle and atmospheric carbon dioxide. In *Climate Change 2001: The Scientific Basis*. Contribution of Working Group I to the Third Assessment report of the Intergovernmental Panel on Climate Change. Cambridge: Cambridge University Press, pp. 183–237.

- Pumpanen, J., Ilvesniemi, H., Peramaki, M. and Hari, P. (2003) Seasonal patterns of soil CO₂ efflux and soil air CO₂ concentration in a Scots pine forest: comparison of two chamber techniques. *Global Change Biology*, **9**, 371–82.
- Raich, J. W. and Potter, C. S. (1995) Global patterns of carbon dioxide emissions from soils. *Global Biogeochemical Cycles*, **9**, 23–36.
- Raich, J. W., Potter, C. S. and Bhagawati, D. (2002) Interannual variability in global soil respiration, 1980–94. *Global Change Biology*, **8**, 800–12.
- Rajakapsha, R., Tobor-Kaplon, M. A. and Baath, E. (2004) Metal toxicity affects fungal and bacterial activities in soil differently. *Applied and Environmental Microbiology*, **70**, 2966–73.
- Rayment, M. B. and Jarvis, P. G. (2000) Temporal and spatial variation of soil CO₂ efflux in a Canadian boreal forest. *Soil Biology and Biochemistry*, **32**, 35–45.
- Reichstein, M., Rey, A., Freibauer, A. *et al.* (2003) Modeling temporal and large-scale spatial variability of soil respiration from soil water availability, temperature and vegetation productivity indices – art. no. 1104. *Global Biogeochemical Cycles*, **17**, 1104.
- Reichstein, M., Subke, J. A., Angeli, A. C. and Tenhunen, J. D. (2005) Does the temperature sensitivity of decomposition of soil organic matter depend upon water content, soil horizon, or incubation time? *Global Change Biology*, **11**, 1754–67.
- Reth, S., Reichstein, M. and Falge, E. (2005) The effect of soil water content, soil temperature, soil pH-value and the root mass on soil CO₂ efflux: a modified model. *Plant and Soil*, **268**, 21–33.
- Savage, K. E. and Davidson, E. A. (2003) A comparison of manual and automated systems for soil CO₂ flux measurements: trade-offs between spatial and temporal resolution. *Journal of Experimental Botany*, **54**, 891–9.
- Shaver, G. R., Giblin, A. E., Nadelhoffer, K. J. *et al.* (2006) Carbon turnover in Alaskan tundra soils: effects of organic matter quality, temperature, moisture and fertilizer. *Journal of Ecology*, **94**, 740–53.
- Sjoberg, G., Nilsson, S. I., Persson, T. and Karlsson, P. (2004) Degradation of hemicellulose, cellulose and lignin in decomposing spruce needle litter in relation to N. *Soil Biology and Biochemistry*, **36**, 1761–8.
- Smith, S. E. and Read, D. J. (1997) *Mycorrhizal Symbiosis*. London: Academic Press.
- Smith, V. R. (2005) Moisture, carbon and inorganic nutrient controls of soil respiration at a sub-Antarctic island. *Soil Biology and Biochemistry*, **37**, 81–91.
- Subke, J. A. and Tenhunen, J. D. (2004) Direct measurements of CO₂ flux below a spruce forest canopy. *Agricultural and Forest Meteorology*, **126**, 157–68.
- Subke, J. A., Reichstein, M. and Tenhunen, J. (2003) Explaining temporal variation in soil CO₂ efflux in a mature spruce forest in Southern Germany. *Soil Biology and Biochemistry*, **35**, 1467–83.
- Suzuki, S., Ishizuka, S., Kitamura, K., Yamanoi, K. and Nakai, Y. (2006) Continuous estimation of winter carbon dioxide efflux from the snow surface in a deciduous broadleaf forest. *Journal of Geophysical Research – Atmospheres*, **111**, D17101, doi 10.1029/2005JD006595.
- Tang, J. W., Baldocchi, D. D., Qi, Y. and Xu, L. K. (2003) Assessing soil CO₂ efflux using continuous measurements of CO₂ profiles in soils with small solid-state sensors. *Agricultural and Forest Meteorology*, **118**, 207–20.
- Tedeschi, V., Rey, A., Manca, G. *et al.* (2006) Soil respiration in a Mediterranean oak forest at different developmental stages after coppicing. *Global Change Biology*, **12**, 110–21.
- Wang, W. J., Zu, Y. G., Wang, H. M. *et al.* (2005) Effect of collar insertion on soil respiration in a larch forest measured with a LI-6400 soil CO₂ flux system. *Journal of Forest Research*, **10**, 57–60.
- Wilson, K. B. and Meyers, T. P. (2001) The spatial variability of energy and carbon dioxide fluxes at the floor of a deciduous forest. *Boundary-Layer Meteorology*, **98**, 443–73.
- Yim, M. H., Joo, S. J., Shutou, K. and Nakane, K. (2003) Spatial variability of soil respiration in a larch plantation: estimation of the number of sampling points required. *Forest Ecology and Management*, **175**, 585–8.

4 • Determination of soil carbon stocks and changes

Mirco Rodeghiero, Andreas Heinemeyer, Marion Schrumpf and Pat Bellamy

4.1 INTRODUCTION

4.1.1 Soil carbon pools and the global carbon cycle

In terrestrial ecosystems soils represent the major reservoir of organic carbon (Table 4.1), but with large and yet unquantified uncertainties in their estimates (mainly due to low soil sample numbers used for global up-scaling and assumptions on mean soil depths). At the global level, the soil organic matter (SOM) pool (estimated to 1 m depth) contains about 1580 Pg of carbon ($\text{Pg} = 10^{15} \text{ g}$), about 610 Pg are stored in the vegetation and about 750 Pg are present in the atmosphere (Schimel, 1995). Carbon is found in soils both in organic and inorganic forms (Table 4.2). Organic carbon is commonly classified into three ‘arbitrary’ pools, mostly for modelling purposes (such as in CENTURY), i.e. fast, slow and passive reflecting the rate of turnover. However, it is difficult to relate these pools to soil carbon fractions (see Section 4.1.5). The total amount of carbonate carbon to 1 m depth is estimated at 695–748 Pg carbon (Batjes, 1996). About one third of organic soil carbon occurs in forests and another third in grasslands and savannas, the rest in wetlands, croplands and other biomes (Janzen, 2004). The global soil organic carbon map (Fig. 4.1, ISLSCP II; ORNL DAAC, <http://daac.ornl.gov/>) shows the areas of high soil organic carbon predominantly in cold boreal (e.g. Northern Canada) and warm and humid tropical regions (e.g. South-East Asia), reflecting areas of deep organic soils (i.e. peatlands). However, Fig. 4.1 also shows that even temperate zones, for example the United Kingdom, can contain considerable amounts of soil organic carbon in wet and cold upland regions.

Most of the soil organic carbon is not inert, but in a continuous dynamic state of accumulation and

decomposition (Janzen, 2004; Schrumpf *et al.*, 2008), the schematic soil carbon cycle in Fig. 4.2 indicates this continuous exchange of carbon between the soil and the atmosphere, mostly as carbon dioxide (CO_2) and methane (CH_4). Consequently, any net carbon loss from soils will increase the CO_2 concentration in the atmosphere and in water bodies, whereas net accumulation in soil carbon (or sedimentation in rivers or lakes etc.) can contribute to the reduction of the atmospheric carbon pool (Ellert *et al.*, 2001; Lal, 2004). This cycling of carbon is increasingly influenced by human activities (IPCC, 2007). On an annual basis, global soil respiration estimates amount to about 80 Pg carbon (Schlesinger and Andrews, 2000; Raich *et al.*, 2002), roughly ten times the annual flux from fossil fuel combustion (7.2 Pg carbon; IPCC, 2007). Crucially, past and current cultivation of soils led to significant soil carbon losses of 50 Pg carbon or more (Janzen, 2006); conversely land-use or management change can offer an opportunity for sequestering atmospheric carbon in soils (Janzen, 2006). Importantly, in the long term, these soil carbon changes can be greater than any above-ground carbon gains. Therefore, soils hold a key role in reducing atmospheric CO_2 levels and their management is subject to scientific (e.g. climate change scenarios) and political (e.g. Kyoto Protocol) analysis. Moreover, peatlands and other organic soils of cold and temperate regions are presently assumed to be a net sink of carbon but they might become a net carbon source (CO_2 and CH_4) with predicted increase in global temperatures (Lal, 2004; Walter *et al.*, 2006). Bellamy *et al.* (2005) and other authors suggest this is already happening.

As even small changes in soil organic carbon pools, due to climatic changes or to human activities, might have large impacts on the global carbon cycle (Garten

Table 4.1 Estimates of soil carbon stocks (Gt carbon equal to either Pg C; $\times 10^{15}$ g C) for major terrestrial biomes. The data in the table differ in the data used for biome area (i.e. land cover map) and carbon density datasets as well as soil depths. The table does not contain double counts (e.g. peatlands are either counted as wetlands or boreal forests etc.).

Biome	IGBP ^a 100 cm		IGBP 100 cm		WBGU ^b 100 cm		ISLSCP II ^c 150 cm		ISLSCP II 130 cm	
	IPCC 2001	GLCM 2000 ^d	GLCM 2000 ^d	IPCC 1990	IPCC 1990	GLCM 2000 ^d	GLCM 2000 ^d	GLCM 2000 ^d	GLCM 2000 ^d	
Forest	Tropical and subtropical	213	209	216	275	109				
	Temperate	153	97	100	131	43				
	Boreal	338	174	471	255	62				
Savanna and grassland	Tropical and subtropical	247	206	264	276	98				
	Temperate	176	171	295	236	80				
Desert and semi-desert		159	199	191	276	86				
	Tundra	115	106	121	158	42				
Boreal		165	76	–	110	29				
	Croplands	–	76	128	101	36				
Wetlands		–	147	225	211	53				
	Bare	–	36	–	50	16				
Total C stock	1566	1497	2011	2079	654					

^a Estimate taken from the IPCC 2001 (Bolin *et al.*, 2000).

^b Estimate of soil carbon taken from the IPCC 1990 (IPCC, 1990) with very high Russian (boreal) forest soil carbon.

^c Soil carbon estimates taken from the ISLSCP II dataset (ISLSCP II, 2005).

^d Land cover map (i.e. percentage land use per grid cell) area was calculated using global 0.5° grid satellite data (GLC 2000 v1.1; GLC 2003) and was overlaid with corresponding grid information on the biomes based on the Holdridge Life Zone data (Leemans, 1992).

Table 4.2 *Estimates of soil organic and inorganic carbon stocks (to 1 m depth) and carbon densities of world soils (data taken from Lal, 2004).*

Soil order	Soil organic carbon		Soil inorganic carbon	
	Density (Mg C ha ⁻¹)	Pool (Pg C)	Density (Mg C ha ⁻¹)	Pool (Pg C)
Alfisols	125	158	34	43
Andisols	220	20	0	0
Aridisols	38	59	290	456
Entisols	42	90	124	263
Gelisols	281	316	6	7
Histosols	1170	179	0	0
Inceptisols	148	190	26	34
Mollisols	134	121	96	116
Oxisols	128	126	0	0
Rocky land	17	22	0	0
Shifting sand	4	2	9	5
Spodosols	191	64	0	0
Udisols	124	137	0	0
Vertisols	133	42	50	21
Total		1526		945

et al., 1999; Vance, 2003) it becomes vital to assess soil organic matter pools and their changes accurately.

4.1.2 Definition of soil organic carbon (SOC) and soil organic matter (SOM)

Soil can be defined as a complex system, consisting of a mixture of organic and mineral particles, soil solution and air, resulting from the interaction between biotic and abiotic factors; it is the medium in which plants acquire water and nutrients through their root systems. Soil organic compounds include all the organic matter present in the soil: living organisms (bacteria, algae, fungi, soil fauna and plant roots), the organic products derived from their activity (faeces, bacterial and fungal synthesized substances and root exudates) and plant and animal remains at various stage of decomposition, passing through several soil horizons and eventually entering various humus stages. Excluding living organisms (including living roots), we can define soil organic matter (SOM) as: 'the plant and animal remains at different stages of decomposition and the substances derived from the biological activity of the soil-living popu-

lation' (Soil Science Society of America, 1984). Soil organic carbon (SOC) is the carbon content of SOM, which is mostly around 50 to 60%. Most soils contain large amounts of SOC in the litter and organic layers (Fig. 4.3). Commonly soils are characterized by a SOM rich topsoil with decreasing soil carbon content down the soil profile, its thickness determined by soil mixing (Fig. 4.3; Table 4.2). In Histosols organic matter layers can extend to many metres depth.

The simplest way to report SOC content is as concentration (i.e. mass of carbon per unit mass of soil; kg kg⁻¹). More frequently SOC is expressed on an area (kg m⁻²) or volume (kg m⁻³) basis, although for inventory purposes SOC concentration, unless specified as per total soil volume, should be defined as carbon density (e.g. kg C m⁻² per unit of soil depth), which requires data on soil bulk density, stone content, depth of sampling and root content.

4.1.3 The soil carbon balance

The total amount of organic carbon stored in a soil is the resulting net balance of all carbon fluxes entering and leaving the soil over time (Fig. 4.2). Most

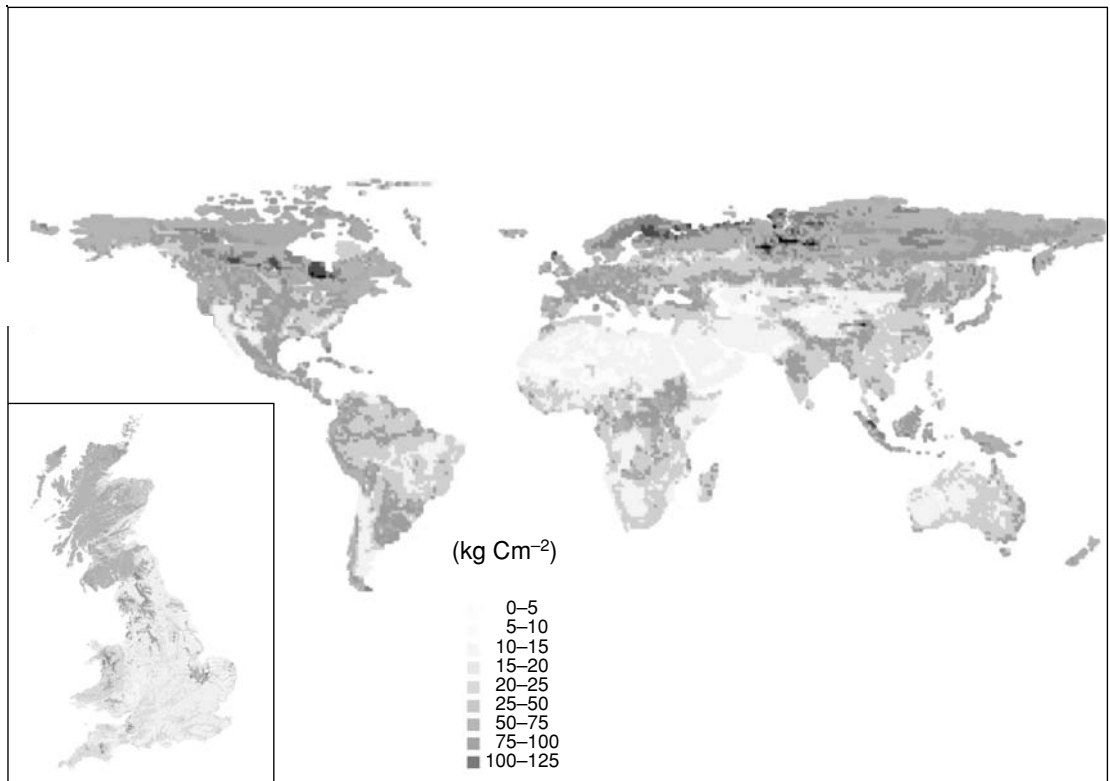

Figure 4.1 Soil carbon densities (organic carbon stocks) in kg C m^{-2} for (large) global 1° grid (150 cm soil depth) derived from the ISLSCP II dataset (ORNL DAAC, <http://daac.ornl.gov/>), and (inset) the 1 km grid (2003 national UK inventory estimate) data (100 cm soil depths) for Great Britain (NSRI, GB, <http://randd.defra.gov.uk/> and project search for SP0511). The maximum value for the global dataset is 124 kg C m^{-2} . Note that the global 1° dataset for the UK would only deliver 135 data point with a maximum of 79 kg C m^{-2} whereas the national 1 km UK dataset contains 250 234 grid value with a maximum of 118 or 39 kg C m^{-2} for 100 and 30 cm, respectively (including Northern Ireland); both map values refer to the same UK carbon legend.

organic matter entering the soil originates from plants. Above-ground litter, mainly derives from woody tissues (e.g. twigs, bark), leaves, flowers, fruits, mosses, lichens and fungi; below-ground inputs include dead roots and their associated mycorrhizal hyphae, root exudates (mainly sugars and organic acids) and sloughing of root surface tissues. However, any above-ground litter will eventually become below-ground input, for example due to bioturbation and cultivation. Although the living fine root biomass constitutes only a small fraction of the total stand biomass, the contribution of fine roots to total soil carbon inputs can be quite substantial. For example, fine root production in forest ecosystems can be assumed to be around 50% to 75% of total net primary productivity (Majdi, 2001; Nadelhoffer and Raich, 1992). In forest ecosystems, this is due to the high biomass of woody tissue

relative to production above ground, coupled with fast rates of growth and turnover relative to below-ground biomass (Ruess *et al.*, 1996). Some recent studies indicate that roots and mycorrhiza are even more important for the accumulation of SOM than above-ground leaf litter (Rasse *et al.*, 2005). Other considerable sources of SOM can be animal faeces, dead animals and wet or dry organic matter soil surface deposition. At agricultural sites, applications of fertilizer including organic matter such as manure or compost can significantly increase the SOM pool. Furthermore, there is some evidence that a small amount of CO_2 can be directly fixed by microbes in the soil, contributing to SOM (Miltner *et al.*, 2005).

In natural ecosystems, losses of carbon from the soil derive mainly from decomposition and mineralization processes of SOM, which lead to the release of CO_2 and

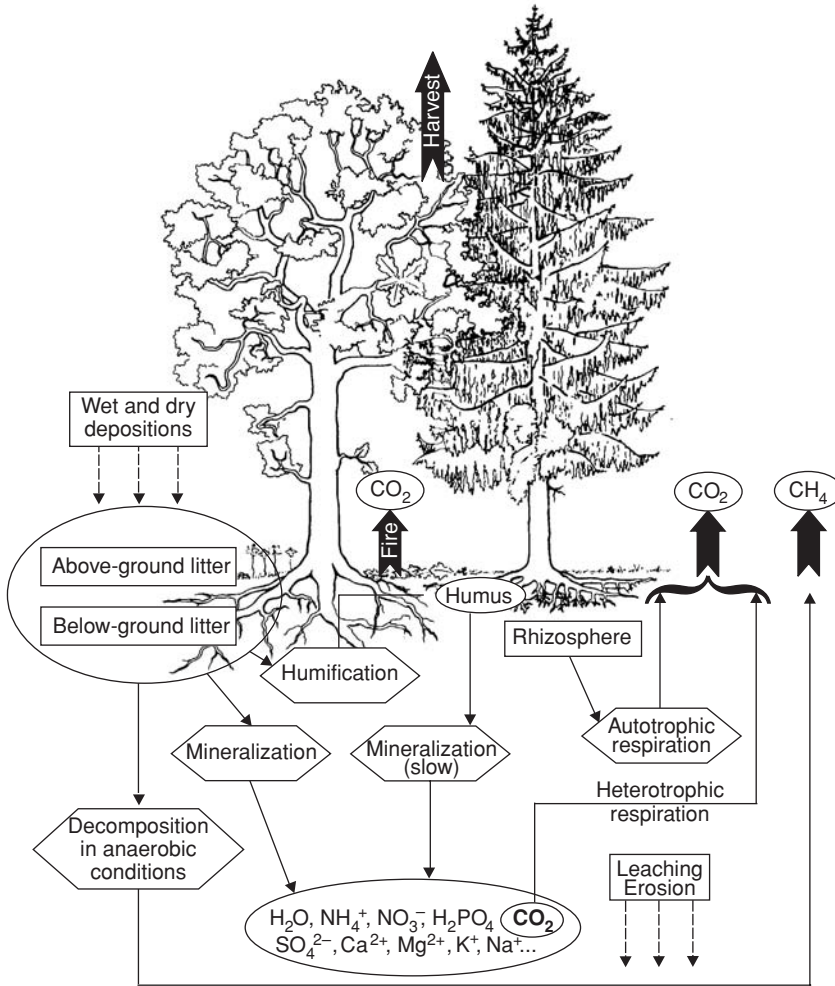

Figure 4.2 Simplified diagram of the soil carbon cycle.

some other trace gases (CH_4 and CO). The production of methane is of importance in particular in wetlands and peatlands, varying between less than 1 to more than $40 \text{ g C m}^{-2} \text{ y}^{-1}$ (Saarnio *et al.*, 2007). Leaching can also cause carbon losses from any soil via dissolved organic carbon (DOC) and dissolved inorganic carbon (DIC). These losses, although high during peak rainfall events (Freeman *et al.*, 2001), are generally small and account for up to $20 \text{ g C m}^{-2} \text{ y}^{-1}$ for DOC and DIC in Europe (Siemens, 2003). The largest annual flux component is generally heterotrophic soil respiration (calculated as the difference between net primary productivity and net ecosystem productivity), estimated to range between $280\text{--}970 \text{ g C m}^{-2}$ in temperate

forest ecosystems (Pregitzer and Euskirchen, 2004). Still, hydrological fluxes of carbon can be significant, especially in relation to a sometimes quite small net ecosystem exchange (Fahey *et al.*, 2005). In arable or other highly disturbed systems, a depletion of soil carbon also occurs due to lower plant litter input through harvesting, faster SOM breakdown (as it is more accessible in soil aggregates disrupted by ploughing) and increased displacement of carbon-rich surface soil through wind and water erosion (Janzen, 2006). In fact, erosion can lead to considerable carbon losses at the plot scale, but net effects are harder to predict when up-scaling since it depends on the fate of the carbon in the deposition area. It is estimated that about 1.14 Pg

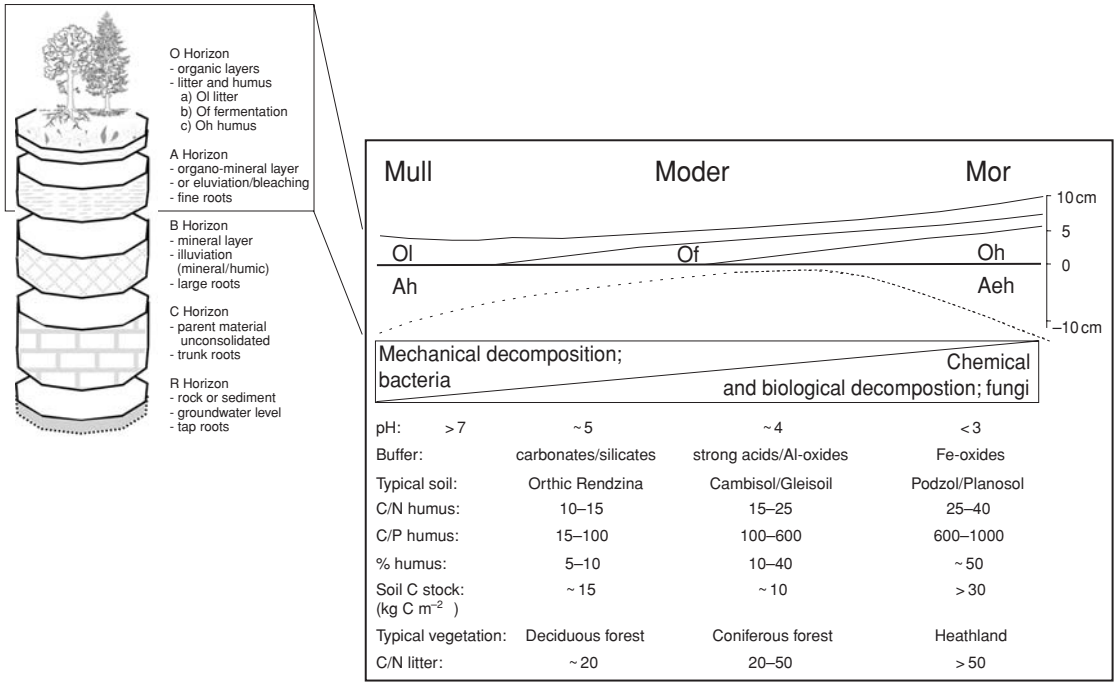

Figure 4.3 Schematic soil profile and humus form description for a typical (semi-natural) mid-latitude soil type (Food and Agriculture Organization of the United Nations (FAO) classification) with generalized information on soil organic carbon and soil biochemical factors. Soil carbon stocks (to 150 cm depth) are taken from the ISLSCP II (ISLSCP II, 2005) database in combination with the FAO soil type map. The enlarged soil profile graphic shows a typical European forest soil with a general overview of organic (i.e. O layers: >30% humus content) and mineral layers and the associated root distribution and basic biochemical pedogenesis processes; most soil carbon is contained in the soil surface layers (i.e. O layers and Ah horizon); % humus refers to the combined O and A horizon layers. Note the link between soil chemical properties and dominant decomposition (i.e. predominantly bacterial vs. fungal decomposition). Data combined from Scheffer and Schachtschabel (1992).

carbon may be annually emitted into the atmosphere through erosion-induced processes (Lal, 2001).

Overall, the largest amounts of net SOC accumulation occur under high or very recalcitrant litter input and low SOC turnover rates; in extreme cases there can be as much as several metres of organic deposits (i.e. peat in Histosols) amounting to several hundred kilograms of carbon per square metre; this is mostly linked to wet and cool, or warm but very humid, regions (Fig. 4.1; e.g. boreal regions and South-East Asian peatlands).

4.1.4 Effects of fire in altering the reservoirs of soil carbon

Nearly all ecosystems in the world will be likely to experience fire activity at some point. Mediterranean ecosystems, for example, are fire dominated and have

been subjected to fire for centuries (Duguay *et al.*, 2006). In tropical peatlands (e.g. Indonesia) fires are mostly anthropogenic, started by local (indigenous) and immigrant farmers or by private companies and government agencies as the principal tool for clearing forests before establishing crops (Page *et al.*, 2002). Moreover fires in tropical savannas (grassland, woodland and forest) are principal sources of CO₂ emission to the atmosphere (Scholes and Andreae, 2000); in these ecosystems, in fact, fire is commonly used to convert forests to agriculture purposes. In the circumpolar taiga (conifer forest) and tundra, fire is one of the most important physical forces that influence vegetation (Timoney and Wein, 1991). In forest ecosystems prescribed fires of low intensity are sometimes used to consume the understorey and part of the forest floor layers to prevent fuel build-up and resulting large-scale forest damage (Ferran *et al.*, 2005).

Fire events mostly consume all litter as well as part of the organic matter; depending on the intensity, this 'burning' can reach quite low into the mineral layers (Duguy *et al.*, 2006) or also peat (Page *et al.*, 2002). Moreover, heating of soil layers alters their physico-chemical properties (Neary *et al.*, 1999) and affects soil nutrients. During a fire, soil nutrients are either volatilized or transformed into ashes and, consequently, after a fire there is generally a net loss of nutrients from the ecosystem (Raison *et al.*, 1985) due to export through leaching, wind blow or erosion (Duguy *et al.*, 2006). However, in the short term soil fertility usually increases after fire due to a higher nitrogen and phosphorus availability in soil solution. Due to the increased pH (i.e. ash) and concentration of base cations soil respiration is temporally enhanced, indicating higher nitrogen mineralization and nitrification. The magnitude of the nutrient flush depends on the temperature and duration of the fire and the amount of organic matter burned (Duguy *et al.*, 2006). Obviously, fire also alters net assimilation rates of the standing vegetation (i.e. leaf damage or loss) causing a decrease in the supply of organic matter and root-derived substrates to the soil for quite some time (Duguy *et al.*, 2006). In particular, in organic soils fires can smoulder underground for long periods leading to considerable carbon losses (Page *et al.*, 2002). Losses of organic carbon and nitrogen caused by volatilization are proportional to fuel consumption or fire intensity or both (Raison *et al.*, 1985). Moreover larger fuel loads result usually in more intense fire and thus larger losses of organic carbon and nitrogen (Duguy *et al.*, 2006). The heat transfer into mineral soil during fire is strongly limited by the insulating effect of the soil (Duguy *et al.*, 2006). For this reason the main short-term effects of fire are expected to occur in the upper 0 to 2 cm layer of mineral soil (Debono and Conrad, 1978).

Duguy *et al.* (2006) reported a significant 25% decrease in soil organic matter from 4.8% to 3.6% due to recurrent fires in a shrubland ecosystem in eastern Spain. In eucalypt forests in Australia, Hopmans *et al.* (2005) found a decrease in labile organic carbon pool fractions and an increase of the proportion of more recalcitrant carbon (i.e. charcoal) in the soil coarse fraction (i.e. >2 mm). Three-and-a-half years after a fire in a garrigue in Spain, Ferran *et al.* (2005) found that the total forest floor layer dry weight amounted to 6.3–9.7 Mg ha⁻¹, approximately half of the unburned control (i.e. 17.6 Mg ha⁻¹); however, fire frequency did not

change soil organic carbon content in the 2.5–10 cm mineral layer. Similarly, Tilman *et al.* (2000) did not detect a significant effect of fire frequencies on soil carbon and fine root mass in either 0–20 cm or 20–100 cm soil depth but a decrease in forest floor carbon. Irvine *et al.* (2007) didn't find significant differences in soil carbon (down to 1 m depth) in semi-arid ponderosa pine stands in Central Oregon between plots with different burning levels. In conclusion, fire in the forest floor and superficial soil layers always decreases carbon contents, whereas losses from the mineral layers depend on fire intensity, frequency and insulating layers. For more detailed information the reader might consult current literature on the topic.

4.1.5 Factors determining soil organic carbon turnover

Organic material entering the soil is subject to biological decay by various types of soil organisms including macro- and megafauna (e.g. earthworms, snails and larvae), mesofauna (e.g. springtails and mites) or microfauna (e.g. nematodes and protozoa), as well as bacteria and fungi. Abiotic chemical oxidation is only of minor importance (Von Lützow *et al.*, 2006). The time organic matter remains in the soil depends on a number of site-specific parameters of which soil temperature, moisture and substrate quality and supply can be seen as most important (Davidson *et al.*, 2006), as they together determine microbial activity.

While probably all SOC can potentially be degraded by microbes, the rate at which it is mineralized also depends on the chemical nature of the organic material itself, its protection against microbial attack and its variability (e.g. litter mixtures might decompose faster; Briones and Ineson, 1996). We can distinguish between primary and secondary chemical recalcitrance of organic matter (Von Lützow *et al.*, 2006): (1) *primary recalcitrance* refers to organic molecules of plant origin, such as lignin, waxes, cutin or suberin, which are less easily degradable by soil organisms than starch or cellulose (Derenne and Largeau, 2001; Bertrand *et al.*, 2006); (2) *secondary recalcitrance*, on the other hand, includes products and residues of soil fauna and microbes (such as murein, chitin, lipids and melanin), charcoal and humic polymers. If chemical recalcitrance were the main factor determining SOM accumulation, this would lead to a selective preservation of those

molecules in old carbon fractions. Instead, a number of studies have shown that apparently old fractions of SOM still contain large amounts of labile organic matter, indicating that other stabilization mechanisms are also involved (Schöning and Kögel-Knabner, 2006), for example sorptive preservation of organic matter in association with certain minerals (such as allophane, poorly crystalline Al and Fe oxides and hydroxides) and metals (Kleber *et al.*, 2005; Wiseman and Püttmann, 2005; Mikutta *et al.*, 2006). Occlusion of organic matter by soil aggregates (in particular in clay soils) can also be of considerable relevance, while intercalation within soil minerals does not seem to be quantitatively important (Von Lützw *et al.*, 2006). In soil carbon models (e.g. CENTURY) such decomposition processes are represented in three arbitrary SOM pools, which only vaguely relate to measurable SOC fractions, with specific turnover rates and an additional clay decomposition modification factor.

4.1.6 Soil organic carbon stocks and climate change

Global temperatures are expected to rise significantly during the twenty-first century and beyond (IPCC, 2007); two hypotheses can be used to predict the potential dynamics of soil carbon stocks in such a changing environment (Garten, 2004).

According to the *first hypothesis* (Fig. 4.4), the decomposition of SOM is more sensitive to temperature change than net primary productivity (NPP),

Hypothesis 1 (Kirschbaum, 1995, 2000)

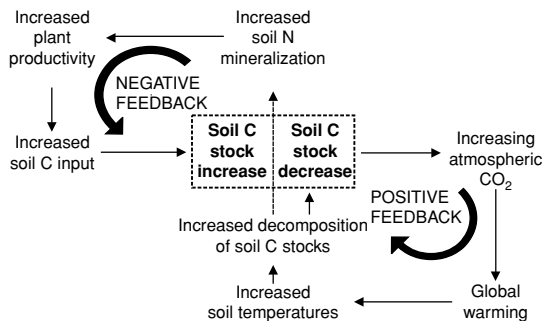

Figure 4.4 Hypothetical effects of climate change due to elevated atmospheric CO₂ concentrations on soil carbon dynamics causing a positive and/or negative feedback to climate change – *Hypothesis 1* (taken from Garten, 2004; modified).

Hypothesis 2 (Berg, 2000; Berg and Meentemeyer, 2002)

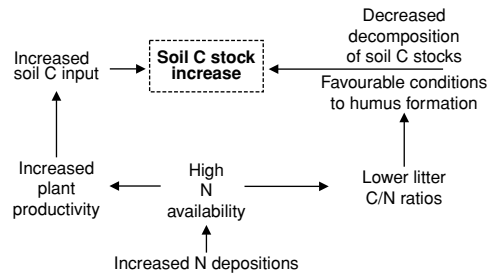

Figure 4.5 Hypothetical effects of environmental change (considering increased N depositions) on soil carbon dynamics causing a negative feedback to climate change – *Hypothesis 2* (taken from Garten, 2004; modified).

consequently increasing temperatures will result in a net transfer of soil carbon to the atmosphere as SOM decomposition is stimulated more than NPP (Kirschbaum, 2000). This would lead to a positive feedback mechanism: the release of soil carbon further increases atmospheric CO₂ concentrations, leading to even higher surface temperatures and consequently more soil carbon loss through accelerated decomposition (Cox *et al.*, 2000). However, there is also a potential inhibitor to this positive feedback. Increased decomposition rates may stimulate greater soil nitrogen availability, leading to higher NPP, which potentially increases carbon inputs into the soil through litter fall and rhizodeposition that would somewhat offset the increased soil carbon loss. In this *first hypothesis* soil carbon dynamics depend on the soil carbon balance changes. Currently it is not known in which direction this soil carbon balance will move (Davidson *et al.*, 2006) but indications are for a net loss (Bellamy *et al.*, 2005). Moreover, according to Sulzman *et al.* (2005), it is inaccurate to assume that an increase in net primary productivity will translate simply into additional below-ground storage. In fact they found that a doubled litter addition in an old growth forest in Oregon resulted in a much higher soil respiration than expected based on the additional carbon added.

The *second hypothesis* (Fig. 4.5) further considers the additional effect of human induced nitrogen (N) fertilization from agricultural fertilizer usage and the combustion of fossil fuel, the former producing predominantly NH₃ (and NO₃), the latter NO_x (NO + NO₂), eventually leading to dry and wet N deposition on vegetation and soil (Galloway and Cowling, 2002). Soil

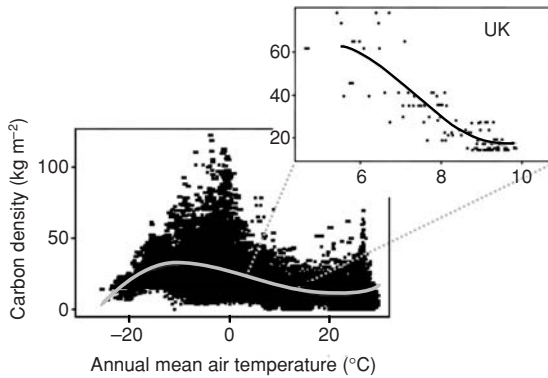

Figure 4.6 Relationship between soil organic carbon densities (carbon stocks) in kg C m^{-2} for global 1° (150 cm soil depth) ISLSCP II data (ORNL DAAC, <http://daac.ornl.gov/>) vs. annual mean air temperatures (CRU05 0.5° 1961–90 mean monthly climatology data, www.cru.uea.ac.uk). The global data show an S-shaped distribution with two maxima in cool (mainly boreal) and tropical regions (where there is a strong correlation with rainfall, data not shown). The inset focuses on the 135 UK data points, showing a strong negative relationship (best fit regression line), indicating a loss of soil carbon of around 5 to 10 kg C m^{-2} per 1°C rise (Heinemeyer *et al.*, unpublished).

carbon stocks might then gain more carbon than they lose due to rising temperatures in a nitrogen-rich environment. Firstly, increased soil N availability would increase NPP and subsequently litter and thus soil carbon inputs (as seen in the first hypothesis). Secondly, although higher N content might stimulate initial litter decomposition it seems to suppress humus decay in later stages (Jandl *et al.*, 2007), thus leading to stabilization of SOM in mineral-associated fractions (Neff *et al.*, 2002). Correspondingly, Berg (2000) and Berg and Meentemeyer (2002) argue that more humus formation occurs with litter of a high N content or a low C/N ratio. In fact, it seems that mineral N input retards decomposition rates of old litter and recalcitrant SOM by suppression of ligninolytic enzymes and chemical stabilization (Berg and Meentemeyer, 2002).

A simple climatic overlay of global soil carbon stocks (Fig. 4.1) illustrates the potential link between key environmental factors such as annual mean air temperature and soil carbon densities (Fig. 4.6); there appears to be a strong correlation between these two variables and in certain regions temperature explains a large part of the variation in soil carbon stocks (Fig. 4.6; UK data). Obviously other factors co-exist and also

impact on soil carbon stocks. However, temperature seems to be one of the most important environmental factors (Amundson, 2001; Rodeghiero and Cescatti, 2005), and interestingly, for the UK analysis, this seems to be supported by measured losses in soil carbon stocks (Bellamy *et al.*, 2005).

4.2 METHODS FOR THE DETERMINATION OF SOIL ORGANIC CARBON CHANGES

When considering a methodology for determining SOC changes we also have to face the problem of trying to detect a small change (i.e. net SOC change over time) in a big number (i.e. soil carbon stock). There are several methods for determining SOC stock changes (Post *et al.*, 2001) and here we shall focus on three methods (Ellert *et al.*, 2001).

1. *Flux approach*: indirectly, by determination of all carbon fluxes entering and leaving the soil over a certain time period.
2. *Repeated inventory approach*: directly, by repeated measurements of SOC stocks at the same location over a period of time.
3. *Examining changes in specific fractions of carbon*: indirectly, by determination of changes in sensitive soil carbon pools or specific fractions (e.g. Six *et al.*, 2002), which might present first indications for long-term changes of total carbon stocks.

Mean soil carbon stocks in Europe, for example, are estimated to be 15.8 kg C m^{-2} to a soil depth of 1 m, and vary from 3.9 kg C m^{-2} for Arenosols (coarse sandy soils) to 72.9 kg C m^{-2} for Histosols (poorly drained, peaty soils) (Batjes, 2002); estimates of mean annual soil carbon stock changes are almost three orders of magnitude lower, with croplands losing soil carbon at a rate of about $70 \text{ g C m}^{-2} \text{ y}^{-1}$, and forests and grasslands gaining carbon at a rate between 37 – $60 \text{ g C m}^{-2} \text{ y}^{-1}$ (Janssens *et al.*, 2005). Therefore, for short-term (<5 years) monitoring, the flux approach is probably the better one, whereas the inventory approach will generate more reliable data in the long term.

4.2.1 The flux approach

In theory, for this *indirect* approach all carbon fluxes into and out of the soil (including methane) would need to be

quantified over time (e.g. over at least one year). Since many fluxes are involved, some of which are difficult to determine (i.e. root exudates, respiration and carbon allocation to mycorrhizal fungi; see Fig. 4.2 and below), a quantification of all fluxes would be very laborious and expensive (note: this would have to include carbon emissions from burning or losses through erosion or harvest products). Therefore, Hanson *et al.* (2000) suggested estimating changes in soil carbon stocks via the following equation:

$$\Delta\text{SOC} = (L_A + L_B) - (R_S - R_R) \quad \text{Eq. (4.1)}$$

where ΔSOC is net carbon change ($\text{g C m}^{-2} \text{ y}^{-1}$) over time; L_A is above-ground litter; L_B is below-ground litter; R_S is total soil CO_2 efflux; R_R is root respiration. The above-ground litter (L_A) is usually sampled with litter traps located on the soil surface collecting all canopy plant residues. Usually in forest ecosystems the woody residues are distinguished into fine woody debris (collected together with the leaf litter) and coarse woody debris, which needs to be sampled separately (e.g. huge branches, stumps or harvest residues along transects). This distinction is due to the different (longer) turnover time of the coarse woody debris. It is crucial to properly evaluate the number of litter traps and their location per unit of surface area with respect to individual canopy structure to reduce sampling errors (Rodeghiero, 2003). For example, within a heterogeneous canopy structure a higher number of traps are required in order to lower sampling errors. The below-ground litter input (L_B) includes all dead root biomass produced during a specified period, which can be derived via: (1) sequential coring; (2) root in-growth cores; (3) rhizotrons and (4) radiocarbon and stable carbon isotope depletion methods (Giardina *et al.*, 2005). However, due to the many assumptions and methodological issues (e.g. higher root growth along rhizotrons due to moisture and angle effects) of these methods, the best would be to apply a combination of approaches, in order to validate the obtained results (Giardina *et al.*, 2005). Besides, there remain many 'flux' components, such as root exudates and mycorrhizal hyphal production and turnover, which can only be estimated with great difficulty. Total soil CO_2 efflux (R_S) is usually evaluated with respiration chambers. The root respiration (R_R) can be determined using various approaches (see reviews by Hanson *et al.*, 2000 and Subke *et al.*, 2006): (1) root exclusion (e.g. girdling, trenching);

(2) physical separation of components; (3) isotope techniques and (4) indirect techniques.

4.2.2 The repeated inventory approach

This approach is based on the *direct* measurement of organic carbon in soil samples taken by two sequential inventories over a long period (i.e. many years). Since annual carbon inputs and outputs are relatively small compared to soil carbon stocks, the time required to detect statistically significant soil carbon stock changes within a site is in the order of at least five to ten years (Post *et al.*, 2001; Smith, 2004).

The soil carbon stock on an area basis (S_C ; kg C m^{-2}) to a depth of, say, 10 cm, can be computed using the following equation:

$$S_C = C_C B_d V H_F \quad \text{Eq. (4.2)}$$

where C_C is soil organic carbon concentration (kg C kg soil^{-1}); B_d is soil bulk density (kg m^{-3}); V is the volume of a soil layer of 10 cm thickness and 1 m^2 surface (i.e. $0.1 \text{ m}^3 \text{ m}^{-2}$); H_F is calculated as $(1 - (\text{stone volume} + \text{root volume})/V)$ and is a dimensionless factor representing the fine soil fraction in a certain soil volume (note that stone and root volumes must be in m^3). The correction for the stone content is especially important as stones contain no organic carbon and not accounting for the stone content (see Section 4.2.4.4) would lead to a substantial overestimation of soil carbon content (Eriksson and Holmgren, 1996; Palmer, 2002; Rodeghiero and Cescatti, 2005).

Depending on the objectives of the monitoring, there are different methodologies available to determine soil carbon concentration, bulk density, and stone and root content, but these methodologies should be fixed over soil type and time. Fortunately, there are some internationally acknowledged protocols that should be taken as guidelines (IPCC, 2003; UNECE, 2003; USDA, 2005; IPCC, 2006) and also some ISO certifications related to soil sampling (ISO, 2002, 2003). Some commonly used methods and their limitations are discussed below. It is important to note that the non-linear negative correlation between carbon concentration and soil bulk density (Fig. 4.7) can lead to an overestimation of soil carbon stocks on an area basis when calculating SOC densities as the product of average carbon concentration, average bulk density and soil depth

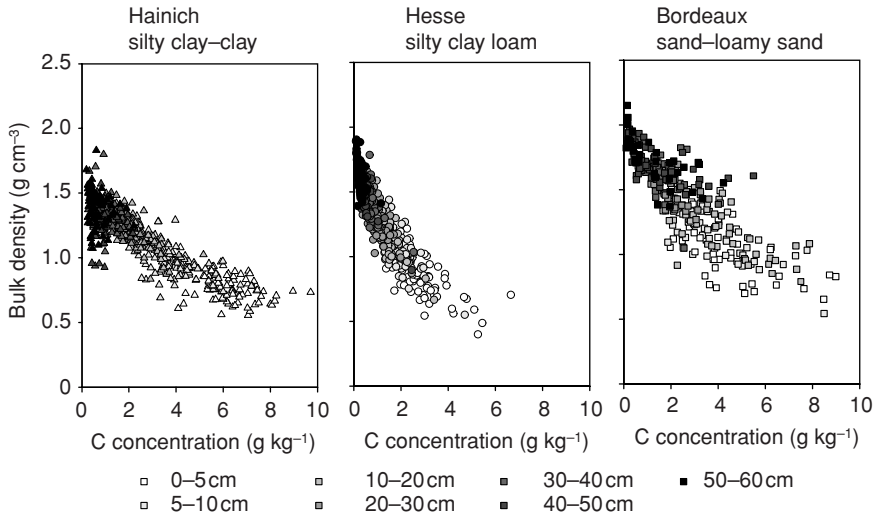

Figure 4.7 Relation between carbon concentrations and bulk densities at different soil depths of two deciduous (Hainich and Hesse) and one coniferous (Bordeaux) forest sites differing in soil texture.

(Conen *et al.*, 2005) unless validated pedotransfer functions are used. Ideally, carbon concentration and bulk density need to be measured for the same soil sample and carbon contents calculated for each individual sample before any eventual averaging.

4.2.3 Examining changes in specific fractions of carbon

Soil organic carbon is composed of many different compounds with different chemical and physical properties, which can be analyzed and subdivided into fractions that are defined by their different turnover times and their pool size. The most common methods to separate the soil organic carbon into fractions are *chemical*, *physical* or a *combination fractionation method* (Von Lützw *et al.*, 2007). The *chemical* methods are based on the extraction of SOM in aqueous solutions, with or without electrolytes, in organic solvents or on the resistance of SOM to oxidation. For example, utilizing sodium hydroxide can determine the fulvic and humic acids and humin content (Palmer, 2002), whereas the chloroform-fumigation method is used to determine the microbial biomass carbon. The *physical* methods, based on the density and dimensions of particles, distinguish between light and heavy SOM fractions, assuming related different chemical, physical and biological properties. The light fraction is considered the youngest

and biologically the most reactive with turnover times between a few months and a few years (Post *et al.*, 2001); it is made of free plant and animal residues (not associated with mineral particles). There is evidence that much of the change in soil organic carbon induced by anthropogenic effects occurs in the light fraction, thus demonstrating the importance of including the measurement of this fraction in monitoring protocols (Jazen *et al.*, 1992). The heavy fraction has been transformed by microbial and faunal action and is stabilized in organo-mineral complexes with clay and silt particles or humic compounds of complex nature. This heavy fraction is the most resistant to further degradation and can remain in the soil for hundreds or even many thousands of years (Post *et al.*, 2001; Schulze and Freibauer, 2005). Finally, the *combined fractionation method* (chemical and physical) can be used to obtain information on different carbon stabilization mechanisms in specific soil horizons and soil types. Among the many available fractionation methods, the most useful are those that lead to homogeneous fractions in terms of their turnover times (Von Lützw *et al.*, 2007). These fractions likely represent functional SOM pools that have been formed by a specific stabilization mechanism (e.g. recalcitrance, organo-mineral interactions etc.); in fact, only such homogeneous fractions enable us to implement any meaningful mechanistic soil carbon model pools with associated turnover times.

Soil analysis

Sampling protocol

Sampling design

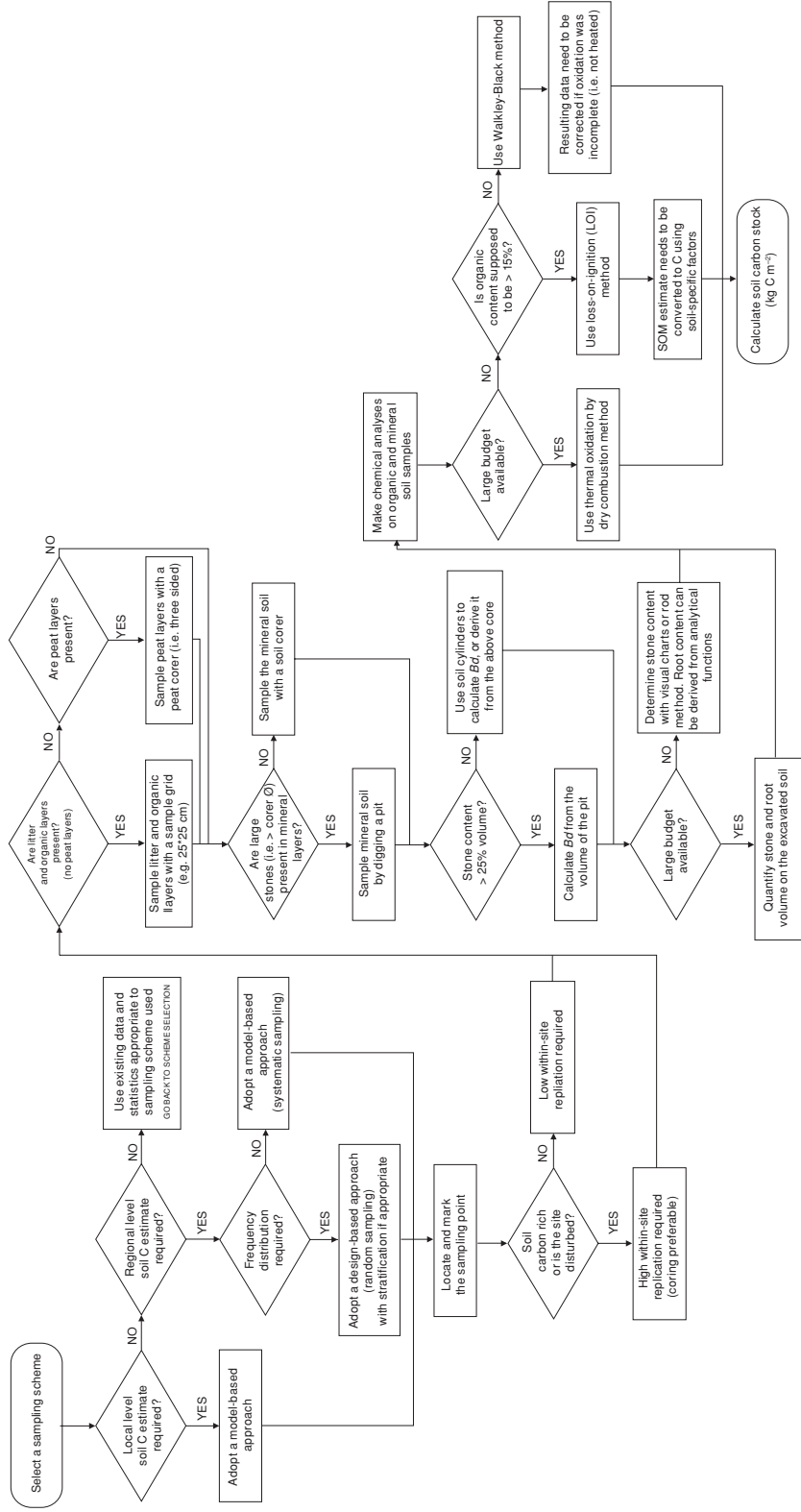

Figure 4.8 Flow chart showing the different steps of soil sampling: from the sampling design, to the soil analysis.

4.2.4 Soil sampling, preparation and analysis

Accurate measurement of soil carbon stocks relies on following a precise sample protocol (including backup samples for possible laboratory inter-comparison or later cross-validation). There are several issues with sampling of soil for analysis; the following section will highlight the most important of these (i.e. sample depth, pooling of samples, bulk density and stone content). In general the best advice is to follow (inter)nationally accepted soil sample protocols (i.e. UNECE, 2003; IPCC, 2003, 2006; USDA, 2005) but to pay attention to site-specific issues such as stoniness or SOM distribution within the soil profile. However, a flow chart which can be of help in working out the major problems related to soil sampling is given in Fig. 4.8.

4.2.4.1 Soil sampling

The way in which a soil sample is taken depends on the aim of the sampling project. Several examples will be given to highlight the problems that can be encountered.

If the distribution of organic carbon throughout the soil profile is of interest the organic and mineral soil layers are collected separately (e.g. soil horizons O, A, B, C; see Fig. 4.3). In forests and soils with poor drainage, huge amounts of organic soil material in different stages of decomposition can accumulate at the soil surface (Fig. 4.3). However, in some soils (e.g. Podsol) much of the SOC can be found in deeper mineral layers. In this particular case, where the whole soil profile is of interest, soil organic as well as above-ground litter layers are usually sampled using square or circular surfaces of constant area (e.g. 25×25 cm), randomly or systematically located inside the sampling area (see MacDicken, 1997; Palmer, 2002; Rodeghiero, 2003). Moreover some dimensional thresholds for woody debris are fixed and gross woody debris (e.g. > 2 cm) can be sampled along additional transects (see, for example, Harmon and Sexton, 1996). The mineral soil can be collected in two ways: by pedogenetic horizon or by depth increments. The choice of the method depends on the objective of the study. Crucially, once the methodology has been chosen, it must be used for the whole monitoring campaign; in fact, it is very difficult or almost impossible to find a correlation between the results of two different methods due to the high variability in carbon concentration in soil horizons (Palmer *et al.*, 2002). The collection of the mineral soil layers can be done using a soil

corer or excavating pits. Usually the soil corer is used in soils with low stone content, whereas pits are used in stony soils where the penetration of the corer to a fixed depth can create problems. Since the creation of soil pits is destructive and time consuming, the total number of soil pits per study site is usually limited; therefore soil corers are the better choice if a higher sample number is needed. However, soil pits allow the use of: (1) sample cylinders of known volume to be inserted into the soil from the side avoiding compaction and thus accurate bulk density estimation and (2) visual charts to estimate stoniness (see Section 4.2.4.4). Although soil profiles are usually sampled to 30 or 100 cm depth (limit of the main rooting depth), organic soils (e.g. peatlands) can be much deeper and the overall depth to be sampled must be specified in the protocol. When sampling organic soils it is important to avoid sample compaction and changes in bulk density (see Section 4.2.4.4). For this, usually three-sided square corers (the fourth side is a cutter) are used of less than 10×10 cm with the sampling depth depending on the purpose of the study, since peat profiles can be much deeper than 1 m (Laiho *et al.*, 2004).

Since organic and mineral layers have different bulk densities (see Section 4.2.4.4), they are usually sampled separately. Problems can arise when fixing a '0 level' for measuring the sampling depth. In fact several authors suggest measuring the sampling depth (e.g. 30 cm) starting from the beginning of the mineral layers independently from the depth of the organic layers (Palmer, 2002; IPCC, 2003; UNECE, 2003; USDA, 2005). In this case the total sampling depth can obviously vary from pit to pit, depending on the depth of the organic horizons. Some others question this approach, arguing that the sampling depth should be measured from the soil surface, so as to maintain that depth constant. Due to the softness and variable depth of the organic layers this last approach is not always the right choice. The important thing is to choose one approach and use it consistently throughout the soil carbon inventory.

When considering the number of soil samples to be collected within a site, Garten and Wullschlegel (1999) developed the concept of *minimum detectable difference* (also see Smith, 2004). They calculated that more than 100 samples (collected with a 2.54 cm diameter corer) have to be collected to detect a 2 to 3% change in soil carbon at any site but that a 10 to 15% change could

Table 4.3 Main methodologies for determining soil carbon content (from MacDicken, 1997 and Palmer, 2002).

Method	Carbon	Principle	Advantages	Disadvantages
Walkley–Black (not heated)	Organic SOM	Organic matter is oxidized to CO ₂ with dichromate in an acid medium.	Very rapid and simple. No need of particular equipment.	Likely incomplete oxidation of organic carbon. Need for correction factors. Disposal of Cr solution.
Walkley–Black (heated)	Organic SOM	As above but in heated solution.	Rapid and simple. Complete oxidation of organic matter occurs.	Chloride, Fe ²⁺ and MnO ₂ interfere with method. Need for correction factors. Specialized equipment needed. Disposal of Cr solution.
Dry combustion	Total (organic, inorganic, charcoal) carbon and SOC	Soil heating at 1000–1500 °C with a catalyst mixture in a stream of O ₂ and measurement of CO ₂ evolved.	Rapid and simple, good precision. Only 10–20 mg of soil needed.	Automated instruments are very expensive. Requires inorganic carbon correction.
LOI (weight loss on ignition)	Organic SOM	Soil samples heated in a muffle furnace (e.g. 400 °C for 16 h). Organic matter estimated by weight loss.	Rapid and inexpensive method.	SOM needs to be converted into SOC with individual conversion factors (regression based). Influence of inorganic C and moisture in clay.

be detected with a reasonable sample size ($n = 16$). The number of soil samples needed to demonstrate the existence of a minimum detectable difference in soil carbon content, for different degrees of statistical confidence, can be obtained by performing a power analysis (Zar, 1996; Smith, 2004). According to Conen *et al.* (2005), on carbon-poor forest sites with little or no disturbance to the soil profile, it is possible to detect changes in total soil organic carbon in the order of 0.5 kg C m^{-2} with manageable sample size even using simple random sampling (i.e. about 50 samples per sampling point); whereas on disturbed forest sites (e.g. ploughed, wind thrown) the required number of samples would be greater than a hundred. In general, carbon-rich soils require a larger number of samples (Conen *et al.*, 2005), because it is more difficult to detect a given, absolute carbon change in a carbon-rich than in a carbon-poor soil (Ellert *et al.*, 2002) due to a relative larger measurement error and variability with higher soil carbon. On a plot scale the heterogeneity of soil carbon will depend, for example, on carbon inputs, bioturbation, texture or iron oxide content (Schrumpf *et al.*, 2008). Consequently, at these sites a paired re-sampling strategy is preferable to a random sampling in order to reduce the sample size (Ellert *et al.*, 2001). The choice of the number of samples within a site depends on the objectives of that sampling and will be discussed in more detail in Section 4.3.

Considering the above problems, it is useful to plan a quality control system based on the collection and analysis of duplicate soil samples (Palmer, 2002). Other potential and very common error sources include, for example, inaccuracy in sampling depth, sample compression (affecting bulk density) due to incorrect use of corers or cylinders, or contamination of the sample during the collection or preparation.

4.2.4.2 Sample treatment and preparation

Generally, care must be taken right from the start, i.e. when taking soil samples back to the laboratory in order to avoid any possible alteration. Soil samples should be allowed to dry at ambient air temperature, although Nelson and Sommers (1996) recommend air-drying samples at 40°C . Whether ambient air temperature or 40°C are used, it is important that the soils are dried as prolonged closure in bags or pots can favour the oxidation of the SOM. Generally, immediate drying prevents further decomposition of organic matter and thus

gives more reliable results. For periods of a few weeks the samples can be stored in a fridge at 4°C , whereas for longer periods (i.e. months) the samples should be stored in a freezer at -20°C (Palmer, 2002). In order to obtain representative and well mixed sub-samples, soils are then usually sieved to 2 mm to obtain the stone-free 'fine-soil' fraction. However, stone and root content need to be recorded beforehand (see Section 4.2.4.4). Sub-samples are then commonly dried for one or two days at 105°C and placed in desiccators before determining air-dry moisture content. For some subsequent analyses (e.g. thermal oxidation, see below) dry soil samples need to be homogenized further by milling or grinding to assure representative aliquots are taken.

4.2.4.3 Soil carbon analyses

There are many methods available to analyze SOM and SOC concentration, each with advantages and disadvantages (Table 4.3; MacDicken, 1997; Palmer, 2002; Bisutti *et al.*, 2004). Whereas wet chemical oxidation methods require the use of hazardous materials, dry combustion analyzers are expensive and can require time-consuming maintenance. In contrast, measurements of SOM with loss-on-ignition (LOI) require only a readily available muffle furnace, drying oven and balance, all relatively inexpensive to purchase, operate and maintain. Commonly the obtained SOM values are then converted into SOC values using conversion factors (e.g. $\text{SOC} = \text{SOM} \times 0.58$). However, some concerns remain over how to convert SOM into SOC content accurately (see Konen *et al.*, 2002) and it is good practice to include an internal laboratory standard in every sample batch analysis. The following section will consider four commonly used procedures in detail.

1. One method widely used during the past fifty years is the Walkley-Black method (based on Walkley and Black, 1934), which measures SOC using a mixture of dichromate and sulphuric acid as oxidation agents with and without heat application (to accelerate and complete the reaction). The advantages are that it is rapid and requires minimum equipment and seems to be most suitable for low organic carbon soils (e.g. $<15\%$). The disadvantages of this method are environmental concerns, as it generates waste containing strong acid and chromium and does not lead to a complete oxidation of all organic soil compounds,

the recovery is therefore highly variable and without heating usually only reaches 75 to 85% of the total organic matter (Bisutti *et al.*, 2004). Therefore, a correction factor has to be applied, based on cross-validation with other methods, which can vary (considerably) between 1.16 to 1.59 for different soils (Nelson and Sommers, 1996) and introduces large uncertainties (see Lettens *et al.*, 2007). However, heating generally improves total carbon oxidation, providing values close to 100% (Bisutti *et al.*, 2004) but this should always be validated by another method as large uncertainties remain.

2. The LOI method measures SOM and is based on the thermal oxidation of organic matter at high temperatures where the weight loss is proportional to the amount of SOM in the sample; this method seems to be more suitable for high organic carbon soils (e.g. >15%). Combustion temperatures given in the literature range between 375 and 800 °C (Bisutti *et al.*, 2004) and further combustion time (usually a few hours) affects the completeness of the oxidation reaction. For more humified organic molecules, temperatures < 500 °C are often not enough for a complete oxidation; while for some more stable compounds such as charcoal, even temperatures of more than 1000 °C are required. An inherent problem of the LOI method is that at higher temperatures water held in soil minerals (even after previous oven drying) is increasingly lost during heating, thus affecting the weight difference. For soils containing inorganic carbon it is assumed that organic matter is oxidized at lower temperatures than carbonate carbon; though most carbonates are probably stable at temperatures up to 450 to 500 °C, MgCO₃ already starts to decompose at temperatures below 400 °C. Overall thermal stability of carbonates depends on their particle size and the SOM content of the sample (Bisutti *et al.*, 2004). Thus, this method should not be applied to samples containing carbonates as well as stable SOM compounds, since the temperature ranges overlap. As the LOI method measures SOM, results are difficult to compare to other methods, as mostly SOM is converted into SOC using soil-specific factors as pointed out by Konen *et al.* (2002).
3. Another method is thermal oxidation by dry combustion using an elemental analyzer or a mass spectrometer. The temperature required for a complete oxidation of SOM by O₂ is 1100 to 1500 °C. This is

a rapid, and probably the most reliable, method to determine SOC content in carbonate-free soil samples. Since only a small amount of soil is required (tens of mg), sample aliquots need to be representative of the whole soil sample. This can be achieved by homogenizing and grinding the sample (e.g. using a mortar or a ball-mill). In samples containing carbonates, those can be removed prior to analysis by acid pre-treatment, e.g. with HCl, H₃PO₄ or H₂SO₃. However, while HCl quantitatively removes all carbonates in the soil with the exception of siderite, it also reacts with some organic carbon in soil samples, especially if samples are heated. The non-oxidizing acids H₃PO₄ and H₂SO₃ are said to be less aggressive against SOM (losses lower than 2%) but they do not remove dolomite and siderite from soil samples (Bisutti *et al.*, 2004). Furthermore, one has to make sure, prior to analysis, that the amount of acid added to the soil and the reaction time is long enough to destroy the carbonates present. Still, some uncertainty about the completeness of the reaction usually remains, and there is a risk of losing SOM during acid treatment. The drying of the samples before organic carbon analyses by dry combustion is also time consuming. However, automatic dry combustion is currently the most widely used and rapid method to analyze soil carbon.

4. The organic carbon content can also be derived indirectly as the difference between total carbon and inorganic carbon in the soil sample. If total carbon is, for example, determined by dry combustion at high temperatures, inorganic carbon can be measured via analyzing the CO₂ evolution after acid treatment of the sample. For the determination of inorganic carbon contents, the same problems as described above for acid treatments and selective removal of SOM by thermal oxidation are also valid here. This method should not be applied to soils containing low amounts of organic carbon but high amounts of inorganic carbon, since the organic carbon content would then be derived as the small difference of two large numbers (total carbon and inorganic carbon) with associated relatively large errors. Overall, the accuracy of the determination of the SOM concentration is always higher in carbonate-free samples.

Because of the many available methods, all with their specific advantages and limitations, it is vital to know

how a sample has been processed when comparing datasets analyzed by different laboratories or inventories. In fact, applying the same protocols at different laboratories can deliver quite different results, exhibiting instrument-specific bias. This enables correction of laboratory-specific differences and is especially important if soil analyses of later soil inventories cannot be performed in the same laboratory or with the same instruments. Though this might sound meticulous, we have to consider the relatively small changes we intend to measure in large existing carbon stocks, which justifies avoiding any bias in sample analyses. For example, Lettens *et al.* (2007) made a comparison between the Walkley–Black and dry combustion methods during the national carbon inventory of Belgium, demonstrating that the latter method led to an increase of 22% of the national stored organic carbon due to underestimation bias by wet oxidation. It might be possible to mathematically correct for such specific methodological bias, enabling comparison of individual worldwide soil carbon inventories (Jankauskas *et al.*, 2006). Otherwise, the comparison of different techniques to determine soil carbon content can often only be done after a stratification of the samples at least by bedrock and texture (Wang *et al.*, 1996). Therefore, it is good practice to store dried soil samples to enable analytical comparisons to be carried out at a later stage (as done by Bellamy *et al.*, 2005).

4.2.4.4 Bulk density and stone content

Bulk density (Bd ; g cm^{-3}) is a measure of soil particle density or compactness in a defined soil volume. Bulk density can be measured on the fine ($< 2 \text{ mm}$) soil fraction, in which case it is necessary to correct for the stone and root volume before calculating carbon stocks, otherwise total carbon stocks might be overestimated.

Commonly, in the mineral layers, bulk density varies between 1 and 2 g cm^{-3} depending on depth, soil type/texture, land use and type of vegetation (De Vos *et al.*, 2005). However, in organic soils (e.g. peat) bulk density can be as low as 0.1 g cm^{-3} and is generally difficult to determine as seasonal moisture changes impact on peat expansion and contraction, considerably changing its bulk density and thus the amount of carbon per unit soil layer. Soil bulk density correlates negatively to SOC content (diminishing with increasing organic carbon content) and also relates to soil texture

(Fig. 4.7). Due to these correlations, soil bulk density can be derived analytically from measures of carbon concentration and/or texture using pedotransfer functions (De Vos *et al.*, 2005). It is important to note that pedotransfer functions not including organic carbon content tend to have small regression coefficients and can predict quite different bulk densities. Furthermore, pedotransfer functions should be calibrated for individual land uses and soil types, and it is important to validate them with field measurements.

In the field, bulk density is usually determined by metal cylinders with a known volume (typically 100 cm^3), which are driven gently into the soil in order to avoid compaction of soil material during sampling. The soil mass per cylinder is weighed after drying (usually at 105°C) and the bulk density of horizon/depth increment (Bd ; g cm^{-3}) is calculated as:

$$Bd = \frac{\text{dry weight of fine soil material/}}{\text{fine soil volume in the cylinder}} \quad \text{Eq. (4.3)}$$

If the soil volume in the metal cylinder includes stones, only the weight of the 2-mm sieved soil sample has to be considered and the volume of the cylinder has to be corrected for the stone and root volume within the cylinder. Overall, the use of metal cylinders for the determination of the bulk density is usually restricted to soils with a stone volume $< 25\%$, since otherwise it is not possible to drive the cylinder properly into the soil.

For the determination of the stone content of a soil horizon, it is not feasible to simply use the stone volume obtained from the metal cylinders of 100 cm^3 , since this would lead to an underestimation of the actual stone content in soils with a higher stone content and/or larger than corer diameter stones. One common method for the determination of bulk density and stone content in stone-rich soils is the excavation method. For this method, a soil monolith with a predefined side length is extracted from the soil and the excavated soil volume has to be determined accurately together with the stone content within the monolith. For the determination of the extracted soil volume, polyurethane foam, sand, water or small plastic balls have been used (Page-Dumroese *et al.*, 1999; Rodeghiero, 2003). An alternative to the volume determination is to try to excavate an exact monolith with exact side length and right angles. Stones reaching into the monolith walls from the pits have to be marked and their selective volume determined

afterwards, since the part inside the monolith belongs to the sample volume while the part still sticking into the soil does not. In order to obtain representative samples of the stone content, the size of the extracted area has to be proportional to the average dimension of the stones (Eriksson and Holmgren, 1996). This method is very laborious, destructive and time consuming but is often the only option in stony soils. Moreover, since it has no obvious bias it is often considered the 'standard' by which other methods are compared (Harrison *et al.*, 2003).

In Sweden and Finland another method has been developed, which can provide faster and cheaper results: the rod penetration method (Viro, 1952). For this method a metal rod (1 cm diameter; Eriksson and Holmgren, 1996) is inserted into the soil with a hammer until it is stopped (to a maximum depth of 40 cm) and the level of penetration of the rod is measured. The operation is randomly repeated 50 to 100 times in a plot. The method has been calibrated by comparison of the average level of penetration of the rod and the effective soil stoniness determined by pit excavation. This method can give reliable results if the soil stoniness is not above 50% in volume (Eriksson and Holmgren, 1996) and is also prescribed by the international directives UNECE (2003). So far, this method has only been calibrated for glacial till soils and its application in other geographic regions still needs to be evaluated.

There is also the possibility of using visual estimates obtained by comparison with surface tables showing the surface area occupied by stones (looking at the side of an excavation pit). Because this method is very subjective, good validation training is essential.

4.2.4.5 Root content

Root biomass (living parts only, as dead roots are part of the SOM) can represent a large portion (e.g. 10 to 40%) of the total biomass of an ecosystem (MacDicken, 1997). Usually the determination of root biomass is carried out by either (1) applying analytical functions linking root biomass to more easily measurable biomass variables (such as root-to-shoot ratios or stem diameter) or (2) sampling root biomass from soil excavation pits (see Section 2.3.1) or soil corers. The choice of the method will depend mostly on economic evaluations since the sampling with both methods is quite difficult and time consuming. Moreover, due to the high spatial (e.g. distance from plant stem) and vertical variability of

the root biomass comparable results are limited. Application of analytical functions is quite limited as they are usually species, site and age specific. However, a collection of functions for the estimation of tree root biomass can be found in Zianis *et al.* (2005). Furthermore, there are also some studies that tested the efficacy and limitation of ground penetrating radar (GPR) in the estimation of large root biomass (e.g. Burtner *et al.*, 2003; Hirano *et al.*, 2009).

4.3 CONSIDERATIONS FOR SOIL CARBON MONITORING SCHEMES

The design of a monitoring scheme depends on the objectives of the scheme and has to consider the appropriate levels of variation in SOC at appropriate scales. For example, is a single site to be investigated for management change effects, or is it a national or regional study monitoring the effects of policy change? The design of the appropriate monitoring scheme would be very different from each other.

The methods for natural resource monitoring in general have been set out in De Gruijter *et al.* (2006) and can be divided into local, regional and global objectives. We will describe the challenges associated with monitoring SOC densities for each of these.

At the *local level* (i.e. where the mean change over time in a small area is the target quantity) the spatial heterogeneity of soil organic carbon and its dynamic nature prevent direct detection of changes on annual or smaller time scales (Post *et al.*, 2001); stratified sampling (e.g. by soil or vegetation type) is one way to increase the precision of the estimates of mean change (see Garnett *et al.*, 2001).

At the *regional level* differences in geology or topography can affect the variation in carbon content. A national or regional soil sampling project should be planned in detail from the beginning and, in particular, the objectives should be agreed and an acceptable level of confidence in the results defined. Following the methodology of designing sampling schemes and choosing the number and position of the sampling plots in De Gruijter *et al.* (2006) the choice is between a design-based and a model-based approach. The design-based approach requires probability sampling (e.g. stratified random sampling) and should be used where the required result is an estimate of the frequency distribution of change in organic carbon or a

parameter of this distribution (e.g. the mean change in organic carbon stock and its standard deviation). The model-based approach, on the other hand, requires systematic sampling (e.g. grid-based sampling) and should be used when prediction of values at individual points or maps are required.

At the national to *global level*, since soils are very dynamic systems, spatial changes have to be considered when estimating carbon balance, as uncertainty increases with up-scaling and the necessary spatial and soil-depth related aggregations. Uncertainties are already large at the regional to national level, and even larger at the global scale. For example, for the global ISLSCP II 1° gridded data (Fig. 4.1 and Table 4.1) only around 4300 real soil pit data for a total of 106 soil type units (i.e. ISRIC-WISE) have been used, without any uncertainty estimate. More importantly, up-scaled soil carbon estimates per biome vary considerably between different datasets (i.e. due to different soil depth and vegetation map data, see Table 4.1). There is certainly scope for an improved global soil dataset using more data and geostatistical approaches.

In practice, soil monitoring schemes tend to be based on soil inventories, designed to estimate regional SOC stock and not its change over time. Thus, when designing a new soil inventory scheme it is important to consider the possibility of repeating the sampling to enable estimation of SOC stock changes. Many soil inventories have been carried out in the past and it can be useful to use the data from these inventories when looking for changes in carbon stocks. However, it is very important that the protocols for these historical inventories are well recorded to ensure that estimates of change are possible (e.g. when using different SOM/SOC methods and conversion factors). Saby *et al.* (2008) have investigated the ability of national soil inventories across Europe to detect changes in organic carbon if they were repeated. They estimate that, with a reasonably dense number of sites, changes in soil carbon should be able to be detected after ten years across the majority of countries in Europe.

Although the design of any SOC monitoring scheme attempts to minimize or allow for all sources of spatial and temporal variability, it is only possible to allow for the within-site or within-plot variability. The size of the 'sample support' and number of individual samples taken within it is an important factor in designing the monitoring scheme. The usual practice

is to take a number of samples at a site and bulk these into one sample, which is then analyzed. This gives an average value with less variability allowing comparison to another site sample taken many years later (Bellamy *et al.*, 2005). Pilot studies can be useful to investigate the within-plot spatial variability of soil carbon and the number of samples that need to be taken at a single site. Regional soil carbon investigations tend to consider only the soil to a depth of usually 30 cm (i.e. topsoil, equal to arable ploughing depth). The choice of sampling depth is determined by two considerations: (1) at a global level around 30 to 70% of the organic carbon is stored in the topsoil (Batjes, 1996; also see Table 4.1) and (2) the topsoil is more frequently subject to anthropogenic and climatic perturbations and land-use changes (Six *et al.*, 1999; Paul *et al.*, 2002; Sun *et al.*, 2004); moreover the organic matter stored in deeper soil layers has turnover times that are much longer than the life span of the above-standing crops or forests. However, some studies demonstrated that soil depths even below 30 cm can have a major impact on the estimates of carbon stock (Harrison *et al.*, 2003; Whitney and Zabowsky, 2004). Therefore, sampling down the entire soil profile is more accurate, in particular for peat soils (i.e. to the mineral soil), as shrinking or expansion of peat due to water table changes alters soil carbon content per depth increment. However, even the mineral soil beneath a peat layer can store large quantities of organic carbon of up to 8 kg C m⁻² (Moore and Turunen, 2004).

4.4 UP-SCALING AND THE ROLE OF MODELS FOR DETECTING SOIL ORGANIC CARBON CHANGES

Regional estimates of carbon stocks can be obtained by extrapolation of data obtained at the plot or field scale. Usually the landscape is divided into homogeneous areas (i.e. stratification) with regard to management and/or soil environmental conditions. Estimates for each patch are then multiplied by its area and the sum of all the areas leads to the regional estimate. Each patch can be defined at various levels based, for example, on soil, climatic or land-use maps, or other data of which there are spatial estimates. The more homogeneous the patches are, the less will be the variation in the estimate of the mean values for each patch. Possible factors for stratification could be: climate, aspect, elevation, soil type and texture. Specifically, significant

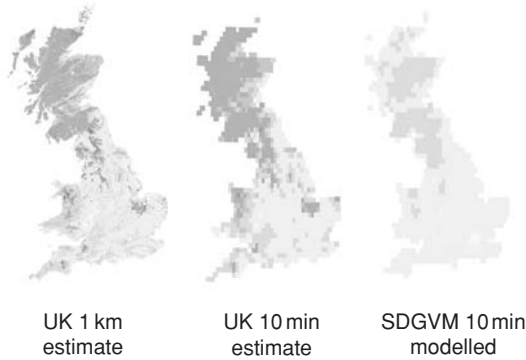

Figure 4.9 Example of up-scaling of best estimate (soil carbon inventory) data (1 km gridded Great Britain soil carbon 2003 inventory) of soil organic carbon densities (carbon stocks) in kg C m^{-2} and its comparison to global model output using a dynamic global vegetation model (SGVM) (with a CENTURY soil carbon sub-model) on a 10 minute grid (all for 100 cm soil depth). Note the good agreement in predominantly arable (mineral soil) regions (e.g. South East England) *vs.* large underestimation in forest and upland (organic soil) regions (e.g. South West England and Scotland) (Heinemeyer *et al.*, unpublished and data source). Legend is the same as in Fig. 4.1.

aggregation errors might be introduced with varying soil texture inside the investigated area. Indeed, silt and clay particles play important roles in physically protecting labile organic matter from decomposition (see Section 4.1.5 and Post *et al.*, 2001).

After a suitable stratification, application of a geographical information system (GIS) can then help significantly with the extrapolation of data to the regional, national or even global scale using many layers related to topography, micro-climate, geology, vegetation and factors that could influence soil formation. Two useful examples are: (1) the US database STATSGO (State Soil Geographic), which contains information on the soils of the entire nation and was thus used to create the national soil carbon map (Guo *et al.*, 2006) and (2) the European soil carbon map (Jones *et al.*, 2005). GIS models can also be used together with digital elevation models (DEMs) in order to account for topography effects on surface area (Garnett *et al.*, 2001). Also satellite images and remote sensing data can help with stratification and land-use change assessments.

The aim of process models is to reproduce the soil carbon dynamics in the form of equations. These models in combination with GIS and remotely sensed

data can be useful to predict changes in the soil carbon stock in the long term (Post *et al.*, 2001). Among the most common and widely used models are: RothC (Rothamsted Carbon Model; Coleman and Jenkinson, 1996); CENTURY (Parton *et al.*, 1988); DNDC (Li *et al.*, 1994) and SOCRATES (Grace and Ladd, 1995), all of which describe processes, such as transformation, protection and mineralization of SOM, at various levels of detail and with different dependencies on environmental conditions. Consequently, each model has its own power and limitations, and their results should always be validated with experimental data.

Another model consideration is the problem of up-scaling to a coarser resolution; Fig. 4.9 illustrates both these problems for the UK. Although model- and ground-based estimates agree well at the 10 minute grid scale in predominantly mineral soil regions, in regions of higher organic soil carbon content (i.e. Scotland), the model fails to deliver a reasonable estimate compared to the up-scaled UK best estimate (based on 1 km grid data). Further, the up-scaling of the best estimate to 10 minute gridded data also leads to an underestimation of carbon stocks in organic carbon-rich soil regions (e.g. Scotland). This example shows that process-based model estimates need to consider the level of detail they will be operated at; this also applies to data inputs (i.e. soil texture data might be available at different scales). However, the uncertainty related to such up-scaling or extrapolation is difficult to estimate without high-resolution ground-based measurements.

4.5 SOIL CARBON STOCK CHANGES: SOME PRACTICAL EXAMPLES

Bellamy *et al.* (2005) determined the carbon stock change in the UK, in the period 1978–2003 at a depth of 15 cm using the data from the national soil inventory of England and Wales. This inventory was based on a sampling grid of 5 km, for a total of 6000 points covering all possible land uses. At each sampling site 25 soil cores were collected in a systematic way and bulked. Forty per cent of the points were sampled again after between 12 and 25 years. This study showed a loss of 13 million tonnes of carbon per year (about 0.6% of the UK soil carbon stocks), corresponding to about 9% of UK CO_2 emissions, equivalent to the UK's CO_2 emission reductions achieved between 1990 and 2002

(12.7 million tonnes of carbon per year). The greatest losses were observed in the organic, carbon-rich soils; moreover, no relationship was found between the rate of loss of soil carbon and land-use type. This study gives a first indication of a real positive feedback effect of climate change on soil carbon stocks, as during the study period average air temperatures in the UK increased by 0.5°C (Schulze and Freibauer, 2005). However, no bulk density data were collected and so these data could not be expressed as carbon densities (i.e. ignoring peat shrinking and expanding effects on measured organic carbon contents per depth increment) and further SOM analysis differed between analyses.

In Belgium Lettens *et al.* (2005) investigated SOC changes in the whole of Belgium ($30\,599\text{ km}^2$), which was divided into 567 landscape units obtained by intersecting maps of land use and soil type. The SOC stock for 1960 was derived from data of carbon concentration, stone content, soil horizon depth and bulk density (using pedotransfer functions). Soil sampling campaigns were performed between 1950 and 1970; they were then repeated in the 1980s and again between 1997 and 2002. Soil carbon stock changes were derived from the differences between sampling periods, e.g. 1960, 1990 and 2002. In 17% of the landscape units, a significant increment of the topsoil (30 cm) carbon stock was observed, whereas 16% showed a significant decrease, both were related to land use. Between 1960 and 2000 the largest and smallest increments were recorded in the mixed and broadleaves forests ($+29\text{ Mg C ha}^{-1}$) and grasslands ($+9\text{ Mg C ha}^{-1}$), respectively. On the whole, the topsoil carbon stock of rural Belgium increased from 140 Mt C in 1960 to 157 Mt C in 2000. The average stock per unit surface increased from 58 Mg C ha^{-1} to 65 Mg C ha^{-1} .

4.6 CONCLUSIONS

Globally soils store a significant quantity of organic carbon (Table 4.1). A major concern is the potential feedback between increasing global air temperatures and enhanced soil respiration, depleting soil carbon stocks and adding to the atmospheric CO_2 rise (Schlesinger and Andrews, 2000). International environmental policy programmes (e.g. the Kyoto Protocol) are increasingly requiring assessment of the soil carbon sink or source potential, and more accurate net soil carbon balance measurements. However, the researcher is faced

with the problem of detecting a 'small change in a big number' requiring consideration of methodology, sampling design and carbon analysis.

There are two most effective methods to determine soil carbon changes over time: (1) the indirect flux approach and (2) the repeated inventory approach. The 'small change in a big number' issue suggests that for short time periods the flux approach is preferable to the inventory approach and *vice versa*. However, for each method there are considerable simplifications and uncertainties (e.g. DOC export, root exudates, mycorrhizal hyphal production as well as analytical issues). Importantly, the inventory approach requires a consistent sampling and analytical approach between inventories to allow meaningful comparison and detect changes in soil carbon stocks with sufficient precision. In particular, soil sampling and measurements of soil bulk density has been highlighted as a source of significant error in SOC stocks and their estimated changes.

Sampling design for the repeated inventory approach depends on the monitoring purpose, the scale of interest (plot, region or country) and the variability of the indicator to be measured at the scale of interest. The collection of samples must follow a strict protocol, which must be maintained for the re-sampling events. Usually for a regional or national monitoring network the samples are taken on a fixed pattern within a site and are bulked to allow for the local spatial variation. Moreover, among the different soil sampling methods, sampling by depth increments can sometimes be more useful than sampling by soil horizon and does not require specialized knowledge, thus saving on necessary field sampling time. The sampling technique itself will depend on the soil type and in particular the soil stone content, either allowing soil coring or requiring soil excavation pits, sometimes the best strategy when considering obtaining accurate stone and root biomass data. Peat soils are a particular case requiring prevention of compaction and soil depth consideration with reference to water content related bulk density changes. Moreover, when planning a sampling scheme it is necessary to consider how many samples will need to be taken to demonstrate a change in soil carbon (minimum detectable difference) and after how long this change will be detectable. In fact, according to Smith (2004), due to the large spatial variability of soil carbon content, the detection of a change in soil carbon stocks

over a five-year period (e.g. the commitment period of the Kyoto Protocol) will be very difficult, if not impossible.

Several methods of analyzing soil for organic carbon were considered: LOI is a straightforward analysis but the necessary assumptions and corrections somewhat limit its accuracy and comparability. Dry combustion with an elemental analyzer is now commonly used, although the small sample size requires well homogenized sub-samples, potentially increasing inter-sample variability. However, it is very important to archive samples for consistency within a (repeated) sampling protocol to allow for laboratory cross-calibration and to assess comparability.

Overall, the conversion of soils from natural ecosystems into managed systems (e.g. ploughing) will lead to significant losses of soil carbon and, conversely, allow considerable amounts of SOM re-accumulation (Post and Kwon, 2000). Consequently, soils have been identified as a potentially significant carbon sink to mitigate increasing atmospheric CO₂ concentration (e.g. Kyoto Protocol; IPCC reports). Nevertheless, the amount of potential carbon sequestered in soil is limited (Gill *et al.*, 2002; Kool *et al.*, 2007) as each soil has a maximum carbon storage capacity or a near equilibrium level mainly depending on vegetation type, precipitation and temperature (Gupta and Rao, 1994). Recently, there has been evidence on the limited soil carbon storage potential under elevated atmospheric CO₂ from natural CO₂ spring and elevated CO₂ canopy level studies (Heath *et al.*, 2005; Kool *et al.*, 2007). However, the total potential of soil carbon sequestration (over a limited period) can be estimated around 0.6 to 1.2 Pg C y⁻¹ (Lal, 2004), which could offset about one third the annual increase in atmospheric carbon (which is currently increasing at a rate of more than 3 Pg C y⁻¹).

REFERENCES

- Amundson, R. (2001) The carbon budget in soils. *Annual Review of Earth Planetary Science*, **29**, 535–62.
- Batjes, N. H. (1996) Total carbon and nitrogen in the soils of the world. *European Journal of Soil Science*, **47**, 151–63.
- Batjes, N. H. (2002) Carbon and nitrogen stocks in the soils of Central and Eastern Europe. *Soil Use and Management*, **18**, 324–9.
- Bellamy, P. H., Loveland, P. J., Bradley, R. I., Lark, R. M. and Kirk, G. J. D. (2005) Carbon losses from all soils across England and Wales 1978–2003. *Nature*, **437**, 245–8.
- Berg, B. (2000) Litter decomposition and organic matter turnover in northern forest soils. *Forest Ecology and Management*, **133**, 13–22.
- Berg, B. and Meentemeyer, V. (2002) Litter quality in a north European transect versus carbon storage potential. *Plant and Soil*, **242**, 83–92.
- Bertrand, I., Chabbert, B., Kurek, B. and Recous, S. (2006) Can the biochemical features and histology of wheat residues explain their decomposition in soil? *Plant and Soil*, **281**, 291–307.
- Bisutti, I., Hilke, I. and Raessler, M. (2004) Determination of total organic carbon: an overview of current methods. *Trends in Analytical Chemistry*, **23**, 716–26.
- Bolin, B., Sukumar, R., Ciais, P. *et al.* (2001) The global perspective. In *IPCC Special Report on Land Use, Land-use Change and Forestry*, ed. R. T. Watson, I. R. Noble, B. Bolin *et al.* Cambridge: Cambridge University Press, pp. 23–51.
- Brienes, M. J. I. and Ineson, P. (1996) Decomposition of eucalyptus leaves in litter mixtures. *Soil Biology and Biochemistry*, **28**, 1381–8.
- Burntor, J. R., Doolittle, J. A., Johnsen, K. H. *et al.* (2003) Utility of ground penetrating radar as a root biomass survey tool in forest systems. *Soil Science Society of America Journal*, **67**, 1607–15.
- Coleman, K. and Jenkinson, D. S. (1996) RothC 26.3: a model for the turnover of carbon in soil. In *Evaluation of Soil Organic Matter Models Using Existing Long-term Datasets*, ed. D. S. Powlson, P. Smith and J. U. Smith, Vol. 38, NATO ASI Series I. Heidelberg: Springer-Verlag, pp. 237–46.
- Conen, F., Zerva, A., Arrouays, D. *et al.* (2005) The carbon balance of forest soils: detectability of changes in soil carbon stocks in temperate and boreal forests. In *The Carbon Balance of Forest Biomes*, ed. H. Griffiths and P. G. Jarvis. Oxford: Bios Scientific Press, pp. 233–47.
- Cox, P. M., Betts, R. A., Jones, C. D. *et al.* (2000) Acceleration of global warming due to carbon-cycle feedbacks in a coupled climate model. *Nature*, **408**, 184–7.
- Davidson, E. A., Janssens, I. A. and Luo, Y. (2006) On the variability of respiration in terrestrial ecosystems: moving beyond Q₁₀. *Global Change Biology*, **12**, 154–64.

- Debano, L. F. and Conrad, C. E. (1978) The effect of fire on nutrients in a chaparral ecosystem. *Ecology*, **59**, 489–97.
- De Gruijter, J., Brus, D., Bierkens, M. and Knotters, M. (2006) *Sampling for Natural Resource Monitoring*. Berlin: Springer.
- Derenne, S. and Largeau, C. (2001) A review of some important families of refractory macromolecules: composition origin, and fate in soils and sediments. *Soil Science*, **166**, 833–47.
- De Vos, B., Van Meirvenne, M., Quataert, P., Deckers, J. and Muys, B. (2005) Predictive quality of pedotransfer functions for estimating bulk density of forest soils. *Soil Science Society of America Journal*, **69**, 500–10.
- Duguay, B., Rovira, P. and Vallejo, R. (2006) Land-use history and fire effects on soil fertility in eastern Spain. *European Journal of Soil Science*, **58**, 83–91.
- Ellert, B. H., Jazen, H. H. and McConkey, B. G. (2001) Measuring and comparing soil carbon storage. In *Chapter 10: Assessment Methods for Soil Carbon*, ed. R. Lal, J. M. Kimble, R. F. Follet and B. A. Stewart. Boca Raton, FL: CRC Press, pp. 131–46.
- Ellert, B. H., Jazen, H. H. and Entz, T. (2002) Assessment of a method to measure temporal change in soil carbon storage. *Soil Science Society of America Journal*, **66**, 1687–95.
- Eriksson, P. C. and Holmgren, P. (1996) Estimating stone and boulder content in forest soils: evaluating the potential of surface penetration method. *Catena*, **28**, 121–34.
- Fahey, T. J., Siccama, T. G., Driscoll, C. T. *et al.* (2005) The biogeochemistry of carbon at Hubbard Brook. *Biogeochemistry*, **75**, 109–76.
- Ferran, A., Delitti, W. and Vallejo, V. R. (2005) Effects of fire recurrence in *Quercus coccifera* L. shrublands of the Valencia Region (Spain): II. Plant and soil nutrients. *Plant Ecology*, **177**, 71–83.
- Freeman, C., Evans, C. D. and Monteith, D. T. (2001) Export of organic carbon from peat soils. *Nature*, **412**, 785.
- Galloway, J. N. and Cowling, E. B. (2002) Reactive nitrogen and the world: 200 years of change. *Ambio*, **31**, 64–71.
- Garnett, M. H., Ineson, P., Stevenson, A. C. and Howard, D. C. (2001) Terrestrial organic carbon storage in a British moorland. *Global Change Biology*, **7**, 375–88.
- Garten, Jr. C. T. (2004) *Soil Carbon Dynamics Along an Elevation Gradient in the Southern Appalachian Mountains*. US Department of Energy, Environmental Science Division, Oak Ridge National Laboratory, ORNL/TM-2004/50, pp. 1–26.
- Garten, C. T. and Wulfschlegel, S. D. (1999) Soil carbon inventories under a bioenergy crop (*Panicum virgatum*): measurements limitations. *Journal of Environmental Quality*, **28**, 1359–65.
- Garten, Jr. C. T., Post III, W. M., Hanson, P. J. and Cooper, L. W. (1999) Forest soil carbon inventories and dynamics along an elevation gradient in the southern Appalachian Mountains. *Biogeochemistry*, **45**, 115–45.
- Giardina, C. P., Coleman, M. D., Hancock, J. E. *et al.* (2005) The response of belowground carbon allocation in forests to global change. In *Tree Species Effects on Soils: Implications for Global Change*, ed. D. Binkley and O. Menyailo, NATO Science Series. Dordrecht: Kluwer Academic Publishers, pp. 120–54.
- Gill, R. A., Polley, H. W., Johnson, H. B. *et al.* (2002) Nonlinear grassland responses to past and future atmospheric CO₂. *Nature*, **417**, 279–82.
- GLC (2003) Global Land Cover 2000 database. European Commission, Joint Research Centre. Available at: www.gvm.jrc.it/glc2000.
- Grace, P. R. and Ladd, J. N. (1995) SOCRATES v2.00 User Manual. Cooperative research centre for soil and land management, PMB 2 Glen Osmond 5064, South Australia.
- Guo, Y., Amundson, R., Gong, P. and Yu, Q. (2006) Quantity and spatial variability of soil carbon in the conterminous United States. *Soil Science Society of America Journal*, **70**, 590–600.
- Gupta, R. K. and Rao, D. L. N. (1994) Potential of wastelands for sequestering carbon by reforestation. *Current Science*, **66**, 378–80.
- Hanson, P. J., Edwards, N. T., Garten, C. T. and Andrews, J. A. (2000) Separating root and soil microbial contributions to soil respiration: a review of methods and observations. *Biogeochemistry*, **48**, 115–46.
- Harrison, R. B., Adams, A. B., Licata, C. *et al.* (2003) Quantifying deep-soil and coarse-soil fractions: avoiding sampling bias. *Soil Science Society of America Journal*, **67**, 1602–6.
- Harmon, M. E. and Sexton, J. (1996) *Guidelines for Measurements of Woody Detritus in Forest Ecosystems*. US LTER Publication No. 20. Seattle: LTER Network Office, University of Washington.
- Heath, J., Ayres, E., Possell, M. *et al.* (2005) Rising atmospheric CO₂ reduces sequestration of root-derived soil carbon. *Science*, **309**, 1711–13.

- Hirano, Y., Dannoura, M., Aono, K. *et al.* (2009) Limiting factors in the detection of tree roots using ground-penetrating radar. *Plant and Soil*, **319**, 15–24.
- Hopmans, P., Bauhus, J., Khanna, P. and Weston, C. (2005) Carbon and nitrogen in forest soils: potential indicators for sustainable management of eucalypt forests in south-eastern Australia. *Forest Ecology and Management*, **220**, 75–87.
- Irvine, J., Law, B. E. and Hibbard, K. A. (2007) Postfire carbon pools and fluxes in semiarid ponderosa pine in Central Oregon. *Global Change Biology*, **13**, 1–13.
- IPCC (1990) *Climate Change: The IPCC Scientific Assessment*, ed. J. T. Houghton, G. J. Jenkins and J. J. Ephraums. Cambridge: Cambridge University Press.
- IPCC (2003) *Good Practice Guidance for Land Use, Land Use Change and Forestry*, ed. J. Penman, M. Gytarsky, T. Hiraishi *et al.* Japan: IPCC/OECD/IEA/IGES.
- IPCC (2006) *Guidelines for National Greenhouse Gas Inventories, Prepared by the National Greenhouse Inventories Programme*, ed. H. S. Eggleston, L. Buendia, K. Miwa, T. Ngara and K. Tanabe, Vol. 4, Agriculture, forestry and other land use. Hayama, Japan: IGES.
- IPCC (2007) *Climate Change 2007: The Physical Science Basis*. Contribution of Working Group I to the Fourth Assessment Report of the Intergovernmental Panel on Climate Change, ed. S. Solomon, D. Qin, M. Manning *et al.* Cambridge: Cambridge University Press.
- ISLSCP II (2005) *Global Gridded Surfaces of Selected Soil Characteristics for the International Satellite Land Surface Climatology Project (ISLSCP) Initiative. II. Data Collection*, ed. F. G. Hall, G. Collatz, S. Los, E. Brown de Colstoun and D. Landis, ISLSCP Initiative II. NASA. DVD/CD-ROM. NASA, 2005. Available at: http://islsnp2.sesda.com/ISLSCP2_1/html_pages/groups/hyd/islsnp2_soils_1deg.html.
- ISO (2002) Soil Quality – Sampling – Part 1: Guidance on the design of sampling programmes, ISO/FDIS 10381–1:2002.
- ISO (2003) Soil Quality – Sampling – Part 4: Guidance on the procedure for investigation of natural, near natural and cultivated sites, ISO/FDIS 10381–4:2003.
- Jankauskas, B., Slepetiene, A., Jankauskiene, G., Fullen, M. A. and Booth, C. A. (2006) A comparative study of analytical methodologies to determine the soil organic matter content of Lithuanian Eutric Albeluvisols. *Geoderma*, **136**, 763–73.
- Jandl, R., Linder, M., Vesterdal, L. *et al.* (2007) How strongly can forest management influence soil carbon sequestration? *Geoderma*, **137**, 253–68.
- Janssens, I. A., Freibauer, A., Schlamadinger, B. *et al.* (2005) The carbon budget of terrestrial ecosystems at country-scale: a European case study. *Biogeosciences*, **2**, 15–26.
- Jazen, H. H., Campbell, C. A., Brandt, S. A., Lafond, G. P. and Townley-Smith, L. (1992) Light-fraction organic matter in soil from long-term rotations. *Soil Science Society of America Journal*, **56**, 1799–806.
- Janzen, H. H. (2004) Carbon cycling in earth systems: a soil science perspective. *Agriculture, Ecosystems and Environment*, **104**, 399–417.
- Janzen, H. H. (2006) The soil carbon dilemma: shall we hoard it or use it? *Soil Biology and Biochemistry*, **38**, 419–24.
- Jones, R. J. A., Hiederer, R., Rusco, E. and Montanarella, L. (2005) Estimating organic carbon in the soils of Europe for policy support. *European Journal of Soil Science*, **56**, 655–71.
- Kirschbaum, M. U. F. (1995) The temperature dependence of soil organic matter decomposition and the effect of global warming on soil organic carbon storage. *Soil Biology and Biochemistry*, **27**, 753–60.
- Kirschbaum, M. U. F. (2000) Will changes in soil organic carbon act as a positive or negative feedback on global warming? *Biogeochemistry*, **48**, 21–51.
- Kleber, M., Mikutta, R., Torn, M. S. and Jahn, R. (2005) Poorly crystalline mineral phases protect organic matter in acid subsoil horizons. *European Journal of Soil Science*, **56**, 717–25.
- Konen, M. E., Jacobs, P. M., Burras, C. L., Talaga, B. J. and Mason, J. A. (2002) Equations for predicting soil organic carbon using loss-on-ignition for North Central U.S. Soils. *Soil Science Society of America Journal*, **66**, 1878–81.
- Kool, D. M., Chung, H., Tate, K. R. *et al.* (2007) Hierarchical saturation of soil carbon pools near a natural CO₂ spring. *Global Change Biology*, **13**, 1282–93.
- Laiho, R., Penttilä, T. and Laine, J. (2004) Variation in soil nutrient concentrations and bulk density within peatland forest sites. *Silva Fennica*, **38**, 29–41.
- Lal, R. (2001) Fate of the eroded soil carbon: emission or sequestration. In *Soil Carbon Sequestration and the Greenhouse Effect*, ed. R. Lal, Vol. 57. Madison, WI: Soil Science Society of America special publication, pp. 173–81.

- Lal, R. (2004). Soil carbon sequestration to mitigate climate change. *Geoderma*, **123**, 1–22.
- Leemans, R. (1992) Global Holdridge life zone classifications. Digital raster data on a 0.5-degree Cartesian orthonormal geodetic (lat/long) 360 × 720 grid. In Global ecosystems database Version 2.0. Boulder, CO: NOAA National Geophysical Data Center. Two independent single-attribute spatial layers. 537 430 bytes in 8 files. (First published in 1989).
- Letens, S., Orshoven, J. V., van Wesemael, B., Muys, B. and Perrin, D. (2005) Soil organic carbon changes in landscape units of Belgium between 1960 and 2000 with reference to 1990. *Global Change Biology*, **11**, 2128–40.
- Letens, S., De Vos, B., Quataert, P. *et al.* (2007) Variable carbon recovery of Walkley–Black analysis and implications for national soil organic carbon accounting. *European Journal of Soil Science*, **58**, 1244–53.
- Li, C., Frolking, S. and Harriss, R. (1994) Modeling carbon biogeochemistry in agricultural soils. *Global Biogeochemical Cycles*, **8**, 237–54.
- MacDicken, K. G. (1997) *A Guide to Monitoring Carbon Storage in Forestry and Agroforestry Projects*. Winrock: International Institute for Agricultural Development.
- Majdi, H. (2001) Changes in fine root production and longevity in relation to water and nutrient availability in a Norway spruce stand in northern Sweden. *Tree Physiology*, **21**, 1057–61.
- Miltner, A., Kopinke, F. D., Kindler, R. *et al.* (2005) Non-photosynthetic CO₂ fixation by soil microorganisms. *Plant and Soil*, **269**, 193–203.
- Mikutta, R., Kleber, M., Torn, M. S. and Jahn, R. (2006) Stabilization of soil organic matter: association with minerals or chemical recalcitrance? *Biogeochemistry*, **77**, 25–56.
- Moore, T. R. and Turunen, J. (2004) Carbon accumulation and storage in mineral subsoil beneath peat. *Soil Science Society of America Journal*, **68**, 690–6.
- Nadelhoffer, K. J. and Raich, J. W. (1992) Fine root production estimates and belowground carbon allocation in forest ecosystems. *Ecology*, **73** (4), 1139–47.
- Neary, D. G., Klopatek, C. C., DeBano, L. F. and Folliot, P. F. (1999) Fire effects on belowground sustainability: a review and synthesis. *Forest Ecology and Management*, **122**, 51–71.
- Neff, J. C., Townsend, A. R., Gleixner, G. *et al.* (2002) Variable effects of nitrogen additions on the stability and turnover of soil carbon. *Nature*, **419**, 915–17.
- Nelson, D. W. and Sommers, L. E. (1996) Total carbon, organic carbon, and organic matter. In *Methods of Soil Analysis*, ed. D. L. Sparks. SSSA Book Series no. 5, Part 3. Chemical methods. Madison, WI: SSSA/ASA, pp. 961–1010.
- Page, S. E., Siegert, F., Rieley, J. O. *et al.* (2002) The amount of carbon released from peat and forest fires in Indonesia during 1997. *Nature*, **420**, 61–5.
- Page-Dumroese, D. S., Jurgensen, M. F., Brown, R. E. and Mroz, G. D. (1999) Comparison of methods for determining bulk densities of rocky forest soils. *Soil Science Society of America Journal*, **63**, 379–83.
- Palmer, C. J. (2002) Techniques to measure and strategies to monitor forest soil carbon. In *The Potential of U.S. Forest Land to Sequester Carbon and Mitigate the Greenhouse Effect*, ed. J. R. Kimble, R. Lal, L. Heath and R. Birdsey. Boca Raton, FL: CRC Press, pp. 73–90.
- Palmer, C. J., Smith, W. D. and Conkling, B. L. (2002) Development of a protocol for monitoring status and trends in forest soil carbon at a national level. *Environmental Pollution*, **116**, 209–19.
- Parton, W. J., Stewart, J. W. B. and Cole, C. V. (1988) Dynamics of C, N, P and S in grasslands soils: a model. *Biogeochemistry*, **5**, 109–31.
- Paul, K. I., Polglase, P. J., Nyakuengama, J. G. and Khanna, P. K. (2002) Change in soil carbon following afforestation. *Forest Ecology and Management*, **168**, 241–57.
- Post, W. M. and Kwon, K. C. (2000) Soil carbon sequestration and land use change: processes and potential. *Global Change Biology*, **6**, 317–27.
- Post, W. M., Izaurralde, R. C., Mann, L. K. and Bliss, N. (2001) Monitoring and verifying changes of organic carbon in soil. *Climatic Change*, **51**, 73–99.
- Pregitzer, K. S. and Euskirchen, E. S. (2004) Carbon cycling and storage in world forests: biome patterns related to forest age. *Global Change Biology*, **10**, 2052–77.
- Raich, J. W., Potter, C. S. and Bhagawati, D. (2002) Interannual variability in global soil respiration, 1980–94. *Global Change Biology*, **8**, 800–12.
- Raison, R. J., Khanna, P. K. and Woods, P. V. (1985) Transfer of elements to the atmosphere during low-intensity prescribed fires in three subalpine eucalypt forests. *Canadian Journal of Forest Research*, **15**, 657–64.

- Rasse, D. P., Rumpel, C. and Dignac, M. F. (2005) Is soil carbon mostly root carbon? Mechanisms for a specific stabilisation. *Plant and Soil*, **269**, 341–56.
- Rodeghiero, M. (2003) Flussi e depositi di carbonio nei suoli di ecosistemi forestali lungo un gradiente altitudinale: variabilità spazio-temporale e determinanti ecologiche. Ph.D. thesis, Università degli Studi di Padova (in Italian, English abstract).
- Rodeghiero, M. and Cescatti, A. (2005) Main determinants of forest soil respiration along an elevation/temperature gradient in the Italian Alps. *Global Change Biology*, **11**, 1024–41.
- Ruess, R. W., Van Cleve, K., Yarie, J. and Viereck, L. A. (1996) Contributions of fine root production and turnover to the carbon and nitrogen cycling in taiga forests of the Alaskan interior. *Canadian Journal of Forest Research*, **26**, 1326–36.
- Saarnio, S., Morero, M., Shurpali, N. J. *et al.* (2007) Annual CO₂ and CH₄ fluxes of pristine boreal mires as a background for the lifecycle analyses of peat energy. *Boreal Environment Research*, **12**, 101–13.
- Saby, N. P. A., Bellamy, P. H., Morvan, X. *et al.* (2008) Will European soil monitoring networks be able to detect changes in topsoil organic carbon context? *Global Change Biology*, **14**, 2432–42.
- Scheffer, F. and Schachtschabel, P. (1992) *Lehrbuch der Bodenkunde*. Stuttgart, Germany: Enke Verlag.
- Schimel, D. S. (1995) Terrestrial ecosystems and the carbon cycle. *Global Change Biology*, **1**, 77–91.
- Schlesinger, W. H. and Andrews, J. A. (2000) Soil respiration and the global carbon cycle. *Biogeochemistry*, **48**, 7–20.
- Scholes, M. and Andreae, M. O. (2000) Biogenic and pyrogenic emissions from Africa and their impact on the global atmosphere. *Ambio*, **29**, 23–9.
- Schöning, I. and Kögel-Knabner, I. (2006) Chemical composition of young and old carbon pools throughout Cambisol and Luvisol profiles under forests. *Soil Biology and Biochemistry*, **38**, 2411–24.
- Schrumpf, M., Schumacher, J., Schöning, I. and Schulze, E.-D. (2008) Monitoring carbon stock changes in European soils: process understanding and sampling strategies. In *The Continental-scale Greenhouse Gas Balance of Europe*, ed. A. J. Dolman, A. Freibauer and R. Valentini. Ecological Studies 203, Springer.
- Schulze, E.-D. and Freibauer, A. (2005) Carbon unlocked from soils. *Nature*, **437**, 205–6.
- Siemens, J. (2003) The European carbon budget: a gap. *Science*, **302**, 1681.
- Six, J., Elliott, E. T. and Paustian, K. (1999) Aggregate and soil organic matter dynamics under conventional and no-tillage systems. *Soil Science Society of America Journal*, **63**, 1350–8.
- Six, J., Callewaert, S., Lenders, S. *et al.* (2002) Measuring and understanding carbon storage in afforested soils by physical fractionation. *Soil Science Society of America Journal*, **66**, 1981–7.
- Smith, P. (2004) How long before a change in soil organic carbon can be detected? *Global Change Biology*, **10**, 1878–83.
- Soil Science Society of America (1984) *Glossary of Soil Science Terms*. Madison, WI: Soil Science Society of America.
- Subke, J.-A., Inghima, I. and Cotrufo, M. F. (2006) Trends and methodological impacts in soil CO₂ efflux partitioning: a metaanalytical review. *Global Change Biology*, **12**, 921–43.
- Sulzman, E. W., Brant, J. B., Bowden, R. D. and Lajtha, K. (2005) Contribution of aboveground litter, belowground litter and rhizosphere respiration to total soil CO₂ efflux in an old growth coniferous forest. *Biogeochemistry*, **73**, 231–56.
- Sun, O. J., Campbell, J., Law, B. E. and Wolf, V. (2004) Dynamics of carbon stocks in soils and detritus across chronosequences of different forest types in the Pacific Northwest, USA. *Global Change Biology*, **10**, 1470–81.
- Tilman, D., Reich, P., Phillips, H. *et al.* (2000) Fire suppression and ecosystem carbon storage. *Ecology*, **81**, 2680–5.
- Timoney, K. P. and Wein, R. W. (1991) The areal pattern of burned tree vegetation in the subarctic region of northwestern Canada. *Arctic*, **44**, 223–30.
- UNECE (2003) *ICP Forest Manual on Methods and Criteria for Harmonized Sampling, Assessment, Monitoring and Analysis of the Effects of Air Pollution on Forests. Part IIIa, Sampling and Analysis of Soil*. United Nations Economic Commission for Europe, Convention on Long-range Transboundary Air Pollution. International Co-operative Programme on Assessment and Monitoring of Air Pollution Effects on Forests.
- USDA (2005) United States Department of Agriculture Forest Service, Soil measurements and sampling. In *Forest Inventory and Analysis Field Methods for Phase 3 Measurements, 2005*. USDA Forest Service and National Association of State Foresters.

- Vance, E. D. (2003) Approaches and technologies for detecting changes in forest soil carbon pools. *Soil Science Society of America Journal*, **67**, 1582.
- Viro, P. J. (1952) On the determination of stoniness. Summary. *Commun. Inst. Forestalia Fennica*, **40**, 1–19.
- Von Lützw, M., Kögel-Knabner, I., Ekschmitt, K. *et al.* (2006) Stabilization of organic matter in temperate soils: mechanisms and their relevance under different soil conditions – a review. *European Journal of Soil Science*, **57**, 426–45.
- Von Lützw, M., Kögel-Knabner, I., Ekschmitt, K. *et al.* (2007) SOM fractionation methods: relevance to functional pools and to stabilization mechanisms. *Soil Biology and Biochemistry*, **39**, 2183–207.
- Walter, K. M., Zimov, S. A., Chanton, J. P., Verbyla, D. and Chapin III, F. S. (2006) Methane bubbling from Siberian thaw lakes as a positive feedback to climate warming. *Nature*, **443**, 71–5.
- Wang, X. J., Smethurst, P. J. and Herbert, A. M. (1996) Relationships between three measures of organic matter or carbon in soils of eucalypt plantations in Tasmania. *Australian Journal of Soil Research*, **34**, 545–53.
- Walkley, A. and Black, I. A. (1934) An examination of the Degtjareff method for determining soil organic matter, and a proposed modification of the chromic acid titration method. *Soil Science*, **37**, 29–38.
- Whitney, N. and Zabowski, D. (2004) Total soil nitrogen in the coarse fraction and at depth. *Soil Science Society of America Journal*, **68**, 612–19.
- Wiseman, C. L. S. and Püttmann, W. (2005) Soil organic carbon and its sorptive preservation in central Germany. *European Journal of Soil Science*, **56**, 65–76.
- Zar, J. H. (1996) *Biostatistical Analysis*, 3rd edn. London: Prentice-Hall International.
- Zianis, D., Muukkonen, P., Mäkipää, R. and Mencuccini, M. (2005) Biomass and stem volume equations for tree species in Europe. *Silva Fennica Monographs*, **4**, 1–63.

5 • Litter decomposition: concepts, methods and future perspectives

Mirco Francesca Cotrufo, Ilaria Del Galdo and Daniela Piermatteo

5.1 LITTER DECOMPOSITION CONCEPT

Litter decomposition is defined as the process through which dead organic material is broken down into particles of progressively smaller size, until the structure can no longer be recognized, and organic molecules are mineralized to their prime constituents: H₂O, CO₂ and mineral components. During the process, recalcitrant organic compounds are formed and dissolved organic carbon may be leached to the mineral soil. It is also universally recognized that there are three main processes through which decomposition occurs: (1) leaching of soluble compounds into the soil, (2) fragmentation of litter into smaller sizes and (3) catabolism by decomposer organisms (i.e. micro-organisms and fauna). Swift *et al.* (1979), presented the triangle (*P–O–Q*), representing individual and interacting factors influencing litter decomposition: i.e. *P* for the physical–chemical environment; *O* for decomposer organisms and *Q* for resource quality (Fig. 5.1).

This definition and understanding, so clearly stated, has guided research on litter decomposition for the past decades, which has been devoted mainly to:

1. quantify rates of litter decay
2. develop mathematical models that better represent decay dynamics
3. identify litter quality factors that control decay rates, and eventually the equation defining the relationship
4. determine dynamics of nutrients and carbon-based compounds during litter decay
5. identify climatic factors that control decay, and eventually the equation defining the relationship
6. identify the interdependence between litter quality and climate
7. evaluate the role of soil organisms.

The body of research has indeed been notable, with a large number of species and all biomes being investigated: from temperate and boreal forests (Berg, 2000) to tropical and sub-tropical forests (Vitousek *et al.*, 1994); Mediterranean ecosystems (Gallardo and Merino, 1993; Fioretto *et al.*, 2001); arctic and sub-arctic (Moore, 1984; Robinson, 2002); grasslands (Vossbrinck *et al.*, 1979; Koukoura, 1998); crops (Schomberg *et al.*, 1994; Wardle *et al.*, 1999) and deserts (Cepedapizarro, 1993). This work has been extensively reported and broad overviews and syntheses are available (Swift *et al.*, 1979; Cadish and Giller, 1997; Berg and McLaugherty, 2003; Gartner and Cardon, 2004; Hättenschwiler *et al.*, 2005).

Despite this large number of studies, general conclusions are still difficult to draw and, as recently underlined by Prescott *et al.* (2004), ‘many of the well-known facts about litter decomposition need to be revised’. Why, despite this extensive research effort, is our knowledge on litter decomposition still weak?

The aims of this chapter are to discuss critically what we do know about litter decomposition, to identify our main gaps of knowledge and why they are, and to suggest eventual ways forward. Our focus is on carbon dynamics in above-ground leaf litter decomposition.

5.2 KNOWLEDGE OF LITTER DECOMPOSITION AND ITS CONTROLLING FACTORS

Often, leaf litter decomposition (i.e. mass loss) follows an exponential decay function, in which remaining mass declines asymptotically towards zero (Olson, 1963). This function assumes a constant specific rate of decay (i.e. a constant fraction of remaining mass is lost per unit time). However, in many cases, the

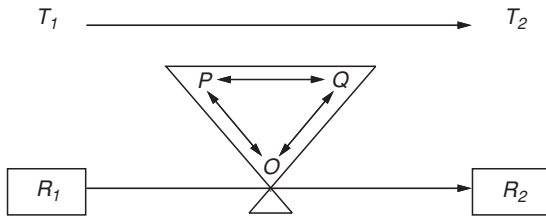

Figure 5.1 Regulation of decomposition processes by the three driving variables: physical–chemical environment (P); resource quality (Q) and decomposer organisms (O), and their interlinked action. The three variables and their interactions control the dynamics of resource (i.e. changing from R_1 to R_2) decomposition along time (i.e. moving from time T_1 to T_2). Adapted from Swift *et al.*, 1979.

remaining mass proceeds toward an apparent asymptote larger than zero, i.e. little further mass loss occurs, at a measurable rate, after several years of field exposure (Howard and Howard, 1974). Several other decay dynamics have been proposed (Wieder and Lang, 1982; Ågren and Bosatta, 1996), yet the single exponential decay function is the simplest model and has been widely used in all biomes and across a wide range of decomposing plant material (Moore *et al.*, 1999; Gholz *et al.*, 2000; Osono and Takeda, 2005).

During decomposition the chemical composition of litter changes due to selective degradation of soluble and structural compounds, to the in-growth of fungal and bacterial cells within the litter and to the transfer, in and out of the litter, of mineral nutrients. Overall, with progressing litter decay, structural compounds accumulate, while soluble nutrients may initially be leached and, subsequently, either immobilized or mineralized depending on microbial demand (Berg and Staaf, 1981). The decomposability of litter decreases with time.

Rates of leaf litter decay are controlled by climate: faster rates are measured under warmer and wetter conditions. Despite this being an obvious statement, it is still debated which climatic index best predicts decay rates. On the basis that temperature increase would speed up decomposition as long as there is water available in the soil, actual evapotranspiration (AET) has been proposed as the climatic index that – because AET also increases with temperature when there is water available for evaporation (Rosenberg *et al.*, 1983) – would best predict decay rates. Several studies support this concept (Meentemeyer, 1978). However, the relationship between AET and decomposition appeared to

vary with the quality of the litter (Berg, 2000), the stage of decay (Johansson *et al.*, 1995) and the geographical region under study (Berg *et al.*, 1993). Furthermore AET has, until recently, been almost impossible to measure with any accuracy, because of the difficulty in estimating the transpiration component. To overcome these limits, Liski *et al.* (2003) proposed a new model, which distinguishes temperature from drought effects. This model was shown to apply in varying environments and over wide geographical areas across Europe, Canada and the USA, being also able to catch the effects of Mediterranean summer drought on slowing down decay. Most recently, using the results from the Long-Term Intensive Decomposition Experiment Team (LIDET), Adair *et al.* (2008) demonstrated that the climate effect on global long-term litter decomposition can be best represented by a composite variable, obtained by multiplying a function of water stress with a variable Q_{10} temperature function (Lloyd and Taylor, 1994).

Under the same environmental conditions, litter quality controls the rate of litter decay: yet there is neither a common definition nor a quantitative index of ‘quality’. The interpretation of the quality concept is linked to degradability: a litter of high quality is by definition a litter with a fast decay rate. Since fast decay means, in the absence of inhibitory substances or ‘modifier’ compounds (*sensu* Swift *et al.*, 1979, i.e. phenolics), high energy and nutrient supply for microbial use, high-quality litter will be characterized by high nutrient (i.e. N and P) concentrations and a high proportion of easily degradable carbon-based compounds (e.g. sugars), as opposed to compounds that require high activation energy to be degraded (i.e. lignin). Translating this understanding into a quantitative assessment of litter quality is not an easy task and, despite the many ‘quality indexes’ proposed (Heal *et al.*, 1997), there is no universally accepted index. Across a wide range of concentrations, mass loss is directly proportional to litter N (Enriquez *et al.*, 1993) and inversely proportional to C-to-N and lignin-to-N ratios (Melillo *et al.*, 1982). When N is not limiting microbial growth, or litter is characterized by specific traits such as toughness and high wax content, other litter traits such as the holocellulose-to-lignocellulose ratio (McClaugherty and Berg, 1987) or leaf width and specific leaf area (Gallardo and Merino, 1993; Gillon *et al.*, 1994, 1999; Perez-Hardeguy *et al.*, 2000) appear to control litter decay and thus define quality. With lignin accumulating in litter over time,

factors controlling the microbial degradation of lignin become key quality parameters in later decay stages. In particular, high N concentrations appear to inhibit the ligninolytic activity of fungi, whereas Mn is shown to promote it (McClougherty and Berg, 1987). In this context, a general and quantitative index of quality/decomposability is clearly lacking. Indirect measurement methods, such as near-infrared spectroscopy, which have been found to provide reliable indicators of decay rates (Gillon *et al.*, 1999; Perez-Hardeguy *et al.*, 2000; Joffre *et al.*, 2001), or thermogravimetry, which has been only little investigated for this purpose (Rubino *et al.*, 2009), may be the way forward.

Climate and quality interact in their functional control of decomposition. In fact, the chemical composition of plant tissues is dependent, among other factors, on the climate of the region where plants grow. For example, under wet and warm conditions, where not limited by other ecosystem properties, nutrient mineralization is enhanced, leading to more nutrients being available for plants, which in turn produces litter that is richer in nutrients and therefore decomposes at a faster rate than would occur in cold and dry climates. Thus climate affects decomposition both directly, through controlling decomposer activity, and indirectly, by changing litter quality (Aerts, 1997). Conversely, on the basis of the thermodynamics of decomposition processes, litter quality has been hypothesized to control the temperature sensitivity of litter decomposition, with low-quality litter having a higher sensitivity (Bosatta and Ågren, 1999). This has been supported by Fierer *et al.* (2005) who found that as litter quality decreases during decay, the temperature sensitivity of litter decomposition increases.

However, the issue is still being debated for soil organic matter (SOM) where both litter quality and other physical–chemical mechanisms control SOM protection and degradability (Giardina and Ryan, 2000; Fang *et al.*, 2005; Knorr *et al.*, 2005).

Litter quality is also a function of the dominant plant species as well as the diversity of plant species contributing to litter production. Adjacent litter types interact, through a combination of biological as well as physical–chemical processes. When litter is a mixture of species of differing quality, non-additive effects emerge, with higher N transfers among litters and generally faster decay rates being measured (Gartner and Cardon, 2004).

Soil organisms govern litter decomposition, with soil fauna mainly feeding and digesting the detritus, and with fungi and bacteria degrading and metabolizing litter constituents, within a complex food web. Soil fauna comprise a small fraction of total soil biomass (10–20%) but are important regulators of soil functions and control, by predation, the abundance and diversity of the microbial community, which is the real ‘decomposition engine’. Microbes are able to degrade virtually all biological compounds, but differences exist between fungi and bacteria, and within genotypes, in the ability to degrade different chemical bonds, within macromolecules (Paul and Clark, 1996). However, in many cases we are still unable to link species or genotypes to specific functions, except on a broad scale and for certain functions (Neufeld *et al.*, 2001; Hobbie *et al.*, 2003; Rich *et al.*, 2003). Fungi, building a hyphal network within the litter layer and into the mineral soil, are able to colonize freshly fallen litter and to transfer N and C between the litter layer and the mineral soil (Zeller *et al.*, 2000). In contrast, bacteria depend on the flow of substrates towards their cells. This ability makes fungi stronger competitors than bacteria under low N conditions. Under unfavourable environmental conditions, microbes become inactive, representing a reservoir of potential decomposition, ready to start when favourable conditions return (Chapin *et al.*, 2002). On this basis, litter decomposition is a function of the biological diversity and activity of the decomposer community. The chemical–physical environment and the litter quality attributes described above exert their control over litter decay rates by affecting both the diversity of the soil community and its rate of activity (Swift *et al.*, 1979).

Global environmental changes, by modifying climate, land cover and management (IPCC, 2001), perturb virtually all of the factors controlling litter decomposition and will significantly alter soil biodiversity (Swift *et al.*, 1998). This will lead to fundamental alteration of the C and N cycling in terrestrial ecosystems.

5.3 MEASURING LITTER DECAY

Most of the studies dealing with above-ground litter interpret the process of litter decomposition as the progressive loss of mass from a fresh litter residue through time, and quantify it by gravimetric determination, at different intervals in time. Usually mass loss is determined from an initial known amount of litter confined

within inert mesh bags, generally incubated on the ground. This is the so-called ‘litter bag method’ first proposed by (Bocock and Gilbert, 1957), and still widely used. The mesh size is chosen depending on whether the macro- or meso-fauna are to be allowed access to the inside of the bag (e.g. Schadler and Brandl, 2005) and to minimize bias due to loss of litter fragments or water retention within bags. Thus, based on the experimental question, a compromise on mesh size is reached. Generally mesh size varies in the range from 0.5 mm (most of fauna excluded, prevention of fragment loss, likely alteration of the physical environment) to 5 mm (fauna included, high risk of fragment loss, little or no alteration of the physical environment). Bags are buried at different depths within the litter–mineral soil profile, again depending on the purpose of the experiment, and generally to mimic the layer in which litter would decompose in the natural environment. Occasionally, other methods of field incubation have been used, ranging from large containers (Virzo De Santo *et al.*, 1993) or cages (Torres *et al.*, 2005), to glass tubes containing soil and litter (Howard and Howard, 1974), or tethering litter material with nylon thread (Gosz *et al.*, 1973).

Similarly to leaf litter, the large majority of studies investigating root litter decomposition have used litter bags, generally buried in the mineral soil, and only occasionally different techniques (i.e. trench plots and subsequent coring) have been used (Silver and Miya, 2001). However, litter bags have been shown to reduce rates of root litter decay and net N mineralization compared to *in situ* approaches, such as intact core incubations (Dornbush *et al.*, 2002). Minirhizotrons have also proven to be a useful method to investigate root dynamics (Hendrick and Pregitzer, 1996).

In other studies, litter decomposition is considered as the mineralization of carbon from litter residue due to microbial respiration and thus is measured as CO₂ production. This is the most widely used method for determining litter decomposition in laboratory experiments (e.g. Anderson and Ineson, 1982). In a few cases, dissolved organic carbon (DOC) is measured in the water leached out from microcosms (e.g. Cotrufo *et al.*, 1994) as a way to measure loss of soluble carbon during litter decay.

The effects of soil fauna on litter decomposition have been studied both in field and laboratory experiments. Despite the fact that experiments may require complex designs to account for the effects of different

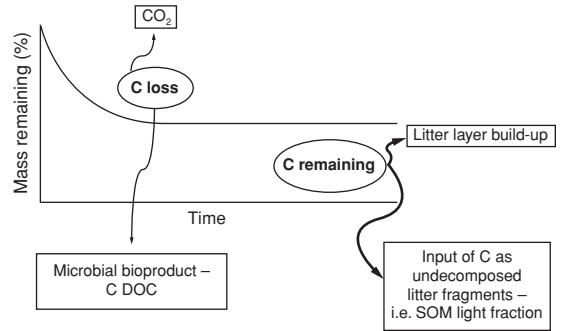

Figure 5.2 Schematic representation of possible carbon fluxes contributing to mass loss and mass remaining, as measured from litter bag studies.

soil organisms, litter decay is, in most cases, determined by either gravimetric determination of mass loss (e.g. Smith and Bradford, 2003) or by measurements of respiration (Coûteaux *et al.*, 1991).

Clearly there is a discrepancy; we describe litter decomposition as the result of three interlinked processes (i.e. leaching, fragmentation and catabolism) and we study it either by measuring one of the three processes (i.e. catabolism – by microbial respiration measurement), or by a rough estimate of two combined together (i.e. leaching and catabolism, by mass loss measurement) and preventing, with mesh bags, the third (i.e. fragmentation) to occur.

For years we have measured mass loss from litter while paying little attention to where this mass was lost to (Fig. 5.2). Carbon can leave the litter to the atmosphere as CO₂ – volatile organic carbon (VOC) and methane emissions have also been measured (Isidorov and Jdanova, 2002; Keppler *et al.*, 2006) but with very minor emission rates as compared to CO₂ – or to the soil in the form of soluble C, microbial bioproducts or litter fragments. In a laboratory study, Rubino *et al.* (2007) recently demonstrated that the carbon input below-ground derived from litter decay represents about 13% of the total carbon loss by the litter, with this fraction being independent of litter quality. Additionally, litter fragmentation may be a key process through which litter is lost from the litter layer and enters the mineral soil. In terms of carbon cycling, there is a huge difference between all these forms of carbon lost from litter: they represent net carbon emissions (CO₂ to the atmosphere), may stimulate priming or conserving (Dormaar, 1990) of stable soil carbon stores (DOC

leaching), control microbial biomass and activity, as well as promote aggregation and SOM formation in the mineral soil (bioproduct and litter fragments). Thus, a change in the relative proportion of mass loss pathways may alter the carbon balance of the ecosystem. However, we know almost nothing about their relative proportion and how it is affected by litter quality, climate and soil organisms. Until a process is properly identified and measured, general principles cannot be formulated and general relationships regarding controlling factors can not be formalized. We suspect this is the case for litter decay. Indeed, the decomposer system is a complex one, yet our approaches and methods of study have been, to date, inadequate to disentangle it. Additionally, confusion arises from the fact that little distinction is usually made between litter decomposition processes occurring on the top of the soil (i.e. within the litter layer) and that of leaf litter fragments, roots and other plant residues within the mineral soil. In our opinion, litter decomposition studies, in particular those carried out in the laboratory, should clearly distinguish between decomposition occurring on the litter layer from that occurring in the mineral soil. They are two different processes since they occur in different biological and chemical–physical environments and they also may play a different role in soil carbon and nutrient cycling.

5.4 LITTER BAG STUDIES TO QUANTIFY STANDING LITTER TURNOVER TIMES: HOW DO WE DEAL WITH THE ASYMPTOTIC VALUE?

Decomposition curves derived from litter bag studies performed on a time scale of several years are often best described by the presence of an asymptotic value, which may vary across a wide range (0%–65%) of the original mass being ‘undecomposable’ (at least over a period of several years), and work has been devoted to the understanding of the factors controlling it (see Berg and McLaugherty, 2003; Osono and Takeda, 2005).

What is the ecological meaning of the asymptote? The hypothesis can be made that an apparent non-zero asymptote represents a spatially segregated process. Only a fraction of the litter decomposes on the forest floor with a measurable decay rate, while the remainder is eventually transferred to the mineral soil and gets incorporated in the SOM as litter debris, where it will likely decompose at a different pace. In the presence of

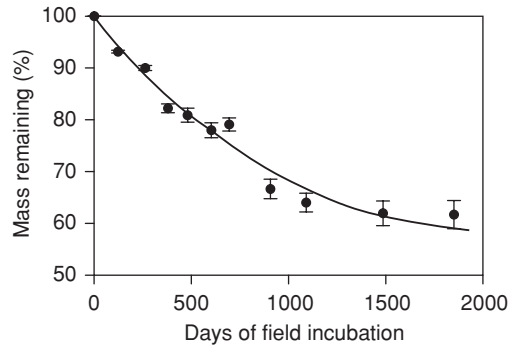

Figure 5.3 Dynamic of leaf litter mass loss as measured at the *Fagus sylvatica* forest of Collelongo, Italy (for details see Cotrufo *et al.*, 2000), by a five year litter bag experiment (bars indicate standard error, $n = 7$). Data were fitted with a single exponential model with asymptote ($y = A + (100 - A) * e^{-kt}$), using Origin version 6 ($R^2 = 0.97$; $A = 54.23$; $k = 0.00116$).

bags this mass remains there, and can thus be measured. In this context, if the aim is to quantify the turnover time of leaf litter standing on the forest floor, greater consistency is needed among the common methods currently used. In a litter bag (2 mm mesh size) decomposition study at Collelongo, a *Fagus sylvatica* forest in a central Italy (Cotrufo *et al.*, 2000), beech leaf litter lost only about 40% of the original weight after five years of incubation on the forest floor (Fig. 5.3). Mass loss was best described by a single exponential model toward a projected asymptotic value of 54.2% (Fig. 5.3; Table 5.1). We also tried multiple exponential models, but they did not give a satisfactory fit. We calculated the mean residence time ($MRT = 1/k$) of the leaf litter from decay rates (k) obtained by fitting mass loss values with single exponential decay functions toward a zero asymptote and towards a 54.2 asymptote. In this latter case, the calculated MRT applies only to the fraction of litter mass loss. In fact, according to this model the remaining fraction has an infinite MRT: another problem of this model! We calculated it only for the purpose of the method comparison and consider it as an estimate of the MRT of the standing litter, assuming that the remaining fraction would correspond to a measure of the litter fragments entering the mineral soil. These MRT were compared to MRT values obtained at the same site by applying the ^{14}C -bomb spike method (Harrison *et al.*, 2000), and by respiration measurements in laboratory incubations (Persson *et al.*, 2000). Data are reported in

Table 5.1 Mean residence value ($MRT = 1/k$) of leaf litter measured at Collelongo, a beech forest in central Italy, by: (1) a litter bag experiment with decay rate (k) calculated by applying an exponential decay function with and without asymptote (A); (2) the ^{14}C -bomb spike method (Harrison *et al.*, 2000); (3) determination of carbon mineralization in laboratory incubation (Persson *et al.*, 2000).

Methodology	MRT (y)	Decay rate	Asymptote (% of initial mass)	R^2 of fit
Litter bag	2.36 ^a	0.42	54.2	0.97
Litter bag	7.83	0.13	0	0.88
^{14}C -bomb spike	5			
Litter respiration in laboratory incubation	10			

^aMRT of the pool (35.8%) that decomposes. The remaining mass (54.2%) has infinite MRT.

Table 5.1. Given the high disparity of MRT values, ranging from ten to about two years, we believe that the different methods captured different processes. Since the ^{14}C -bomb spike method derives leaf litter MRT from the measurement of the ^{14}C content of the standing litter, applying a box model to describe carbon flow along the soil profile (Harkess *et al.*, 1986), it does not require any litter manipulation, and for that reason we use it as a reference method. Thus, if we assume the MRT of five years to be our reference value, the incubation method, by measuring decomposition rate solely as the rate of respiration of decomposer microbes, strongly overestimates it. Similarly, the litter bag method overestimates MRT, when decay is assumed to proceed to 100% mass loss: both methods do not account for litter fragments lost to the mineral soil. On the other hand, litter bags underestimate MRT, when the fraction remaining (i.e. asymptotic value) is considered not to decompose (Table 5.1), indicating bias due to the presence of the bags.

Clearly methodological studies are needed to test the above hypothesis; however, available decay data should be used with caution and referred to the specific decomposition component process measured.

5.5 MODELLING LITTER DECAY

The concept that litter decay follows one or more exponential decay functions (Olson, 1963) is incorporated in nearly all litter decomposition models, which mainly differ in: (1) the interpretation of litter quality and its dynamics during decay; (2) the number and kind of functional controls by environmental factors; (3) the

C and N flows from the decomposing litter into other pools and (4) the presence and role of organisms. Almost all models – with the exception of APSIM (agricultural production systems simulator) (Keating *et al.*, 2003) – assume that there is no litter quantity effect on the specific rate of decay.

Discussing how litter decomposition models incorporate the effects of the physical environment and of the biological community is beyond our scope. Previous studies addressed these issues (Smith *et al.*, 1997; Paul, 2001). Here we emphasize how the current limits of our understanding of litter quality and decomposition affects our ability to model it.

Since the early decomposition models (Minderman, 1968; Hunt, 1977; Jenkinson and Rayner, 1977), litter has been represented by two or more organic matter pools, differing in quality/degradability, which decompose according to first-order kinetics, through carbon flows to microbial biomass and to recalcitrant SOM pools, and CO_2 production. The continuous-quality theory (Bosatta and Ågren, 1985, 1991, 2003; Ågren and Bosatta, 1996) introduced a new approach in which litter consists of a continuum of cohorts which, with progressing decomposition, lose carbon and change their chemistry towards increasing recalcitrance. Despite its potential value (Joffre *et al.*, 2001), the continuous-quality theory, to our knowledge, has not been widely adopted as a component of soil carbon models.

When models represent litter by two or more discrete carbon pools, the criteria of compartmentalization are defined either chemically, kinetically or functionally. Chemically defined pools recognize the discrete

Table 5.2 Pools, number and type, and decomposition rate constants (k) for first-order kinetics at 15°C and optimal moisture conditions, used for litter pools by some of the more common decomposition models. DPM and RPM refer to decomposable and recalcitrant plant material, respectively.

Compartment Model	No. of pools	Type	Pools	K (a^{-1})	Reference
CENTURY	2	Functional	Metabolic	14.8	Parton <i>et al.</i> , 1994
			Structural	3.9	
Gendec	3	Chemical	Labile	36	Paul and Juma, 1981
			Holocellulose	15	
			Lignin	1.8	
Roth-C	2	Kinetic	DPM	10	Jenkinson <i>et al.</i> , 1987
			RPM	0.3	Jenkinson <i>et al.</i> , 1992
Socrates	2	Kinetic	DPM	2	Ladd <i>et al.</i> , 1995
			RPM	1.5	

chemical components of litter (e.g. Minderman, 1968), they have the advantage that chemical components (i.e. water-soluble carbohydrates, holocellulose and lignin) can be analytically determined (Allen, 1989; Rowland and Roberts, 1994), yet the question arises of whether these pools decompose independently or in interactions. Simulations with models adopting this approach indicated that, for short-term carbon decomposition of plant residues under laboratory conditions, litter quality can be well represented by the 'acid-resistant' fraction (*sensu* Rowland and Roberts, 1994), provided that interactions are considered between different compounds (Henriksen and Breland, 1999; Corbeels, 2001).

Kinetically defined pools do not directly correspond to experimentally verifiable fractions. Therefore, it may lead to uncertainties on how to quantify these conceptual pools for different types of litter. For example, the Roth-C model (Jenkinson and Rayner, 1977) distinguishes two kinetically defined pools of plant litter: decomposable (DPM) and resistant plant material (RPM). In this model the DPM/RPM is the sole attribute for litter quality. Values for the DPM/RPM ratio are specified on the basis of broadly defined biomes and were estimated by fitting the Roth-C model to measured respiration data of plant material decaying in soil microcosms (Jenkinson *et al.*, 1991). It is to be pointed out that Roth-C generally depicts agro-ecosystems and thus focuses on soil processes and the litter layer is not explicitly modelled.

Functionally or morphologically defined compartmentalization defines plant litter as being made of a metabolic (i.e. labile) and a structural (i.e. resistant) pool. The metabolic component represents the cytoplasmic compounds of plant cells, whereas the structural pool represents cell wall compounds bound to proteins and lignified structures. These cell structures decompose somewhat independently and the physical structure of plant material, at the micro-scale, is an important attribute to quality. The size of these functional pools has been determined by a regression type function of litter quality attributes. Examples of this type of litter characterization are found in the CENTURY (Parton *et al.*, 1987, 1988) and GRAZPLAN (Hunt, 1977) models. CENTURY divides plant residues into a metabolic and structural pool as a function of the initial lignin-to-N ratio of the litter, such that the fraction of litter going into the structural pool increases with increasing lignin-to-N ratio. GRAZPLAN adopts the concept of Hunt (1977) and uses the initial residue C-to-N ratio as litter quality attribute, to divide litter into a metabolic and structural pool. The regression type functions allow extrapolation of the functional pool concept to other litter types. Parton *et al.* (1994) showed that the structural litter pool in CENTURY is closely correlated to the cellulose plus lignin fraction as determined by proximate analysis.

The CENTURY model incorporates two other effects of litter quality on the decomposition process.

Firstly, the decay rate of the structural material is a function of its lignin content, such that increasing lignin content slows the decay rate. Secondly, the lignin fraction of the structural pool is directly incorporated into the pool of slow organic matter with a relatively low proportional carbon loss. CENTURY also differentiates between above-ground and below-ground litter, and assumes a 20% slower decomposition rate for the above-ground litter fractions compared to the below-ground.

Potential decomposition rates vary considerably between similar litter fractions of different models (Table 5.2). The various models differ significantly in the assumptions on the litter pools and – more importantly – on the microbial turnover and formation of secondary SOM pools (Paustian *et al.*, 1997).

Arguably, litter decomposition models describe litter quality and its control on carbon transfers to SOM with considerable uncertainty, also with respect to the interactions and feedbacks between litter quality and the physical and biological environments. Future research is needed where theoretical and experimental work is designed and executed in coordination, to measure ‘true’ processes and to model measurable pools and fluxes. This goal is less likely to be achieved if experimental and modelling research is conducted by physically distinct research groups, which often do not interact with each other. However, in recent years rapid progress is being made in this direction, with integrated projects having both modelling and experimental tasks, and, in particular, with individual research groups, or even individual scientists, often exhibiting both areas of expertise.

5.6 EMERGING ISSUES

5.6.1 Interaction and feedback between root activity and litter decay

Soil organisms live in the soil environment together with roots, in a complex net of trophic interactions, which control, on the one hand, microbial abundance and turnover, via the predation by soil fauna, and, on the other, the supply of nutrients to plants (Moore *et al.*, 2003). A live and active rhizosphere strongly influences the functional diversity of the soil biota (Schulze *et al.*, 2005). To what extent do these interactions extend to the litter layer? Recent findings have demonstrated

positive mutual feedbacks between litter and roots in which the input of fresh litter on the forest floor stimulated rhizosphere respiration and, in turn, an active rhizosphere promoted above-ground needle litter respiration (Subke *et al.*, 2004). These findings reinforce the established concept of fresh carbon input priming of SOM decomposition (Kuzyakov, 2002). Mechanisms of priming have been investigated and recent findings seem to indicate stimulation of microbes able to provide specific enzyme for soil carbon degradation (Fontaine *et al.*, 2004). Additionally, increased litter inputs were observed to alter the pattern of root distribution along the soil profile, in a moist fertile tropical forest soil (Sayer *et al.*, 2006). While further research is needed to establish the mechanisms of the root–litter interactions and their control over decomposition and nitrogen mineralization processes, models of soil carbon dynamics should consider including root–litter interactions more explicitly.

5.6.2 Incorporation of above-ground litter-derived carbon to SOM

The quantity of litter residue is believed to have no effect on specific decay rates, under the assumption of first-order kinetics. While this may be valid for the litter layer, it does not necessarily hold for the soil environment. According to Six *et al.* (2000) when fresh plant debris enters the soil, it promotes the formation of soil aggregates, which, in turn, physically protect organic matter from microbial attack, slowing down the turnover rate. The mechanism behind promotion of aggregate formation is mediated by microbes, whereby greater fresh carbon input stimulates microbial activity and production of microbial-derived binding agents. Apart from it being promoted by macro-fauna and, in particular, by earthworms (see the review by Six *et al.*, 2004), we know very little about the dynamics of litter fragmentation, the inclusion of litter fragments into SOM and its control over soil carbon turnover. Additionally above-ground litter-derived carbon enters the soil transported by fungal hyphae, as bacterial metabolites and DOC. Future litter decomposition research should focus on the identification and quantification of these different mechanisms by which carbon is incorporated into mineral soil, their relative proportion and sensitivity to environmental factors, and their effects on overall soil carbon storage.

5.6.3 Functional role of soil microbes: does the fungal-to-bacteria ratio affect carbon flow from litter to recalcitrant SOM?

Based on the evidence that fungi use carbon more efficiently than bacteria and are composed of more recalcitrant structural carbon, the hypothesis arises that increasing fungal abundance relative to bacteria would increase soil carbon stores (Allison *et al.*, 2005). Despite the fact that this concept has not been confirmed as a primary mechanism to enhance carbon sequestration in soils, the effect on soil carbon storage of changes from a fungal versus a bacteria dominated decomposer community needs to be assessed. The potential influence of differences in microbial community composition has relevance with respect to land-use and management changes, as well as to possible mitigation strategy to increase carbon sequestration in soils. Fungi, thanks to their enzyme system, can degrade all biologically formed compounds, whereas most bacteria, actinomycetes apart, are known to lack lignin-degrading enzymes. In general, for bacteria to degrade complex macromolecules, they need to establish a highly diversified community of genetically unrelated species, each of which produces a few enzymes that, in a coordinated action, break down the macromolecules (Chapin *et al.*, 2002). Further, synergic interactions appear to be established during litter decomposition between different microbial functional groups and litter chemistry (Torres *et al.*, 2005). A better understanding of the control of microbial diversity on the carbon flow from litter to recalcitrant SOM is needed. Further, the role that mycorrhizae play in litter decomposition (Gadgil and Gadgil, 1971) is still not clearly defined.

5.7 CUTTING-EDGE METHODOLOGIES

In the natural environment, leaf litter decomposes on the top of the soil due to the physical effects of weathering agents, and mostly due to the biological activity of soil fauna and micro-organisms. As a result, carbon is lost from the litter as CO₂ and as DOC, along with transfer of microbial biomass and litter fragments to the soil below the litter layer. If we want to measure accurately the rate of leaf litter turnover, we should use methods that allow determination of decay rates without impeding any of these processes. Additionally, we

need to apply methods that allow quantification of the differing carbon fluxes.

Litter bags, by limiting fragmentation and their transport to the mineral soil, have an inherent bias when used to quantify surface litter turnover rates. Several other approaches have been used to confine litter, trying to minimize the bias due to bags, such as tethering litter material with nylon thread prior to field incubation. This technique has been mainly adopted for branches (Gosz *et al.*, 1973; Cotrufo and Ineson, 2000). It is of interest that this technique has been criticized because of biases due to mass loss by fragmentation (Anderson, 1973). A possible alternative way to determine leaf litter decay rates, without altering the natural environment, is by measuring the annual litter fall and dividing it by the mean annual standing litter pool (i.e. $k = \text{litter fall}/\text{standing litter pool}$) (Olson, 1963). The limit of this method is that it assumes the system is at a steady state. This method was applied at an *Arbutus unedo* coppiced woodland in central Italy, where from April 2004 to April 2005, standing litter was measured monthly by collecting the standing litter inside round soil collars (25 cm in diameter; 10 cm high, $n = 12$), placed at random on the forest floor. The collected pool was then oven dried and weighed. Litter fall was determined by means of litter traps (diameter = 30 cm), established to cover about 1/1000 of the study area. A yearly decay rate of 0.41 ± 0.01 , corresponding to a leaf litter MRT of 2.43 ± 0.08 , was measured, which compares well with values of litter decay of Mediterranean *Macchia* species, of similar quality (Moro and Domingo, 2000).

Leaf litter MRT was elegantly determined by using the ¹⁴C-bomb spike (Harrison *et al.*, 2000); however, the progressive fast decay of the ¹⁴C enrichment in the atmosphere makes this method not applicable for future determination of surface leaf litter turnover rates.

A powerful way of following carbon dynamics during litter decomposition is by the use of isotopic labelled material. Several experiments used ¹⁴C-enriched leaf litter, and decay rates were derived by measuring either the ¹⁴CO₂ produced during decay (Gorissen and Cotrufo, 2000) or the ¹⁴C remaining in the soil (Coûteaux *et al.*, 2002). This technique makes it possible to trace accurately the fate of litter-derived carbon to SOM fractions of different ages (Magid *et al.*, 2002), to DOC in soil profiles (Qualls and Bridgman, 2005) and to the soil biota (Fließbach *et al.*, 1995), as well as the

determination of priming effects induced by fresh substrate addition to soils (Jenkins, 1971). Certainly the use of the ^{14}C isotope offers the advantage of having an almost unambiguous isotopic label, but it is very expensive and its use is often limited to controlled laboratory conditions.

Stable carbon isotopes are currently seen as the most powerful tool for studies of carbon fluxes from the global to the patch scale (Ehleringer *et al.*, 2000). They can be used by artificial, i.e. pulse labelling (Bromand *et al.*, 2001) or natural ^{13}C -labelling techniques (Balesdent *et al.*, 1987), by applying the two-source mixing model. Mary *et al.* (1992) measured decomposition of C_4 plant residues, characterized by $\delta^{13}\text{C}$ values of about -12% , by incubating such residues in soil exclusively cropped with C_3 plants, and therefore having a $\delta^{13}\text{C}$ of about -27% , within laboratory units, and determining the isotopic composition of the evolved CO_2 . The use of ^{13}C -labelled plant material has subsequently found wide application in litter decomposition studies (Zeller *et al.*, 2000; Magid *et al.*, 2002), also when labelling was obtained by exposing plant to atmospheres enriched with fossil fuel-derived (i.e. depleted in ^{13}C) CO_2 (Ross *et al.*, 2002; Subke *et al.*, 2004). Apart from quantifying litter decay rates, the use of labelled litter material becomes very powerful when combined with SOM fractionation or molecular biology techniques. By combining the use of labelled litter with SOM fractionation techniques, the specific contribution of litter decay to different SOM pools can be identified and quantified. Similarly, the use of ^{13}C -labelled plant material makes it possible to trace root or litter-derived carbon input to soil via fungal- or bacterial-mediated fluxes through determination of $\delta^{13}\text{C}$ of biomarkers such as phospholipid fatty acids (Rubino *et al.*, 2009) or nucleic acids (Radajewski *et al.*, 2000; see also Kutsch *et al.*, Chapter 9; Griffiths *et al.*, 2004). Similarly, Curie-point pyrolysis, by thermally degrading large soil organic matter compounds, yields volatile products that relate to their compounds of origin (i.e. proteins, carbohydrates, lignin, phenol etc.), in a reliable and reproducible way (Gleixner and Schmidt, 1997). Providing that there is a difference in $\delta^{13}\text{C}$ values between litter and soil carbon big enough to be detected, the mass balance approach can be applied to quantify the contribution of litter-derived carbon in soil compounds resulting from the pyrolysis of soil matrix. Moreover, pyrolysis gas

chromatography–combustion–isotope ratio mass spectrometry (Py-GC-C-IRMS) is a reliable method to assess the turnover time of different SOM compounds when a shift from C_4 to C_3 plants (or vice versa) occurs (Gleixner *et al.*, 1999, 2002). We believe that the rapid advances in molecular biology and mass spectrometry methodologies will make a breakthrough in our ability to understand mechanisms and quantify processes of litter decomposition. Modelling advancements will follow.

ACKNOWLEDGEMENTS

This work was supported by the European Community, research contracts EVK2–1999–00242 (FORCAST) and EVK2–CT–2002–00158 (MIND) as well as by the MIUR, Italy, through the Interlink programme.

REFERENCES

- Adair, E., Parton, W. G., Del Grosso, S. J. *et al.* (2008) Simple three-pool model accurately describes patterns of long-term litter decomposition in diverse climates. *Global Change Biology*, **14**, 2636–60.
- Aerts, R. (1997) Climate, leaf litter chemistry and leaf litter decomposition in terrestrial ecosystems: a triangular relationship. *Oikos*, **79**, 439–49.
- Ågren, G. I. and Bosatta, E. (1996) *Theoretical Ecosystem Ecology: Understanding Element Cycles*. Cambridge: Cambridge University Press.
- Allen, S. E. (1989) *Chemical Analysis of Ecological Materials*. Oxford: Blackwell Scientific Publications.
- Allison, V. J., Miller, R. M., Jastrow, J. D., Matamala, R. and Zak, D. R. (2005) Changes in soil microbial community structure: a tallgrass prairie chronosequence. *Soil Science Society of America Journal*, **69**, 1412–21.
- Anderson, J. M. (1973) The breakdown and decomposition of sweet chestnut (*Castanea sativa* Mill.) and beech (*Fagus sylvatica* L.) leaf litter in two deciduous woodlands. I Breakdown, leaching and decomposition. *Oecologia*, **12**, 251–74.
- Anderson, J. M. and Ineson, P. (1982) A soil microcosm system and its applications to measurements of respiration and nutrient leaching. *Soil Biology and Biochemistry*, **14**, 415–16.
- Balesdent, J., Mariotti, A. and Guillet, B. (1987) Natural ^{13}C abundance as a tracer for studies of soil organic matter dynamics. *Soil Biology and Biochemistry*, **19**, 25–30.

- Berg, B. (2000) Litter decomposition and organic matter turnover in northern forest soils. *Forest Ecology and Management*, **133**, 13–22.
- Berg, B. and McClaugherty, C. (2003) *Plant Litter, Decomposition, Humus Formation, Carbon Sequestration*. Berlin: Springer-Verlag.
- Berg, B. and Staaf, H. (1981) Leaching, accumulation and release of nitrogen in decomposing forest litter. In *Terrestrial Nitrogen Cycles*, ed. F. E. Clark and T. Rosswall. Stockholm: Ecological Bulletin 33, pp. 163–78.
- Berg, B., Berg, M. P., Bottner, P. *et al.* (1993) Litter mass-loss rates in pine forests of Europe and eastern United States: some relationships with climate and litter quality. *Biogeochemistry*, **20**, 127–59.
- Bocock, K. L. and Gilbert, O. (1957) The disappearance of leaf litter under different woodland conditions. *Plant and Soil*, **9**, 179–85.
- Bosatta, E. and Ågren, G. I. (1985) Theoretical analysis of decomposition of heterogeneous substrates. *Soil Biology and Biochemistry*, **17**, 601–10.
- Bosatta, E. and Ågren, G. I. (1991) Dynamics of carbon and nitrogen in the organic matter of the soil: a general theory. *American Naturalist*, **138**, 227–45.
- Bosatta, E. and Ågren, G. I. (1999) Soil organic matter quality interpreted thermodynamically. *Soil Biology and Biochemistry*, **31**, 1889–91.
- Bosatta, E. and Ågren, G. I. (2003) Exact solutions to the continuous-quality equation for soil organic matter turnover. *Journal of Theoretical Biology*, **224**, 97–105.
- Bromand, S., Whalen, J. K., Janzen, H. H., Schjoerring, J. K. and Ellert, B. H. (2001) A pulse-labelling method to generate ^{13}C enriched plant materials. *Plant and Soil*, **235**, 253–7.
- Cadish, G. and Giller, K. E. (1997) *Driven by Nature: Plant Litter Quality and Decomposition*. Wallingford: CABI publishing.
- Cepedapizarro, J. G. (1993) Litter decomposition in deserts: an overview with an example from coastal arid Chile. *Revista Chilena De Historia Natural*, **66**, 323–36.
- Chapin, F. S., Matson, P. A. and Mooney, H. A. (2002) *Principles of Terrestrial Ecosystem Ecology*. New York: Springer-Verlag.
- Corbeels, M. (2001) Plant litter and decomposition: general concepts and model approaches. *NEE Workshop Proceedings, CRC for Greenhouse Accounting*.
- Cotrufo, M. F. and Ineson, P. (2000) Does elevated atmospheric CO_2 concentrations affect wood decomposition? *Plant and Soil*, **224**, 51–7.
- Cotrufo, M. F., Ineson, P. and Rowland, A. P. (1994) Decomposition of tree leaf litters grown under elevated CO_2 : effect of litter quality. *Plant and Soil*, **163**, 121–30.
- Cotrufo, M. F., Miller, M. and Zeller, B. (2000) Litter decomposition. In *Carbon and Nitrogen Cycling in European Forest Ecosystems*, ed. E. D. Schulze. Vol. 142. Ecological Studies. Berlin: Springer-Verlag, pp. 276–96.
- Coûteaux, M. M., Mousseau, M., Célérier, M. L. and Bottner, P. (1991) Increased atmospheric CO_2 and litter quality: decomposition of sweet chestnut leaf litter with animal feed webs of different complexities. *Oecologia*, **61**, 54–64.
- Coûteaux, M. M., Sarmiento, L., Bottner, P., Acevedo, D. and Thiery, J. M. (2002) Decomposition of standard plant material along an altitudinal transect (65–3968 m) in the tropical Andes. *Soil Biology and Biochemistry*, **34**, 69–78.
- Dormaer, J. F. (1990) Effect of active roots on the decomposition of soil organic materials. *Biology and Fertility of Soils*, **10**, 121–6.
- Dornbush, M. E., Isenhardt, T. M. and Raich, J. W. (2002) Quantifying fine-root decomposition: an alternative to buried litterbags. *Ecology*, **83**, 2985–90.
- Ehleringer, J. R., Buchmann, N. and Flanagan, L. B. (2000) Carbon isotope ratios in belowground carbon cycle processes. *Ecological Applications*, **10**, 412–22.
- Enríquez, S., Duarte, C. M. and Sand-Jensen, K. (1993) Patterns in decomposition rates among photosynthetic organisms: the importance of detritus C:N:P content. *Oecologia*, **94**, 457–71.
- Fang, C., Smith, P., Moncrieff, J. B. and Smith, J. U. (2005) Similar response of labile and resistant soil organic matter pools to changes in temperature. *Nature*, **433**, 57–9.
- Fierer, N., Craine, J. M., McLauchlan, K. and Schimel, J. P. (2005) Litter quality and the temperature sensitivity of decomposition. *Ecology*, **86**, 320–6.
- Fioretto, A., Papa, S., Sorrentino, G. and Fuggi, A. (2001) Decomposition of *Cistus incanus* leaf litter in a Mediterranean maquis ecosystem: mass loss, microbial enzyme activities and nutrient changes. *Soil Biology and Biochemistry*, **33**, 311–21.
- Fliessbach, A., Sarig, S., Walenzik, G., Steinberger, Y. and Martens, R. (1995) Mineralization and assimilation

- processes of ^{14}C -labeled shoots of *Stipa capensis* in a Negev desert soil. *Applied Soil Ecology*, **2**, 155–64.
- Fontaine, S., Bardoux, G., Benet, D. *et al.* (2004) Mechanisms of the priming effect in a Savannah soil amended with cellulose. *Soil Science Society of America Journal*, **68**, 125–31.
- Gadgil, R. L. and Gadgil, P. D. (1971) Mycorrhiza and litter decomposition. *Nature*, **233**, 133.
- Gallardo, A. and Merino, J. (1993) Leaf decomposition in two Mediterranean ecosystems of southwest Spain: influence of substrate quality. *Ecology*, **74**, 152–61.
- Gallardo, A. and Merino, J. (1999) Control of leaf litter decomposition rate in a Mediterranean shrubland as indicated by N, P and lignin concentrations. *Pedobiologia*, **43**, 64–72.
- Gartner, T. B. and Cardon, Z. G. (2004) Decomposition dynamics in mixed-species leaf litter. *Oikos*, **104**, 230–46.
- Gholz, H. L., Wedin, D. A., Smitherman, S. M., Harmon, M. E. and Parton, W. J. (2000) Long-term dynamics of pine and hardwood litter in contrasting environments: toward a global model of decomposition. *Global Change Biology*, **6**, 751–65.
- Giardina, C. P. and Ryan, M. G. (2000) Evidence that decomposition rates of organic carbon in mineral soil do not vary with temperature. *Nature*, **404**, 858–61.
- Gillon, D., Joffre, R. and Ibrahima, A. (1994) Initial litter properties and decay-rate: a microcosm experiment on Mediterranean species. *Canadian Journal of Botany*, **72**, 946–54.
- Gillon, D., Joffre, R. and Ibrahima, A. (1999) Can litter decomposability be predicted by near infrared reflectance spectroscopy? *Ecology*, **80**, 175–86.
- Gleixner, G. and Schmidt, H. L. (1997) Carbon isotope effects on the fructose-1,6-bisphosphate aldolase reaction, origin for non-statistical ^{13}C distributions in carbohydrates. *Journal of Biological Chemistry*, **272**, 5382–7.
- Gleixner, G., Bol, R. and Balesdent, J. (1999) Molecular insight into soil carbon turnover. *Rapid Communications in Mass Spectrometry*, **13**, 1278–83.
- Gleixner, G., Poirier, N., Bol, R. and Balesdent, J. (2002) Molecular dynamics of organic matter in a cultivated soil. *Organic Geochemistry*, **33**, 357–66.
- Gorissen, A. and Cotrufo, M. F. (2000) Decomposition of leaf and root tissue of three perennial grass species grown at two levels of atmospheric CO_2 and N supply. *Plant and Soil*, **224**, 75–84.
- Gosz, J. R., Likens, G. E. and Bormann, F. H. (1973) Nutrient release from decomposing leaf and branch litter in Hubbard Brook Forest, New-Hampshire. *Ecological Monographs*, **43**, 173–91.
- Griffiths, R. I., Manefield, M., Ostle, N. *et al.* (2004) $^{13}\text{CO}_2$ pulse labelling of plants in tandem with stable isotope probing: methodological considerations for examining microbial function in the rhizosphere. *Journal of Microbiological Methods*, **58**, 119–29.
- Harkess, D. D., Harrison, A. F. and Bacon, P. J. (1986) Temporal distribution of 'bomb' ^{14}C in a forest soil. *Radiocarbon*, **28**, 328–37.
- Harrison, A. F., Harkness, D. D., Rowland, A. P., Garnett, J. S. and Bacon, P. J. (2000) Annual carbon and nitrogen fluxes in soils along the European forest transect, determined using ^{14}C . In *Carbon and Nitrogen Cycling in European Forest Ecosystems*, ed. E. D. Schulze. Vol. 142. Ecological Studies. Berlin: Springer-Verlag, pp. 237–56.
- Hättenschwiler, S., Tiunov, A. V. and Scheu, S. (2005) Biodiversity and litter decomposition in terrestrial ecosystems. *Annual Review of Ecology and Evolution Systematics*, **36**, 191–218.
- Heal, O., Anderson, J. and Swift, M. (1997) Plant litter quality and decomposition: an historical overview. In *Driven by Nature: Plant Litter Quality and Decomposition*, ed. G. Cadish and K. E. Giller. Wallingford: CAB International, pp. 3–30.
- Hendrick, R. L. and Pregitzer, K. S. (1996) Applications of minirhizotrons to understand root function in forests and other natural ecosystems. *Plant and Soil*, **185**, 293–304.
- Henriksen, T. M. and Breland, T. A. (1999) Evaluation of criteria for describing crop residue degradability in a model of carbon and nitrogen turnover in soil. *Soil Biology and Biochemistry*, **31**, 1135–49.
- Hobbie, E. A., Watrud, L. S., Maggard, S., Shiroyama, T. and Rygielwicz, P. T. (2003) Carbohydrate use and assimilation by litter and soil fungi assessed by carbon isotopes and BIOLOG (R) assays. *Soil Biology and Biochemistry*, **35**, 303–11.
- Howard, P. J. A. and Howard, D. M. (1974) Microbial decomposition of tree and shrub leaf litter. 1. Weight loss and chemical composition of decomposing litter. *Oikos*, **25**, 341–52.

- Hunt, H. W. (1977) A simulation model for decomposition in grasslands. *Ecology*, **58**, 469–84.
- IPCC (2001) *Third Assessment Report Climate Change 2001: Impacts, Adaptation and Vulnerability*. Cambridge: Cambridge University Press.
- Isidorov, V. and Jdanova, M. (2002) Volatile organic compounds from leaves litter. *Chemosphere*, **48**, 975–9.
- Jenkinson, D. S. (1971) Studies on decomposition of ^{14}C labelled organic matter in soil. *Soil Science*, **111**, 64–70.
- Jenkinson, D. S. and Rayner, J. H. (1977) The turnover of soil organic matter in some of the Rothamsted classical experiments. *Soil Science*, **123**, 298–305.
- Jenkinson, D. S., Hart, P. B. S., Rayner, J. H. and Parry, L. C. (1987) Modelling the turnover of organic matter in long-term experiments at Rothamsted. *INTECOL Bulletin*, **15**, 1–8.
- Jenkinson, D. S., Adams, D. E. and Wild, A. (1991) Model estimates of CO_2 emissions from soil in response to global warming. *Nature*, **351**, 304–6.
- Jenkinson, D. S., Harkness, D. D., Vance, E. D., Adams, D. E. and Harrison, A. F. (1992) Calculating net primary production and annual input of organic matter to soil from the amount and radiocarbon content of soil organic matter. *Soil Biology and Biochemistry*, **24**, 295–308.
- Joffre, R., Ågren, G. I., Gillon, D. and Bosatta, E. (2001) Organic matter quality in ecological studies: theory meets experiment. *Oikos*, **93**, 451–8.
- Johansson, M. B., Berg, B. and Meentemeyer, V. (1995) Litter mass-loss rates in late stages of decomposition in a climatic transect of pine forests: long-term decomposition in a Scots Pine forest. *Canadian Journal of Botany*, **73**, 1509–21.
- Keating, B. A., Carberry, P. S., Hammer, G. L. *et al.* (2003) An overview of APSIM, a model designed for farming systems simulation. *European Journal of Agronomy*, **18**, 267–88.
- Kepler, F., Hamilton, J. G., Brass, M. and Rockmann, T. (2006) Methane emissions from terrestrial plants under aerobic conditions. *Nature*, **439**, 187–91.
- Knorr, W., Prentice, I. C., House, J. I. and Holland, E. A. (2005) Long-term sensitivity of soil carbon turnover to warming. *Nature*, **433**, 298–301.
- Koukoura, Z. (1998) Decomposition and nutrient release from C_3 and C_4 plant litters in a natural grassland. *Acta Oecologica – International Journal of Ecology*, **19**, 115–23.
- Kuzyakov, Y. (2002) Review: factors affecting rhizosphere priming effects. *Journal of Plant Nutrition and Soil Science*, **165**, 382–96.
- Ladd, J. N., Amato, M., Grace, P. R. and Vanveen, J. A. (1995) Simulation of ^{14}C turnover through the microbial biomass in soils incubated with ^{14}C -labeled plant residues. *Soil Biology and Biochemistry*, **27**, 777–83.
- Liski, J., Nissinen, A., Erhard, M. and Taskinen, O. (2003) Climatic effects on litter decomposition from Arctic Tundra to tropical rainforest. *Global Change Biology*, **9**, 575–84.
- Lloyd, J. and Taylor, J. A. (1994) On the temperature dependence of soil respiration. *Functional Ecology*, **8**, 315–23.
- Magid, J., Cadisch, G. and Giller, K. E. (2002) Short and medium term plant litter decomposition in a tropical Ultisol elucidated by physical fractionation in a dual ^{13}C and ^{14}C isotope study. *Soil Biology and Biochemistry*, **34**, 1273–81.
- Mary, B., Mariotti, A. and Morel, J. L. (1992) Use of ^{13}C variations at natural abundance for studying the biodegradation of root mucilage, roots and glucose in soil. *Soil Biology and Biochemistry*, **24**, 1065–72.
- McClagherty, C. A. and Berg, B. (1987) Cellulose, lignin and nitrogen concentrations as rate regulating factors in late stages of forest litter decomposition. *Pedobiologia*, **30**, 101–12.
- Meentemeyer, V. (1978) Macroclimate and lignin control of litter decomposition rates. *Ecology*, **59**, 465–72.
- Melillo, J. M., Aber, J. D. and Muratore, J. F. (1982) Nitrogen and lignin control of hardwood leaf litter decomposition dynamics. *Ecology*, **63**, 621–6.
- Minderman, G. (1968) Addition, decomposition and accumulation of organic matter in forests. *Journal of Ecology*, **56**, 355–62.
- Moore, J. C., McCann, K., Setälä, H. and de Ruiter, P. C. (2003) Top-down is bottom-up: does predation in the rhizosphere regulate aboveground dynamics? *Ecology*, **84**, 846–57.
- Moore, T. R. (1984) Litter decomposition in a subarctic spruce-lichen woodland, eastern Canada. *Ecology*, **65**, 299–308.
- Moore, T. R., Trofymow, J. A., Taylor, B. *et al.* (1999) Litter decomposition rates in Canadian forests. *Global Change Biology*, **5**, 75–82.
- Moro, M. J. and Domingo, F. (2000) Litter decomposition in four woody species in a Mediterranean climate: weight loss, N and P dynamics. *Annals of Botany*, **86**, 1065–71.

- Neufeld, J. D., Driscoll, B. T., Knowles, R. and Archibald, F. S. (2001) Quantifying functional gene populations: comparing gene abundance and corresponding enzymatic activity using denitrification and nitrogen fixation in pulp and paper mill effluent treatment systems. *Canadian Journal of Microbiology*, **47**, 925–34.
- Olson, J. S. (1963) Energy storage and the balance of producers and decomposers in ecological systems. *Ecology*, **44**, 322–31.
- Osono, T. and Takeda, H. (2005) Limit values for decomposition and convergence process of lignocellulose fraction in decomposing leaf litter of 14 tree species in a cool temperate forest. *Ecological Research*, **20**, 51–8.
- Parton, W. J., Schimel, D. S., Cole, C. V. and Ojima, D. S. (1987) Analysis of factors controlling soil organic matter levels in Great Plains grasslands. *Soil Science Society of America Journal*, **51**, 1173–9.
- Parton, W. J., Stewart, J. W. B. and Cole, C. V. (1988) Dynamics of C, N, P and S in grassland soils: a model. *Biogeochemistry*, **5**, 109–31.
- Parton, W. J., Ojima, D. S., Cole, C. V. and Schimel, D. S. (1994) A general model for soil organic matter dynamics: sensitivity to litter chemistry, texture and management. In *Quantitative Modeling of Soil Forming Processes*, ed. R. B. Bryant and R. W. Arnold. Vol. SSSA Special Publication No. 39. Madison, WI, pp. 147–67.
- Paul, E. A. (2001) Temperature and moisture effects on decomposition. *NEE Workshop Proceedings, CRC for Greenhouse Accounting*, pp. 95–102.
- Paul, E. A. and Clark, F. E. (1996) *Soil Microbiology and Biochemistry*, 2nd edn. San Diego, CA: Academic Press.
- Paul, E. A. and Juma, N. G. (1981) Mineralization and immobilization of soil nitrogen by microorganisms. *Ecological Bulletins*, **33**, 179–99.
- Paustian, K., Ågren, G. and Bosatta, E. (1997) Modelling litter quality effects on decomposition and soil organic matter dynamics. In *Driven by Nature: Plant Litter Quality and Decomposition*, ed. G. Cadisch and K. E. Giller. Wallingford: CAB International, pp. 313–35.
- Perez-Hardeguy, N., Diaz, S., Cornelissen, J. H. C. *et al.* (2000) Chemistry and toughness predict leaf litter decomposition rates over a wide spectrum of functional types and taxa in central Argentina. *Plant and Soil*, **218**, 21–30.
- Persson, T., Karlsson, P. S., Seyferth, U., Sjöberg, R. M. and Rudebeck, A. (2000) Carbon mineralisation in European forest soils. In *Carbon and Nitrogen Cycling in European Forest Ecosystems*, ed. E. D. Schulze. Vol. 142. Ecological studies. Berlin: Springer-Verlag.
- Prescott, C. E., Blevins, L. L. and Staley, C. (2004) Litter decomposition in British Columbia forests: controlling factors and influences of forestry activities. *Journal of Ecosystems and Management*, **5**, 45–57.
- Qualls, R. G. and Bridgman, S. D. (2005) Mineralization rate of ¹⁴C-labelled dissolved organic matter from leaf litter in soils of a weathering chronosequence. *Soil Biology and Biochemistry*, **37**, 905–16.
- Radajewski, S., Ineson, P., Parekh, N. R. and Murrell, J. C. (2000) Stable-isotope probing as a tool in microbial ecology. *Nature*, **403**, 646–9.
- Rich, J. J., Heichen, R. S., Bottomley, P. J., Cromack, K. and Myrold, D. D. (2003) Community composition and functioning of denitrifying bacteria from adjacent meadow and forest soils. *Applied and Environmental Microbiology*, **69**, 5974–82.
- Robinson, C. H. (2002) Controls on decomposition and soil nitrogen availability at high latitudes. *Plant and Soil*, **242**, 65–81.
- Rosenberg, N., Blad, B. and Verma, S. (1983) *Microclimate: the Biological Environment*. New York: Wiley.
- Ross, D. J., Tate, K. R., Newton, P. C. D. and Clark, H. (2002) Decomposition of C₃ and C₄ grass litter sampled under different concentrations of atmospheric carbon dioxide at a natural CO₂ spring. *Plant and Soil*, **240**, 275–86.
- Rowland, A. P. and Roberts, J. D. (1994) Lignin and cellulose fraction in decomposition studies using acid-detergent fibre methods. *Communications in Soil Science and Plant Analysis*, **25**, 269–77.
- Rubino, M., Lubritto, C., D'Onofrio, A. *et al.* (2007) An isotopic method for testing the influence of leaf litter quality on carbon fluxes during composition. *Oecologia*, **154**, 155–66.
- Rubino, M., Lubritto, C., D'Onofrio, A. *et al.* (2009) Isotopic evidences for microbiologically mediated and direct C input to soil compounds from three different leaf litters during their decomposition. *Environmental Chemistry Letters*, **7**, 85–95.
- Sayer, E. J., Tanner, E. V. J. and Cheesman, A. W. (2006) Increased litterfall changes fine root distribution in a moist tropical forest. *Plant and Soil*, **281**, 5–13.
- Schadler, M. and Brandl, R. (2005) Do invertebrate decomposers affect the disappearance rate of litter mixtures? *Soil Biology and Biochemistry*, **37**, 329–37.

- Schomberg, H. H., Steiner, J. L. and Unger, P. W. (1994) Decomposition and nitrogen dynamics of crop residues: residue quality and water effects. *Soil Science Society of America Journal*, **58**, 372–81.
- Schulze, W. X., Gleixner, G., Kaiser, K. *et al.* (2005) A proteomic fingerprint of dissolved organic carbon and of soil particles. *Oecologia*, **142**, 335–43.
- Silver, W. L. and Miya, R. K. (2001) Global patterns in root decomposition: comparisons of climate and litter quality effects. *Oecologia*, **129**, 407–19.
- Six, J., Elliott, E. T. and Paustian, K. (2000) Soil macroaggregate turnover and microaggregate formation: a mechanism for C sequestration under no-tillage agriculture. *Soil Biology and Biochemistry*, **32**, 2099–103.
- Six, J., Bossuyt, H., Degryze, S. and Denef, K. (2004) A history of research on the link between (micro)aggregates, soil biota, and soil organic matter dynamics. *Soil and Tillage Research*, **79**, 7–31.
- Smith, P., Smith, J. U., Powlson, D. S., McGill, W. B. and Arah, J. R. M. (1997) A comparison of the performance of nine soil organic matter models using datasets from seven long-term experiments. *Geoderma*, **81**, 153–225.
- Smith, V. C. and Bradford, M. A. (2003) Litter quality impacts on grassland litter decomposition are differently dependent on soil fauna across time. *Applied Soil Ecology*, **24**, 197–203.
- Subke, J. A., Hahn, V., Battipaglia, G. *et al.* (2004) Feedback interactions between needle litter decomposition and rhizosphere activity. *Oecologia*, **139**, 551–9.
- Swift, M. J., Heal, O. W. and Anderson, J. M. (1979) *Decomposition in Terrestrial Ecosystems*. Oxford: Blackwell Scientific Publications.
- Swift, M. J., Andren, O., Brussaard, L. *et al.* (1998) Global change, soil biodiversity, and nitrogen cycling in terrestrial ecosystems: three case studies. *Global Change Biology*, **4**, 729–43.
- Tang, J., Baldocchi, D. D. and Liukang, X. (2003) Assessing soil CO₂ efflux using continuous measurements of CO₂ profiles in soils with small solid-state sensors. *Agricultural and Forest Meteorology*, **118**, 207–20.
- Torres, P. A., Abril, A. B. and Bucher, E. H. (2005) Microbial succession in litter decomposition in the semi-arid Chaco woodland. *Soil Biology and Biochemistry*, **37**, 49–54.
- Virzo De Santo, A., Berg, B., Rutigliano, F. A., Alfani, A. and Fioretto, A. (1993) Factors regulating early-stage decomposition of needle litters in 5 different coniferous forests. *Soil Biology and Biochemistry*, **25**, 1423–33.
- Vitousek, P. M., Turner, D. R., Parton, W. J. and Sanford, R. L. (1994) Litter decomposition on the Mauna Loa environmental matrix, Hawai'i. I: Patterns, mechanisms, and models. *Ecology*, **75**, 418–29.
- Vossbrinck, C. R., Coleman, D. C. and Woolley, T. A. (1979) Abiotic and biotic factors in litter decomposition in a semi-arid grassland. *Ecology*, **60**, 265–71.
- Wardle, D. A., Yeates, G. W., Nicholson, K. S., Bonner, K. I. and Watson, R. N. (1999) Response of soil microbial biomass dynamics, activity and plant litter decomposition to agricultural intensification over a seven-year period. *Soil Biology and Biochemistry*, **31**, 1707–20.
- Wieder, R. K. and Lang, G. E. (1982) A critique to the analytical methods used in examining decomposition data obtained from litter bags. *Ecology*, **63**, 1636–42.
- Zeller, B., Colin-Belgrand, M., Dambrine, E., Martin, F. and Bottner, P. (2000) Decomposition of ¹⁵N-labelled beech litter and fate of nitrogen derived from litter in a beech forest. *Oecologia*, **123**, 550–9.

6 • Characterization of soil organic matter

Karolien Denef, Alain F. Plante and Johan Six

6.1 INTRODUCTION

Soil organic matter (SOM) generally refers to the non-living organic material within the soil matrix that was once part of, or produced by, a living organism. It is usually determined on soil that has passed through a 2-mm sieve, and therefore is free of coarse animal residues, surface litter and large roots. Soil organic matter can be of plant, animal or microbial origin, and consists of a continuum of materials in various stages of alteration due to both biotic and abiotic processes (Baldock and Skjemstad, 2000). Methods used in the past to estimate directly SOM content involved the destruction of the organic matter by treatment with hydrogen peroxide (H_2O_2) or by ignition of the soil at high temperature (Nelson and Sommers, 1996). Both of these techniques, however, are subject to significant error: oxidation of SOM by H_2O_2 is incomplete, and some inorganic soil constituents decompose upon heating.

While different elements such as C, N, P, S etc. are bound into organic compounds, we will concentrate on soil organic carbon (SOC) for the purposes of this chapter because it is the dominant element, and because of its role in the global carbon cycle. Organic carbon to SOM conversion factors for surface soils typically range from 1.72 to 2.0 g SOM g^{-1} C (Nelson and Sommers, 1996). Direct measurement of total soil carbon involves the conversion of all forms of carbon to carbon dioxide (CO_2) by wet or dry combustion and subsequent quantification of the evolved CO_2 . Soil organic carbon may be determined by (1) analysis of soil samples for total carbon and inorganic carbon, followed by subtraction of the inorganic carbon portion from the total carbon, (2) determination of total carbon after destruction of inorganic carbon (e.g. by acid treatment) or (3) oxidation of organic compounds by $\text{Cr}_2\text{O}_7^{2-}$ (Nelson and Sommers, 1996). The last approach is generally

referred to as the Walkley–Black method. Wet and dry combustion methods are considered to yield absolute values of carbon, while other methods such as Walkley–Black are calibrated against the wet and dry combustion methods.

Whole-soil SOM content is a dynamic property. It represents the balance between plant, animal, microbial and erosional inputs, and losses due to mineralization, leaching and erosion. A posteriori measurements of changes in whole soil SOM contents after changes in land-use or management practices provided the original basis for estimates of SOM dynamics. However, the bulk of whole soil SOM is stabilized and has turnover times measured in hundreds to thousands of years. Changes in whole soil SOC after changes in land-use or management practices are therefore difficult to detect in the short term (< 5 years). High spatial variability poses an additional problem, and several studies have reported the number of samples and time required to demonstrate a minimum detectable difference in whole-soil SOC (e.g. Garten and Wullschlegel, 2000; Conen *et al.*, 2003; Smith, 2004).

The increased demand for better SOC stock assessments and better predictions of the changes in SOC stocks as a result of land use/land cover and climate change has become a significant driver for the past few decades of SOM research. This has triggered large-scale and long-term measurements of SOC pools as well as more mechanistic process level studies (Sollins *et al.*, 2007). A large number of SOM fractionation and characterization techniques have been developed to gain insight in the stabilization and destabilization mechanisms that underlie SOM dynamics in the short and long term (Kögel-Knabner, 2000; Six *et al.*, 2000a; von Lützwow *et al.*, 2006; Kleber *et al.*, 2007; Sollins *et al.*, 2007; von Lützwow *et al.*, 2007) and/or to identify SOM

fractions that respond more rapidly to changes in, for example, land use, management or climate than whole soil SOM and thus could serve as early indicators or verifiers for total SOM change (Six *et al.*, 1998; Leifeld and Kögel-Knabner, 2005).

The intention of this chapter is to give a general overview of existing SOM fractionation and characterization techniques, to discuss their shortcomings and to suggest directions for future research by giving some examples of promising new techniques.

6.2 OVERVIEW OF TECHNIQUES TO FRACTIONATE AND CHARACTERIZE SOIL ORGANIC MATTER

Soil organic matter consists of many classes of compounds with different biochemical properties and varying degrees of association with the mineral matrix, which differentially contribute to the overall dynamics of total SOM. Most models of SOM dynamics, however, do not explicitly take into account the biological, physical or chemical mechanisms that act to stabilize SOM. Instead, they divide SOM into several kinetic compartments (e.g. active, slow and passive, according to the CENTURY model) based on assumed turnover times, and define their dynamics in terms of transfers from one compartment to another (e.g. Parton *et al.*, 1987, 1988; Jenkinson, 1990). These models could greatly benefit from the integration of measurable and separable SOM fractions defined by different stabilization mechanisms and degrees of stabilization (Christensen, 1996b; Elliott *et al.*, 1996; Six and Jastrow, 2002; Smith *et al.*, 2002). Numerous fractionation schemes have been developed with the purpose of separating 'functional' SOM fractions that are more homogeneous in terms of their biochemical properties and turnover times. Their relevance for clarifying SOM stabilization and destabilization mechanisms or for SOM modelling purposes has been recently reviewed by von Lützow *et al.* (2007).

6.2.1 Soil organic matter fractionation

6.2.1.1 Biological fractionation

Biological fractionation separates SOM into labile and recalcitrant portions through microbial mineralization. The underlying assumption is that the microbial biomass will mineralize the labile portion first,

leaving the recalcitrant portion behind, resulting in a relative accumulation of refractory compounds in carbon-depleted soils (Rühlmann, 1999; Kiem *et al.*, 2000). This approach, however, requires an undesirably long time to distinguish labile from recalcitrant SOC and is limited to systems with negligible organic inputs. One of the best means by which biological fractionation can be assessed is through the use of isotopes (^{13}C , ^{14}C , ^{15}N) in labelling experiments, ^{13}C natural abundance or ^{14}C radiocarbon dating experiments. Carbon-13 natural abundance studies utilize known and dated vegetation changes (Cerri *et al.*, 1985; Balesdent *et al.*, 1987; Balesdent and Mariotti, 1996). Examples of these vegetation changes include shifts from C_4 grasslands to C_3 crops, or cultivation of C_4 corn in temperate areas dominated by C_3 native vegetation. While different plant parts and compounds have different ^{13}C to ^{12}C ratios, and while microbial decomposition of these materials results in some fractionation, SOC generally retains the integrated signature of its parent vegetation (Balesdent and Mariotti, 1996). The progressive change in the isotopic signature allows a quantitative estimate of the turnover time and size of the SOC components. Radiocarbon (^{14}C) measurements can provide estimates of much longer turnover times (Wang *et al.*, 1996; Paul *et al.*, 1997; Trumbore, 2000), but estimates must take into account recent ^{14}C -bomb inputs. While there is evidence from the radiocarbon dating of microbial respiration to suggest that microbial biomass will mineralize the labile portion first (e.g. Trumbore, 2000), other studies examining isotopic signatures of respired CO_2 and phospholipid fatty acids (PLFA) suggest that a component of the microbial community is capable of using substrates with older carbon (e.g. Waldrop and Firestone, 2004; Rethemeyer *et al.*, 2005; Kramer and Gleixner, 2006). The idea of active recycling of SOM carbon by soil microbes, as suggested by Gleixner *et al.* (2002), could form a possible explanation for the older isotopic signature observed in biochemically labile SOM compounds (Gleixner *et al.*, 1999, 2002; Derrien *et al.*, 2006) and respired CO_2 and microbial PLFA (see references above). Shifts from younger to older carbon utilization could also be induced by changes in environmental conditions (e.g. temperature, N additions) and have been ascribed to changes in microbial community composition and accompanying changes in enzyme activities (Dioumaeva *et al.*, 2002; Waldrop and Firestone, 2004).

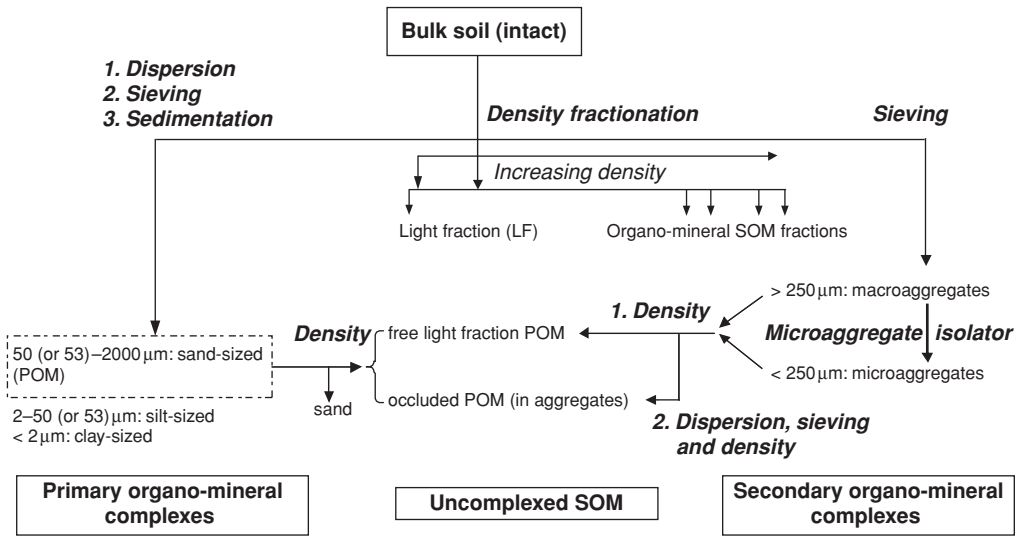

Figure 6.1 Overview of the most commonly used physical fractionation methods to isolate uncomplexed SOM based on size (POM) or density (LF) from mineral-bound organic matter in primary particle and aggregate size fractions.

6.2.1.2 Physical fractionation

The physical organization of a soil controls SOM accessibility to soil microbes and could as such determine the biochemical characteristics and stability of SOM. Most physical fractionation techniques therefore aim at isolating homogeneous fractions (in terms of properties and turnover) that represent functional SOM pools that are formed by a specific stabilization mechanism (e.g. recalcitrance, spatial inaccessibility and organo-mineral interactions (Sollins *et al.*, 1996; Six and Jastrow, 2002; von Lützwow *et al.*, 2006). The distribution of SOM among physical fractions in the soil is generally assessed by applying various degrees of disruption to the soil, followed by the separation of physical fractions based on size or density (Elliott and Cambardella, 1991; Christensen, 1992; Golchin *et al.*, 1994; Six *et al.*, 1998, 2000b; Christensen, 2001; Sollins *et al.*, 2006) (Fig. 6.1). This allows the separation of uncomplexed SOM and of various primary (i.e. sand, silt, clay) or secondary (i.e. soil aggregates) organo-mineral fractions differing in size or density. Physical fractionation of SOM has revealed that soil size and density separates differ in chemistry, origin, rates of turnover and dynamics (Puget *et al.*, 2000; Liao *et al.*, 2006a, 2006b; Sollins *et al.*, 2006).

Uncomplexed SOM has been defined by Gregorich *et al.* (2006) as SOM that is not bound to mineral

particles. However, it is difficult to isolate either completely mineral-free SOM or SOM-free minerals, particularly in fine-textured soils. Assuming a density of 1.4 g cm^{-3} for the organic phase (Adams, 1973; Mayer *et al.*, 2004) and 2.6 g cm^{-3} for the mineral phase, Chenu and Plante (2006) calculated the SOM contents of density fractions using a simple mixing model and found that a density fraction of $< 1.6 \text{ g cm}^{-3}$ would contain $> 73\%$ SOM and a density fraction of $> 2.2 \text{ g cm}^{-3}$ would contain $< 21\%$ SOM. The most popular density reagent is sodium polytungstate (SPT, $\text{Na}_6(\text{H}_2\text{W}_{12}\text{O}_{40})$), which is non-toxic, expensive but can be regenerated (Six *et al.*, 1999b), but also solubilizes a significant and functionally distinct portion of SOM (Crow *et al.*, 2007). Microscopic investigations and chemical characterization indicate a dominant plant origin of uncomplexed SOM (Oades *et al.*, 1987; Golchin *et al.*, 1994). In comparison to whole soil, uncomplexed SOM is enriched in carbohydrates (Dalal and Henry, 1988) and has a higher lignin content and C/N ratio (Gregorich *et al.*, 2006). Uncomplexed SOM fractions often respond more rapidly to land-use or soil-management changes than mineral-associated SOM fractions (e.g. Cambardella and Elliott, 1992; Gregorich and Janzen, 1996; Six *et al.*, 1998; Gerzabek *et al.*, 2001; Chan *et al.*, 2002). However, several studies have suggested that more stabilized

mineral-associated SOM fractions are better indicators for soil quality changes upon changes in land use or management despite their longer turnover times compared to uncomplexed organic materials (Jastrow, 1996; Stemmer *et al.*, 1999; Chenu *et al.*, 2001; Deneff *et al.*, 2004; Leifeld and Kögel-Knabner, 2005; Deneff *et al.*, 2007). Related to this, controversy also exists about the turnover rate of uncomplexed SOM. Skjemstad *et al.* (1990) reported surprisingly long residence times for density-separated uncomplexed SOM (i.e. light fraction, LF). In soils converted to pasture, they found that 60% of the LF was derived from old rainforest vegetation 35 years after conversion to pasture, and 20% of the LF was forest derived after 83 years. Different factors such as vegetation type, climate, soil texture, soil mineralogy, faunal activity, as well as methodology (e.g. choice of separation solution density) can significantly influence the amount, quality and turnover of uncomplexed SOM (Skjemstad and Dalal, 1987). Future work should consider the composition and stability of physical SOM fractions in different soil types and environments following standardized fractionation procedures.

There also exists confusion about the nomenclature of uncomplexed SOM. Light fraction and particulate organic matter (POM) are the two most common isolated fractions to assess uncomplexed SOM. As Gregorich *et al.* (2006) suggested, LF is a fraction of uncomplexed SOM isolated by density alone (using dense liquids typically in the range of 1.6–2.0 g cm⁻³), while POM is a fraction isolated by size alone (typically > 50 or 53 µm). The uncomplexed nature of LF SOM obtained at densities < 1.6–2.0 g cm⁻³ was supported by Sollins *et al.* (2006) who showed a wide range of C/N ratios between 10 and 40 for the < 2.0 g cm⁻³ fractions, whereas a more consistent C/N ratio of 10 was altered for fractions with a density of > 2.0 g cm⁻³. Depending on the fractionation method, LF and POM fractions can greatly differ in their biochemical properties (Gregorich *et al.*, 2006). When LF or POM is separated after chemical or mechanical disruption of the soil, it includes uncomplexed SOM that was occluded in aggregates as well as uncomplexed SOM located outside aggregates. Light fraction obtained by density fractionation on intact or minimal disrupted soil consists only of non-aggregate-occluded light fraction (i.e. free LF) (Christensen, 2001). After removal of the free LF, the aggregate-occluded POM fraction is usually obtained

upon mechanical or chemical aggregate disruption and sieving (Fig. 6.1). Chemical and isotopic comparison of the free LF and aggregate-occluded POM fractions generally suggest that aggregate-occluded POM is more microbially processed and relatively more stabilized than the free LF (Golchin *et al.*, 1994; Helfrich *et al.*, 2006; Liao *et al.*, 2006b). However, the outcome of such compositional comparisons are greatly influenced by the type of fractionation method used (Kölbl *et al.*, 2005).

Separation of organic matter in *primary particle size fractions* is usually obtained by an assumed 'complete' dispersion of the soil, followed by sieving and sedimentation (Christensen, 1996a) (Fig. 6.1). For the purpose of primary particle fractionation, complete dispersion is usually defined by or calibrated against soil texture, even though silt- and clay-sized microaggregates may persist after the dispersion treatment (e.g. North, 1976; Balabane and Plante, 2004). Chemical characterization of SOM in primary particle fractions has demonstrated an increased contribution of plant- (*vs.* microbial-) derived substances from clay- to silt- to sand-sized organo-mineral fractions, with significant enrichment of the silt-sized fraction in aromatic compounds (Baldock *et al.*, 1992; Guggenberger *et al.*, 1995; Christensen, 1996a). In addition, a decrease in lignin content (Amelung *et al.*, 1999) and C/N ratio of organo-mineral complexes (Guggenberger *et al.*, 1995) with decreasing particle size have been observed, indicating an enhanced degree of SOM humification or a higher microbial processing from sand- to silt- to clay-sized complexes. These observations suggest that, as plant residues are decomposed while residing in the sand-sized fraction, newly formed microbial products become associated with clay-sized complexes, and more recalcitrant substances end up in the silt-sized fraction. It is generally believed that carbon is more stabilized in finer particle size fractions, due to adsorption and chemical binding on clay mineral surfaces as well as aggregate formation (Baldock and Skjemstad, 2000). Evidence for this comes from carbon isotope analyses of particle-size fractions generally showing increasing mean residence time with decreasing particle size (e.g. Anderson and Paul, 1984; Balesdent, 1996). However, when comparing mean residence times of soil organic carbon across particle size fractions from several studies, von Lützow *et al.* (2007) found lower turnover times for the fine (< 0.2 µm) *vs.* coarse (0.2–2 µm) clay

fraction, which could be attributed to an incomplete disaggregation of coarse clay-sized microaggregates during dispersion (Guggenberger and Zech, 1999; Chenu and Plante, 2006). Another plausible explanation, however, could be found in differences in mineralogical properties. Soil mineral properties (e.g. mineral assemblage, mineral charge, effective cation exchange capacity (ECEC), specific or reactive surface area, polyvalent cations, organometal complexes, crystallinity and type of oxides) have been found to have a significant impact on the amount, chemical composition and turnover of SOC in clay fractions due to different SOM–mineral binding mechanisms for different clay minerals (Wattel-Koekkoek *et al.*, 2003; Kleber *et al.*, 2004; Schöning *et al.*, 2005). In many soils, the type of soil mineral assemblage appears to be even more important for SOC storage than total clay content (Saggar *et al.*, 1996; Torn *et al.*, 1997; Percival *et al.*, 2000).

Residence times of organo–mineral associations not only depend on mineralogy, but also greatly on soil type, vegetation, land use and environmental conditions as well as method of age determination (^{13}C versus ^{14}C) and SOM fractionation. Carbon turnover times estimated by ^{13}C natural abundance are generally an order of magnitude smaller than those estimated by radiocarbon dating because of the different time scales measured by the two different methods (Paul *et al.*, 2001; Six and Jastrow, 2002). Comparing ^{13}C and ^{14}C mean residence times of particle size fractions across different ecosystems, von Lützow *et al.* (2007) found wide and overlapping ranges of turnover times of SOM in different particle size fractions. Therefore, it seems absolute values for turnover times of SOM fractions cannot be compared among studies.

High gradient magnetic separation (HGMS) has been used as a tool to separate Fe oxides and Fe-rich clay minerals from soil clays (Schulze and Dixon, 1979; Jaynes and Bigham, 1986). This technique has been applied in tropical SOM turnover studies to investigate why SOM appears to be less stable (i.e. faster turnover rates) under tropical than under temperate conditions (Jenkinson and Ayanaba, 1977; Trumbore, 1993; Tiessen *et al.*, 1994). In tropical soils, SOM is mainly stabilized through complexation with Fe and Al oxyhydroxides (Parfitt *et al.*, 1997; Schwertmann *et al.*, 2005) and interactions of clay particles with Fe and Al ions (Theng, 1976). Results from studies using HGMS (Hughes, 1982; Shang and Tiessen, 1998) revealed the

greatest carbon enrichment in the fractions of intermediate magnetic susceptibility, whereas both the highly magnetic fraction of predominantly well crystallized Fe and the non-magnetic fraction were carbon poor (Shang and Tiessen, 1998). The authors attributed this to the fact that highly crystalline Fe oxides have a much lower sorption capacity to bind with SOM compared to poor-crystalline Fe- and Al-oxides (Turchenek and Oades, 1979; Duiker *et al.*, 2003). Mikutta *et al.* (2005) attempted to chemically characterize poorly crystalline minerals by selective dissolution with acid oxalate and dithionite–citrate, and physically characterized them by surface area determinations (BET– N_2). Their results supported HGMS findings that the capacity of the mineral matrix to protect SOM against decomposition is largely controlled by the content of poorly crystalline minerals. Chemical and isotopic characterization of HGMS fractions revealed a greater C/N ratio and a vegetation–resembling ^{13}C signature of the most magnetic (well crystallized) clay fraction, suggesting that the SOM in this fraction is derived mostly from plant materials and is relatively untransformed by microbial processes (Shang and Tiessen, 2000). The more enriched $\delta^{13}\text{C}$ values and lower C/N ratio, characterizing the non-magnetic clay fraction, suggested a more decomposed fraction of mainly microbial origin.

Soil organic matter associated with secondary organo–mineral complexes or *soil aggregate fractions* encompass primary particle-associated SOM, uncomplexed SOM, micro-organisms (bacteria, fungal hyphae and micro-fauna) and fine roots. Aggregate size separation methods have been utilized in many studies to identify mechanisms controlling SOM storage as well as changes in C and N pools associated with land-use/land-cover changes (Elliott, 1986; Beare *et al.*, 1994b; Cambardella and Elliott, 1994; Six *et al.*, 1998, 2000b, 2002; Liao *et al.*, 2006a), following the concept of aggregate hierarchy as proposed by Tisdall and Oades (1982). This concept assumes a hierarchical order of aggregates with different types of organic binding agents acting at the different stages: primary organo–mineral fractions are bound together into microaggregates (< 250 μm) by persistent materials of mainly microbial origin. Microaggregates are held together within macroaggregates (> 250 μm) through the binding action of roots and fungal hyphae (temporary) and readily decomposable plant- and microbial-derived polysaccharides (transient). According to this

concept, macroaggregates are more enriched in carbon but at the same time more transient and sensitive to physical disturbance compared to microaggregates (Tisdall and Oades, 1982). Support for aggregate hierarchy comes from studies reporting greater concentrations of organic carbon and biomass carbon (Elliott, 1986; Singh and Singh, 1995; Jastrow *et al.*, 1996; Six *et al.*, 2000a; Ashman *et al.*, 2003), as well as POM contents (Cambardella and Elliott, 1993; Beare *et al.*, 1994b; Puget *et al.*, 1996) in macroaggregates compared to microaggregates. Moreover, relative to SOM associated with smaller sized aggregates, macroaggregate-associated SOM has been generally found to be (1) more labile, as supported by direct relationships between C/N ratios of aggregate-SOM and aggregate size and mineralization studies (Elliott, 1986; Beare *et al.*, 1994a; Aoyama *et al.*, 1999; Gregorich *et al.*, 2003); (2) less decomposed, as demonstrated by decreasing plant-derived and increasing microbial-derived components with decreasing aggregate size (Monreal *et al.*, 1997) and (3) younger, as demonstrated by ^{13}C natural abundance (e.g. Skjemstad *et al.*, 1990; Puget *et al.*, 1995; Angers and Giroux, 1996; Jastrow *et al.*, 1996; Six *et al.*, 1999a) as well as ^{13}C tracer studies (Angers *et al.*, 1997; Denef *et al.*, 2001a). While aggregate hierarchy is generally expressed in fine textured soils dominated by 2:1 minerals where SOM is the primary aggregate binding agent, this is not the case in oxide-dominated soils (Oades and Waters, 1991; Feller *et al.*, 1996; Six *et al.*, 2000a; Zotarelli *et al.*, 2005; de Azevedo and Schulze, 2007).

Many methods have combined different physical fractionation methods in an attempt to target spatially explicit SOM fractions where carbon stabilization is most pronounced or land-use, management or environmental forces have the greatest impact (Six *et al.*, 2000b; Del Galdo *et al.*, 2003; Denef *et al.*, 2004; Leifeld and Kögel-Knabner, 2005; Del Galdo *et al.*, 2006). For example, the use of complex fractionation schemes by Six and colleagues have demonstrated across widely varying ecosystems, soil types and environments the importance of macroaggregate-occluded microaggregates (53–250 μm) as long-term stabilization sites for SOM (Six *et al.*, 2000b; Del Galdo *et al.*, 2003; Denef *et al.*, 2004; Kong *et al.*, 2005) and the potential of this aggregate fraction to serve as an early indicator for total SOC stock changes upon land-use change (Denef *et al.*, 2007). These microaggregates were

isolated by an isolator device (Six *et al.*, 2000b) that allows complete break-up of macroaggregates while minimizing the breakdown of the released microaggregates (Fig. 6.1). Research should be further directed at the chemical (Simpson *et al.*, 2004), microbial (Mummey *et al.*, 2006a, 2006b), and isotopic characterization (Six *et al.*, 2000b; Denef *et al.*, 2001b) of this microaggregate fraction among other potential diagnostic SOM fractions to better understand their dynamics as well as their fundamental importance to soil structure and function.

6.2.1.3 Chemical fractionation

Similar to physical fractionation, the goal of chemical fractionation of SOC is to isolate pools of carbon with similar properties and dynamics, and sometimes to isolate an organic fraction from the background mineral soil material. Depending on the carbon fraction of interest, a chemical treatment will be selected that removes more or less SOC. Conversely, chemical treatments such as hydrofluoric acid (HF) have been designed to dissolve the mineral portion of the sample, leaving behind the SOC (Skjemstad *et al.*, 1994; Schmidt *et al.*, 1997). These latter treatments are generally used to improve spectroscopic analyses of whole-soil samples rather than a means to fractionate SOM.

The simplest chemical fractionation of SOM uses cold distilled or deionized water to isolate dissolved organic matter (DOM) as a pool of readily decomposable carbon (Chantigny, 2003). Hot-water extraction was first proposed by Keeney and Bremner (1966) to determine easily available soil N, and has since been applied to isolate labile C (Haynes, 2005). Hot-water extractable SOC consists largely of labile carbohydrates and amino acids (Leinweber *et al.*, 1995), and is primarily of microbial origin (Sparling *et al.*, 1998). A number of other chemical fractionations have been devised to isolate labile pools of SOC. Blair *et al.* (1995) suggested that a fraction of organic carbon oxidizable with potassium permanganate (KMnO_4) was a useful index of labile SOC. However, Tirol-Padre and Ladha (2004) found better correlations of permanganate oxidizable carbon with total SOC than with water-soluble carbon and microbial biomass carbon. Skjemstad *et al.* (2006) also compared the method to POM and found that permanganate oxidizable carbon was relatively insensitive to rapid SOC gains, which is contrary to the definition of a labile carbon pool. Both studies found

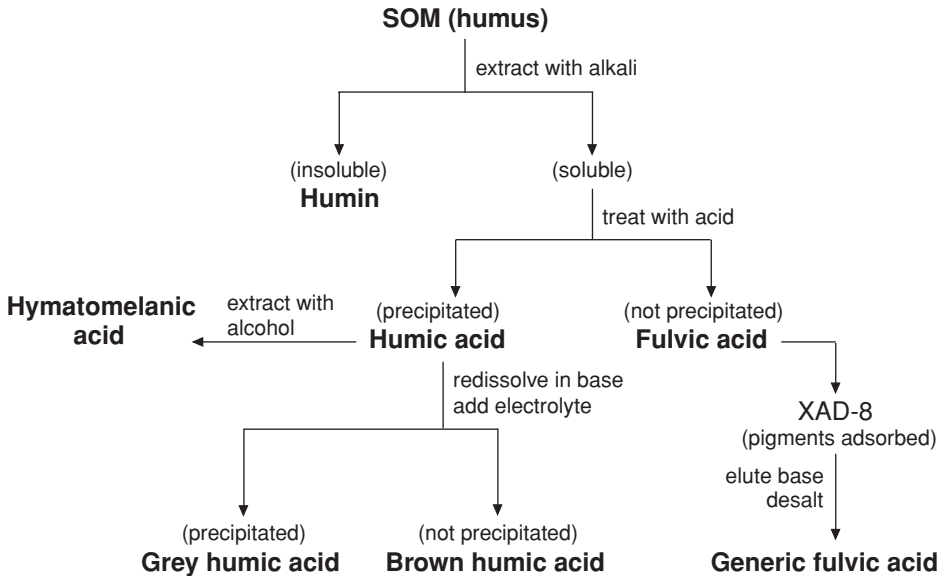

Figure 6.2 Chemical fractionation scheme of soil organic matter based on solubility characteristics (from Stevenson, 1994).

that the method is sensitive to the presence of lignin, and concluded that caution should be exercised when attempting to relate permanganate oxidizable carbon to labile SOC.

For much of the history of its study, SOM has been frequently synonymous with 'humic substances'. Humic substances conventionally defined as 'a series of relatively high-molecular weight, brown to black coloured substances formed by secondary synthesis reactions' (Stevenson, 1994). They are essentially a category of organic substance that cannot be classified into the normal categories such as proteins, lipids, polysaccharides etc. This vague definition has often led to defining these materials operationally in terms of the methods used to extract them from soils (MacCarthy, 2001), and decades of research has shown much of this characterization to be impractical or incorrect. Humic substances have traditionally been isolated using aqueous base or neutral salt solutions, and combinations of aqueous base (e.g. 0.5N NaOH) and pyrophosphate (e.g. 0.1M Na₄P₂O₇) (see review by Hayes, 2006). Soil organic matter fractionation operationally based on solubility in acid and base was first introduced by Sprenge (1837) and evolved through the mid-nineteenth century through the work of Berzelius (1839) and Mulder (1861). The classic fractionation scheme consists of humic acid, fulvic acid, the non-extractable

humic acid, and other fractions including hyatomelanic acid and grey and brown humic acids (Stevenson, 1994; Fig. 6.2). An enormous literature exists on the fractionation and analysis of humic substances from soils, and the reader is directed to several in-depth reviews (Aiken *et al.*, 1985; Hayes *et al.*, 1989; Stevenson, 1994). The operational definition of SOM fractions based on solubility characteristics has led to significant criticism, and many have abandoned the methods and terminology altogether. Stevenson (1994) identified several problems in the fractionation procedure (including the dissolution of fresh organic debris). The fractionation is generally not quantitative and it is nearly impossible to devise a scheme that separates humic from non-humic substances because both share some of the same chemical functional groups, and because it is difficult to identify the point in the decay process at which the transition from non-humic to humic substance occurs (MacCarthy, 2001). Moreover, the usefulness of the obtained fractions as kinetic fractions also appears to be rather limited. While several researchers have found that the age or mean residence times for each of the fractions based on ¹⁴C-dating were significantly different (e.g. Campbell *et al.*, 1967; Anderson and Paul, 1984), Balesdent (1996) found similar kinetics of enrichment in new ¹³C and concluded that the fractionation scheme was not useful in investigating carbon turnover.

Lastly, difficulties in characterizing humic substances (described later) have also demonstrated that the approach has limited value for predicting SOM behaviour.

Chemical fractionation of SOM to isolate stable or recalcitrant SOC is frequently performed using acid hydrolysis. A common acid hydrolysis technique involves refluxing whole-soil or isolated physical fractions in 6M HCl at 116 °C for 18 hours, though other acids and temperatures have been used. The hydrolysis reaction, through the process of protonation and hydration, solubilizes compounds with O- and N-containing functional side-groups (Barriuso *et al.*, 1987). Fatty acids, proteins and polysaccharides are susceptible to acid hydrolysis treatment, whereas long-chain alkyls, waxes, lignin and other aromatics are resistant to hydrolysis (Martel and Paul, 1974; Schnitzer and Preston, 1983; Paul *et al.*, 2000). Studies have found that the non-hydrolyzable fraction from a wide range of samples represents 35–65% of the total soil carbon (Paul *et al.*, 2006), and is generally 1300–1800 years older than total soil carbon (Leavitt *et al.*, 1996; Paul *et al.*, 1997, 2001). The acid hydrolysis method has been broadly adopted in studies of SOM dynamics and coupled with ¹⁴C-dating to estimate the size and turnover rate of the stable SOM pool in models (Leavitt *et al.*, 1996; Falloon *et al.*, 1998; Paul *et al.*, 2006). Recent criticism of the technique has argued that under land-use change, non-hydrolyzable carbon in soils may be lost or gained during relatively short periods of time relative to the age of the resistant carbon pool, which is inconsistent with its assumed recalcitrant chemical nature (Paul *et al.*, 2006; Plante *et al.*, 2006).

Other chemicals have been used to separate stable or recalcitrant SOM from labile fractions. These chemical treatments include hydrogen peroxide (H₂O₂), sodium hypochlorite (NaOCl) and disodium peroxodisulphate (Na₂S₂O₈). Some of these treatments were originally designed to remove as much SOC as possible to improve the characterization of the mineral fraction (Mikutta *et al.*, 2005), though none are 100% effective. The SOM remaining in treated residues has been regarded as a resistant fraction. Theng *et al.* (1992) and Righi *et al.* (1995) proposed that H₂O₂-resistant SOM represented a resistant fraction protected in inter-clay layers. However, Plante *et al.* (2004) found that, similar to acid hydrolysis, the proportion of H₂O₂-resistant clay-associated carbon did not increase with

decreasing total carbon. Generally, these chemical treatments remove a greater proportion of SOM than acid hydrolysis, and SOC in the resistant residues is smaller than what is generally assumed to exist based on turnover times calculated using common models. Zimmerman *et al.* (2007a) compared NaOCl treatment to acid hydrolysis and found that NaOCl removed more SOC (63 to 91%) than did acid hydrolysis (35 to 66%). They also found that ¹⁴C activities of NaOCl-resistant SOC were lower than those of hydrolysis-resistant SOC, suggesting that SOM isolated by NaOCl treatment is older than that obtained by acid hydrolysis. The authors concluded that oxidation with NaOCl is better than acid hydrolysis with HCl to obtain an operationally defined resistant fraction of SOM.

6.2.1.4 Black carbon fractionation and quantification

One SOC fraction that has received an increasing amount of attention is generally referred to as 'black carbon' (BC). Black carbon exists in soil as the product of vegetation fires and the incomplete combustion of fossil fuels. This pool of SOM is particularly difficult to isolate because it consists of a continuum of combustion products ranging from slightly charred and degradable biomass to highly condensed and refractory soot (Hedges *et al.*, 2000), which results in physical and chemical heterogeneity. This heterogeneity results in the occurrence of BC in both coarse and fine size fractions, as well as in both light and heavy fractions. Black carbon is distinguished from the rest of SOM by its presumed biochemical recalcitrance and long turnover times, although several studies have demonstrated that BC is less recalcitrant than commonly assumed (see Knicker, 2007 for a recent review). Techniques for the identification and quantification of BC fall into six general classes: microscopic, optical, thermal, chemical, spectroscopic and molecular marker (Schmidt and Noack, 2000; Masiello, 2004). Additionally, techniques exist that blend these six measurement types. Microscopic techniques measure the number of charcoal pieces identifiable under an optical microscope, while optical techniques measure the 'blackness' of a sample. Thermal methods measure BC remaining after oxidation upon heating, while chemical techniques measure BC remaining after chemical oxidation. Spectroscopic techniques target NMR regions characteristic of combustion products and estimate total BC concentration

based on the strength of these bands after removal of non-BC SOM; while molecular marker techniques measure the concentration of a particular compound or class of compounds associated with BC. Clearly, each of these techniques measures a different region within the combustion continuum, causing significant over- or under-estimations. In a study comparing six BC quantification methods on eight soils, Schmidt *et al.* (2001) found values ranging over two orders of magnitude, differences between methods varying by factors of 14 to 571 and no systematic methodological biases. Further evidence of a continuum of BC in terms of thermal stability was provided by Leifeld (2007) using oxidative differential scanning calorimetry, a dynamic thermal method that scans the reactivity (thermal stability) of a sample over a wide temperature range. Spectroscopic and molecular marker techniques (e.g. Brodowski *et al.*, 2005b) hold great potential to quantify the widest range of BC materials because they focus on the chemical signature of burning. Currently, the most frequently used means of fractionating and quantifying BC is using a preparatory oxidation step followed by quantification of the aromatic region by ^{13}C -NMR (e.g. Simpson and Hatcher, 2004).

6.2.2 Soil organic matter characterization

In addition to attempts to separate SOM into functional fractions by physical or chemical fractionation, a great deal of effort has been put into characterizing the chemical composition of SOM, either following extraction from the soil matrix or *in situ*.

6.2.2.1 Compound-specific characterization

Within a chemical SOM extract, molecular compounds can be characterized and quantified by online coupling of gas (GC) or liquid (LC) chromatographs to conventional GC or LC detectors (e.g. flame ionization (FID), refractive index) or mass-spectrometers (MS). Such compound-specific analyses can provide information about the origin (e.g. plant *vs.* microbial derived, or fungal *vs.* bacterial) or biochemical composition (e.g. carbohydrates, lignin, lipids, proteins) of the SOM fraction, and could help us better understand the underlying mechanisms of carbon stabilization (Lorenz *et al.*, 2007).

Lignin, for example, is a structurally complex biopolymer exclusively produced by vascular plants, and used as tracer for plant origin of SOM. Due to

its molecular composition and complexity, lignin is often considered to be a recalcitrant biomolecule, relatively resistant to decomposition. However, its contribution to the stable (passive) SOM pool is under debate (Heim and Schmidt, 2007). The most widely used technique for soil lignin analysis is the alkaline cupric oxide (CuO) oxidation method (Hedges and Ertel, 1982; Kögel, 1986), which releases several lignin phenol monomers with benzoyl- (H), vanillyl- (V), syringyl- (S) and cinnamyl- (C) structures and acid, aldehyde and ketone side-chains (Kögel and Bochter, 1985). The sum of V-, S- and C- phenolic CuO oxidation products (VSC) provides a quantitative measure of the lignin content in the soil, while the mass ratios of acids to aldehydes of the V- and S-units indicate the state of oxidative degradation of the lignin phenols and allows an assessment of the humification state of the SOM (Hedges and Ertel, 1982; Kögel, 1986; Hedges *et al.*, 1988; Hatcher *et al.*, 1995). Another commonly used technique for the analysis of lignin involves the thermochemolysis with tetramethylammonium hydroxide (TMAH) (Hatcher *et al.*, 1995; Nierop *et al.*, 2001). With TMAH thermochemolysis, lignin monomers are obtained analogous to those obtained with the CuO procedure, revealing similar information about the content and state of degradation of lignin. However, TMAH thermochemolysis is more sensitive in detecting lignin degradation than the CuO method. It also is less time consuming and thus more suitable for routine analyses (Hatcher *et al.*, 1995). A major drawback of the TMAH thermochemolysis technique, however, is its inability to determine if an aromatic methoxyl group produced by the procedure was originally present as a hydroxyl or a methoxyl functionality, because the procedure involves methylation of phenols while leaving the original methoxyl groups unaltered (Filley, 2003). Using ^{13}C -labelled TMAH and structural mass spectrometry analysis, Filley *et al.* (1999) were able to distinguish between original methoxyl groups on non-degraded lignin and those analytically added by TMAH (i.e. ^{13}C -labelled methyl group) on lignin residues that had undergone demethylation during microbial decay. It therefore provides a rapid and sensitive tool for tracking microbial modifications of lignin in different terrestrial environments (Filley *et al.*, 2000). Moreover, ^{13}C -TMAH thermochemolysis can distinguish methylated compounds from non-lignin sources (such as tannins or other phenolics), as opposed to the conventional

(unlabelled) TMAH method, where these compounds are usually ascribed to a lignin source (Fillely *et al.*, 2006; Nierop and Fillely, 2007).

Carbohydrates form another important and widely studied class of SOM compounds of both plant and microbial origin. Although carbohydrates are considered to be among the most easily biodegradable substrates (Cheshire, 1979), their concentration in soils is substantial, suggesting physical or chemical stabilization or active recycling of this carbon pool by soil microbes (Gleixner *et al.*, 1999, 2002; Derrien *et al.*, 2006). The determination of carbohydrates is commonly carried out in three steps: (1) *extraction* of carbohydrates from samples by hot-water extraction (e.g. Ball *et al.*, 1996) or acid hydrolysis with sulphuric acid (Cheshire and Mundie, 1966; Oades *et al.*, 1970; Larre-Larrouy and Feller, 2001) or 4M trifluoroacetic acid (TFA) (Amelung *et al.*, 1996; Rumpel and Dignac, 2006) followed by purification, (2) *derivatization* by either the trimethylsilyl, alditol acetate, aldononitrile acetate, trifluoroacetate or O-methyl oxime acetate procedure (see reviews by Guerrant and Moss, 1984; Black and Fox, 1996) or by methyl boronic acid derivatization (Gross and Glaser, 2004; Bock *et al.*, 2007), and subsequent (3) *GC analysis* of the monomers. Compound-specific characterization of carbohydrate SOM differentiates between microbial-derived sugars (dominated by hexoses) and plant-derived sugars (dominated by pentoses) (Oades, 1984; Moers *et al.*, 1990). Different ratios of hexoses to pentoses have been used to indicate the origin of soil carbohydrates (Oades, 1984; Hu *et al.*, 1995; Glaser *et al.*, 2000). In particular, ratios of (mannose + galactose)/(xylose + arabinose) and (rhamnose + fucose)/(xylose + arabinose) < 0.5 indicate a dominance of plant polysaccharides while ratios > 2.0 indicate a high microbial sugar synthesis (Oades, 1984; Guggenberger and Zech, 1994; Rumpel and Dignac, 2006). Carbohydrate analyses on physical SOM fractions have shown predominantly plant origin of particulate organic matter >50 µm (POM) and increasing proportions of microbial-derived sugars with decreasing particle size (Cheshire, 1979; Angers and Mehuys, 1990; Guggenberger *et al.*, 1994, 1995; Guggenberger and Zech, 1999; Puget *et al.*, 1999; Larre-Larrouy and Feller, 2001; Larre-Larrouy *et al.*, 2003; Derrien *et al.*, 2006; Bock *et al.*, 2007), suggesting an increasing microbial conversion of saccharides with decreasing particle size. However, the relative contribution of microbial-

and plant-derived sugars to the total extracted carbohydrate fraction varies depending on the specific extraction method adopted, in particular the type of extraction solvent used (Cheshire, 1979; Haynes and Francis, 1993; Ball *et al.*, 1996; Puget *et al.*, 1999).

Amino sugars comprise only about 1–5% of the total SOC pool, but are reliable molecular markers for total (living and decomposing) microbial biomass as they are synthesized by micro-organisms but not by higher plants (Benzing-Purdie, 1984; Zhang and Amelung, 1996; Chantigny *et al.*, 1997). The concentration of amino sugars is therefore routinely applied to indicate microbial contributions to SOM (Zhang *et al.*, 1998; Amelung, 2001; Solomon *et al.*, 2001; Turrión *et al.*, 2002; Glaser *et al.*, 2004). Amino sugars are usually determined according to the method of Zhang and Amelung (1996): (1) *extraction* by acid hydrolysis with 6N hydrochloric acid, followed by purification and neutralization, (2) *derivatization* by the aldononitrile (Guerrant and Moss, 1984) or methyl boronic acid (Gross and Glaser, 2004) procedure and (3) *GC analysis* of the monomers. Comparisons of the concentrations of glucosamine, galactosamine, mannosamine and muramic acid, in the soil with those in the soil microbial biomass showed that amino sugars are mainly derived from microbial necromass and become stabilized in the soil (Glaser *et al.*, 2004). Due to the predominant fungal origin of glucosamine compared to the predominant and even exclusive bacterial origin of galactosamine and muramic acid, respectively (Parsons, 1981; Amelung, 2001), the ratios of glucosamine over muramic acid or galactosamine (or the sum of these two) have been used to differentiate between the relative contribution of fungi and bacteria to SOM turnover and accumulation in soil (Zhang *et al.*, 1998; Guggenberger *et al.*, 1999a; Amelung, 2001). Amino sugar analysis has been combined with physical fractionation to clarify microbial-derived SOM dynamics and SOM (de)stabilization mechanisms. For example, by analyzing amino sugar concentrations in different aggregate size fractions, fungal-derived SOM accumulation under no-till was attributed to the preferential stabilization of fungal-derived amino sugars in macroaggregate-occluded microaggregates (Simpson *et al.*, 2004). Zhang *et al.* (1998) proposed sorption onto clay particles as a major stabilization mechanism of amino sugars based on observations of progressive accumulation of amino sugars in SOM with decreasing particle size. However,

a lack of correlation between clay or TOC content and individual amino sugar concentrations did not support sorption as a major stabilization mechanism (Glaser *et al.*, 2004). The possibility of microbial recycling (cf. Gleixner *et al.*, 2002) of amino sugars as preservation mechanism remains to be further investigated.

Extractable lipids form another important group of organic substances in the soil and have been of particular interest in SOM research due to their role in SOM accumulation and SOM stability (Naafs *et al.*, 2004; Rumpel *et al.*, 2004b), their use as vegetation tracers (VanBergen *et al.*, 1997; Marseille *et al.*, 1999; Bull *et al.*, 2000b; Wiesenberg *et al.*, 2004a) as well as microbial tracers (Zelles, 1999), and their diagnostic potential to infer SOM transformation and stabilization processes (Bull *et al.*, 2000a; Quenea *et al.*, 2004; Otto and Simpson, 2005). Soil lipids consist of various components such as alkanolic acids, alkanols, alkenes, alkanes, ketones, resins, terpenoids and steroids present both as free compounds or combined as waxes, triglycerides and/or phospholipids (Dinel *et al.*, 1990; Kögel-Knabner, 2002). A wide range of procedures has been applied for soil lipid extraction, including Soxhlet extraction (Naafs *et al.*, 2004; Nierop *et al.*, 2005), sonication followed by solvent extraction (Otto *et al.*, 2005), simple shaking with solvent (Quenea *et al.*, 2004) and accelerated solvent extraction (Rumpel *et al.*, 2004b; Wiesenberg *et al.*, 2004b; Jansen *et al.*, 2006). However, 100% recoveries are not always guaranteed as significant amounts of lipids can be trapped in complex organic polymers (e.g. humin) that cannot be directly extracted with solvents (Grasset and Ambles, 1998). The composition of total lipid extracts from soils is usually determined by gas chromatography–mass spectrometry (GC/MS).

6.2.2.2 Whole-soil SOM characterization

For a time during the mid to late 1900s, the chemical structure of the majority of SOM (i.e. humic substances) was constructed from the products of chemical and pyrolytic degradations followed by ‘an imaginative synthesis of all the information and the postulation of a grand structure’ (Burdon, 2001). However, more recent innovations in spectroscopic, microscopic, pyrolysis and soft ionization techniques suggest a new concept of humic substances consisting of a supramolecular association of many relatively small and chemically diverse organic molecules of plant and microbial origin

(e.g. Wershaw, 1999; Piccolo, 2001; Sutton and Sposito, 2005).

Recent advances in analytical instrumentation have allowed the chemical characterization of SOM *in situ*, that is, without extraction. Two approaches represent the current state of the art for the characterization of SOM *in situ*: pyrolysis mass spectrometry (Py-MS) and nuclear magnetic resonance (NMR). Nuclear magnetic resonance spectroscopy has been applied to humic substances in the liquid state for decades (e.g. Barton and Schnitzer, 1963). Since then, solid-state ^{13}C -NMR spectroscopy has become an important tool in the characterization of SOM (Wilson, 1987). Solid-state ^{13}C -NMR is generally used to determine the concentrations of the main functional groups of SOM in whole-soil samples and isolated physical fractions. The most common type of ^{13}C -NMR used in SOM studies is cross-polarization, magic angle spinning NMR (CPMAS ^{13}C -NMR) (Preston, 1996; Kögel-Knabner, 1997). The MAS technique compensates for the chemical-shift anisotropy of solid samples, while cross-polarization between ^1H and ^{13}C spins leads to improved signal enhancement, which allows investigation of solid samples at natural ^{13}C abundance. The principle of ^{13}C -NMR involves the excitation of nuclei by a magnetic field. Solid-state ^{13}C -NMR spectra are recorded as a difference, or chemical shift (δ , ppm), between the resonance frequency of the sample and a reference (typically tetramethylsilane, TMS, $(\text{CH}_3)_4\text{Si}$) (Fig. 6.3). Different chemical shift regions are assigned to different chemical functional groups (Table 6.1). A review of ^{13}C -NMR on more than 300 bulk soil samples showed a remarkable similarity between all soils with respect to the distribution of different forms of carbon, despite the wide range of land use, climate, cropping practice, fertilizer or manure application, and different spectrometer characteristics and experimental conditions used (Mahieu *et al.*, 1999). The analysis found that functional groups in whole soils were always in the same order of abundance: O-alkyl C (mean of 45% of the spectrum, increasing with soil carbon content), alkyl C (25%), aromatic C (20%), and carbonyl and amide C (10%, decreasing with soil carbon content). These results suggest that the application of NMR for differentiating SOM quality due to land-use or climate differences may be limited. A significant problem with ^{13}C -NMR is that the low carbon concentration in some soil and fraction samples results in long

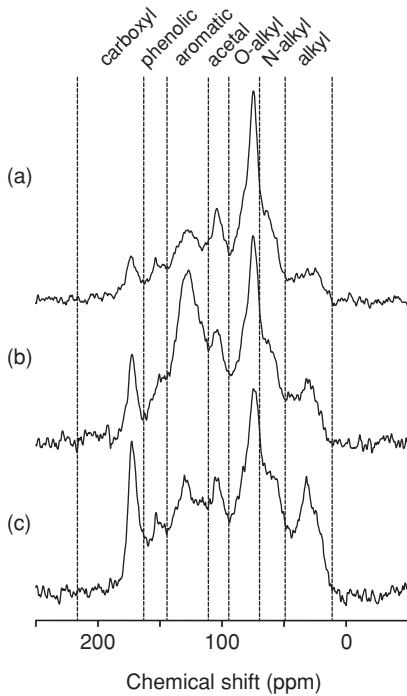

Figure 6.3 Solid-state ^{13}C -NMR spectra of (a) free POM, (b) aggregate-occluded POM and (c) heavy, mineral-associated SOM fractions (from Poirier *et al.*, 2005).

acquisition times, low resolution and low signal-to-noise ratios of the spectra (Kögel-Knabner, 1997). Another problem is the potential presence of paramagnetic elements, which broaden NMR signals and lead to spectra with overlapping resonance lines. Some of the organic carbon bound to paramagnetic nuclei may therefore be invisible to ^{13}C -NMR. These problems can be overcome by concentrating the organic matter in the sample through dissolution of the mineral material with HF. While some SOM is solubilized and lost during HF treatment, no significant alteration of the structural composition of SOM occurs (Schmidt *et al.*, 1997; Goncalves *et al.*, 2003).

While ^{13}C -NMR spectroscopy can generate information on the gross chemical composition of SOM, specific compounds are not identified. An alternative technique is analytical pyrolysis, which generates data at the molecular level (Schnitzer and Schulten, 1992). Analytical pyrolysis has been widely used to study the chemical composition of plant materials, extracted humic substances and SOM (Leinweber and Schulten, 1999).

Table 6.1 Chemical shift assignments in CPMAS ^{13}C -NMR spectra (from Swift, 1996).

Shift range (ppm)	Possible assignments
0–50	Unsubstituted saturated aliphatic C atoms
10–20	Terminal methyl groups
15–50	Methylene groups in alkyl chains
25–50	Methine groups in alkyl chains
29–33	Methylene C α , β , δ , ϵ from terminal methyl groups
35–50	Methylene C atoms of branched alkyl chains
41–42	α -C in aliphatic chains
45–46	R_2NCH_3
50–95	Aliphatic C singly bonded to one O or N atom
51–61	Aliphatic esters and ethers; methoxy, ethoxy
57–65	C in CH_2OH groups; C_6 in polysaccharides
65–85	C in $\text{CH}(\text{OH})$ groups; ring C atoms of polysaccharides; ether-bonded aliphatic C
90–110	C singly bonded to two O atoms; anomeric in polysaccharides, acetal or ketal
110–160	Aromatic and unsaturated C
110–120	Protonated aromatic C, aryl H
118–122	Aromatic C <i>ortho</i> to O-substituted aromatic C
120–140	Unsubstituted and alkyl-substituted aromatic C
140–160	Aromatic C substituted by O and N; aromatic ether, phenol, aromatic amines
160–230	Carbonyl, carboxyl, amide, ester C atoms
160–190	Largely carboxyl C atoms
190–230	Carbonyl C atoms

The thermal energy imparted by heating the samples in an inert atmosphere causes the breakdown of chemical bonds within the SOM macromolecules, yielding pyrolysis products characteristic of the original structure. The thermolytic degradation of SOM is followed

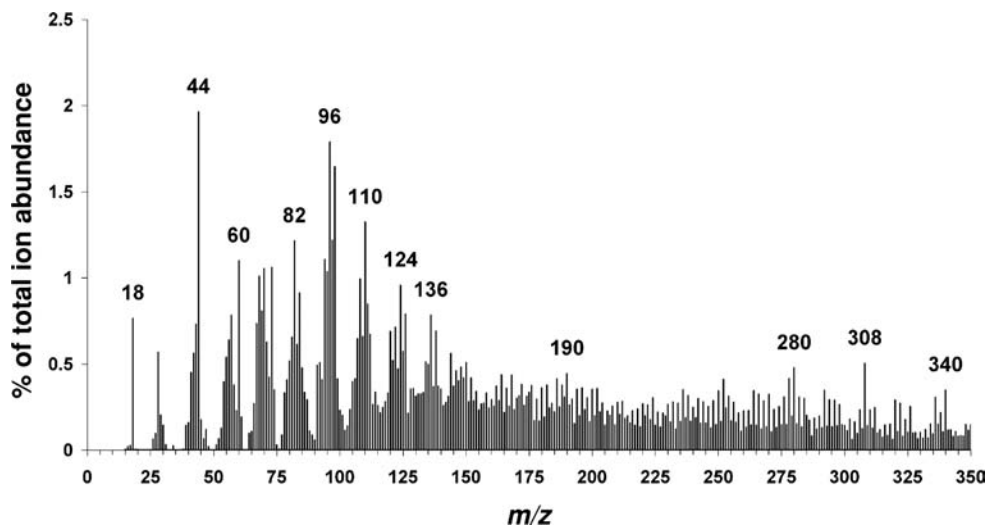

Figure 6.4 Integrated spectrum from the Py-MBMS analysis of a 0–5 cm layer of a forest soil sample. m/z values of compounds of interest are marked above the peaks (from Magrini *et al.*, 2002).

by analytical characterization of the pyrolysis products. The most common techniques are pyrolysis gas chromatography mass spectrometry, Py-GC/MS (Saiz-Jimenez, 1994), pyrolysis field ionization mass spectrometry, Py-FIMS (Schnitzer and Schulten, 1995) and more recently pyrolysis molecular beam mass spectrometry, Py-MBMS (Magrini *et al.*, 2002). In each case, the resulting mass spectra can be used as a fingerprint of that sample (Fig. 6.4). Interpretation of the pyrolysis data requires detailed knowledge of the pyrolysis behaviour of the compounds under study. Similar to other mass spectrometry approaches, databases continue to grow as more users apply the technique. Table 6.2 summarizes the identification of major signals in typical Py-FIMS spectra. The difficulty, however, is that many pyrolysis products can originate from chemically diverse SOM precursors (Saiz-Jimenez, 1994). One solution that is proposed is simultaneous pyrolysis and derivatization with tetramethylammonium hydroxide (TMAH) (Chefetz *et al.*, 2000). Pyrolysis/methylation results in the hydrolysis and methylation of polar components, yielding methyl esters of carboxylic acids and of hydroxyl groups. The result is that many polar compounds become volatile, rendering them more amenable for GC analysis. Comparisons of pyrolysis/methylation to conventional pyrolysis demonstrate that pyrolysis, as traditionally performed, is biased by the thermal degradation of functional groups mainly in benzenecarboxylic

and phenolic acids that represent an important part of the macromolecule, as well as by the production of artefacts from fatty acids (Saiz-Jimenez, 1994).

The big advantage of ^{13}C -NMR over analytical pyrolysis is that it is non-destructive and avoids the potential for secondary reactions. However, ^{13}C -NMR is less sensitive than analytical pyrolysis, and is subject to interferences by paramagnetic metal ions. While NMR and analytical pyrolysis are widely differing experimental methods that generate data at different chemical ‘scales’, the two methods can identify essentially the same types of compounds in SOM (Table 6.3). Results from both techniques have significantly contributed to the new paradigm that humic substances consist of a highly diverse, aliphatic admixture of biomolecules rather than the old model that they are dominated by distinct, highly aromatic chemical compounds (Schulten and Leinweber, 2000).

6.3 SHORTCOMINGS

The reductionist approach of separating heterogeneous SOM into more homogeneous and diagnostic fractions has generated an enormous amount of information about the physical and chemical characteristics of SOM (see above and Sollins *et al.*, 1996; Six *et al.*, 2002; Krull *et al.*, 2003; von Lützow *et al.*, 2006). Yet, a good understanding of the feedback and interactions between these

Table 6.2 Identification of major signals in Py-FIMS spectra (from Schnitzer and Schulten, 1992).

m/z	Identification
60, 72, 82, 84, 96, 98, 110, 112, 114, 126, 132, 144, 162	Carbohydrates with pentose and hexose subunits
94, 108, 110, 122, 124, 126, 138, 140, 154	Phenols
124, 138, 140, 150, 152, 154, 164, 166, 168, 178, 180, 182, 194, 196, 208, 210, 212	Monomeric lignins
246, 260, 270, 272, 274, 284, 286, 296, 298, 300, 310, 312, 314, 316, 326, 328, 330, 340, 342, 356	Dimeric lignins
256, 270, 284, 298, 312, 326, 340, 354, 368, 382, 396, 410, 424, 438, 452, 466, 480, 494, 508	n-C ₁₆ to n-C ₃₄ fatty acids
380, 394, 408, 422	n-C ₂₇ to n-C ₃₀ alkanes
92, 106, 120, 134, 148	Methyl-, dimethyl-, trimethyl-, tetramethyl- and pentamethyl-benzene
106, 120, 134, 148, 162, 176, 190, 204, 218, 232, 246, 260, 274, 288, 302, 316, 330, 344, 358, 372, 386	Ethyl- to docosyl-benzene
142, 156, 170, 184, 198	Methyl-, dimethyl-, trimethyl-, tetramethyl- and pentamethyl-naphthalene
192, 206, 220, 234	Methyl-, dimethyl-, trimethyl-, tetramethyl- and pentamethyl-phenanthrene
59	Acetamide
67	Pyrrole
79	Pyridine
81	Methyl pyrrole
95	Hydroxypyridine or formyl-pyrrole or dimethyl pyrrole
103	Benzonitrile
109	Trimethyl pyrrole
123	Tetramethyl pyrrole
648, 662, 676, 704, 732	n-C ₄₄ to n-C ₅₀ alkyl monoesters
202, 216, 230, 244, 258, 272, 286, 300, 314, 328, 342	n-C ₁₀ to n-C ₂₀ alkyl diesters

characteristics of SOM and the biological activity mediated by SOM is still limited. The linkage between the bio-physico-chemical quality of SOM and the turnover of SOM remains especially poorly understood, or even elusive. This elusiveness is probably a result of potential shortcomings or traps inherently associated with the reductionist approach. Some of these inherent shortcomings are as follows.

6.3.1 The remaining gap between SOM fractionation and characterization

Most SOM characterization techniques have been developed and most often been applied to the whole

soil. Consequently, most characterization approaches are not sensitive enough to detect small differences in SOM quality between different SOM pools. For example, Six *et al.* (2001) detected no biochemical differences between free versus occluded POM fractions with solution ¹³C-NMR analyses. In contrast, isotope analyses revealed clear differences in carbon dynamics between the two POM fractions, and compound-specific analyses of CuO-oxidation products showed a more decomposed stage of the free POM than the occluded POM. Helfrich *et al.* (2006) did not observe any trend in alkyl-C/*O*-alkyl-C or aryl-C/*O*-alkyl-C across four different aggregate size classes by NMR analyses. However, isotope analyses on the same aggregate size classes from

Table 6.3 *Compounds identified in whole soils by solid-state ^{13}C -NMR and by Py-FIMS (from Schnitzer, 2001).*

^{13}C -NMR	Py-FIMS
Carbohydrate C	Carbohydrates
Phenolic C	Phenols
Aromatic C	Lignin monomers
Aromatic C	Lignin dimers
CH_3 , $(\text{CH}_2)_n$, ester groups	n-fatty acids
CH_3 , $(\text{CH}_2)_n$	n-alkanes
CH_3 , $(\text{CH}_2)_n$, ester groups	n-alkylmonoesters
CH_3 , $(\text{CH}_2)_n$, ester groups	n-alkyldiesters
CH_3 , $(\text{CH}_2)_n$, aromatic C	n-alkylbenzenes
CH_3 , aromatic C	methylnaphthalenes
CH_3 , aromatic C	methylphenanthrenes
C in N-containing compounds	N-compounds

the same soil indicated that these aggregates represent different SOM pools (John *et al.*, 2005). Numerous other studies have also revealed a relationship between aggregate size and carbon dynamics (e.g. Elliott, 1986; Jastrow *et al.*, 1996; Six *et al.*, 1998). Nevertheless, Helfrich *et al.* (2006) did observe a greater alkyl-C/*O*-alkyl-C ratio in the free POM compared to the occluded POM by NMR, which indicates, in contrast to Six *et al.* (2001), that occluded POM is more decomposed than free POM. The same was found in several other studies (e.g. Golchin *et al.*, 1994; Sohi *et al.*, 2001; Kölbl and Kögel-Knabner, 2004; Kölbl *et al.*, 2005), but the differences in proportions of the organic moieties were not always very pronounced, and were sometimes contradictory.

6.3.2 The current fractionation methodologies frequently isolate non-uniform SOM pools with different turnover times

The wealth of different fractionation methods that have been employed indicate that all the different methodologies are a step in the direction of defining more uniform SOM pools, but none of them have totally resolved the issue of non-uniformity (von Lützwow *et al.*, 2007). For example, laboratory incubations following density fractionations are not always in support of the concept that the light fraction is readily decomposable

whereas the heavy fraction is recalcitrant (Swanston *et al.*, 2002; Crow *et al.*, 2006, 2007). A comparison of the ^{13}C abundance among different physical fractions obtained from a combination of magnetic, particle size and density fractionations by Shang and Tiessen (2000) showed that losses of old forest (C3)-derived carbon and accrual of new sorghum (C4)-derived Carbon occurred in different organo-mineral size fractions with different magnetic susceptibility. Another ^{14}C -labelling study comparing different physical fractionation methods (Magid *et al.*, 1996) indicated that the active fractions of SOM were distributed among several different size and density fractions. Bosatta and Ågren (1985) would argue that it is impossible to meet uniformity in SOM pools because the heterogeneity of SOM is best represented by a continuous quality function. Therefore any fractionation methodology would have to isolate an infinite number of fractions in order to have uniform fractions. Recently, however, many efforts have been put towards modelling measured fractions (Christensen, 1996b; Elliott *et al.*, 1996; Arah, 2000; Six and Jastrow, 2002) and defining a reasonable number of different fractions that are both measurable and modellable (Smith *et al.*, 2002). The most promising methods isolate fractions physically, and then chemically characterize labile *vs.* more recalcitrant moieties (e.g. Balesdent and Mariotti, 1996; Six *et al.*, 2002; Sohi *et al.*, 2005; Olk and Gregorich, 2006; Zimmermann *et al.*, 2007b).

6.3.3 Biochemical characteristics of SOM have seldom been directly linked to microbial functioning and resulting SOM dynamics

As described above, many different approaches have been employed to biochemically characterize SOM, but this is based on the inherent complexity of the organic compounds without any link to microbial functioning and with only a relationship to decomposability through inference. Nevertheless, several studies do exist where physically isolated SOM fractions were incubated to evaluate their potential decomposability as a biological indication of stability (e.g. Cambardella and Elliott, 1994; Schutter and Dick, 2002; Crow *et al.*, 2006; Oorts *et al.*, 2006). Other studies have attempted to clarify SOM stabilization mechanisms through biological means by measuring extracellular enzyme activities in physically isolated SOM fractions

(Kandeler *et al.*, 1999; Allison and Jastrow, 2006). However, the decomposability of physically isolated fractions can vary depending on the type of density reagent used (Magid *et al.*, 1996), and could be different in isolated state than *in situ*. Direct investigations of *in situ* mineralization of physical SOM fractions are limited to tracer (^{14}C , ^{13}C) incubations following changes in labelled plant-residue carbon concentrations in different SOM fractions over time (e.g. Magid *et al.*, 1996; Guggenberger *et al.*, 1999b). Several studies have also directly linked size and density SOM fractions and their biochemical characteristics to whole-soil C and N dynamics (e.g. Gregorich *et al.*, 1989; Janzen *et al.*, 1992; Gregorich *et al.*, 2006). For example, physically uncomplexed SOM has been suggested to immobilize mineralized N because of its C/N ratio being relatively higher than that of whole soil but lower than that of its plant litter source (see Six and Jastrow, 2002; Gregorich *et al.*, 2006). Whalen *et al.* (2000) reported heavy density SOM to be a greater source of potentially mineralizable N than light fraction (LF) even though LF is considered a more labile source of mineralizable C and N due to its physical uncomplexed state (Hassink, 1995).

6.3.4 The relationship between the dynamics of specific SOM fractions and the dynamics of whole SOM has not often been considered

Most often, studies have isolated and focused on one or two SOM fractions in terms of their characteristics and dynamics (see Christensen, 1996a). However, how their dynamics relate to overall SOM dynamics and can be used as a diagnostic tool for changes in the dynamics of whole SOM has not been fully explored. Numerous studies have shown that POM and LF are more sensitive SOM fractions than whole SOM (Christensen, 1992; Six and Jastrow, 2002; Gregorich *et al.*, 2006), but a change in dynamics of these fractions is difficult to translate into an expected change in whole SOM, especially in the long term. For example, an increase in POM or LF fractions does not automatically correspond to an increase in whole SOM in the longer term (e.g. Six *et al.*, 2001). Similarly, changes in total soil carbon are not always paralleled by changes in LF or POM (e.g. Leifeld and Kögel-Knabner, 2005). Yet, a few studies have demonstrated the microaggregate-SOM fraction to be the most responsive fraction to management and

land-use change (Six *et al.*, 2000b; Del Galdo *et al.*, 2003; Deneff *et al.*, 2004; Kong *et al.*, 2005), to account for much of the stock change in total SOC upon management change (Deneff *et al.*, 2004) and to be an early indicator for future total SOC changes upon land-use or management change (Deneff *et al.*, 2004, 2007).

6.3.5 Isolated single compounds or compound classes often represent such a small proportion of the total SOM content that the quantification or modelling of their dynamics may have little relation to the dynamics of SOM as a whole

As suggested above, compound-specific analyses have some promise in furthering our understanding of SOM dynamics by differentiating functional fractions within the heterogeneous SOM pool. However, the small pool size of these specific compounds often prevents the generalization to the much larger whole SOM pool. For example, amino sugars have been used as biomarkers for microbial SOM (see above and Guggenberger *et al.*, 1999b; Amelung, 2001; Simpson *et al.*, 2004; Glaser *et al.*, 2006), but total amino sugars only comprise 1–5% of total SOM. It is well known that microbial-derived SOM is much greater than 1–5% of total SOM. Consequently, one could question how much the observed dynamics of amino sugars can be extrapolated to the whole fraction of microbial-derived SOM, which is a heterogeneous fraction consisting of polysaccharides, lipids etc.

The above outline of shortcomings is not meant to nullify the methods used. Each of these methods can contribute a significant amount of information concerning the composition and dynamics of SOM, but each also has its limitations: no single method is sufficient or even appropriate for any given objective. These limitations should be taken into consideration in future studies and should help us in developing new approaches to elucidate SOM dynamics (see below).

6.4 DIRECTIONS FOR FUTURE RESEARCH AND PROMISING NEW TECHNIQUES

6.4.1 Quantification of the turnover of different SOM fractions by isotope analysis

While *in situ* and compound-specific SOM characterization techniques can provide useful information about

the *composition, biochemical stability* or *origin* of SOM, no indication of the *dynamics* or *fate* of SOM constituents in the soil environment can be derived. Information on the reactivity and turnover rates of SOM constituents could greatly improve SOM models that so far only distinguish conceptually discrete SOM compartments with different pre-defined stabilities (e.g. Jenkinson *et al.*, 1994). Recent developments in mass spectrometry have enabled the coupling of molecular marker analysis with stable isotope analysis. This technology, also called compound-specific stable isotope analysis (CSSIA), appears to be promising for quantifying sequestration and turnover rates of specific SOM fractions since it allows differentiating between older and more recent molecules of SOM fractions (for a review, see Glaser, 2005). It could also reveal information about the plant origin of soil organic substances (e.g. C3 vs. C4) or about a soil's biological quality in natural or managed agricultural systems by differentiating chemically similar but isotopically different organic substances preserved or transformed by the microbial population (e.g. Ostle *et al.*, 1999).

Curie-point pyrolysis coupled to gas-chromatography-combustion-isotope ratio mass spectrometry (py-GC-C-IRMS) allows simultaneous characterization of the chemical structure of SOM and analysis of the isotopic composition of the different pyrolysis products. Using this technique, a study on cultivated soils after a vegetation change from C3 wheat to C4 maize indicated a lack of lignin-derived phenols with a C3-signal (Gleixner *et al.*, 1999, 2002). The authors suggested that lignin must be severely biodegraded and greatly transformed from its original form in cultivated soils. Other studies have also suggested low stability of lignin in soils, based on lignin-phenol distributions and degree of alteration across soil depths, particle size or density fractions (Rumpel *et al.*, 2002; Kiem and Kögel-Knabner, 2003; Rumpel *et al.*, 2004a; Sollins *et al.*, 2006; Nierop and Filley, 2007), and ^{13}C signatures of lignin-phenols by GC-C-IRMS (Dignac *et al.*, 2005; Heim and Schmidt, 2007). This low stability is further supported by Rasse *et al.* (2006) who developed a two-pool model, calibrated on lignin-specific ^{13}C isotopic analyses, and estimated turnover rates faster than one year for the plant-residue lignin pool and 0.05 y^{-1} for the soil-protected lignin pool. Furthermore, they suggested that 92% of the plant-residue lignin pool is mineralized as CO_2 or

transformed into other non-lignin products, while only 8% reaches the soil-protected lignin fraction. Based on the model, the authors suggested that VSC-lignin turnover in soils is controlled by the transfer of VSC-lignin molecules from decomposing plant tissues to soil-protected fractions, rather than by chemical recalcitrance per se, as originally suggested by traditional chemical SOM characterization methods. On the other hand, py-GC-C-IRMS analyses have shown surprisingly long residence times for pyrolysis products derived from N-containing components (proteins, amino acids, peptides, chitin) and polysaccharides (VanBergen *et al.*, 1997; Gleixner *et al.*, 1999, 2002). These components appear to comprise a preserved SOM fraction of predominant microbial origin (Kiem and Kögel-Knabner, 2003), stabilized by microbial recycling or by chemical and physical protection mechanisms through interactions with the soil mineral matrix rather than by biochemical recalcitrance.

Stable isotope (^{13}C) analysis of individual amino sugars by GC-C-IRMS was recently used to discriminate between old and new microbial-derived carbon (Glaser and Gross, 2005) and could serve as a tool to determine formation, stabilization and turnover rates of microbial SOM. Applying this technique in a free-air carbon dioxide enrichment (FACE) experimental site exposed to ^{13}C -depleted CO_2 , Glaser *et al.* (2006) found a complete turnover of individual amino sugars after seven years of elevated CO_2 . However, the GC-C-IRMS technology requires substantial derivatization (e.g. acetylation) of amino sugars to increase their volatility necessary for GC separation. Necessary ^{13}C corrections due to carbon addition upon derivatization significantly reduce the sensitivity of CSSIA of amino sugars, which can be problematic for natural abundance studies (Glaser and Gross, 2005). As an alternative, He *et al.* (2006) applied a conventional GC/MS approach to trace ^{15}N or ^{13}C isotope changes in glucosamine, galactosamine and muramic acid. Though also limited to isotopic enrichment studies, this technology allows the simultaneous analyses of ^{13}C and ^{15}N . A recently developed analytical technology, i.e. high performance liquid chromatography-combustion-IRMS (HPLC-C-IRMS), has enabled the high-precision determination of the $^{13}\text{C}/^{12}\text{C}$ isotope ratio of polar and thermo-labile compounds that can be chromatographically separated in aqueous phase (Krummen *et al.*, 2004). By avoiding the requirement for derivatization, this technology,

though currently still limited to ^{13}C analysis, has greatly broadened the types of biomarkers that can be analyzed in conjunction with stable isotope analysis. The use of HPLC-C-IRMS for CSSIA of biomarkers in soil science should be explored in the future.

Compound-specific stable isotope analysis has also recently been applied to individual amino acids for the purposes of determining soil organic N dynamics with respect to changes in land use, management or vegetation (e.g. Ostle *et al.*, 1999). For example, ^{15}N enrichment in amino acids relative to bulk soil in managed grassland (N fertilized) and arable land (tilled and N fertilized), while being the same for unmanaged natural grassland, suggested enhanced SOM turnover due to management (Ostle *et al.*, 1999). In a later study, Bol *et al.* (2004) found decreasing concentrations and concomitant decreasing ^{15}N signatures in phenylalanine upon conversion from arable land to fallow, indicating the potential of this amino acid as a biomarker for land-use change. More studies are needed in this field to confirm the potential of the use of CSSIA in amino acids as a tool to assess changes in soil biological quality, and SOM dynamics in particular, in different ecosystems.

6.4.2 Relating SOM quality and dynamics to microbial functioning

Some promising new developments in soil ecology are currently being explored with the purpose of linking SOM dynamics to microbial functioning, and to characterize SOM quality in terms of its biological reactivity (see also Kutsch *et al.*, Chapter 9). Compound-specific isotope analyses have been done on microbial biomarker phospholipid fatty acids (PLFAs) by GC-C-IRMS (for ^{13}C -PLFA) and accelerator mass spectrometry (for ^{14}C -PLFA) to identify the sources (e.g. C3 *vs.* C4 plant material) of the organic substrate used by the active microbial community in various ecosystems (Burke *et al.*, 2003; Bouillon *et al.*, 2004) and under different environmental conditions (Waldrop and Firestone, 2004). Based on ^{13}C -PLFA analyses, Waldrop and Firestone (2004) were able to relate warming-induced alterations in carbon resource utilization patterns to changes in microbial community composition. By analyzing both ^{13}C and ^{14}C content of PLFAs, Kramer and Gleixner (2006) were able to determine the degree to which recent plant material *vs.* older SOM

served as carbon substrates for soil micro-organisms. In addition, a growing number of papers are being published on ^{13}C -enrichment or depletion experiments in combination with ^{13}C -PLFA analysis for purposes of linking microbial communities to specific biogeochemical processes (Boschker *et al.*, 1998) or distinguishing microbial groups actively involved in the assimilation of carbon derived from different quality substrates (Butler *et al.*, 2003; Murase *et al.*, 2006; Williams *et al.*, 2006), often in relation to management (e.g. liming, Treonis *et al.*, 2004) or global change (e.g. elevated CO_2 effects, Phillips *et al.*, 2002; Billings and Ziegler, 2005).

A major drawback of PLFA analysis is that it does not allow for specific detection of individual species of the microbial communities. It is possible that the activity of different microbial species in processing SOM differs or is differently affected by land-use or environmental conditions. Culture-independent molecular approaches are emerging that enable the linking of microbial species identity with a measure of functional contribution to SOM dynamics. Stable-isotope probing (SIP) of nucleic acids (DNA, rRNA) is one of those molecular methods capable of identifying members of microbial populations that are specifically active in metabolizing and circulating SOC derived from a ^{13}C -labelled substrate (Radajewski *et al.*, 2000; Mane-field *et al.*, 2002; Lueders *et al.*, 2004). However, nucleic acid-based SIP methodologies have a number of shortcomings and their use for linking metabolic function with taxonomic identity is debated (see also Kutsch *et al.*, Chapter 9). Molecular analyses of 'functional genes' that encode enzymes that catalyze key steps in biogeochemical pathways could be an alternative means to study the molecular mechanisms regulating SOM dynamics (Zak *et al.*, 2006).

6.4.3 Exploration of new avenues to characterize whole-soil and fraction SOM quality

Thermal analysis of whole-soil and isolated fraction samples by thermogravimetry-differential scanning calorimetry (TG-DSC) appears to hold some promise in characterizing SOM, should the link between thermal stability and biological stability be firmly established. This method is of great interest since it is applicable to whole-soil samples without the requirement of time-consuming pre-treatments (e.g. chemical extraction) as

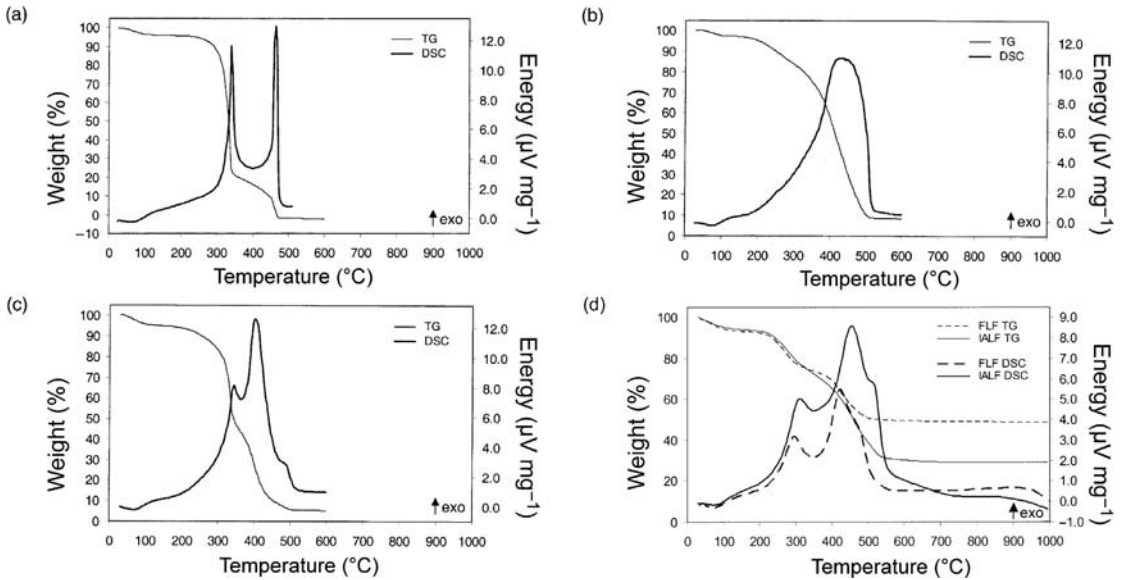

Figure 6.5 Thermogravimetry–differential scanning calorimetry (TG–DSC) thermograms for (a) cellulose, (b) lignin, (c) cellulose and lignin mixed (50:50 w/w), and (d) free light fraction soil organic matter (FLF-SOM) and intra-aggregate light fraction soil organic matter (IALF-SOM) from arable soil (from Lopez-Capel *et al.*, 2005b).

well as to isolated fractions. Through the continuous and simultaneous measurement of weight loss (TG) and energy change (DSC) during heating, the method differentiates between a thermally labile organic fraction lost in a first exothermic region (approx. 300–350 $^{\circ}\text{C}$) and a more thermally resistant organic fraction lost in a second exothermic region (approx. 400–450 $^{\circ}\text{C}$) (Fig. 6.5). Comparisons with ^{13}C -NMR analysis by Lopez-Capel *et al.* (2005a) revealed close correlations of the thermally labile organic fraction with *O*-alkyl C and the thermally resistant organic fraction with aromatic carbon, suggesting that thermal analysis can provide an index of SOM quality. Several studies have applied TG–DSC in an attempt to compare proportions of labile (aliphatic) *vs.* more resistant (aromatic) carbon components in whole-soil SOM, physical SOM fractions, plant tissue, dung and compost (Dell'Abate *et al.*, 2000; Lopez-Capel *et al.*, 2005a, 2005b), to quantify thermally stable black carbon in soils (Leifeld, 2007) and to characterize chemical changes in SOM fractions under contrasting land uses (Lopez-Capel *et al.*, 2005a; Plante *et al.*, 2005). In the study of Plante *et al.* (2005), TG–DSC was applied to clay-sized fractions of soils ranging from forest to cultivated and long-term bare fallow soils. A shift was observed in the distribution

of clay-associated SOM from thermally labile to thermally resistant fractions with increasing time under cultivation. This indicated that thermal properties of SOM components appear to be linked to their biological decomposability as it is generally believed that SOM decomposition induces a shift to more biologically resistant fractions (Plante *et al.*, 2005).

The TG–DSC technique has also recently been coupled to isotope ratio mass spectrometry (IRMS) and quadrupole mass spectrometry (QMS), enabling the determination of the isotope ratios as well as the composition of the evolved gases during a single heating experiment on one intact soil sample (Lopez-Capel *et al.*, 2005b; Manning *et al.*, 2005; Lopez-Capel *et al.*, 2006). In addition to the biochemical information provided by the conventional TG–DSC analysis system, QMS results could provide further information about the chemical stability of the SOM sources of C as well as N within a soil sample, while the isotope signatures of the thermally labile and recalcitrant components could give further insights into the dynamics of these SOM components. In one of the first application studies, Lopez-Capel *et al.* (2005b) were able to demonstrate that N in pasture soil samples was mostly associated with a thermally resistant aromatic organic fraction.

Non-destructive techniques to assess SOM quantity and quality provide exciting new avenues to increase the speed, number, quality and relevance of SOM analyses (Janik *et al.*, 1998) and allow the construction of large databases to explore general relationships between SOM quality and dynamics (Shepherd and Walsh, 2002). Infrared spectroscopy has long been used to investigate forages and other organic agricultural products. Until recently, infrared analyses of soils were limited to qualitative and semi-quantitative studies. Technological advances, particularly diffuse reflectance infrared Fourier-transform (DRIFT) methods, and advances in multivariate statistics are making the infrared method better suited to widespread use for SOM analysis. Infrared spectral signatures of the object under consideration are defined by the reflectance or absorbance, as a function of wavelength in the electromagnetic spectrum. Fundamental features related to various components of the object occur at energy levels that allow molecules to rise to higher vibrational states. These features generally occur for SOM in the mid-infrared (MIR) range (2500–25 000 nm), which is dominated by intense vibration fundamentals, and the near-infrared (NIR) region (700–2500 nm), which is dominated by much weaker and broader signals from vibration overtones and combination bands (McCarty *et al.*, 2002; Shepherd and Walsh, 2002). Estimates of soil properties of interest are generated from spectral information by calibration using multivariate statistical procedures such as principal components regression (PCR), partial least squares regression (PLS), or step-wise multiple linear regression (SMLR) and others (Chang *et al.*, 2001; Shepherd and Walsh, 2002; Leifeld, 2006; Janik *et al.*, 2007). A significant shortcoming of this approach is that it is difficult to generate a 'universal' calibration model that will accurately determine a particular property for all soils (Madari *et al.*, 2005). However, several strategies for real-time selection of individual calibration sets have been developed.

Many studies have shown the capability of MIR and NIR spectroscopy for determining several soil properties, including total soil C and N contents, texture, aggregation and CEC (Chang *et al.*, 2001; Brown *et al.*, 2006; Madari *et al.*, 2006; Vagen *et al.*, 2006). Infrared analyses of bulk soil samples without fractionation have also been well correlated to several SOM fractions such as POM, silt- and clay-associated SOM, and black carbon (Zimmermann *et al.*, 2007b). Infrared

spectroscopy has also been shown to have the potential to determine litter and organic residue quality and related decomposition rates (Joffre *et al.*, 2001; Shepherd *et al.*, 2003, 2005), as well as SOM quality and composition (Terhoeven-Urselmans *et al.*, 2006). Leifeld (2006) successfully calibrated DRIFT with NMR data obtained from whole soil and fraction SOM. Capriel *et al.* (1995) also used DRIFT to estimate alkyl-C as a measure for the degree of hydrophobicity of SOM. It is furthermore very encouraging that MIR and NIR spectroscopy have also been successfully used to estimate soil C and N mineralization rates (Fyströ, 2002; Mutuo *et al.*, 2006), respiration rates (Palmborg and Nordgren, 1993) and enzyme activity (Mimmo *et al.*, 2002). These studies indicate the potential for MIR and NIR spectroscopy to directly relate SOM quality to SOM dynamics and microbial functioning across a large set of samples.

Another rapid spectroscopic technique that has recently been suggested for SOM study is the laser-induced breakdown spectroscopy (LIBS) (Bublitz *et al.*, 2001; Harmon *et al.*, 2006). However, the technique has only been developed to determine whole-soil carbon contents (Cremers *et al.*, 2001; Ebinger *et al.*, 2003). On the other hand, there are several x-ray based techniques such as near edge x-ray absorption fine structure (NEXAFS), energy dispersive x-ray (EDX), scanning transmission x-ray microscopy (STXM) and x-ray photoelectron spectroscopy (XPS), which can yield great detail about not only SOM quality, but also its microscale location within the soil matrix (Amelung *et al.*, 2002; Jokic *et al.*, 2003; Brodowski *et al.*, 2005a; Lehmann *et al.*, 2005; Solomon *et al.*, 2005). These techniques are, however, quite laborious, require significant infrastructure and are therefore not currently suitable for rapid assessments.

6.5 CONCLUSIONS

A large number of techniques have been developed for the characterization of SOM. It is apparent that a suite of techniques combining physical or chemical fractionation, analytical pyrolysis or NMR for biochemical characterization, and isotopic analysis techniques for an assessment of dynamics, is necessary for an exhaustive examination of the nature and dynamics of SOM. Soil organic matter fractionation and characterization approaches have led to major achievements in

the understanding of carbon stabilization and destabilization mechanisms in the short and long term. From these results it has become clear that carbon cycling and stabilization in soils is a function of both the mineral and structural properties of the soil as well as the biochemical characteristics of the SOM. While SOM fractionation schemes have revealed a few diagnostic SOM fractions in terms of their responsiveness to land-use or management practices (e.g. uncomplexed SOM, microaggregate-SOM), they mostly fail to separate truly homogeneous SOM fractions in terms of their turnover times or biochemical properties, and they usually do not link SOM fractions to specific stabilization mechanisms unequivocally. A quantitative assessment of the relative contributions of different (and possibly co-occurring) stabilization mechanisms to the stability of specific SOM fractions requires further investigation.

The use of molecular biomarkers and compound-specific isotope analysis in SOM research could reveal the dynamics of specific, meaningful SOM components within heterogeneous SOM fractions and clarify SOM transformations. In particular, the concept of microbial 'recycling' or 're-synthesis' of specific molecular components needs further investigation since it appears to be an important process controlling the longevity of SOM components in the soil. In addition, SOM research could greatly benefit from recent technological developments in microbial ecology that allow identifying the microbial communities or species involved in SOM decomposition. In this way, SOM dynamics under changing environmental conditions (e.g. climate change) or human activities could be better understood and potentially foreseen through the structural and activity-related responses of the microbial community.

Studies on SOM characteristics are mostly limited to the surface layers of soils and need to be extended to a wider variety of soil types and environments if we want to generalize stabilization mechanisms and functionality of specific SOM fractions. Standardization of fractionation and characterization methods will be crucial when evaluating SOM characteristics across soil layers, soil types and environments. Subsoil investigations will also require improvement in analytical sensitivity due to the low organic carbon concentrations and mineral predominance in deeper soil layers. At the opposite end of the scale, significant advances remain

to be made by observing 'microbial life at the microbial scale' (Schimel, 2007) and our understanding of SOM characteristics may be informed by application of advances in the field of nanotechnology.

Most experimental methodologies that fractionate or characterize SOM destroy to some degree (depending on methodology) the natural state of SOM, causing information about its stabilization mechanisms to be lost. Therefore, future SOM research could greatly benefit from non-destructive characterization techniques that provide information on *in situ* chemical and biological characteristics as well as physical distribution of SOM fractions. Promising non-destructive techniques (such as MIR, NIR and DRIFT spectroscopy) continue to evolve and should make important contributions to rapidly assess SOM quantity and quality, and directly relate SOM quality to SOM dynamics and microbial functioning across a large set of samples.

In conclusion, to better understand SOM stabilization processes and to make better predictions of SOM dynamics, the following will be essential: (1) SOM research that combines existing, but more standardized, methodologies to characterize the molecular composition of meaningful SOM fractions and provides measures of SOM stability (e.g. age, turnover times) and microbial functioning; (2) collaborative research to maximize the potential of highly specific and costly techniques requiring highly skilled expertise in the methodologies, instrumentation and data analysis; (3) comparative studies that allow a generalization of findings across soil types, soil layers and environments; and (4) more long-term field manipulation experiments, preferably with C3–C4 conversions or other isotopic tracers to obtain better estimates of turnover rates of specific SOM fractions.

REFERENCES

- Adams, W. A. (1973) Effect of organic matter on bulk and true densities of some uncultivated podzolic soils. *Journal of Soil Science*, **24**, 10–17.
- Aiken, G. R., McKnight, D. M., Wershaw, R. L. and MacCarthy, P. (1985) *Humic Substances in Soil, Sediment and Water: Geochemistry, Isolation and Characterization*. New York: Wiley Interscience.
- Allison, S. D. and Jastrow, J. D. (2006) Activities of extracellular enzymes in physically isolated fractions of

- restored grassland soils. *Soil Biology and Biochemistry*, **38**, 3245–56.
- Amelung, W. (2001) Methods using amino sugars as markers for microbial residues in soil. In *Assessment Methods for Soil Carbon*, ed. R. Lal, J. M. Kimble, R. F. Follet and B. A. Stewart. Boca Raton, FL: CRC Press, pp. 233–72.
- Amelung, W., Cheshire, M. V. and Guggenberger, G. (1996) Determination of neutral and acidic sugars in soil by capillary gas-liquid chromatography after trifluoroacetic acid hydrolysis. *Soil Biology and Biochemistry*, **28**, 1631–9.
- Amelung, W., Flach, K. W. and Zech, W. (1999) Lignin in particle-size fractions of native grassland soils as influenced by climate. *Soil Science Society of America Journal*, **63**, 1222–8.
- Amelung, W., Kaiser, K., Kammerer, G. and Sauer, G. (2002) Organic carbon at soil particle surfaces: evidence from X-ray photoelectron spectroscopy and surface abrasion. *Soil Science Society of America Journal*, **66**, 1526–30.
- Anderson, D. W. and Paul, E. A. (1984) Organo-mineral complexes and their study by radiocarbon dating. *Soil Science Society of America Journal*, **48**, 298–301.
- Angers, D. A. and Giroux, M. (1996) Recently deposited organic matter in soil water-stable aggregates. *Soil Science Society of America Journal*, **60**, 1547–51.
- Angers, D. A. and Mehuys, G. R. (1990) Barley and alfalfa cropping effects on carbohydrate contents of a clay soil and its size fractions. *Soil Biology and Biochemistry*, **22**, 285–8.
- Angers, D. A., Recous, S. and Aita, C. (1997) Fate of carbon and nitrogen in water-stable aggregates during decomposition of $^{13}\text{C}^{15}\text{N}$ -labelled wheat straw in situ. *European Journal of Soil Science*, **48**, 295–300.
- Aoyama, M., Angers, D. A., N'Dayegamiye, A. and Bissonnette, N. (1999) Protected organic matter in water-stable aggregates as affected by mineral fertilizer and manure applications. *Canadian Journal of Soil Science*, **79**, 419–25.
- Arah, J. R. M. (2000) Modeling SOM cycling in rice-based production systems. In *Carbon and Nitrogen Dynamics in Flooded Soils*, ed. G. J. D. Kirk and D. C. Oik. Philippines: International Rice Research Institute, pp. 163–79.
- Ashman, M. R., Hallett, P. D. and Brookes, P. C. (2003) Are the links between soil aggregate size class, soil organic matter and respiration rate artefacts of the fractionation procedure? *Soil Biology and Biochemistry*, **35**, 435–44.
- Balabane, M. and Plante, A. F. (2004) Aggregation and carbon storage in silty soil using physical fractionation techniques. *European Journal of Soil Science*, **55**, 415–27.
- Baldock, J. A. and Skjemstad, J. O. (2000) Role of the soil matrix and minerals in protecting natural organic materials against biological attack. *Organic Geochemistry*, **31**, 697–710.
- Baldock, J. A., Oades, J. M., Waters, A. G. *et al.* (1992) Aspects of the chemical structure of soil organic materials as revealed by solid-state ^{13}C NMR-spectroscopy. *Biogeochemistry*, **16**, 1–42.
- Balesdent, J. (1996) The significance of organic separates to carbon dynamics and its modelling in some cultivated soils. *European Journal of Soil Science*, **47**, 485–93.
- Balesdent, J. and Mariotti, A. (1996) Measurement of soil organic matter turnover using ^{13}C natural abundance. In *Mass Spectrometry of Soils*, ed. T. W. Boutton and S. Yamasaki. New York: Dekker, pp. 83–111.
- Balesdent, J., Mariotti, A. and Guillet, B. (1987) Natural ^{13}C abundance as a tracer for studies of soil organic matter dynamics. *Soil Biology and Biochemistry*, **19**, 25–30.
- Ball, B. C., Cheshire, M. V., Robertson, E. A. G. and Hunter, E. A. (1996) Carbohydrate composition in relation to structural stability, compactibility and plasticity of two soils in a long-term experiment. *Soil and Tillage Research*, **39**, 143–60.
- Barriuso, E., Portal, J. M. and Andreux, F. (1987) Kinetics and mechanisms of the acid-hydrolysis of organic-matter in a humic-rich mountain soil. *Canadian Journal of Soil Science*, **67**, 647–58.
- Barton, D. H. R. and Schnitzer, M. (1963) A new experimental approach to the humic acid problem. *Nature*, **198**, 217–18.
- Beare, M. H., Cabrera, M. L., Hendrix, P. F. and Coleman, D. C. (1994a) Aggregate-protected and unprotected organic-matter pools in conventional-tillage and no-tillage soils. *Soil Science Society of America Journal*, **58**, 787–95.
- Beare, M. H., Hendrix, P. F. and Coleman, D. C. (1994b) Water-stable aggregates and organic-matter fractions in conventional-tillage and no-tillage soils. *Soil Science Society of America Journal*, **58**, 777–86.
- Benzing-Purdie, L. (1984) Amino sugar distribution in four soils as determined by high resolution gas chromatography. *Soil Science Society of America Journal*, **48**, 219–22.
- Berzelius, J. (1839) *Lehrbuch der Chemie*. Dresden and Leipzig: Woehler.

- Billings, S. A. and Ziegler, S. E. (2005) Linking microbial activity and soil organic matter transformations in forest soils under elevated CO₂. *Global Change Biology*, **11**, 203–12.
- Black, G. E. and Fox, A. (1996) Recent progress in the analysis of sugar monomers from complex matrices using chromatography in conjunction with mass spectrometry or stand-alone tandem mass spectrometry. *Journal of Chromatography A*, **720**, 51–60.
- Blair, G. J., Lefroy, R. D. B. and Lise, L. (1995) Soil carbon fractions based on their degree of oxidation, and the development of a carbon management index for agricultural systems. *Australian Journal of Agricultural Research*, **46**, 1459–66.
- Bock, M., Glaser, B. and Millar, N. (2007) Sequestration and turnover of plant- and microbially derived sugars in a temperate grassland soil during 7 years exposed to elevated atmospheric pCO₂. *Global Change Biology*, **13**, 478–90.
- Bol, R., Ostle, N. J., Chenu, C. C. *et al.* (2004) Long term changes in the distribution and delta ¹⁵N values of individual soil amino acids in the absence of plant and fertiliser inputs. *Isotopes in Environmental and Health Studies*, **40**, 243–56.
- Bosatta, E. and Ågren, G. I. (1985) Theoretical analysis of decomposition of heterogeneous substrates. *Soil Biology and Biochemistry*, **17**, 601–10.
- Boschker, H. T. S., Nold, S. C., Wellsbury, P. *et al.* (1998) Direct linking of microbial populations to specific biogeochemical processes by ¹³C-labelling of biomarkers. *Nature*, **392**, 801–5.
- Bouillon, S., Moens, T., Koedam, N. *et al.* (2004) Variability in the origin of carbon substrates for bacterial communities in mangrove sediments. *FEMS Microbiology Ecology*, **49**, 171–9.
- Brodowski, S., Amelung, W., Haumaier, L., Abetz, C. and Zech, W. (2005a) Morphological and chemical properties of black carbon in physical soil fractions as revealed by scanning electron microscopy and energy-dispersive X-ray spectroscopy. *Geoderma*, **128**, 116–29.
- Brodowski, S., Rodionov, A., Haumaier, L., Glaser, B. and Amelung, W. (2005b) Revised black carbon assessment using benzene polycarboxylic acids. *Organic Geochemistry*, **36**, 1299–310.
- Brown, D. J., Shepherd, K. D., Walsh, M. G., Mays, M. D. and Reinsch, T. G. (2006) Global soil characterization with VNIR diffuse reflectance spectroscopy. *Geoderma*, **132**, 273–90.
- Bublitz, J., Dolle, C., Schade, W., Hartmann, A. and Horn, R. (2001) Laser-induced breakdown spectroscopy for soil diagnostics. *European Journal of Soil Science*, **52**, 305–12.
- Bull, I. D., van Bergen, P. F., Nott, C. J., Poulton, P. R. and Evershed, R. P. (2000a) Organic geochemical studies of soils from the Rothamsted classical experiments – V. The fate of lipids in different long-term experiments. *Organic Geochemistry*, **31**, 389–408.
- Bull, I. D., Nott, C. J., van Bergen, P. F., Poulton, P. R. and Evershed, R. P. (2000b) Organic geochemical studies of soils from the Rothamsted Classical Experiments – VI. The occurrence and source of organic acids in an experimental grassland soil. *Soil Biology and Biochemistry*, **32**, 1367–76.
- Burdon, J. (2001) Are the traditional concepts of the structures of humic substances realistic? *Soil Science*, **166**, 752–69.
- Burke, R. A., Molina, M., Cox, J. E., Osher, L. J. and Piccolo, M. C. (2003) Stable carbon isotope ratio and composition of microbial fatty acids in tropical soils. *Journal of Environmental Quality*, **32**, 198–206.
- Butler, J. L., Williams, M. A., Bottomley, P. J. and Myrold, D. D. (2003) Microbial community dynamics associated with rhizosphere carbon flow. *Applied and Environmental Microbiology*, **69**, 6793–800.
- Cambardella, C. A. and Elliott, E. T. (1992) Particulate soil organic-matter changes across a grassland cultivation sequence. *Soil Science Society of America Journal*, **56**, 777–83.
- Cambardella, C. A. and Elliott, E. T. (1993) Carbon and nitrogen distribution in aggregates from cultivated and native grassland soils. *Soil Science Society of America Journal*, **57**, 1071–6.
- Cambardella, C. A. and Elliott, E. T. (1994) Carbon and nitrogen dynamics of soil organic-matter fractions from cultivated grassland soils. *Soil Science Society of America Journal*, **58**, 123–30.
- Campbell, C. A., Paul, E. A., Rennie, D. A. and McCallum, K. J. (1967) Applicability of carbon-dating method of analysis to soil humus studies. *Soil Science*, **104**, 217–24.
- Capriel, P., Beck, T., Borchert, H., Gronholz, J. and Zachmann, G. (1995) Hydrophobicity of the organic-matter in arable soils. *Soil Biology and Biochemistry*, **27**, 1453–8.

- Cerri, C., Feller, C., Balesdent, J., Victoria, R. and Plenecassagne, A. (1985) Particle-size fractionation and stable carbon isotope distribution applied to the study of soil organic-matter dynamics. *Comptes Rendus De L'Academie Des Sciences Serie II*, **300**, 423–8.
- Chan, K. Y., Heenan, D. P. and Oates, A. (2002) Soil carbon fractions and relationship to soil quality under different tillage and stubble management. *Soil and Tillage Research*, **63**, 133–9.
- Chang, C. W., Laird, D. A., Mausbach, M. J. and Hurburgh, C. R. (2001) Near-infrared reflectance spectroscopy – principal components regression analyses of soil properties. *Soil Science Society of America Journal*, **65**, 480–90.
- Chantigny, M. H. (2003) Dissolved and water-extractable organic matter in soils: a review on the influence of land use and management practices. *Geoderma*, **113**, 357–80.
- Chantigny, M. H., Angers, D. A., Prevost, D., Vezina, L. P. and Chalifour, F. P. (1997) Soil aggregation and fungal and bacterial biomass under annual and perennial cropping systems. *Soil Science Society of America Journal*, **61**, 262–7.
- Chefetz, B., Chen, Y., Clapp, C. E. and Hatcher, P. G. (2000) Characterization of organic matter in soils by thermochemolysis using tetramethylammonium hydroxide (TMAH). *Soil Science Society of America Journal*, **64**, 583–9.
- Chenu, C. and Plante, A. F. (2006) Clay-sized organo-mineral complexes in a cultivation chronosequence: revisiting the concept of the 'primary organo-mineral complex'. *European Journal of Soil Science*, **57**, 596–607.
- Chenu, C., Arias, M. and Besnard, E. (2001) The influence of cultivation on the composition and properties of clay-organic matter associations in soils. In *Sustainable Management of Soil Organic Matter*, ed. R. M. Rees, B. C. Ball, C. D. Campbell and C. A. Watson. Wallingford: CABI Publishing, pp. 207–13.
- Cheshire, M. V. (1979) *Nature and Origin of Carbohydrates in Soil*. London: Academic Press.
- Cheshire, M. V. and Mundie, C. M. (1966) The hydrolytic extraction of carbohydrates from soil by sulphuric acid. *Journal of Soil Science*, **17**, 372–81.
- Christensen, B. T. (1992) Physical fractionation of soil and organic matter in primary particles and density separates. *Advances in Soil Science*, **20**, 2–90.
- Christensen, B. T. (1996a) Carbon in primary and secondary organomineral complexes. In *Structure and Organic Matter Storage in Agricultural Soils*, ed. M. R. Carter and B. A. Stewart. Boca Raton, FL: CRC Press, pp. 97–165.
- Christensen, B. T. (1996b) Matching measurable soil organic matter fractions with conceptual pools in simulation models of carbon turnover: Revision of model structure. In *Evaluation of Soil Organic Matter Models*, ed. D. S. Powlson, P. Smith and J. U. Smith. Berlin: Springer, pp. 143–59.
- Christensen, B. T. (2001) Physical fractionation of soil and structural and functional complexity in organic matter turnover. *European Journal of Soil Science*, **52**, 345–53.
- Conen, F., Yakutin, M. V. and Sambuu, A. D. (2003) Potential for detecting changes in soil organic carbon concentrations resulting from climate change. *Global Change Biology*, **9**, 1515–20.
- Cremers, D. A., Ebinger, M. H., Breshears, D. D. *et al.* (2001) Measuring total soil carbon with laser-induced breakdown spectroscopy (LIBS). *Journal of Environmental Quality*, **30**, 2202–6.
- Crow, S. E., Sulzman, E. W., Rugh, W. D., Bowden, R. D. and Lajtha, K. (2006) Isotopic analysis of respired CO₂ during decomposition of separated soil organic matter pools. *Soil Biology and Biochemistry*, **38**, 3279–91.
- Crow, S. E., Swanston, C. W., Lajtha, K., Brooks, J. R. and Keirstead, H. (2007) Density fractionation of forest soils: methodological questions and interpretation of incubation results and turnover time in an ecosystem context. *Biogeochemistry*, **85**, 69–90.
- Dalal, R. C. and Henry, R. J. (1988) Cultivation effects on carbohydrate contents of soil and soil fractions. *Soil Science Society of America Journal*, **52**, 1361–5.
- de Azevedo, A. C. and Schulze, D. G. (2007) Aggregate distribution, stability and release of water dispersible clay for two subtropical oxisols. *Scientia Agricola*, **64**, 36–43.
- Del Galdo, I., Six, J., Peressotti, A. and Cotrufo, M. F. (2003) Assessing the impact of land-use change on soil C sequestration in agricultural soils by means of organic matter fractionation and stable C isotopes. *Global Change Biology*, **9**, 1204–13.
- Del Galdo, I., Oechel, W. C. and Cotrufo, M. F. (2006) Effects of past, present and future atmospheric CO₂ concentrations on soil organic matter dynamics in a chaparral ecosystem. *Soil Biology and Biochemistry*, **38**, 3235–44.
- Dell'Abate, M. T., Benedetti, A. and Sequi, P. (2000) Thermal methods of organic matter maturation

- monitoring during a composting process. *Journal of Thermal Analysis and Calorimetry*, **61**, 389–96.
- Denef, K., Six, J., Bossuyt, H. *et al.* (2001a) Influence of dry-wet cycles on the interrelationship between aggregate, particulate organic matter, and microbial community dynamics. *Soil Biology and Biochemistry*, **33**, 1599–611.
- Denef, K., Six, J., Paustian, K. and Merckx, R. (2001b) Importance of macroaggregate dynamics in controlling soil carbon stabilization: short-term effects of physical disturbance induced by dry-wet cycles. *Soil Biology and Biochemistry*, **33**, 2145–53.
- Denef, K., Six, J., Merckx, R. and Paustian, K. (2004) Carbon sequestration in microaggregates of no-tillage soils with different clay mineralogy. *Soil Science Society of America Journal*, **68**, 1935–44.
- Denef, K., Zotarelli, L., Boddey, R. M. and Six, J. (2007) Microaggregate-associated carbon as a diagnostic fraction for management-induced changes in soil organic carbon in two Oxisols. *Soil Biology and Biochemistry*, **39**, 1165–72.
- Derrien, D., Marol, C., Balabane, M. and Balesdent, J. (2006) The turnover of carbohydrate carbon in a cultivated soil estimated by ^{13}C natural abundances. *European Journal of Soil Science*, **57**, 547–57.
- Dignac, M. F., Bahri, H., Rumpel, C. *et al.* (2005) Carbon-13 natural abundance as a tool to study the dynamics of lignin monomers in soil: an appraisal at the Closeau experimental field (France). *Geoderma*, **128**, 3–17.
- Dinel, H., Schnitzer, M. and Mehugs, G. R. (1990) Soil lipids: origin, nature, contents, decomposition and effect on soil physical properties. In *Soil Biochemistry*, ed. J. M. Bollag and G. Stotzky. Vol. 6. New York: Marcel Dekker, pp. 397–427.
- Dioumaeva, I., Trumbore, S., Schuur, E. A. G. *et al.* (2002) Decomposition of peat from upland boreal forest: temperature dependence and sources of respired carbon. *Journal of Geophysical Research – Atmospheres*, **108**, D3, WFX 3–1 to WFX 3–12; doi: 10.1029/2001JD000848.
- Duiker, S. W., Rhoton, F. E., Torrent, J., Smeck, N. E. and Lal, R. (2003) Iron (hydr)oxide crystallinity effects on soil aggregation. *Soil Science Society of America Journal*, **67**, 606–11.
- Ebinger, M. H., Norfleet, M. L., Breshears, D. D. *et al.* (2003) Extending the applicability of laser-induced breakdown spectroscopy for total soil carbon measurement. *Soil Science Society of America Journal*, **67**, 1616–19.
- Elliott, E. T. (1986) Aggregate structure and carbon, nitrogen, and phosphorus in native and cultivated soils. *Soil Science Society of America Journal*, **50**, 627–33.
- Elliott, E. T. and Cambardella, C. A. (1991) Physical separation of soil organic-matter. *Agriculture Ecosystems and Environment*, **34**, 407–19.
- Elliott, E. T., Paustian, K. and Frey, S. D. (1996) Modeling the measurable or measuring the modelable: a hierarchical approach to isolating meaningful soil organic matter fractions. In *Evaluation of Soil Organic Models*, ed. D. S. Powlson, P. Smith and J. O. Smith. Berlin: Springer, pp. 161–79.
- Falloon, P., Smith, P., Coleman, K. and Marshall, S. (1998) Estimating the size of the inert organic matter pool from total soil organic carbon content for use in the Rothamsted carbon model. *Soil Biology and Biochemistry*, **30**, 1207–11.
- Feller, C., Albrecht, A., Tessier, D., Carter, M. R. and Stewart, B. A. (1996) Aggregation and organic matter storage in kaolinitic and smectic tropical soils. In *Structure and Organic Matter Storage in Agricultural Soils*, ed. M. R. Carter and B. A. Stewart. Boca Raton, FL: CRC Press, pp. 309–59.
- Filley, T. R. (2003) Assessment of fungal wood decay by lignin analysis using tetramethylammonium hydroxide (TMAH) and ^{13}C -labeled TMAH thermochemolysis. In *Wood Deterioration and Preservation: Advances in Our Changing World*, ed. B. Goodell, D. D. Nicholas and T. P. Schultz. ACS Symposium Series **845**, pp. 119–39.
- Filley, T. R., Minard, R. D. and Hatcher, P. G. (1999) Tetramethylammonium hydroxide (TMAH) thermochemolysis: proposed mechanisms based upon the application of ^{13}C -labeled TMAH to a synthetic model lignin dimer. *Organic Geochemistry*, **30**, 607–21.
- Filley, T. R., Hatcher, P. G., Shortle, W. C. and Praseuth, R. T. (2000) The application of ^{13}C -labeled tetramethylammonium hydroxide (^{13}C -TMAH) thermochemolysis to the study of fungal degradation of wood. *Organic Geochemistry*, **31**, 181–98.
- Filley, T. R., Nierop, K. G. J. and Wang, Y. (2006) The contribution of polyhydroxyl aromatic compounds to tetramethylammonium hydroxide lignin-based proxies. *Organic Geochemistry*, **37**, 711–27.
- Fystro, G. (2002) The prediction of C and N content and their potential mineralisation in heterogeneous soil samples using Vis-NIR spectroscopy and comparative methods. *Plant and Soil*, **246**, 139–49.

- Garten, C. T. and Wullschlegel, S. D. (2000) Soil carbon dynamics beneath switchgrass as indicated by stable isotope analysis. *Journal of Environmental Quality*, **29**, 645–53.
- Gerzabek, M. H., Haberhauer, G. and Kirchmann, H. (2001) Soil organic matter pools and carbon-13 natural abundances in particle-size fractions of a long-term agricultural field experiment receiving organic amendments. *Soil Science Society of America Journal*, **65**, 352–8.
- Glaser, B. (2005) Compound-specific stable-isotope ($\delta^{13}\text{C}$) analysis in soil science. *Journal of Plant Nutrition and Soil Science*, **168**, 633–48.
- Glaser, B. and Gross, S. (2005) Compound-specific delta ^{13}C analysis of individual amino sugars: a tool to quantify timing and amount of soil microbial residue stabilization. *Rapid Communications in Mass Spectrometry*, **19**, 1409–16.
- Glaser, B., Turrión, M. B., Solomon, D., Ni, A. and Zech, W. (2000) Soil organic matter quantity and quality in mountain soils of the Alay Range, Kyrgyzia, affected by land use change. *Biology and Fertility of Soils*, **31**, 407–13.
- Glaser, B., Turrión, M. B. and Alef, K. (2004) Amino sugars and muramic acid: biomarkers for soil microbial community structure analysis. *Soil Biology and Biochemistry*, **36**, 399–407.
- Glaser, B., Millar, N. and Blum, H. (2006) Sequestration and turnover of bacterial- and fungal-derived carbon in a temperate grassland soil under long-term elevated atmospheric pCO_2 . *Global Change Biology*, **12**, 1521–31.
- Gleixner, G., Bol, R. and Balesdent, J. (1999) Molecular insight into soil carbon turnover. *Rapid Communications in Mass Spectrometry*, **13**, 1278–83.
- Gleixner, G., Poirier, N., Bol, R. and Balesdent, J. (2002) Molecular dynamics of organic matter in a cultivated soil. *Organic Geochemistry*, **33**, 357–66.
- Golchin, A., Oades, J. M., Skjemstad, J. O. and Clarke, P. (1994) Study of free and occluded particulate organic-matter in soils by solid-state ^{13}C CP/MAS NMR-spectroscopy and scanning electron-microscopy. *Australian Journal of Soil Research*, **32**, 285–309.
- Goncalves, C. N., Dalmolin, R. S. D., Dick, D. P. *et al.* (2003) The effect of 10% HF treatment on the resolution of CPMAS ^{13}C NMR spectra and on the quality of organic matter in Ferralsols. *Geoderma*, **116**, 373–92.
- Grasset, L. and Ambles, A. (1998) Structural study of soil humic acids and humin using a new preparative thermochemolysis technique. *Journal of Analytical and Applied Pyrolysis*, **47**, 1–12.
- Gregorich, E. G. and Janzen, H. H. (1996) Storage and soil carbon in the light fraction and macroorganic matter. In *Structure and Organic Matter Storage in Agricultural Soils*. Advances in Soil Science Series, ed. M. R. Carter and B. A. Stewart. Boca Raton, FL: CRC Press, pp. 167–90.
- Gregorich, E. G., Kachanoski, R. G. and Voroney, R. P. (1989) Carbon mineralization in soil size fractions after various amounts of aggregate disruption. *Journal of Soil Science*, **40**, 649–59.
- Gregorich, E. G., Beare, M. H., Stoklas, U. and St-Georges, P. (2003) Biodegradability of soluble organic matter in maize-cropped soils. *Geoderma*, **113**, 237–52.
- Gregorich, E. G., Beare, M. H., McKim, U. F. and Skjemstad, J. O. (2006) Chemical and biological characteristics of physically uncomplexed organic matter. *Soil Science Society of America Journal*, **70**, 975–85.
- Gross, S. and Glaser, B. (2004) Minimization of carbon addition during derivatization of monosaccharides for compound-specific delta ^{13}C analysis in environmental research. *Rapid Communications in Mass Spectrometry*, **18**, 2753–64.
- Guerrant, G. O. and Moss, C. W. (1984) Determination of monosaccharides as aldononitrile, O-methyloxime, alditol, and cyclitol acetate derivatives by gas-chromatography. *Analytical Chemistry*, **56**, 633–8.
- Guggenberger, G. and Zech, W. (1994) Composition and dynamics of dissolved carbohydrates and lignin-degradation products in 2 coniferous forests, NE Bavaria, Germany. *Soil Biology and Biochemistry*, **26**, 19–27.
- Guggenberger, G. and Zech, W. (1999) Soil organic matter composition under primary forest, pasture, and secondary forest succession, Region Hueta Norte, Costa Rica. *Forest Ecology and Management*, **124**, 93–104.
- Guggenberger, G., Christensen, B. T. and Zech, W. (1994) Land-use effects on the composition of organic-matter in particle-size separates of soil. 1. Lignin and carbohydrate signature. *European Journal of Soil Science*, **45**, 449–58.
- Guggenberger, G., Zech, W., Haumaier, L. and Christensen, B. T. (1995) Land-use effects on the composition of

- organic matter in particle-size separates of soils: II. CPMAS and solution ^{13}C NMR analysis. *European Journal of Soil Science*, **46**, 147–58.
- Guggenberger, G., Frey, S. D., Six, J., Paustian, K. and Elliott, E. T. (1999a) Bacterial and fungal cell-wall residues in conventional and no-tillage agroecosystems. *Soil Science Society of America Journal*, **63**, 1188–98.
- Guggenberger, G., Elliott, E. T., Frey, S. D., Six, J. and Paustian, K. (1999b) Microbial contributions to the aggregation of a cultivated grassland soil amended with starch. *Soil Biology and Biochemistry*, **31**, 407–19.
- Harmon, R. S., DeLucia, F. C., McManus, C. E. *et al.* (2006) Laser-induced breakdown spectroscopy: an emerging chemical sensor technology for real-time field-portable, geochemical, mineralogical, and environmental applications. *Applied Geochemistry*, **21**, 730–47.
- Hassink, J. (1995) Density fractions of soil macroorganic matter and microbial biomass as predictors of C-mineralization and N-mineralization. *Soil Biology and Biochemistry*, **27**, 1099–108.
- Hatcher, P. G., Nanny, M. A., Minard, R. D., Dible, S. D. and Carson, D. M. (1995) Comparison of two thermochemolytic methods for the analysis of lignin in decomposing gymnosperm wood: the CuO oxidation method and the method of thermochemolysis with tetramethylammonium hydroxide (TMAH). *Organic Geochemistry*, **23**, 881–8.
- Hayes, M. H. B. (2006) Solvent systems for the isolation of organic components from soils. *Soil Science Society of America Journal*, **70**, 986–94.
- Hayes, M. H. B., MacCarthy, P., Malcolm, R. and Swift, R. S. (1989) *Humic Substances II. In Search of Structure*. Chichester: Wiley Interscience.
- Haynes, R. J. (2005) Labile organic matter fractions as central components of the quality of agricultural soils: an overview. In *Advances in Agronomy*, ed. D. L. Sparks. Vol. 85. Advances in Agronomy. San Diego, CA: Academic Press, pp. 221–68.
- Haynes, R. J. and Francis, G. S. (1993) Changes in microbial biomass-C, soil carbohydrate-composition and aggregate stability induced by growth of selected crop and forage species under field conditions. *Journal of Soil Science*, **44**, 665–75.
- He, H. B., Xie, H. T. and Zhang, X. D. (2006) A novel GC/MS technique to assess ^{15}N and ^{13}C incorporation into soil amino sugars. *Soil Biology and Biochemistry*, **38**, 1083–91.
- Hedges, J. I. and Ertel, J. R. (1982) Characterization of lignin by gas capillary chromatography of cupric oxide oxidation-products. *Analytical Chemistry*, **54**, 174–8.
- Hedges, J. I., Blanchette, R. A., Weliky, K. and Devol, A. H. (1988) Effects of fungal degradation on the CuO oxidation-products of lignin: a controlled laboratory study. *Geochimica et Cosmochimica Acta*, **52**, 2717–26.
- Hedges, J. I., Eglinton, G., Hatcher, P. G. *et al.* (2000) The molecularly-uncharacterized component of nonliving organic matter in natural environments. *Organic Geochemistry*, **31**, 945–58.
- Heim, A. and Schmidt, M. W. I. (2007) Lignin turnover in arable soil and grassland analysed with two different labelling approaches. *European Journal of Soil Science*, **58**, 599–608.
- Helfrich, M., Ludwig, B., Buurman, P. and Flessa, H. (2006) Effect of land use on the composition of soil organic matter in density and aggregate fractions as revealed by solid-state ^{13}C NMR spectroscopy. *Geoderma*, **136**, 331–41.
- Hu, S., Coleman, D. C., Beare, M. H. and Hendrix, P. F. (1995) Soil carbohydrates in aggrading and degrading agroecosystems: influences of fungi and aggregates. *Agriculture Ecosystems and Environment*, **54**, 77–88.
- Hughes, J. C. (1982) High-gradient magnetic separation of some soil clays from Nigeria, Brazil and Colombia. 1. The interrelationships of iron and aluminum extracted by acid ammonium oxalate and carbon. *Journal of Soil Science*, **33**, 509–19.
- Janik, L. J., Merry, R. H. and Skjemstad, J. O. (1998) Can mid infrared diffuse reflectance analysis replace soil extractions? *Australian Journal of Experimental Agriculture*, **38**, 681–96.
- Janik, L. J., Skjemstad, J. O., Shepherd, K. D. and Spouncer, L. R. (2007) The prediction of soil carbon fractions using mid-infrared partial least square analysis. *Australian Journal of Soil Research*, **45**, 73–81.
- Jansen, B., Nierop, K. G. J., Kotte, M. C., de Voogt, P. and Verstraten, J. M. (2006) The applicability of accelerated solvent extraction (ASE) to extract lipid biomarkers from soils. *Applied Geochemistry*, **21**, 1006–15.
- Janzen, H. H., Campbell, C. A., Brandt, S. A., Lafond, G. P. and Townleysmith, L. (1992) Light fraction organic matter in soils from long-term crop rotations. *Soil Science Society of America Journal*, **56**, 1799–806.
- Jastrow, J. D. (1996) Soil aggregate formation and the accrual of particulate and mineral-associated organic matter. *Soil Biology and Biochemistry*, **28**, 665–76.

- Jastrow, J. D., Boutton, T. W. and Miller, R. M. (1996) Carbon dynamics of aggregate-associated organic matter estimated by carbon-13 natural abundance. *Soil Science Society of America Journal*, **60**, 801–7.
- Jaynes, W. F. and Bigham, J. M. (1986) Concentration of iron-oxides from soil clays by density gradient centrifugation. *Soil Science Society of America Journal*, **50**, 1633–9.
- Jenkinson, D. S. (1990) The turnover of organic carbon and nitrogen in soil. *Philosophical Transactions of the Royal Society of London Series B – Biological Sciences*, **329**, 361–8.
- Jenkinson, D. S. and Ayanaba, A. (1977) Decomposition of ¹⁴C-labeled plant material under tropical conditions. *Soil Science Society of America Journal*, **41**, 912–15.
- Jenkinson, D. S., Bradbury, N. J. and Coleman, K. (1994) How the Rothamsted Classical Experiments have been used to develop and test models for the turnover of carbon and nitrogen in soil. In *Long-term Experiments in Agricultural and Ecological Sciences*, ed. R. A. Leigh and A. E. Johnston. Wallingford: CAB International.
- Joffre, R., Agren, G. I., Gillon, D. and Bosatta, E. (2001) Organic matter quality in ecological studies: theory meets experiment. *Oikos*, **93**, 451–8.
- John, B., Yamashita, T., Ludwig, B. and Flessa, H. (2005) Storage of organic carbon in aggregate and density fractions of silty soils under different types of land use. *Geoderma*, **128**, 63–79.
- Jokic, A., Cutler, J. N., Ponomarenko, E., Van Der Kamp, G. and Anderson, D. W. (2003) Organic carbon and sulphur compounds in wetland soils: insights on structure and transformation processes using K-edge XANES and NMR spectroscopy. *Geochimica et Cosmochimica Acta*, **67**, 2585–97.
- Kandeler, E., Palli, S., Stemmer, M. and Gerzabek, M. H. (1999) Tillage changes microbial biomass and enzyme activities in particle-size fractions of a Haplic Chernozem. *Soil Biology and Biochemistry*, **31**, 1253–64.
- Keeney, D. R. and Bremner, J. M. (1966) Comparison and evaluation of laboratory methods of obtaining an index of soil nitrogen availability. *Agronomy Journal*, **58**, 498–503.
- Kiem, R. and Kögel-Knabner, I. (2003) Contribution of lignin and polysaccharides to the refractory carbon pool in C-depleted arable soils. *Soil Biology and Biochemistry*, **35**, 101–18.
- Kiem, R., Knicker, H., Korschens, M. and Kögel-Knabner, I. (2000) Refractory organic carbon in C-depleted arable soils, as studied by ¹³C NMR spectroscopy and carbohydrate analysis. *Organic Geochemistry*, **31**, 655–68.
- Kleber, M., Mertz, C., Zikeli, S., Knicker, H. and Jahn, R. (2004) Changes in surface reactivity and organic matter composition of clay subfractions with duration of fertilizer deprivation. *European Journal of Soil Science*, **55**, 381–91.
- Kleber, M., Sollins, P. and Sutton, R. (2007) A conceptual model of organo-mineral interactions in soils: self-assembly of organic molecular fragments into zonal structures on mineral surfaces. *Biogeochemistry*, **85**, 9–24.
- Knicker, H. (2007) How does fire affect the nature and stability of soil organic nitrogen and carbon? A review. *Biogeochemistry*, **85**, 91–118.
- Kögel, I. (1986) Estimation and decomposition pattern of the lignin component in forest humus layers. *Soil Biology and Biochemistry*, **18**, 589–94.
- Kögel, I. and Bochter, R. (1985) Characterization of l Lignin in forest humus layers by high-performance liquid-chromatography of cupric oxide oxidation-products. *Soil Biology and Biochemistry*, **17**, 637–40.
- Kögel-Knabner, I. (1997) ¹³C and ¹⁵N NMR spectroscopy as a tool in soil organic matter studies. *Geoderma*, **80**, 243–70.
- Kögel-Knabner, I. (2000) Analytical approaches for characterizing soil organic matter. *Organic Geochemistry*, **31**, 609–25.
- Kögel-Knabner, I. (2002) The macromolecular organic composition of plant and microbial residues as inputs to soil organic matter. *Soil Biology and Biochemistry*, **34**, 139–62.
- Kölbl, A. and Kögel-Knabner, I. (2004) Content and composition of free and occluded particulate organic matter in a differently textured arable Cambisol as revealed by solid-state ¹³C NMR spectroscopy. *Journal of Plant Nutrition and Soil Science*, **167**, 45–53.
- Kölbl, A., Leifeld, J. and Kögel-Knabner, I. (2005) A comparison of two methods for the isolation of free and occluded particulate organic matter. *Journal of Plant Nutrition and Soil Science*, **168**, 660–7.
- Kong, A. Y. Y., Six, J., Bryant, D. C., Denison, R. F. and van Kessel, C. (2005) The relationship between carbon input, aggregation, and soil organic carbon stabilization

- in sustainable cropping systems. *Soil Science Society of America Journal*, **69**, 1078–85.
- Kramer, C. and Gleixner, G. (2006) Variable use of plant- and soil-derived carbon by microorganisms in agricultural soils. *Soil Biology and Biochemistry*, **38**, 3267–78.
- Krull, E. S., Baldock, J. A. and Skjemstad, J. O. (2003) Importance of mechanisms and processes of the stabilisation of soil organic matter for modelling carbon turnover. *Functional Plant Biology*, **30**, 207–22.
- Krummen, M., Hilkert, A. W., Juchelka, D. *et al.* (2004) A new concept for isotope ratio monitoring liquid chromatography/mass spectrometry. *Rapid Communications in Mass Spectrometry*, **18**, 2260–6.
- Larre-Larrouy, M. C. and Feller, C. (2001) Carbon and monosaccharide distribution in particle-size fractions from a clayey ferrallitic soil (Congo). *Communications in Soil Science and Plant Analysis*, **32**, 2925–42.
- Larre-Larrouy, M. C., Albrecht, A., Blanchart, E., Chevallier T. and Feller, C. (2003) Carbon and monosaccharides of a tropical Vertisol under pasture and market-gardening: distribution in primary organomineral separates. *Geoderma*, **117**, 63–79.
- Leavitt, S. W., Follett, R. F. and Paul, E. A. (1996) Estimation of slow- and fast-cycling soil organic carbon pools from 6N HCl hydrolysis. *Radiocarbon*, **38**, 231–9.
- Lehmann, J., Liang, B. Q., Solomon, D. *et al.* (2005) Near-edge X-ray absorption fine structure (NEXAFS) spectroscopy for mapping nano-scale distribution of organic carbon forms in soil: application to black carbon particles. *Global Biogeochemical Cycles*, **19**.
- Leifeld, J. (2006) Application of diffuse reflectance FT-IR spectroscopy and partial least-squares regression to predict NMR properties of soil organic matter. *European Journal of Soil Science*, **57**, 846–57.
- Leifeld, J. (2007) Thermal stability of black carbon characterised by oxidative differential scanning calorimetry. *Organic Geochemistry*, **38**, 112–27.
- Leifeld, J. and Kögel-Knabner, I. (2005) Soil organic matter fractions as early indicators for carbon stock changes under different land-use? *Geoderma*, **124**, 143–55.
- Leinweber, P. and Schulten, H. R. (1999) Advances in analytical pyrolysis of soil organic matter. *Journal of Analytical and Applied Pyrolysis*, **49**, 359–83.
- Leinweber, P., Schulten, H. R. and Korschens, M. (1995) Hot water extracted organic matter: chemical composition and temporal variations in a long-term field experiment. *Biology and Fertility of Soils*, **20**, 17–23.
- Liao, J. D., Boutton, T. W. and Jastrow, J. D. (2006a) Storage and dynamics of carbon and nitrogen in soil physical fractions following woody plant invasion of grassland. *Soil Biology and Biochemistry*, **38**, 3184–96.
- Liao, J. D., Boutton, T. W. and Jastrow, J. D. (2006b) Organic matter turnover in soil physical fractions following woody plant invasion of grassland: evidence from natural ^{13}C and ^{15}N . *Soil Biology and Biochemistry*, **38**, 3197–210.
- Lopez-Capel, E., Sohi, S. P., Gaunt, J. L. and Manning, D. A. C. (2005a) Use of thermogravimetry-differential scanning calorimetry to characterize modelable soil organic matter fractions. *Soil Science Society of America Journal*, **69**, 136–40.
- Lopez-Capel, E., Bol, R. and Manning, D. A. C. (2005b) Application of simultaneous thermal analysis mass spectrometry and stable carbon isotope analysis in a carbon sequestration study. *Rapid Communications in Mass Spectrometry*, **19**, 3192–8.
- Lopez-Capel, E., Abbott, G. D., Thomas, K. M. and Manning, D. A. C. (2006) Coupling of thermal analysis with quadrupole mass spectrometry and isotope ratio mass spectrometry for simultaneous determination of evolved gases and their carbon isotopic composition. *Journal of Analytical and Applied Pyrolysis*, **75**, 82–9.
- Lorenz, K., Lal, R., Preston, C. M. and Nierop, K. G. J. (2007) Strengthening the soil organic carbon pool by increasing contributions from recalcitrant aliphatic bio(macro)molecules. *Geoderma*, **142**, 1–10.
- Lueders, T., Manefield, M. and Friedrich, M. W. (2004) Enhanced sensitivity of DNA- and rRNA-based stable isotope probing by fractionation and quantitative analysis of isopycnic centrifugation gradients. *Environmental Microbiology*, **6**, 73–8.
- MacCarthy, P. (2001) The principles of humic substances. *Soil Science*, **166**, 738–51.
- Madari, B. E., Reeves, J. B., Coelho, M. R., Machado, P. and De-Polli, H. (2005) Mid- and near-infrared spectroscopic determination of carbon in a diverse set of soils from the Brazilian National Soil Collection. *Spectroscopy Letters*, **38**, 721–40.
- Madari, B. E., Reeves, J. B., Machado, P. *et al.* (2006) Mid- and near-infrared spectroscopic assessment of soil compositional parameters and structural indices in two Ferralsols. *Geoderma*, **136**, 245–59.
- Magid, J., Gorissen, A. and Giller, K. E. (1996) In search of the elusive 'active' fraction of soil organic matter: three size-density fractionation methods for tracing the fate of

- homogeneously ^{14}C -labelled plant materials. *Soil Biology and Biochemistry*, **28**, 89–99.
- Magrini, K. A., Evans, R. J., Hoover, C. M., Elam, C. C. and Davis, M. F. (2002) Use of pyrolysis molecular beam mass spectrometry (py-MBMS) to characterize forest soil carbon: method and preliminary results. *Environmental Pollution*, **116**, S255–S268.
- Mahieu, N., Powlson, D. S. and Randall, E. W. (1999) Statistical analysis of published carbon-13 CPMAS NMR spectra of soil organic matter. *Soil Science Society of America Journal Proceedings*, **63**, 307–19.
- Manefield, M., Whiteley, A. S., Griffiths, R. I. and Bailey, M. J. (2002) RNA stable isotope probing: a novel means of linking microbial community function to phylogeny. *Applied Environmental Microbiology*, **68**, 5367–73.
- Manning, D. A. C., Lopez-Capel, E. and Barker, S. (2005) Seeing soil carbon: use of thermal analysis in the characterization of soil C reservoirs of differing stability. *Mineralogical Magazine*, **69**, 425–35.
- Marseille, F., Disnar, J. R., Guillet, B. and Noack, Y. (1999) n-alkanes and free fatty acids in humus and Al horizons of soils under beech, spruce and grass in the Massif-Central (Mont-Lozere), France. *European Journal of Soil Science*, **50**, 433–41.
- Martel, Y. A. and Paul, E. A. (1974) Effects of cultivation on organic-matter of grassland soils as determined by fractionation and radiocarbon dating. *Canadian Journal of Soil Science*, **54**, 419–26.
- Masiello, C. A. (2004) New directions in black carbon organic geochemistry. *Marine Chemistry*, **92**, 201–13.
- Mayer, L. M., Schick, L. L., Hardy, K. R., Wagal, R. and McCarthy, J. (2004) Organic matter in small mesopores in sediments and soils. *Geochimica et Cosmochimica Acta*, **68**, 3863–72.
- McCarty, G. W., Reeves, J. B., Reeves, V. B., Follett, R. F. and Kimble, J. M. (2002) Mid-infrared and near-infrared diffuse reflectance spectroscopy for soil carbon measurement. *Soil Science Society of America Journal*, **66**, 640–6.
- Mikutta, R., Kleber, M. and Jahn, R. (2005) Poorly crystalline minerals protect organic carbon in clay subfractions from acid subsoil horizons. *Geoderma*, **128**, 106–15.
- Mimmo, T., Reeves, J. B., McCarty, G. W. and Galletti, G. (2002) Determination of biological measures by mid-infrared diffuse reflectance spectroscopy in soils within a landscape. *Soil Science*, **167**, 281–7.
- Moers, M. E. C., Baas, M., Deleeuw, J. W., Boon, J. J. and Schenck, P. A. (1990) Occurrence and origin of carbohydrates in peat samples from a red mangrove environment as reflected by abundances of neutral monosaccharides. *Geochimica et Cosmochimica Acta*, **54**, 2463–72.
- Monreal, C. M., Schulten, H. R. and Kodama, H. (1997) Age, turnover and molecular diversity of soil organic matter in aggregates of a Gleysol. *Canadian Journal of Soil Science*, **77**, 379–88.
- Mulder, G. (1861) *Die Chemie der Ackerkrumme*. Berlin: Muller.
- Mummey, D. L., Holben, W., Six, J. and Stahl, P. (2006a) Spatial stratification of soil bacterial populations in aggregates of diverse soils. *Microbial Ecology*, **51**, 404–11.
- Mummey, D. L., Rillig, M. C. and Six, J. (2006b) Endogeic earthworms differentially influence bacterial communities associated with different soil aggregate size fractions. *Soil Biology and Biochemistry*, **38**, 1608–14.
- Murase, J., Matsui, Y., Katoh, M., Sugimoto, A. and Kimura, M. (2006) Incorporation of ^{13}C -labeled rice-straw-derived carbon into microbial communities in submerged rice field soil and percolating water. *Soil Biology and Biochemistry*, **38**, 3483–91.
- Mutuo, P. K., Shepherd, K. D., Albrecht, A. and Cadisch, G. (2006) Prediction of carbon mineralization rates from different soil physical fractions using diffuse reflectance spectroscopy. *Soil Biology and Biochemistry*, **38**, 1658–64.
- Naafs, D. F. W., van Bergen, P. F., de Jong, M. A., Oonincx, A. and de Leeuw, J. W. (2004) Total lipid extracts from characteristic soil horizons in a podzol profile. *European Journal of Soil Science*, **55**, 657–69.
- Nelson, D. W. and Sommers, L. E. (1996) Total carbon, organic carbon and organic matter. In *Methods of Soil Analysis: Part III. Chemical Methods*, ed. D. L. Sparks, A. L. Page, P. A. Helmke *et al.* Madison: Soil Science Society of America, pp. 961–1010.
- Nierop, K. G. J. and Filley, T. R. (2007) Assessment of lignin and (poly-)phenol transformations in oak (*Quercus robur*) dominated soils by ^{13}C -TMAH thermochemolysis. *Organic Geochemistry*, **38**, 551–65.
- Nierop, K. G. J., Pulleman, M. M. and Marinissen, J. C. Y. (2001) Management induced organic matter differentiation in grassland and arable soil: a study using pyrolysis techniques. *Soil Biology and Biochemistry*, **33**, 755–64.

- Nierop, K. G. J., Naafs, D. F. W. and van Bergen, P. F. (2005) Origin, occurrence and fate of extractable lipids in Dutch coastal dune soils along a pH gradient. *Organic Geochemistry*, **36**, 555–66.
- North, P. F. (1976) Towards an absolute measurement of soil structural stability using ultrasound. *Journal of Soil Science*, **27**, 451–9.
- Oades, J. M. (1984) Soil organic-matter and structural stability: mechanisms and implications for management. *Plant and Soil*, **76**, 319–37.
- Oades, J. M. and Waters, A. G. (1991) Aggregate hierarchy in soils. *Australian Journal of Soil Research*, **29**, 815–28.
- Oades, J. M., Kirkman, M. A. and Wagner, G. H. (1970) The use of gas-liquid chromatography for the determination of sugars extracted from soils by sulfuric acid. *Soil Science Society of America Journal*, **34**, 230–5.
- Oades, J. M., Vassallo, A. M., Waters, A. G. and Wilson, M. A. (1987) Characterization of organic-matter in particle-size and density fractions from a red-brown earth by solid-state ^{13}C NMR. *Australian Journal of Soil Research*, **25**, 71–82.
- Olk, D. C. and Gregorich, E. G. (2006) Overview of the symposium proceedings: 'Meaningful pools in determining soil carbon and nitrogen dynamics'. *Soil Science Society of America Journal*, **70**, 967–74.
- Oorts, K., Nicolardot, B., Merckx, R., Richard, G. and Boizard, H. (2006) C and N mineralization of undisturbed and disturbed soil from different structural zones of conventional tillage and no-tillage systems in northern France. *Soil Biology and Biochemistry*, **38**, 2576–86.
- Ostle, N. J., Bol, R., Petzke, K. J. and Jarvis, S. C. (1999) Compound specific $\delta^{15}\text{N}$ values: amino acids in grassland and arable soils. *Soil Biology and Biochemistry*, **31**, 1751–5.
- Otto, A. and Simpson, M. J. (2005) Degradation and preservation of vascular plant-derived biomarkers in grassland and forest soils from Western Canada. *Biogeochemistry*, **74**, 377–409.
- Otto, A., Shunthirasingham, C. and Simpson, M. J. (2005) A comparison of plant and microbial biomarkers in grassland soils from the Prairie Ecozone of Canada. *Organic Geochemistry*, **36**, 425–48.
- Palmborg, C. and Nordgren, A. (1993) Modeling microbial activity and biomass in forest soil with substrate quality measured using near-infrared reflectance spectroscopy. *Soil Biology and Biochemistry*, **25**, 1713–18.
- Parfitt, R. L., Theng, B. K. G., Whitton, J. S. and Shepherd, T. G. (1997) Effects of clay minerals and land use on organic matter pools. *Geoderma*, **75**, 1–12.
- Parsons, J. W. (1981) *Chemistry and Distribution of Amino Sugars in Soils and Soil Organisms*, ed. E. A. Paul and J. N. Ladd. New York: Marcel Dekker, pp. 197–227.
- Parton, W. J., Schimel, D. S., Cole, C. V. and Ojima, D. S. (1987) Analysis of factors controlling soil organic-matter levels in great-plains grasslands. *Soil Science Society of America Journal*, **51**, 1173–9.
- Parton, W. J., Stewart, J. W. B. and Cole, C. V. (1988) Dynamics of C, N, P and S in grassland soils: a model. *Biogeochemistry*, **5**, 109–31.
- Paul, E. A., Follett, R. F., Leavitt, S. W. *et al.* (1997) Radiocarbon dating for determination of soil organic matter pool sizes and dynamics. *Soil Science Society of America Journal*, **61**, 1058–67.
- Paul, E. A., Morris, S. J. and Böhm, S. (2000) The determination of soil C pool sizes and turnover rates: biophysical fractionation and tracers. In *Assessment Methods for Soil Carbon*, ed. R. Lal, J. M. Kimble, R. F. Follett and B. A. Stewart. Boca Raton, FL: CRC Press, pp. 193–206.
- Paul, E. A., Collins, H. P. and Leavitt, S. W. (2001) Dynamics of resistant soil carbon of Midwestern agricultural soils measured by naturally occurring ^{14}C abundance. *Geoderma*, **104**, 239–56.
- Paul, E. A., Morris, S. J., Conant, R. T. and Plante, A. F. (2006) Does the acid hydrolysis-incubation method measure meaningful soil organic carbon pools? *Soil Science Society of America Journal*, **70**, 1023–35.
- Percival, H. J., Parfitt, R. L. and Scott, N. A. (2000) Factors controlling soil carbon levels in New Zealand grasslands: is clay content important? *Soil Science Society of America Journal*, **64**, 1623–30.
- Phillips, R. L., Zak, D. R., Holmes, W. E. and White, D. C. (2002) Microbial community composition and function beneath temperate trees exposed to elevated atmospheric carbon dioxide and ozone. *Oecologia*, **131**, 236–44.
- Piccolo, A. (2001) The supramolecular structure of humic substances. *Soil Science*, **166**, 810–32.
- Plante, A. F., Chenu, C., Balabane, M., Mariotti, A. and Righi, D. (2004) Peroxidase oxidation of clay-associated organic matter in a cultivation chronosequence. *European Journal of Soil Science*, **55**, 471–8.
- Plante, A. F., Pernes, M. and Chenu, C. (2005) Changes in clay-associated organic matter quality in a C depletion

- sequence as measured by differential thermal analyses. *Geoderma*, **129**, 186–99.
- Plante, A. F., Conant, R. T., Paul, E. A., Paustian, K. and Six, J. (2006) Acid hydrolysis of easily dispersed and microaggregate-derived silt- and clay-sized fractions to isolate resistant soil organic matter. *European Journal of Soil Science*, **57**, 456–67.
- Poirier, N., Sohi, S. P., Gaunt, J. L. *et al.* (2005) The chemical composition of measurable soil organic matter pools. *Organic Geochemistry*, **36**, 1174–89.
- Preston, C. M. (1996) Applications of NMR to soil organic matter analysis: history and prospects. *Soil Science*, **161**, 144–66.
- Puget, P., Chenu, C. and Balesdent, J. (1995) Total and young organic-matter distributions in aggregates of silty cultivated soils. *European Journal of Soil Science*, **46**, 449–59.
- Puget, P., Besnard, E. and Chenu, C. (1996) Particulate organic matter fractionation according to its location in soil aggregate structure. *Comptes Rendus De L'Academie Des Sciences Serie Ii Fascicule a-Sciences De La Terre et Des Planetes*, **322**, 965–72.
- Puget, P., Angers, D. A. and Chenu, C. (1999) Nature of carbohydrates associated with water-stable aggregates of two cultivated soils. *Soil Biology and Biochemistry*, **31**, 55–63.
- Puget, P., Chenu, C. and Balesdent, J. (2000) Dynamics of soil organic matter associated with particle-size fractions of water-stable aggregates. *European Journal of Soil Science*, **51**, 595–605.
- Queena, K., Derenne, S., Largeau, C., Rumpel, C. and Marloti, A. (2004) Variation in lipid relative abundance and composition among different particle size fractions of a forest soil. *Organic Geochemistry*, **35**, 1355–70.
- Radajewski, S., Ineson, P., Parekh, N. R. and Murrell, J. C. (2000) Stable-isotope probing as a tool in microbial ecology. *Nature*, **403**, 646–9.
- Rasse, D. P., Dignac, M. F., Bahri, H. *et al.* (2006) Lignin turnover in an agricultural field: from plant residues to soil-protected fractions. *European Journal of Soil Science*, **57**, 530–8.
- Rethemeyer, J., Kramer, C., Gleixner, G. *et al.* (2005) Transformation of organic matter in agricultural soils: radiocarbon concentration versus soil depth. *Geoderma*, **128**, 94–105.
- Righi, D., Dinel, H., Schulten, H. R. and Schnitzer, M. (1995) Characterization of clay-organic-matter complexes resistant to oxidation by peroxide. *European Journal of Soil Science*, **46**, 423–9.
- Rühlmann, J. (1999) A new approach to estimating the pool of stable organic matter in soil using data from long-term field experiments. *Plant and Soil*, **213**, 149–60.
- Rumpel, C. and Dignac, M. F. (2006) Chromatographic analysis of monosaccharides in a forest soil profile: analysis by gas chromatography after trifluoroacetic acid hydrolysis and reduction-acetylation. *Soil Biology and Biochemistry*, **38**, 1478–81.
- Rumpel, C., Kögel-Knabner, I. and Bruhn, F. (2002) Vertical distribution, age, and chemical composition of organic carbon in two forest soils of different pedogenesis. *Organic Geochemistry*, **33**, 1131–42.
- Rumpel, C., Eusterhues, K. and Kögel-Knabner, I. (2004a) Location and chemical composition of stabilized organic carbon in topsoil and subsoil horizons of two acid forest soils. *Soil Biology and Biochemistry*, **36**, 177–90.
- Rumpel, C., Seraphin, A., Goebel, M. O. *et al.* (2004b) Alkyl C and hydrophobicity in B and C horizons of an acid forest soil. *Journal of Plant Nutrition and Soil Science*, **167**, 685–92.
- Saggar, S., Parshotam, A., Sparling, G. P., Feltham, C. W. and Hart, P. B. S. (1996) ¹⁴C-labelled ryegrass turnover and residence times in soils varying in clay content and mineralogy. *Soil Biology and Biochemistry*, **28**, 1677–86.
- Saiz-Jimenez, C. (1994) Analytical pyrolysis of humic substances: pitfalls, limitations, and possible solutions. *Environmental Science and Technology*, **28**, 1773–80.
- Schimel, J. (2007) Soil microbiology, ecology and biochemistry for the 21st century. In *Soil Microbiology, Ecology and Biochemistry*, ed. E. A. Paul. New York: Elsevier, pp. 503–14.
- Schmidt, M. W. I. and Noack, A. G. (2000) Black carbon in soils and sediments: analysis, distribution, implications, and current challenges. *Global Biogeochemical Cycles*, **14**, 777–93.
- Schmidt, M. W. I., Knicker, H., Hatcher, P. G. and Kögel-Knabner, I. (1997) Improvement of ¹³C and ¹⁵N CPMA NMR spectra of bulk soils, particle size fractions and organic material by treatment with 10% hydrofluoric acid. *European Journal of Soil Science*, **48**, 319–28.
- Schmidt, M. W. I., Skjemstad, J. O., Czimeczik, C. I. *et al.* (2001) Comparative analysis of black carbon in soils. *Global Biogeochemical Cycles*, **15**, 163–7.

- Schnitzer, M. (2001) The *in situ* analysis of organic matter in soils. *Canadian Journal of Soil Science*, **81**, 249–54.
- Schnitzer, M. and Preston, C. M. (1983) Effects of acid hydrolysis on the ^{13}C NMR spectra of humic substances. *Plant and Soil*, **75**, 201–11.
- Schnitzer, M. and Schulten, H. R. (1992) The analysis of soil organic matter by pyrolysis-field ionization mass spectrometry. *Soil Science Society of America Journal*, **56**, 1811–17.
- Schnitzer, M. and Schulten, H. R. (1995) Analysis of organic matter in soil, extracts and whole soils by pyrolysis mass spectrometry. In *Advances in Agronomy*, ed. D. L. Sparks. Vol. 55. Advances in Agronomy. San Diego CA: Academic Press, pp. 167–217.
- Schöning, I., Knicker, H. and Kögel-Knabner, I. (2005) Intimate association between O/N-alkyl carbon and iron oxides in clay fractions of forest soils. *Organic Geochemistry*, **36**, 1378–90.
- Schulten, H. R. and Leinweber, P. (2000) New insights into organic-mineral particles: composition, properties and models of molecular structure. *Biology and Fertility of Soils*, **30**, 399–432.
- Schulze, D. G. and Dixon, J. B. (1979) High-gradient magnetic separation of iron-oxides and other magnetic minerals from soil clays. *Soil Science Society of America Journal*, **43**, 793–9.
- Schutter, M. E. and Dick, R. P. (2002) Microbial community profiles and activities among aggregates of winter fallow and cover-cropped soil. *Soil Science Society of America Journal*, **66**, 142–53.
- Schwertmann, U., Wagner, F. and Knicker, H. (2005) Ferrihydrite-humic associations: magnetic hyperfine interactions. *Soil Science Society of America Journal*, **69**, 1009–15.
- Shang, C. and Tiessen, H. (1998) Organic matter stabilization in two semiarid tropical soils: size, density, and magnetic separations. *Soil Science Society of America Journal*, **62**, 1247–57.
- Shang, C. and Tiessen, H. (2000) Carbon turnover and carbon-13 natural abundance in organo-mineral fractions of a tropical dry forest soil under cultivation. *Soil Science Society of America Journal*, **64**, 2149–55.
- Shepherd, K. D. and Walsh, M. G. (2002) Development of reflectance spectral libraries for characterization of soil properties. *Soil Science Society of America Journal*, **66**, 988–98.
- Shepherd, K. D., Palm, C. A., Gachengo, C. N. and Vanlauwe, B. (2003) Rapid characterization of organic resource quality for soil and livestock management in tropical agroecosystems using near-infrared spectroscopy. *Agronomy Journal*, **95**, 1314–22.
- Shepherd, K. D., Vanlauwe, B., Gachengo, C. N. and Palm, C. A. (2005) Decomposition and mineralization of organic residues predicted using near infrared spectroscopy. *Plant and Soil*, **277**, 315–33.
- Simpson, M. J. and Hatcher, P. G. (2004) Determination of black carbon in natural organic matter by chemical oxidation and solid-state ^{13}C nuclear magnetic resonance spectroscopy. *Organic Geochemistry*, **35**, 923–35.
- Simpson, R. T., Frey, S. D., Six, J. and Thiet, R. K. (2004) Preferential accumulation of microbial carbon in aggregate structures of no-tillage soils. *Soil Science Society of America Journal*, **68**, 1249–55.
- Singh, S. and Singh, J. S. (1995) Microbial biomass associated with water-stable aggregates in forest, savanna and cropland soils of a seasonally dry tropical region, India. *Soil Biology and Biochemistry*, **27**, 1027–33.
- Six, J. and Jastrow, J. D. (2002) Organic matter turnover. In *Encyclopedia of Soil Science*, ed. R. Lal. New York: Marcel Dekker, pp. 936–42.
- Six, J., Elliott, E. T., Paustian, K. and Doran, J. W. (1998) Aggregation and soil organic matter accumulation in cultivated and native grassland soils. *Soil Science Society of America Journal*, **62**, 1367–77.
- Six, J., Elliott, E. T. and Paustian, K. (1999a) Aggregate and soil organic matter dynamics under conventional and no-tillage systems. *Soil Science Society of America Journal*, **63**, 1350–8.
- Six, J., Schultz, P. A., Jastrow, J. D. and Merckx, R. (1999b) Recycling of sodium polytungstate used in soil organic matter studies. *Soil Biology and Biochemistry*, **31**, 1193–6.
- Six, J., Paustian, K., Elliott, E. T. and Combrink, C. (2000a) Soil structure and organic matter: I. Distribution of aggregate-size classes and aggregate-associated carbon. *Soil Science Society of America Journal*, **64**, 681–9.
- Six, J., Elliott, E. T. and Paustian, K. (2000b) Soil macroaggregate turnover and microaggregate formation: a mechanism for C sequestration under no-tillage agriculture. *Soil Biology and Biochemistry*, **32**, 2099–103.
- Six, J., Guggenberger, G., Paustian, K. *et al.* (2001) Sources and composition of soil organic matter fractions between and within soil aggregates. *European Journal of Soil Science*, **52**, 607–18.

- Six, J., Conant, R. T., Paul, E. A. and Paustian, K. (2002) Stabilization mechanisms of soil organic matter: implications for C-saturation of soils. *Plant and Soil*, **241**, 155–76.
- Skjemstad, J. O. and Dalal, R. C. (1987) Spectroscopic and chemical differences in organic-matter of 2 Vertisols subjected to long periods of cultivation. *Australian Journal of Soil Research*, **25**, 323–35.
- Skjemstad, J. O., Lefeuvre, R. P. and Prebble, R. E. (1990) Turnover of soil organic matter under pasture as determined by ^{13}C natural abundance. *Australian Journal of Soil Research*, **28**, 267–76.
- Skjemstad, J. O., Clarke, P., Taylor, J. A., Oades, J. M. and Newman, R. H. (1994) The removal of magnetic materials from surface soils: a solid state ^{13}C CP/MAS NMR study. *Australian Journal of Soil Research*, **32**, 1215–29.
- Skjemstad, J. O., Swift, R. S. and McGowan, J. A. (2006) Comparison of the particulate organic carbon and permanganate oxidation methods for estimating labile soil organic carbon. *Australian Journal of Soil Research*, **44**, 255–63.
- Smith, J. U., Smith, P., Monaghan, R. and MacDonald, J. (2002) When is a measured soil organic matter fraction equivalent to a model pool? *European Journal of Soil Science*, **53**, 405–16.
- Smith, P. (2004) How long before a change in soil organic carbon can be detected? *Global Change Biology*, **10**, 1878–83.
- Sohi, S. P., Mahieu, N., Arah, J. R. M. *et al.* (2001) A procedure for isolating soil organic matter fractions suitable for modeling. *Soil Science Society of America Journal*, **65**, 1121–28.
- Sohi, S. P., Mahieu, N., Powlson, D. S. *et al.* (2005) Investigating the chemical characteristics of soil organic matter fractions suitable for modeling. *Soil Science Society of America Journal*, **69**, 1248–55.
- Sollins, P., Homann, P. and Caldwell, B. A. (1996) Stabilization and destabilization of soil organic matter: mechanisms and controls. *Geoderma*, **74**, 65–105.
- Sollins, P., Swanston, C., Kleber, M. *et al.* (2006) Organic C and N stabilization in a forest soil: evidence from sequential density fractionation. *Soil Biology and Biochemistry*, **38**, 3313–24.
- Sollins, P., Swanston, C. and Kramer, M. (2007) Stabilization and destabilization of soil organic matter: a new focus. *Biogeochemistry*, **85**, 1–7.
- Solomon, D., Lehmann, J. and Zech, W. (2001) Land use effects on amino sugar signature of chromic Luvisol in the semi-arid part of northern Tanzania. *Biology and Fertility of Soils*, **33**, 33–40.
- Solomon, D., Lehmann, J., Kinyangi, J., Liang, B. Q. and Schafer, T. (2005) Carbon K-Edge NEXAFS and FTIR-ATR spectroscopic investigation of organic carbon speciation in soils. *Soil Science Society of America Journal*, **69**, 107–19.
- Sparling, G., Vojvodic-Vukovic, M. and Schipper, L. A. (1998) Hot-water-soluble C as a simple measure of labile soil organic matter: the relationship with microbial biomass C. *Soil Biology and Biochemistry*, **30**, 1469–72.
- Sprengel, C. (1837) *Die Bodenkunde oder die Lehre vom Boden*. Leipzig.
- Stemmer, M., von Lützw, M., Kandeler, E., Pichlmayer, F. and Gerzabek, M. H. (1999) The effect of maize straw placement on mineralization of C and N in soil particle size fractions. *European Journal of Soil Science*, **50**, 73–85.
- Stevenson, F. J. (1994) *Humus Chemistry: Genesis, Composition, Reactions*. 2nd edn. New York: John Wiley & Sons.
- Sutton, R. and Sposito, G. (2005) Molecular structure in soil humic substances: the new view. *Environmental Science and Technology*, **39**, 9009–15.
- Swanston, C. W., Caldwell, B. A., Homann, P. S., Ganio, L. and Sollins, P. (2002) Carbon dynamics during a long-term incubation of separate and recombined density fractions from seven forest soils. *Soil Biology and Biochemistry*, **34**, 1121–30.
- Swift, R. S. (1996) Organic matter characterization. In *Methods of Soil Analysis: Part III. Chemical Methods*, ed. D. L. Sparks, A. L. Page, P. A. Helmke *et al.* Madison, WI: Soil Science Society of America, pp. 1011–69.
- Terhoeven-Urselmans, T., Michel, K., Helfrich, M., Flessa, H. and Ludwig, B. (2006) Near-infrared spectroscopy can predict the composition of organic matter in soil and litter. *Journal of Plant Nutrition and Soil Science*, **169**, 168–74.
- Theng, B. K. G. (1976) Interactions between montmorillonite and fulvic acid. *Geoderma*, **15**, 243–51.
- Theng, B. K. G., Tate, K. R. and Beckerheidmann, P. (1992) Towards establishing the age, location, and identity of the inert soil organic-matter of a Spodosol. *Zeitschrift für Pflanzenernährung und Bodenkunde*, **155**, 181–4.

- Tiessen, H., Cuevas, E. and Chacon, P. (1994) The role of soil organic-matter in sustaining soil fertility. *Nature*, **371**, 783–5.
- Tirol-Padre, A. and Ladha, J. K. (2004) Assessing the reliability of permanganate-oxidizable carbon as an index of soil labile carbon. *Soil Science Society of America Journal*, **68**, 969–78.
- Tisdall, J. M. and Oades, J. M. (1982) Organic-matter and water-stable aggregates in soils. *Journal of Soil Science*, **33**, 141–63.
- Torn, M. S., Trumbore, S. E., Chadwick, O. A., Vitousek, P. M. and Hendricks, D. M. (1997) Mineral control of soil organic carbon storage and turnover. *Nature*, **389**, 170–3.
- Treonis, A. M., Ostle, N. J., Stott, A. W. *et al.* (2004) Identification of groups of metabolically-active rhizosphere microorganisms by stable isotope probing of PLFAs. *Soil Biology and Biochemistry*, **36**, 533–7.
- Trumbore, S. (2000) Age of soil organic matter and soil respiration: radiocarbon constraints on belowground C dynamics. *Ecological Applications*, **10**, 399–411.
- Trumbore, S. E. (1993) Comparison of carbon dynamics in tropical and temperate soils using radiocarbon measurements. *Global Biogeochemical Cycles*, **7**, 275–90.
- Turchenek, L. W. and Oades, J. M. (1979) Fractionation of organo-mineral complexes by sedimentation and density techniques. *Geoderma*, **21**, 311–43.
- Turrión, M. B., Glaser, B. and Zech, W. (2002) Effects of deforestation on contents and distribution of amino sugars within particle-size fractions of mountain soils. *Biology and Fertility of Soils*, **35**, 49–53.
- Vagen, T. G., Shepherd, K. D. and Walsh, M. G. (2006) Sensing landscape level change in soil fertility following deforestation and conversion in the highlands of Madagascar using Vis-NIR spectroscopy. *Geoderma*, **133**, 281–94.
- VanBergen, P. F., Bull, I. D., Poulton, P. R. and Evershed, R. P. (1997) Organic geochemical studies of soils from the Rothamsted Classical Experiment – I. Total lipid extracts, solvent insoluble residues and humic acids from Broadbalk Wilderness. *Organic Geochemistry*, **26**, 117–35.
- von Lützow, M., Kögel-Knabner, I., Ekschmitt, K. *et al.* (2006) Stabilization of organic matter in temperate soils: mechanisms and their relevance under different soil conditions – a review. *European Journal of Soil Science*, **57**, 426–45.
- von Lützow, M., Kögel-Knabner, I., Ekschmitt, K. *et al.* (2007) SOM fractionation methods: relevance to functional pools and to stabilization mechanisms. *Soil Biology and Biochemistry*, **39**, 2183–207.
- Waldrop, M. P. and Firestone, M. K. (2004) Altered utilization patterns of young and old soil C by microorganisms caused by temperature shifts and N additions. *Biogeochemistry*, **67**, 235–48.
- Wang, Y., Amundson, R. and Trumbore, S. (1996) Radiocarbon dating of soil organic matter. *Quaternary Research*, **45**, 282–8.
- Wattel-Koekkoek, E. J. W., Buurman, P., Van Der Plicht, J., Wattel, E. and van Breemen, N. (2003) Mean residence time of soil organic matter associated with kaolinite and smectite. *European Journal of Soil Science*, **54**, 269–78.
- Wershaw, R. L. (1999) Molecular aggregation of humic substances. *Soil Science*, **164**, 803–13.
- Whalen, J. K., Bottomley, P. J. and Myrold, D. D. (2000) Carbon and nitrogen mineralization from light- and heavy-fraction additions to soil. *Soil Biology and Biochemistry*, **32**, 1345–52.
- Wiesenberg, G. L. B., Schwarzbauer, J., Schmidt, M. W. I. and Schwark, L. (2004a) Source and turnover of organic matter in agricultural soils derived from n-alkane/n-carboxylic acid compositions and C-isotope signatures. *Organic Geochemistry*, **35**, 1371–93.
- Wiesenberg, G. L. B., Schwark, L. and Schmidt, M. W. I. (2004b) Improved automated extraction and separation procedure for soil lipid analyses. *European Journal of Soil Science*, **55**, 349–56.
- Williams, M. A., Myrold, D. D. and Bottomley, P. J. (2006) Carbon flow from ¹³C-labeled straw and root residues into the phospholipid fatty acids of a soil microbial community under field conditions. *Soil Biology and Biochemistry*, **38**, 759–68.
- Wilson, M. A. (1987) *NMR Techniques and Applications in Geochemistry and Soil Chemistry*. Oxford: Pergamon Press.
- Zak, D. R., Blackwood, C. B. and Waldrop, M. P. (2006) A molecular dawn for biogeochemistry. *Trends in Ecology and Evolution*, **21**, 288–95.
- Zelles, L. (1999) Fatty acid patterns of phospholipids and lipopolysaccharides in the characterisation of microbial communities in soil: a review. *Biology and Fertility of Soils*, **29**, 111–29.

- Zhang, X. D. and Amelung, W. (1996) Gas chromatographic determination of muramic acid, glucosamine, mannosamine, and galactosamine in soils. *Soil Biology and Biochemistry*, **28**, 1201–6.
- Zhang, X. D., Amelung, W., Ying, Y. A. and Zech, W. (1998) Amino sugar signature of particle-size fractions in soils of the native prairie as affected by climate. *Soil Science*, **163**, 220–9.
- Zimmermann, M., Leifeld, J., Abiven, S., Schmidt, M. W. I. and Fuhrer, J. (2007a) Sodium hypochlorite separates an older soil organic matter fraction than acid hydrolysis. *Geoderma*, **139**, 171–9.
- Zimmermann, M., Leifeld, J. and Fuhrer, J. (2007b) Quantifying soil organic carbon fractions by infrared-spectroscopy. *Soil Biology and Biochemistry*, **39**, 224–31.
- Zotarelli, L., Alves, B. J. R., Urquiaga, S. *et al.* (2005) Impact of tillage and crop rotation on aggregate-associated carbon in two Oxisols. *Soil Science Society of America Journal*, **69**, 482–91.

7 • Respiration from roots and the mycorrhizosphere

Fernando E. Moyano, Owen K. Atkin, Michael Bahn, Dan Bruhn, Andrew J. Burton, Andreas Heinemeyer, Werner L. Kutsch and Gerhard Wieser

7.1 INTRODUCTION

The largest flux in the global carbon cycle is the uptake of CO₂ by plants as photosynthesis. Estimates of gross primary production (GPP), or total amount of CO₂ assimilated by terrestrial plants, range between about 109 and 120 Pg C per year at the global scale (Schlesinger, 1997; Zhao *et al.*, 2005). Except for carbon that remains stored in passive organic matter pools, as fossil fuel, and an estimated 0.2 Pg C per year sedimenting on the ocean floors, assimilated carbon is eventually returned to the atmosphere by respiration, either by plants or by heterotrophic organisms. The time between the fixation of a carbon atom by the plant and its conversion back to CO₂ is extremely variable, ranging between a few hours and thousands of years. How long it remains part of organic compounds will depend on its turnover within the plant and, eventually, as part of soil organic matter.

Carbon assimilated by plants is translocated to plant organs where it can be used as building material for structural biomass, for storage or as substrate for respiration. Carbon imported into roots can also be exuded or transferred to symbionts such as mycorrhizal fungi (Farrar, 1999). The amount of assimilated carbon used for each purpose will depend on the plant's requirements, which are further determined by plant and environmental factors. Different studies on a number of plant species have shown the amount of carbon respired to be, on average, 50% of the carbon assimilated through photosynthesis per unit time, with numbers ranging between 35% and 80% (Lambers, 1985; Amthor, 2000a). Other studies have shown that, on average, nearly half of the carbohydrates from photosynthesis are translocated to roots where around 40% of this carbon is used for respiration (Lambers, 1987; Farrar and Williams, 1990). However, these proportions can vary. Amounts of carbon respired by roots

have been seen to range between 8% and 52% of total fixed CO₂ (Lambers *et al.*, 1996; Atkin *et al.*, 2000a). Carbon exported to underground plant organs and respired in the soil environment – either by the plant itself or by other organisms – contributes to soil respiration. The factors controlling the respiration of this root-derived carbon and the techniques for measuring these respiration processes are the focus of this chapter.

Part of the carbon allocated below-ground is not utilized for biosynthesis or as substrate for respiration by the plant, but is used by organisms associated with plant roots in the rhizosphere and the mycorrhizosphere. The *rhizosphere* is usually defined as the region of soil influenced by the root system, i.e. where the microbial population is affected by nutrient uptake and release of compounds by the root (Russell, 1982; Paul and Clark, 1989). This region of influence is typically some millimetres to centimetres wide, with boundaries that can change depending on root structure, presence of root hairs, and soil and plant-microbe characteristics. The release of exudates, secretions and root residues (e.g. sloughed-off cells and fine roots) by the root into the rhizosphere soil is known as *rhizodeposition* (Kuzyakov and Domanski, 2000; Nguyen, 2003). Rhizodeposition results in a very high concentration of micro-organisms in the rhizosphere as compared to the soil not directly influenced by the root (Grayston *et al.*, 1997). The *mycorrhizosphere* includes the mycorrhizal hyphal system and its zone of influence, reaching parts of the litter layer and very fine soil pores inaccessible to roots. As a result, it extends much further into the soil than the rhizosphere.

Respiration from plant roots and associated micro-organisms comprise major sources leading to CO₂ efflux from soils. Root respiration was early recognized as an important fraction of soil CO₂ efflux that

in some cases amounts to more than the fraction of CO_2 produced by decomposition of soil organic matter. Wiant (1967) defined *root respiration* as ‘all soil respiration derived from organic compounds originating from plants including the respiration of living root tissue, the respiration of symbiotic mycorrhizal fungi and associated microorganisms, and the decomposer organisms operating on root exudates and recent dead root tissue in the rhizosphere’. This broad definition results from the fact that the mentioned components are all linked to the direct supply of carbohydrates from the plant through its roots, as opposed to respiration coming from decomposition of soil organic matter in litter and bulk soil.

Although widely used as defined by Wiant (1967), the term *root respiration* is now often used in a more strict sense, referring only to the respiration of the live root tissue. The terms *autotrophic soil respiration* and *assimilate fed soil respiration* have been used to include all respiration of roots and root-derived compounds, although they are often not strictly defined and can lead to confusion. Additional terms describing processes included in Wiant’s definition, among others, are *rhizomicrobial respiration*, *rhizosphere respiration*, *mycorrhizal respiration* and *mycorrhizosphere respiration*. These terms are sometimes used differently by different authors. For example, *rhizomicrobial respiration* is defined by Dilly *et al.* (2000) and Kutsch *et al.* (2001a) as respiration of both roots and associated micro-organisms, while for Kuzyakov and Cheng (2001) and Nguyen (2003) the term only includes respiration of the latter. One should also be cautious with the terms *soil autotrophic* and *root respiration*, which in the literature have been widely used without distinguishing between respiration by roots alone and respiration by associated micro-organisms. To avoid confusion and on logical grounds, *soil autotrophic respiration* should refer strictly to respiration from plants (i.e. roots). The following are the definitions that we think are more useful and that will be used throughout this chapter (Fig. 7.1):

- **Root respiration:** respiration of the living root tissue (i.e. excluding symbionts such as mycorrhizal hyphae).
- **Rhizomicrobial respiration:** respiration of rhizodeposits and plant assimilate supplies by micro-organisms in the rhizosphere, not including mycorrhiza.

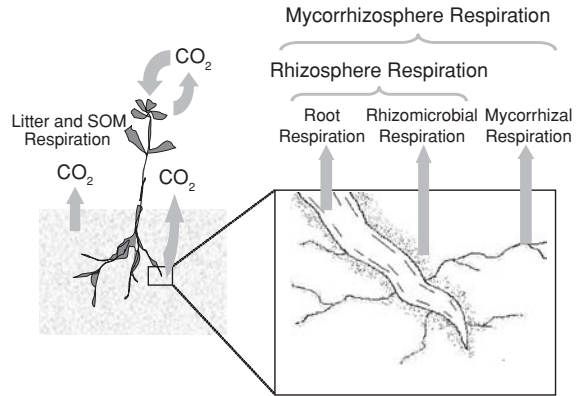

Figure 7.1 Diagram showing the sources of root-derived carbon respiration – respiration from the living root tissue, respiration of rhizodeposits by micro-organisms in the rhizosphere and respiration from mycorrhizal hyphae – and their grouping into rhizosphere and mycorrhizosphere respiration. Litter and soil organic matter (SOM) respiration are the carbon fluxes not deriving from live roots.

- **Rhizosphere respiration:** root plus rhizomicrobial respiration.
- **Mycorrhizal respiration:** respiration of mycorrhizal fungi (i.e. including carbohydrates derived from plant roots).
- **Mycorrhizosphere respiration:** rhizosphere plus mycorrhizal respiration.

In the following section, we will start with general aspects of root/mycorrhizosphere respiration and continue with the most important factors affecting it. In Section 7.3 we will discuss methods used for measuring root/mycorrhizosphere respiration in the field and the laboratory, along with methods for determining temperature response and acclimation of root respiration. Section 7.4 presents methods for determining root biomass and turnover as well as other means for estimating root/mycorrhizosphere respiration at the ecosystem scale. Concluding remarks are given in Section 7.5.

7.2 ROOT AND MYCORRHIZOSPHERE RESPIRATION

7.2.1 Eco-physiology of root respiration

Respiration is the major loss of carbon in roots where it is required for a number of processes, including synthesis of biomass, translocation of photosynthates, uptake of ions from the soil, assimilation of N

(including N_2 -fixation) and S into organic compounds, protein turnover and cellular ion-gradient maintenance (Amthor, 2000a). Respiration can also be a result of so-called wastage processes (e.g. futile cycles and mitochondrial electron transport uncoupled from oxidative phosphorylation) that only result in CO_2 and heat production. In the short term, and as a consequence of the mentioned processes, respiration is regulated by the availability of adenosine diphosphate (ADP) and nicotinamide adenine dinucleotide phosphate (NADP), so that it responds to the demand for respiratory energy. Theoretical models are used to explain relations between respiration and underlying processes (Amthor, 2000a). A simplified approach is to divide respiration into growth and maintenance processes, a distinction that can be useful for understanding factors controlling respiration (Sprugel and Benecke, 1991; Amthor, 1994; Sprugel *et al.*, 1995). *Growth respiration* is defined as the carbon costs of newly constructed tissue. The cost of producing a certain amount of new tissue (gram C respired per gram C of newly produced tissue) is unaffected by temperature (Penning de Vries *et al.*, 1974). *Maintenance respiration* by contrast is the basal cost for maintaining established tissue (gram C respired per gram tissue C within a certain time) and is highly sensitive to temperature, as well as being positively related to plant N content (de Wit *et al.*, 1970).

In relation to the total amount respired by living plants, the respiration of root-derived carbon can range between 8% and 52% of the CO_2 fixed by photosynthesis, while most estimates give values of around 20% (Lambers *et al.*, 1996; Atkin *et al.*, 2000a). This relationship will depend on many factors including plant species, age and presence of mycorrhiza.

7.2.2 Regulation of root respiration by plant and environmental factors

Many environmental, abiotic and biotic, as well as physio-morphological factors are involved in determining the short- and long-term rates of mycorrhizosphere respiration. The most relevant factors are listed in this section with a summary of their effects on root respiration. Both diurnal and seasonal changes may be potentially related, among others, to changes in temperature, soil moisture, nutrient demand/supply, assimilate supply and plant phenology. These factors can likewise be important for mycorrhizal and rhizomicrobial

respiration. Unfortunately, studies measuring the specific response of rhizomicrobial respiration are lacking, and those focusing on the mycorrhizal component are few and will be discussed separately in Section 7.2.3.2. It should be noted, however, that although the present section deals with the response of root respiration, many of the cited studies may have included, at least partially, the rhizomicrobial and mycorrhizal components.

7.2.2.1 Temperature

Temperature is very often a limiting factor for root activity especially in the temperate and cold climates, accounting for much of the seasonal variation in root respiration (Fig. 7.2). In general, CO_2 efflux is reduced

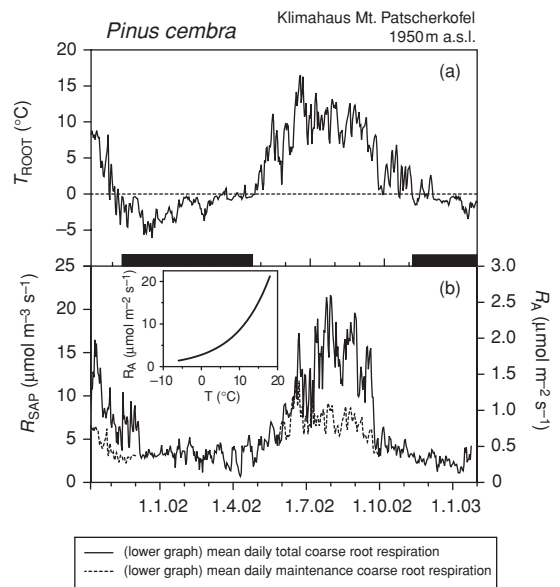

Figure 7.2 Seasonal course of mean daily root cambium temperature (T_{ROOT}) in upper graph (a) and the corresponding mean daily total (solid line) and maintenance (dotted line) coarse root respiration per unit sapwood volume (R_{SAP}) and per unit root surface area (R_A) in the lower graph (b) of an adult *Pinus cembra* tree at Mt. Patscherkofel, Austria during the period 7 October 2001 to 21 January 2003. Total coarse root respiration was obtained from continuous measurements of an automated gas exchange system. Solid bars indicate the period of winter snow cover (\approx dormant period). The inner panel shows the temperature response of maintenance respiration (R_m) obtained from measurements conducted during the dormant season (temperature range -6 to 2.5°C ; $R_m = 2.81 \exp[\ln 3.10(T/10)]$; $r^2 = 0.72$) extrapolated for the obtained annual temperature range (modified after Wieser and Bahn, 2004).

to the level of maintenance respiration during winter (Linder and Troeng, 1981; Benecke, 1985; Wieser and Bahn, 2004) and is highest during the growing season as a result of cell growth and higher temperatures increasing maintenance costs (Fig. 7.2). Temperature changes result in an immediate change in respiration rates by a direct effect on enzyme activity and can also affect respiration by influencing other factors such as water availability and movement of nutrients. High temperatures – typically above 50 °C – can lead to disintegration of enzyme complexes, structural injury or cell death, thus lowering respiration rates (Palta and Nobel, 1989a). In the longer term, plant thermal acclimation (see below) can play an important role in the temperature–respiration relationship.

The short-term temperature sensitivity of root respiration (typically determined on a diurnal scale) depends on the occurring temperature range (Atkin *et al.*, 2000a; Tjoelker *et al.*, 2001; Atkin *et al.*, 2005a), and often, at least partially, on the prevailing temperature of the previous days. Q_{10} values of plant respiration (see Kutsch *et al.*, Chapter 1, Section 1.4.5 for definition) are often close to 2, but temperature sensitivity varies considerably between and within plant species (Atkin *et al.*, 2000a) and Q_{10} values for fine roots tend to be slightly higher than 2 (Burton *et al.*, 2002).

When comparing published root Q_{10} values, it is important to consider the different growth conditions and range of measurement temperatures used in the different studies. Moreover, the nature of the tissue used in different studies must be taken into account. In most studies, measurements of respiration in roots are made using whole root systems (e.g. Smakman and Hofstra, 1982; Bouma *et al.*, 1997; Covey-Crump *et al.*, 2002; Loveys *et al.*, 2003) or root segments of differing age/function (e.g. Higgins and Spomer, 1976; Crawford and Palin, 1981; Sowell and Spomer, 1986; Weger and Guy, 1991; Zogg *et al.*, 1996; Pregitzer *et al.*, 1997, 1998; Burton *et al.*, 2002). In whole root systems, the estimates of Q_{10} will depend on the proportion of immature and mature roots and the Q_{10} of each developmental stage. Q_{10} values of 1.5 for coarse woody roots and 2.0 for fine roots (< 2 mm diameter) were reported in a *Pinus radiata* stand (Ryan *et al.*, 1996). Comparisons of root Q_{10} values should ideally be made on tissues of defined developmental age.

The Q_{10} of plant respiration has been shown to change in response to different growth temperatures

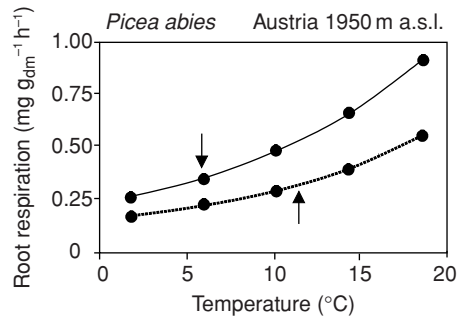

Figure 7.3 The relationship between temperature and root respiration of Norway spruce (*Picea abies*) seedlings grown at 1950 m (dotted line) and 630 m (full line) above sea level. Measurements were made in laboratory conditions using excavated roots detached from the trees. Note that when measured at the prevailing temperature of each site, as indicated by arrows, no significant difference in respiration was detected (redrawn after data from Framba, 1980).

(Tjoelker *et al.*, 1999; Atkin *et al.*, 2000a; Loveys *et al.*, 2003; Atkin *et al.*, 2005a), an effect called thermal acclimation. *Thermal acclimation* of respiration is commonly defined as a change in the shape of the short-term temperature–response curve of respiratory CO₂ release and/or O₂ uptake, in response to a change in growth temperature. Acclimation can be caused by short-term temperature changes, i.e. a few days, or long-term temperature changes. In the latter case, thermal acclimation occurs more commonly in new tissues produced following a change in the temperature regime, and thus a greater degree of acclimation might be expected in plants with rapid rates of root replacement rather than those with long-lived fine roots (Atkin and Tjoelker, 2003).

A study on Norway spruce in a high and a low elevation site in the central Austrian Alps has shown that at the same measurement temperature respiratory CO₂ losses of roots are higher in trees from cold climates than in trees from warm climates. However, when root respiration is compared at its actual thermal site conditions (an ecological context) roots from colder high-elevation sites did not exhibit a higher respiration rate when compared to the warmer low-elevation sites (Fig. 7.3). This would indicate the effects of acclimation, although genetic variation along elevational ecotypes may also contribute to the observed differences.

Temperature response, the use of Q_{10} and acclimation will be discussed further in Sections 7.3.4 and 7.3.5.

7.2.2.2 Moisture

Soil moisture can become a limiting factor for root respiration in arid environments but also in wetlands and humid temperate zones, especially in summer months in the top organic layers. Soil water potential in the rhizosphere, as determined by water content and soil physical properties, has an influence on the growth and functioning of the root. Various studies relating soil respiration to soil water content show that the optimum for soil respiration is normally found at intermediate values of water content (Davidson *et al.*, 2000). This is true for both autotrophic and heterotrophic respiration, although the response to water stress of roots may be different from that of soil microbes. The availability of soluble soil substrates as a function of water content is of less importance to roots than for soil microbes. Further, roots may have adaptations to resist water stress, such as extracting water from deeper soil horizons.

Root respiration is reduced during drought (Bryla *et al.*, 1997; Burton *et al.*, 1998), the effect being more pronounced in warmer than in cooler soils (Bryla *et al.*, 2001). A result of soil drying is reduced root water content, with a subsequent reduction in root cell turgor pressure. Since turgor pressure is necessary for growth, this will lead to a reduction of metabolic activity and respiration rates. Soil drying can at some point lead to cell death and subsequent root respiration reductions. Resistance to drought varies among species and even among different roots from the same individual (Palta and Nobel, 1989b). On the other hand, excess water in soils also will reduce root growth and function, mainly by decreasing the availability of oxygen.

Apparently no data are available on the effects of soil moisture on the respiration of large coarse roots of field-grown trees, although there is evidence that at low soil water availability coarse root respiration declines as shown for excised *Pinus taeda* roots by Maier and Kress (2000).

7.2.2.3 Nutrients

Plant available mineral nutrients as well as nutrient content in plant tissues influence root respiration. Plants grown at a high supply of nutrients have higher specific root respiration rates than plants grown at lower

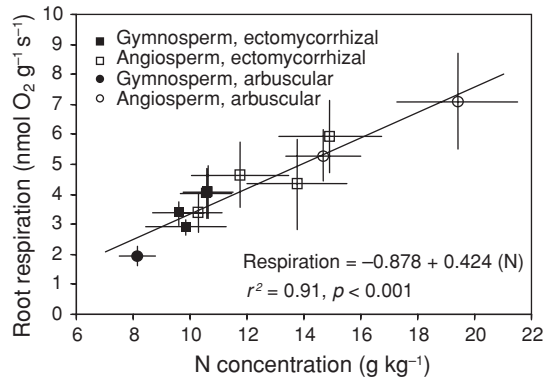

Figure 7.4 Relationship between fine root N concentration and fine root respiration at 18 °C for species from ten North American forest types. Error bars indicate one standard error of the mean (Burton *et al.*, 2002).

nutrient supplies (Lambers *et al.*, 1981; Kuiper, 1983). Additionally, root respiration at a reference temperature may be higher during periods of high nutrient demand, e.g. in late spring/early summer when the vegetation grows fast (Bahn *et al.*, 2006). Poorter *et al.* (1995) report that specific root respiration decreases with decreasing nitrate supply, which may vary from day to day, but especially on a seasonal scale. These relationships are presumably explained by differences in the rates of ion uptake. Higher uptake rates mean higher costs, resulting in higher respiration rates. On the other hand, increased nutrient availability can lead in the longer term to decreases in fine root biomass, with a resulting decrease in carbon allocation to fine root and respiration (Keyes and Grier, 1981).

Nitrogen content in plant tissues also correlates with respiration rates. Ryan *et al.* (1996) and Burton *et al.* (2002) found strong correlations between fine root N content and respiration rates (Fig. 7.4). Given that most nitrogen in plant cells is in protein, which needs replacement and repair and is closely linked to cell activity, the increase in respiration with higher N content is largely due to an increase in maintenance respiration.

7.2.2.4 Insolation and carbohydrate supply

Carbohydrates required for root respiration are provided by the import of newly assimilated carbon, by the use of carbon stored in the plant or even by uptake of organic molecules from the soil (Lambers, 1987; Farrar and Williams, 1990). Effects of changes in assimilate

supply on root respiration vary with plant age and between species, with some plants being more and others less constrained (Gunn and Farrar, 1999). Root metabolism can be closely related to the transport of carbohydrates from the shoots to the roots or buffered by storage, as shown in a study by Farrar (1999), where roots maintained their respiration rate for several days after plants were kept in the dark, losing their metabolic capacity only after six days. Respiration rates in source leaves, on the other hand, fell below normal rates within one to two days of darkening.

Newly assimilated carbon can reach roots and be respired in short periods of time. Even though plant respiration is well correlated with daytime photosynthesis and with tissue concentrations of soluble carbohydrates for plants in the laboratory (Amthor, 1994; Lambers *et al.*, 1996), this relationship is dependent on the vegetation type under field conditions (Atkin *et al.*, 2000b; McCutchan and Monson, 2001; Vose and Ryan, 2002). By relating eddy covariance data with partitioned soil respiration, Moyano *et al.* (2008) found lag times of four and five days (depending on the forest type) between carbon assimilation and its maximum effect on rhizosphere respiration. In a field study using ^{14}C in poplar trees, Horwath *et al.* (1994) calculated a delay of two days for the respiration of newly fixed carbon to peak in the mycorrhizosphere. Similarly, Ekblad and Högberg (2001) calculated a delay of one to four days and determined a 65% contribution of new photosynthates to total soil respiration by using ^{13}C measurements in a boreal coniferous forest, whereas Kuzyakov and Cheng (2001, 2004) observed diurnal dynamics of CO_2 soil efflux responding to photosynthetic activity in wheat and maize plants.

Insolation can be an important factor explaining respiration rates in smaller plants, such as grasses and tree seedlings (Fitter *et al.*, 1998; Lipp and Andersen, 2003), whose roots cannot utilize large stored carbon reserves, such as those available in large woody plants (Phillips and Fahey, 2005). In *Picea abies* and *Pinus cembra* seedlings, root respiration was highest when shoots were illuminated (Eccher, 1972; Framba, 1980), strongly suggesting that root respiration activity is directly dependent on the supply of photosynthates from the foliage (Amthor, 1994). Some studies have shown cumulative radiation flux of the previous days being positively related to root respiration rates in grasslands (Fitter *et al.*, 1998), while others observed

negative (Edwards *et al.*, 2004) or no consistent relationships (Bahn *et al.*, 2006). Thus, insolation, as a measure of carbohydrate supply, can be a short-term factor regulating root respiration, with effects depending on the plant's carbon storage and demands.

7.2.2.5 Soil and atmospheric CO_2 concentrations

Below-ground tissues (e.g. roots and tubers) are often exposed to a CO_2 concentration ($[\text{CO}_2]$) far higher than that found in the atmosphere, with values ranging between a few hundred to more than ten thousand $\mu\text{mol mol}^{-1}$ and generally increasing with soil depth (Cramer and Richards, 1999; Sands *et al.*, 2000). Direct inhibition of respiration by high $[\text{CO}_2]$ has been reported in roots of some species (Qi *et al.*, 1994; Burton *et al.*, 1997; van der Westhuizen and Cramer, 1998; McDowell *et al.*, 1999), while other studies have found little or no inhibition of root respiration by elevated soil $[\text{CO}_2]$ (Bouma *et al.*, 1997; Burton *et al.*, 2002). Acclimation of below-ground tissue may be expected to occur to much higher $[\text{CO}_2]$ than that of leaves; however, the fluctuations of soil $[\text{CO}_2]$ through the growing season may be high (Sands *et al.*, 2000) as well as those within days (Bouma and Bryla, 2000). Moreover, the mechanisms by which significant inhibition might occur have not been elucidated (González-Meler and Siedow, 1999). It has been noticed that artefacts in measurements such as leakage problems and gas analyzer cross-sensitivity to water vapour can lead to false results in respiration rates (Burton *et al.*, 2002). Thus, many of the previous reports of large effects of soil $[\text{CO}_2]$ on plant tissue respiration may be a result of such artefacts (Amthor, 2000b).

Contrary to below-ground $[\text{CO}_2]$, elevated atmospheric $[\text{CO}_2]$ can have a positive effect on root respiration by stimulating photosynthesis and reducing water requirements (Pendall *et al.*, 2004). In addition, higher atmospheric $[\text{CO}_2]$ have been seen to increase fine root biomass and to decrease their N content (Zak *et al.*, 2000). Atmospheric CO_2 concentrations can therefore affect root respiration through a number of factors, generally having a net positive effect that will depend on the plant species and stage of development (King *et al.*, 2004).

7.2.2.6 Root morphology and plant age

Fine roots, as opposed to *coarse roots*, are generally defined as all roots having a diameter of less than 2 mm

(some definitions set limits of 5 mm or higher). Fine roots are metabolically more active and present higher specific respiration and turnover rates than coarse roots. Specific root respiration and its Q_{10} decrease with increasing root diameter (Ryan *et al.*, 1996; Pregitzer *et al.*, 1998; Bahn *et al.*, 2006), decreasing specific root length (Tjoelker *et al.*, 2005) or the ratio of long to fine roots (Kutsch *et al.*, 2001a). Such effects may be partly related to a decrease in N concentration (Ryan *et al.*, 1996; Pregitzer *et al.*, 1998; Bahn *et al.*, 2006) and an increase in tissue and plant age (Palta and Nobel, 1989b; George *et al.*, 2003; Volder *et al.*, 2005).

Seasonal changes in ecosystem root respiration are strongly influenced by changes in root biomass (Bahn *et al.*, 2006). Also, the proportion of roots of different diameter may vary in the course of the season and thus affect ecosystem root respiration. Within a plant or species, young fine roots have been noted to have much higher respiration rates than older roots, presumably due to higher growth respiration and their primary role for nutrient absorption (Bouma *et al.*, 2001; Fahey and Yavitt, 2005).

Plant development affects root respiratory activity and as trees become older carbon allocation patterns will change, and thus will be reflected in the respiratory demand of tissues. For example, Framba (1980) found that in both *Picea abies* and *Pinus cembra* specific root respiration rates of 4-year-old seedlings were higher than in 22-year-old trees.

7.2.3 Rhizomicrobial and mycorrhizal respiration

7.2.3.1 Rhizomicrobial respiration

The rhizosphere is an environment that differs largely from the surrounding soil. Differences can be seen in the amounts of microbes, inorganic ions and organic material, as well as in pH values and concentrations of oxygen and CO₂ (Lambers *et al.*, 1991). It is also a dynamic environment, influenced by the amounts and quality of rhizodeposits and soil characteristics. Reviews on rhizodeposition and rhizosphere carbon dynamics are given by Grayston *et al.* (1997), Kuzyakov and Domanski (2000), Toal *et al.* (2000) and Nguyen (2003). Even though rhizodeposits represent a loss of reduced carbon, the plant benefits from higher nutrient availability resulting from the increased biological activity around the root. Uren (2000) suggests that the amount of root

exudates produced varies with plant species, plant age, substrate and stress factors. Between 5% and 21% of plant photosynthate was seen to be released as root exudates in studies with cereal (Haller and Stolp, 1985; Flores *et al.*, 1996).

Isotope methods have been used for estimating carbon fluxes originating from rhizomicrobial respiration. Results from a number of studies differ largely, with estimates of rhizomicrobial respiration ranging from 5% to 60% of rhizosphere respiration (Kuzyakov and Domanski, 2000). Kuzyakov (2002) compared the *isotope dilution method* (Cheng *et al.*, 1993), the *model rhizodeposition method* (Swinnen, 1994), the *¹⁴CO₂ dynamics method* (Kuzyakov *et al.*, 1999) and the *exudates elution method* (Kuzyakov and Siniakina, 2001) by applying each under the same experimental conditions, and concluded that rhizomicrobial respiration represents between 50% and 60% of rhizosphere respiration in *Lolium perenne*. These methods combine the use of isotopes with pulse labelling, sampling of respired CO₂, elusion of exudates and modelling of carbon dynamics. Although the use of isotopes seems to be a promising path for studying microbes in the rhizosphere, uncertainties for these methods remain large (results ranging from approx. 40% to 80%) and developments in rhizosphere respiration partitioning are still needed (Werth and Kuzyakov, 2005).

Rising concentrations of atmospheric CO₂ are expected to increase rhizomicrobial respiration in response to enhanced rhizodeposition (Paterson *et al.*, 1997; Zak *et al.*, 2000). These changes in microbial activity in the rhizosphere could in turn affect plant growth or have a priming effect on the decomposition of soil organic matter (Pendall *et al.*, 2004).

7.2.3.2 Mycorrhizal respiration

Mycorrhizae are root–fungal systems where plant and fungus exchange carbon for nutrients, respectively, through extensive physical connections. Although mycorrhizae include roots as well as the fungal partner, the term *mycorrhizal respiration* refers henceforth by convention only to the fungal respiration component, in particular the external hyphae.

Mycorrhizal fungi grow both inside roots and in the soil as a potentially far-reaching extra-radical mycelium (ERM). Given the close relationship with roots (functionally they are basically an extension of the root system itself) and the difficulty involved in isolating the fungal

mycelium, it is not surprising that the fungal component has been usually ignored or treated as an extension of the plant root when looking at sources of respired carbon. In part, this is a result of the methods used, most of which cannot distinguish between them. However, the importance of the mycorrhizal mycelium as a source of respiration depending on plant substrates was already observed over two decades ago (Kucey and Paul, 1982; Soderstrom and Read, 1987; Paul and Clark, 1989). It is thus surprising that most reviews on carbon flux from roots to the soil (see references in the previous section) have failed to recognize the importance of mycorrhizal fungi.

There is more than one reason to study the flow of carbon through mycorrhizal fungi, and in particular the ERM, separately from roots:

1. Ectomycorrhizal mycelia can reach 8000 m per metre length of root (Leake *et al.*, 2004), and make up one third of soil microbial biomass in coniferous forests (Högberg and Högberg, 2002).
2. A large fraction of the carbon translocated below ground is allocated to the ERM. Estimates range between 2% and 20% for arbuscular mycorrhizae (AM) and between 7% and 30% for ectomycorrhizae (EM) (Leake *et al.*, 2004). Much of this is respired by the ERM itself, but another large part (e.g. cell wall components such as chitin and glomalin) might enter recalcitrant soil organic matter (Staddon, 2005; Godbold *et al.*, 2006).
3. The mycorrhizal status can up-regulate net photosynthesis rates (Smith and Read, 1997), consequently increasing the amount of carbon exported to the root system.
4. Further, the response of mycorrhizal fungi and roots to environmental factors may differ. Although mycorrhizal carbon flux can be expected to be a major contributor to soil respiration, surprisingly little is known of how it responds to environmental changes.

Difficulties in separating root from mycorrhizal respiration have resulted in mycorrhizal fungi being included in the autotrophic flux component. Consequently, root respiration *sensu stricto* has been overestimated (Pendall *et al.*, 2004). On the other hand, the ignored ERM respiration component when using respiration rates of excised (mycorrhizal-deprived) roots, might explain why scaled-up root respiration measurements show low estimates of mycorrhizosphere

respiration when compared to girdling (Högberg *et al.*, 2001) or trenching experiments that include the ERM component (Simard *et al.*, 1997; Högberg *et al.*, 2002).

Ectomycorrhizal fungi seem to be a larger soil respiration component than AM fungi. Phillips and Fahey (2005) estimated around 7% and 12% mycorrhizal respiration for sugar maple (AM) and yellow birch (EM), respectively, and in general it is estimated that up to 20% of net photosynthesis can be allocated to the mycorrhizal mycelium (Smith and Read, 1997). For AM so far only few studies provide fungal ERM respiration: around 1% of net photosynthesis for *Plantago lanceolata* (Heinemeyer *et al.*, 2006), similar to an estimated value of 0.8% given by Jakobsen and Rosendahl (1990), but lower than a 4.8% value for winter barley from Moyano *et al.* (2007).

Until recently not much emphasis has been put on investigating the mycorrhizal response per se, i.e. on a separated mycelium, based on, for example, mesh exclusion (see Section 7.3.2.4). Heinemeyer and Fitter (2004) demonstrated with this technique for AM fungi that, even if the ERM responded positively to temperature, this was due to changes in specific root length of the plant, although only the fungus experienced a temperature treatment. A recent laboratory study by Heinemeyer *et al.* (2006) combined stable isotope pulse labelling ($^{13}\text{CO}_2$) on *Plantago lanceolata* plants with warming of a separated AM mycelium. They found that mean ERM respiration was unaffected by warming the mycelium by $6^\circ\text{C} \pm 3^\circ\text{C}$ but strongly covaried with photosynthetically active radiation (PAR) received during the 12 hours before gas sampling (Fig. 7.5). Such fast carbon turnover was also observed by mesh separation in a grassland site (Johnson *et al.*, 2002a, 2002b). However, ERM growth responded positively to warming and increased by 75% during two weeks of warming.

Heinemeyer *et al.* (2007) used continuous monitoring of soil respiration at mycorrhizal mesh collars (see Section 7.3.2.4) to explicitly determine the rate of EM respiration in the field, its environmental control and contribution to overall soil respiration. Already 38 days after collar insertion in May, the mean respiration rates from the collars with mycorrhizal in-growth had significantly increased ($p < 0.05$) relative to those without mycorrhizal in-growth (1.82 vs. $1.49 \mu\text{mol m}^{-2} \text{s}^{-1}$). These results indicate a rapid colonization of the collars by EMs, supporting published EM mycelia growth rates of up to 10 mm per day (Leake *et al.*, 2004).

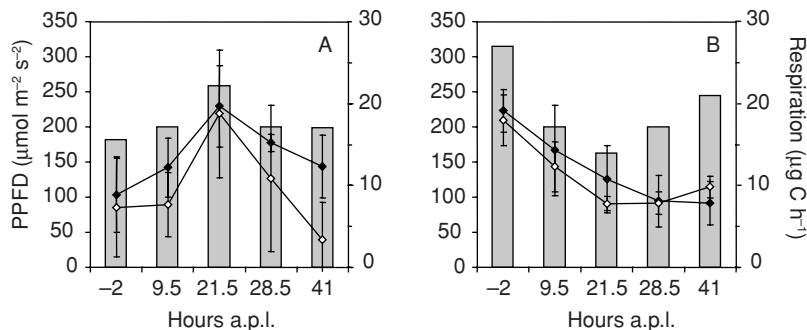

(PPFD: photosynthetic photon flux density)

Figure 7.5 Mean total ERM respiration in ambient (open diamonds) and heated (filled diamonds) fungal compartments (as the difference of mycorrhizal and non-mycorrhizal compartments) for the first (A) and second (B) $^{13}\text{CO}_2$ pulse label during the 41 hours after pulse labelling (a.p.l.) \pm SE (standard error) and corresponding mean PAR (bars) received during a 12 hour period before each measurement. There were no significant differences between temperature treatments for either pulse, however, respiration covaried significantly with PAR: (A) $F_{1,7} = 13.81$, $p = 0.007$; (B) $F_{1,7} = 6.71$, $p = 0.037$ (redrawn from Heinemeyer *et al.*, 2006).

This experiment revealed proportional contributions of $\sim 65\%$ from soil, 25% from EMs and 10% from roots (calculated as a percentage of the mean rate at the shallow collars). This EM flux contribution to total soil respiration is strikingly similar to a laboratory ^{14}C -based estimate of EM hyphal respiration of $\sim 20\%$ by Rygielwicz and Andersen (1994).

Most importantly, despite a strong exponential relationship (Q_{10}) between soil temperature (at 5 cm) and respiration in the collars excluding ($R^2 = 0.88$) or including ($R^2 = 0.68$) EM hyphae, EM respiration (the difference of the latter two) was almost unaffected by soil temperature (Fig. 7.6). This contradicts a recent suggestion that soil and rhizosphere organisms have the same Q_{10} (Bååth and Wallander, 2003).

Diurnal cycles at non-mycorrhizal collars correlated more strongly with soil temperature than mycorrhizal collar replicates (R^2 values: 0.63 and 0.35 respectively), whereas the calculated ERM respiration (difference between treatments) was unaffected by temperature (R^2 value: 0.01). Further, clear differences in the temperature responses during daylight versus night-time hours were observed for mycorrhizal collar respiration and the calculated ERM respiration but not for non-mycorrhizal collar respiration. Consequently, factors other than temperature appear to control this diurnal cycling of ERM respiration. The most likely explanation is a time lag in substrate supply from above-ground photosynthates to the rhizosphere as

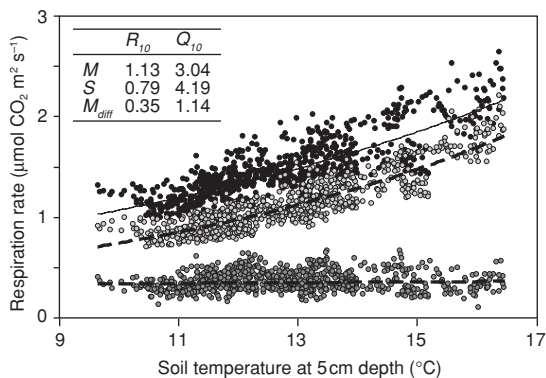

Figure 7.6 Relationship between soil temperature at 5 cm depth and the mean hourly rate of respiration at the mycorrhizal (M , ●) and non-mycorrhizal collars (S , ○) and the difference of both (M_{diff} , ●) during Campaign 2 (9 September to 11 October 2005). Exponential relationships are plotted for each dataset (M —, S — —, M_{diff} - - -) and the Q_{10} and R^2 values displayed for each (Heinemeyer *et al.*, 2007).

suggested for forest ecosystems (Tang *et al.*, 2005; Moyano *et al.*, 2008).

A decline in soil moisture from 25% to 10% during a minor drought decreased the EM contribution to soil respiration considerably from $\sim 25\%$ to $<10\%$ ($p < 0.001$) and increased almost instantaneously with rewetting to $>30\%$ ($p < 0.001$; data not shown).

Finally, a recent meta-analysis demonstrated that EM growth is positively affected by elevated CO_2

(Alberton *et al.*, 2005) and, critically, it was found that the activity of ERM was stimulated more than the overall plant response. The possibility of altered assimilate supply to EM may have major effects on soil biota and below-ground carbon cycling and storage, such as antagonistic interactions between EM and saprophytic fungi (Stark and Kytoviita, 2005) or increased EM respiration (Gorissen and Kuyper, 2000) and the potential for rapid turnover of mycorrhizal carbon (as shown for arbuscular mycorrhiza, Staddon *et al.*, 2003).

These data stress the importance of the mycorrhizal part of soil respiration and encourage investigating the mycorrhizal component further. In particular, in EM systems it may well be the ERM that contributes most of the autotrophic flux component and not the roots.

7.3 MEASURING ROOT AND MYCORRHIZOSPHERE RESPIRATION

In this section we will discuss direct measurements of root respiration, both in the laboratory and in the field, as well as the use of Q_{10} and other approaches for quantifying acclimation. One indirect method, the use of micro meshes, will be described in this chapter. However, other exclusion (*i.e.* trenching) methods for determining respiration rates of mycorrhizosphere components are described in Chapter 8.

7.3.1 General considerations

7.3.1.1 *Field vs. laboratory measurements: which method to use*

A number of difficulties are associated with measuring root respiration and mycorrhizosphere respiration. Disturbances to the plant–soil system as a consequence of the method used will likely change natural respiration rates through changes in factors such as rhizodeposition amounts, CO₂ concentrations, moisture, disruption of fungal hyphae etc. Further, no clear spatial limits between root-derived carbon and soil organic matter respiration sources exist in natural systems. Plant rhizodeposits are respired together with older soil carbon by the same micro-organisms in the mycorrhizosphere. As a consequence, some components of mycorrhizosphere respiration cannot be determined by direct measurements but need to be estimated indirectly.

The choice of method will ultimately depend on the hypotheses to be tested. Laboratory methods are carried out under conditions that differ largely from natural field conditions. It is therefore difficult to make conclusions about field fluxes only from laboratory measurements. On the other hand, one can more easily separate soil components and precisely control factors affecting respiration rates, making laboratory methods a better tool for understanding the influence of individual factors. Laboratory methods allow for the determination of temperature response curves from a wide range of temperatures that can be applied in a relatively short time. Temperature response estimated from measurements in the field can be more problematic due to small diurnal temperature changes, and if done over longer periods, changes in other confounding factors (*e.g.* soil moisture, insolation etc.).

The large number of environmental factors affecting mycorrhizosphere respiration makes field methods less suitable for identifying the influence of individual factors. Next to this, most field methods disturb the natural conditions of the root–soil system to some degree, resulting in changes in the fluxes measured. But field methods have the advantage of giving values that will come closer to ‘real’ field fluxes, and measurements will respond to the normal fluctuations of the surrounding environment.

7.3.1.2 *Expressing respiration rates*

Depending on the purpose of the experiment the investigator needs to consider how to express the measured rates of respiratory gas exchange as a specific root respiration. Simple standardizing and commonly used measures are: root fresh weight, dry weight, root length or ground surface area. However, it is not straightforward to standardize at what water content the fresh weight is to be measured between species and/or experiments. Thus, the mass of dry root is often used as the base at which a specific root respiration is expressed. However, the calculated values of root respiration on a dry weight basis strongly depend on the amount of inert structural tissue in the root material. Therefore, attempts to express root respiration on a metabolical activity basis are made by relating the gas exchange measurements to, for example, the N content, total protein content (Lowry *et al.*, 1951) or fumarate (mitochondrial specific enzyme) activity (Vanemmerik *et al.*, 1992).

7.3.1.3 Measuring root respiration temperature response

To generate a temperature–response curve for root respiration, it is often not practical to measure rates of root respiration using attached, intact roots. However, several investigators have developed cuvettes that enclose roots, and are placed back in the soil for measurements during extended periods of time (Rakonczay *et al.*, 1997; Bryla *et al.*, 2001). More often, either detached whole roots or root pieces are used. Excision effects on root respiration when assessed within 30 minutes after severing of the shoot may be minimal (Lambers *et al.*, 1993). However, a possible increase as a response to wounding should be considered (Bloom and Caldwell, 1988). Repeated measurements of respiration at different temperatures using detached roots do lead to a progressive reduction of respiration at a standard temperature (Loveys *et al.*, 2003) due to substrate limitation. Alternatively, separate roots may be used for each measuring temperature with care taken to control for root order, size and age.

7.3.2 Field methods

Field methods for quantifying root respiration and mycorrhizosphere respiration typically involve either root excision or the use of intact roots that extend into chambers. In both cases, infrared gas analyzers (IRGAs) are normally used to measure an increase in CO₂ concentration due to respiration. Occasionally, CO₂ traps such as NaOH and KOH are used to estimate CO₂ production (Mori and Hagihara, 1991; Cheng *et al.*, 2005) or oxygen sensors are used to measure respiration as O₂ depletion (Zogg *et al.*, 1996). Carbon dioxide traps should be avoided as they increase the soil CO₂ gradient, leading to overestimated flux rates.

7.3.2.1 Excision methods

Excision methods take roots that have been freshly removed from the soil and place them in a cuvette for a rapid determination of CO₂ efflux using an IRGA. In some cases, roots are washed in the field prior to measuring respiration. More commonly, soil and organic debris are physically removed prior to measurements (Burton and Pregitzer, 2003), with additional adhering material washed from the roots later in a laboratory setting, in order to determine the actual dry weight of root material in the sample. The mass of material

removed during this final cleaning typically is < 5% of the total mass of the sample for which respiration was measured (Burton *et al.*, 2002). Microbial respiration in any adhering soil and organic debris will be measured as root respiration, but its contribution will be minimal if microbial respiration per unit gram of the material is low relative to that of the root tissue. Comparisons of specific respiration rates of forest soil material (Zak *et al.*, 1999) and tree roots (Burton *et al.*, 2002) suggest this to be the case, but actual measurements of the respiration rate of the removed rhizosphere material would have to be made to confirm this assumption. However, mycorrhizal roots may retain much of their hyphal sheath (i.e. EM) or other mycelium parts, which will be included in the ‘root respiration’ measurements. Cuvettes used for excised roots can include standard cuvettes designed for measurement of leaf and needle photosynthesis (Ryan *et al.*, 1996) or cuvettes designed for root respiration (Burton and Pregitzer, 2003). Cuvette volumes vary widely depending in part on the size of the sample to be analyzed. Cuvettes as small as 5 cm³ (Ryan *et al.*, 1996) and as large as 12.7 L (Mori and Hagihara, 1991) have been used. When an open system is being used for gas analysis, the cuvette volume should not be greatly larger than needed to contain the sample. Excessive cuvette volume unnecessarily increases the time needed for a steady–state respiration rate to be achieved after inserting a sample. It is also desirable to use cuvettes that can maintain roots at ambient temperature (or other desired temperatures). Standard photosynthesis cuvettes for IRGAs are available with temperature control devices that are adequate, but these will cause a more rapid depletion of battery power, which can be a concern in remote field locations. A simple alternative involves the use of a cuvette that contains a metal base that extends into the soil (Burton and Pregitzer, 2003). The base acts as a heat sink that maintains ambient soil temperature within the cuvette chamber. In addition, drying of the roots induced by the air stream through the cuvette in open systems can be avoided by either putting the root samples on wet paper or inserting a wash bottle with water upstream of the chamber (Kutsch *et al.*, 2001a).

There are a number of artefacts potentially related to root respiration measurements of plants grown in natural soils, especially when (1) roots are separated from the soil and (2) are excised. The removal of soil may not only affect plant–microbe interactions and potentially

cause loss of highly active root hairs, but also stops the nutrient and assimilate supply. Since respiratory costs for nutrient uptake are high, the absence of nutrient supply affects root respiration. Poorter *et al.* (1995) showed for a slow- and a fast-growing grass species that reductions in nutrient availability resulted in a decrease in root respiration. We are not aware of any study reporting how fast root respiration decreases after nutrient supply from its natural environment has been stopped by a separation of roots from the soil.

Excision of roots is unavoidable when roots are extracted from the soil in ecosystems, especially in grasslands. Excision methods allow the root-rhizosphere system to develop and function naturally, until the time roots are removed for measurement. The accuracy of excised respiration rates depends largely on the assumption that the root activity remains unaffected by excision, at least for the length of time needed to complete the measurements. Essentially, the hope is to achieve a snapshot while the roots are still respiring at the same rate they were prior to removal from their natural environment. Effects of excision on root respiration could include increased respiration due to wounding responses (Cabrera and Saltveit, 2003); decreased respiration due to the interruption of carbohydrate supply to the root, attached mycorrhiza and adhering microbes dependent on exudation; and disruption of normal physiological processes due to the removal of the physical, chemical and biological environment with which the root was interacting. Measured effects of excision on short-term root respiration rates have varied from significant decreases (Bloom and Caldwell, 1988) to little or no effect (Marshall and Perry, 1987; Lee *et al.*, 2003; Lipp and Andersen, 2003). Burton *et al.* (2002) report that respiration of fine roots from different forest sites was not affected by time since collection for up to four hours. Bahn *et al.* (2006) observed for grassland roots that respiration decreased by less than 5% of the initial value within five hours after sampling. A method to minimize possible effects of root wounding is to use single excisions and to sample intact root mats containing many fine root segments (Burton and Pregitzer, 2003). Completing measurements rapidly can lessen the potential impacts of carbohydrate loss. Lipp and Andersen (2003), for example, found relatively constant rates of root respiration for six hours after excision, a time period much longer than the 15 to 30 minutes that are required to complete usual excision

measurements (Ryan *et al.*, 1996; Burton and Pregitzer, 2003); but, logically, this will depend on the carbohydrate status of the roots, i.e. starved roots vs. well-fed roots.

It is important to consider which parts of the root-rhizosphere system are contributing to respiration rates measured by various approaches. Excision methods will exclude most of the respiration of mycorrhizal hyphae and potentially a significant portion of respiration associated with rhizosphere microbes. The respiration of internal structures of arbuscular mycorrhizae and portions of ectomycorrhizae and rhizosphere microbial communities not removed by cleaning will be included. However, since much of the soil and organic matter adhering to roots, and thus much of the rhizosphere, is removed in typical root excision procedures (Burton and Pregitzer, 2003), a significant portion of the contribution of these components is missed.

In summary, the mentioned potential artefacts in studies on the respiration of roots in ecosystems can be minimized by:

- carrying out root respiration measurements *in situ* or, in case this is not possible, completing the measurements rapidly, ideally within 30 minutes and not more than 4 to 5 hours after sampling
- always using the same procedure and checking for time differences
- brushing roots free of loose soil and organic matter rather than washing or rinsing them, but keeping roots moist
- keeping the measured root system as intact as possible, i.e. minimizing cutting effects
- always using a fresh batch of root tissue in order to avoid substrate decline.

Measurements of root respiration at higher CO₂ concentration need to consider the problem that large concentration gradients between the chamber and its environment may result in experimental artefacts due to leakage problems, as stated in Section 7.2.2.5 (Burton *et al.*, 2002).

7.3.2.2 Intact-root chamber methods

Intact-root chamber methods are sometimes used in a similar fashion to excised-root cuvettes, with the roots inserted into the chamber just prior to measurement, and the chamber volume containing only roots and the atmosphere (Cropper and Gholz, 1991). In these cases,

the potential problems associated with root removal from the soil environment apply except for an excision wounding response. More typically, intact-root chamber systems surround the roots with a soil material (Cropper and Gholz, 1991; Gansert, 1994, 1995; Bryla *et al.*, 2001). The entire chamber is then buried in place, with measurements of root respiration made periodically. For these chambers, measured respiration rates will include contributions from roots, mycorrhizal fungi, including some hyphae, and rhizosphere microbes utilizing rhizodeposits. Intact-root chambers usually are sealed, but variations include open-top chambers over which soil respiration cuvettes are periodically placed to measure respiration rates (Fahey and Yavitt, 2005). Another method is to insert tips of fresh fine roots into small plastic containers filled with sand or sieved mineral soil and leave them to develop a fine root system during the next months (Kutsch *et al.*, 2001a). These containers can contain holes in the bottom, so the moisture content can be kept in the same range as the surrounding soil. For the respiration measurements the containers can be inserted into measuring chambers placed on the soil surface.

Buried chambers allow the root system to experience ambient temperatures, but if the chamber is sealed, moisture content in the system may differ substantially from that in the bulk soil. If chambers are kept in place for an extended period of time, it also becomes difficult to know the mass of the respiring material at any given point in time, other than those just prior to final destructive sampling of the chamber contents.

Choice of the soil medium for intact-root chamber systems is a major factor that could influence measured respiration rates. Artificial media, such as organic-free sand (Vogt *et al.*, 1989; Kutsch *et al.*, 2001a; Fahey and Yavitt, 2005) and sand-vermiculite mixtures (Cheng *et al.*, 2005) have been used to minimize respiratory contributions from the decomposition of bulk soil organic matter. However, mycorrhizosphere respiration measured using these media can be much lower than those for native soil (Cheng *et al.*, 2005). It is also possible to use native soil and then determine mycorrhizosphere respiration rates by subtracting rates determined from root-free, soil-only chambers. However, most intact-root chamber systems have a fairly small root mass, thus this approach is difficult to apply unless native bulk soil has a low organic matter content and creates a respiration flux that is similar in magnitude to or smaller

than that of mycorrhizosphere respiration. Cheng *et al.* (2005) used soil from C₄ ecosystems in chambers containing intact roots of C₃ plants. The difference in isotopic signature between C₄ and C₃ sources allowed separation of CO₂ efflux from bulk soil and root and rhizomicrobial components. However, they found that respiration rates of longleaf pine roots were much lower in non-native C₄ grassland soil than in native longleaf pine-wiregrass soil.

Open and closed gas flow systems both have been used for excised root and intact-root chamber methods. In open systems, the change in CO₂ content of atmosphere entering and leaving the cuvette or chamber is used to determine respiration rate. This requires that a large enough change in concentration occurs for the IRGA to accurately detect it. If changes in CO₂ concentration are too small for accurate detection, then larger samples can be used or gas flow rates can be reduced. It should be noted, however, that reducing the flow rate can increase the likelihood of significant errors if the system contains even minor leaks (Burton and Pregitzer, 2003). Such effects in the past have led several investigators to falsely conclude that CO₂ concentrations used during the measurement affected plant tissue respiration rates (Amthor, 2000b; Burton and Pregitzer, 2003). A potential advantage of the open system is that input CO₂ concentration can be set at levels representative of soil-atmosphere CO₂ concentrations (Burton *et al.*, 2002; Cheng *et al.*, 2005). This will avoid the diffusing out of CO₂ that may be stored in the roots and subsequent overestimation of respiration rates until a new steady state is reached. It is also recommended that all systems be checked using empty cuvettes and chambers at several CO₂ concentrations to assess the potential influence of gas leaks on results.

7.3.2.3 Measurement techniques for respiration of large coarse roots

Measurements on large woody coarse roots – hereafter referred to as large coarse roots – cannot be made with the procedures described above, mainly because of the impossibility of enclosing them in regular chambers. Large coarse root respiration can either be measured using cut root sections under laboratory conditions or *in situ* by installing chambers over the root part to be sampled.

In the first case, excised root sections are removed from a tree and CO₂ evolution is measured in the laboratory under controlled conditions (Tranquillini, 1959; Kimura *et al.*, 1968). This method allows the use of a large sample size for determining within- and between-tree variations in respiration rates. General complications related to excision methods will also apply, with the additional disadvantage that an adequate sampling involves considerable destruction of the tree. It is thus impossible to follow seasonal trends in respiration on the same sample (Sprugel *et al.*, 1995) and, as a result, it may be impossible to separate maintenance from growth respiration.

Another common approach is to fix chambers permanently onto intact large coarse roots above or below the soil surface and continuously monitor the CO₂ efflux through the bark over prolonged periods of time (Linder and Troeng, 1981; Benecke, 1985; Wieser and Bahn, 2004). This method is less disturbing than the excision method but requires complex equipment to maintain air flow through the chambers, and to monitor flow rates and changes in CO₂ concentration. Due to these hardware requirements, usually only a small sample size can be studied in parallel. Care is also needed to ensure that permanently installed respiration chambers do not significantly alter environmental conditions, which may affect respiration rates.

A solution to the problem of a small sample size is the use of removable chambers that can be clamped onto a root section (Ryan *et al.*, 1996; Desrochers *et al.*, 2002). This allows within- and between-tree variations to be measured within a single day, and measurements on the same site over an entire growing season. Growth respiration can be easily distinguished from maintenance respiration by means of repeated measurements at the same site. However, the need to install and leak-test such clamp-on respiration cuvettes, and then to wait for an equilibrium each time a measurement will be made, reduces the number of possible measurements.

Chambers used for monitoring large coarse root respiration are often made of Perspex[®], and enclose either a complete section (Fig. 7.7) or only a part of the circumference of a root. Due to the absence of a large overheating, most field studies on large coarse root respiration use chambers with no environmental control.

When estimating large coarse root respiration *in situ* the following precautions are necessary.

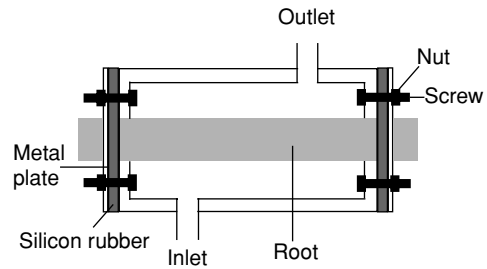

Figure 7.7 Clear Perspex chamber made of two half shells with adjacent walls for continuous *in situ* measurements of CO₂ efflux. Half shells enclosing the root are pressed together with pile clamps and the bearing surface is sealed with a neoprene foam tape. At both ends of the chamber the root is coated with putty and PTFE tape and the root is pressure sealed with soft silicon rubber by tightening nuts on screws that press the rubber sealing against the chamber and the root. An inlet and an outlet port allow the chamber to be connected to an infrared gas analyzer, operating in the differential mode to measure CO₂ efflux, and an electronic mass flowmeter for the flow rate.

- After rinsing and drying the root surface, thick or fissured bark should carefully be pared down below the point of chamber contact, stopping short before the living tissue (phloem or cambium).
- Putty and non-hardening insulating foam (without toxic volatiles) should be used to ensure a gas-tight seal between chambers and the bark. Chambers should be checked for gas leaks by applying an overpressure of up to 20 mbar.
- When chambers are attached to roots throughout one entire growing season or longer, allowance for expansion is necessary in order to prevent bark constriction under the seals of the chambers. It is also recommended to estimate changes in surface area and sapwood volume under the chamber-covered areas.
- Simultaneously to gas exchange measurements, tissue temperature should be monitored in and outside the chambers with temperature sensors inserted into the bark down to the cambial surface.
- When working with chambers permanently sealed to a root it is important to have a continuous supply of ambient air. Condensation of moisture in tubing and chambers should be prevented by insulating and heating all the pneumatic tubing or by partial (but not complete) drying of the inlet air.
- When measurements are not being made, glass wool can be placed into the inlet and outlet tubing in order

to prevent insects from entering the chamber but allow sufficient gas exchange (Vose and Ryan, 2002).

Advantages and disadvantages of *in situ* large coarse root respiration measurements are similar to those for measurements in finer roots. An additional complication is that some of the CO₂ respired in the sapwood may be carried upward into stem, branches and foliage instead of being released through the bark, so that measured root respiration may be underestimated. Teskey and McGuire (2005) observed a proportional correlation between the CO₂ concentration in xylem sap and CO₂ efflux from the stem, which suggests that CO₂ can be easily transported within the plant. However, until now this problem has never been resolved satisfactorily (Sprugel and Benecke, 1991).

7.3.2.4 Mesh exclusion method

Arbuscular mycorrhizal or ectomycorrhizal hyphal respiration can be separated from root and soil respiration by using nylon meshes with pore sizes that allow the in-growth of fungal hyphae while excluding roots (Johnson *et al.*, 2001a). Typically, cores of either undisturbed or sieved soil are established in the field and a certain time period is allowed for the in-growth of mycorrhizal hyphae. The cores can range in diameter depending on the study (from 2 to 20 cm have been used) and can be inside deep collars that have windows covered by meshes, or directly in mesh bags. The collars can be hammered directly into the ground, thus avoiding the disturbance caused by removing soil cores. This may not be possible in some harder soils. Depending on the vegetation, one can use meshes with 41 µm pores to allow EM hyphae but no tree fine roots, or meshes with 20 µm pores to allow AM hyphae while excluding very fine (e.g. grass) roots. Additionally, 1 µm meshes can be used to exclude both hyphae and roots. The presence of pores has the additional advantage of allowing the flow of water and dissolved substances through the mesh, thus minimizing the disturbance of natural conditions. However, mesh bags might still prevent water flow out of the bag in very fine (i.e. clay) soils, thus moisture should be monitored closely in all treatments. With CO₂ efflux measurements from these different treatments and of total soil respiration (using shallow collars, not cutting any roots), the contribution of mycorrhizal and root respiration can be calculated separately. The following points should be considered when using this method.

- Soil cores should be deep enough to include the main rooting zone. A problem can be deeper roots but they are unlikely to contribute much to the overall flux (because of oxygen limitation and their main functioning in passive water uptake).
- Enough time should be given for decomposition of remaining dead roots and mycorrhizal hyphae colonization of the soil core. The waiting time for the latter will depend on the soil core size and the growth activity of mycorrhizal hyphae. Decomposition and in-growth can be considered 'complete' when differences in soil respiration among treatments are stable.
- As mycorrhizal hyphae and active fine roots are predominantly found in the organic rich topsoil layers, any collar inserted only a few centimetres deep into the soil will cut through this assimilate supply ultimately reducing the soil CO₂ efflux. Shallow collars should be used to capture such fluxes. A good seal between ground and collar can be achieved by cutting through the top dry litter layer around the collar and then pressing it gently into the Of/Oh layer, fixing it with metal hooks down to the ground.
- A possible diffusion of CO₂ into the soil cores through the meshes should be estimated, e.g. by using a control deep collar with no windows.

In the laboratory, the same mesh sizes can be used and gas samples can be taken in sample vials and analyzed with an IRGA to obtain fluxes. The rotation of cores in order to sever hyphal connections is sometimes performed in field or laboratory experiments. This technique can be used to immediately terminate the flow of carbon and nutrients through mycorrhizal hyphae and to compare fluxes before and after hyphal severance (Johnson *et al.*, 2002b).

A limitation to the method is given by the fact that only the contribution of the mycelium inside the cores can be measured. The density of AM hyphae will decrease with the distance from the root, so that calculated mycorrhizal respiration will represent a minimum estimate; smaller cores may be desirable in this case. Hyphal density in EM systems does not necessarily decrease with root distance, but in this case, the respiration of the mycorrhizal sheath around the roots will be missed. However, such estimates are still useful to study the proportion and response of mycorrhizal respiration to environmental factors. On the other hand, massive proliferation of roots and mycorrhizal hyphae against

the side of the mesh might lead to an overestimation of respiration rates. This can easily be checked for by appropriate controls (e.g. deep collars without mesh), especially in EM systems.

As with other exclusion techniques, potential changes in nutrient and water status, as well as the lack of competition with roots and mycorrhiza, could alter microbial respiration of soil organic matter and litter in the mycorrhiza-free soil. Possible priming effects on respiration could also change as a result of root and mycorrhizal fungi exudates being absent in treatments excluding these components.

7.3.2.5 Field measurements to take in conjunction with root respiration

As seen in Section 7.2, a variety of potential controlling factors can be measured in conjunction with field measurements of mycorrhizosphere respiration. By accounting for the effects of these factors, one can better model ecosystem-level carbon flux from mycorrhizosphere respiration and in some cases can utilize them as statistical covariates, allowing experimental responses to be clearly identified.

An assessment of the roots measured also should be made. Beside dry weight and length, to which mycorrhizosphere respiration is usually related, this could include the root size classes or orders measured, root N concentration, depth, root age or other demographic classifications (white, brown, woody) and presence of mycorrhizal structures. For intact-root chamber methods, such characteristics for roots in the chamber may differ significantly than those for roots in the bulk soil, leading to different respiration rates (Fahey and Yavitt, 2005). For excised-root methods, one has to be sure to measure roots from the wide variety of sizes, orders, ages and depths present, to truly scale results up to ecosystem-level fluxes.

Researchers wishing to model seasonal or annual mycorrhizosphere respiration fluxes should take multiple measurements throughout the period of interest as well as diurnal measurements if possible. Using a single Q_{10} to adjust rates to temperatures that differ greatly from measurement days is not recommended, as Q_{10} can vary widely with species, season and temperature, and will depend largely on substrate supply and status of the root (Atkin *et al.*, 2000b; Burton *et al.*, 2002; Atkin and Tjoelker, 2003). Where possible, field-based

estimates of seasonal or annual mycorrhizosphere respiration should be compared to independently derived estimates based on carbon budgeting, isotopic methods or other techniques to assess the correctness of their overall magnitudes. Careful comparisons of multiple techniques (Cheng *et al.*, 2005; Kuzyakov and Larionova, 2005) will let us further assess the accuracy and pitfalls of common techniques, such as root excision and intact-root chamber systems.

7.3.3 Laboratory methods

7.3.3.1 O_2 consumption and CO_2 release methods

In the laboratory, respiration rates in roots may be determined in enclosed cuvettes using infrared gas analyzers that measure net CO_2 efflux or using Clark-type oxygen electrodes that measure net O_2 uptake. During mitochondrial respiration, O_2 is consumed in the electron transport chain by both the ATP producing cytochrome C oxidase and the non-ATP producing alternative oxidase. Carbon dioxide is released by the decarboxylations of pyruvate and malate in the mitochondrial tricarboxylic acid (TCA) cycle. Thus, root respiration measured as O_2 consumption or as CO_2 release may not be identical; the ratio of CO_2 to O_2 is termed the respiratory quotient, RQ. The RQ has been found to vary between species, sections of roots and depends on the nitrogen source (Lambers *et al.*, 1996).

'Oxygen cuvettes' are used to determine rates of root respiration in either roots bathed in a buffered hydroponic medium (e.g. 10 mM HEPES and 10 mM MES, pH 5.8) placed in liquid phase chambers or in cleaned root segments placed in gas phase chambers. In both cases, temperature-controlled water baths (e.g. Burton *et al.*, 1996) are often used. The buffered medium has the advantage that it is easy to apply chemicals and control temperature. Further, with these types of measurements it is easier to estimate root respiration alone without any signal from microbial respiration. Prior to measuring root respiration, the O_2 electrode needs to be calibrated using air-saturated water (liquid phase chamber) or standard gases (gas phase chamber) that are in equilibrium with the temperature of measurement – large errors in calibration can occur when using air-saturated water that has not been allowed to equilibrate to the temperature of measurement. The uptake

of O₂ by roots is measured polarographically after sealing roots in a closed cuvette (Walker, 1985); typically, it is advisable to wait a few minutes before commencing a determination of the rate of O₂ depletion. Rates are then measured over a 10 to 45 minute period, provided the O₂ concentration in the solution remains above 10% to 20% of that of air saturation. A constant temperature during measurements is important, firstly because of the temperature sensitivity of the electrode, and secondly because of the change in solubility of O₂ in water at different temperatures.

Root CO₂ release is related to the root's carbon balance, and can be measured with IRGAs in either open or closed mode connected to an enclosing cuvette. Thus, root respiration is either measured as CO₂ differentials or as a build-up of CO₂ concentrations inside the cuvette. Currently, there are no commercially available root cuvettes of this kind. Cuvettes are custom built (Qi *et al.*, 1994; Christ and Korner, 1995; Leverenz *et al.*, 1999), and usually so that it seals around the root-shoot junction. In this way, root respiration can be measured in a somewhat more natural environment, with the root still connected to the shoot and the root in a soil medium. However, this makes it difficult to add chemicals in a controlled manner. Further, the temperature control of the root is poor and, depending on the type of medium, root respiration is measured at a background of microbial respiration. Carbon dioxide efflux rates can also be measured using intact roots bathed in buffered hydroponic media, in an open flow-through system (Poorter *et al.*, 1990; Atkin *et al.*, 1996). When using an open system, enclosing more tissue within the chamber may increase the measured CO₂ differentials. This may be accomplished by measuring entire root systems in a larger cuvette. Examples of custom-built chambers for roots include a chamber using an extended heat sink for insertion into soil or a water bath (Burton and Pregitzer, 2003).

The potential direct inhibitory effect of high CO₂ concentration, on root respiration is something that needs to be considered for root respiration measurements in general. As pointed out by Reuveni *et al.* (1993), to obtain stable reliable readings of O₂ consumption by roots in closed cuvettes with O₂ electrodes, at least a 10% reduction is needed from the initial 20.8%. For simplicity, if a respiratory quotient (i.e. CO₂ release/O₂ uptake) of 1 is assumed then a build-up of CO₂ in the cuvette from 350 ppm to 20 000 ppm

can be expected. However, many of the previously reported effects of CO₂ concentration on plant tissue respiration may have resulted from experimental artefacts, as discussed in Section 7.2.2.5.

7.3.3.2 *Measuring root respiration temperature response in the laboratory*

Direct effects of temperature on root respiration may be termed the temperature sensitivity of root respiration. Two important methodological aspects of studying the temperature sensitivity of root respiration are (1) to ensure a good temperature control of the root material and (2) to ensure that the response of root respiration to changing temperature is obtained quickly and within the same root material. Temperature control of root material is best obtained using Clark-type electrodes coupled to a temperature-controlled water bath. As the root material is immersed in water medium with a stirrer the desired temperature control of the root material is ensured. In cuvettes enclosing a soil-root core, in which root respiration is measured as CO₂ release, the temperature control of the root tissue is usually less accurate/certain, although the cuvette can be covered by a water jacket coupled to a water bath or placed inside a temperature-controlled growing chamber. On the other hand, root respiration measurements in Clark-type cuvettes are typically restricted to only a few measurements due to O₂ depletion. Root respiration measured as CO₂ release from soil cores does not suffer this problem. Thus, the response of root respiration of the same material to several different temperatures is better achieved by CO₂-release measurements. Therefore, the choice of how root respiration is to be measured in response to temperature depends on whether the investigator prioritizes accurate temperature control of the tissue or that the temperature response be determined within the same root material.

7.3.4 Calculating the Q_{10}

Q_{10} values are often used to describe the short-term temperature response of root respiration. Berry and Raison (1981) suggested that Q_{10} offers an important advantage over Arrhenius theory (derived from physical chemistry) when interpreting the temperature dependence of respiration; that being that Q_{10} does not imply a mechanistic explanation (whereas the use of an apparent activation energy, E_a , does). The Q_{10} is simply the

ratio of respiration at one temperature to that at 10 °C lower. The Q_{J0} can be calculated according to:

$$Q_{J0} = \left(\frac{R_T}{R_{T_0}} \right)^{\left[\frac{10}{T-T_0} \right]} \quad \text{Eq. (7.1)}$$

where R_T is the respiration rate measured at a given temperature (T) and R_{T_0} is the respiration rate measured at a reference temperature (T_0). In Eq. (7.1), T and T_0 do not have to be 10 °C apart. A rearrangement of Eq. (7.1) provides the following formula:

$$R_T = R_{T_0} Q_{J0}^{\left[\frac{(T-T_0)}{10} \right]} \quad \text{Eq. (7.2)}$$

in which R_T may be predicted as a function of the Q_{J0} and the measurement temperature (T).

When rates of respiration have been determined over a range of measurement temperatures (but below the optimum temperature), a simple exponential function will often adequately describe the temperature response. Respiration at any given T (R_T) can be predicted using a model of the form:

$$R_T = R_{0^\circ\text{C}}(e^{kT}) \quad \text{Eq. (7.3)}$$

where $R_{0^\circ\text{C}}$ is respiration at 0 °C and k is a temperature coefficient. Equation (7.3) may be fitted using standard non-linear regression techniques. Alternatively, k may be determined by linear regression of ln-transformed respiration plotted against measurement temperature (T) (derived by ln-transforming both sides of Eq. (7.3); note: this value of k may differ from that obtained from Eq. (7.3)). Q_{J0} may be then estimated from k using the following formula:

$$Q_{J0} = e^{10k} \quad \text{Eq. (7.4)}$$

Equations (7.1) through (7.4) do not, however, provide information on the extent to which the temperature coefficient of respiration changes with measuring temperature (rather, they provide an estimate of the average Q_{J0} for the temperature range T_0 to T).

The short-term response of respiration to temperature is not strictly exponential, except perhaps over a limited temperature range below the optimum temperature. In other words, the temperature sensitivity of respiration may change with measurement temperature, implying that Q_{J0} is temperature dependent. This may be revealed by a lack of fit of respiration against measurement temperature when using exponential temperature-response functions (Eq. (7.2) or (7.3)). To overcome these limitations, an estimate of Q_{J0} at

each temperature is needed. If the regression slope of ln-transformed respiration against measurement temperature (k in Eq. (7.3) and (7.4)) is linear, then a single Q_{J0} value can be used across all temperatures over a defined measurement temperature interval. However, the slope may not be constant, as would be evident by the lack of linearity in the regression fit, and a significant polynomial fit to the ln-transformed respiration versus temperature data. This fitted polynomial equation can then be differentiated to get the slope (i.e. k) at each temperature; these slopes may then be used to calculate Q_{J0} values at each temperature (Eq. (7.4)). It should be noted that the use of ln-transformed respiration versus temperature plots to determine the temperature dependence of Q_{J0} requires the analysis to be based on a large number of measurements conducted at several temperatures. Reliance on too few replicates and/or measurement temperatures may result in insufficient statistical power to adequately distinguish between a linear or polynomial fit to the ln-transformed respiration versus temperature plots, and perhaps erroneous conclusions being made about the temperature dependence of the Q_{J0} .

When the above analysis clearly shows that Q_{J0} varies with measuring temperature, the extent of that temperature dependence can be approximated via linear regression of the Q_{J0} values plotted against T to yield a formula:

$$Q_{J0} = c - bT \quad \text{Eq. (7.5)}$$

where c is the Q_{J0} at 0 °C and b is the slope of the Q_{J0} versus T plot. Tjoelker *et al.* (2001) and Atkin *et al.* (2005b) provide generalized equations to describe the approximate temperature dependence of root Q_{J0} across biomes and contrasting plant taxa. It should be noted that if the data range includes respiration measured at values lower and higher than the optimum temperature, then Q_{J0} may in fact exhibit a non-linear decline with increasing measurement temperature throughout a broad temperature range.

7.3.4.1 Fitting curves to measured data

Curve fitting to measured respiration data can be accomplished in several ways. Here, we describe the use of standard non-linear regression techniques to fit curves by iteration to existing data using Eq. (7.3), a special case of Eq. (7.2), where R_{T_0} is $R_{0^\circ\text{C}}$ (i.e. respiration at 0 °C) and T substitutes $T - T_0$. In cases where Q_{J0}

is temperature independent, estimates of $R_{0^\circ\text{C}}$ and the average Q_{J0} over the temperature range are estimated parameters, based on non-linear regression. The resulting expression may then be used to predict respiration and plot the fitted curves.

Whenever Q_{J0} is temperature dependent (e.g. data are measured over a broad temperature range that approaches or includes the temperature optimum of respiration), curve fitting to measured data requires Eq. (7.2) to be modified. By substituting Eq. (7.5) into Eq. (7.2) (and $T - T_o$ with T), the following expression is obtained:

$$R_T = R_{0^\circ\text{C}}(c - bT)^{[T/10]} \quad \text{Eq. (7.6)}$$

where $R_{0^\circ\text{C}}$ is respiration at 0°C , and c and b are constants that describe the intercept and slope of Q_{J0} versus temperature plots, respectively. Again, standard non-linear regression methods can be used to estimate $R_{0^\circ\text{C}}$, c and b . These values will then be used to predict R_T and plot the fitted curves.

7.3.4.2 Predicting respiration in the absence of a measured temperature response

In cases where the temperature response of respiration has not been determined experimentally, respiration at different temperatures (R_T) can be modelled. Assuming that the Q_{J0} value is temperature insensitive, then the rates of R_T at any given temperature (T) can be predicted using Eq. (7.2). However, as stated above, Q_{J0} is often temperature sensitive. Then, an equation that takes into account the temperature dependence of the Q_{J0} is needed to successfully predict rates of R_T at given temperatures. Intuitively, one might replace the single Q_{J0} value in Eq. (7.2) with a term that describes the temperature dependence of the Q_{J0} ($\text{Root}Q_{J0} = 3.00 - 0.0450T$, where T is temperature; Tjoelker *et al.* (2001); Atkin *et al.* (2005b)). However, this approach fails to accurately predict rates of R_T , particularly at measuring temperatures that are much higher than the reference temperature, owing to the fact that the Q_{J0} describes the proportional change in respiration across a 10°C interval. To predict rates of R_T when using a temperature-dependent Q_{J0} , Atkin *et al.* (2005b) concluded that the Q_{J0} at the midpoint between the reference (T_o) and prediction temperature (T) should be used as shown in the following equation:

$$R_T = R_{T_o} [x - y((T + T_o)/2)]^{[(T - T_o)/10]} \quad \text{Eq. (7.7)}$$

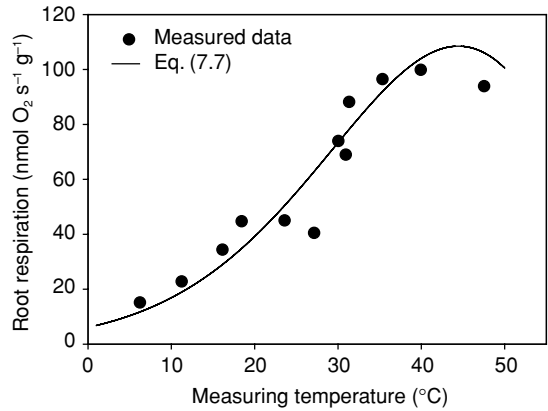

Figure 7.8 Rates of respiration predicted using Eq. (7.7) against observed data (Covey-Crump *et al.*, 2002). Assumed values in the equation: R_{T_o} was taken as the rate of respiration at 0°C ($6.01 \text{ nmol O}_2 \text{ g}^{-1} \text{ s}^{-1}$), $x = 3.00$ and $y = 0.045$ (Atkin *et al.*, 2005b; Tjoelker *et al.*, 2001). See text for further details.

where x and y are constants that describe the temperature dependence of the Q_{J0} . To use Eq. (7.7), an initial R_{T_o} value at T_o is either measured or obtained from published literature. Rates of respiration at new temperature (R_T) can then be predicted using a temperature-dependent Q_{J0} equation (e.g. Eq. (7.5)). Eq. (7.7) may be used in predicting temporal changes (e.g. diurnal) in respiration with changing ambient temperatures by solving for a new R_T for each successive temperature-measurement interval (Fig. 7.8).

7.3.5 Methodology for quantifying the degree of acclimation

7.3.5.1 Set temperature method

One of the most common characteristics of acclimation is that a change in growth temperature results in a change in respiration at a set measuring temperature (Atkin *et al.*, 2005b). Thus, comparisons of rates of respiration at a set measuring temperature can provide an indication of the degree of acclimation (*AcclimSetTemp*). Using the set temperature method, the degree of acclimation can be quantified as the rate exhibited at a particular measurement temperature by a cold-grown plant divided by the rate exhibited by a warm-grown plant. High ratios indicate high degrees of acclimation (with a ratio of 1.0 indicating no difference between cold- and warm-grown plants, i.e. no

acclimation). *AcclimSetTemp* values greater than 1.0 are common, suggesting that most plant species are capable of acclimation via up-regulation of respiration in cold compared to warm temperatures, at least when defined by the differences in respiration at a set temperature.

In cases where Q_{J0} is constant after acclimation, this approach yields constant ratios of rates of respiration of cold-grown to warm-grown plants, regardless of the measuring temperature. However, changes in measuring temperature result in temperature-dependent changes in *AcclimSetTemp* if the mean Q_{J0} differs between the cold- and warm-grown plants (Atkin *et al.*, 2000b). Given that acclimation can be associated with changes in Q_{J0} (Atkin *et al.*, 2005b), this means that *AcclimSetTemp* ratios need to be treated with caution, especially when comparing results from separate studies where different measuring temperatures were used. However, within individual studies the ratio is likely to provide estimates of the extent of acclimation.

7.3.5.2 Homeostasis-based methods

Homeostasis is also one of the defining characteristics of acclimation; many studies have defined *full acclimation* as the situation when plants grown at different temperatures exhibit identical rates of respiration, when measured at their respective growth temperatures (Atkin *et al.*, 2005b). Homeostasis forms the basis of several methods used to assess the degree of acclimation. In Larigauderie and Körner (1995) and Tjoelker *et al.* (1999), homeostasis was assessed via determining the ratio of respiration of warm-grown plants to that of cold-grown plants, each measured at their respective growth temperature. Larigauderie and Körner (1995) defined this ratio as the *long-term acclimation ratio* (LTR_{10}), the proportional change in respiration of plants grown and measured at one temperature compared with those grown and measured at a temperature 10 °C lower (LTR_{10} is analogous to the Q_{J0} of the short-term temperature response function). Full acclimation (i.e. perfect homeostasis) was assumed to have occurred when LTR_{10} is equal to 1.0. LTR_{10} values that are greater than 1.0 but less than the Q_{J0} indicate partial acclimation. No acclimation would occur when LTR_{10} and Q_{J0} values are equal. By comparing LTR_{10} values with published values of Q_{J0} , Larigauderie and Körner (1995) assigned

a degree of acclimation to each plant species (not a specific value, but rather whether the degree of acclimation was near-full, high, medium to low or very low). The LTR_{10} method is useful in providing an insight into inter-specific differences in the degree of acclimation. Comparing LTR_{10} values with short-term Q_{J0} values from the same species avoids potentially misleading conclusions concerning the degree of acclimation associated with low LTR_{10} values. For example, viewed in isolation, a low LTR_{10} such as 1.3 might suggest a very high degree of acclimation. However, if the Q_{J0} of the same tissue were also low (e.g. 1.5), then little adjustment in rates of respiration would have occurred in response to the change in growth temperature. By comparing LTR_{10} and Q_{J0} values, the magnitude of acclimation in respiration to temperature can be appropriately compared.

The method of comparing LTR_{10} with Q_{J0} values does, however, have some drawbacks. Firstly, the method does not allow a definitive degree of acclimation value to be applied to any one species. Secondly, it requires LTR_{10} to be compared with Q_{J0} values; however, deciding on which Q_{J0} value to compare the LTR_{10} may be problematic if short-term temperature response data are missing, or if Q_{J0} itself changes as a result of acclimation. If growth temperature affects Q_{J0} , then the conclusions reached will depend on which Q_{J0} value is used (i.e. should one use the Q_{J0} of the warm- or cold-grown plants?). Finally, the biological basis for stating that full acclimation is when LTR_{10} equals 1.0 has not been demonstrated; in some cases cold-grown plants exhibit faster rates of respiration than do warm-grown plants, when each is measured at their respective growth temperatures (Loveys *et al.*, 2003).

Another limitation to the LTR_{10} method is that it does not assign a quantitative degree of acclimation value. Atkin *et al.* (2005b) proposed a method for assigning such a value using the range of LTR_{10} values that occur between no acclimation (i.e. $AcclimLTR_{10} = 0$, which is when the LTR_{10} and the short-term Q_{J0} are equal), and full acclimation (i.e. $AcclimLTR_{10} = 1.0$). This range is equivalent to the short-term Q_{J0} minus 1.0. Therefore, the degree of acclimation is:

$$Acclim_{LTR_{10}} = 1 - \left(\frac{LTR_{10} - 1}{Q_{J0} - 1} \right) \quad \text{Eq. (7.8)}$$

Thus, knowledge of the short-term Q_{J0} and LTR_{10} means that a quantitative degree of acclimation to any

plant tissue can be assigned. Use of this approach requires the use of mean values of Q_{10} and LTR_{10} for different growth temperatures.

Loveys *et al.* (2003) proposed the *homeostasis method* approach (a modification of the above method of comparing LTR_{10} and Q_{10} values), where the degree of acclimation (*AcclimHomeo*) is taken as the ratio of respiration exhibited by cold-grown plants divided by respiration of the warm-grown plants (each measured at their respective growth temperature). The degree of acclimation increases as *AcclimHomeo* increases. *AcclimHomeo* is the inverse of the LTR_{10} (Loveys *et al.*, 2003); another difference is that the homeostasis method does not require that *AcclimHomeo* be compared with Q_{10} . This has advantages and disadvantages; a definitive degree of acclimation is provided without the need for comparison with variable Q_{10} values that can be growth-temperature dependent. Moreover, it does not assume full acclimation, and allows for cases where cold-grown plants exhibit faster rates of respiration than warm-grown plants, each measured at their respective growth temperature. However, the method does not take into account tissues whose Q_{10} is low (and thus already lead to a high *AcclimHomeo* value, even without large adjustments in respiration occurring). Fortunately, few species exhibit Q_{10} values that differ substantially from the common mean values of 2.0–2.5. Thus, the *AcclimHomeo* ratio probably provides a good indication of the degree of acclimation of respiration to contrasting growth temperatures. It is probably most useful for comparisons of multiple species grown under identical conditions.

7.3.5.3 Quantifying acclimation: which method to use?

If generalizations are to be made about the degree of temperature acclimation of respiration in plants, greater effort will be needed to standardize the methods by different research groups. Ideally, acclimation is best quantified using Eq. (7.8), as this takes into account both the short- and long-term responses of respiration to temperature. However, in some studies it may not be possible to obtain estimates of both Q_{10} and LTR_{10} ; in such cases the *set temperature method* should be used (with the knowledge that the *AcclimSetTemp* value is measurement-temperature dependent). Alternatively, measurements might be best made at the growth temperature (in cases where temperature control during

measurements is limited) with analyses then being made using the *homeostasis method*. Ultimately, the choice of which method to use will depend on the nature of the comparison being made (e.g. pre-existing plants that experience a change in growth temperature, versus plants that develop under contrasting temperature regimes).

7.4 MYCORRHIZOSPHERE RESPIRATION AT THE ECOSYSTEM SCALE

Since direct measurements of root or mycorrhizosphere respiration are related to a certain amount of root biomass or root length, scaling up from chamber measurements to the ecosystem scale requires additional information about the root biomass or root density and their dynamics. The fine root biomass is highly dynamic so a singular measurement does not provide sufficient information to estimate annual sums of mycorrhizosphere respiration. In addition, a full below-ground carbon balance also requires the turnover of fine root biomass. Carbon allocation to the root system and its subsequent usage for the build-up of root biomass is a highly plastic process that is driven by the phenology and the dynamic of climatic and site constraints (Hendricks *et al.*, 1993; Middelhoff, 2000; Hendricks *et al.*, 2006).

Surprisingly, there is no standard method to derive the dynamic of the fine root biomass or fine root production. Sequential coring (Kalela, 1955; Persson, 1978; Vogt and Bloomfield, 1991; Vogt and Persson, 1991) is still the most often used approach, even if it clearly underestimates fine root production in most cases. Usually, this method is conducted with sharp root corers that are driven into the rooted zone of the soil. A statistically significant number of samples have to be collected at intervals of about three to six weeks. Coring locations have to be positioned randomly within a defined plot. Root production or mortality can be calculated either from the difference between minimum and maximum of fine root bio- and necromass within a measuring period of at least 12 months (*minimum-maximum method*, Hertel and Leuschner, 2002) or from the mean root mass of two consecutive measurements. The problem of the method is that one has to assume that fine root production and mortality occur asynchronously (Hendricks *et al.*, 2006). Mortality of some roots during a net growth phase is not acquired, nor is root growth

during a net mortality phase. To avoid the resulting underestimation one has to quantify the changes in live and dead root mass in consecutive intervals and subtract the losses of necromass due to decomposition (*compartmental flow method*, Hertel and Leuschner, 2002).

In in-growth core experiments, volumes with local soil material but free of roots are created and the amounts of roots growing into these volumes are detected (Persson, 1980; Powell and Day, 1991; Majdi *et al.*, 2005). Usually, soil cores are taken from the site, sieved and relocated after extraction of all roots. Hertel and Leuschner (2002) removed only macroscopically visible live and dead root material by hand. They assumed that smaller dead rootlets would be decomposed during the experiment. The remaining soil material can be replaced into the hole either in a mesh bag that allows fast re-sampling or directly with the edges marked at the soil surface. Care has to be taken that the structure and density of the soil samples is conserved as much as possible. Since the in-growth cores supply a soil volume that excludes competition with other roots the method may result in an overestimation of fine root production.

Another tool to study root dynamics are minirhizotrons (Hendrick and Pregitzer, 1992; Majdi, 1996; Johnson *et al.*, 2001b). They consist of clear glass or plastic tubes that are installed in the rooted soil. The roots growing along the outside walls of the tubes can be monitored by means of a specialized video camera. By taking repeated images through time, the turnover of roots can be monitored from growth to decay.

The best estimates of root dynamics and turnover are obtained by a combination of the considered methods (Lauenroth, 2000; Hertel and Leuschner, 2002; Hendricks *et al.*, 2006). The total mycorrhizosphere respiration can be calculated by multiplying the biomass-specific respiration rate with the root biomass representative of a certain period. However, it has to be considered that biomass-specific respiration rates may vary depending on phenology, activity or structural properties of the roots (Kutsch *et al.*, 2001a). Another error may arise if mycorrhiza-free roots are measured in the laboratory and ecosystem-scale mycorrhizosphere respiration is calculated by multiplying the rates obtained by these measurements with root biomass. In this case the mycorrhizosphere respiration might be underestimated.

Another approach to calculate mycorrhizosphere respiration at the ecosystem scale is to subtract above-ground litter input from total soil respiration (Ewel *et al.*, 1987; Bowden *et al.*, 1993). However, this approach, which should not be applied at shorter time scales than annual balances, assumes that the soil carbon budget is balanced and cannot distinguish between the direct respiration of assimilates and the mineralization of dead fine roots and usually results in higher values than pure mycorrhizosphere respiration estimates.

Total below-ground carbon usage of the vegetation (mycorrhizosphere respiration plus fine root production) can also be estimated from total ecosystem carbon or nitrogen budgets (Aber *et al.*, 1985; Nadelhoffer *et al.*, 1985; Kutsch *et al.*, 2001b, 2005; Hendricks *et al.*, 2006). In the case of carbon budgeting, gross primary production (GPP) has to be derived either from eddy covariance measurements or from canopy gas exchange models. Below-ground carbon usage can be calculated by subtracting above-ground plant biomass production and above-ground plant respiration from GPP. The remaining part can be split into mycorrhizosphere respiration, fine root turnover and coarse root increment. Values calculated for different ecosystems are given as an example of this method in Table 7.1

7.5 CONCLUDING REMARKS

Mycorrhizosphere respiration combines all sources of CO₂ respiring compounds derived from live plant roots. Physiological, ecological and environmental conditions determine where this carbon is respired – either by the root itself, by bacteria and fungi in the rhizosphere, or by mycorrhizal hyphae – as well as the amounts of carbon respired. Although many field and laboratory methods have been developed to determine respiration rates and controls of each component, each with its own advantages and drawbacks, partitioning respired carbon in the mycorrhizosphere remains a challenge. One major problem still to be solved is the disturbance of natural soil conditions while making measurements. Linking methods described in this chapter with the use of isotopic tracers (e.g. pulse and continuous labelling) is now being explored as a way forward in this area.

Further attention should be given to studying fluxes through root-associated micro-organisms. The exclusion of rhizosphere and mycorrhizal hyphae components when using most methods becomes especially

Table 7.1 *Estimated proportion of mycorrhizosphere respiration in various ecosystems. Data after Kutsch et al. (2001b) and Kutsch (unpublished data). The model was developed from data obtained from chambers containing roots and mycorrhiza in the Bornhöved sites, and later used to obtain estimates for the Hainich forest.*

Site	Years	Vegetation	GPP g m ⁻² a ⁻¹	NPP g m ⁻² a ⁻¹	Above-ground respiration g m ⁻² a ⁻¹	Mycorrhizosphere respiration g m ⁻² a ⁻¹	[% GPP]
Bornhöved	1992–93	Beech forest	1324	656	437	231	17.4
Bornhöved	1992–93	Alder forest	2420	843	397	1181	48.8
Bornhöved	1992–93	Cropland (maize)	1682	1059	362	261	15.5
Hainich	2000–07	Beech dominated mixed forest	1612	746	429	437	27.5

important when considering the high proportion of root carbon exported to these sources, as shown by isotope and micro-pore mesh techniques. These and other innovations (e.g. use of shallow collars to capture undisturbed fine root and mycorrhizal respiration) make it clear that method development will lead to a better understanding of mycorrhizosphere carbon fluxes and from there to an improved modelling of the soil system.

The response of mycorrhizosphere respiration to climatic change poses a further challenge to this area of research. The effects of changing CO₂ concentrations and temperature on mycorrhizosphere components, as well as degrees of acclimation, can play an important role in determining soil carbon dynamics in future scenarios. The response to these factors of different vegetation types or even of particular species of mycorrhizal fungi, necessary for determining ecosystem and global-scale dynamics, is only starting to be explored.

REFERENCES

- Aber, J. D., Melillo, J. M., Nadelhoffer, K. J., McClaugherty, C. A. and Pastor, J. (1985) Fine root turnover in forest ecosystems in relation to quantity and form of nitrogen availability: a comparison of two methods. *Oecologia*, **66**, 317–21.
- Alberton, O., Kuyper, T. W. and Gorissen, A. (2005) Taking myco-centrism seriously: mycorrhizal fungal and plant responses to elevated CO₂. *New Phytologist*, **167**, 859–68.
- Amthor, J. S. (1994). Higher plant respiration and its relationship to photosynthesis. In *Ecology of Photosynthesis: Ecological Studies*, ed. E.-D. Schulze and M. M. Caldwell. Vol. 100. Berlin: Springer, pp. 71–101.
- Amthor, J. S. (2000a) The McCree–de Wit–Penning de Vries–Thornley respiration paradigms: 30 years later. *Annals of Botany*, **86**, 1–20.
- Amthor, J. S. (2000b) Direct effect of elevated CO₂ on nocturnal *in situ* leaf respiration in nine temperature deciduous tree species is small. *Tree Physiology*, **20**, 139–44.
- Atkin, O. K. and Tjoelker, M. G. (2003) Thermal acclimation and the dynamic responses of plant respiration to temperature. *Trends in Plant Science*, **8**, 343–51.
- Atkin, O. K., Botman, B. and Lambers, H. (1996) The causes of inherently slow growth in alpine plants: an analysis based on the underlying carbon economies of alpine and lowland *Poa* species. *Functional Ecology*, **10**, 698–707.
- Atkin, O. K., Edwards, E. J. and Loveys, B. R. (2000a) Response of root respiration to changes in temperature and its relevance to global warming. *New Phytologist*, **147**, 141–54.
- Atkin, O. K., Holly, C. and Ball, M. C. (2000b) Acclimation of snow gum (*Eucalyptus pauciflora*) leaf respiration to seasonal and diurnal variations in temperature: the importance of changes in the capacity and temperature sensitivity of respiration. *Plant, Cell and Environment*, **23**, 15–26.
- Atkin, O. K., Bruhn, D., Hurry, V. M. and Tjoelker, M. G. (2005a) The hot and the cold: unravelling the variable

- response of plant respiration to temperature. *Functional Plant Biology*, **32**, 87–105.
- Atkin, O. K., Bruhn, D. and Tjoelker, M. G. (2005b) Response of plant respiration to changes in temperature: mechanisms and consequences of variations in Q_{10} values and acclimation. In *Advances in Photosynthesis and Respiration. Plant Respiration: From Cell to Ecosystem*, ed. H. Lambers and M. Ribas-Carbó. Vol. 18. Dordrecht: Springer, pp. 95–135.
- Bååth, E. and Wallander, H. (2003) Soil and rhizosphere microorganisms have the same Q_{10} for respiration in a model system. *Global Change Biology*, **9**, 1788–91.
- Bahn, M., Knapp, M., Garajova, Z., Pfahringer, N. and Cernusca, A. (2006) Root respiration in temperate mountain grasslands differing in land use. *Global Change Biology*, **12**, 995–1006.
- Benecke, U. (1985) Tree respiration in steepland stands of *Nothofagus truncata* and *Pinus radiata*. In *Establishing and Tending of Subalpine Forest: Research and Management*, ed. H. Turner and W. Tranquillini. Vol. 270. Eidgenössische Anstalt für das forstliche Versuchswesen, pp. 61–70.
- Berry, J. A. and Raison, J. K. (1981) Responses of macrophytes to temperature. In *Physiological Plant Ecology I. Responses to the Physical Environment*, ed. O. L. Lange, P. S. Nobel, C. B. Osmond and H. Zeigler. Berlin: Springer-Verlag, pp. 277–338.
- Bloom, A. J. and Caldwell, R. M. (1988) Root excision decreases nutrient absorption and gas fluxes. *Plant Physiology*, **87**, 794–6.
- Bouma, T. J. and Bryla, D. R. (2000) On the assessment of root and soil respiration for soils of different textures: interactions with soil moisture contents and soil CO₂ concentrations. *Plant and Soil*, **227**, 215–21.
- Bouma, T. J., Nielsen, K. L., Eissenstat, D. M. and Lynch, J. P. (1997) Estimating respiration of roots in soil: interactions with soil CO₂, soil temperature and soil water content. *Plant and Soil*, **195**, 221–32.
- Bouma, T. J., Yanai, R. D., Elkin, A. D. *et al.* (2001) Estimating age-dependent costs and benefits of roots with contrasting life span: comparing apples and oranges. *New Phytologist*, **150**, 685–95.
- Bowden, R. D., Nadelhoffer, K. J., Boone, R. D., Melillo, J. M. and Garrison, J. B. (1993) Contributions of aboveground litter, belowground litter, and root respiration to total soil respiration in a temperate mixed hardwood forest. *Canadian Journal of Forest Research*, **23**, 1402–7.
- Bryla, D. R., Bouma, T. J. and Eissenstat, D. M. (1997) Root respiration in citrus acclimates to temperature and slows during drought. *Plant Cell and Environment*, **20**, 1411–20.
- Bryla, D. R., Bouma, T. J., Hartmond, U. and Eissenstat, D. M. (2001) Influence of temperature and soil drying on respiration of individual roots in citrus: integrating greenhouse observations into a predictive model for the field. *Plant Cell and Environment*, **24**, 781–90.
- Burton, A. J. and Pregitzer, K. S. (2003) Field measurements of root respiration indicate little to no seasonal temperature acclimation for sugar maple and red pine. *Tree Physiology*, **23**, 273–80.
- Burton, A. J., Pregitzer, K. S., Zogg, G. P. and Zak, D. R. (1996) Latitudinal variation in sugar maple fine root respiration. *Canadian Journal of Forest Research*, **26**, 1761–8.
- Burton, A. J., Zogg, G. P., Pregitzer, K. S. and Zak, D. R. (1997) Effect of measurement CO₂ concentration on sugar maple root respiration. *Tree Physiology*, **17**, 421–7.
- Burton, A. J., Pregitzer, K. S., Zogg, G. P. and Zak, D. R. (1998) Drought reduces root respiration in sugar maple forests. *Ecological Applications*, **8**, 771–8.
- Burton, A. J., Pregitzer, K. S., Ruess, R. W., Hendrik, R. L. and Allen, M. F. (2002) Root respiration in North American forests: effects of nitrogen concentration and temperature across biomes. *Oecologia*, **131**, 559–68.
- Cabrera, R. M. and Saltveit, M. E. (2003) Survey of wound-induced ethylene production by excised root segments. *Physiologia Plantarum*, **119**, 203–11.
- Cheng, W., Coleman, D. C., Carroll, C. R. and Hoffman, C. A. (1993) *In situ* measurements of root respiration and soluble C concentrations in the rhizosphere. *Soil Biology and Biochemistry*, **25**, 1189–96.
- Cheng, W. X., Fu, S. L., Susfalk, R. B. and Mitchell, R. J. (2005) Measuring tree root respiration using ¹³C natural abundance: rooting medium matters. *New Phytologist*, **167**, 297–307.
- Christ, R. A. and Korner, C. (1995) Responses of shoot and root gas-exchange, leaf blade expansion and biomass production to pulses of elevated CO₂ in hydroponic wheat. *Journal of Experimental Botany*, **46**, 1661–7.
- Covey-Crump, E. M., Attwood, R. G. and Atkin, O. K. (2002) Regulation of root respiration in two species of *Plantago* that differ in relative growth rate: the effect of short- and long-term changes in temperature. *Plant Cell and Environment*, **25**, 1501–13.

- Cramer, M. D. and Richards, M. B. (1999) The effect of rhizosphere dissolved inorganic carbon on gas exchange characteristics and growth rates of tomato seedlings. *Journal of Experimental Botany*, **50**, 79–87.
- Crawford, R. M. M. and Palin, M. A. (1981) Root respiration and temperature limits to the north-south distribution of four perennial maritime plants. *Flora*, **171**, 338–54.
- Cropper, W. P. J. and Gholz, H. L. (1991) *In situ* needle and fine root respiration in mature slash pine (*Pinus elliottii*) trees. *Canadian Journal of Forest Research*, **21**, 1589–95.
- Davidson, E. A., Verchot, L. V., Cattanio, J. H., Ackerman, I. L. and Carvalho, J. E. M. (2000) Effects of soil water content on soil respiration in forests and cattle pastures of eastern Amazonia. *Biogeochemistry*, **48**, 53–69.
- de Wit, C. T., Brouwer, R. and Penning de Vries, F. W. T. (1970) The simulation of photosynthetic systems. In *Prediction and Measurement of Photosynthetic Productivity*, ed. I. Setlik. Wageningen: Centre for Agricultural Publishing and Documentation, pp. 47–70.
- Desrochers, A., Landhäusser, S. M. and Lieffers, V. J. (2002) Coarse and fine root respiration in aspen (*Populus tremuloides*). *Tree Physiology*, **22**, 725–32.
- Dilly, O., Bach, H. J., Buscot, F. *et al.* (2000) Characteristics and energetic strategies of the rhizosphere in ecosystems of the Bornhoved Lake district. *Applied Soil Ecology*, **15**, 201–10.
- Eccher, M. (1972) Die Wurzelatmung von Holzpflanzen und ihre Bedeutung für die Stoffproduktion. University of Innsbruck, Innsbruck.
- Edwards, E. J., Benham, D. G., Marland, L. A. and Fitter, A. H. (2004) Root production is determined by radiation flux in a temperate grassland community. *Global Change Biology*, **10**, 209–27.
- Ekblad, A. and Höglberg, P. (2001) Natural abundance of ^{13}C in CO_2 respired from forest soils reveals speed of link between tree photosynthesis and root respiration. *Oecologia*, **127**, 305–8.
- Ewel, K. C., Cropper, W. P. and Gholz, H. L. (1987) Soil CO_2 evolution in Florida slash pine plantations. I. Importance of root respiration. *Canadian Journal of Forest Research*, **17**, 330–3.
- Fahey, T. J. and Yavitt, J. B. (2005) An *in situ* approach for measuring root-associated respiration and nitrate uptake of forest trees. *Plant and Soil*, **272**, 125–31.
- Farrar, J. F. (1999) Carbohydrate: where does it come from, where does it go? In *Plant Carbohydrate Biochemistry*, ed. J. A. Bryant, M. M. Burrell and N. J. Kruger. Oxford: Bios Scientific Publishers, pp. 29–46.
- Farrar, J. F. and Williams, J. H. H. (1990). Control of the rate of respiration in roots. In *Compartmentation of Plant Metabolism in Non-photosynthetic Tissues*, ed. M. J. Emes. Cambridge: Cambridge University Press, pp. 167–88.
- Fitter, A. H., Graves, J. D., Self, G. K. *et al.* (1998) Root production, turnover and respiration under two grassland types along an altitudinal gradient: influence of temperature and solar radiation. *Oecologia*, **114**, 20–30.
- Flores, H. E., Weber, C. and Puffett, J. (1996) Underground plant metabolism: the biosynthetic potential of roots. In *Plant Roots: The Hidden Half*, 2nd edn, ed. Y. Waisel, A. Eshel and U. Kafkafi. New York: Marcel Dekker, pp. 931–56.
- Framba, L. (1980) Beiträge zur Methodik der Wurzelatmungsmessung und ihre Anwendung bei der physiologischen Charakterisierung von jungen Nadelbäumen. University of Innsbruck, Innsbruck.
- Gansert, D. (1994) Root respiration and its importance for the carbon balance of beech saplings (*Fagus sylvatica* L.) in a montane beech forest. *Plant and Soil*, **167**, 109–19.
- Gansert, D. (1995) *Die Wurzel- und Sproßrespiration junger Buchen (Fagus sylvatica L.) in einem montanen Moder-Buchenwald*. Göttingen: Cuvillier Verlag.
- George, K., Norby, R. J., Hamilton, J. G. and DeLucia, E. H. (2003) Fine-root respiration in a loblolly pine and sweetgum forest growing in elevated CO_2 . *New Phytologist*, **160**, 511–22.
- Godbold, D. L., Hoosbeek, M. R., Lukac, M. *et al.* (2006) Mycorrhizal hyphal turnover as a dominant process for carbon input into soil organic matter. *Plant and Soil*, **281**, 15–24.
- González-Meler, M. A. and Siedow, J. N. (1999) Direct inhibition of mitochondrial respiratory enzymes by elevated CO_2 : does it matter at the tissue or whole-plant level? *Tree Physiology*, **19**, 253–9.
- Gorissen, A. and Kuyper, T. W. (2000) Fungal species-specific responses of ectomycorrhizal Scots pine (*Pinus sylvestris*) to elevated $[\text{CO}_2]$. *New Phytologist*, **146**, 163–8.
- Grayston, S. J., Vaughan, D. and Jones, D. (1997) Rhizosphere carbon flow in trees, in comparison with annual plants: the importance of root exudation and its impact on microbial activity and nutrient availability. *Applied Soil Ecology*, **5**, 29–56.
- Gunn, S. and Farrar, J. F. (1999) Effects of a 4 °C increase in temperature on partitioning of leaf area and dry mass,

- root respiration and carbohydrates. *Functional Ecology*, **13**, 12–20.
- Haller, T. and Stolp, H. (1985) Quantitative estimation of root exudation of maize plants. *Plant Soil*, **86**, 207–16.
- Heinemeyer, A. and Fitter, A. H. (2004) Impact of temperature on the arbuscular mycorrhizal (AM) symbiosis: growth responses of the host plant and its AM fungal partner. *Journal of Experimental Botany*, **55**, 525–34.
- Heinemeyer, A., Ineson, P., Ostle, N. and Fitter, A. H. (2006) Respiration of the external mycelium in the arbuscular mycorrhizal symbiosis shows strong dependence on recent photosynthates and acclimation to temperature. *New Phytologist*, **171**, 159–70.
- Heinemeyer, A., Hartley, I. P., Evans, S. P., Carreira De La Fuente, J. A. and Ineson, P. (2007) Forest soil CO₂ flux: uncovering the contribution and environmental responses of ectomycorrhizas. *Global Change Biology*, **13**, 1786–97.
- Hendrick, R. L. and Pregitzer, K. S. (1992) The demography of fine roots in a northern hardwood forest. *Ecology*, **73**, 1094–104.
- Hendricks, J. J., Nadelhoffer, K. J. and Aber, J. D. (1993) Assessing the role of fine roots in carbon and nutrient cycling. *Trends in Ecology and Evolution*, **8**, 174–8.
- Hendricks, J. J., Hendrick, R. L., Wilson, C. A. *et al.* (2006) Assessing the patterns and controls of fine root dynamics: an empirical test and methodological review. *Journal of Ecology*, **94**, 40–57.
- Hertel, D. and Leuschner, C. (2002) A comparison of four different fine root production estimates with ecosystem carbon balance data in a *Fagus-Quercus* mixed forest. *Plant and Soil*, **239**, 237–51.
- Higgins, P. D. and Spomer, G. G. (1976) Soil temperature effects on root respiration and the ecology of alpine and subalpine plants. *Botanical Gazette*, **137**, 110–20.
- Högberg, M. N. and Högberg, P. (2002) Extramatrical ectomycorrhizal mycelium contributes one-third of microbial biomass and produces, together with associated roots, half the dissolved organic carbon in a forest soil. *New Phytologist*, **154**, 791–5.
- Högberg, P., Nordgren, A., Buchmann, N. *et al.* (2001) Large-scale forest girdling shows that current photosynthesis drives soil respiration. *Nature*, **411**, 789–92.
- Högberg, P., Nordgren, A. and Agren, G. I. (2002) Carbon allocation between tree root growth and root respiration in boreal pine forest. *Oecologia*, **132**, 579–81.
- Horwath, W. R., Pregitzer, K. S. and Paul, E. A. (1994) ¹⁴C allocation in tree soil systems. *Tree Physiology*, **14**, 1163–76.
- Jakobsen, I. and Rosendahl, L. (1990) Carbon flow into soil and external hyphae from roots of mycorrhizal cucumber plants. *New Phytologist*, **115**, 77–83.
- Johnson, D., Leake, J. R. and Read, D. J. (2001a) Novel in-growth core system enables functional studies of grassland mycorrhizal mycelial networks. *New Phytologist*, **152**, 555–62.
- Johnson, D., Leake, J. R., Ostle, N., Ineson, P. and Read, D. J. (2002a) *In situ* ¹³CO₂ pulse-labelling of upland grassland demonstrates a rapid pathway of carbon flux from arbuscular mycorrhizal mycelia to the soil. *New Phytologist*, **153**, 327–34.
- Johnson, D., Leake, J. R. and Read, D. J. (2002b) Transfer of recent photosynthate into mycorrhizal mycelium of an upland grassland: short-term respiratory losses and accumulation of ¹⁴C. *Soil Biology and Biochemistry*, **34**, 1521–4.
- Johnson, M. G., Tingey, D. T., Phillips, D. L. and Storm, M. J. (2001b) Advancing fine root research with minirhizotrons. *Environmental and Experimental Botany*, **45**, 263–89.
- Kalela, E. K. (1955) Über die Veränderungen in den Wurzelerhältnissen der Kiefernbestände im Laufe der Vegetationsperiode. *Acta Forestalia Fennica*, **65**, 1–54.
- Keyes, M. R. and Grier, C. C. (1981) Above-ground and below-ground net production in 40-year-old Douglas-Fir stands on low and high productivity sites. *Canadian Journal of Forest Research*, **11**, 599–605.
- Kimura, M., Mototani, I. and Hogetsu, K. (1968) Ecological and physiological studies on the vegetation of Mt. Shimagare VI: growth and dry matter production of young *Abies* stand. *The Botanical Magazine Tokyo*, **81**, 287–96.
- King, J. S., Hanson, P. J., Bernhardt, E. *et al.* (2004) A multiyear synthesis of soil respiration responses to elevated atmospheric CO₂ from four forest FACE experiments. *Global Change Biology*, **10**, 1027–42.
- Kucey, R. M. N. and Paul, E. A. (1982) Carbon flow, photosynthesis, and N₂ fixation in mycorrhizal and nodulated Faba Beans (*Vicia-Faba L.*). *Soil Biology and Biochemistry*, **14**, 407–12.
- Kuiper, D. (1983) Genetic differentiation in *Plantago-Major*: growth and root respiration and their role in phenotypic adaptation. *Physiologia Plantarum*, **57**, 222–30.

- Kutsch, W. L., Staack, A., Wötzel, J., Middelhoff, U. and Kappen, L. (2001a) Field measurements of root respiration and total soil respiration in an alder forest. *New Phytologist*, **150**, 157–68.
- Kutsch, W. L., Eschenbach, C., Dilly, O. *et al.* (2001b) The carbon cycle of contrasting landscape elements of the Bornhöved Lake district. In *Ecosystem Properties and Landscape Function in Central Europe*, ed. R. Lenz, R. Hantschel and J. D. Tenhunen. Vol. 147. Ecological Studies. Berlin: Springer, pp. 75–95.
- Kutsch, W. L., Liu, C. J., Hörmann, G. and Herbst, M. (2005) Spatial heterogeneity of ecosystem carbon fluxes in a broadleaved forest in Northern Germany. *Global Change Biology*, **11**, 70–88.
- Kuzyakov, Y. (2002) Separating microbial respiration of exudates from root respiration in non-sterile soils: a comparison of four methods. *Soil Biology and Biochemistry*, **34**, 1621–31.
- Kuzyakov, Y. and Cheng, W. (2001) Photosynthesis controls of rhizosphere respiration and organic matter decomposition. *Soil Biology and Biochemistry*, **33**, 1915–25.
- Kuzyakov, Y. and Cheng, W. (2004) Photosynthesis controls of CO₂ efflux from maize rhizosphere. *Plant and Soil*, **263**, 85–99.
- Kuzyakov, Y. and Domanski, G. (2000) Carbon input by plants into the soil. Review. *Journal of Plant Nutrition and Soil Science*, **163**, 421–31.
- Kuzyakov, Y. and Larionova, A. A. (2005) Root and rhizomicrobial respiration: a review of approaches to estimate respiration by autotrophic and heterotrophic organisms in soil. *Journal of Plant Nutrition and Soil Science*, **168**, 503–20.
- Kuzyakov, Y. and Siniakina, S. V. (2001) A novel method for separating root-derived organic compounds from root respiration in non-sterilized soils. *Journal of Plant Nutrition and Soil Science*, **164**, 511–17.
- Kuzyakov, Y., Kretschmar, A. and Stahr, K. (1999) Contribution of *Lolium perenne* rhizodeposition to carbon turnover of pasture soil. *Plant and Soil*, **213**, 127–36.
- Lambers, H. (1985) Respiration in intact plants and tissues: its regulation and dependence on environmental factors, metabolism and invaded organisms. In *Encyclopedia of Plant Physiology*, ed. R. Douce and D. A. Day. Berlin: Springer-Verlag, pp. 418–73.
- Lambers, H. (1987) Growth, respiration, exudation and symbiotic association: the fate of carbon translocated to roots. In *Root Development and Function*, ed. P. J. Gregory, J. V. Lake and D. A. Rose. Cambridge: Cambridge University Press, pp. 125–46.
- Lambers, H., Posthumus, F., Stulen, I. *et al.* (1981) Energy-metabolism of *Plantago*-Major Ssp-Major as dependent on the supply of mineral nutrients. *Physiologia Plantarum*, **51**, 245–52.
- Lambers, H., van der Werf, A. and Konings, H. (1991) Respiratory patterns in root in relation to their functioning. In *Plant Roots: The Hidden Half*, ed. Y. Waisel, A. Eshel and U. Kafkafi. New York: Marcel Dekker, pp. 229–64.
- Lambers, H., van der Werf, A. and Bergkotte, M. (1993) Respiration: the alternative pathway. In *Methods in Comparative Plant Ecology: A Laboratory Manual*, ed. G. A. F. Hendry and J. P. Grime. London: Chapman and Hall, pp. 140–4.
- Lambers, H., Atkin, O. K. and Scheurwater, I. (1996) Respiratory pattern in roots in relation to their functioning. In *Plant Roots: The Hidden Half*, 2nd edn, ed. Y. Waisel, A. Eshel and U. Kafkafi. New York: Marcel Dekker, pp. 323–62.
- Larigauderie, A. and Körner, C. (1995) Acclimation of leaf dark respiration to temperature in alpine and lowland plant species. *Annals of Botany*, **76**, 245–52.
- Lauenroth, W. K. (2000) Methods of estimating belowground net primary production. In *Methods in Ecosystem Science*, ed. O. Sala. New York: Springer-Verlag, pp. 58–71.
- Leake, J. R., Johnson, D., Donnelly, D. P. *et al.* (2004) Networks of power and influence: the role of mycorrhizal mycelium in controlling plant communities and agroecosystem functioning. *Canadian Journal of Botany*, **82**, 1016–45.
- Lee, M.-S., Nakane, K., Nakatsubo, T. and Koizumi, H. (2003) Seasonal changes in the contribution of root respiration to total soil respiration in a cool-temperate deciduous forest. *Plant and Soil*, **255**, 311–18.
- Leverenz, J. W., Bruhn, D. and Saxe, H. (1999) Responses of two provenances of *Fagus sylvatica* seedlings to a combination of four temperature and two CO₂ treatments during their first growing season: gas exchange of leaves and roots. *New Phytologist*, **144**, 437–54.
- Linder, S. and Troeng, E. (1981) The seasonal variation in stem and coarse root respiration of a 20-year old Scots pine (*Pinus sylvestris* L.). In *Radial Growth in Trees*, ed.

- W. Tranquillini. Vol. 142. Wien: Mitteilungen der forstlichen Bundesversuchsanstalt, pp. 125–39.
- Lipp, C. C. and Andersen, C. P. (2003) Role of carbohydrate supply in white and brown root respiration of ponderosa pine. *New Phytologist*, **160**, 523–31.
- Loveys, B. R., Atkinson, L. J., Sherlock, D. J. *et al.* (2003) Thermal acclimation of leaf and root respiration: an investigation comparing inherently fast- and slow-growing plant species. *Global Change Biology*, **9**, 895–910.
- Lowry, O. H., Rosenbrough, H. J., Farr, A. L. and Randall, R. J. (1951) Protein measurement with the Folin phenol reagent. *Biological Chemistry*, **193**, 265–75.
- Maier, C. A. and Kress, L. W. (2000) Soil CO₂ evolution and root respiration in 11 year-old loblolly pine (*Pinus taeda*) plantations as affected by moisture and nutrient availability. *Canadian Journal of Forest Research*, **30**, 347–59.
- Majdi, H. (1996) Root sampling methods: applications and limitations of the minirhizotron technique. *Plant and Soil*, **185**, 255–8.
- Majdi, H., Pregitzer, K., Moren, A. S., Nylund, J. E. and Agren, G. I. (2005) Measuring fine root turnover in forest ecosystems. *Plant and Soil*, **276**, 1–8.
- Marshall, J. D. and Perry, D. A. (1987) Basal and maintenance respiration of mycorrhizal and nonmycorrhizal root systems of conifers. *Canadian Journal of Forest Research*, **17**, 872–7.
- McCutchan, C. L. and Monson, R. K. (2001) Night-time respiration rate and leaf carbohydrate concentrations are not coupled in two alpine perennial species. *New Phytologist*, **149**, 419–30.
- McDowell, N. G., Marshall, J. D., Qi, J. G. and Mattson, K. (1999) Direct inhibition of maintenance respiration in western hemlock roots exposed to ambient soil carbon dioxide concentrations. *Tree Physiology*, **19**, 599–605.
- Middelhoff, U. (2000) *Simulationsgestützte Analyse der raum-zeitlichen Verteilung der Biomasse in einem Erlenwald unter besonderer Beachtung der Feinwurzelndynamik*. Aachen: Shaker Verlag.
- Mori, S. and Hagihara, A. (1991) Root respiration in *Chamaecyparis obtusa* trees. *Tree Physiology*, **8**, 217–25.
- Moyano, F. E., Kutsch, W. L. and Schulze, E.-D. (2007) Response of mycorrhizal, rhizosphere and soil basal respiration to temperature and photosynthesis in a barley field. *Soil Biology and Biochemistry*, **39**, 843–53.
- Moyano, F. E., Kutsch, W. L. and Rebbmann, C. (2008) Soil respiration fluxes in relation to photosynthetic activity in broad-leaf and needle-leaf forest stands. *Agricultural and Forest Meteorology*, **148**, 135–43.
- Nadelhoffer, K. J., Aber, J. D. and Melillo, J. M. (1985) Fine roots, net primary production, and soil nitrogen availability: a new hypothesis. *Ecology*, **66**, 1377–90.
- Nguyen, C. (2003) Rhizodeposition of organic C by plants: mechanisms and controls. *Agronomie*, **23**, 375–96.
- Palta, J. A. and Nobel, P. S. (1989a) Root respiration of *Agave deserti*: influence of temperature, water status and root age on daily patterns. *Journal of Experimental Botany*, **40**, 181–6.
- Palta, J. A. and Nobel, P. S. (1989b) Influences of water status, temperature, and root age on daily patterns of root respiration for two cactus species. *Annals of Botany*, **63**, 651–62.
- Paterson, E., Hall, J. M., Rattray, E. A. S. *et al.* (1997) Effect of elevated CO₂ on rhizosphere carbon flow and soil microbial processes. *Global Change Biology*, **3**, 363–77.
- Paul, E. A. and Clark, F. E. (1989) *Soil Microbiology and Biochemistry*. New York: Academic Press.
- Pendall, E., Bridgman, S., Hanson, P. J. *et al.* (2004) Below-ground process responses to elevated CO₂ and temperature: a discussion of observations, measurement methods, and models. *New Phytologist*, **162**, 311–22.
- Penning de Vries, F. W. T., Brunsting, A. H. M. and Van Laar, H. H. (1974) Products, requirements and efficiency of biosynthesis: a quantitative approach. *Journal of Theoretical Biology*, **45**, 339–77.
- Persson, H. (1978) Root dynamics in a young Scots pine stand in Central Sweden. *Oikos*, **30**, 508–19.
- Persson, H. (1980) Fine-root dynamics in a Scots pine stand with and without near optimum nutrient and water regimes. *Acta Phytogeographica Suecica*, **68**, 101–10.
- Phillips, R. P. and Fahey, T. J. (2005) Patterns of rhizosphere carbon flux in sugar maple (*Acer saccharum*) and yellow birch (*Betula allegheniensis*) saplings. *Global Change Biology*, **11**, 983–95.
- Poorter, H., Remkes, C. and Lambers, H. (1990) Carbon and nitrogen economy of 24 wild species differing in relative growth rate. *Plant Physiology*, **94**, 621–7.
- Poorter, H., Vandeijver, C., Boot, R. G. A. and Lambers, H. (1995) Growth and carbon economy of a fast-growing and a slow-growing grass species as dependent on nitrate supply. *Plant and Soil*, **171**, 217–27.
- Powell, S. W. and Day, F. P. (1991) Root production in four communities in the Great Dismal Swamp. *American Journal of Botany*, **78**, 288–97.

- Pregitzer, K. S., Kubiske, M. E., Yu, C. K. and Hendrick, R. L. (1997) Root architecture, carbon and nitrogen in four temperate forest species. *Oecologia*, **111**, 302–8.
- Pregitzer, K. S., Laskowski, M. J., Burton, A. J., Lessard, V. C. and Zak, D. R. (1998) Variation in sugar maple root respiration with root diameter and soil depth. *Tree Physiology*, **18**, 665–70.
- Qi, J. E., Marshall, J. D. and Mattson, K. G. (1994) High soil carbon-dioxide concentrations inhibit root respiration of Douglas-Fir. *New Phytologist*, **128**, 435–42.
- Rakonczay, Z., Seiler, J. R. and Samuelson, L. J. (1997) A method for the *in situ* measurement of fine root gas exchange of forest trees. *Environmental and Experimental Botany*, **37**, 107–13.
- Reuveni, J., Gale, J. and Mayer, A. M. (1993) Reduction of respiration by high ambient CO₂ and the resulting error in measurements of respiration made with O₂ electrodes. *Annals of Botany*, **72**, 129–31.
- Russell, R. S. (1982) *Plant Root Systems*, 1st edn. McGraw-Hill.
- Ryan, M. G., Hubbard, R. M., Pongracic, S., Raison, R. J. and McMurrie, R. E. (1996) Foliage, fine-root, woody-tissue and stand respiration in *Pinus radiata* in relation to nitrogen status. *Tree Physiology*, **16**, 333–43.
- Rygiewicz, P. T. and Andersen, C. P. (1994) Mycorrhizae alter quality and quantity of carbon allocated below ground. *Nature*, **369**, 58–60.
- Sands, R., Nugroho, P. B., Leung, D. W. M., Sun, O. J. and Clinton, P. W. (2000) Changes in soil CO₂ and O₂ concentrations when radiata pine is grown in competition with pasture or weeds and possible feedbacks with radiata pine root growth and respiration. *Plant and Soil*, **225**, 213–25.
- Schlesinger, W. H. (1997) *Biogeochemistry: An Analysis of Global Change*, 2nd edn. New York: Academic Press.
- Simard, S. W., Perry, D. A., Jones, M. D. *et al.* (1997) Net transfer of carbon between ectomycorrhizal tree species in the field. *Nature*, **388**, 579–82.
- Smakman, G. and Hofstra, R. J. J. (1982) Energy metabolism of *Plantago lanceolata*, as affected by change in root temperature. *Physiologia Plantarum*, **56**, 33–7.
- Smith, S. E. and Read, D. J. (1997) *Mycorrhizal Symbiosis*. London: Academic Press.
- Soderstrom, B. and Read, D. J. (1987) Respiratory activity of intact and excised ectomycorrhizal mycelial systems growing in unsterilized soil. *Soil Biology and Biochemistry*, **19**, 231–6.
- Sowell, J. B. and Spomer, G. G. (1986) Ecotypic variation in root respiration rate among elevational populations of *Abies lasiocarpa* and *Picea engelmannii*. *Oecologia*, **68**, 375–9.
- Sprugel, D. G. and Benecke, U. (1991) Measuring woody-tissue respiration and photosynthesis. In *Techniques and Approaches in Forest Tree Ecophysiology*, ed. J. P. Lassiö and T. M. Hinckley. Boca Raton, FL: CRC Press, pp. 329–55.
- Sprugel, D. G., Ryan, M. R., Brooks, J. R., Vogt, K. A. and Martin, T. A. (1995) Respiration from the organ level to the stand. In *Resource Physiology of Conifers: Acquisition, Allocation, and Utilization*, ed. W. K. Smith and T. M. Hinckley. San Diego, CA: Academic Press, pp. 255–99.
- Staddon, P. L. (2005) Mycorrhizal fungi and environmental change: the need for a myco-centric approach. *New Phytologist*, **167**, 635–7.
- Staddon, P. L., Ramsey, C. B., Ostle, N., Ineson, P. and Fitter, A. H. (2003) Rapid turnover of hyphae of mycorrhizal fungi determined by AMS microanalysis of ¹⁴C. *Science*, **300**, 1138–40.
- Stark, S. and Kytöviita, M. M. (2005) Evidence of antagonistic interactions between rhizosphere microorganisms and mycorrhizal fungi associated with birch (*Betula pubescens*). *Acta Oecologica – International Journal of Ecology*, **28**, 149–55.
- Swinnen, J. (1994) Evaluation of the use of a model rhizodeposition technique to separate root and microbial respiration in soil. *Plant and Soil*, **165**, 89–101.
- Tang, J. W., Baldocchi, D. D. and Xu, L. (2005) Tree photosynthesis modulates soil respiration on a diurnal time scale. *Global Change Biology*, **11**, 1298–304.
- Teskey, R. O. and McGuire, M. A. (2005) CO₂ transported in xylem sap affects CO₂ efflux from *Liquidambar styraciflua* and *Platanus occidentalis* stems, and contributes to observed wound respiration phenomena. *Trees – Structure and Function*, **19**, 357–62.
- Tjoelker, M. G., Oleksyn, J. and Reich, P. B. (1999) Acclimation of respiration to temperature and CO₂ in seedlings of boreal tree species in relation to plant size and relative growth rate. *Global Change Biology*, **5**, 679–91.
- Tjoelker, M. G., Oleksyn, J. and Reich, P. B. (2001) Modelling respiration of vegetation: evidence for a general temperature-dependent Q(10). *Global Change Biology*, **7**, 223–30.

- Tjoelker, M. G., Craine, J. M., Wedin, D., Reich, P. B. and Tilman, D. (2005) Linking leaf and root trait syndromes among 39 grassland and savannah species. *New Phytologist*, **167**, 493–508.
- Toal, M. E., Yeomans, C., Killham, K. and Meharg, A. A. (2000) A review of rhizosphere carbon flow modelling. *Plant and Soil*, **222**, 263–81.
- Tranquillini, W. (1959) Die Stoffproduktion der Zirbe (*Pinus cembra* L.) an der Waldgrenze während eines Jahres II. Zuwachs und CO₂-Bilanz. *Planta*, **54**, 130–51.
- Uren, N. C. (2000) Types, amounts, and possible functions of compounds released into the rhizosphere by soil-grown plants. In *The Rhizosphere: Biochemistry and Organic Substances at the Soil-Plant Interface*, ed. R. Pinto, Z. Varanini and P. Nannipieri. New York: Marcel Dekker, pp. 19–40.
- van der Westhuizen, M. M. and Cramer, M. D. (1998) The influence of elevated rhizosphere dissolved inorganic carbon concentrations on respiratory O₂ and CO₂ flux in tomato roots. *Journal of Experimental Botany*, **49**, 1977–85.
- Vanemmerik, W. A. M., Wagner, A. M. and Vanderplas, L. H. W. (1992) A quantitative comparison of respiration in cells and isolated-mitochondria from *Petunia-Hybrida* suspension-cultures: a high-yield isolation procedure. *Journal of Plant Physiology*, **139**, 390–6.
- Vogt, K. A. and Bloomfield, J. (1991) Tree root turnover and senescence. In *Plant Roots: The Hidden Half*, ed. Y. Waisel, A. Eshel and U. Kafkaki. New York: Marcel Dekker, pp. 287–306.
- Vogt, K. A. and Persson, H. (1991) Root methods. In *Techniques and Approaches in Forest Tree Ecophysiology*, ed. J. P. Lassoie and T. Hinckley. Boca Raton, FL: CRC Press, pp. 477–502.
- Vogt, K. A., Vogt, D. J., Moore, E. E. and Sprougel, D. G. (1989) Methodological considerations in measuring biomass, production, respiration and nutrient resorption for tree roots in natural ecosystems. In *Applications of Continuous and Steady-state Methods in Root Biology*, ed. J. Torrey and L. J. Winship. Dordrecht, the Netherlands: Kluwer Academic Publishers.
- Volder, A., Smart, D. R., Bloom, A. J. and Eissenstat, D. M. (2005) Rapid decline in nitrate uptake and respiration with age in fine lateral roots of grape: implications for root efficiency and competitive effectiveness. *New Phytologist*, **165**, 493–501.
- Vose, J. M. and Ryan, M. G. (2002) Seasonal respiration of foliage, fine roots, and woody tissues in relation to growth, tissue N, and photosynthesis. *Global Change Biology*, **8**, 182–93.
- Walker, D. A. (1985). Measurement of oxygen and chlorophyll fluorescence. In *Techniques in Bioproductivity and Photosynthesis*, ed. Coombs. Oxford: Pergamon Press, pp. 95–106.
- Weger, H. G. and Guy, R. D. (1991) Cytochrome and alternative pathway respiration in white spruce (*Picea glauca*) roots. Effects of growth and measurement temperature. *Physiologia Plantarum*, **83**, 675–81.
- Werth, M. and Kuzyakov, Y. (2005) Root-derived carbon in soil respiration and microbial biomass determined by ¹⁴C and ¹³C. *Soil Biology and Biochemistry*, **40**, 625–37.
- Wiant, H. V. (1967) Has contribution of litter decay to forest soil respiration been overestimated. *Journal of Forestry*, **65**, 408.
- Wieser, G. and Bahn, M. (2004) Seasonal and spatial variation of woody tissue respiration in a *Pinus cembra* tree at the alpine timberline in the central Austrian Alps. *Trees – Structure and Function*, **18**, 576–80.
- Zak, D. R., Holmes, W. E., MacDonald, N. W. and Pregitzer, K. S. (1999) Soil temperature, matric potential, and the kinetics of microbial respiration and nitrogen mineralization. *Soil Science Society of America Journal*, **63**, 575–84.
- Zak, D. R., Pregitzer, K. S., King, J. S. and Holmes, W. E. (2000) Elevated atmospheric CO₂, fine roots and the response of soil microorganisms: a review and hypothesis. *New Phytologist*, **147**, 201–22.
- Zhao, M. S., Heinsch, F. A., Nemani, R. R. and Running, S. W. (2005) Improvements of the MODIS terrestrial gross and net primary production global data set. *Remote Sensing of Environment*, **95**, 164–76.
- Zogg, G. P., Zak, D. R., Burton, A. J. and Pregitzer, K. S. (1996) Fine root respiration in northern hardwood forests in relation to temperature and nitrogen availability. *Tree Physiology*, **16**, 719–25.

8 • Separating autotrophic and heterotrophic components of soil respiration: lessons learned from trenching and related root-exclusion experiments

Daniel Epron

8.1 INTRODUCTION

Soil respiration (R_S , Fig. 8.1) is the sum of an autotrophic component (R_A) produced by roots and the associated rhizosphere (mycorrhizae and rhizosphere bacteria) and a heterotrophic component (R_H) originating from soil micro-organisms that decompose the organic materials from both above-ground and below-ground litter (Bowden *et al.*, 1993; Boone *et al.*, 1998; Epron *et al.*, 1999). Autotrophic respiration involves root carbohydrates and root exudates that have very low residence time in soil, while the heterotrophic component involves carbon compounds with a longer residence time, ranging from months to years for fresh litter and from years to centuries for old soil organic matter. All components are thought to be differently influenced by climatic conditions and site characteristics (Boone *et al.*, 1998; Epron *et al.*, 2001; Lavigne *et al.*, 2004; Dilustro *et al.*, 2005) and are thought to respond differently to elevated atmospheric CO₂ or soil warming (Rustad *et al.*, 2001; King *et al.*, 2004; Pendall *et al.*, 2004; Soe *et al.*, 2004; Eliasson *et al.*, 2005). Thus, separate estimations of these components are required for analyzing and modelling soil respiration and its response to climate or perturbation, for providing a better knowledge of carbon budgets of ecosystems and for improving carbon sequestration in soil (Hanson *et al.*, 2000; Ryan and Law, 2005; Subke *et al.*, 2006). Reliable estimates of heterotrophic respiration are also required to evaluate the variation in soil carbon stocks (ΔC_S) as the difference between litter production (L) and the heterotrophic component of soil respiration

($\Delta C_S = L - R_H$), when the loss of soluble or volatile organic carbon is negligible (Hanson *et al.*, 2000). Similarly, carbon sequestration in an ecosystem (i.e. net ecosystem production, NEP) can be evaluated as the difference between the change in plant biomass (biomass increment, ΔB and litter production), and the heterotrophic component of soil respiration ($NEP = \Delta B + L - R_H$, Law *et al.*, 2001).

Estimation of the contribution of root respiration to total soil respiration varies widely, from 22% (Tate *et al.*, 1993) to 90% of total soil respiration (Thierron and Laudelout, 1996) with most values ranging between 50% and 60% (Nakane *et al.*, 1983, 1996; Hanson *et al.*, 2000; Epron *et al.*, 2001; Bond-Lamberty *et al.*, 2004b). A significant part of this variability is probably a consequence of limitations in the various methods that have been employed. The various methods that enable the separation of autotrophic from heterotrophic respiration have been examined critically by Hanson *et al.* (2000) and, more recently, by Kuzyakov (2006) and Subke *et al.* (2006). Root respiration can be estimated by comparing *in situ* soil respiration and microbial respiration of soil samples from which roots were removed (Lamade *et al.*, 1996; Thierron and Laudelout, 1996), or alternatively, heterotrophic respiration can be estimated by subtracting specific respiration of excavated roots from soil respiration (Maier and Kress, 2000; Kutsch *et al.*, 2001; Law *et al.*, 2001; Bahn *et al.*, 2006). These component integration methods are criticized because of disturbance effects due to the physical separation of the components (soil coring and sieving, root sorting

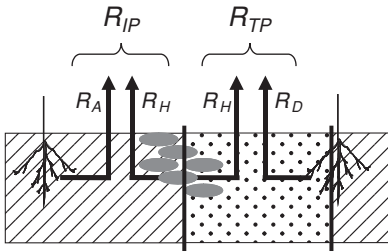

Figure 8.1 Soil respiration and its components (R_{IP} , soil respiration in intact, control plots; R_{TP} , soil respiration in trenched (or girdled) plots; R_A , autotrophic respiration; R_H , heterotrophic respiration; R_D , additional heterotrophic respiration associated to the decomposition of root killed after trenching, clear cutting, clipping or girdling).

and cleaning) and because of potential errors when scaling mass-based rates of microbial (or root) respiration to area-based rates of soil respiration. Autotrophic and heterotrophic components of soil respiration can also be estimated indirectly by regressing soil respiration against root biomass (Kucera and Kirham, 1971), but this approach is valid only when there is a strong correlation between root biomass and soil respiration, which might be more often the case in grassland than in forest ecosystems. Autotrophic respiration can also be calculated by subtracting litter, root and soil organic matter decomposition rates from soil respiration (Ewel *et al.*, 1987; Epron *et al.*, 2001) but there are large uncertainties both on the decomposition kinetics of some compartments, or on microbial efficiency (i.e. the fraction of carbon not lost as CO_2 during decomposition). The partitioning of soil respiration into autotrophic and heterotrophic components of soil respiration has also been obtained with isotopic techniques, using bomb derived ^{14}C signature (Dörr and Münnich, 1986; Gaudinski *et al.*, 2000; Trumbore, 2000; Schuur and Trumbore, 2006) or by pulse labelling plant materials with ^{14}C or ^{13}C CO_2 (Swinnen, 1994; Cheng, 1996). The greatest uncertainty with pulse labelling methods is the time lag required for a uniform labelling of all carbon pools that contribute to the autotrophic respiration. Continuous ^{13}C labelling has been successfully applied in free-air carbon dioxide enrichment (FACE) or related experiments since recently assimilated carbon (photosynthates) that was respired by roots was strongly depleted as compared with older carbon due to CO_2 enrichment with industrial CO_2 (Andrews *et al.*, 1999; Lin *et al.*,

1999). The partitioning is derived from a linear mixing model assuming two sources of CO_2 in soil with a pronounced difference in their isotopic signature, but these labelling approaches are expensive and are not easily adaptable to all kinds of ecosystems. A similar mass balance partitioning technique using natural isotopic abundance of soil CO_2 sources after substitution of C_3 crops by C_4 plants that are less depleted in ^{13}C than C_3 plants (Rochette and Flanagan, 1997; Rochette *et al.*, 1999) has also led to reasonable partitioning of soil respiration. However, in most cases, the $^{13}\text{C}/^{12}\text{C}$ ratio in soil organic matter SOM remains close to the ratio in the original vegetation and isotopic fractionation during respiration or diffusion is not negligible. In such conditions, root-respired CO_2 cannot be easily distinguished from SOM-derived CO_2 .

Root exclusion techniques are the most widely used methods in forest ecosystems. Autotrophic respiration can be estimated by subtracting the annual soil respiration recorded on small trenched plots from the one recorded on the main plot (Ewel *et al.*, 1987; Bowden *et al.*, 1993; Epron *et al.*, 2006). At a larger scale, root respiration can be estimated by comparing soil respiration between intact and clear-felled plots (Nakane *et al.*, 1983, 1996; Epron *et al.*, 2006) or between intact and girdled plots (Högberg *et al.*, 2001; Bhupinderpal-Singh *et al.*, 2003; Högberg *et al.*, 2005). The first objective of this chapter is to present trenching and other root-exclusion techniques for separating autotrophic and heterotrophic components of soil respiration and to provide technical recommendations for designing field studies. Calculations and underlying assumptions will be presented and limitations and shortcomings will be discussed. Finally, knowledge gained from field studies using root-exclusion approaches will be reviewed. However, readers should refer to recent reviews by Kuzyakov (2006) and Subke *et al.* (2006) for a broader overview including other approaches for partitioning soil respiration.

8.2 ROOT EXCLUSION: THE TRENCHING APPROACH

The trenching approach is the most widely used root-exclusion method for separating autotrophic and heterotrophic components of soil respiration and will be considered first. Trenched plots are small,

vegetation-free areas, surrounded by a trench that severs all roots from trees growing in the vicinity of the plot.

Trenched plots are necessarily small as they are installed between trees, and their size will finally depend on tree spacing. Reported areas ranged from less than 0.5 m² in dense forests to more than 10 m² in tree plantations (Table 8.1, Fig. 8.2). Above-ground parts of plants growing in trenched plots have to be removed by cutting them off at the soil surface. Herbicide is sometimes applied on the cut plants or on the severed roots visible on the trench walls to kill roots that would otherwise survive and respire after trenching (Lee *et al.*, 2003). Care should be taken to avoid new vegetation developing on the trenched plots. Clipping the surface periodically is more appropriate than using herbicides that may affect the microbial community. Digging depth depends on rooting depth and typically ranges between 30 cm in soils that exhibit a superficial clay layer and 2 m in deep sandy soils (Table 8.1). The trench should ideally extend 20 cm below the limit of the rooting zone (Bowden *et al.*, 1993). The depth of the trench should therefore be adapted to site characteristics, and should be chosen knowing the rooting pattern. The number of trenched plots per stand, typically around four to five in most studies (Table 8.1), is limited by the size of the stand and by the fact that digging trenches is labour intensive. As a general rule it is better to install several small trenched plots than a few larger ones, in order to cover spatial variability adequately. Trenching is either done by digging a large trench around the plot and lining it before filling it in again, or by making vertical cuts with a steel knife. Lining prevents root re-growth. The most frequently used lining materials are plastic film, plastic board or landscaping fabric. The latter should be recommended when lateral water circulation is important. Potential root re-growth, especially from below the lined trenches, cannot be completely eliminated and should be carefully checked. Measurements should not be made near the edge of the plot since lateral diffusion of CO₂ through some types of lining materials might alter CO₂ fluxes (Lavigne *et al.*, 2003). Measurement locations within trenched plots typically range between 1 and 12 depending on the plot size and number. Total numbers of measurements should be adjusted to maintain the confidence interval within an acceptable range, considering that the number of subplot measurements will not reduce plot to plot variance. It is good practice

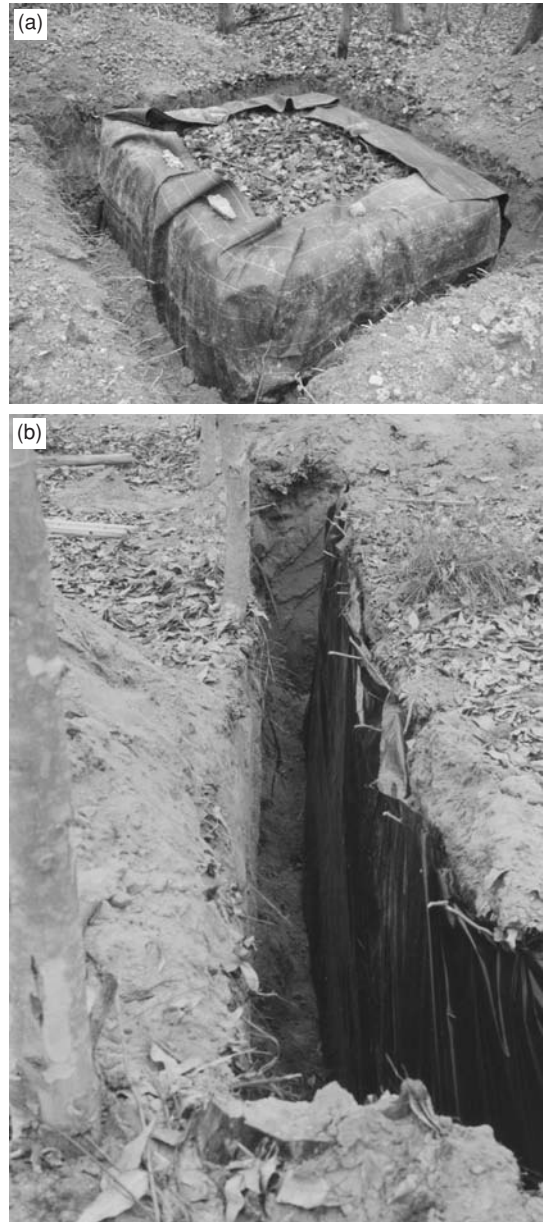

Figure 8.2 Typical examples of trenching experiments in (a) a beech forest (Hesse, France; photo J. Ngao); (b) a Eucalyptus plantation (Hinda, Congo; photo C. Jourdan).

to measure soil respiration on trenched plot locations for a certain period of time before trenching in order to be quite sure that differences in soil respiration following trenching can be ascribed to the cessation of autotrophic respiration.

Table 8.1 Typical examples of partitioning experiments using either trenched plot (TP), clearcut plot (CC) or girdled plot (GP) approaches. Plot areas, depth of trenches and number of replicates are given where available. Studies in which root decomposition (R_D) and difference in soil water content (W_S) were considered (YES) or were not considered (NO) are mentioned. The autotrophic contribution of soil respiration (R_A) is also given. This is not an exhaustive literature survey. Readers should refer to the recent meta-analysis by Subke et al. (2006) for a complete overview.

Ecosystem	Site	Method	Area (m ²)	Depth (m)	N	R_D	W_S	R_A (%)	Reference
<i>Pinus elliotii</i> , FL, USA	9 y.o.	TP	8.8	1.0	4	YES	NO	51	Ewel et al., 1987
<i>Pinus elliotii</i> , FL, USA	29 y.o.	TP	8.8	1.0	4	YES	NO	62	Ewel et al., 1987
Mixed, MA, USA	–	TP	9.0	0.7–1.0	3	NO	NO	33	Bowden et al., 1993
<i>Fagus sylvatica</i> , France	30 y.o.	TP	3.0	1.0	2	YES	YES	60	Epron et al., 1999
<i>Picea mariana</i> , Canada	drained	TP	4.0	0.5–0.8	1	NO	NO	22	O'Connell et al., 2003
<i>Picea mariana</i> , Canada	poorly drained	TP	4.0	0.5–0.8	1	NO	NO	18	O'Connell et al., 2003
<i>Abies balsamea</i> , Canada	cool	TP	4.0	0.3	5	YES	NO	38	Lavigne et al., 2003
<i>Abies balsamea</i> , Canada	moderate	TP	2.0	0.3	5	YES	NO	56	Lavigne et al., 2003
<i>Abies balsamea</i> , Canada	warm	TP	2.0	0.3	5	YES	NO	64	Lavigne et al., 2003
<i>Picea mariana</i> , Canada	4–152 y.o.	TP	1.0	0.5	8	NO	NO	0–40	Bond-Lamberty et al., 2004a
<i>Eucalyptus</i> , Congo	3 y.o.	TP	10.2	2.0	4	YES	NO	26	Epron, unpublished
<i>Pinus densiflora</i> , Japan	80 y.o.	CC	600	–	1	YES	NO	50	Ewel et al., 1987
<i>Fagus sylvatica</i> , Germany	146 y.o.	CC	710	–	1	NO	NO	40	Brumme, 1995
<i>Pinus banksiana</i> , Canada	70 y.o.	CC	–	–	1	NO	NO	35	Striegl and Wickland, 1998
<i>Quercus serrata</i> , Japan	102 y.o.	CC	200	–	2	YES	NO	51	Nakane et al., 1996
<i>Cryptomeria japonica</i> , Japan	10 y.o.	CC	6.2	–	1	YES	NO	57	Ohashi et al., 2000
<i>Eucalyptus</i> , Congo	8 y.o.	CC	18 ha	–	1	YES	YES	41	Epron et al., 2006
<i>Pinus sylvestris</i> , Sweden	45–55 y.o.	GP	900	–	3	–	NO	50	Högberg et al., 2001
Mixed coniferous, Sweden	>100 y.o.	GP	700	–	3	–	NO	>50	Högberg et al., 2005
<i>Picea abies</i> , Sweden	40 y.o.	GP	1000	–	3	–	NO	50–63	Olsson et al., 2005
<i>Fagus sylvatica</i> , Germany	40–50 y.o.	GP	–	–	5	–	NO	50	Andersen et al., 2005

8.2.1 Calculations and assumptions

If one assumes that roots die immediately after trenching, then heterotrophic respiration is the only source of CO₂ in trenched plots:

$$R_H = R_{TP} \quad \text{Eq. (8.1)}$$

and autotrophic respiration can be simply calculated by subtracting soil respiration recorded over the trenched plots (R_{TP}) from soil respiration recorded over the intact plots (R_{IP}):

$$R_A = R_{IP} - R_{TP} \quad \text{Eq. (8.2)}$$

A basic assumption is that the trenching treatment does not affect the heterotrophic component of soil respiration in the trenched plots. However, as we assume that death and subsequent decomposition follow immediately after trenching (see discussion below), decomposition of cut roots will contribute to and therefore modify heterotrophic respiration over the trenched plots. Fine roots that decompose rapidly are expected to transiently increase soil respiration during the first months after trenching, while coarse roots will decompose more slowly, increasing soil respiration over a longer period of time at an extent that depends on initial root biomass (B_{Ro}). The CO₂ efflux resulting from the decomposition of detached roots (R_D) has to be subtracted from the integrated values of R_{TP} over the considered time interval according to Eq. (8.4).

$$R_A = R_{IP} - (R_{TP} - R_D) \quad \text{Eq. (8.3)}$$

$$R_H = R_{TP} - R_D \quad \text{Eq. (8.4)}$$

with R_D , the CO₂ efflux resulting from the decomposition of killed roots. This correction requires additional data such as initial root biomass B_{Ro} , and the relative mass remaining at the end of the measuring season (RMR) for each diameter class. Integrated over time since the trenching date, respiration associated with the decomposition of killed roots can therefore be calculated as:

$$R_D = \sum_{i=1}^n (1 - a_i) \cdot C_i \cdot B_{Ro_i} \cdot (1 - \text{RMR}_i) \quad \text{Eq. (8.5)}$$

with a_i being the fraction of carbon that enters the soil carbon pool (microbial efficiency), $1 - a_i$ being the loss as CO₂ during mineralization, C_i the root carbon content, RMR_{*i*} the remaining root mass for the *i*th diameter class, and n being the number of diameter classes. Parameter

C_i can be easily determined and is typically about 0.48 g C g⁻¹. Values of a_i are more difficult to determine. Using ¹³C depleted leaf litter we found a microbial efficiency of 0.2 for leaf decomposition in a temperate beech stand (Ngao *et al.*, 2005). Values ranging between 0.2 and 0.5 are often assumed for carbon flow from different kinds of plant residues in SOM models (Parton *et al.*, 1987; Jenkinson, 1990; Dewar, 1991; Corbeels *et al.*, 2005).

The RMR can be either measured or calculated assuming a simple exponential decay function, and knowing the decay constant (k):

$$\text{RMR} = \frac{B_R}{B_{Ro}} = \exp(-k_i \cdot t) \quad \text{Eq. (8.6)}$$

with t , the elapsed time from the beginning of the experiment. In this case, Eq. (8.5) becomes

$$R_D = \sum_{i=1}^n (1 - a_i) \cdot C_i \cdot B_{Ro_i} \cdot (1 - \exp(-k_i \cdot t)) \quad \text{Eq. (8.7)}$$

Instantaneous values of R_D may also be calculated at any given time t (R_{Di}) after the trenching by differentiating Eq. (8.7) and subtracting the result from the instantaneous values of R_{TP} . This allows the calculation of an instantaneous rate of autotrophic and heterotrophic respiration, providing that the root decomposition is reasonably well fitted with an exponential function:

$$R_{Di} = \sum_{i=1}^n (1 - a_i) \cdot C_i \cdot k_i \cdot B_{Ro_i} \cdot \exp(-k_i \cdot t) \quad \text{Eq. (8.8)}$$

Other assumptions are that the lack of new below-ground inputs or the changes in soil water content will not alter soil respiration in the trenched plots. They will be discussed later in the limitations section.

8.2.2 Limitations and shortcomings

There is still a debate whether trenched-plot (or girdled-plot) respiration should be corrected for the decomposition of roots killed during the trenching stage. Bowden *et al.* (1993) argued that the contribution of killed-root decomposition was negligible. However, when estimated, R_D accounts for 15 to 35% of R_{TP} (Nakane *et al.*, 1996; Epron *et al.*, 1999; Lee *et al.*, 2003). Neglecting R_D would therefore lead to overestimated values of R_H and underestimated values of R_A (Fig. 8.3), and would rule out stand comparison if root biomass is different. A major problem when considering root decomposition

is to decide when a cut root ceases respiring and begins to decompose. In other words, when should we consider that soil respiration of trenched plots no longer includes any autotrophic component, and at what point in time should the decomposition model be initiated? High respiration rates are often reported after trenching (Lee *et al.*, 2003) and there is a large agreement that it is better to allow trenched plots to equilibrate for some months before beginning measurements. After a reasonable delay, one might expect that the contribution of cut-root respiration to soil respiration will become negligible.

Another limitation is that trenching may strongly influence soil water content by eliminating tree water uptake. In many studies, differences in soil water content between normal and trenched plots have been neglected. However, higher soil water contents in trenched plots could strongly enhance heterotrophic soil respiration in sandy soils, or reduce R_H in soils with high water holding capacity and low O_2 diffusivity. In a beech stand in Hesse (Eastern France), the soil water content was twice as high in the trenched plots as in the main plot in late summer and early autumn 1997 (Epron *et al.*, 1999). If we had neglected the differences in seasonal courses of soil water content between the main and the trenched plots, the contribution of root respiration to soil carbon efflux would have been underestimated (Fig. 8.3). Empirical models linking soil respiration to soil water content can be used to account for these differences, providing that soil water content is recorded in both intact and trenched plots. Without any correction

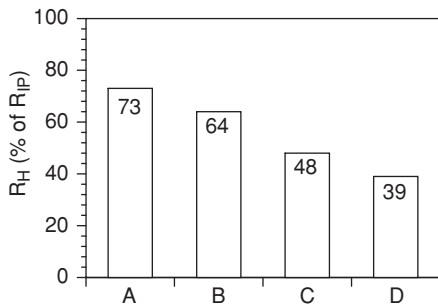

Figure 8.3 Annual contribution of heterotrophic respiration to soil respiration in a beech forest (Hesse, France) (A) if no correction is applied, i.e. $R_H = R_{TP}$, (B) if a correction for the decomposition of killed root is applied, (C) if a correction for difference in soil water content between trenched plots and intact plots is applied and (D) if both corrections applied (adapted from Epron *et al.*, 1999).

for differences in soil water content, R_A estimates will be conservative and R_H is more or less overestimated in many cases.

The input of soil organic matter from fine root mortality is suppressed in trenching experiments. Most heterotrophic respiration is derived from recently produced material (Trumbore, 2000) and the lack of fresh inputs below ground may lead to underestimation of R_H . Partitioning of autotrophic and heterotrophic respiration from root exclusion experiments relies on the assumptions that changes in the rate of rhizodeposition or in the rate of release of nutrients and easily accessible carbon from residue decomposition would not affect heterotrophic respiration by their impacts on microbial communities. However, Högberg and Högberg (2002) and Lee *et al.* (2003) showed that root trenching affects microbial communities in soil as revealed by changes in nitrogen dynamics and microbial biomass.

8.3 ROOT EXCLUSION: OTHER RELATED APPROACHES

8.3.1 Artificial gaps

Comparisons of soil respiration between artificial gaps (clear-cut areas) and undisturbed areas have frequently been used to separate autotrophic from heterotrophic respiration (Nakane *et al.*, 1983; Brumme, 1995; Nakane *et al.*, 1996; Striegl and Wickland, 1998, Table 1; Ohashi *et al.*, 2000; Epron *et al.*, 2006). Artificial gaps can be seen as large trenched plots with the same limitations as true trenched plots, i.e. uncertainties concerning the pattern of root decomposition, and the difference in soil water content between clear-cut and undisturbed areas (Epron *et al.*, 2006). Other potential limitations of artificial gaps are an increase in soil temperature due to change in incoming global radiation, mechanical disturbance of the soil during the logging stage and a reduction in above-ground litter inputs. In large-scale gaps, the vegetation may not be controlled, in which case the autotrophic component of soil respiration would gradually reappear because of new seedling growth or sprouting vegetation. If the vegetation sprouts vigorously one might conclude that the autotrophic contribution was never eliminated. The main advantage of artificial gaps versus trenched plots is a higher spatial representativeness of the former. Since artificial gap formation requires a large and homogeneous area, it has mostly been used in tree plantations. The input

of soil organic matter from fine root mortality and leaf litter fall is suppressed in clear-cut experiments in an even more pronounced manner than in trenching experiments. This could substantially affect the estimation of R_H when fine root life span is low as expected in some tropical species. In a *Eucalyptus* plantation, estimation of annual R_H was increased by 30% when a correction was attempted for the lack of input of soil organic matter from fine root mortality (Epron *et al.*, 2006).

8.3.2 Girdling experiments

The large-scale girdling technique (Högberg *et al.*, 2001; Bhupinderpal-Singh *et al.*, 2003; Andersen *et al.*, 2005; Binkley *et al.*, 2006; Frey *et al.*, 2006) is an interesting alternative to artificial gap formation as it temporarily maintains a canopy, thus limiting changes in soil temperature and mechanical logging disturbance. This technique was initially developed in boreal plantations and it has been recently reviewed (Högberg *et al.*, 2005). Tree girdling is typically done by stripping the bark and phloem of the stem, thus depriving the root and the rhizosphere of current photosynthates. As in clear-cut plots, measurements should not be made near the edge of the girdled plot since roots belonging to trees outside the plot can contribute to soil respiration. In smaller plots, girdling can be associated with the trenching of roots around the girdled plots (Scott-Denton *et al.*, 2006). Root death and decomposition seem to be delayed more in girdled plots than in clear-cut or trenched plots, and tree transpiration is partly maintained, at least at the beginning (Högberg *et al.*, 2001). However, differences in soil water content between girdled and control plots suggest that the transpiration of girdled trees is reduced (Olsson *et al.*, 2005).

The main limitation is probably the fact that root respiration can be sustained by carbohydrate reserves, and that there is still an autotrophic component in the soil respiration recorded on the girdled plot. This is also true of trenched plots, but to a lesser degree. This was clearly highlighted in a Norway spruce stand where starch content decreased in roots of girdled trees, suggesting that roots of girdled trees still used the stored carbohydrates (Olsson *et al.*, 2005). Similarly, girdling did not reduce live fine root biomass in a Brazilian *Eucalyptus* plantation for at least five months after treatment, indicating that large reserves of carbohydrates in the root systems sustained root respiration (Binkley *et al.*, 2006). The question even arises whether the girdling

approach is likely to provide unbiased estimates of autotrophic and heterotrophic contributions to soil respiration, since root respiration still contributes to soil respiration at least in some kinds of forest ecosystems (Binkley *et al.*, 2006).

Girdling may also alter the activity of the microbial community due to changes in both soil water and soil nutrient balances, and the suppression of root exudates. In plots with girdled trees, Scott-Denton *et al.* (2006) showed that the seasonal increase in microbial biomass was lower than in control plots for a *Pinus contorta* forest. Suppression of the priming effect on labelled litter decomposition in girdled plots of spruce was neatly demonstrated by tracing CO₂ coming from litter decomposition (Subke *et al.*, 2004), and putative effects of root exclusion on relatively stable pools of soil organic matter cannot be excluded.

8.3.3 Clipping experiments

The trenching and girdling approaches are not suitable for grassland ecosystems. An alternative technique is to clip the above-ground part of the plant (Craine *et al.*, 1999; Wan and Luo, 2003; Bahn *et al.*, 2006). The root system and the rhizosphere are deprived of current photosynthates in a similar way to girdled trees, and R_A is thought to decline progressively. As in artificial gaps, an increase in soil temperature due to changes in incoming global radiation is expected. Indeed, clipping increased soil and root respiration by increasing soil temperature on meadows (Bahn *et al.*, 2006). When corrected for temperature effects soil respiration was reduced by 20 to 50%, while respiration of excavated roots was little affected, suggesting that carbohydrate reserves sustained root metabolism for several days and that microbial respiration strongly responded to short-term changes in assimilate supply (Bahn *et al.*, 2006). This highlights the control of microbial decomposition of soil organic matter by labile carbon supplied by root through rhizodeposition.

8.4 LESSONS LEARNED FROM ROOT EXCLUSION EXPERIMENTS

8.4.1 Seasonal variation in partitioning

The contribution of root respiration to soil respiration is often higher in summer than in winter, which reflects a higher temperature sensitivity for R_A

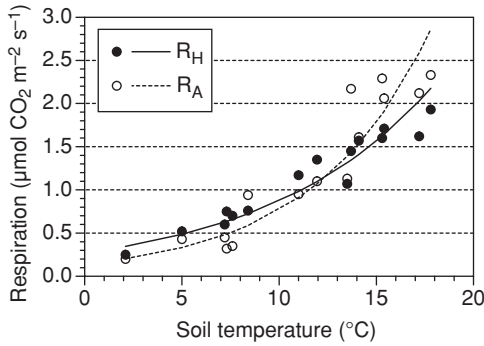

Figure 8.4 Relationships between soil temperature at 10 cm depth and either autotrophic (R_A , open symbols) or heterotrophic (R_H , closed symbols) component of soil respiration in beech forest (Hesse, France, adapted from Epron *et al.*, 2001).

than for R_H (Ewel *et al.*, 1987; Epron *et al.*, 2001; Lavigne *et al.*, 2003; Bond-Lamberty *et al.*, 2004a). Indeed, Boone *et al.* (1998) reported apparent Q_{10} of 4.6 and 2.5 for R_A and R_H , respectively. Similarly, Epron *et al.* (2001) also reported higher apparent Q_{10} for R_A (3.9 compared to 2.3, Fig. 8.4). Rhizosphere respiration was more sensitive to temperature than respiration from decomposition of above-ground litter, and respiration from oxidation of soil organic matter in a tallgrass prairie of the Great Plains (Wan and Luo, 2003). These apparent Q_{10} values for R_A are much higher than those reported for enzymatic reactions or plant tissue respiration. Excised or excavated roots often exhibited Q_{10} values of approximately 2 (Ryan *et al.*, 1996; Bouma *et al.*, 1997; Epron *et al.*, 2001). On a seasonal basis, Q_{10} parameters may confound the effects of temperature and those of changes in root biomass and root and shoot activities (Epron *et al.*, 2001). In contrast to these results, Lee *et al.* (2003) reported that R_A was not related to soil temperature, probably because the peak in root growth occurred when soil temperature was still low. In many other situations, effects of both climate and phenology on R_A can be confounded. Similarly, a low temperature sensitivity for R_H might be explained by high microbial activity in autumn and early spring when fresh litter is available, while organic matter is more limiting for R_H in late spring and summer. Such patterns in apparent Q_{10} should not be interpreted as a change in Q_{10} , but more likely as substrate-driven changes in soil respiration (Davidson *et al.*, 2006). Lavigne *et al.* (2004) reported lower sensitivity to a decrease in soil water content for R_H than for R_A , in agreement

with a high sensitivity of root respiration to soil water content (Burton *et al.*, 1998). In contrast, the heterotrophic component of soil respiration rate is more susceptible to seasonal drought than the rhizospheric component in a *Pinus contorta* forest (Scott-Denton *et al.*, 2006). A low R_H sensitivity to moderate drought should be restricted to acidic soils where fungi dominate the microbial community, whereas bacterial communities are thought to be more prone to moderate drought.

8.4.2 Site to site variations in partitioning

In balsam fir forests, variation in R_S between sites along a temperature gradient is due to large variation in R_A while R_H is less variable (Lavigne *et al.*, 2003). The response of soil respiration to temperature on a spatial scale is therefore controlled more by root than by microbial activity, highlighting a greater carbon allocation to roots in warm sites. Long-term fertilization is thought to reduce both heterotrophic and autotrophic components of soil respiration in an almost identical way in forest ecosystems. This lack of fertilization effect on soil respiration and on the partitioning of soil respiration was observed for a boreal coniferous forest with girdled plots (Olsson *et al.*, 2005) and for a temperate deciduous forest with trenched plots (Huet and Epron, unpublished results). These findings contrasted with those reported for grasslands where a stimulation of soil respiration after fertilization has been reported (Verburg *et al.*, 2004).

8.4.3 Age effects on partitioning

At longer time scales, partitioning between R_A and R_H changes with stand age, but in a contradictory way. A decrease in both R_A and R_H accounted for the observed decrease in R_S over a Sitka spruce chronosequence in Ireland, but the relative contribution of R_A also decreased (Saiz *et al.*, 2006). This was explained by a decrease in fine root biomass and the decrease in root activity with stand aging. In contrast, the relative contribution of R_A increased with stand age in *Pinus elliottii* plantations, from 51% in a 9-year-old stand to 62% in a 29-year-old stand (Ewel *et al.*, 1987). Increase in R_A relative to R_H with stand age might reflect an increase in root biomass. An increase in autotrophic contribution to soil respiration with stand age has also been reported in a black spruce chronosequence in young stands, but a decrease in R_A contribution to soil respiration was

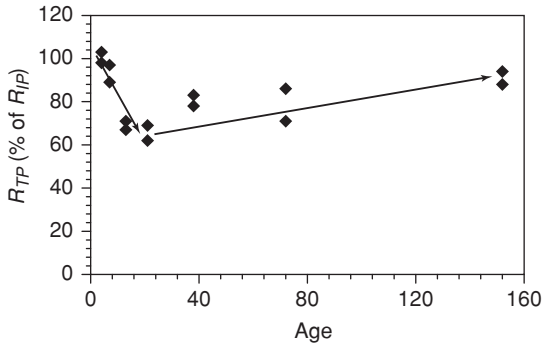

Figure 8.5 Heterotrophic contribution to annual soil respiration (i.e. ratio of soil respiration on trenched plots and soil respiration on intact plots, R_{TP}/R_{IP}) in black spruce stands of different ages (Thompson, Manitoba, Canada, adapted from Bond-Lamberty *et al.*, 2004a). R_{TP} values are not corrected for root decomposition and difference in soil water content.

reported for the oldest stands and this decrease was attributed to a decrease in primary production in the oldest stands (Bond-Lamberty *et al.*, 2004a; Fig. 8.5). A similar increase in R_A with stand age was observed in a *Eucalyptus* plantation (Epron and Nouvellon, unpublished data). In the youngest stand, not only the relative value of R_H is higher than in other stands, but also its absolute value, probably because of the decomposition of residues from the previous stands. R_H was strongly enhanced after harvest in a *Eucalyptus* stand where large amounts of residue exhibiting high rates of decomposition were left both in and on the soil (Epron *et al.*, 2006).

8.4.4 Global aspects of partitioning

On a global scale, the relative contribution of R_H declines with increasing soil respiration (Bond-Lamberty *et al.*, 2004b; Subke *et al.*, 2006) highlighting that partitioning between R_A and R_H is not constant among ecosystems. Soil respiration is well related to gross primary productivity (Janssens *et al.*, 2001) and root respiration is strongly coupled with photosynthate supply (Ekblad and Högberg, 2001; Fessenden and Ehleringer, 2003). A higher below-ground carbon allocation in productive ecosystems that would favour the autotrophic component of soil respiration is therefore expected. There is also a positive relationship between detritus inputs and R_H (Bond-Lamberty *et al.*, 2004b), and, since detritus production is also linked to ecosystem primary productivity, both components of

soil respiration may not change in an independent way. Moreover, the microbial decomposition of soil organic matter is probably tightly linked to organic carbon supply into the rhizosphere.

8.5 CONCLUDING REMARKS

Most of the root-exclusion experiments suggest that autotrophic respiration accounts for half of the total soil respiration in mature forests, and most of these estimates are conservative since fine root decomposition and difference in soil water content have often been neglected. No root-exclusion method is fully satisfactory for partitioning R_A and R_H . All rely on several assumptions and care should be taken to correct or to constrain estimation of R_A and R_H . Several recent results have highlighted the control of microbial decomposition of soil organic matter by labile carbon supplied by roots through rhizodeposition and this further questions our ability to separate autotrophic and heterotrophic components of soil respiration by root-exclusion methods (Subke *et al.*, 2004; Bahn *et al.*, 2006). The hyphal exclusion technique (Johnson *et al.*, 2001), which has been recently applied for estimating mycorrhizal respiration of a grassland plant (Heinemeyer *et al.*, 2006), is potentially of great value for improving partitioning of soil respiration. A better description of underlying processes of both autotrophic and heterotrophic components of soil respiration (Subke *et al.*, 2004; Ngao *et al.*, 2005) and the validation of modelled soil organic matter decomposition using root-exclusion data (Epron *et al.*, 2001) offer promising perspectives for a better understanding of soil carbon dynamics and their response to global changes in terms of carbon sequestration in soils.

ACKNOWLEDGEMENTS

I would like to thank Valérie Le Dantec and Yann Nouvellon for helpful discussions when writing this chapter. They were involved in most of the experimental works I have carried out using root-exclusion experiments.

REFERENCES

- Andersen, C., Nikolov, I., Nikolova, P., Matyssek, R. and Häberle, K.-H. (2005) Estimating autotrophic belowground respiration in spruce and beech forests: decreases following girdling. *European Journal of Forest Research*, **124**, 155–63.

- Andrews, J. A., Harrison, K. G., Matamala, R. and Schlesinger, W. H. (1999) Separation of root respiration from total soil respiration using carbon-13 labelling during free-air carbon dioxide enrichment (FACE). *Soil Science Society of America Journal*, **63**, 1429–35.
- Bahn, M., Knapp, M., Garajova, Z., Pfahringer, N. and Cernusca, A. (2006) Root respiration in temperate mountain grasslands differing in land use. *Global Change Biology*, **12**, 995–1006.
- Bhupinderpal-Singh, N. A., Löfvenius, M. O., Högberg, M. N., Mellander and P.-E., Högberg, P. (2003) Tree root and soil heterotrophic respiration as revealed by girdling of boreal Scots pine forest: extending observations beyond the first year. *Plant, Cell and Environment*, **26**, 1287–96.
- Binkley, D., Stape, J. L., Takahashi, E. N. and Ryan, M. G. (2006) Tree-girdling to separate root and heterotrophic respiration in two *Eucalyptus* stands in Brazil. *Oecologia*, **148**, 447–54.
- Bond-Lamberty, B., Wang, C. and Gower, S. T. (2004a) Contribution of root respiration to soil surface CO₂ flux in a boreal black spruce chronosequence. *Tree Physiology*, **24**, 1387–95.
- Bond-Lamberty, B., Wang, C. and Gower, S. T. (2004b) A global relationship between the heterotrophic and autotrophic components of soil respiration? *Global Change Biology*, **10**, 1756–66.
- Boone, R. D., Nadelhoffer, K. J., Canary, J. D. and Kaye, J. P. (1998) Roots exert a strong influence on the temperature sensitivity of soil respiration. *Nature*, **396**, 570–2.
- Bouma, T., Nielsen, K. L., Eissenstat, D. M. and Lynch, J. P. (1997) Estimating respiration of roots in soil: interactions with soil CO₂, soil temperature and soil water content. *Plant and Soil*, **195**, 221–32.
- Bowden, R. D., Nadelhoffer, K. J., Boone, R. D., Melillo, J. M. and Garrison, J. B. (1993) Contributions of aboveground litter, belowground litter, and root respiration to total soil respiration in a temperate mixed hardwood forest. *Canadian Journal of Forest Research*, **23**, 1402–7.
- Brumme, R. (1995) Mechanisms of carbon and nutrient release and retention in beech forest gaps. III. Environmental regulation of soil respiration and nitrous oxide emissions along a microclimatic gradient. *Plant and Soil*, **168–9**, 593–600.
- Burton, A. J., Pregitzer, K. S., Zogg, G. P. and Zak, D. R. (1998) Drought reduces root respiration in sugar maple forests. *Ecological Applications*, **8**, 771–8.
- Cheng, W. (1996) Measurement of rhizosphere respiration and organic matter decomposition using natural ¹³C. *Plant and Soil*, **183**, 263–8.
- Corbeels, M., McMurtrie, R. E., Pepper, D. A. and O'Connell, A. M. (2005) A process-based model of nitrogen cycling in forest plantations. Part I. Structure, calibration and analysis of the decomposition model. *Ecological Modelling*, **187**, 426–48.
- Craine, J. M., Wedin, D. A. and Chapin III, F. S. (1999) Predominance of ecophysiological controls on soil CO₂ flux in a Minnesota grassland. *Plant and Soil*, **207**, 77–86.
- Davidson, E. A., Janssens, I. A. and Luo, Y. (2006) On the variability of respiration in terrestrial ecosystems: moving beyond Q₁₀. *Global Change Biology*, **12**, 154–64.
- Dewar, R. C. (1991) Analytical model of carbon storage in the trees, soils and wood products of managed forests. *Tree Physiology*, **8**, 239–58.
- Dilustro, J. J., Collins, B., Duncan, L. and Crawford, C. (2005) Moisture and soil texture effects on soil CO₂ efflux components in southeastern mixed pine forests. *Forest Ecology and Management*, **204**, 85–95.
- Dörr, H. and Münnich, K. O. (1986) Annual variations of the ¹⁴C content of soil CO₂. *Radiocarbon*, **28**, 338–45.
- Ekblad, A. and Högberg, P. (2001) Natural abundance of ¹³C in CO₂ respired from forest soils reveals speed of link between tree photosynthesis and root respiration. *Oecologia*, **127**, 305–8.
- Eliasson, P. E., McMurtrie, R. E., Pepper, D. A. *et al.* (2005) The response of heterotrophic CO₂ flux to soil warming. *Global Change Biology*, **11**, 167–81.
- Epron, D., Farque, L., Lucot, E. and Badot, P. M. (1999) Soil CO₂ efflux in a beech forest: the contribution of root respiration. *Annals of Forest Science*, **56**, 289–95.
- Epron, D., Le Dantec, V., Dufrêne, E. and Granier, A. (2001) Seasonal dynamics of soil carbon dioxide efflux and simulated rhizosphere respiration in a beech forest. *Tree Physiology*, **21**, 145–52.
- Epron, D., Nouvellon, Y., Deleporte, P. *et al.* (2006) Soil carbon balance in a clonal *Eucalyptus* plantation in Congo: effects of logging on carbon inputs and soil CO₂ efflux. *Global Change Biology*, **12**, 1021–31.
- Ewel, K. C., Cropper, W. P. and Gholz, H. L. (1987) Soil CO₂ evolution in Florida slash pine plantations. II. Importance of root respiration. *Canadian Journal of Forest Research*, **17**, 330–3.
- Fessenden, J. E. and Ehleringer, J. R. (2003) Temporal variation in $\delta^{13}\text{C}$ of ecosystem respiration in the Pacific

- Northwest: links to moisture stress. *Oecologia*, **136**, 129–36.
- Frey, B., Hagedorn, F. and Giudici, F. (2006) Effect of girdling on soil respiration and root composition in a sweet chestnut forest. *Forest Ecology and Management*, **225**, 271–7.
- Gaudinski, J. B., Trumbore, S. E., Davidson, E. A. and Zheng, S. (2000) Soil carbon cycling in a temperate forest: radiocarbon-based estimates of residence times, sequestration rates and partitioning of fluxes. *Biogeochemistry*, **51**, 33–69.
- Hanson, P. J., Edwards, N. T., Garten, C. T. and Andrews, J. A. (2000) Separating root and soil microbial contributions to soil respiration: a review of methods and observations. *Biogeochemistry*, **48**, 115–46.
- Heinemeyer, A., Ineson, P., Ostle, N. and Fitter, A. H. (2006) Respiration of the external mycelium in the arbuscular mycorrhizal symbiosis shows strong dependence on recent photosynthates and acclimation to temperature. *New Phytologist*, **171**, 159–70.
- Högberg, M. N. and Högberg, P. (2002) Extramatrical ectomycorrhizal mycelium contributes one-third of microbial biomass and produces, together with associated roots, half the dissolved organic carbon in a forest soil. *New Phytologist*, **154**, 791–5.
- Högberg, M., Nordgren, A., Högberg, M. N. *et al.* (2005) Fractional contributions by autotrophic and heterotrophic respiration to soil-surface CO₂ efflux in boreal forests. In *The Carbon Balance of Forest Biomes*, ed. H. Griffiths and P. G. Jarvis. Taylor & Francis Group, pp. 251–67.
- Högberg, P., Nordgren, A., Buchmann, N. *et al.* (2001) Large-scale forest girdling shows that current photosynthesis drives soil respiration. *Nature*, **411**, 789–92.
- Janssens, I. A., Lankreijer, H., Metteucci, G. *et al.* (2001) Productivity overshadows temperature in determining soil and ecosystem respiration across European forests. *Global Change Biology*, **7**, 269–78.
- Jenkinson, D. S. (1990) The turnover of organic carbon and nitrogen in soil. *Philosophical Transactions of the Royal Society London B*, **329**, 361–8.
- Johnson, D., Leake, J. R. and Read, D. J. (2001) Novel in-growth core system enables functional studies of grassland mycorrhizal mycelial networks. *New Phytologist*, **152**, 555–62.
- King, J. S., Hanson, P. J., Bernhardt, E. *et al.* (2004) A multiyear synthesis of soil respiration responses to elevated atmospheric CO₂ from four forest FACE experiments. *Global Change Biology*, **10**, 1027–42.
- Kucera, C. L. and Kirham, R. (1971) Soil respiration studies in tallgrass prairie in Missouri. *Ecology*, **52**, 912–15.
- Kutsch, W. L., Staack, A., Wötzel, J., Middlehoff, U. and Kappen, L. (2001) Field measurements of root respiration and total soil respiration in an alder forest. *New Phytologist*, **150**, 157–68.
- Kuzyakov, Y. (2006) Sources of CO₂ efflux from soil and review of partitioning methods. *Soil Biology and Biochemistry*, **38**, 425–48.
- Lamade, E., Djegui, N. and Leterme, P. (1996) Estimation of carbon allocation to the roots from soil respiration measurements of oil palm. *Plant and Soil*, **181**, 329–39.
- Lavigne, M. B., Boutin, R., Foster, R. J. *et al.* (2003) Soil respiration responses to temperature are controlled more by roots than by decomposition in balsam fir ecosystems. *Canadian Journal of Forest Research*, **33**, 1744–53.
- Lavigne, M. B., Foster, R. J. and Goodine, G. (2004) Seasonal and annual changes in soil respiration in relation to soil temperature, water potential and trenching. *Tree Physiology*, **24**, 415–24.
- Law, B. E., Thornton, P. E., Irvine, J., Anthony, P. M. and Van Tuyl, S. (2001) Carbon storage and fluxes in ponderosa pine forests at different developmental stages. *Global Change Biology*, **7**, 755–77.
- Lee, M.-S., Nakane, K., Nakatsubo, T. and Koizumi, H. (2003) Seasonal changes in the contribution of root respiration to total soil respiration in a cool-temperate deciduous forest. *Plant and Soil*, **255**, 311–18.
- Lin, G., Ehleringer, J. R., Rygielwicz, P. T., Johnson, M. G. and Tingey, D. T. (1999) Elevated CO₂ and temperature impacts on different components of soil CO₂ efflux in Douglas-fir terracosms. *Global Change Biology*, **5**, 157–68.
- Maier, C. A. and Kress, L. W. (2000) Soil CO₂ evolution and root respiration in 11 year-old loblolly pine (*Pinus taeda*) plantations as affected by moisture and nutrient availability. *Canadian Journal of Forest Research*, **30**, 347–59.
- Nakane, K., Yamamoto, M. and Tsubota, H. (1983) Estimation of root respiration rate in a mature forest ecosystem. *Japanese Journal of Ecology*, **33**, 397–408.
- Nakane, K., Kohno, T. and Horikoshi, T. (1996) Root respiration rate before and just after clear-felling in a mature, deciduous, broad-leaved forest. *Ecological Research*, **11**, 111–19.

- Ngao, J., Epron, D., Brechet, C. and Granier, A. (2005) Estimating the contribution of leaf litter decomposition to soil CO₂ efflux in a beech forest using ¹³C-depleted litter. *Global Change Biology*, **11**, 1768–76.
- O'Connell, K. E. B., Gower, S. T. and Norman, J. M. (2003) Net ecosystem production of two contrasting boreal black spruce forest communities. *Ecosystems*, **6**, 248–60.
- Ohashi, M., Gyokusen, K. and Saito, A. (2000) Contribution of root respiration to total soil respiration in a Japanese cedar (*Cryptomeria japonica* D. Don) artificial forest. *Ecological Research*, **15**, 323–33.
- Olsson, P., Linder, S., Giesler, R. and Högberg, P. (2005) Fertilization of boreal forest reduces both autotrophic and heterotrophic soil respiration. *Global Change Biology*, **11**, 1745–53.
- Parton, W. J., Schimel, D. S., Cole, C. V. and Ojima, D. S. (1987) Analysis of factors controlling soil organic matter levels in Great Plains grasslands. *Soil Science of American Journal*, **51**, 1173–9.
- Pendall, E., Bridgman, S., Hanson, P. J. *et al.* (2004) Below-ground process responses to elevated CO₂ and temperature: a discussion of observations, measurement methods, and models. *New Phytologist*, **162**, 311–22.
- Rochette, P. and Flanagan, L. B. (1997) Quantifying rhizosphere respiration in a corn crop under field conditions. *Soil Science Society of America Journal*, **61**, 466–74.
- Rochette, P., Flanagan, L. B. and Gregorich, E. G. (1999) Separating soil respiration into plant and soil components using analyses of the natural abundance of carbon-13. *Soil Science Society of America Journal*, **63**, 1207–13.
- Rustad, L. E., Campbell, J. L., Marion, G. M. *et al.* (2001) A meta-analysis of the response of soil respiration, net nitrogen mineralization, and aboveground plant growth to experimental ecosystem warming. *Oecologia*, **126**, 543–62.
- Ryan, M. G. and Law, B. E. (2005) Interpreting, measuring, and modelling soil respiration. *Biogeochemistry*, **73**, 3–27.
- Ryan, M. G., Hubbard, R. M., Pongracic, S., Raison, R. J. and McMurtrie, R. E. (1996) Foliage, fine-root, woody-tissue and stand respiration in *Pinus radiata* in relation to nitrogen status. *Tree Physiology*, **16**, 333–43.
- Saiz, G., Byrne, K., Butterbach-Bahl, K. *et al.* (2006) Stand age-related effects on soil respiration in a first rotation Sitka spruce chronosequence in central Ireland. *Global Change Biology*, **12**, 1007–20.
- Schuur, E. A. G. and Trumbore, S. E. (2006) Partitioning sources of soil respiration in boreal black spruce forest using radiocarbon. *Global Change Biology*, **12**, 165–76.
- Scott-Denton, L. E., Rosenstiel, T. N. and Monson, R. K. (2006) Differential controls by climate and substrate over the heterotrophic and rhizospheric components of soil respiration. *Global Change Biology*, **12**, 205–16.
- Soe, A. R. B., Giesemann, A., Anderson, T.-H., Weigel, H.-J. and Buchmann, N. (2004) Soil respiration under elevated CO₂ and its partitioning into recently assimilated and older carbon sources. *Plant and Soil*, **262**, 85–94.
- Striegl, R. G. and Wickland, K. P. (1998) Effects of a clear-cut harvest on soil respiration in a jack pine-lichen woodland. *Canadian Journal of Forest Research*, **28**, 534–9.
- Subke, J.-A., Hahn, V., Battipaglia, G. *et al.* (2004) Feedback interactions between needle litter decomposition and rhizosphere activity. *Oecologia*, **139**, 551–9.
- Subke, J.-A., Inghima, I. and Cotrufo, M. F. (2006) Trends and methodological impacts in soil CO₂ efflux partitioning: a metaanalytical review. *Global Change Biology*, **12**, 921–43.
- Swinnen, J. (1994) Evaluation of the use of a model rhizodeposition technique to separate root and microbial respiration in soil. *Plant and Soil*, **165**, 89–101.
- Tate, K. R., Ross, D. J., O'Brien, B. J. and Kelliher, F. M. (1993) Carbon storage and turnover, and respiratory activity, in the litter and soil of an old-growth southern beech (*Nothofagus*) forest. *Soil Biology and Biochemistry*, **25**, 1601–12.
- Thierron, V. and Laudelout, H. (1996) Contribution of root respiration to total CO₂ efflux from the soil of a deciduous forest. *Canadian Journal of Forest Research*, **26**, 1142–8.
- Trumbore, S. (2000) Age of soil organic matter and soil respiration: radiocarbon constraints on belowground dynamics. *Ecological Applications*, **10**, 399–411.
- Verbarg, P. S. J., Arnone, J. A., Obrist, D. *et al.* (2004) Net ecosystem carbon exchange in two experimental grassland ecosystems. *Global Change Biology*, **10**, 498–508.
- Wan, S. and Luo, Y. (2003) Substrate regulation of soil respiration in a tallgrass prairie: results of a clipping and shading experiment. *Global Biogeochemical Cycles*, **17**, 1–12.

9 • Measuring soil microbial parameters relevant for soil carbon fluxes

Werner L. Kutsch, Joshua Schimel and Karolien Denef

9.1 INTRODUCTION

The role of microbiota in soil carbon dynamics is a fitting example of the ‘borderland character’ mentioned in the introduction of this book. For years, the flux community largely followed the unspoken paradigm that ‘everything is everywhere’, which means that there is a universal potential of micro-organisms to decompose all kinds of organic matter, and that soil carbon dynamics, therefore, only depend on soil organic matter quality, soil properties and climate. A key distinction that controls whether the ‘everything is everywhere’ perspective is workable, however, is considering whether environmental conditions are in steady-state or non-steady-state conditions. Under steady-state conditions, microbial influences will be least apparent as they will have acclimatized to the existing physical, chemical or climatic constraints. Under non-steady-state conditions, however, extant microbial populations may reflect past, rather than present, conditions and their behaviour may be paramount and potentially counter-intuitive.

There is evidence that micro-organisms respond sensitively to changing environmental conditions by: (1) adjusting their intra- as well as extracellular enzymatic repertoire and, consequently, their physiological performance; (2) changes in the species composition and (3) growth or reduction of the microbial biomass.

There are several approaches to analyze the response of micro-organisms to changing environmental conditions.

1. Microbial eco-physiology (Anderson, 1994) focuses on the microbial biomass and its performance. More recent approaches (Lynch *et al.*, 2004; Zak *et al.*, 2006) include community oriented approaches that allow linking metabolic pathways to species composition or, at least, functional groups.
2. Microbial biochemistry analyses to determine the production and activity of microbial components, in particular enzymes. Since microbiota release a high portion of their enzymes, extracellular enzymes are included here (Sinsabaugh, 1994).
3. Microbial capability analyses to evaluate the capability of the microbial community to process specific substances.
4. Isotopic tracer analyses to follow the pathways from substrate into biomass. In combination with specific molecular biomarkers, they allow different functional groups to be distinguished (Boschker *et al.*, 1998).

This chapter will introduce the different methodological approaches that are listed here. Each of these approaches provides useful information for interpreting and modelling soil carbon fluxes measured in the field, and provides opportunities for further integrating field with laboratory studies. The chapter will explore these potentials by introducing the different concepts and by showing some examples for linking them closer to field measurements of soil carbon dynamics. The second half of this chapter will show how the different methodological approaches can be used to address more conceptual questions about acclimation and plant–microbe interactions.

It is important to stress that there are no ‘silver bullets’ in that no single technique will give all the answers. Therefore, the final topic of this chapter will be on:

5. Scaling and models as an important tool for integrating information between different approaches and across scales.

9.2 METHODS FOR ECO-PHYSIOLOGICAL CHARACTERIZATION OF SOIL MICROBIOTA

Eco-physiology is the science of processes in organisms in relation with the environmental factors and the expression of those processes in the environment. Ecological questions such as matter and energy balances, and stress response or survival in extreme environments are answered using physiological methods. Microbial eco-physiology aims to characterize the physiological state of microbial communities in relation to their environmental constraints by 'physiological' or 'metabolic quotients', which relate metabolic rates to the amount of microbial biomass, and to available carbon or nitrogen. In this concept the whole microbial biomass is usually regarded as an entity, although newer techniques may allow us to examine sub-group physiological processes. According to Anderson (1994), metabolic quotients can be a powerful tool in understanding energy transfer or principles of homeostasis at the microbial community level and, in turn, elucidate principles of terrestrial ecosystem development.

Most of the eco-physiological analyses of soil microbiota are carried out on soil samples in the laboratory and are related to microbial biomass, which can be estimated by different methods (for a comparison see Powlson (1994), Martens (1995) and a recent review by Jenkinson *et al.* (2004)). Physiological features such as respiration or arginine ammonification are related to the biomass or soil organic carbon to receive information about the status of the microbial community. Method descriptions can be found in the books written or edited by Alef and Nannipieri (1995), Tate (2000) and Paul (2007). An overview of concepts 'beyond the biomass' was edited by Ritz *et al.* (1994) and recent concepts of soil biology with a focus on 'a community and ecosystem approach' by Bardgett (2005).

9.2.1 Biomass

The most important parameter used to characterize biological soil processes is the microbial biomass because it is 'a primary catalyst of biogeochemical processes as well as an energy and nutrient reservoir' (Tate, 2000). In many studies, the soil microbial biomass is seen 'as a whole, just as one might choose to study a forest as an entity, although well aware that it is made up of different

kinds of trees' (Jenkinson *et al.*, 2004). This is of course due to the fact that a characterization of the soil microbial community to the species level has been almost impossible, although more recent approaches allow us to distinguish between systematic or functional groups.

The two most frequently used methods to measure biomass are based on the fact that chloroform (trichloromethane, CHCl_3) disrupts cell membranes, allowing the contents to leak out. In an older approach, the quantity of microbial biomass was calculated from an increase of respiration following the fumigation with chloroform (chloroform fumigation incubation, CFI; Jenkinson, 1976; Jenkinson and Powlson, 1976). About a decade later the direct extraction of fumigated biomass components for subsequent C and N analyses was developed (chloroform fumigation extraction, CFE; Brookes *et al.*, 1982, 1985; Vance *et al.*, 1987). Usually, a soil sample is divided into two portions of which one is fumigated with ethanol-free chloroform for 24 hours and the other left as a control. Thereafter, the two soil samples are extracted by 0.5M K_2SO_4 , filtered and analyzed for total dissolved C or N. The difference between the C or N content of the fumigated and non-fumigated soil solution is proportional to the microbial biomass C or N, although the proportionality may vary between soils (Sparling and West, 1988; Beck *et al.*, 1997). A more recent development incorporates fumigation and extraction into a single quick step (Gregorich *et al.*, 1990; Fierer *et al.*, 2003).

Another, more indirect measure of microbial biomass can be derived from the increase in respiration of a soil sample following the addition of easily decomposable material, such as glucose or yeast extract. The basic assumption for the substrate-induced respiration (SIR; Anderson and Domsch, 1978) is that microflora in different soils have a similar maximum potential respiration rate per unit biomass and so the maximum respiration rate when carbon is saturating is an index of the biomass.

The fourth commonly used method is based on the quantification of adenosine triphosphate (ATP) as a universal cell content that is present in living cells, but degraded very rapidly in free soils. There are several extraction methods of ATP from soil samples (Tate and Jenkinson, 1982; Eiland, 1983; Martens, 1995). For ATP analysis, the luciferin-luciferase system is commonly used. Since the concentration of ATP per biomass carbon is highly variable, there is no standard

conversion coefficient and ATP content is usually used in combination with one of the other methods.

The most important factor controlling the amount of microbial biomass (C_{mic}) is substrate availability. However, C_{mic} is not simply correlated to the total organic carbon content of the soil (C_{org}). It can vary between less than 0.5% and more than 3% depending on soil type, vegetation and land use (Anderson and Domsch, 1990; Balota *et al.*, 2003; Dilly *et al.*, 2003; Fig. 9.1). The C_{mic}/C_{org} ratio also depends on the nature of the chemical substrates since microbes can efficiently assimilate labile carbon, but poorly assimilate more complex and stabilized carbon.

According to general ecological theory (Odum, 1969), the C_{mic}/C_{org} ratio should slightly increase during ecosystem succession in a constant environment. This is due to an inherent trend towards efficiency in energy utilization, i.e. fastest catabolic activity at lowest energy costs and lowest maintenance energy costs (Anderson, 2003). However, since no ecosystem develops under constant environmental conditions, this trend is overruled by the response of the microbial biomass to plant succession, to changes in substrate availability and quality, and to disturbances such as drought, freezing and thawing cycles, flooding or fire. Human-induced activities, such as pollution, land-use changes, ploughing or fertilization may also induce changes in the efficiency of the microbial biomass. Consequently, the dynamics of the C_{mic}/C_{org} ratio can provide useful information about the quality of a soil and its carbon dynamics: a low ratio indicates low organic matter quality and/or a disturbed or stressed microbial community that needs a high proportion of its resources for respiration, whereas a high ratio indicates a highly efficient community that usually develops under undisturbed conditions when soil carbon is stable or even increasing (Bardgett, 2005; Dilly, 2005).

9.2.2 Ratios of different microbial biomass estimates

Since the above described methods of microbial biomass assessment do not always agree with each other when applied in parallel, the ratios between the different estimates can reveal basic information about the state of the microbial biomass. CFE and CFI reflect the whole biomass because most organisms are lysable in chloroform and their releases are captured by extraction or

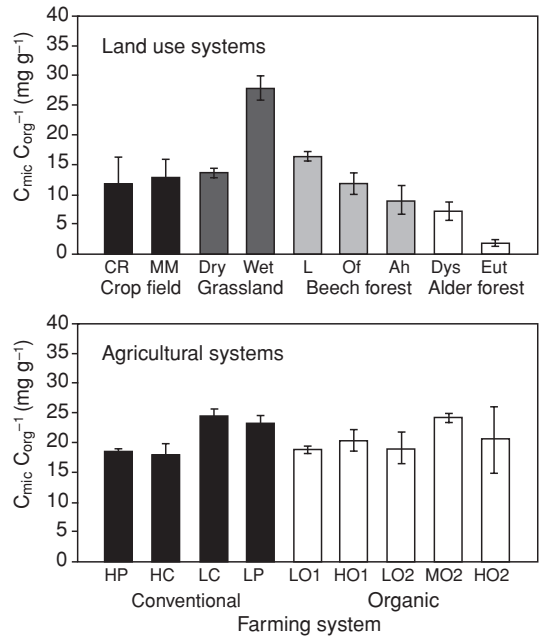

Figure 9.1 Variation of biotic-fixed C (C_{mic}/C_{org} ratio) in soils with different land-use systems and different agricultural practices; bars extend to the 95% confidence limits (redrawn after Dilly *et al.*, 2003).

CR: Crop rotation field, Bornhöved, northern Germany, Ap horizon
 MM: Maize monoculture, Bornhöved, northern Germany, Ap horizon
 Dry: Dry grassland, Bornhöved, northern Germany, Ah horizon
 Wet: Wet grassland, Bornhöved, northern Germany, Aa horizon
 L: Beech forest, Bornhöved, northern Germany, L horizon
 Of: Beech forest, Bornhöved, northern Germany, Of horizon
 Ah: Beech forest, Bornhöved, northern Germany, Ah horizon
 Dys: Dystric alder forest, Bornhöved, northern Germany, nH horizon
 Eut: Eutric alder forest, Bornhöved, northern Germany, nH horizon

HP: Maize, high N supply, Scheyern, southern Germany, Ap horizon
 HC: Maize, medium N supply, Scheyern, southern Germany, Ap horizon
 LC: Maize, medium N supply, Scheyern, southern Germany, Ap horizon
 LP: Maize, low N supply, Scheyern, southern Germany, Ap horizon
 LO1: Clover-lucerne-grass, Scheyern, southern Germany, Ap horizon
 HO1: Clover-lucerne-grass, Scheyern, southern Germany, Ap horizon
 LO2: Clover-lucerne-grass, Scheyern, southern Germany, Ap horizon
 MO2: Clover-lucerne-grass, Scheyern, southern Germany, Ap horizon
 HO2: Clover-lucerne-grass, Scheyern, southern Germany, Ap horizon

mineralization, respectively. In contrast, SIR is a measure for only those members of the microbial community that quickly react to an easily decomposable energy source (Vedder *et al.*, 1996; Beck *et al.*, 1997). The ATP content represents a constituent that occurs in all living

organisms and is, therefore, controlled by the physiological state of cells (Nannipieri *et al.*, 1990).

Based on these basic considerations, the ratios of different microbial biomass measures can be related to two closely corresponding ecological concepts that describe the state of the microbial biomass: the rapidly growing micro-organisms that primarily metabolize easily degradable compounds are termed zymogenous and r-strategists, whereas slow growing micro-organisms that are predominantly associated with the steady decomposition of more complex compounds are called autochthonous or K-strategists (Winogradsky, 1924; Tate, 2000). High SIR/CFE ratios, as well as high ATP/CFE ratios, are often found in litter or rhizosphere when fresh nutrients are introduced and indicate a microbial community dominated by r-selected species (Dilly, 2006).

9.2.3 Basal respiration and metabolic quotients

Even if microbial biomass has proven to be a very useful parameter to characterize the biogeochemical potential of soils, it cannot be directly related to actual mineralization rates. The reason for that are changes in microbial physiological state and activity.

The physiological state of the soil microbial community and its potential to mineralize organic substance can be derived from eco-physiological indices that describe the specific activity of the microbial community. Eco-physiological indices are generated by basing physiological performances (respiration, carbon uptake, growth/death etc.) on the total microbial biomass (Pirt, 1975; Slater, 1979; Anderson and Domsch, 1986; Anderson, 1994). An environmental impact that affects members of a microbial community should be detectable at the community level by a change of a particular total microbial community activity (Anderson, 2003).

The most commonly used eco-physiological indices related to soil carbon dynamics are the basal respiration and the metabolic quotient ($q\text{CO}_2$). Basal respiration is defined as the respiration of a soil sample in the laboratory without substrate addition (Anderson and Domsch, 1990). It is measured with sieved and pre-incubated soil under defined conditions in the laboratory, i.e. at 50% of water-holding capacity and at temperatures between 20 °C and 30 °C (Joergensen and Emmerling, 2006) and either related to soil dry weight

or soil organic carbon content (C_{org}). Of course, this physical disturbance creates artificially elevated respiration rates. Therefore, the basal respiration rate of a soil sample cannot directly be scaled to field fluxes. Nevertheless, it shows a physiological potential of the soil microbes. The $q\text{CO}_2$ describes the rate of respiration per unit microbial biomass. It is expressed in $\text{mg CO}_2\text{-C g}^{-1} C_{\text{mic}} \text{h}^{-1}$ and can vary substantially among soils. One problem in comparing $q\text{CO}_2$ values from different studies is the, already discussed, uncertainty due to the different methods for deriving soil microbial biomass. Therefore, the method used for the biomass estimation must be clearly documented.

Changes in the metabolic quotient can depend on multiple factors that influence the activity and the efficiency of the microbial biomass. Dilly and Munch (1996, 1998) described a decreasing $q\text{CO}_2$ with progressive litter decomposition and increasing soil depth in a beech forest in northern Germany. Chronosequence studies by Insam and Domsch (1988) and Insam and Haselwandter (1989) also showed decreasing $q\text{CO}_2$ with successional age as well as age of agricultural soils (Anderson and Domsch, 1990). This reflected the transition from more r-selected (zymogenous) to more K-selected (autochthonous) organisms that are growing very slowly, but are tolerant of poor conditions; so, they are less active per unit biomass. This, again, conforms to the ecological theory mentioned above that there is an inherent trend towards efficiency in energy utilization. The use of biomass estimates and metabolic quotients to evaluate human impact on soil micro-organisms was recently reviewed by Joergensen and Emmerling (2006).

In spite of the broad success of the metabolic quotient as a measure of soil quality in terms of age, structure and stress status of the microbial biomass, it has been used to a much lesser extent as a measure for the carbon turnover potential of soils, as an indicator of acclimation or as a tool to calibrate models. It is surprising that $q\text{CO}_2$ has been used so little as a tool for model calibration, because it integrates all the physico-chemical effects of the environment on the functioning of the microbial communities. Kutsch and Dilly (1999) stated that eco-physiological measures can be a bridge between studies of matter fluxes and studies dealing with the microbiological and biocoenotic characterization of soils or whole ecosystems, since the basal respiration related to soil carbon content or the $q\text{CO}_2$ can serve as an integrated measure of the adaptation of

the microbial community to the actual soil quality at hand.

9.2.4 Community oriented approaches

More recent approaches focus on community ecology to characterize the microbial biomass. A number of them distinguish between systematic or functional groups to relate changes in community composition to soil functioning. One useful tool for doing this is the characterization of microbial phospholipid fatty acids (PLFAs). Phospholipid fatty acids are a diverse group of cell membrane lipids and can serve as specific biomarkers for microbial groups since they differ in length and structure between bacteria, fungi and actinomycetes (Vestal and White, 1989). A PLFA profile can quantify the contributions of key groups of micro-organisms (e.g. gram-negative bacteria, fungi etc.) to the whole microbial community, which can then be related to the functioning of the community. Studies have used PLFA profiles to discern the relative importance of environmental variables in governing the composition of microbial communities and to discriminate among different soils (Bardgett *et al.*, 1996; Porazinska *et al.*, 2003) or to identify microbial community responses to soil management, land use or environmental change (Boschker *et al.*, 1998; Treonis *et al.*, 2004; Evershed *et al.*, 2006). Usually, fatty acids are extracted from a soil sample, separated based on polarity by solid phase extraction, and subjected to esterification to form fatty acid methyl esters (FAMEs). The FAMEs can be identified by comparing their chromatographic retention times and mass spectra to those of fatty acid standards, and are expressed using a standard nomenclature (Frostegård *et al.*, 1993).

Information about the composition of the microbial community at the species level can be obtained from molecular approaches that allow measuring gene sequences from the microbial biomass. Zak *et al.* (2006) promoted a concept that focuses on 'functional genes'. They define a functional gene as a sequence that encodes a key enzyme in a biogeochemical process (Fig. 9.2). The presence of a functional gene in its genome determines the membership of a species in a functional group engaged in a particular biogeochemical process. From this point of view one species can belong to different functional groups.

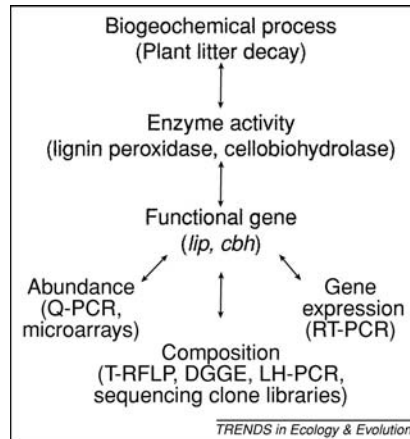

Figure 9.2 A conceptual model linking biogeochemical processes to functional genes via the activity of enzymes mediating key steps in biogeochemical pathways. Plant litter decay is used as an example to illustrate how functional genes and enzymes control a particular biogeochemical process. Listed beneath the aspects of functional gene analysis are the molecular techniques that provide insight into the abundance, composition and activity of functional genes and the organisms in which those genes occur (Zak *et al.*, 2006).

Abundance of functional genes

- Q-PCR: quantitative polymerase chain reactions (Hawkes *et al.*, 2005).
- Microarrays: oligonucleotide probes assembled on a microscope slide (Cho and Tiedje, 2002).

Composition of functional genes

- T-RFLP: terminal restriction fragment length polymorphism (Tiedje *et al.*, 1999).
- DGGE: denaturing gradient gel electrophoresis (Torsvik *et al.*, 1998; Gelsomino *et al.*, 1999; Tiedje *et al.*, 1999).
- LH-PCR: amplicon length heterogeneity polymerase chain reaction (Suzuki *et al.*, 1998; Ritchie *et al.*, 2000; Mills *et al.*, 2007).

Gene expression

- RT-PCR: reverse transcription and subsequent amplification (Borneman and Triplett, 1997).

Microbes regulate biogeochemical cycles by expressing functional genes and altering gene expression under different environmental conditions. Therefore, molecular tools reveal the basic mechanisms of microbial acclimation as described by the other approaches for the microbial biomass as an entity. They

can also show shifts in the species composition during litter degradation that co-occur with shifts in eco-physiological performance. However, one needs to consider that the presence of a functional gene does not indicate that the 'function' is active. A microbe may possess a functional gene without transcribing it and synthesizing actual enzymes; a microbe may also synthesize enzymes that are inactive due to a lack of substrate.

9.2.5 Extracellular enzyme activities

Being small, bacteria and fungi cannot take up and digest large soil organic matter polymers. They therefore release enzymes that degrade the polymers and assimilate only the small dissolved components for growth. Recent studies have focused on the role of extracellular enzymes and their activity for organic matter degradation and carbon processing (Carreiro *et al.*, 2000; Saiya-Cork *et al.*, 2002; Sinsabaugh *et al.*, 2002; Berg and McLaugherty, 2003; Michel and Matzner, 2003; DeForest *et al.*, 2004; Gallo *et al.*, 2004; Marx *et al.*, 2005). However, the dynamics of these enzymes remain uncertain. Few studies have investigated the mechanisms underlying the production and activity of extracellular enzymes and the importance of biotic and abiotic factors in regulating enzyme stability (e.g. Allison, 2006; Allison and Jastrow, 2006). A better understanding of enzyme dynamics could provide more insights in the physiological response/adaptation of microbial communities to environmental change (e.g. atmospheric N deposition, climate change), and will be essential for making more accurate predictions of soil carbon sequestration.

Many studies on extracellular enzymes focus on lignin and cellulose degrading enzymes, because these substrates are the two most abundant biochemical constituents of plant litter and they are decomposed by different classes of microbial extracellular enzymes. Lignin is degraded oxidatively by phenol oxidases and peroxidases. Cellulose is degraded hydrolytically by exoglucanases, endoglucanases and β -glucosidases (Sinsabaugh and Liptak, 1997).

There is a strong link between the activity of these enzymes and N availability. Fog (1988) and Hammel (1997) report that expression of lignin degrading enzymes is down-regulated by high N availability in some white-rot basidiomycetes, leading to a reduction in the rates of lignin and humus degradation. This was

only partly confirmed in N-fertilization experiments, however, by Waldrop *et al.* (2004) who found different responses to N enrichment in different forest ecosystems. Cellulose degradation is often limited by N availability (Fog, 1988; Berg and Matzner, 1997), and consequently enhanced by N additions.

Similar to some eco-physiological properties, enzyme activities can provide some kind of capacity parameter of the microbial community that describes the potential decay rate when all climatic parameters are optimum. Dilly and Munch (1996) showed that extracellular β -glucosidase activity and basal respiration showed the same course during the degradation of litter in a 20-month litterbag experiment. Since lignin and cellulose degrading enzymes are key enzymes of soil biogeochemistry, linking studies of extracellular enzymes with functional genomics as described above offers a great potential for future studies.

9.2.6 Specific substrate use

A common approach to assess the functional capacity of the microbial community has been by evaluating the substrates that microbes are capable of metabolizing. The most common version of this approach is the use of BiOLOG or ECOLOG plates (Garland and Mills, 1991), in which a microtiter plate loaded with solutions containing different substrates are inoculated with a soil suspension. The greatest limitation of this approach is that it evaluates the presence of microbes that are capable of growing rapidly (days rather than weeks) on that particular substrate in liquid media. It has been known for decades (Waksman, 1932) that this is likely a small and bacteria-dominated proportion of the microbial community and thus it can be difficult to interpret the results of BiOLOG measurements in an ecologically meaningful way. Nevertheless, Balsler and Firestone (2005) found that BiOLOG profiles correlated well with nitrification potential and somewhat with soil CO₂ production. Another issue to consider in evaluating BiOLOG-type results is that it is unlikely that microbes that can process the simple substrates used in such assays are ever actually absent from the soil, even if they do not grow in a BiOLOG plate.

A number of particularly creative approaches have used BiOLOG to examine ecological questions. Lindstrom *et al.* (1999) inoculated BiOLOG plates with a series of dilutions to show that the microbial

communities from crude-oil contaminated tundra soils were dominated by generalist bacteria, while control soils were dominated by specialists. As samples from control sites were diluted, they lost the ability to process many substrates, while at high dilution with the same cell densities, contaminated samples did not lose the ability to use substrates. Balsler *et al.* (2002) used BiOLOG to compare the communities of suspended and surface-attached bacteria and showed that they are different. Thus, despite the inherent limitations, BiOLOG has the power, when used carefully, to provide useful information on the functional capacity of soil microbial communities.

9.2.7 Tracers

Isotopes are a useful supplemental tool to label substances and follow the pathways of organic matter degradation and microbial functioning. Isotope tracers provide the opportunity to measure three things: (1) the rate at which specific compounds are processed; (2) the fate of the carbon processed (CO₂, SOM) and (3) the organisms responsible for assimilating processed carbon. Calculating the rate at which a specific organic molecule is processed with tracers requires measuring the size of the native pool of that molecule at the beginning and end of an assay, so that the average enrichment of the tracer can be calculated. Then, from the amount of the tracer processed and the enrichment of the pool one can calculate the amount of the native molecule processed. This is very rarely done with organic compounds, though it is the basis of isotope dilution methods of estimating N mineralization and nitrification. A modification of this approach has been merely to estimate the turnover time of a specific compound by measuring the rate at which the added compound is processed and assuming that native, unlabelled molecules have the same turnover time. Jones and Kielland (2002) used this approach to estimate the flow of N through the amino acid pool in a taiga forest soil. For such assays, either ¹³C or ¹⁴C can be used. The sensitivity and cost of ¹⁴C is usually less than for ¹³C unless solid samples are being analyzed – few labs have biological oxidizers for solid ¹⁴C samples. Also, for evaluating carbon flow into microbial PLFAs, ¹³C is normally used.

Tracers also allow evaluating the fate of specific compounds. For carbon, the flow of substrate-derived ¹³C or ¹⁴C through physical fractions, microbial

biomass, CO₂, DOC and even specific molecular compounds can be quantified. Tracers can also be used to evaluate microbial substrate use efficiency (SUE) (e.g. Frey *et al.*, 2001; Thiet *et al.*, 2006), which is the proportion of utilized substrate-carbon that is assimilated into microbial biomass. Microbes that are actively growing will have high SUE, while microbes that are stressed or starved will respire more of the carbon for maintenance and so have low SUE (Fierer and Schimel, 2002). Thus, this can be a powerful assay for characterizing the physiological state of the microbial biomass.

9.2.8 Stable isotope probing

Stable isotope probing (SIP) is a method used for labelling micro-organisms *in situ* using substrate that is highly enriched with stable isotope (¹³C, ¹⁵N, ¹⁸O) in order to link microbial identity to functional activity (see reviews by Neufeld *et al.*, 2007a, 2007b). Stable isotope probing in combination with microbial biomarker analyses has made it possible to identify and characterize the microbial groups or organisms that are actively involved in the assimilation of the labelled substrate (Murase *et al.*, 2006; Williams *et al.*, 2006). Stable isotope probing experiments in combination with ¹³C-PLFA analysis (by GC-IRMS) have proven successfully as a means to analyze the role of microbial groups in biogeochemical transformations (Boschker *et al.*, 1998; Bull *et al.*, 2000; Evershed *et al.*, 2006) or to detect rapid shifts between active microbial populations with changing management (e.g. liming, Treonis *et al.*, 2004), land-use or environmental conditions (Boschker *et al.*, 1998; Treonis *et al.*, 2004; Billings and Ziegler, 2005; Evershed *et al.*, 2006).

The SIP approach has been recently extended to nucleic acids (DNA, rRNA) to identify microbial species that are actively growing on a particular ¹³C-labelled substrate (Radajewski *et al.*, 2000; Manefield *et al.*, 2002b; Lueders *et al.*, 2004b) and to elucidate their role in a particular process (Manefield *et al.*, 2002a; McDonald *et al.*, 2005). This method is based on the isolation of the entire genome of a group of micro-organisms that participate in a metabolic function of interest, followed by species identification by molecular biological techniques. By metabolizing the ¹³C-labelled substrate, the active microbial populations will incorporate the ¹³C-label into their biomass, including their DNA and rRNA. Due to its increased density,

^{13}C -labelled DNA and rRNA can then be recovered from total community nucleic acid extractions by centrifugation in caesium chloride (CsCl) and caesium trifluoroacetate (CsTFA) centrifugation gradients, respectively (Radajewski and Murrell, 2001; Morris *et al.*, 2002; Lueders *et al.*, 2004a, 2004b). The nucleic acids isolated from the ^{13}C -labelled active members of the microbial community can be characterized taxonomically and functionally by gene probing, PCR, cloning and sequence analysis (Radajewski *et al.*, 2000; Manefield *et al.*, 2002b). The effectiveness of the separation of ^{13}C -labelled from unlabelled nucleic acids requires a large amount of ^{13}C -label to be incorporated into the nucleic acids of the target micro-organisms. This is especially the case for DNA-SIP. rRNA has been suggested to be a more responsive biomarker of the active microbial community than DNA, because transcription is independent of cell division (in contrast to DNA synthesis) and RNA is present at much higher copy numbers than DNA in the cell (Manefield *et al.*, 2002a, 2002b). The potential of nucleic acid-based SIP methodology for linking metabolic function with taxonomic identity has a number of drawbacks (for a review see Neufeld *et al.*, 2007a). The few successful applications of SIP-DNA or -RNA are limited to identifying metabolically restricted groups of micro-organisms such as methylotrophs and methanotrophs (Radajewski *et al.*, 2000; Morris *et al.*, 2002), phenol degraders (Manefield *et al.*, 2002a) and autotrophic ammonia-oxidizing bacteria (Whitby *et al.*, 2001) that grow in the presence of high concentrations of ^{13}C -labelled substrates, although a few successful applications exist where root-carbon assimilating rhizosphere communities were characterized by SIP-RNA upon $^{13}\text{CO}_2$ pulse-labelling (e.g. Rangel-Castro *et al.*, 2005). In such substrate-enrichment incubation experiments, the isolated ^{13}C -labelled nucleic acid fraction is not necessarily representative of the microbial population active at natural *in situ* substrate concentrations. Furthermore, a requirement for the use of SIP to identify microbial species involved in specific metabolic functions is the availability of PCR primers that are universal for the small-subunit rRNA genes of bacteria, Archaea and Eukarya.

Some potential lies in the use of selective PCR primers targeting 'functional genes' to study defined populations that are known to regulate soil processes. An example of such an approach entails the use of 16S

rRNA gene amplicates from the ^{13}C -labelled DNA for cloning and hybridization probe design (e.g. fluorescent *in situ* hybridization (FISH) probe design). In this way, entire gene clusters can be obtained from uncultivated bacteria whose function has been defined, enabling the design of improved PCR primers and limiting the bias implicit in the use of selective PCR primers. Using this technology, Ginige *et al.* (2005) successfully probe-targeted denitrifiers capable of using methanol (Ginige *et al.*, 2004) and acetate (Ginige *et al.*, 2005) as a sole source of carbon. Another recently developed technology is based on separating particular classes of small subunit rRNA (SSU rRNA, or 16S and 18S rRNA) from mixtures of total RNA by biotin-labelled oligonucleotide probes and capture by streptavidin-coated paramagnetic beads, followed by stable isotope analysis. In this way, the specific microbial groups of interest are first selected and isolated from the total RNA mixture, and examined for their ^{13}C composition afterwards. In a study by MacGregor *et al.* (2002), SSU rRNA was found to be a suitable biomarker that could be useful for studies on carbon flow in natural microbial communities as the ^{13}C signature of SSU rRNA of *E. coli* grown in pure culture reflected that of the carbon source. However, some limitations were associated with this method, such as the requirement for relatively large amounts of RNA for reliable isotope measurements.

A potential limitation of the SIP approach is that only the microbes that actually assimilate carbon can be analyzed. Under conditions of extremely low substrate use efficiency, all the utilized substrate-carbon may be respired, which makes it impossible to evaluate which organisms respired the carbon.

9.3 MICROBIAL ACCLIMATION AND STRESS RESPONSE

Every organism has to face changes in environmental factors that influence its physiological performance. When factors shift away from the optimum range, the conditions can become sub-optimal or even harmful. For these situations, the term 'stress' is used. Microbes must have physiological mechanisms to survive and remain active in the face of stress or they will die. However, in most cases there is no distinct threshold between the 'normal range' of an environmental factor and 'stressful conditions'. Therefore, it is not always

possible to distinguish between acclimation to a change that still is within the normal range of variation and stress response that might strongly alter the physiology of single organisms or the community structure.

Nevertheless, since stress responses involve physiological costs at the organism level and can alter the composition of the active microbial community (Schimel *et al.*, 2007), they can also influence ecosystem-level carbon, energy and nutrient flows. Microbes acclimate to stress by altering resource allocation from growth to survival mechanisms, unless the stress is so great that it is lethal or forces microbes into dormancy (Farrar and Reboli, 1999; Suzina *et al.*, 2004). Stress tolerance involves shifting carbon allocation from cell polymers to osmolytes, cryoprotectants, chaperones and other specialized stress-acclimation compounds that are soluble, labile and frequently N rich (Schimel *et al.*, 2007). Thus, these compounds are easily metabolized when the stress ends and at least partially responsible for the pulse of respiration that is commonly observed after rewetting or thaw (Fierer and Schimel, 2003).

9.3.1 Microbial acclimation to climate and stress by climatic factors

Soil temperature and moisture are the most important climatic factors that influence the physiological performance of micro-organisms and, consequently, the organic matter turnover in soils.

Temperature acclimation has been a widely discussed issue in the context of global warming, because it severely influences predictions about global carbon fluxes in a future climate (see Chapter 1). Smaller and short-term changes (e.g. during diurnal courses) may simply alter the process rates, whereas mid- and long-term changes (from annual courses to long-term trends in climate) may alter the temperature response. Practically, temperature acclimation of the soil microbiota is difficult to measure, because one needs to unravel the complex interactions between substrate depletion, physiological acclimation and changes in species composition and activity. Nevertheless, an integrated use of the different methods described above has a high potential to develop stronger linkages and provide deeper insight (see also Section 9.4).

Microbial responses to low temperature are a particularly important aspect of temperature responses. Northern environments are warming rapidly and are

therefore vulnerable to changing freeze–thaw regimes. Microbial activity continues at temperatures below freezing, but not only are temperature responses distinctly different than they are above freezing (Mikan *et al.*, 2002), microbial processes also change below freezing. To survive low temperature, microbes must induce a suite of cold acclimation mechanisms including changing lipid composition, synthesizing new proteins and possibly accumulating other cryoprotectants (Methe *et al.*, 2005). An important component of this physiological shift is that it occurs *above* 0°C; thus, rather than waiting for the freeze to occur, microbes appear to pre-acclimate, analogous to frost hardening in plants (Lennartsson and Ogren, 2002).

If soil moisture decreases within the normal range of fluctuations, substrate diffusion varies and microbes may experience resource limitation that can slow biogeochemical process rates (Stark and Firestone, 1995). High moisture may reduce process rates by limiting oxygen diffusion. This is reflected by the typical optimum shape of the soil moisture response curve. Beyond a threshold, decreasing water potentials impose direct physiological stress. As soils dry and water potentials drop, cells must accumulate compatible solutes to avoid dehydration (Harris, 1981). Bacteria typically accumulate amino compounds (Csonka, 1989), while fungi accumulate polyols (Witteveen and Visser, 1995).

Rewetting a dry soil or thawing a frozen soil requires microbes to rapidly reverse their physiological acclimations to drought or freezing to prevent cell rupture and other effects. In case of rewetting, they have to adjust osmotically within a few minutes. Fierer and Schimel (2003) have shown by ¹⁴C-labelling that most of the respiratory burst after rewetting comes from the microbial biomass and they conclude that most of it comes from released cytoplasmic solutes. The pulse of respiration on rewetting or thaw can be equivalent to roughly 10% or more of the total microbial biomass (Skogland *et al.*, 1988; Herrmann and Witter, 2002), and this is likely an underestimate of total microbial carbon mobilized, since not all the carbon metabolized is respired.

9.3.2 Microbial acclimation to chemical soil properties

As pointed out before, the microbial community can quickly adjust to the chemical composition of the

organic matter, e.g. by a rapid growth or increase in activity after addition of easily decomposable matter. However, microbes also respond to other chemical soil properties, such as pH. Changes in the pH of soil often result in a shift of the microbial community that can be detected easily by measuring the ratio of fungal to bacterial biomass, by PLFA analysis (Bardgett and McAlister, 1999; Bååth and Anderson, 2003; de Vries *et al.*, 2006) or by determining the physiological activity of the different components of the community (e.g. by SIR, Beare *et al.*, 1991). Blagodatskaya and Anderson (1999) carried out laboratory experiments to study the pH impact on soil microbial communities under controlled conditions. After an initial pH stress (shown by a high initial $q\text{CO}_2$ and immediate biomass loss), the survivors of a microbial community adapted to the new soil pH. Adaptation went along with a continuous decrease of the $q\text{CO}_2$ and the final $q\text{CO}_2$ values and $C_{\text{mic}}/C_{\text{org}}$ ratios obtained under laboratory conditions correspond to those that are commonly found for natural sites of similarly low pH (Anderson, 2003).

9.3.3 Plant–microbe interactions

Beside manifold direct interactions between plants and soil microbiota (as described in Chapter 7), indirect interactions mediated by the matter cycling in ecosystems have been taken into consideration more during the last years. Ecosystems can differ widely in the nutrient availability of their habitat. In addition, the amount of nutrients incorporated into organisms or organically bound increases during ecosystem development. As inorganic nutrients become less available, competition for nutrients between plants and free soil microorganisms increases. The competitors force each other to strategies of improved nutrient uptake and retention, which results in changing leaf and litter traits of the vegetation (e.g. C/N ratios), physico-chemical properties of litter and topsoils, and the composition and activity of microbial communities (Wardle, 2002). Also, perturbations may affect only parts of the vegetation or particular groups of decomposers, and alter the activity spectrum of the microbial community.

The resulting change in decomposition rates has arisen from ‘bottom-up’ (Moorhead and Sinsabaugh, 2006) and can be characterized by the whole methodological equipment described above. Combined with the novel methods for chemical characterization of litter

and soil organic matter, as described in Chapters 5 and 6, this would substantially improve our understanding of functional groups and their activity.

9.4 INTEGRATION AND THE USE OF MICROBIOLOGICAL INFORMATION IN MODELLING SOIL CARBON DYNAMICS

9.4.1 The need for different scales and scale transition

Integration of microbiological information can only be achieved when it is considered that there is neither a ‘silver bullet’ in methods nor a ‘golden scale’. Future research has to develop a hierarchical approach with a focus on scale transfer of information.

- At the lowest scale, community shifts can be recorded by different molecular and genetic tools, and combined with activity patterns by stable isotope probing of PFLAs and nucleic acids.
- At the next scale, the more ‘traditional’ view on the physiological expression of the whole microbial community or biomass provides information about the integral of the molecular processes, possibly emerging new properties, but also about the relevance or irrelevance of the lower scale information.
- Finally, the insights from these scales have to be coupled to the interpretation of field observations at soil profile or even ecosystem scale, and integrated into global modelling approaches.

The importance of stress in structuring the composition and function of soil microbial communities suggests that our current conception of microbial ‘functional groups’, which is largely based on process-based groups such as nitrifiers or denitrifiers, requires an additional dimension of environmental response, such as drought tolerators, or cold acclimators, to fully account for microbial process responses to environmental change. This matrix of function and environmental response creates the niche space that presumably drives the patterns of microbial diversity found in soil.

9.4.2 Modelling

There are few approaches that explicitly use microbiological information in modelling soil respiration or soil carbon dynamics.

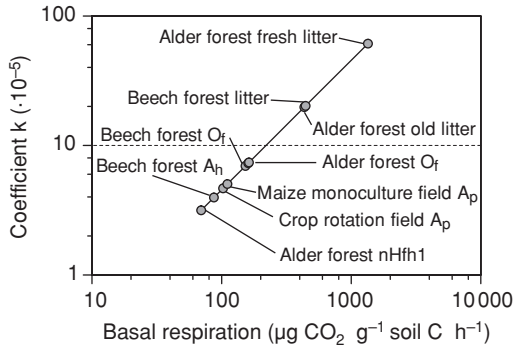

Figure 9.3 A case study by using results from basal respiration measurements in the laboratory for calibrating a model of soil respiration in four different ecosystems from the Bornhöved Lake district. The model used a first-order function. The decay rate constant was taken from the basal respiration related to the organic carbon in the soil.

A simple but efficient approach was used by Kutsch *et al.* (2001) who calibrated the rate constants by laboratory measurements of basal respiration while modelling the soil respiration in different ecosystems with a first-order reaction (Parton *et al.*, 1987):

$$\frac{dC}{dt} = k \cdot C \cdot f(T) \cdot f(\Theta) \quad \text{Eq. (9.1)}$$

where $\frac{dC}{dt}$ is the actual decomposition rate, k is the rate constant, C is the pool size and $f(T)$ and $f(\Theta)$ are response functions to soil temperature and moisture, respectively. In forest soils fresh litter, organic matter and humic substances were defined as pools, whereas in a crop field a two-pool model with the fast and slowly decomposable organic matter was used (Fig. 9.3 and Fig. 9.4). The specific rate constant k for each pool was derived from its basal respiration and modified by temperature and moisture conditions.

Even if models using first-order kinetics reasonably represent carbon dynamics under steady-state conditions, Schimel and Weintraub (2003) criticize that soil organic matter decomposition is not simply a first-order reaction, because it is catalyzed by extracellular enzymes that are produced by micro-organisms. They argue that the dynamics of the catalyst have to be considered to understand the linkages between C and N, and the dynamics of non-steady-state conditions; they propose

that the ‘return on investment’ microbes get from producing exoenzymes is a key control of decomposition (Fig. 9.5).

In a more complex approach, Moorehead and Sinsabaugh (2006) stress that ‘decomposition is conducted largely by a community of micro-organisms whose collective activity is controlled by litter chemistry, nutrient availability, environmental conditions, and biotic interactions’ (see also Swift *et al.*, 1979; Gerson and Chet, 1981; Berg and McClaugherty, 2003; Paul, 2007). In their synthesis they formulated a concept to model the interaction between litter chemistry and microbial activity via the response of extracellular enzyme production to the ratio between holocellulose and lignin including also growth and mortality of the microbial biomass and nitrogen fertilization.

The challenge, however, in relating these novel model approaches quantitatively to soil carbon dynamics is that many of the parameters are difficult to estimate. For example, the size of exoenzyme pools, their turnover time and the actual kinetic terms for SOM breakdown are all unknown. Therefore, many parameters have to be either approximated from laboratory experiments, which may be laborious, or by inverse modelling that may result in arbitrary values during the calibration of a model to field measured fluxes.

9.5 CONCLUSIONS

In this chapter, we have reviewed the methods available for studying soil microbial communities and their function, related to carbon cycling. We have shown that novel approaches have become possible after significant progress in molecular and isotope techniques. The challenge for future research is to integrate these approaches by finding better devices to couple field measurements of soil respiration, microbiological analyses in the laboratory and modelling. For this purpose, more integrated studies that comprise field measurements, micro- and mesocosm experiments and laboratory studies are required. They should point to the following questions.

- How do microbial community dynamics influence the mineralization or stabilization of soil organic carbon and nitrogen?

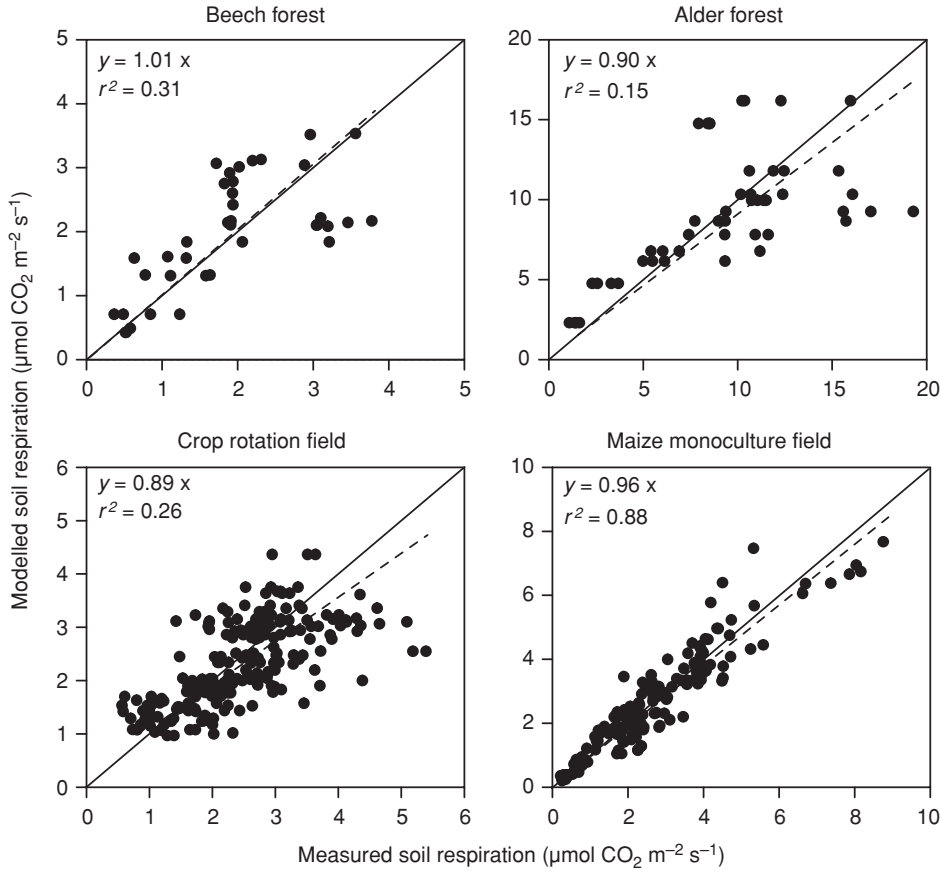

Figure 9.4 The figures show the comparison between measured (*x*-axis) and modelled (*y*-axis) values of soil respiration. Some extremely high values in the wet alder forest might be a result of the decrease of the water table during a dry period in summer.

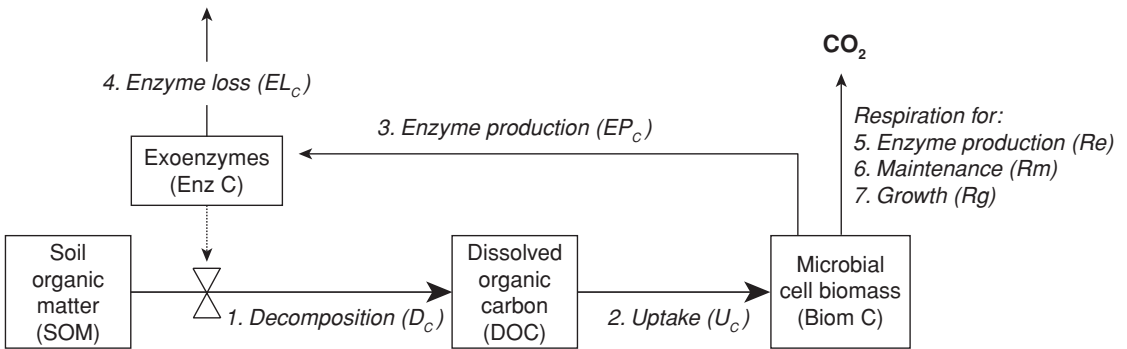

Figure 9.5 Structure of the model approach by Schimel and Weintraub (2003) that takes microbial biomass and extracellular enzymes into account. Solid lines indicate flows of material, dashed lines connected to ‘valves’ indicate regulation points. Decomposition is a function of exoenzyme concentration and the fundamental K_d constant, rather than of just SOM concentration. Microbes use all the available carbon.

In particular, future research has to unravel the role of diversity and community changes in controlling the different pathways of decomposition and in partitioning between them.

- What is the role of microbial acclimation in biogeochemical processes in a world undergoing global warming?

Microbial acclimation either by physiological changes or by changes in species composition is often denied to be an important part in the puzzle of flux acclimation to changing temperatures. The recent discussion has mainly focused on pool depletion and temperature sensitivity of different pools (Fang *et al.*, 2005; Knorr *et al.*, 2005; Davidson *et al.*, 2006). The techniques described in this chapter allow much deeper insights into microbial acclimation and may change the perspective from the substrate to the actors of matter transformation in soils.

- Is it possible to contrast the effects of microbial acclimation and nutrient or energy limitation on temperature sensitivity of mineralization?

The novel microbiological approaches can for sure provide useful information for general insights as well as for prediction of soil carbon dynamics. For the first time, it will be possible to connect structural and functional aspects of soil microbial communities. A lot of important new results about the dynamics of microbial communities and the mediation of biogeochemical cycles by micro-organisms can be expected for the next years.

REFERENCES

- Alef, K. and Nannipieri, P. (1995) *Methods in Applied Soil Microbiology and Biochemistry*. San Diego, CA: Academic Press.
- Allison, S. D. (2006) Soil minerals and humic acids alter enzyme stability: implications for ecosystem processes. *Biogeochemistry*, **81**, 361–73.
- Allison, S. D. and Jastrow, J. D. (2006) Activities of extracellular enzymes in physically isolated fractions of restored grassland soils. *Soil Biology and Biochemistry*, **38**, 3245–56.
- Anderson, T. H. (1994) Physiological analysis of microbial communities in soil: applications and limitations. In *Beyond the Biomass*, ed. K. Ritz, J. Dighton and K. E. Giller. Chichester: Wiley, pp. 67–76.
- Anderson, T. H. (2003) Microbial eco-physiological indicators to assess soil quality. *Agriculture, Ecosystems and Environment*, **98**, 285–93.
- Anderson, J. P. E. and Domsch, K. H. (1978) A physiological method for the quantitative measurement of microbial biomass in soils. *Soil Biology and Biochemistry*, **10**, 215–21.
- Anderson, T. H. and Domsch, K. H. (1986) Carbon assimilation and microbial activity in soil. *Zeitschrift Pflanzenernährung Bodenkunde*, **149**, 457–68.
- Anderson, T. H. and Domsch, K. H. (1990) Application of eco-physiological quotients (qCO₂ and qD) on microbial biomasses from soils of different cropping histories. *Soil Biology and Biochemistry*, **22**, 251–5.
- Bååth, E. and Anderson, T. H. (2003) Comparison of soil fungal/bacterial ratios in a pH gradient using physiological and PLFA-based techniques. *Soil Biology and Biochemistry*, **35**, 955–63.
- Balota, E. L., Colozzi, A., Andrade, D. S. and Dick, R. P. (2003) Microbial biomass in soils under different tillage and crop rotation systems. *Biology and Fertility of Soils*, **38**, 15–20.
- Balser, T. C. and Firestone, M. K. (2005) Linking microbial community composition and soil processes in a California annual grassland and mixed-conifer forest. *Biogeochemistry*, **73**, 395–415.
- Balser, T. C., Kirchner, J. W. and Firestone, M. K. (2002) Methodological variability in microbial community level physiological profiles. *Soil Science Society of America Journal*, **66**, 519–23.
- Bardgett, R. D. (2005) *The Biology of Soil: A Community and Ecosystem Approach*. Oxford: Oxford University Press.
- Bardgett, R. D. and McAlister, E. (1999) The measurement of soil fungal : bacterial biomass ratios as an indicator of ecosystem self-regulation in temperate meadow grasslands. *Biology and Fertility of Soils*, **29**, 282–90.
- Bardgett, R. D., Hobbs, P. J. and Frostegård, A. (1996) Changes in the structure of soil microbial communities following reductions in the intensity of management of an upland grassland. *Biology and Fertility of Soils*, **22**, 261–64.
- Beare, M. H., Neely, C. L., Coleman, D. C. and Hargrove, W. L. (1991) Characterization of a substrate-induced respiration method for measuring fungal, bacterial and total microbial biomass on plant residues. *Agriculture, Ecosystems and Environment*, **34**, 65–73.
- Beck, T., Joergensen, R. G., Kandeler, E. *et al.* (1997) An inter-laboratory comparison of ten different ways of

- measuring soil microbial biomass C. *Soil Biology and Biochemistry*, **29**, 1023–32.
- Berg, B. and Matzner, E. (1997) Effect of N deposition on decomposition of plant litter and soil organic matter in forest systems. *Environmental Reviews*, **5**, 1–25.
- Berg, B. and McClaugherty, C. A. (2003) *Plant Litter: Decomposition, Humus Formation, Carbon Sequestration*. Berlin: Springer Verlag.
- Billings, S. A. and Ziegler, S. E. (2005) Linking microbial activity and soil organic matter transformations in forest soils under elevated CO₂. *Global Change Biology*, **11**, 203–12.
- Blagodatskaya, E. V. and Anderson, T. H. (1999) Adaptive responses of soil microbial communities under experimental acid stress in controlled laboratory studies. *Applied Soil Ecology*, **11**, 207–16.
- Borneman, J. and Triplett, E. W. (1997) Rapid and direct method for extraction of RNA from soil. *Soil Biology and Biochemistry*, **29**, 1621–4.
- Boschker, H. T. S., Nold, S. C., Wellsbury, P. *et al.* (1998) Direct linking of microbial populations to specific biogeochemical processes by ¹³C-labelling of biomarkers. *Nature*, **392**, 801–5.
- Brookes, P. C., Powlson, D. S. and Jenkinson, D. S. (1982) Measurement of microbial biomass phosphorus in soil. *Soil Biology and Biochemistry*, **14**, 319–29.
- Brookes, P. C., Landman, A., Pruden, G. and Jenkinson, D. S. (1985) Chloroform fumigation and the release of soil nitrogen: a rapid direct extraction method for measuring microbial biomass nitrogen in soil. *Soil Biology and Biochemistry*, **17**, 837–42.
- Bull, I. D., Parekh, N. R., Hall, G. H., Ineson, P. and Evershed, R. P. (2000) Detection and classification of atmospheric methane oxidizing bacteria in soil. *Nature*, **405**, 175–8.
- Carreiro, M. M., Sinsabaugh, R. L., Repert, D. A. and Parkhurst, D. F. (2000) Microbial enzyme shifts explain litter decay responses to simulated nitrogen deposition. *Ecology*, **81**, 2359–65.
- Cho, J.-C. and Tiedje, J. M. (2002) Quantitative detection of microbial genes by using DNA microarray. *Applied Environmental Microbiology*, **68**, 1425–30.
- Csonka, L. N. (1989) Physiological and genetic responses of bacteria to osmotic stress. *Microbiological Reviews*, **53**, 121–47.
- Davidson, E. A., Janssens, I. A. and Luo, Y. Q. (2006) On the variability of respiration in terrestrial ecosystems: moving beyond Q₁₀. *Global Change Biology*, **12**, 154–64.
- de Vries, F. T., Hoffland, E., van Eekeren, N., Brussaard, L. and Bloem, J. (2006) Fungal/bacterial ratios in grasslands with contrasting nitrogen management. *Soil Biology and Biochemistry*, **38**, 2092–103.
- DeForest, J. L., Zak, D. R., Pregitzer, K. S. and Burton, A. J. (2004) Atmospheric nitrate deposition and the microbial degradation of cellobiose and vanillin in a northern hardwood forest. *Soil Biology and Biochemistry*, **36**, 965–71.
- Dilly, O. (2005) Microbial energetics in soil. *Microorganisms in Soils: Roles in Genesis and Functions*, ed. F. Buscot and A. Varma. Berlin and Heidelberg: Springer-Verlag, pp. 123–38.
- Dilly, O. (2006) Ratios of microbial biomass estimates to evaluate microbial physiology in soil. *Biology and Fertility of Soils*, **42**, 241–6.
- Dilly, O. and Munch, J. C. (1996) Microbial biomass content, basal respiration and enzyme activities during the course of decomposition of leaf litter in a Black Alder (*Alnus Glutinosa* (L.) Gaertn.) forest. *Soil Biology and Biochemistry*, **28**, 1073–81.
- Dilly, O. and Munch, J. C. (1998) Ratios between estimates of microbial biomass content and microbial activity in soils. *Biology and Fertility of Soils*, **27**, 374–9.
- Dilly, O., Blume, H. P., Sehy, U., Jimenez, M. and Munch, J. C. (2003) Variation of stabilised, microbial and biologically active carbon and nitrogen in soil under contrasting land use and agricultural management practices. *Chemosphere*, **52**, 557–69.
- Eiland, F. (1983) A simple method for quantitative determination of ATP in soil. *Soil Biology and Biochemistry*, **15**, 665–70.
- Evershed, R. P., Crossman, Z. M., Bull, I. D. *et al.* (2006) ¹³C-labelling of lipids to investigate microbial communities in the environment. *Current Opinion in Biotechnology*, **17**, 72–82.
- Fang, C., Smith, P., Moncrieff, J. B. and Smith, J. U. (2005) Similar response of labile and resistant soil organic matter pools to changes in temperature. *Nature*, **433**, 57–9.
- Farrar, W. and Reboli, A. (1999) The genus *Bacillus* – medical. In *The Prokaryotes: An Evolving Electronic Resource for the Microbiological Community*, ed. M. Dworkin. New York: Springer.
- Fierer, N. and Schimel, J. P. (2002) Effects of drying–rewetting frequency on soil carbon and nitrogen transformations. *Soil Biology and Biochemistry*, **34**, 777–87.

- Fierer, N. and Schimel, J. P. (2003) A proposed mechanism for the pulse in carbon dioxide production commonly observed following the rapid rewetting of a dry soil. *Soil Science Society of America Journal*, **67**, 798–805.
- Fierer, N., Schimel, J. P. and Holden, P. A. (2003) Influence of drying-rewetting frequency on soil bacterial community structure. *Microbial Ecology*, **45**, 63–71.
- Fog, K. (1988) The effect of added nitrogen on the rate of decomposition of organic matter. *Biological Reviews*, **63**, 433–62.
- Frey, S. D., Gupta, V., Elliott, E. T. and Paustian, K. (2001) Protozoan grazing affects estimates of carbon utilization efficiency of the soil microbial community. *Soil Biology and Biochemistry*, **33**, 1759–68.
- Frostegård, A., Tunlid, A. and Bååth, E. (1993) Phospholipid fatty acid composition, biomass, and activity of microbial communities from 2 soil types experimentally exposed to different heavy metals. *Applied and Environmental Microbiology*, **59**, 3605–17.
- Gallo, M., Amonette, R., Lauber, C., Sinsabaugh, R. L. and Zak, D. R. (2004) Microbial community structure and oxidative enzyme activity in nitrogen-amended north temperate forest soils. *Microbial Ecology*, **48**, 218–29.
- Garland, J. L. and Mills, A. L. (1991) Classification and characterization of heterotrophic microbial communities on the basis of patterns of community-level sole-carbon-source utilization. *Applied Environmental Microbiology*, **57**, 2351–9.
- Gelsomino, A., Keijzer-Wolters, A. C., Cacco, G. and van Elsas, J. D. (1999) Assessment of bacterial community structure in soil by polymerase chain reaction and denaturing gradient gel electrophoresis. *Journal of Microbiological Methods*, **38**, 1–15.
- Gerson, U. and Chet, I. (1981) Are allochthonous and autochthonous soil microorganisms r- and K-selected? *Revue d'Écologie et de Biologie du Sol*, **18**, 285–9.
- Ginige, M. P., Hugenholtz, P., Daims, H. *et al.* (2004) Use of stable-isotope probing, full-cycle rRNA analysis, and fluorescence *in situ* hybridization-microautoradiography to study a methanol-fed denitrifying microbial community. *Applied and Environmental Microbiology*, **70**, 588–96.
- Ginige, M. P., Keller, J. and Blackall, L. L. (2005) Investigation of an acetate-fed denitrifying microbial community by stable isotope probing, full-cycle rRNA analysis, and fluorescent *in situ* hybridization-microautoradiography. *Applied and Environmental Microbiology*, **71**, 8683–91.
- Gregorich, E. G., Wen, G., Voroney, R. P. and Kachaniski, R. G. (1990) Calibration of a rapid direct chloroform extraction method for measuring soil microbial biomass C. *Soil Biology and Biochemistry*, **22**, 1009–11.
- Hammel, K. E. (1997) Fungal degradation of lignin. In *Driven by Nature: Plant Litter Quality and Decomposition*, ed. G. Cadisch and K. E. Giller. Wallingford: CAB International, pp. 33–46.
- Harris, R. F. (1981) Effect of water potential on microbial growth and activity. In *Water Potential Relations in Soil Microbiology*, ed. F. Parr, W. R. Gardner and L. F. Elliott. Madison, WI: American Society of Agronomy, pp. 23–95.
- Hawkes, C. V., Wren, I. F., Herman, D. J. and Firestone, M. K. (2005) Plant invasion alters nitrogen cycling by modifying the soil nitrifying community. *Ecology Letters*, **8**, 976–85.
- Herrmann, A. and Witter, E. (2002) Sources of C and N contributing to the flush in mineralization upon freeze-thaw cycles in soils. *Soil Biology and Biochemistry*, **34**, 1495–505.
- Insam, H. and Domsch, K. H. (1988) Relationship between soil organic carbon and microbial biomass on chronosequences of reclamation sites. *Microbial Ecology*, **15**, 177–88.
- Insam, H. and Haselwandter, K. (1989) Metabolic quotient of the soil microflora in relation to plant succession. *Oecologia*, **79**, 174–8.
- Jenkinson, D. S. (1976) The effects of biocidal treatments on metabolism in soil. IV. The decomposition of fumigated organisms in soil. *Soil Biology and Biochemistry*, **8**, 203–8.
- Jenkinson, D. S. and Powlson, D. S. (1976) The effects of biocidal treatments on metabolism in soil. V. A method for measuring soil biomass. *Soil Biology and Biochemistry*, **8**, 209–13.
- Jenkinson, D. S., Brookes, P. C. and Powlson, D. S. (2004) Measuring soil microbial biomass. *Soil Biology and Biochemistry*, **36**, 5–7.
- Joergensen, R. G. and Emmerling, C. (2006) Methods for evaluating human impact on soil microorganisms based on their activity, biomass, and diversity in agricultural soils. *Journal of Plant Nutrition and Soil Science*, **169**, 295–309.
- Jones, D. L. and Kielland, K. (2002) Soil amino acid turnover dominates the nitrogen flux in permafrost-dominated taiga forest soils. *Soil Biology and Biochemistry*, **34**, 209–19.

- Knorr, W., Prentice, I. C., House, J. I. and Holland, E. A. (2005) Long-term sensitivity of soil carbon turnover to warming. *Nature*, **433**, 298–433.
- Kutsch, W. L. and Dilly, O. (1999) Ecophysiology of plant and microbial interactions in terrestrial ecosystems. In *Ökophysiologie pflanzlicher Interaktionen*, ed. W. Beyschlag and T. Steinlein. Vol. 14. Bielefelder Ökologischer Beiträge, pp. 74–84.
- Kutsch, W. L., Eschenbach, C., Dilly, O. *et al.* (2001) The carbon cycle of contrasting landscape elements of the Bornhöved Lake district. In *Ecosystem Properties and Landscape Function in Central Europe*, ed. R. Lenz, R. Hantschel and J. D. Tenhunen. Vol. 147. Ecological Studies. Berlin: Springer, pp. 75–95.
- Lennartsson, M. and Ogren, E. (2002) Causes of variation in cold hardiness among fast-growing willows (*Salix spp.*) with particular reference to their inherent rates of cold hardening. *Plant Cell and Environment*, **25**, 1279–88.
- Lindstrom, J. E., Barry, R. P. and Braddock, J. F. (1999) Long-term effects on microbial communities after a subarctic oil spill. *Soil Biology and Biochemistry*, **31**, 1677.
- Lueders, T., Wagner, B., Claus, P. and Friedrich, M. W. (2004a) Stable isotope probing of rRNA and DNA reveals a dynamic methylotroph community and trophic interactions with fungi and protozoa in oxic rice field soil. *Environmental Microbiology*, **6**, 60–72.
- Lueders, T., Manefield, M. and Friedrich, M. W. (2004b) Enhanced sensitivity of DNA- and rRNA-based stable isotope probing by fractionation and quantitative analysis of isopycnic centrifugation gradients. *Environmental Microbiology*, **6**, 73–8.
- Lynch, J. M., Benedetti, A., Insam, H. (2004) Microbial diversity in soil: ecological theories, the contribution of molecular techniques and the impact of transgenic plants and transgenic microorganisms. *Biology and Fertility of Soils*, **40**, 363–85.
- MacGregor, B. J., Bruchert, V., Fleischer, S. and Amann, R. (2002) Isolation of small-subunit rRNA for stable isotopic characterization. *Environmental Microbiology*, **4**, 451–64.
- Manefield, M., Whiteley, A. S., Griffiths, R. I. and Bailey, M. J. (2002a) RNA stable isotope probing, a novel means of linking microbial community function to phylogeny. *Applied Environmental Microbiology*, **68**, 5367–73.
- Manefield, M., Whiteley, A. S., Ostle, N., Ineson, P. and Bailey, M. J. (2002b) Technical considerations for RNA-based stable isotope probing: an approach to associating microbial diversity with microbial community function. *Rapid Communications in Mass Spectrometry*, **16**, 2179–83.
- Martens, R. (1995) Current methods for measuring microbial biomass C in soil: potentials and limitations. *Biology and Fertility of Soils*, **19**, 87–99.
- Marx, M. C., Kandeler, E., Wood, M., Wermbter, N. and Jarvis, S. C. (2005) Exploring the enzymatic landscape: distribution and kinetics of hydrolytic enzymes in soil particle-size fractions. *Soil Biology and Biochemistry*, **37**, 35–48.
- McDonald, I. R., Radajewski, S. and Murrell, J. C. (2005) Stable isotope probing of nucleic acids in methanotrophs and methylotrophs: a review. *Organic Geochemistry*, **36**, 779–87.
- Methe, B. A., Nelson, K. E., Deming, J. W. *et al.* (2005) The psychrophilic lifestyle as revealed by the genome sequence of *Colwellia psychrerythraea* ³⁴H through genomic and proteomic analyses. *Proceedings of the National Academy of Sciences of the United States of America*, **102**, 10913–18.
- Michel, K. and Matzner, E. (2003) Response of enzyme activities to nitrogen addition in forest floors of different C-to-N ratios. *Biology and Fertility of Soils*, **38**, 102–9.
- Mikan, C. J., Schimel, J. P. and Doyle, A. P. (2002) Temperature controls of microbial respiration in arctic tundra soils above and below freezing. *Soil Biology and Biochemistry*, **34**, 1785–95.
- Mills, D. K., Entry, J. A., Gillevet, P. M. and Mathee, K. (2007) Assessing microbial community diversity using amplicon length heterogeneity polymerase chain reaction. *Soil Science Society of America Journal*, **71**, 572–8.
- Moorhead, D. L. and Sinsabaugh, R. L. (2006) A theoretical model of litter decay and microbial interaction. *Ecological Monographs*, **76**, 151–74.
- Morris, S. A., Radajewski, S., Willison, T. W. and Murrell, J. C. (2002) Identification of the functionally active methanotroph population in a peat soil microcosm by stable-isotope probing. *Applied and Environmental Microbiology*, **68**, 1446–53.
- Murase, J., Matsui, Y., Katoh, M., Sugimoto, A. and Kimura, M. (2006) Incorporation of ¹³C-labeled rice-straw-derived carbon into microbial communities in submerged rice field soil and percolating water. *Soil Biology and Biochemistry*, **38**, 3483–91.

- Nannipieri, P., Greco, S. and Ceccanti, B. (1990) Ecological significance of the biological activity in soil. In *Soil Biochemistry*, ed. J. M. Bollag and G. Stotzky. Vol. 6. New York: Marcel Dekker, pp. 293–355.
- Neufeld, J. D., Wagner, M. and Murrell, J. C. (2007a) Who eats what, where and when? Isotope-labelling experiments are coming of age. *The Isme Journal*, **1**, 103–10.
- Neufeld, J. D., Dumont, M. G., Vohra, J. and Murrell, J. C. (2007b) Methodological considerations for the use of stable isotope probing in microbial ecology. *Microbial Ecology*, **53**, 435–42.
- Odum, E. P. (1969) The strategy of ecosystem development. *Science*, **164**, 262–70.
- Parton, W. J., Schimel, D. S., Cole, C. V. and Ojima, D. S. (1987) Analysis of factors controlling soil organic matter levels in Great Plains grasslands. *Soil Science Society of America Journal*, **51**, 1173–9.
- Paul, E. A. (2007) *Soil Microbiology, Ecology and Biochemistry*, 3rd edn. San Diego, CA: Academic Press.
- Pirt, S. J. (1975) *The Principles of Microbe and Cell Cultivation*. Oxford: Blackwell Scientific Publications.
- Porazinska, D. L., Bardgett, R. D., Blaauw, M. B. *et al.* (2003) Relationships at the aboveground–belowground interface: plants, soil biota, and soil processes. *Ecological Monographs*, **73**, 377–95.
- Powelson, D. S. (1994) The soil microbial biomass: before, beyond, back. In *Beyond the Biomass*, ed. K. Ritz, J. Dighton and K. Giller. Chichester: Wiley.
- Radajewski, S. and Murrell, J. C. (2001) Stable isotope probing for detection of methanotrophs after enrichment with $^{13}\text{CH}_4$. *Methods in Molecular Biology*, **179**, 149–57.
- Radajewski, S., Ineson, P., Parekh, N. R. and Murrell, J. C. (2000) Stable-isotope probing as a tool in microbial ecology. *Nature*, **403**, 646–9.
- Rangel-Castro, J. I., Killham, K., Ostle, N. *et al.* (2005) Stable isotope probing analysis of the influence of liming on root exudate utilization by soil microorganisms. *Environmental Microbiology*, **7**, 828–38.
- Ritchie, N. J., Schutter, M. E., Dick, R. P. and Myrold, D. D. (2000) Use of length heterogeneity PCR and fatty acid methyl ester profiles to characterize microbial communities in soil. *Applied and Environmental Microbiology*, **66**, 1668–75.
- Ritz, K., Dighton, J. and Giller, K. (1994) *Beyond the Biomass*. Chichester: Wiley.
- Saiya-Cork, K. R., Sinsabaugh, R. L. and Zak, D. R. (2002) The effects of long term nitrogen deposition on extracellular enzyme activity in an *Acer saccharum* forest soil. *Soil Biology and Biochemistry*, **34**, 1309–15.
- Schimel, J. P. and Weintraub, M. N. (2003) The implications of exoenzyme activity on microbial carbon and nitrogen limitation in soil: a theoretical model. *Soil Biology and Biochemistry*, **35**, 549–63.
- Schimel, J., Balsler, T. C. and Wallenstein, M. D. (2007) Microbial stress-response physiology and its implications for ecosystem function. *Ecology*, **88**, 1386–94.
- Sinsabaugh, R. L. (1994) Enzymic analysis of microbial pattern and process. *Biology and Fertility of Soils*, **17**, 69–74.
- Sinsabaugh, R. L. and Liptak, M. (1997) Enzymatic conversion of plant biomass. In *The Mycota: Environmental and Microbial Relationships*, ed. B. Soderstrom and D. T. Wicklow. Berlin: Springer-Verlag, pp. 347–57.
- Sinsabaugh, R. L., Carreiro, M. M. and Repert, D. A. (2002) Allocation of extracellular enzymatic activity in relation to litter composition, N deposition, and mass loss. *Biogeochemistry*, **60**, 1–24.
- Skogland, T., Lomeland, S. and Goksoyr, J. (1988) Respiratory burst after freezing and thawing of soil: experiments with soil bacteria. *Soil Biology and Biochemistry*, **20**, 851–66.
- Slater, J. H. (1979) Microbial population and community dynamics. In *Microbial Ecology. A Conceptual Approach*, ed. J. M. Lynch and N. J. Poole. Oxford: Blackwell Scientific Publications, pp. 45–63.
- Sparling, G. P. and West, A. W. (1988) A direct extraction method to estimate soil microbial C: calibration *in situ* using microbial respiration and ^{14}C labelled cells. *Soil Biology and Biochemistry*, **20**, 337–43.
- Stark, J. and Firestone, M. K. (1995) Mechanisms for soil moisture effects on activity of nitrifying bacteria. *Applied and Environmental Microbiology*, **61**, 218–21.
- Suzina, N. E., Mulyukin, A. L., Kozlova, A. N. *et al.* (2004) Ultrastructure of resting cells of some non-spore-forming bacteria. *Microbiology*, **73**, 435–47.
- Suzuki, M., Rappe, M. S. and Giovannoni, S. J. (1998) Kinetic bias in estimates of coastal picoplankton community structure obtained by measurements of small-subunit rRNA gene PCR amplicon length heterogeneity. *Applied and Environmental Microbiology*, **64**, 4522–9.

- Swift, M. J., Heal, O. W. and Anderson, J. M. (1979) *Decomposition in Terrestrial Ecosystems*. Studies in Ecology, Vol. 5. Los Angeles, CA: University of California Press.
- Tate, K. R. and Jenkinson, D. S. (1982) Adenosine triphosphate measurement in soil: an improved method. *Soil Biology and Biochemistry*, **14**, 331–5.
- Tate, R. L. I. (2000) *Soil Microbiology*. Chichester: Wiley & Sons.
- Thiet, R. K., Frey, S. D. and Six, J. (2006) Do growth yield efficiencies differ between soil microbial communities differing in fungal : bacterial ratios? Reality check and methodological issues. *Soil Biology and Biochemistry*, **38**, 837–44.
- Tiedje, J. M., Asuming-Brempong, S., Nusslein, K., Marsh, T. L. and Flynn, S. J. (1999) Opening the black box of soil microbial diversity. *Applied Soil Ecology*, **13**, 109–22.
- Torsvik, V., Daae, F. L., Sandaa, R. A. and Ovreas, L. (1998) Novel techniques for analysing microbial diversity in natural and perturbed environments. *Journal of Biotechnology*, **64**, 53–62.
- Treonis, A. M., Ostle, N. J., Stott, A. W. *et al.* (2004) Identification of groups of metabolically-active rhizosphere microorganisms by stable isotope probing of PLFAs. *Soil Biology and Biochemistry*, **36**, 533–7.
- Vance, E. D., Brookes, P. C. and Jenkinson, D. S. (1987) An extraction method for measuring soil microbial biomass C. *Soil Biology and Biochemistry*, **19**, 703–7.
- Vedder, B., Kampichler, C., Bachmann, G., Bruckner, A. and Kandeler, E. (1996) Impact of faunal complexity on microbial biomass and N turnover in field mesocosms from a spruce forest soil. *Biology and Fertility of Soils*, **22**, 22–30.
- Vestal, J. R. and White, D. C. (1989) Lipid analysis in microbial ecology: quantitative approaches to the study of microbial communities. *BioScience*, **29**, 535–41.
- Waksman, S. A. (1932) *Principles of Soil Microbiology*. Baltimore, MD: Williams and Wilkins.
- Waldrop, M. P., Zak, D. R., Sinsabaugh, R. L., Gallo, M. and Lauber, C. (2004) Nitrogen deposition modifies soil carbon storage through changes in microbial enzymatic activity. *Ecological Applications*, **14**, 1172–7.
- Wardle, D. A. (2002) *Communities and Ecosystems: Linking the Aboveground and Belowground Components*. Monographs in population biology, Vol. 34. Princeton, NJ: Princeton University Press.
- Whitby, C. B., Hall, G., Pickup, R. *et al.* (2001) ¹³C incorporation into DNA as a means of identifying the active components of ammonia-oxidizer populations. *Letters in Applied Microbiology*, **32**, 398–401.
- Williams, M. A., Myrold, D. D. and Bottomley, P. J. (2006) Carbon flow from ¹³C-labeled straw and root residues into the phospholipid fatty acids of a soil microbial community under field conditions. *Soil Biology and Biochemistry*, **38**, 759–68.
- Winogradsky, S. (1924) Sur la microflora autochtone de la terre arable. *Comptes rendus hebdomadaire des séances de Academie des Sciences (Paris) D*, **178**, 1236–9.
- Witteveen, C. F. B. and Visser, J. (1995) Polyol pools in *Aspergillus niger*. *FEMS Microbiology Ecology*, **134**, 57–62.
- Zak, D. R., Blackwood, C. B. and Waldrop, M. P. (2006) A molecular dawn for biogeochemistry. *Trends in Ecology and Evolution*, **21**, 288–95.

10. Trophic interactions and their implications for soil carbon fluxes

Edward Ayres, Diana H. Wall and Richard D. Bardgett

10.1 INTRODUCTION

Trophic interactions, the consumption of one organism, or a part of it, by another, are a fundamental component of all ecosystems. The vast majority of net primary productivity is eventually consumed, either by herbivores if the tissue is still alive, or by decomposers if the tissue has died (e.g. Cebrian, 2004). Similarly, these primary consumers are themselves consumed either by predators, parasites or decomposers (secondary consumers). Thus, trophic interactions form the pathways through which carbon flows through an ecosystem and, to a large extent, these interactions control ecosystem carbon dynamics, either directly (via consumption of another organism) or indirectly (e.g. altering competition between the prey individual/population and other organisms).

In this chapter we consider the principal ways by which trophic interactions influence soil carbon fluxes (Fig. 10.1). Firstly, we discuss the impacts of both above- and below-ground herbivores on carbon flux into, and out of, the soil and the interactions between herbivores, plants and soil organisms (dashed box in Fig. 10.1). Secondly, we investigate the role of soil fauna in organic matter decomposition, either directly via the consumption of litter, or indirectly via feeding on saprotrophs or the movement of organic matter (dotted box in Fig. 10.1). Thirdly, we examine the role of resource availability versus predation in structuring soil food webs, followed by the linkages between soil biodiversity and a range of ecosystem processes, including plant growth, litter decomposition and carbon mineralization (solid box in Fig. 10.1). Finally, we synthesize the findings from these three topics and highlight areas where we feel future work on the relationships between trophic interactions and soil carbon dynamics should be directed.

10.2 ABOVE- AND BELOW-GROUND HERBIVORY

10.2.1 Short-term responses to herbivores

We have split the effects of herbivores on carbon fluxes into predominantly short-term or long-term impacts, but we recognize that these effects are manifested along a continuum. Traditionally, the effects of selective feeding by herbivores on plant communities (long term: years to decades) and the addition of pulses of relatively labile organic matter to soils (short term: hours to months), such as excreta and carcasses, were considered the main pathways by which herbivores influenced soils and soil biological processes. However, over the last two decades there has been increasing recognition that plant physiological responses to herbivory also influence soils and soil biota (Holland *et al.*, 1996; Bardgett *et al.*, 1998; Hamilton and Frank, 2001; Bardgett and Wardle, 2003). Given the physiological nature of these plant responses they tend to influence soils over time scales of hours to months, in contrast to plant community responses to herbivory that typically occur over years to decades (see Section 10.2.2). In this sub-section we focus on short-term relationships between herbivory and soil carbon fluxes, investigating the influence of herbivore-induced changes in labile organic matter inputs, plant inducible defences and root morphology/physiology on carbon dynamics.

10.2.1.1 Animal waste products and soil carbon dynamics

The addition of excreta to soils represents an indirect pathway by which herbivores alter plant carbon fluxes to soils. A proportion of the plant material consumed by herbivores is returned to the soil partially digested or digested but unassimilated, typically containing

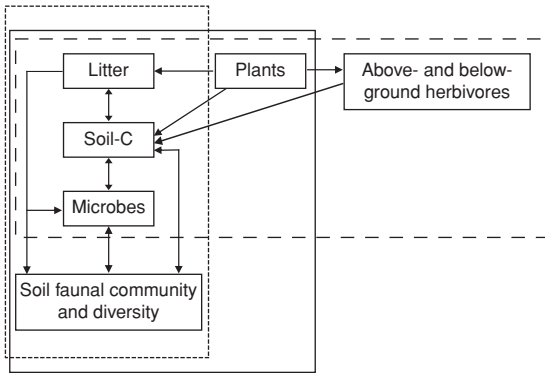

Figure 10.1 Schematic diagram of carbon flux through the major components of a simplified food web. The boxes represent the topics covered in the sub-sections of this chapter: above- and below-ground herbivory (dashed box); trophic interactions in soils and decomposition (dotted box); and soil biota community structure and diversity (solid box).

simpler, more labile compounds than the parent material. It has long been known that faeces addition can cause major changes in soil properties such as fertility; indeed manure has been used as an agricultural fertilizer for thousands of years (McNeill and Winiwarter, 2004). These effects on soils are not limited to the manure of vertebrates, since frass (invertebrate excreta), as well as urine, body parts and carcasses, can all influence below-ground processes (Haynes and Williams, 1993; Lovett and Ruesink, 1995; Frost and Hunter, 2004). This influx of labile resources typically stimulates the activity and biomass of soil microbes resulting in faster rates of decomposition and nutrient mineralization. Several studies have shown that dung (Pastor *et al.*, 1993; Lovell and Jarvis, 1996; Bardgett *et al.*, 1998) and frass (Lovett and Ruesink, 1995; Frost and Hunter, 2004) addition to soil increases microbial biomass or activity, as well as soil faunal abundance (Ettema and Bongers, 1993). Similarly, in a field experiment, Williams *et al.* (2000) detected an increase in the number of soil bacteria in response to synthetic sheep urine additions, as well as positive or negative effects on soil respiration dependent on site. Dung and urine inputs have been related to an enhancement of soil organic matter, nutrient availability, microbial biomass and activity in the field (Ruess and McNaughton, 1987; McNaughton *et al.*, 1997; Haynes and Williams, 1999; Bardgett and Wardle, 2003). Haynes and Williams (1999) observed

increased soil organic carbon, soluble carbon, microbial biomass and activity in areas with greater dung and urine inputs, and experimental addition of dung and urine to soil mirrored these changes in soil properties.

Besides promoting soil respiration, dung additions can increase carbon loss via leaching. In a field experiment in southwest England using dung with distinct C-isotope signatures, Bol *et al.* (2000) detected that dung-derived carbon in soil leachates peaked 21–26 days after dung application. Furthermore, dung application resulted in a ‘priming’ effect whereby it increased the quantity of soil-derived carbon leached from soil (Bol *et al.*, 2000). Carbon from dung additions can be quickly incorporated into the soil pool, with 7% of topsoil (0–1 cm) carbon derived from dung added only one week earlier (Bol *et al.*, 2004). However, due to rapid turnover and leaching, only a small quantity (~9–17%) of dung-derived carbon was present in soils after 70 to 150 days (Bol *et al.*, 2000, 2004).

As illustrated above, the positive effect of dung and urine on soil nutrient availability represents an important pathway by which herbivores increase plant nutrient uptake and production (McNaughton *et al.*, 1997; Frank and Groffman, 1998; Wardle, 2002; Bardgett and Wardle, 2003). Persistent increases in soil nutrient availability, as a result of herbivore waste inputs have the potential to alter plant community structure, which in turn could influence soil carbon dynamics (see Section 10.2.2).

10.2.1.2 Herbivore-induced changes in litter chemistry and soil carbon dynamics

A second short-term effect of herbivores on soil carbon cycling occurs via their impact on plant litter quality. At the individual plant scale, herbivore attack can result in changes in the chemical composition of plant material, such as the production of compounds that make plant material less palatable to herbivores (Zangerl, 1990; Wold and Marquis, 1997). However, only recently has this response been related to below-ground carbon cycling. Findlay *et al.* (1996) demonstrated that spider mite damage to leaves of cottonwood plants resulted in greater phenolic concentrations in leaf litter, and, as a consequence, litter mass loss was reduced such that after 21 days twice as much litter mass remained from the spider mite treatment than from the control. These findings suggest that insect herbivory on foliage may slow

rates of decomposition, thereby leading to the accumulation of soil organic matter (Findlay *et al.*, 1996). In contrast, scale insects and stem-boring moths increased nutrient concentrations, and decreased carbon:nitrogen and lignin:nitrogen, in needle litter from pinyon pines, probably as a result of a reduction of nutrient resorption prior to senescence (Chapman *et al.*, 2003). Chapman *et al.* (2003) suggested that this increase in litter quality explained why trees susceptible to herbivore attack by either of these species produced litter that decomposed faster than litter from unsusceptible trees. Similarly, browsing mammals including moose have been shown to enhance leaf litter N concentrations of taiga trees in a boreal forest, resulting in faster rates of litter mass loss and respiration (Kielland *et al.*, 1997). Therefore, the plant species, as well as the type of herbivory, may influence the direction of any effect on litter quality, as well as subsequent impacts on litter decomposition and soil carbon sequestration. Moreover, as with dung and urine inputs, herbivore-induced differences in nutrient release from litter, and hence soil nutrient availability, has the potential to alter plant community structure, with further consequences for below-ground carbon dynamics (see Section 10.2.2).

10.2.1.3 Herbivore-induced changes in roots and soil carbon dynamics

Many studies have shown that herbivory enhances below-ground carbon allocation and carbon inputs to soil through changes in root biomass, turnover and exudation. Although in general, large above-ground herbivores appear to reduce plant above-ground biomass (Milchunas and Lauenroth, 1993), medium-intensity herbivory can actually stimulate above-ground plant productivity in fertile sites, with declines in plant biomass only occurring under high-intensity herbivory (McNaughton, 1979). Similarly, at the individual plant scale, several studies have demonstrated positive, neutral and negative effects of foliar herbivory on root biomass for a range of plant functional types (Milchunas and Lauenroth, 1993; Guitian and Bardgett, 2000; Ayres *et al.*, 2004, 2007) suggesting that carbon allocation below ground may be altered by herbivory. Response of root biomass to foliar herbivory may be plant species specific and may relate to a species' natural history. For instance, Ayres *et al.* (2004) observed a reduction in root biomass of *Abies alba*, a relatively slow growing evergreen tree, in response to clipping,

whereas, *Fagus sylvatica*, a faster growing deciduous species, subjected to the same level of defoliation exhibited no reduction in root biomass. Likewise, Guitian and Bardgett (2000) found clipping reduced root biomass, and increased resource allocation above ground, in two grazing tolerant grasses, whereas root biomass of a grazing intolerant grass was not affected by defoliation, but resource allocation below ground was increased. As with foliar herbivory, even root herbivores do not necessarily result in a reduction in root biomass. Indeed, root herbivory can stimulate root production (Bardgett *et al.*, 1999), again suggesting enhanced carbon flux below ground, and neutral effects are also common (Denton *et al.*, 1999; Yeates *et al.*, 1999; Ayres *et al.*, 2007).

Root exudates represent a major flux of carbon into the soil and are an important resource for soil biota, as evidenced by greater microbial biomass in rhizosphere soil relative to bulk soil (Hamilton and Frank, 2001). Several experiments have shown that foliar herbivory enhances the flux of recently assimilated carbon below ground. For example, the quantity of leaf mass of $^{14}\text{CO}_2$ -labelled *Zea mays* consumed by grasshoppers positively correlated with recovery of ^{14}C in its roots, root exudates and below-ground respiration (Holland *et al.*, 1996). Similarly, Hamilton and Frank (2001) demonstrated that defoliation of *Poa pratensis*, a grazing tolerant grass, enhanced soil and soil soluble carbon, as well as the recovery of plant-derived ^{13}C in the soil and soil solution. This increase in plant carbon inputs stimulated microbial biomass and activity, resulting in enhanced soil N availability, plant N uptake and photosynthesis (Hamilton and Frank, 2001). Defoliation has been shown to increase plant carbon exudation in several other grass species (Paterson and Sim, 1999, 2000; Paterson *et al.*, 2003; Murray *et al.*, 2004). There have been fewer studies on the influence of below-ground herbivory on plant carbon exudation. Freckman *et al.* (1991) observed a reduction in the rate and quantity of ^{11}C transport to roots, suggesting carbon exudation may be reduced in the presence of root herbivores. In contrast, infection of *Trifolium repens* with plant-parasitic nematodes enhanced carbon exudation and the recovery of plant-derived carbon in soil microbes (Yeates *et al.*, 1998, 1999). Moreover, greater concentrations of soil solution carbon have been observed in field plots (Tu *et al.*, 2002) and microcosms containing different grassland plants (*T. repens*, *Lolium perenne* or *Agrostis*

capillaris) (Treonis *et al.*, 2005) inoculated with plant-parasitic nematodes, suggesting increased rhizodeposition as a consequence of root herbivory.

The type of damage caused by a herbivore can influence its effects on soil. However, since most studies on the effects of foliar herbivory on rhizodeposition and soil properties involve artificial herbivory (i.e. clipping) we have only a limited understanding of this. Frost and Hunter (2004) found consistently greater rates of respiration from soil planted with *Quercus rubra* when defoliated by caterpillars than by clipping, despite similar reductions in leaf area. Similarly, Yeates *et al.* (1999) observed differences in plant-derived ^{14}C recovery from soil and soil microbes in pots containing *T. repens* inoculated with a range of root-feeding nematode species. More studies involving a range of herbivore species or functional types (e.g. defoliators, sap feeders, gall formers and plant parasites) are required to test the generality of their impacts on root carbon flux to soil. There is also a paucity of data relating to the duration of herbivore-induced impacts on root carbon flux. Patterson and Sim (1999, 2000) measured root exudation from grasses in response to clipping and found that although there was an increase in plant carbon exudation, the effect disappeared after three to five days, suggesting increases in carbon flux to soils may be relatively minor over longer time scales. However, other studies suggest the effects of defoliation on soils, and the consequences of this for plants, can last for months (Ayres *et al.*, 2004; Mikola *et al.*, 2005). Ayres *et al.* (2004) observed significant differences in response to foliar herbivory in soil planted with two tree species several months after the last defoliation event. In particular, faster rates of N mineralization were observed in soils planted with defoliated trees, indicating increased microbial activity, and there were signs that the trees would exhibit differences in carbon assimilation in the following growing season (Ayres *et al.*, 2004) with potential consequences for carbon flux below ground.

The unimodal relationship between plant productivity and intensity of herbivory (McNaughton, 1979), typical of productive grasslands (De Mazencourt *et al.*, 1999), may also occur for plant carbon inputs to soils, i.e. with maximum carbon flux to soils at intermediate levels of herbivory, although this hypothesis has not been tested. Support for this is provided by observations of peak microbial biomass in the presence of intermediate numbers of a root herbivore (Denton *et al.*, 1999) and

at intermediate grazing intensity (Bardgett *et al.*, 2001). Soil microbes are commonly carbon limited (Zak *et al.*, 1994; Wardle, 2002), so an increase in their abundance may suggest increased plant carbon inputs to soil. However, in two microcosm experiments, which varied the intensity of defoliation, there was no evidence of greater carbon fluxes to soils at intermediate levels of herbivory, since microbial biomass either increased (Guitian and Bardgett, 2000) or decreased (Mikola *et al.*, 2001a) with defoliation intensity. It should be noted that enhanced plant carbon inputs to soils as a result of herbivory may not result in increased soil carbon. Increased carbon exudation is typically accompanied by increased soil microbial biomass and/or activity, and plant-derived carbon is often detected in below-ground respiration (Holland *et al.*, 1996; Bardgett *et al.*, 1999; Hamilton and Frank, 2001; Tu *et al.*, 2002). Indeed, a two-year experiment in which two tree species were subjected to 50% defoliation, isotopic techniques revealed that soil sequestration of plant-derived carbon did not differ from the control for either species (Ayres *et al.*, 2004).

10.2.2 Long-term responses to herbivores

The long-term effects of herbivory on soils, typically via their influence on plant community composition, differ markedly from their short-term effects. As discussed in the previous section, there are several indirect ways that herbivores can influence plant community structure and, hence, soil carbon dynamics. Selective feeding represents a direct mechanism by which herbivores can substantially alter plant communities. Plant species, and individuals within a species, differ in the nutritional quality and accessibility of their tissues to herbivores, and therefore herbivores selectively target or avoid certain plant functional types, species or individuals (Cates and Orians, 1975; Fraser and Grime, 1999; Moore and Foley, 2005). This selective feeding frequently alters the competitive balance between plant species, resulting in changes in plant community structure, with positive or negative effects on primary productivity and plant litter quality (Augustine and McNaughton, 1998; Bardgett and Wardle, 2003). Since palatability and decomposition of plant material correlate positively (Grime *et al.*, 1996), these changes in plant community structure influence the amount, quality and turnover of carbon entering soil (Bardgett and Wardle, 2003).

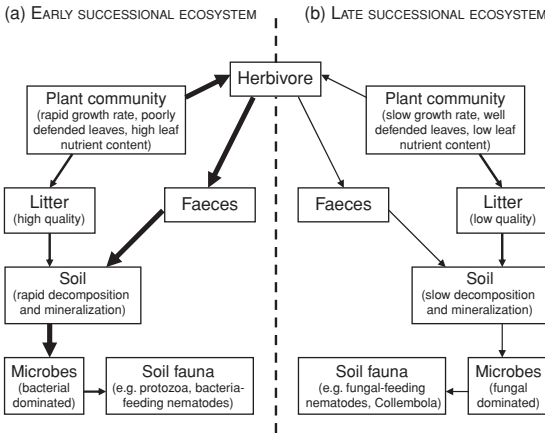

Figure 10.2 Ecosystem properties and organic matter flow through an ecosystem as influenced by herbivory: (a) herbivores retard plant succession and increase organic matter cycling; (b) herbivores accelerate plant succession and decrease organic matter cycling. Arrow thickness denotes magnitude of organic matter flux. After Bardgett and Wardle (2003).

Herbivory typically enhances below-ground nutrient cycling, including carbon turnover, when it promotes the dominance of fast growing, grazing tolerant plant species over late successional species that typically produce poor quality litter (Bardgett and Wardle, 2003). This can be seen in fertile grasslands, where herbivory often increases primary productivity, plant nutrient uptake, litter quality, soil nutrient availability and below-ground respiration (McNaughton, 1979, 1983; Ruess and McNaughton, 1987; Holland and Detling, 1990; Bardgett *et al.*, 1997; McNaughton *et al.*, 1997; Tracy and Frank, 1998), suggesting faster rates of carbon turnover in soils (Fig. 10.2). Positive effects of herbivory on below-ground nutrient dynamics occur in enclosure experiments in other ecosystems, including early successional taiga forest (Kielland *et al.*, 1997; Ruess *et al.*, 1998), arctic tundra (Molvar *et al.*, 1993; Van der Wal *et al.*, 2004) and, to some extent, in Scots pine forests (Stark *et al.*, 2000). Furthermore, despite apparently faster rates of carbon turnover, several studies reported increased soil carbon content associated with herbivory (Ruess and McNaughton, 1987; Molvar *et al.*, 1993; Bardgett *et al.*, 2001; Reeder and Schuman, 2002); however, this does not always occur (Tracy and Frank, 1998).

In contrast to the findings outlined above, herbivores have also been shown to have negative effects

on soil biological properties and nutrient cycling. This occurs when herbivory leads to a decline in the abundance of faster growing, palatable plant species, and their replacement by slower growing, less palatable species (Bardgett and Wardle, 2003). For instance, the classic study by Pastor *et al.* (1993) demonstrated that moose browsing of hardwood trees in boreal forests increased the abundance of unpalatable spruce trees, resulting in reductions in the quality of litter inputs to soils, which in turn reduced microbial activity, soil C and N content, and N mineralization rates. Similarly, an enclosure study in an oak savanna ecosystem showed that herbivory decreased above-ground standing crop, plant and litter N content, and soil N availability (Ritchie *et al.*, 1998) and, in an upland regenerating forest, browsing by red deer reduced litter decomposition, soil N availability and dissolved organic C in the soil solution (Harrison and Bardgett, 2003, 2004) (Fig. 10.2b).

It should be noted, however, that the effects of herbivory on ecosystems are difficult to predict. For example, in an extensive survey of the effects of introduced browsing mammals at 30 sites in New Zealand, Wardle *et al.* (2001) found that, despite often reducing the abundance of palatable plant species, herbivores had idiosyncratic effects on a range of ecosystem properties, including soil and litter C and N content, and soil microbial biomass and activity. These idiosyncrasies were attributed to the different mechanisms by which herbivores influence soils (Wardle *et al.*, 2001), therefore, although the schematic diagram presented in Fig. 10.2 provides a useful framework to understand the effects of herbivory on carbon dynamics, there are likely to be community- and site-specific exceptions.

10.2.3 Impacts of herbivores on food webs

As outlined earlier, both above- and below-ground herbivory can alter the abundance and activity of the soil microbial community, with consequences for nutrient cycling. However, the effects of herbivory on soil organisms are not limited to microbial primary consumers; they also influence the abundance of soil fauna that feed on microbes, thereby altering soil carbon dynamics. Herbivory has been shown to influence the abundance of protozoa, rotifers, enchytraeids, microarthropods and a range of nematode feeding groups in pot (Mikola *et al.*, 2001a, 2001b; Techau *et al.*, 2004; but see Ilmarinen

et al., 2005) and enclosure experiments (Bardgett *et al.*, 1997; Stark *et al.*, 2000; Wardle *et al.*, 2001). However, the direction of the response of soil fauna to herbivory may be context dependent. For example, Bardgett *et al.* (1997) observed positive effects of sheep grazing on total nematode abundance in brown earth soils, but not in acidic podzol soils. Likewise, in an enclosure study in New Zealand forests, Wardle *et al.* (2001) observed site-specific increases or decreases in microbial feeding and predaceous nematodes, tardigrades, copepods and rotifers in response to above-ground herbivores; however, significant effects of herbivory on mites, collembolans and soil macro-fauna were almost universally negative regardless of trophic position. A meta-analysis of above-ground herbivore effects on the mycorrhizal associations of 37 plant species showed negative effects in 23 cases, whereas positive effects were only seen in two species (Gehring and Whitham, 1994). Negative effects of herbivory on mycorrhizal associations have been broadly attributed to reductions in photosynthesis and plant carbon allocation below ground due to reduced leaf area (e.g. Gehring and Whitham, 1991; Rossow *et al.*, 1997; Gange *et al.*, 2002).

It is very difficult to draw conclusions about the effects of herbivore-induced changes in soil food web structure on carbon cycling (Bardgett and Wardle, 2003); however, a shift in the relative importance of the bacterial and fungal energy channel might be associated with changes in rates of decomposition and soil respiration. The bacterial energy channel (e.g. bacteria, protozoa and bacterial-feeding nematodes) is associated with rapid rates of decomposition, nutrient cycling and plant growth, whereas the fungal energy channel (e.g. fungi and fungal-feeding microarthropods and nematodes) is associated with slower rates of organic matter turnover and plant productivity (Moore and de Ruiter, 1991; Coleman and Crossley, 1996). It has been suggested that herbivores may shift the soil decomposer subsystem towards a bacterial-dominated energy channel when they increase the quality of plant inputs, e.g. when herbivory benefits the dominant plant species and retards colonization by later successional plant species which produce poor quality litter, as typically occurs in grasslands (discussed in Section 10.2.2) (Bardgett, 2005) (Fig. 10.2a). In contrast, herbivores may shift the food web towards fungal dominance when they are detrimental to the dominant plant species and accelerate colonization by species that produce poorer quality litter

(Bardgett, 2005) (Fig. 10.2b). In agreement with this, heavily grazed temperate grasslands have been shown to promote bacterial-dominated microbial communities (Bardgett *et al.*, 2001; Grayston *et al.*, 2001, 2004) and greater numbers of bacterial-feeding nematodes (Ingham and Deltung, 1984), whereas the removal of, or reductions in, grazing promotes fungal dominance within the microbial community (Bardgett *et al.*, 2001). More studies are needed, however, to test the generality of these responses.

To date, experiments investigating herbivory and soil processes have not considered predators and parasites of herbivores, despite their role in limiting herbivore abundance and activity. Given that several plant species have been shown to actively attract these secondary consumers when exposed to both above- and below-ground herbivory via emission of volatile compounds (Turlings *et al.*, 1990; De Moraes *et al.*, 1998; Rasmann *et al.*, 2005), parasites and predators of herbivores may alter the direct and indirect effects of herbivores on soil carbon dynamics. For instance, Rasmann *et al.* (2005) demonstrated that maize exposed to root-feeding beetle larvae releases a compound that attracts entomopathogenic nematodes and increases infection of beetle larvae. Moreover, the presence of specific soil fauna has been shown to influence populations of both above-ground herbivores and parasitoids (Bezemer *et al.*, 2003, 2005). Preisser (2003) showed that the addition of an entomopathogenic nematode to the rhizosphere of bush lupines being attacked by the root-feeding ghost moth caterpillar significantly reduced caterpillar abundance and increased plant growth and seed production. Moreover, bush lupines, which are N-fixers, can strongly influence the coastal ecosystems where they occur (Preisser, 2003), with potential consequences for soil carbon dynamics. Thus, multi-trophic experiments that examine the extent to which predators/parasites alter the effects of herbivores on soils are needed.

10.3 TROPHIC INTERACTIONS IN SOILS AND DECOMPOSITION

Soil organic matter and plant litter represent the main sources of carbon entering the soil food web and trophic interactions can substantially alter the rate of organic matter decomposition. Decomposition is a fundamental determinant of soil carbon pools and the balance between decomposition and plant litter inputs

determines whether soils are sinks or sources of carbon, as well as controlling the re-cycling of a range of nutrients that are essential for both plants and soil organisms. The vast majority of plant production enters the soil food web as exudates, dead leaves, roots and their associated mycorrhizal mycelia, or wood. Soil microbes are directly responsible for decomposing most of this material since they are often the only organisms in soils that produce enzymes capable of degrading recalcitrant plant-derived compounds such as lignin. However, numerous experiments have shown that the presence of a range of different soil fauna, including collembolans, mites, enchytraeids, isopods and earthworms, typically increase rates of mass loss and carbon mineralization (Seastedt, 1984; Setälä *et al.*, 1996; Cortez and Bouche, 1998; Edsberg, 2000; Hedlund and Öhrn, 2000; Hättenschwiler and Bretscher, 2001) suggesting soil animals mediate decomposition. The generally positive effect of soil animals on decomposition has been attributed to several mechanisms: (1) partial digestion of dead plant matter and returning it to the soil; (2) fragmentation of plant material, thereby increasing the surface area available for microbial colonization; (3) bringing microbes and organic matter into direct contact and (4) grazing on soil microbes (Swift *et al.*, 1979; Seastedt, 1984; Wardle, 2002; Bardgett, 2005). These mechanisms are discussed in turn below; however, it should be noted that they occur simultaneously in soils.

Saprotrophic soil fauna (i.e. fauna that consume dead organic matter) derive carbon and other nutrients from organic matter that is partially physically and chemically degraded in their gut. However, some of this organic matter is returned to the soil in faecal pellets. As with herbivores (see Section 10.2.1), the organic matter that is returned to the soil is typically more labile and easier to decompose than the original material (Zaady *et al.*, 2003), leading to accelerated rates of decomposition. For example, termite faecal matter had a lower C:N ratio than partially decomposed litter, their food source, as well as surface litter and soil (Zaady *et al.*, 2003); low C:N ratios are indicative of palatable substrates and often correlate with decomposition rates. Similarly, isopod and collembolan faeces contain greater concentrations of potassium and calcium than their food source, possibly indicating greater palatability; however, concentrations of phosphate were reduced in faeces from both taxa, as were N concentrations in collembolan faeces (Teuben and Verhoef, 1992). Indeed, fresh

earthworm casts exhibit greater levels of carbon loss than soil, suggesting faster rates of decomposition (Martin, 1991; Lavelle and Martin, 1992); however, this is probably due to the fragmentation of organic matter as well as its partial digestion. Moreover, although the rate of carbon loss from earthworm casts was initially greater than that from soil, the decomposition rate of casts declined rapidly, such that after 420 days the carbon content of the casts was 10% greater than that of the soil (initial cast and soil carbon content were similar). This suggests that over longer time scales earthworm casts may enhance below-ground carbon sequestration (Martin, 1991; Lavelle and Martin, 1992).

Fragmentation of organic matter, resulting in increased surface area available for colonization by bacteria and fungi, is thought to be one of the main ways that soil fauna enhance decomposition (Swift *et al.*, 1979; Seastedt, 1984). Schulmann and Tiunov (1999) fed the earthworm *Lumbricus terrestris* on intact leaf laminae and observed litter fragments in casts ranging from 0.03–0.25 mm² depending on the availability of sand particles, and Heemsbergen *et al.* (2004) demonstrated variation in litter fragmentation between eight species of soil macro-fauna. Several other faunal groups, including mites and collembolans, probably fragment organic matter, but this has rarely been investigated due to technical difficulties in measuring fragmentation (Anderson, 1975; Seastedt, 1984). Moreover, increased fragmentation has been shown to result in enhanced respiration from beech litter amended with glucose, although in some cases respiration declined from the smallest fragments (<5 mm²), possibly due to damage to microbes as a result of the fragmentation method (Maraun and Scheu, 1995).

One place where soil fauna bring plant litter and soil microbes into close contact is in their gut. Microorganisms live in the gut of many soil fauna, indeed in some cases these microbes form symbiotic relationships with their host, producing enzymes that break down recalcitrant organic compounds, thereby allowing the fauna access to nutrients that would otherwise be inaccessible, while the microbes receive a continuous substrate supply (Slaytor, 2000; Dillon and Dillon, 2004). For example, microbes and protozoa in the gut of termites produce enzymes capable of decomposing cellulose and lignin (Slaytor, 2000). However, the contribution of these nutrients to termite metabolism is thought to be minor (Slaytor, 2000) and their

relative importance in organic matter decomposition is currently unknown. The role of soil fauna in bringing microbes and organic matter in contact does not end in the gut. Along with the remaining undigested organic matter that is excreted into the soil, microbes from the gut are visible in faecal material (Adamo and Gealt, 1996; Frouz *et al.*, 2002, 2003) where they continue to decompose organic matter.

Termites and leaf cutter ants play an important role in bringing plant matter into contact with decomposers as a result of their external symbioses with fungal saprotrophs. Yamada *et al.* (2005) showed that termite populations and fungal combs (i.e. 'gardens') respired 11% of annual leaf litter carbon in a dry forest in Thailand, with the fungi accounting for 64% of the respired carbon. Moreover, they estimated that termites and their fungal combs respire 5–39% of annual litter carbon from three tropical savannas and three dry tropical forests, but less (~1%) in three wet tropical forests (Yamada *et al.*, 2005). Likewise, earthworms are known to drag litter from the surface into their burrows, which may increase its availability to soil dwelling biota. This continuous supply of organic matter, along with earthworm mucilage, sustains respiration rates and microbial populations that are 4–9 and 2–5 times greater, respectively, in the walls of burrows than in control soil (Tiunov and Scheu, 1999). However, using ¹³C-labelled plant material, Bossuyt *et al.* (2005) found that earthworms can increase the quantity of plant-derived carbon incorporated into soil aggregates, where it is likely to receive physical protection from soil organisms, potentially limiting carbon cycling. Dung beetles also play an important role in fragmenting animal waste and relocating it from the surface into the soil (Yokoyama *et al.*, 1991), as well as stimulating microbial activity in dung, resulting in enhanced rates of carbon loss (Stevenson and Dindal, 1987) and sometimes enhancing fungal (Yokoyama *et al.*, 1991) or bacterial (Lussenhop *et al.*, 1980) growth. Moreover, dung beetles have been shown to enhance C and N fluxes from dung to soil, where it acts as a substrate for microbes (Yokoyama *et al.*, 1991).

The relative importance of each of these mechanisms (partial digestion of organic matter, litter fragmentation, and bringing microbes and organic matter into direct contact) that are carried out by soil fauna in relation to decomposition is extremely difficult, if not impossible, to determine because these mechanisms typically occur simultaneously. In contrast, the effect

of soil faunal grazing of microbes on rates of decomposition, which is discussed below, can be seen more clearly. Grazing by microarthropods and nematodes can influence the activity and growth of soil bacteria and fungi (Bengtsson and Rundgren, 1983; Dyer *et al.*, 1992; Vreeken-Buijs *et al.*, 1997; Hedlund and Öhrn, 2000; Moore *et al.*, 2003; Bonkowski, 2004), suggesting it may alter rates of decomposition. Hedlund and Öhrn (2000) observed greater soil respiration rates when the collembolan *Folsomia fimetaria* was added to soil microcosms inoculated with one of three fungal species. Moreover, when a mite species that preyed upon *F. fimetaria* was added the respiration rate was even greater, suggesting low levels of grazing stimulate fungal activity more than high-intensity grazing (Hedlund and Öhrn, 2000). The addition of microbial-feeding fauna has been shown to increase respiration and litter mass loss (Cragg and Bardgett, 2001), indicative of faster rates of decomposition. These findings emphasize the importance of multi-trophic interactions in regulating soil respiration and decomposition.

In addition to altering the activity of microbes, soil fauna may alter the microbial community structure through selective feeding, which in turn may alter rates of decomposition. Soil fauna are often assumed to be generalist feeders; however, there are a number of examples that demonstrate a degree of specificity, suggesting they are capable of altering microbial community structure. Evidence of selective feeding is provided by variation in the natural abundance of ¹⁵N between oribatid mite species, suggesting different species select different food sources (Schneider *et al.*, 2004). Collembola have been shown to preferentially feed on specific fungal species (Hedlund and Öhrn, 2000), metabolically active hyphae, in contrast to inactive or dead hyphae (Moore *et al.*, 1985), and nutrient rich parts of fungal biomass (Leonard, 1984). Furthermore, selective feeding by soil fauna has been linked to changes in rates of decomposition by individual fungal species (Newell, 1984a, 1984b). In the presence of two fungal species, the collembolan *Onychiurus latus* fed preferentially on *Marasmius androsaceus*, rather than *Mycena galopus* (Newell, 1984a). *M. androsaceus* had a faster growth rate, and colonized and decomposed spruce litter faster than *M. galopus*. Moreover, grazing by *O. latus* further increased mass loss when litter was inoculated with *M. androsaceus*, but inhibited mass loss when inoculated with *M. galopus* (Newell, 1984b).

As illustrated above, earthworms play a key role in decomposition: partially digesting and fragmenting litter, moving leaf litter from the soil surface into the soil and bringing microbial decomposers into direct contact with organic matter (Cortez and Bouche, 1998). However, the relative importance of organisms in relation to carbon cycling does not just vary between functional groups of soil organisms; species within functional groups also differ in their effects on soil properties. For example, Laakso and Setälä (1999) found that model ecosystems that contained the enchytraeid *Cognettia sphagnetorum* had greater soil ammonium concentrations, plant N uptake and plant growth than model ecosystems that contained other microbial-detrivore fauna, indicating that it plays a unique role in ecosystem processes. Similarly, in a microcosm experiment where litter was inoculated with one of three fungal feeding collembolan species, Cragg and Bardgett (2001) observed that *Folsomia candida* increased respiration, leaching of dissolved organic carbon and litter mass loss more than other species, suggesting it plays a greater role in decomposition.

10.4 SOIL BIOTIC COMMUNITY STRUCTURE AND DIVERSITY

In this section we first discuss the relative importance of bottom-up versus top-down regulation of soil food webs in relation to carbon fluxes between trophic levels. This is followed by a summary of current knowledge on the relationship between soil biodiversity and carbon dynamics.

10.4.1 Trophic interactions and carbon fluxes through soil food webs

Top-down or bottom-up control of soil organisms can have important consequences on the effect of various biotic interactions, e.g. predation and competition, on carbon fluxes through the soil food web. In general, long-term additions of labile carbon substrates to soils increase microbial biomass, indicating bottom-up control of microbes (Jonasson *et al.*, 1996; Mikola and Setälä, 1998a; Wardle, 2002), in agreement with food web models (Fu *et al.*, 2000). However, some authors have suggested that top-down forces control bacteria, whereas fungi are typically bottom-up controlled (Wardle and Yeates, 1993; Wardle, 2002). Assuming

soil microbes are generally bottom-up controlled, the presence of microbial consumers may have little effect on the size, and carbon content, of the microbial community; yet evidence from the literature often does not support this view. For instance, bacterial consumers reduced bacterial biomass in microcosm (Allen-Morley and Coleman, 1989) and field studies (Santos *et al.*, 1981; Ingham *et al.*, 1986). Other studies have shown that various bacterial groups respond differently to grazing, some increasing and others decreasing (Griffiths *et al.*, 1999; Ronn *et al.*, 2002). Likewise, fungal hyphal length or biomass has been shown to either increase or decrease in response to grazing (Hedlund and Augustsson, 1995; Hedlund and Öhrn, 2000).

There is an ongoing debate on the importance of multi-trophic interactions in terrestrial ecosystems (Strong, 1992; Polis, 1994; Pace *et al.*, 1999; Wardle, 2002); however, there is clear evidence that trophic interactions can influence carbon fluxes across multiple trophic levels, at least under certain conditions. For example, the addition of labile carbon substrates has been shown to increase the abundance of micro- and macro-arthropods, earthworms and microbial-feeding nematodes (Seastedt *et al.*, 1988; Mikola and Setälä, 1998a; Scheu and Schaefer, 1998). In contrast, substrate addition did not affect millipedes or predatory nematodes, and reduced the abundance of centipedes (Mikola and Setälä, 1998a; Scheu and Schaefer, 1998). Likewise, the removal of plants from 0.8×1.2 m field plots reduced soil microbial biomass and the abundance of collembolans, earthworms and predatory nematodes, but did not affect mites or microbial-feeding nematodes (Wardle *et al.*, 1999). Preisser (2003) provided evidence of a trophic cascade between entomopathogenic nematodes, root-feeding caterpillars and bush lupines, with potential consequences for soil carbon dynamics (discussed in Section 10.2.3). Correspondingly, there is compelling evidence from experimental and modelling studies that microbial consumers stimulate N mineralization and promote primary productivity, with associated changes in carbon dynamics (Ingham *et al.*, 1985; Hunt *et al.*, 1987; Moore and Hunt, 1988; Setälä and Huhta, 1991; Laakso and Setälä, 1999, discussed in Section 10.2.3; Moore *et al.*, 2003; Bonkowski, 2004). Results from other studies are mixed, with some demonstrating trophic cascades in soil (Allen-Morley and Coleman, 1989; Hedlund and Öhrn, 2000), while others do not (Mikola and Setälä, 1998b).

Trophic cascades can also be manifested through mutualisms between soil organisms and plants with consequences for carbon dynamics (Moore *et al.*, 2003). Johnson *et al.* (2005) showed that the addition of fungal-feeding collembolans to grassland soils disrupted arbuscular mycorrhizal fungal networks and reduced ^{13}C -enrichment of mycorrhizosphere respiration by 32%, indicating the presence of some soil fauna may inhibit carbon fluxes through certain pathways. Since mycorrhizas may contribute some of the most recalcitrant carbon compounds to soils (e.g. chitin and glomalin), changes in their biomass or physiology could have profound effects on soil carbon dynamics (Rillig and Allen, 1999; Langley *et al.*, 2006). In addition, grazing of mycorrhizas by soil fauna can result in positive (Setälä, 1995) or negative (Warnock *et al.*, 1982) effects on plant growth, which could influence plant carbon fluxes to the soil either directly or indirectly via shift in plant community composition. Long-term field studies as well as models are needed to determine the conditions that result in bottom-up or top-down control of various parts of the soil food web. In addition, the effect of multi-trophic interactions on carbon dynamics requires further attention to determine their importance in soils.

10.4.2 Biodiversity and ecosystem function

Soils are extremely diverse, containing tens or hundreds of thousands of species per square metre. Globally, species of bacteria, fungi and mites number tens of thousands, and thousands of nematode, protozoa, collembolan, ant and earthworm species have been described (Brussaard *et al.*, 1997; Wall and Virginia, 1997; Wall, 2004 and references therein). In recent years, the relationship between biodiversity and ecosystem function, particularly in relation to carbon dynamics, has come under increasing scrutiny. The realization that rates of species extinctions are increasing, probably as a result of anthropogenic actions (Vitousek *et al.*, 1997; Dirzo and Raven, 2003), has made the need for such data all the more pressing.

Microcosm studies have provided little support for the notion that greater species richness within a taxonomic group enhances carbon cycling. For example, Cragg and Bardgett (2001) exposed grassland plant litter to zero, one, two or three species of collembolan and monitored rates of mass loss and respiration. The results showed that community composition, rather

than species richness, influenced litter decomposition; communities that contained the dominant collembolan *Folsomia candida* had greater rates of mass loss and respiration, whereas these measures were not significantly different between microcosms containing the two other species and microcosms incubated without collembolans (Cragg and Bardgett, 2001). In contrast, greater fungal species richness resulted in greater respiration from microcosms containing forest humus; however, the effect was limited to the species-poor treatments (between one and six species) suggesting considerable species redundancy (Setälä and McLean, 2004). Similarly, Liiri *et al.* (2002a) showed that mite and collembolan species richness enhanced tree growth in microcosms, but that this effect was limited to the species-poor end of the spectrum. In this study, variation in community composition did not affect tree growth and growth was not related to the presence of any of the dominant faunal species, suggesting the enhancement was a 'true' biodiversity effect, not a 'sampling effect' (Liiri *et al.*, 2002a). Other studies that have examined the association between species richness within taxa and ecosystem properties in soils typically observe neutral or weakly positive relationships, with positive effects generally limited to species-poor treatments (Mikola and Setälä, 1998a; Scheu *et al.*, 2002; Cole *et al.*, 2004). Thus, although there is some evidence from microcosm studies that species richness in soil may enhance ecosystem processes related to carbon cycling, the effects are typically weak and generally only occur at low levels of diversity, which are not typical of most soils. Rather, species-specific traits appear to be more important in regulating ecosystem properties and processes.

There is more experimental evidence to support the hypothesis that greater functional or trophic diversity in soils result in an enhancement of ecosystem processes, although this does not always occur (Huhta *et al.*, 1998; Setälä, 2002). At the coarse scale several studies have shown an increase in a range of ecosystem processes, including litter mass loss, respiration and plant growth, when meso- and macro-fauna are present, rather than absent, in soil (Bengtsson *et al.*, 1988; Setälä and Huhta, 1990; Setälä and Huhta, 1991; Laakso and Setälä, 1999). Moreover, as well as enhancing rates of decomposition, the presence of soil macro-fauna can greatly alter the relationship between litter species richness and litter mass loss (Hättenschwiler and Gasser, 2005). At a finer resolution, studies that have employed various mesh

sizes to exclude different size fauna from litter have demonstrated enhanced decomposition when all fauna could access litter, and decomposition decreased successively as macro-fauna and meso-fauna were excluded from the litter bags (Setälä *et al.*, 1996; Irmiler, 2000; Smith and Bradford, 2003), lending support to the notion that functional or trophic diversity influences soil carbon dynamics. Similarly, Bradford *et al.* (2002) observed faster rates of decomposition and altered plant community structure in microcosms containing more complex soil faunal communities (based on body size); however, primary productivity and total ecosystem carbon balance were not affected. In a microcosm experiment where both species richness and functional richness of soil macro-fauna were manipulated independently, Heemsbergen *et al.* (2004) observed a positive relationship between functional diversity and ecosystem processes, including soil respiration and litter mass, whereas there was no relationship between species richness and these processes, suggesting functional diversity is of greater relevance to ecosystem processes than species richness alone. Similarly, others have demonstrated that soil containing fauna from a range of taxonomic groups, rather than fauna from a single taxon, result in greater soil microbial biomass, litter mass loss, soil respiration and plant nutrient content (Bardgett and Chan, 1999; Zimmer *et al.*, 2005), suggesting increased carbon cycling. Other studies have found no relationship between functional or trophic complexity of the soil community, based on body size or taxonomic group, and ecosystem processes such as primary productivity and nutrient retention (Setälä, 2000; Liiri *et al.*, 2002b). Moreover, in a model of C and N transfer between plants, microbes and soil fauna where 15 functional groups of soil organisms were deleted one at a time, only three deletions (bacteria, saprotrophic fungi and root-feeding nematodes) resulted in changes of an ecosystem process by over 10%, suggesting that ecosystem functions are resilient to loss of biodiversity (Hunt and Wall, 2002). In general it appears that greater complexity of the soil faunal community in terms of functional and trophic diversity typically, but not always, results in faster rates of carbon cycling through the soil in the form of enhanced decomposition and respiration.

Although soils are typically very species rich, soils in extreme environments such as hot and cold deserts are species poor. For instance, only 23 and 3 nematode species have been observed in the Mojave

desert, Nevada, USA (Freckman and Mankau, 1986), and the Dry Valleys of Antarctica (Freckman and Virginia, 1997), respectively; by comparison temperate forests and grasslands often support over one hundred nematode species (Johnson *et al.*, 1972; Yeates, 1972; Bongers and Ferris, 1999). Given that the relationship between biodiversity and ecosystem functioning appears strongest at low levels of biodiversity (discussed above), even small reductions in species richness in low-diversity ecosystems have the potential to result in large changes in soil carbon cycling and other processes. However, due to a lack of studies that have investigated the link between soil biodiversity and carbon dynamics in species-poor ecosystems, we are not aware of any examples that demonstrate such an effect. The Dry Valleys of Antarctica may represent a good ecosystem to study these relationship since they are species poor (Freckman and Virginia, 1997) and the distribution of the dominant soil faunal species, the nematode *Scottinema lindsayae*, is associated with soil organic carbon (Barrett *et al.*, 2004), suggesting it plays a role in carbon cycling. Moreover, the abundance of nematodes, including *S. lindsayae*, has declined by over 40% in recent years in the Dry Valleys, associated with declining air temperature (Doran *et al.*, 2002), suggesting a possible shift in soil biodiversity in future decades, which could impact carbon dynamics.

10.5 CONCLUSION

In this chapter we have attempted to highlight the importance of trophic interactions in relation to soil carbon fluxes with a particular emphasis on key mechanisms and topical areas of research. Here, we synthesize findings from the three broad areas we considered in relation to carbon cycling, namely, above- and below-ground herbivory, trophic interactions in soils and decomposition, and soil biota community structure and diversity, and suggest some directions for future research.

In the short term, and typically at the individual plant scale, above- and below-ground herbivores influence rates of organic matter turnover through a range of mechanisms. Firstly, the partial digestion and addition of high-quality, labile plant material to soil, e.g. excreta, frequently stimulates the soil microbial community resulting in enhanced rates of soil respiration and decomposition. Secondly, herbivory can influence

soil carbon dynamics via effects on plant litter quality, with both positive and negative effects on litter quality reported, dependent on the type of herbivory and plant species. Thirdly, both above- and below-ground herbivory typically enhance root exudation, stimulating the microbial population and enhancing soil respiration rates. Over longer time scales, and at the plant community level, herbivores can either stimulate or retard soil carbon cycling, depending on the response of the plant community. Although we currently appear to have a relatively good understanding of the mechanisms that mediate the relationship between herbivory and soil carbon dynamics, we feel that future work should strive to improve the realism of such studies by: (1) employing real herbivores, i.e. not clipping; (2) investigating the effects of a range of herbivore species/functional types on soil carbon fluxes and (3) employing a more holistic approach that considers interactions between herbivore species, and also the influence of predators/parasites of herbivores. The effect of various global change factors (e.g. temperature, precipitation, land-use change and ultraviolet radiation) on herbivores, and other biota that influence soil carbon dynamics, also requires greater attention (Bale *et al.*, 2002).

As with herbivory, there is a range of mechanisms by which the trophic interactions of soil fauna influence rates of decomposition, a fundamental component of ecosystem carbon cycling. Since these mechanisms operate concurrently it is difficult to determine their relative importance; however, it is clear that litter fragmentation, the partial digestion of plant material, and the role of soil fauna in bringing microbes and organic matter into contact, strongly influence rates of decomposition. Similarly, faunal grazing on microbial populations frequently results in faster rates of decomposition and carbon cycling in soils. At the coarsest level there is compelling evidence that soil fauna in general enhance organic matter decomposition, but at finer resolution individual species or functional groups differ in their relative contribution to the decomposition of organic matter. Biotic interactions clearly influence carbon fluxes through the soil food web; however, these effects are often inconsistent suggesting context is highly important. For instance, whether soil microorganisms are controlled by top-down or bottom-up forces greatly influences the impact of microbial consumers on carbon fluxes, yet it is not clear what circumstances control the switch from one type of regulation

to the other. Models have proved useful in studying nutrient fluxes through food webs; however, there is a need to test their predictions in laboratory and field experiments to determine their importance. Although relatively simple experiments provide useful evidence of the mechanisms that control soil carbon dynamics, more complex experiments and models are required to understand the relationships between the soil food web and carbon fluxes, in particular because of the emergent properties that are not captured in studies of simple communities.

Results from a number of microcosm studies suggest that greater functional or trophic diversity accelerates organic matter turnover, although this does not always occur. However, experimental evidence of a positive relationship between soil species richness and carbon dynamics is scarce, and the positive effects that are sometimes observed tend to be weak. Only at low levels of biodiversity are stronger associations between richness and carbon cycling detected. Since soils are typically highly species rich the biodiversity of soil fauna may be relatively unimportant in many ecosystems. However, in certain circumstances, e.g. in low diversity ecosystems or in relation to specialist processes, soil species richness may be an important determinant of ecosystem process rates. Certainly more studies on the relationship between diversity and soil carbon flux are required before we can accurately describe the circumstances under which it regulates carbon cycling. There is a particular need for field-based experiments of this type, which can be more reliably related to natural ecosystems and the threats they face, although there are inherent difficulties with such studies. A good starting point for such experiments may be biological coldspots where low species richness may make manipulations easier and where the effects of biodiversity on carbon dynamics are likely to be strongest.

One of the main challenges for the future is disentangling the role of specific groups of soil organisms in processes of carbon cycling. To date, isotopic techniques have proved especially useful in determining the effect of trophic interactions on carbon fluxes, and new techniques are available, such as stable isotope probing (SIP), that allow carbon fluxes to be linked directly to functionally active members of the soil community in intact soils, in particular, the role of specific microbes (Staddon, 2004; Zak *et al.*, 2006). This is illustrated by the use of stable isotope probing to identify

microbial methylotrophs by exposing soil to ^{13}C -labelled methanol and sequencing ^{13}C -enriched DNA extracted directly from soil (Radajewski *et al.*, 2000, 2002). Similarly, Treonis *et al.* (2004) determined that fungi and gram-negative bacteria rapidly consume exudates from $^{13}\text{CO}_2$ -labelled plants by measuring ^{13}C -enrichment of phospholipid fatty acids (PLFAs), whereas gram-positive bacterial PLFAs were less enriched, indicating lower rates of consumption. The application of isotope probing, and future technological advancements, to the topics raised in this chapter will enhance our understanding of the relationship between trophic interactions and soil carbon dynamics. However, we stress that carbon dynamics cannot be fully understood without considering the cycling and relative availabilities of other nutrients, such as nitrogen and phosphorus, which often influence food selection and decomposition rates (Leonard, 1984; Fraser and Grime, 1999; Moore and Foley, 2005), and thereby rates of carbon cycling in soil.

ACKNOWLEDGEMENTS

We are grateful to an anonymous reviewer and to Breana Simmons, Johnson Nkem and Andreas Heinemeyer whose comments greatly improved this chapter. This work was funded in part by the US National Science Foundation (DEB and McMurdo LTER – OPP).

REFERENCES

- Adamo, J. A. and Gealt, M. A. (1996) A demonstration of bacterial conjugation within the alimentary canal of *Rhabditis* nematodes. *FEMS Microbiology Ecology*, **20**, 15–22.
- Allen-Morley, C. R. and Coleman, D. C. (1989) Resilience of soil biota in various food webs to freezing perturbations. *Ecology*, **70**, 1127–41.
- Anderson, J. M. (1975) Succession, diversity and trophic relationships of some soil animals in decomposing leaf litter. *Journal of Animal Ecology*, **44**, 475–95.
- Augustine, D. J. and McNaughton, S. J. (1998) Ungulate effects on the functional species composition of plant communities: herbivore selectivity and plant tolerance. *Journal of Wildlife Management*, **62**, 1165–83.
- Ayres, E., Heath, J., Possell, M., Black, H. I. J., Kerstiens, G. and Bardgett, R. D. (2004) Tree physiological responses to above-ground herbivory directly modify below-ground processes of soil carbon and nitrogen cycling. *Ecology Letters*, **7**, 469–79.
- Ayres, E., Dromph, K. M., Cook, R., Ostle, N. and Bardgett, R. D. (2007) Influence of above-ground and below-ground herbivory of a legume on nutrient transfer to soil and neighbouring plants. *Functional Ecology*, **21**, 256–63.
- Bale, J. S., Masters, G. J., Hodkinson, I. D. *et al.* (2002) Herbivory in global climate change research: direct effects of rising temperature on insect herbivores. *Global Change Biology*, **8**, 1–16.
- Bardgett, R. D. (2005) *The Biology of Soil: A Community and Ecosystem Approach*. Oxford: Oxford University Press.
- Bardgett, R. D. and Chan, K. F. (1999) Experimental evidence that soil fauna enhance nutrient mineralization and plant nutrient uptake in montane grassland ecosystems. *Soil Biology and Biochemistry*, **31**, 1007–14.
- Bardgett, R. D. and Wardle, D. A. (2003) Herbivore-mediated linkages between aboveground and belowground communities. *Ecology*, **84**, 2258–68.
- Bardgett, R. D., Leemans, D. K., Cook, R. and Hobbs, P. J. (1997) Seasonality of the soil biota of grazed and ungrazed hill grasslands. *Soil Biology and Biochemistry*, **29**, 1285–94.
- Bardgett, R. D., Wardle, D. A. and Yeates, G. W. (1998) Linking above-ground and below-ground interactions: how plant responses to foliar herbivory influence soil organisms. *Soil Biology and Biochemistry*, **30**, 1867–78.
- Bardgett, R. D., Denton, C. S. and Cook, R. (1999) Below-ground herbivory promotes soil nutrient transfer and root growth in grassland. *Ecology Letters*, **2**, 357–60.
- Bardgett, R. D., Jones, A. C., Jones, D. L. *et al.* (2001) Soil microbial community patterns related to the history and intensity of grazing in sub-montane ecosystems. *Soil Biology and Biochemistry*, **33**, 1653–64.
- Barrett, J. E., Virginia, R. A., Wall, D. H. *et al.* (2004) Variation in biogeochemistry and soil biodiversity across spatial scales in a polar desert ecosystem. *Ecology*, **85**, 3105–18.
- Bengtsson, G. and Rundgren, S. (1983) Respiration and growth of a fungus, *Mortierella-Isabellina*, in response to grazing by *Onychiurus-Armatus* (Collembola). *Soil Biology and Biochemistry*, **15**, 469–73.
- Bengtsson, G., Berdén, M. and Rundgren, S. (1988) Influence of soil animals and metals on decomposition processes: a microcosm experiment. *Journal of Environmental Quality*, **17**, 113–19.

- Bezemer, T. M., Wagenaar, R., van Dam, N. M. and Wäckers, F. L. (2003) Interactions between above- and below-ground insect herbivores as mediated by the plant defense system. *Oikos*, **101**, 555–62.
- Bezemer, T. M., De Deyn, G. B., Bossinga, T. M. *et al.* (2005) Soil community composition drives aboveground plant–herbivore–parasitoid interactions. *Ecology Letters*, **8**, 652–61.
- Bol, R., Amelung, W., Freidrich, C. and Ostle, N. (2000) Tracing dung-derived carbon in temperate grassland using ¹³C natural abundance measurements. *Soil Biology and Biochemistry*, **32**, 1337–43.
- Bol, R., Amelung, W. and Freidrich, C. (2004) Role of aggregate surface and core fraction in the sequestration of carbon from dung in a temperate grassland soil. *European Journal of Soil Science*, **55**, 71–7.
- Bongers, T. and Ferris, H. (1999) Nematode community structure as a bioindicator in environmental monitoring. *Trends in Ecology and Evolution*, **14**, 224–8.
- Bonkowski, M. (2004) Protozoa and plant growth: the microbial loop in soil revisited. *New Phytologist*, **162**, 617–31.
- Bossuyt, H., Six, J. and Hendrix, P. F. (2005) Protection of soil carbon by microaggregates within earthworm casts. *Soil Biology and Biochemistry*, **37**, 251–8.
- Bradford, M. A., Jones, T. H., Bardgett, R. D. *et al.* (2002) Impacts of soil faunal community composition on model grassland ecosystems. *Science*, **298**, 616–18.
- Brussaard, L., Behan-Pelletier, V. M., Bignell, D. E. *et al.* (1997) Biodiversity and ecosystem functioning in soil. *Ambio*, **26**, 563–70.
- Cates, R. G. and Orians, G. H. (1975) Successional status and the palatability of plants to generalist herbivores. *Ecology*, **56**, 410–18.
- Cebrian, J. (2004) Role of first-order consumers in ecosystem carbon flow. *Ecology Letters*, **7**, 232–40.
- Chapman, S. M., Hart, S. C., Cobb, N. S., Whitman, T. G. and Koch, G. W. (2003) Insect herbivory increases litter quality and decomposition: an extension of the acceleration hypothesis. *Ecology*, **84**, 2867–76.
- Cole, L., Dromph, K. M., Boaglio, V. and Bardgett, R. D. (2004) Effect of density and species richness of soil mesofauna on nutrient mineralization and plant growth. *Biology and Fertility of Soils*, **39**, 337–43.
- Coleman, D. C. and Crossley, D. A. J. (1996) *Fundamentals of Soil Ecology*. 1st edn. San Diego, CA: Academic Press.
- Cortez, J. and Bouche, M. B. (1998) Field decomposition of leaf litters: earthworm–microorganism interactions – the ploughing-in effect. *Soil Biology and Biochemistry*, **30**, 795–804.
- Cragg, R. G. and Bardgett, R. D. (2001) How changes in soil faunal diversity and composition within a trophic group influence decomposition processes. *Soil Biology and Biochemistry*, **33**, 2073–81.
- De Mazencourt, C., Laureau, M. and Abbadie, L. (1999) Grazing optimization and nutrient cycling: potential impact of large herbivores in a savanna system. *Ecological Applications*, **9**, 784–97.
- De Moraes, C. M., Lewis, W. J., Paré, P. W., Alborn, H. T. and Tumlinson, J. H. (1998) Herbivore-infested plants selectively attract parasitoids. *Nature*, **393**, 570–3.
- Denton, C. S., Bardgett, R. D., Cook, R. and Hobbs, P. J. (1999) Low amounts of root herbivory positively influence the rhizosphere microbial community in a temperate grassland soil. *Soil Biology and Biochemistry*, **31**, 155–65.
- Dillon, R. J. and Dillon, V. M. (2004) The gut bacteria of insects: nonpathogenic interactions. *Annual Review of Entomology*, **49**, 71–92.
- Dirzo, R. and Raven, P. H. (2003) Global state of biodiversity and loss. *Annual Review of Environment and Resources*, **28**, 137–67.
- Doran, P. T., Priscu, J. C., Lyons, W. B. *et al.* (2002) Antarctic climate cooling and terrestrial ecosystem response. *Nature*, **415**, 517–20.
- Dyer, H. C., Boddy, L. and Preston-Meeck, C. M. (1992) Effect of the nematode *Panagrellus redivivus* on growth and enzyme production by *Phanerochaete velutina* and *Stereum hirsutum*. *Mycological Research*, **96**, 1019–28.
- Edsberg, E. (2000) The quantitative influence of enchytraeids (Oligochaeta) and microarthropods on decomposition of coniferous raw humus in microcosms. *Pedobiologia*, **44**, 132–47.
- Ettema, C. H. and Bongers, T. (1993) Characterization of nematode colonization and succession in disturbed soil using the Maturity Index. *Biology and Fertility of Soils*, **16**, 79–85.
- Findlay, S., Carreiro, M., Krischik, V. and Jones, C. G. (1996) Effects of damage to living plants on leaf litter quality. *Ecological Applications*, **6**, 269–75.
- Frank, D. A. and Groffman, P. M. (1998) Ungulate vs. landscape control of soil C and N processes in grasslands of Yellowstone National Park. *Ecology*, **79**, 2229–41.
- Fraser, L. H. and Grime, J. P. (1999) Interacting effects of herbivory and fertility on a synthesized plant community. *Journal of Ecology*, **87**, 514–15.

- Freckman, D. W. and Mankau, R. (1986) Abundance, distribution, biomass, and energetics of soil nematodes in a Northern Mojave Desert ecosystem. *Pedobiologia*, **29**, 129–42.
- Freckman, D. W. and Virginia, R. A. (1997) Low-diversity Antarctic soil nematode communities: distribution and response to disturbance. *Ecology*, **78**, 363–9.
- Freckman, D. W., Barker, K. R., Coleman, D. C. *et al.* (1991) The use of the ^{14}C technique to measure plant responses to herbivorous soil nematodes. *Functional Ecology*, **5**, 810–18.
- Frost, C. J. and Hunter, M. D. (2004) Insect canopy herbivory and frass deposition affect soil nutrient dynamics and export in oak mesocosms. *Ecology*, **85**, 3335–47.
- Frouz, J., Elhottová, D., Sustr, V., Kristufek, V. and Hubert, J. (2002) Preliminary data about the compartmentalization of the gut of the saprophagous dipteran larvae *Penthetria holosericea* (Bibionidae). *European Journal of Soil Biology*, **38**, 47–51.
- Frouz, J., Kristufek, V., Li, X. *et al.* (2003) Changes in the amount of bacteria during gut passage of leaf litter and during coprophagy in three species of Bibionidae (Diptera) larvae. *Folia Microbiologica*, **48**, 535–42.
- Fu, S., Cabrera, M. L., Coleman, D. C. *et al.* (2000) Soil carbon dynamics of conventional tillage and no-till agroecosystems at Georgia Piedmont – HSB-C models. *Ecological Modelling*, **131**, 229–48.
- Gange, A. C., Bower, E. and Brown, V. K. (2002) Differential effects of insect herbivory on arbuscular mycorrhizal colonization. *Oecologia*, **131**, 103–12.
- Gehring, C. A. and Whitham, T. G. (1991) Herbivore driven mycorrhizal mutualism in insect susceptible Pinyon pine. *Nature*, **353**, 556–7.
- Gehring, C. A. and Whitham, T. G. (1994) Interactions between aboveground herbivores and the mycorrhizal mutualists of plants. *Trends in Ecology and Evolution*, **9**, 251–5.
- Grayston, S. J., Griffith, G. S., Mawdsley, J. L., Campbell, C. D. and Bardgett, R. D. (2001) Accounting for variability in soil microbial communities of temperate upland grassland ecosystems. *Soil Biology and Biochemistry*, **33**, 533–51.
- Grayston, S. J., Campbell, C. D., Bardgett, R. D. *et al.* (2004) Assessing shifts in microbial community structure across a range of grasslands of differing management intensity using CLPP, PLFA and community DNA techniques. *Applied Soil Ecology*, **25**, 63–84.
- Griffiths, B. S., Bonkowski, M., Dobson, G. and Caul, S. (1999) Changes in soil microbial community structure in the presence of microbial-feeding nematodes and protozoa. *Pedobiologia*, **43**, 297–304.
- Grime, J. P., Cornelissen, J. H. C., Thompson, K. and Hodgson, J. G. (1996) Evidence of a causal connection between anti-herbivore defense and the decomposition rate of leaves. *Oikos*, **77**, 489–94.
- Guitian, R. and Bardgett, R. D. (2000) Plant and soil microbial responses to defoliation in temperate semi-natural grassland. *Plant and Soil*, **220**, 271–7.
- Hamilton, E. W. and Frank, D. A. (2001) Can plants stimulate soil microbes and their own nutrient supply? Evidence from a grazing tolerant grass. *Ecology*, **82**, 2397–402.
- Harrison, K. A. and Bardgett, R. D. (2003) How browsing by red deer impacts on litter decomposition in a native regenerating woodland in the Highlands of Scotland. *Biology and Fertility of Soils*, **38**, 393–9.
- Harrison, K. A. and Bardgett, R. D. (2004) Browsing by red deer negatively impacts on soil nitrogen availability in regenerating native forest. *Soil Biology and Biochemistry*, **36**, 115–26.
- Hättenschwiler, S. and Bretscher, D. (2001) Isopod effects on decomposition of litter produced under elevated CO_2 , N deposition and different soil types. *Global Change Biology*, **7**, 565–79.
- Hättenschwiler, S. and Gasser, P. (2005) Soil animals alter plant litter diversity effects on decomposition. *Proceedings of the National Academy of Sciences*, **102**, 1519–24.
- Haynes, R. J. and Williams, P. H. (1993) Nutrient cycling and soil fertility in the grazed pasture ecosystem. *Advances in Agronomy*, **49**, 119–99.
- Haynes, R. J. and Williams, P. H. (1999) Influence of stock camping behavior on the soil microbiological and biochemical properties of grazed pastoral soils. *Biology and Fertility of Soils*, **28**, 253–8.
- Hedlund, K. and Augustsson, A. (1995) Effects of enchytraeid grazing on fungal growth and respiration. *Soil Biology and Biochemistry*, **27**, 905–9.
- Hedlund, K. and Öhrn, M. S. (2000) Tritrophic interactions in a soil community enhance decomposition rates. *Oikos*, **88**, 585–91.
- Heemsbergen, D. A., Berg, M. P., Loreau, M. *et al.* (2004) Biodiversity effects on soil processes explained by interspecific functional dissimilarity. *Science*, **306**, 1019–20.

- Holland, E. A. and Detling, J. K. (1990) Plant response to herbivory and belowground nitrogen cycling. *Ecology*, **71**, 1040–9.
- Holland, J. N., Cheng, W. X. and Crossley, D. A. (1996) Herbivore-induced changes in plant carbon allocation: assessment of below-ground C fluxes using carbon-14. *Oecologia*, **107**, 87–94.
- Huhta, V., Persson, T. and Setälä, H. (1998) Functional implications of soil fauna diversity in boreal forests. *Applied Soil Ecology*, **10**, 277–88.
- Hunt, H. W. and Wall, D. H. (2002) Modelling the effects of loss of soil biodiversity on ecosystem function. *Global Change Biology*, **8**, 33–50.
- Hunt, H. W., Coleman, D. C., Ingham, E. R. *et al.* (1987) The detrital food web in a shortgrass prairie. *Biology and Fertility of Soils*, **3**, 57–68.
- Iilmarinen, K., Mikola, J., Nieminen, M. and Vestberg, M. (2005) Does plant growth phase determine the response of plants and soil organisms to defoliation? *Soil Biology and Biochemistry*, **37**, 433–43.
- Ingham, E. R., Trofymow, J. A., Ames, R. N. *et al.* (1986) Trophic interactions and nitrogen cycling in a semi-arid grassland soil. I. Seasonal dynamics of the natural populations, their interactions and effects on nitrogen cycling. *Journal of Applied Ecology*, **23**, 597–614.
- Ingham, R. E. and Detling, J. K. (1984) Plant-herbivore interactions in a North American mixed-grass prairie. III. Soil nematode populations and root biomass on *Cynomys ludovicianus* colonies and adjacent uncolonized areas. *Oecologia*, **63**, 307–13.
- Ingham, R. E., Trofymow, J. A., Ingham, E. R. and Coleman, D. C. (1985) Interactions of bacteria, fungi, and their nematode grazers: effects on nutrient cycling and plant-growth. *Ecological Monographs*, **55**, 119–40.
- Irmiler, U. (2000) Changes in the fauna and its contribution to mass loss and N release during litter decomposition in two deciduous forests. *Pedobiologia*, **44**, 105–18.
- Johnson, D., Kresk, M., Wellington, E. M. H. *et al.* (2005) Soil invertebrates disrupt carbon flow through fungal networks. *Science*, **309**, 1047.
- Johnson, S. R., Ferris, V. R. and Ferris, J. M. (1972) Nematode community structure of forest woodlots. I. Relationships based on similarity coefficients of nematode species. *Journal of Nematology*, **4**, 175–82.
- Jonasson, S., Vestergaard, P., Jensen, M. and Michelsen, A. (1996) Effects of carbohydrate amendments on nutrient partitioning, plant and microbial performance of a grassland-shrub ecosystem. *Oikos*, **75**, 220–6.
- Kielland, K., Bryant, J. P. and Reuss, R. W. (1997) Moose herbivory and carbon turnover of early successional stands in interior Alaska. *Oikos*, **80**, 25–30.
- Laakso, J. and Setälä, H. (1999) Sensitivity of primary production to changes in the architecture of belowground food webs. *Oikos*, **87**, 57–64.
- Langley, J. A., Chapman, S. K. and Hungate, B. A. (2006) Ectomycorrhizal colonization slows root decomposition: the post-mortem fungal legacy. *Ecology Letters*, **9**, 955–9.
- Lavelle, P. and Martin, A. (1992) Small-scale and large-scale effects of endogenic earthworms on soil organic matter dynamics in soils of the humid tropics. *Soil Biology and Biochemistry*, **24**, 1491–8.
- Leonard, M. A. (1984) Observations on the influence of culture conditions on the fungal preference of *Folsomia candida* (Collembola; Isotomidae). *Pedobiologia*, **26**, 361–7.
- Liiri, M., Setälä, H., Haimi, J., Pennanen, T. and Fritze, H. (2002a) Relationship between soil microarthropod species diversity and plant growth does not change when the system is disturbed. *Oikos*, **96**, 137–49.
- Liiri, M., Setälä, H., Haimi, J., Pennanen, T. and Fritze, H. (2002b) Soil processes are not influenced by the functional complexity of soil decomposer food webs under disturbance. *Soil Biology and Biochemistry*, **34**, 1009–20.
- Lovell, R. D. and Jarvis, S. C. (1996) Effect of cattle dung on soil microbial biomass C and N in a permanent pasture soil. *Soil Biology and Biochemistry*, **28**, 291–9.
- Lovett, G. M. and Ruesink, A. E. (1995) Carbon and nitrogen mineralization from decomposing gypsy moth frass. *Oecologia*, **104**, 133–8.
- Lussenhop, J., Kumar, R., Wicklow, D. T. and Lloyd, J. E. (1980) Insect effects on bacteria and fungi in cattle dung. *Oikos*, **34**, 54–85.
- Maraun, M. and Scheu, S. (1995) Influence of beech litter fragmentation and glucose concentration on the microbial biomass in 3 different litter layers of a beech wood. *Biology and Fertility of Soils*, **19**, 155–8.
- Martin, A. (1991) Short- and long-term effects of the endogenic earthworm *Millsonia anomala* (Omodeo) (Megascolecidae: Oligochaeta) of tropical savannas, on soil organic matter. *Biology and Fertility of Soils*, **11**, 234–8.
- McNaughton, S. J. (1979) Grazing as an optimization process: grass-ungulate relationships in the Serengeti. *American Naturalist*, **113**, 691–703.

- McNaughton, S. J. (1983) Ecology of a grazing system: the Serengeti. *Ecological Monographs*, **55**, 259–94.
- McNaughton, S. J., Banyikwa, F. F. and McNaughton, M. M. (1997) Promotion of the cycling of diet-enhancing nutrients by African grazers. *Science*, **278**, 1798–800.
- McNeill, J. R. and Winiwarter, V. (2004) Breaking the sod: humankind, history, and soil. *Nature*, **304**, 1627–9.
- Mikola, J. and Setälä, H. (1998a) Relating species diversity to ecosystem functioning: mechanistic backgrounds and experimental approach with a decomposer food web. *Oikos*, **83**, 180–94.
- Mikola, J. and Setälä, H. (1998b) No evidence of trophic cascades in an experimental microbial-based soil food web. *Ecology*, **79**, 153–64.
- Mikola, J., Yeates, G. W., Barker, G. M., Wardle, D. A. and Bonner, K. I. (2001a) Effects of defoliation intensity on soil food-web properties in an experimental grassland community. *Oikos*, **92**, 333–43.
- Mikola, J., Yeates, G. W., Wardle, D. A., Barker, G. M. and Bonner, K. I. (2001b) Response of soil food-web structure to defoliation of different plant species combinations in an experimental grassland community. *Soil Biology and Biochemistry*, **33**, 205–14.
- Mikola, J., Ilmarinen, K., Nieminen, M. and Vestberg, M. (2005) Long-term soil feedback on plant N allocation in defoliated grassland miniecosystems. *Soil Biology and Biochemistry*, **37**, 899–904.
- Milchunas, D. G. and Lauenroth, W. K. (1993) Quantitative effects of grazing on vegetation and soils over a global range of environments. *Ecological Monographs*, **63**, 327–66.
- Molvar, E. M., Bowyer, R. T. and Ballenberghe, V. V. (1993) Moose herbivory, browse quality, and nutrient cycling in an Alaskan treeline community. *Oecologia*, **94**, 472–9.
- Moore, B. D. and Foley, W. J. (2005) Tree use by koalas in a chemically complex landscape. *Nature*, **435**, 488–90.
- Moore, J. C. and Hunt, H. W. (1988) Resource compartmentation and the stability of real ecosystems. *Nature*, **333**, 261–3.
- Moore, J. C. and de Ruiter, P. C. (1991) The identification and evaluation of food webs in soil. *Agriculture, Ecosystems and Environment*, **34**, 371–97.
- Moore, J. C., St. John, T. V. and Coleman, D. C. (1985) Ingestion of vesicular-arbuscular mycorrhizal hyphae and spores by soil microarthropods. *Ecology*, **66**, 1979–81.
- Moore, J. C., McCann, K., Setälä, H. and de Ruiter, P. C. (2003) Top-down is bottom-up: does predation in the rhizosphere regulate aboveground dynamics? *Ecology*, **84**, 846–57.
- Murray, P., Ostle, N., Kenny, C. and Grant, H. (2004) Effect of defoliation on patterns of carbon exudation from *Agrostis capillaris*. *Journal of Plant Nutrition and Soil Science*, **167**, 487–93.
- Newell, K. (1984a) Interaction between two decomposer basidiomycetes and a collembolan under Sitka spruce: distribution, abundance and selective grazing. *Soil Biology and Biochemistry*, **16**, 227–34.
- Newell, K. (1984b) Interaction between two decomposer basidiomycetes and a collembolan under Sitka spruce: grazing and its potential effects on fungal distribution and litter decomposition. *Soil Biology and Biochemistry*, **16**, 235–9.
- Pace, M. L., Cole, J. J., Carpenter, S. R. and Kitchell, J. F. (1999) Trophic cascades revealed in diverse ecosystems. *Trends in Ecology and Evolution*, **14**, 483–8.
- Pastor, J., Dewey, B., Naiman, R. J., McInnes, P. F. and Cohen, Y. (1993) Moose browsing and soil fertility in the boreal forests of Isle-Royale-National-Park. *Ecology*, **74**, 467–80.
- Paterson, E. and Sim, A. (1999) Rhizodeposition and C-partitioning of *Lolium perenne* in axenic culture affected by nitrogen and defoliation. *Plant and Soil*, **216**, 155–64.
- Paterson, E. and Sim, A. (2000) Effect of nitrogen supply and defoliation on loss of organic compounds from roots of *Festuca rubra*. *Journal of Experimental Botany*, **51**, 1449–57.
- Paterson, E., Thornton, B., Sim, A. and Pratt, S. (2003) Effects of defoliation and atmospheric CO₂ depletion on nitrate acquisition, and exudation of organic compounds by roots of *Festuca rubra*. *Plant and Soil*, **250**, 293–305.
- Polis, G. A. (1994) Food webs, trophic cascades and community structure. *Australian Journal of Ecology*, **19**, 121–36.
- Preisser, E. L. (2003) Field evidence for a rapidly cascading underground food web. *Ecology*, **84**, 869–74.
- Radajewski, S., Ineson, P., Parekh, N. R. and Murrell, J. C. (2000) Stable-isotope probing as a tool in microbial ecology. *Nature*, **403**, 646–9.
- Radajewski, S., Webster, G., Reay, D. S. *et al.* (2002) Identification of active methylotroph populations in an acidic forest soil by stable isotope probing. *Microbiology*, **148**, 2331–42.

- Rasmann, S., Köllner, T. G., Degenhardt, J. *et al.* (2005) Recruitment of entomopathogenic nematodes by insect-damaged maize roots. *Nature*, **434**, 732–7.
- Reeder, J. D. and Schuman, G. E. (2002) Influence of livestock grazing on C sequestration in semi-arid mixed-grass and short-grass rangelands. *Environmental Pollution*, **116**, 457–63.
- Rillig, M. C. and Allen, M. F. (1999) What is the role of arbuscular mycorrhizal fungi in plant-to-ecosystem responses to elevated atmospheric CO₂? *Mycorrhiza*, **9**, 1–8.
- Ritchie, M. E., Tilman, D. and Knops, J. M. H. (1998) Herbivore effects on plant and nitrogen dynamics in oak savanna. *Ecology*, **79**, 165–77.
- Ronn, R., McCaig, A. E., Griffiths, B. S. and Prosser, J. I. (2002) Impact of protozoan grazing on bacterial community structure in soil microcosms. *Applied and Environmental Microbiology*, **68**, 6094–105.
- Rossow, L. J., Bryant, J. P. and Kielland, K. (1997) Effects of above-ground browsing by mammals on mycorrhizal infection in an early successional taiga ecosystem. *Oecologia*, **110**, 94–8.
- Ruess, R. W. and McNaughton, S. J. (1987) Grazing and the dynamics of nutrient and energy regulated microbial processes in the Serengeti grasslands. *Oikos*, **49**, 101–10.
- Ruess, R. W., Hendrick, R. L. and Bryant, J. P. (1998) Regulation of fine root dynamics by mammalian browsers in early successional Alaskan taiga forests. *Ecology*, **79**, 2706–20.
- Santos, P. F., Phillips, J. and Whitford, W. G. (1981) The role of mites and nematodes in early stages of buried litter decomposition in a desert. *Ecology*, **62**, 664–9.
- Scheu, S. and Schaefer, M. (1998) Bottom-up control of the soil macrofauna community in a beech wood on limestone: manipulation of food resources. *Ecology*, **79**, 1573–85.
- Scheu, S., Schlitt, N., Tiunov, A. V., Newington, J. E. and Jones, T. H. (2002) Effects of the presence and community composition of earthworms on microbial community functioning. *Oecologia*, **133**, 254–60.
- Schneider, K., Migge, S., Norton, R. A. *et al.* (2004) Trophic niche differentiation in soil microarthropods (Oribatida, Acari): evidence from stable isotope ratios (¹⁵N/¹⁴N). *Soil Biology and Biochemistry*, **36**, 1769–74.
- Schulmann, O. P. and Tiunov, A. V. (1999) Leaf litter fragmentation by the earthworm *Lumbricus terrestris* L. *Pedobiologia*, **43**, 453–8.
- Seastedt, T. R. (1984) The role of microarthropods in decomposition and mineralization processes. *Annual Review of Entomology*, **29**, 25–46.
- Seastedt, T. R., James, S. W. and Todd, T. C. (1988) Interactions among soil invertebrates, microbes and plant growth in the tallgrass prairie. *Agriculture, Ecosystems and Environment*, **24**, 219–28.
- Setälä, H. (1995) Growth of birch and pine seedlings in relation to grazing by soil fauna on ectomycorrhizal fungi. *Ecology*, **76**, 1844–51.
- Setälä, H. (2000) Reciprocal interactions between Scots pine and soil food web structure in the presence and absence of ectomycorrhiza. *Oecologia*, **125**, 109–18.
- Setälä, H. (2002) Sensitivity of ecosystem functioning to changes in trophic structure, functional group composition and species diversity in belowground food webs. *Ecological Research*, **17**, 207–15.
- Setälä, H. and Huhta, V. (1990) Evaluation of the soil fauna impact on decomposition in a simulated coniferous forest soil. *Biology and Fertility of Soils*, **10**, 163–9.
- Setälä, H. and Huhta, V. (1991) Soil fauna increase betula pendula growth: laboratory experiments with coniferous forest floor. *Ecology*, **72**, 665–71.
- Setälä, H. and McLean, M. A. (2004) Decomposition rate of organic substrates in relation to the species diversity of soil saprophytic fungi. *Oecologia*, **139**, 98–107.
- Setälä, H., Marshall, V. and Trofymow, T. (1996) Influence of body size of soil fauna on litter decomposition and ¹⁵N uptake by poplar in a pot trial. *Soil Biology and Biochemistry*, **28**, 1661–75.
- Slaytor, M. (2000) Energy metabolism in the termite and its gut microbiota. In *Termites: Evolution, Sociality, Symbioses, Ecology*, ed. T. Abe, D. E. Bignell and M. Higashi. Dordrecht, the Netherlands: Kluwer Academic Press, pp. 307–32.
- Smith, V. C. and Bradford, M. A. (2003) Litter quality impacts on grassland litter decomposition are differently dependent on soil fauna across time. *Applied Soil Ecology*, **24**, 197–203.
- Staddon, P. L. (2004) Carbon isotopes in functional soil ecology. *Trends in Ecology and Evolution*, **19**, 148–54.
- Stark, S., Wardle, D. A., Ohtonen, R., Helle, T. and Yeates, G. W. (2000) The effect of reindeer grazing on decomposition, mineralization and soil biota in a dry oligotrophic Scots pine forest. *Oikos*, **90**, 301–10.
- Stevenson, B. G. and Dindal, D. L. (1987) Insect effects on decomposition of cow dung in microcosms. *Pedobiologia*, **30**, 81–92.

- Strong, D. R. (1992) Are trophic cascades all wet? Differentiation and donor-control in speciose ecosystems. *Ecology*, **73**, 747–54.
- Swift, M. J., Heal, O. W. and Anderson, J. M. (1979) *Decomposition in Terrestrial Ecosystems*. Oxford: Blackwell.
- Techau, M. E. C., Bjørnlund, L. and Christensen, S. (2004) Simulated herbivory effects on rhizosphere organisms in pea (*Pisum sativum*) depended on phosphate. *Plant and Soil*, **264**, 185–94.
- Teuben, A. and Verhoef, H. A. (1992) Direct contribution by soil arthropods to nutrient availability through body and faecal nutrient content. *Biology and Fertility of Soils*, **14**, 71–5.
- Tiunov, A. V. and Scheu, S. (1999) Microbial respiration, biomass, biovolume and nutrient status in burrow walls of *Lumbricus terrestris* L. (Lumbricidae). *Soil Biology and Biochemistry*, **31**, 2039–48.
- Tracy, B. F. and Frank, D. A. (1998) Herbivore influence on soil microbial biomass and nitrogen mineralization in a northern grassland ecosystem: Yellowstone National Park. *Oecologia*, **114**, 556–62.
- Treonis, A. M., Ostle, N. J., Scott, A. W. *et al.* (2004) Identification of groups of metabolically-active rhizosphere microorganisms by stable isotope probing of PLFAs. *Soil Biology and Biochemistry*, **36**, 533–7.
- Treonis, A. M., Grayston, S. J., Murray, P. J. and Dawson, L. A. (2005) Effects of root feeding, crane fly larvae on soil microorganisms and the composition of the rhizosphere solutions collected from grassland plants. *Applied Soil Ecology*, **28**, 203–15.
- Tu, C., Koenning, S. R. and Hu, S. (2002) Root-parasitic nematodes enhance soil microbial activities and nitrogen mineralization. *Microbial Ecology*, **46**, 134–44.
- Turlings, T. C. J., Tumlinson, J. H. and Lewis, W. J. (1990) Exploitation of herbivore-induced plant odors by host-seeking parasitic wasps. *Science*, **250**, 1251–3.
- Van der Wal, R., Bardgett, R. D., Harrison, K. A. and Stien, A. (2004) Vertebrate herbivores and ecosystem control: cascading effects of faeces on tundra. *Ecography*, **27**, 242–52.
- Vitousek, P. M., Mooney, H. A., Lubchenco, J. and Melillo, J. M. (1997) Human domination of Earth's ecosystems. *Science*, **277**, 494–9.
- Vreeken-Buijs, M. J., Geurs, M., de Ruiter, P. C. and Brussaard, L. (1997) The effects of bacterivorous mites and amoebae on mineralization in a detrital based below-ground food web: microcosm experiment and simulation of interactions. *Pedobiologia*, **41**, 481–93.
- Wall, D. H. (ed) (2004) *Sustaining Biodiversity and Ecosystem Services in Soils and Sediments*. Island Press: Washington, DC.
- Wall, D. H. and Virginia, R. A. (1997) The world beneath our feet: soil biodiversity and ecosystem functioning. In *Nature and Human Society: The Quest for a Sustainable World*, ed. P. H. Raven. Washington, DC: National Academy Press.
- Wardle, D. A. (2002) *Communities and Ecosystems: Linking the Aboveground and Belowground Components*. Monographs in Population Biology. Vol. 34. Princeton, NJ: Princeton University Press.
- Wardle, D. A. and Yeates, G. W. (1993) The dual importance of competition and predation as regulatory forces in terrestrial ecosystems: evidence from decomposer food-webs. *Oecologia*, **93**, 303–6.
- Wardle, D. A., Bonner, K. I., Barker, G. M. *et al.* (1999) Plant removals in perennial grassland: vegetation dynamics, decomposers, soil biodiversity, and ecosystem properties. *Ecological Monographs*, **69**, 535–68.
- Wardle, D. A., Barker, G. M., Yeates, G. W., Bonner, K. I. and Ghani, A. (2001) Introduced browsing mammals in New Zealand natural forests: aboveground and belowground consequences. *Ecological Monographs*, **71**, 587–614.
- Warnock, A. J., Fitter, A. H. and Usher, M. B. (1982) The influence of a springtail *Folsomia candida* (Insecta : Collembola) on the mycorrhizal association of leek, *Allium porrum* and the vesicular arbuscular endophyte *Glomus fasciculatum*. *New Phytologist*, **90**, 285–92.
- Williams, B. L., Grayston, S. J. and Reid, E. J. (2000) Influence of synthetic sheep urine on the microbial biomass, activity and community structure in two pastures in the Scottish uplands. *Plant and Soil*, **225**, 175–85.
- Wold, E. N. and Marquis, R. J. (1997) Induced defense in white oak: effects on herbivores and consequences for the plant. *Ecology*, **78**, 1356–69.
- Yamada, A., Inoue, T., Wiwatwitaya, D. *et al.* (2005) Carbon mineralization by termites in tropical forests, with emphasis on fungus combs. *Ecological Research*, **20**, 453–60.
- Yeates, G. W. (1972) Nematodes of a Danish beech forest. I. Methods and general analysis. *Oikos*, **23**, 178–89.

- Yeates, G. W., Saggiar, S., Denton, C. S. and Mercer, C. F. (1998) Impact of clover cyst nematode (*Heterodera trifolii*) infection on soil microbial activity in the rhizosphere of white clover (*Trifolium repens*): a pulse-labelling experiment. *Nematologica*, **44**, 81–90.
- Yeates, G. W., Saggiar, S., Hedley, C. B. and Mercer, C. F. (1999) Increase in ¹⁴C-carbon translocation to the soil microbial biomass when five species of plant-parasitic nematodes infest roots of white clover. *Nematology*, **1**, 295–300.
- Yokoyama, K., Kai, H., Koga, T. and Toshiharu, A. (1991) Nitrogen mineralization and microbial populations in cow dung, dung balls and underlying soil affected by paracoprid dung beetles. *Soil Biology and Biochemistry*, **23**, 649–53.
- Zaady, E., Groffman, P. M., Shachak, M. and Wilby, A. (2003) Consumption and release of nitrogen by the harvester termite *Anacanthotermes ubachi* navas in northern Negev desert, Israel. *Soil Biology and Biochemistry*, **35**, 1299–303.
- Zak, D. R., Tilman, D., Parmenter, R. R. *et al.* (1994) Plant production and soil microorganisms in late-successional ecosystem: a continental-scale study. *Ecology*, **75**, 2333–47.
- Zak, D. R., Blackwood, C. B. and Waldrop, M. P. (2006) A molecular dawn for biogeochemistry. *Trends in Ecology and Evolution*, **21**, 288–95.
- Zangerl, A. R. (1990) Furanocoumarin induction in wild parsnip: evidence for an induced defense against herbivores. *Ecology*, **71**, 1926–32.
- Zimmer, M., Kautz, G. and Topp, W. (2005) Do woodlice and earthworms interact synergistically in leaf litter decomposition? *Functional Ecology*, **19**, 7–16.

11 • Semi-empirical modelling of the response of soil respiration to environmental factors in laboratory and field conditions

Markus Reichstein and Ivan A. Janssens

11.1 INTRODUCTION

Soil respiration, globally $68\text{--}80 \text{ Pg C y}^{-1}$, represents the second largest carbon flux between ecosystems and the atmosphere (Schimel *et al.*, 1996; Raich *et al.*, 2002). This is more than ten times the current rate of fossil fuel combustion and indicates that each year around 10% of the atmosphere's CO_2 cycles through the soil. Thus, even a small change in soil respiration could significantly intensify – or mitigate – current atmospheric increases of CO_2 , with potential feedbacks to climate change. Despite this global significance and the considerable scientific commitment to its study over the last decades, there is still limited comprehensive understanding of the factors controlling temporal and across-ecosystem variability of soil respiration.

This understanding is largely hampered by the fact that studies are often conducted and compared at different temporal and spatial scales that are not compatible. Since, particularly in large-scale studies, factors influencing soil respiration often correlate with each other, responses of soil respiration to those factors are confounded and only apparent relationships are obtained.

For the purpose of this chapter, methods (and their associated problems) for analyzing soil respiration data from different scales are reviewed and jointly interpreted with emphasis on the temperature dependence of soil respiration.

11.2 MODELLING SOIL RESPIRATION: AN OVERVIEW

11.2.1 General modelling approaches

Soil respiration – defined as the CO_2 efflux from the soil surface – originates from the metabolic activity of roots (autotrophic respiration), micro-organisms

(bacteria, actinomycetes and fungi) and soil meso- and macro-fauna (heterotrophic respiration). Under certain circumstances significant amounts of CO_2 can abiotically evolve through geochemical processes in carbonate soils (Kowalski *et al.*, 2008).

While photosynthetic assimilation and soil respiration are reciprocal ecosystem processes, from a modelling point of view it is important to note that their characteristics differ substantially. These differences can be clearly identified by analyzing questions such as: 'What is the functional unit?', 'What are the biochemical processes involved?' or 'What do we know about the organisms performing the process?' (Table 11.1). In the case of photosynthesis, the leaf is easily identified as the functional unit with clear boundaries, a well-known organization of tissues and a general biochemistry (Calvin cycle). In contrast, the soil is very heterogeneous and does not consist of a single functional unit. Instead, a large number of organisms and enzymes are decomposing a large variety of chemical substances. Moreover, while virtually all higher plants are described at the species level and many plant species of various functional types have been studied extensively, only a vast minority of soil microbes have been described at all. Consequently, for photosynthesis modelling, species-oriented and reductionistic approaches have been successful, while soil respiration is often modelled as a whole ('holistic' approach), and processes are more easily related to the substances that are decomposed rather than to decomposing species.

For soil respiration modelling, the soil has virtually always been assumed as homogeneous or horizontally homogeneous (i.e. layer structure). However, soil is also horizontally a very heterogeneous system, which is constantly modified and organized by organismic activity (Fig. 11.1). This leads to a clustering of the respiratory

Table 11.1 *Differing characteristics of the processes of photosynthetic assimilation and decomposition and their consequences for modelling approaches.*

Photosynthesis	Decomposition
<ul style="list-style-type: none"> ● leaf as functional unit ● CO₂ assimilation: ‘simple’ reaction kinetics and substrate, secondary metabolism not very important ● species relatively well-known → species-oriented approach → reductionistic approach possible 	<ul style="list-style-type: none"> ● very heterogeneous and no single functional unit ● ‘very complex’ kinetics, as substrate is very diverse and high molecular ● less than 10% of species described at all → substrate-oriented approach → holistic approach more appropriate

activity. Hence, one has to consider, that the prevailing environmental conditions within those hot spot areas govern soil activity and respiration (and not necessarily the average conditions within that soil layer).

Also in the temporal domain processes from various time scales overlap and superimpose on the resulting soil biological activity and soil respiration (Fig. 11.2). Consequently, a currently observed soil flux can be the result of processes that have occurred a long time ago. A typical example for this would be the unusually high and persisting soil respiration from crop fields that have been established on drained peatland. Another relevant example are the flushes of CO₂ that evolve after a long soil drying and subsequent rewetting. Under these conditions soil respiration rates often exceed rates under well watered conditions before the drying. This so-called Birch effect has been first observed in the laboratory and is usually explained by the rapid mineralization of microbes that died during the drying (Birch, 1958). Recently this effect was found to play an important effect also for ecosystem carbon dynamics (Borken *et al.*, 2003; Xu and Baldocchi, 2004). The scheme in Fig. 11.2 also elucidates that the type of model developed to describe soil respiration (i.e. the processes included) must be in accordance with the temporal scale of the model application.

11.2.2 Biotic factors

Given that soil respiration is predominantly a combination of biological processes, it is conceptually evident that biotic factors are important determinants of soil

respiration. Roots as well as micro-organisms ultimately depend on the carbon supply that is assimilated by the green vegetation and enters the soil via phloem transport to the root and subsequent root exudation, or via the deposition and incorporation of dead plant material into the soil (litter fall). The proportion of root respiration has been shown to vary between 30 and 70% (Bond-Lamberty *et al.*, 2004; Subke *et al.*, 2006). Extreme values of 10% and 90% have been reported, but those numbers have resulted from extreme conditions or methodological problems. Global analysis of soil respiration datasets has clearly shown that soil respiration is strongly correlated with both gross and net primary productivity (Raich and Schlesinger, 1992; Raich and Tufekcioglu, 2000; Janssens *et al.*, 2001).

Despite the obvious importance of biological control over soil respiration, empirical models have often not included those factors but focused mainly on the abiotic controls. Even for global and inter-annual variation, models have been developed that predict soil respiration solely from climate variables (Raich and Potter, 1995; Raich *et al.*, 2002). The hypothesis behind these climatically driven models is that vegetation productivity and climate are correlated and their effect on soil respiration cannot be disentangled. However, Reichstein *et al.* (2003a) showed that it is possible and necessary to separate climatic and biological effects on soil respiration, since their biologically driven model explained an order of magnitude more site-to-site variability than a climate driven model.

Mechanistic models generally rely on a few common paradigms when modelling soil respiration. Root respiration is modelled – as for other plant

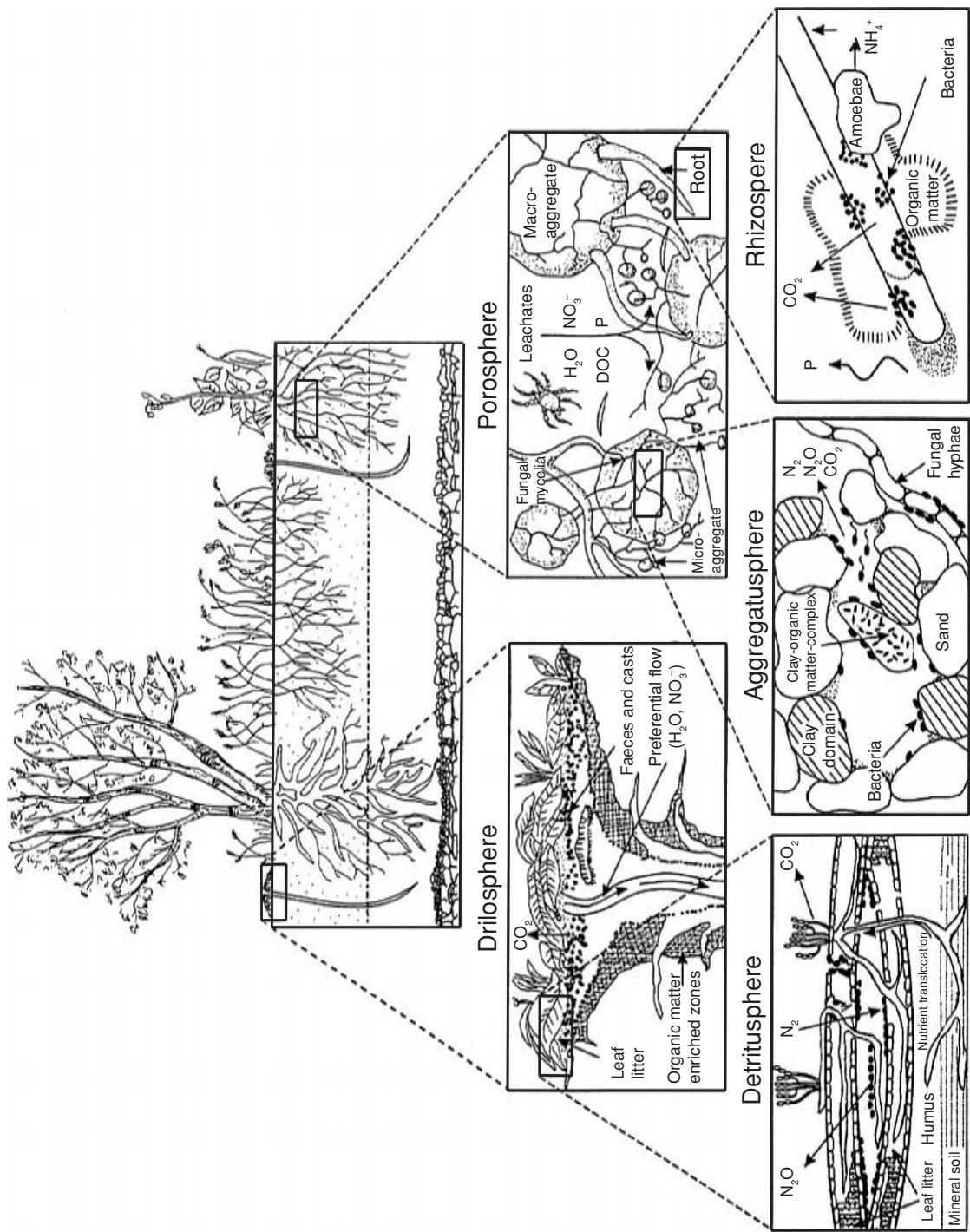

Figure 11.1. Arenas of high biological activity in soil systems. While these 'hot spots' often make up less than 10% of the soil volume, they commonly represent more than 90% of the activity (Beare *et al.*, 1995).

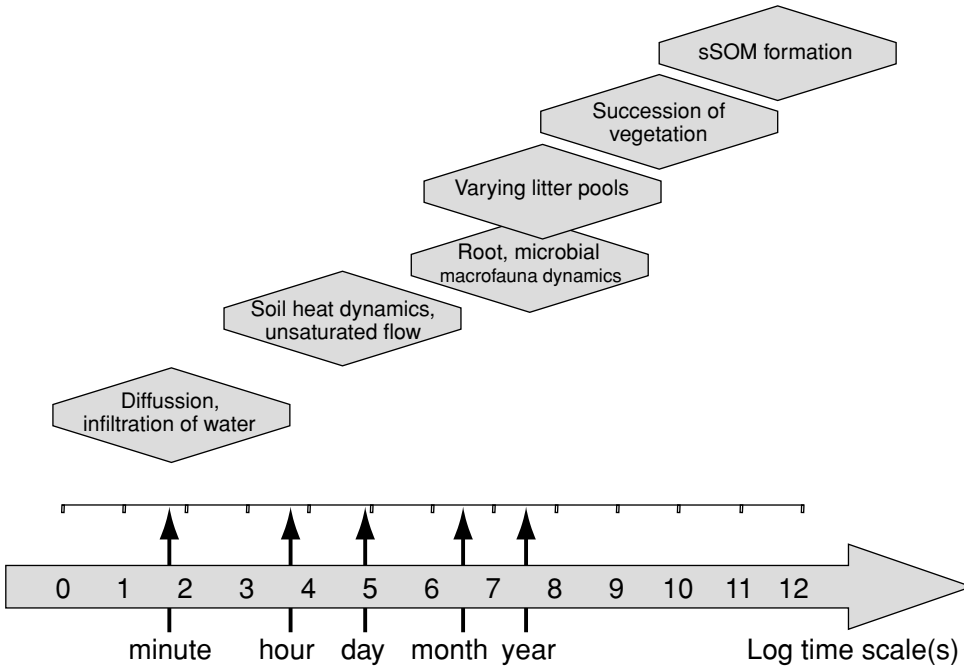

Figure 11.2 Dominant temporal scales of factors and processes influencing soil respiration. (sSOM = stable soil organic matter.)

tissues – as the sum of growth and maintenance respiration, according to the 30-year-old so-called Penning-de-Vries paradigm (Amthor, 2000). In these mechanistic models, heterotrophic respiration is usually modelled as the decomposition of two to eight soil organic matter pools with different turnover times. According to this approach each pool decomposes with a first-order kinetic, analogue to nuclear decay

$$\frac{dC_i}{dt} = I_i - k_i \cdot C_i$$

where I_i is the input to the pool I , C_i is the pool size (e.g. kg m^{-2}) and k_i is the first-order decomposition rate constant (cf. Fig. 11.3). Labile pools with high decomposition rates are sugar, alcohols and starch, while cellulose, ligno-cellulose, waxes and lignin are considered more stable components. Humification is modelled as transition from a more labile to a more stable pool. This concept goes back to Meentemeyer (1978).

In these mechanistic models a number of processes (e.g. priming or microbial growth dynamics) are typically not explicitly considered, nor is there a direct link (other than litter fall) from assimilation to below-ground processes. Moreover, the parameterization of

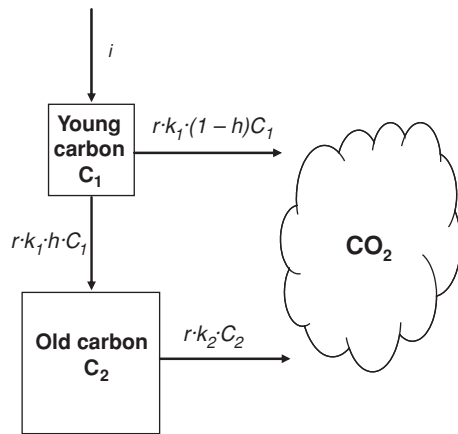

Figure 11.3 Simplest useful soil organic matter decomposition model (two pools, five parameters), the Introductory Carbon Balance Model (ICBM) (Andrén and Kätterer, 1997).

these models is quite uncertain, because the assumed two to eight soil carbon pools cannot be separately quantified, nor can the transfers of carbon between them. Recent girdling experiments seem to indicate that current mechanistic models underestimate the importance

Table 11.2 *Typical function used for describing soil respiration in relation to temperature.*

Name/author	Function	Background	Properties	df^a
Q_{10} , van't Hoff	$f(T) = a * Q_{10}^{[(T-T_{ref})/10]}$	empirical	always above 0	2
Ratkowsky <i>et al.</i> (1982)	$f(T) = a*(T - T_{min})^2$	empirical studies on microbial growth	zero respiration at $T = T_{min}$	2
Arrhenius	$f(T) = a * e^{-Ea/(R * T)}$	physical chemistry	always > 0, very similar to Q_{10} ,	2
Lloyd & Taylor (1994)	$f(T) = a * e^{-Ea/(T - T_{min})}$	Arrhenius + study on field respiration	zero respiration at $T = T_{min}$, no optimum	3
O'Connell & Kirschbaum (1990)	$f(T) = a * e^{b * T(1 - 0.5T/T_{opt})}$	empirical studies on soil respiration in laboratory	optimum function	3

^adegrees of freedom (i.e. number of free parameters).

of the interactions between above-ground and below-ground processes (Högberg *et al.*, 2001; Subke *et al.*, 2004). Biological-focused, food web-based models of soil respiration have been developed (Hunt, 1977; Hunt *et al.*, 1977), but did not receive much general attention.

11.2.3 Abiotic factors

Temperature influences virtually all biological and physico-chemical processes. This has been empirically observed in the nineteenth century (Arrhenius, 1889; van't Hoff, 1898). Not surprisingly, temperature has also been the most obvious and most often studied factor influencing soil respiration, with studies dating back to the 1920s (Waksman and Gerretsen, 1931). All studies confirm a non-linear, positive direct relationship between temperature and soil respiration. A number of shapes have been proposed, but the most commonly used are the ones that have been analyzed in a number of reviews (Lloyd and Taylor, 1994; Kirschbaum, 1995; Kätterer *et al.*, 1998). The simplest, but theoretically not justified function is the so-called exponential Q_{10} relationship (Table 11.2), where the parameter Q_{10} is the factor by which soil respiration increases with a 10 °C temperature increase. The overall median Q_{10} of soil respiration is 2.4 (Raich and Schlesinger, 1992), but there is huge variation both spatially and temporally (Reichstein *et al.*, 2003a). Moreover, the exponential Q_{10} equation does not always provide the best fit of the soil respiration data. Svante Arrhenius worked with

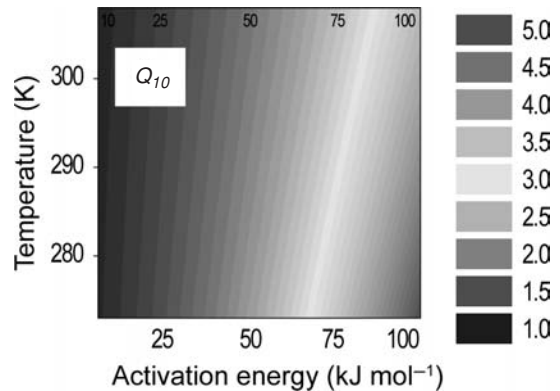

Figure 11.4 Dependence of Q_{10} (calculated a posteriori from fluxes predicted with the Arrhenius equation) on temperature and activation energy.

van't Hoff to improve the temperature response function of biochemical reactions and developed his world-famous Arrhenius function. The Arrhenius function reveals that for reactions with an activation energy (E_a) around 50 kJ mol⁻¹, and at temperatures between 273 K and 303 K, the Q_{10} is around two, in agreement with field observations. The Arrhenius equation further predicts that the Q_{10} decreases with increasing temperature (Fig. 11.4), as is also commonly observed in nature (Tjoelker *et al.*, 2001; Atkin and Tjoelker, 2003; Janssens and Pilegaard, 2003; see Davidson and Janssens, 2006 for a more theoretical explanation of this phenomenon). The Arrhenius function also predicts

that decomposition of compounds with higher activation energies (i.e. less reactive and more recalcitrant molecules) should have higher Q_{10} s of decomposition.

One should, however, keep in mind that the temperature sensitivity refers to relative rates, and that the absolute rate of the reaction is much lower for compounds requiring high E_a . While the relative rate of decomposition of recalcitrant soil organic matter with high activation energy may be very sensitive to temperature, the change in absolute rate may be small and difficult to detect in experiments.

While Arrhenius kinetics are the best mechanistic description of biochemical reaction rates under unlimited conditions, they might not be applicable under conditions of changing substrate availability. This is because decomposition is an enzyme-catalyzed process, best described by Michaelis–Menten kinetics (Michaelis and Menten, 1913; Davidson and Janssens, 2006). Michaelis–Menten kinetics predict a decline in the Q_{10} as substrate availability declines (Davidson *et al.*, 2006). Thus, in addition to substrate quality and temperature, temporal and spatial differences in substrate availability can also contribute to the large variability in Q_{10} observed in nature.

Neither Arrhenius, nor Michaelis–Menten kinetics are likely to integrate over the entire soil column perfectly, because they assume constant enzyme concentrations, which is unlikely to be the case given the fluctuating microbial population size and structure. These processes occurring at higher scales could offset any climate change-induced increase in respiratory activity at lower scales (the direct effect on the reaction rates) and are commonly referred to as ‘temperature acclimation’. However, although the existence of these acclimatory processes is beyond doubt, their ecological importance remains to be tested.

Thus, it is questionable whether a simple transfer from first principles-based temperature response functions to the complex process of soil respiration is justified. Instead, more flexible, exponential relationships have been derived from empirical field data that imply an even stronger variation of the Q_{10} with temperature. Since all biological processes exhibit optimum temperatures (enzymes are deactivated at higher temperatures), the optimum function (Kirschbaum, 1995) may be considered the most appropriate description. However, soil temperatures rarely reach the typically high optimum temperatures, such that within the normal range of

temperatures the monotonic exponential function may be equally valid and often reproduces the observed data best (Janssens *et al.*, 2003).

The effect of soil water status on soil respiration has been described empirically via absolute or relative measures of volumetric water content and soil water potential as reviewed by Rodrigo *et al.* (1997) (see examples in Table 11.3). It is usually assumed that both very low and very high water contents reduce soil respiration, via direct inhibition of biological activity or inhibition of oxygen diffusion, respectively. The relationship between soil water status and soil respiratory processes is complex, since many individual processes vary either with soil water content, with soil water potential or both (in particular gas and solute diffusion, enzyme activities, and growth and mortality of micro-organisms (Marshall and Holmes, 1988; Killham, 1994). Nevertheless, in most models of drought effects on soil respiration, soil water content is assumed to multiplicatively affect soil respiration together with temperature, i.e. $R_{soil} = f(\text{temperature}) \times g(\text{soil water status})$. Soil water potential has often been considered the physiologically more appropriate predictor of activities in soil, because it expresses the actual availability of water independent of texture (Miller and Johnson, 1964; Davidson *et al.*, 1998). However, plausible arguments for soil water content as a predictor have also been presented, such as the number and extent of micro-environments where microbial activity may take place being a function of the volume of the water in the soil (Orchard and Cook, 1983; Fang and Moncrieff, 1999). Furthermore, nutrient, substrate and oxygen diffusion seems to be better described as dependent on soil water content (Skopp *et al.*, 1990). A practical advantage of water content as a predictor is that it is more readily measured in the field than water potential, but the criticism remains that water content is not comparable among different soil texture classes. A possible way to partly overcome this problem is to express soil water content as a proportion of water holding (field) capacity or available water, because then the effect of texture on water availability is included to some extent.

Obviously, there are indirect effects of drought on soil respiration, for instance the impact on soil macro-fauna, which may retreat into deeper soil layers and/or become dormant under drought. Also, rewetting events often increase soil respiration by large amounts, which can only be explained by remineralization of dead

Table 11.3 *Typical model formulations used for soil drought effects on soil respiration.*

Formulation ^a	References
Dependency on volumetric soil moisture θ	
$f(\theta) = a \cdot \theta + b$ (plain linear)	Stanford and Epstein, 1974
$f(\theta) = a \cdot \frac{\theta - \theta_b}{\theta_{opt} - \theta_b} + b$ (scaled linear)	Myers <i>et al.</i> , 1982
$f(\theta) = a \cdot e^{b \cdot \theta}$ (exponential)	Keith <i>et al.</i> , 1997
$f(\theta) = e^{-e^{(a-b \cdot \theta)}}$ (Gompertz)	Janssens <i>et al.</i> , 2003
$f(\theta) = a \cdot \theta^b$ (power)	Skopp <i>et al.</i> , 1990
$f(\theta) = \frac{a \cdot b \cdot \theta}{a \cdot \theta + b}$ (first degree polynomial)	Hanson <i>et al.</i> , 1993
$f(\theta) = \frac{\theta}{a1 + \theta}$ (hyperbolic)	Bunnell <i>et al.</i> 1977
Dependency on soil water potential Ψ	
$f(\Psi) = m \cdot \log_{10}(-\Psi) + c$	Sommers <i>et al.</i> , 1981; Orchard and Cook, 1983; Andr�n and Paustian, 1987
$f(\Psi) = \frac{\log_{10}(-\Psi) - \log_{10}(-\Psi_{min})}{\log_{10}(-\Psi_{opt}) - \log_{10}(-\Psi_{min})}$ (log-linear)	
$f(\Psi) = a \cdot e^{b \cdot \Psi}$ (exponential)	Davidson <i>et al.</i> , 1998
Dependency on proportion of water holding capacity P	
$f(P) = e^{(a \cdot (P - P_{ref}) + b \cdot (P - P_{ref})^2)}$ (exponential)	Howard and Howard, 1993

^asymbols a , b , θ_{opt} , θ_b , $a1$, m , c , Ψ_{min} , Ψ_{opt} , P_{ref} are model parameters determining the shape and scale of the functions.

biomass or by desorption processes, which make labile substrate available to microbes (Orchard and Cook, 1983). Rewetting may also mitigate substrate limitation and thus increase the temperature sensitivity of decomposition (Davidson and Janssens, 2006). However, modelling efforts at the plot scale are currently far from being able to include such biotic effects. Similarly, the seasonality of other processes such as root-exudation and growth respiration, which might also be drought influenced, are typically neglected in models of soil respiration. While the temperature dependency of soil respiration has been analyzed for different compartments (roots, litter and mineral soil), with often quite different results, however (partly due to methodological problems discussed in this chapter) (Anderson, 1991; Boone *et al.*, 1998; Liski *et al.*, 1999; B   th and Wallander, 2003; Moyano *et al.*, 2007), no such efforts have been undertaken with respect to drought effects that confound temperature effects. Finally, the assumption of a simple multiplicative effect of temperature and moisture on respiration without any interaction is often made without further testing, and the validity of this assumption is questionable (Carlyle and Than, 1988; Borken *et al.*, 1999; Reichstein *et al.*, 2003b).

Abiotic factors other than soil water availability and soil temperature have been much less systematically studied, but include soil acidity, oxygen and nutrient availability. Oxygen can be a limiting factor of soil respiration in waterlogged soils, or after rain events that cause anaerobic conditions within aggregates. The response of soil respiration to soil acidity is thought to be an optimum function, where bacteria allegedly operate optimally under neutral conditions while fungi prefer slightly acidic soil pH. A recent study has shown that such optimum curves can be found through analysis of field data of respiration (Reth *et al.*, 2005), although confounding factors have to be considered.

11.3 EXTRACTING THE RESPONSE OF SOIL RESPIRATION TO ENVIRONMENTAL FACTORS

While a general description of the response of soil respiration to environmental factors (see above) seems quite straightforward, there are a number of complications that occur when a formal modelling of soil respiration, e.g. in response to temperature, is looked for.

These complications mainly arise from misunderstandings about what ‘the response of soil respiration to temperature’ actually is and from different interpretations at different scales. The largest misunderstanding may occur between field ecologists and mechanistic modellers of soil respiration. The former would define the response of soil respiration to temperature basically from the scatter between observed soil CO₂ efflux and measured temperature. The latter would say there is no such definition of ‘the response of soil respiration to temperature’ as a whole, but defines how individual components – e.g. rate constants of decomposition, root maintenance and growth respiration – depend on temperature. These two opposite approaches can lead to very different results that are per se not comparable as will be outlined in the next sections.

11.3.1 Analyzing soil respiration at the laboratory scale

Measuring and modelling soil respiration in the laboratory has the advantage that the influence of different factors can be analyzed under controlled conditions. Disadvantages of such methods can be summarized under the notion of introducing artificial conditions that are not further discussed here. In the laboratory usually only respiration stemming from the mineralization of soil organic matter is observed, while roots are either sieved out or considered inactive, since they do not get any supply of photosynthates. Thus, with such experiments it should be possible to easily obtain the temperature dependence of soil organic matter mineralization. However, even in this case the situation is not as ‘controlled’ as it might appear, mainly due to the dynamic nature of the decomposition process (Fig. 11.5). At higher temperatures, the easily decomposable fraction will be mineralized more quickly than at lower temperatures. This implies that after a certain time there will be more easily decomposable matter left over in the low-temperature than in the high-temperature treatment, resulting in a relatively higher soil respiration rate in the low-temperature treatment. Estimating the Q_{10} of the decomposition process by comparing the different temperature treatments therefore would suggest a decreasing Q_{10} with incubation time (i.e. acclimation). When the easily decomposable fraction in the low-temperature treatment is nearly completely decayed, then the Q_{10} rises again. So, the

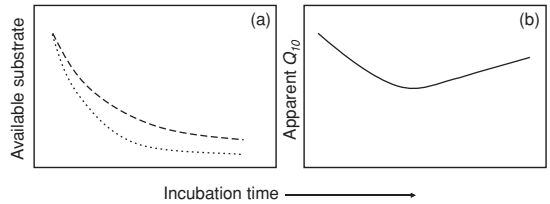

Figure 11.5 (a) Theoretical dynamics of the available SOM substrate during an incubation experiment at high (dotted line) and lower temperature (dashed line). (b) Resulting apparent Q_{10} time-series that would result from relating the instantaneous fluxes from the high- and the low- temperature treatment (see Reichstein *et al.* (2000) for details and real data analysis). The Q_{10} relationship was only used for simplicity; the principle holds for any function.

Q_{10} -dynamics actually are dominated by the changing amount of decomposable matter in the different temperature treatments. In the incubations literature, it is very often not reported when and how the Q_{10} was derived. Hence, the large scatter of Q_{10} s in the review by Kirschbaum (1995) may have been caused by similar spurious changes in Q_{10} .

Consequently it is dangerous to derive the Q_{10} of carbon mineralization from the respiration rates at only one arbitrary incubation time, because then the temperature effect is confused with the incubation-time effect. There are four ways to solve this problem: (1) Calculate the Q_{10} values from only the respiration rates at the beginning of the incubation (e.g. Winkler *et al.*, 1996), because the composition of the samples is still unaltered. This solution would provide comparable Q_{10} s, but only for the labile carbon pools that dominate the early fluxes. (2) Use the respiration rates at a very late incubation time (e.g. Ross and Cairns, 1978), when the light fraction is (nearly) mineralized and respiration rates are nearly constant. This solution would again provide comparable Q_{10} s, but only for the less labile carbon pools that dominate the late fluxes. (3) Fit a model of carbon mineralization combined with a temperature response function of the rate constants to the mineralization curves. (4) Express fluxes per unit carbon remaining or per gram of dry matter remaining. Thus, fluxes measured in the warmer conditions at time t will be comparable with fluxes in the colder conditions at time $t + a$. With approaches (1) and (2) only a small part of a long-term incubation is considered. Moreover, at the beginning of an incubation soil respiration may still be

influenced by disturbance introduced by sample preparation (Blet-Charaudeau *et al.*, 1990; Schinner *et al.*, 1993), while at the end of an incubation experiment inhibiting metabolites may have accumulated, which could adulterate the temperature dependence of carbon mineralization (Kirschbaum, 1995). Therefore, it is strongly recommended to fit a model of carbon mineralization combined with a temperature response function of rate constants to the temperature-dependent mineralization curves (e.g. Updegraff *et al.*, 1995; Kätterer *et al.*, 1998). This approach provides the temperature dependence of decomposition rate constants, and, additionally, the model is compatible with current carbon balance models (e.g. Parton *et al.*, 1987; Andrén and Kätterer, 1997), which also use temperature-dependent rate constants. Solution (4) would solve the problems depicted in Fig. 11.5, because Q_{10} s would be compared by comparison of fluxes at similar y -values rather than at similar x -values. The advantage is that information on changes in Q_{10} throughout the decomposition process is gained, but unfortunately this information is not applicable to other studies without the use of a mechanistic model, as suggested in solution (3).

11.3.2 Analyzing soil respiration at the plot scale

The rapid development of soil respiration chambers with reliable infrared gas analyzers has allowed diurnal as well as year-round observations of *in situ* soil respiration. These studies have also been used to derive the response of soil respiration to environmental factors, most often soil temperature and water availability. However, the observed response can be easily confounded by other biotic or abiotic factors, such that care has to be taken when interpreting and extrapolating the results, e.g. in the context of global change. Here, the effect of seasonally varying factors and the effect of fluxes coming from different soil layers are discussed.

When analyzing seasonal variation of soil respiration, the problem is that several factors co-vary (e.g. temperature, moisture, plant assimilation and root activity). When the variation is then attributed to one factor only, background correlations with other factors can confound the relationship. A typical situation is depicted with the temperature–soil respiration relationship in Fig. 11.6. In a summer active ecosystem (e.g. a summer-green deciduous forest) the typically higher biological activity in summer adds on to

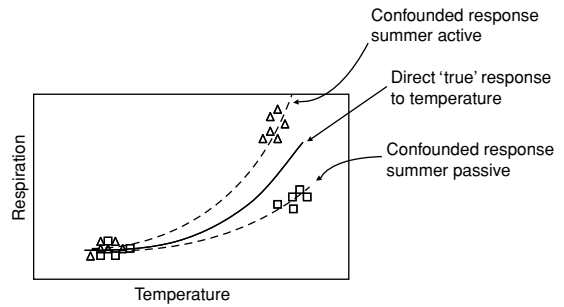

Figure 11.6 Schematic representation of the confounding effects introduced into a temperature dependence of soil respiration derived from annual data. Triangles and squares are hypothetical data for summer active and summer passive ecosystems, respectively.

the ‘pure’ or direct temperature response. In such an ecosystem the true temperature sensitivity would be overestimated using seasonal data. This phenomenon was clearly described by Curiel Yuste *et al.* (2004) for a mixed coniferous–deciduous temperate forest. In that particular study, apparent annual Q_{10} s were much higher in deciduous than in coniferous plots, while short-term Q_{10} s did not differ. In this study, the (spurious) annual Q_{10} s were strongly correlated with the annual changes in leaf area index (LAI), a proxy for photosynthetic activity. The opposite effect occurs in summer passive (e.g. summer-drought affected) ecosystems (Fig. 11.6). Another prominent example of such a misinterpretation of seasonal data is the study from a trenching experiment (Boone *et al.*, 1998), where the temperature sensitivity of root respiration appeared to be higher than that of bulk soil respiration. In view of the fact that the actual physiological temperature response of root respiration probably does not differ from heterotrophic respiration (Bååth and Wallander, 2003), this result can only be explained by a stronger seasonality of root biomass or by the increased carbon allocation to roots during summer, hence a spurious apparent temperature sensitivity. Also it cannot be ruled out that the strong decline of Q_{10} at higher temperatures in the review by Lloyd and Taylor (1994) is partly caused by interaction with soil moisture limitations, i.e. that the currently most commonly used function is a spurious or confounded one.

The relation between observed *in situ* respiration rates and soil temperature is also ill defined since soil respiration originates from different depths, with each

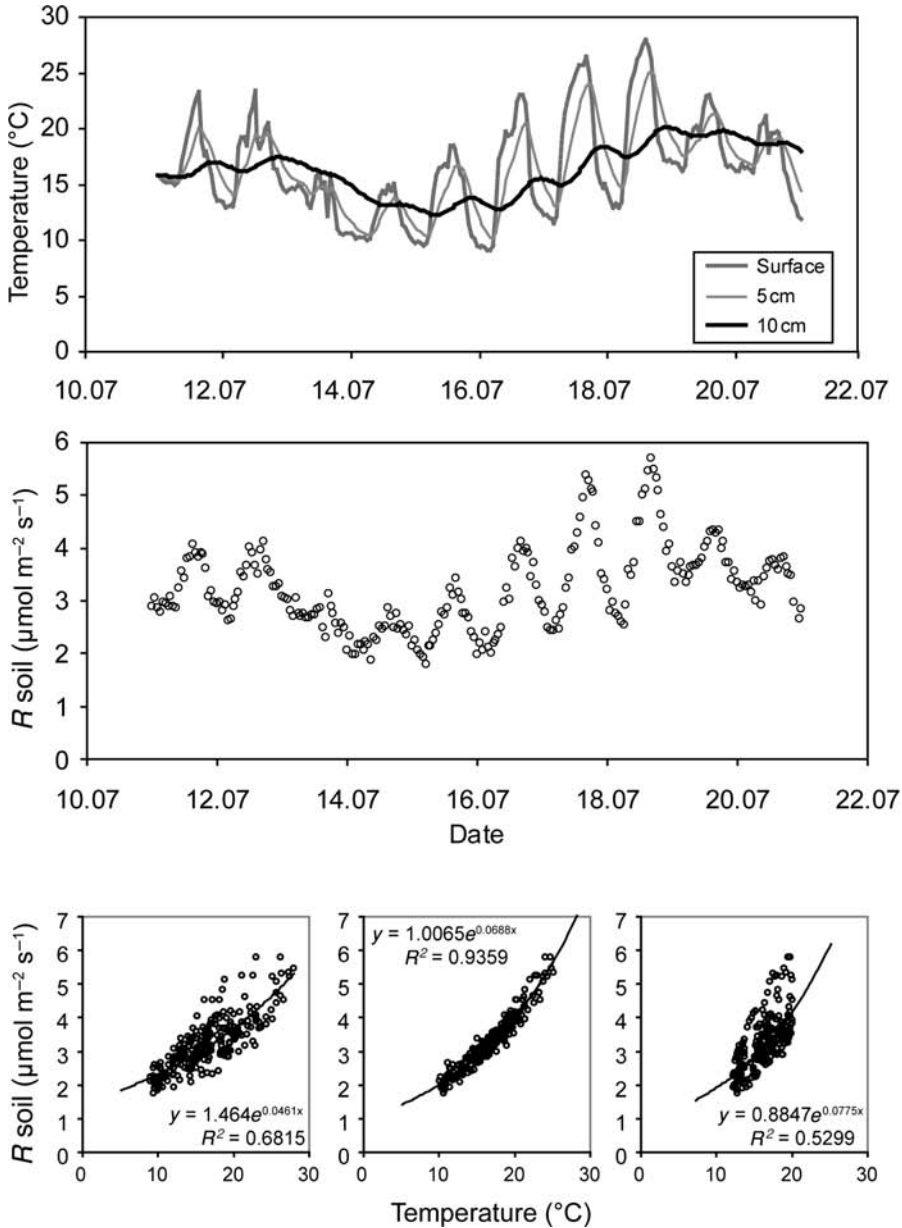

Figure 11.7 Upper panel: soil temperature at soil surface, 5 cm and 10 cm depth; centre: soil respiration; lower panel: scatter plots of soil respiration versus surface, 5 cm and 10 cm temperature (from left to right), with fitted exponential function. Artificial data.

depth having its own temperature dynamics. Depending on which depth for soil temperature is used as a predictor in the regression with soil respiration, varying temperature sensitivities will result: the deeper the depth of temperature, the smaller is the amplitude of temperature and consequently the larger the estimated temperature sensitivity, e.g. the Q_{10} , will be (Pavelka

et al., 2007, see also Fig. 11.7). Moreover apparent hysteresis effects are observed through this effect (Reichstein *et al.*, 2005). Theoretically, solving this problem would require fitting a multi-source model to the respiration data, but experience shows that such a model is often over-parameterized. An alternative solution would be to use the temperature at that depth where

the best correlation is obtained (5 cm in Fig. 11.7), although there are indications that even this introduces a bias (Graf *et al.*, 2008). Nevertheless, even if the depth were standardized, temperature sensitivities obtained from different studies would still be only partly comparable, because thermal properties (insulation and heat capacity), as well as the depth of the main respiratory activity, differ between soils (and even seasonally within the same soil). From these examples it should be clear that empirically derived apparent Q_{10} values are not comparable to Q_{10S} used in mechanistic models.

11.3.3 Analyzing soil respiration at larger scales

Analyzing soil respiration at larger scales brings the spatial dimension into play, where site-to-site variability has to be modelled. From site to site, all factors that were discussed above, potentially (co-)vary strongly. Thus, because of the likelihood of confounding effects, a direct link from empirical results obtained at this scale to mechanistic model parameters is even less likely than from results at the field scale. For example, a result showing that decomposition rates did not vary significantly with temperature along a continental gradient (Giardina and Ryan, 2000) does not invalidate the fundamental temperature dependence of decomposition rate constants that is used in carbon balance models. Instead, the correct interpretation is that there are other factors that override the temperature effect.

Similarly, there has been some controversy about biological and climatic controls of soil respiration stemming from different interpretation of large-scale analysis. In several studies, Raich and co-workers have shown that a major fraction of the spatio-temporal variability of soil respiration can be statistically explained by monthly temperature and precipitation, i.e. by purely climatic drivers (Raich and Potter, 1995; Raich *et al.*, 2002). This apparently contradicts other findings that indicate that productivity (biological control) is the main determinant of soil respiration across continental scales (Valentini *et al.*, 2000; Janssens *et al.*, 2001). Again, these are only correlative relationships being obscured by the background correlation between productivity and climate. With a careful analysis it may be possible, however, to statistically separate biological and climatic controls on soil respiration. Reichstein *et al.* (2003b) have done such an analysis with a model that used temperature, precipitation and leaf area index as predictors, and

showed that both categories are important for describing spatial and temporal variation of soil respiration. While this model has an equally good statistical fit to the data, it is expected that it better accounts for variations caused by biotic and abiotic factors, e.g. with respect to inter-annual variations of soil respiration, that were very small according to the climate-driven model (Raich *et al.*, 2002).

Instead of trying to directly establish fundamental relationships (like the temperature dependence of decomposition rate constants) from large-scale patterns, it would be more fruitful to test whether soil carbon balance models generate the spatial patterns (e.g. continental or environmental gradients) that are empirically observed. Model-data synthesis approaches promise a better capability to link observed data and ecosystem model parameters by parameter optimization schemes (Tarantola, 1994; case studies for ecosystem productivity: Reichstein *et al.*, 2003b; Knorr and Kattge, 2005; Sacks *et al.*, 2006).

11.4 CONCLUSION

The most important conclusion from this overview is that modelling the response of soil respiration to environmental factors depends on the spatial (and temporal) scale one is looking at. Results from one scale cannot be easily transferred to another scale and require an appropriate interpretation at the scale of interest. In particular field studies results may easily be confounded by co-varying factors that hamper the direct derivation of univariate relationships between soil respiration and environmental factors. The best link between response functions in mechanistic models and soil respiration data can be obtained via controlled laboratory experiments and model-data synthesis techniques using field data. Instead of directly comparing field-derived dependencies and functional dependencies in ecosystem models, one should rather evaluate whether those models are able to reproduce the emergent patterns at field and global scale.

REFERENCES

- Amthor, J. S. (2000) The McCree-de Wit-Penning de Vries-Thornley respiration paradigms: 30 years later. *Annals of Botany*, **86**, 1–20.
- Anderson, J. M. (1991) The effects of climate change on decomposition processes in grassland and coniferous forests. *Ecological Applications*, **1**, 326–47.

- Andrén, O. and Kätterer, T. (1997) ICBM: the introductory carbon balance model for exploration of soil carbon balances. *Ecological Applications*, **7**, 1226–36.
- Andrén, O. and Paustian K. (1987) Barley straw decomposition in the field: comparison of models. *Ecology*, **68**, 1190–200.
- Arrhenius, S. (1889) Über die Reaktionsgeschwindigkeit bei der Inversion von Rohrzucker durch Säuren. *Zeitschrift für Physikalische Chemie*, **4**, 226–48.
- Atkin, O. K. and Tjoelker, M. G. (2003) Thermal acclimation and the dynamic response of plant respiration to temperature. *Trends in Plant Science*, **8**, 343–51.
- Bååth, E. and Wallander, H. (2003) Soil and rhizosphere microorganisms have the same Q_{10} for respiration in a model system. *Global Change Biology*, **9**, 1788–91.
- Beare, M. H., Coleman, D. C., Crossley, D. A. J., Hendrix, P. F. and Odum, E. P. (1995) A hierarchical approach to evaluating the significance of soil biodiversity to biogeochemical cycling. *Plant and Soil*, **170**, 5–22.
- Birch, H. F. (1958) The effect of soil drying on humus decomposition and nitrogen availability. *Plant and Soil*, **10**, 9–31.
- Blet-Charaudeau, C., Muller, J. and Laudelout, H. (1990) Kinetics of carbon dioxide evolution in relation to microbial biomass and temperature. *Soil Science Society of America Journal*, **54**, 1324–8.
- Bond-Lamberty, B., Wang, C. and Gower, S. T. (2004) A global relationship between the heterotrophic and autotrophic components of soil respiration? *Global Change Biology*, **10**, 1756–66.
- Boone, R. D., Nadelhoffer, K., Canary, J. D. and Kaye, J. P. (1998) Roots exert a strong influence on the temperature sensitivity of soil respiration. *Nature*, **396**, 570–72.
- Borken, W., Xu, Y.-J., Brumme, R. and Lamersdorf, N. (1999) A climate change scenario for carbon dioxide and dissolved organic carbon fluxes from a temperate forest soil: drought and rewetting effects. *Soil Science Society of America Journal*, **63**, 1848–55.
- Borken, W., Davidson, E. A., Savage, K., Gaudinski, J. and Trumbore, S. E. (2003) Drying and wetting effects on carbon dioxide release from organic horizons. *Soil Science Society of America Journal*, **67**, 1888–96.
- Bunnell, F. L., Tait, D. E. N., Flanagan, P. W. and Van Cleve, K. (1977) Microbial respiration and substrate weight loss. I. A general model of the influences of abiotic variables. *Soil Biology and Biochemistry*, **9**, 33–40.
- Carlyle, J. C. and Than, U. B. (1988) Abiotic controls of soil respiration beneath an eighteen-year-old *Pinus radiata* stand in south-eastern Australia. *Journal of Ecology*, **76**, 654–62.
- Curriel Yuste, J., Janssens, I. A., Carrara, A. and Ceulemans, R. (2004) Annual Q_{10} of soil respiration reflects plant phenological patterns as well as temperature sensitivity. *Global Change Biology*, **10**, 161–9.
- Davidson, E. A. and Janssens, I. A. (2006) Temperature sensitivity of soil carbon decomposition and feedbacks to climate change. *Nature*, **440**, 165–73.
- Davidson, E. A., Belk, E. and Boone, R. D. (1998) Soil water content and temperature as independent or confounded factors controlling soil respiration in temperate mixed hardwood forest. *Global Change Biology*, **4**, 217–27.
- Davidson, E. A., Janssens, I. A. and Luo, Y. Q. (2006) On the variability of respiration in terrestrial ecosystems: moving beyond Q_{10} . *Global Change Biology*, **12**, 154–64.
- Fang, C. and Moncrieff, J. B. (1999) A model for soil CO_2 production and transport 1: model development. *Agricultural and Forest Meteorology*, **95**, 225–36.
- Giardina, C. P. and Ryan, M. G. (2000) Evidence that decomposition rates of organic carbon in mineral soil do not vary with temperature. *Nature*, **404**, 858–61.
- Graf, A., Weihermüller, L., Huisman, J. A. *et al.* (2008) Measurement depth effects on the apparent temperature sensitivity of soil respiration in field studies. *Biogeosciences Discussions*, **5**, 1867–98.
- Hanson, P. J., Wullschlegel, S. D., Bohlmann, S. A. and Todd, D. E. (1993) Seasonal and topographic patterns of forest floor CO_2 efflux from an upland oak forest. *Tree Physiology*, **13**, 1–15.
- Högberg, P., Nordgren, A., Buchmann, N. *et al.* (2001) Large-scale forest girdling shows that current photosynthesis drives soil respiration. *Nature*, **411**, 789–92.
- Howard, D. M. and Howard, P. J. A. (1993) Relationships between CO_2 evolution, moisture content and temperature for a range of soil types. *Soil Biology and Biochemistry*, **25**, 1537–46.
- Hunt, H. W. (1977) A simulation model for decomposition in grasslands. *Ecology*, **58**, 469–84.
- Hunt, H. W., Cole, C. V., Klein, D. A. and Coleman, D. C. (1977) A simulation model for the effect of predation on bacteria in continuous culture. *Microbial Ecology*, **3**, 259–78.

- Janssens, I. A. and Pilegaard, K. (2003) Large seasonal changes in Q_{10} of soil respiration in a beech forest. *Global Change Biology*, **9**, 911–18.
- Janssens, I. A., Lankreijer, H., Matteucci, G. *et al.* (2001) Productivity overshadows temperature in determining soil and ecosystem respiration across European forests. *Global Change Biology*, **7**, 269–78.
- Janssens, I. A., Dore, S., Epron, D. *et al.* (2003) Climatic influences on seasonal and spatial differences in soil CO_2 efflux. In *Fluxes of Carbon, Water and Energy of European Forests*, ed. R. Valentini. Vol. 163. Ecological Studies. Berlin: Springer, pp. 233–53.
- Kätterer, T., Reichstein, M., Andrén, O. and Lomander, A. (1998) Temperature dependence of organic matter decomposition: a critical review using literature data analyzed with different models. *Biology and Fertility of Soils*, **27**, 258–62.
- Keith, H., Jacobsen, K. L. and Raison, R. J. (1997) Effects of soil phosphorus availability, temperature and moisture on soil respiration in *Eucalyptus pauciflora* forest. *Plant and Soil*, **190**, 127–41.
- Killham, K. (1994) *Soil Ecology*. Cambridge: Cambridge University Press.
- Kirschbaum, M. U. F. (1995) The temperature dependence of soil organic matter decomposition, and the effect of global warming on soil organic carbon storage. *Soil Biology and Biochemistry*, **27**, 753–60.
- Knorr, W. and Kattge, J. (2005) Inversion of terrestrial ecosystem model parameter values against eddy covariance measurements by Monte Carlo sampling. *Global Change Biology*, **11**, 1333–51.
- Kowalski, A. S., Serrano-Ortiz, P., Janssens, I. A. *et al.* (2008) Can flux tower research neglect geochemical CO_2 exchange? *Agricultural and Forest Meteorology*, **148**, 1045–54.
- Liski, J., Ilvesniemi, H., Mäkelä, A. and Westman, C. J. (1999) CO_2 emissions from soil in response to climatic warming are overestimated: the decomposition of old soil organic matter is tolerant of temperature. *Ambio*, **28**, 171–4.
- Lloyd, J. and Taylor, J. A. (1994) On the temperature dependence of soil respiration. *Functional Ecology*, **8**, 315–23.
- Marshall, T. J. and Holmes, J. W. (1988) *Soil Physics*. Cambridge: Cambridge University Press.
- Meentemeyer, V. (1978) Macroclimate and lignin control of litter decomposition rates. *Ecology*, **59**, 465–72.
- Michaelis, L. and Menten, M. L. (1913) Die Kinetik der Invertinwirkung. *Biochemische Zeitschrift*, **49**, 334–6.
- Miller, R. D. and Johnson, D. D. (1964) The effect of soil moisture tension on carbon dioxide evolution, nitrification, and nitrogen mineralization. *Soil Science Society of America Journal*, **28**, 644–7.
- Moyano, F., Kutsch, W. and Schulze, E.-D. (2008) Response of mycorrhizal, rhizosphere and soil basal respiration to temperature and photosynthesis in a barley field. *Soil Biology and Biochemistry*, **39**, 843–53.
- Myers, R. J. K., Campbell, C. A. and Weier, K. L. (1982) Quantitative relationships between net nitrogen mineralization and moisture content of soils. *Canadian Journal of Soil Science*, **62**, 111–24.
- O'Connell, A. M. (1990) Microbial decomposition (respiration) of litter in eucalypt forests of south-western Australia: an empirical model based on laboratory incubations. *Soil Biology and Biochemistry*, **22**, 153–60.
- Orchard, V. A. and Cook, F. J. (1983) Relationship between soil respiration and soil moisture. *Soil Biology and Biochemistry*, **15**, 447–53.
- Parton, W. J., Schimel, D. S., Cole, C. V. and Ojima, D. S. (1987) Analysis of factors controlling soil organic matter levels in the Great Plains. *Soil Science Society of America Journal*, **51**, 1173–9.
- Pavelka, M., Acosta, M., Marek, M. V., Kutsch, W. and Janous, D. (2007) Dependence of the Q_{10} values on the depth of the soil temperature measuring point. *Plant and Soil*, **292**, 171–9.
- Raich, J. W. and Potter, C. S. (1995) Global patterns of carbon dioxide emissions from soils. *Global Biogeochemical Cycles*, **9**, 23–36.
- Raich, J. W. and Schlesinger, W. H. (1992) The global carbon dioxide flux in soil respiration and its relationship to vegetation and climate. *Tellus*, **44B**, 81–99.
- Raich, J. W. and Tufekcioglu, A. (2000) Vegetation and soil respiration: correlations and controls. *Biogeochemistry*, **48**, 71–90.
- Raich, J. W., Potter, C. S. and Bhagawati, D. (2002) Interannual variability in global soil respiration, 1980–1994. *Global Change Biology*, **8**, 800–12.
- Ratkowsky, D. A., Olley, J., Mcmeekin, T. A. and Ball, A. (1982) Relationship between temperature and growth rate of bacteria. *Journal of Bacteriology*, **149**, 1–5.
- Reichstein, M., Bednorz, F., Broll, G. and Kätterer, T. (2000) Temperature dependence of carbon mineralisation: conclusions from a long-term incubation

- of subalpine soil samples. *Soil Biology and Biochemistry*, **32**, 947–58.
- Reichstein, M., Rey, A., Freibauer, A. *et al.* (2003a) Modeling temporal and large-scale spatial variability of soil respiration from soil water availability, temperature and vegetation productivity indices. *Global Biogeochemical Cycles*, **17**, 1104, doi:10.1029/2003GB002035.
- Reichstein, M., Tenhunen, J., Rouspard, O. *et al.* (2003b) Inverse modeling of seasonal drought effects on canopy CO₂/H₂O exchange in three Mediterranean ecosystems. *Journal of Geophysical Research*, **108**, 4726, doi:10.1029/2003JD003430.
- Reichstein, M., Subke, J.-A., Angeli, A. C. and Tenhunen, J. D. (2005) Does the temperature sensitivity of decomposition of soil organic matter depend upon water content, soil horizon, or incubation time? *Global Change Biology*, **11**, 1754–67.
- Reth, S., Reichstein, M. and Falge, E. (2005) The effect of soil water content, soil temperature, soil pH-value and the root mass on soil CO₂ efflux: a modified model. *Plant and Soil*, **268**, 21–33.
- Rodrigo, A., Recous, S., Neel, C. and Mary, B. (1997) Modelling temperature and moisture effects on C–N transformations in soils: comparison of nine models. *Ecological Modelling*, **102**, 325–9.
- Ross, D. J. and Cairns, A. (1978) Influence of temperature on biochemical processes in some soils from tussock grasslands. 1. Respiratory activity. *New Zealand Journal of Science*, **21**, 581–9.
- Sacks, W. J., Schimel, D. S., Monson, R. K. and Braswell, B. H. (2006) Model-data synthesis of diurnal and seasonal CO₂ fluxes at Niwot Ridge, Colorado. *Global Change Biology*, **12**, 240–59.
- Schimel, D., Alves, D., Enting, I. *et al.* (1996) CO₂ and the carbon cycle. In *Climate Change 1995: The Science of Climate Change*. Contribution of Working Group I to the Second Assessment Report of the IPCC, ed. J. T. Houghton, L. G. M. Filho, B. A. Callander *et al.* Cambridge: Cambridge University Press, pp. 65–86.
- Schinner, F., Öhlinger, R., Kandeler, E. and Margesin, R. (1993) *Bodenbiologische Arbeitsmethoden*. Berlin: Springer Verlag.
- Skopp, J., Jawson, M. D. and Doran, J. W. (1990) Steady-state aerobic microbial activity as a function of soil-water content. *Soil Science Society of America Journal*, **54**, 1619–25.
- Sommers, L. E., Gilmour, C. M., Wildung, R. E. and Beck, S. M. (1981) The effect of water potential on decomposition processes in soils. In *Water Potential Relations in Soil Microbiology*, ed. J. F. Parr, W. R. Gardner and L. F. Elliott. Soil Science Society of America Special Publication No. 9. Madison, WI: American Society of Agronomy, pp. 97–117.
- Stanford, G. and Epstein, E. (1974) Nitrogen mineralization – water relations in soils. *Soil Science Society of America Journal*, **38**, 103–7.
- Subke, J.-A., Hahn, V., Battipaglia, G. *et al.* (2004) Feedback interactions between needle litter decomposition and rhizosphere activity. *Oecologia*, **139**, 551–9.
- Subke, J.-A., Inglima, I. and Francesca Cotrufo, M. (2006) Trends and methodological impacts in soil CO₂ efflux partitioning: a metaanalytical review. *Global Change Biology*, **12**, 921–43.
- Tarantola, A. (1994) *Inverse Problem Theory: Methods for Data Fitting and Model Parameter Estimation*. Amsterdam: Elsevier.
- Tjoelker, M. G., Oleksyn, J. and Reich, P. B. (2001) Modelling respiration of vegetation: evidence for a general temperature-dependent Q₁₀. *Global Change Biology*, **7**, 223–30.
- Updegraff, K., Pastor, J., Bridgham, S. D. and Johnston, C. A. (1995) Environmental and substrate controls over carbon and nitrogen mineralization in northern wetlands. *Ecological Applications*, **5**, 151–63.
- Valentini, R., Matteucci, G., Dolman, A. J. *et al.* (2000) Respiration as the main determinant of carbon balance in European forests. *Nature*, **404**, 861–5.
- van't Hoff, J. H. (1898) *Lectures on Theoretical and Physical Chemistry. Part 1: Chemical Dynamics* (translated by Lehfeldt, R. A.). London: Edward Arnold.
- Waksman, S. A. and Gerretsen, F. C. (1931) Influence of temperature and moisture upon the nature and extent of decomposition of plant residues by microorganisms. *Ecology*, **12**, 33–60.
- Winkler, J. P., Cherry, R. S. and Schlesinger, W. H. (1996) The Q₁₀ relationship of microbial respiration in a temperate forest soil. *Soil Biology and Biochemistry*, **28**, 1067–72.
- Xu, L. and Baldocchi, D. D. (2004) Seasonal variation in carbon dioxide exchange over a Mediterranean annual grassland in California. *Agricultural and Forest Meteorology*, **123**, 79–96.

12 • Modelling soil carbon dynamics

Pete Falloon and Pete Smith

12.1 INTRODUCTION

The need for models of soil organic matter (SOM) turnover is similar to the need for many models of environmental processes: they are used to better understand processes; extrapolate or interpolate experimental results in time, space and to different environmental conditions; and to investigate scenarios and hypotheses that are beyond the realm of experimental work. As a result of this, a wide variety of SOM models have been developed, differing in their formulation and purpose. There are a number of approaches to modelling SOM turnover including process-based multi-compartment models, models that consider each fresh addition of plant debris as a separate cohort that decays in a continuous way, and models that account for carbon and nitrogen transfers through various trophic levels in a soil food web. This chapter aims to give a broad overview of currently available SOM models, highlighting areas of model application, identifying strengths and weaknesses and future directions for model development. We focus on two of the most widely used SOM models, RothC and CENTURY, to provide detailed case studies of model formulation, development and application.

12.2 SOIL ORGANIC MATTER MODELS

There are several sources of metadata and information on SOM models. CAMASE (Plentinger and Penning de Vries, 1996) contains 98 agro-ecosystems models having soil components, and the Global Change and Terrestrial Ecosystems Soil Organic Matter Network (GCTE-SOMNET) database (Smith *et al.*, 1996a, 1996b: online at <http://saffron.rothamsted.bbsrc.ac.uk/cgi-bin/somnet/>) contains metadata on over 30 current

operational SOM models. Several authors have previously reviewed SOM models extensively. Molina and Smith (1998) reviewed 24 SOMNET registered models for carbon and nitrogen processes in soils; McGill (1996) classified and reviewed 10 SOM models, with respect to environmental conditions, scale, regulation by soil properties and compartmentalization; Jenkinson (1990) classified SOM models. Smith *et al.* (1999) reviewed SOM modelling in tropical ecosystems, covering model use, input requirements and outputs; Smith *et al.* (1998) reviewed SOM models with respect to the description of soil biota; Donigian *et al.* (1994) extensively reviewed 14 soil organic carbon models.

There is a huge diversity in the understanding and interpretation of SOM processes in current SOM models (Molina and Smith, 1998), the first of which were conceived some 60 years ago (Henin and Dupuis, 1945; Henin *et al.*, 1959). Soil organic matter models can be broadly classified as (1) single homogeneous compartment; (2) two compartment; (3) non-compartmental decay or (4) multi-compartmental. Models in categories (1) and (2) are mostly (but not exclusively) static (i.e. where the model status does not depend on the model status in the previous timestep, e.g. constant environmental conditions), whereas the models in categories (3) and (4) are mostly dynamic (i.e. where the current model status depends on the status in the previous timestep, e.g. time-varying environmental conditions); the dynamic models can be further split into organism-oriented and process-oriented models (Paustian, 1994). A SOM model is concerned with simulating the decomposition of SOM and thus may simulate SOM as a whole, or soil organic carbon (SOC), nitrogen or other nutrients. Soil organic matter models may also be part of a larger model package – for example the RothC model (Coleman *et al.*, 1997) includes a simple soil water

module, while the CENTURY model system (Parton *et al.*, 1987) includes more complex modules or sub-models for plant growth, management operations, and soil water and temperature.

12.2.1 Process-based, multi-compartment SOM models

Most models are process based, i.e. they focus on the processes mediating the movement and transformations of matter or energy and usually assume first-order rate kinetics (Paustian, 1994). Early models simulated the SOM as one homogeneous compartment (Jenny, 1941). Some years later Beek and Frisel (1973) and Jenkinson (1977) proposed two-compartment models, and as computers became more accessible, multi-compartment models were developed (McGill, 1996; Molina and Smith, 1998). Of the 33 SOM models currently represented within the GCTE-SOMNET database accessible at www.rothamsted.ac.uk/aen/somnet/ (Smith *et al.*, 1996b, 1996c), 30 are multi-compartment, process-based models. Each compartment or SOM pool within a model is characterized by its position in the model's structure and its decay rate. Decay rates are usually expressed by first-order kinetics with respect to the concentration (C) of the pool

$$dC/dt = -kC$$

where t is the time. The rate constant k of first-order kinetics is related to the time required to reduce by half the concentration of the pool *when there is no input*. The pool's half-life ($h = (\ln 2)/k$), or its turnover time ($\tau = 1/k$) are sometimes used instead of k to characterize a pool's dynamics: the lower the decay rate constant, the higher the half-life, the turnover time and the stability of the organic pool.

The flows of carbon within most models represent a sequence of carbon going from plant and animal debris to the microbial biomass, then to soil organic pools of increasing stability. Some models also use feedback loops to account for catabolic and anabolic processes, and microbial successions. The output flow from an organic pool is usually split. It is directed to a microbial biomass pool, another organic pool and, under aerobic conditions, to CO_2 . This split simulates the simultaneous anabolic and catabolic activities and growth of a microbial population feeding on one substrate. Two parameters are required to quantify the split

flow. They are often defined by a microbial (utilization) efficiency and stabilization (humification) factor, which control the flow of decayed carbon to the biomass and humus pools, respectively. The sum of the efficiency and humification factors must be inferior to one to account for the released CO_2 . Molina and Smith (1998) provide a thorough review of the structure and underlying assumptions of different process-based SOM models.

12.2.2 Cohort models describing decomposition as a continuum and analytically solved models

Another approach to modelling SOM turnover is to treat each fresh addition of plant debris into the soil as a cohort (McGill, 1996). Such models consider one SOM pool that decays with a feedback loop into itself. Q-SOIL (Bosatta and Ågren, 1995), for example, is represented by a single rate equation. The SOM pool is divided into an infinite number of components, each characterized by its 'quality' with respect to degradability as well as impact on the physiology of the decomposers. The rate equation for the model Q-SOIL represents the dynamics of each SOM component of quality q and is quality dependent. Exact solutions to the rate equations are obtained analytically (e.g. Bosatta and Ågren, 1994). In analytically solved models such as ICBM (e.g. Andrén and Kätterer, 2001) the 'model' can be restricted to the equations describing soil carbon transformations and other functions (e.g. weather-to-soil-climate) can be made external to the model (but they can be included in the model package). One advantage of this is that the model, in an analytically solved form, can be used for very simple 'what if?' calculations and projections without the need for computationally demanding simulations required by discrete models (Andrén and Kätterer, 2001).

12.2.3 Food web models

Another type of model simulates carbon and nitrogen transfers through a food web of soil organisms (Paustian, 1994; Smith *et al.*, 1998); such models explicitly account for different trophic levels or functional groups of biota in the soil (Hunt *et al.*, 1984, 1987, 1991; de Ruiter *et al.*, 1993; de Ruiter and Van Faassen, 1994; de Ruiter *et al.*, 1995). Some models have been developed that combine an explicit description of the soil biota with a

process-based approach (McGill *et al.*, 1981). Food web models require a detailed knowledge of the biology of the system to be simulated (mostly unknown) and are usually parameterized for application at specific sites.

12.2.4 Factors affecting SOM turnover in models

Rate ‘constants’ (k) are constant for a given set of biotic and abiotic conditions. For non-optimum environmental circumstances, the simplest way to modify the maximum value of k is by multiplication by a reduction factor μ – ranging from 0 to 1. Environmental factors considered by SOM models include temperature, water, pH, nitrogen, oxygen, clay content, cation exchange capacity, type of crop/plant cover and tillage.

Many studies show the effect of temperature on microbially mediated transformations in soil, either expressed as a reduction factor or the Arrhenius equation, as shown in Eq. (12.1)

$$k_2 = k_1 Q_{10}^{(T_2 - T_1)/10} \quad \text{Eq. (12.1)}$$

In this equation, k_2 and k_1 are rate constants at two observed temperatures T_2 and T_1 . Ågren *et al.* (1996) stated that this relationship lacks any theoretical justification and could be hard to apply to a system such as a population of soil organisms, where the total activity is determined by a whole range of different organisms with quite different responses to temperature. A further difficulty is that Q_{10} values also change with temperature and between systems (Ågren *et al.*, 1996; Lomander *et al.*, 1998). There is evidence to suggest that there is little change in the rate constant, but a change in the utilization of substrate pools and a shift in function and composition of microbial communities (Zogg *et al.*, 1997). More recently Giardina and Ryan (2000) challenged the assumption that SOM decomposition is temperature dependent by showing that old SOM in forest soils does not decompose more rapidly in soils from warmer climates than in soils from colder regions.

Water and oxygen have a major impact on the microbial physiology. While some models simulate O_2 concentrations in soil explicitly (Grant, 1991; Sierra and Renault, 1996), many define the extent of anaerobiosis on the basis of soil pore space filled with water (WFPS; e.g. Doran *et al.*, 1988; Skopp *et al.*, 1990). Soil clay content and total SOM are correlated. Various

schemes simulate the effect of clay on rate equations to obtain SOM accumulation. Nitrogen is an essential element for microbial growth, which will be maximal when enough N is assimilated to maintain the microbial C:N ratio (e.g. Molina *et al.*, 1983). Table 12.1 presents an overview of the 33 models represented in the GCTE-SOMNET (Smith *et al.*, 1996b) including the factors affecting SOM turnover.

12.2.5 Soil organic matter model evaluation

There are many reasons for evaluating the performance of a SOM model. Model evaluation shows how well a model can be expected to perform in a given situation. It can help to improve the understanding of the system (especially where the model fails), provide confidence in the model’s ability to predict future changes in SOM or, where there is no data, and it can be used to assess the uncertainties associated with the model’s predictions. Models can be evaluated at a number of different levels. They can be evaluated at the individual process level, at the level of a sub-set of processes (e.g. net mineralization), or the model’s overall outputs (e.g. changes in total SOM over time) can be tested against measured laboratory and field data. Models can also be evaluated for their applicability in different situations, e.g. for scaling up simulated net carbon storage from a site-specific to a regional level (Izarraulde *et al.*, 1996). Molina and Smith (1998) provide many examples of different forms of SOM model evaluation.

At the most basic level, comparing the performance of SOM models involves comparing predicted changes in SOM from a number of models. If more complex model packages including plant growth and soil climate modules are being compared then comparison of more variables and model sensitivity to them may be necessary to identify the reasons for differences between models. However, the differences between the central SOM decomposition modules in compartmental SOM models are generally small and may give similar results when driven with equivalent input data (e.g. Falloon and Smith, 2002).

Smith *et al.* (1997) completed the most comprehensive evaluation of SOM models to date. Nine models were tested against twelve datasets from seven long-term experiments representing arable rotations, managed and unmanaged grassland, forest plantations and natural woodland regeneration. The results showed

Table 12.1 Overview of SOM models represented within GCTE-SOMNET in January 2001.

MODEL	INPUTS	FACTORS				OUTPUTS	REFERENCE
		Meteorology	Soil and plant	Management	AFFECTING DECADE RATE CONSTANTS		
ANIMO	Day, Week, Month	P, AT, Ir, EvW	Des, Lay, Imp, Cl, OM, N, pH	Rot, Ti, Fert, Man, Res, Irr, AtN	T, W, pH, N, O	C, N, W, ST, gas	Rijtema and Kroes (1991)
APSIM	Day	P, AT, Ir	Lay, W, C, N, BD, Wi, PG, PS	Rot, Ti, Fert, Irr	T, W, pH, N	C, N, W, ST, gas	McCown <i>et al.</i> (1996)
Candy	Day	P, AT, Ir	D, Imp, W, N, C, Wi, PD, Nup	Rot, Ti, Fert, Man, Res, Irr, AtN	T, W, N, Cl	C, N, W, ST, gas	Franko (1996)
CENTURY	Month	P, AT	W, Cl, OM, pH, C, N	Rot, Ti, Fert, Man, Res, Irr, AtN	T, W, N, Cl	C, BioC, 13C, 14C, N, W, ST, gas	Parton <i>et al.</i> (1987)
Chenfang Lin Model	Day	ST	OM, BD, W	Man, Res	T, W, F	C, BioC, gas	Lin <i>et al.</i> (1987)
DAISY	Hour, Day	P, AT, Ir, EvG	Lay, Cl, C, N, PG, PS	Rot, Ti, Fert, Man, Res, Irr, AtN	T, W, N, Cl	C, BioC, N, W, ST, gas	Müller <i>et al.</i> (1996)
DNDC	Hour, Day, Month	P, AT	Lay, Cl, OM, pH, BD	Rot, Ti, Fert, Man, Res, Irr, AtN	T, W, N, Cl, Ti	C, BioC, N, W, ST, gas	Li <i>et al.</i> (1994)
DSSAT	Hour, Day, Month, Year	P, AT, Ir	Des, Lay, Imp, W, Cl, PS, OM, pH, C, N	Rot, Ti, Fert, Man, Res, Irr	T, W, N, Cl, Ti	C, BioC, N, W, ST	Hoogenboom <i>et al.</i> (1994)
D3R	Day	P, AT	Y, PS	Rot, Ti, Res	T, W, N, Cx, Ti	Decomp. of surface and buried residue	Douglas and Rickman (1992)
Ecosys	Minute, Hour	P, AT, Ir, WS, RH	Lay, W, Cl, CEC, PS, OM, pH, N, BD, PG, PS	Rot, Ti, Fert, Man, Res, Irr, AtN	T, W, N, O, Cl, Cv	C, BioC, N, W, ST, pH, Ph, EC, gas, ExCat	Grant (1995)

EPIC	Day	P, AT	Lay, Imp, W, Cl, OM, pH, C, BD, Wi	Rot, Ti, Fert, Man, Res, Irr, AtN	T, W, N, pH, Cl, Ce, Cv	C, BioC, N, W, ST	Williams (1990)
FERT	Day	P, AT, WS	Des, Lay, W, Cl, OM, pH, C, N, BD, W, Ph, K, Nup, Y, PS	Rot, Ti, Fert, Man, Res, Irr	T, W, N, pH, Cv	C, N, Ph, K	Kan and Kan (1991)
ForClim-D	Year	P, AT	W, AG	None	T, W	C	Perruchoud (1996)
GENDEC	Day, Month	ST, W	W, InertC, LQ	Can be used – not essential	T, W, N	C, BioC, N, gas, LQ	Moorhead and Reynolds (1991)
HPM/EFM	Day	P, AT, Ir, WS	W, Cl, PS	Rot, Fert, Irr, AtN	T, W, N	C, BioC, N, W, gas	Thornley and Verberne (1989)
ICBM	Day, Year	Combination of weather and climate	Many desirable: none essential	C inputs to soil	T, W, Cl	C	Andrén and Kätterer (1997)
KLIMAT-SOIL-YIELD	Day, Year	P, AT, ST, Ir, EvG, EvS, VPD, SH	Des, Lay, Imp, W, Cl, PS, OM, pH, C, N	Fert, Man, Res, Irr	T, W, N, Cl	C, BioC, N, W, ST	Sirotenko (1991)
CNSP Pasture Model	Day	P, AT, Ir	Lay, Imp, W, Cl, CEC, OM, pH, C, N, PS, AS	Fert	T, W, N, pH	C, N, W, ST	McCaskill and Blair (1990)
Humus Balance	Year	Climate based on P and AT	Des, Lay, PS, OM, pH, C, N	Rot, Fert, Man	N, H, Cl, Cv	C, N	Schevtsova and Mikhailov (1992)
MOTOR	User specified	P, AT, EvG	Des, OM	Rot, Ti, Fert, Man	T, W, N, Cl, Ti	C, BioC, 13C, 14C, gas	Whitmore <i>et al.</i> (1997)
NAM SOM	Year	P, AT	Des, PS, OM, Ero	Man, Res	T, W, Cl, Cv	C, BioC	Ryzhova (1993)

(cont.)

Table 12.1 (cont.)

MODEL	INPUTS		Meteorology	Soil and plant	Management	FACTORS AFFECTING DECAY RATE			REFERENCE
	Timestep	Day				CONSTANTS	OUTPUTS	Soil outputs	
NC SOIL	Day	Day	ST, (P, AT)	W, OM, C, N	Fert, Man, Res	T, W, N, pH, Cl, Ti	C, BioC, 14C, N, 15N, gas	Molina <i>et al.</i> (1983)	
NICCE	Hour, Day	Hour, Day	P, AT, Ir, WS	Imp, OM, C, N, W, TC, PG	Fert, Man, Res, Irr, AtN	T, W, Cl, N	C, BioC, 13C, 14C, N, 15N, W, ST, gas	Van Dam and Van Breemen (1995)	
O'Brien Model	Year	Year	None	Lay, C, 14C	None	None	C, 14C	O'Brien (1984)	
O'Leary Model	Day	Day	P, AT	Lay, W, Cl, pH, N	Ti, Fert, Res	T, W, N, Cl, Ti	C, BioC, N, W, ST, gas, ResC, ResN	O'Leary (1994)	
Q-Soil	Year	Year	Optional	C, N	Rot, Fert, Man, Res, AtN	T, W, N	C, BioC, 13C, N	Bosatta and Ågren (1994)	
RothC	Month	Month	P, AT, EvW	Cl, C, InertC (can be estimated)	Man, Res, Irr	T, W, Cl, Cv	C, BioC, gas, 14C	Coleman <i>et al.</i> (1997)	
SOCRATES	Week	Week	P, AT	CEC, Y	Rot, Fert, Res	T, W, N, Cv, Ce	C, BioC, gas	Grace and Ladd (1995)	
SOMM	Day	Day	P, ST	OM, N, AshL, NL	Man	T, W, N	C, N, gas	Chertov and Komarov (1996)	
Sandia	Week	Week	P, AT, EvG	Imp, Cl, W, Y	Rot, Fert, Man, Res, Irr, AtN	T, W, N, Cl	C, BioC, N, 15N, W, gas	Smith <i>et al.</i> (1996a)	
Verberne	Day	Day	P, AT, Ir, WS, EvS	Des, W, Cl, PS, OM, C, N	Man, AtN	T, W, N, Cl	C, BioC, N, W	Verberne <i>et al.</i> (1990)	

VOYONS	Day, Week, Month	P, ST	Cl, OM, C, N	Fert, Man, Res, Irr, AtN	T, W, Cl	C, BioC, 13C, 14C, N ₂ gas	André <i>et al.</i> (1994)
Wave	Day	P, AT, Ir, EvG	Lay, OM, C, N, W, PG	Rot, Ti, Fert, Man, Res, Irr, AtN	T, W, N	C, N, W, ST, gas	Vanloooster <i>et al.</i> (1995)

Key

Meteorology: P = Precipitation, AT = Air temperature, ST = Soil temperature, Ir = Irradiation, EvW = Evaporation over water, EvG = Evaporation over grass, EvS = Evaporation over bare soil, WS = Wind speed, RH = Relative humidity, VPD = Vapour pressure deficit, SH = Sun hours.

Soil and plant inputs: Des = Soil description, Lay = Soil layers, Imp = Depth of impermeable layer, Cl = Clay content, OM = Organic matter content, N = Soil nitrogen content/dynamics, C = Soil carbon content/dynamics, InertC = Soil inert carbon content, pH = pH, W = Soil water characteristics, Wi = Wilting point, PD = Soil particle size distribution, CEC = Cation exchange capacity, Ero = Annual erosion losses, BD = Soil bulk density, TC = Thermal conductivity, PG = Plant growth characteristics, PS = Plant species composition, AS = Animal species present, AG = Animal growth characteristics, Y = Yield, Nup = Plant nitrogen uptake, LQ = Litter quality, AshL = Ash content of litter, NL = N content of litter.

Management input details: Rot = Rotation, Ti = Tillage practice, Fert = Inorganic fertilizer applications, Man = Organic manure applications, Res = Residue management, Irr = Irrigation, AtN = Atmospheric nitrogen inputs.

Factors affecting decay rate constants: T = Temperature, W = Water, pH = pH, N = Nitrogen, O = Oxygen, Cl = Clay, Ce = Cation exchange capacity, Cv = Cover crop, Ti = Tillage, F = Fauna.

Soil outputs: C, N, W, LQ and ST as above. BioC = Biomass carbon, 13C = ¹³C dynamics, 14C = ¹⁴C dynamics, 15N = ¹⁵N dynamics, gas = Gaseous losses (e.g. CO₂, N₂O, N₂), ResC = Surface residue carbon, ResN = Surface residue nitrogen, Ph = Phosphorus dynamics, K = Potassium dynamics, EC = Electrical conductivity, ExCat = Exchangeable cations.

NB: N in the soil inputs and outputs section is used to denote all aspects of the N cycle. Further details regarding optimum decay conditions, SOM components, rate constants, methods of pool fitting and refractory SOM are given in Molina and Smith (1998) and Falloon and Smith (2000). A metadatabase of all models is available via www.rothamsted.ac.uk/aen/somnet/.

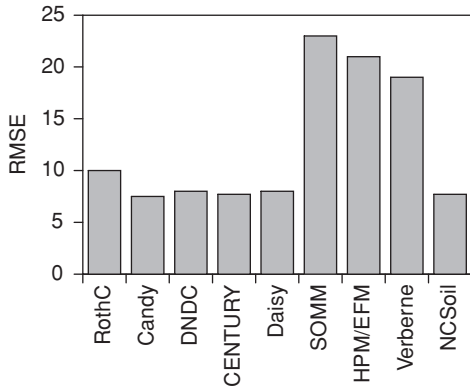

Figure 12.1 Overall RMSE (root mean square error) value for nine SOM models when simulating changes in total soil organic carbon in up to twelve datasets from seven long-term experiments. The RMSE values of the models with the same letter (a or b) do not differ significantly (two sample, two tailed t -test; $p > 0.05$), but the RMSE values of the two groups (a and b) do differ significantly (two sample, two tailed t -test; $p < 0.05$). See Smith *et al.* (1997) for further details.

that six models had significantly lower overall errors (RMSE) than another group of three models (Fig. 12.1).

The poorer performance of three of the models was related to failures in other parts of the ecosystem models, thus providing erroneous inputs into the SOM module (Smith *et al.*, 1997).

The difficulty in accurately measuring SOC presents both problems and opportunities for SOM modellers. Challenges in measuring SOC include: obtaining representative undisturbed soil cores, obtaining samples for different layer depths accurately, using adequate replicates, conversion of SOC concentration to mass through accurate bulk density measurements, the high random spatial variation in SOC and changing methodology – thus unbiased and high-precision time-series measurements of SOC are rare. On the other hand, eddy covariance flux tower measurements of total net ecosystem exchange (i.e. net uptake or C-release) flux tower measurements are often unreplicated and make measurements at time scales incompatible with most SOM models and dependent on many assumption and correction factors. Detection of relatively small differences in SOC compared to a large background value may also present problems. In reality, this means that there is rarely enough adequate data for model calibration and validation (Andr n and K tterer, 2001)

and the absence of replicated SOC measurements for many experiments makes it difficult to critically assess model fit to measurements (Falloon and Smith, 2003), although this also implies that models may be of equal (or even greater) use than measurements in assessing SOC changes particularly over large areas (Andr n and K tterer, 2001).

12.2.6 Soil organic matter model application

Soil organic matter models are often used as research tools in so far that their different representation of the dynamics of carbon and nitrogen in soil and can be used to distinguish between competing hypotheses (e.g. Molina *et al.*, 1990) or to further understanding of SOM turnover processes more generally (e.g. Jenkinson and Coleman, 1994; Smith *et al.*, 1997; Falloon *et al.*, 1998a, 2000; Romanya *et al.*, 2000; Falloon and Smith, 2002; Falloon *et al.*, 2002). Another increasing application of SOM models is in agronomy; many SOM models are now being used to improve agronomic efficiency and environmental quality through incorporation into decision support systems, e.g. SUNDIAL-FRS (Smith *et al.*, 1996a), DSSAT (Hoogenboom *et al.*, 1994) and APSIM (McCown *et al.*, 1996).

Soil organic matter models are now used, more than ever, to extrapolate our understanding of SOM dynamics both temporally (into the future) and spatially (to assess carbon fluxes from whole regions or continents). An early example of a regional scale application was the use of the CENTURY model to predict the effects of alternative management practices and policies in agro-ecosystems of the central United States (Donigian *et al.*, 1994). Since then, many studies have adopted similar methodologies to assess SOM dynamics at the regional (Falloon *et al.*, 1998b; Falloon and Smith, 2002), national (Lee and Phillips, 1993; Parshotam *et al.*, 1996) and global scales (Post *et al.*, 1982, 1985; Parton *et al.*, 1987; Esser, 1990; Goto *et al.*, 1993; Potter *et al.*, 1993; Goldewijk *et al.*, 1994; Schimel *et al.*, 1994; Melillo *et al.*, 1995; Post *et al.*, 1996). Soil organic matter models of outcomes or predictions are increasingly being used by policy makers at the national, regional or global scales, for example in the post-Kyoto Protocol debate on the ability of the terrestrial biosphere to store carbon (IPCC, 2000) according to the IPCC Good Practice Guidelines (IPCC, 1996); models can also be used in countries' reports under the United Nations Framework Convention on

Climate Change (UNFCCC) and the Kyoto Protocol (see Chapter 13, Smith *et al.*). With such an important role in society, it is important that SOM models are transparent, well evaluated and well documented. There is still a variety of understanding and different percentage assumptions incorporated in our current SOM models. Future developments in SOM models will further improve our understanding and ideally allow models to be used truly predictively, without the need for site-specific calibration. These developments will then improve estimates of, and reduce, the uncertainty associated with SOM model predictions.

12.2.7 Model weaknesses

There may be many weaknesses and limitations of SOM models, since most were parameterized under particular management or climatic regions. Ideally, SOM models should account for all major SOM controlling factors, such as parent material, time, climate, litter quality (decomposed) biota and management. These factors may have complex interactions, and separate analysis of controls could limit predictions of their effects on SOM (Burke *et al.*, 1989). Many models have been evaluated under different climatic and management conditions, but rarely compared using common datasets.

Few models simulate aggregation processes, which may be important in the stabilization of plant residues, microbial biomass and humic substances (Parton *et al.*, 1989; Paul *et al.*, 1995). Differences in drainage are often not accounted for in SOM models. However, SOM accumulation in grassland and forest soils may be partly attributable to reduced drainage (Jenkinson, 1988). Soil organic matter models also need better integration with landscape processes, and better description of plant root development (Paul *et al.*, 1995), layering, dissolved organic carbon and deep soil processes (Parton *et al.*, 1989, 1994; Jenkinson *et al.*, 1999). Few compartmental models explicitly account for meso-fauna and macroorganisms such as earthworms (Parton *et al.*, 1989; Wooster, 1993; Lavelle *et al.*, 1997), which are an important part of the SOM system (Buringh, 1984; Smith *et al.*, 1998).

In terms of soils, it is generally suggested that models such as RothC and CENTURY (Parton *et al.*, 1989; Jenkinson *et al.*, 1992; Motavalli *et al.*, 1995) may be limited by failing to account for pH effects on soil carbon turnover (Jenkinson, 1988). This may be important

in soils with low litter quality and fungal decomposition and thus pronounced litter layer development, or grasslands with constant mineral fertilizer applications (Kelly *et al.*, 1997). Soil organic matter models generally predict faster carbon turnover than observed in very acid soils (Motavalli *et al.*, 1995), since decomposition is up to two-thirds slower (Kelly *et al.*, 1997, especially in the early stages) under acid conditions, although overall model errors may be small (Jenkinson *et al.*, 1999). Model improvement needs information on both the short- and long-term effects of pH on SOM, in particular the effects on the microbial biomass (Jenkinson *et al.*, 1992). Few models are able to predict SOC changes in variable charge and allophanic soils (Oades *et al.*, 1989; Jenkinson *et al.*, 1991; Motavalli *et al.*, 1995; Smith *et al.*, 1996c; Falloon *et al.*, 1998a; Falloon and Smith, 2000; Falloon *et al.*, 2000). Some authors have used 'effective' clay contents, based on % clay, % ferrihydrite and % allophane to get model agreement with measured data (Parshotam and Hewitt, 1995; Tate *et al.*, 1996); others have suggested using surface area measurements (Saggar *et al.*, 1994) or accounting for mineralogy (Parton *et al.*, 1989). Most models are also unable to simulate SOC changes in subsoils, permanently waterlogged and consequent CH₂ fluxes, very dry (Falloon *et al.*, 2008), highly organic and recent volcanic soils (Jenkinson *et al.*, 1991; Smith *et al.*, 1997; Falloon *et al.*, 1998a). However, recently ECOSSE has been developed from RothC and SUNDIAL for organic soils (Smith *et al.*, 2007) and RothC has been extended to subsoils (Jenkinson and Coleman, 2008).

Several authors have suggested that current SOM models may be limited in their applicability to tropical systems, and few models have been tested under arid conditions. Possible reasons could include differences in soil fauna, the much faster turnover time of slow and passive SOM pools in the tropics, different temperature and moisture relationships with metabolic rates, differences in mineralogy (Wooster, 1993; Shang and Tiessen, 1998) and solution chemistry (Parton *et al.*, 1989) in tropical soils. Inadequate description of nutrients (N, P and K) and inability to account for aluminium (Al) toxicity may also limit SOM model predictions in tropical soils (Parton *et al.*, 1989; Shang and Tiessen, 1998). Finally, the compartments of SOM models (i.e. C pools) are usually theoretical without measurable counterparts making it difficult to initialize the models and validate model-calculated results for the individual pools.

12.3 ROTH C AND CENTURY: TWO OF THE MOST WIDELY USED SOM MODELS

The Rothamsted carbon model (RothC, Coleman and Jenkinson, 1996) and CENTURY (Parton *et al.*, 1987) are the most widely used and evaluated SOM models worldwide (Parshotam and Hewitt, 1995), and are now being used at scales from site to globe in carbon cycling studies. Both models were originally developed in the 1970s and 1980s, and many other SOM models are similar in structure to RothC and CENTURY. RothC was originally calibrated using data from long-term arable experiments at Rothamsted, UK, and extended to other systems, while CENTURY was developed for the grassland systems of the Central Great Plains and then extended to arable ecosystems and forests.

There are a number of differences in the ways in which RothC and CENTURY simulate SOM turnover processes. Before describing these differences in detail, a major difference is in the *type* of model. RothC is purely concerned with soil processes, and as such is not linked to a plant production model. The CENTURY SOM model, however, is part of a larger ecosystem model that simulates crop, grass and tree growth and the effects of different management practices on both plant production and SOM. Coleman and Jenkinson (1996) and Metherell *et al.* (1993) give full descriptions of RothC and CENTURY, respectively. While both models have also been adapted to simulate N and S dynamics, only CENTURY simulates P dynamics. Model structure is discussed in detail below. Figure 12.2 shows the structure of the RothC and CENTURY SOM models. The actual SOM model pool names

are in *italics* in these figures and RothC/CENTURY equivalents are shown in normal type for comparison. Important to note is that the RothC SOM models dynamics only simulates the top 30 cm of soil while the CENTURY model simulates the top 20 cm.

12.3.1 Carbon inputs to the SOM models

In RothC, the user defines carbon inputs to the soil in terms of both quantity and quality. The amount of carbon entering the soil is defined in 'land management' files, and residue/litter quality is defined using the ratio of decomposable plant material (DPM) to resistant plant material (RPM). There are three suggested values for DPM/RPM, based on simulation of SOM dynamics in Rothamsted long-term experiments, although user-defined values may also be used. The default DPM/RPM values are: 1.44 for arable crops and managed grasslands; 0.67 for unmanaged grasslands and scrub; and 0.25 for woodlands and forests. In other words, there is a greater proportion of decomposable carbon input in arable crops, whereas tree litter is assumed to be much more resistant in nature. As well as plant carbon inputs, the user may also define any organic amendments to the soil, such as farmyard manure (FYM). The model assumes that FYM is more decomposed than normal plant carbon inputs, and contains DPM 49%, RPM 49% and HUM 2% (Coleman and Jenkinson, 1996).

In CENTURY, the relevant (crop, grass or forest) plant-growth model determines plant carbon inputs. The user defines parameters that set the maximum potential plant production, which is then modified by

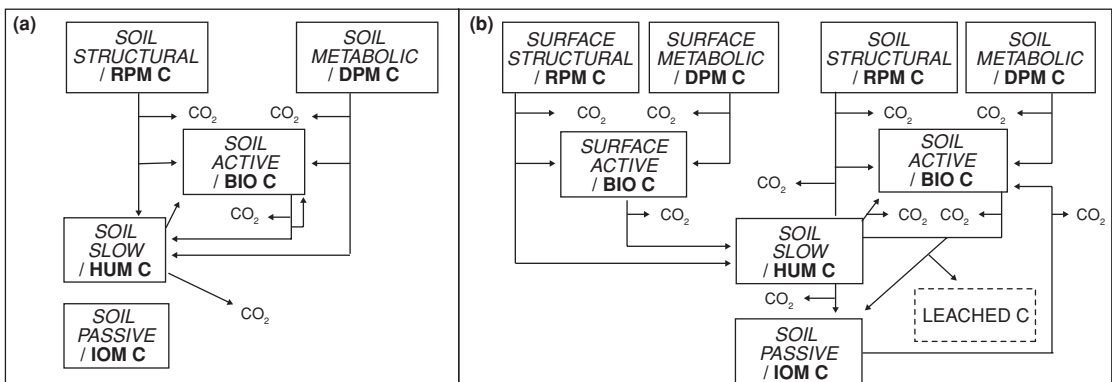

Figure 12.2 The structure of the SOM models of (a) RothC and (b) CENTURY.

temperature and water and nutrient availability, thus indirectly setting carbon returns to the soil. So it is of much importance to validate modelled NPP in relation to SOM turnover and predicted soil C-fluxes, CENTURY uses lignin : N ratios to define litter quality, which is determined by the plant production model. The lignin : N ratio also determines how incoming litter is split between structural (more resistant) and metabolic (more labile) compartments. Organic amendments such as FYM are also partitioned between the structural and metabolic compartments. With material containing a greater proportion of lignin, more of the carbon input is partitioned into the structural pool. The structural compartment contains all of the lignin matter. The model has both above- and below-ground input compartments, which represent carbon inputs from litter and branch fall, and root death and senescence, respectively (Metherell *et al.*, 1993).

12.3.2 Water budget models

RothC uses a simple water balance model that calculates the soil moisture deficit (SMD). The maximum SMD for the 0–23 cm layer of a particular soil is calculated using a function related to soil clay content. To allow for the reduction in evaporation, this maximum SMD is divided by 1.8 for bare soils. Next, the accumulated SMD is calculated from the first month when 0.75 (open-pan evaporation) exceeds rainfall until it reaches the maximum SMD. Once the maximum SMD is reached, the soil remains at this maximum SMD until the rainfall starts to exceed 0.75 (evaporation) and the soil wets up again. The factor 0.75 is conventional for converting open pan evaporation to evapotranspiration from a growing crop (Coleman and Jenkinson, 1996).

The CENTURY model includes a simplified water budget model, which calculates monthly evaporation and transpiration water loss, water content of a variable number of 15 cm soil layers, snow water content and saturated flow of water between soil layers (Fig. 12.3). The potential evapotranspiration rate (PET) is calculated as a function of the average monthly maximum and minimum air temperature using equations based on those of Linacre (1977). Bare soil water loss is a function of standing dead and litter biomass (lower for high biomass levels), rainfall and PET. Interception water loss is a function of above-ground biomass (increases with biomass), rainfall and PET. Potential

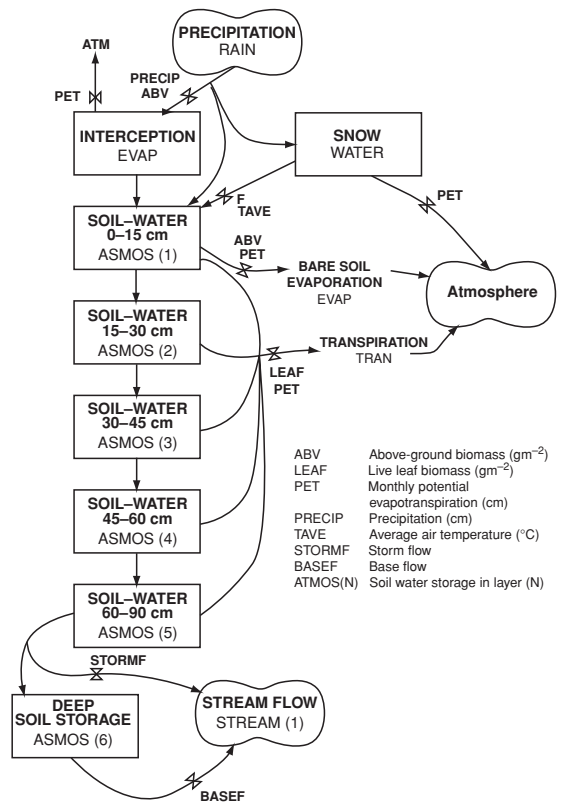

Figure 12.3 The CENTURY water sub-model (after Metherell *et al.*, 1993).

transpiration water loss (PTTR) is a function of the live leaf biomass and PET. Interception and bare soil water losses are calculated as fractions of the monthly precipitation and are subtracted from the total monthly precipitation. Remaining water is then added to the soil.

Water is distributed to the different layers by adding the water to the top layer (0–15 cm) and then draining excess water (water above field capacity) to the next layer. Transpiration water loss occurs after the water is added to the soil. Water loss occurs first as interception, then by bare soil evaporation and transpiration. The maximum monthly evapotranspiration water loss rate is equal to PET. Water leached below the last soil layer is not available for evapotranspiration and is a measure of inter-flow, runoff or leaching losses from the soil profile. Water going below the profile can be lost as fast stream flow or leached into the subsoil where it can accumulate or move into the stream flow.

CENTURY's water model also simulates leaching of the labile mineral N (NO_3 and NH_4), P and S pools.

12.3.3 Soil temperature models

In RothC, air temperature is used rather than soil temperature – monthly air temperature often satisfactorily represents the monthly mean soil temperature in the surface soil layer (Coleman and Jenkinson, 1996) and furthermore, air temperature data is more easily obtainable for most sites

In CENTURY, average monthly soil temperature near the soil surface is calculated using equations developed by Parton (1984). This method calculates maximum soil temperature as a function of the maximum air temperature and the canopy biomass (lower for high biomass), and minimum soil temperature is calculated using a function of the minimum air temperature and canopy biomass (higher for larger biomass). The actual soil temperature used for decomposition (and plant growth rate) functions is the average of the monthly minimum and maximum soil temperatures.

12.3.4 Model SOM pools, exchanges and turnover rates

In RothC (Fig. 12.2a), SOC is split into four active compartments that decompose by a first-order process and have their own characteristic rate constants. The model also assumes a small amount of SOC is resistant to decomposition (inert organic matter, IOM), which is totally inert and also receives no carbon inputs. The four active compartments (and their maximum decomposition rates) are decomposable plant material (DPM; $k = 10.0 \text{ y}^{-1}$), resistant plant material (RPM; $k = 0.3 \text{ y}^{-1}$), microbial biomass (BIO; $k = 0.66 \text{ y}^{-1}$) and humified organic matter (HUM; $k = 0.02 \text{ y}^{-1}$). These k values were set by calibrating the model to data from long-term field experiments at Rothamsted (Jenkinson *et al.*, 1987, 1992) and are not normally altered when using the model.

Both DPM and RPM decompose to form CO_2 (lost from the system), BIO and HUM. The proportion that goes to CO_2 and to BIO + HUM is determined by the clay content of the soil. The BIO + HUM is then split into 46% BIO and 54% HUM. BIO and HUM both decompose to form more CO_2 , BIO and HUM. If an active compartment contains $Y t C \text{ ha}^{-1}$, this declines

to $Y e^{-abck t} t C \text{ ha}^{-1}$ at the end of the month. In this equation, a is the rate modifying factor for temperature, b is the rate modifying factor for moisture, c is the plant retainment rate modifying factor, k is the decomposition rate constant for that compartment and t is 1/12, since k is based on a yearly decomposition rate. Therefore $Y (1 - e^{-abck t})$ is the amount of the material in any compartment that decomposes in a particular month (Coleman and Jenkinson, 1996).

The rate modifying factor for soil moisture, (b), used each month is calculated as follows. If the accumulated SMD is less than 0.444 of the maximum SMD, then b is set to 1.0, i.e. no effect of moisture. Otherwise, b is calculated as in the following equation (and shown in Fig. 12.4a):

$$b = 0.2 + (1.0 - 0.2) * \frac{(\text{max. SMD} - \text{acc. SMD})}{(\text{max. SMD} - 0.444 \text{ max. SMD})}$$

The model uses average monthly air temperature (tm) to calculate the decomposition rate modifier for temperature (a) according to the following equation (Fig. 12.4b):

$$a = \frac{47.9}{1 + e^{\left(\frac{106}{tm+18.3}\right)}}$$

The plant retainment factor (c) slows decomposition if growing plants are present. If soil is vegetated, $c = 0.6$ and if soil is bare $c = 1.0$. Finally, RothC allows for differences in soil texture by changing the proportion of CO_2 evolved and (BIO + HUM) formed during decomposition, rather than by using a rate modifying factor, such as that used for temperature. The ratio $\text{CO}_2/(\text{BIO} + \text{HUM})$, x , is calculated from the clay content of the soil using the equation below:

$$x = 1.67(1.85 + 1.60 \exp(-0.0786\% \text{clay}))$$

Then $x/(x + 1)$ is evolved as CO_2 and $1/(x + 1)$ is formed as BIO + HUM. The scaling factor 1.67 is used to set the $\text{CO}_2/(\text{BIO} + \text{HUM})$ ratio in Rothamsted soils (23.4% clay) to 3.51, based on experimental data: the same scaling factor is used for all soils. Figure 12.4c shows how the clay content of the soil affects the soil texture factor (Coleman and Jenkinson, 1996).

The CENTURY SOM sub-model (Fig. 12.2b) includes three soil organic matter pools and four litter pools (two surface and two sub-surface), and a surface microbial pool, that decompose by first-order

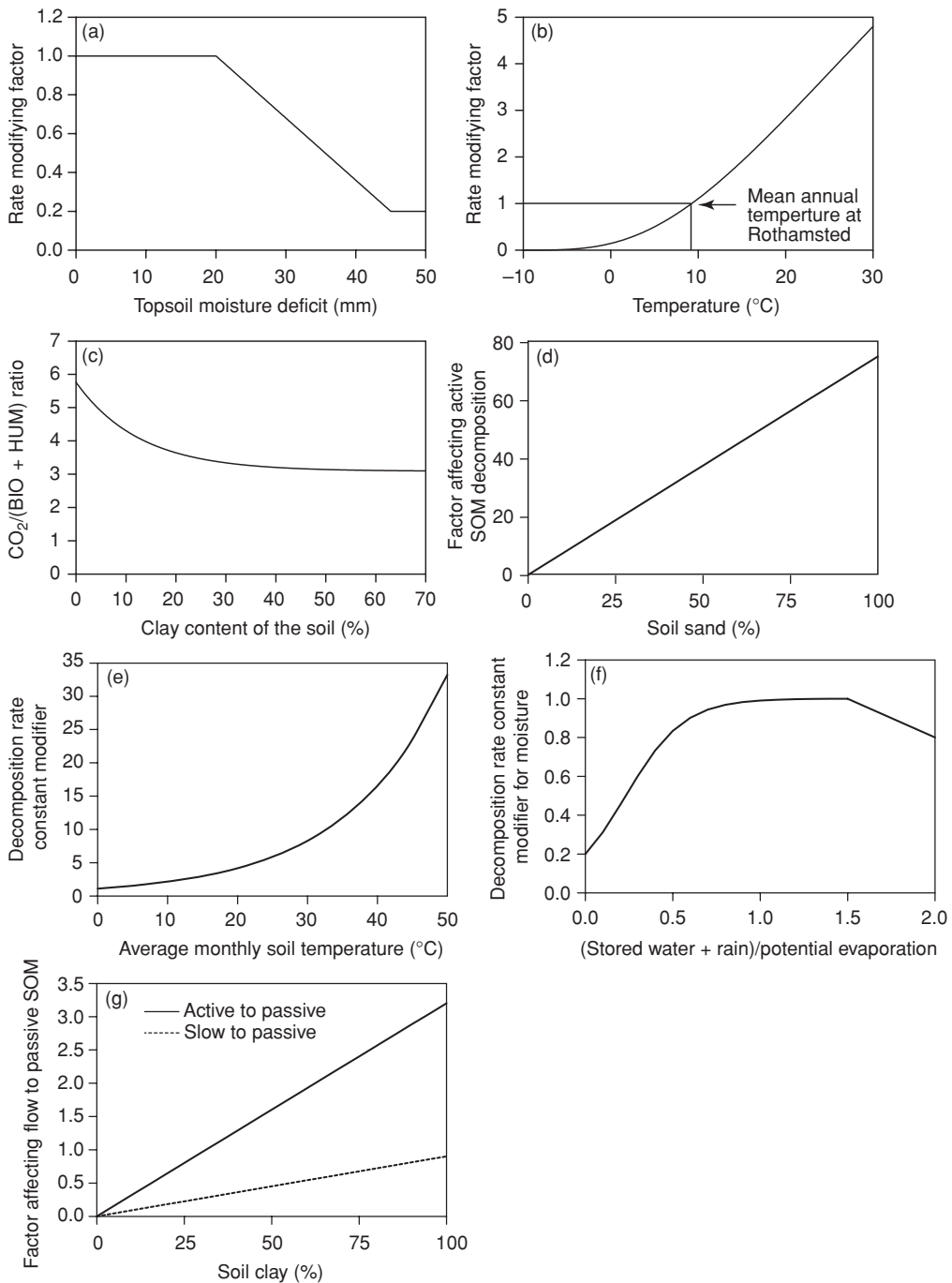

Figure 12.4 (a) The rate modifying factor for moisture in RothC (after Coleman and Jenkinson, 1996); (b) the rate modifying factor for temperature in RothC; (c) how clay % affects the ratio $CO_2/(BIO + HUM)$ in RothC; (d) the active SOM decomposition rate constant modifier for texture in CENTURY; (e) the decomposition rate constant modifier for temperature in CENTURY; (f) the decomposition rate constant modifier for moisture in CENTURY; (g) the texture factors affecting the flow of active and slow SOM to passive SOM in CENTURY.

kinetics and have characteristic decomposition rate constants. The soil organic matter pools (and their maximum decomposition rates) are active ($k = 7.3 \text{ y}^{-1}$), slow ($k = 0.2 \text{ y}^{-1}$) and passive ($k = 0.0066 \text{ y}^{-1}$). The litter pools are surface structural ($k = 3.9 \text{ y}^{-1}$), surface metabolic ($k = 14.8 \text{ y}^{-1}$), soil structural ($k = 4.9 \text{ y}^{-1}$) and soil metabolic ($k = 18.5 \text{ y}^{-1}$), and the surface microbial pool is surface active ($k = 6 \text{ y}^{-1}$, Metherell *et al.*, 1993). In a similar way to RothC, the decomposition of both plant residues and SOM are driven by the microbial pools and decomposition results in CO_2 loss via respiration.

The loss of CO_2 on decomposition of the active pool increases with increasing soil sand content. The effect of sand content on the decomposition rate of active SOM (EFTEXT; Fig. 12.4d) is calculated according to Metherell *et al.* (1993):

$$EFTEXT = 0.25 + 0.75(\%SAND)$$

Decomposition products flow into a surface active pool or one of three SOM pools. The maximum potential decomposition rate is reduced to an actual decomposition rate by functions of soil moisture and soil temperature. Decomposition may also increase due to cultivation. The impact of temperature on the actual decomposition rate is driven by average monthly soil temperature. The decomposition rate modifier for temperature (TFUNC; Fig. 12.4e) is calculated from the average monthly soil temperature (STEMP) as follows (Metherell *et al.*, 1993):

$$TFUNC = 0.125 + e^{(0.07 \cdot STEMP)}$$

The ratio of (stored topsoil water + current month's precipitation) to potential evapotranspiration determines the impact of moisture on decomposition. The decomposition rate modifier for moisture (WFUNC; Fig. 12.4f) is calculated from the ratio of (stored water + precipitation) to potential evapotranspiration (RAT), from the equations below (Metherell *et al.*, 1993):

$$WFUNC = \frac{1.0}{1.0 + 30 \cdot e^{(-8.5 \cdot RAT)}}$$

if $RAT > 1.5$

$$WFUNC = 1.0 - 0.7 \cdot \frac{(RAT - 1.5)}{1.5}$$

Lignin material is assumed to go directly to the slow carbon pool during the decomposition of structural plant material. Soil clay and silt content also affect the efficiency of stabilizing active SOM into slow SOM and passive SOM. This has the effect of creating more stable SOC in finer textured soils. The efficiency of stabilizing active SOM into passive SOM (FPSIS3; Fig. 12.4g) is calculated (Metherell *et al.*, 1993) from:

$$FPSIS3 = 0.003 + 0.032(CLAY\%)$$

The efficiency of stabilizing slow SOM into passive SOM (FPS2S3) is calculated (Metherell *et al.*, 1993) from:

$$FPSIS3 = 0.003 + 0.009(CLAY\%)$$

CENTURY also simulates leaching of organic matter. Finally, the model uses a soil drainage factor that allows a soil to have different degrees of wetness. Anaerobic conditions have the effect of reducing the decomposition rate (Metherell *et al.*, 1993).

12.3.5 Other model processes

CENTURY is able to simulate the fate of ^{14}C and ^{13}C tracers in the soil–plant system, while RothC can model the ^{14}C age of the topsoil. CENTURY simulates N, P and S dynamics, and recent developments to a daily version of RothC have enabled N and S dynamics to be modelled. CENTURY is also capable of modelling DOC loss from soils, while RothC currently cannot. Both models are applicable to arable, grassland and forest systems. However, neither model has been developed to accurately simulate the development of pronounced litter, i.e. humus layers (although CENTURY simulates litter production, litter decay does not account for pH and is not well simulated), so applicability to forested systems may be limited to the mineral soil only. Both RothC and CENTURY can simulate the effects of FYM application on SOM. The CENTURY model is also able to simulate the impact of several management practices and other factors on SOM, such as tillage, harvesting, different organic amendments, irrigation, grazing, erosion, fire and tree removal.

Table 12.2 *Major input variables for the RothC and CENTURY models.*

	RothC	CENTURY
Soil variables	Clay content IOM % SOC	Sand content Silt content Clay content Bulk density SOC content
Monthly weather variables	Total precipitation Mean temperature Total evaporation	Total precipitation Mean maximum °C Mean minimum °C
Management variables	Residue quality (DPM/RPM) ^a Soil cover Residue carbon input Manure carbon inputs	Residue lignin/N ratio Plant C and N content Atmospheric N deposition

^a DPM/RPM = ratio of decomposable plant material/resistant plant material.

12.3.6 Data requirements and output variables

RothC uses two input files, a land management file (with C inputs, FYM and plant cover), a weather file (with rainfall, temperature, evaporation, clay content and sample depth) and input from the command line, and can be run in DOS batch mode or via a Windows user interface. The data required to run RothC are shown in Table 12.2.

RothC produces output data on a monthly timestep including total C, C in DPM, RPM, BIO and HUM, CO₂ evolved, IOM and radiocarbon age. Predictive use of the model requires estimation of (1) the IOM pool for the model and (2) C inputs to the soil.

The user may specify many input variables and parameters in CENTURY. Major input variables for CENTURY are given in Table 12.2.

The CENTURY model takes input from monthly weather data files, files containing fixed parameters primarily relating to organic matter decomposition (not normally adjusted between runs) and files containing site-specific parameters such as precipitation, soil texture and the initial conditions for soil organic matter. The user can also specify crop, cultivation, fertilization, fire, grazing, harvest, irrigation, organic matter addition, tree and tree removal options. Radiocarbon dates may also be input. Runs of the model are executed

using ‘schedule’ files that specify the order and timing of events such as harvesting and fertilization. The model runs using a monthly or daily (DAYCENT, Parton *et al.*, 1998) timestep. The model has many output variables, of interest here are labelled, unlabelled and total carbon in SOM pools and total carbon, carbon inputs and CO₂ loss. Predictive use of CENTURY requires setting of the distribution of SOC between model pools, especially the ‘passive SOM’ pool, which changes very little throughout the course of normal simulations.

12.3.7 Examples of RothC and CENTURY evaluation and application: short term and small scale

There have been relatively few applications of RothC or CENTURY to investigate short-term (decadal time scales or less) aspects of the soil carbon cycle – the observed data available for such studies have largely been used in calibrating the models themselves. Since the original development of RothC and CENTURY, applications have also tended to focus on longer term (annual to decadal time scales or greater) issues as discussed in the section on SOM model application and in the examples given in the section below.

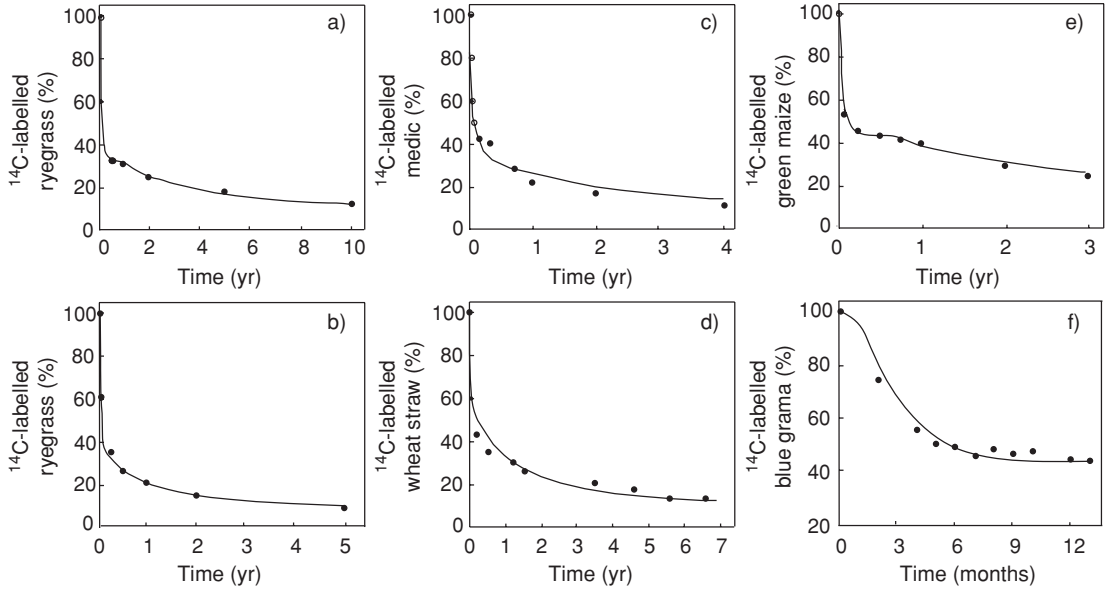

Figure 12.5 RothC calibration to labelled decomposition of plant materials in different climates: (a) Rothamsted, UK; (b) Ibadan, Nigeria; (c) Northfield, Australia; (d) Patarra, Costa Rica; (e) Vienna, Austria; (f) Pawnee, USA (Jenkinson *et al.*, 1991).

Datasets describing the decomposition of uniformly ¹⁴C-labelled plant materials under field conditions have been widely used to parameterize RothC and CENTURY, covering time scales of one to ten years and a variety of litter types and environmental conditions (e.g. Parton *et al.*, 1987; e.g. Jenkinson *et al.*, 1991; Parton *et al.*, 1994). Exercises such as these were used to fit model parameters (such as the DPM/RPM ratio in RothC for different vegetation types, and decomposition constants for CENTURY). An example of this is given in Fig. 12.5, which shows how RothC was fitted to labelled plant material decomposition data from different environments. These datasets confirm the ability of RothC and CENTURY to mimic short-term soil carbon dynamics.

Virtually no studies have attempted to use RothC or CENTURY to investigate the dynamics of the soil microbial biomass (SMB) pool in the short term, although Fig. 12.6 depicts a comparison of measured and modelled SMB values from long-term experimental studies. The measured data shown here represent SMB values at one point in time. More recently, Niklaus and Falloon (2006) combined carbon isotope labelling and modelling with RothC to investigate soil carbon dynamics under an elevated CO₂ grassland for a six-year period.

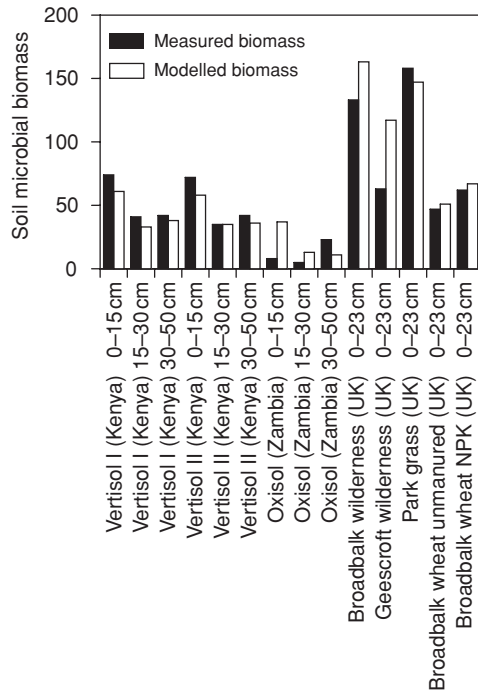

Figure 12.6 Measured and RothC-modelled soil microbial biomass measurements from different experiments (data from Jenkinson *et al.*, 1992, 1999).

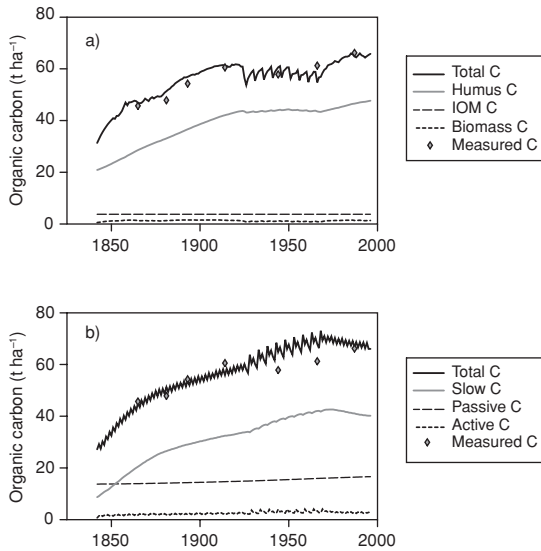

Figure 12.7 Simulated and measured SOC for the Broadbalk Experiment, Farm Yard Manure treatment using (a) RothC and (b) CENTURY.

12.3.8 Examples of RothC and CENTURY evaluation and application: long term and small scale

The vast majority of RothC and CENTURY applications have focused on evaluating the models against measured datasets of changes in SOC over decadal to century time scales. Data from many sites across the globe have been utilized (for a detailed multi-site intercomparison, see Smith *et al.*, 1997), discussed in the section on SOM model application. Figure 12.7 shows a comparison of RothC and CENTURY for the Rothamsted Broadbalk Experiment FYM plot, which receives 35 t ha⁻¹ FYM annually. Both models are able to capture long-term SOC dynamics, including a period in the middle of the experiment where fallowing was introduced. The plots also demonstrate the different pool concepts of the model – the fast (BIO and active) pools are smallest and most responsive, while the intermediate pools reflect the behaviour of total SOC most closely; RothC has a very small inert pool of carbon while CENTURY uses a larger, very stable (but not inert) pool of carbon.

Figure 12.8 shows a comparison of (a) CENTURY, (b) RothC and (c) RothC driven by CENTURY carbon

inputs for the Rothamsted Woburn Ley Arable Experiment (after Falloon and Smith, 2002). Three treatments were simulated on this sandy soil – an all-arable rotation (arable-roots), an arable rotation with one year in six under hay (arable-hay) and an arable ley rotation with three years in six under grass (grazed-ley) treatments. Both models reproduced measured trends in SOC, which highlights their ability to simulate the effects of management on SOC in the long term. These simulations were part of an exercise to evaluate RothC and CENTURY against relevant long-term datasets before application to estimate carbon sequestration potential for an area of Central Hungary (Fig. 12.9, Falloon *et al.*, 2002).

12.3.9 Examples of RothC and CENTURY evaluation and application: large scale

The section on SOM model application lists a number of regional SOM model studies. Figure 12.9 shows results from the application of RothC and CENTURY to investigate land management scenarios for carbon sequestration in a region of Central Hungary (Falloon *et al.*, 2002). This approach, linking detailed spatial databases to dynamic SOM models, is a powerful method for studying regional-scale SOM dynamics, integrating detailed knowledge on soils, climate and land use with state-of-the-art SOM models, and allowing identification of ‘hot spots’ for carbon sequestration.

RothC has also been applied to 1 km-level databases of soil and land use, and coarser resolution databases of climate in the UK (Falloon *et al.*, 2006). Most of Great Britain was shown to lose soil carbon, which clearly has an impact on soil quality issues, as well as being a potential positive feedback mechanism to climate change via the enhanced release of CO₂. By investigating carbon sequestration scenarios either alone or in combination with climate change scenarios (Fig. 12.10, Falloon *et al.*, 2006), RothC also showed that carbon mitigation potential could be weakened in the future by climate change. It is also important to note that the modelled impact of (climate scenario + carbon sequestration scenario) does not equal the impact of (climate scenario) + (carbon sequestration scenario): models predict interactions between management, soil and climate that are non-linear and non-additive.

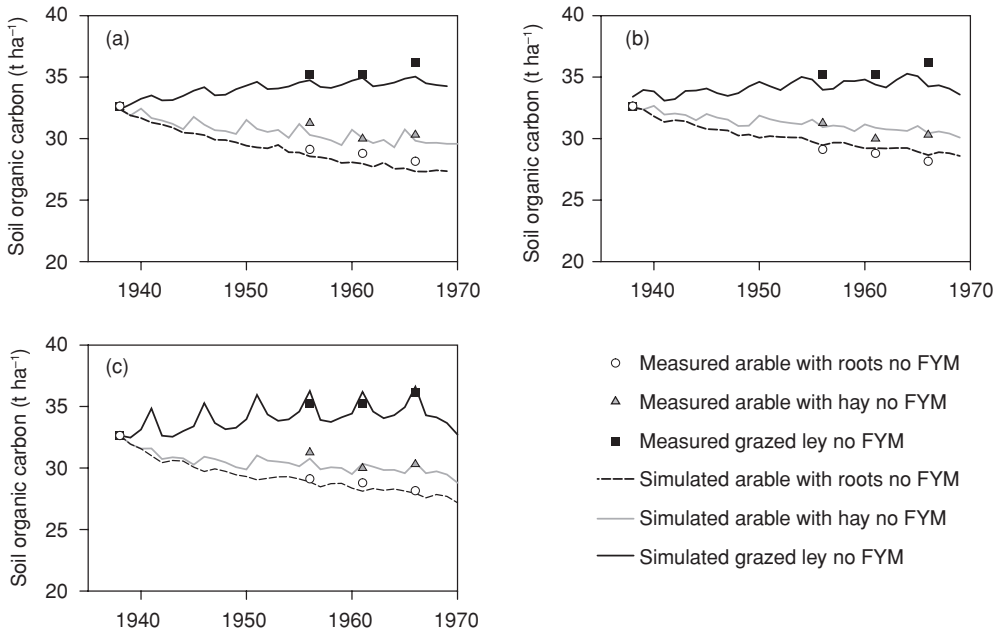

Figure 12.8 Comparison of measured SOC trends for the Woburn Ley Arable Experiment, UK, with simulated values from (a) CENTURY, (b) RothC and (c) RothC driven with carbon inputs from CENTURY (after Falloon and Smith, 2002).

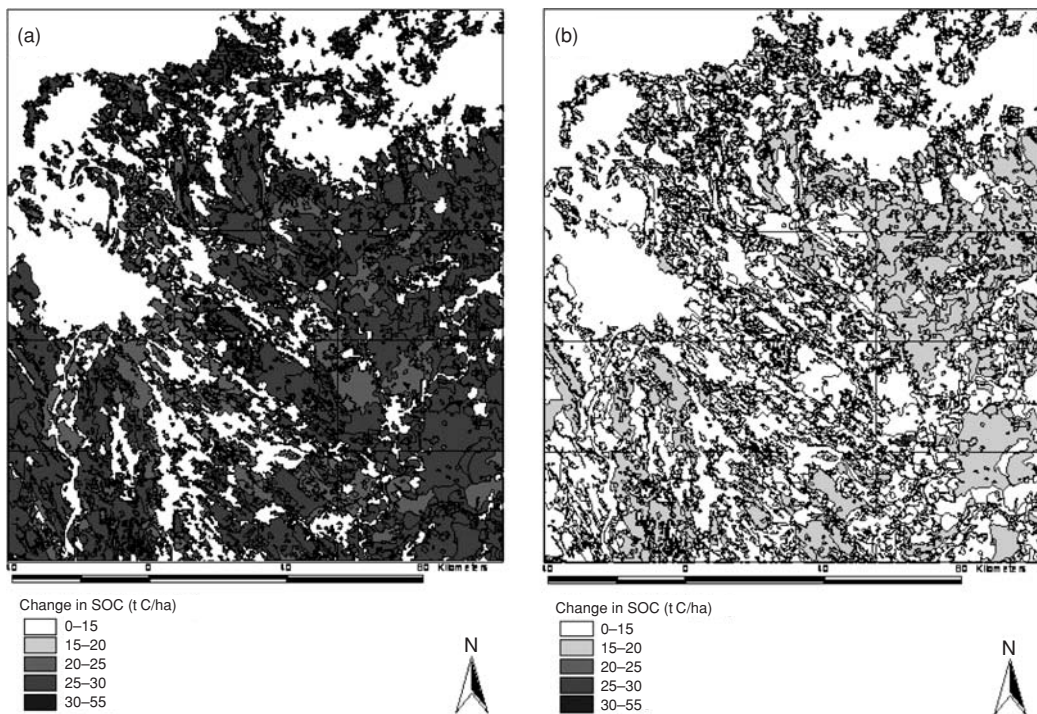

Figure 12.9 Predicted change in soil carbon over 100 years due to a land management change (application of $4.26\ t\ ha^{-1}\ y^{-1}$ cereal straw to all arable land) using (a) RothC model and (b) CENTURY model (after Falloon *et al.*, 2002).

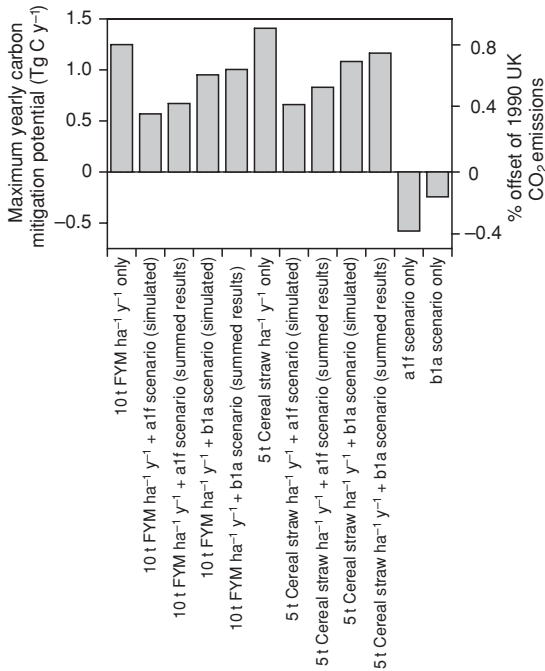

Figure 12.10 Carbon mitigation potential of land management options with/without climate change interactions for the UK, predicted by the RothC model from 1 km data (Falloon *et al.*, 2004).

The impact of future climate on global SOC stocks was investigated by Jenkinson *et al.* (1991), who predicted a significant release of soil carbon due to increased global temperatures. A more sophisticated approach was taken by Jones *et al.* (2005), who showed a similar trend using both the SOM decomposition model of the coupled-carbon-climate Global Circulation Model HadCM3 and the RothC model. Some regions of the globe lost soil carbon while others gained soil carbon, due to differences in the balance between changes in litter input and changes in decomposition rate under climate change, although the predicted vegetation loss in the Amazon had the largest negative influence on soil carbon stocks globally overall.

12.4 CONCLUSIONS AND FUTURE DIRECTIONS

Soil organic matter models are being increasingly used to support policy decisions regarding future climate change and land management. It is thus more important than ever before that (1) the science behind SOM

models is robust, (2) SOM models are comprehensively evaluated using reliable observed datasets as widely as possible and (3) SOM models encompass appropriate mechanisms for the tasks required of them.

Although there is a wealth of measured data from carefully monitored long-term agronomic experiments for evaluating SOM models, there are comparatively few similar datasets from natural ecosystems, and relatively few long-term experiments related to land-use change rather than land-management changes. Furthermore, soil carbon measurements from the available experiments are rarely available in replicate and hence attributing uncertainty to these measurements, and ultimately confidence in SOM model predictions, is limited (Falloon and Smith, 2003). There has been relatively little stringent testing of SOM models using short-term datasets of soil carbon dynamics such as microbial biomass or CO₂ flux since their original development.

Specific areas for scientific development of SOM models include: linking model SOM pools to measurements; improving understanding of subsoil processes; better modelling of litter decomposition processes; modelling carbon turnover in organic very wet, very dry or allophanic soils; linking soil, plant and climate models; estimating carbon inputs to soil for model validation; and better understanding spatial heterogeneity in SOC in the landscape.

ACKNOWLEDGEMENTS

Pete Falloon's contribution was supported by the UK Department of the Environment, Food and Rural Affairs under contract PECD 7/12/37. The authors would like to thank Olof Andrén and one anonymous reviewer for their comments on an earlier version of this chapter.

REFERENCES

- Ågren, G. I., Kirschbaum, M. U. F., Johnson, D. F. and Bosatta, E. (1996) Ecosystem physiology: soil organic matter. In *Global Change: Effects on Coniferous Forests and Grasslands*, ed. A. I. Breyer, D. O. Hall, J. M. Melillo and G. I. Ågren. John Wiley and Sons, pp. 207–28.
- André, M., Thiery, J. M. and Courmac, L. (1994) ECOSIMP model: prediction of CO₂ concentration changes and carbon status in closed ecosystems. *Advances in Space Research*, **14**, 323–6.

- Andrén, O. and Kätterer, T. (1997) ICBM: the introductory carbon balance model for exploration of soil carbon balances. *Ecological Applications*, **7**, 1226–36.
- Andrén, O. and Kätterer, T. (2001) Basic principles for soil carbon sequestration and calculating dynamic country-level balances including future scenarios. In *Assessment Methods for Soil Carbon*, ed. R. Lal, J. M. Kimble, R. F. Follett and B. A. Stewart. Boca Raton, FL: Lewis Publishers, pp. 495–511.
- Beek, J. and Frissel, M. J. (1973) *Simulation of Nitrogen Behaviour in Soils*. Wageningen, the Netherlands: Pudoc.
- Bosatta, E. and Ågren, G. I. (1994) Theoretical analysis of microbial biomass dynamics in soils. *Soil Biology and Biochemistry*, **26**, 143–8.
- Bosatta, E. and Ågren, G. I. (1995) Theoretical analyses of interactions between inorganic nitrogen and soil organic-matter. *European Journal of Soil Science*, **46**, 109–14.
- Buringh, P. (1984) The role of terrestrial vegetation in the global carbon cycle: measurement by remote sensing. In *Organic Carbon in Soils of the World*, ed. G. M. Woodwell. Chichester: Scope, John Wiley and Sons, pp. 91–109.
- Burke, I. C., Yonker, C. M., Parton, W. J. *et al.* (1989) Texture, climate, and cultivation effects on soil organic-matter content in US grassland soils. *Soil Science Society of America Journal*, **53**, 800–5.
- Chertov, O. G. and Komarov, A. S. (1996) SOMM: a model of soil organic matter and nitrogen dynamics in terrestrial ecosystems. In *Evaluation of Soil Organic Matter Models Using Existing, Long-term Data-sets*, ed. D. S. Powlson, P. Smith and J. U. Smith. NATO ASI I38. Berlin: Springer, pp. 231–6.
- Coleman, K. and Jenkinson, D. S. (1996) RothC-26.3: a model for the turnover of carbon in soil. In *Evaluation of Soil Organic Matter Models Using Existing, Long-term Data-sets*, ed. D. S. Powlson, P. Smith and J. U. Smith. NATO ASI I38. Berlin: Springer, pp. 134–60.
- Coleman, K., Jenkinson, D. S., Crocker, G. J. *et al.* (1997) Simulating trends in soil organic carbon in long-term experiments using RothC-26.3. *Geoderma*, **81**, 29–44.
- de Ruiter, P. C. and Van Faassen, H. G. (1994) A comparison between an organic matter dynamics model and a food web model simulating nitrogen mineralization in agro-ecosystems. *European Journal of Agronomy*, **3**, 347–54.
- de Ruiter, P. C., Vanveen, J. A., Moore, J. C., Brussaard, L. and Hunt, H. W. (1993) Calculation of nitrogen mineralization in soil food webs. *Plant and Soil*, **157**, 263–73.
- de Ruiter, P. C., Neutel, A.-M. and Moore, J. C. (1995) Energetics and stability in belowground food webs. In *Food Webs: Integration of Patterns and Dynamics*, ed. G. A. Polis and K. O. Winemiller. New York: Chapman and Hall, pp. 201–10.
- Donigian, A. S., Barnwell, T. O., Jackson, R. B. *et al.* (1994) *Assessment of Alternative Management Practices and Policies Affecting Soil Carbon in Agroecosystems of the Central United States*. Athens: US EPA Report EPA/600/R-94/067.
- Doran, J. W., Mielke, L. N. and Stamatiadis, S. (1988) Microbial activity and N cycling as regulated by soil water-filled pore space. In *11th Conf. Inter. Soil Tillage Res. Org.* Vol. 1. Edinburgh, Scotland, pp. 49–54.
- Douglas, C. L. and Rickman, R. W. (1992) Estimating crop residue decomposition from air-temperature, initial nitrogen-content, and residue placement. *Soil Science Society of America Journal*, **56**, 272–8.
- Esser, G. (1990) Modelling global terrestrial sources and sinks of CO₂ with special reference to soil organic matter. In *Soils and the Greenhouse Effect*, ed. A. F. Bouwman. New York: John Wiley and Sons, pp. 247–61.
- Falloon, P. and Smith, P. (2000) Modelling refractory soil organic matter. *Biology and Fertility of Soils*, **30**, 388–98.
- Falloon, P. and Smith, P. (2002) Simulating SOC changes in long-term experiments with RothC and CENTURY: model evaluation for a regional scale application. *Soil Use and Management*, **18**, 101–11.
- Falloon, P. and Smith, P. (2003) Accounting for changes in soil carbon under the Kyoto Protocol: need for improved long-term data sets to reduce uncertainty in model projections. *Soil Use and Management*, **19**, 265–9.
- Falloon, P., Smith, P., Coleman, K. and Marshall, S. (1998a) Estimating the size of the inert organic matter pool from total soil organic carbon content for use in the Rothamsted carbon model. *Soil Biology and Biochemistry*, **30**, 1207–11.
- Falloon, P., Smith, P., Smith, J. U. *et al.* (1998b) Regional estimates of carbon sequestration potential: linking the Rothamsted carbon model to GIS databases. *Biology and Fertility of Soils*, **27**, 236–41.
- Falloon, P., Smith, P., Coleman, K. and Marshall, S. (2000) How important is inert organic matter for predictive soil carbon modelling using the Rothamsted carbon model? *Soil Biology and Biochemistry*, **32**, 433–6.

- Falloon, P., Smith, P., Szabo, J. and Pasztor, L. (2002) Comparison of approaches for estimating carbon sequestration at the regional scale. *Soil Use and Management*, **18**, 164–74.
- Falloon, P., Smith, P., Bradley, R. I. *et al.* (2006) RothC UK: a dynamic modelling system for estimating changes in soil C at 1-km resolution in the UK. *Soil Use and Management*, **22**, 274–88.
- Falloon, P., Jones, C. D., Ades, M. and Paul, K. (2008) Soil moisture controls of future global soil carbon changes: an unconsidered source of uncertainty. *Global Biogeochemical Cycles* (in revision).
- Franco, U. (1996) Modelling approaches of soil organic matter turnover within the CANDY system. In *Evaluation of Soil Organic Matter Models Using Existing, Long-term Data-sets*, ed. D. S. Powlson, P. Smith and J. U. Smith. NATO ASI 138. Berlin: Springer-Verlag, pp. 247–54.
- Giardina, C. P. and Ryan, M. G. (2000) Evidence that decomposition rates of organic carbon in mineral soil do not vary with temperature. *Nature*, **404**, 858–61.
- Goldewijk, K. K., Vanminnen, J. G., Kreileman, G. J. J., Vloedveld, M. and Leemans, R. (1994) Simulating the carbon flux between the terrestrial environment and the atmosphere. *Water Air and Soil Pollution*, **76**, 199–230.
- Goto, N., Sakoda, A. and Suzuki, M. (1993) Modelling soil carbon dynamics as a part of the carbon cycle in terrestrial ecosystems. *Ecological Modelling*, **74**, 183–204.
- Grace, P. R. and Ladd, J. N. (1995) *SOCRATES v2.00 User Manual*. PMB 2, Glen Osmond 5064, South Australia: Cooperative Research Centre for Soil and Land Management.
- Grant, R. F. (1991) A technique for estimating denitrification rates at different soil temperatures, water contents, and nitrate concentrations. *Soil Science*, **152**, 41–52.
- Grant, R. F. (1995) Dynamics of energy, water, carbon and nitrogen in agricultural ecosystems: simulation and experimental validation. *Ecological Modelling*, **81**, 169–81.
- Henin, S. and Dupuis, M. (1945) Essai de bilan de la matière organique du sol. *Annales Agronomiques*, **15**, 17–29.
- Henin, S., Monnier, G. and Turc, L. (1959) Un aspect de la dynamique des matières organiques du sol. *Comptes Rendus Hebdomadaires Des Seances De L'Academie Des Sciences*, **248**, 138–41.
- Hoogenboom, G., Jones, J. W., Hunt, L. A., Thornton, P. K. and Tsuji, G. Y. (1994) An integrated decision support system for crop model applications. *ASAE Meeting Paper 94–3025*, 23.
- Hunt, H. W., Coleman, D. C., Cole, C. V. *et al.* (1984) Simulation model of a food web with bacteria, amoebae, and nematodes in soil. In *Current Perspectives in Microbial Ecology*, ed. M. J. Klug and C. A. Reddy. Washington, DC: American Society for Microbiology, pp. 346–52.
- Hunt, H. W., Coleman, D. C., Ingham, E. R. *et al.* (1987) The detrital food web in a shortgrass prairie. *Biology and Fertility of Soils*, **3**, 57–68.
- Hunt, H. W., Trlica, M. J., Redente, E. F. *et al.* (1991) Simulation-model for the effects of climate change on temperate grassland ecosystems. *Ecological Modelling*, **53**, 205–46.
- IPCC (1996) *The Revised 1996 Guidelines for National Greenhouse Gas Inventories*. Geneva, Switzerland.
- IPCC (2000) *Land Use, Land-use Change, and Forestry. A Special Report of the IPCC*. Cambridge: Cambridge University Press.
- Izarraulde, R. C., McGill, W. B., Jans-Hammermeister, D. C. *et al.* (1996) *Development of a Technique to Calculate Carbon Fluxes in Agricultural Soils at the Ecodistrict Level Using Simulation Models and Various Aggregation Methods*. University of Alberta, Edmonton, Canada. Report no. 01586–3–1280/01-XSG.
- Jenkinson, D. S. (1977) Studies on decomposition of plant material in soil. 4. Effect of rate of addition. *Journal of Soil Science*, **28**, 417–23.
- Jenkinson, D. S. (1988) Soil organic matter and its dynamics. In *Russell's Soil Conditions and Plant Growth*, ed. A. Wild. London: Longman, pp. 504–607.
- Jenkinson, D. S. (1990) The turnover of organic-carbon and nitrogen in soil. *Philosophical Transactions of the Royal Society of London Series B – Biological Sciences*, **329**, 361–8.
- Jenkinson, D. S. and Coleman, K. (1994) Calculating the annual input of organic-matter to soil from measurements of total organic-carbon and radiocarbon. *European Journal of Soil Science*, **45**, 167–74.
- Jenkinson, D. S. and Coleman, K. C. (2008) The turnover of organic carbon in subsoils. Part 2. Modelling carbon turnover. *European Journal of Soil Science*, **59**, 400–13.
- Jenkinson, D. S., Hart, P. B. S., Rayner, J. H. and Parry, L. C. (1987) Modelling the turnover of organic matter in long-term experiments at Rothamsted. *INTECOL Bulletin*, **15**, 1–8.

- Jenkinson, D. S., Adams, D. E. and Wild, A. (1991) Model estimates of CO₂ emissions from soil in response to global warming. *Nature*, **351**, 304–6.
- Jenkinson, D. S., Harkness, D. D., Vance, E. D., Adams, D. E. and Harrison, A. F. (1992) Calculating net primary production and annual input of organic-matter to soil from the amount and radiocarbon content of soil organic-matter. *Soil Biology and Biochemistry*, **24**, 295–308.
- Jenkinson, D. S., Meredith, J., Kinyamario, J. I. *et al.* (1999) Estimating net primary production from measurements made on soil organic-matter. *Ecology*, **80**, 2762–73.
- Jenny, H. (1941) *Factors of Soil Formation. A System of Quantitative Pedology*. New York: McGraw-Hill.
- Jones, C., McConnell, C., Coleman, K. *et al.* (2005) Global climate change and soil carbon stocks: predictions from two contrasting models for the turnover of organic carbon in soil. *Global Change Biology*, **11**, 154–66.
- Kan, E. E. and Kan, N. A. (1991) Simulation-model of soil fertility. *Physiology and Biochemistry of Cultivated Plants* (in Russian), **23**, 3–17.
- Kelly, R. H., Parton, W. J., Crocker, G. J. *et al.* (1997) Simulating trends in soil organic carbon in long-term experiments using the CENTURY model. *Geoderma*, **81**, 75–90.
- Lavelle, P. B. P., Charpentier, F. C., Rossi, J. P. *et al.* (1997) Large-scale effects of earthworms on soil organic matter and nutrient dynamics. In *Proceedings of the International Symposium on Earthworm Ecology 1996*. Columbus, Ohio.
- Lee, J. J. and Phillips, D. L. (1993) The effect of trends in tillage practices on erosion and carbon content of soils in the United-States Corn-Belt. *Water Air and Soil Pollution*, **70**, 389–401.
- Li, C. S., Frolking, S. and Harriss, R. (1994) Modeling carbon biogeochemistry in agricultural soils. *Global Biogeochemical Cycles*, **8**, 237–54.
- Lin, C., Liu, T. S. and Hu, T. L. (1987) Assembling a model for organic residue transformation in soils. *Proc. Natl. Council (Taiwan)*, Part B **11**, 175–86.
- Linacre, E. T. (1977) Simple formula for estimating evaporation rates in various climates, using temperature data alone. *Agricultural Meteorology*, **18**, 409–24.
- Lomander, A., Katterer, T. and Andren, O. (1998) Modelling the effects of temperature and moisture on CO₂ evolution from top- and subsoil using a multi-compartment approach. *Soil Biology and Biochemistry*, **30**, 2023–30.
- McCaskill, M. R. and Blair, G. J. (1990) A model of S, P and N uptake by a perennial pasture. 1. Model construction. *Fertilizer Research*, **22**, 161–72.
- McCown, R. L., Hammer, G. L., Hargreaves, J. N. G., Holzworth, D. P. and Freebairn, D. M. (1996) APSIM: a novel software system for model development, model testing and simulation in agricultural systems research. *Agricultural Systems*, **50**, 255–71.
- McGill, W. B. (1996) Review and classification of ten soil organic matter (SOM) models. In *Evaluation of Soil Organic Matter Models Using Existing, Long-term Data-sets*, ed. D. S. Powlson, P. Smith and J. U. Smith. NATO ASI I38. Berlin: Springer-Verlag, pp. 111–33.
- McGill, W. B., Hunt, H. W., Woodmansee, R. G. and Reuss, J. O. (1981) PHOENIX, a model of the dynamics of carbon and nitrogen in grassland soil. In *Terrestrial Nitrogen Cycles. Processes, Ecosystem Strategies and Management Impacts*, ed. F. E. Clark and T. Roswall. Vol. 33. Ecological Bulletins, pp. 49–115.
- Melillo, J. M., Kicklighter, D. W., McGuire, A. D., Peterjon, W. T. and Newkirk, K. M. (1995) Global change and its effect on soil organic carbon stocks. In *Role of Nonliving Organic Matter in the Earth's Carbon Cycle*, ed. R. G. Zepp and C. H. Sonntag. New York: John Wiley and Sons, pp. 175–89.
- Metherell, A. K., Harding, L. A., Cole, C. V. and Parton, W. J. (1993) *CENTURY Soil Organic Matter Model Environment*. Technical documentation, Agroecosystem Version 4.0. Great Plains System Research Unit Technical Report No. 4. USDA-ARS. Fort Collins, Colorado.
- Molina, J. A. E. and Smith, P. (1998) Modeling carbon and nitrogen processes in soils. In *Advances in Agronomy*, ed. D. L. Sparks. Vol. 62. Academic Press, pp. 253–98.
- Molina, J. A. E., Clapp, C. E., Shaffer, M. J., Chichester, F. W. and Larson, W. E. (1983) NCSOIL, a model of nitrogen and carbon transformations in soil: description, calibration, and behavior. *Soil Science Society of America Journal*, **47**, 85–91.
- Molina, J. A. E., Hadas, A. and Clapp, C. E. (1990) Computer-simulation of nitrogen turnover in soil and priming effect. *Soil Biology and Biochemistry*, **22**, 349–53.
- Moorhead, D. L. and Reynolds, J. F. (1991) A general-model of litter decomposition in the northern Chihuahuan Desert. *Ecological Modelling*, **56**, 197–19.
- Motavalli, P. P., Palm, C. A., Parton, W. J., Elliott, E. T. and Frey, S. D. (1995) Soil pH and organic C dynamics in tropical forest soils: evidence from laboratory and

- simulation studies. *Soil Biology and Biochemistry*, **27**, 1589–99.
- Müller, T., Jensen, L. S., Hansen, S. and Nielsen, N. E. (1996) Simulating soil carbon and nitrogen dynamics with the soil-plant-atmosphere system model DAISY. In *Evaluation of Soil Organic Matter Models Using Existing, Long-term Data-sets*, ed. D. S. Powlson, P. Smith and J. U. Smith. NATO ASI I38. Berlin: Springer-Verlag, pp. 275–81.
- Niklaus, P. A. and Falloon, P. D. (2006) Estimating carbon sequestration under elevated CO₂ by combining carbon isotope labelling with soil carbon cycle modelling. *Global Change Biology*, **12**, 1909–21.
- O'Brien, B. J. (1984) Soil organic-carbon fluxes and turnover rates estimated from radiocarbon enrichments. *Soil Biology and Biochemistry*, **16**, 115–20.
- O'Leary, G. J. (1994) Soil water and nitrogen dynamics of dryland wheat in the Victorian Wimmera and Mallee. Ph.D. thesis, University of Melbourne.
- Oades, J. M., Gillman, G. P. and Uehara, G. (1989) Interactions of soil organic matter and variable-charge clays. In *Dynamics of Soil Organic Matter*, ed. D. C. Coleman, J. M. Oades and G. Uehara. Honolulu, Hawaii: University of Hawaii, pp. 69–95.
- Parshotam, A. and Hewitt, A. E. (1995) Application of the Rothamsted carbon turnover model to soils in degraded semiarid land in New-Zealand. *Environment International*, **21**, 693–7.
- Parshotam, A., Tate, K. R. and Giltrap, D. J. (1996) Potential effects of climate and land-use change on soil carbon and CO₂ emissions from New Zealand's indigenous forests and unimproved grasslands. *Weather and Climate*, **15**, 47–56.
- Parton, W. J. (1984) Predicting soil temperatures in a shortgrass steppe. *Soil Science*, **138**, 93–101.
- Parton, W. J., Schimel, D. S., Cole, C. V. and Ojima, D. S. (1987) Analysis of factors controlling soil organic-matter levels in Great-Plains grasslands. *Soil Science Society of America Journal*, **51**, 1173–9.
- Parton, W. J., Sanford, R. L., Sanchez, P. A. *et al.* (1989) Modelling soil organic matter dynamics in tropical soils. In *Dynamics of Soil Organic Matter in Tropical Ecosystems*, ed. D. C. Coleman, J. M. Oades and G. Uehara. Honolulu, Hawaii: NifTAL Project, University of Hawaii Press, pp. 69–95.
- Parton, W. J., Ojima, D. S., Cole, C. V. and Schimel, D. S. (1994) A general model for soil organic matter dynamics: sensitivity to litter chemistry, texture and management. In *Quantitative Modelling of Soil Forming Processes, SSSA Special Publication 39*. Madison, WI: SSSA, pp. 147–67.
- Parton, W. J., Hartman, M., Ojima, D. and Schimel, D. (1998) DAYCENT and its land surface submodel: description and testing. *Global and Planetary Change*, **19**, 35–48.
- Paul, E. A., Horwath, W. R., Harris, D. *et al.* (1995) Establishing the pool sizes and fluxes in CO₂ emissions from soil organic matter turnover. In *Soils and Global Change*, ed. R. Lal, J. M. Kimble, E. Levine and B. A. Stewart. CRC Press, pp. 297–305.
- Paustian, K. (1994) Modelling soil biology and biochemical processes for sustainable agricultural research. In *Soil Biota. Management in Sustainable Farming Systems*, ed. C. E. Pankhurst, V. V. S. R. Gupta, P. R. Grace. Melbourne: CSIRO Information Services, pp. 182–93.
- Perruchoud, D. O. (1996) Modeling the dynamic of non-living organic carbon in a changing climate: a case study for temperate forests. Ph.D. thesis.
- Plentinger, M. C. and Penning de Vries, F. W. T. (eds) (1996) CAMASE: Register of Agro-ecosystems Models. Available at <http://library.wur.nl/way/bestanden/clc/1763788.pdf>.
- Post, W. M., Emanuel, W. R., Zinke, P. J. and Stangenberger, A. G. (1982) Soil carbon pools and world life zones. *Nature*, **298**, 156–9.
- Post, W. M., Pastor, J., Zinke, P. J. and Stangenberger, A. G. (1985) Global patterns of soil-nitrogen storage. *Nature*, **317**, 613–16.
- Post, W. M., King, A. W. and Wullschlegel, S. D. (1996) Soil organic matter models and global estimates of soil organic carbon. In *Evaluation of Soil Organic Matter Models Using Existing, Long-term Data-sets*, ed. D. S. Powlson, P. Smith and J. U. Smith. NATO ASI Vol. I38. Berlin: Springer-Verlag, pp. 201–22.
- Potter, C. S., Randerson, J. T., Field, C. B. *et al.* (1993) Terrestrial ecosystem production: a process-model based on global satellite and surface data. *Global Biogeochemical Cycles*, **7**, 811–41.
- Rijtema, P. E. and Kroes, J. G. (1991) Some results of nitrogen simulations with the model ANIMO. *Fertilizer Research*, **27**, 189–98.
- Romanya, J., Cortina, J., Falloon, P., Coleman, K. and Smith, P. (2000) Modelling changes in soil organic matter after planting fast-growing *Pinus radiata* on Mediterranean agricultural soils. *European Journal of Soil Science*, **51**, 627–41.

- Ryzhova, I. M. (1993) Analysis of sensitivity of soil vegetation systems to variations in carbon turnover parameters based on a mathematical-model. *Eurasian Soil Science*, **25**, 43–50.
- Saggar, S., Tate, K. R., Feltham, C. W., Childs, C. W., Parshotam, A. (1994) Carbon turnover in a range of allophanic soils amended with ^{14}C -labelled glucose. *Soil Biology and Biochemistry*, **26**, 1263–71.
- Schevtsova, L. K. and Mikhailov, B. G. (1992) *Control of Soil Humus Balance Based on Statistical Analysis of Long-term Field Experiments Database*. Moscow (in Russian): VIUA.
- Schimel, D. S., Braswell, B. H., Holland, E. A. *et al.* (1994) Climatic, edaphic, and biotic controls over storage and turnover of carbon in soils. *Global Biogeochemical Cycles*, **8**, 279–93.
- Shang, C. and Tiessen, H. (1998) Organic matter stabilization in two semiarid tropical soils: size, density, and magnetic separations. *Soil Science Society of America Journal*, **62**, 1247–57.
- Sierra, J. and Renault, P. (1996) Respiratory activity and oxygen distribution in natural aggregates in relation to anaerobiosis. *Soil Science Society of America Journal*, **60**, 1428–38.
- Sirotenko, O. D. (1991) The USSR climate-soil-yield simulation system. *Meteorologia i Gidrologia* (in Russian), **4**, 67–73.
- Skopp, J., Jawson, M. D. and Doran, J. W. (1990) Steady-state aerobic microbial activity as a function of soil-water content. *Soil Science Society of America Journal*, **54**, 1619–25.
- Smith, J. U., Bradbury, N. J. and Addiscott, T. M. (1996a) SUNDIAL: a PC-based system for simulating nitrogen dynamics in arable land. *Agronomy Journal*, **88**, 38–43.
- Smith, P., Smith, J. U. and Powlson, D. S. (1996b) *Soil Organic Matter Network (SOMNET): 1996 Model and Experimental Metadata*. Wallingford, UK.
- Smith, P., Powlson, D. S., Smith, J. U. and Glendining, M. J. (1996c) The GCTE SOMNET: a global network and database of soil organic matter models and long-term data-sets. *Soil Use and Management*, **108**, 57.
- Smith, P., Smith, J. U., Powlson, D. S. *et al.* (1997) A comparison of the performance of nine soil organic matter models using datasets from seven long-term experiments. *Geoderma*, **81**, 153–225.
- Smith, P., Andren, O., Brussaard, L. *et al.* (1998) Soil biota and global change at the ecosystem level: describing soil biota in mathematical models. *Global Change Biology*, **4**, 773–84.
- Smith, P., Falloon, P., Coleman, K. *et al.* (1999) Modelling soil carbon dynamics in tropical ecosystems. In *Global Climate Change and Tropical Soils (Advances in Soil Science)*, ed. R. Lal, J. M. Kimble, R. F. Follett and B. A. Stewart. Boca Raton, FL: CRC Press, pp. 341–64.
- Smith, P., Smith, J. U., Flynn, H. *et al.* (2007) *ECOSSE: Estimating Carbon in Organic Soils: Sequestration and Emissions. Final Report*. SEERAD Report.
- Tate, K. R., Giltrap, D. J., Parshotam, A. *et al.* (1996) Impacts of climate change on soils and land systems in New Zealand. In *Greenhouse 1994: Coping with Climate Change*, ed. W. Bouma, G. Pearman and M. R. Manning. Adelaide: CSIRO Press, pp. 190–204.
- Thornley, J. H. M. and Verberne, E. L. J. (1989) A model of nitrogen flows in grassland. *Plant Cell and Environment*, **12**, 863–86.
- Van Dam, D. and Van Breemen, N. (1995) NICCE: a model for cycling of nitrogen and carbon isotopes in coniferous forest ecosystems. *Ecological Modelling*, **79**, 255–75.
- Vanclouster, M., Viaene, P., Diels, J. and Feyen, J. (1995) A deterministic evaluation analysis applied to an integrated soil-crop model. *Ecological Modelling*, **81**, 183–95.
- Verberne, E. L. J., Hassink, J., Dewilligen, P., Groot, J. J. R. and Vanveen, J. A. (1990) Modeling organic-matter dynamics in different soils. *Netherlands Journal of Agricultural Science*, **38**, 221–38.
- Whitmore, A. P., Klein-Gunnewiek, H., Crocker, G. J. *et al.* (1997) Simulating trends in soil organic carbon in long-term experiments using the Verberne/MOTOR model. *Geoderma*, **81**, 137–51.
- Williams, J. R. (1990) The erosion-productivity impact calculator (EPIC) model: a case history. *Philosophical Transactions of the Royal Society of London, Series B* **329**, 421–8.
- Woomer, P. L. (1993) Modelling soil organic matter dynamics in tropical ecosystems: model adoption, uses and limitations. In *Soil Organic Matter Dynamics and Sustainability of Tropical Agriculture*, ed. K. Mulongoy and R. Merckx. IITA, K. U. Leuven and Wiley-Sayce, pp. 279–94.
- Zogg, G. P., Zak, D. R., Ringelberg, D. B. *et al.* (1997) Compositional and functional shifts in microbial communities due to soil warming. *Soil Science Society of America Journal*, **61**, 475–81.

13. The role of soils in the Kyoto Protocol

Pete Smith, Pete Falloon and Werner L. Kutsch

13.1 INTRODUCTION

The world's soils contain approximately 1500 Pg (1 Pg = 1 Gt = 10^{15} g) of organic carbon (Batjes, 1996), roughly three times the amount of carbon in vegetation and twice the amount in the atmosphere (IPCC, 2001; Denman *et al.*, 2007). The annual fluxes of CO₂ from atmosphere to land (global net primary productivity, NPP) and land to atmosphere (respiration and fire) are of the order of 60 Pg C y⁻¹ (IPCC, 2000b). During the 1990s, fossil fuel combustion and cement production emitted 6.4 ± 1.3 Pg C y⁻¹ to the atmosphere, while land-use change emitted 1.6 ± 0.8 Pg C y⁻¹. Atmospheric carbon increased at a rate of 3.2 ± 0.1 Pg C y⁻¹, the oceans absorbed 2.3 ± 0.8 Pg C y⁻¹ and there was an estimated terrestrial sink of 2.6 ± 1.3 Pg C y⁻¹ (Schimel *et al.*, 2001; Denman *et al.*, 2007). The amount of carbon stored in soils globally is therefore large compared to gross and net annual fluxes of carbon to and from the terrestrial biosphere, and the pools of carbon in the atmosphere and vegetation. Because of this, increasing the size of the global soil carbon pool by even a small proportion has the potential to sequester large amounts of carbon, and thus soils have an important role to play in mitigating climate change.

Human intervention, via cultivation and disturbance, has decreased and still is decreasing the soil carbon pools relative to the store typically achieved under native vegetation. Historically, these processes have caused a loss of soil carbon of between 40 and 90 Pg C globally (Paustian *et al.*, 1998; Houghton *et al.*, 1999; Lal, 1999). Thus, stopping further land-use change has become an important issue. Soil carbon sequestration can be achieved by increasing the net flux of carbon from the atmosphere to the terrestrial biosphere by increasing global NPP (thus increasing carbon inputs to the soil), by storing a larger proportion of

the carbon from NPP in the longer term carbon pools in the soil, by adding additional carbon-containing materials to the soil (such as manures or cereal straw) or by slowing decomposition. For soil carbon sinks, the best options are therefore to increase carbon stocks in soils that have been depleted in carbon, i.e. agricultural soils and degraded soils (Lal, 2004a; Smith, 2004a), since the capacity for increasing carbon storage is greatest in these soils. It is also important to minimize further losses of soil carbon stocks by more judicious land management, for example avoiding land degradation and the drainage of peatlands (e.g. Bellamy *et al.*, 2005).

The aim of this chapter is to discuss the role of soils in the Kyoto Protocol framework, indicate the possible magnitude of expected carbon mitigation potential for soils, and outline future challenges for scientists and policy makers. This chapter will focus particularly on agricultural soils that have a special role to play in the Kyoto framework since they (1) tend to have a depleted soil carbon relative to comparable soils under native vegetation and thus have a large capacity for increasing soil carbon storage and (2) are actively 'manageable' and thus can be manipulated for carbon sequestration.

It is important to note that the trace gases methane (CH₄) and nitrous oxide (N₂O) are also potent greenhouse gases and are emitted from, and absorbed by, soils. For this reason, soils also have a second role to play – reducing emissions of other trace gases than CO₂ to the atmosphere – in combating climate change. Nitrous oxide is formed primarily from nitrification and denitrification processes. Nitrous oxide is a by-product of nitrification and an intermediate during denitrification. Nitrous oxide fluxes from agricultural soils (0.53 Pg C equivalents y⁻¹) account for more than 50% of the global anthropogenic N₂O flux (Robertson, 2004).

Table 13.1 *Soil carbon sequestration measures in agricultural land (after Smith, 2004c).*

(a) Cropland	(b) Grazing land
<ul style="list-style-type: none"> • Zero/reduced tillage • Set-aside/Conservation Reserve Programme • Convert to permanent crops • Convert to deep-rooting crops • Improve efficiency of animal manure use • Improve efficiency of crop residue use • Agricultural use of sewage sludge • Application of compost to land • Rotational changes • Fertilizer use • Irrigation • Bioenergy crops • Extensification/De-intensification of farming • Organic farming (a combination of many different individual practices) • Convert cropland to grassland • Management to reduce wind and water erosion 	<ul style="list-style-type: none"> • Improve efficiency of animal manure use • Improve efficiency of crop residue use • Improve livestock management to reduce soil disturbance • Improve livestock management to maximize manure C returns • Agricultural use of sewage sludge • Convert to deeper-rooting species • Application of compost to land • Fertilizer use • Irrigation • Extensification/De-intensification of farming • Improved management to reduce wind and water erosion

The majority (52%) of the methane flux from agriculture arises from enteric fermentation in ruminants, with biomass burning (19%) and animal waste treatment (8%) accounting for other significant proportions (Robertson, 2004). The only significant soil source of methane in agriculture arises from rice cultivation (0.25 Pg C equivalents y^{-1}), which accounts for 22% of agricultural emissions or 12% of total anthropogenic fluxes (Robertson, 2004). There are also significant fluxes of N_2O and methane from natural ecosystems, and, conversely, CH_4 might be oxidized in considerable amounts under certain land-use management. However, since carbon storage and trace gas fluxes from natural ecosystems offer less greenhouse mitigation potential and are harder to manage, we focus on the role of agricultural soils in this chapter.

13.2 HOW MUCH COULD AGRICULTURAL SOILS CONTRIBUTE TO COMBATING CLIMATE CHANGE?

Agricultural soils can act as sources and sinks for CO_2 and other greenhouse gases. Whether soils act as a sink or source, and the sink/source strength, depends critically upon the management of the soil. The greenhouse gas mitigation potential for agricultural soils results

from reducing emissions or from increasing carbon inputs. For CO_2 this entails reducing the CO_2 efflux from the soil or sequestering carbon in the soil. For N_2O , this entails reducing N_2O emissions. For CH_4 , this entails reducing CH_4 emissions from soils emitting CH_4 (e.g. rice paddy soils) and maximizing the methane oxidation potential of other soils.

Cropland soils can be a large source of CO_2 (Janssens *et al.*, 2003). There is significant potential to reduce the efflux of carbon from agricultural soils, and to sequester carbon in them. Estimates of the potential for additional soil carbon sequestration vary widely. The most recent global estimate is that of Lal (2004a) of 0.9 ± 0.3 Pg C y^{-1} ; over 50 years, this level of carbon sequestration would potentially restore a large part of the carbon lost from soils historically. However, soil carbon sequestration rates have a limited duration and cannot be maintained indefinitely. Mitigation options for agricultural soil carbon are given in Table 13.1.

Options for N_2O mitigation are given in Table 13.2. Mitigation of CH_4 fluxes from agricultural soils needs to focus almost entirely on the rice paddy fluxes. Rice crop management to reduce CH_4 emissions including yield improvement with well managed, high-yield rice crops have significantly lower CH_4 emissions due to more carbon being allocated to the grain than to the

Table 13.2 *Nitrous oxide mitigation options for agricultural soils (after Smith et al., 2004).*

Practices	
Inorganic fertilizer	<p>Suitable type and characteristics e.g.</p> <ul style="list-style-type: none"> – ammonium providing fertilizer vs. nitrate fertilizer – slow-release inhibitors – inhibitors <p>Application techniques</p> <ul style="list-style-type: none"> – synchronization/timing (e.g. split-application to coincide with crop demand) – placement, burial may reduce flux <p>Amount/rate of application, appropriate fertilizer recommendations required</p>
Organic fertilizer	<p>Type</p> <ul style="list-style-type: none"> – Farm/yard manure (flux dependent on degree of maturity/degradation, moisture content) – Liquid fertilizer/slurry (give higher fluxes than dried material, avoid spreading with mineral fertilizer) – industrial waste – household waste – biogas residue – fermented manure <p>Timing (less critical than inorganic)</p> <p>Application techniques</p> <p>Storage, processing, and handling (temperature, duration, capacity, cover etc.)</p> <p>Amount/rate of application (apply at recommended rate to coincide with crop demand)</p>
Biological N fixation	Avoid mono cropping, flux dependent on legumes/grass mixture ratio and is mostly after ploughing; net effect is unknown
Crop residue	<p>(Important for C sequestration)</p> <p>Quality and size (C : N ratio, total N)</p> <p>Quantity (weight)</p> <p>Application/incorporation techniques (note the interaction with tillage; priming effect on soil N₂O flux mainly with incorporation) avoid wet conditions</p>
Farming system and management	Extensive cropping may be better than intensive – further research needed to assess this difference and the effect of the arable/livestock ratio. Also compare to intensive areas with other land use on spare land
Tillage	<p>Important for carbon sequestration but interacts with soil physical conditions</p> <p>Ploughing or deep ploughing may reduce trace gas emissions but decrease carbon sequestration</p> <p>Conservation (reduced) tillage may be intermediate but more information required</p>
Crop rotation	<p>Catch crops reduce bare soils (possible link to BNF)</p> <p>Amelioration crops (crop type, i.e. deep rooting or shallow rooting)</p>
Water management	Drainage useful but irrigation should be avoided, flooding water buffers may have an effect
Compaction status	<p>Appropriate timing and size of machinery required</p> <p>Manage grazing to avoid poaching</p>

rhizosphere where it can undergo methanogenesis. Other mitigation options in rice include residue management and irrigation scheduling (Robertson, 2004).

Robertson (2004) emphasizes the need for a systems approach for assessing greenhouse gas mitigation potential in agriculture. For example, increasing soil carbon stocks in the soil through reduced tillage can lead to anaerobic zones in some soils and thereby increase N_2O emissions (MacKenzie *et al.*, 1998; Smith *et al.*, 2001; Six *et al.*, 2004; Li *et al.*, 2005). Similarly, management to reduce CH_4 emissions in rice paddy fields might increase N_2O emissions. Trade-offs between the greenhouse gases are complex (Robertson *et al.*, 2000), but should always be considered.

Estimation of mitigation potential is often confounded by the choice of constraints. Some authors quote biological potentials (Metting *et al.*, 1999), others consider either limitation of available land or resources (Smith *et al.*, 2000), or economic and social constraints (Cannell, 2003; Freibauer *et al.*, 2004). Smith (2004a) provided a figure showing how these mitigation potential estimates differ and how the potential is reduced by a number of constraints (Fig. 13.1).

An analysis of the estimates presented in Freibauer *et al.* (2004) and the assumptions used by Cannell (2003) suggest that the realistic sustainable (or conservative) achievable potential of greenhouse gas mitigation (taking into account limitations in land use, resources, economics, and social and political factors) may be about 10 to 20% of the biological potential. Although this value is derived predominantly from so-called ‘expert judgement’, it may be useful in assessing how different estimates of greenhouse gas mitigation potential can be compared and how they might realistically contribute to greenhouse gas stabilization.

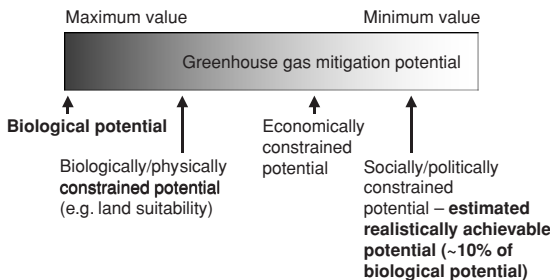

Figure 13.1 How different constraints reduce the greenhouse gas mitigation potential from its theoretical biological maximum to realistically achievable potentials that are much lower (adapted from Smith, 2004a).

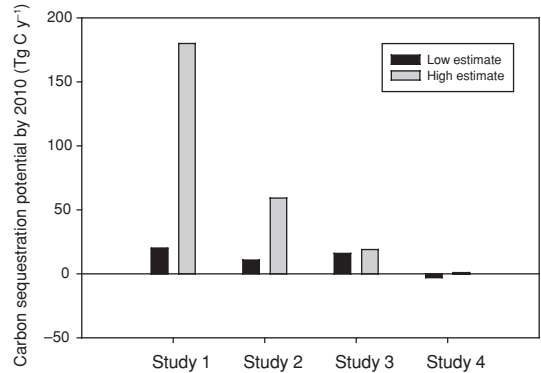

Figure 13.2 Estimates of cropland soil carbon sequestration potential in EU-15 from previous studies and from this study. Study 1 is from Vleeshouwers and Verhagen (2002) with the low estimate for straw incorporation and the high figure for conversion of all cropland to grassland. Study 2 is from Smith *et al.* (2000) with figures scaled from geographical Europe (including Baltic States but excluding Russia) to EU-15 as per Smith *et al.* (1997). The low estimate is from the combined land-management scenario with extensification of surplus arable land and straw incorporation; the high estimate is for the combined ‘optimal’ scenario (see Smith *et al.*, 2000 for further details). Study 3 is from Freibauer *et al.* (2004) with values assessed for realistically achievable potential by 2010 (about 1/5 of the estimated biological potential). Study 4 uses figures based on measured trends in 1990 to 2000 and extrapolations to 2010 (Smith *et al.*, 2004).

In a study of European agricultural greenhouse gas mitigation potential, a range of estimates of carbon sequestration potential were compared. The results (Fig. 13.2) show that by including more constraints in the calculation, the estimated mitigation potential is drastically reduced.

Estimates on the left of Fig. 13.2 are for biological potential while those on the right extrapolate from current trends. These findings show that, despite a high biological potential for carbon sequestration in European agricultural soils, lack of policy incentives to implement carbon sequestration measures means that virtually none of this potential will be realized by the end of the first Kyoto commitment period in 2012.

13.3 THE FUTURE FOR SOIL CARBON SEQUESTRATION

Smith (2004b) recently calculated how future carbon emissions and CO_2 stabilization targets might influence the relevance of soil carbon sequestration

as a greenhouse gas mitigation measure. The future trajectory of carbon emissions over the next century depends upon many factors. The IPCC developed a range of standard reference emission scenarios (SRES) to provide estimates of possible emissions under a range of different possible futures (IPCC, 2000a). These possible futures depend upon the degree to which greenhouse gas mitigation policies become global and upon whether environmental or economic concerns take precedence over the next century.

For example, among the A1 family of scenarios (global – free market), a number of possible emissions trajectories exist depending upon whether the energy sector remains fossil fuel intensive (A1FI), whether the rapid introduction of new energy technologies allows a move away from carbon-intensive energy sources (A1T) or whether there is a mix of fossil fuel/alternative energy sources (A1B).

The A2 scenario family represents a very heterogeneous world with continuously increasing global population and regionally oriented economic growth that is more fragmented and slower than in other storylines. The B1 scenario family depicts a convergent world with the same global population as in the A1 situation but with rapid changes in economic structures toward a service and information economy, with reductions in material intensity, and the introduction of clean and resource-efficient technologies. Finally, the B2 assumption represents a world in which the emphasis is on local solutions to economic, social and environmental sustainability, with continuously increasing population (lower than A2) and intermediate economic development.

In all of these scenarios, the global population will grow, become wealthier and per-capita energy demand will increase over the next century (IPCC, 2000a), but to a different extent. Consequently, for each of the scenarios carbon emission trajectories have been determined (IPCC, 2000a) and annual carbon emissions (Pg C y^{-1}) by 2100 are estimated to be A1FI \sim 30, A1B \sim 17, A1T \sim 7, A2 \sim 28, B1 \sim 6, B2 \sim 18.

Emissions trajectories can also be calculated for a range of atmospheric CO_2 stabilization targets (e.g. 450, 550, 650 and 750 ppm). For each stabilization target, the allowed carbon emission trajectories, which cannot be exceeded if the target is to be reached, can be calculated. The difference between the allowed emission trajectory for stabilization at a given target concentration, and the emissions associated with the estimated global energy

demand is the carbon emission gap. For a stabilization target of 550 ppm, carbon emission gaps for each scenario by 2100 (in Pg C y^{-1}) are A1FI = 25, A1B = 12, A1T = 2, A2 = 22, B1 = 1, B2 = 13 (IPCC, 2001).

The current annual emission of CO_2 -carbon to the atmosphere is $6.3 \pm 1.3 \text{ Pg C y}^{-1}$. Carbon emission gaps by 2100 could be as high as 25 Pg C y^{-1} meaning that the carbon emission problem could be up to four times greater than at present. The maximum (biological, Fig. 13.1) annual global carbon sequestration potential is $0.9 \pm 0.3 \text{ Pg C y}^{-1}$ meaning that even if these rates could be maintained until 2100, soil carbon sequestration would contribute only a maximum of 2 to 5% towards reducing the carbon emission gap under the highest emission scenarios. Considering the limited duration of carbon sequestration options in removing carbon from the atmosphere, we see that soil carbon sequestration could play only a minor role in closing the emission gap by 2100. It is clear from these figures that if we wish to stabilize atmospheric CO_2 concentrations by 2100, the increased global population and its increased energy demand can only be supported if there is a large-scale switch to non-carbon emitting technologies for producing energy.

Given that soil carbon sequestration can play only a minor role in closing the carbon emission gap by 2100, is there any role for carbon sequestration in climate mitigation in the future? The answer is yes. If atmospheric CO_2 levels are to be stabilized at reasonable concentrations by 2100 (e.g. 450–650 ppm), drastic reductions in emissions are required over the next 20 to 30 years (IPCC, 2000a). During this critical period, the sum of all measures to reduce net carbon emissions to the atmosphere will play an important role – there will likely be no single solution (IPCC, 2000a). Given that soil carbon sequestration is probably to be most effective in its first 20 years of implementation, it should form a central role in any portfolio of measures to reduce atmospheric CO_2 concentrations over the next 20 to 30 years while new energy technologies are developed and implemented (Smith, 2004b).

13.4 THE ROLE OF SOILS IN THE KYOTO PROTOCOL

The Kyoto Protocol (Annex B, available from www.cop3.de/) lists the Quantified Emission Limitation or Reduction Commitments for 39 of the parties that ratified the United Nations Framework Convention

on Climate Change (UNFCCC). For example, the European Union (EU) is committed to an 8% reduction in CO₂ emissions compared to baseline (1990) levels during the first commitment period (2008–12). The EU member states have rearranged this commitment internally since the Kyoto Protocol was signed, such that the sum of the EU commitments is still an 8% reduction, but, for example, the UK is committed to a 12.5% reduction (DETR, 1998) while Greece is allowed to increase emissions by 25%.

The Kyoto Protocol allows carbon emissions to be offset by demonstrable removal of carbon from the atmosphere. Thus, land-use/land-management change and forestry activities that are shown to reduce atmospheric CO₂ levels can be included in the Kyoto emission reduction targets. These activities include afforestation, reforestation and deforestation (Article 3.3 of the Kyoto Protocol) and may include the improved management of agricultural soils, grazing, land management, forest management and revegetation (Article 3.4). On the other hand, additional carbon emissions caused by land-use change (e.g. due to deforestation) have also to be accounted for. These carbon emissions as well as the offset by carbon sequestration have to be reported as part of national greenhouse gas inventories. The respective guidelines (IPCC, 2006) define precise rules for preparing annual greenhouse gas inventories in the Agriculture, Forestry and Other Land Use sector (AFOLU, see also: www.ipcc-nggip.iges.or.jp/public/2006gl/vol4.html). In the following sections, we briefly describe the AFOLU procedure and methods.

13.4.1 The AFOLU guidelines

The AFOLU guidelines define six land-use categories: Forest Land (FL), Cropland (CL), Grassland (GL), Wetlands (WL), Settlements (SL) and Other Land (OL). Within each land-use category different strata or subdivisions of land area (depending on, e.g. climate zone, ecotype, soil type and management regime) can be defined. Carbon stock changes within a stratum are estimated by considering carbon cycle processes between the five carbon pools:

$$\Delta C_{LUi} = \Delta C_{AB} + \Delta C_{BB} + \Delta C_{DW} + \Delta C_{LI} \\ + \Delta C_{SO} + \Delta C_{HWP}$$

where ΔC_{LUi} : carbon stock changes for a stratum of a land-use category.

Subscripts denote the following carbon pools:

AB:	above-ground biomass
BB:	below-ground biomass
DW:	deadwood
LI:	litter
SO:	soils
HWP:	harvested wood products.

Depending on relevance, data and model availability, as well as resources and capacity to collect and analyze additional information, the reporting country has to choose between different tiers in estimating changes in carbon pools and fluxes. These tiers increase in complexity as shown in the box below.

Tiers

Tier 1 methods are designed to be the simplest to use, for which equations and default parameter values are provided by the guidelines (IPCC, 2006). *Tier 2* can use the same methodological approach as *Tier 1* but applies emission and stock change factors that are based on country- or region-specific data. Higher temporal and spatial resolution and more disaggregated activity data are typically used in *Tier 2*. At *Tier 3*, higher order methods are used, including models (as described in [Chapter 12](#), Falloon and Smith) and inventory measurement systems (as described in [Chapter 4](#), Rodeghiero *et al.*) tailored to address national circumstances, repeated over time, and driven by high-resolution activity data and disaggregated at sub-national level. These higher order methods provide estimates of greater certainty than lower tiers. Such systems may include comprehensive field sampling repeated at regular time intervals and/or GIS-based systems of age, class/production data, soils data, and land-use and management activity data, integrating several types of monitoring (IPCC, 2006).

The choice of the tier methods depends on the relevance of the land-use category. So-called key source/sink categories have to be reported at least with *Tier 2* methods. A key source/sink category is prioritized within the national inventory system because its estimate has a significant influence on a country's total inventory of greenhouse gases in terms of the absolute level, the trend, or the uncertainty in emissions and removals. Key category analysis helps a country to achieve the most reliable inventory given the resources available (IPCC, 2006).

The guidelines distinguish between lands that remain in the same category but are affected by management changes and lands which are converted to another category. Changes in management or land-use category are called *activities* (reported in area) and have to be multiplied with an *emission factor* that describes the source/sink strength of each kind of activity (reported in tonnes CO₂ per area and year).

13.4.2 Methodological challenges

Since there is a significant role for carbon sequestration in climate mitigation in the next 20 to 30 years, it will be essential to accurately monitor the amounts of carbon sequestered in order to estimate its role in closing the carbon emission gap. The ambitious Tier 2 and Tier 3 methods regarding changes in soil carbon stocks reflect these requirements (Aalde *et al.*, 2006).

Changes in soil carbon sinks and sources have to be accounted for on a net–net basis, comparing the net flux of carbon from a given activity during the commitment period with the equivalent net flux of carbon in the baseline year. Sinks and sources of carbon must be accounted for ‘taking into account uncertainties, transparency in reporting, verifiability’. Several methodological challenges arise.

- Levels of soil sampling need to be adequate to represent spatial variation, overcome resolution problems (detectable levels of change) and satisfy verification requirements; this could be extremely costly, depending on the scale and design of carbon sequestration projects.
- To achieve the highest levels of certainty, any chosen method (such as stock changes) would need to be backed up by a second independent assessment method such as flux methods or models. However, flux measurements at a sufficient density to represent individual land-use sectors and specific land-use and management activities are expensive. It is also difficult to factor out the individual contributions of soil, roots and above-ground vegetation (Aalde *et al.*, 2006).
- Further, with any measurement system, it is very difficult to demonstrate that changes in carbon stocks are directly due to human-induced activity rather than other causes such as nitrogen deposition, CO₂ fertilization or indeed changes in climate – although well validated models could have a role to play in this regard.

13.4.2.1 Field measurements

There are three levels in the current Kyoto verification framework:

- Level 1: Monitoring and self-reporting by parties on emissions and removals of greenhouse gases by Article 3.4 activities according to IPCC reporting guidelines and good practice guidelines.
- Level 2: Validation and verification at the national level, including by peer and public review.
- Level 3: Validation and verification at the international level by expert review teams according to Article 8 of the protocol.

Measurement methods for assessing changes in land carbon stocks are summarized in Table 13.3. At its most stringent, verifiability under Kyoto activities would require the sampling of each geo-referenced piece of land subject to an Article 3.4 activity at the beginning and end of a commitment period, using a sampling regime that gives adequate statistical power (see Chapter 3, Subke *et al.*, and Chapter 4, Rodeghiero *et al.*). Soil and vegetation samples would be archived and the data from each piece of land aggregated to produce a national figure. Separate methods would be required to deliver a second set of independent verification data (Smith, 2004c). However, such an undertaking at the national level would likely be prohibitively expensive. An intermediate level of stringency would require areas under a given practice to be geo-referenced from remote sensing or ground survey. Changes in carbon would be derived from controlled experiments on representative climatic regions and soil types, or modelled using a well evaluated, well documented and archived model. Intensively studied benchmark sites would also be available for verification. At its least stringent, verifiability would entail the reporting of areas under a given practice (without geo-referencing) and the use of default values for a carbon stock change for each practice, to infer a change for all areas under that practice. A less stringent definition of verifiability would allow simple methods, such as those derived from IPCC default values for CO₂ fluxes from soil, to be used for estimating changes in soil carbon. These may enable low-level verifiability to be achieved by most parties during the first commitment period (2008–12).

In practice, most parties could achieve only the least stringent level of verification. The most sophisticated systems currently in use would achieve intermediate

Table 13.3 *Measurement methods for assessing losses or accumulations of carbon on land. Compiled from information in IPCC (2000b) after Smith (2004c).*

Stock change measurements methods	Flux measurement methods	Remote sensing to determine geographic extent and change
<ul style="list-style-type: none"> • Vegetation inventory • Stemwood volume – forest inventory • Total tree biomass – allometry • Wood products – models of wood products • Soil and litter • Woody debris – volume and mass measured • Litter – sampling and carbon analysis – highly spatially variable • Mineral soil – sampling and carbon analysis – highly spatially variable (sampling strategy, methods and sampling depth all need to be considered) 	<ul style="list-style-type: none"> • Chambers, eddy covariance – for scales less 1 km² • Tall towers, balloons for convective boundary layer budgeting – landscape, regional scale • Flask measurements and flux measurements from aircraft; coupled with inversion analysis – continental scale 	<ul style="list-style-type: none"> • Current resolution (NOAA-AVHRR) is 1 km² but 30 m possible soon • Geographic extent possible, vegetation type possible, residue over, tillage, and perhaps soil organic carbon and moisture content of bare soil will become possible in near future

verification, and none could meet the most stringent standards. It is generally felt that the IPCC is likely to recommend, and COP likely to choose, the least stringent level of verifiability for Kyoto accounting. This would entail simple area-based accounting with country-specific emission factors. Several countries (e.g. Denmark and Portugal in the EU) have elected for cropland management, but have no complex verification systems in place.

A particular consideration with measurement-based approaches is cost. A recent study by Garten and Wullschleger (1999) showed that demonstrating a change in soil carbon of 5 t C ha⁻¹ over five years (or 10 to 15% of background C) would require 16 samples to obtain 90% statistical significance. The smallest

changes that can be reasonably detected are 1 t C ha⁻¹ over five years (or 2 to 3% of background C) with the same level of confidence (90%), but only with very large (>100) sample numbers. Soil carbon sample costs typically range from US\$3 to about US\$20 depending on labour costs. Since demonstrating a change in soil carbon of 1 to 5 tonnes C ha⁻¹ would require 16 to 100 samples (at 90% confidence), the sample costs (at \$10, or \$160 to \$1000) would likely exceed the current value of the carbon sequestered (1 to 5 tonnes C at \$20, or \$20 to \$100).

13.4.2.2 Modelling

The need to provide information on uncertainty in carbon sequestration estimates presents further

challenges, not least given that the IPCC (2000b) recommends the use of models in combination with direct sampling methods. For example, consider the use of a dynamic modelling approach for carbon sequestration estimates. Such models (as presented in Chapter 12, Falloon and Smith) are usually tested against datasets of long-term changes in soil organic carbon (SOC), but many datasets have only mean SOC values available at each sample date, with no estimates of error about the mean. Falloon and Smith (2003) showed that when using datasets that do not include estimates of error about the mean, it is not possible to reduce the error (root mean squared error) between modelled and measured values below 6.8 to 8.5%, even with site-specific model calibration. Using error as an indicator of the certainty that can be attached to model projections, a significant reduction in uncertainty would be needed for Kyoto Protocol accounting. This could be achieved by better replication of soil measurements at benchmark sites, which would allow model error to be separated from measurement error. Thus more comprehensive model testing could be completed, and more certainty could be attached to model projections. This would be a practical option for benchmark testing of models at a small number of global sites, but would be prohibitively expensive to implement were it needed for more routine monitoring assessments at a large number of sites. At the national scale, information on uncertainty is even scarcer (Smith, 2004c). A further limitation with national or regional scale approaches is the availability and quality of input data, such as spatial information on land use, productivity and soil types. One possibility is to employ probabilistic approaches such as Monte Carlo statistical techniques with dynamic models, although this would only address uncertainties in model outputs, and would be computationally expensive for larger scale applications.

Finally, there are a number of limitations in many of the current soil carbon models – some of these are discussed by Falloon and Smith (Chapter 12). Importantly, most soil carbon models currently do not account for organic soils (with the exception of ECOSSE – Smith *et al.*, 2007). Most soil carbon models are not generally applicable to permanently waterlogged or very dry soils (Falloon *et al.*, 2008b) and have not been parameterized for use with subsoils or recent volcanic soils with a high allophane content (Falloon *et al.*, 2006) although the RothC model has recently been extended

for subsoils (Jenkinson and Coleman, 2008). For more information on challenges for soil modelling, see Chapter 12 (Falloon and Smith).

13.4.2.3 Integrating different methods

Future challenges lie in developing robust, transparent carbon accounting and verification systems that combine models with a variety of direct and indirect measurement techniques that are repeatable and can be performed quickly and cheaply, allowing for projections to be verified by two independent datasets where possible. Collection of information to contribute to uncertainty estimates in these assessments is crucial, and replication of soil measurements at global benchmark sites is an example of how this might be achieved. Modelling techniques that can separate the influence of human-induced changes in activity on changes in carbon stocks from changes driven by other causes (such as statistical detection and attribution, and data assimilation) will help contribute to these aims. Recent work (see Chapter 12, Falloon and Smith) has also shown that the carbon cycle itself could be vulnerable to future climate change, which implies that the impact of climate change on future soil carbon sequestration potential should be carefully considered (Falloon *et al.*, 2008a). This implies that models with a systems approach are likely to be of great use by integrating the different driving factors – such as changes in climate, land use and soil properties, and their interactions. These issues should be met with urgency if carbon sequestration is to play the significant role it deserves in climate mitigation in the next 20 to 30 years.

13.4.3 Multiple benefits from greenhouse gas mitigation by agricultural soils

Soil carbon sequestration is a process under the control of human management and, as such, the social dimension needs to be considered when implementing soil carbon sequestration practices. Since there will be increasing competition for limited land resources in the coming century, soil carbon sequestration cannot be viewed in isolation from other environmental and social needs. The IPCC (2001) has noted that global, regional and local environmental issues such as climate change, loss of biodiversity, desertification, stratospheric ozone depletion, regional acid deposition and local air quality are inextricably linked. Soil degradation clearly belongs

in this list. The importance of integrated approaches to sustainable environmental management is becoming ever clearer.

In any scenario, there will be winners and losers. The key to increasing soil carbon sequestration, as part of wider programmes to enhance sustainability, is to maximize the number of winners and minimize the number of losers. One possibility for improving the social/cultural acceptability of soil carbon sequestration measures would be to include compensation costs for losers when costing implementation strategies. By far the best option, however, is to identify win-win measures (Lal, 2004a), i.e. those that increase carbon stocks while at the same time improving other aspects of the environment, e.g. improved soil fertility, soil tilth, nutrient cycling, water holding capacity and drainage, decreased erosion or greater profitability, e.g. improved yield of agricultural or forestry products. For instance, soil carbon sequestration on degraded soils would considerably aid their restoration, thus both increasing carbon stocks and bringing additional environmental improvements. There are also a number of management practices available that could be implemented to protect and enhance existing carbon sinks now, and in the future, i.e. a no-regrets policy. Smith and Powlson (2003) developed these arguments for soil sustainability, but the no-regrets policy option is equally applicable to soil carbon sequestration. A no-regrets climate change policy is a choice among policies that are equally beneficial, apart from the consideration of climate change. A no-regrets climate policy should therefore have non-climate benefits (for example, the benefits of increasing soil carbon mentioned above) as well as being robust to climate change. Therefore soil carbon storage is a legitimate no-regrets climate policy using this definition because, for example, increasing carbon storage means improving agricultural land while also mitigating climate change.

Since such practices are consistent with, and may even be encouraged by, many current international agreements and conventions, their rapid adoption should be encouraged as widely as possible.

13.4.4 Integration of different conventions

The soil carbon sequestration strategy is the common link between three UN Framework Conventions:

Climate Change, Biodiversity and Desertification Control. Soil carbon sequestration can reduce the rate of enrichment of atmospheric CO₂ by 0.6 to 1.2 Pg C y⁻¹ while enhancing biodiversity and controlling desertification. Restoration of degraded/desertified soils and ecosystems is an important ancillary benefit of soil carbon sequestration.

Of all the ancillary benefits, the impact of soil carbon sequestration in advancing global food security can neither be ignored nor overemphasized. Severe soil degradation is a common problem among all regions threatened by food insecurity including sub-Saharan Africa, Central and South Asia, the Andean region, the Caribbean etc. The soil carbon pool in these regions has been strongly depleted because of the extractive agricultural practices such as complete residue removal for fodder and fuel, uncontrolled and excessive grazing, nutrient mining caused by low external input of chemical fertilizers and organic amendments etc. Increasing the soil's carbon pool is necessary to improving its quality and enhancing productivity of crops, pastures and tree plantations grown on them. The soil carbon pool of many soils of South Asia and sub-Saharan Africa is as low as 0.1 to 0.2%, in contrast to the critical limit of the soil carbon concentration of 1.1% for maintenance of an adequate level of soil quality (Aune and Lal, 1997). The entry point for breaking the vicious cycle of degraded soils – depleted soil carbon pool – low crop yields – poverty – hunger – further degradation of soils – is through adopting land-use and management systems that restore soil carbon pools (Lal, 2004b). There is a very close link between soil carbon sequestration and global food security. Indeed, soil carbon sequestration is an important ancillary benefit of the inevitable necessity of enhancing soil quality for feeding the global population of 6 billion in 2000, which is expected to reach 7.5 billion by 2020 and 9.4 billion by 2050.

13.5 SUMMARY AND CONCLUSIONS

There is considerable biological potential to reduce greenhouse gas emissions from agricultural soils but many factors prevent the realization of the full biological potential. When considering greenhouse gas mitigation, it is important to consider all of the greenhouse gases together, as a management practice suitable for reducing one gas may increase emissions of another. The

potential impact of future climate change on mitigation potential should also be carefully considered (Falloon *et al.*, 2008a; and see Chapter 12, Falloon and Smith). Successful greenhouse gas mitigation options for agricultural soils will likely be those that provide other economic and environmental benefits, and win–win strategies should be targeted. In the long term, soil-based greenhouse gas mitigation options (including carbon sequestration) can play only a small role in reducing the gap between projected emissions and the reduction in emissions necessary to achieve atmospheric CO₂ stabilization. Nevertheless, since it is critical that we reduce greenhouse gas emissions over the next 20 to 30 years to achieve CO₂ stabilization within a century, and since there is no single solution, soil-based greenhouse gas mitigation options should form an important part of a broad portfolio of measures aimed at reducing and monitoring greenhouse gas emissions.

ACKNOWLEDGEMENTS

Pete Falloon's contribution was supported by the UK Department of the Environment, Food and Rural Affairs under contract PECD 7/12/37.

REFERENCES

- Aalde, H., Gonzalez, P., Gytarsky, M. *et al.* (2006) Generic methodologies applicable to multiple landuse categories. In *2006 IPCC Guidelines for National Greenhouse Gas Inventories Prepared by the National Greenhouse Gas Inventories Programme*, ed. H. S. Eggleston, L. Buendia, K. Miwa, T. Ngara and K. Tanabe. Hayama, Japan: IGES.
- Aune, J. B. and Lal, R. (1997) Agricultural productivity in the tropics and critical limits of properties of Oxisols, Ultisols, and Alfisols. *Tropical Agriculture*, **74**, 96–103.
- Batjes, N. H. (1996) Total carbon and nitrogen in the soils of the world. *European Journal of Soil Science*, **47**, 151–63.
- Bellamy, P. H., Loveland, P. J., Bradley, R. I., Lark, R. M. and Kirk, G. J. D. (2005) Carbon losses from all soils across England and Wales 1978–2003. *Nature*, **437**, 245–8.
- Cannell, M. G. R. (2003) Carbon sequestration and biomass energy offset: theoretical, potential and achievable capacities globally, in Europe and the UK. *Biomass and Bioenergy*, **24**, 97–116.
- Denman, K. L., Brasseur, G., Chidthaisong, A. *et al.* (2007) Couplings between changes in the climate system and biogeochemistry. In *Climate Change 2007: The Physical Science Basis. Contribution of Working Group I to the Fourth Assessment Report of the Intergovernmental Panel on Climate Change*, ed. S. Solomon, D. Qin, M. Manning *et al.* Cambridge: Cambridge University Press.
- DETR (1998) *UK Climate Change Programme: Department of the Environment, Transport and the Regions Consultation Paper*. London: Department of the Environment, Transport and the Regions, HMSO.
- Falloon, P. and Smith, P. (2003) Accounting for changes in soil carbon under the Kyoto Protocol: need for improved long-term data sets to reduce uncertainty in model projections. *Soil Use and Management*, **19**, 265–9.
- Falloon, P., Smith, P., Bradley, R. I. *et al.* (2006) RothC UK: a dynamic modelling system for estimating changes in soil C at 1-km resolution in the UK. *Soil Use and Management*, **22**, 274–88.
- Falloon, P., Smith, P., Betts, R. *et al.* (2008a) Carbon sequestration and greenhouse gas fluxes in cropland soils: climate opportunities and threats. In *Climate Change and Crops*, ed. S. N. Singh. Berlin: Springer.
- Falloon, P. D., Jones, C. D., Ades, M. and Paul, K. (2008b) Soil moisture controls of future global soil carbon changes: an unconsidered source of uncertainty. *Global Biogeochemical Cycles* (in revision).
- Freibauer, A., Rounsevell, M. D. A., Smith, P. and Verhagen, J. (2004) Carbon sequestration in the agricultural soils of Europe. *Geoderma*, **122**, 1–23.
- Garten, C. T. and Wulschleger, S. D. (1999) Soil carbon inventories under a bioenergy crop (Switchgrass): measurement limitations. *Journal of Environmental Quality*, **28**, 1359–65.
- Houghton, R. A., Hackler, J. L. and Lawrence, K. T. (1999) The US carbon budget: contributions from land-use change. *Science*, **285**, 574–8.
- IPCC (2000a) *Special Report on Emissions Scenarios*. Cambridge: Cambridge University Press.
- IPCC (2000b) *Land Use, Land-use Change, and Forestry. A Special Report of the IPCC*. Cambridge: Cambridge University Press.
- IPCC (2001) *Climate Change 2001: The Scientific Basis (Contribution of Working Group I to the Third Assessment Report of the Intergovernmental Panel on Climate Change)*. Cambridge: Cambridge University Press.

- IPCC (2006) *2006 IPCC Guidelines for National Greenhouse Gas Inventories, Prepared by the National Greenhouse Gas Inventories Programme*, ed. H. S. Eggleston, L. Buendia, K. Miwa, T. Ngara and K. Tanabe. Hayama, Japan: IGES.
- Janssens, I. A., Freibauer, A., Ciais, P. *et al.* (2003) Europe's terrestrial biosphere absorbs 7 to 12% of European anthropogenic CO₂ emissions. *Science*, **300**, 1538–43.
- Jenkinson, D. S. and Coleman, K. C. (2008) The turnover of organic carbon in subsoils. Part 2. Modelling carbon turnover. *European Journal of Soil Science*, **59**, 400–13.
- Lal, R. (1999) Soil management and restoration for C sequestration to mitigate the accelerated greenhouse effect. *Progress in Environmental Science*, **1**, 307–26.
- Lal, R. (2004a) Soil carbon sequestration to mitigate climate change. *Geoderma*, **123**, 1–22.
- Lal, R. (2004b) Soil carbon sequestration impacts on global climate change and food security. *Science*, **304**, 1623–7.
- Li, C. S., Frolking, S. and Butterbach-Bahl, K. (2005) Carbon sequestration in arable soils is likely to increase nitrous oxide emissions, offsetting reductions in climate radiative forcing. *Climatic Change*, **72**, 321–38.
- MacKenzie, A. F., Fan, M. X. and Cadrin, F. (1998) Nitrous oxide emission in three years as affected by tillage, corn–soybean–alfalfa rotations, and nitrogen fertilization. *Journal of Environmental Quality*, **27**, 698–703.
- Metting, F. B., Smith, J. L. and Amthor, J. S. (1999) Science needs and new technology for soil carbon sequestration. In *Carbon Sequestration in Soils: Science, Monitoring and Beyond*, ed. N. J. Rosenberg, R. C. Izaurralde and E. L. Malone. Columbus, OH: Battelle Press, pp. 1–34.
- Paustian, K., Cole, C. V., Sauerbeck, D. and Sampson, N. (1998) CO₂ mitigation by agriculture: an overview. *Climatic Change*, **40**, 135–62.
- Robertson, G. P. (2004) Abatement of nitrous oxide, methane and other non-CO₂ greenhouse gases: the need for a systems approach. In *The Global Carbon Cycle. Integrating Humans, Climate, and the Natural World. Scope 62*, ed. C. B. Field and M. R. Raupach. Washington, DC: Island Press, pp. 493–506.
- Robertson, G. P., Paul, E. A. and Harwood, R. R. (2000) Greenhouse gases in intensive agriculture: contributions of individual gases to the radiative forcing of the atmosphere. *Science*, **289**, 1922–5.
- Schimel, D. S., House, J. I., Hibbard, K. A. *et al.* (2001) Recent patterns and mechanisms of carbon exchange by terrestrial ecosystems. *Nature*, **414**, 169–72.
- Six, J., Ogle, S. M., Breidt, F. J. *et al.* (2004) The potential to mitigate global warming with no-tillage management is only realized when practised in the long term. *Global Change Biology*, **10**, 155–60.
- Smith, P. (2004a) Engineered biological sinks on land. In *The Global Carbon Cycle. Integrating Humans, Climate, and the Natural World, Scope 62*, ed. C. B. Field and M. R. Raupach. Washington, DC: Island Press, pp. 479–91.
- Smith, P. (2004b) Soils as carbon sinks: the global context. *Soil Use and Management*, **20**, 212–18.
- Smith, P. (2004c) Monitoring and verification of soil carbon changes under Article 3.4 of the Kyoto Protocol. *Soil Use and Management*, **20**, 264–70.
- Smith, P. and Powlson, D. S. (2003) Sustainability of soil management practices: a global perspective. In *Soil Biological Fertility: A Key to Sustainable Land Use in Agriculture*, ed. L. K. Abbott and D. V. Murphy. Dordrecht, the Netherlands: Kluwer Academic Publishers, pp. 241–54.
- Smith, P., Smith, J. U., Powlson, D. S. *et al.* (1997) A comparison of the performance of nine soil organic matter models using seven long-term experimental datasets. *Geoderma*, **81**, 153–225.
- Smith, P., Powlson, D. S., Smith, J. U., Falloon, P. and Coleman, K. (2000) Meeting Europe's climate change commitments: quantitative estimates of the potential for carbon mitigation by agriculture. *Global Change Biology*, **6**, 525–39.
- Smith, P., Goulding, K. W., Smith, K. A. *et al.* (2001) Enhancing the carbon sink in European agricultural soils: including trace gas fluxes in estimates of carbon mitigation potential. *Nutrient Cycling in Agroecosystems*, **60**, 237–52.
- Smith, P., Amézquita, M. C., Buendia, L. *et al.* (2004) Greenhouse gas emissions from European croplands. Concerted Action CarboEurope-GHG.
- Smith, P., Smith, J. U., Flynn, H. *et al.* (2007) *ECOSSE: Estimating Carbon in Organic Soils: Sequestration and Emissions. Final Report*. SEERAD Report.
- Vleeshouwers, L. M. and Verhagen, A. (2002) Carbon emission and sequestration by agricultural land use: a model study for Europe. *Global Change Biology*, **8**, 519–30.

14. Synthesis: emerging issues and challenges for an integrated understanding of soil carbon fluxes

Michael Bahn, Werner L. Kutsch and Andreas Heinemeyer

14.1 INTRODUCTION

In view of a rapidly changing climate system the terrestrial carbon cycle has received an increasing amount of attention over the last two decades, both from scientists and the public. Much progress has been made on characterizing the net exchange of CO₂ between terrestrial ecosystems and the atmosphere (NEE) (Baldocchi *et al.*, 2001; Schimel *et al.*, 2001; Chapin *et al.*, 2006; Friend *et al.*, 2007; Luysaert *et al.*, 2007; Baldocchi *et al.*, 2008). However, to improve our estimates of the carbon sequestration potential of ecosystems and to be able to project current flux observations into the future, it is important to obtain a better understanding of the component fluxes of NEE, and how they are regulated in response to changing environments. Our knowledge of the assimilatory component of the carbon cycle (i.e. photosynthesis) is well advanced both at the leaf and the canopy level (Farquhar *et al.*, 1980; de Pury and Farquhar, 1997). In contrast, there are still substantial gaps in our understanding of the respiratory component, which is a major determinant of ecosystem carbon balance (Valentini *et al.*, 2000; Huxman *et al.*, 2003; Luo and Zhou, 2006; Trumbore, 2006). Even though emissions of CO₂ from soils globally constitute the second largest flux of carbon between terrestrial ecosystems and the atmosphere (Raich and Schlesinger, 1992; Schlesinger and Andrews, 2000), their potential response to global change is still largely assessed on the basis of simplistic assumptions and relationships (for recent critical reviews cf. Davidson and Janssens, 2006; Davidson *et al.*, 2006; Högberg and Read, 2006; Trumbore, 2006).

A prime reason why our progress in the understanding of soil carbon fluxes has lagged behind and remains a major challenge is related to the fact that soils are the result of complex physical, chemical and

biological interactions that are intrinsically linked, and are highly dependent on above-ground processes such as photosynthesis, above-ground biomass quality and turnover, herbivory and nutrient demand for growth (Fig. 14.1). To be able to advance our ability for assessing the role of soils in the terrestrial carbon balance and evaluating effects of globally changing environments, it appears desirable – if not mandatory – to develop and apply an integrated methodology for studying soil carbon fluxes, spanning a range of disciplines including traditional soil sciences, plant, microbial and animal ecology and physiology, and to reconcile experimental (both laboratory and field based) with modelling efforts. In this book we have compiled current and emerging concepts and methodological approaches for a broad range of perspectives. Although each chapter may well stand alone and advance our knowledge in the respective field, the individual chapters relate to a number of neighbouring disciplines that deserve recognition for developing an integrated understanding of processes. This brief synthetic summary attempts to depict some of the emerging key issues and links between topics and perspectives, and to outline some major challenges that lie ahead.

14.2 PARTITIONING SOIL RESPIRATION

Separating and linking the various sources of soil CO₂ efflux is required for identifying whether the soil is a net sink or source of CO₂ (Randerson *et al.*, 2002), and is a prerequisite for better understanding and predicting the response of soil respiration to changing environments. For example, it is of major importance for global climate modelling to account for possible effects of increased temperature on emissions of CO₂ from soils and its subsequent feedback on the global climate. It is, however, still unclear whether and to what extent the

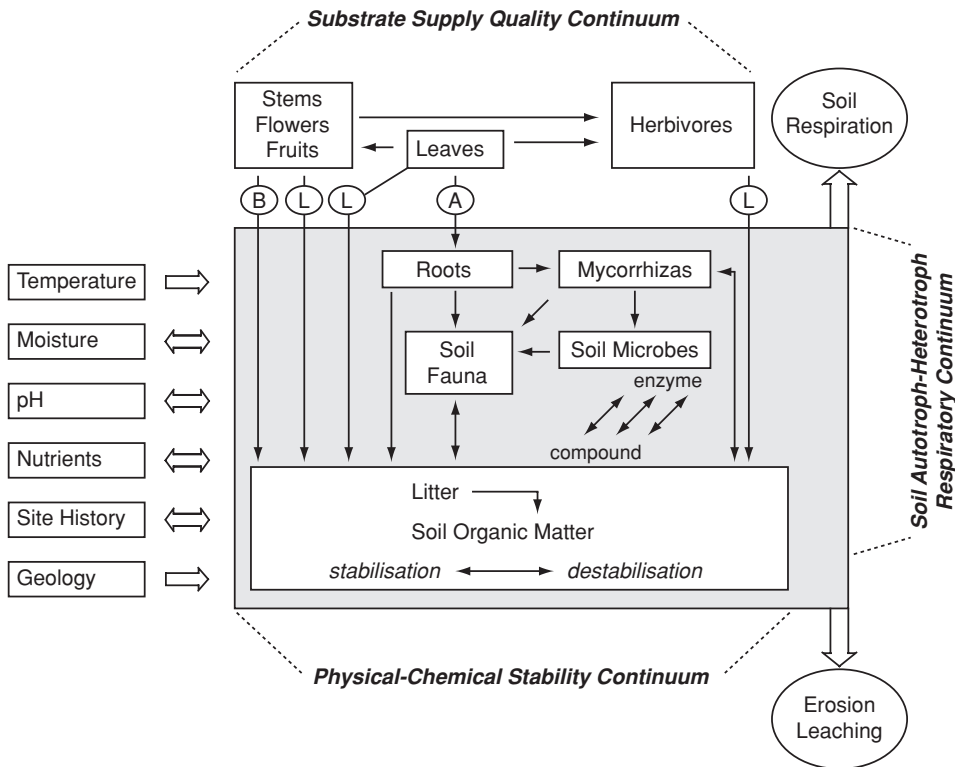

Figure 14.1 Fluxes of carbon into, in and from the soil and its various compartments in the context of the continua of substrate input quality, of respiratory fluxes from soil autotrophs and heterotrophs, and of the physical and chemical stability of soil organic matter. On the left side major abiotic factors are listed that may affect soil carbon fluxes and may also be partly influenced by biotic effects. Geology may have a notable influence on soil carbon fluxes via inorganic carbon (not shown). Note that both the quantity and the quality of carbon fluxes may be modulated by feedbacks not shown, as, for example, related to herbivory or changes in nutrient demand and/or supply. (B: black carbon; L: litter of various quality; A: photosynthetic assimilates.)

decomposition of soil organic matter is enhanced by global warming (Cox *et al.*, 2000; Luo *et al.*, 2001; Melillo *et al.*, 2002; Eliasson *et al.*, 2005; Jones *et al.*, 2005), and what is the potential role of acclimation of various components of soil respiration versus that of a non-uniform depletion of soil organic compounds of different stability and kinetic properties (Kirschbaum, 2004; Davidson *et al.*, 2006; Conant *et al.*, 2008; Gu *et al.*, 2008). Temperature sensitivity of the various autotrophic and heterotrophic components might differ and respiratory acclimation may occur to differing degrees and at different temporal scales, and possibly involve different mechanisms, which still deserve to be clarified in more detail (Atkin *et al.*, 2005). Apart from climate warming, a range of environmental changes have been shown to affect soil

respiration with potentially differential effects on the different flux components, including elevated CO₂ (Hungate *et al.*, 1997; Gill *et al.*, 2002; Pendall *et al.*, 2003; King *et al.*, 2004; Steinmann *et al.*, 2004), drought or changing precipitation patterns (Knapp *et al.*, 2002; Harper *et al.*, 2005; Borken *et al.*, 2006; Heinemeyer *et al.*, 2007), fire (Harden *et al.*, 2000; Johnson and Matchett, 2001; Czimczik *et al.*, 2006; Irvine *et al.*, 2007) and changes in land management and land use (Davidson *et al.*, 2000; Bremer and Ham, 2002; Verburg *et al.*, 2004; Bahn *et al.*, 2006).

While it is obvious that an improved partitioning of soil respiration into its major component fluxes is highly relevant, it should be acknowledged that the separation of components in the plant–mycorrhiza–soil and microbe–soil organic matter continuum (Fig. 14.1)

may pose a profound conceptual and experimental challenge (Chapters 7, Moyano *et al.* and 8, Epron; Borken *et al.*, 2006; Högberg and Read, 2006; cf. also the recent discussion between Kuzyakov 2006a, 2006b and Högberg *et al.*, 2006). For example, the separation of roots and mycorrhizae, as well as their respective respiration rates, is practically impossible without interfering with their symbiotic exchange of carbohydrates, water and nutrients, which in turn may influence respiration rates (Chapter 7, Moyano *et al.*, but see recent advances, e.g. Heinemeyer *et al.*, 2006; Moyano *et al.*, 2007). Likewise, it has been shown that an input of fresh organic carbon from litter or root exudates may stimulate or inhibit the microbial decomposition of older soil organic matter (Kuzyakov, 2002; Pendall *et al.*, 2003; Fontaine *et al.*, 2004; Subke *et al.*, 2004; Fontaine *et al.*, 2007; Chapter 6, Denef *et al.*), indicating that the involved components are intimately linked. It still needs to be demonstrated – but appears likely – that such rhizosphere priming effects may potentially also feed back on the autotrophic component. Experimental evidence indicates that amendments of fresh organic carbon may affect competition between microbial populations (Fontaine *et al.*, 2004) and increase nitrogen immobilization (Jonasson *et al.*, 1996; Wardle, 2002). Nitrogen immobilization may in turn affect plant respiratory activity related to nutrient uptake and interspecific competition, thereby altering the autotrophic component of soil respiration.

As summarized in a number of recent reviews (Hanson *et al.*, 2000; Kuzyakov, 2006a; Subke *et al.*, 2006; Chapters 7, Moyano *et al.* and 8, Epron), partitioning of soil CO₂ fluxes has been attempted by physical separation, manipulative reduction of the assimilate supply and subsequent elimination of root and rhizosphere respiration (trenching, girdling, mesh exclusion, clipping and shading), as well as isotopic approaches. Non-isotopic approaches provide direct measures of CO₂ emissions from the various soil components, but typically disturb the soil environment. Hence, these approaches need to account for a range of direct and indirect transient effects related to the disturbance of the soil system and/or the alteration of rhizosphere priming effects (Chapters 7, Moyano *et al.* and 8, Epron). As a recently emerging field, isotopic approaches to tracing sources of CO₂ flux appear preferable because they are non-intrusive and potentially provide a clue as to the metabolic origin of respired CO₂. Labelling with ¹³C

can be achieved by converting the dominant vegetation from C₃ to C₄ species (Rochette *et al.*, 1999), by adding ¹³C-enriched or depleted litter (Subke *et al.*, 2004; Ngao *et al.*, 2005), by continuous addition of CO₂ of different ¹³C signature to an ecosystem, e.g. in FACE experiments (cf. review by Pendall *et al.*, 2004), by pulse-labelling (Ostle *et al.*, 2000, 2003, 2007; Högberg *et al.*, 2008; Bahn *et al.*, 2009), or by making use of a decreased photosynthetic discrimination of ¹³C during periods of low air humidity (Bowling *et al.*, 2002; Ekblad *et al.*, 2005). Such experiments have indicated that much of the carbon assimilated by a canopy is respired within a few hours (grassland) or days (forests), while a portion is also incorporated in plant, faunal and microbial biomass. Unfortunately, it remains extremely difficult to interpret isotopic signatures of soil respired CO₂, because our knowledge of post-photosynthetic isotopic fractionation is still very limited (Badeck *et al.*, 2005; Brandes *et al.*, 2006; Bowling *et al.*, 2008). Such fractionation may occur during biosynthesis, the transport of assimilates, during respiratory processes (with species-specific and phenological differences) and during diffusion of CO₂ in the soil and, in addition, might be related to sink–source relationships (pers. commun., N. Buchmann). In pulse–chase labelling experiments also the direct physical diffusion of labelled CO₂ into and out of the soil may complicate the interpretation of results. Much work is still needed to illuminate such processes, but is pivotal for improving the potential of applying stable isotopes for a consistent partitioning of soil CO₂ efflux into its component sources.

Radiocarbon (¹⁴C) has also been used for pulse–chase labelling studies, mostly in mesocosms (Kuzyakov and Domanski, 2000), and only very recently also in the field, applying accelerator mass spectrometry for detecting the signal provided by a low-level ¹⁴C label (Carbone *et al.*, 2007). The strong global label of radiocarbon produced by nuclear weapons testing in the late 1950s and early 1960s has been used for estimating the mean residence time of organic matter compounds in the soil, as well as determining the age of the respiratory carbon source (Dorr and Munnich, 1986; Gaudinski *et al.*, 2000). Ultimately, the only source of variation of radiocarbon values of respiration fluxes is the residence time of carbon within the ecosystem (Trumbore, 2000). Thus, radiocarbon permits a separation of the contribution of fast (short ecosystem residence time and thus root and rhizosphere respiration) versus slower

(microbial decomposition of SOM) cycling carbon (Gaudinski *et al.*, 2000; Schuur and Trumbore, 2006).

To be able to advance our possibilities of tracing carbon sources and fluxes, the assumptions underlying isotopic approaches deserve rigorous testing. We therefore recommend the application of isotopes to be embedded in a range of complementary approaches (e.g. manipulation experiments and incubation of components) that help constrain assumptions and related uncertainties.

Ultimately, the topic of partitioning soil respiration into its component sources should be regarded in the broader frame of allocation of assimilated carbon to maintenance, growth, storage and transfer to other organisms and the related respiratory processes (Lambers *et al.*, 1998; Larcher, 2004; Trumbore, 2006; for a representation of carbon fluxes between biota and SOM see Fig. 14.1). A way forward will be to nest integrated experiments in larger carbon flux studies, combining environmental gradients, ecosystem manipulations and mesocosm studies, and to link experimental observations at different temporal scales with process-based models (see Sections 14.5 and 14.6).

14.3 SOIL ORGANIC MATTER QUALITY

Revealing the linkages between the biophysical–chemical state and the turnover of SOM remains one of the major challenges that needs to be addressed more explicitly in future research. In particular, the following efforts are needed:

1. exploration of new avenues to characterize SOM as a complex ensemble of distinct fractions;
2. quantification of the turnover of these fractions accounting for physical and chemical stabilization and destabilization mechanisms; and
3. linking SOM dynamics more explicitly to microbial functioning (see Chapters 5 Cotrufo *et al.* and 9 Kutsch *et al.*).

In this context it is important to see that there is still no consistent theory of recalcitrance available (Trumbore, 2006), partly for the reason that the concepts of molecular recalcitrance of substrates and those of stabilization and destabilization mechanisms have not been separated (Marschner *et al.*, 2008). For example, a simple amino acid can be stabilized onto a clay mineral, but it is not recalcitrant in the molecular sense, as it would be readily decomposed once desorbed. Addressing these

issues will result in further development of a functional fractionation scheme as outlined by von Lützow *et al.* (2007), providing meaningful SOM fractions with specific stability and an indication of different mechanisms of stabilization and destabilization. Furthermore, a tool to bridge the gap between the physical–chemical characteristics of SOM and microbial functioning and resulting SOM turnover is needed (Fig. 14.1). For this purpose, stable isotope techniques such as ^{13}C -labelled substrate addition to follow the incorporation into and transfer among SOM fractions and microbial communities could be applied. In this context, new technologies such as RNA–SIP (stable isotope probing) appear very promising, which enable an identification of micro-organisms that are actively involved in specific metabolic processes under *in situ* conditions (Radajewski *et al.*, 2000; Vandenkoornhuys *et al.*, 2007). Also, combined ^{13}C and ^{14}C measurements of respired CO_2 and SOM pools could be conducted to follow dynamics and determine responses of older soil carbon to environmental change (Fontaine *et al.*, 2007). Finally, it remains a major task to assess the effects of soil carbon input (quantity and quality, allocation) on SOM decomposition, stabilization and destabilization (Fig. 14.1). The dynamics of litter fragmentation, the inclusion of litter fragments into SOM and its control over soil carbon turnover need to be studied in more detail, especially in relation to priming effects and to variations in microbial composition and diversity (Chapters 6 Denef *et al.* and 9 Kutsch *et al.*). Alternatives to current definitions of input quality, which are based, for example, on C/N or lignin/N ratios, could represent more biologically meaningful measures, such as respiratory quotient ($\text{CO}_2\text{produced}/\text{O}_2\text{consumed}$) or incorporation of ^{13}C (from labelled substrate) into microbial biomass or PLFAs (Chapter 5 Cotrufo *et al.*).

Apart from the above aspects that focus on the interface between the quantity and quality of litter and SOM and microbial communities, it should be acknowledged that the soil fauna may play an important and sometimes overlooked role in soil carbon turnover (Chapter 10 Ayres *et al.*). This may, on the one hand, concern the fragmentation of litter and the response of decomposition to changing litter diversity (Hättenschwiler and Gasser, 2005; Hättenschwiler *et al.*, 2005), as well as bioturbation (Lavelle and Spain, 2001). On the other hand, there is growing evidence that variations in the architecture of the decomposer food web may strongly influence the breakdown and

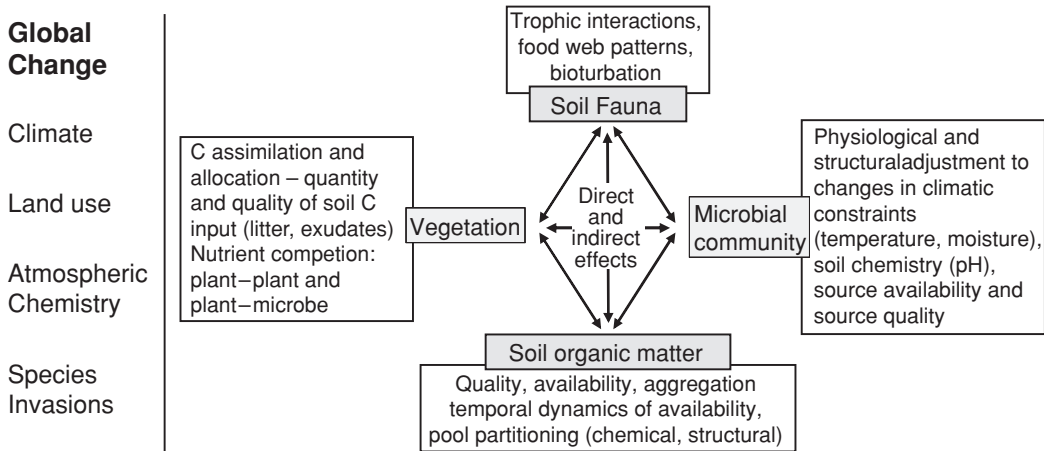

Fig. 14.2 Factors affecting soil carbon fluxes in changing abiotic and biotic environments.

dynamics of fresh organic carbon entering the soil (Mikola *et al.*, 2002; Heemsbergen *et al.*, 2004; Bradford *et al.*, 2007) as well as the sensitivity of non-labile soil carbon to climate change (Briones *et al.*, 2007).

In the context of global change (Fig. 14.2) it should be noted that future research needs to consider more explicitly a vertical stratification of SOM and its quality. Also microbial community composition and its link to the carbon cycle may substantially vary with soil depth (Allison *et al.*, 2007). For example, earlier studies suggesting that less intensive forms of tillage, such as conservation tillage, not only reduce loss of soil organic carbon (SOC) from agricultural soils, but even sequester substantial amounts of carbon (e.g. Lal *et al.*, 2003) and were often based on a sampling of not more than the upper 20 to 30 cm of the soil. Baker *et al.* (2007) questioned the general validity of such conclusions, pointing out that different forms of tillage may affect the vertical distribution of SOC in soil layers well below 30 cm. Deeper soil layers often also bear the memory of previous land use (e.g. conversions between forest and grassland), which may increase uncertainties to estimates of SOM at larger scales, when based on remotely sensed current land cover and SOM data for the uppermost soil layer. Furthermore, there is evidence that climate warming and/or changes in land use and agricultural practice that increase the distribution of nutrients or fresh carbon along the soil profile could stimulate the loss of ancient buried carbon in deeper soil layers (Fierer *et al.*, 2003; Fontaine *et al.*, 2007).

14.4 THE ROLE OF BIOTA AND THEIR INTERACTIONS

Soil carbon fluxes are intrinsically mediated by interactions between biota, both above and below ground (Fig. 14.1; Chapter 10 Ayres *et al.*). Such interactions include competition, facilitation, symbiosis, inhibition, herbivory and predation, and are often highly species specific, thus also need to be considered in a biodiversity context (Loreau *et al.*, 2002; Bardgett *et al.*, 2005). Biota may change not only in response to changes in climate and land use, but also through biotic invasions (Fig. 14.2), which may have substantial impacts on ecosystem processes, such as soil carbon fluxes (Bohlen *et al.*, 2004; for an overview see Bardgett, 2005). Also, global change-induced shifts in plant and soil microbial communities, and their respective effects on substrate quality (litter, root exudates and SOM quality), may feed back on plant–plant and plant–microbial competition for growth-limiting nutrients such as nitrogen, and in turn influence carbon turnover (Fig. 14.1; Chapter 10 Ayres *et al.*, Fontaine *et al.*, 2003; Wardle *et al.*, 2004; Bardgett, 2005). Such interactions between the carbon and the nutrient cycle need to be considered more explicitly when analyzing potential effects of global change (climate, land use, atmospheric chemistry) on soil carbon fluxes (Fig. 14.2) and carbon storage (van Groenigen *et al.*, 2006; Bradford *et al.*, 2008).

The role of soil biota in soil aggregation and thus physical SOM protection has yet to be unravelled. Key questions that need to be addressed include the following.

1. How can the contribution of biological vs. physical aggregation be quantified (Jastrow *et al.*, 1998)?
2. How do global changes influence microbial diversity and composition, including shifts between bacterial- and fungal-dominated food webs in soil, and what are the functional implications of such changes in microbial communities for carbon dynamics? As recently discussed by van der Heijden *et al.* (2008), answering this question is complicated and will require the development of experimental systems in which it is possible to manipulate microbial diversity without influencing other factors and contamination from the outside.
3. How does altered food web architecture and diversity influence the fate of carbon entering the soil? Here, it is important that work is not limited to decomposer food webs, but should also consider the role of more complex trophic interactions and trophic cascades, for example involving effects of herbivores, predators and parasites (Chapter 10 Ayres *et al.*) in response to global change. Furthermore, effects of changing CO₂ concentrations, water availability and temperature on mycorrhizosphere components, as well as degrees of acclimation, can play an important role in determining soil carbon dynamics in future scenarios (Heinemeyer *et al.*, 2006, 2007; Bardgett *et al.*, 2008) and need to be explored in more detail in the future (see Chapters 7 Mayano, 8 Epron, 9 Kutsch *et al.* and 10 Ayres).

14.5 SOIL CARBON MODELS

In general, current modelling approaches describe SOM as conceptual pools, passively decomposing according to first-order kinetics modified mainly by soil temperature and soil moisture (but often also soil texture and litter quality). Because physical and chemical stabilization and destabilization as well as interactions between SOM, microbiota, meso- and macrofauna, and root-derived carbon input are not or only marginally included in most models, they are often not able to describe potentially important phenomena such as priming effects (see above), respiratory flushes after drought and rewetting (Birch, 1958; Franzluebbers *et al.*, 2000; Fierer and Schimel, 2003; Borken and Matzner, 2009) or temperature acclimation (Chapters 1 Kutsch *et al.* a, 7 Moyano *et al.* and 9 Kutsch *et al.* b; Atkin *et al.*, 2005). Since these models –

which we may classify as ‘dead-soil paradigm models’ – under-represent the role of soil biological–physical–chemical interactions they are not well suited for extrapolation to future climate conditions, such as required e.g. for the IPCC assessments. Furthermore, root-derived respiration is rarely included in SOM model output, making model validation with real field data difficult (Luckai and Larocque, 2002). Consequently, the following challenges need to be met by the soil modelling community in order to incorporate recent insights into the next generation of soil carbon models.

- Respiration of the autotrophic and heterotrophic soil components may respond differently to carbon supply, temperature and moisture, which needs to be addressed jointly by modellers and experimental scientists. In this context, it would be useful to develop a new type of carbon allocation model that also accounts for root exudation and its potential effects on soil respiration (Ryan and Law, 2005; Sacks *et al.*, 2006).
- Realistic representation of SOM fractionation in models seems to become possible as new techniques have been developed in soil chemistry. Zimmermann *et al.* (2007) showed that a fractionation scheme can be used to calibrate the RothC Model. They state that the ‘use of measured fractions to initialize RothC has the advantage that processes that are ignored in the model, but which influence SOC, are taken into account in SOC partitioning. Thus, measured fractions reflect better than any model the conditions under which SOC is accumulated. Moreover, measured fractions are determined independently of the model.’
- There are several conceptual approaches to include the dynamics of microbial populations into SOM models. A model approach by Schimel and Weintraub (2003) takes microbial biomass and extracellular enzymes into account. A more complex concept to model the interaction between litter chemistry and microbial activity was suggested by Moorhead and Sinsabaugh (2006; see details in Chapter 9 Kutsch *et al.*). Once the dynamics of microbial populations are explicitly modelled, the ‘priming effect’ can be incorporated in simulation studies (Fontaine and Barot, 2005). In addition, the microbial dynamics can be related exemplarily to SOM fractions. To be able to account for stabilization mechanisms of SOM more explicitly, our understanding of processes

causing spatial inaccessibility of OM to decomposers needs to be improved and considered in future modelling approaches (von Lützow *et al.*, 2008). Therefore, novel model structures may be required for integrating knowledge from differently specialized scientific communities.

- Also, the exact presentation of soil heterogeneity and soil physical processes (e.g. heat conduction and water distribution) has been identified as an important issue (Reichstein *et al.*, 2005; Bahn *et al.*, 2008), particularly when field experiments are conducted, where possible confounding factors (e.g. lag effects introduced by lagged heat penetration into the soil, as opposed to direct coupling to photosynthate transport) may be corrected for by high-precision modelling. Furthermore, preferential flows may play an important role for water relations on clayey soils and the transport of POM and may be biological ‘hot spots’ in the soil (Bundt *et al.*, 2001), but have rarely been considered in models.

There is a clear trade-off between model complexity (aimed at ‘realism’) and the ability to parameterize the model from observations. However, once one is confident with the model structure, Bayesian multiple-constraint inverse modelling techniques (Chapter 11 Reichstein and Janssens) can strongly facilitate the identification of model parameters of apparently overparameterized models. The best link between response functions in mechanistic models and soil respiration data can be obtained via controlled laboratory experiments and data assimilation techniques using field data (Williams *et al.*, 2005). Instead of directly comparing derived (e.g. temperature) dependencies to functional dependencies in ecosystem models, one should rather evaluate if those models with their functional dependencies are able to reproduce the emergent pattern at field and global scale (Chapter 11 Reichstein and Janssens).

14.6 TOWARDS MORE INTEGRATED EXPERIMENTAL APPROACHES

Figure 14.2 summarizes a range of key factors determining soil carbon fluxes in a globally changing environment and identifies a range of issues that might need to be addressed by experiments. The above sections clearly underline that a major progress in our understanding of the controls of soil carbon fluxes under changing

environmental and climatic conditions will ultimately require integrated plant–soil experiments that are carried out at a range of scales.

Purely observational studies may be useful for a general description of ecosystems at their current stage of development and a given set of environmental controls, but effects are often confounded. For example: firstly, global radiation jointly affects photosynthesis and soil temperature, which may both influence soil respiration rates; secondly, low soil moisture tends to occur during hot periods and may result in both desiccation stress and a reduction in the diffusion of organic solutes (Grant and Rochette, 1994), thus reducing substrate supply to soil microbial communities; and thirdly, in temperate regions plant and microbial biomass often peak during summer when soil temperatures are highest, which may bias Q_{10} estimates of soil respiration on an annual basis. Such a co-variation of parameters precludes a clear analysis of the individual effects of abiotic and biotic determinants of soil carbon fluxes, as would be needed for more process-based models (Davidson and Janssens, 2006; Davidson *et al.*, 2006).

The shortcomings of manipulative or simplified (e.g. micro- or mesocosms) studies are the likely occurrence of artefacts, which may substantially alter the carbon supply and allocation processes. Consequently, results, though based on well defined conditions, may have little relevance at the ecosystem scale. Potential problems that are inherent to a number of eco-physiological approaches include the following.

- Trenching, girdling and mesh-exclusion experiments manipulate not only the assimilate supply to roots and the mycorrhizosphere but may also affect root turnover, soil moisture and soil nutrient availability (Chapter 8 Epron).
- Soil laboratory incubations may lead to initially unrealistic high initial values of basal respiration (due to initial disturbance of soil aggregates when removing roots) and subsequent underestimation of heterotrophic respiration due to a depletion of fresh organic carbon (as no root turnover or exudation is taking place).
- Seedlings (as used in many micro- and mesocosm studies) may differ in their physiology from mature plants (Garnier and Freijesen, 1994). In this context Ayres *et al.* (2004) conclude that more complex experiments and models (than those based on simple

mesocosm studies) are required to understand the relationships between the soil food web and carbon fluxes, in particular because of the emergent properties that are not captured in studies of simple communities (see also [Chapter 10](#) Ayres *et al.*).

A promising approach would be to design integrated experiments in which comparative studies across soil, vegetation or climatic gradients are combined with ecosystem manipulation experiments and with laboratory-based mesocosm studies nested in larger ecosystem studies. Moreover, transplanting soil monoliths across environmental gradients may yield useful insights (Briones *et al.*, 1997). Key parameters to manipulate could include the quantity (e.g. changing the amount of litter or exudate inputs, plant productivity, LAI) and quality of carbon input (see Section 14.3; [Chapters 5](#) Cotrufo *et al.* and [6](#) Denef *et al.*), as well as nutrient availability and the composition of the food web ([Chapter 10](#) Ayres *et al.*). Clearly, pulse labelling and the incubation of isotopically labelled substrate will be a useful tool for tracing carbon fluxes within such manipulative approaches (see Section 14.2; [Chapters 5](#) Cotrufo *et al.* and [6](#) Denef *et al.*).

14.7 LINKING EXPERIMENTS AND MODELLING

The link between experiments, observational studies and process modelling is an important cross-cutting issue that deserves increased attention in the future. A close link between modelling and experimental work strongly helps with (1) the design of experiments, (2) the interpretation of results from observational studies and experiments and (3) evaluation of the significance of experimental findings at higher levels of integration, e.g. ecosystem, region and earth system (up-scaling).

Increased interactions between experimentalists and modellers can be useful to:

- test different fundamental model hypotheses and parameterizations (model structural development)
- test model and parameter identification techniques (a methodological development that could be done with artificial data, but where real data provides added ‘real-world’ tests)

- test the ‘information content’ of experimental designs via identification of sensitive and uncertain parameters and optimal experimental design strategies
- separate patterns/signals in experiments and to help to interpret experimental data (with ‘established’ models).

Important prerequisites for successful model–data integration include a harmonization of the terminology between modellers and experimentalists and the disclosure of errors and uncertainties in models and experimental data (Reichstein and Beer, 2008).

14.8 GLOBAL DATABASE

Deepening our understanding of the controlling factors of soil carbon fluxes is undoubtedly one of the major challenges for future research in the terrestrial carbon cycle. It is obvious that a comprehensive integrated assessment of processes underlying soil carbon fluxes can only be achieved for a very limited number of case studies. To improve our global estimates of soil carbon fluxes in changing environments ([Fig. 14.2](#)) these process-oriented studies should therefore cover a range of key ecosystems representing the variability of the major global biomes.

At the same time it will be important to continue a global assessment of soil carbon stocks and fluxes, especially for ecosystems and regions that have so far been heavily under-represented, e.g. in the Southern hemisphere. Particular attention will need to be paid also to ecosystems whose carbon turnover is restricted by groundwater table and/or permafrost, as they may potentially release large quantities of CO₂ in response to environmental change. Notably, peatlands and wetlands are important sources of methane (a highly climate-relevant carbon compound not considered in this book) and can also emit considerable amounts of CO₂ when groundwater levels fall or land use changes (Lafleur *et al.*, 2001; Whiting and Chanton, 2001; Hirano *et al.*, 2007). Ecosystems with permafrost soils are highly susceptible to climate warming, as thawing of these soils has been shown to induce significant carbon losses (Oechel *et al.*, 1993; Goulden *et al.*, 1998; Melillo *et al.*, 2002; Dutta *et al.*, 2006; but see Turetsky *et al.*, 2007).

A number of reviews and meta-analyses have attempted to synthesize the wealth of information already available on soil carbon stocks ([Chapter 3](#) Subke

et al.; Lal, 2004) and fluxes (Raich and Schlesinger, 1992; Raich *et al.*, 2002) at a global scale. While providing important estimates and showing interesting trends, such meta-analyses have often suffered from datasets based on diverging definitions (e.g. concerning definitions of sample depth or the components of soil respiration) and methodologies (e.g. in particular SOM to SOC conversion factors or sampling frequency, collar insertion and use of static vs. dynamic chambers). Therefore, future studies on soil carbon stocks and fluxes need to be carried out in a comparable way (for collaborative transect studies see e.g. Janssens *et al.*, 2001; Bahn *et al.*, 2008), considering important rules of experimental design and avoiding common pitfalls (see Chapters 3 Subke *et al.*, 4 Rodeghiero *et al.* and 15 Bahn *et al.*). Furthermore, access to global datasets, in particular on soil CO₂ efflux, need to be facilitated. An initiative to establish an international database has recently been launched as part of the programme ‘The Role of Soils in the Terrestrial Carbon Cycle’ funded by the European Science Foundation. This database aims to collect original datasets of soil respiration together with as much supplementary data as possible. While storing climatic data, chemical, physical and biological properties of the soil and ecosystem information, this database will open a unique possibility for integrated synthesis studies, similar to a recent global flux tower network study by Luysaert *et al.* (2007). It will be web based, see www.soilrespiration.net.

14.9 CONCLUSIONS

In summary, a number of key topics emerge that need to be addressed for advancing our understanding of soil carbon fluxes which include the following.

- Considering carbon allocation within plants and the carbon flow through the plant–soil continuum (both depending strongly on plant species composition) and their consequences for soil respiration and its component fluxes.
- Assessing the accessibility of soil carbon compounds (i.e. fresh vs. older organic carbon) to decomposition will need to be considered and embedded in a biologically relevant context, as interactions of different trophic levels may play an important role for soil carbon turnover.
- Unravelling processes determining SOM stabilization versus mobilization, as modulated by the abiotic and biotic environment, thereby accounting for priming effects, microbial composition and functional diversity, memory effects related to site history and subsoil processes more explicitly.
- Improving process-based models, which should strive towards linking carbon pools and fluxes and improving the representation of interactions between plants, soil biota, SOM and the mineral matrix. Furthermore, accounting for the vertical differentiation of microclimate, soil structure, carbon pools and biota in soils may substantially improve the usefulness of models for disentangling factors that determine soil CO₂ production and efflux.

In short, scientists interested in a more complete understanding of soil carbon fluxes need to overcome their disciplinary boundaries and link their work to adjacent but immediately relevant fields. A suggested way forward will be to nest integrated experiments in larger carbon flux studies, combining environmental gradients, ecosystem manipulations and mesocosm studies, and to link experimental observations at different temporal scales with process-based models. It is hoped that such concerted efforts will increase our capacity to understand, predict and mitigate effects of a globally changing environment on soil carbon fluxes.

ACKNOWLEDGEMENTS

This chapter has profited greatly from discussions during the ESF SIBAE workshop ‘Disentangling abiotic and biotic effects on soil respiration’ held in Innsbruck (Austria) in March 2007; a workshop on ‘Model data integration for soil carbon dynamics’ held in Jena (Germany) in October 2007; and the final conference of the ESF-programme ‘The role of soils in the terrestrial carbon balance’ held in Nancy (France) in November 2007. We acknowledge comments on the manuscript by Richard Bardgett, Nina Buchmann, Eric Davidson, Ivan Janssens, Jens Leifeld and Markus Reichstein.

REFERENCES

- Allison, V. J., Yermakov, Z., Miller, R. M., Jastrow, J. D. and Matamala, R. (2007) Using landscape and depth gradients to decouple the impact of correlated

- environmental variables on soil microbial community composition. *Soil Biology and Biochemistry*, **39**, 505–16.
- Atkin, O. K., Bruhn, D., Hurry, V. M. and Tjoelker, M. G. (2005) The hot and the cold: unravelling the variable response of plant respiration to temperature. *Functional Plant Biology*, **32**, 87–105.
- Ayres, E., Heath, J., Possell, M. *et al.* (2004) Tree physiological responses to above-ground herbivory directly modify below-ground processes of soil carbon and nitrogen cycling. *Ecology Letters*, **7**, 469–79.
- Badeck, F. W., Tcherkez, G., Nogues, S., Piel, C. and Ghashghaie, J. (2005) Post-photo synthetic fractionation of stable carbon isotopes between plant organs: a widespread phenomenon. *Rapid Communications in Mass Spectrometry*, **19**, 1381–91.
- Bahn, M., Knapp, M., Garajova, Z., Pfahringer, N. and Cernusca, A. (2006) Root respiration in temperate mountain grasslands differing in land use. *Global Change Biology*, **12**, 995–1006.
- Bahn, M., Rodeghiero, M., Anderson-Dunn, M. *et al.* (2008) Soil respiration in European grasslands in relation to climate and assimilate supply. *Ecosystems*, **11**, 1352–67.
- Bahn, M., Schmitt, M., Siegwolf, R., Richter, A. and Brüggemann, N. (2009) Does photosynthesis affect grassland soil respired CO₂ and its carbon isotope composition on a diurnal timescale? *New Phytologist*, **182**, 452–60.
- Baker, J. M., Ochsner, T. E., Venterea, R. T. and Griffis, T. J. (2007) Tillage and soil carbon sequestration: what do we really know? *Agriculture Ecosystems and Environment*, **118**, 1–5.
- Baldocchi, D., Falge, E., Gu, L. H. *et al.* (2001) FLUXNET: a new tool to study the temporal and spatial variability of ecosystem-scale carbon dioxide, water vapor, and energy flux densities. *Bulletin of the American Meteorological Society*, **82**, 2415–34.
- Bardgett, R. D. (2005) *The Biology of Soil: A Community and Ecosystem Approach*. Oxford: Oxford University Press.
- Bardgett, R. D., Hopkins, D. W. and Usher, M. B. (eds) (2005) *Biological Diversity and Function in Soils*. Cambridge: Cambridge University Press.
- Bardgett, R. D., Freeman C. D. and Ostle, N. J. (2008) Microbial contributions to climate change through carbon cycle feedbacks. *The ISME Journal*, **2**, 805–14.
- Birch, H. F. (1958) The effect of soil drying on humus decomposition and nitrogen availability. *Plant and Soil*, **10**, 9–31.
- Bohlen, P. J., Pelletier, D. M., Groffman, P. M., Fahey, T. J. and Fisk, M. C. (2004) Influence of earthworm invasion on redistribution and retention of soil carbon and nitrogen in northern temperate forests. *Ecosystems*, **7**, 13–27.
- Borken, W., Savage, K., Davidson, E. A. and Trumbore, S. E. (2006) Effects of experimental drought on soil respiration and radiocarbon efflux from a temperate forest soil. *Global Change Biology*, **12**, 177–93.
- Borken, W. and Matzner, E. (2009) Reappraisal of drying and wetting effects on C and N mineralization and fluxes in soils. *Global Change Biology*, **15**, 808–24.
- Bowling, D. R., McDowell, N. G., Bond, B. J., Law, B. E. and Ehleringer, J. R. (2002) ¹³C content of ecosystem respiration is linked to precipitation and vapor pressure deficit. *Oecologia*, **131**, 113–24.
- Bowling, D. R., Pataki, D. E. and Randerson, J. T. (2008) Carbon isotopes in terrestrial ecosystem pools and CO₂ fluxes. *New Phytologist*, **178**, 24–40.
- Bradford, M. A., Tordoff, G. M., Black, H. I. J. *et al.* (2007) Carbon dynamics in a model grassland with functionally different soil communities. *Functional Ecology*, **21**, 690–7.
- Bradford, M., Fierer, N., Reynolds, J. F. (2008) Soil carbon stocks in experimental mesocosms are dependent on the rate of labile carbon, nitrogen and phosphorus inputs to soils. *Functional Ecology*, **22**, 964–74.
- Brandes, E., Kodama, N., Whittaker, K. *et al.* (2006) Short-term variation in the isotopic composition of organic matter allocated from the leaves to the stem of *Pinus sylvestris*: effects of photosynthetic and postphotosynthetic carbon isotope fractionation. *Global Change Biology*, **12**, 1922–39.
- Bremer, D. J. and Ham, J. M. (2002) Measurement and modeling of soil CO₂ flux in a temperate grassland under mowed and burned regimes. *Ecological Applications*, **12**, 1318–28.
- Briones, M. J. I., Ineson, P. and Pearce, T. G. (1997) Effects of climate change on soil fauna: responses of enchytraeids, Diptera larvae and tardigrades in a transplant experiment. *Applied Soil Ecology*, **6**, 117–34.
- Briones, M. J. I., Ostle, N. J. and Garnett, M. H. (2007) Invertebrates increase the sensitivity of non-labile soil carbon to climate change. *Soil Biology and Biochemistry*, **39**, 816–18.
- Bundt, M., Widmer, F., Pesaro, M., Zeyer, J. and Blaser, P. (2001) Preferential flow paths: biological ‘hot spots’ in soils. *Soil Biology and Biochemistry*, **33**, 729–38.

- Carbone, M. S., Czimczik, C. I., McDuffee, K. E. and Trumbore, S. E. (2007) Allocation and residence time of photosynthetic products in a boreal forest using a low-level ^{14}C pulse-chase labeling technique. *Global Change Biology*, **13**, 466–77.
- Chapin, F. S., Woodwell, G. M., Randerson, J. T. *et al.* (2006) Reconciling carbon-cycle concepts, terminology, and methods. *Ecosystems*, **9**, 1041–50.
- Conant, R. T., Drijber, R. A., Haddix, M. L. *et al.* (2008) Sensitivity of organic matter decomposition to warming varies with its quality. *Global Change Biology*, **14**, 868–77.
- Cox, P. M., Betts, R. A., Jones, C. D., Spall, S. A. and Totterdell, I. J. (2000) Acceleration of global warming due to carbon-cycle feedbacks in a coupled climate model. *Nature*, **408**, 184–7.
- Czimczik, C. I., Trumbore, S. E., Carbone, M. S. and Winston, G. C. (2006) Changing sources of soil respiration with time since fire in a boreal forest. *Global Change Biology*, **12**, 957–71.
- Davidson, E. A. and Janssens, I. A. (2006) Temperature sensitivity of soil carbon decomposition and feedbacks to climate change. *Nature*, **440**, 165–73.
- Davidson, E. A., Verchot, L. V., Cattanio, J. H., Ackerman, I. L. and Carvalho, J. E. M. (2000) Effects of soil water content on soil respiration in forests and cattle pastures of eastern Amazonia. *Biogeochemistry*, **48**, 53–69.
- Davidson, E. A., Janssens, I. A. and Luo, Y. (2006) On the variability of respiration in terrestrial ecosystems: moving beyond Q_{10} . *Global Change Biology*, **12**, 154–64.
- de Pury, D. G. G. and Farquhar, G. D. (1997) Simple scaling of photosynthesis from leaves to canopies without the errors of big-leaf models. *Plant Cell and Environment*, **20**, 537–57.
- Dorr, H. and Munnich, K. O. (1986) Annual variations of the ^{14}C content of soil CO_2 . *Radiocarbon*, **28**, 338–45.
- Dutta, K., Schuur, E. A. G., Neff, J. C. and Zimov, S. A. (2006) Potential carbon release from permafrost soils of Northeastern Siberia. *Global Change Biology*, **12**, 2336–51.
- Eklblad, A., Bostrom, B., Holm, A. and Comstedt, D. (2005) Forest soil respiration rate and $\delta^{13}\text{C}$ is regulated by recent above ground weather conditions. *Oecologia*, **143**, 136–42.
- Eliasson, P. E., McMurtrie, R. E., Pepper, D. A. *et al.* (2005) The response of heterotrophic CO_2 flux to soil warming. *Global Change Biology*, **11**, 167–81.
- Farquhar, G. D., Caemmerer, S. V. and Berry, J. A. (1980) A biochemical model of photosynthetic CO_2 assimilation in leaves of C_3 species. *Planta*, **149**, 78–90.
- Fierer, N. and Schimel, J. P. (2003) A proposed mechanism for the pulse in carbon dioxide production commonly observed following the rapid rewetting of a dry soil. *Soil Science Society of America Journal*, **67**, 798–805.
- Fierer, N., Allen, A. S., Schimel, J. P. and Holden, P. A. (2003) Controls on microbial CO_2 production: a comparison of surface and subsurface soil horizons. *Global Change Biology*, **9**, 1322–32.
- Fontaine, S. and Barot, S. (2005) Size and functional diversity of microbe populations control plant persistence and long-term soil carbon accumulation. *Ecology Letters*, **8**, 1075–87.
- Fontaine, S., Mariotti, A. and Abbadie, L. (2003) The priming effect of organic matter: a question of microbial competition? *Soil Biology and Biochemistry*, **35**, 837–43.
- Fontaine, S., Bardoux, G., Abbadie, L. and Mariotti, A. (2004) Carbon input to soil may decrease soil carbon content. *Ecology Letters*, **7**, 314–20.
- Fontaine, S., Barot, S., Barre, P. *et al.* (2007) Stability of organic carbon in deep soil layers controlled by fresh carbon supply. *Nature*, **450**, 277–310.
- Franzluebbers, A. J., Haney, R. L., Honeycutt, C. W., Schomberg, H. H. and Hons, F. M. (2000) Flush of carbon dioxide following rewetting of dried soil relates to active organic pools. *Soil Science Society of America Journal*, **64**, 613–23.
- Friend, A. D., Arneeth, A., Kiang, N. Y. *et al.* (2007) FLUXNET and modelling the global carbon cycle. *Global Change Biology*, **13**, 610–33.
- Garnier, E. and Freijsen, A. H. J. (1994) On ecological inference from laboratory experiments conducted under optimum conditions. In *A Whole Plant Perspective on Carbon-Nitrogen Interactions*, ed. J. Roy and E. Garnier. The Hague: SPB Academic Publishing, pp. 267–92.
- Gaudinski, J. B., Trumbore, S. E., Davidson, E. A. and Zheng, S. H. (2000) Soil carbon cycling in a temperate forest: radiocarbon-based estimates of residence times, sequestration rates and partitioning of fluxes. *Biogeochemistry*, **51**, 33–69.
- Gill, R. A., Polley, H. W., Johnson, H. B. *et al.* (2002) Nonlinear grassland responses to past and future atmospheric CO_2 . *Nature*, **417**, 279–82.
- Goulden, M. L., Wofsy, S. C., Harden, J. W. *et al.* (1998) Sensitivity of boreal forest carbon balance to soil thaw. *Science*, **279**, 214–17.

- Gu L., Hanson, P. J., Mac Post, W. and Liu, Q. (2008) A novel approach for identifying the true temperature sensitivity from soil respiration measurements. *Global Biogeochemical Cycles*, **22**, doi:10.1029/2007/GB003164
- Grant, R. F. and Rochette, P. (1994) Soil microbial respiration at different water potentials and temperatures: theory and mathematical-modeling. *Soil Science Society of America Journal*, **58**, 1681–90.
- Hanson, P. J., Edwards, N. T., Garten, C. T. and Andrews, J. A. (2000) Separating root and soil microbial contributions to soil respiration: a review of methods and observations. *Biogeochemistry*, **48**, 115–46.
- Harden, J. W., Trumbore, S. E., Stocks, B. J. *et al.* (2000) The role of fire in the boreal carbon budget. *Global Change Biology*, **6**, 174–84.
- Harper, C. W., Blair, J. M., Fay, P. A., Knapp, A. K. and Carlisle, J. D. (2005) Increased rainfall variability and reduced rainfall amount decreases soil CO₂ flux in a grassland ecosystem. *Global Change Biology*, **11**, 322–34.
- Hättenschwiler, S. and Gasser, P. (2005) Soil animals alter plant litter diversity effects on decomposition. *Proceedings of the National Academy of Sciences of the USA*, **102**, 1519–24.
- Hättenschwiler, S., Tiunov, A. V. and Scheu, S. (2005) Biodiversity and litter decomposition in terrestrial ecosystems. *Annual Review of Ecology and Evolution Systematics*, **36**, 191–218.
- Heemsbergen, D. A., Berg, M. P., Loreau, M. *et al.* (2004) Biodiversity effects on soil processes explained by interspecific functional dissimilarity. *Science*, **306**, 1019–20.
- Heinemeyer, A., Ineson, P., Ostle, N. and Fitter, A. H. (2006) Respiration of the external mycelium in the arbuscular mycorrhizal symbiosis shows strong dependence on recent photosynthates and acclimation to temperature. *New Phytologist*, **171**, 159–70.
- Heinemeyer, A., Hartley, I. P., Evans, S. P., De la Fuente, J. A. C. and Ineson, P. (2007) Forest soil CO₂ flux: uncovering the contribution and environmental responses of ectomycorrhizas. *Global Change Biology*, **13**, 1786–97.
- Hirano, T., Segah, H., Harada, T. *et al.* (2007) Carbon dioxide balance of a tropical peat swamp forest in Kalimantan, Indonesia. *Global Change Biology*, **13**, 412–25.
- Högberg, P. and Read, D. J. (2006) Towards a more plant physiological perspective on soil ecology. *Trends in Ecology and Evolution*, **21**, 548–54.
- Högberg, P., Buchmann, N. and Read, D. J. (2006) Comments on Yakov Kuzyakov's review 'Sources of CO₂ efflux from soil and review of partitioning methods' (*Soil Biology and Biochemistry*, **38**, 425–48). *Soil Biology and Biochemistry*, **38**, 2997–8.
- Högberg, P., Högberg, M. N., Göttlicher, S. G. *et al.* (2008) High temporal resolution tracing of photosynthate carbon from the tree canopy to forest soil microorganisms. *New Phytologist*, **177**, 220–8.
- Hungate, B. A., Holland, E. A., Jackson, R. B. *et al.* (1997) The fate of carbon in grasslands under carbon dioxide enrichment. *Nature*, **388**, 576–9.
- Huxman, T. E., Turnipseed, A. A., Sparks, J. P., Harley, P. C. and Monson, R. K. (2003) Temperature as a control over ecosystem CO₂ fluxes in a high-elevation, subalpine forest. *Oecologia*, **134**, 537–46.
- Irvine, J., Law, B. E. and Hibbard, K. A. (2007) Postfire carbon pools and fluxes in semiarid ponderosa pine in Central Oregon. *Global Change Biology*, **13**, 1748–60.
- Janssens, I. A., Lankreijer, H., Matteucci, G. *et al.* (2001) Productivity overshadows temperature in determining soil and ecosystem respiration across European forests. *Global Change Biology*, **7**, 269–78.
- Jastrow, J. D., Miller, R. M. and Lussenhop, J. (1998) Contributions of interacting biological mechanisms to soil aggregate stabilization in restored prairie. *Soil Biology and Biochemistry*, **30**, 905–16.
- Johnson, L. C. and Matchett, J. R. (2001) Fire and grazing regulate belowground processes in tallgrass prairie. *Ecology*, **82**, 3377–89.
- Jonasson, S., Vestergaard, P., Jensen, M. and Michelsen, A. (1996) Effects of carbohydrate amendments on nutrient partitioning, plant and microbial performance of a grassland–shrub ecosystem. *Oikos*, **75**, 220–6.
- Jones, C., McConnell, C., Coleman, K. *et al.* (2005) Global climate change and soil carbon stocks: predictions from two contrasting models for the turnover of organic carbon in soil. *Global Change Biology*, **11**, 154–66.
- King, J. S., Hanson, P. J., Bernhardt, E. *et al.* (2004) A multiyear synthesis of soil respiration responses to elevated atmospheric CO₂ from four forest FACE experiments. *Global Change Biology*, **10**, 1027–42.
- Kirschbaum, M. U. F. (2004) Soil respiration under prolonged soil warming: are rate reductions caused by acclimation or substrate loss? *Global Change Biology*, **10**, 1870–7.

- Knapp, A. K., Fay, P. A., Blair, J. M. *et al.* (2002) Rainfall variability, carbon cycling, and plant species diversity in a mesic grassland. *Science*, **298**, 2202–5.
- Kuzyakov, Y. (2002) Review: factors affecting rhizosphere priming effects. *Journal of Plant Nutrition and Soil Science*, **165**, 382–96.
- Kuzyakov, Y. (2006a) Sources of CO₂ efflux from soil and review of partitioning methods. *Soil Biology and Biochemistry*, **38**, 425–48.
- Kuzyakov, Y. (2006b) Response to the comments by Peter Hogberg, Nina Buchmann and David J. Read on the review ‘Sources of CO₂ efflux from soil and review of partitioning methods’ (*Soil Biology and Biochemistry*, **38**, 425–448). *Soil Biology and Biochemistry*, **38**, 2999–3000.
- Kuzyakov, Y. and Domanski, G. (2000) Carbon input by plants into the soil. Review. *Journal of Plant Nutrition and Soil Science – Zeitschrift Fur Pflanzenernahrung Und Bodenkunde*, **163**, 421–31.
- Lafleur, P. M., Griffis, T. J. and Rouse, W. R. (2001) Interannual variability in net ecosystem CO₂ exchange at the arctic treeline. *Arctic Antarctic and Alpine Research*, **33**, 149–57.
- Lal, R. (2004) Soil carbon sequestration impacts on global climate change and food security. *Science*, **304**, 1623–7.
- Lal, R., Follett, R. F. and Kimble, J. M. (2003) Achieving soil carbon sequestration in the United States: a challenge to the policy makers. *Soil Science*, **168**, 827–45.
- Lambers, H., Chapin, F. S. I. and Pons, T. L. (1998) *Plant Physiological Ecology*. New York: Springer.
- Larcher, W. (2004) *Physiological Plant Ecology: Ecophysiology and Stress Physiology of Functional Groups*. Berlin: Springer-Verlag.
- Lavelle, P. and Spain, A. V. (2001) *Soil Ecology*. Dordrecht: Kluwer Academic Publishers.
- Loreau, M., Naeem, S. and Inchausti, P. (eds) (2002) *Biodiversity and Ecosystem Functioning: Synthesis and Perspectives*. Oxford: Oxford University Press.
- Luckai, N. and Larocque, G. R. (2002) Challenges in the application of existing process-based models to predict the effect of climate change on C pools in forest ecosystems. *Climatic Change*, **55**, 39–60.
- Luo, Y. Q., Wan, S. Q., Hui, D. F. and Wallace, L. L. (2001) Acclimatization of soil respiration to warming in a tall grass prairie. *Nature*, **413**, 622–5.
- Luo, Y. and Zhou, X. (2006) *Soil Respiration and the Environment*. Academic Press.
- Luyssaert, S., Inglisma, I., Jung, M. *et al.* (2007) CO₂ balance of boreal, temperate, and tropical forests derived from a global database. *Global Change Biology*, **13**, 2509–37.
- Marschner, B., Brodowski, S., Dreves, A., Gleixner, G., Gude, A., Grootes P. M., Hamer, U., Heim, A., Jandl, G., Ji, R., Kaiser, K., Kalbitz, K., Kramer, C., Leinweber, P., Rethemeyer, J., Schäffer, A., Schmidt, M. W. I., Schwark, L. and Wiesenberg, G. L. B. (2008) How relevant is recalcitrance for the stabilization of organic matter in soils? *Journal of Plant Nutrition and Soil Science*, **171**, 91–110.
- Melillo, J. M., Steudler, P. A., Aber, J. D. *et al.* (2002) Soil warming and carbon-cycle feedbacks to the climate system. *Science*, **298**, 2173–6.
- Mikola, J., Bardgett, R. D. and Hedlund, K. (2002) Biodiversity, ecosystem functioning and soil decomposer food webs. In *Biodiversity and Ecosystem Functioning: Synthesis and Perspectives*, ed. M. Loreau, S. Naeem and P. Inchausti. Oxford: Oxford University Press.
- Moorhead, D. L. and Sinsabaugh, R. L. (2006) A theoretical model of litter decay and microbial interaction. *Ecological Monographs*, **76**, 151–74.
- Moyano, F. E., Kutsch, W. L. and Schulze, E.-D. (2007) Response of mycorrhizal, rhizosphere and soil basal respiration to temperature and photosynthesis in a barley field. *Soil Biology and Biochemistry*, **39**, 843–53.
- Ngao, J., Epron, D., Brechet, C. and Granier, A. (2005) Estimating the contribution of leaf litter decomposition to soil CO₂ efflux in a beech forest using ¹³C-depleted litter. *Global Change Biology*, **11**, 1768–76.
- Oechel, W. C., Hastings, S. J., Vourlitis, G. *et al.* (1993) Recent change of Arctic Tundra ecosystems from a net carbon-dioxide sink to a source. *Nature*, **361**, 520–3.
- Ostle, N., Ineson, P., Benham, D. and Sleep, D. (2000) Carbon assimilation and turnover in grassland vegetation using an *in situ* ¹³CO₂ pulse labelling system. *Rapid Communications in Mass Spectrometry*, **14**, 1345–50.
- Ostle, N., Whiteley, A. S., Bailey, M. J. *et al.* (2003) Active microbial RNA turnover in a grassland soil estimated using a ¹³CO₂ spike. *Soil Biology and Biochemistry*, **35**, 877–85.
- Ostle, N., Briones, M. J. I., Ineson, P. *et al.* (2007) Isotopic detection of recent photosynthate carbon flow into grassland rhizosphere fauna. *Soil Biology and Biochemistry*, **39**, 768–77.
- Pendall, E., Del Grosso, S., King, J. Y. *et al.* (2003) Elevated atmospheric CO₂ effects and soil water feedbacks on soil

- respiration components in a Colorado grassland. *Global Biogeochemical Cycles*, **17**, 1104, doi: 10.1029/2003GB002035.
- Pendall, E., Bridgham, S., Hanson, P. J. *et al.* (2004) Below-ground process responses to elevated CO₂ and temperature: a discussion of observations, measurement methods, and models. *New Phytologist*, **162**, 311–22.
- Radajewski, S., Ineson, P., Parekh, N. R. and Murrell, J. C. (2000) Stable-isotope probing as a tool in microbial ecology. *Nature*, **403**, 646–9.
- Raich, J. W. and Schlesinger, W. H. (1992) The global carbon-dioxide flux in soil respiration and its relationship to vegetation and climate. *Tellus Series B – Chemical and Physical Meteorology*, **44**, 81–99.
- Raich, J. W., Potter, C. S. and Bhagawati, D. (2002) Interannual variability in global soil respiration, 1980–94. *Global Change Biology*, **8**, 800–12.
- Randerson, J. T., Chapin, F. S., Harden, J. W., Neff, J. C. and Harmon, M. E. (2002) Net ecosystem production: a comprehensive measure of net carbon accumulation by ecosystems. *Ecological Applications*, **12**, 937–47.
- Reichstein, M., Subke, J. A., Angeli, A. C. and Tenhunen, J. D. (2005) Does the temperature sensitivity of decomposition of soil organic matter depend upon water content, soil horizon, or incubation time? *Global Change Biology*, **11**, 1754–67.
- Reichstein, M. and Beer, C. (2008) Soil respiration across scales: The importance of a model–data integration framework for data interpretation. *Journal of Plant Nutrition and Soil Science*, **171**, 344–54.
- Rochette, P., Angers, D. A. and Flanagan, L. B. (1999) Maize residue decomposition measurement using soil surface carbon dioxide fluxes and natural abundance of carbon-13. *Soil Science Society of America Journal*, **63**, 1385–96.
- Ryan, M. G. and Law, B. E. (2005) Interpreting, measuring, and modeling soil respiration. *Biogeochemistry*, **73**, 3–27.
- Sacks, W. J., Schimel, D. S., Monson, R. K. and Braswell, B. H. (2006) Model–data synthesis of diurnal and seasonal CO₂ fluxes at Niwot Ridge, Colorado. *Global Change Biology*, **12**, 240–59.
- Schimel, D. S., House, J. I., Hibbard, K. A. *et al.* (2001) Recent patterns and mechanisms of carbon exchange by terrestrial ecosystems. *Nature*, **414**, 169–72.
- Schimel, J. P. and Weintraub, M. N. (2003) The implications of exoenzyme activity on microbial carbon and nitrogen limitation in soil: a theoretical model. *Soil Biology and Biochemistry*, **35**, 549–63.
- Schlesinger, W. H. and Andrews, J. A. (2000) Soil respiration and the global carbon cycle. *Biogeochemistry*, **48**, 7–20.
- Schuur, E. A. G. and Trumbore, S. E. (2006) Partitioning sources of soil respiration in boreal black spruce forest using radiocarbon. *Global Change Biology*, **12**, 165–76.
- Steinmann, K. T. W., Siegwolf, R., Saurer, M. and Korner, C. (2004) Carbon fluxes to the soil in a mature temperate forest assessed by ¹³C isotope tracing. *Oecologia*, **141**, 489–501.
- Subke, J. A., Hahn, V., Battipaglia, G. *et al.* (2004) Feedback interactions between needle litter decomposition and rhizosphere activity. *Oecologia*, **139**, 551–9.
- Subke, J. A., Inghima, I. and Cotrufo, M. F. (2006) Trends and methodological impacts in soil CO₂ efflux partitioning: a metaanalytical review. *Global Change Biology*, **12**, 921–43.
- Trumbore, S. (2000) Age of soil organic matter and soil respiration: radiocarbon constraints on belowground C dynamics. *Ecological Applications*, **10**, 399–411.
- Trumbore, S. (2006) Carbon respired by terrestrial ecosystems: recent progress and challenges. *Global Change Biology*, **12**, 141–53.
- Turetsky, M. R., Wieder, R. K., Vitt, D. H., Evans, R. J. and Scott, K. D. (2007) The disappearance of relict permafrost in boreal North America: effects on peatland carbon storage and fluxes. *Global Change Biology*, **13**, 1922–34.
- Valentini, R., Matteucci, G., Dolman, A. J. *et al.* (2000) Respiration as the main determinant of carbon balance in European forests. *Nature*, **404**, 861–6.
- van der Heijden, M. G. A., Bardgett, R. D. and van Straalen, N. M. (2008) The unseen majority: soil microbes as drivers of plant diversity and productivity in terrestrial ecosystems. *Ecology Letters*, **11**, 296–310.
- van Groenigen, K. J., Six, J., Hungate, B. A. *et al.* (2006) Element interactions limit soil carbon storage. *Proceedings of the National Academy of Sciences of the United States of America*, **103**, 6571–4.
- Vandenkoornhuise, P., Mahe, S., Ineson, P. *et al.* (2007) Active root-inhabiting microbes identified by rapid incorporation of plant-derived carbon into RNA. *Proceedings of the National Academy of Sciences of the United States of America*, **104**, 16970–5.
- von Lütow, M., Kögel-Knabner, I., Ludwig, B., Matzner, E., Flessa, H., Ekschmitt, K., Guggenberger, G.,

- Marschner, B. and Kalbitz K. (2008) Stabilization mechanisms of organic matter in four temperate soils: Development and application of a conceptual model. *Journal of Plant Nutrition and Soil Science*, **171**, 91–110.
- Verburg, P. S. J., Arnone, J. A., Obrist, D. *et al.* (2004) Net ecosystem carbon exchange in two experimental grassland ecosystems. *Global Change Biology*, **10**, 498–508.
- von Lützow, M., Kögel-Knabner, I., Ekschmitt, K. *et al.* (2007) SOM fractionation methods: relevance to functional pools and to stabilization mechanisms. *Soil Biology and Biochemistry*, **39**, 2183–207.
- Wardle, D. A. (2002) *Communities and Ecosystems: Linking the Aboveground and Belowground Components*. Monographs in Population Biology. Vol. 34. Princeton, NJ: Princeton University Press.
- Wardle, D. A., Bardgett, R. D., Klironomos, J. N. *et al.* (2004) Ecological linkages between aboveground and belowground biota. *Science*, **304**, 1629–33.
- Whiting, G. J. and Chanton, J. P. (2001) Greenhouse carbon balance of wetlands: methane emission versus carbon sequestration. *Tellus Series B – Chemical and Physical Meteorology*, **53**, 521–8.
- Williams, M., Schwarz, P. A., Law, B. E., Irvine, J. and Kurpius, M. R. (2005) An improved analysis of forest carbon dynamics using data assimilation. *Global Change Biology*, **11**, 89–105.
- Zimmermann, M., Leifeld, J., Schmidt, M. W. I., Smith, P. and Fuhrer, J. (2007) Measured soil organic matter fractions can be related to pools in the RothC model. *European Journal of Soil Science*, **58**, 658–67.

15 • *Appendix*: Towards a standardized protocol for the measurement of soil CO₂ efflux

Michael Bahn, Werner L. Kutsch, Andreas Heinemeyer and Ivan A. Janssens

15.1 INTRODUCTION

Soil CO₂ efflux, more commonly termed soil respiration, is considered to be the second largest flux of carbon between terrestrial ecosystems and the atmosphere. Current estimates of global soil respiration are in the range of 68–80 Pg C a⁻¹ (Raich and Potter, 1995; Raich *et al.*, 2002), which exceeds estimated annual rates from fossil fuel combustion by an order of magnitude (Schlesinger and Andrews, 2000; IPCC, 2007). It must be noted that these estimates of global soil CO₂ efflux are based on a very limited dataset: (1) the distribution of data for biomes is biased towards forests in the Northern hemisphere; (2) a considerable proportion of the data is based on static chamber measurements, which tend to underestimate soil respiration at high flux rates (Norman *et al.*, 1997; Chapter 2, Pumpanen *et al.*); (3) annual estimates are often based on simplistic relationships (generally only temperature and sometimes also soil moisture) that capture only a limited fraction of the diurnal, seasonal, annual and inter-annual variation of soil respiration and (4) the spatial variation of soil respiration is generally not well captured, both within ecosystems and across similar ecosystems at a regional scale.

A further major problem for obtaining sensible estimates of global soil CO₂ efflux is related to the fact that even though an increasing amount of data is becoming available, these more recent datasets are often not easily comparable due to different methodologies and to the limited availability of ancillary parameters. Consequently, the global implementation of a standardized approach for measuring soil CO₂ fluxes would be a major step ahead, similar to what has recently been achieved for eddy covariance measurements of the net ecosystem exchange of CO₂ between ecosystems and the atmosphere (Aubinet *et al.*, 2000; Baldocchi *et al.*, 2001).

In the following, we discuss major issues that need to be considered towards achieving this goal and suggest a common protocol for measuring soil CO₂ efflux that aims to provide a baseline for making datasets comparable across ecosystems and biomes. Many of these suggestions may also be of general interest to studies on soil CO₂ fluxes at different temporal and spatial scales.

Given a finite availability of project resources, the question addressed by a study will ultimately determine what parameters are to be measured at what temporal and spatial resolution. However, regardless of how limited the resources, the aim of a protocol for estimating annual total soil fluxes should be to reduce the uncertainty within and across sites by making measurements in a comparable way, avoiding measurement bias or artefacts, and covering the annual range of environmental conditions prevailing at a site. As there are inevitable trade-offs in the spatial and temporal resolution of measurements (Savage and Davidson, 2003), the experimental design should carefully account for both spatial and temporal variability, as required by the specific hypotheses addressed in the study (see Chapter 3, Subke *et al.*).

15.2 METHODOLOGICAL CONSIDERATIONS

15.2.1 Initial site survey

A first, but commonly overlooked, necessity is to evaluate the spatial variability of soil CO₂ efflux and its potential drivers at the site (see Chapter 3, Subke *et al.*). This will not only determine the required number of replicates to capture spatial variability (e.g. semivariogram) but will also allow meaningful spatial allocation of sample points (e.g. stratified sampling). Moreover, this

initial assessment should be linked to moisture gradients or variation in soil depth, amounts of litter, organic matter etc. across the site or to an identification of the effects of tree distance on measured fluxes, as all of these will influence soil respiration measurements.

15.2.2 Chamber design

Among the chamber methods currently available the closed dynamic chamber is the most commonly used. Soil respiration systems available on the market generally provide comparable flux rates, even though soil diffusivity to CO₂ (as related to soil structure/porosity and soil water content) may change the performance of the system and thus affect the result (Pumpanen *et al.*, 2004; Chapter 2, Pumpanen *et al.*). Furthermore, it should be noted that different handling even by experienced scientists may cause larger errors within a system than among systems (Pumpanen *et al.*, 2004). Thus, it is highly recommended that the system applied for a study is cross-compared under a range of environmental conditions against those used by other research groups (Le Dantec *et al.*, 1999; Bahn *et al.*, 2008). Comparisons between closed and open dynamic systems should consider that the effective volume (i.e. the total volume of air covered by the chamber headspace, including the air-filled soil pores) may be a sensitive parameter for closed systems (Drewitt *et al.*, 2002), while it is not relevant for flux calculations in open systems (see Chapter 2, Pumpanen *et al.*, Eqs. (2.1) and (2.2)). Generally, it should be noted that the effective volume correction is still an unresolved issue, as the underlying assumptions may deserve a closer inspection (E. Davidson, personal communication).

There are a number of basic aspects that need to be considered when operating chamber systems, including (1) a proper sealing between the collar (see below) and the chamber to avoid leaks and (2) a sufficient mixing of the chamber headspace air, while avoiding pressure effects (see below). Especially on wet soils with low soil CO₂ efflux rates, dilution effects of water vapour on chamber CO₂ concentrations may lead to an underestimation of CO₂ flux rates (e.g. Welles *et al.*, 2001) and may need to be accounted for, though they normally only cause minor errors. When working with a closed system the ratio of chamber volume to surface area of the collar should be optimized to achieve adequate measurement resolution. Furthermore, chambers

should always be placed carefully on a collar to avoid pressurization of chamber (see below), which may cause a transient reduction of soil CO₂ efflux (Davidson *et al.*, 2002). When using an open system care should be taken that the CO₂ concentration of the system inlet air is stable, as both rapid changes or slow drifts of ambient air may cause differential values between analysis and reference air that do not correspond to real soil CO₂ efflux rates.

A major error concerning all chamber-based studies of soil respiration is related to the differential pressure between the soil and the chamber headspace (PDC), which may have substantial effects on measured soil CO₂ efflux rates (Kutsch, 1996; Lund *et al.*, 1999; Longdoz *et al.*, 2000; Chapter 2, Pumpanen *et al.*). PDC effects should be taken into account in the whole system setup, in particular chamber construction (pump and fan). Vents have been shown to minimize PDC effects, however, they may increase soil CO₂ flux into the chamber headspace during wind (Venturi effect, see Bain *et al.*, 2005). Thus the design and positioning of vents may be critical for avoiding PDC effects during windy conditions (Xu *et al.*, 2006). Such effects might need to be tested especially for home-made chambers, using a sealed chamber bottom rather than an open soil chamber collar, so as to avoid equilibration of pressure differences in the soil pores. Changes in soil moisture may alter the above described PDC effects considerably, effects being more pronounced in dry than moist soil.

A second potential error inherent to all chamber-based measurements is that soil CO₂ efflux depends on the concentration gradient between soil and atmosphere, thus the CO₂ concentration in the chamber headspace should resemble that normally occurring at the soil surface. An underestimation of soil respiration rate due to a reduced CO₂ concentration gradient is likely to increase with increasing soil CO₂ efflux rate and, depending on the type of system used, measurement time (closed type) or mass flow rate through the system (open type).

Thirdly, turbulent transport of CO₂, especially during windy situations ('pressure pumping', Takle *et al.*, 2004), may have short-term effects on soil CO₂ efflux that might need to be considered when interpreting soil respiration measurements (Kutsch *et al.*, 2001).

For calculating soil CO₂ efflux rates from closed chamber measurements both linear and non-linear models have been used, which may yield different

results. Before the appropriate model is chosen it is essential to remove data that have been influenced by measurement artefacts, such as pressure changes related to chamber placement or high CO₂ concentrations in the chamber headspace (Davidson *et al.*, 2002). For quality assessment of data see Section 15.3.

15.2.3 Manual chambers versus autochambers

While manual chambers are well suited for covering spatial variability, automated chambers offer an important opportunity to study the temporal variation of soil CO₂ efflux also during periods that are unfavourable for manual measurements, e.g. at night, during rainfall etc. (Savage and Davidson, 2003). There is increasing evidence that soil respiration at a given soil temperature may vary during the day, resulting in a diurnal hysteresis in the temperature–respiration relationship (Reichstein *et al.*, 2005a; Tang *et al.*, 2005). Irrespective of whether this effect is caused by an inappropriate selection of the depth at which soil temperature is measured or not (Reichstein *et al.* 2005a, Bahn *et al.* 2008, see below), this phenomenon may be relevant for assessing short-term effects of rain events or assimilate supply on soil CO₂ efflux (Baldocchi *et al.*, 2006; Heinemeyer *et al.*, 2007) or for estimating annual totals of soil respiration (but see Savage and Davidson, 2003). While providing soil CO₂ efflux rates at a high time resolution and thus offering new insights into the processes determining soil CO₂ efflux, automated soil respiration systems also introduce the challenge of handling large quantities of data that deserve a rigorous quality assurance and quality control (Savage *et al.*, 2008). Such larger datasets also offer a statistically sound basis for analyzing systematic sampling uncertainties and random measurement errors and estimating uncertainties of fluxes aggregated for different time scales (Hollinger and Richardson, 2005; Richardson and Hollinger, 2005), an issue that has so far been insufficiently considered by the soil respiration community.

15.2.4 Collars

Collars are mainly important for (1) providing a stable seal between the soil chamber and the soil surface and (2) identifying unique spatial reference points enabling statistically sound analyses of temporal changes in soil respiration. The diameter of collars will obviously depend

on the dimension of the chamber. There is a size-dependent trade-off between physical and physiological effects of a collar. The larger the collar, the smaller the edge effect related to the physical presence of the collar (especially soil cracks channelling CO₂ and water). The smaller the collar, the smaller the effect on disturbance of the root and mycorrhizal system, including severing of roots and effects of reduced assimilate transport to the rhizosphere (Heinemeyer *et al.*, 2007). To minimize these effects it is pivotal to insert collars as little as possible into the soil. Chamber legs or collar hooks can help in stabilizing even very shallow collars. Collar installation may furthermore disturb the soil structure and cause a flush of CO₂, thus should be made at least 24 hours before measurements start. In case it is necessary to remove above-ground vegetation to obtain soil – rather than ecosystem – respiration rates in short vegetation (e.g. grassland), it is important to protect the bare soil from heating up and drying out, e.g. by using a water permeable shading cloth. While long-term installation of collars is helpful for improved analysis of time-courses (repeated measures, see above) it should be considered that possible artefacts caused by collars may change over time (e.g. soil moisture, litter accumulation, faunal and microbial composition).

15.2.5 Profiles of soil CO₂ concentration

Besides chambers, CO₂ profile measurements are emerging as a very useful approach to monitor the production and diffusion of CO₂ in and across soil layers, which permits a vertical partitioning of sources of soil CO₂ efflux (Hirano *et al.*, 2003; Tang *et al.*, 2003; Davidson *et al.*, 2006a). However, it must be emphasized that their suitability for estimating soil CO₂ efflux depends very much on the availability of a validated model of soil diffusivity (Moldrup *et al.*, 1999), which requires air-filled porosity and tortuosity as input parameters. It is strongly advised that soil diffusivity is measured also independently for a range of soil moisture conditions either on intact soil cores in the lab (Jassal *et al.*, 2005) or in the field using independent measurements of fluxes of tracers such as radon or SF₆ (Werner *et al.*, 2004; Davidson *et al.*, 2006a).

In earlier studies soil CO₂ profiles were obtained by periodical suction of soil air through gas sampling tubes buried at various depths, and subsequent analysis of CO₂ concentration. This approach may induce

a pressure gradient in the soil, which may affect soil air movement and ultimately alter CO₂ concentrations. More recently, solid-state CO₂ sensors have become available that permit a continuous monitoring of CO₂ concentrations at various soil depths. When installing and activating solid-state CO₂ sensors in the soil, care should be taken to avoid disturbance of the soil environment and to minimize effects of local soil heating by the sensors (Hirano *et al.*, 2003; Jassal *et al.*, 2004). The latter can be achieved by thermal insulation of sensors and by activating sensors for shorter time intervals, which should be defined by considering also the warm-up time required for stable sensor readings under different environmental conditions.

15.2.6 Ancillary parameters

Ancillary parameters are essential for calculating, interpreting and up-scaling soil CO₂ efflux rates, as well as for later cross-site synthesis activities. Determining which ancillary parameters are most essential depends on the scope of the study and the means available. A complete list of such parameters is provided in Table 15.1, some parameters being required for all soil respiration studies and some to be included depending on the scope (e.g. hypotheses) and possibilities of a particular study.

15.2.6.1 Minimum requirements

As for any ecosystem study a general site description should be provided, which should characterize the soil (type, texture, depth, bulk density, carbon content and pH), geology (indicating potential contributions of inorganic carbon), and current and past land management and disturbance that may exert a strong influence on soil carbon dynamics.

Soil temperature is a critical parameter, accounting for most of the variability of soil respiration. Soil moisture is particularly important for the interpretation of soil CO₂ efflux rates when limiting either physiological activity and substrate diffusion (low soil moisture) or diffusion of O₂ and CO₂ (high soil moisture). It is of crucial importance that each measurement of soil respiration can be related to a measurement of soil temperature and soil moisture. This is particularly true for discontinuous measurements with portable systems that target spatial heterogeneity or differences between treatments or sites. Simultaneous measurements of soil

temperature and soil moisture should ideally be made adjacent to each collar during each measurement of soil respiration. Likewise, systems designed for continuous measurements of soil respiration should be equipped with soil temperature and soil moisture sensors at each chamber, to be able to interpret temporal discontinuities between chambers. Independent of the system used, each site where soil respiration measurements are conducted should have a continuous monitoring of soil temperature and moisture at several depths.

Estimates of the *in situ* temperature sensitivity of soil respiration (Q_{10}) are based on the relationship of observed soil CO₂ efflux rates versus the temperature at an often arbitrarily chosen soil depth, which may not represent the layer in which most of the CO₂ is actually produced. However, as temperature and its diel and seasonal amplitude change with soil depth, the apparent Q_{10} value varies depending on the measurement depth (Pavelka *et al.*, 2007; Graf *et al.*, 2008). Reichstein *et al.* (2005a) showed that considering more than a single soil layer as a source of CO₂ may significantly increase the explained diurnal variability in the temperature sensitivity of respiration (see also Chapter 11, Reichstein and Janssens). Thus a continuous measure of soil temperature and moisture at three soil depths is recommended, the depths depending on the presence and thickness of any site-specific litter layer that may be present, on rooting depth and soil horizons. The one soil temperature against which soil respiration yields the best regression fit should indicate the soil layer that contributes most actively to total CO₂ production (but see Graf *et al.*, 2008). Note that this layer may vary during the course of the season, e.g. due to phenological changes or root growth and specific activity or changes in soil moisture with depth. Pavelka *et al.* (2007) showed that soil temperature profiles can be used to normalize the Q_{10} of soil efflux to one reference temperature, which is important for site inter-comparisons.

In addition to obtaining a vertical profile of soil temperature and moisture it is desirable to measure the horizontal heterogeneity by adding further sensors at a given soil depth.

Soil moisture should ideally be measured at the same positions as soil temperature. While soil water potential is the more appropriate measure for physiological interpretations, soil water content is critical information for assessing the diffusion component, which is needed for obtaining flux rates from profiles of soil CO₂

Table 15.1 *Ancillary parameters required for calculating, interpreting and up-scaling soil CO₂ flux and efflux rates. L1, L2 and L3 refer to different levels of investigation and indicate minimum requirements, additional interesting information and in-depth information that requires a higher input of human/financial resources, respectively. For further details see text.*

Minimum requirement (L1)	L2	L3
General site characteristics		
Vegetation		
Soil: type, texture, depth, bulk density, pH	Soil water characteristics for each soil layer/horizon	
Geology		
Land management/disturbance history		
Meso-/microclimate		
Soil temperature (3 depths, 1–many horizontal reps per site)	Air temperature and humidity (possibly in canopy)	
Soil water content (3 depths, 1–many horizontal reps per site)	Soil water potential (3 depths, 1–many horizontal reps per site)	
Precipitation	Snow cover	
Wind speed (possibly near chamber vent)	Photosynthetically active radiation (<i>see site productivity</i>)	
Carbon source		
	<i>Site productivity (proxies):</i> Leaf Area Index (peak/seasonal dynamics), litter fall	Gross Primary Productivity
	<i>Litter quality (proxies):</i> residence time of litter (measure litter fall and litterstock), C/N ratio	Litter chemical compounds
	Litter and soil C content (both on mass and area basis) separately for each layer/horizon	Soil organic matter quality
Further biotic factors		
	Fine root biomass	Components of soil respiration (<i>in situ</i>)
	Phenology	Ecosystem engineers (fauna)
	Microbial biomass/basal respiration	Plant–microbe–SOM interactions

concentration. Quality control of moisture probes is an important but often overlooked factor. Moisture probes may also need to be calibrated for site-specific conditions. Ideally, soil moisture characteristics are measured for each soil layer, linking water potential and volumetric water content.

Continuous measurements at the site should also include at least continuously recorded precipitation and wind speed at chamber level (to identify potential errors in flux measurements related to the Venturi effect and pressure pumping). Further parameters that might be helpful for linking soil respiration rates to

photosynthetic activity of the canopy include photosynthetically active radiation (PAR), air temperature and humidity.

15.2.6.2 Additional parameters

To allow a more profound interpretation of soil CO₂ efflux rates at different temporal and spatial scales it is necessary to obtain information on the carbon inputs and on biotic factors that may strongly influence soil respiration. Carbon inputs that support the heterotrophic component of soil respiration can be estimated from above-ground litter production (in agricultural systems: crop residues) and fine root turnover. The latter is difficult to measure and, therefore, constitutes a large source of uncertainty in soil carbon balances.

Estimates of gross primary productivity are useful parameters to interpret root and mycorrhizal (autotrophic) component soil respiration at different time scales (Janssens *et al.*, 2001; Sampson *et al.*, 2007; Bahn *et al.*, 2008). If data from net ecosystem CO₂ exchange measurements are not available, proxies such as leaf area index (LAI) (Reichstein *et al.*, 2003; Hibbard *et al.*, 2005) might be used and could be combined with PAR, air temperature and humidity for improving estimates and obtaining a better time resolution.

Litter carbon content, both on a mass and surface-area basis, may be of great interest for interpreting soil respiration (Hanson *et al.*, 2003). Proxies of litter quality include the residence time of litter (derived either from measured litter fall and litter stock or from mesh bag experiments) and C/N ratios. Analysis of chemical compounds yields better insights into litter quality (Chapter 5, Cotrufo *et al.*), but in most cases will be far too elaborate for interpreting soil respiration rates. Soil carbon content has also been used to interpret soil respiration (Rodeghiero and Cescatti, 2005), but the degree to which soil efflux is coupled to soil carbon content may be largely determined by the proportions of labile versus recalcitrant carbon (Gu *et al.*, 2004; Davidson and Janssens, 2006), as well as priming effects on soil organic matter decomposition through fresh organic carbon from litter fall and root exudation (Kuzyakov, 2002; Pendall *et al.*, 2003; Subke *et al.*, 2004). Thus information on organic matter quality/decomposability should ideally complement a standardized assessment of soil carbon content (Chapter 4, Rodeghiero *et al.*; Chapter 6, Denef *et al.*).

Biotic factors affecting soil respiration have already been discussed as related to photosynthetic soil carbon input. A separation of plant and microbial components of soil respiration is expected to yield important information on the response of soil respiration components to changing environments (see Chapter 14, Bahn *et al.*), but leads beyond the scope of this chapter (for a review of approaches see Chapter 7, Moyano *et al.*; Hanson *et al.*, 2000; Kuzyakov, 2006; Subke *et al.*, 2006). Also the importance of ecosystem engineers and interactions between plants, microbes and soil organic matter quality is treated in more detail elsewhere in this book (Chapter 6, Denef *et al.*; Chapter 9, Kutsch *et al.*; Chapter 10, Ayres *et al.*).

15.3 QUALITY ASSESSMENT AND QUALITY CONTROL

Quality assessment is difficult for soil respiration data, because many datasets are discontinuous and, for example, temperature responses may be influenced by confounding effects (Davidson *et al.*, 2006b) and by acclimation (see Chapter 1, Kutsch *et al.*; Chapter 7, Moyano *et al.*; Chapter 14, Bahn *et al.*). Automated soil respiration systems have recently become more commonly used, and produce larger quantities of data that require consistent protocols for data analysis (Savage *et al.*, 2008). Generally, the most robust approach is to first remove raw measurements that provide physically impossible or unreasonable data and to make sure that calculated flux rates are based on constant chamber headspace concentration changes over time (closed systems) or steady-state conditions (open systems). In a second step, spike detection in time series and deviations from temperature response curves are important criteria to flag uncertain data within a dataset.

The international soil respiration database provides a web-based tool for quality control on the submitted datasets (www.soilrespiration.net). The quality checks by the database comprise currently the following procedures that are also recommended for soil respiration datasets in general:

- test for completeness of data
- Grubbs' test for outliers after Grubbs (1969) and Sachs and Hedderich (2006)
- spike detection (MAD – median absolute deviation, Papale *et al.* (2006)
- Non-linear regression and prediction interval.

In the test for completeness it is checked whether each dataset is complete, containing time stamp, collar number, respiration rate, soil temperature and soil moisture. Applying Grubbs' test and MAD to analyze time series for spikes and outliers, each value is tested in relation to values measured before and thereafter. The latter test applies a non-linear temperature and moisture response function to the measurements from each single collar (as for example based on the soil respiration model described by Reichstein *et al.* (2005b) and flags values beyond the confidence interval of the regression function.

Spike detection is usually applied to continuous datasets and can fail with discontinuous data, whereas the application of a temperature and moisture response model should be possible for both types of data. Flagged datasets should not be rejected automatically, because extraordinarily high or low fluxes may be the result of another factor that is not included in the data. For example, spikes can naturally occur due to rain events (Fierer and Schimel, 2003), changes in the groundwater table (Kutsch *et al.*, 2001) and sudden PAR or temperature changes (Elberling and Brandt, 2003; Monson *et al.*, 2006). It is strongly advised that continuously recorded microclimate data are considered for the interpretation of flagged data. Especially during windy conditions, soil CO₂ efflux data may be noisy due to pressure effects. Thus, while identification of critical data can be well achieved by automated approaches, the final decision on including or excluding data needs to be taken from the overall context, which is best judged by the responsible scientist.

ACKNOWLEDGEMENTS

The outline of this protocol was discussed in detail and agreed on by the participants of the ESF-RSTCB International Soil Respiration Database Workshop, Crete, 9–11 November 2006. We acknowledge constructive comments on the manuscript by Eric Davidson, Andrew Black and Dayle McDermitt.

REFERENCES

- Aubinet, M., Grelle, A., Ibrom, A. *et al.* (2000) Estimates of the annual net carbon and water exchange of forests: the EUROFLUX methodology. *Advances in Ecological Research*, **30**, 113–75.
- Bahn, M., Rodeghiero, M., Anderson-Dunn, M. *et al.* (2008) Soil respiration in European grasslands in relation to climate and assimilate supply. *Ecosystems*, **11**, 1352–67.
- Bain, W. G., Hutrya, L., Patterson, D. C. *et al.* (2005) Wind-induced error in the measurement of soil respiration using closed dynamic chambers. *Agricultural and Forest Meteorology*, **131**, 225–32.
- Baldocchi, D., Falge, E., Gu, L. H. *et al.* (2001) FLUXNET: a new tool to study the temporal and spatial variability of ecosystem-scale carbon dioxide, water vapor, and energy flux densities. *Bulletin of the American Meteorological Society*, **82**, 2415–34.
- Baldocchi, D., Tang, J. W. and Xu, L. K. (2006) How switches and lags in biophysical regulators affect spatial-temporal variation of soil respiration in an oak-grass savanna – art. no. G02008. *Journal of Geophysical Research – Biogeosciences*, **111**, 2008.
- Davidson, E. A. and Janssens, I. A. (2006) Temperature sensitivity of soil carbon decomposition and feedbacks to climate change. *Nature*, **440**, 165–73.
- Davidson, E. A., Savage, K., Verchot, L. V. and Navarro, R. (2002) Minimizing artifacts and biases in chamber-based measurements of soil respiration. *Agricultural and Forest Meteorology*, **113**, 21–37.
- Davidson, E. A., Savage, K. E., Trumbore, S. E. and Borken, W. (2006a) Vertical partitioning of CO₂ production within a temperate forest soil. *Global Change Biology*, **12**, 944–56.
- Davidson, E. A., Janssens, I. A. and Luo, Y. Q. (2006b) On the variability of respiration in terrestrial ecosystems: moving beyond Q₁₀. *Global Change Biology*, **12**, 154–64.
- Drewitt, G. B., Black, T. A., Nestic, Z. *et al.* (2002) Measuring forest floor CO₂ fluxes in a Douglas-fir forest. *Agricultural and Forest Meteorology*, **110**, 299–317.
- Elberling, B. and Brandt, K. K. (2003) Uncoupling of microbial CO₂ production and release in frozen soil and its implications for field studies of arctic C cycling. *Soil Biology and Biochemistry*, **35**, 263–72.
- Fierer, N. and Schimel, J. P. (2003) A proposed mechanism for the pulse in carbon dioxide production commonly observed following the rapid rewetting of a dry soil. *Soil Science Society of America Journal*, **67**, 798–805.
- Graf, A., Weihermüller, L., Huisman, J. A. *et al.* (2008) Measurement depth effects on the apparent temperature sensitivity of soil respiration in field studies. *Biogeosciences Discussions*, **5**, 1867–98.

- Grubbs, F. E. (1969) Procedures for detecting outlying observations in samples. *Technometrics*, **11**, 1–21.
- Gu, L. H., Post, W. M. and King, A. W. (2004) Fast labile carbon turnover obscures sensitivity of heterotrophic respiration from soil to temperature: a model analysis – art. no. GB1022. *Global Biogeochemical Cycles*, **18**, B1022.
- Hanson, P. J., Edwards, N. T., Garten, C. T. and Andrews, J. A. (2000) Separating root and soil microbial contributions to soil respiration: a review of methods and observations. *Biogeochemistry*, **48**, 115–46.
- Hanson, P. J., O'Neill, E. G. and Chambers, M. L. S. (2003) Soil respiration and litter decomposition. In *North American Temperate Deciduous Forest Responses to Changing Precipitation Regimes*, ed. P. J. Hanson and S. D. Wullschlegel. New York: Springer, pp. 163–89.
- Heinemeyer, A., Hartley, I. P., Evans, S. P., De la Fuente, J. A. C. and Ineson, P. (2007) Forest soil CO₂ flux: uncovering the contribution and environmental responses of ectomycorrhizas. *Global Change Biology*, **13**, 1786–97.
- Hibbard, K. A., Law, B. E., Reichstein, M. and Sulzman, J. (2005) An analysis of soil respiration across northern hemisphere temperate ecosystems. *Biogeochemistry*, **73**, 29–70.
- Hirano, T., Kim, H. and Tanaka, Y. (2003) Long-term half-hourly measurement of soil CO₂ concentration and soil respiration in a temperate deciduous forest – art. no. 4631. *Journal of Geophysical Research – Atmospheres*, **108**, 4631.
- Hollinger, D. Y. and Richardson, A. D. (2005) Uncertainty in eddy covariance measurements and its application to physiological models. *Tree Physiology*, **25**, 873–85.
- IPCC (2007) *Climate Change 2007: The Physical Science Basis – Contribution of Working Group I to the Fourth Assessment Report of the IPCC*. Report of the Intergovernmental Panel on Climate Change. Cambridge and New York: Cambridge University Press.
- Janssens, I. A., Lankreijer, H., Matteucci, G. *et al.* (2001) Productivity overshadows temperature in determining soil and ecosystem respiration across European forests. *Global Change Biology*, **7**, 269–78.
- Jassal, R. S., Black, T. A., Drewitt, G. B. *et al.* (2004) A model of the production and transport of CO₂ in soil: predicting soil CO₂ concentrations and CO₂ efflux from a forest floor. *Agricultural and Forest Meteorology*, **124**, 219–36.
- Jassal, R. S., Black, T. A., Novak, M. *et al.* (2005) Relationship between soil CO₂ concentrations and forest-floor CO₂ effluxes. *Agricultural and Forest Meteorology*, **130**, 176–92.
- Kutsch, W. L. (1996) Untersuchung zur Bodenatmung zweier Ackerstandorte im Bereich der Bornhöveder Seenkette. *EcoSys, Beiträge zur Ökosystemforschung*, **Suppl. 16**.
- Kutsch, W. L., Staack, A., Wötzel, J., Middelhoff, U. and Kappen, L. (2001) Field measurements of root respiration and total soil respiration in an alder forest. *New Phytologist*, **150**, 157–68.
- Kuzyakov, Y. (2002) Review: factors affecting rhizosphere priming effects. *Journal of Plant Nutrition and Soil Science*, **165**, 382–96.
- Kuzyakov, Y. (2006) Sources of CO₂ efflux from soil and review of partitioning methods. *Soil Biology and Biochemistry*, **38**, 425–48.
- Le Dantec, V., Epron, D. and Dufrene, E. (1999) Soil CO₂ efflux in a beech forest: comparison of two closed dynamic systems. *Plant and Soil*, **214**, 125–32.
- Longdoz, B., Yernaux, M. and Aubinet, M. (2000) Soil CO₂ efflux measurements in a mixed forest: impact of chamber disturbances, spatial variability and seasonal evolution. *Global Change Biology*, **6**, 907–17.
- Lund, C. P., Riley, W. J., Pierce, L. L. and Field, C. B. (1999) The effects of chamber pressurization on soil-surface CO₂ flux and the implications for NEE measurements under elevated CO₂. *Global Change Biology*, **5**, 269–81.
- Moldrup, P., Olsen, T., Yamaguchi, T., Schjonning, P. and Rolston, D. E. (1999) Modelling diffusion and reaction in soil. IX. The Buckingham-Burdine-Campbell equation for gas diffusivity in undisturbed soil. *Soil Science*, **164**, 542–51.
- Monson, R. K., Burns, S. P., Williams, M. W. *et al.* (2006) The contribution of beneath-snow soil respiration to total ecosystem respiration in a high-elevation, subalpine forest. *Global Biogeochemical Cycles*, **20**, GB3030, doi:10.1029/2005GB002684.
- Norman, J. M., Kucharik, C. J., Gower, S. T. *et al.* (1997) A comparison of six methods for measuring soil-surface carbon dioxide fluxes. *Journal of Geophysical Research – Atmospheres*, **102**, D24, 28771–7.

- Papale, D., Reichstein, M., Aubinet, M. *et al.* (2006) Towards a standardized processing of Net Ecosystem Exchange measured with eddy covariance technique: algorithms and uncertainty estimation. *Biogeosciences*, **3**, 571–83.
- Pavelka, M., Acosta, M., Marek, M. V., Kutsch, W. and Janous, D. (2007) Dependence of the Q_{10} values on the depth of the soil temperature measuring point. *Plant and Soil*, **292**, 171–9.
- Pendall, E., Del Grosso, S., King, J. Y. *et al.* (2003) Elevated atmospheric CO₂ effects and soil water feedbacks on soil respiration components in a Colorado grassland. *Global Biogeochemical Cycles*, **17**, 1046, doi:10.1029/2001GB001821.
- Pumpanen, J., Kolari, P., Ilvesniemi, H. *et al.* (2004) Comparison of different chamber techniques for measuring soil CO₂ efflux. *Agricultural and Forest Meteorology*, **123**, 159–76.
- Raich, J. W. and Potter, C. S. (1995) Global patterns of carbon dioxide emissions from soils. *Global Biogeochemical Cycles*, **9**, 23–36.
- Raich, J. W., Potter, C. S. and Bhagawati, D. (2002) Interannual variability in global soil respiration, 1980–94. *Global Change Biology*, **8**, 800–12.
- Reichstein, M., Rey, A., Freibauer, A. *et al.* (2003) Modeling temporal and large-scale spatial variability of soil respiration from soil water availability, temperature and vegetation productivity indices – art. no. 1104. *Global Biogeochemical Cycles*, **17**, 1104.
- Reichstein, M., Subke, J. A., Angeli, A. C. and Tenhunen, J. D. (2005a) Does the temperature sensitivity of decomposition of soil organic matter depend upon water content, soil horizon, or incubation time? *Global Change Biology*, **11**, 1754–67.
- Reichstein, M., Katterer, T., Andren, O. *et al.* (2005b) Temperature sensitivity of decomposition in relation to soil organic matter pools: critique and outlook. *Biogeosciences*, **2**, 317–21.
- Richardson, A. D. and Hollinger, D. Y. (2005) Statistical modeling of ecosystem respiration using eddy covariance data: maximum likelihood parameter estimation, and Monte Carlo simulation model and parameter uncertainty, applied to three simple models. *Agricultural and Forest Meteorology*, **131**, 191–208.
- Rodeghiero, M. and Cescatti, A. (2005) Main determinants of forest soil respiration along an elevation/temperature gradient in the Italian Alps. *Global Change Biology*, **11**, 1024–41.
- Sachs, L. and Hedderich, J. (2006) *Angewandte Statistik. Methodensammlung mit R; mit 180 Tabellen*, 12th edn. Berlin: Springer.
- Sampson, D. A., Janssens, I. A., Yuste, J. C. and Ceulemans, R. (2007) Basal rates of soil respiration are correlated with photosynthesis in a mixed temperate forest. *Global Change Biology*, **13**, 2008–17.
- Savage, K., Davidson, E. A. and Richardson, A. D. (2008) A conceptual and practical approach to data quality and analysis procedures for high-frequency soil respiration measurements. *Functional Ecology*, doi: 10.1111/j.1365-2435.2008.01414.x.
- Savage, K. E. and Davidson, E. A. (2003) A comparison of manual and automated systems for soil CO₂ flux measurements: trade-offs between spatial and temporal resolution. *Journal of Experimental Botany*, **54**, 891–9.
- Schlesinger, W. H. and Andrews, J. A. (2000) Soil respiration and the global carbon cycle. *Biogeochemistry*, **48**, 7–20.
- Subke, J. A., Hahn, V., Battipaglia, G. *et al.* (2004) Feedback interactions between needle litter decomposition and rhizosphere activity. *Oecologia*, **139**, 551–9.
- Subke, J. A., Inglema, I. and Cotrufo, M. F. (2006) Trends and methodological impacts in soil CO₂ efflux partitioning: a metaanalytical review. *Global Change Biology*, **12**, 921–43.
- Take, E. S., Massman, W. J., Brandle, J. R. *et al.* (2004) Influence of high-frequency ambient pressure pumping on carbon dioxide efflux from soil. *Agricultural and Forest Meteorology*, **124**, 193–206.
- Tang, J. W., Baldocchi, D. D., Qi, Y. and Xu, L. K. (2003) Assessing soil CO₂ efflux using continuous measurements of CO₂ profiles in soils with small solid-state sensors. *Agricultural and Forest Meteorology*, **118**, 207–20.
- Tang, J. W., Baldocchi, D. D. and Xu, L. (2005) Tree photosynthesis modulates soil respiration on a diurnal time scale. *Global Change Biology*, **11**, 1298–304.
- Welles, J. M., Demetriades-Shah, T. H. and McDermitt, D. K. (2001) Considerations for measuring ground CO₂ effluxes with chambers. *Chemical Geology*, **177**, 3–13.
- Werner, D., Grathwohl, P. and Hohener, P. (2004) Review of field methods for the determination of the tortuosity and effective gas-phase diffusivity in the vadose zone. *Vadose Zone Journal*, **3**, 1240–8.
- Xu, L., Furtaw, M. D., Madsen, R. A. *et al.* (2006) On maintaining pressure equilibrium between a soil CO₂ flux chamber and the ambient air. *Journal of Geophysical Research*, **111**, D08S10, doi:10.1029/2005JD006435.

Index

- Abiotic control 208
Absorption method 18
Above-ground processes 257
Accelerator mass spectrometry 108
Accessibility of soil C compounds 265
Acclimation 8–9, 145, 147
Acid conditions 229
Acid hydrolysis 98, 100
Activation energy 211
Active compartment 232
Actual evapotranspiration (AET) 77
Adsorption 94
Afforestation 250
AFOLU agriculture, forestry and other land use 250
AFOLU guidelines 250
AFOLU activities 251
Aggregates 94, 100, 263
 formation 94
 macro ~ 96, 100
 micro ~ 95, 96, 100
 size 104
Aggregation
 biological vs. physical 262
Agronomic efficiency 228
Agronomy 228
Air pressure 22–3
Air temperature 232
Al-oxide 95
Al-oxyhydroxide 95
Allocation 165, 189, 260, 263
Allophanic soils 229
Amino acids 96, 108
Amino sugars 100, 106
 bacterial origin 100
 fungal origin 100
Anaerobiosis 223
Ancillary parameters 275
APSIM 228
Arid environment 131
Arid conditions 229
Aromatic compounds 94, 103
Arrhenius 211
Arrhenius equation 223
Artefacts 138, 272, 274
Artificial gaps 162
Assimilate supply 131, 136, 259, 263, 274
Assimilation 210
Asymptotic value 80
Atmosphere 245
Atmospheric CO₂ stabilisation 249
ATP 170
Automated soil respiration systems 274, 277
Autotrophic component of soil respiration 7, 128, 157, 160, 162, 258, 259, 262
Autotrophic respiration 4, 157, 158, 161

Bacteria 5, 78, 84
Bacterial communities 164, 192
Bacterial energy channel 192
Bacterial origin 100
Basal respiration 263
Baseline 250
Bayesian multiple-constraint inverse modelling technique 263
Biodiversity 196, 254, 261
BiOLOG 174
Biological potentials 248
Biomarkers 106, 108, 111
Biomass quality 257
Biomass turnover 257
Biomes 76
Biota 261
Biotic factors 277
Bioturbation 260
Birch effect 208
Black Carbon 98, 109, 110
Bottom-up control of microbes 195
Box model 81
Browsing 189, 191
Bulk density 65

¹³C, Carbon Isotope 85, 92, 95, 96, 97, 105, 106, 107, 158, 194, 196, 199, 234, 259
¹³C signature 107
¹⁴C, Radiocarbon 80, 84–5, 92, 95, 98, 99, 105, 106, 158, 189, 234, 259, 267
¹⁴C-dating, Radiocarbon dating 95, 97, 98
C_{mic}/C_{org} ratio 171
C:N ratio 93, 94, 95, 96, 106, 193, 223, 277

C, Carbon
 accounting and verification systems 253
 allocation 165, 260, 263, 265
 below-ground 189
 and nutrient cycle interactions 261
 balance 80
 black 98, 109, 110
 contents 110
 cycle 49
 exudation 189
 inorganic 91
 input 79, 230, 277
 organic 91
 pools 81
 resistant 98
 sequestration 84, 157, 165, 237, 245
 sequestration potential 248, 249
 storage 261
 supply 263
CAMASE 221
Canopy photosynthesis 8
Carbohydrates 82, 96, 100, 163, 259
Carbonates 64
Carcasses 187
Cation exchange capacity 223
Cellulose 174
Cement production 245
Centipedes 195
CENTURY 10, 82–3, 92, 222, 228, 229, 230–9
CFE 171
CFI 171
CH₄ 248
Chamber
 air mixing 26
 closed dynamic 16, 273
 design 26, 272
 open dynamic
 static 272
Chemical fractionation 96
Chemical oxidation 98
Chemical properties 2
Chemical protection 107
Chemical recalcitrance 55
Chemical treatment 96

- Chronosequence 164, 172
 Clay 223, 234
 Clay content 95, 223
 Clay fraction 94, 95
 Clay particles 100
 Clear-cut experiments 160, 163
 Climate 78, 157, 164
 Climate change 4, 56, 111, 237, 239
 Climate warming 261
 Climatic index 77
 Clipping 159, 163, 189, 259
 Closed chamber 16, 18, 19
 Closed dynamic chamber 16, 273
 Closed static chamber 16, 272
 Clustering 207
 CO₂, Carbon dioxide
 concentration gradient 273
 diffusion 159, 275
 efflux 272
 elevated 258
 profile 274
 turbulent transport 273
 Coarse roots 132, 139
 Cohort 222
 Cold acclimation 177
 Collar 25, 26, 36, 273, 274, 278
 Collembola 193, 194
 Combustion, wet or dry 91
 Community 261
 Community composition 196
 Competition 195, 261
 plant–microbial 261
 plant–plant 261
 Component fluxes 257
 Component integration methods 157
 Concentration gradients 19, 20–21
 Confounding effects 217
 Confounding factors 136, 207, 213, 215
 Continuous–quality theory 81
 Controlled experiments 251
 Conversion 94
 Conversion factors 91
 Copepods 192
 Crop 235
 Cropland 246
 Cropland management 252
 Cryoprotectants 177
 Cultivation 234, 235, 245
 Cuvettes 137

 Debris 222
 Decay dynamics 77
 Decay rate 77, 84, 222
 Decision support system 228
 Decomposability 105, 106
 Decomposable Plant Material (DPM) 230
 Decomposer 187
 Decomposer community 78
 Decomposer food web 260
 Decomposer organisms 76
 Decomposer system 80
 Decomposition 77, 161, 162, 188, 192,
 193, 260, 265
 constants 236
 functional control 78
 of above-ground litter 164
 of killed roots 160, 161
 of SOM 258
 Decomposition rate 83, 192, 232
 maximum potential 234
 modifier for moisture (TFUNC) 234
 modifier for temperature (WFUNC)
 234
 Deep soil processes 229
 Defoliation 189, 190
 Deforestation 250
 Denitrification 245
 Density fraction 107
 Density fractionation 93, 94, 105
 Density reagent 106
 Desertification 254
 Destabilization 260
 Detritus 165
 Diffuse reflectance infrared
 Fourier–transform (DRIFT) 110,
 111
 Diffusion 3, 275
 of CO₂ 159, 275
 of O₂ 275
 Dissolved organic carbon (DOC) 79, 84,
 195, 229, 234
 Dissolved organic matter (DOM) 96
 Disturbance 22, 136, 215, 245, 274, 275
 Diversity 265
 Diurnal hysteresis 274
 Diurnal variability 38–9
 Dormancy 177
 DNA 175
 Drainage 229
 Drought 164, 212, 258, 262
 Dry combustion 64
 DSSAT 228
 Dung 188
 Dung beetles 194
 Duration of herbivore-induced impacts
 190

 Earthworms 83, 193, 195, 229
 Earthworm mucilage 194
 Economic and social constraints 248
 Economic structures 249
 Ecophysiological approach 263
 Ecophysiology 170–5
 ECOSSE 253

 Ecosystem C balance 257
 Ecosystem engineers 277
 Ecosystem matter cycling 4
 Eddy covariance 19, 26, 252
 Effective volume 273
 Emission factor 251
 Empirical models 208
 Enchytraeid 191, 193, 195
 Energy demand 249
 Environmental quality 228
 Enzymes 193
 activity 92, 105
 Erosion 91, 234, 254
 Error 39, 43, 58, 63
 European Science Foundation 265
 Evaluation 237
 Excreta 187
 Experiment 263
 clear-cut experiment 163
 integrated experiment 264
 manipulation experiment 264
 long-term field experiment 232
 Experimental 257
 Experimental blocking 45
 Experimental design 45, 264
 Experimental manipulation 43
 Extracellular enzymes 174, 179
 Extractable lipids 101
 Extreme environments 197
 Exudates 127, 259
 Exudation 189, 208, 277

 Fallowing 237
 Farmyard manure 230
 Fatty acids 98, 103
 Fatty acid methyl esters (FAME) 173
 Fe-oxide 95
 Fe-oxyhydroxide 95
 Faeces 188
 Fertility 188
 Fertilization 164, 235
 Fine roots 132
 Fine root biomass 147
 Fine root production 147
 Fine root turnover 277
 Fire 54, 234, 235, 258
 First-order kinetic 179, 210, 222, 232, 262
 First-order process 232
 Flux tower measurement 228
 Food security 254
 Food web 222, 262
 bacterial-dominated 262
 decomposer 260
 fungal-dominated 262
 soil food web 192, 195, 264
 Food web-based models 211
 Forest 29

- Forest ecosystem 158
 Fossil fuel combustion 245
 Fractions 93, 94, 105, 262
 Fractionation 84, 91, 92, 105, 106, 260
 chemical 6
 density 99
 method 105
 particle 94, 105
 physical 94
 techniques 93, 99
 Fragmentation 93
 Frass 84, 193
 Free Air Carbon dioxide Enrichment (FACE) 188, 259
 Fulvic acid 107
 Fumigation 97
 Functional diversity 170
 Functional genes 196, 197
 Fungal energy channel 173
 Fungal mycelium 192
 Fungal origin 134
 Fungi 100
 Futile cycles 5, 36, 78, 84, 129, 164

 Gas chromatography-C isotope ratio mass spectrometry (GC-C-IRMS) 99
 Gas chromatography-mass spectrometry (GC/MS) 107, 108
 GCTE-SOMNET 101
 Geographic Information System (GIS) 221
 GHG mitigation 43
 GHG mitigation potential 248
 Girdling 248
 Global 4, 160, 163, 210, 259, 263
 Global change 249
 Global scale 257, 261
 Global soil CO₂ efflux 265
 Global population 272
 Global warming 249
 Grassland 258
 Gravimetric determination 29
 Grazing 78
 Gross primary productivity 193, 194, 195, 234, 235, 275
 Ground level eddy covariance 165, 277
 Groundwater table 19–20
 Growth rate 278
 Growth respiration 194
 Gut 129, 140, 193

 HadCM3
 Harvest, Harvesting 239
 High gradient magnetic separation (HGMS) 234, 235
 Herbivore(s), Herbivory 95
 above-ground 187, 188, 189, 191, 257, 261, 262 1100,
 below-ground 187
 impact duration 187
 Heterogeneity 190
 Heterotrophic soil respiration 275
 Hexoses 1, 7, 157, 162, 210, 258, 262
 High performance liquid chromatography-combustion-IRMS (HPLC-C-IRMS) 100
 Holocellulose 107
 Homeostatis 77, 82
 Hot water extraction 146
 Humic acid 100
 Humic substances 97
 Humification 97, 101, 102
 Humin 99, 210, 222
 Hypothesis formulation 97
 Hypothesis testing 43, 44

 Incubation 222
 Incubation time 263
 Infrared gas analyzers (IRGA) 214
 Infrared spectroscopy 18, 137
 In-growth core 110
 Inorganic C 148
 Integrated experiments 91, 263
 Interactions 264, 265
 Interactions C and nutrient cycle 237
 Interception 261
 Inventory 231
 IPCC 58
 Irrigation 228
 Isopods 234, 235
 Isotopes 193, 259
 Isotope dilution method 4, 92
 Isotope ratio mass spectrometry (IRMS) 133
 Isotope tracers 109
 Isotopic composition 175
 Isotopic enrichment 85, 107
 Isotopic techniques 109, 139, 259
 Isotopic tracer analysis 110, 158, 169, 259

 Kyoto Protocol 43
 K-strategist 11, 172, 228, 245, 249

 Labile soil organic matter 96, 105, 109, 277
 Labile substrate 92, 187
 Labelled plant material 85
 Labelling experiment 236
 Laboratory 259
 Laboratory incubations 214
 Laboratory measurement 40–1

 Lag effect 136
 Land management 263
 Land use 258, 275
 Land use change 108, 173, 258, 261
 Land-use/land-cover change 93, 98, 106, 108, 245, 250, 264
 Laser-induced breakdown spectroscopy (LIBS) 95
 Leaching 110
 Leaf area index (LAI) 91, 188, 234
 Leaf cutter ants 215, 277
 Light fraction (LF) 194
 Lignin 92, 106
 Lignin analysis 78, 82, 94, 97, 98, 99, 107, 174, 193, 234
 Lignin content 99
 Lignin degradation 83, 93, 99
 Lignin-degrading enzymes 99
 Lignin : N ratio 84
 Lignocellulose 231
 Limitations 77
 Lipids 159
 extratable 97, 101, 106
 extraction 101
 Liquid chromatograph (LC) 101
 Litter 99
 chemical composition 6, 77ff., 157, 232, 234, 259, 262, 273, 275, 276
 labelled 77, 213
 residence time 85
 Litter bag 79ff., 277
 Litter C content 79, 80, 81, 174
 Litter decay 179
 Litter decomposition 76ff., 79, 81
 models 7, 76, 78, 79, 172, 189
 temperature sensitivity 81
 Litter fall 78
 Litter fragmentation 84
 Litter fragments 79, 83, 84, 260
 Litter production 81
 Litter quality 277
 Litter turnover 7, 77, 78, 82, 188, 189, 190, 231, 262, 277
 LOI method 64
 Long-term Acclimation Ratio (LTR10) 64
 Long-term experiments 146

 Marcoaggregates 93
 Macroarthropods 96, 100
 Macro-fauna 195
 Macroorganisms 79
 Maintenance respiration 229
 Management 129, 140
 Manipulation experiment 106, 228, 230, 237, 250, 253, 254
 Manipulative 264

- Mass 259
 Mass balance approach
 Mass balance partitioning technique 85
 Mass flow 158
 Mass loss 3
 Mass spectrometry (MS) 77, 78, 79, 80
 Material intensity 107
 Mean residence time (MRT) 80, 235, 249
 ¹³C 80–1, 94, 95
 ¹⁴C 95
 litter 95
 organic matter 259, 277
 Memory effect 208, 210, 263
 Mesh bags 265
 Mesh exclusion method 79
 Mesocosm 141, 259, 263
 Meso-fauna 263, 264
 Metabolic compartment 79, 229
 Metabolic quotient 231
 Methane 79, 172, 264
 Microaggregates 245, 246, 264
 Microarthropods 95, 96, 100, 106
 Microbial 191, 195
 Microbial acclimation 83
 Microbial activity 181
 Microbial biochemistry 194, 262
 Microbial biomass 169
 Microbial community 92, 96, 100, 163, 169, 170, 190, 222, 229, 236
 abundance 108, 163, 192, 260, 261, 263
 activity 191
 dynamics 191
 Microbial composition 8
 Microbial decomposition 260
 Microbial-derived sugars 259
 Microbial diversity 100
 Microbial eco-physiology 178, 260
 Microbial efficiency 8, 169
 Microbial functioning 161
 Microbial physiology 105, 108, 110, 111
 Microbial population 223
 Microbial respiration 262
 Microbial turnover 92
 Micro-organisms 83
 Mid infrared (MIR) 208
 Millipedes 110, 111
 Mineralogy 195
 Mineralization 229
 Minimum detectable difference 91, 92
 Minirhizotrons 61, 91
 Mite 79, 148
 Mitigation potential 193, 194, 195
 Mn, Mangan 85, 93
 Model and parameter identification technique 78
 Model-data integration 264
 Models, modelling 264
 calibration 9, 207, 257, 262, 264
 empirical 228
 evaluation 208
 validation 223, 237
 Molecular marker 228
 Monitoring 99, 107
 Monte Carlo statistical techniques 58, 251
 MRT 253
 Mutualism 84
 Multi-compartment model 196
 Multi-trophic interactions 222
 Mycorrhiza 194
 arbuscular mycorrhiza 4, 128, 133–6, 157, 196, 258, 337
 ectomycorrhiza 134
 Mycorrhizal hyphae 134
 Mycorrhizal respiration 141
 Mycorrhizosphere 128
 Mycorrhizosphere respiration 127, 128, 134, 263

 N, nitrogen 92, 107, 194
 N availability 131, 223
 N concentrations 174
 N contents 78
 N fertilization 110
 N immobilization 56
 N mineralization 259
 National inventory system 79
 Natural ¹³C abundance 250
 Natural isotopic abundance 92
 Near-infrared (NIR) 158
 Near-infrared spectroscopy (NIRS) 110, 111
 Nematode 78
 entomopathogenic Nematode 189, 192, 195
 Nitrification 192
 Nitrogen, N 245, 259
 Nitrous oxide, N₂O 131, 223
 No-regrets climate change policy 245, 248
 Non-humic substances 254
 Nuclear magnetic resonance (NMR) 97
 Nutritional quality 98, 101, 103, 105, 109, 110
 Nutrient(s) 190
 Nutrient availability 163, 229, 259, 261
 Nutrient cycling 178, 188, 213
 below-ground 254
 Nutrient cycle interactions 191
 Nutrient demand 261
 Nutrient retention 197, 257

 Observation 142
 Ocean 44
 Open chamber 245
 Open dynamic chamber 16
 Organic amendments 17, 273
 Organic C 234
 Organic soils 259
 Organo-mineral complexes
 Organo-mineral fractions 95
 Oxygen, O₂ 95
 Oxygen availability 223
 Oxygen consumption 213
 Oxygen diffusion 212

 P, Phosphorus
 Palatable, Palatability 230
 Parameterize 188, 190, 193
 Parasites 236
 Particle fractionation 187, 192, 262
 Particle size 94
 Particulate organic matter (POM) 94, 100, 105, 107
 free POM 94, 96, 104, 105, 106, 110
 occluded POM 104
 Partitioning of soil respiration 104, 105
 PCR primers 160, 165, 257, 260
 Peatlands 176
 Pentoses 245, 264
 Performance 100
 Permafrost 264
 Perturbation 264
 pH 157
 pH stress 223
 Phenols 178
 Phenolic 99, 107
 Phenological changes 188
 Phenology 275
 Phospholipid fatty acids (PFLAs) 164
 Phospholipids 92, 108, 173, 175, 199, 260
 Photosynthates 101
 Photosynthetic activity 263
 Photosynthesis 257, 277
 Physical fractionation 134, 207, 257, 263
 Physical fractionation methods 93
 Physical protection of SOM 96
 Physical soil structure 107
 Plant
 Plant community
 Plant cover 190
 Plant retention factor 223
 Plant root 232
 Plant–soil continuum 229
 Policy decisions 265
 Polysaccharides 239
 Predation 97, 98, 106
 Predators 195
 Precipitation 187, 192, 262

- Pressure 235, 258, 276
 Pressure effects on soil efflux
 Pressure differential soil-chamber
 headspace (PDC) 273, 278
 Pressure gradient 273
 Pressure pumping 275
 Primary consumer 273, 276
 Primary production, productivity 191
 Priming 165, 191
 Priming effect 79, 83, 85, 133
 Process based models 83, 188, 259, 262,
 265, 277
 Productivity 68, 265
 Proteins 191, 217, 254
 Protocol (for soil CO₂ efflux
 measurements) 97, 98
 Protozoa 272, 277
 Pulse labelling 191, 259
 Pyrolysis 85, 158, 163, 259
 Pyrolysis gas chromatography mass
 spectrometry (Py-GC/MS) 85, 101,
 103, 107, 110
 Pyrolysis field ionization mass
 spectrometry (Py-FIMS) 103
 Pyrolysis mass spectrometry (Py-MS) 103
 Pyrolysis molecular beam mass
 spectrometry (Py-MBMS) 101, 103
- Q₁₀ 130, 142, 143, 164, 211, 214, 223, 275
 Q-SOIL 164, 275
 Quality assessment 222, 276
 Quality assurance 274, 277
 Quality control 274, 276
 Quality of soil organic matter 2, 3, 108,
 110, 274, 277
- Radiocarbon, see ¹⁴C
 Radiocarbon dating 92, 235, 259
 Rain events 95, 97
 Rate constant (k) 274, 278
 Recalcitrance 98, 223
 Recalcitrant soil organic matter 94, 98,
 260
 Reforestation 76, 81, 92, 98, 105, 134, 277
 Remote sensing 250
 Repeated inventory 251
 Residence time 57
 litter 93, 157
 Residues 277
 Resistant C pool 161
 Resistant Plant Material (RPM) 98, 109,
 1344,
 Resolution 230
 spatial
 temporal 272
 Resource allocation 272
 Resource availability 189
- Respiration 187
 Autotrophic respiration 79
 Autotrophic soil respiration 4, 157,
 158, 161
 Basal respiration 128, 160
 Growth respiration 263
 Heterotrophic soil respiration 129, 140
 Maintenance respiration 157, 162, 210
 Microbial respiration 129, 140
 Mycorrhizal respiration 92
 Mycorrhizosphere respiration 128
 Rhizomicrobial respiration 128, 134
 Rhizosphere respiration 128
 Root respiration 128, 164, 259
 Soil respiration 128, 137, 157, 165, 208,
 215, 257
 Substrate-induced respiration 5–6,
 165, 207, 215, 257, 260, 274, 277
 Respiratory flushes 170
 Rewetting 262
 Rhizodeposition 177, 212, 262
 Rhizosphere 127, 133, 163, 190
 Rhizosphere bacteria 127, 133, 157, 248
 Rhizosphere priming effects 157, 259
 Rice 259
 Root 246
 Root biomass 36, 157, 208, 259
 Root carbohydrates 66, 189
 Root chambers 157
 Root decomposition 137, 138
 Root exclusion techniques 160, 161,
 162
 Root exudates 158
 Root exudation 133, 157, 163, 189, 259
 Root growth 189, 208, 277
 Root hairs 275
 Root herbivores 138
 Root herbivory 189, 190
 Root life span 189
 Root litter decomposition 163
 Root-litter interactions 79
 Rooting depth 83
 Rothamsted Broadbalk Experiment 159,
 275
 Rothamsted Woburn Ley-Arable
 experiment 237
 RothC 237
 Rotifers 10, 82, 221, 229, 230–9, 253
 r-strategist 191
 rRNA 172
 Ruminants 175, 246
- Sample treatment 265
 Sampling design 63
 random
 stratified 41
 systematic 41
- Saprophytic fungi 41
 Saprotrophic soil fauna 136
 Scale 193
 transfer of information 34, 41
 Seasonality 178
 Sedimentation 213
 Semivariogram 94
 Sequential coring 272
 Shading 147
 Sieving 259
 Silt 94
 Site description 234
 Site history 275
 Site-to-site variability 265
 Snow cover 217
 Social dimension 44
 Soil 253
 Soil aggregates 213
 Soil aggregate fractions 83, 93, 194, 263
 Soil aggregation 95
 Soil biota 261
 Soil biodiversity 222, 261
 Soil carbon analysis 78, 195, 197
 dry combustion 63
 LOI method 64
 ‘Walkley-Black-method’ 64
 Soil carbon balance 63
 Soil carbon balance models 51
 Soil carbon cycle 217
 Soil carbon monitoring 49
 Soil carbon pools 66
 global 49
 Soil carbon sequestration 245
 Soil carbon stocks 246, 249
 Soil carbon storage 6
 Soil clay
 Soil CO₂ efflux 231
 global 272, 273, 278
 sources 272
 Soil components 257
 autotrophic 262
 heterotrophic 262
 Soil degradation 262
 Soil depth 253
 Soil diffusivity 261, 273, 275
 Soil drainage factor 273, 274
 Soil fauna 234
 saprotrophic 8, 78, 83, 187, 191, 193,
 260
 Soil faunal communities 193
 Soil faunal grazing of microbes 197
 Soil fertility 194
 Soil food web 254
 Soil fungi 192, 195, 264
 Soil inventories
 Soil layers 67

- Soil macro-fauna 111
- Soil management 196
- Soil microbes 93
- Soil microbial biomass 92, 188
- Soil mineral properties 236
- Soil moisture 95
 - deficit 36, 131, 135, 262, 263, 272, 273, 274, 275, 278
 - modifying factor 231
- Soil O₂ concentration 232
- Soil organic carbon (SOC)
 - changes 51, 91
 - fractions 57
 - global stocks 98
 - turnover 239
 - stock 55, 91
- Soil organic matter (SOM)
 - SOM characterization 6, 51, 91, 95, 110
 - SOM content 91, 104, 108
 - SOM decomposition 91
 - SOM dynamics 258
 - SOM fractions 106, 108, 111
 - SOM fractionation 84, 91, 92, 105, 106, 109, 110, 111, 260
 - chemical method 59, 91, 97, 110, 262
 - physical method 59
 - SOM modelling 59
 - limitations 92, 107, 161, 262
 - SOM pools 229
 - SOM priming 85, 93, 106
 - SOM quality 83
 - SOM stabilization 2, 108, 110, 111
 - SOM stabilization vs. mobilization 92
 - SOM turnover 265
- Soil organisms 260
- Soil physical processes 83
- Soil properties 263
 - C and N content 110
 - texture 110
 - aggregation 110
- Soil quality 110
- Soil respiration 3, 94
 - soil respiration measurement
 - partitioning soil respiration 5–6, 215, 274, 277
 - seasonal variation 165, 257, 260
 - variability 215
- Soil sampling 207
- Soil temperature 61
- Soil texture 35, 163, 164, 216, 232, 234, 262, 263, 275
- Soil tilth 212, 235
- Soil types 254
- Soil water content 111
- Soil water potential 160, 162, 163, 164, 212, 275
- Soil water status 212, 275
- Solide state ¹³C NMR 212–13
- Sorption 101
- Sorptive preservation 100
- Spatial 56
 - Spatial heterogeneity
 - Spatial measurement integration 38, 40, 275
 - Spatial resolution
 - Spatial sampling 272
 - Spatial variability 30
 - Spatial variation 159, 274
- Species 251, 272
 - Species composition
 - Species redundancy 169
 - Species richness 196
- Spike detection in time series 196
- Stable C isotopes 277
- Stable isotope analysis 85
 - compound specific~ (CSSIA) 107
- Stable isotope probing (SIP) 107
- Stable isotope pulse labelling 108, 175–6, 198, 260
- Stabilization 134
 - chemical 100, 229
 - mechanism 260
 - physical 101
- Stand age 260
- Standard reference emission scenarios (SRES) 164
- Static chamber 249
- Statistical analysis 272
- Statistical evaluation 45
- Stratification
- Stratified sample design 67
- Structural compartment
- Structural mass spectrometry 231
- Steady state 99
- Stone content 169
- Stress 65
 - Stress-acclimation 176
 - Stress tolerance 177
- Subsoil processes 177
- Substrate availability 239
- Substrate diffusion 212
- Substrate-induced respiration (SIR) 275
- Substrate limitation 170
- Substrate supply 213
- Sugars 263
 - microbial-derived
 - plant-derived 100
- SUNDIAL-FRS 100
- Sustainability 10, 228
- Symbiosis 254
- Systematic errors 21, 194
- Tartigrades
- Temperature 192
- Temperature acclimation 8–9, 129, 211–12, 223
- Temperature response function 177, 212
- Temperature sensitivity 211
- Temporal resolution 163, 164, 212, 216, 258
- Temporal variation 29, 272
- Termites 274
- Terrestrial sink 193, 194
- Thaw, thawing 245
- Thermal acclimation 177
- Thermochemolysis 130
- Thermogravimetry 99
- Thermogravimetry–differential scanning calorimetry (TG-DSC) 78
- Tillage 108, 109
 - reduced Tillage 223, 234, 261
- Top-down forces 248
- Transpiration 195
- Tree removal 231
- Trenching 234, 235
- Triglycerides 4, 158–62, 259, 263
- Trophic 101
 - Trophic cascade
 - Trophic diversity 195
 - Trophic interactions 196
 - Trophic levels 8, 83, 187
- Turnover of SOM 195, 265
- Turnover rate 260
- Turnover time 94, 98, 107
- Two-compartment model 80, 91, 92, 95, 98, 111, 222
- Uncertainty 34, 250
- Up-scaling 223, 239, 252, 253, 272, 274, 277
- Urine 34, 41, 67
- Variability 188
- Variogram analysis 6, 157, 264
- Vent 38
- Venturi effect 273
- Volatile organic compounds (VOC) 25, 79
- Volcanic soils 157, 229
- Water 63, 91
 - Water balance 223, 259, 263, 264
 - Water holding capacity 231
 - Water potential 254
 - Water stress 177
- Waxes 131
- Wetlands 98, 101
- Wind 264
- Wind speed 25, 276
- X-ray 110