

Hans Lambers
E. Stuart Chapin III
Thijs L. Pons

Plant Physiological Ecology

Second Edition

 Springer

Plant Physiological Ecology
Second Edition

Hans Lambers F. Stuart Chapin III
Thijs L. Pons

Plant Physiological Ecology

Second Edition

 Springer

Hans Lambers
The University of Western Australia
Crawley, WA
Australia
hans.lambers@uwa.edu.au

F. Stuart Chapin III
University of Alaska
Fairbanks, AK
USA
terry.chapin@uaf.edu

Thijs L. Pons
Utrecht University
The Netherlands
T.L.Pons@bio.uu.nl

ISBN: 978-0-387-78340-6 e-ISBN: 978-0-387-78341-3
DOI: 10.1007/978-0-387-78341-3

Library of Congress Control Number: 2008931587

© 2008 Springer Science+Business Media, LLC

All rights reserved. This work may not be translated or copied in whole or in part without the written permission of the publisher (Springer Science+Business Media, LLC, 233 Spring Street, New York, NY 10013, USA), except for brief excerpts in connection with reviews or scholarly analysis. Use in connection with any form of information storage and retrieval, electronic adaptation, computer software, or by similar or dissimilar methodology now known or hereafter developed is forbidden.

The use in this publication of trade names, trademarks, service marks, and similar terms, even if they are not identified as such, is not to be taken as an expression of opinion as to whether or not they are subject to proprietary rights.

Printed on acid-free paper

springer.com

Foreword to Second Edition

In the decade that has passed since the first edition of this book, the global environment has changed rapidly. Even the most steadfast “deny-ers” have come to accept that atmospheric CO₂ enrichment and global warming pose serious challenges to life on Earth. Regrettably, this acceptance has been forced by calamitous events rather than by the long-standing, sober warnings of the scientific community.

There seems to be growing belief that “technology” will save us from the worst consequences of a warmer planet and its wayward weather. This hope, that may in the end prove to be no more than wishful thinking, relates principally to the built environment and human affairs. Alternative sources of energy, utilized with greater efficiency, are at the heart of such hopes; even alternative ways of producing food or obtaining water may be possible. For plants, however, there is no alternative but to utilize sunlight and fix carbon and to draw water from the soil. (Under a given range of environmental conditions, these processes are already remarkably efficient by industrial standards.) Can we “technologize” our way out of the problems that plants may encounter in capricious, stormier, hotter, drier, or more saline environments? Climate change will not alter the basic nature of the stresses that plants must endure, but it will result in their occurrence in places where formerly their impact was small, thus exposing species and vegetation types to more intense episodes of stress than they are able to handle. The timescale on which the climate is changing is too fast to wait for evolution to come up with solutions to the problems.

For a variety of reasons, the prospects for managing change seem better in agriculture than in forests or in wild plant communities. It is possible to intervene dramatically in the normal process of evolutionary change by genetic manipulation. Extensive screening of random mutations in a target species such as *Arabidopsis thaliana* can reveal genes that allow plants to survive rather simplified stress tests. This is but the first of many steps, but eventually these will have their impact, primarily on agricultural and industrial crops. There is a huge research effort in this area and much optimism about what can be achieved. Much of it is done with little reference to plant physiology or biochemistry and has a curiously empirical character. One can sense that there is impatience with plant physiology that has been too slow in defining stress tolerance, and a belief that if a gene can be found that confers tolerance, and it can be transferred to a species of interest, it is not of prime

importance to know exactly what it does to the workings of the plant. Such a strategy is more directed toward outcomes than understanding, even though the technology involved is sophisticated. Is there a place for physiological ecology in the new order of things? The answer is perhaps a philosophical one. Progress over the centuries has depended on the gradual evolution of our understanding of fundamental truths about the universe and our world. Scientific discovery has always relished its serendipitous side but had we been satisfied simply with the outcomes of trial and error we would not be where we are today.

It is legitimate to ask what factors set the limits on stress tolerance of a given species. To answer this one must know first how the plant “works”; in general, most of this knowledge is to hand but is based on a relatively few model species that are usually chosen because of the ease with which they can be handled in laboratory conditions or because they are economically important. As well as describing the basic physiology of plants the authors of this book set out to answer more difficult questions about the differences between species with respect to environmental variables. The authors would be the first to admit that comprehensive studies of comparative physiology and biochemistry are relatively few. Only in a few instances do we really understand how a species, or in agriculture, a genotype, pulls off the trick of surviving or flourishing in conditions where other plants fail.

Of course, the above has more than half an eye on feeding the increasing world population in the difficult times that lie ahead. This has to be every thinking person’s concern. There is, however, more to it than that. Large ecosystems interact with climate, the one affecting the other. It would be as rash, for example, to ignore the effects of climate change on forests as it would be to ignore its effects on crops.

There is more to the successful exploitation of a given environment than can be explained exclusively in terms of a plant’s physiology. An important thrust in this book is the interaction, often crucial, between plants and beneficial, pathogenic or predatory organisms that share that environment. Manipulation of these interactions is the perennial concern of agriculture either directly or unintentionally. Changes in temperature and seasonality alter established relations between organisms, sometimes catastrophically when, for example, a pathogen or predator expands its area of influence into plant and animal populations that have not been exposed to it previously. Understanding such interactions may not necessarily allow us to avoid the worst consequences of change but it may increase our preparedness and our chances of coming up with mitigating strategies.

DAVID T. CLARKSON
Oak House
Cheddar, UK
January 2008

About the Authors

Hans Lambers is Professor of Plant Ecology and Head of School of Plant Biology at the University of Western Australia, in Perth, Australia. He did his undergraduate degree at the University of Groningen, the Netherlands, followed by a PhD project on effects of hypoxia on flooding-sensitive and flooding-tolerant *Senecio* species at the same institution.

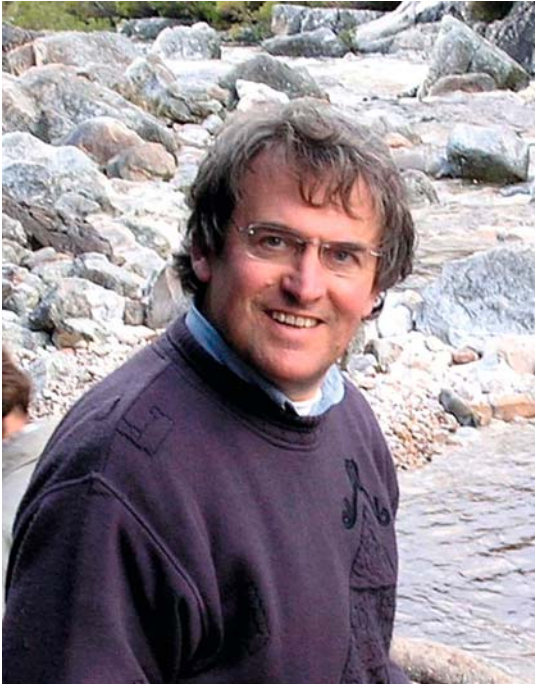

From 1979 to 1982, he worked as a postdoc at The University of Western Australia, Melbourne University, and the Australian National University in Australia, working on respiration and nitrogen metabolism. After a postdoc at his Alma Mater, he became Professor of Ecophysiology at Utrecht University, the Netherlands, in 1985, where he focused on plant respiration and the physiological basis of variation in relative growth rate among herbaceous plants. In 1998, he moved to the University of Western Australia, where he focuses on mineral nutrition and water relations, especially in species occurring on severely phosphorus-impooverished soils in a global biodiversity hotspot. He has been editor-in-chief of the journal *Plant and Soil* since 1992 and features on ISI's list of highly cited authors in the field of animal and plant sciences since 2002. He was elected Fellow of the Royal Netherlands Academy of Arts and Sciences in 2003.

F. Stuart Chapin III is Professor of Ecology at the Institute of Arctic Biology, University of Alaska Fairbanks, USA. He did his undergraduate degree (BA) at Swarthmore College, PA, United States, and then was a Visiting Instructor in Biology (Peace Corps) at Universidad Javeriana, Bogota, Columbia, from 1966 to 1968. After that, he worked toward his PhD, on temperature compensation in phosphate absorption along a latitudinal gradient at Stanford University, United States. He started at the University of Alaska Fairbanks in 1973, focusing on plant mineral nutrition, and was Professor at this



institution from 1984 till 1989. In 1989, he became Professor of Integrative Biology, University of California, Berkeley, USA. He returned to Alaska in 1996. His current main research focus is on effects of global change on vegetation, especially in arctic environments. He features on ISI's list of highly cited authors in ecology/environment, and was elected Member of the National Academy of Sciences, USA in 2004.

Thijs L. Pons recently retired as Senior Lecturer in Plant Ecophysiology at the Institute of Environmental Biology, Utrecht University, the Netherlands. He did his undergraduate degree at Utrecht University, the Netherlands, where he also worked toward his PhD, on a project on shade-tolerant and shade-avoiding species. He worked in Bogor, Indonesia, from 1976 to 1979, on the biology of weeds in



rice. Back at Utrecht University, he worked on the ecophysiology of seed dormancy and germination. From the late 1980s onward he focused on photosynthetic acclimation, including environmental signaling in canopies. He spent a sabbatical at the University of California, Davis, USA, working with Bob Pearcy on effects of sunflecks. His interest in photosynthetic acclimation was expanded to tropical rainforest canopies when he became involved in a project on the scientific basis of sustainable forest management in Guyana, from 1992 to 2000. He is associate editor for the journal *Plant Ecology*.

Foreword to First Edition

The individual is engaged in a struggle for existence (Darwin). That struggle may be of two kinds: The acquisition of the resources needed for establishment and growth from a sometimes hostile and meager environment and the struggle with competing neighbors of the same or different species. In some ways, we can define *physiology* and *ecology* in terms of these two kinds of struggles. Plant ecology, or plant sociology, is centered on the relationships and interactions of species within communities and the way in which populations of a species are adapted to a characteristic range of environments. Plant physiology is mostly concerned with the individual and its struggle with its environment. At the outset of this book, the authors give their definition of *ecophysiology*, arriving at the conclusion that it is a point of view about physiology. A point of view that is informed, perhaps, by knowledge of the real world outside the laboratory window. A world in which, shall we say, the light intensity is much greater than the 200–500 $\mu\text{mol photons m}^{-2} \text{s}^{-1}$ used in too many environment chambers, and one in which a constant 20°C day and night is a great rarity. The standard conditions used in the laboratory are usually regarded as treatments. Of course, there is nothing wrong with this in principle; one always needs a baseline when making comparisons. The idea, however, that the laboratory control is the norm is false and can lead to misunderstanding and poor predictions of behavior.

The environment from which many plants must acquire resources is undergoing change and degradation, largely as a result of human activities and the relentless increase in population. This has thrown the spotlight onto the way in which these changes may feed back on human well-being. Politicians and the general public ask searching questions of biologists, agriculturalists, and foresters concerning the future of our food supplies, building materials, and recreational amenities. The questions take on the general form, “Can you predict how ‘X’ will change when environmental variables ‘Y’ and ‘Z’ change?” The recent experience of experimentation, done at high public expense, on CO₂ enrichment and global warming, is a sobering reminder that not enough is known about the underlying physiology and biochemistry of plant growth and metabolism to make the confident predictions that the customers want to hear. Even at the level of individual plants, there seems to be no clear prediction, beyond that the response depends on species and other ill-defined circumstances. On the broader scale, predictions about the response of

plant communities are even harder to make. In the public mind, at least, this is a failure. The only way forward is to increase our understanding of plant metabolism, of the mechanisms of resource capture, and the way in which the captured resources are allocated to growth or storage in the plant. To this extent, I can see no distinction between plant physiology and ecophysiology. There are large numbers of missing pieces of information about plant physiology—period. The approach of the new millennium, then, is a good time to recognize the need to study plant physiology anew, bringing to bear the impressive new tools made available by gene cloning and recombinant DNA technology. This book is to be welcomed if it will encourage ecologists to come to grips with the processes which determine the behavior of “X” and encourage biochemistry and physiology students to take a more realistic view of the environmental variables “Y” and “Z”.

The book starts, appropriately, with the capture of carbon from the atmosphere. Photosynthesis is obviously the basis of life on earth, and some of the most brilliant plant scientists have made it their life’s work. As a result, we know more about the molecular biophysics and biochemistry of photosynthesis than we do about any other plant process. The influence of virtually every environmental variable on the physiology of photosynthesis and its regulation has been studied. Photosynthesis, however, occurs in an environment over which the individual plant has little control. In broad terms, a plant must cope with the range of temperature, rainfall, light intensity, and CO₂ concentration to which its habitat is subjected. It cannot change these things. It must rely on its flexible physiological response to mitigate the effects of the environment. At a later stage in the book, the focus shifts below ground, where the plant has rather more control over its options for capturing resources. It may alter the environment around its roots in order to improve the nutrient supply. It may benefit from microbial assistance in mobilizing resources or enter into more formal contracts with soil fungi and nodule-forming bacteria to acquire nutrient resources that would otherwise be unavailable or beyond its reach. Toward its close, the book turns to such interactions between plants and microbes and to the chemical strategies that have evolved in plants that assist them in their struggles with one another and against browsing and grazing animals. The authors end, then, on a firmly ecological note, and introduce phenomena that most laboratory physiologists have never attempted to explore. These intriguing matters remind us, as if reminders were needed, of “how little we know, how much to discover” (Springer and Leigh).

DAVID T. CLARKSON
IACR-Long Ashton Research Station
University of Bristol
April 1997

Acknowledgments

Numerous people have contributed to the text and illustrations in this book by commenting on sections and chapters, providing photographic material, making electronic files of graphs and illustrations available, or drawing numerous figures. In addition to those who wrote book reviews or sent us specific comments on the first edition of *Plant Physiological Ecology*, we wish to thank the following colleagues, in alphabetical order, for their valuable input: Owen Atkin, Juan Barcelo, Wilhelm Barthlott, Carl Bernacchi, William Bond, Elizabeth Bray, Siegmund Breckle, Mark Brundrett, Steve Burgess, Ray Callaway, Marion Cambridge, Art Cameron, Pilar Castro-Díez, David Clarkson, Stephan Clemens, Herve Cochard, Tim Colmer, Hans Cornelissen, Marjolein Cox, Michael Cramer, Doug Darnowski, Manny Delhaize, Kingsley Dixon, John Evans, Tatsuhiro Ezawa, Jaume Flexas, Brian Forde, Peter Franks, Oula Ghannoum, Alasdair Grigg, Foteini Hassiotou, Xinhua He, Martin Heil, Angela Hodge, Richard Houghton, Rick Karban, Herbert Kronzucker, John Kuo, Jon Lloyd, Jian Feng Ma, Ken Marcum, Bjorn Martin, Justin McDonald, John Milburn, Ian Max Møller, Liesje Mommer, Ulo Niinemets, Ko Noguchi, Ram Oren, Stuart Pearse, Carol Peterson, Larry Peterson, John Pickett, Corné Pieterse, Bartosz Płachno, Malcolm Press, Dean Price, Miquel Ribas-Carbó, Peter Reich, Sarah Richardson, Peter Ryser, Yuzou Sano, Rany Schnell, Ted Schuur, Tim Setter, Michael Shane, Tom Sharkey, Sally Smith, Janet Sprent, Ernst Steudle, Youshi Tazoe, Mark Tjoelker, Robert Turgeon, David Turner, Kevin Vessey, Eric Visser, Rens Voesenek, Xianzhong Wang, Jennifer Watling, Mark Westoby, Wataru Yamori, Satoshi Yano, and Wenhao Zhang.

Finally HL wishes to thank Miquel and Pepi for their fabulous hospitality when he was dealing with the final stages of the revision of the text. Good company, music, food, and wine in Palma de Mallorca significantly added to the final product.

HANS LAMBERS
F. STUART CHAPIN III
THIJS L. PONS

Abbreviations

<i>a</i>	radius of a root (a_r) or root plus root hairs (a_e)
<i>A</i>	rate of CO ₂ assimilation; also total root surface
A_n	net rate of CO ₂ assimilation
A_f	foliage area
A_{max}	light-saturated rate of net CO ₂ assimilation at ambient C_a
A_s	sapwood area
ABA	abscisic acid
ADP	adenosine diphosphate
AM	arbuscular mycorrhiza
AMP	adenosine monophosphate
APAR	absorbed photosynthetically active radiation
ATP	adenosine triphosphate
<i>b</i>	individual plant biomass; buffer power of the soil
<i>B</i>	stand biomass
c_s	concentration of the solute
<i>C</i>	nutrient concentration in solution; also convective heat transfer
C_3	photosynthetic pathway in which the first product of CO ₂ fixation is a 3-carbon intermediate
C_4	photosynthetic pathway in which the first product of CO ₂ fixation is a 4-carbon intermediate
C_a	Atmospheric CO ₂ concentration
C_c	CO ₂ concentration in the chloroplast
C_i	Intercellular CO ₂ concentration
C_{li}	initial nutrient concentration
C_{min}	solution concentration at which uptake is zero
C:N	carbon:nitrogen ratio
CAM	crassulacean acid metabolism
CC	carbon concentration
CE	carbohydrate equivalent
chl	chlorophyll
CPF	carbon dioxide production value
<i>d</i>	plant density; also leaf dimension
<i>D</i>	diffusivity of soil water
D_e	diffusion coefficient of ion in soil
DHAP	dihydroxyacetone phosphate
DM	dry mass

DNA	deoxyribonucleic acid
e	water vapor pressure in the leaf (e_i ; or e_l in Sect. 2.5 of the Chapter 4A) or atmosphere (e_a); also emissivity of a surface
E	transpiration rate
f	tortuosity
F	rate of nutrient supply to the root surface; also chlorophyll fluorescence, minimal fluorescence (F_0), maximum (F_m), in a pulse of saturating light (F_m'), variable (F_v)
FAD(H ₂)	flavine adenine dinucleotide (reduced form)
FM	fresh mass
FR	far-red
g	diffusive conductance for CO ₂ (g_c) and water vapor (g_w); boundary layer conductance (g_a); mesophyll conductance (g_m); stomatal conductance (g_s); boundary layer conductance for heat transport (g_{ah})
GA	gibberellic acid
GE	glucose equivalent
GOGAT	glutamine 2-oxoglutarate aminotransferase
HCH	hydroxycyclohexenone
HIR	high-irradiance response
I	irradiance, above (I_o) or beneath (I) a canopy; irradiance absorbed; also nutrient inflow
I_{max}	maximum rate of nutrient inflow
IAA	indoleacetic acid
IR _s	short-wave infrared radiation
J	rate of photosynthetic electron flow
J_{max}	maximum rate of photosynthetic electron flow measured at saturating I and C_a
J_v	water flow
k	rate of root elongation; extinction coefficient for light
K	carrying capacity (e.g., K species)
k_{cat}	catalytic constant of an enzyme
K_i	inhibitor concentration giving half-maximum inhibition
K_m	substrate concentration at half V_{max} (or I_{max})
l	leaf area index
L	rooting density; also latent heat of evaporation; also length of xylem element
L_p	root hydraulic conductance
LAI	leaf area index
LAR	leaf area ratio
LFR	low-fluence response
LHC	light-harvesting complex
LMA	leaf mass per unit area
LMR	leaf mass ratio
LR	long-wave infrared radiation that is incident (LR _{in}), reflected (LR _r), emitted (LR _{em}), absorbed (SR _{abs}), or net incoming (LR _{net}); also leaf respiration on an area (LR _a) and mass (LR _m) basis
mRNA	messenger ribonucleic acid
miRNA	micro ribonucleic acid
M	energy dissipated by metabolic processes
ME	malic enzyme
MRT	mean residence time
N_w	mol fraction, that is, the number of moles of water divided by the total number of moles
NAD(P)	nicotinamide adenine dinucleotide(phosphate) (in its oxidized form)
NAD(P)H	nicotinamide adenine dinucleotide(phosphate) (in its reduced form)
NAR	net assimilation rate
NDVI	normalized difference vegetation index
NEP	net ecosystem production
NIR	near-infrared reflectance; net rate of ion uptake
NMR	nuclear magnetic resonance
NPP	net primary production
NPQ	nonphotochemical quenching
NUE	nitrogen-use efficiency, or nutrient-use efficiency

p	vapor pressure
p_o	vapor pressure of air above pure water
P	atmospheric pressure; also turgor pressure
P_{fr}	far-red-absorbing configuration of phytochrome
P_i	inorganic phosphate
P_r	red-absorbing configuration of phytochrome
PAR	photosynthetically active radiation
PC	phytochelatins
PEP	phospho <i>enol</i> pyruvate
PEPC	phospho <i>enol</i> pyruvate carboxylase
PEPCK	phospho <i>enol</i> pyruvate carboxykinase
pH	hydrogen ion activity; negative logarithm of the H^+ concentration
PGA	phosphoglycerate
pmf	proton-motive force
PNC	plant nitrogen concentration
PNUE	photosynthetic nitrogen-use efficiency
PQ	photosynthetic quotient; also plastoquinone
PR	pathogenesis-related protein
PS	photosystem
PV'	amount of product produced per gram of substrate
q_N	quenching of chlorophyll fluorescence due to non-photochemical processes
qP	photochemical quenching of chlorophyll fluorescence
Q	ubiquinone (in mitochondria), in reduced state (Q_r = ubiquinol) or total quantity (Q_t); also quinone (in chloroplast)
Q_{10}	temperature coefficient
Q_A	primary electron acceptor in photosynthesis
r	diffusive resistance, for CO_2 (r_c), for water vapor (r_w), boundary layer resistance (r_a), stomatal resistance (r_s), mesophyll resistance (r_m); also radial distance from the root axis; also respiration; also growth rate (in volume) in the Lockhart equation; also proportional root elongation; also intrinsic rate of population increase (e.g., r species)
r_i	spacing between roots
r_o	root diameter
R	red
R	radius of a xylem element; also universal gas constant
R_a	molar abundance ratio of $^{13}C/^{12}C$ in the atmosphere
R_d	dark respiration
R_{day}	dark respiration during photosynthesis
R_e	ecosystem respiration
R_p	whole-plant respiration; also molar abundance ratio of $^{13}C/^{12}C$ in plants
R_h	heterotrophic respiration
R^*	minimal resource level utilised by a species
RGR	relative growth rate
RH	relative humidity of the air
RMR	root mass ratio
RNA	ribonucleic acid
RQ	respiratory quotient
RR	rate of root respiration
RuBP	ribulose-1,5-bisphosphate
Rubisco	ribulose-1,5-bisphosphate carboxylase/oxygenase
RWC	relative water content
S	nutrient uptake by roots
$S_{c/o}$	specificity of carboxylation relative to oxygenation by Rubisco
SHAM	salicylhydroxamic acid
SLA	specific leaf area
SMR	stem mass ratio
SR	short-wave solar radiation that is incident (SR_{in}), reflected (SR_r), transmitted (SR_{tr}), absorbed (SR_{abs}), used in photosynthesis (SR_A), emitted in fluorescence (SR_{FL}), or net incoming (SR_{net}); also rate of stem respiration
SRL	specific root length

t^*	time constant
tRNA	transfer ribonucleic acid
T	temperature
T_L	leaf temperature
TCA	tricarboxylic acid
TR	total radiation that is absorbed (TR_{abs}) or net incoming (TR_{net})
u	wind speed
UV	ultraviolet
V	volume
V_c	rate of carboxylation
V_o	rate of oxygenation
V_{cmax}	maximum rate of carboxylation
V_w^o	molar volume of water
VIS	visible reflectance
VLFR	very low fluence response
V_{max}	substrate-saturated enzyme activity
VPD	vapor pressure deficit
w	mole fraction of water vapor in the leaf (w_i) or atmosphere (w_a)
WUE	water-use efficiency
Y	yield threshold (in the Lockhart equation)
γ	surface tension
Γ	CO ₂ -compensation point
Γ^*	CO ₂ -compensation point in the absence of dark respiration
δ	boundary layer thickness; also isotopic content
Δ	isotopic discrimination
ΔT	temperature difference
ϵ	elastic modulus; also emissivity
η	viscosity constant
θ	curvature of the irradiance response curve; also volumetric moisture content (mean value, θ' , or at the root surface, θ_a)
λ	energy required for transpiration
μ_w	chemical potential of water
μ_{w0}	chemical potential of pure water under standard conditions
σ	Stefan–Boltzman constant
ϕ	quantum yield (of photosynthesis); also yield coefficient (in the Lockhart equation); also leakage of CO ₂ from the bundle sheath to the mesophyll; also relative yield of de-excitation processes
Ψ	water potential
Ψ_{air}	water potential of the air
Ψ_m	matric potential
Ψ_p	pressure potential; hydrostatic pressure
Ψ_π	osmotic potential

Contents

Foreword to Second Edition (by David T. Clarkson)	v
About the Authors	vii
Foreword to First Edition (by David T. Clarkson)	ix
Acknowledgments	xi
Abbreviations	xiii
1. Assumptions and Approaches	1
Introduction – History, Assumptions, and Approaches	1
1 What Is Ecophysiology?	1
2 The Roots of Ecophysiology	1
3 Physiological Ecology and the Distribution of Organisms	2
4 Time Scale of Plant Response to Environment	4
5 Conceptual and Experimental Approaches	6
6 New Directions in Ecophysiology	7
7 The Structure of the Book	7
References	8
2. Photosynthesis, Respiration, and Long-Distance Transport	11
2A. Photosynthesis	11
1 Introduction	11
2 General Characteristics of the Photosynthetic Apparatus	11
2.1 The “Light” and “Dark” Reactions of Photosynthesis	11
2.1.1 Absorption of Photons	12
2.1.2 Fate of the Excited Chlorophyll	13
2.1.3 Membrane-Bound Photosynthetic Electron Transport and Bioenergetics	14
2.1.4 Photosynthetic Carbon Reduction	14
2.1.5 Oxygenation and Photorespiration	15

2.2	Supply and Demand of CO ₂ in the Photosynthetic Process	16
2.2.1	Demand for CO ₂ —the CO ₂ —Response Curve	16
2.2.2	Supply of CO ₂ —Stomatal and Boundary Layer Conductances	21
2.2.3	The Mesophyll Conductance	22
3	Response of Photosynthesis to Light	26
3.1	The Light Climate Under a Leaf Canopy	26
3.2	Physiological, Biochemical, and Anatomical Differences Between Sun and Shade Leaves	27
3.2.1	The Light-Response Curve of Sun and Shade Leaves	27
3.2.2	Anatomy and Ultrastructure of Sun and Shade Leaves	29
3.2.3	Biochemical Differences Between Shade and Sun Leaves	32
3.2.4	The Light-Response Curve of Sun and Shade Leaves Revisited	33
3.2.5	The Regulation of Acclimation	35
3.3	Effects of Excess Irradiance	36
3.3.1	Photoinhibition—Protection by Carotenoids of the Xanthophyll Cycle	36
3.3.2	Chloroplast Movement in Response to Changes in Irradiance	41
3.4	Responses to Variable Irradiance	42
3.4.1	Photosynthetic Induction	43
3.4.2	Light Activation of Rubisco	43
3.4.3	Post-illumination CO ₂ Assimilation and Sunfleck-Utilization Efficiency	45
3.4.4	Metabolite Pools in Sun and Shade Leaves	45
3.4.5	Net Effect of Sunflecks on Carbon Gain and Growth	47
4	Partitioning of the Products of Photosynthesis and Regulation by “Feedback”	47
4.1	Partitioning Within the Cell	47
4.2	Short-Term Regulation of Photosynthetic Rate by Feedback	48
4.3	Sugar-Induced Repression of Genes Encoding Calvin-Cycle Enzymes	51
4.4	Ecological Impacts Mediated by Source-Sink Interactions	51
5	Responses to Availability of Water	51
5.1	Regulation of Stomatal Opening	53
5.2	The A—C _c Curve as Affected by Water Stress	54
5.3	Carbon-Isotope Fractionation in Relation to Water-Use Efficiency	56
5.4	Other Sources of Variation in Carbon-Isotope Ratios in C ₃ Plants	57
6	Effects of Soil Nutrient Supply on Photosynthesis	58
6.1	The Photosynthesis—Nitrogen Relationship	58
6.2	Interactions of Nitrogen, Light, and Water	59
6.3	Photosynthesis, Nitrogen, and Leaf Life Span	59
7	Photosynthesis and Leaf Temperature: Effects and Adaptations	60
7.1	Effects of High Temperatures on Photosynthesis	60
7.2	Effects of Low Temperatures on Photosynthesis	61
8	Effects of Air Pollutants on Photosynthesis	63
9	C ₄ Plants	64
9.1	Introduction	64
9.2	Biochemical and Anatomical Aspects	64

9.3	Intercellular and Intracellular Transport of Metabolites of the C ₄ Pathway	67
9.4	Photosynthetic Efficiency and Performance at High and Low Temperatures	68
9.5	C ₃ —C ₄ Intermediates	71
9.6	Evolution and Distribution of C ₄ Species	73
9.7	Carbon-Isotope Composition of C ₄ Species	75
10	CAM Plants	75
10.1	Introduction	75
10.2	Physiological, Biochemical, and Anatomical Aspects	76
10.3	Water-Use Efficiency	79
10.4	Incomplete and Facultative CAM Plants	79
10.5	Distribution and Habitat of CAM Species	80
10.6	Carbon-Isotope Composition of CAM Species	81
11	Specialized Mechanisms Associated with Photosynthetic Carbon Acquisition in Aquatic Plants	82
11.1	Introduction	82
11.2	The CO ₂ Supply in Water	82
11.3	The Use of Bicarbonate by Aquatic Macrophytes	83
11.4	The Use of CO ₂ from the Sediment	84
11.5	Crassulacean Acid Metabolism (CAM) in Aquatic Plants	85
11.6	Carbon-Isotope Composition of Aquatic Plants	85
11.7	The Role of Aquatic Macrophytes in Carbonate Sedimentation	85
12	Effects of the Rising CO ₂ Concentration in the Atmosphere	87
12.1	Acclimation of Photosynthesis to Elevated CO ₂ Concentrations	89
12.2	Effects of Elevated CO ₂ on Transpiration—Differential Effects on C ₃ , C ₄ , and CAM Plants	90
13	Summary: What Can We Gain from Basic Principles and Rates of Single-Leaf Photosynthesis?	90
	References	91

2B.	Respiration	101
1	Introduction	101
2	General Characteristics of the Respiratory System	101
2.1	The Respiratory Quotient	101
2.2	Glycolysis, the Pentose Phosphate Pathway, and the Tricarboxylic (TCA) Cycle	103
2.3	Mitochondrial Metabolism	103
2.3.1	The Complexes of the Electron-Transport Chain	104
2.3.2	A Cyanide-Resistant Terminal Oxidase	105
2.3.3	Substrates, Inhibitors, and Uncouplers	105
2.3.4	Respiratory Control	106
2.4	A Summary of the Major Points of Control of Plant Respiration	107
2.5	ATP Production in Isolated Mitochondria and In Vivo	107
2.5.1	Oxidative Phosphorylation: The Chemiosmotic Model	107
2.5.2	ATP Production In Vivo	107
2.6	Regulation of Electron Transport via the Cytochrome and the Alternative Paths	109
2.6.1	Competition or Overflow?	109
2.6.2	The Intricate Regulation of the Alternative Oxidase	110

2.6.3	Mitochondrial NAD(P)H Dehydrogenases That Are Not Linked to Proton Extrusion	112
3	The Ecophysiological Function of the Alternative Path	112
3.1	Heat Production	112
3.2	Can We Really Measure the Activity of the Alternative Path?	113
3.3	The Alternative Path as an Energy Overflow	114
3.4	NADH Oxidation in the Presence of a High Energy Charge	117
3.5	NADH Oxidation to Oxidize Excess Redox Equivalents from the Chloroplast	117
3.6	Continuation of Respiration When the Activity of the Cytochrome Path Is Restricted	118
3.7	A Summary of the Various Ecophysiological Roles of the Alternative Oxidase	118
4	Environmental Effects on Respiratory Processes	119
4.1	Flooded, Hypoxic, and Anoxic Soils	119
4.1.1	Inhibition of Aerobic Root Respiration	119
4.1.2	Fermentation	119
4.1.3	Cytosolic Acidosis	120
4.1.4	Avoiding Hypoxia: Aerenchyma Formation	121
4.2	Salinity and Water Stress	122
4.3	Nutrient Supply	123
4.4	Irradiance	123
4.5	Temperature	127
4.6	Low pH and High Aluminum Concentrations	129
4.7	Partial Pressures of CO ₂	130
4.8	Effects of Plant Pathogens	131
4.9	Leaf Dark Respiration as Affected by Photosynthesis	132
5	The Role of Respiration in Plant Carbon Balance	132
5.1	Carbon Balance	132
5.1.1	Root Respiration	132
5.1.2	Respiration of Other Plant Parts	133
5.2	Respiration Associated with Growth, Maintenance, and Ion Uptake	134
5.2.1	Maintenance Respiration	134
5.2.2	Growth Respiration	136
5.2.3	Respiration Associated with Ion Transport	140
5.2.4	Experimental Evidence	140
6	Plant Respiration: Why Should It Concern Us from an Ecological Point of View?	143
	References	144
2C.	Long-Distance Transport of Assimilates	151
1	Introduction	151
2	Major Transport Compounds in the Phloem: Why Not Glucose?	151
3	Phloem Structure and Function	153
3.1	Symplastic and Apoplastic Transport	154
3.2	Minor Vein Anatomy	154
3.3	Sugar Transport against a Concentration Gradient	155
4	Evolution and Ecology of Phloem Loading Mechanisms	157
5	Phloem Unloading	157
6	The Transport Problems of Climbing Plants	160
7	Phloem Transport: Where to Move from Here?	161
	References	161

3. Plant Water Relations	163
1 Introduction	163
1.1 The Role of Water in Plant Functioning	163
1.2 Transpiration as an Inevitable Consequence of Photosynthesis	164
2 Water Potential	165
3 Water Availability in Soil	165
3.1 The Field Capacity of Different Soils	169
3.2 Water Movement Toward the Roots	170
3.3 Rooting Profiles as Dependent on Soil Moisture Content	171
3.4 Roots Sense Moisture Gradients and Grow Toward Moist Patches	173
4 Water Relations of Cells	174
4.1 Osmotic Adjustment	175
4.2 Cell-Wall Elasticity	175
4.3 Osmotic and Elastic Adjustment as Alternative Strategies	177
4.4 Evolutionary Aspects	178
5 Water Movement Through Plants	178
5.1 The Soil—Plant—Air Continuum	178
5.2 Water in Roots	179
5.3 Water in Stems	183
5.3.1 Can We Measure Negative Xylem Pressures?	185
5.3.2 The Flow of Water in the Xylem	186
5.3.3 Cavitation or Embolism: The Breakage of the Xylem Water Column	188
5.3.4 Can Embolized Conduits Resume Their Function?	191
5.3.5 Trade-off Between Conductance and Safety	192
5.3.6 Transport Capacity of the Xylem and Leaf Area	194
5.3.7 Storage of Water in Stems	195
5.4 Water in Leaves and Water Loss from Leaves	196
5.4.1 Effects of Soil Drying on Leaf Conductance	196
5.4.2 The Control of Stomatal Movements and Stomatal Conductance	199
5.4.3 Effects of Vapor Pressure Difference or Transpiration Rate on Stomatal Conductance	201
5.4.4 Effects of Irradiance and CO ₂ on Stomatal Conductance	203
5.4.5 The Cuticular Conductance and the Boundary Layer Conductance	203
5.4.6 Stomatal Control: A Compromise Between Carbon Gain and Water Loss	204
6 Water-Use Efficiency	206
6.1 Water-Use Efficiency and Carbon-Isotope Discrimination	206
6.2 Leaf Traits That Affect Leaf Temperature and Leaf Water Loss	207
6.3 Water Storage in Leaves	209
7 Water Availability and Growth	210
8 Adaptations to Drought	211
8.1 Desiccation Avoidance: Annuals and Drought-Deciduous Species	211
8.2 Dessication Tolerance: Evergreen Shrubs	212
8.3 Resurrection Plants	212
9 Winter Water Relations and Freezing Tolerance	214
10 Salt Tolerance	216
11 Final Remarks: The Message That Transpires	216
References	217

4. Leaf Energy Budgets: Effects of Radiation and Temperature	225
4A. The Plant's Energy Balance	
1 Introduction	225
2 Energy Inputs and Outputs	225
2.1 Short Overview of a Leaf's Energy Balance	225
2.2 Short-Wave Solar Radiation	226
2.3 Long-Wave Terrestrial Radiation	229
2.4 Convective Heat Transfer	230
2.5 Evaporative Energy Exchange	232
2.6 Metabolic Heat Generation	234
3 Modeling the Effect of Components of the Energy Balance on Leaf Temperature	234
4 A Summary of Hot and Cool Topics	235
References	235
4B. Effects of Radiation and Temperature	
1 Introduction	237
2 Radiation	237
2.1 Effects of Excess Irradiance	237
2.2 Effects of Ultraviolet Radiation	237
2.2.1 Damage by UV	238
2.2.2 Protection Against UV: Repair or Prevention	238
3 Effects of Extreme Temperatures	239
3.1 How Do Plants Avoid Damage by Free Radicals at Low Temperature?	239
3.2 Heat-Shock Proteins	241
3.3 Are Isoprene and Monoterpene Emissions an Adaptation to High Temperatures?	241
3.4 Chilling Injury and Chilling Tolerance	242
3.5 Carbohydrates and Proteins Conferring Frost Tolerance	243
4 Global Change and Future Crops	244
References	244
5. Scaling-Up Gas Exchange and Energy Balance from the Leaf to the Canopy Level	247
1 Introduction	247
2 Canopy Water Use	247
3 Canopy CO ₂ Fluxes	251
4 Canopy Water-Use Efficiency	252
5 Canopy Effects on Microclimate: A Case Study	253
6 Aiming for a Higher Level	253
References	253
6. Mineral Nutrition	255
1 Introduction	255
2 Acquisition of Nutrients	255
2.1 Nutrients in the Soil	255
2.1.1 Nutrient Availability as Dependent on Soil Age	255

2.1.2	Nutrient Supply Rate	257
2.1.3	Nutrient Movement to the Root Surface	259
2.2	Root Traits That Determine Nutrient Acquisition	262
2.2.1	Increasing the Roots' Absorptive Surface	262
2.2.2	Transport Proteins: Ion Channels and Carriers	263
2.2.3	Acclimation and Adaptation of Uptake Kinetics	265
2.2.4	Acquisition of Nitrogen	269
2.2.5	Acquisition of Phosphorus	270
2.2.6	Changing the Chemistry in the Rhizosphere	275
2.2.7	Rhizosphere Mineralization	279
2.2.8	Root Proliferation in Nutrient-Rich Patches: Is It Adaptive?	280
2.3	Sensitivity Analysis of Parameters Involved in Phosphate Acquisition	282
3	Nutrient Acquisition from "Toxic" or "Extreme" Soils	284
3.1	Acid Soils	284
3.1.1	Aluminum Toxicity	284
3.1.2	Alleviation of the Toxicity Symptoms by Soil Amendment	287
3.1.3	Aluminum Resistance	287
3.2	Calcareous Soils	288
3.3	Soils with High Levels of Heavy Metals	289
3.3.1	Why Are the Concentrations of Heavy Metals in Soil High?	289
3.3.2	Using Plants to Clean or Extract Polluted Water and Soil: Phytoremediation and Phytomining	290
3.3.3	Why Are Heavy Metals So Toxic to Plants?	291
3.3.4	Heavy-Metal-Resistant Plants	291
3.3.5	Biomass Production of Sensitive and Resistant Plants	296
3.4	Saline Soils: An Ever-Increasing Problem in Agriculture	296
3.4.1	Glycophytes and Halophytes	297
3.4.2	Energy-Dependent Salt Exclusion from Roots	297
3.4.3	Energy-Dependent Salt Exclusion from the Xylem	298
3.4.4	Transport of Na ⁺ from the Leaves to the Roots and Excretion via Salt Glands	298
3.4.5	Compartmentation of Salt Within the Cell and Accumulation of Compatible Solutes	301
3.5	Flooded Soils	301
4	Plant Nutrient-Use Efficiency	302
4.1	Variation in Nutrient Concentration	302
4.1.1	Tissue Nutrient Concentration	302
4.1.2	Tissue Nutrient Requirement	303
4.2	Nutrient Productivity and Mean Residence Time	304
4.2.1	Nutrient Productivity	304
4.2.2	The Mean Residence Time of Nutrients in the Plant	304
4.3	Nutrient Loss from Plants	306
4.3.1	Leaching Loss	306
4.3.2	Nutrient Loss by Senescence	307
4.4	Ecosystem Nutrient-Use Efficiency	308
5	Mineral Nutrition: A Vast Array of Adaptations and Acclimations	310
	References	310

7. Growth and Allocation	321
1 Introduction: What Is Growth?	321
2 Growth of Whole Plants and Individual Organs	321
2.1 Growth of Whole Plants	322
2.1.1 A High Leaf Area Ratio Enables Plants to Grow Fast	322
2.1.2 Plants with High Nutrient Concentrations Can Grow Faster	322
2.2 Growth of Cells	323
2.2.1 Cell Division and Cell Expansion: The Lockhart Equation	323
2.2.2 Cell-Wall Acidification and Removal of Calcium Reduce Cell-Wall Rigidity	324
2.2.3 Cell Expansion in Meristems Is Controlled by Cell-Wall Extensibility and Not by Turgor	327
2.2.4 The Physical and Biochemical Basis of Yield Threshold and Cell-Wall Yield Coefficient	328
2.2.5 The Importance of Meristem Size	328
3 The Physiological Basis of Variation in RGR – Plants Grown with Free Access to Nutrients	328
3.1 SLA Is a Major Factor Associated with Variation in RGR	330
3.2 Leaf Thickness and Leaf Mass Density	332
3.3 Anatomical and Chemical Differences Associated with Leaf Mass Density	332
3.4 Net Assimilation Rate, Photosynthesis, and Respiration	333
3.5 RGR and the Rate of Leaf Elongation and Leaf Appearance	333
3.6 RGR and Activities per Unit Mass	334
3.7 RGR and Suites of Plant Traits	334
4 Allocation to Storage	335
4.1 The Concept of Storage	336
4.2 Chemical Forms of Stores	337
4.3 Storage and Remobilization in Annuals	337
4.4 The Storage Strategy of Biennials	338
4.5 Storage in Perennials	338
4.6 Costs of Growth and Storage: Optimization	340
5 Environmental Influences	340
5.1 Growth as Affected by Irradiance	341
5.1.1 Growth in Shade	341
5.1.2 Effects of the Photoperiod	345
5.2 Growth as Affected by Temperature	346
5.2.1 Effects of Low Temperature on Root Functioning	346
5.2.2 Changes in the Allocation Pattern	346
5.3 Growth as Affected by Soil Water Potential and Salinity	347
5.3.1 Do Roots Sense Dry Soil and Then Send Signals to the Leaves?	348
5.3.2 ABA and Leaf Cell-Wall Stiffening	348
5.3.3 Effects on Root Elongation	348
5.3.4 A Hypothetical Model That Accounts for Effects of Water Stress on Biomass Allocation	349
5.4 Growth at a Limiting Nutrient Supply	349
5.4.1 Cycling of Nitrogen Between Roots and Leaves	349
5.4.2 Hormonal Signals That Travel via the Xylem to the Leaves	350
5.4.3 Signals That Travel from the Leaves to the Roots	351
5.4.4 Integrating Signals from the Leaves and the Roots	351

5.4.5	Effects of Nitrogen Supply on Leaf Anatomy and Chemistry	352
5.4.6	Nitrogen Allocation to Different Leaves, as Dependent on Incident Irradiance	352
5.5	Plant Growth as Affected by Soil Compaction	354
5.5.1	Effects on Biomass Allocation: Is ABA Involved?	354
5.5.2	Changes in Root Length and Diameter: A Modification of the Lockhart Equation	354
5.6	Growth as Affected by Soil Flooding	355
5.6.1	The Pivotal Role of Ethylene	356
5.6.2	Effects on Water Uptake and Leaf Growth	357
5.6.3	Effects on Adventitious Root Formation	358
5.6.4	Effects on Radial Oxygen Loss	358
5.7	Growth as Affected by Submergence	358
5.7.1	Gas Exchange	359
5.7.2	Perception of Submergence and Regulation of Shoot Elongation	359
5.8	Growth as Affected by Touch and Wind	360
5.9	Growth as Affected by Elevated Concentrations of CO ₂ in the Atmosphere	361
6	Adaptations Associated with Inherent Variation in Growth Rate	362
6.1	Fast- and Slow-Growing Species	362
6.2	Growth of Inherently Fast- and Slow-Growing Species Under Resource-Limited Conditions	363
6.2.1	Growth at a Limiting Nutrient Supply	364
6.2.2	Growth in the Shade	364
6.3	Are There Ecological Advantages Associated with a High or Low RGR?	364
6.3.1	Various Hypotheses	364
6.3.2	Selection on RGR _{max} Itself, or on Traits That Are Associated with RGR _{max} ?	365
6.3.3	An Appraisal of Plant Distribution Requires Information on Ecophysiology	366
7	Growth and Allocation: The Messages About Plant Messages	367
	References	367

8. Life Cycles: Environmental Influences and Adaptations 375

1	Introduction	375
2	Seed Dormancy and Germination	375
2.1	Hard Seed Coats	376
2.2	Germination Inhibitors in the Seed	377
2.3	Effects of Nitrate	378
2.4	Other External Chemical Signals	378
2.5	Effects of Light	380
2.6	Effects of Temperature	382
2.7	Physiological Aspects of Dormancy	384
2.8	Summary of Ecological Aspects of Seed Germination and Dormancy	385
3	Developmental Phases	385
3.1	Seedling Phase	385
3.2	Juvenile Phase	386
3.2.1	Delayed Flowering in Biennials	387
3.2.2	Juvenile and Adult Traits	388

3.2.3	Vegetative Reproduction	388
3.2.4	Delayed Greening During Leaf Development in Tropical Trees	390
3.3	Reproductive Phase	391
3.3.1	Timing by Sensing Daylength: Long-Day and Short-Day Plants	391
3.3.2	Do Plants Sense the Difference Between a Certain Daylength in Spring and Autumn?	393
3.3.3	Timing by Sensing Temperature: Vernalization	393
3.3.4	Effects of Temperature on Plant Development	394
3.3.5	Attracting Pollinators	394
3.3.6	The Cost of Flowering	395
3.4	Fruiting	396
3.5	Senescence	397
4	Seed Dispersal	397
4.1	Dispersal Mechanisms	397
4.2	Life-History Correlates	398
5	The Message to Disperse: Perception, Transduction, and Response	398
	References	398
9.	Biotic Influences	403
9A.	Symbiotic Associations	403
1	Introduction	403
2	Mycorrhizas	403
2.1	Mycorrhizal Structures: Are They Beneficial for Plant Growth?	404
2.1.1	The Infection Process	408
2.1.2	Mycorrhizal Responsiveness	410
2.2	Nonmycorrhizal Species and Their Interactions with Mycorrhizal Species	412
2.3	Phosphate Relations	413
2.3.1	Mechanisms That Account for Enhanced Phosphate Absorption by Mycorrhizal Plants	413
2.3.2	Suppression of Colonization at High Phosphate Availability	415
2.4	Effects on Nitrogen Nutrition	416
2.5	Effects on the Acquisition of Water	417
2.6	Carbon Costs of the Mycorrhizal Symbiosis	418
2.7	Agricultural and Ecological Perspectives	419
3	Associations with Nitrogen-Fixing Organisms	421
3.1	Symbiotic N ₂ Fixation Is Restricted to a Fairly Limited Number of Plant Species	422
3.2	Host—Guest Specificity in the Legume—Rhizobium Symbiosis	424
3.3	The Infection Process in the Legume—Rhizobium Association	424
3.3.1	The Role of Flavonoids	425
3.3.2	<i>Rhizobial nod Genes</i>	425
3.3.3	Entry of the Bacteria	427
3.3.4	Final Stages of the Establishment of the Symbiosis	428
3.4	Nitrogenase Activity and Synthesis of Organic Nitrogen	429

3.5	Carbon and Energy Metabolism of the Nodules	431
3.6	Quantification of N ₂ Fixation In Situ	432
3.7	Ecological Aspects of the Nonsymbiotic Association with N ₂ -Fixing Microorganisms	433
3.8	Carbon Costs of the Legume – Rhizobium Symbiosis	434
3.9	Suppression of the Legume – Rhizobium Symbiosis at Low pH and in the Presence of a Large Supply of Combined Nitrogen	435
4	Endosymbionts	436
5	Plant Life Among Microsymbionts	437
	References	437
9B.	Ecological Biochemistry: Allelopathy and Defence against Herbivores	445
1	Introduction	445
2	Allelopathy (Interference Competition)	445
3	Chemical Defense Mechanisms	448
3.1	Defense Against Herbivores	448
3.2	Qualitative and Quantitative Defense Compounds	451
3.3	The Arms Race of Plants and Herbivores	451
3.4	How Do Plants Avoid Being Killed by Their Own Poisons?	455
3.5	Secondary Metabolites for Medicines and Crop Protection	457
4	Environmental Effects on the Production of Secondary Plant Metabolites	460
4.1	Abiotic Factors	460
4.2	Induced Defense and Communication Between Neighboring Plants	462
4.3	Communication Between Plants and Their Bodyguards	464
5	The Costs of Chemical Defense	466
5.1	Diversion of Resources from Primary Growth	466
5.2	Strategies of Predators	468
5.3	Mutualistic Associations with Ants and Mites	469
6	Detoxification of Xenobiotics by Plants: Phytoremediation	469
7	Secondary Chemicals and Messages That Emerge from This Chapter	472
	References	473
9C.	Effects of Microbial Pathogens	479
1	Introduction	479
2	Constitutive Antimicrobial Defense Compounds	479
3	The Plant's Response to Attack by Microorganisms	481
4	Cross-Talk Between Induced Systemic Resistance and Defense Against Herbivores	485
5	Messages from One Organism to Another	488
	References	488
9D.	Parasitic Associations	491
1	Introduction	491
2	Growth and Development	492
2.1	Seed Germination	492
2.2	Haustoria Formation	493
2.3	Effects of the Parasite on Host Development	496
3	Water Relations and Mineral Nutrition	498
4	Carbon Relations	500

5	What Can We Extract from This Chapter?	501
	References	501
9E.	Interactions Among Plants	505
1	Introduction	505
2	Theories of Competitive Mechanisms	509
3	How Do Plants Perceive the Presence of Neighbors?	509
4	Relationship of Plant Traits to Competitive Ability	512
4.1	Growth Rate and Tissue Turnover	512
4.2	Allocation Pattern, Growth Form, and Tissue Mass Density	513
4.3	Plasticity	514
5	Traits Associated with Competition for Specific Resources	516
5.1	Nutrients	516
5.2	Water	517
5.3	Light	518
5.4	Carbon Dioxide	518
6	Positive Interactions Among Plants	521
6.1	Physical Benefits	521
6.2	Nutritional Benefits	521
6.3	Allelochemical Benefits	521
7	Plant–Microbial Symbiosis	522
8	Succession	524
9	What Do We Gain from This Chapter?	526
	References	527
9F.	Carnivory	533
1	Introduction	533
2	Structures Associated with the Catching of the Prey and Subsequent Withdrawal of Nutrients from the Prey	533
3	Some Case Studies	536
3.1	<i>Dionaea Muscipula</i>	537
3.2	The Suction Traps of <i>Utricularia</i>	539
3.3	The Tentacles of <i>Drosera</i>	541
3.4	Pitchers of <i>Sarracenia</i>	542
3.5	Passive Traps of <i>Genlisea</i>	542
4	The Message to Catch	543
	References	543
10.	Role in Ecosystem and Global Processes	545
10A.	Decomposition	545
1	Introduction	545
2	Litter Quality and Decomposition Rate	546
2.1	Species Effects on Litter Quality: Links with Ecological Strategy	546
2.2	Environmental Effects on Decomposition	547
3	The Link Between Decomposition Rate and Nutrient Supply	548
3.1	The Process of Nutrient Release	548
3.2	Effects of Litter Quality on Mineralization	549
3.3	Root Exudation and Rhizosphere Effects	550
4	The End Product of Decomposition	552
	References	552

10B. Ecosystem and Global Processes:	
Ecophysiological Controls	555
1 Introduction	555
2 Ecosystem Biomass and Production	555
2.1 Scaling from Plants to Ecosystems	555
2.2 Physiological Basis of Productivity	556
2.3 Disturbance and Succession	558
2.4 Photosynthesis and Absorbed Radiation	559
2.5 Net Carbon Balance of Ecosystems	561
2.6 The Global Carbon Cycle	561
3 Nutrient Cycling	563
3.1 Vegetation Controls over Nutrient Uptake and Loss	563
3.2 Vegetation Controls over Mineralization	565
4 Ecosystem Energy Exchange and the Hydrologic Cycle	565
4.1 Vegetation Effects on Energy Exchange	565
4.1.1 Albedo	565
4.1.2 Surface Roughness and Energy Partitioning	566
4.2 Vegetation Effects on the Hydrologic Cycle	567
4.2.1 Evapotranspiration and Runoff	567
4.2.2 Feedbacks to Climate	568
5 Moving to a Higher Level: Scaling from Physiology to the Globe	568
References	569
Glossary	573
Index	591

1

Assumptions and Approaches

Introduction—History, Assumptions, and Approaches

1. What Is Ecophysiology?

Plant ecophysiology is an experimental science that seeks to describe the **physiological mechanisms** underlying ecological observations. In other words, ecophysiologicals, or physiological ecologists, address ecological questions about the controls over the growth, reproduction, survival, abundance, and geographical distribution of plants, as these processes are affected by interactions of plants with their physical, chemical, and biotic environment. These ecophysiological patterns and mechanisms can help us understand the functional significance of specific plant traits and their evolutionary heritage.

The questions addressed by ecophysiologicals are derived from a higher level of integration, i.e., from “ecology” in its broadest sense, including questions originating from agriculture, horticulture, forestry, and environmental sciences. However, the ecophysiological explanations often require mechanistic understanding at a lower level of integration (physiology, biochemistry, biophysics, molecular biology). It is, therefore, quintessential for an ecophysiologicalist to have an appreciation of both ecological questions and biophysical, biochemical, and molecular methods and processes. In addition, many societal issues, often pertaining to agriculture, environmental change, or nature conservation, benefit from an ecophysiological perspective. A modern ecophysiologicalist thus requires a good understanding of both the molecular aspects of plant processes and

the functioning of the intact plant in its environmental context.

2. The Roots of Ecophysiology

Plant ecophysiology aims to provide causal, mechanistic explanations for ecological questions relating to survival, distribution, abundance, and interactions of plants with other organisms. Why does a particular species live where it does? How does it manage to grow there successfully, and why is it absent from other environments? These questions were initially asked by geographers who described the global distributions of plants (Schimper 1898, Walter 1974). They observed consistent patterns of morphology associated with different environments and concluded that these differences in morphology must be important in explaining plant distributions. Geographers, who know climatic patterns, could therefore predict the predominant life forms of plants (Holdridge 1947). For example, many desert plants have small, thick leaves that minimize the heat load and danger of overheating in hot environments, whereas shade plants often have large, thin leaves that maximize light interception. These observations of morphology provided the impetus to investigate the physiological traits of plants from contrasting physical environments (Blackman 1919, Pearsall 1938, Ellenberg 1953, Larcher 1976).

Although ecophysiologicalists initially emphasized physiological responses to the abiotic environment [e.g., to calcareous vs. acidic substrates (Clarkson 1966) or dry vs. flooded soils (Crawford 1978)], physiological interactions with other plants, animals, and microorganisms also benefit from an understanding of ecophysiology. As such, ecophysiology is an essential element of every ecologist's training.

A second impetus for the development of ecophysiology came from agriculture and physiology. Even today, agricultural production in industrialized nations is limited to 25% of its potential by drought, infertile soils, and other environmental stresses (Boyer 1985). A major objective of agricultural research has always been to develop crops that are less sensitive to environmental stress so they can withstand periods of unfavorable weather or be grown in less favorable habitats. For this reason agronomists and physiologists have studied the mechanisms by which plants respond to or resist environmental stresses. Because some plants grow naturally in extremely infertile, dry, or salty environments, ecophysiologicalists were curious to know the mechanisms by which this is accomplished.

Plant ecophysiology is the study of physiological responses to the environment. The field developed rapidly as a relatively unexplored interface between ecology and physiology. Ecology provided the questions, and physiology provided the tools to determine the mechanism. Techniques that measured the microenvironment of plants, their water relations, and their patterns of carbon exchange became typical tools of the trade in plant ecophysiology. With time, these studies have explored the mechanisms of physiological adaptation at ever finer levels of detail, from the level of the whole plant to its biochemical and molecular bases. For example, initially plant growth was described in terms of changes in plant mass. Development of portable equipment for measuring leaf gas exchange enabled ecologists to measure rates of carbon gain and loss by individual leaves (Reich et al. 1997). Growth analyses documented carbon and nutrient allocation to roots and leaves and rates of production and death of individual tissues. These processes together provide a more thorough explanation for differences in plant growth in different environments (Mooney 1972, Lambers & Poorter 1992). Studies of plant water relations and mineral nutrition provide additional insight into controls over rates of carbon exchange and tissue turnover. More recently, we have learned many details about the biochemical basis of photosynthesis and respiration in different environments and, finally, about the molecular basis for differences in key photosynthetic and respiratory proteins. This

mainstream of ecophysiology has been highly successful in explaining why plants are able to grow where they do.

3. Physiological Ecology and the Distribution of Organisms

Although there are 270000 species of land plants (Hammond 1995), a series of **filters** eliminates most of these species from any given site and restricts the actual vegetation to a relatively small number of species (Fig. 1). Many species are absent from a given plant community for **historical reasons**. They may have evolved in a different region and never dispersed to the site under consideration. For example, the tropical alpine of South America has few species in common with the tropical alpine of Africa, despite similar environmental conditions, whereas eastern Russia and Alaska have very similar species composition because of extensive migration of species across a land bridge connecting these regions when Pleistocene glaciations lowered sea level 20000–100000 years ago.

Of those species that arrive at a site, many lack the appropriate physiological traits to survive the physical environment. For example, whalers inadvertently brought seeds of many weedy species to Svalbard, north of Norway, and to Barrow, in northern Alaska. However, in contrast to most temperate regions, there are currently no exotic weed species in these northern sites (Billings 1973). Clearly, the **physical environment** has filtered out many species that may have arrived but lacked the physiological traits to grow, survive, and reproduce in the Arctic.

Biotic interactions exert an additional filter that eliminates many species that may have arrived and are capable of surviving the physical environment. Most plant species that are transported to different continents as ornamental or food crops never spread beyond the areas where they were planted because they cannot compete with native species (a biotic filter). Sometimes, however, a plant species that is introduced to a new place without the diseases or herbivores that restricted its distribution in its native habitat becomes an aggressive invader, for example, *Opuntia ficus-indica* (prickly pear) in Australia, *Solidago canadensis* (golden rod) in Europe, *Cytisus scoparius* (Scotch broom) in North America, and *Acacia cyclops* (red-eyed wattle) and *A. saligna* (orange wattle) in South Africa. Because of biotic interactions, the actual distribution of a species (realized niche, as determined by **ecological amplitude**) is more restricted than the range of conditions

FIGURE 1. Historical, physiological, and biotic filters that determine the species composition of vegetation at a particular site.

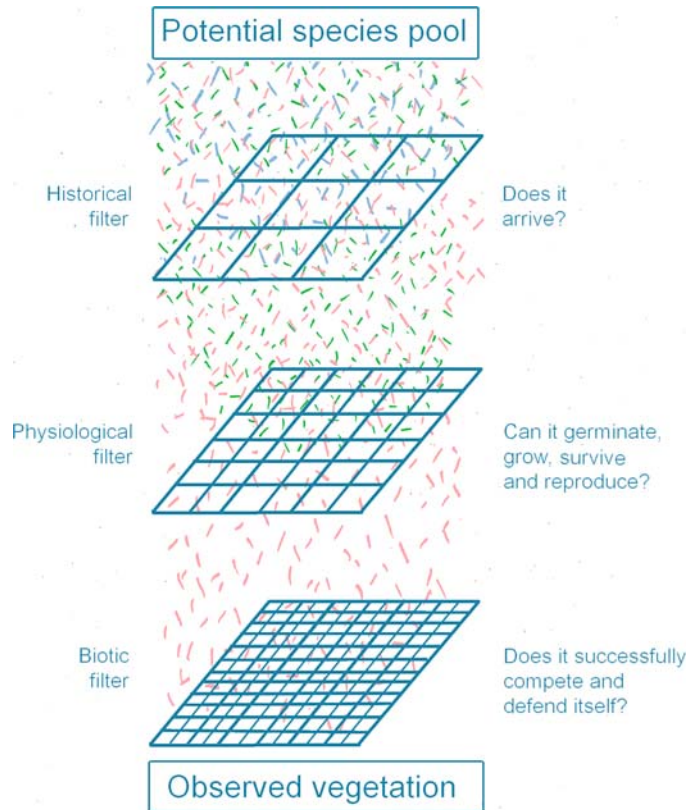

where it can grow and reproduce (its fundamental niche, as determined by **physiological amplitude**) (Fig. 2).

Historical, physiological, and biotic filters are constantly changing and interacting. Human and natural introductions or extinctions of species, chance dispersal events, and extreme events such as volcanic eruptions or floods change the species pool present at a site. Changes in climate, weathering of soils, and introduction or extinction of species change the physical and biotic environment. Those plant species that can grow and reproduce under the new conditions or respond evolutionarily so that their physiology provides a better match to this environment will persist. Because of these interacting filters, the species present at a site are simply those that arrived and survived. There is no reason to assume that the species present at a site attain their maximal physiologically possible rates of growth and reproduction (Vrba & Gould 1986). In fact, controlled-environment studies typically demonstrate that a given species is most common under environmental conditions that are distinctly suboptimal for

most physiological processes because biotic interactions prevent most species from occupying the most favorable habitats (Fig. 2).

Given the general principle that species that are present at any site reflect their arrival and survival, why does plant species diversity differ among sites that differ in soil fertility? Typically, this diversity increases with decreasing soil fertility, up to a maximum, and then declines again (Grime 1979, Huston 1994). To answer this question, we need detailed ecophysiological information on the various mechanisms that allow plants to compete and coexist in different environments. The information that is required will depend on which ecosystem is studied. In biodiverse (i.e., species-rich), nutrient-poor, tropical rainforests, with a wide variation in light climate, plant traits that enhance the conversion of light into biomass or conserve carbon are likely to be important for an understanding of plant diversity. In the biodiverse, nutrient-impooverished sandplains of South Africa and Australia, however, variation in root traits that are associated with nutrient acquisition offers clues to understanding plant species diversity.

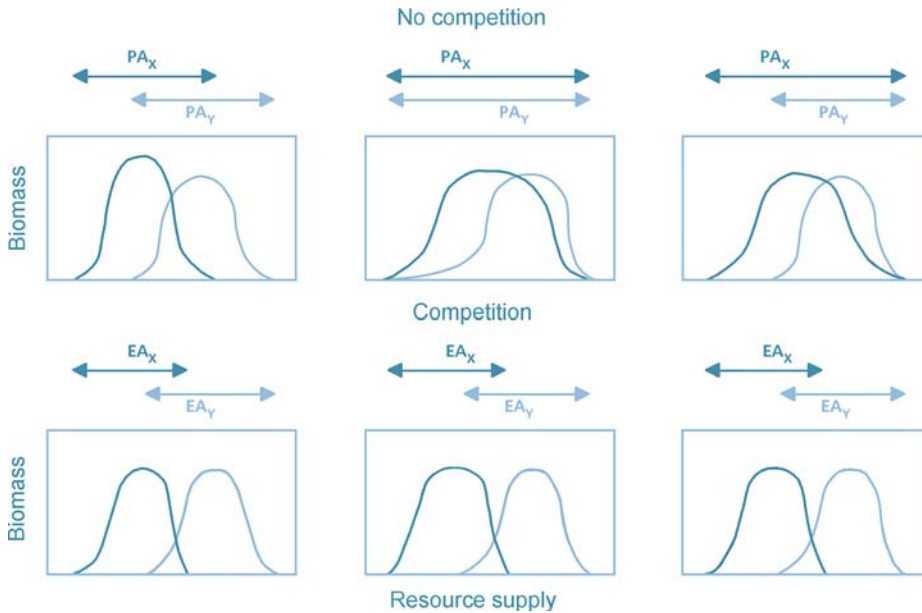

FIGURE 2. Biomass production of two hypothetical species (x and y) as a function of resource supply. In the absence of competition (*upper panels*), the physiological amplitude of species x and y (PA_x and PA_y , respectively) defines the range of conditions over which each species can grow. In the presence of competition (*lower panels*), plants grow over a smaller range of conditions (their ecological amplitude, EA_x and EA_y) that is

constrained by competition from other species. A given pattern of species distribution (e.g., that shown in the bottom panels) can result from species that differ in their maximum biomass achieved (*left-hand pair of graphs*), shape of resource response curve (*center pair of graphs*), or physiological amplitude (*right-hand pair of graphs*). Adapted from Walter (1973).

4. Time Scale of Plant Response to Environment

We define **stress** as an environmental factor that reduces the rate of some physiological process (e.g., growth or photosynthesis) below the maximum rate that the plant could otherwise sustain. Stresses can be generated by abiotic and/or biotic processes. Examples of stress include low nitrogen availability, heavy metals, high salinity, and shading by neighboring plants. The immediate response of the plant to stress is a reduction in performance (Fig. 3). Plants compensate for the detrimental effects of stress through many mechanisms that operate over different time scales, depending on the nature of the stress and the physiological processes that are affected. Together, these compensatory responses enable the plant to maintain a relatively constant rate of physiological processes despite occurrence of stresses that periodically reduce performance. If a plant is going to be successful in a stressful environment, then there must be some degree of stress **resistance**. Mechanisms of

stress resistance differ widely among species. They range from **avoidance** of the stress, e.g., in deep-rooting species growing in a low-rainfall area, to stress **tolerance**, e.g., in Mediterranean species that can cope with a low leaf water content.

Physiological processes differ in their sensitivity to stress. The most meaningful physiological processes to consider are growth and reproduction, which integrate the stress effects on fine-scale physiological processes as they relate to fitness, i.e., differential survival and reproduction in a competitive environment. To understand the mechanism of plant response, however, we must consider the response of individual processes at a finer scale (e.g., the response of photosynthesis or of light-harvesting pigments to a change in light intensity). We recognize at least three distinct time scales of plant response to stress:

1. The **stress response** is the immediate detrimental effect of a stress on a plant process. This generally occurs over a time scale of seconds to days, resulting in a decline in performance of the process.

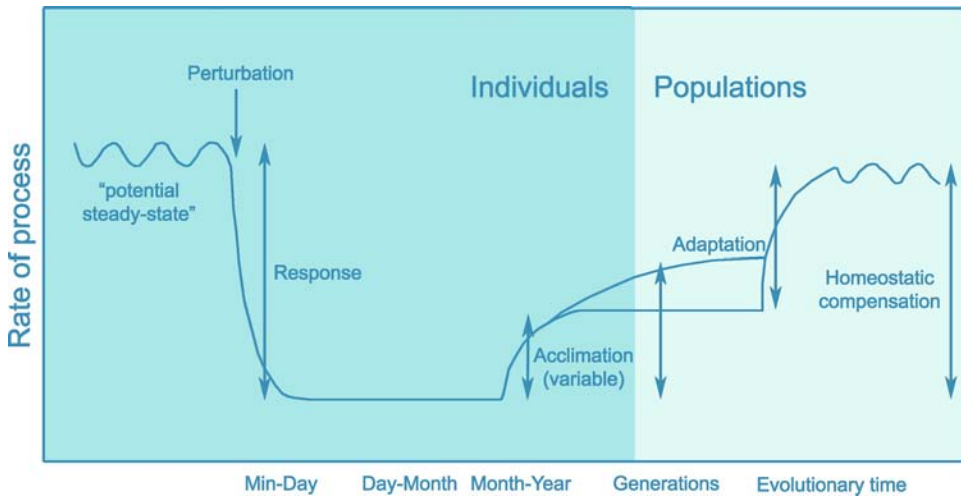

FIGURE 3. Typical time course of plant response to environmental stress. The immediate response to environmental stress is a reduction in physiological activity. Through *acclimation*, individual plants compensate for this stress such that activity returns toward the control level. Over evolutionary time, populations *adapt* to environmental stress, resulting in a further increase in

activity level toward that of the unstressed unadapted plant. The total increase in activity resulting from acclimation and adaptation is the *in situ* activity observed in natural populations and represents the total homeostatic compensation in response to environmental stress.

2. **Acclimation** is the morphological and physiological adjustment by individual plants to compensate for the decline in performance following the initial stress response. Acclimation occurs in response to environmental change through changes in the activity or synthesis of new biochemical constituents such as enzymes, often associated with the production of new tissue. These biochemical changes then initiate a cascade of effects that are observed at other levels, such as changes in rate or environmental sensitivity of a specific process (e.g., photosynthesis), growth rate of whole plants, and morphology of organs or the entire plant. Acclimation to stress always occurs within the lifetime of an individual, usually within days to weeks. Acclimation can be demonstrated by comparing genetically similar plants that are growing in different environments.
3. **Adaptation** is the evolutionary response resulting from genetic changes in populations that compensate for the decline in performance caused by stress. The physiological mechanisms of response are often similar to those of acclimation, because both require changes in the activity or synthesis of biochemical constituents and cause changes in rates of individual physiological processes, growth rate, and morphology. In

fact, adaptation may alter the potential of plants to acclimate to short-term environmental variation. Adaptation, as we define it, differs from acclimation in that it requires genetic changes in populations and therefore typically requires many generations to occur. We can study adaptation by comparing genetically distinct plants grown in a common environment.

Not all genetic differences among populations reflect adaptation. Evolutionary biologists have often criticized ecophysiologicalists for promoting the "Panglossian paradigm", i.e., the idea that just because a species exhibits certain traits in a particular environment, these traits must be beneficial and must have resulted from natural selection in that environment (Gould & Lewontin 1979). Plants may differ genetically because their ancestral species or populations were genetically distinct before they arrived in the habitat we are studying or other historical reasons may be responsible for the existence of the present genome. Such differences are not necessarily adaptive.

There are at least two additional processes that can cause particular traits to be associated with a given environment:

1. Through the quirks of history, the ancestral species or population that arrived at the site may

have been pre-adapted, i.e., exhibited traits that allowed continued persistence in these conditions. Natural selection for these traits may have occurred under very different environmental circumstances. For example, the tree species that currently occupy the mixed deciduous forests of Europe and North America were associated with very different species and environments during the Pleistocene, 100,000 years ago. They co-occur now because they migrated to the same place some time in the past (the **historical filter**), can grow and reproduce under current environmental conditions (the **physiological filter**), and out-competed other potential species in these communities and successfully defended themselves against past and present herbivores and pathogens (the **biotic filter**).

2. Once species arrive in a given geographic region, their distribution is fine-tuned by ecological sorting, in which each species tends to occupy those habitats where it most effectively competes with other plants and defends itself against natural enemies (Vrba & Gould 1986).

5. Conceptual and Experimental Approaches

Documentation of the correlation between plant traits and environmental conditions is the raw material for many ecophysiological questions. Plants in the high alpine of Africa are strikingly similar in morphology and physiology to those of the alpine of tropical South America and New Guinea, despite very different phylogenetic histories. The similarity of physiology and morphology of shrubs from Mediterranean regions of western parts of Spain, South Africa, Chile, Australia, and the United States suggests that the distinct floras of these regions have undergone **convergent evolution** in response to similar climatic regimes (Mooney & Dunn 1970). For example, evergreen shrubs are common in each of these regions. These shrubs have small, thick leaves, which continue to photosynthesize under conditions of low water availability during the warm, dry summers characteristic of Mediterranean climates. The shrubs of all Mediterranean regions effectively retain nutrients when leaves are shed, a trait that could be important on infertile soils, and often resprout after fire, which occurs commonly in these regions. Documentation of a correlation of traits with environment, however, can

never determine the relative importance of adaptation to these conditions and other factors such as pre-adaptation of the ancestral floras and ecological sorting of ancestral species into appropriate habitats. Moreover, traits that are measured under field conditions reflect the combined effects of differences in magnitude and types of environmental stresses, genetic differences among populations in stress response, and acclimation of individuals to stress. Thus, documentation of correlations between physiology and environment in the field provides a basis for interesting ecophysiological hypotheses, but these hypotheses can rarely be tested without complementary approaches such as growth experiments or phylogenetic analyses.

Growth experiments allow one to separate the effects of **acclimation** by individuals and genetic differences among populations. Acclimation can be documented by measuring the physiology of genetically similar plants grown under different environmental conditions. Such experiments show, for example, that plants grown at low temperature generally have a lower optimum temperature for photosynthesis than warm-grown plants (Billings et al. 1971). By growing plants collected from alpine and low-elevation habitats under the same environmental conditions, we can demonstrate genetic differences: with the alpine plant generally having a lower temperature optimum for photosynthesis than the low-elevation population. Thus, many alpine plants photosynthesize just as rapidly as their low-elevation counterparts, due to both acclimation and **adaptation**. Controlled-environment experiments are an important complement to field observations. Conversely, field observations and experiments provide a context for interpreting the significance of laboratory experiments.

Both acclimation and adaptation reflect complex changes in many plant traits, making it difficult to evaluate the importance of changes in any particular trait. Ecological modeling and molecular modification of specific traits are two approaches to explore the ecological significance of specific traits. Ecological models can range from simple empirical relationships (e.g., the temperature response of photosynthesis) to complex mathematical models that incorporate many indirect effects, such as negative feedbacks of sugar accumulation to photosynthesis. A common assumption of these models is that there are both **costs** and **benefits** associated with a particular trait, such that no trait enables a plant to perform best in all environments (i.e., there are no “super-plants” or “Darwinian demons” that are

superior in all components). That is presumably why there are so many interesting physiological differences among plants. These models seek to identify the conditions under which a particular trait allows superior performance or compare performance of two plants that differ in traits. The theme of **trade-offs** (i.e., the costs and benefits of particular traits) is one that will recur frequently in this book.

A second, more experimental approach to the question of optimality is **molecular modification** of the gene that encodes a trait, including the regulation of its expression. In this way we can explore the consequences of a change in photosynthetic capacity, sensitivity to a specific hormone, or response to shade. This molecular approach is an extension of comparative ecophysiological studies, in which plants from different environments that are as similar as possible except with respect to the trait of interest are grown in a common environment. Molecular modification of single genes allows evaluation of the physiological and ecological consequences of a trait, while holding constant the rest of the biology of the plants.

6. New Directions in Ecophysiology

Plant ecophysiology has several new and potentially important contributions to make to biology. The rapidly growing human population requires increasing supplies of food, fiber, and energy, at a time when the best agricultural land is already in production or being lost to urban development and land degradation. It is thus increasingly critical that we identify traits or suites of traits that maximize sustainable food and fiber production on both highly productive and less productive sites. The development of varieties that grow effectively with inadequate supplies of water and nutrients is particularly important in less developed countries that often lack the economic and transportation resources to support high-intensity agriculture. Molecular biology and traditional breeding programs provide the tools to develop new combinations of traits in plants, including GMOs (genetically modified organisms). Ecophysiology is perhaps the field that is best suited to determine the costs, benefits, and consequences of changes in these traits, as whole plants, including GMOs, interact with complex environments.

Past ecophysiological studies have described important physiological differences among plant species and have demonstrated many of the

mechanisms by which plants can live where they occur. These same physiological processes, however, have important effects on the environment, shading the soil, removing nutrients that might otherwise be available to other plants or soil microorganisms, transporting water from the soil to the atmosphere, thus both drying the soil and increasing atmospheric moisture. These plant effects can be large and provide a mechanistic basis for understanding processes at larger scales, such as community, ecosystem, and climatic processes (Chapin 2003). For example, forests that differ only in species composition can differ substantially in productivity and rates of nutrient cycling. Simulation models suggest that species differences in stomatal conductance and rooting depth could significantly affect climate at regional and continental scales (Foley et al. 2003, Field et al. 2007). As human activities increasingly alter the species composition of large portions of the globe, it is critical that we understand the ecophysiological basis of community, ecosystem, and global processes.

7. The Structure of the Book

We assume that the reader already has a basic understanding of biochemical and physiological processes in plants. Chapters 2A–C in this book deal with the primary processes of carbon metabolism and transport. After introducing some biochemical and physiological aspects of photosynthesis (Chapter 2A), we discuss differences in photosynthetic traits among species and link these with the species' natural habitat. Trade-offs are discussed, like that between a high water-use efficiency and a high efficiency of nitrogen use in photosynthesis (Chapter 2A). In Chapter 2B we analyze carbon use in respiration and explore its significance for the plant's carbon balance in different species and environments. Species differences in the transport of photosynthates from the site of production to various sinks are discussed in Chapter 2C. For example, the phloem transport system in climbing plants involves an interesting trade-off between transport capacity and the risk of major damage to the system. A similar trade-off between capacity and safety is encountered in Chapter 3, which deals with plant water relations. Subsequently, the plant's energy balance (Chapter 4A) and the effects of radiation and temperature (Chapter 4B) are discussed. After these chapters that describe photosynthesis, water use, and energy balance in individual leaves and whole plants, we then scale

the processes up to the level of an entire canopy, demonstrating that processes at the level of a canopy are not necessarily the sum of what happens in single leaves, due to the effects of the surrounding leaves (Chapter 5). Chapter 6 discusses mineral nutrition and the numerous ways in which plants cope with soils with low nutrient availability or toxic metal concentrations (e.g., sodium, aluminum, heavy metals). These first chapters emphasize those aspects that help us to analyze ecological problems. Moreover, they provide a sound basis for later chapters in the book that deal with a higher level of integration.

The following chapters deal with patterns of growth and allocation (Chapter 7), life-history traits (Chapter 8), and interactions of individual plants with other organisms: symbiotic microorganisms (Chapter 9A); ecological biochemistry, discussing allelopathy and defense against herbivores (Chapter 9B); microbial pathogens (Chapter 9C); parasitic plants (Chapter 9D); interactions among plants in communities (Chapter 9E); and animals used as prey by carnivorous plants (Chapter 9F). These chapters build on information provided in the initial chapters.

The final chapters deal with ecophysiological traits that affect decomposition of plant material in contrasting environments (Chapter 10A) and with the role of plants in ecosystem and global processes (Chapter 10B). Many topics in the first two series of chapters are again addressed in this broader context. For example, allocation patterns and defense compounds affect decomposition. Photosynthetic pathways and allocation patterns affect to what extent plant growth is enhanced at elevated levels of carbon dioxide in the atmosphere.

Throughout the text, “boxes” are used to elaborate on specific problems, without cluttering up the text. They are meant for students seeking a deeper understanding of problems discussed in the main text. A glossary provides quick access to the meaning of technical terms used in both this book and the plant ecophysiological literature. The references at the end of each chapter are an entry point to relevant literature in the field. We emphasize review papers that provide broad syntheses but also include key experimental papers in rapidly developing areas (“the cutting edge”). In general, this book aims at students who are already familiar with basic principles in ecology, physiology, and biochemistry. It should provide an invaluable text for both undergraduates and postgraduates and a reference for professionals.

References

- Billings, W.D. 1973. Arctic and alpine vegetation: Similarities, differences, and susceptibility to disturbance. *BioScience* **23**: 697–704.
- Billings, W.D., Godfrey, P.J., Chabot, B.F., & Bourque, D.P. 1971. Metabolic acclimation to temperature in arctic and alpine ecotypes of *Oxyria digyna*. *Arc. Alp. Res.* **3**: 277–289.
- Blackman, V.H. 1919. The compound interest law and plant growth. *Ann. Bot.* **33**: 353–360.
- Boyer, J.S. 1985. Water transport. *Annu. Rev. Plant Physiol.* **36**: 473–516.
- Chapin III, F.S., 2003. Effects of plant traits on ecosystem and regional processes: A conceptual framework for predicting the consequences of global change. *Ann. Bot.* **91**: 455–463.
- Clarkson, D.T. 1966. Aluminium tolerance in species within the genus *Agrostis*. *J. Ecol.* **54**: 167–178.
- Crawford, R.M.M. 1978. Biochemical and ecological similarities in marsh plants and diving animals. *Naturwissenschaften* **65**: 194–201.
- Ellenberg, H. 1953. Physiologisches und ökologisches Verhalten derselben Pflanzarten. *Ber. Deutsch. Bot. Ges.* **65**: 351–361.
- Field, C.B., Lobell, D.B., Peters, H.A., & Chiariello, N.R. 2007. Feedbacks of terrestrial ecosystems to climate change. *Annu. Rev. Env. Res.* **32**: 1–29.
- Foley, J.A., Costa, M.H., Delire, C., Ramankutty, N., & Snyder, P. 2003. Green surprise? How terrestrial ecosystems could affect earth's climate. *Front. Ecol. Environ.* **1**: 38–44.
- Gould, S.J. & Lewontin, R.C. 1979. The spandrels of San Marco and the Panglossian paradigm: A critique of the adaptationists programme. *Proc. R. Soc. Lond. B.* **205**: 581–598.
- Grime, J.P. 1979. Plant strategies and vegetation processes. Wiley, Chichester.
- Hammond, P.M. 1995. The current magnitude of biodiversity. In: Global biodiversity assessment, V.H. Heywood (ed.). Cambridge University Press, Cambridge, pp. 113–138.
- Holdridge, L.R. 1947. Determination of world plant formations from simple climatic data. *Science* **105**: 367–368.
- Huston, M.A. 1994. Biological diversity. Cambridge University Press, Cambridge.
- Lambers, H. & Poorter, H. 1992. Inherent variation in growth rate between higher plants: A search for physiological causes and ecological consequences. *Adv. Ecol. Res.* **22**: 187–261.
- Larcher, W. 1976. Ökologie der Pflanzen. Ulmer, Stuttgart.
- Mooney, H.A. 1972. The carbon balance of plants. *Annu. Rev. Ecol. Syst.* **3**: 315–346.
- Mooney, H.A. & Dunn, E.L. 1970. Convergent evolution of Mediterranean-climate sclerophyll shrubs. *Evolution* **24**: 292–303.
- Pearsall, W.H. 1938. The soil complex in relation to plant communities. *J. Ecol.* **26**: 180–193.
- Reich, P.B., Walters, M.B., & Ellsworth, D.S. 1997. From tropics to tundra: Global convergence in plant functioning. *Proc. Natl. Acad. Sci.* **94**: 13730–13734.

- Schimper, A.F.W. 1898. Pflanzengeographie und physiologische Grundlage. Verlag von Gustav Fischer, Jena.
- Vrba, E.S. & Gould, S.J. 1986. The hierarchical expansion of sorting and selection: Sorting and selection cannot be equated. *Paleobiology* **12**: 217–228.
- Walter, H. 1973. Die Vegetation der Erde in ökophysiologischer Betrachtung. 3rd ed. Gustav Fischer Verlag, Jena.
- Walter, H. 1974. Die Vegetation der Erde. Gustav Fischer Verlag, Jena.

2

Photosynthesis, Respiration, and Long-Distance Transport

2A. Photosynthesis

1. Introduction

Approximately 40% of a plant's dry mass consists of carbon, fixed in photosynthesis. This process is vital for growth and survival of virtually all plants during the major part of their growth cycle. In fact, life on Earth in general, not just that of plants, totally depends on current and/or past photosynthetic activity. Leaves are beautifully specialized organs that enable plants to intercept light necessary for photosynthesis. The light is captured by a large array of chloroplasts that are in close proximity to air and not too far away from vascular tissue, which supplies water and exports the products of photosynthesis. In most plants, CO₂ uptake occurs through leaf pores, the stomata, which are able to rapidly change their aperture (Sect. 5.4 of Chapter 3 on plant water relations). Once inside the leaf, CO₂ diffuses from the intercellular air spaces to the sites of carboxylation in the chloroplast (C₃ species) or in the cytosol (C₄ and CAM species).

Ideal conditions for photosynthesis include an ample supply of water and nutrients to the plant, and optimal temperature and light conditions. Even when the environmental conditions are less favorable, however, such as in a desert, alpine environments, or the understory of a forest, photosynthesis, at least of the adapted and acclimated plants, continues (for a discussion of the concepts of **acclimation** and **adaptation**, see Fig. 3 and

Sect. 4 in Chapter 1 on assumptions and approaches). This chapter addresses how such plants manage to photosynthesize and/or protect their photosynthetic machinery in adverse environments, what goes wrong in plants that are not adapted and fail to acclimate, and how photosynthesis depends on a range of other physiological activities in the plant.

2. General Characteristics of the Photosynthetic Apparatus

2.1 The "Light" and "Dark" Reactions of Photosynthesis

To orient ourselves, we imagine zooming in on a chloroplast: from a tree, to a leaf, to a cell in a leaf, and then to the many chloroplasts in a single cell, where the primary processes of photosynthesis occur. In C₃ plants most of the chloroplasts are located in the mesophyll cells of the leaves (Fig. 1). Three main processes are distinguished:

1. Absorption of photons by pigments, mainly chlorophylls, associated with two photosystems. The pigments are embedded in internal membrane structures (**thylakoids**) and absorb a major part of the energy of the photosynthetically

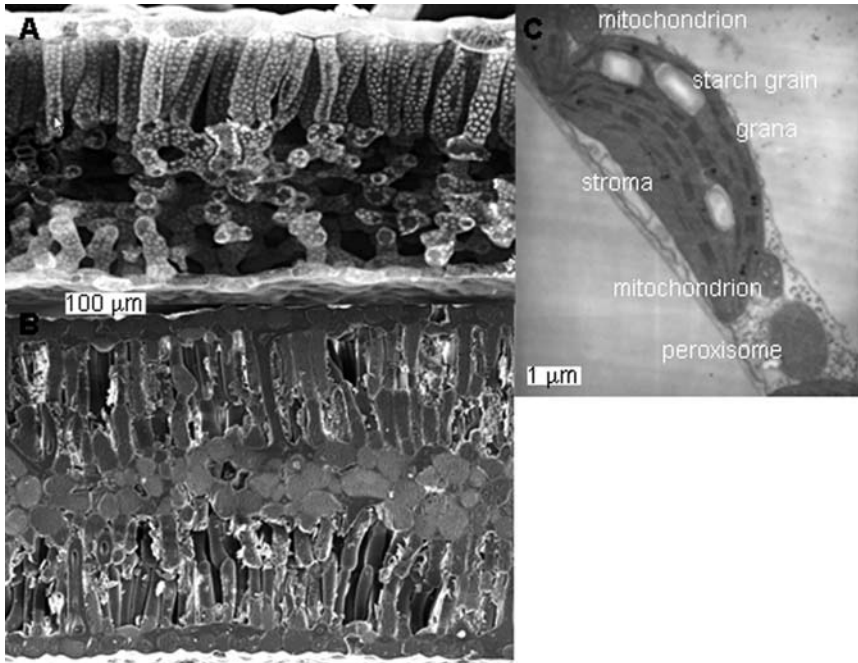

FIGURE 1. (A) Scanning electron microscope cross-sectional view of a dorsiventral leaf of *Nicotiana tabacum* (tobacco), showing palisade tissue beneath the upper (adaxial) epidermis, and spongy tissue adjacent to the (lower) abaxial epidermis. (B) Scanning electron microscope cross-sectional view of an isobilateral leaf of *Hakea prostrata* (harsh hakea). (C) Transmission electron microscope micrograph of a tobacco chloroplast, showing appressed (grana) and unappressed regions of

the thylakoids, stroma, and starch granules. Note the close proximity of two mitochondria (top and bottom) and one peroxisome (scale bar is 1 μm) (*Nicotiana tabacum*: courtesy J.R. Evans, Research School of Biological Sciences, Australian National University, Canberra, Australia; *Hakea prostrata*: courtesy M.W. Shane, School of Plant Biology, The University of Western Australia, Australia).

active radiation (PAR; 400–700 nm). They transfer the excitation energy to the reaction centers of the photosystems where the second process starts.

- Electrons derived from the splitting of water with the simultaneous production of O_2 are transported along an electron-transport chain embedded in the thylakoid membrane. NADPH and ATP produced in this process are used in the third process. Since these two reactions depend on light energy, they are called the “light reactions” of photosynthesis.
- The NADPH and ATP are used in the photosynthetic carbon-reduction cycle (Calvin cycle), in which CO_2 is assimilated leading to the synthesis of C_3 compounds (triose-phosphates). These processes can proceed in the absence of light and are referred to as the “dark reactions” of photosynthesis. As discussed in Sect. 3.4.2, however, some of the enzymes involved in the “dark” reactions require light for their activation, and hence the

difference between “light” and “dark” reaction is somewhat blurred.

2.1.1 Absorption of Photons

The reaction center of **photosystem I** (PS I) is a chlorophyll dimer with an absorption peak at 700 nm, hence called P_{700} . There are about 110 “ordinary” chlorophyll *a* (chl *a*) molecules per P_{700} as well as several different protein molecules, to keep the chlorophyll molecules in the required position in the thylakoid membranes (Lichtenthaler & Babani 2004). The number of PS I units can be quantified by determining the amount of P_{700} molecules, which can be assessed by measuring absorption changes at 830 nm.

The reaction center of **photosystem II** (PS II) contains redox components, including a chlorophyll *a* molecule with an absorption peak at 680 nm, called

P_{680} , pheophytin, which is like a chlorophyll molecule but without the Mg atom, and the first quinone acceptor of an electron (Q_A) (Chow 2003). Redox cofactors in PS II are bound to the structure of the so-called **D1/D2 proteins** in PS II. PS I and PS II units do not contain chl *b* (Lichtenthaler & Babani 2004). Several protein molecules keep the chlorophyll molecules in the required position in the thylakoid membranes. In vitro, P_{680} is too unstable to be used to quantify the amount of PS II. The **herbicide** atrazine binds specifically to one of the complexing protein molecules of PS II, however; when using ^{14}C -labeled atrazine, this binding can be quantified and used to determine the total amount of PS II. Alternatively, the quantity of functional PS II centers can be determined, in vivo, by the O_2 yield from leaf disks, exposed to 1% CO_2 and repetitive light flashes. A good correlation exists between the two assays. The O_2 yield per flash provides a convenient, direct assay of PS II in vivo when conditions are selected to avoid limitation by PS I (Chow et al. 1989).

A large part of the chlorophyll is located in the **light-harvesting complex** (LHC). These chlorophyll molecules act as antennae to trap light and transfer its excitation energy to the reaction centers of one of

the photosystems. The reaction centers are strategically located to transfer electrons along the electron-transport chains. The ratio of chl *a*/chl *b* is about 1.1–1.3 for LHC (Lichtenthaler & Babani 2004).

Leaves appear green in white light, because chlorophyll absorbs more efficiently in the blue and red than in the green portions of the spectrum; beyond approximately 720 nm, there is no absorption by chlorophyll at all. The **absorption spectrum** of intact leaves differs from that of free chlorophyll in solution, and leaves absorb a significant portion of the radiation in regions where chlorophyll absorbs very little in vitro (Fig. 2). This is due to (1) the modification of the absorption spectra of the chlorophyll molecules bound in protein complexes in vivo, (2) the presence of accessory pigments, such as carotenoids, in the chloroplast, and, most importantly, (3) light scattering within the leaf (Sect. 3.2.2).

2.1.2 Fate of the Excited Chlorophyll

Each quantum of red light absorbed by a chlorophyll molecule raises an electron from a ground state to an excited state. Absorption of light of shorter wavelengths (e.g., blue light) excites the chlorophyll to an even higher energy state. In the

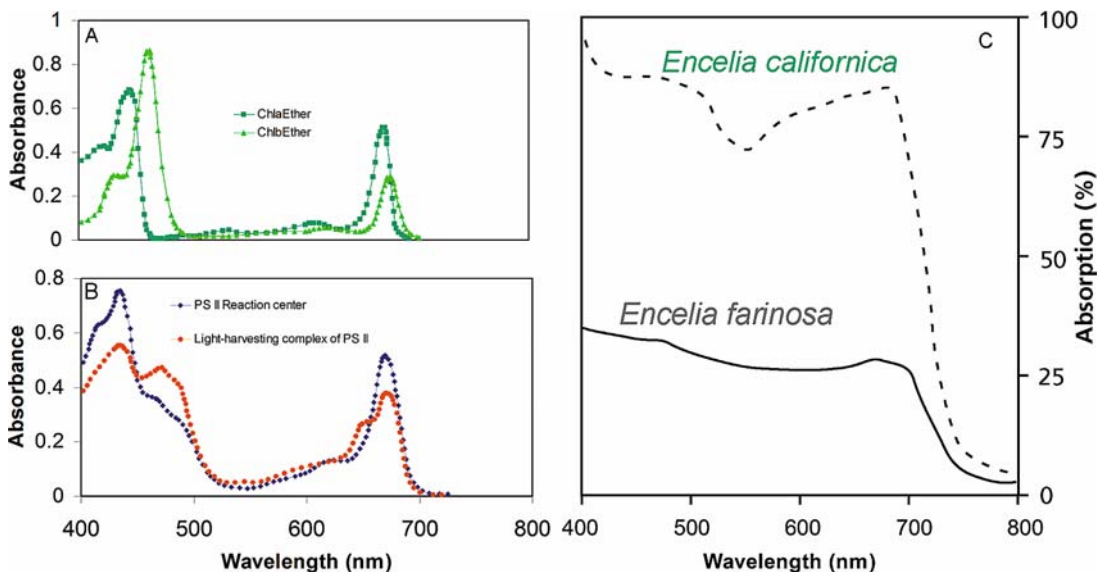

FIGURE 2. (A) The relative absorbance spectrum of chlorophyll *a* and chlorophyll *b*; absorbance = $-\log$ (transmitted light/incident light); (B) The relative absorbance spectrum of pigment-protein complexes: PS II reaction centre and PS II light-harvesting complex; (courtesy J.R. Evans, Research School of Biological Sciences, Australian National University, Canberra, Australia.

(C) Light absorption of an intact green leaf of *Encelia californica*; for comparison the absorption spectrum of an intact white (pubescent) leaf of *Encelia farinosa* (brittlebush) is also given. From Ehleringer et al. (1976), *Science* 227: 1479–1481. Reprinted with kind permission from AAS.

higher energy state after absorption of blue light, however, chlorophyll is unstable and rapidly gives up some of its energy to the surroundings as heat, so that the elevated electron immediately falls back into the orbit of the electron excited by red light. Thus, whatever the wavelength of the light absorbed, chlorophyll reaches the same excitation state upon photon capture. In this excitation state, chlorophyll is stable for 10^{-9} seconds, after which it disposes of its available energy in one of three ways (Krause & Weis 1991):

1. The primary pathway of excitation energy is its highly efficient transfer to other chlorophyll molecules, and ultimately to the reaction center where it is used in **photochemistry**, driving biochemical reactions.
2. The excited chlorophyll can also return to its ground state by converting its excitation energy into **heat**. In this process no photon is emitted.
3. The excited chlorophyll can emit a photon and thereby return to its ground state; this process is called **fluorescence**. Most fluorescence is emitted by chl *a* of PS II. The wavelength of fluorescence is slightly longer than that of the absorbed light, because a portion of the excitation energy is lost before the fluorescence photon is emitted. Chlorophylls usually fluoresce in the red; it is a deeper red (the wavelength is about 10 nm longer) than the red absorption peak of chlorophyll. Fluorescence increases when photochemistry and/or dissipation are low relative to photon absorption, but the process is not regulated as such. This can occur under conditions of excessive light, severely limiting CO₂ supply, or stresses that inhibit photochemistry.

The primary photochemical reactions of PS II and PS I occur at a much faster rate than subsequent electron transport (Sect. 2.1.3), which in turn occurs faster than carbon reduction processes (Sect. 2.1.4). Since the three compartments of the photosynthetic apparatus operate in series, they are each tightly regulated to coordinate their activity under changing conditions.

2.1.3 Membrane-Bound Photosynthetic Electron Transport and Bioenergetics

The excitation energy captured by the pigments is transferred to the reaction centers of PS I and PS II. PS I and PS II are associated with different regions of the thylakoid membrane. PS I is located in the stroma-exposed “**unappressed**” regions, and PS II is largely associated with the “**appressed**” regions

where thylakoids border other thylakoids (grana) (Fig. 1). In PS II an electron, derived from the splitting of water into O₂ and protons, is transferred to pheophytin, and then to plastoquinone (Q_A, bound to D2 protein, a one-electron carrier), followed by transfer to Q_B (bound to D1 protein, a two-electron carrier), and then to free plastoquinone. Plastoquinone (PQ) is subsequently reduced and transported to the cytochrome b/f complex. In the process protons are transported across the membrane into the thylakoid lumen (Fig. 3). The two sources of protons acidify and charge the thylakoid lumen positively. The **electrochemical potential gradient** across the thylakoid membrane, representing a **proton-motive force**, is subsequently used to phosphorylate ADP, thus producing ATP. This reaction is catalyzed by an ATPase, or coupling factor, located in the stroma-exposed, unappressed regions of the thylakoids. In **linear electron transport**, electrons are transferred from the cytochrome b/f complex to PS I through plastocyanin (PC) that migrates through the thylakoid lumen. NADP is reduced by ferredoxin as the terminal acceptor of electrons from PS I which results in formation of NADPH. In **cyclic electron transport**, electrons are transferred from PS I back to cytochrome b/f through plastoquinone, thus contributing to proton extrusion in the lumen and subsequent ATP synthesis. NADPH and ATP are used in the carbon-reduction cycle that is located in the stroma. Linear electron transport is the principal pathway, whereas the engagement of cyclic electron transport is tuned to the demand for ATP relative to NADPH. Other components of the photosynthetic membrane are also regulated, particularly with respect to the prevailing light conditions.

2.1.4 Photosynthetic Carbon Reduction

Ribulose-1,5-bisphosphate (RuBP) and CO₂ are the substrates for the principal enzyme of the carbon-reduction or Calvin cycle: ribulose-1,5-bisphosphate carboxylase/oxygenase (**Rubisco**) (Fig. 4). The first product of carboxylation of RuBP by Rubisco is phosphoglyceric acid (PGA) a compound with three carbon atoms, hence, the name **C₃ photosynthesis**. With the consumption of the ATP and NADPH produced in the light reactions, PGA is reduced to a triose-phosphate (triose-P), some of which is exported to the cytosol in exchange for inorganic phosphate (P_i). In the cytosol, triose-P is used to produce sucrose and other metabolites that are exported via the phloem or used in the leaves. Most of the triose-P remaining in the chloroplast is used to regenerate RuBP through a series of

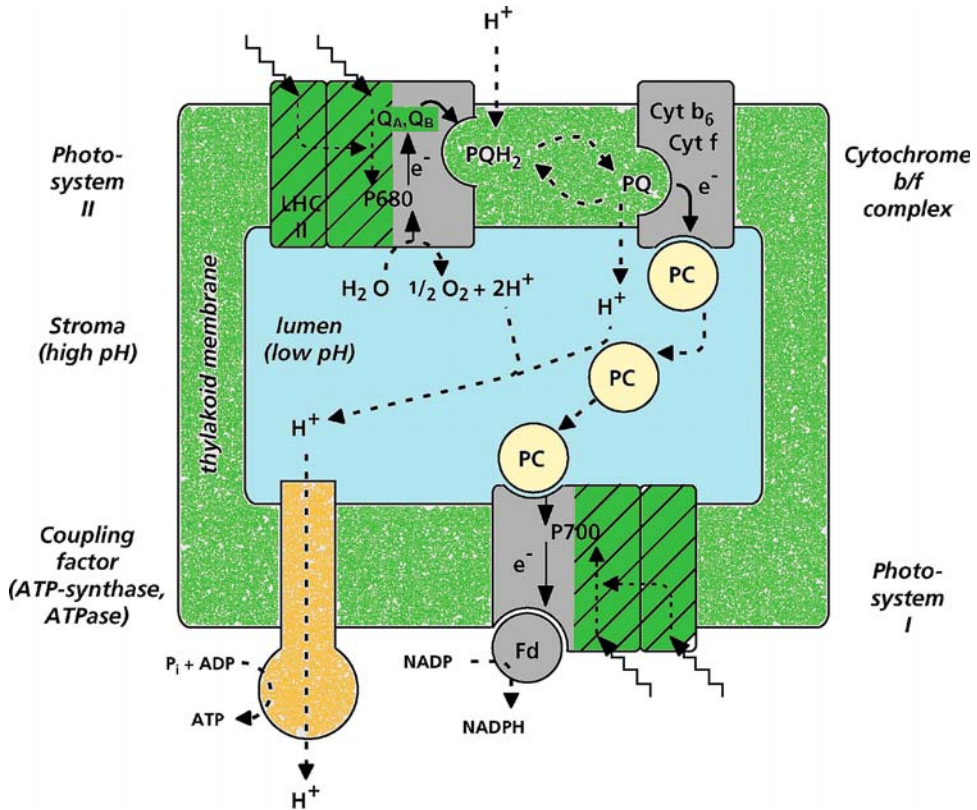

FIGURE 3. Schematic representation of the thylakoid membrane, enclosing the thylakoid lumen, showing the transfer of excitation energy and of electrons, migration of molecules and chemical reactions. P₇₀₀: reaction

center of photosystem I; P₆₈₀: reaction center of photosystem II; LHC: light-harvesting complex; Q: quinones; PC, plastocyanin; Fd: ferredoxin; cyt: cytochromes.

reactions that are part of the **Calvin cycle** in which ATP and NADPH are consumed (Fig. 4). About 1/6 of the triose-P remaining in the chloroplast is used to produce **starch**, which is stored inside the chloroplast, or is **exported**. During the night, starch may be hydrolyzed, and the product of this reaction, triose-P, is exported to the cytosol. The photosynthetic carbon-reduction cycle has various control points and factors that function as stabilizing mechanisms under changing environmental conditions.

2.1.5 Oxygenation and Photorespiration

Rubisco catalyzes not only the **carboxylation** of RuBP, but also its **oxygenation** (Fig. 5). The ratio of the carboxylation and the oxygenation reaction strongly depends on the relative concentrations of CO₂ and O₂ and on leaf temperature. The products of the carboxylation reaction are two C₃ molecules (PGA), whereas the oxygenation reaction produces only one PGA and one C₂ molecule:

phosphoglycolate. This C₂ molecule is first dephosphorylated in the chloroplast, producing glycolate (Fig. 5), which is exported to the peroxisomes, where it is metabolized to glyoxylate and then **glycine**. Glycine is exported to the mitochondria where two molecules are converted to produce one serine with the release of one molecule of CO₂ and one NH₃. Serine is exported back to the peroxisomes, where a transamination occurs, producing one molecule of hydroxypyruvate and then glycerate. Glycerate moves back to the chloroplast, to be converted into PGA. So, out of two phosphoglycolate molecules one glycerate is made and one C-atom is lost as CO₂. The entire process, starting with the oxygenation reaction, is called **photorespiration**, as it consumes O₂ and releases CO₂; it depends on light, or, more precisely, on photosynthetic activity. The process is distinct from “dark respiration” that largely consists of mitochondrial decarboxylation processes that proceed independent of light. Dark respiration is discussed in Chapter 2B on respiration.

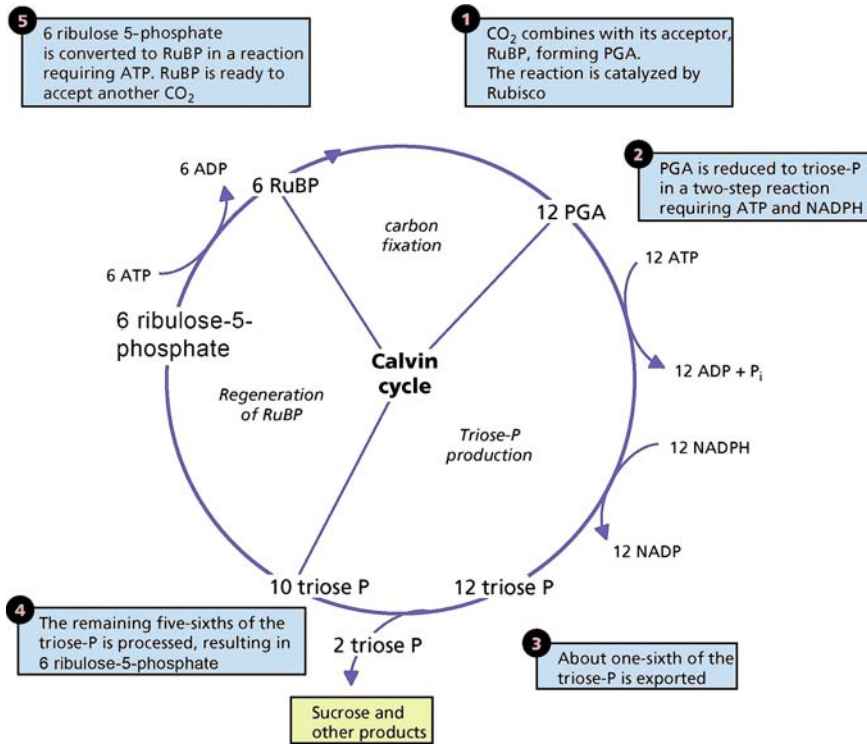

FIGURE 4. Schematic representation of the photosynthetic carbon reduction cycle (Calvin cycle) showing major steps: carbon fixation, triose-P production and regeneration of RuBP. 1: CO₂ combines with its substrate, ribulose-1,5-bisphosphate (RuBP), catalyzed by ribulose biphosphate carboxylase/oxygenase (Rubisco), producing phosphoglyceric acid (PGA). 2: PGA is reduced to triose-phosphate (triose-P), in a

two-step reaction; the reaction for which ATP is required is the conversion of PGA to 1,3-bisphosphoglycerate, catalyzed by phosphoglycerate kinase. 3 and 4: Part of the triose-P is exported to the cytosol, in exchange for P_i; the remainder is used to regenerate ribulose-1-monophosphate. 5: ribulose-1-monophosphate is phosphorylated, catalyzed by ribulose-5-phosphate kinase, producing RuBP.

2.2 Supply and Demand of CO₂ in the Photosynthetic Process

The rate of photosynthetic carbon assimilation is determined by both the supply and demand for CO₂. The **supply** of CO₂ to the chloroplast is governed by diffusion in the gas and liquid phases and can be limited at several points in the pathway from the air surrounding the leaf to the site of carboxylation inside. The **demand** for CO₂ is determined by the rate of processing the CO₂ in the chloroplast which is governed by the structure and biochemistry of the chloroplast (Sect. 2.1), by environmental factors such as irradiance, and factors that affect plant demand for carbohydrates (Sect. 4.2). Limitations imposed by either supply or demand can determine the overall rate of carbon assimilation, as explained below.

2.2.1 Demand for CO₂—the CO₂-Response Curve

The response of photosynthetic rate to CO₂ concentration is the principal tool to analyze the demand for CO₂ and partition the limitations imposed by demand and supply (Warren 2007, Flexas et al. 2008) (Fig. 6). The graph giving net CO₂ assimilation (A_n) as a function of CO₂ concentration at the site of Rubisco in the chloroplast (C_c) is referred to as the **A_n - C_c curve**. With rising CO₂, there is no net CO₂ assimilation, until the production of CO₂ in respiration (mainly photorespiration, but also some dark respiration occurring in the light) is fully compensated by the fixation of CO₂ in photosynthesis. The CO₂ concentration at which this is reached is the **CO₂-compensation point** (Γ). In C₃ plants this is largely determined by the kinetic properties of Rubisco,

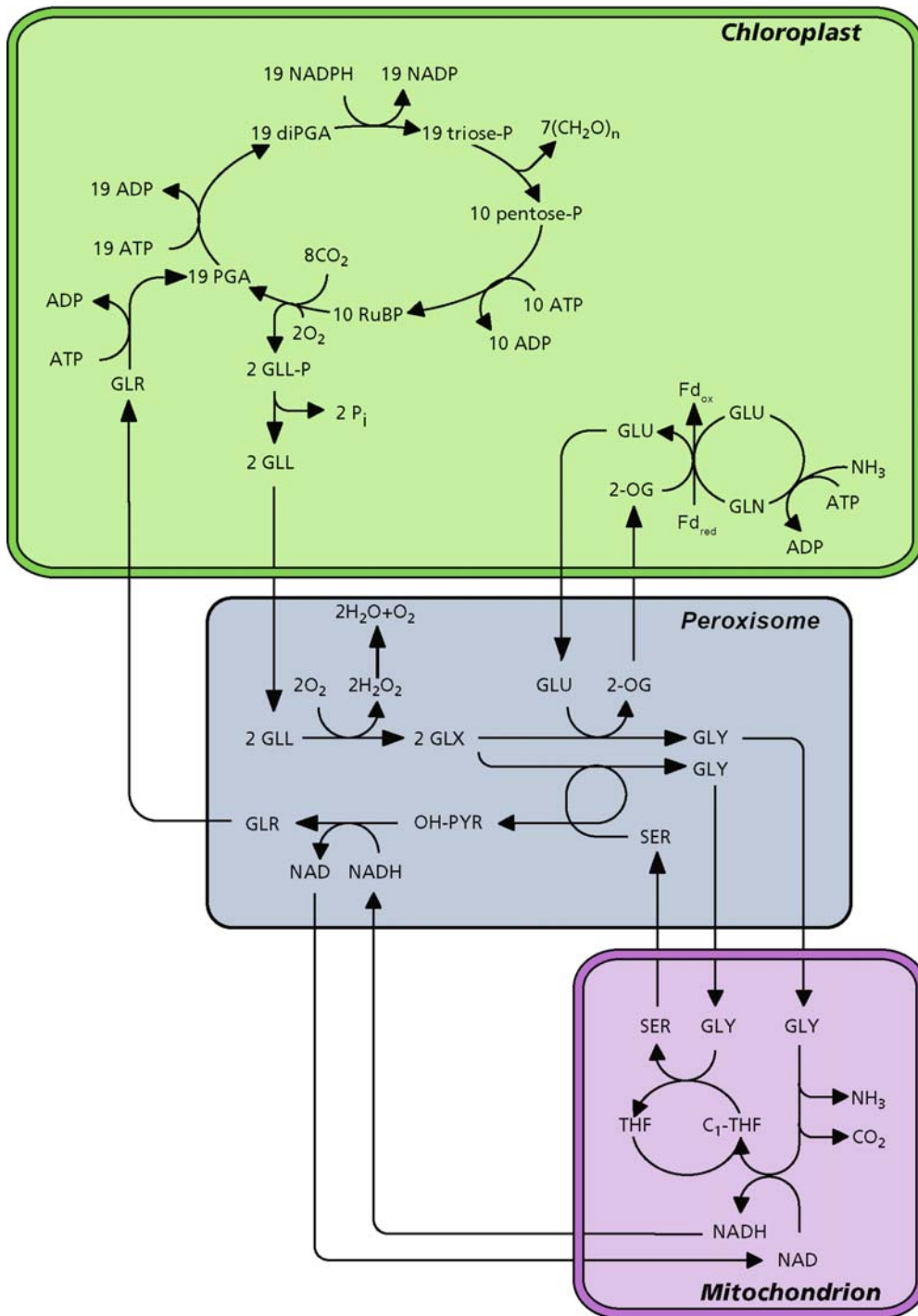

FIGURE 5. Reactions and organelles involved in photorespiration. In C₃ plants, at 20% O₂, 0.035% CO₂, and 20°C, two out of ten RuBP molecules are oxygenated, rather than carboxylated. The oxygenation reaction produces phosphoglycolate (GLL-P), which is dephosphorylated to glycolate (GLL). Glycolate is subsequently metabolized in peroxisomes and mitochondria, in which glyoxylate

(GLX) and the amino acids glycine (GLY) and serine (SER) play a role. Serine is exported from the mitochondria and converted to hydroxypyruvate (OH-PYR) and then glycylate (GLR) in the peroxisomes, after which it returns to the chloroplast (after Ogren 1984). Reprinted with kind permission from the Annual Review of Plant Physiology, Vol. 35, copyright 1984, by Annual Reviews Inc.

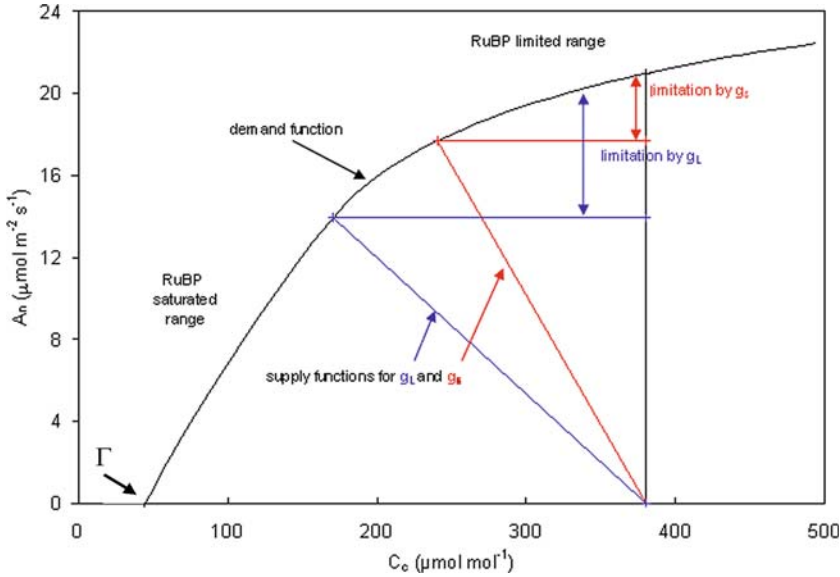

FIGURE 6. The relationship between the rate of net CO_2 assimilation (A_n) and the CO_2 concentration at the site of Rubisco in the chloroplasts (C_c) for a C_3 leaf: the “demand function”. The concentration at which $A_n = 0$ is the CO_2 -compensation point (Γ). The rate of diffusion of CO_2 from the atmosphere to the intercellular spaces and to Rubisco in the chloroplast is given by the “supply functions” (the red and blue lines). The slopes of these lines are the leaf conductance (g_L) and mesophyll

conductance (g_m), respectively. The intersection of the “supply functions” with the “demand function” is the actual rate of net CO_2 assimilation at a value of C_i and C_c that occurs in the leaf intercellular spaces (C_i) and at the site of Rubisco (C_c) for C_a in normal air (indicated by the vertical line). The difference in A_n described by the demand function and the two horizontal lines depicts the degree of limitation imposed by the mesophyll resistance and leaf resistance.

with values for Γ in the range $40\text{--}50 \mu\text{mol} (\text{CO}_2) \text{mol}^{-1}$ (air) (at 25°C and atmospheric pressure).

Two regions of the CO_2 -response curve above the compensation point can be distinguished. At low C_c , that is below values normally found in leaves (approximately $165 \mu\text{mol mol}^{-1}$), photosynthesis increases steeply with increasing CO_2 concentration. This is the region where CO_2 limits the rate of functioning of Rubisco, whereas RuBP is present in saturating quantities (**RuBP-saturated** or **CO_2 -limited region**). This part of the A_n - C_c relationship is also referred to as the **initial slope** or the **carboxylation efficiency**. At light saturation and with a fully activated enzyme (Sect. 3.4.2 for details on “activation”), the initial slope governs the carboxylation capacity of the leaf which in turn depends on the amount of active Rubisco.

In the region at high C_c , the increase in A_n with increasing C_c levels off. CO_2 no longer restricts the carboxylation reaction, but now the rate at which RuBP becomes available limits the activity of Rubisco (**RuBP-limited region**). This rate, in turn, depends on the activity of the Calvin cycle, which ultimately depends on the rate at which ATP and

NADPH are produced in the light reactions; in this region, photosynthetic rates are limited by the rate of electron transport. This may be due to limitation by light or, at light saturation, by a limited capacity of electron transport (Box 2A.1). Even at a high C_c , in the region where the rate of electron transport, J , no longer increases with increasing C_c , the rate of net CO_2 assimilation continues to increase slightly, because the oxygenation reaction of Rubisco is increasingly suppressed with increasing CO_2 concentration, in favor of the carboxylation reaction. At a normal atmospheric concentration of CO_2 (C_a) and O_2 (ca. 380 and $210000 \mu\text{mol mol}^{-1}$, respectively) and at a temperature of 20°C , the ratio between the carboxylation and oxygenation reaction is about 4:1. How exactly this ratio and various other parameters of the A_n - C_c curve can be assessed is further explained in Box 2A.1. Typically, plants operate at a C_c where **CO_2 and electron transport co-limit** the rate of CO_2 assimilation (i.e., the point where the Rubisco-limited/RuBP-saturated and the RuBP-limited part of the CO_2 -response curve intersect). This allows effective utilization of all components of the light and dark reactions.

Box 2A.1 Modeling C₃ Photosynthesis

Based on known biochemical characteristics of Rubisco and the requirement of NADPH₂ and ATP for CO₂ assimilation, Farquhar et al. (1980) developed a model of photosynthesis in C₃ plants. This model was recently updated, based on the CO₂ concentration in the chloroplast (C_c) rather than the intercellular CO₂ concentration (C_i) (Sharkey et al. 2007). It is widely used in ecophysiological research and more recently also in global change modeling. The model elegantly demonstrates that basic principles of the biochemistry of photosynthesis explain physiological properties of photosynthesis of intact leaves.

Net CO₂ assimilation (A_n) is the result of the rate of carboxylation (V_c) minus photorespiration and other respiratory processes. In photorespiration, one CO₂ molecule is produced per two oxygenation reactions (V_o) (Fig. 5). The rate of dark respiration during photosynthesis may differ from dark respiration at night, and is called “day respiration” (R_{day}):

$$A_n = V_c - 0.5V_o - R_{day} \quad (1)$$

CO₂-limited and O₂-limited rates of carboxylation and oxygenation are described with standard Michaelis–Menten kinetics. When both substrates are present, however, they competi-

tively inhibit each other. An effective Michaelis–Menten constant for the carboxylation reaction (K_m) that takes into account competitive inhibition by O₂ is described as

$$K_m = K_c(1 + O/K_o) \quad (2)$$

where K_c and K_o are the Michaelis–Menten constants for the carboxylation and oxygenation reaction, respectively, and O is the oxygen concentration.

The rate of carboxylation in the CO₂-limited part of the CO₂-response curve (Fig. 1) can then be described as

$$V_c = \frac{V_{cmax} \cdot C_c}{C_c + K_m} \quad (3)$$

where V_{cmax} is the rate of CO₂ assimilation at saturating C_c (note that the subscript “max” refers to the rate at saturating C_c).

The ratio of oxygenation and carboxylation depends on the specificity of Rubisco for CO₂ relative to O₂ (S_{c/o}) which varies widely among photosynthetic organisms (Von Caemmerer 2000), but much less so among C₃ higher plants (Galmés et al. 2005). Increasing temperature, however, decreases the specificity, because K_o decreases faster with increasing temperature than K_c does (Fig. 35).

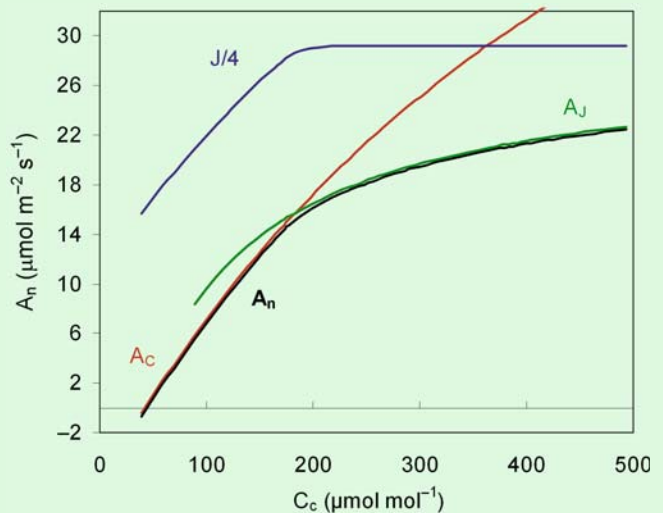

FIGURE 1. The response of net photosynthesis (A_n) to the CO₂ concentration in the chloroplast (C_c) at 25°C and light saturation (solid black line). Calculations were made as explained in the text, with values for V_{cmax}, J_{max}, and R_{day} of 90, 117, and 1 μmol m⁻² s⁻¹, respectively. The lower part of the A_n-C_c relationship (A_c; red line) is limited by the carboxylation capacity (V_{cmax}) and the upper part (A_j; green line) by the electron-transport capacity (J_{max}; blue line). The rate of electron transport (J/4; blue line) is also shown.

continued

Box 2A.1 Continued

The CO₂-compensation point in the absence of R_{day} (Γ^*) depends on the specificity factor and the O₂ concentration (O):

$$\Gamma^* = 0.5 \quad O / (S_{c/o} \cdot S_c / S_o) \quad (4)$$

Γ^* increases more strongly with rising temperature than would be expected from the decrease in $S_{c/o}$ because the solubility in water for CO₂ (S_c) decreases more with increasing temperature than does that for O₂ (S_o). Γ^* shows little variation among C₃ angiosperms as follows from the similarity of $S_{c/o}$. Γ^* is determined experimentally and used to calculate the ratio of carboxylation and oxygenation as dependent on CO₂:

$$V_o / V_c = 2\Gamma^* / C_c \quad (5)$$

thus avoiding the need for incorporating the specificity factor and solubilities (Equation 4).

In the RuBP-limited part of the CO₂-response curve (Fig. 1.1), the rate of electron transport (J) is constant. Increasing C_c increases the rate of carboxylation at the expense of the rate of oxygenation. There is a minimum requirement of four electrons per carboxylation or oxygenation reaction. Hence, the minimum electron transport rate (J) required for particular rates of carboxylation and oxygenation is

$$J = 4(V_c + V_o) \quad (6)$$

At light saturation, J is limited by the capacity of electron transport and is called J_{max} .

Using Equations (5) and (6), the rate of carboxylation can then be expressed as

$$V_c = J / \{4(1 + 2\Gamma^* / C_c)\} \quad (7)$$

The CO₂-limited and RuBP-saturated rate of photosynthesis (A_c) can then be calculated using Equations (1), (3), and (5) as

$$A_c = \frac{V_{\text{cmax}}(C_c - \Gamma^*)}{C_c + K_m} - R_{\text{day}} \quad (8)$$

The RuBP-limited rate of photosynthesis (A_j) can be calculated using Equations (1), (5), and (7) as

$$A_j = \frac{J(C_c - \Gamma^*)}{4(C_c + 2\Gamma^*)} - R_{\text{day}} \quad (9)$$

The minimum of Equations (8) and (9) describes the full CO₂-response curve as shown in Fig. 1.

In the above equations, gas concentrations are expressed as molar fraction (mol mol⁻¹). If required, partial pressure can be converted to molar fraction by dividing it by total air pressure.

The CO₂ conductance for CO₂ diffusion in the mesophyll (g_m) can only be calculated when the concentration in the chloroplast (C_c) is known. g_m can then be calculated from C_i as

$$A_n / g_m = C_i - C_c \quad (10)$$

Information about g_m may not always be available. As an approximation, the same model can be used assuming that $C_c = C_i$. Parameter values specific for that scenario should then be used (see below).

Parameter values for the above equations are normally given for 25°C. Values for other temperatures can be calculated from their temperature dependencies, as described by the generic equation:

$$\text{parameter} = \exp(c - \Delta H_\alpha / RT_L) \quad (11)$$

Where T_L is leaf temperature (K), R is the molar gas constant, c is a dimensionless constant, and ΔH_α is the activation energy (kJ mol⁻¹). Parameter values estimated for *Nicotiana tabacum* (tobacco) for the CO₂ response at 25°C, an atmospheric pressure, of 99.1 kPa, and an infinite ($C_c = C_i$) and a finite g_m , together with the temperature dependencies for the latter scenario (Bernacchi et al. 2001, 2002) are

CO ₂ response parameter	$C_c = C_i$		finite g_m ($C_c < C_i$)	
	at 25°C	at 25°C	c	ΔH_α
Γ^* (μmol mol ⁻¹)	42.75	37.43	19.02	24.46
K_c (μmol mol ⁻¹)	404.9	272.4	38.28	80.99
K_o (mmol mol ⁻¹)	278.4	165.8	14.68	23.72

Temperature dependencies of model parameters describing the rates of metabolic processes that are leaf specific (J_{max} , V_{max} , R_{day}) are calculated in a similar manner, but Equation (11) must then be multiplied by the rates at 25°C. For constants and activation energies, see Bernacchi et al. (2001, 2003).

continued

Box 2A.1 Continued

Values of C_c depend on the balance between supply and demand for CO_2 . The demand function is described above; the supply function is described in Sect. 2.2.2. Electron-transport rates depend on irradiance (Sect. 3.2.1), where the

equation describing net CO_2 assimilation as a function of irradiance can be used to calculate J by substituting J and J_{\max} for A_n and A_{\max} , respectively. A combination of these mathematical equations makes it possible to model C_3 photosynthesis over a wide range of environmental conditions.

2.2.2 Supply of CO_2 —Stomatal and Boundary Layer Conductances

The supply of CO_2 by way of its diffusion from the surrounding atmosphere to the intercellular spaces (this CO_2 concentration is denoted as C_i) and to the site of carboxylation in the chloroplasts (this CO_2 concentration is described as C_c) represents a limitation for the rate of photosynthesis. The magnitude of the limitation can be read from the A_n - C_c curve as the difference in photosynthetic rate at C_a and C_i and C_c , respectively (Fig. 6). To analyze diffusion limitations it is convenient to use the term **resistance**, because resistances can be summed to arrive at the total resistance for the pathway. When considering fluxes, however, it is more convenient to use **conductance**, which is the reciprocal of resistance, because the flux varies in proportion to the conductance.

In a steady state, the rate of net CO_2 assimilation (A_n) equals the rate of CO_2 diffusion into the leaf. The rate of CO_2 diffusion can be described by **Fick's first law**. Hence:

$$A_n = g_c(C_a - C_c) = (C_a - C_c)/r_c \quad (1)$$

where, g_c is the leaf conductance for CO_2 transport; C_a and C_c are the mole or volume fractions of CO_2 in air at the site of carboxylation and in air, respectively; r_c is the inverse of g_c (i.e., the leaf resistance for CO_2 transport).

The leaf conductance for CO_2 transport, g_c , can be derived from measurements on leaf transpiration, which can also be described by Fick's first law in a similar way:

$$E = g_w(w_i - w_a) = (w_i - w_a)r_w \quad (2)$$

where g_w is the leaf conductance for water vapor transport; w_i and w_a are the mole or volume fractions of water vapor in air in the intercellular spaces and in air, respectively; r_w is the inverse of g_w (i.e., the leaf resistance for water vapor transport); and E is the rate of leaf transpiration. E can be measured directly. The water vapor concentration in the leaf can be calculated from measurements of the leaf's

temperature, assuming a saturated water vapor pressure inside the leaf. Under most conditions this is a valid assumption. Therefore, the leaf conductance for water vapor transport can be determined.

The total leaf resistance for water vapor transfer, r_w is largely composed of two components that are in series: the **boundary layer resistance**, r_a , and the **stomatal resistance**, r_s . The boundary layer is the thin layer of air adjacent to the leaf that is modified by the leaf (Fig. 6 in Chapter 4A on the plant's energy balance). Turbulence is greatly reduced there, and transport is largely via diffusion. Its limit is commonly defined as the point at which the properties of the air are 99% of the values in ambient air. The boundary layer resistance can be estimated by measuring the rate of evaporation from a water-saturated piece of filter paper of exactly the same shape and size as that of the leaf. Conditions that affect the boundary layer, such as wind speed, should be identical to those during measurements of the leaf resistance. The stomatal resistance for water vapor transfer (r_s) can now be calculated since r_w and r_a are known:

$$r_w = r_a + r_s \quad (3)$$

The resistance for CO_2 transport (r_c) across boundary layer and stomata can be calculated from r_w taking into account that the diffusion coefficients of the two molecules differ. The ratio H_2O diffusion/ CO_2 diffusion in air is approximately 1.6, because water is smaller and diffuses more rapidly than CO_2 . This value pertains only to the movement of CO_2 inside the leaf air spaces and through the stomata. For the boundary layer above the leaf, where both turbulence and diffusion influence flux, the ratio is approximately 1.37.

$$r_c = (r_a \cdot 1.37) + (r_s \cdot 1.6) = 1/g_c \quad (4)$$

C_i can now be calculated from Equation (1), after substitution of C_i for C_c . If calculated according to this, C_i is the CO_2 concentration at the point where evaporation occurs inside the leaf (i.e., largely the mesophyll cell walls bordering the substomatal

cavity), but higher than C_c , the CO_2 concentration at the point where Rubisco assimilates CO_2 (Sect. 2.2.3).

In C_3 plants, C_i is generally maintained at around $250 \mu\text{mol mol}^{-1}$, but may increase to higher values at a low irradiance and higher humidity of the air, and decrease to lower values at high irradiance, low water availability, and low air humidity. For C_4 plants, C_i is around $100 \mu\text{mol mol}^{-1}$ (Osmond et al. 1982).

Under most conditions, the stomatal conductance is considerably less than the boundary layer conductance (g_a is up to $10 \text{ mol m}^{-2} \text{ s}^{-1}$, at wind speeds of up to 5 m s^{-1} ; g_s has values of up to $1 \text{ mol m}^{-2} \text{ s}^{-1}$ at high stomatal density and widely open stomata), so that stomatal conductance strongly influences CO_2 diffusion into the leaf. For large leaves in still humid air, where the boundary layer is thick, however, the situation is opposite.

2.2.3 The Mesophyll Conductance

For the transport of CO_2 from the substomatal cavity to the chloroplast, a **mesophyll conductance** (also called **internal conductance**), g_m (or resistance, r_m)

should be considered. Hence, we can describe the net rate of net CO_2 assimilation by

$$A_n = (C_a - C_c)/(r_a + r_s + r_m) \quad (5)$$

Until fairly recently, the mesophyll conductance has been assumed to be large and has often been ignored in analyses of gas-exchange measurements. However, recent evidence shows that this is not justified (Warren 2007, Flexas et al. 2008). In addition, we have come to realize that g_m changes with environmental conditions, and often quite rapidly, compared with changes in stomatal conductance (Flexas et al. 2007a, Warren 2007).

Two types of measurements are commonly employed for the estimation of C_c , which is subsequently used to calculate g_m . **Carbon-isotope fractionation** (Box 2A.2) during gas exchange, and simultaneous measurement of **chlorophyll fluorescence** and gas exchange. The two methods rely on a number of assumptions that are largely independent, but they yield similar results (Evans & Loreto 2000). From the estimates made so far, it appears that g_m is of similar magnitude as g_s ; whilst g_m is generally somewhat higher, the opposite can also be observed (Galmés et al. 2007). Consequently, C_c is

Box 2A.2 Fractionation of Carbon Isotopes in Plants

CO_2 in the Earth's atmosphere is composed of different carbon isotopes. The majority is $^{12}\text{CO}_2$; approximately 1% of the total amount of CO_2 in the atmosphere is $^{13}\text{CO}_2$; a much smaller fraction is the radioactive species $^{14}\text{CO}_2$ (which will not be dealt with in the present context). Modern ecophysiological research makes abundant use of the fact that the isotope composition of plant biomass differs from that of the atmosphere. Carbon isotopes are a crucial tool in estimating time-integrated measures of photosynthetic performance of individual plants or plant communities, information that would be difficult or impossible to obtain from direct physiological measurements. It is of special interest that carbon-isotope composition differs among plants that differ in photosynthetic pathway or water-use efficiency. How can we account for that?

The molar abundance ratio, R , of the two carbon isotopes is the ratio between ^{13}C and ^{12}C . The

constants K^{12} and K^{13} refer to the rate of processes and reactions in which ^{12}C and ^{13}C participate, respectively. The "isotope effect" is described as

$$R_{\text{source}}/R_{\text{product}} = k^{12}/k^{13} \quad (1)$$

For plants, the isotope effect is, to a small extent, due to the slower diffusion in air of $^{13}\text{CO}_2$, when compared with that of the lighter isotope $^{12}\text{CO}_2$ (1.0044 times slower; during diffusion in water, there is little fractionation) (Table 1). The isotope effect is largely due to the biochemical properties of Rubisco, which reacts more readily with $^{12}\text{CO}_2$ than it does with $^{13}\text{CO}_2$. As a result, Rubisco discriminates against the heavy isotope. For Rubisco from *Spinacia oleracea* (spinach), the discrimination is 30.3%, whereas smaller values are found for this enzyme from bacteria (Guy et al. 1993).

continued

Box 2A.2 Continued

TABLE 1. The magnitude of fractionation during CO₂ uptake.

Process or enzyme	Fractionation (%)
Diffusion in air	4.4
Diffusion through the boundary layer	2.9
Dissolution of CO ₂	1.1
Diffusion of aqueous CO ₂	0.7
CO ₂ and HCO ₃ ⁻ in equilibrium	-8.5 at 30°C -9.0 at 25°C
CO ₂ - HCO ₃ ⁻ catalyzed by carbonic anhydrase	1.1 at 25°C
HCO ₃ ⁻ - CO ₂ in water, catalyzed by carbonic anhydrase	10.1 at 25°C
PEP carboxylase	2.2
Combined process	-5.2 at 30°C -5.7 at 25°C
Rubisco	30 at 25°C

Source: Henderson et al. 1992.

On the path from intercellular spaces to Rubisco a number of additional steps take place, where some isotope fractionation can occur. Taken together, the isotope effect in C₃ plants is approximated by the empirical equation (Farquhar et al. 1982):

$$R_a/R_p = 1.0044 [(C_a - C_i)/C_a] + 1.027 C_i/C_a \quad (2)$$

where R_a and R_p are the molar abundance ratios of the atmospheric CO₂ and of the C fixed by the plant, respectively; the symbols C_a and C_i are the atmospheric and the intercellular partial pressure of CO₂, respectively. The value 1.027 is an empirical value, incorporating the major fractionation by Rubisco, as well as accounting for the internal diffusion resistance for CO₂ (g_m).

Since values for R_a/R_p appear rather "clumsy," data are commonly expressed as fractionation values, Δ ("capital delta"), defined as $(R_a/R_p - 1) \times 1000$, or:

$$\begin{aligned} \Delta &= [(1.0044 C_a - 1.0044 C_i + 1.027 C_i)/C_a] - 1 \\ &= [(1.0044 C_a + 0.0226 C_i)/C_a] - 1 \\ &= (4.4 + 22.6 C_i/C_a) \times 10^{-3} \end{aligned} \quad (3)$$

The isotope composition is described as $\delta^{13}\text{C}$ ("lower case delta"):

$$\delta^{13}\text{C} (\text{‰}) = (R_{\text{sample}}/R_{\text{standard}} - 1) \cdot 1000 \quad (4)$$

Values for $\Delta^{13}\text{C}$ and $\delta^{13}\text{C}$ are related as

$$\Delta = (\delta_{\text{source}} - \delta_{\text{plant}}) / (1 + \delta_{\text{plant}}) \quad (5)$$

where $\delta_{\text{source}} \cong -8\%$ if the source is air (δ_{air} (to be entered as -0.008 in Equation (5)); a δ_{plant} value of -27% , therefore, converts to a Δ value of 19.5%). The standard is a cretaceous limestone consisting mostly of the fossil carbonate skeletons of *Belemnitella americana* (referred to as PDB-belemnite). By definition, it has a $\delta^{13}\text{C}$ value equal to 0% . Plant $\delta^{13}\text{C}$ values are negative, because they are depleted in ^{13}C compared with the fossil standard. Diffusion and carboxylation discriminate against $^{13}\text{CO}_2$; δ -values for C₃ plants are approx. -27% , showing that Rubisco is the predominant factor accounting for the observed values and that diffusion is less important.

For C₄ plants, the following empirical equation has been derived:

$$\Delta = 4.4 + [-5.7 + (30 - 1.8)\phi - 4.4] C_i/C_a \quad (6)$$

where ϕ refers to the leakage of CO₂ from the bundle sheath to the mesophyll.

Where do these equations lead us? Within C₃ plants the $\delta^{13}\text{C}$ of whole-plant biomass gives a better indication of C_i over a longer time interval than can readily be obtained from gas-exchange measurements. The value of C_i in itself is a reflection of stomatal conductance (g_s), relative to photosynthetic activity (A). As such, $\delta^{13}\text{C}$ provides information on a plant's water-use efficiency (WUE) (Sect. 5.2). How do we arrive there? As can be derived from Equation (3), the extent of the fractionation of carbon isotopes depends on the intercellular partial pressures of CO₂, relative to that in the atmosphere. If C_i is high, g_s is large relative to A , and much of the $^{13}\text{CO}_2$ discriminated against by Rubisco diffuses back to the atmosphere; hence the fractionation is large. If C_i is low, then relatively more of the accumulated $^{13}\text{CO}_2$ is fixed by Rubisco, and therefore the fractionation of the overall photosynthesis process is less. Comparison of WUE calculated on the basis of $\delta^{13}\text{C}$ is only valid at constant vapor pressure difference (Δw) and is called intrinsic WUE (A/g_s).

continued

Box 2A.2 Continued

Under many situations $\delta^{13}\text{C}$ is a good proxy for WUE and it can be used for, e.g., paleoclimatic studies and genetic screening for drought-tolerant varieties. However, under conditions where Δw varies or g_s and g_m are not strongly correlated, $\delta^{13}\text{C}$ may not be a good predictor of WUE.

Carbon-isotope fractionation values differ between C_3 , C_4 , and CAM species (Sects. 9 and 10). In C_4 plants, little of the $^{13}\text{CO}_2$ that is discriminated against by Rubisco diffuses back to the atmosphere. This is prevented, first, by the diffusion barrier between the vascular bundle sheath and the mesophyll cells. Second, the mesophyll cells contain PEP carboxylase, which scavenges most of the CO_2 that escapes from the bundle sheath (Table 1). Fractionation during photosynthesis in C_4 plants is therefore dominated by fractionation during diffusion (4.4%). There is also little fractionation in CAM plants, where the heavy isotopes discriminated against cannot readily diffuse out of the leaves because the stomata are closed for most of the day. The actual $\delta^{13}\text{C}$ of CAM plant biomass depends on the fractions of the carbon fixed by CAM and C_3 photosynthesis.

Aquatic plants show relatively little fractionation, due to unstirred layers surrounding the leaf, rather than to a different photosynthetic pathway (Sect. 11.6). The unstirred boundary layers cause diffusion to be a major limitation for their photosynthesis, so that fractionation in these

plants tends toward the value found for the diffusion process (Fig. 1).

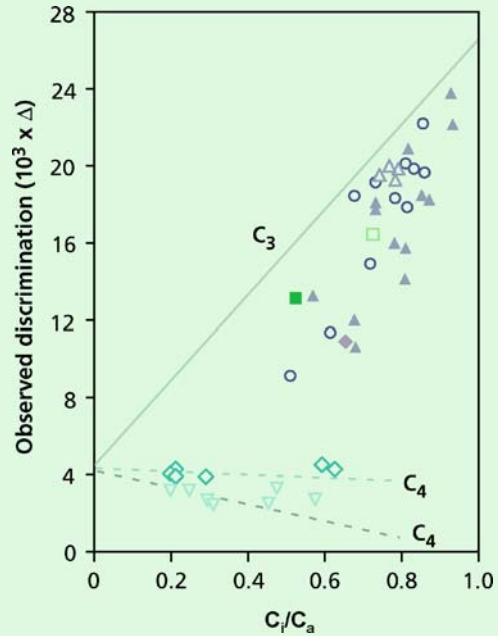

FIGURE 1. The relationship between the ratio of the internal and the atmospheric CO_2 concentration, at a constant C_a of $340 \mu\text{mol mol}^{-1}$. Data for both C_3 and C_4 species are presented; the lines are drawn on the basis of a number of assumptions, relating to the extent of leakage of CO_2 from the bundle sheath back to the mesophyll (Evans et al. 1986, *Australian Journal of Plant Physiology* 13: 281–292). Copyright CSIRO, Australia.

substantially lower than C_i (the CO_2 concentration in the intercellular spaces); a difference of about $80 \mu\text{mol mol}^{-1}$ is common, as compared with $C_a - C_i$ of about $100 \mu\text{mol mol}^{-1}$. The mesophyll conductance varies widely among species and correlates with the photosynthetic capacity (A_{max}) of the leaf (Fig. 7). Interestingly, the relationship between mesophyll conductance and photosynthesis is rather similar for scleromorphic and mesophytic leaves, but scleromorphs tend to have a somewhat larger draw-down of CO_2 between intercellular space and chloroplast ($C_i - C_c$) (Warren & Adams 2006).

The mesophyll conductance is a complicated trait, involving diffusion of CO_2 in the intercellular spaces in the gas phase, dissolving of CO_2 in the liquid phase, conversion of CO_2 into HCO_3^- catalyzed by carbonic anhydrase, and diffusion in the

liquid phase and across membranes. The resistance in the gas phase is low and is considered as normally not a limiting factor (Bernacchi et al. 2002). Diffusion in the liquid phase is much slower (10^4 times less), and the path length is minimized by chloroplast position against the cell wall opposite intercellular spaces (Fig. 1). This component likely represents a large fraction of total r_m , and **carbonic anhydrase** is important for minimizing it (Gillon & Yakir 2000). Evidence for an important role for the area of chloroplasts bordering intercellular spaces as a determinant of g_m stems from a positive relationship with this parameter per unit leaf area (Evans & Loreto 2000). Data about a similar parameter, chloroplast area per leaf area, are more widely available and vary by an order of magnitude among species (Table 1) which is likely associated with g_m . There

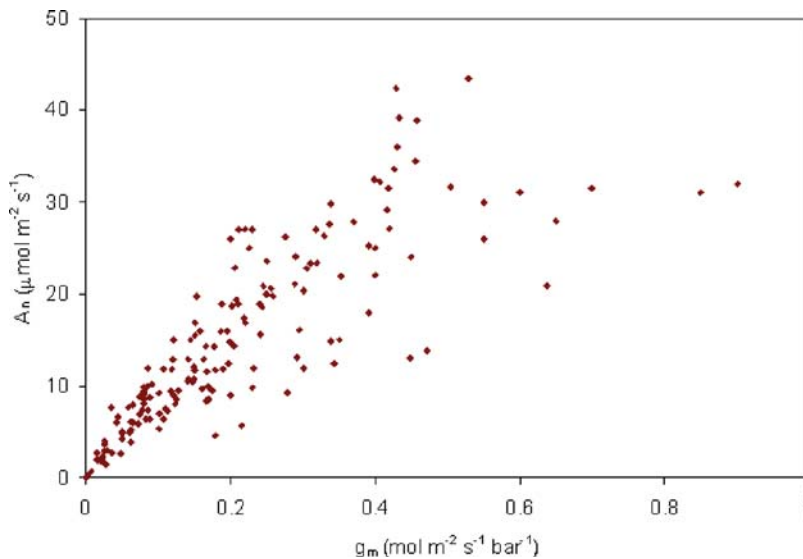

FIGURE 7. The relationship between the rate of photosynthesis (A_n) and maximum mesophyll conductance (g_m), determined for a wide range of species. Values for scleromorphic leaves are at most $0.21 \text{ mol m}^{-2} \text{ s}^{-1} \text{ bar}^{-1}$ (g_m) and $22.9 \text{ } \mu\text{mol m}^{-2} \text{ s}^{-1}$ (A_n), whereas those for mesomorphic leaves span the entire range shown here. The units of conductance as used in this graph differ from those used elsewhere in this text. The reason is

that when CO_2 is dissolving to reach the sites of carboxylation, the amount depends on the partial pressure of CO_2 and conductance has the units used in this graph. For air space conductance the units could be the same as used elsewhere: $\text{mol m}^{-2} \text{ s}^{-1}$, if CO_2 is given as a mole fraction (based on data compiled in Flexas et al. 2008). Courtesy, J. Flexas, Universitat de les Illes Balears, Palma de Mallorca, Balears, Spain.

is evidence that specific **aquaporins** facilitate transport of CO_2 across membranes. Their role in the transport of CO_2 might account for rapid modulation of g_m in response to environmental factors such as temperature, CO_2 , and desiccation (Flexas et al. 2006a). The mesophyll conductance is proportional to chloroplast surface area within a given functional group. The difference in g_m between functional groups is associated with mesophyll cell wall

thickness, which varies from $0.1 \text{ } \mu\text{m}$ in annuals, $0.2\text{--}0.3 \text{ } \mu\text{m}$ in deciduous, broad-leaved species, and $0.3\text{--}0.5 \text{ } \mu\text{m}$ in evergreen, broad-leaved species (Terashima et al. 2006).

When stomatal and mesophyll conductance are considered in conjunction with the assimilation of CO_2 , the “supply function” (Equation 1) tends to intersect the “demand function” in the region where carboxylation and electron transport are co-limiting (Fig. 6).

TABLE 1. The area of the chloroplast in palisade (P) and spongy (S) mesophyll ($\text{Area}_{\text{chlor}}$) expressed per unit leaf area ($\text{Area}_{\text{leaf}}$) for species from the mountain range of the East Pamirs, Tadjikistan (3500–4500 m).*

	$(\text{Area}_{\text{chlor}}) / \text{Area}_{\text{leaf}}$				
	P	S	P+S	Lowest (P+S)	Highest (P+S)
Perennial dicotyledonous herbs (54)	12	9	18	3	41
Cushion plants (4)	20	11	26	12	40
Dwarf semishrubs (12)	16	6	21	5	48
Subshrubs (8)	9	7	15	7	24

Source: Pyankov & Kondratchuk (1995, 1998).

* The number of investigated species is given in brackets. The sum P+S differs from P+S, because data pertain to both dorsiventral (P+S) and isopalisade (P) species.

3. Response of Photosynthesis to Light

The level of irradiance is an important ecological factor on which all photo-autotrophic plants depend. Only the photosynthetically active part of the spectrum (PAR; 400–700 nm) directly drives photosynthesis. Other effects of radiation pertain to the photoperiod, which triggers flowering and other developmental phenomena in many species, the direction of the light, and the spectral quality, characterized by the red/far-red ratio, which is of major importance for many aspects of morphogenesis. These effects are discussed in Chapter 7 on growth and allocation and Chapter 8 on life cycles; effects of infrared radiation are discussed in Chapter 4A on the plant's energy balance and its significance through temperature effects on photosynthesis in Sect. 7. Effects of ultraviolet radiation are treated briefly in Sect. 2.2 of Chapter 4B on effects of radiation and temperature.

Low light intensities pose stresses on plants because irradiance limits photosynthesis and thus net carbon gain and plant growth. Responses of the photosynthetic apparatus to shade can be at two levels: either at the structural level, or at the level of the biochemistry in chloroplasts. Leaf anatomy, and structure and biochemistry of the photosynthetic apparatus are treated in Sect. 3.2.2; aspects of morphology at the whole plant level are discussed in Sect. 5.1 of Chapter 7 on growth and allocation.

High light intensities may also be a stress for plants, causing damage to the photosynthetic apparatus, particularly if other factors are not optimal. The kind of damage to the photosynthetic apparatus that may occur and the mechanisms of plants to cope with excess irradiance are treated in Sect. 3.3.

To analyze the response of photosynthesis to irradiance, we distinguish between the dynamic response of photosynthesis to light (or any other environmental factor) and the steady-state response. A steady-state response is achieved after exposure of a leaf to constant irradiance for some time until a constant response is reached. Dynamic responses are the result of perturbations of steady-state conditions due to sudden changes in light conditions resulting in changes in photosynthetic rates.

Certain genotypes have characteristics that are adaptive in a shady environment (shade-adapted plants). In addition, all plants have the capability to acclimate to a shady environment, to a greater or lesser extent, and form a shade plant phenotype (shade form). The term **shade plant** may therefore refer to an “adapted” genotype or an “acclimated”

phenotype. Similarly, the term **sun plant** normally refers to a plant grown in high-light conditions, but is also used to indicate a shade-avoiding species or ecotype. The terms sun leaf and shade leaf are used more consistently; they refer to leaves that have developed at high and low irradiance, respectively.

3.1 The Light Climate Under a Leaf Canopy

The average **irradiance** decreases exponentially through the plant canopy, with the extent of light attenuation depending on both the amount and arrangement of leaves (Monsi & Saeki 1953, 2005):

$$I = I_0 e^{-kL} \quad (6)$$

where I is the irradiance beneath the canopy; I_0 is the irradiance at the top of the canopy; k is the extinction coefficient; and L is the leaf area index (total leaf area per unit ground area). The extinction coefficient is low for vertically inclined leaves (for example 0.3–0.5 for grasses), higher for a more horizontal leaf arrangement, and approaching 1.0 for randomly distributed, small, perfectly horizontal leaves. A clumped leaf arrangement and deviating leaf angles result in intermediary values for k . A low extinction coefficient allows more effective light transfer through canopies dominated by these plants. Leaves are more vertically inclined in high-light than in cloudy or shaded environments. This minimizes the probability of photoinhibition and increases light penetration to lower leaves in high-light environments, thereby maximizing whole-canopy photosynthesis (Terashima & Hikosaka 1995). Values for leaf area index range from less than 1 in sparsely vegetated communities like deserts or tundra to 5–7 for crops to 5–10 for forests (Schulze et al. 1994).

The **spectral composition** of shade light differs from that above a canopy, due to the selective absorption of photosynthetically active radiation by leaves. Transmittance of photosynthetically active radiation is typically less than 10%, whereas transmittance of far-red (FR, 730 nm) light is substantial (Fig. 6 in Chapter 8 on life cycles). As a result, the ratio of red (R, 660 nm) to far-red (the R/FR ratio) is lower in canopy shade. This affects the photoequilibrium of **phytochrome**, a pigment that allows a plant to perceive shading by other plants (Box 7.2), and requires adjustment of the photosynthetic apparatus.

Another characteristic of the light climate in and under a leaf canopy is that direct sunlight may arrive as “packages” of high intensity: **sunflecks**.

So there are short spells of high irradiance against a background of a low irradiance. Such sunflecks are due to the flutter of leaves, movement of branches and the changing angle of the sun. Their duration ranges from less than a second to minutes. Sunflecks typically have lower irradiance than direct sunlight due to penumbral effects, but large sunflecks (those greater than an angular size of 0.5 degrees) can approach irradiances of direct sunlight (Chazdon & Pearcy 1991).

3.2 Physiological, Biochemical, and Anatomical Differences Between Sun and Shade Leaves

Shade leaves exhibit a number of traits that make them quite distinct from leaves that developed in full daylight. We first discuss these traits and then some of the problems that may arise in leaves from exposure to high irradiance. In the last section we discuss signals and transduction pathways that allow the formation of sun vs. shade leaves.

3.2.1 The Light-Response Curve of Sun and Shade Leaves

The steady-state rate of CO₂ assimilation increases asymptotically with increasing irradiance. Below the **light-compensation point** ($A_n = 0$), there is insufficient light to compensate for respiratory carbon loss due to photorespiration and dark respiration (Fig. 8). At low light intensities, A_n increases linearly with irradiance, with the light-driven electron transport limiting photosynthesis. The initial slope of the light-response curve based on *absorbed* light (**quantum yield**) describes the efficiency with which light is converted into fixed carbon (typically about 0.06 moles CO₂ fixed per mole of quanta under favorable conditions and a normal atmospheric CO₂ concentration). When the light-response curve is based on *incident* light, the leaf's absorptance also determines the quantum yield; this initial slope is called the **apparent quantum yield**. At high irradiance, photosynthesis becomes light-saturated and is limited by carboxylation rate, which is governed by some combination of CO₂ diffusion into the leaf and carboxylation capacity. The shape of the light-response curve can be satisfactorily described by a nonrectangular hyperbola (Fig. 9):

$$A_n = \frac{\phi I + A_{\max} - \sqrt{(\phi I + A_{\max})^2 - 4 \Theta \phi_{\max}}}{2\Theta} - R_d \quad (7)$$

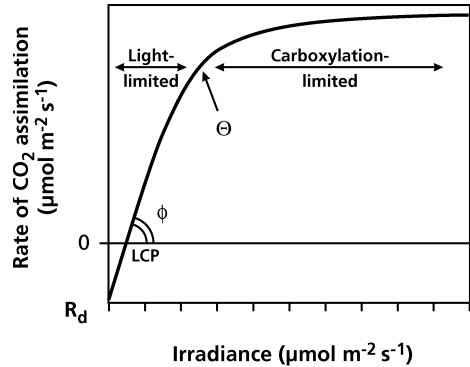

FIGURE 8. Typical response of net photosynthesis to irradiance, drawn according to Equation (7) in the text. The intercept with the x-axis is the light-compensation point (LCP), the initial slope of the line gives the quantum yield (ϕ) and the intercept with the y-axis is the rate of dark respiration (R_d). The curvature of the line is described by θ . At low irradiance, the rate of CO₂ assimilation is light-limited; at higher irradiance A_n is carboxylation limited. A_{\max} is the light-saturated rate of CO₂ assimilation at ambient C_a .

where A_{\max} is the light-saturated rate of gross CO₂ assimilation (net rate of CO₂ assimilation + dark respiration) at infinitely high irradiance, ϕ is the (apparent) quantum yield (on the basis of either incident or absorbed photons), Θ is the curvature factor, which can vary between 0 and 1, and R_d is the dark respiration during photosynthesis. The Equation can also be used to describe the light dependence of electron transport, when A is then replaced by J and A_{\max} by J_{\max} (Box 2A.1). This mathematical description is useful because it contains variables with a clear physiological meaning that can be derived from light-response curves and used to model photosynthesis.

Sun leaves differ from shade leaves primarily in their higher light-saturated rates of photosynthesis (A_{\max}) (Fig. 9). The rate of dark respiration typically covaries with A_{\max} . The initial slope of the light-response curves of light-acclimated and shade-acclimated plants (the **quantum yield**) is the same, except when shade-adapted plants become inhibited or damaged at high irradiance (photoinhibition or photodestruction) which reduces the quantum yield. The apparent quantum yield (i.e., based on incident photon irradiance) may also vary with variation in absorptance due to differences in chlorophyll concentration per unit leaf area. This is typically not important in the case of acclimation to light (Sect. 3.2.3), but cannot be ignored when factors such as nutrient availability and senescence

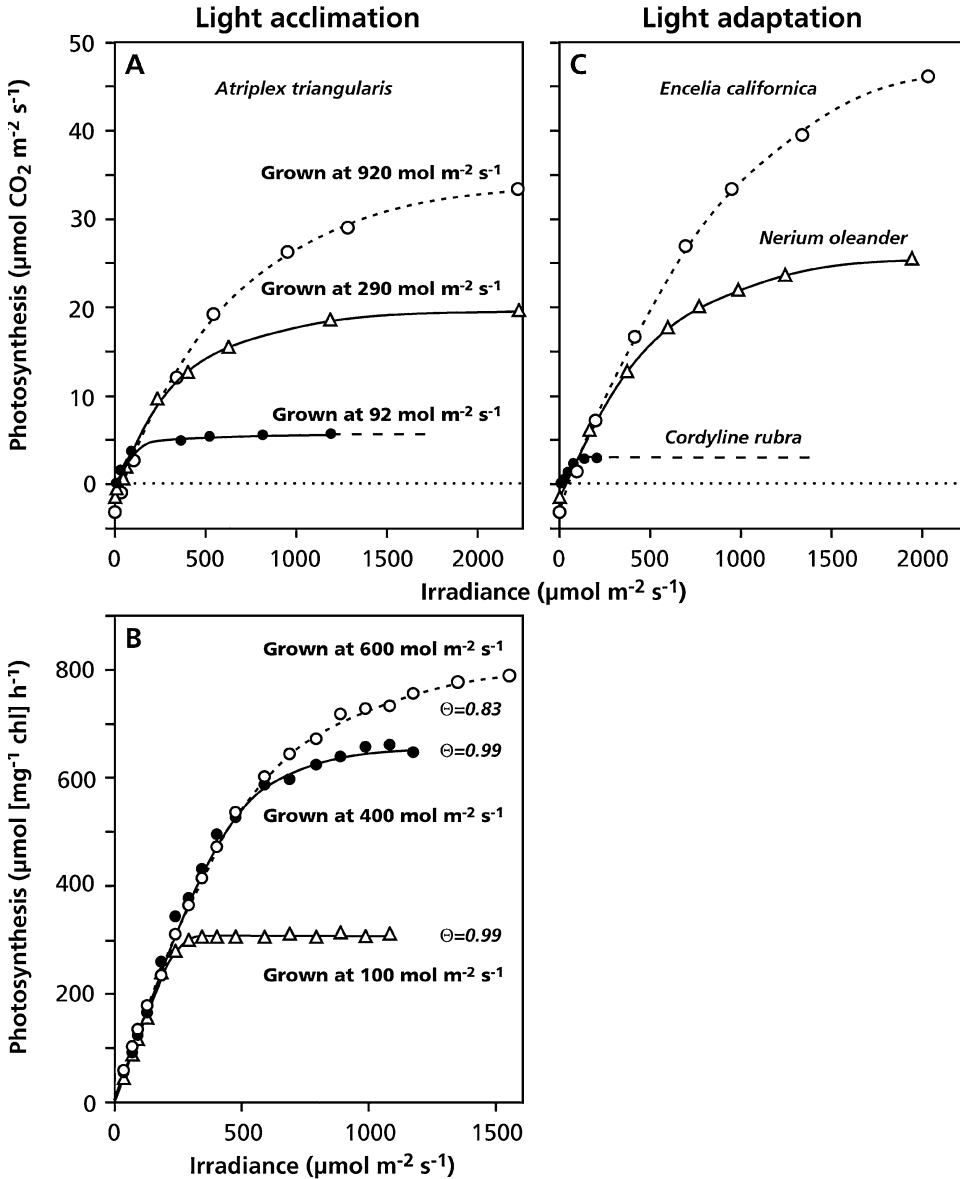

FIGURE 9. Photosynthesis as a function of irradiance for different species and growing conditions. Light acclimation: (A) for *Atriplex triangularis* (Björkman 1981) and (B) for a thin algal culture (*Coccomyxa* sp.) grown at different levels of irradiance 100, 400, or 600 $\mu\text{mol m}^{-2} \text{ s}^{-1}$ (B) note the difference in “curvature”, for which the

Θ values (Equation 6) are given in B, between the three curves (after Ögren 1993). Copyright American Society of Plant Biologists. Light adaptation: (C) for species which naturally occur at a high, intermediate, or low irradiance (after Björkman 1981).

play a role. The transition from the light-limited part to the light-saturated plateau is generally abrupt in shade leaves, but more gradual in sun leaves (higher A_{max} and lower Θ in sun leaves). Although shade leaves typically have a low A_{max} , they have lower light-compensation points and higher rates of

photosynthesis at low light because of their lower respiration rates per unit leaf area (Fig. 9).

Just as in acclimation, most plants that have evolved under conditions of high light have higher light-saturated rates of photosynthesis (A_{max}), higher light-compensation points, and lower rates

of photosynthesis at low light than do shade-adapted plants when grown under the same conditions.

3.2.2 Anatomy and Ultrastructure of Sun and Shade Leaves

One mechanism by which sun-grown plants, or sun leaves on a plant, achieve a high A_{\max} (Fig. 9) is by producing **thicker** leaves (Fig. 10) which provides space for more chloroplasts per unit leaf area. The increased thickness is largely due to the formation of longer palisade cells in the mesophyll and, in species that have this capacity, the development of multiple palisade layers in sun leaves (Hanson 1917). Plants that naturally occur in high-light environments (e.g., grasses, *Eucalyptus* and *Hakea* species) may have palisade parenchyma on both sides of the leaf (Fig. 10). Such leaves are naturally positioned (almost) vertically, so that both sides of the leaf receive a high irradiance. Anatomy constrains the potential of leaves to acclimate, e.g., the acclimation potential of shade leaves to a high-light environment is limited by the space in mesophyll cells bordering intercellular spaces (Oguchi et al. 2005). Full acclimation to a new light environment, therefore, typically requires the production of new leaves.

The spongy mesophyll in dorsiventral leaves of dicotyledons increases the **path length** of light in

leaves by reflection at the gas-liquid interfaces of these irregularly oriented cells. The relatively large proportion of spongy mesophyll in shade leaves therefore enhances leaf absorptance, due to the greater internal light scattering (Vogelmann et al. 1996). When air spaces of shade leaves of *Hydrophyllum canadense* (broad-leaved waterleaf) or *Asarum canadense* (Canadian wild-ginger) are infiltrated with mineral oil to eliminate this phenomenon, light absorptance at 550 and 750 nm is reduced by 25 and 30%, respectively (Fig. 11). In sun leaves, which have relatively less spongy mesophyll, the effect of infiltration with oil is much smaller. The optical path length in leaves ranges from 0.9 to 2.7 times that of an equivalent amount of pigment in water, greatly increasing the effectiveness of light absorption in thin leaves of shade plants (Rühle & Wild 1979).

Leaves of obligate shade plants, as can for instance be found in the understory of a tropical rainforest, may have specialized anatomical structures that enhance light absorption even further. Epidermal and sub-epidermal cells may act as lenses that concentrate light on chloroplasts in a thin layer of mesophyll.

There are fewer chloroplasts per unit area in shade leaves as compared with sun leaves due to the reduced thickness of mesophyll. The **ultrastructure** of the chloroplasts of sun and shade leaves shows distinct differences (Fig. 12). Shade

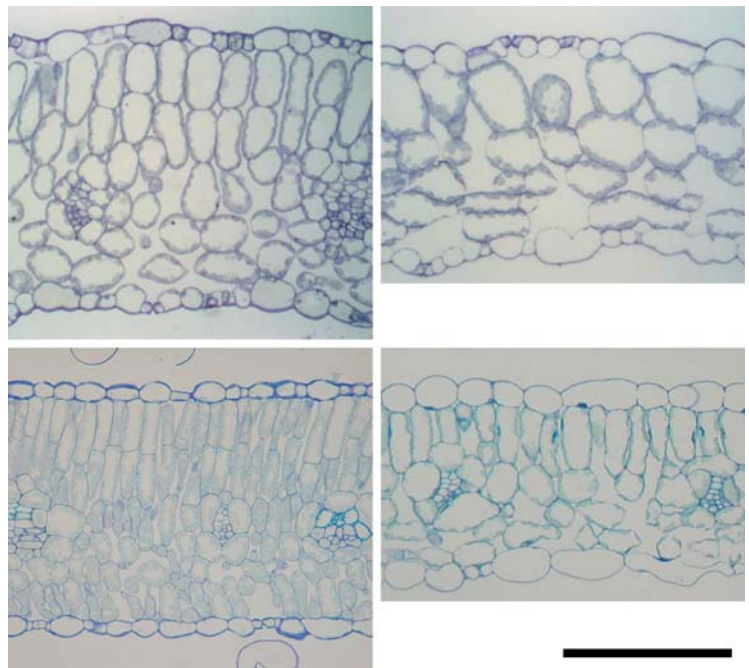

FIGURE 10. Light-microscopic transverse sections of sun and shade leaves of two species: (Top) *Arabidopsis thaliana* (thale cress) and (Bottom) *Chenopodium album* (pig-weed). Note that the sun leaves of *Arabidopsis thaliana* have two cell layers for the palisade tissue while those of *Chenopodium album* have only one layer. Shade leaves of both species have only one cell layer. Scale bar = 100 μm (courtesy S. Yano, National Institute for Basic Biology, Okazaki, Japan).

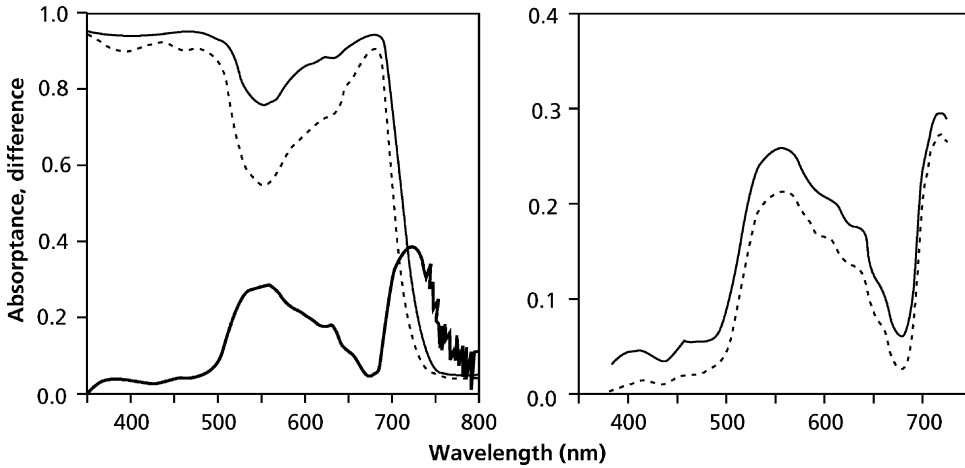

FIGURE 11. (A) Light absorbance in a shade leaf of *Hydrophyllum canadense* (broad-leaved waterleaf). The **solid line** gives the absorbance of a control leaf. The **broken line** shows a leaf infiltrated with mineral oil, which reduces light scattering. The difference between the two

lines is given as the **thick solid line**. (B) The difference in absorbance between an oil-infiltrated leaf and a control leaf of *Acer saccharum* (sugar maple). The **solid line** gives the difference for a shade leaf, the **broken line** for a sun leaf (after DeLucia et al. 1996).

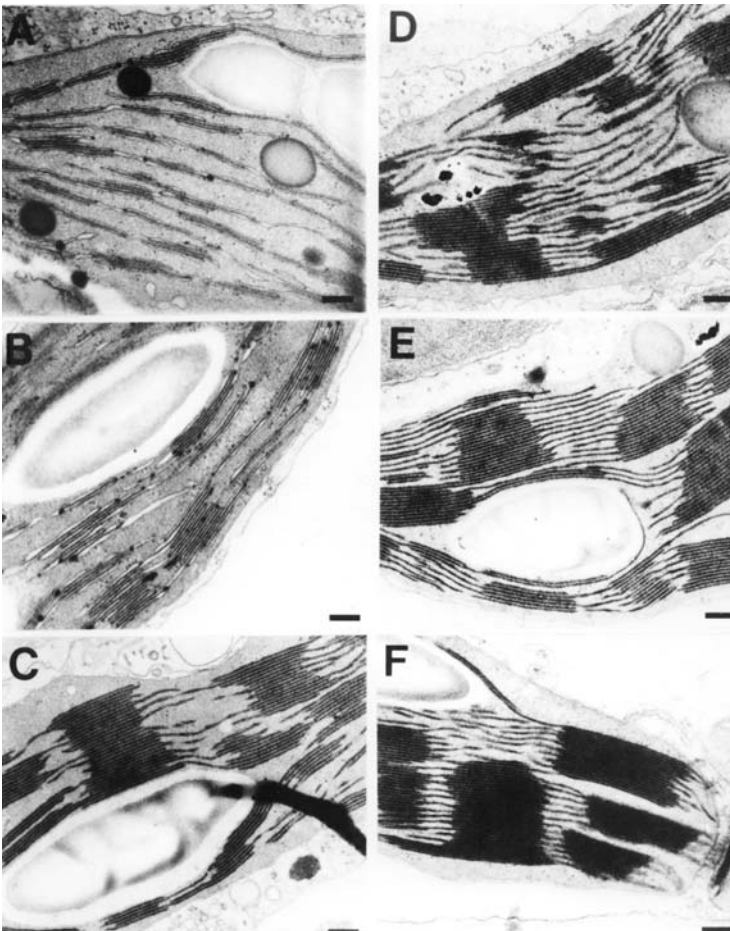

FIGURE 12. Electron micrographs of chloroplasts in sun (A–C) and shade (D–F) leaves of *Schefflera arboricola* (dwarf umbrella plant). Chloroplasts found in upper palisade parenchyma tissue (A, D), lower palisade parenchyma tissue (B, E) and spongy mesophyll tissue (C, F). Note the difference in grana between sun and shade leaves and between the upper and lower layer inside the leaf. Scale bar = 0.2 μm (courtesy A.M. Syme and C. Critchley, Department of Botany, The University of Queensland, Australia).

Box 2A.3

Carbon-Fixation and Light-Absorption Profiles Inside Leaves

We are already familiar with differences in biochemistry and physiology *between* sun and shade leaves (Sect. 3.2). If we consider the gradient in the level of irradiance inside a leaf, however, then should we not expect similar differences *within* leaves? Indeed, palisade mesophyll cells at the adaxial (upper) side of the leaf tend to have characteristics associated with acclimation to high irradiance: a high Rubisco/chlorophyll and chl *a*/chl *b* ratio, high levels of xanthophyll-cycle carotenoids, and less stacking of the thylakoids (Fig. 13; Terashima & Hikosaka 1995). On the other hand, the spongy mesophyll cells at the abaxial (lower) side of the leaf have chloroplasts with a lower Rubisco/chlorophyll and chl *a*/chl *b* ratio, characteristic for acclimation to low irradiance. What are the consequences of such profiles within the leaf for the exact location of carbon fixation in the leaf?

To address this question we first need to know the light profile within a leaf which can be measured with a fiberoptic microprobe that is moved through the leaf, taking light readings at different wavelengths (Vogelmann 1993). Chlorophyll is not homogeneously distributed in a cell; rather, it is concentrated in the chloroplasts that may have an heterogeneous distribution within and between cells. In addition, inside the leaf, absorption varies because of scattering at the air-liquid interfaces that modify pathlength (e.g., between palisade and spongy mesophyll) (Sect. 3.2.4). How can we obtain information on light absorption?

After a period of incubation in the dark, chlorophyll fluorescence of a healthy leaf is proportional to the light absorbed by that leaf (Box 2A.4). Vogelmann & Evans (2002) illuminated leaves at the adaxial side and at the side of a transversal cut, and measured the distribution of fluorescence over the cut surface using imaging techniques. Fluorescence obtained with adaxial light represents light absorption, whereas lighting the cut surface represents chlorophyll concentration. In leaves of *Spinacia oleracea* (spinach), going from the upper leaf surface deeper into the leaf, the chlorophyll concentration increases to 50 $\mu\text{mol m}^{-2}$ over the first 250 μm in the palisade layer, remains similar deeper down in the palisade and spongy mesophyll, but then declines steeply toward the lower surface over the last 100 μm of

the spongy mesophyll layer (Fig. 1A). As expected from the absorption characteristics of chlorophyll (Fig. 2), green light is less strongly absorbed than blue and red, penetrates deeper into the leaf, and, consequently, shows there a higher absorption (Fig. 1A). The data on light absorption and chlorophyll concentration allow the calculation of an extinction coefficient, which varies surprisingly little across a leaf. Differences in scattering between the two mesophyll layers are apparently not very important as is also evident from measurements of infiltrated leaves (Fig. 11; Vogelmann & Evans 2002).

What are the consequences of the profiles of absorption and chlorophyll concentration for the distribution of photosynthetic activity across a section of a leaf? The profile of photosynthetic capacity (A_{max}) can be measured following fixation of $^{14}\text{CO}_2$ ensuring light saturation for all chloroplasts (Evans & Vogelmann 2003); alternatively, the profile of Rubisco concentration can be used (Nishio et al. 1993). Both techniques require making thin sections parallel to the leaf surface. A_{max} peaks where chlorophyll reaches its maximum in the palisade mesophyll, and declines to a lower value in the spongy mesophyll (Fig. 1A). A_{max} per chlorophyll decreases similarly from the palisade to the spongy mesophyll. We can use the profiles of A_{max} and absorbed irradiance to calculate photosynthetic activity (A) in each layer from the light-response curve, using virtually the same equation as introduced in Sect. 3.2.1 (the only difference being that R_{day} is left out):

$$A = \frac{\phi I + A_{\text{max}} - \{(\phi I + A_{\text{max}})^2 - 4\theta\phi I A_{\text{max}}\}^{0.5}}{2\theta} \quad (1)$$

where ϕ is the maximum quantum yield, I is the absorbed irradiance and θ describes the curvature. The calculated light-response curves of the adaxial layers are like those of sun leaves, whereas those of the abaxial layers are like the ones of shade leaves. Photosynthetic activity peaks close to the adaxial surface in low light, but the maximum shifts to deeper layers at higher irradiances (Fig. 1B). Since green light

continued

Box 2A.3 Continued

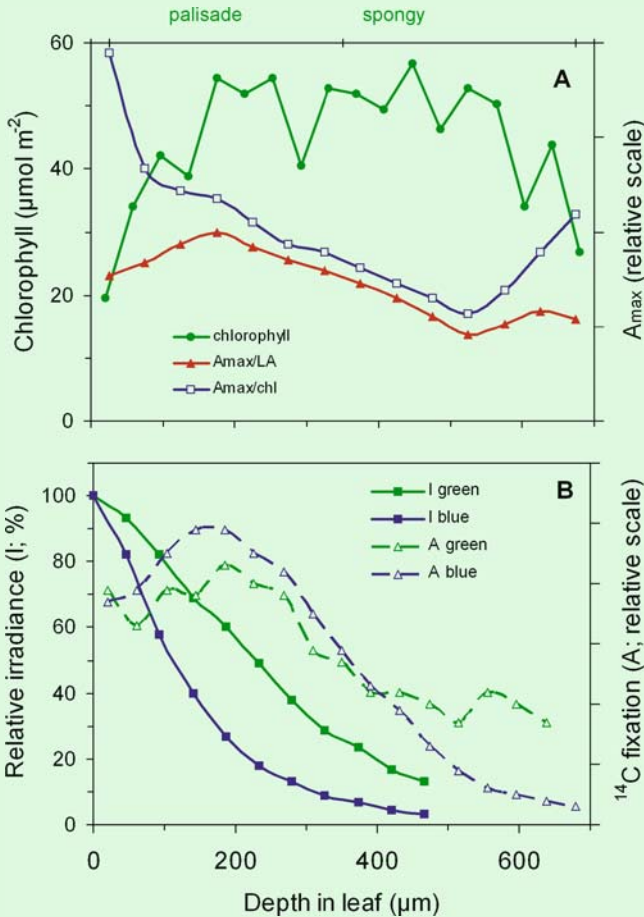

FIGURE 1. Profiles of chlorophyll and light absorption (A), and photosynthesis (B) in a leaf of *Spinacia oleracea* (spinach). The distribution of chlorophyll was derived from measurements of chlorophyll fluorescence, using a light source to illuminate the cut surface of a transversal section of the leaf. The absorption of green and blue light was also measured with chlorophyll fluorescence, but with light striking the upper leaf surface. The light-saturated photosynthetic electron transport rate (A_{\max}) was derived from ^{14}C -fixation profiles and photosynthetic activity at and irradiance of 500 and 50 $\mu\text{mol m}^{-2} \text{s}^{-1}$ in green and blue light were calculated using Equation (1) (Vogelmann & Evans 2002; Evans & Vogelmann 2003).

has a lower absorbance, A in that spectral region is more homogeneously distributed across the leaf profile, whereas blue light causes a sharp

peak closer to the upper surface. Calculated profiles of A show a close match with the experimental data of the ^{14}C -fixation profile.

chloroplasts have a smaller volume of stroma, where the Calvin-cycle enzymes are located, but larger grana, which contain the major part of the chlorophyll. Such differences are found both between plants grown under different light conditions and between sun and shade leaves on a single plant, as well as when comparing chloroplasts from the upper and lower side of one, relatively thick, leaf of *Schefflera arboricola* (dwarf umbrella plant) (Fig. 12). The adaxial (upper) regions have a chloroplast ultrastructure like sun leaves, whereas

shade acclimation is found in the abaxial (lower) regions of the leaf (Box 2A.3).

3.2.3 Biochemical Differences Between Shade and Sun Leaves

Shade leaves **minimize light limitation** through increases in capacity for light capture and decreased carboxylation capacity and mesophyll conductance, but this does not invariably lead to higher chlorophyll concentrations per unit leaf area which

determines their absorbance (Terashima et al. 2001, Warren et al. 2007). Some highly shade-adapted species [e.g., *Hedera helix* (ivy) in the juvenile stage], however, may have substantially higher chlorophyll levels per unit leaf area in shade. This might be due to the fact that their leaves do not get much thinner in the shade; however, there may also be some photodestruction of chlorophyll in high light in such species. In most species, however, higher levels of chlorophyll per unit fresh mass and per chloroplast in shade leaves are compensated for by the smaller number of chloroplasts and a lower fresh mass per area. This results in a rather constant chlorophyll level per unit area in sun- and shade leaves.

The ratio between chlorophyll *a* and chlorophyll *b* ($\text{chl } a/\text{chl } b$) is lower in shade-acclimated leaves. These leaves have relatively more chlorophyll in the **light-harvesting complexes**, which contain large amounts of chl *b* (Lichtenthaler & Babani 2004). The decreased $\text{chl } a/\text{chl } b$ ratio is therefore a reflection of the greater investment in LHCs (Evans 1988). The larger proportion of LHC is located in the **larger grana** of the shade-acclimated chloroplast (Fig. 12). Sun leaves also contain more xanthophyll carotenoids, relative to chlorophyll (Box 2A.3; Lichtenthaler 2007).

Sun leaves have larger amounts of Calvin-cycle enzymes per unit leaf area as compared with shade leaves, due to more cell layers, a larger number of chloroplasts per cell, and a larger volume of stroma, where these enzymes are located, per chloroplast, compared with shade leaves. Sun leaves also have more stroma-exposed thylakoid membranes, which contain the b_6f cytochromes and ATPase (Fig. 13). All these components enhance the **photosynthetic capacity** of sun leaves. Since the amount of chlorophyll per unit area is more or less equal among leaf types, sun leaves also have a higher photosynthetic capacity per unit chlorophyll. The biochemical gradients for Rubisco/chlorophyll across a leaf are similar to those observed within a canopy, with adaxial (upper) cells having more Rubisco, but less chlorophyll than abaxial (lower) cells (Terashima & Hikosaka 1995).

3.2.4 The Light-Response Curve of Sun and Shade Leaves Revisited

Table 2 summarizes the differences in characteristics between shade-acclimated and sun-acclimated leaves (Walters 2005). The higher A_{max} of sun leaves as compared with shade leaves is associated with a greater amount of compounds that determine

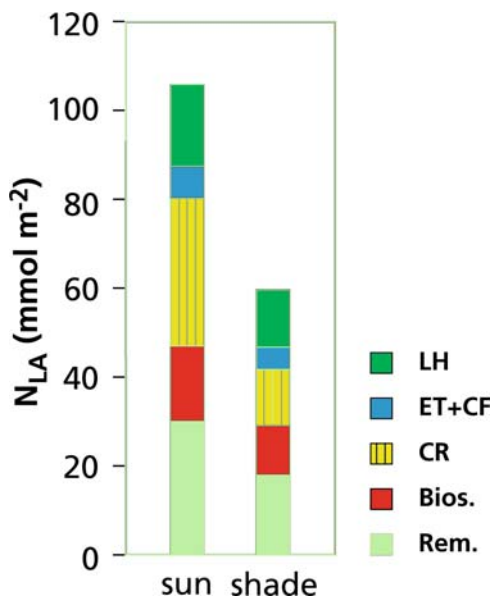

FIGURE 13. Nitrogen partitioning among various components in shade- and sun-acclimated leaves. Most of the leaf's N in herbaceous plants is associated with photosynthesis. Some of the fractions labeled Bios. (Biosynthesis) and Rem. (Remainder) are indirectly involved in synthesis and maintenance processes associated with the photosynthetic apparatus. LH = light harvesting (LHC, PS I, PS II), ET+CF = electron transport components and coupling factor (ATPase), CR = enzymes associated with carbon reduction (Calvin cycle, mainly Rubisco), Bios = biosynthesis (nucleic acids and ribosomes), Rem = remainder, other proteins and N-containing compounds (e.g., mitochondrial enzymes, amino acids, cell wall proteins, alkaloids) (after Evans & Seemann 1989).

photosynthetic capacity which are located in the greater number of chloroplasts per area and in the larger stroma volume and the stroma-exposed thylakoids in chloroplasts. The increase of A_{max} with increasing amount of these compounds is almost linear (Evans & Seemann 1989). Hence, investment in compounds determining photosynthetic capacity is proportionally translated into photosynthetic rate at high irradiance levels.

The higher rate of dark respiration in sun leaves is not only due to a greater demand for respiratory energy for the maintenance of the larger number of leaf cells and chloroplasts, because respiration rates drop rapidly upon shading, whereas A_{max} is still high (Pons & Percy 1994). Much of the demand for ATP is probably associated with the export of the products of photosynthesis from the leaf and other processes

TABLE 2. Overview of generalized differences in characteristics between shade- and sun-acclimated leaves.

	Sun	Shade
Structural		
Leaf dry mass per area	High	Low
Leaf thickness	Thick	Thin
Palisade parenchyma thickness	Thick	Thin
Spongy parenchyma thickness	Similar	Similar
Stomatal density	High	Low
Chloroplast per area	Many	Few
Thylakoids per stroma volume	Low	High
Thylakoids per granum	Few	Many
Biochemical		
Chlorophyll per chloroplast	low	high
Chlorophyll per area	similar	similar
Chlorophyll per dry mass	low	high
Chlorophyll <i>a/b</i> ratio	high	low
Light-harvesting complex per area	low	high
Electron transport components per area	high	low
Coupling factor (ATPase) per area	high	low
Rubisco per area	high	low
Nitrogen per area	high	low
Xanthophylls per area	high	low
Gas exchange		
Photosynthetic capacity per area	high	low
Dark respiration per area	high	low
Photosynthetic capacity per dry mass	similar	similar
Dark respiration per dry mass	similar	similar
Carboxylation capacity per area	high	low
Electron transport capacity per area	high	low
Quantum yield	similar	similar
Curvature of light-response curve	gradual	acute

associated with a high photosynthetic activity (Sect. 4.4 in Chapter 2B on plant respiration).

The preferential absorption of photons in the red and blue regions of the spectrum by a leaf is not a simple function of its irradiance and chlorophyll concentration. A relationship with a negative exponent would be expected, as described for monochromatic light and pigments in solution (Lambert-Beer's law). The situation in a leaf is more complicated, however, because preferential absorption of red light by chlorophyll causes changes in the spectral distribution of light through the leaf. Moreover, the path length of light is complicated, due to reflection inside the leaf and to changes in the proportions of direct and diffuse light. Empirical equations, such as a hyperbole, can be used to describe light absorption by chlorophyll. For a healthy leaf, the quantum yield based on incident light is directly proportional to the amount of photons absorbed.

The cause of the decrease in convexity (Equation 7) of the light-response curve with increasing growth irradiance (Fig. 9) is probably partly associated with the level of light-acclimation of the chloroplast in the cross-section of a leaf in relation to the distribution of light within the leaf (Leverenz 1987).

A high A_{\max} per unit area and per unit chlorophyll (but not per unit biomass) of sun leaves is beneficial in high-light conditions, because the prevailing high irradiance can be efficiently exploited, and photon absorption per unit photosynthetic capacity is not limiting photosynthetic rates. Such a high A_{\max} , however, would not be of much use in the shade, because the high irradiance required to utilize the capacity occurs only infrequently, and a high A_{\max} is associated with high rates of respiration and a large investment of resources. On the other hand, a high chlorophyll concentration per unit photosynthetic capacity and per unit biomass in thin shade leaves maximizes the capture of limiting photons in

FIGURE 14. Light-saturated rate of CO₂ assimilation (A_{\max}) per unit chlorophyll in relation to growth irradiance for four different species. *Plantago lanceolata* (snake plantain) (Poot et al. 1996), *Betula pendula* (European white birch, Bp) (Öquist et al. 1982), *Alocasia macrorrhiza* (giant taro, Am) (Sims & Pearcy 1989), *Hedera helix* (ivy, Hh) (T.L. Pons, unpublished data).

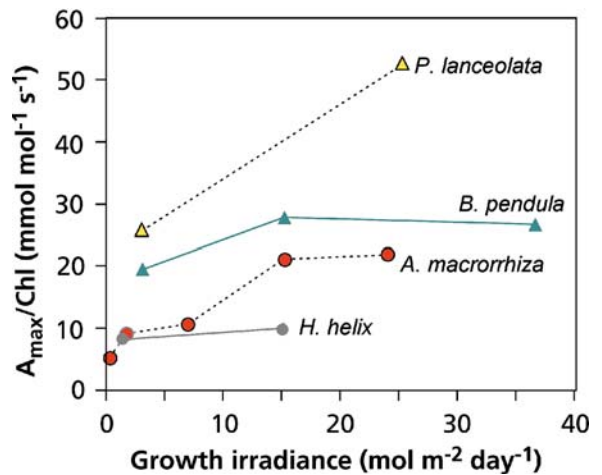

low-light conditions which is advantageous at low irradiance. Apparently, there is a “trade-off” between investment of resources in carbon-assimilating capacity and in light harvesting as reflected in the ratio of photosynthetic capacity to chlorophyll concentration. This ratio represents light acclimation at the chloroplast level.

Although A_{\max} per unit chlorophyll responds qualitatively similar to growth irradiance in all plants, there are differences among species (Fig. 14; Murchie & Horton 1997). Four functional groups can be discerned:

1. Shade-avoiding species, such as the pioneer tree *Betula pendula* (European white birch) have a high A_{\max} /chlorophyll ratio. This ratio, however, does not change much with growth irradiance.
2. Fast-growing herbaceous species from habitats with a dense canopy and/or a variable light availability have high A_{\max} /chlorophyll ratios, which decrease strongly with decreasing irradiance. *Plantago lanceolata* (snake plantain) and *Arabidopsis thaliana* (thale cress) (Bailey et al. 2001) are examples.
3. A plastic response is also found in shade-adapted plants such as herbaceous understory species [*Alocasia macrorrhiza* (giant taro)] that depend on gaps for reproduction, and forest trees that tolerate shade as seedlings. The A_{\max} /chlorophyll ratio, however, is much lower over the entire range of irradiance levels.
4. A low A_{\max} /chlorophyll ratio that changes little with growth irradiance is found in woody shade-adapted species, such as juvenile *Hedera helix* (ivy).

3.2.5 The Regulation of Acclimation

As mentioned in previous sections, light acclimation consists of changes in leaf structure and chloroplast

number at the leaf level, and changes in the photosynthetic apparatus at the chloroplast level. Some aspects of leaf anatomy, including morphology of epidermal cells and the number of stomata, are controlled by **systemic signals** originating in mature leaves (Lake et al. 2001, Coupe et al. 2006). Chloroplast properties are mostly determined by the **local light environment** of the developing leaves (Yano & Terashima 2001).

Studies of regulation at the chloroplast level have yielded significant insights. Each of the major components of the photosynthetic apparatus has part of their subunits encoded in the chloroplast and others in the nucleus. Acclimation of chloroplast composition thus likely entails coordinated changes in transcription of both genomes. The abundance of mRNAs coding for photosynthetic proteins, however, does not respond clearly during acclimation which suggests that post-transcriptional modifications play an important role (Walters 2005). Several perception mechanisms of the spectral and irradiance component of the light climate have been proposed.

Mutants lacking cryptochrome and phytochrome photoreceptors (CRY1, CRY2, PHYA), or having defects in their signaling pathway, show changes in chloroplast composition and disturbance of normal acclimation (Smith et al. 1993, Walters et al. 1999). Hence, these photoreceptors are either actually involved in perception of the light environment with respect to photosynthetic acclimation, or their action is a prerequisite for normal development of the photosynthetic apparatus. There is also evidence for a role of signals from photosynthesis itself in the regulation of acclimation, either directly or indirectly. Several of these have been identified, such as the redox state of components of the photosynthetic membrane or in the stroma, the ATP/ADP ratio, reactive oxygen species,

and the concentration of carbohydrates, including glucose and trehalose-6-phosphate (Walters 2005), but a definitive answer about their precise role is still lacking. **Systemic signals** play a role in the effect of the light environment of mature leaves on the acclimation of young, growing leaves, irrespective of their own light environment (Yano & Terashima 2001).

3.3 Effects of Excess Irradiance

All photons absorbed by the photosynthetic pigments result in excited chlorophyll, but at irradiance levels beyond the linear, light-limited region of the light-response curve of photosynthesis, not all excited chlorophyll can be used in photochemistry (Figs. 8, 15). The fraction of excitation energy that cannot be used increases with irradiance and under conditions that restrict the rate of electron transport and Calvin-cycle activity such as low temperature and desiccation. This is potentially harmful for plants, because the excess excitation may result in serious damage, if it is not dissipated. To avoid damage, plants have mechanisms to safely dispose of this excess excitation energy. When these mechanisms are at work, the quantum yield of photosynthesis is **temporarily** reduced (minutes), a normal phenomenon at high irradiance. The excess excitation energy, however, may also cause damage to the photosynthetic membranes if the dissipation mechanisms are inadequate. This is called

photoinhibition, which is due to an imbalance between the rate of photodamage to PS II and the rate of repair of damaged PS II. Photodamage is initiated by the direct effects of light on the O₂-evolving complex and, thus, photodamage to PS II is unavoidable (Nishiyama et al. 2006). A reduction in quantum yield that is re-established within minutes to normal healthy values is referred to as **dynamic photoinhibition** (Osmond 1994); it is predominantly associated with changes in the xanthophyll cycle (Sect. 3.3.1). More serious damage that takes hours to revert to control conditions leads to **chronic photoinhibition**; it is mostly related to temporarily impaired D1 (Sect. 2.1.1; Long et al. 1994). Even **longer-lasting** photoinhibition (days) can be referred to as **sustained photoinhibition** (Sect. 7.2). A technique used for the quantification of photoinhibition is the measurement of quantum yield by means of chlorophyll fluorescence (Box 2A.4).

3.3.1 Photoinhibition—Protection by Carotenoids of the Xanthophyll Cycle

Plants that are acclimated to high light dissipate excess energy through reactions mediated by a particular group of **carotenoids** (Fig. 16). This dissipation process is induced by accumulation of protons in the thylakoid lumen which is triggered by excess light. Acidification of the lumen induces an enzymatic conversion of the carotenoid violaxanthin into antheraxanthin and zeaxanthin (Gilmore 1997). The

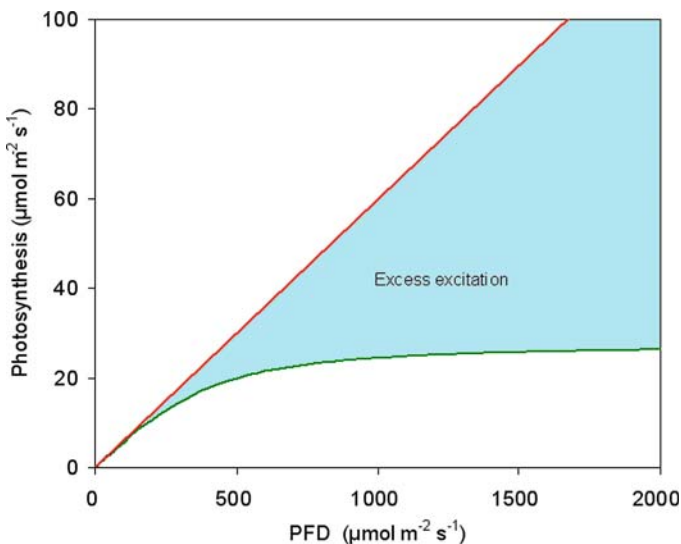

FIGURE 15. Response of photosynthesis to light intensity. Photosynthesis increases hyperbolically with irradiance, but photon absorption, and thus the generation of excited chlorophylls, increases linearly. The difference (blue area) between the two processes increases with increasing irradiance and represents the excess excitation energy.

Box 2A.4 Chlorophyll Fluorescence

When chlorophyllous tissue is irradiated with photosynthetically active radiation (400–700 nm) or wavelengths shorter than 400 nm, it emits radiation of longer wavelengths (approx. 680–760 nm). This fluorescence originates mainly from chlorophyll *a* associated with photosystem II (PS II). The measurement of the kinetics of chlorophyll fluorescence has been developed into a sensitive tool for probing state variables of the photosynthetic apparatus in vivo. In an ecophysiological context, this is a useful technique to quantify effects of stress on photosynthetic performance that is also applicable under field conditions.

Photons absorbed by chlorophyll give rise to (1) an excited state of the pigment which is channelled to the reaction center and may give rise to photochemical charge separation. The quantum yield of this process is given by ϕ_P . Alternative routes for the excitation energy are (2) dissipation as heat (ϕ_D) and (3) fluorescent emission (ϕ_F). These three processes are competitive. This leads to the assumption that the sum of the quantum yields of the three processes is unity:

$$\phi_P + \phi_D + \phi_F = I \tag{1}$$

Since only the first two processes are subject to regulation, the magnitude of fluorescence depends on the added rates of photochemistry and heat dissipation. Measurement of fluorescence, therefore, provides a tool for quantification of these processes.

Basic Fluorescence Kinetics

When a leaf is subjected to strong white light after incubation in darkness, a characteristic pattern of fluorescence follows, known as the Kautsky curve (Bolh ar-Nordenkampf &  gren 1993, Schreiber et al. 1995). It rises immediately to a low value (F_0), which is maintained only briefly in strong light, but can be monitored for a longer period in weak intermittent light (Fig. 1, left). This level of fluorescence (F_0) is indicative of open reaction centers due to a fully oxidized state of the primary electron acceptor Q_A . In strong saturating irradiance, fluorescence

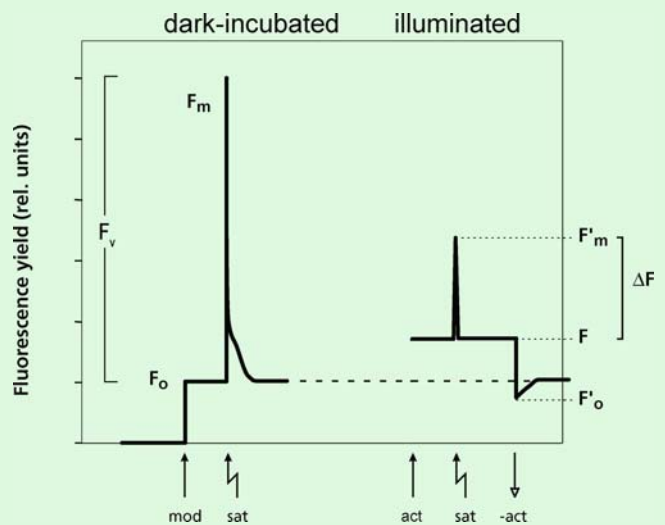

FIGURE 1. Fluorescence kinetics in dark-incubated and illuminated leaves in response to a saturating pulse of white light. mod = modulated measuring light on; sat = saturating pulse on; act=actinic light on for a prolonged period together with modulated measuring light; -act = actinic light off. For explanation of fluorescence symbols see text (after Schreiber et al. 1995).

continued

Box 2A.4 Continued

rises quickly to a maximum value (F_m) (Fig. 1, left) which indicates closure of all reaction centers as a result of fully reduced Q_A . When light is maintained, fluorescence decreases gradually (quenching) to a stable value as a result of induction of photosynthetic electron transport and dissipation processes.

After a period of illumination at a sub-saturating irradiance, fluorescence stabilizes at a value F , somewhat above F_0 (Fig. 1, right). When a saturating pulse is given under these conditions, fluorescence does not rise to F_m , but to a lower value called F_m' . Although reaction centers are closed at saturating light, dissipation processes compete now with fluorescence which causes the quenching of F_m to F_m' .

Since all reaction centers are closed during the saturating pulse, the photochemical quantum yield (ϕ_P) is practically zero and, therefore, the quantum yields of dissipation at saturating light (ϕ_{Dm}) and fluorescence at saturating light (ϕ_{Fm}) are unity:

$$\phi_{Dm} + \phi_{Fm} = 1 \quad (2)$$

It is further assumed that there is no change in the relative quantum yields of dissipation and fluorescence during the saturating pulse:

$$\frac{\phi_{Dm}}{\phi_{Fm}} = \frac{\phi_D}{\phi_F} \quad (3)$$

Photochemical quantum yield (ϕ_P) is also referred to as ϕ_{II} because it originates mainly from PSII. It can now be expressed in fluorescence parameters only, on the basis of Equations (1), (2), and (3).

$$\phi_{II} = \frac{\phi_{Fm} - \phi_F}{\phi_{Fm}} \quad (4)$$

The fluorescence parameters F_0 and F_m can be measured with time-resolving equipment, where the sample is irradiated in darkness with $\lambda < 680$ nm and fluorescence is detected as emitted radiation at $\lambda > 680$ nm. White light sources, however, typically also have radiation in the wavelength region of chlorophyll fluorescence. For measurements in any light condition, systems have been developed that use a weak modulated light source in conjunction with a

detector that monitors only the fluorescence emitted at the frequency and phase of the source. A strong white light source for generating saturating pulses ($> 5,000 \mu\text{mol m}^{-2}\text{s}^{-1}$) and an actinic light source typically complete such systems. The modulated measuring light is sufficiently weak for measurement of F_0 . This is the method used in the example given in Fig. 1. The constancy of the measuring light means that any change in fluorescence signal is proportional to ϕ_F . This means that the maximum quantum yield (ϕ_{II}) as measured in dark-incubated leaves is

$$\phi_{II} = (F_m - F_0)/F_m = F_v/F_m \quad (5)$$

where F_v is the variable fluorescence, the difference between maximal and minimal fluorescence. In illuminated samples the expression becomes

$$\phi_{II} = (F_m' - F)/F_m' = \Delta F/F_m' \quad (6)$$

where ΔF is the increase in fluorescence due to a saturating pulse superimposed on the actinic irradiance. $\Delta F/F_m'$ has values equal to or lower than F_v/F_m ; the difference increases with increasing irradiance.

The partitioning of fluorescence quenching due to photochemical (qP) and nonphotochemical (qN) processes can be determined. These are defined as

$$qP = (F_m' - F)/(F_m' - F_0') = \Delta F/F_v' \quad (7)$$

$$qN = 1 - (F_m' - F_0')/(F_m - F_0) = 1 - F_v'/F_v \quad (8)$$

F_0 may be quenched in light, and is then called F_0' (Fig. 1 right). The measurement of this parameter may be complicated, particularly under field conditions. We can also use another term for nonphotochemical quenching (NPQ) which does not require the determination of F_0' :

$$\text{NPQ} = (F_m - F_m')/F_m' \quad (9)$$

The theoretical derivation of the fluorescence parameters as based on the assumptions described above is supported by substantial empirical evidence. The biophysical background of the processes, however, is not always fully understood.

continued

Box 2A.4 *Continued***Relationships with Photosynthetic Performance**

Maximum quantum yield after dark incubation (F_v/F_m) is typically very stable at values around 0.8 in healthy leaves. F_v/F_m correlates well with the quantum yield of photosynthesis measured as O_2 production or CO_2 uptake at low irradiance (Fig. 2). In particular, the reduction of the quantum yield by photoinhibition can be evaluated with this fluorescence parameter. A decrease in F_v/F_m can be due to a decrease in F_m and/or an increase in F_0 . A fast- and a slow-relaxing component can be distinguished. The fast component is alleviated within a few hours of low light or darkness

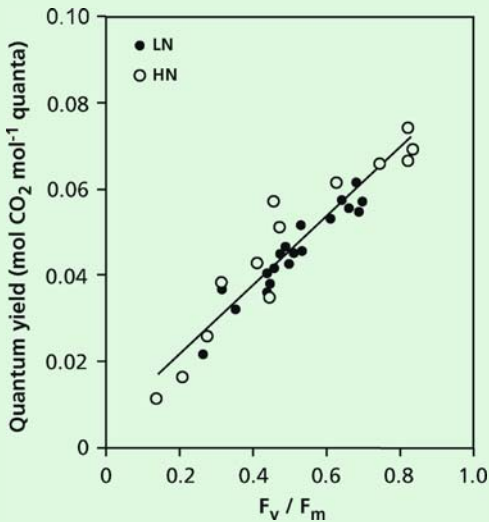

FIGURE 2. The relationship between quantum yield, as determined from the rate of O_2 evolution at different levels of low irradiance, and the maximum quantum yield of PS II determined with chlorophyll fluorescence (F_v/F_m , $\phi_{II,m}$). Measurements were made on *Glycine max* (soybean) grown at high (open symbols) and low (filled symbols) N supply and exposed to high light for different periods prior to measurement (after Kao & Forseth 1992).

and is therefore only evident during daytime; it is supposed to be involved in protection of PS II against over-excitation. The slow-relaxing component remains several days and is considered as an indication of (longer-lasting) damage to PS II. Such damage can be the result of sudden exposure of shade leaves to full sun light, or a combination of high irradiance and extreme (high or low) temperature. The way plants cope with this combination of stress factors determines their performance in particular habitats where such conditions occur.

Quantum yield in light ($\Delta F/F_m'$) can be used to derive the rate of electron transport (J_F).

$$J_F = I \Delta F / F_m' \text{ abs } 0.5 \quad (10)$$

where I is the irradiance and abs is the photon absorption by the leaf and 0.5 refers to the equal partitioning of photons between the two photosystems (Genty et al. 1989). For comparison of J_F with photosynthetic gas-exchange rates, the rate of the carboxylation (V_c) and oxygenation (V_o) reaction of Rubisco must be known. In C_4 plants and in C_3 plants at low O_2 and/or high CO_2 , V_o is low and can be ignored. Hence, the rate of electron transport can also be derived from the rate of O_2 production or CO_2 uptake (J_c). For a comparison of J_F with J_c in normal air in C_3 plants, V_o must be estimated from the intercellular partial pressure of CO_2 (Box 2A.1). Photosynthetic rates generally show good correlations with J_F (Fig. 3). J_F may be somewhat higher than J_c (Fig. 3). This can be ascribed to electron flow associated with nonassimilatory processes, or with assimilatory processes that do not result in CO_2 absorption, such as nitrate reduction. Alternatively, the chloroplast population monitored by fluorescence is not representative for the functioning of all chloroplasts across the whole leaf depth. The good correlation of gas exchange and fluorescence data in many cases indicates that J_F is representative for the whole-leaf photosynthetic rate, at least in a relative sense. Hence, J_F is also referred to as the relative rate of electron transport.

continued

Box 2A.4 Continued

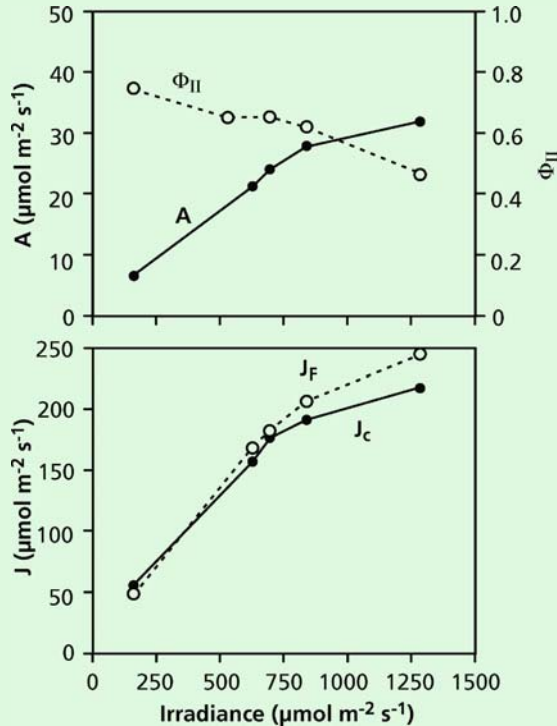

FIGURE 3. Relationship of chlorophyll fluorescence parameters and rates of CO_2 assimilation in the C_3 plant *Flaveria pringlei*. A = rate of CO_2 assimilation; Φ_{II} = quantum yield of PS II in light (F/F_m); J_F =

electron-transport rate calculated from Φ_{II} and irradiance; J_c = electron-transport rate calculated from gas-exchange parameters (after Krall & Edwards 1992). Copyright Physiologia Plantarum.

dissipation process also requires a special **photosystem II subunit S (PsbS)** (Li et al. 2002). Mutants of *Arabidopsis thaliana* (thale cress) that are unable to convert violaxanthin to zeaxanthin in excessive light exhibit greatly reduced nonphotochemical quenching, and are more sensitive to photoinhibition than wild-type plants (Niyogi et al. 1998). Similarly, PsbS-deficient mutants have a reduced fitness at intermittent, moderate levels of excess light (Külheim et al. 2002).

Zeaxanthin triggers a kind of “lightning rod” mechanism. It is involved in the induction of conformational changes in the light-harvesting antennae of PS II which facilitates the dissipation of excess excitations (Fig. 17; Pascal et al. 2005). This energy dissipation can be measured by chlorophyll fluorescence (Box 2A.4) and is termed

high-energy-dependent or pH-dependent fluorescence quenching. In the absence of a properly functioning **xanthophyll cycle**, excess energy could, among others, be passed on to O_2 . This leads to photooxidative damage when scavenging mechanisms cannot deal with the resulting **reactive oxygen species (ROS)**. For example, **herbicides** that inhibit the synthesis of carotenoids cause the production of vast amounts of ROS that cause chlorophyll to bleach and thus kill the plant (Wakabayashi & Böger 2002). In the absence of any inhibitors, ROS inhibit the repair of PS II, in particular the synthesis of the **D1 protein** of PS II, by their effect on mRNA translation. It is a normal phenomenon when plants are exposed to full sunlight even in the absence of other stress factors (Nishiyama et al. 2006).

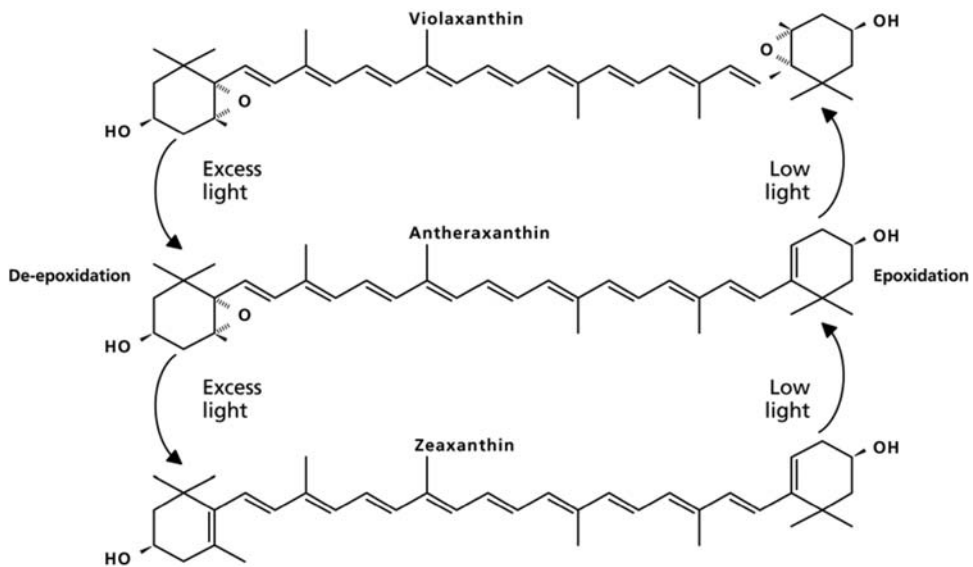

FIGURE 16. Scheme of the xanthophyll cycle and its regulation by excess or limiting light. Upon exposure to excess light, a rapid stepwise removal (de-epoxidation) of two oxygen functions (the epoxy groups) in violaxanthin takes place; the pH optimum of this reaction, which is catalyzed a de-epoxidase, is acidic. This de-epoxidation results in a lengthening of the conjugated

system of double bonds from 9 in violaxanthin to 10 and 11 in antheraxanthin and zeaxanthin, respectively. The de-epoxidation step occurs in minutes. Under low-light conditions, the opposite process, epoxidation, takes place. It may take minutes, hours, or days, depending on environmental conditions (Demmig-Adams & Adams 1996, 2006).

However, when shade plants are exposed to full sunlight, or when other stresses combine with high irradiance (e.g., desiccation, high or low temperature) then more excessive damage can occur, involving destruction of membranes and oxidation of chlorophyll (bleaching), causing a longer-lasting reduction in photosynthesis.

In sun-exposed sites, diurnal changes in irradiance are closely tracked by the level of **antheraxanthin** and **zeaxanthin**. In shade conditions, sunflecks lead to the rapid appearance of antheraxanthin and zeaxanthin and reappearance of **violaxanthin** between subsequent sunflecks. This regulation mechanism ensures that no competing dissipation of energy occurs when light is limiting for photosynthesis, whereas damage is prevented when light is absorbed in excess. Typically, sun-grown plants not only contain a larger fraction of the carotenoids as zeaxanthin in high light, but their total pool of **carotenoids** is larger also (Fig. 18; Adams et al. 1999). The pool of reduced **ascorbate**, which plays a role in the xanthophyll cycle (Fig. 17), is also several-fold greater in plants acclimated to high light (Logan et al. 1996).

3.3.2 Chloroplast Movement in Response to Changes in Irradiance

The leaf's absorbance is affected by the concentration of chlorophyll in the leaf and the path length of light in the leaf, as well as by the location of the chloroplasts. **Light-induced movements** of chloroplasts are affected only by wavelengths below 500 nm. High intensities in this wavelength region cause the chloroplasts to line up along the vertical walls, parallel to the light direction, rather than along the lower cell walls, perpendicular to the direction of the radiation, as in control leaves. Chloroplasts are anchored with **actin networks** and their final positioning relies on connections to actin (Staijer et al. 1997). Chloroplast movements are pronounced in aquatic plants, such as *Vallisneria gigantea* (giant vallis) and shade-tolerant understory species, such as *Oxalis oregana* (redwood sorrel) where they may decrease the leaf's absorbance by as much as 20%, thereby increasing both transmittance and reflectance. Other species [e.g., the shade-avoiding *Helianthus annuus* (sunflower)] show no blue light-induced chloroplast movement or change

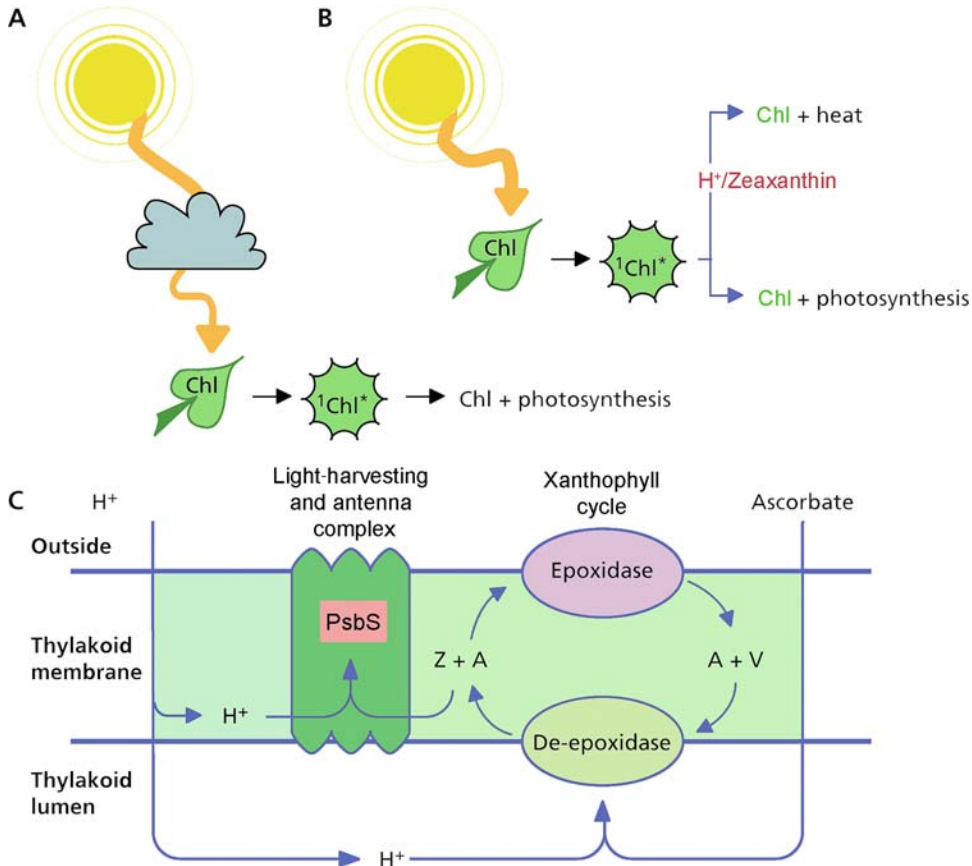

FIGURE 17. *Top*: Depiction of the conditions where (A) all or (B) only part of the sunlight absorbed by chlorophyll within a leaf is used for photosynthesis. Safe dissipation of excess energy requires the presence of zeaxanthin as well as a low pH in the photosynthetic membranes. The same energized form of chlorophyll is used either for photosynthesis or loses its energy as heat. *Bottom*: Depiction of the regulation of the biochemistry of the xanthophyll cycle as well as the induction of xanthophyll-cycle-dependent energy dissipation by pH. De-epoxidation to antheraxanthin (A) and

zeaxanthin (Z) from violaxanthin (V), catalyzed by a de-epoxidase with an acidic pH optimum, takes place at a low pH in the lumen of the thylakoid as well in the presence of reduced ascorbate. Protonation of a residue of a photosystem II subunit S (PsbS) is essential for the functioning of the cycle. In addition, a low pH of certain domains within the membrane, together with the presence of zeaxanthin or antheraxanthin, is required to induce the actual energy dissipation. This dissipation takes place within the light-collecting antenna complex of PS II (modified after Demmig-Adams & Adams 1996).

in absorbance. Chloroplast movements in shade plants exposed to high light avoid photoinhibition (Brugnoli & Björkman 1992).

3.4 Responses to Variable Irradiance

So far we have discussed mostly steady-state responses to light, meaning that a particular environmental condition is maintained until a constant response is achieved. Conditions in the real world,

however, are typically not constant, irradiance being the most rapidly varying environmental factor. Since photosynthesis primarily depends on irradiance, the dynamic response to variation in irradiance deserves particular attention.

The irradiance level above a leaf canopy changes with time of day and with cloud cover, often by more than an order of magnitude within seconds. In a leaf canopy, irradiance, particularly direct radiation, changes even more. In a forest, direct sunlight may penetrate through holes in

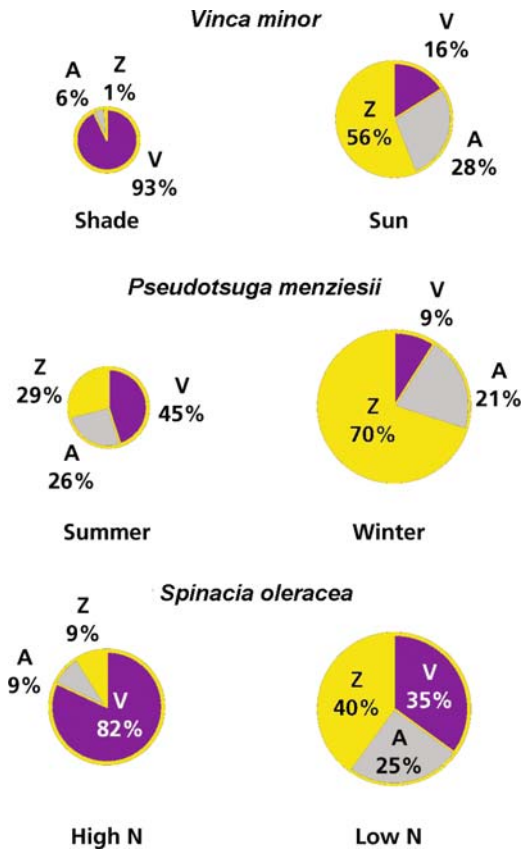

FIGURE 18. Differences in zeaxanthin (Z), violaxanthin (V) and antheraxanthin (A) contents of leaves upon acclimation to the light level [*Vinca minor* (periwinkle)], season [*Pseudotsuga menziesii* (Douglas fir)] and N supply [*Spinacia oleracea* (spinach)]. The total areas reflect the concentration of the three carotenoids relative to that of chlorophyll (after Demmig-Adams & Adams 1996).

the overlying leaf canopy, casting **sunflecks** on the forest floor. These move with wind action and position of the sun, thus exposing both leaves in the canopy and shade plants in the understory to short periods of bright light. Sunflecks typically account for 40–60% of total irradiance in understory canopies of dense tropical and temperate forests and are quite variable in duration and intensity (Chazdon & Pearcy 1991).

3.4.1 Photosynthetic Induction

When a leaf that has been in darkness or low light for hours is transferred to a saturating level of

irradiance, the photosynthetic rate increases only gradually over a period of up to one hour to a new steady-state rate (Fig. 19), with stomatal conductance increasing more or less in parallel. We cannot conclude, however, that limitation of photosynthesis during induction is invariably due to stomatal opening (Allen & Pearcy 2000). If stomatal conductance limited photosynthesis, the intercellular CO_2 concentration (C_i) should drop immediately upon transfer to high irradiance, but, in fact, there is a more gradual decline over the first minutes, and then a slow increase until full induction (Fig. 19). Stomatal patchiness might play a role (Sect. 5.1), but there are also additional limitations at the chloroplast level. The demand for CO_2 increases faster than the supply in the first minutes as evident from the initial decline in C_i . Its subsequent rise indicates that the supply increases faster than the demand, as shown in Fig. 20, where A_n is plotted as a function of C_i during photosynthetic induction. During the first one or two minutes there is a fast increase in demand for CO_2 (fast induction component) which is due to fast light induction of some Calvin-cycle enzymes and build-up of metabolite pools (Sassenrath-Cole et al. 1994). The slower phase of increase in demand until approximately 10 minutes is dominated by the light-activation of Rubisco. After that, C_i increases and A_n increases along the A_n - C_i curve, indicating that a decrease in stomatal limitation dominates further rise in photosynthetic rate (Fig. 20).

Loss of photosynthetic induction occurs in low light, but at a lower rate than induction in high light, particularly in forest understory species. Hence, in a sequence of sunflecks, photosynthetic induction increases from one sunfleck to the next, until a high induction state is reached, when sunflecks can be used efficiently (Fig. 19).

3.4.2 Light Activation of Rubisco

Rubisco, as well as other enzymes of the Calvin cycle, are **activated by light**, before they have a high catalytic activity (Fig. 21; Portis 2003). The increase in Rubisco activity, due to its activation by light, closely matches the increased photosynthetic rate at a high irradiance apart from possible stomatal limitations. Two mechanisms are involved in the activation of Rubisco. Firstly, CO_2 binds covalently to a lysine residue at the enzyme's active site (**carbamylation**), followed by binding of Mg^{2+} and RuBP. In this activated state, Rubisco is able to catalyze the reaction with CO_2 or O_2 . Rubisco is **deactivated** when (1) RuBP binds to a decarbamylated

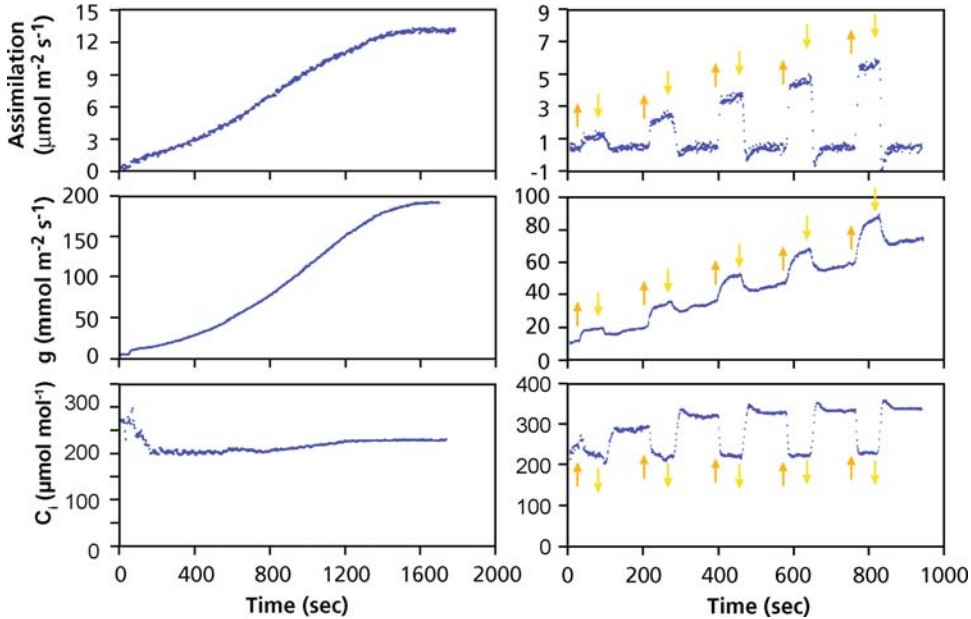

FIGURE 19. Photosynthetic induction in *Toona australis*, which is an understory species from the tropical rainforest in Australia. (*Left panels*) Time course of the rate of CO₂ assimilation (A_n) (*top*), stomatal conductance (g_s) (*middle*), and the intercellular CO₂ concentration (C_i) (*bottom*) of plants that were first exposed to a low

irradiance level and then transferred to high saturating irradiance. (*Right panels*) Leaves are exposed to five “sunflecks”, indicated by arrows, with a low background level of irradiance in between (Chazdon & Pearcy 1986).

Rubisco, (2) 2-carboxy-D-arabinitol 1-phosphate (CA1P), an analogue of the extremely short-lived intermediate of the RuBP carboxylation reaction,

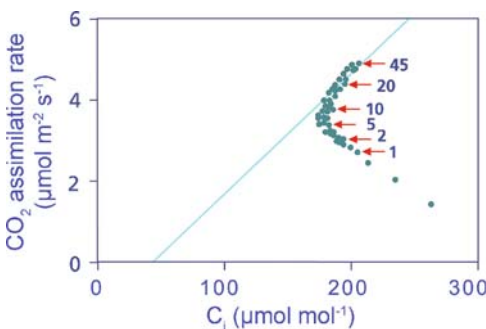

FIGURE 20. Photosynthetic response of *Alocasia macro-rhiza* (giant taro) to intercellular CO₂ concentration (C_i) during the induction phase after a transition from an irradiance level of 10 to 500 $\mu\text{mol m}^{-2} \text{s}^{-1}$ (light saturation). The solid line represents the A_n - C_i relationship of a fully induced leaf calculated as Rubisco-limited rates. Numbers indicate minutes after transition (after Kirschbaum & Pearcy 1988).

binds to the carbamylated Rubisco, and (3) a product produced by the catalytic “misfire” of Rubisco (“misprotonation”), xylulose-1,5-bisphosphate (Salvucci & Crafts-Brandner 2004a), binds to a carbamylated Rubisco. Secondly, **Rubisco activase** plays a role in catalyzing the dissociation of inhibitors from the active site of Rubisco; its activity increases with increasing rate of electron transport (Fig. 21). The activity of Rubisco activase is regulated by ADP/ATP and redox changes mediated by thioredoxin in some species.

Light activation of Rubisco, a natural process that occurs at the beginning of the light period in all plants, is an important aspect of the regulation (fine-tuning) of photosynthesis. In the absence of such light activation, the three phases of the Calvin cycle (carboxylation, reduction, and regeneration of RuBP) may compete for substrates, leading to oscillation of the rate of CO₂ fixation upon the beginning of the light period. It may also protect active sites of Rubisco during inactivity in darkness (Portis 2003), but the regulation mechanism occurs at the expense of low rates of CO₂ assimilation during periods of low induction.

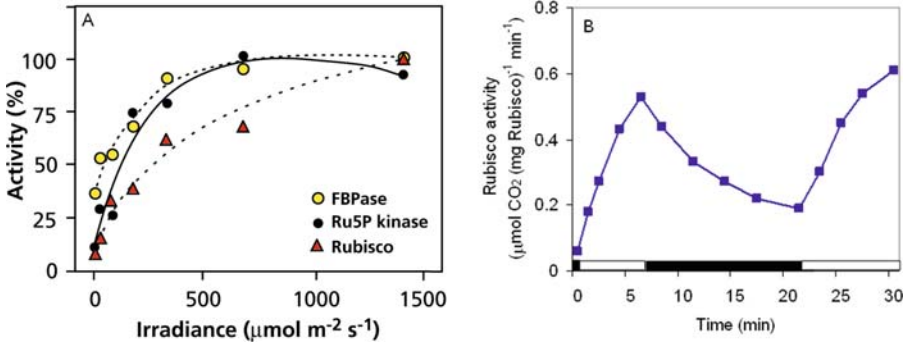

FIGURE 21. (A) Light activation of Rubisco and two other Calvin cycle enzymes, Ribulose-5-phosphate kinase and fructose-bisphosphatase (Salvucci 1989). Copyright Physiologia Plantarum. (B) Time course of Rubisco

activation level during sequential light (open symbols) and dark (filled symbols) periods (after Portis et al. 1986). Copyright American Society of Plant Biologists.

3.4.3 Post-illumination CO_2 Assimilation and Sunfleck-Utilization Efficiency

The rate of O_2 evolution, the product of the first step of electron transport, stops immediately after a sunfleck, whereas CO_2 assimilation continues for a brief period thereafter. This is called **post-illumination CO_2 fixation** (Fig. 22). CO_2 assimilation in the Calvin cycle requires both NADPH and ATP, which are generated during the light reactions. Particularly in short sunflecks, this post-illumination CO_2 fixation is important relative to photosynthesis during the sunfleck, thus increasing total CO_2 assimilation due to the sunfleck above what would be expected from steady-state measurements (Fig. 23).

CO_2 assimilation due to a sunfleck also depends on **induction state**. Leaves become increasingly induced with longer sunflecks of up to a few

minutes (Fig. 25). At low induction states, sunfleck-utilization efficiency decreases below what would be expected from steady-state rates (Fig. 23). Forest understory plants tend to utilize sunflecks more efficiently than plants from short vegetation, particularly flecks of a few seconds to a few minutes. Accumulation of larger Calvin-cycle metabolite pools and longer maintenance of photosynthetic induction are possible reasons. Efficient utilization of sunflecks is crucial for understory plants, since most radiation comes in the form of relatively long-lasting sunflecks, and half the plant's assimilation may depend on these short periods of high irradiance.

3.4.4 Metabolite Pools in Sun and Shade Leaves

As explained in Sect. 2.1.3, the photophosphorylation of ADP depends on the proton gradient across

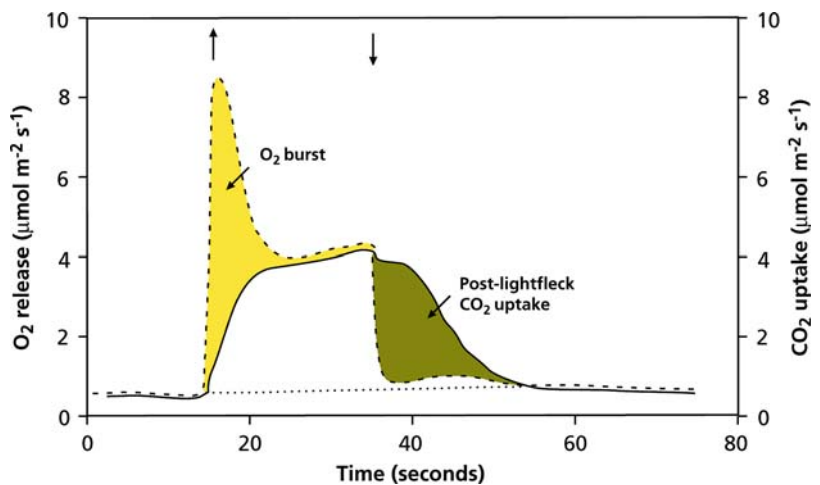

FIGURE 22. CO_2 uptake and O_2 release in response to a "sunfleck". Arrows indicate the beginning and end of the "sunfleck" (Percy 1990). With kind permission from the Annual Review of Plant Physiology Plant Molecular Biology, Vol. 41, copyright 1990, by Annual Reviews Inc.

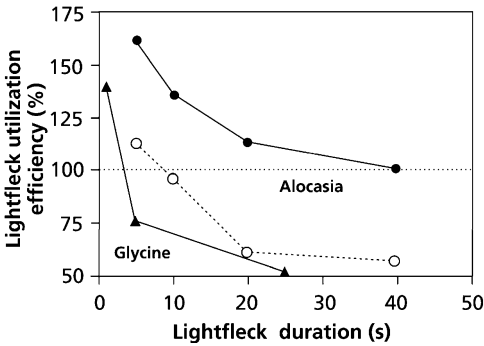

FIGURE 23. Efficiency of “sunfleck” utilization as dependent on duration of the “sunfleck” and induction state in two species. *Alocasia macrorrhiza* (giant taro, an understory species) measured at high (closed symbols) and low induction state (open symbols). Induction state of *Glycine max* (soybean, a sun species) is approximately 50% of maximum. Efficiencies are calculated as total CO₂ assimilation due to the sunfleck relative to that calculated from the steady-state rates at the high irradiance (sunfleck) and the low (background) irradiance (Pearcy 1988, Pons & Pearcy 1992).

the thylakoid membrane. This gradient is still present immediately following a sunfleck, and ATP can therefore still be generated for a brief period. The formation of NADPH, however, directly depends on the flux of electrons from water, via the photosystems and the photosynthetic electron-transport chain, and therefore comes to an immediate halt after the sunfleck. Moreover, the concentration of NADPH in the cell is too low to sustain Calvin-cycle activity. Storage of the reducing equivalents takes place in **triose-phosphates** (Table 3), which are intermediates of the Calvin cycle.

To allow the storage of reducing power in intermediates of the Calvin cycle, the phosphorylating step leading to the substrate for the reduction reaction must proceed. This can be realized by regulating the activity of two enzymes of the Calvin cycle which both utilize ATP: phosphoglycerate kinase and ribulose-phosphate kinase (Fig. 4). When competing for ATP in vitro, the second kinase tends to dominate, leaving little ATP for phosphoglycerate kinase. If this were to happen in vivo as well, no storage of reducing equivalents in triose-phosphate would be possible, and CO₂ assimilation would not continue beyond the sunfleck. The concentration of triose-phosphate at the end of a

TABLE 3. The potential contribution of triose-phosphates and ribulose-1,5-bisphosphate to the post-illumination CO₂ assimilation of *Alocasia macrorrhiza* (giant taro) and *Phaseolus vulgaris* (common bean), grown either in full sun or in the shade.*

	<i>Alocasia macrorrhiza</i>		<i>Phaseolus vulgaris</i>	
	Shade	Sun	Shade	Sun
RuBP ($\mu\text{mol m}^{-2}$)	2.0	14.5	2.9	5.3
Triose phosphates ($\mu\text{mol m}^{-2}$)	16.3	18.0	19.8	10.5
Total potential CO ₂ fixation ($\mu\text{mol m}^{-2}$)	12	25	15	12
Potential efficiency (%)	190	204	154	120
Triose-P/RuBP	4.9	0.7	4.1	1.2
Post-illumination ATP required ($\mu\text{mol g}^{-1}$ Chl)	13	22	63	29

Source: Sharkey et al. (1986a).

*The values for the intermediates give the difference in their pool size at the end of the lightfleck and 1 min later. The total potential CO₂ assimilation is RuP₂ + 3/5 triose-P pool size. The potential efficiency was calculated on the assumption that the rate of photosynthesis during the 5 s lightfleck was equal to the steady-state value measured after 20 minute in high light.

sunfleck is relatively greater in shade leaves than in sun leaves, whereas the opposite is found for ribulose-1,5-bisphosphate (Table 3). This indicates that the activity of the steps in the Calvin cycle leading to ribulose-phosphate is suppressed. Thus competition for ATP between the kinase is prevented, and the reducing power from NADPH can be transferred to 1,3-bisphosphoglycerate, leading to the formation of triose-phosphate. Storage of reducing power occurs in species that are adapted to shade, e.g., *Alocasia macrorrhiza* (giant taro), as well as in leaves acclimated to shade, e.g., shade leaves of common bean (*Phaseolus vulgaris*).

3.4.5 Net Effect of Sunflecks on Carbon Gain and Growth

Although most understory plants can maintain a positive carbon balance with diffuse light in the absence of sunflecks, daily carbon assimilation and growth rate in moist forests correlates closely with irradiance received in sunflecks (Fig. 24). Moreover, sunflecks account for an increasing proportion of total carbon gain (9–46%) as their size and frequency increase. In dry forests, where understory plants experience both light and water limitation, sunflecks may reduce daily carbon gain on cloud-free days (Allen & Pearcy 2000). Thus, the net impact of

sunflecks on carbon gain depends on both cumulative irradiance and other potentially limiting factors.

4. Partitioning of the Products of Photosynthesis and Regulation by “Feedback”

4.1 Partitioning Within the Cell

Most of the products of photosynthesis are exported out of the chloroplast to the cytosol as **triose-phosphate** in exchange for P_i . Triose-phosphate is the substrate for the synthesis of sucrose in the cytosol (Fig. 25) and for the formation of cellular components in the **source** leaf. Sucrose is largely exported to other parts (**sinks**) of the plant, via the phloem.

Partitioning of the products of the Calvin cycle within the cell is controlled by the concentration of P_i in the cytosol. If this concentration is high, rapid exchange for triose-phosphate allows export of most of the products of the Calvin cycle. If the concentration of P_i drops, the exchange rate will decline, and the concentration of triose-phosphate in the chloroplast increases. Inside the chloroplasts, the triose-phosphates are used for the synthesis of **starch**, releasing P_i within the chloroplast. So, the partitioning of the products of photosynthesis between export to the cytosol and storage compounds in the chloroplasts is largely determined by the availability of P_i in the cytosol. This regulation can be demonstrated by experiments using leaf discs in which the concentration of cytosolic P_i is manipulated (Table 4).

In intact plants the rate of photosynthesis may also be reduced when the plant’s demand for carbohydrate (reduced sink strength) is decreased, for example by the removal of part of the fruits or “girdling” of the petiole (Table 4). [Girdling involves damaging the phloem tissue of the stem, either by a temperature treatment or mechanically, leaving the xylem intact.] Restricting the export of assimilates by reduced sink capacity or more directly by blocking the phloem sequesters the cytosolic P_i in phosphorylated sugars, leading to **feedback inhibition** of photosynthesis. When the level of P_i in the cytosol is increased, by floating the leaf discs on a phosphate buffer, the rate of photosynthesis may also drop [e.g., in *Cucumis sativus* (cucumber) Table 4], but there is no accumulation of starch. This is likely due to the very rapid export of triose-phosphate from the chloroplasts, in exchange for P_i , depleting the Calvin cycle of intermediates.

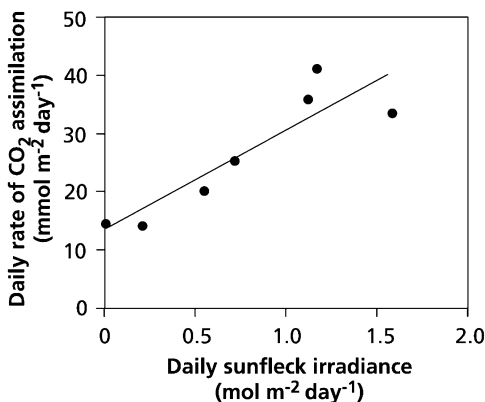

FIGURE 24. (A) Total carbon gain of *Adenocaulon bicolor* as a function of daily photon flux contributed by sunflecks in the understory of a temperate redwood forest. (B) Relative growth rate of *Euphorbia forbesii* (filled circles) and *Claoxylon sandwicense* (open circles) as a function of average duration of potential sunflecks (estimated from hemispherical photographs) in the understory of a tropical forest (after Chazdon & Pearcy 1991).

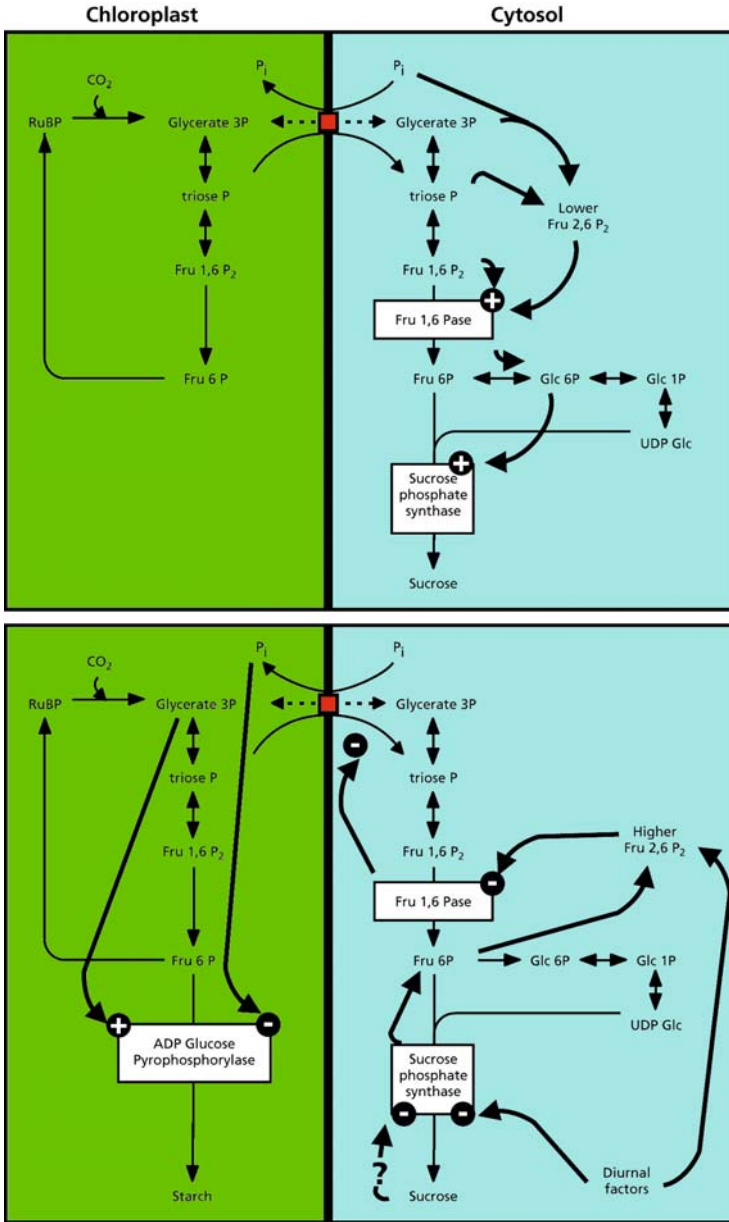

FIGURE 25. The formation of triose-phosphate in the Calvin cycle. Triose-P is exported to the cytosol, in exchange for inorganic phosphate (P_i), or used as a substrate for the synthesis of starch in the chloroplast.

4.2 Short-Term Regulation of Photosynthetic Rate by Feedback

Under conditions of “feedback inhibition” (Sect. 4.1), phosphorylated intermediates of the pathway leading to sucrose accumulate, inexorably decreasing the cytosolic P_i concentration. In the absence of sufficient P_i in the chloroplast, the formation of ATP is reduced and the activity of the Calvin cycle declines. That is, less intermediates are available and less

RuBP is regenerated, so that the carboxylating activity of Rubisco and hence the rate of photosynthesis drops.

How important is feedback inhibition in plants whose sink has not been manipulated? To answer this question, we can determine the O₂ sensitivity of photosynthesis. Normally, the rate of net CO₂ assimilation increases when the O₂ concentration is lowered from a normal 21% to 1 or 2%, due to the suppression of the oxygenation reaction. When the

TABLE 4. Rates of CO₂ assimilation ($\mu\text{mol m}^{-2}\text{s}^{-1}$) and the accumulation of ¹⁴C in soluble sugars ("ethanol-soluble") and starch ("HClO₄-soluble") (¹⁴C as % of total ¹⁴C recovered) in leaf discs of *Gossypium hirsutum* (cotton) and *Cucumis sativus* (cucumber) floating on a Tris-maleate buffer, a phosphate buffer, or a mannose solution.*

	Control			Girdled		
	CO ₂ Fixation	Ethanol-Soluble	HClO ₄ -Soluble	CO ₂ Fixation	Ethanol-Soluble	HClO ₄ Soluble
Cotton						
Tris-maleate	18	83	17	12	76	24
Phosphate	18	87	13	10	83	17
Mannose	12	54	46	10	76	24
Cucumber						
Tris-maleate	13	76	24	6	40	60
Phosphate	9	82	18	5	76	24
Mannose	9	55	45	4	40	60

Source: Plaut et al. (1987).

* Leaves were taken from control plants ("control") or from plants whose petioles had been treated in such a way as to restrict phloem transport ("girdled"). The concentration of cytosolic P_i can be decreased by incubating leaf discs in a solution containing mannose. Mannose is readily taken up and enzymatically converted into mannose phosphate, thus sequestering some of the P_i originally present in the cytosol. Under these conditions starch accumulates in the chloroplasts. At extremely low cytosolic P_i concentrations, the rate of photosynthesis is also reduced. When leaf discs are taken from plants with reduced sink capacity, the addition of mannose has very little effect, because the cytosolic P_i concentration is already low before mannose addition.

activity of Rubisco is restricted by the regeneration of RuBP, lowering the O₂ concentration enhances the net rate of CO₂ assimilation to a lesser extent. Feedback inhibition is found at a high irradiance and also at a low temperature, which restricts phloem loading. Under these conditions the capacity to assimilate CO₂ exceeds the capacity to export and further metabolize the products of photosynthesis. Consequently, phosphorylated intermediates of the pathway from triose-phosphate to sucrose accumulate which sequesters phosphate. As a result, P_i starts to limit photosynthesis, and the rate of photosynthesis declines as soon as the capacity to channel triose-phosphate to starch is saturated. Figure 26, showing the response of the net rate of CO₂ assimilation to N₂ + CO₂ at four levels of irradiance and a leaf temperature of 15°C, illustrates this point.

The assessment of feedback inhibition of photosynthesis using the O₂ sensitivity of this process is complicated by the fact that the relative activities of the carboxylating and oxygenating reactions of Rubisco also depend on temperature (Sect. 7.1). To resolve this problem, a mathematical model of photosynthesis has been used (Box 2A.1). This model incorporates biochemical information on the photosynthetic reactions and simulates the effect of

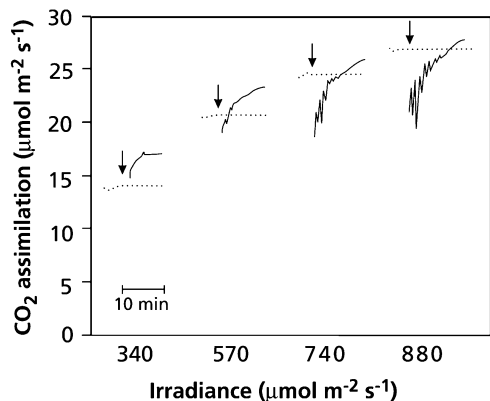

FIGURE 26. The response of the CO₂ assimilation rate to a change in O₂ concentration at four levels of irradiance. The broken lines give the steady-state rate of CO₂ assimilation. The gas phase changes from air to N₂ + CO₂ at the time indicated by the arrows. The CO₂ concentration in the atmosphere surrounding the leaf is maintained at 550 $\mu\text{mol mol}^{-1}$ and the leaf temperature at 15°C. At a relatively low irradiance (340 $\mu\text{mol m}^{-2}\text{s}^{-1}$) the rate of CO₂ assimilation is rapidly enhanced when the O₂ concentration is decreased, whereas at high irradiance (880 $\mu\text{mol m}^{-2}\text{s}^{-1}$), CO₂ assimilation first decreases and is only marginally enhanced after several minutes, indicative of feedback inhibition (after Sharkey et al. 1986b). Copyright American Society of Plant Biologists.

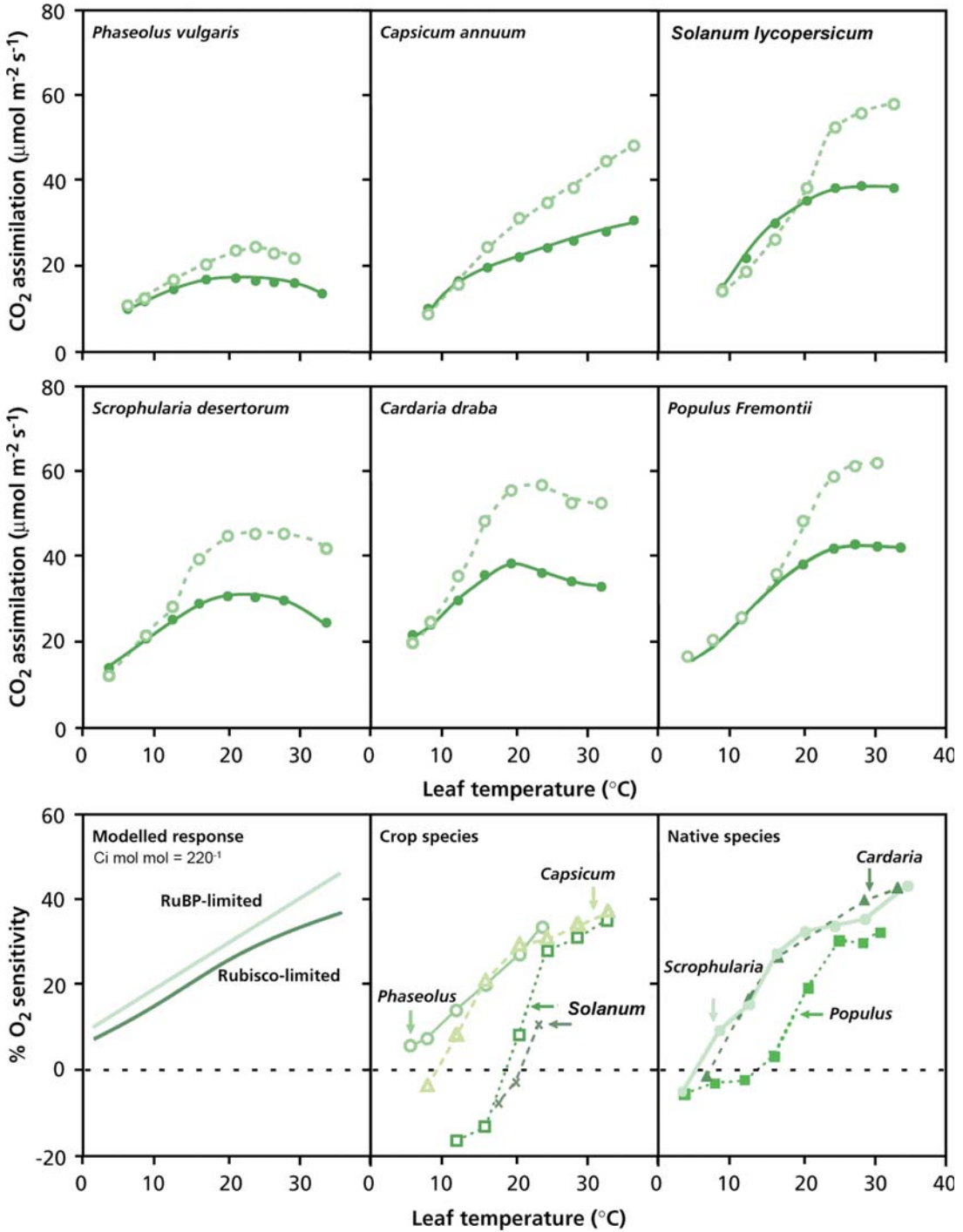

FIGURE 27. The effect of temperature on the net rate of photosynthesis (*bottom*) for a number of species. All plants were grown outdoors (after Sage & Sharkey 1987). Copyright American Society of Plant Biologists.

lowering the O₂ concentration at a range of temperatures. Comparison of the observed effect of the decrease in O₂ concentration (Fig. 27, lower middle and right panels) with the experimental observations (Fig. 27, lower left panel), allows conclusions on the extent of feedback inhibition in plants under normal conditions. The lower right panels show distinct feedback inhibition for *Solanum lycopersicum* (tomato) and *Populus fremontii* (Fremont cottonwood) at low temperatures, and less feedback inhibition for *Phaseolus vulgaris* (common bean), *Capsicum annuum* (pepper), *Scrophularia desertorum* (figwort), and *Cardaria draba* (hoary cress).

Comparison of the modeled results in the lower left panel with the experimental results in the other lower panels in Fig. 27 shows that photosynthesis of plants growing under natural conditions can be restricted by feedback, especially at relatively low temperatures. Feedback inhibition is predominantly associated with species accumulating starch in their chloroplasts, rather than sucrose and hexoses in the cytosol and vacuoles. Since genetically transformed plants of the same species, lacking the ability to store starch, behave like the starch-accumulating wild type, the reason for this difference remains obscure (Goldschmidt & Huber 1992). Perhaps it reflects the mode of phloem loading (i.e., either symplastic or apoplastic; Chapter 2C on long-distance transport).

4.3 Sugar-Induced Repression of Genes Encoding Calvin-Cycle Enzymes

The feedback mechanism outlined in Sect. 4.2 operates in the short term, adjusting the activity of the existing photosynthetic apparatus to the capacity of export and sink activity, but mechanisms at the level of **gene transcription** play a more important role in the long term. They modify photosynthetic capacity and can override regulation by light, tissue type, and developmental stage (Smeekens & Rook 1998). Leaves of *Triticum aestivum* (wheat) fed with 1% glucose have a lower photosynthetic capacity as well as lower levels of mRNA coding for several Calvin-cycle enzymes, including the small subunit of Rubisco (Jones et al. 1996). Regulation of photosynthetic gene expression by **carbohydrates** plays an important role in the control of the activity of the “source” (leaves) by the demand in the “sink” (e.g., fruits) (Paul & Foyer 2001). Sensing of carbohydrate levels is mediated by a specific **hexokinase**, which is an enzyme that phosphorylates hexose while hydrolyzing ATP (Smeekens 2000). This regulation at the level of gene transcription plays a role in the

acclimation of the photosynthetic apparatus to elevated concentrations of atmospheric CO₂ (Sect. 12), and, more generally in adjusting photosynthetic capacity to environmental and developmental needs.

4.4 Ecological Impacts Mediated by Source-Sink Interactions

Many ecological processes affect photosynthesis through their impact on plant demand for carbohydrate (Sect. 4.2). In general, processes that increase carbohydrate demand increase the rate of photosynthesis, whereas factors that reduce demand reduce photosynthesis.

Although defoliation generally reduces carbon assimilation by the defoliated plant by reducing the biomass of photosynthetic tissue, it may cause a compensatory increase in photosynthetic rate of remaining leaves through several mechanisms. The increased sink demand for carbohydrate generally leads to an increase in A_{\max} in the remaining leaves. Defoliation also reduces environmental constraints on photosynthesis by increasing light penetration through the canopy, and by increasing the biomass of roots available to support each remaining leaf. The resulting increases in light and water availability may enhance photosynthesis under shaded and dry conditions, respectively.

Growth at elevated atmospheric [CO₂] may lead to a down-regulation of photosynthesis, involving sensing of the leaves' carbohydrate status (Sect. 12.1), and other ecological factors discussed here probably act on photosynthesis in a similar manner. Box 2A.5 provides a brief overview of gas-exchange equipment, especially portable equipment that can be used in the field for ecological surveys.

5. Responses to Availability of Water

The inevitable loss of water, when the stomata are open to allow photosynthesis, may lead to a decrease in leaf relative water content (RWC), if the water supply from roots does not match the loss from leaves. The decline in RWC may directly or indirectly affect photosynthesis. In this section we describe effects of the water supply on photosynthesis, and discuss genetic adaptation and phenotypic acclimation to water shortage.

Box 2A.5 The Measurement of Gas Exchange

The uptake and release of CO₂ in photosynthesis and respiration and the release of H₂O during transpiration of plants or leaves is measured using gas-exchange systems. Several types exist (e.g., Field et al. 1989, Long & Hällgren 1993). Here we briefly address the operation of so-called open systems and potential complications with their use, with particular attention to the now commonly used portable systems that are commercially available.

The essence of a gas-exchange system is a transparent chamber that encloses the photosynthetically active tissue. Air enters the chamber at a specified flow rate (f_m) measured and controlled by a flow-controller. The leaf changes the concentrations of CO₂ and H₂O inside the chamber. The magnitude of the difference in CO₂ and H₂O concentration between the air entering the chamber (C_e and W_e) and at the outlet (C_o and W_o) depends on its gas-exchange activity. The net photosynthetic rate (A_n) is then calculated following Von Caemmerer & Farquhar (1981).

$$A_n = f_m/L_a \{C_e - C_o(1 - W_e)/(1 - W_o)\} \quad (1)$$

A_n is expressed per unit leaf area (L_a), but another basis, e.g., dry mass can also be used. The last part of the equation refers to the correction for the volume increase and, consequently, concentration decrease caused by the simultaneously occurring transpiration (E). E can be calculated similarly by substituting W_e and W_o for C_e and C_o . When leaf temperature is also measured, stomatal conductance (g_s) can be calculated using E and assuming a saturated vapor pressure in the intercellular spaces of the leaf. From g_s and A_n , intercellular CO₂ concentration (C_i) can be calculated. The principle is explained in Sect. 2.2.2, but corrections are necessary (Von Caemmerer & Farquhar 1981). The calculations assume homogeneity of parameter values across the measured area. A powerful analysis of photosynthetic performance can be made when these four gas-exchange parameters are available, as explained in the text. A further development is the combination of gas-exchange with the measurement of chlorophyll

fluorescence (Box 2A.4) that gives a measure of electron-transport rate allowing estimates of the CO₂ concentration in the chloroplast (C_c), conductance for CO₂ transport in the mesophyll (g_m), photorespiration, and engagement of alternative electron sinks (Long & Bernacchi 2003).

A typical leaf chamber contains a fan that homogenizes the air which makes C_o and W_o representative of the air around the leaf (C_a and W_a , respectively). The fan further increases the boundary layer conductance (Chapter 4A), which allows a better control of leaf temperature and reduces possible errors associated with the estimation of g_s . It further contains a sensor for leaf and/or air temperature and a light sensor is attached. Most of the recent models of portable systems are also equipped with temperature control. Concentrations of CO₂ and H₂O at the inlet and outlet of the leaf chamber are measured with an infra-red gas analyzer (IRGA). The concentration of CO₂ and H₂O can be manipulated in the more advanced models that are also equipped with a light source. The systems are completed with computerized control, data-acquisition and data-processing. This versatile equipment can be used to measure photosynthetic performance in ambient conditions and for measuring the response of gas-exchange activity to environmental factors such as humidity, CO₂, temperature and light.

The ease of gas-exchange measurement brings the danger of less critical use. Some sources of error and guidelines for their avoidance are given by Long & Bernacchi (2003); here, the most important problems are addressed. Modern systems have small chambers that clamp with gaskets on a leaf, thus limiting the measurement to a part of the leaf. This has the advantage that also small leaves can easily be measured and that the condition of homogeneity mentioned above is more easily met. However, the use of a small area has its draw-backs. In these chambers, a significant part of the leaf is covered by the gasket. The leaf area under the gasket continues to respire, and part of the CO₂ produced diffuses to the leaf chamber where it

continued

Box 2A.5 Continued

results in overestimation of respiration rates (Pons & Welschen 2002). In homobaric leaves, air can escape through the intercellular spaces depending on the overpressure in the chamber which complicates matters further (Jahnke & Pieruschka 2006). CO_2 and H_2O can also diffuse through the gasket, and more likely along the interface between gasket and leaf. This is particularly important when concentrations inside and outside the chamber are different, such as when measuring a CO_2 response and at high humidity in a dry environment (Flexas et al. 2007b, Rodeghiero et al. 2007). Large errors can be caused by these imperfections, particularly when using small chambers at low gas-exchange rates. Suggestions are given in the above-mentioned publications for minimizing and

correcting these errors, but that is not always straightforward and sometimes not possible.

When measuring gas-exchange rates under ambient conditions in the field, glasshouse, or growth chamber, ambient light is attenuated, particularly around the edges. Ambient air is often used for such measurements. The uptake of CO_2 results in a decreased CO_2 concentration in the chamber, causing a further underestimation of A_n compared with in situ rates. The reading for E deviates also from in situ rates due to a chamber climate in terms of humidity, temperature, and turbulence that differs from outside. When using short periods of enclosure, g_s is probably not affected by the chamber climate. Corrections of A_n and E can be made from assumed or separately measured short-term humidity, temperature, light, and CO_2 effects, using measurements of environmental parameters in undisturbed conditions.

5.1 Regulation of Stomatal Opening

Stomatal opening tends to be regulated such that photosynthesis is approximately **co-limited** by CO_2 diffusion through stomata and light-driven electron transport. This is seen in Fig. 6 as the intersection between the line describing the leaf's conductance for CO_2 transport (**supply function**) and the A - C_c curve (**demand function**). A higher conductance and higher C_c would only marginally increase CO_2 assimilation, but would significantly increase transpiration, since transpiration increases linearly with g_s , as a result of the constant difference in water vapor concentration between the leaf and the air ($w_i - w_a$) (Sect. 2.2.2, Fig. 28; Sect. 5.4.3 of Chapter 3 on plant water relations). At lower conductance, water loss declines again linearly with g_s ; however, C_c also declines, because the demand for CO_2 remains the same, and the difference with C_a increases. This increased CO_2 concentration gradient across the stomata counteracts the decrease in g_s . Hence, photosynthesis declines less than does transpiration with decreasing C_c and C_i . The result is an increasing **water-use efficiency** (WUE) (carbon gain per water lost) with decreasing g_s . Less of the total photosynthetic capacity is used at a low C_c and C_i , however, leading to a reduced **photosynthetic N-use efficiency** (PNUE) (carbon gain per unit leaf N; Sect. 6.1).

Plants tend to reduce stomatal opening under water stress so that WUE is maximized at the expense of PNUE. Under limited availability of N, stomata may open further, increasing PNUE at the

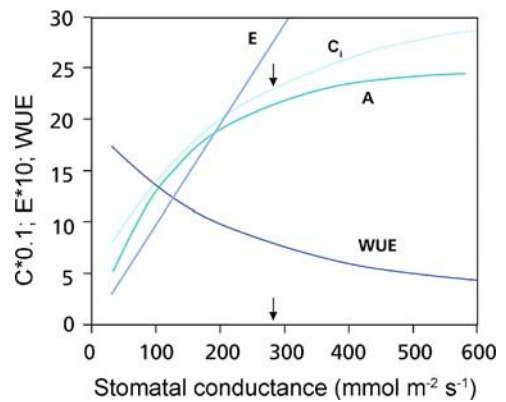

FIGURE 28. The effect of stomatal conductance (g_s) on the transpiration rate (E , $\text{mmol m}^{-2} \text{s}^{-1}$), rate of CO_2 assimilation (A , $\mu\text{mol m}^{-2} \text{s}^{-1}$), intercellular CO_2 concentration (C_i , $\mu\text{mol mol}^{-1}$) and photosynthetic water-use efficiency (WUE, $\text{mmol CO}_2 (\text{mol H}_2\text{O})^{-1} \text{s}^{-1}$) as a function of stomatal conductance. Calculations were made assuming a constant leaf temperature of 25°C and a negligible boundary layer resistance. The arrow indicates g_s at the co-limitation point of carboxylation and electron transport. For the calculations, Equations as described in Box 2A.1 and Sect. 2.2.2 have been used.

TABLE 5. Intrinsic water-use efficiency (WUE, A/g_s) and nitrogen-use efficiency of photosynthesis (PNUE, A/N_{LA}) of leaves of *Helianthus annuus* (sunflower), growing in a field in the middle of a hot, dry summer day in California.*

	N_{LA} Mmol m ⁻²	A $\mu\text{mol m}^{-2} \text{s}^{-1}$	g_s mol m ⁻² s ⁻¹	C_i $\mu\text{mol mol}^{-1}$	WUE $\mu\text{mol mol}^{-1}$	PNUE $\mu\text{mol mol}^{-1} \text{s}^{-1}$
High N + W	190	37	1.2	240	31	195
Low W	180	25	0.4	200	63	139
Low N	130	27	1.0	260	27	208

Source: Fredeen et al. (1991).

* Plants were irrigated and fertilized (high N + W), only irrigated but not fertilized (low N), or only fertilized but not irrigated (low W). Since transpiration is approximately linearly related to g_{sr} , A/g_s is used as an approximation of WUE.

expense of WUE (Table 5). This trade-off between efficient use of water or N explains why perennial species from lower-rainfall sites in eastern Australia have higher leaf N concentration, lower light-saturated photosynthetic rates at a given leaf N concentration, and lower stomatal conductance at a given rate of photosynthesis (implying lower C_i) when compared with similar species from higher-rainfall sites. By investing heavily in photosynthetic enzymes, a larger draw-down of C_i is achieved, and a given photosynthetic rate is possible at a lower stomatal conductance. The benefit of the strategy is that dry-site species reduce water loss at a given rate of photosynthesis, down to levels similar to wet-site species, despite occurring in lower-humidity environments. The cost of high leaf N is higher costs incurred by N acquisition and possibly increased herbivory risk (Wright et al. 2001).

When a plant is subjected to water stress, stomata tend to close. This response is regulated initially by **abscisic acid** (ABA), a phytohormone that is produced by roots in contact with dry soil and is transported to the leaves (Sect. 5.4.1 of Chapter 3 on plant water relations; Box 7.2). There are also effects that are not triggered by ABA arriving from the roots, mediated via ABA produced in the leaf (Holbrook et al. 2002, Christmann et al. 2005). In addition, both electrical and hydraulic signals control stomatal conductance in response to soil moisture availability (Grams et al. 2007). Stomatal conductance may also decline in response to increasing vapor pressure deficit (VPD) of the air (Sect. 5.4.3 of Chapter 3 on plant water relations). The result of these regulatory mechanisms is that, in many cases, transpiration is fairly constant over a range of VPDs, and leaf water potential is constant over a range of soil water potentials. Water loss is therefore restricted when dry air likely imposes water stress (a **feedforward response**) or when the plant experiences incipient water stress (a **feedback response**). In dry

environments these two regulatory mechanisms often cause midday stomatal closure and therefore a decline in photosynthesis (Fig. 34 in Chapter 3 on plant water relations).

It was long assumed that stomata respond homogeneously over the entire leaf; however, leaves of water-stressed plants exposed to ¹⁴CO₂ show often a heterogeneous distribution of fixed ¹⁴C. This shows that some stomata close completely (there is no radioactivity close to these stomata), whereas others hardly change their aperture (label is located near these stomata) (Downton et al. 1988, Terashima et al. 1988). This patchy stomatal closure can also be visualized dynamically and nondestructively with thermal and chlorophyll fluorescence imaging techniques (Mott & Buckley 2000); patches with closed stomata are identified by their high temperature and low quantum yield. **Patchiness** of stomatal opening complicates the calculation of C_i (Sect. 2.2.2), because the calculation assumes a homogeneous distribution of gas exchange parameters across the leaf lamina.

Leaves of plants that reduce stomatal conductance during the middle of the day may only close some of their stomata, while others remain open. This nonuniform reaction of stomata may occur only when plants are rapidly exposed to water stress, whereas stomata may respond in a more uniform manner when the stress is imposed more slowly (Gunasekera & Berkowitz 1992). Stomatal patchiness can also occur in dark-adjusted leaves upon exposure to bright light (Eckstein et al. 1996, Mott & Buckley 2000).

5.2 The A– C_c Curve as Affected by Water Stress

Water stress alters both the **supply** and the **demand** functions of photosynthesis (Flexas & Medrano

FIGURE 29. The response of net photosynthesis to (A) intercellular CO_2 concentration (C_i), and (B) CO_2 concentration in the chloroplasts (C_c), for well watered (blue symbols) and severely water-stressed plants (purple symbols) (after Flexas et al. 2006b).

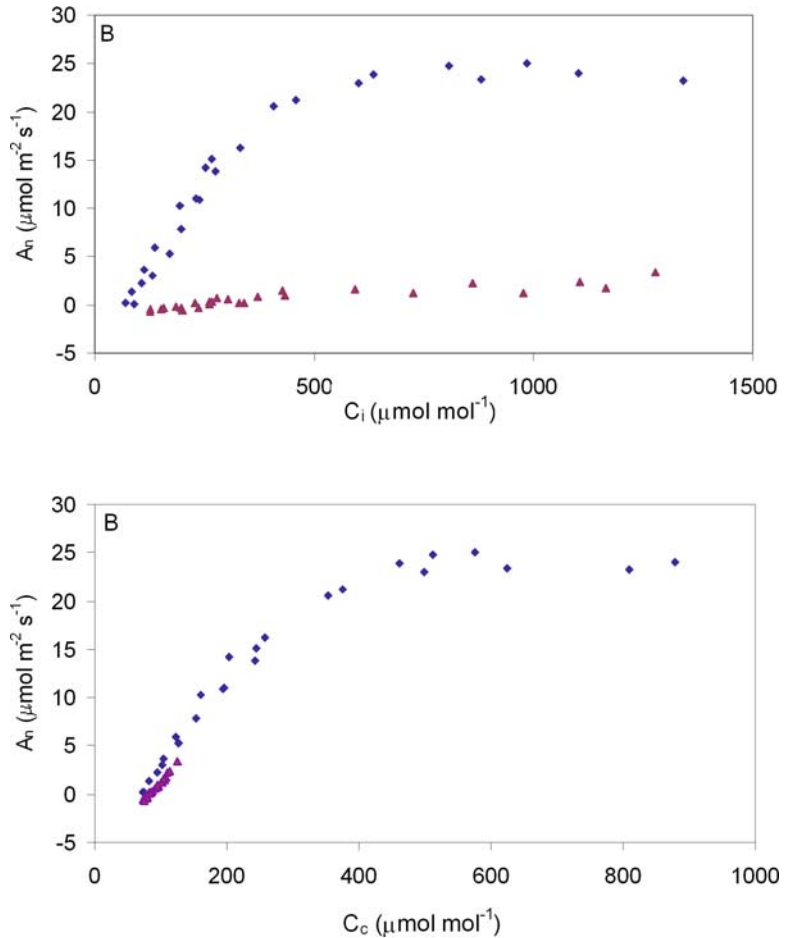

2002, Grassi & Magnani 2005), but the main effect is on stomatal and mesophyll conductance, unless the stress is very severe (Fig. 29; Flexas et al. 2004). When only the conductance declines with plant desiccation, the slope of the A_n - C_c curve is unaffected (Fig. 29B). Because high irradiance and high temperature often coincide with drought, however, photoinhibition may be involved which reduces the demand function. Similarly, if growth is inhibited more strongly than photosynthesis by water stress, feedback inhibition may play an additional role. The net effect of the down-regulation of photosynthetic capacity under severe water stress is that C_c is higher than would be expected if a decrease in conductance were the only factor causing a reduction in assimilation in water-stressed plants. The reduction in photosynthetic capacity allows photosynthesis to continue operating near the break-point between the RuBP-limited and the CO_2 -limited regions of the A - C_c curve. Thus drought-acclimated plants

maximize the effectiveness of both light and dark reactions of photosynthesis under dry conditions at the cost of reduced photosynthetic capacity under favorable conditions. The decline in photosynthetic capacity in water-stressed plants is associated with declines in all biochemical components of the photosynthetic process.

The changes in stomatal regulation of gas exchange in species and cultivars that are genetically adapted to drought are similar to those described above for drought acclimation. Drought-adapted wheat (*Triticum aestivum*) cultivars have a lower stomatal conductance and operate at a lower C_i than do less adapted cultivars. In addition, stomatal conductance and photosynthesis in desert shrubs are lower than in less drought-adapted plants and they decline less in response to water stress, largely due to osmotic adjustment (Sect. 4.1 of Chapter 3 on plant water relations).

5.3 Carbon-Isotope Fractionation in Relation to Water-Use Efficiency

Carbon-isotope composition of plant tissues provides an integrated measure of the photosynthetic water-use efficiency ($WUE = A/E$) or, more precisely, the intrinsic WUE (A/g_s) during the time when the carbon in these tissues was assimilated (Fig. 30). As explained in Box 2A.2, air has a $\delta^{13}C$ of approximately -8‰ , and the major steps in C_3 photosynthesis that fractionate are diffusion (4.4‰) and carboxylation (30‰, including dissolution of CO_2). The isotopic composition of a leaf will approach that of the process that most strongly limits photosynthesis. If stomata were almost closed and diffusion were the rate-limiting step, $\delta^{13}C$ of leaves would be about -12.4‰ (i.e., $-8 + -4.4$); if carboxylation were the only limiting factor, we would expect a $\delta^{13}C$ of -38‰ (i.e., $-8 + -30$). A typical range of $\delta^{13}C$ in C_3 plants is -25 to -29‰ , indicating co-limitation by diffusion and carboxylation (O'Leary 1993); however, $\delta^{13}C$ values vary among plant species and environment depending on the rate of CO_2 assimilation and stomatal and mesophyll conductance. The fractionation, $\Delta^{13}C$, is defined as (Box 2A.2):

$$\Delta^{13}C = [4.4 + 22.6(C_i/C_a)] \times 10^{-3}, \text{ or :} \quad (8)$$

$$\delta^{13}C_{\text{air}} - \delta^{13}C_{\text{leaf}} = 4.4 + 22.6(C_i/C_a),$$

which indicates that a high C_i/C_a (due to high stomatal conductance or low rate of CO_2 assimilation) results in a large fractionation (strongly negative $\delta^{13}C$). We can now use this information to estimate an integrated WUE for the plant, but we must be aware of one significant problem: Equation (8) uses

C_i , and does not take **mesophyll conductance** into account; it uses C_i , and assumes that the mesophyll conductance scales with stomatal conductance. Therefore, some of the fractionation data have to be interpreted with great care, because they may reflect differences in mesophyll conductance, rather than (only) stomatal conductance (Grassi & Magnani 2005, Warren & Adams 2006).

The water-use efficiency ($WUE = A_n/E$) is given by

$$WUE = A_n/E = g_c(C_a - C_i)/g_w(w_i - w_a) \quad (9)$$

$$= C_a(1 - C_i/C_a)/1.6(w_i - w_a)$$

given that $g_w/g_c = 1.6$ (the molar ratio of diffusion of water vapor and CO_2 in air). Equation (9) tells us that the WUE is high, if the conductance is low in comparison with the capacity to assimilate CO_2 in the mesophyll. Under these circumstances C_i (and C_i/C_a) will be small. The right-hand part of Equation (9) then approximates $[C_a/(1.6(w_i - w_a))]$ and diffusion is the predominant component determining fractionation of carbon isotopes and approaches a value of 4.4‰. On the other hand, if the stomatal conductance is large, WUE is small, C_i approximates C_a and the right-hand part of Equation (8) approaches 27‰. Fractionation of the carbon isotopes is now largely due to the biochemical fractionation by Rubisco. Values for WUE thus obtained can only be compared at the same vapor pressure difference ($w_i - w_a$), e.g., within one experiment or a site at the same atmospheric conditions. Therefore, the WUE derived from $\delta^{13}C$ of plant carbon is mostly referred to as **intrinsic WUE** (A_n/g_s), which is equivalent to a value normalized at a constant VPD of 1 mol mol^{-1} .

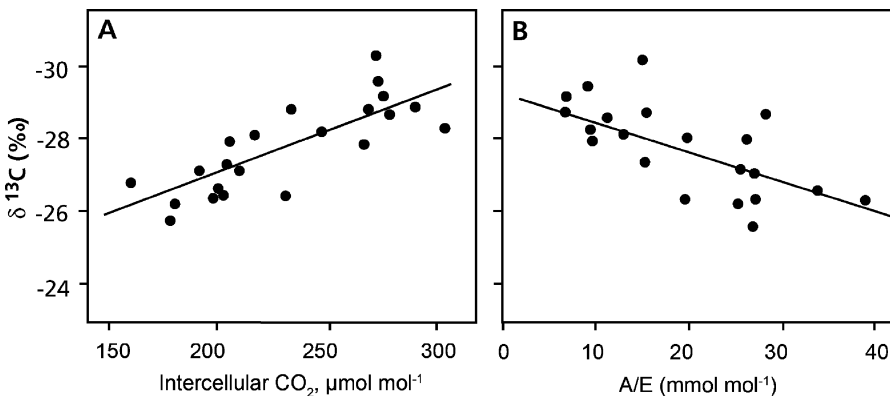
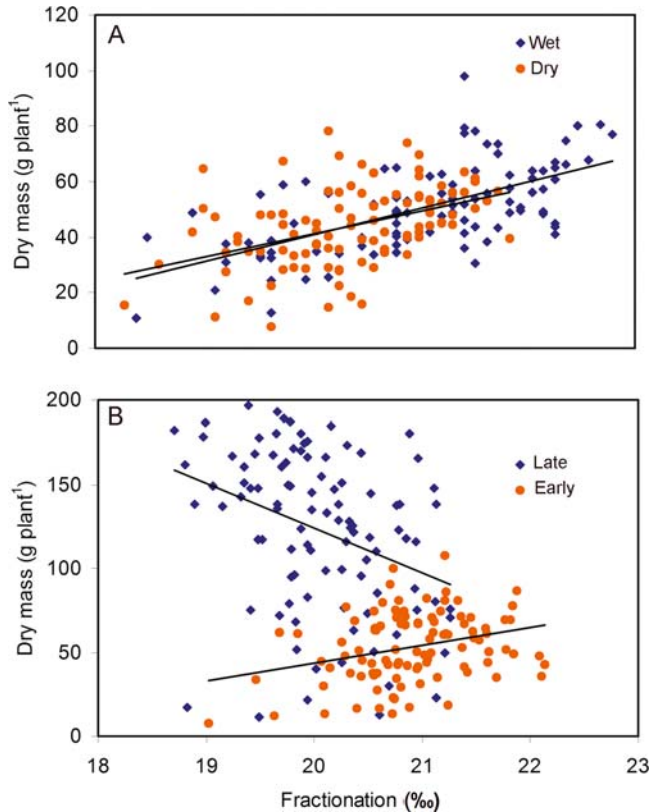

FIGURE 30. The relationship between carbon-isotope composition ($\delta^{13}C$) and (A) average intercellular CO_2 concentration, and (B) daily photosynthetic water-use efficiency, assimilation/transpiration (A/E). The data

points refer to mistletoes and host plants in central Australia (Ehleringer et al. 1985). Copyright by the American Association for the Advancement of Science.

FIGURE 31. Association between dry mass and carbon-isotope fractionation in the F_2 generation of *Solanum lycopersicum* x *Solanum pennellii* (tomato) grown in a wet and a dry environment in 1995 (A) and terminated early and late in 1996 (B). The regression is across the two environments in 1995, whereas in 1996 the regressions are for the early and the late environments separately (Martin et al. 1999). Copyright Crop Science Society of America.



As expected from the theoretical analysis above, there is a good correlation between WUE and the carbon-isotope fractionation (Fig. 30). *Triticum aestivum* (wheat) grown under dry conditions has a higher WUE and a lower carbon-isotope fractionation than plants well supplied with water (Farquhar & Richards 1984). Moreover, those genotypes that perform best under drought (greatest WUE) have the lowest carbon-isotope fractionation, so that isotopic composition can be used to select for genotypes with improved performance under conditions where water is limiting (Fig. 31). A similar correlation between WUE and $\delta^{13}\text{C}$ has been found for cultivars of other species [e.g., *Hordeum vulgare* (barley) (Hubick & Farquhar 1989) and *Arachis hypogaea* (peanut) (Wright et al. 1988, Hubick 1990)].

5.4 Other Sources of Variation in Carbon-Isotope Ratios in C_3 Plants

Given the close relationship between WUE and $\delta^{13}\text{C}$, carbon-isotopic composition can be used to infer average WUE during growth (Fig. 30; Sect. 6

of Chapter 3 on plant water relations). For example, $\delta^{13}\text{C}$ is higher (less negative) in **desert plants** than in **mesic plants**, and it is higher in tissue produced during dry seasons (Smedley et al. 1991) or in dry years. This indicates that plants growing in dry conditions have a lower C_i than those in moist conditions. Other factors can alter isotopic composition without altering WUE. For example, $\delta^{13}\text{C}$ of plant tissue is higher at the bottom than at the top of the canopy. This is to a limited extent due to the contribution of ^{13}C -depleted CO_2 from soil respiration, but mostly to the lower C_i of sunlit top leaves compared with the shaded understory leaves (Buchmann et al. 1997). A complicating factor with the derivation of WUE from $\delta^{13}\text{C}$ is that isotope fractionation is operating at the level of Rubisco in the chloroplast, whereas the theoretical model is based on C_i . Possible variation in the draw-down of CO_2 from the intercellular spaces to the chloroplast (Sect. 2.2.3), due to the mesophyll resistance, is not taken into account, and may cause variation in $\delta^{13}\text{C}$ that is not associated with WUE.

Annuals fractionate more strongly against ^{13}C than **perennials**; additionally, herbs fractionate more than grasses, and **root parasites** [e.g.,

Comandra umbellata (pale bastard toadflax)] more than any of the surrounding species (Smedley et al. 1991). These patterns suggest a high stomatal conductance and low WUE in annuals, herbs, and hemiparasites. The low WUE of hemiparasitic plants is important in nutrient acquisition (Sect. 3 in Chapter 9D on parasitic associations).

6. Effects of Soil Nutrient Supply on Photosynthesis

6.1 The Photosynthesis–Nitrogen Relationship

Since the photosynthetic machinery accounts for more than half of the N in a leaf (Fig. 13) and much of the remainder is indirectly associated with its photosynthetic function, photosynthesis is strongly affected by N availability. A_{\max} increases linearly with leaf N per unit area (Fig. 32), regardless of whether the variation in leaf N is caused by differences in soil N availability, growth irradiance, or leaf age, and holds also when similar species are compared (Fig. 32). The slope of this relationship is much steeper for C_4 plants than for C_3 plants (Sect. 9.5), and differs also among C_3 plants (Sect. 4.2.1 of Chapter 6 on mineral nutrition; Evans 1989). When leaves with different N concentration are compared of plants grown at different N availability, the photosynthetic rate per unit N (**photosynthetic N-use efficiency**; PNUE) at the growth irradiance is highest in leaves with low N concentrations. This is due to the higher degree of utilization of the photosynthetic apparatus (Fig. 33); hence, a higher efficiency at the expense of photosynthetic rate.

The strong A_{\max} vs. N relationship cannot be due to any simple direct N limitation of photosynthesis, because both carbon-isotope studies and $A-C_c$ curves generally show that photosynthesis is co-limited by CO_2 diffusion and photosynthetic capacity. Rather, the entire photosynthetic process is down-regulated under conditions of N limitation, with declines in Rubisco, chlorophyll, and stomatal conductance (Sect. 5.1, Table 5). The net effect of this coordinated response of all photosynthetic components is that C_i/C_a and $\delta^{13}C$ show no consistent relationship with leaf N (Rundel & Sharifi 1993).

In some field studies, especially in conifers, which often grow on low-P soils, photosynthesis may show little correlation with tissue N, but a strong correlation with tissue [P] (Reich & Schoettle

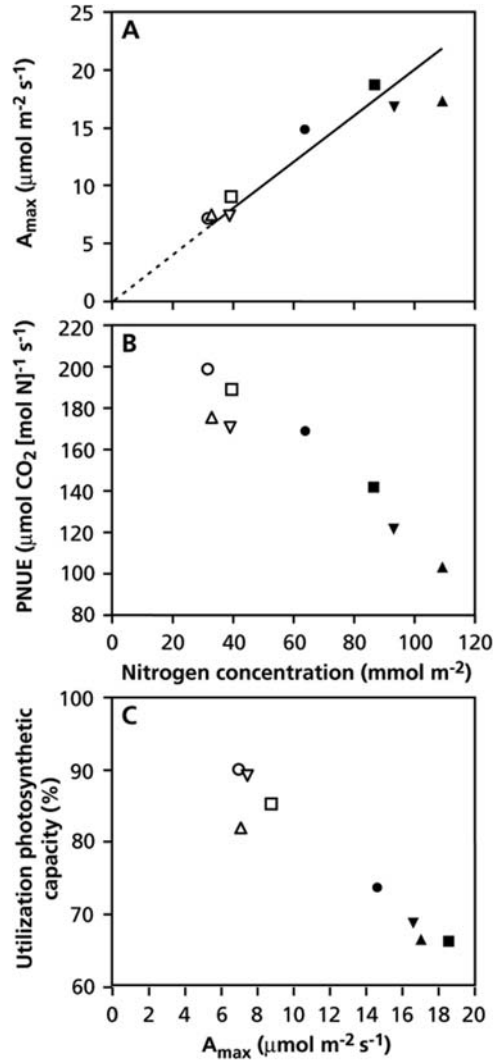

FIGURE 32. The light-saturated rate of photosynthesis (A_{\max}) of four grasses grown at high (filled symbols) and low (open symbols) N supply (A) and their photosynthetic N-use efficiency (PNUE) determined at growth irradiance (B) plotted against leaf N per unit area. Note the higher PNUE for plants grown at a low N supply. (C) The proportional utilization of the total photosynthetic capacity at growth irradiance, calculated as the ratio of the rate at growth irradiance and A_{\max} in relation to A_{\max} (Pons et al. 1994). Copyright SPB Academic Publishing.

1988). The low photosynthetic rate of plants grown at low P supply may reflect feedback inhibition due to slow growth and low concentrations of P_i in the cytosol (Sect. 4.1) or low concentrations of Rubisco and other photosynthetic enzymes.

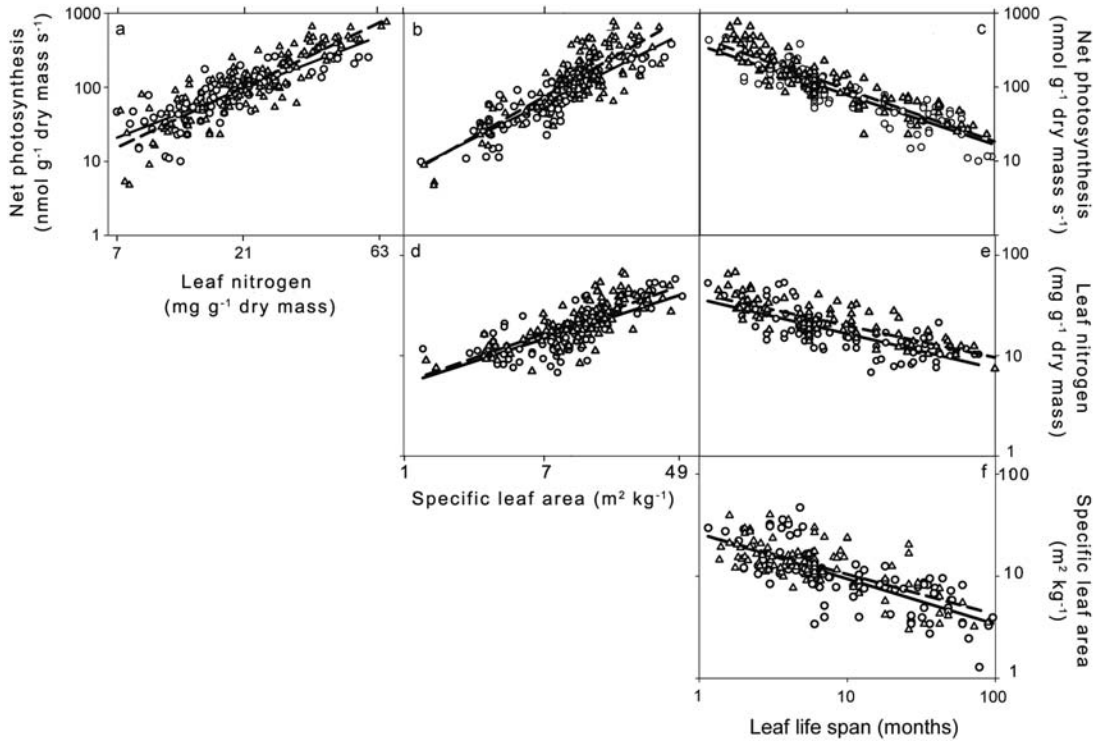

FIGURE 33. Relations of (A) mass-based maximum rate of CO₂ assimilation, (B) leaf N concentration, and (C) specific leaf area of young mature leaves as a function of

their expected leaf life-span. The symbols refer to a data set for 111 species from six biomes (after Reich et al. 1997).

6.2 Interactions of Nitrogen, Light, and Water

Because of the coordinated responses of all photosynthetic processes, any environmental stress that reduces photosynthesis will reduce both the diffusional and the biochemical components (Table 5). Therefore, N concentration per unit leaf area is typically highest in sun leaves, and declines toward the bottom of a canopy. In canopies of *Nicotiana tabacum* (tobacco), this partially reflects higher rates of CO₂ assimilation of young, high-N leaves in high-light environments (Boonman et al. 2007). In multi-species canopies, however, the low leaf [N] per area in understory species clearly reflects the adjustment of photosynthetic capacity to the reduced light availability (Table 5; Niinemets 2007).

6.3 Photosynthesis, Nitrogen, and Leaf Life Span

As discussed in Chapter 6 on mineral nutrition and Chapter 7 on growth and allocation,

plants acclimate and adapt to low soil N and low soil moisture by producing long-lived leaves that are thicker and have a high leaf mass density, a low specific leaf area (SLA; i.e., leaf area per unit leaf mass) and a low leaf N concentration. Both broad-leaved and conifer species show a single strong negative correlation between leaf life-span and either leaf N concentration or mass-based photosynthetic rate (Fig. 33; Reich et al. 1997). The low SLA in long-lived leaves relates to structural properties required to withstand unfavorable environmental conditions (Chapter 7 on growth and allocation). There is a strong positive correlation between SLA and leaf N concentration for different data sets (Fig. 33). Together, the greater leaf thickness and low N concentrations per unit leaf mass result in low rates of photosynthesis on a leaf-mass basis in long-lived leaves (Fig. 33). Maximum stomatal conductance correlates strongly with leaf N, because g_s scales with A_{max} (Wright et al. 2004).

7. Photosynthesis and Leaf Temperature: Effects and Adaptations

Temperature has a major effect on enzymatically catalyzed reactions and membrane processes, and therefore affects photosynthesis. Because the **activation energy** of different reactions often differs among plants acclimated or adapted to different temperature regimes, photosynthesis may be affected accordingly (for a discussion of the concepts of **acclimation** and **adaptation**, see Fig. 3 and Sect. 4 of Chapter 1 on assumptions and approaches). In this section temperature effects on photosynthesis will be explained in terms of underlying biochemical, biophysical, and molecular processes.

Differences among plants in their capacity to perform at extreme temperatures often correlate with the plant's capacity to photosynthesize at these temperatures. This may reflect both the adjustment of photosynthesis to the demand of the sinks (Sect. 4) and changes in the photosynthetic machinery during acclimation and adaptation.

7.1 Effects of High Temperatures on Photosynthesis

Many plants exhibit an optimum temperature for photosynthesis close to their normal growth temperature, showing **acclimation** (Fig. 34; Berry &

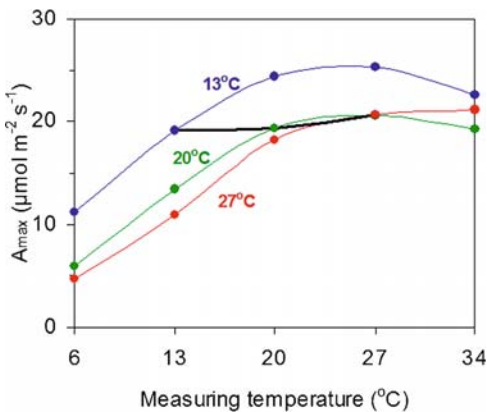

FIGURE 34. Temperature dependence of light-saturated rates of photosynthesis of *Plantago major* (common plantain) grown at three temperatures. The black line connects measurements at the growth temperatures (after Atkin et al. 2006). Copyright Blackwell Science Ltd.

Björkman 1980, Yamori et al. 2005). Below this optimum, enzymatic reaction rates, primarily associated with the “**dark reactions**”, are temperature limited. At high temperatures the **oxygenating** reaction of Rubisco increases more than the **carboxylating** one so that photorespiration becomes proportionally more important. This is partly because the **solubility** of CO₂ declines with increasing temperature more strongly than does that of O₂. Part of the effect of temperature on photosynthesis of C₃ plants is due to the effects of temperature on **kinetic properties** of Rubisco. V_{max} increases with increasing temperature, but the K_m-values increase also, and more steeply for CO₂ than for O₂ (Fig. 35). This means that the affinity for CO₂ decreases more strongly than that for O₂. Additionally, electron transport (Cen & Sage 2005) and g_m (Yamori et al. 2006a, Warren 2007) may decline at elevated temperatures. The combined temperature effects on solubility, affinity, and mesophyll conductance cause a proportional increase in **photorespiration**, resulting in a decline in net photosynthesis at high temperature when electron-transport rates cannot keep up with the increased inefficiency.

Adaptation to high temperature typically causes a shift of the temperature optimum for net photosynthesis to higher temperatures (Fig. 36; Berry & Björkman 1980). Similarly, the temperature optimum for photosynthesis shifts to higher temperatures when coastal and desert populations of *Atriplex lentiformis* **acclimate** to high temperatures (Percy 1977).

Apart from the increase in photorespiration discussed above, there are several other factors important for determining **acclimation** and **adaptation** of photosynthesis to temperature. In leaves of *Spinacia oleracea* (spinach) the **Rubisco activation state** decreases with increasing temperatures above the optimum temperatures for photosynthesis, irrespective of growth temperature, while the activation state remains high at lower temperatures. Rubisco thermal stabilities of spinach leaves grown at low temperature are lower than those of leaves grown at high temperature. Photosynthetic performance in spinach is largely determined by the Rubisco kinetics at low temperature and by Rubisco kinetics and Rubisco activation state at high temperature (Yamori et al. 2006b). Furthermore, Rubisco can become inactivated at moderately high temperatures. Species adapted to hot environments often show temperature optima for photosynthesis that are quite close to the temperature at which enzymes are inactivated. The lability of **Rubisco activase** plays a major role in the decline of photosynthesis at high temperatures (Salvucci & Crafts-Brandner 2004b, Hikosaka et al. 2006). Thermal acclimation of *Acer rubrum* (red

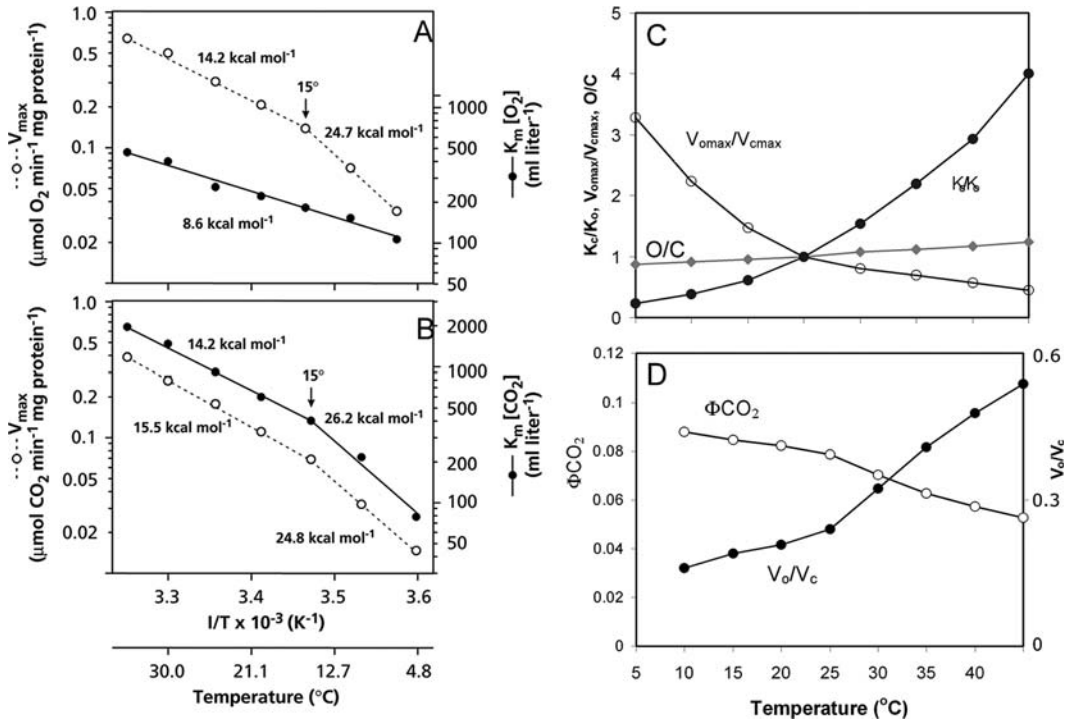

FIGURE 35. Temperature dependence of V_{max} and the K_m of (A) the oxygenating and (B) the carboxylating reaction of Rubisco. V_{max} is the rate of the carboxylating or oxygenating reaction at a saturating concentration of CO_2 and O_2 , respectively. The K_m is the concentration of CO_2 and O_2 at which the carboxylating and oxygenating reaction, respectively, proceed at the rate which equals $1/2V_{max}$. Note that a logarithmic scale is used for the y-axis and that the inverse of the absolute temperature is plotted on the x-axis (“Arrhenius-plot”). In such a graph, the slope gives the activation energy, a measure for the temperature dependence of the reaction (Berry

& Raison 1981). (C) The combined effects of temperature on kinetic properties as shown in (A) and (B) and relative solubility of O_2 and CO_2 (O/C) have been modeled, normalized to values at 20°C. (D) Relative rates of the oxygenating and carboxylation reactions of Rubisco (V_o/V_c) and quantum yield (ϕCO_2) modeled using the same parameter values as in (C). For calculation of V_o/V_c and ϕCO_2 , it was assumed that partial pressures of CO_2 and O_2 in the chloroplast were 27 Pa and 21 kPa, respectively. Kinetic parameters used were calculated from Jordan and Ogren (1981) (courtesy I. Terashima, The University of Tokyo, Japan).

maple) from Florida in comparison with genotypes from Minnesota, US, is associated with maintenance of a high ratio of Rubisco activase to Rubisco (Weston et al. 2007). In *Gossypium hirsutum* (cotton) expression of the gene encoding Rubisco activase is influenced by post-transcriptional mechanisms that probably contribute to acclimation of photosynthesis during extended periods of heat stress (DeRidder & Salvucci 2007).

High temperatures also require a high degree of saturation of the membrane lipids of the thylakoid for integrated functioning of its components and prevention of leakiness (Sharkey 2005). Therefore, not only Rubisco activity, but also membrane-bound processes of electron transport may be limiting photosynthesis at high temperatures.

7.2 Effects of Low Temperatures on Photosynthesis

When plants grown at a moderate temperature are transferred to a lower temperature, but within the range normal for the growing season, photosynthesis is initially reduced (Fig. 34). Photon absorption is not affected by temperature, but the rate of electron transport and biochemical processes are reduced as a direct consequence of the lower temperature. Particularly, sucrose metabolism and/or phloem loading can become limiting for photosynthesis, causing feedback inhibition (Fig. 27). Acclimation to the lower growth temperature involves up-regulation of the limiting components of the photosynthetic apparatus. Hence, the capacity

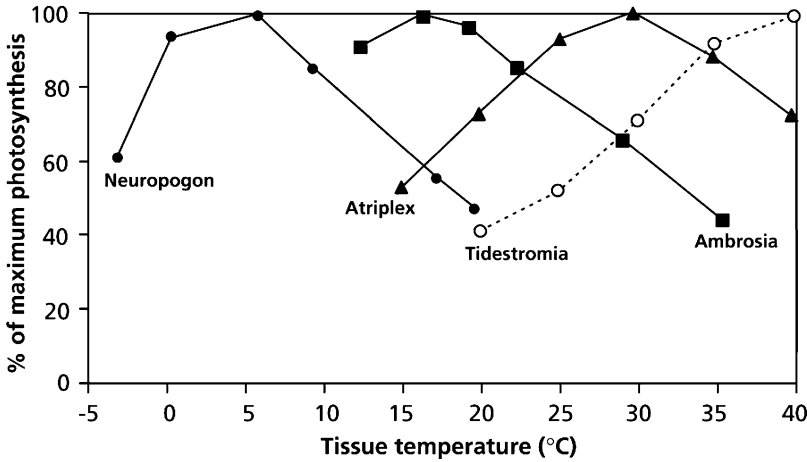

FIGURE 36. Photosynthetic response to temperature in plants from contrasting temperature regimes. Curves from left to right are for *Neurotopogon acromelanus*, an Antarctic lichen, *Ambrosia chamissonis*, a cool coastal

dune plant, *Atriplex hymenelytra*, an evergreen desert shrub, and *Tidestromia oblongifolia*, a summer-active desert perennial (after Mooney 1986).

for electron transport (J_{\max}) is increased, and Rubisco levels increase as well with the proportional increase in carboxylation capacity (V_{cmax}) (Atkin et al. 2006). Feedback inhibition is alleviated by increased expression of enzymes of the sucrose synthesis pathway (Stitt & Hurry 2002). Acclimation comprises therefore an increase in photosynthetic capacity which is associated with an increase in leaf thickness, whereas chlorophyll concentrations remains more or less similar, thus causing an increase in A_{\max} per unit chlorophyll. The change is accompanied by a decrease in antenna size of PS II. Hence, acclimation to low temperature resembles to a considerable extent acclimation to high irradiance (Huner et al. 1998). In *Plantago major* (common plantain) species, the result of acclimation is that, just as with respiration (Fig. 17 in Chapter 2B on respiration), photosynthetic rates are virtually independent of growth temperature (Fig. 35).

When cold is more extreme, damage is likely to occur. Many (sub)tropical plants grow poorly or become damaged at temperatures between 10 and 20°C. Such damage is called “chilling injury” and differs from frost damage, which only occurs below 0°C. Part of the chilling injury is associated with the photosynthetic apparatus. The following aspects play a role:

1. Decrease in membrane fluidity
2. Changes in the activity of membrane-associated enzymes and processes, such as the photosynthetic electron transport
3. Loss of activity of cold-sensitive enzymes.

Chilling resistance probably involves **reduced saturation** of membrane fatty acids which increases membrane fluidity and so compensates for the effect of low temperature on membrane fluidity (Chapter 4B on effects of radiation and temperature).

Chilling often leads to **photoinhibition** and **photooxidation**, because the biophysical reactions of photosynthesis (photon capture and transfer of excitation energy) are far less affected by temperature than the biochemical steps, including electron transport and activity of the Calvin cycle (Sect. 3.3). The leaves of evergreen plants in cold climates typically develop and expand during the warm spring and summer months, and are retained during the winter months when all growth ceases. Upon exposure to low temperature and high irradiance, the conversion of the light-harvesting **violaxanthin** to the energy-quenching **zeaxanthin** (Sect. 3.3.1) occurs within minutes. In addition to this ubiquitous process of “flexible dissipation”, several forms of “sustained dissipation” exist. The sustained dissipation does not relax upon darkening of the leaves, but it is still ΔpH -dependent; it is flexible in the sense that, e.g., warming of leaves allows this state to be quickly reversed. The difference in the underlying mechanism between flexible and sustained ΔpH -independent dissipation is not related to zeaxanthin, because this xanthophyll is involved in both types of thermal dissipation (Demmig-Adams & Adams 2006). Therefore, under lasting stress conditions and in some plant species, the flexible, ΔpH -independent engagement and disengagement of zeaxanthin in dissipation is replaced by a

TABLE 6. Differences in the response of photosynthesis and photoprotection between crops/weeds and evergreens. Typical changes in intrinsic photosynthetic capacity, ΔpH -independent dissipation, zeaxanthin and antheraxanthin (Z + A) retention, in annual crops/biennial weeds vs. evergreen species in response to transfer of shade-acclimated plants to high light or in response to the transition from summer to winter conditions.

	Shade to sun transfer		Summer to winter transition	
	Annual crop	Evergreen	Tropical annual/biennial Crop/weed	Temperate evergreen
Photosynthetic capacity	↑	↓	↑	↓↓
ΔpH -independent dissipation	*	↑↑	*	↑↑
Z+A retention	*	↑↑	*	↑↑

Source: Demmig-Adams & Adams (2006).

*Seen only transiently and at moderate levels upon transition.

highly effective, but less flexible continuous engagement of zeaxanthin in dissipation that does not require a ΔpH . It is not yet known which factors other than zeaxanthin are involved in the ΔpH -dependent, less flexible, but potent form of dissipation that is particularly pronounced in long-lived, slow-growing evergreen species (Table 6).

Hardening of *Thuja plicata* (western red cedar) seedlings (i.e., acclimation to low temperatures) is associated with some loss of chlorophyll and with increased levels of carotenoids, giving the leaves a red-brown color. Exposure to low temperatures causes a decline in photosynthetic capacity and the quantum yield of photosynthesis, as evidenced by the decline in chlorophyll fluorescence (i.e., in the ratio F_v/F_m ; Box 2A.4). The carotenoids prevent damage that might otherwise occur as a result of photooxidation (Sect. 3.3.1). Upon transfer of the seedlings to a normal temperature (dehardening) the carotenoids disappear within a few days (Weger et al. 1993). Other temperate conifers such as *Pinus banksiana* (jack pine) exhibit "purpling", which is caused by the accumulation of anthocyanin in epidermal cells. This appears to protect the needles against photoinhibition of PS II through a simple screening of irradiance (Huner et al. 1998). Accumulation of photoprotective anthocyanins gives rise to typical autumn colors, e.g., in *Cornus stolonifera* (red-osier dogwood) (Feild et al. 2001).

In the alpine and arctic species *Oxyria digyna* (alpine mountainsorrel), an increased resistance to photoinhibition is caused by an increased capacity to repair damaged PS II reaction centers and increased nonphotochemical quenching. Maximum rates of photosynthesis by arctic and alpine plants measured in the field are similar to those of temperate-zone species, but are reached at lower

temperatures—often 10–15°C (Fig. 36). These substantial photosynthetic rates at low temperatures are achieved in part by high concentrations of Rubisco, as found in acclimation of lowland plants. This may account for the high tissue N concentration of arctic and alpine plants despite low N availability in soils (Körner & Larcher 1988). Although temperature optima of arctic and alpine plants are 10–30°C lower than those of temperate plants, they are still 5–10°C higher than average summer leaf temperatures in the field.

8. Effects of Air Pollutants on Photosynthesis

Many air pollutants reduce plant growth, partly through their negative effects on photosynthesis. Pollutants like SO₂ and ozone (O₃) that enter the leaf through stomata, directly damage the photosynthetic cells of the leaf. In general, any factor that increases stomatal conductance (e.g., high supply of water, high light intensity, high N supply) increases the movement of pollutants into the plant, and therefore their impact on photosynthesis. At low [O₃], decreased production *Glycine max* (soybean) corresponds to a decrease in leaf photosynthesis, but at higher [O₃] the larger loss in production is associated with decreases in both leaf photosynthesis and leaf area (Morgan et al. 2003). Rates of net photosynthesis and stomatal conductance in *Fagus sylvatica* (beech) are about 25% lower when the O₃ concentration is double that of the background concentration in Kranzberg Forest (Germany), while V_{cmax} is and g_m are not affected (Warren et al. 2007). The major effect of SO₂ on growth and yield of *Vicia faba* (faba bean) is due to leaf injury (necrosis

and abscission of leaves), rather than direct effects on gas exchange characteristics (photosynthesis and respiration) (Kropf 1989).

9. C₄ Plants

9.1 Introduction

The first sections of this chapter dealt primarily with the characteristics of photosynthesis of C₃ species. There are also species with photosynthetic characteristics quite different from these C₃ plants. These so-called C₄ species belong to widely different taxonomic groups (Table 7); the C₄ syndrome is very rare among tree species; *Chamaesyce olovaluana* (Euphorbiaceae) is a canopy-forming C₄ tree from Hawaii (Sage 2004). Although their different anatomy has been well documented for over a century, the biochemistry and physiology of C₄ species has been elucidated more recently. It is hard to say who first “discovered” the C₄ pathway of photosynthesis

(Hatch & Slack 1998); however, Hatch & Slack (1966) certainly deserve credit for combining earlier pieces of information with their own findings and proposing the basic pathway as outlined in this section.

None of the metabolic reactions or anatomical features of C₄ plants are really unique to these species; however, they are all linked in a manner quite different from that in C₃ species. Based on differences in biochemistry, physiology, and anatomy, three subtypes of C₄ species are discerned (Table 8). In addition, there are intermediate forms between C₃ and C₄ metabolism (Sect. 9.6).

9.2 Biochemical and Anatomical Aspects

The anatomy of C₄ plants differs strikingly from that of C₃ plants (Fig. 37). C₄ plants are characterized by their **Kranz anatomy**, a sheath of thick-walled cells surrounding the vascular bundle (“Kranz” is the German word for “wreath”). These thick walls of the bundle sheath cells may be impregnated with suberin, but this does not appear to be essential to reduce

TABLE 7. The 19 families containing members with the C₄ photosynthetic pathway.*

Family	Number of lineages	Subtypes
Monocots		
Poaceae	11	NADP-ME, NAD-ME, PCK
Cyperaceae	4	NADP-ME, NAD-ME
Hydrocharitaceae	1	Single-cell NADP-ME
Dicots		
Acanthaceae	1	–
Aizoaceae	2	NADP-ME
Amaranthaceae	3	NADP-ME, NAD-ME
Asteraceae	3	NADP-ME
Boraginaceae	1	NAD-ME
Brassicaceae	1	–
Caryophyllaceae	1	NAD-ME
Chenopodiaceae	10	NADP-ME, NAD-ME & single-cell NAD-ME
Euphorbiaceae	1	NADP-ME
Gisekiaceae	1	NAD-ME
Molluginaceae	1	NAD-ME
Nyctaginaceae	1	NAD-ME
Polygonaceae	1	–
Portulacaceae	2	NADP-ME, NAD-ME
Scrophulariaceae	1	–
Zygophyllaceae	2	NADP-ME

Source: Sage (2004).

*The number of lineages represents the putative times of independent evolution of C₄ in the family. The biochemical subtypes (not known for all species) are as defined in Table 8 and Fig. 37. Single-cell C₄ is explained in the text.

TABLE 8. Main differences between the three subtypes of C₄ species.*

Subtype	Major decarboxylase in BSC	Decarboxylation occurs in	Major substrate moving from		Photosystems in BSC
			MC to BSC	BSC to MC	
NADP-ME	NADP-malic enzyme	Chloroplast	Malate	Pyruvate	I and II ^a
NAD-ME	NAD-malic enzyme	Mitochondria	Aspartate	Alanine	I and II
PCK	PEP carboxykinase	Cytosol	Aspartate + malate	Alanine + PEP	I and II

*MC is mesophyll cells; BSC is vascular bundle sheath cells.

^aSome NADP-ME monocots, including *Zea mays* (corn) have only PS I in BSC chloroplasts.

the gas diffusion between the bundle sheath and the mesophyll. In some C₄ species (NADP-ME types), the cells of the bundle sheath contain large chloroplasts with mainly stroma thylakoids and very little grana. The bundle sheath cells are connected via **plasmodesmata** with the adjacent thin-walled mesophyll cells, with large intercellular spaces.

CO₂ is first assimilated in the mesophyll cells, catalyzed by **PEP carboxylase**, a light-activated enzyme, located in the cytosol. PEP carboxylase uses phosphoenolpyruvate (PEP) and HCO₃⁻ as substrates. HCO₃⁻ is formed by hydration of CO₂, catalyzed by **carbonic anhydrase**. The high affinity of PEP carboxylase for HCO₃⁻ reduces C_i to about 100 μmol mol⁻¹, less than half the C_i of C₃ plants (Sect. 2.2.2). PEP is produced in the light from pyruvate and ATP, catalyzed by pyruvate P_i-dikinase, a light-activated enzyme located in the

chloroplast. The product of the reaction catalyzed by PEP carboxylase is oxaloacetate, which is reduced to malate. Alternatively, oxaloacetate may be transaminated in a reaction with alanine, forming aspartate. Whether malate or aspartate, or a mixture of the two, are formed, depends on the subtype of the C₄ species (Table 8). Malate (or aspartate) diffuses via plasmodesmata to the vascular bundle sheath cells, where it is decarboxylated, producing CO₂ and pyruvate (or alanine). CO₂ is then fixed by Rubisco in the chloroplasts of the **bundle sheath cells**, which have a normal Calvin cycle, as in C₃ plants. Rubisco is not present in the mesophyll cells, which do not have a complete Calvin cycle and only store starch when the bundle sheath chloroplasts reach their maximum starch concentrations.

Fixation of CO₂ by PEP carboxylase and the subsequent decarboxylation occur relatively fast,

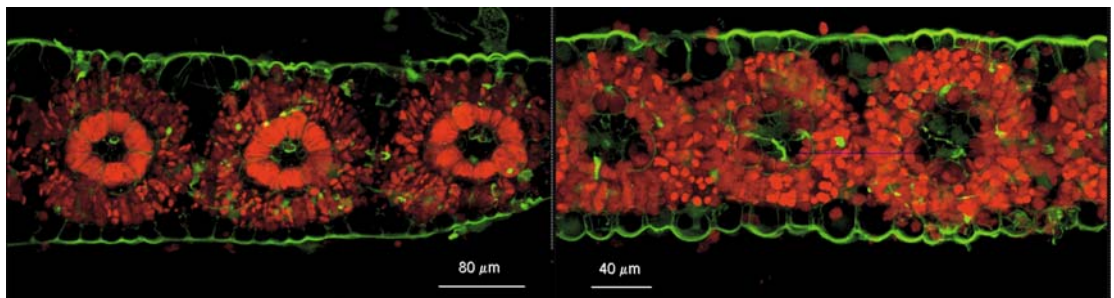

FIGURE 37. (Facing page) Schematic representation photosynthetic metabolism in the three C₄ types distinguished according to the decarboxylating enzyme. NADP-ME, NADP-requiring malic enzyme; PCK, PEP carboxykinase; NAD-ME, NAD-requiring malic enzyme. Numbers refer to enzymes. (1) PEP carboxylase, (2) NADP-malate dehydrogenase, (3) NADP-malic enzyme, (4) pyruvate P_i-dikinase, (5) Rubisco, (6) PEP carboxykinase, (7) alanine aminotransferase, (8) aspartate amino transferase, (9) NAD-malate dehydrogenase, (10) NAD-malic enzyme (after Lawlor 1993). (Above) Cross-sections of leaves of monocotyledonous C₄ grasses (Ghannoum et al. 2005). Chlorophyll a

autofluorescence of a leaf cross-section of (Left) *Panicum miliaceum* (French millet, NAD-ME), and (Right) *Sorghum bicolor* (millet, NAD-ME). The images were obtained using confocal microscopy. Cell walls are shown in green and chlorophyll a autofluorescence in red. Most of the autofluorescence emanates from bundle sheath cells in the NAD-ME species (Left) and from the mesophyll cells in the NADP-ME species (Right), showing the difference in chlorophyll distribution between the two subtypes (courtesy O. Ghannoum, Centre for Horticulture and Plant Sciences, University of Western Sydney, Australia). Copyright American Society of Plant Biologists.

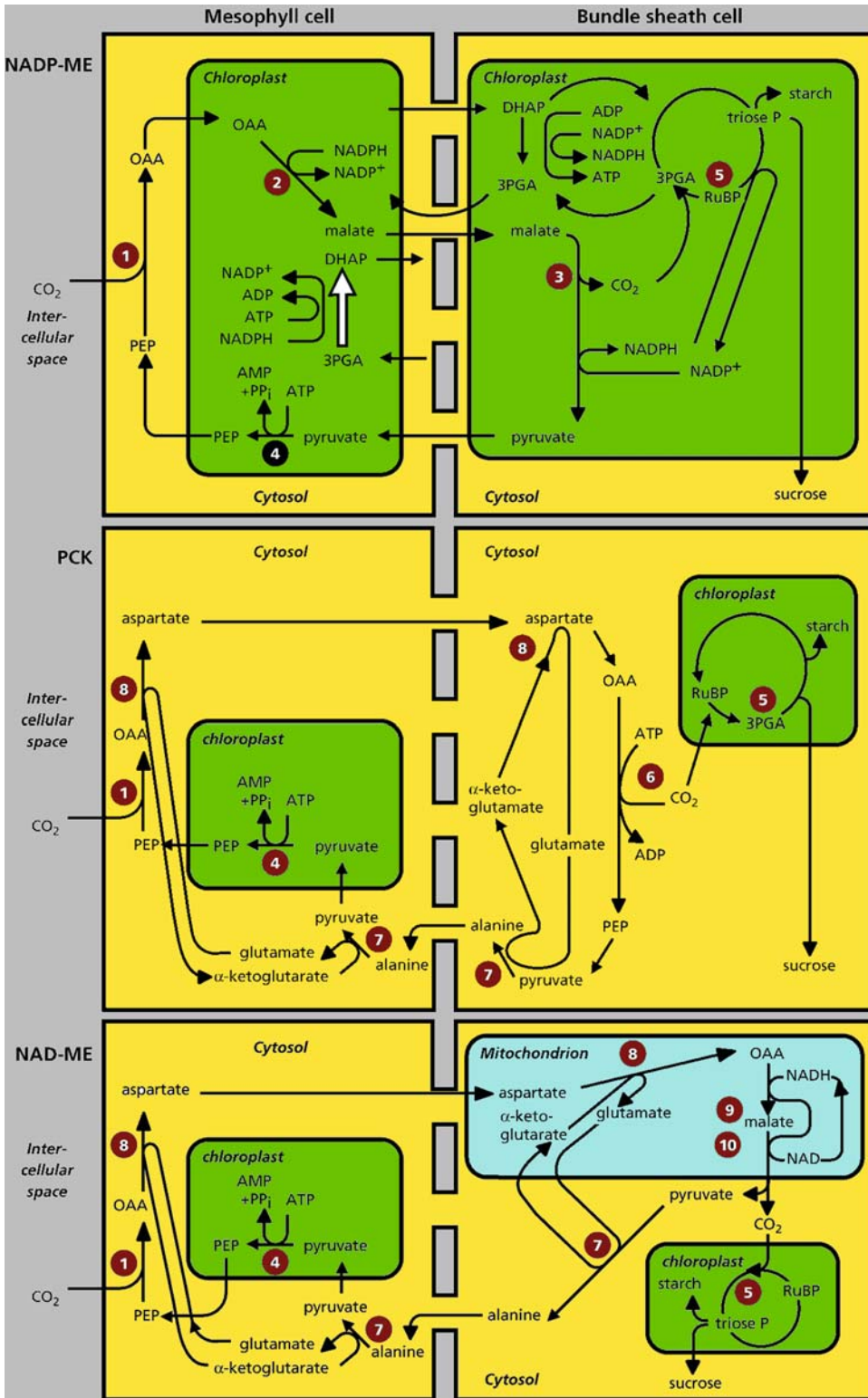

FIGURE 37. (continued)

allowing the build-up of a high concentration of CO₂ in the vascular bundle sheath. When the outside CO₂ concentration is 380 μmol mol⁻¹, that at the site of Rubisco in the chloroplasts of the vascular bundle is 1000–2000 μmol mol⁻¹. The C_i, that is the CO₂ concentration in the intercellular spaces in the mesophyll, is only about 100 μmol mol⁻¹. With such a steep gradient in the CO₂ concentration it is inevitable that some CO₂ diffuses back from the bundle sheath to the mesophyll, but this is only about 20%. In other words, C₄ plants have a mechanism to enhance the CO₂ concentration at the site of Rubisco to an extent that its **oxygenation** reaction is virtually fully inhibited. Consequently, C₄ plants have negligible rates of **photorespiration**.

Based on the enzyme involved in the decarboxylation of the C₄ compounds transported to the vascular bundle sheath, three groups of C₄ species are discerned: NADP-malic enzyme-, NAD-malic enzyme- and PEP carboxykinase-types (Table 8, Fig. 37). The difference in biochemistry is closely correlated with anatomical features of the bundle sheath and mesophyll of the leaf blade as viewed in transverse sections with the light microscope (Ellis 1977). In NAD-ME-subtypes, which decarboxylate malate (produced from imported aspartate) in the bundle sheath mitochondria, the mitochondrial frequency is several-fold higher than that in NADP-ME-subtypes. The specific activity of the mitochondrial enzymes involved in C₄ photosynthesis is also greatly enhanced (Hatch & Carnal 1992). The NAD-ME group of C₄ species tends to occupy the driest habitats, although the reason for this is unclear (Ellis et al. 1980, Ehleringer & Monson 1993).

Decarboxylation of malate occurs only during assimilation of CO₂, and vice versa. The explanation for this is that the NADP needed to decarboxylate malate is produced in the Calvin cycle, during the assimilation of CO₂. At least in the more “sophisticated” NADP-ME C₄ plants such as *Zea mays* (corn) and *Saccharum officinale* (sugar cane), the NADPH required for the photosynthetic reduction of CO₂ originates from the activity of NADP malic enzyme. Since two molecules of NADPH are required per molecule of CO₂ fixed by Rubisco, this amount of NADPH is not sufficient for the assimilation of all CO₂. Additional NADPH is required to an even larger extent if aspartate, or a combination of malate and aspartate, diffuses to the bundle sheath. It is assumed that this additional NADPH can be imported via a “shuttle”, involving PGA and dihydroxyacetone phosphate (DHAP). Part of the PGA that originates in the bundle-sheath chloroplasts returns to the mesophyll. Here it is reduced, producing DHAP, which diffuses to the bundle sheath.

Alternatively, NADPH required in the bundle sheath cells might originate from the removal of electrons from water. This reaction requires the activity of PS II, next to PS I. PS II is only poorly developed in the bundle sheath cells, at least in the “more sophisticated” C₄ species. The poor development of PS II activity in the bundle sheath indicates that very little O₂ is evolved in these cells that contain Rubisco, which greatly favors the carboxylation reaction over the oxygenation.

The formation of PEP from pyruvate in the mesophyll cells catalyzed by pyruvate P_i-dikinase, requires one molecule of ATP and produces AMP, instead of ADP; this corresponds to the equivalent of two molecules of ATP per molecule of PEP. This represents the metabolic costs of the **CO₂ pump** of the C₄ pathway. It reduces photosynthetic efficiency of C₄ plants, when compared with that of C₃ plants under nonphotorespiratory conditions. In summary, C₄ photosynthesis concentrates CO₂ at the site of carboxylation by Rubisco in the bundle sheath, but this is accomplished at a metabolic cost.

9.3 Intercellular and Intracellular Transport of Metabolites of the C₄ Pathway

Transport of the metabolites that move between the two cell types occurs by **diffusion** through **plasmodesmata**. The concentration gradient between the mesophyll and bundle sheath cells is sufficiently high to allow diffusion at a rate that readily sustains photosynthesis, with the exception of that of pyruvate. How can we account for rapid transport of pyruvate from the bundle sheath to the mesophyll if there is no concentration gradient?

Uptake of pyruvate in the chloroplasts of the mesophyll cells is a light-dependent process, requiring a specific energy-dependent carrier. Active uptake of pyruvate into the chloroplast reduces the pyruvate concentration in the cytosol of these mesophyll cells to a low level, creating a concentration gradient that drives diffusion from the bundle sheath cells (Flügge et al. 1985).

In the chloroplasts of the mesophyll cells, pyruvate is converted into PEP, which is exported to the cytosol in exchange for P_i. The same translocator that facilitates this transport is probably also used to export triose-phosphate in exchange for PGA. This translocator operates in the reverse direction in mesophyll and bundle sheath chloroplasts, in that PGA is imported and triose-phosphate is exported in the mesophyll chloroplasts, while the chloroplasts in the bundle sheath export PGA and import triose phosphate.

The chloroplast envelope of the mesophyll cells also contains a translocator for the transport of dicarboxylates (malate, oxaloacetate, aspartate, and glutamate). Transport of these carboxylates occurs by exchange. The uptake of oxaloacetate, in exchange for other dicarboxylates, is competitively inhibited by these other dicarboxylates, with the values for K_i being in the same range as those for K_m . [K_i is the inhibitor (i.e., dicarboxylate) concentration at which the inhibition of the transport process is half that of the maximum inhibition by that inhibitor; K_m is the substrate (oxaloacetate) concentration at which the transport process occurs at half the maximum rate.] Such a system does not allow rapid import of oxaloacetate. A special transport system, transporting oxaloacetate without exchange against other dicarboxylates, takes care of rapid import of oxaloacetate into the mesophyll chloroplasts.

9.4 Photosynthetic Efficiency and Performance at High and Low Temperatures

The differences in anatomy and biochemistry result in strikingly different A_n - C_i curves between C_3 and

C_4 . First, the **CO₂-compensation point** of C_4 plants is only 0–5 $\mu\text{mol mol}^{-1}$ CO₂, as compared with 40–50 $\mu\text{mol mol}^{-1}$ in C_3 plants (Fig. 38). Second, this compensation point is not affected by O₂ concentration, as opposed to that of C_3 plants which is considerably less at a low O₂ concentration (i.e., when photorespiration is suppressed). Thirdly, the C_i (the internal concentration of CO₂ in the mesophyll) at a C_a of 380 $\mu\text{mol mol}^{-1}$ is only about 100 $\mu\text{mol mol}^{-1}$, compared with approximately 250 $\mu\text{mol mol}^{-1}$ in C_3 plants (Fig. 38).

There are also major differences in the characteristics of the light-response curves of CO₂ assimilation of C_3 and C_4 species. The initial slope of the light-response represents the light-limited part and is referred to as the **quantum yield**. Photochemical activity is limited by the rate of electron transport under these conditions. Changes in quantum yield are thus caused by changes in the partitioning between carboxylation and oxygenation reactions of Rubisco. When measured at 30°C or higher, the quantum yield is considerably higher for C_4 plants and independent of the O₂ concentration, in contrast to that of C_3 plants. Therefore, at relatively high temperatures, the quantum yield of photosynthesis

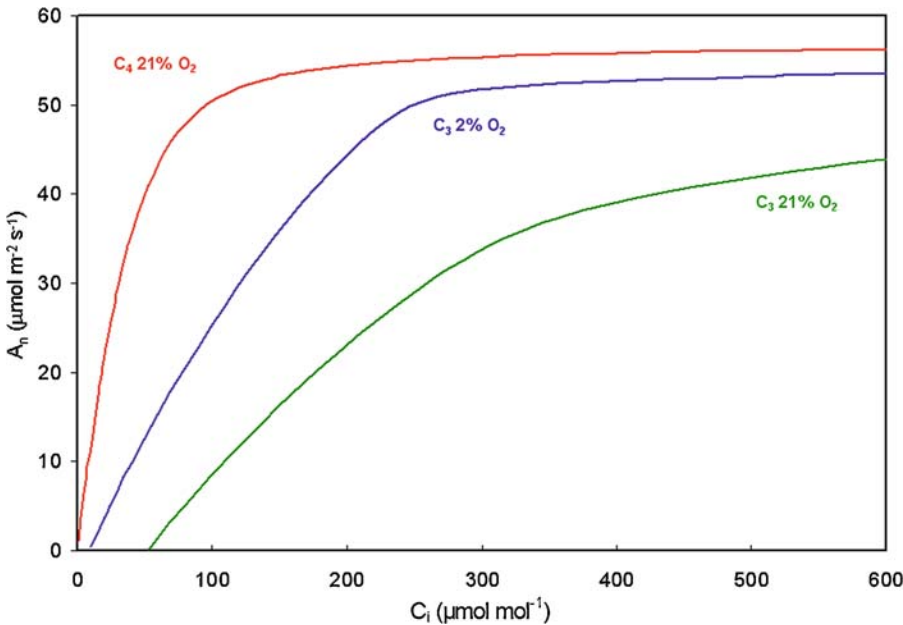

FIGURE 38. Response of net photosynthesis (A_n) to intercellular CO₂ concentration in the mesophyll (C_i) of C_3 and C_4 plants. C_3 plants respond strongly to O₂ as shown by the lines for normal atmospheric (21%) and low (2%) O₂ concentrations, whereas C_4 plants do not. The CO₂-response curves were calculated based on models

described by Von Caemmerer (2000). Parameter values for the C_3 model were $V_{\text{cmax}} = 150$ and $J_{\text{max}} = 225 \mu\text{mol m}^{-2} \text{s}^{-1}$ (see Box 2A.1), and in the C_4 model $V_{\text{cmax}} = 60$ and $V_{\text{pmax}} = 120 \mu\text{mol m}^{-2} \text{s}^{-1}$, where V_{pmax} is the maximum PEP carboxylase activity. Arrows indicate typical C_i values at 380 $\mu\text{mol CO}_2 \text{mol}^{-1}$ air.

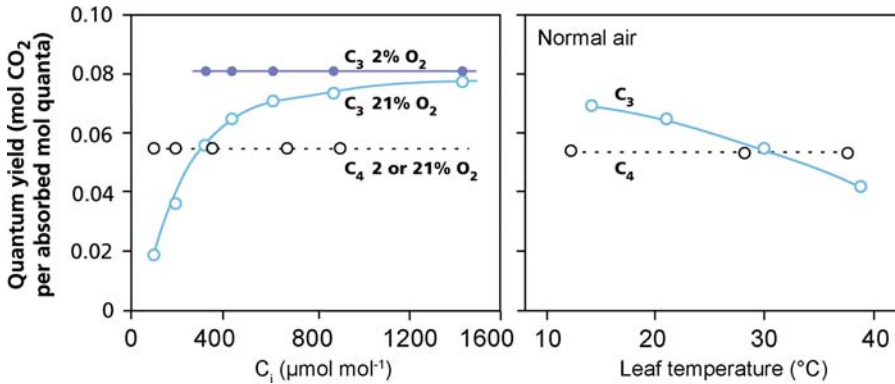

FIGURE 39. The effect of temperature and the intercellular CO₂ concentration (C_i) on the quantum yield of the photosynthetic CO₂ assimilation in a C₃ and a C₄ plant (after Ehleringer & Björkman 1977).

is higher for C₄ plants, and is not affected by **temperature**. By contrast, the quantum yield of C₃ plants declines with increasing temperature, due to the proportionally increasing oxygenating activity of Rubisco (Fig. 39). At an atmospheric O₂ and CO₂ concentration of 21% and 350 μmol mol⁻¹, respectively, the quantum yield is higher for C₄ plants at high temperatures due to photorespiration in C₃ species, but lower at low temperatures due to the additional ATP required to regenerate PEP in C₄ species. When measured at a low O₂ concentration

(to suppress photorespiration) and a C_a of 350 μmol mol⁻¹, the quantum yield is invariably higher for C₃ plants.

The rate of CO₂ assimilation of C₄ plants typically saturates at higher irradiance than that of C₃ plants, because A_{max} of C₄ plants is generally higher. This is facilitated by a high C_v, the CO₂ concentration at the site of Rubisco. In C₃ plants with their generally lower A_{max}, the light-response curve levels off at lower irradiances, because CO₂ becomes the limiting factor for the net CO₂ assimilation. At

TABLE 9. Variation in kinetic parameters of the ubiquitous carboxylating enzyme Rubisco at 25°C for eight species in four groups.*

	Presence of CCM	K _m (CO ₂)		k _{cat} S ⁻¹
		In water μM	In air μmol mol ⁻¹	
Cyanobacteria				
<i>Synechococcus</i>	+	293	–	12.5
Green algae				
<i>Chlamydomonas reinhardtii</i>	+	29	–	5.8
C₄ terrestrial plants				
<i>Amaranthus hybridus</i>	+	16	480	3.8
<i>Sorghum bicolor</i>	+	30	900	5.4
<i>Zea mays</i>	+	34	1020	4.4
C₃ terrestrial plants				
<i>Triticum aestivum</i>	–	14	420	2.5
<i>Spinacia oleracea</i>	–	14	420	3.7
<i>Nicotiana tabacum</i>	–	11	330	3.4

Source: Tcherkez et al (2006).

* Shown are the Michaelis–Menten constant K_m(CO₂), inversely related to substrate (CO₂) affinity, and the catalytic turnover rate at saturating CO₂ (k_{cat}, mol CO₂ (mol catalytic sites)⁻¹). K_m(CO₂) in air is calculated from the value provided for water using the solubility of CO₂ at 25°C (33.5 mmol L⁻¹ at standard atmospheric pressure). CCM = carbon-concentrating mechanism.

TABLE 10. The number of chloroplasts and of mitochondria plus peroxisomes in bundle sheath cells compared with those in mesophyll cells (BSC/MC) and the CO₂-compensation point (Γ , $\mu\text{mol mol}^{-1}$, of C₃, C₄, and C₃-C₄ intermediates belonging to the genera *Panicum*, *Neurachne*, *Flaveria*, and *Moricandia*.

Species	Photosynthetic pathway	BSC/MC		Γ
		Chloroplasts	Mitochondria + peroxisomes	
<i>P. milioides</i>	C ₃ -C ₄	0.9	2.4	19
<i>P. miliaceum</i>	C ₄	1.1	8.4	1
<i>N. minor</i>	C ₃ -C ₄	3.1	20.0	4
<i>N. munroi</i>	C ₄	0.8	4.9	1
<i>N. tenuifolia</i>	C ₃	0.6	1.2	43
<i>F. anomala</i>	C ₃ -C ₄	0.9	2.3	9
<i>F. floridana</i>	C ₃ -C ₄	1.4	5.0	3
<i>F. linearis</i>	C ₃ -C ₄	2.0	3.6	12
<i>F. oppositifolia</i>	C ₃ -C ₄	1.4	3.6	14
<i>F. brownii</i>	C ₄ -like	4.2	7.9	2
<i>F. trinerva</i>	C ₄	2.2	2.4	0
<i>F. pringlei</i>	C ₃	0.5	1.0	43
<i>M. arvensis</i>	C ₃ -C ₄	1.4	5.2	32
<i>M. spinosa</i>	C ₃ -C ₄	1.6	6.0	25
<i>M. foleyi</i>	C ₃	1.5	3.3	51
<i>M. moricandioides</i>	C ₃	2.0	2.8	52

Source: Brown & Hattersley (1989).

increasing atmospheric CO₂ concentrations the irradiance at which light saturation is reached shifts to higher levels also in C₃ plants.

The high concentration of CO₂ in the vascular bundle sheath of C₄-plants, the site of Rubisco, allows different kinetic properties of Rubisco. Table 9 shows that indeed the $K_m(\text{CO}_2)$ of Rubisco from terrestrial C₃ plants is lower than that from C₄ plants. A high K_m , that is a low affinity, for CO₂ of Rubisco is not a disadvantage for the photosynthesis of C₄ plants, considering the high C_c in the bundle sheath. For C₃ plants a low K_m for CO₂ is vital, since the C_i is far from saturating for Rubisco in their mesophyll cells. The advantage of the high K_m of the C₄ Rubisco is thought to be indirect in that it allows a high **maximum rate** per unit protein of the enzyme (V_{max} or k_{cat}). That is, the tighter CO₂ is bound to Rubisco, the longer it takes for the carboxylation to be completed. In C₃ plants, a high affinity is essential, so that k_{cat} cannot be high. C₄ plants, which do not require a high affinity, do indeed have an enzyme with a high k_{cat} , allowing more moles of CO₂ to be fixed per unit Rubisco and time at the high C_c (Table 10). Interestingly, the alga *Chlamydomonas reinhardtii*, which has a CO₂-concentrating mechanism (Sect. 11.3), also has a Rubisco enzyme with a high K_m (low affinity) for CO₂ and a high V_{max} and k_{cat} (Table 10). Apparently, there is a trade-

off in Rubisco between CO₂ specificity [a low $K_m(\text{CO}_2)$] and catalytic capacity (a high k_{cat}).

The biochemical and physiological differences between C₄ and C₃ plants have important ecological implications. The abundance of C₄ monocots in regional floras correlates most strongly with growing season temperature, whereas C₄ dicot abundance correlates more strongly with aridity and salinity (Ehleringer & Monson 1993). At regional and local scales, areas with **warm-season rainfall** have greater C₄ abundance than regions with cool-season precipitation. Along local gradients, C₄ species occupy microsites that are warmest or have driest soils. In communities with both C₃ and C₄ species, C₃ species are most active early in the growing season when conditions are cool and moist, whereas C₄ activity increases as conditions become warmer and drier. Together these patterns suggest that high photosynthetic rates at high temperature (due to **lack of photorespiration**) and high water-use efficiency (WUE) (due to the **low C_i**, which enables C₄ plants to have a **lower stomatal conductance** for the same CO₂ assimilation rate) are the major factors governing the ecological distribution of the C₄ photosynthetic pathway. Any competitive advantage of the high WUE of C₄ plants, however, has been difficult to document experimentally (Ehleringer & Monson 1993). This

may well be due to the fact that, in a competitive situation, any water that is left in the soil by a plant with a high WUE is available for a competitor with lower WUE. Although WUE of C₄ plants is higher, the C₄ pathway does not give them a higher drought tolerance.

C₄ plants generally have lower tissue N concentrations, because they have 3–6 times less Rubisco than C₃ plants and very low levels of the photorespiratory enzymes, though some of the advantage is lost by the investment of N in the enzymes of the C₄ pathway. C₄ plants also have equivalent or higher photosynthetic rates than C₃ plants, resulting in a higher rate of photosynthesis per unit of leaf N (**Photosynthetic N-Use Efficiency, PNUE**), especially at high temperatures (Fig. 40). The higher PNUE of C₄ plants is accounted for by: (1) suppression of the oxygenase activity of Rubisco, so that the enzyme is only used for the carboxylation reaction; (2) the lack of photorespiratory enzymes; (3) the higher catalytic activity of Rubisco due to its high k_{cat} and the high C_c (Table 10). Just as in a comparison of C₃ species that differ in PNUE (Sect. 4.2.1 of Chapter 6 on mineral nutrition), there is no consistent tendency of C₄ species to have increased abundance or a competitive advantage in low-N soils (Christie & Detling 1982, Sage & Pearcy 1987a). This suggests that the high PNUE of C₄ species is less important than their high WUE and high optimum temperature of photosynthesis in explaining patterns of distribution.

One of the key enzymes of the C₄ pathway in *Zea mays* (corn), pyruvate P_i-dikinase, readily loses its activity at low temperature and hence the leaves' photosynthetic capacity declines. This accounts for part of the chilling sensitivity of most C₄ plants. Loss

of activity of pyruvate P_i-dikinase at low temperatures can be prevented by protective ("compatible") compounds (Sect. 3.4.5 of Chapter 3 on plant water relations), but it remains to be investigated if this plays a major role in intact C₄ plants (Krall et al. 1989).

9.5 C₃–C₄ Intermediates

In the beginning of the 1970s, when the C₄ pathway was unraveled, there were attempts to cross C₃ and C₄ species of *Atriplex* (saltbush). This was considered a useful approach to enhance the rate or efficiency of photosynthesis and yield of C₃ parents. The complexity of anatomy and biochemistry of the C₄ plants, however, is such that these crosses have not produced any useful progeny (Brown & Bouton 1993). Since molecular techniques have become available which allow silencing and over-expression of specific genes in specific cells, attempts have been made to reduce the activity of glycine decarboxylase, the key enzyme in photorespiration, in mesophyll cells of C₃ plants and over-express the gene in the bundle sheath. Although these attempts have been successful from a molecular point of view in that the aim of selectively modifying the enzyme activity was achieved, no results have yet been obtained to show enhanced rates of photosynthesis. This is perhaps not unexpected, in view of the rather small advantage true C₃–C₄ intermediates are likely to have in comparison with C₃ relatives.

Further attempts to transform C₃ crops into C₄ were inspired by the discovery of plants that perform a C₄ pathway without intercellular compartmentation between mesophyll and bundle sheath. *Suaeda aralocaspica* (formerly known as *Borszczowia aralocas-*

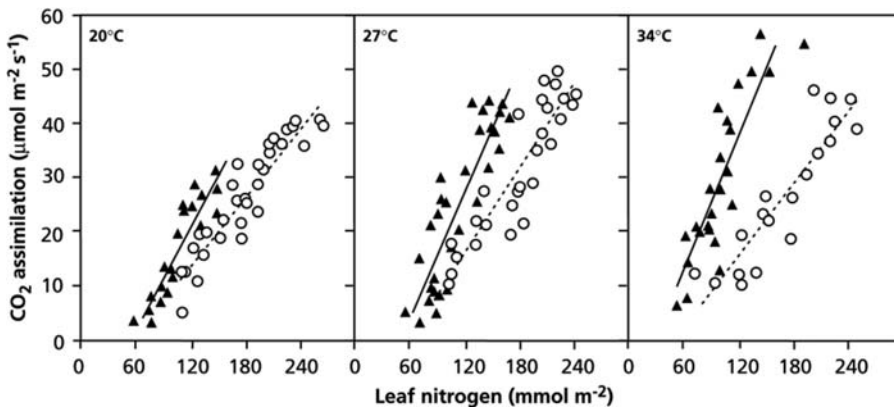

FIGURE 40. The rate of CO₂ assimilation as a function of the organic N concentration in the leaf and the temperature, as measured for the C₃ plant *Chenopodium album*

(pigweed, circles) and the C₄ plant *Amaranthus retroflexus* (triangles) (after Sage & Pearcy 1987b). Copyright American Society of Plant Biologists.

pica, seepweed) and *Bienertia cycloptera* have the complete C_4 cycle operating in mesophyll cells. PEP carboxylation and regeneration occur at the distal ends of the cell exposed to the intercellular air spaces. The C_4 acids produced must therefore diffuse from here to the opposite, proximal end of the cell where they are decarboxylated. An elongated vacuole provides high resistance to CO_2 efflux and thus CO_2 accumulates where Rubisco is located. In this regard, the general layout of these C_3 – C_4 intermediates is similar to that of Kranz-type C_4 plants, the major difference being the lack of a cell wall segregating the PCA and PCR compartments (Sage 2002, 2004). The existence of single-cell C_4 in terrestrial plants opens new possibilities for introducing the C_4 pathway in C_3 crops, because it does not require complicated anatomical changes (Surridge 2002).

Over 20 plant species exhibit photosynthetic traits that are intermediate between C_3 and C_4 plants (e.g., species in the genera *Alternanthera*, *Flaveria*, *Neurachne*, *Moricandia*, *Panicum*, and *Parthenium*). These show **reduced rates of photorespiration** and **CO_2 -compensation points** in the range of 8 to $35 \mu\text{mol mol}^{-1}$, compared with 40 – $50 \mu\text{mol mol}^{-1}$ in C_3 and 0 to $5 \mu\text{mol mol}^{-1}$ in C_4 plants (Table 10). They have a weakly developed Kranz anatomy, compared with the true C_4 species, but Rubisco is located both in the mesophyll and the bundle sheath cells (Brown & Bouton 1993).

Two main types of intermediates are distinguished. In the first type (e.g., *Alternanthera ficoides*, *Alternanthera enella*, *Moricandia arvensis*, and *Panicum milioides*) the activity of key enzymes of the C_4 pathway is very low, and they do not have a functional C_4 acid cycle. Their low CO_2 -compensation point is due to the light-dependent recapture by mesophyll cells of CO_2 released in photorespiration in the bundle sheath cells, which contain a large fraction of the organelles involved in photorespiration, compared with that in C_3 species (Table 10). In these C_3 – C_4 intermediates a system has evolved to salvage CO_2 escaping from the bundle sheath cells, but they do not have the CO_2 -concentrating mechanism of true C_4 species (Ehleringer & Monson 1993). In the leaves of this type of intermediate species, **glycine decarboxylase**, a key enzyme in photorespiration that releases the photorespiratory CO_2 , occurs exclusively in the cells surrounding the vascular bundle sheath (Morgan et al. 1992). Products of the oxygenation reaction, including glycine, probably move to the bundle sheath cells. Presumably, the products are metabolized in the bundle sheath, so that serine can move back to the mesophyll (Fig. 41). Due to the exclusive location of glycine decarboxylase in the bundle sheath cells, the release of CO_2 in photorespiration occurs close to the vascular tissue, with chloroplasts occurring between these mitochondria and the intercellular spaces.

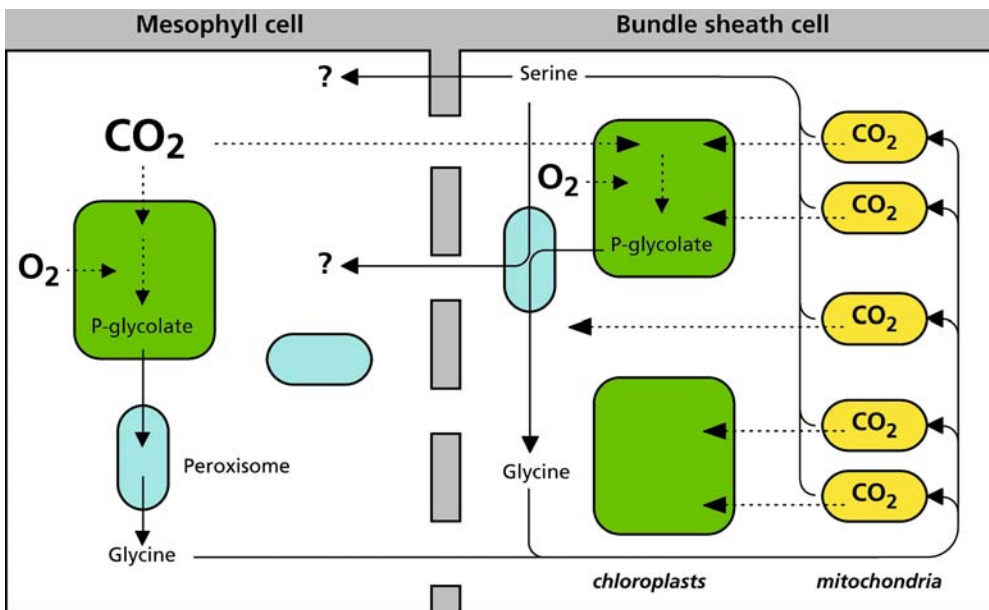

FIGURE 41. A model of the photorespiratory metabolism in leaves of the C_3 – C_4 intermediate *Moricandia arvensis*, showing the recapture of CO_2 released by glycine decarboxylase. The model accounts for the low

CO_2 -compensation point and the low apparent rate of photorespiration in this type of intermediate (Morgan et al. 1992). Copyright SPB Academic Publishing.

Glycine decarboxylase is only found in the enlarged mitochondria arranged along the cell walls adjacent to the vascular tissue and overlain by chloroplasts. This location of glycine decarboxylase increases the diffusion path for CO₂ between the site of release and the atmosphere and allows the recapture of a large fraction of the photorespiratory CO₂ released by glycine decarboxylase, by Rubisco located in the bundle sheath. The location of glycine decarboxylase in the bundle sheath allows some build-up of CO₂, but not to the same extent as in the true C₄ plants. Since the oxygenation reaction of Rubisco is only suppressed in the bundle sheath, and there probably only partly, whereas oxygenation in the mesophyll cells occurs to the same extent as in C₃ plants, the advantage in terms of the net rate of CO₂ assimilation is rather small, compared with that in a true C₄ plant (Von Caemmerer 1989).

In the second type of intermediate species (e.g., *Flaveria anomala* and *Neurachne minor*), the activity of key enzymes of the C₄ pathway is considerable. Rapid fixation of ¹⁴CO₂ into C₄ acids, followed by transfer of the label to Calvin-cycle intermediates, has been demonstrated. These species have a limited capacity for C₄ photosynthesis, but lower quantum yields than either C₃ or C₄, presumably because the operation of the C₄ cycle in these plants does not really lead to a concentration of CO₂ to the extent it does in true C₄ species.

In addition to the C₃-C₄ intermediate species, there are some species [e.g., *Eleocharis vivipara* (sprouting spikerush) and *Nicotiana tabacum* (tobacco)] that are capable of either C₃ or C₄ photosynthesis in different tissues (Ueno et al. 1988, Ueno 2001). Tobacco, a typical C₃ plant, shows characteristics of C₄ photosynthesis in cells of stems and petioles that surround the xylem and phloem; these cells are supplied with carbon for photosynthesis from the vascular system, and not from stomata. These photosynthetic cells possess high activities of enzymes characteristic of C₄ photosynthesis which allows the decarboxylation of four-carbon organic acids from the xylem and phloem, thus releasing CO₂ for photosynthesis (Hibberd & Quick 2002).

C₄ plants that can shift to a CAM mode occur in the genus *Portulaca* (Sect. 10.4).

9.6 Evolution and Distribution of C₄ Species

C₄ species represent approximately 5% of all higher plant species, C₃ species accounting for about 85% and CAM species (Sect. 10) for 10%. C₄ photosynthesis first arose in grasses, 24–35 million years ago,

and in dicots 15–21 million years ago (Sage 2004). However, it took several millions of years before the C₄ pathway spread on several continents and became dominant over large areas, between 8 and 6 million years ago, as indicated by changes in the carbon-isotope ratios of fossil tooth enamel in Asia, Africa, North America, and South America (Cerling et al. 1997). A decreasing **atmospheric CO₂ concentration**, as a result of the photosynthetic activity of plants and possibly much more so due to tectonic and subsequent geochemical events, has been a significant factor contributing to C₄ evolution. Briefly, the collision of the Indian subcontinent caused the uplift of the Tibetan Plateau. With this, Earth crust consuming CO₂ became exposed over a vast area. The reaction $\text{CaSiO}_3 + \text{CO}_2 \rightleftharpoons \text{CaCO}_3 + \text{SiO}_2$ is responsible for the dramatic decline in atmospheric CO₂ concentration (Raymo & Ruddiman 1992, Ehleringer & Monson 1993). Since CO₂ levels were already low when the first C₄ plants evolved, other factors must have been responsible for the rapid spread of C₄ plants many millions of years after they first arose.

The universal carboxylating enzyme Rubisco does not operate efficiently at the present low CO₂ and high O₂ atmospheric conditions. Low atmospheric CO₂ concentrations would increase photorespiration and thus favor the **CO₂-concentrating mechanisms** and **lack of photorespiration** that characterize C₄ species. Considering the three subtypes of C₄ species and their occurrence in at least 19 different families of widely different taxonomic groups, C₄ plants must have evolved from C₃ ancestors independently about 48 times on different continents (**convergent evolution**) (Table 7). Morphological and eco-geographical information combined with molecular evidence suggests that C₄ photosynthesis has evolved twice in different lineages within the genus *Flaveria* (Sage 2004). The physiology of C₃-C₄ intermediates suggests that the mechanism to recapture CO₂ evolved before the CO₂-concentrating mechanism (Sect. 9.5). The phylogeny of *Flaveria* species, as deduced from an analysis of the nucleotide sequences encoding a subunit of glycine decarboxylase, suggests that C₄ species originated from C₃-C₄ intermediates, and that C₄ in this genus developed relatively recently (Sage 2004).

C₄ photosynthesis originated in **arid regions** of low latitude, where **high temperatures** in combination with **drought** and/or **salinity**, due to a globally drying climate and increased **fire frequency**, promoted the spread of C₄ plants (Keeley & Rundel 2005, Beerling & Osborne 2006). A major role for climatic factors as the driving force for C₄ evolution is also indicated by C₄ distributions in

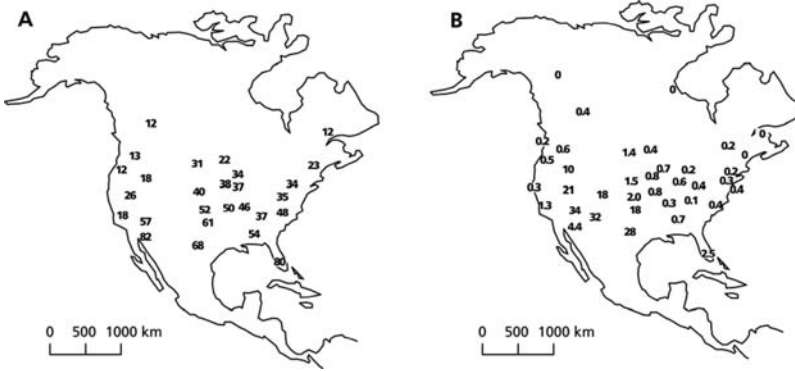

FIGURE 42. Geographic distribution of C_4 species in North America. *Left*: percentage of grass taxa that are C_4 plants. *Right*: percentage of dicotyledon taxa that are C_4 plants in regional floras of North America (Teeri & Stowe 1976, and Stowe & Teeri 1978, as cited in Osmond et al. 1982).

Mesoamerican sites that have experienced contrasting moisture variations since the last glacial maximum. Analyses of the carbon-isotope composition of leaf wax components indicate that regional climate exerts a strong control over the relative abundance of C_3 and C_4 species, and that in the absence of favorable moisture and temperature conditions a low atmospheric CO_2 concentration alone does not favor C_4 expansion (Huang et al. 2001).

Low altitudes in tropical areas continue to be centers of distribution of C_4 species. Tropical and temperate lowland grasslands, with abundant warm-season precipitation, are dominated by C_4 species. At higher elevations in these regions C_3 species are dominant, both in cover and in composition, for example on the summits of the Drakenberg in South Africa (Vogel et al. 1978) and on highland

plains in a temperate arid region of Argentina (Cavagnaro 1988).

The high concentration of CO_2 at the site of Rubisco, allows net CO_2 assimilation at relatively high temperatures, where photorespiration results in low net photosynthesis of C_3 species due to the increased oxygenating activity of Rubisco. This explains why C_4 species naturally occur in warm, open ecosystems, where C_3 species are less successful (Figs. 42 and 43). There is no a priori reason, however, why C_4 photosynthesis could not function in cooler climates. The lower quantum yield of C_4 species at low temperature would be important in dense canopies where light limits photosynthesis (and where **quantum yield** is therefore important). Quantum yield, however, is less important at higher levels of irradiance, and there is quite a wide tem-

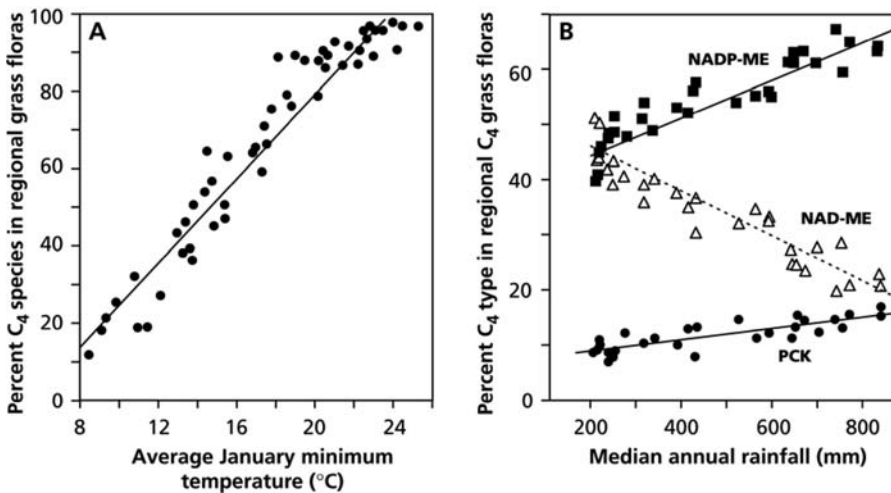

FIGURE 43. *Left*: The percentage occurrence of C_4 metabolism in grass floras of Australia in relation to temperature in the growing season (January). *Right*: The

percentage occurrence of C_4 grass species of the three metabolic types in regional floras in Australia in relation to median annual rainfall (Henderson et al. 1995).

perature range where the quantum yield is still high compared with that of C_3 plants (Fig. 39). The high sensitivity to low temperature of pyruvate P_i -dikinase, a key enzyme in the C_4 pathway may be the main reason why C_4 species have rarely expanded to cooler places (Sect. 7.2). Compatible solutes can decrease the low-temperature sensitivity of this enzyme and this could allow the expansion of C_4 species into more temperate regions in the future. Alternatively, rising atmospheric CO_2 concentration may offset the advantages of the CO_2 -concentrating mechanism of C_4 photosynthesis (Sect. 12).

9.7 Carbon-Isotope Composition of C_4 Species

Although Rubisco of C_4 plants discriminates between $^{12}CO_2$ and $^{13}CO_2$, just like that of C_3 plants, the fractionation in C_4 species is considerably less than that in C_3 plants. This is explained by the small extent to which inorganic carbon **diffuses back** from the vascular bundle to the mesophyll (Sect. 9.2). Moreover, the inorganic carbon that does diffuse back to the mesophyll cells will be **refixed** by PEP carboxylase, which has a very high affinity for bicarbonate (Box 2A.2). Most of the $^{13}CO_2$ that accumulates in the bundle sheath is ultimately assimilated; hence the isotope fractionation of CO_2 is very small in C_4 species (Fig. 44).

The isotopic differences between C_3 and C_4 plants (Fig. 44) are large compared with isotopic changes occurring during digestion by herbivores or decomposition by soil microbes. This makes it possible to determine the relative abundance of C_3 and C_4 species in the diets of animals by analyzing tissue samples of animals ("You are what you eat") or as sources of soil organic matter in paleosols (old soils). These studies have shown that many general-

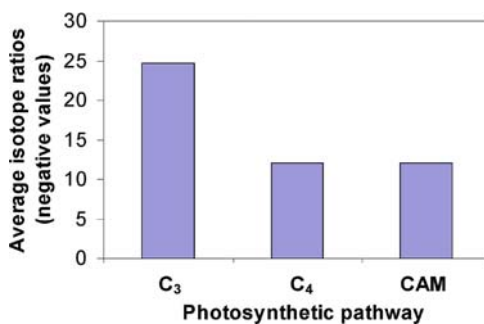

FIGURE 44. The carbon-isotope composition of C_3 , C_4 , and CAM plants (Sternberg et al. 1984).

ist herbivores show a preference for C_3 rather than C_4 plants (Ehleringer & Monson 1993). C_3 species, however, also tend to have more toxic secondary metabolites, which cause other herbivores to show exactly the opposite preference.

10. CAM Plants

10.1 Introduction

In addition to C_3 and C_4 species, there are many succulent plants with another photosynthetic pathway: **Crassulacean Acid Metabolism (CAM)**. This pathway is named after the Crassulaceae, a family in which many species show this type of metabolism. CAM, however, also occurs commonly in other families, such as the Cactaceae, Euphorbiaceae, Orchidaceae, and Bromeliaceae [e.g., *Ananas comosus* (pineapple)]. There are about 10000 CAM species from 25 to 30 families (Table 11), all angiosperms, with the exception of a few fern species that also have CAM characteristics.

The unusual capacity of CAM plants to fix CO_2 into organic acids in the dark, causing **nocturnal acidification**, with de-acidification during the day, has been known for almost two centuries. A full appreciation of CAM as a photosynthetic process was greatly stimulated by analogies with C_4 species.

The productivity of most CAM plants is fairly low. This is not an inherent trait of CAM species, however, because some cultivated CAM plants (e.g., *Agave mapisaga* and *Agave salmiana*) may achieve an average above-ground productivity of 4 kg dry mass $m^{-2}yr^{-1}$. An even higher productivity has been observed for irrigated, fertilized, and carefully pruned *Opuntia amyoclea* and *Opuntia ficus-indica*

TABLE 11. Taxonomic survey of flowering plant families known to have species showing crassulacean acid metabolism (CAM) in different taxa.

Agavaceae	Geraniaceae
Aizoaceae	Gesneriaceae
Asclepiadiaceae	Labiatae
Asteraceae	Liliaceae
Bromeliaceae	Oxalidaceae
Cactaceae	Orchidaceae
Clusiaceae	Piperaceae
Crassulaceae	Polypodiaceae
Cucurbitaceae	Portulacaceae
Didieraceae	Rubiaceae
Euphorbiaceae	Vitaceae

Source: Kluge & Ting (1978) and Medina (1996).

(prickly pears) ($4.6 \text{ kg m}^{-2} \text{ yr}^{-1}$; Nobel et al. 1992). These are among the highest productivities reported for any species. In a comparison of two succulent species with similar growth forms, *Cotyledon orbiculata* (pig's ear) (CAM) and *Othonna optima* (C_3), during the transition from the rainy season to subsequent drought, the daily net rate of CO_2 assimilation is similar for the two species. This shows that rates of photosynthesis of CAM plants may be as high as those of C_3 plants, if morphologically similar plants adapted to the similar habitats are compared (Eller & Ferrari 1997).

As with C_4 plants, none of the enzymes or metabolic reactions of CAM are really unique to these species. The reactions proceed at different times of the day, however, quite distinct from C_3 and C_4 species. Based on differences in the major decarboxylating enzyme, two subtypes of CAM species are discerned (Sect. 10.2). In addition, there are intermediate forms between C_3 and CAM, as well as facultative CAM plants (Sect. 10.4).

10.2 Physiological, Biochemical, and Anatomical Aspects

CAM plants are characterized by their **succulence** (but this is not pronounced in epiphytic CAM plants; Sect. 10.5), the capacity to fix CO_2 at night via **PEP carboxylase**, the accumulation of **malic acid** in the vacuole, and subsequent de-acidification during the day, when CO_2 is released from malic acid and fixed in the Calvin cycle, using Rubisco.

CAM plants show a strong fluctuation in pH of the cell sap, due to the synthesis and breakdown of malic acid. The concentration of this acid may increase to 100 mM. By isolating vacuoles of the CAM plant *Kalanchoe daigremontiana* (devil's backbone), it was shown that at least 90% of all the acid in the cells is in the vacuole. The kinetics of malic acid efflux from the leaves of *Kalanchoe daigremontiana* provides further evidence for the predominant location of malic acid in the vacuole.

At night, CO_2 is fixed in the cytosol, catalyzed by **PEP carboxylase**, producing oxaloacetate (Fig. 45). PEP originates from the breakdown of glucose in glycolysis; glucose is formed from starch. Oxaloacetate is immediately reduced to malate, catalyzed by malate dehydrogenase. Malate is transported to the large vacuoles in an energy-dependent manner. A H^+ -ATPase and a pyrophosphatase pump H^+ into the vacuole, so that malate can move down an electrochemical potential gradient (Sect. 2.2.2 of Chapter

6 on mineral nutrition). In the vacuole it will be present as malic acid.

The release of malic acid from the vacuole during the day is supposedly passive. Upon release it is decarboxylated, catalyzed by **malic enzyme** (NAD- or NADP-dependent), or by **PEP carboxykinase** (PEPCK). Like C_4 species, CAM species are subdivided depending on the decarboxylating enzyme. The malic enzyme subtypes (ME-CAM) have a cytosolic NADP-malic enzyme, as well as a mitochondrial NAD-malic enzyme; they use a chloroplastic pyruvate P_i -dikinase to convert the C_3 fragment originating from the decarboxylation reaction into carbohydrate via PEP. PEPCK-type CAM plants have very low malic enzyme activities (as opposed to PEPCK- C_4 plants) and no pyruvate P_i -dikinase activity, but high activities of PEP carboxykinase.

The C_3 fragment (pyruvate or PEP) that is formed during the decarboxylation, is converted into starch and the CO_2 that is released is fixed by **Rubisco**, much the same as in C_3 plants. During the decarboxylation of malic acid and the fixation of CO_2 by Rubisco in the Calvin cycle, the stomata are closed. They are open during the nocturnal fixation of CO_2 .

The CAM traits can be summarized as follows:

1. Fluctuation of organic acids, mainly of malic acid, during a diurnal cycle;
2. Fluctuation of the concentration of sugars and starch, opposite to the fluctuation of malic acid;
3. A high activity of PEP carboxylase (at night) and of a decarboxylase (during the day);
4. Large vacuoles in cells containing chloroplasts;
5. Some degree of succulence;
6. The CO_2 assimilation by the leaves occurs predominantly at night.

Four "phases" in the diurnal pattern of CAM are discerned (Fig. 46). **Phase I**, the carboxylation phase, starts at the beginning of the night. Toward the end of the night, the rate of carboxylation declines and the malic acid concentration reaches its maximum. The stomatal conductance and the CO_2 fixation change more or less in parallel. During phase I, carbohydrates are broken down. **Phase II**, at the beginning of the day, is characterized by a high rate of CO_2 fixation, generally coinciding with an increased stomatal conductance. CO_2 fixation by PEP carboxylase and malic acid formation coincide with the fixation of CO_2 by Rubisco. Gradually, fixation by PEP carboxylase is taken over by fixation by Rubisco. In the last part of phase II, C_3 photosynthesis predominates, using exogenous CO_2 as the substrate. Phase II typically occurs

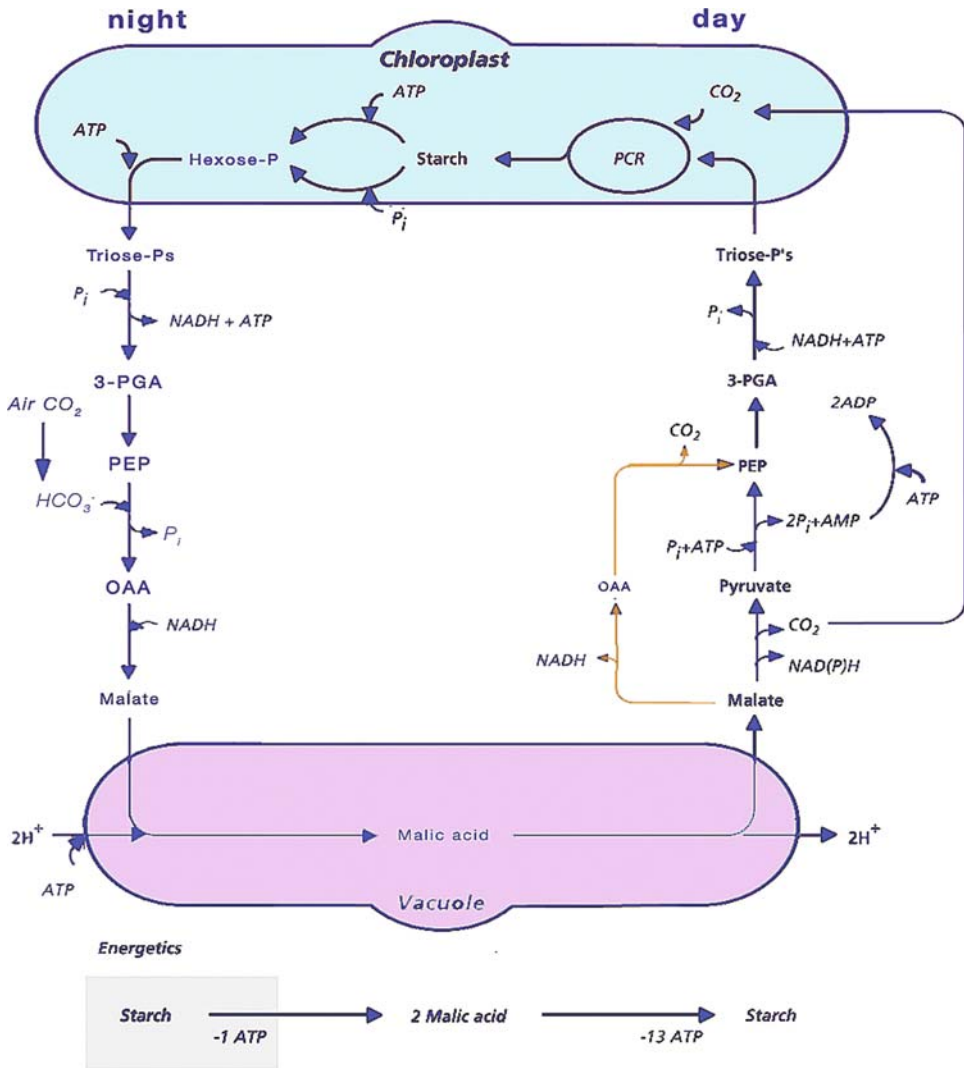

FIGURE 45. Metabolic pathway and cellular compartmentation of Crassulacean Acid Metabolism (CAM), showing the separation in night and day of

carboxylation and decarboxylation. The steps specific for PEPCK-CAM plants are depicted in red.

under laboratory conditions, following an abrupt dark-to-light transition, but is not apparent under natural conditions. In **phase III** the stomata are fully closed and malic acid is decarboxylated. The C_i may then increase to values above $10000 \mu\text{mol mol}^{-1}$. This is when normal C_3 photosynthesis takes place and when sugars and starch accumulate. When malic acid is depleted, the stomata open again, possibly because C_i drops to a low level; this is the beginning of **phase IV**. Gradually more exogenous and less endogenous CO_2 is being fixed by Rubisco. In this last phase, CO_2 may be fixed by PEP carboxylase again, as indicated by the

photosynthetic quotient (PQ), i.e., the ratio of O_2 release and CO_2 uptake. Over an entire day the PQ is about 1 (Table 12), but deviations from this value occur, depending on the carboxylation process (Fig. 47).

In phase III, when the stomata are fully closed, malic acid is decarboxylated, and the C_i is very high, **photorespiration** is suppressed, as indicated by the relatively slow rate of O_2 uptake (as measured using $^{18}\text{O}_2$; Fig. 47). In phase IV, when malic acid is depleted and the stomata open again, photorespiration does occur, as demonstrated by increased uptake of $^{18}\text{O}_2$.

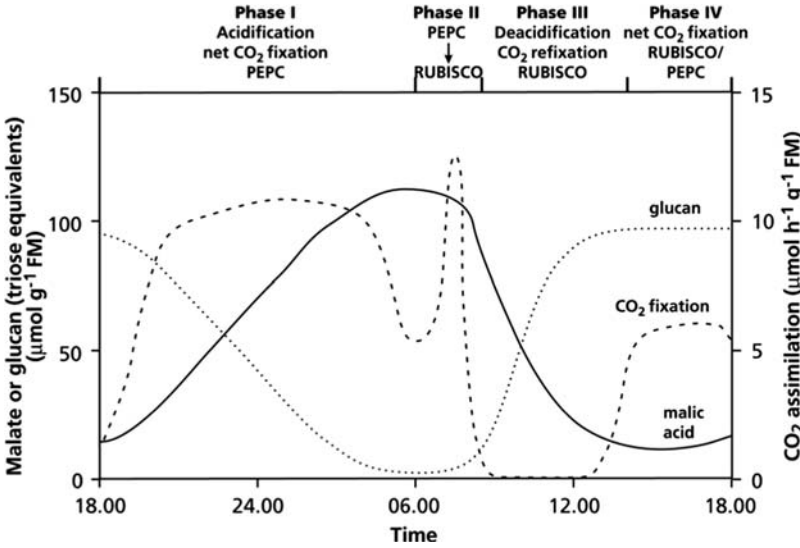

FIGURE 46. CO_2 fixation in CAM plants, showing diurnal patterns for net CO_2 assimilation, malic acid concentration and carbohydrate concentrations (PEPC is PEP carboxylase). Four phases are distinguished, as described in Sect. 10.2 (after Osmond & Holtum 1981).

How do CAM plants regulate the activity of the two carboxylating enzymes and decarboxylating enzymes in a coordinated way to avoid futile cycles? Rubisco is inactive at night for the same reason as in C_3 plants: this enzyme is part of the Calvin cycle that depends on the light reactions and is inactivated in the dark (Sect. 3.4.2). In addition, the kinetic properties of PEP carboxylase are modulated. In *Mesembryanthemum crystallinum* (ice plant) and in *Crassula argentea* (jade plant), PEP carboxylase occurs in two configurations: a “day-configuration” and a “night-configuration”. The night-configuration is relatively insensitive to malate (the K_i for malate is 0.06–0.9 mM, depending on pH) and has a high affinity for PEP (the K_m for PEP is 0.1–0.3 mM). The day-configuration is strongly inhibited by malate (the K_i for malate is 0.004–0.07 mM, again depending on the pH) and has a low affinity for PEP (the K_m for PEP is 0.7–1.25 mM). Therefore, when

malate is rapidly exported to the vacuole at night in phase I, the carboxylation of PEP readily takes place, whereas it is suppressed during the day in phase III. The modification of the kinetic properties involves the **phosphorylation** and **de-phosphorylation** of PEP carboxylase (Nimmo et al. 2001).

Through modification of its kinetic properties, the inhibition of PEP carboxylase prevents a futile cycle of carboxylation and concomitant decarboxylation reactions. Further evidence that such a futile cycle does not occur comes from studies on the labeling with ^{13}C of the first or fourth carbon atom in malate. If a futile cycle were to occur, doubly labeled malate should appear, as fumarase in the mitochondria would randomize the label in the malate molecule. Such randomization only occurs during the acidification phase, indicating rapid exchange of the malate pools of the cytosol and the mitochondria, before malate enters the vacuole.

TABLE 12. Cumulative daily net CO_2 and O_2 exchange in the dark and in the light periods (12 hours each) and the daily Photosynthetic Quotient for the entire 24 hours period of a shoot of *Ananas comosus* (pineapple).*

	Cumulative daily net CO_2 and O_2 exchange (mmol shoot^{-1})					Daily Photosynthetic Quotient
	Dark		Light			
	CO_2 assimilation	O_2 consumption	CO_2 assimilation	O_2 release		
Day 1	10.6	6.4	10.4	27.1	0.99	
Day 2	11.1	6.3	10.7	27.5	0.98	

Source: Coté et al. (1989).

* Photosynthetic quotient is the ratio of the total net amount of O_2 evolved to the net CO_2 fixed in 24 hours (i.e., the total amount of O_2 evolved in the light period minus the total amount of O_2 consumed in the dark period) to the total amount of CO_2 fixed in the light plus dark period. Measurements were done over two consecutive days.

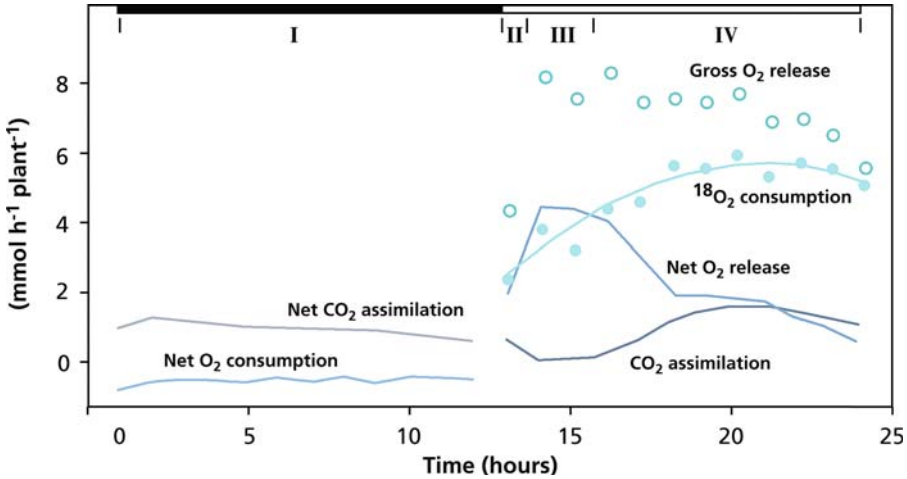

FIGURE 47. Gas exchange of *Ananas comosus* (pineapple) during the dark and light period. O_2 consumption during the day is measured using the stable isotope $^{18}O_2$. Gross O_2 release is the sum of net O_2 production and

$^{18}O_2$ consumption. The phases are the same as those shown in Fig. 45 (after Coté et al. 1989). Copyright American Society of Plant Biologists.

TABLE 13. Effects of malate and glucose-6-phosphate (G6P) on the kinetic parameters of PEP carboxylase.*

	V_{max} $mmol\ mg^{-1}\ (Chl)\ min^{-1}$	Ratio mM	K_m	Ratio
Control	0.42	1.0	0.13	1.0
+ 1 mM G6P	0.45	1.07	0.08	0.61
+ 2 mM G6P	0.47	1.12	0.05	0.39
+ 5 mM malate	0.31	0.74	0.21	1.60
+ 5 mM malate and 2 mM G6P	0.34	0.81	0.05	0.39

Next to malate, glucose 6-phosphate is also an effector of PEP carboxylase (Table 13). The physiological significance of this effect is that glucose 6-phosphate, which is produced from glucose, during its conversion into PEP thus stimulates the carboxylation of PEP.

Temperature has exactly the opposite effect on the kinetic properties of PEP carboxylase from a CAM plant and that from a C_4 plant (Fig. 48). These temperature effects help to explain why a low temperature at night enhances acidification.

10.3 Water-Use Efficiency

Since CAM plants keep their stomata closed during the day when the vapor pressure difference ($w_i - w_a$) between the leaves and the surrounding air is highest, and open at night when $w_i - w_a$ is lowest, they have a very high **water-use efficiency**. As long as they are not severely stressed which leads to

complete closure of their stomata, the WUE of CAM plants tends to be considerably higher than that of both C_3 and C_4 plants (Table 8 in Chapter 3 on plant water relations).

Populations of the leaf-succulent *Sedum wrightii* (Crassulaceae) differ greatly in their leaf thickness, $\delta^{13}C$ values (ranging from -13.8 to -22.9%), the proportion of day *vs.* night CO_2 uptake, and growth. The largest plants exhibit the greatest proportion of day *vs.* night CO_2 uptake and hence the lowest WUE, suggesting an inverse relation between the plants' ability to conserve water and their ability to gain carbon (Kalisz & Teeri 1986).

10.4 Incomplete and Facultative CAM Plants

When exposed to severe desiccation, some CAM plants may not even open their stomata during the

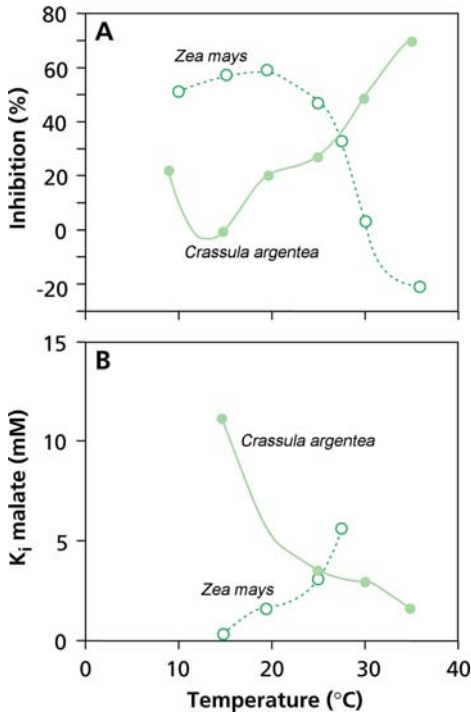

FIGURE 48. The effect of temperature on kinetic properties of PEP carboxylase from leaves of a *Crassula argentea* (jade plant, a CAM plant) and *Zea mays* (corn, a C_4 plant). (A) Effect on percent inhibition by 5 mM malate. (B) Effect on the inhibition constant (K_i) for malate (Wu & Wedding 1987). Copyright American Society of Plant Biologists.

night (Bastide et al. 1993), but they may continue to show a diurnal fluctuation in malic acid concentration, as first found in *Opuntia basilaris* (prickly pear). The CO_2 they use to produce malic acid at night does not come from the air, but is derived from respiration. It is released again during the day, allowing some Rubisco activity. This metabolism is termed **CAM idling**. Fluorescence measurements have indicated that the photosystems remain intact during severe drought. CAM idling can be considered as a modification of normal CAM. The plants remain “ready to move” as soon as the environmental conditions improve, but keep their stomata closed during severe drought.

Some plants show a diurnal fluctuation in the concentration of malic acid without a net CO_2 uptake at night, but with normal rates of CO_2 assimilation during the day. These plants are capable of **recapturing** most of the CO_2 derived from dark respiration at night, and to use this as a substrate for PEP carboxylase. This is termed **CAM cycling** (Patel & Ting 1987). In *Peperomia camptotricha*, 50% of

the CO_2 released in respiration during the night is fixed by PEP carboxylase. At the beginning of the day, some of the CO_2 that is fixed at night becomes available for photosynthesis, even when the stomatal conductance is very low. In *Talinum calycinum* (fame flower), naturally occurring on dry rocks, CAM cycling may reduce water loss by 44%. CAM cycling enhances a plant’s water-use efficiency (Harris & Martin 1991).

CAM idling typically occurs in ordinary CAM plants that are exposed to severe water stress and have a very low stomatal conductance throughout the day and night. CAM cycling occurs in plants that have a high stomatal conductance and normal C_3 photosynthesis during the day, but refix the CO_2 produced in dark respiration at night which ordinary C_3 plants lose to the atmosphere.

In a limited number of species, CAM only occurs upon exposure to drought stress: **facultative CAM plants**. For example, in plants of *Agave deserti*, *Clusia uuitana*, *Mesembryanthemum crystallinum* (ice plant), and *Portulacaria afra* (elephant’s foot), irrigation with saline water or drought can change from a virtually normal C_3 photosynthesis to the CAM mode (Fig. 49; Winter et al. 1992). We know of one genus containing C_4 species that can shift from a normal C_4 mode under irrigated conditions, to a CAM mode under water stress: *Portulaca grandiflora* (moss rose), *Portulaca mundula* (hairy purslane), and *Portulaca oleracea* (common purslane) (Koch & Kennedy 1982, Mazen 1996). The transition from the C_3 or C_4 to the CAM mode coincides with an enhanced PEP carboxylase activity and of the mRNA encoding this enzyme. Upon removal of NaCl from the root environment of *Mesembryanthemum crystallinum* (ice plant), the level of mRNA encoding PEP carboxylase declines in 2 to 3 hours by 77%. The amount of the PEP carboxylase enzyme itself declines more slowly: after 2 to 3 days the activity is half its original level (Vernon et al. 1988).

10.5 Distribution and Habitat of CAM Species

CAM is undoubtedly an adaptation to drought, since CAM plants close their stomata during most of the day. This is illustrated in a survey of epiphytic bromeliads in Trinidad (Fig. 50). There are two major ecological groupings of CAM plants: **succulents** from arid and semi-arid regions and **epiphytes** from tropical and subtropical regions (Ehleringer & Monson 1993). In addition, there are some submerged aquatic plants exhibiting CAM (Sect. 11.5). Although CAM plants are uncommon

FIGURE 49. Induction of CAM in the facultative CAM species *Mesembryanthemum crystallinum* (ice plant), growing in its natural habitat on rocky coastal cliffs of the Mediterranean Sea. Upon prolonged exposure to drought, the leaf water content (A) declines, and the nocturnal malate concentration (B) increases (yellow symbols and bars, day; turquoise symbols and bars, night). There is a shift from the C₃ mode to CAM, coinciding with less carbon-isotope fractionation (C) (Osmond et al. 1982).

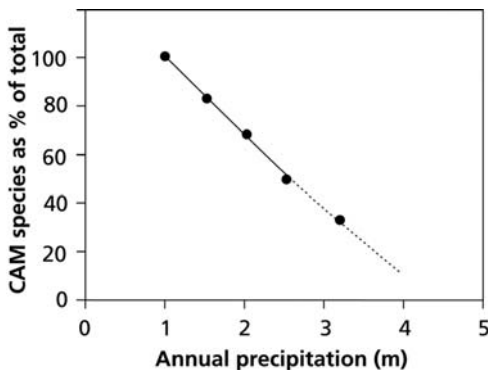
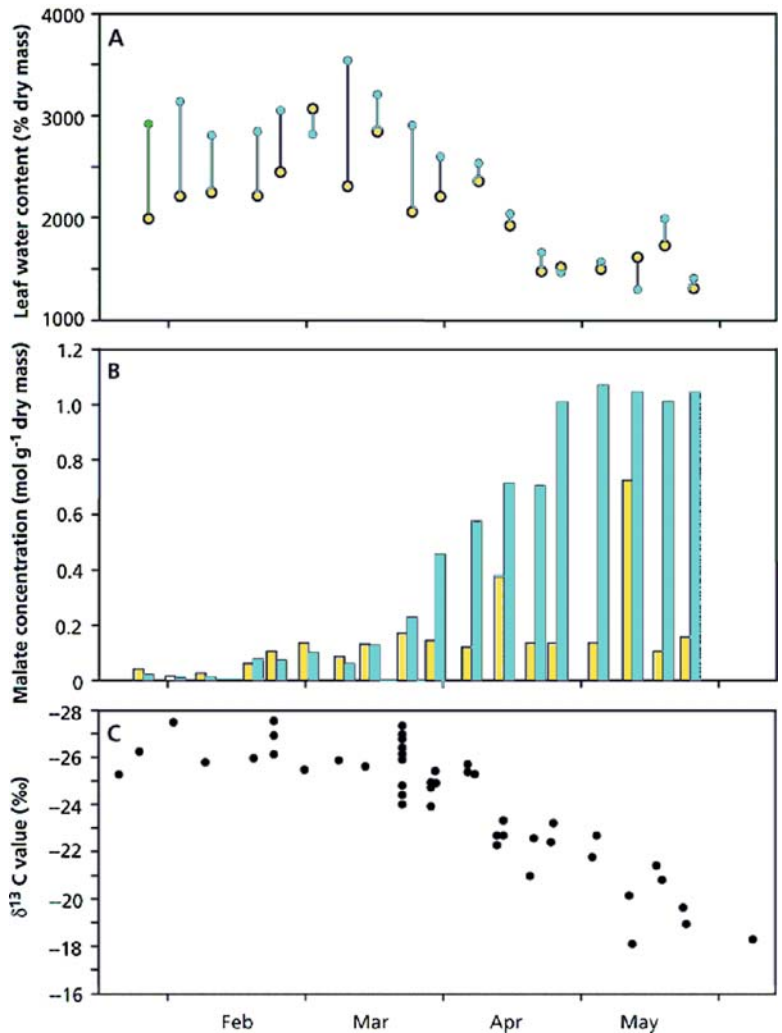

FIGURE 50. The relationship between percentage of epiphytic bromeliad species with CAM in a tropical forest and mean annual rainfall across the north-south precipitation gradient in Trinidad (Winter & Smith 1996).

in cold environments, this may reflect their evolutionary origin in warm climates rather than a temperature sensitivity of the CAM pathway (Nobel & Hartsock 1990). Roots of some orchids which lack stomata also show CAM.

In temperate regions and alpine habitats worldwide, CAM plants, or species showing incomplete or facultative CAM, occur on shallow soils and rock outcrops, niches that are rather dry in moist climates.

10.6 Carbon-Isotope Composition of CAM Species

Like Rubisco from C₃ and C₄ plants, the enzyme from CAM plants discriminate against ¹³CO₂, but,

the fractionation at the leaf level is considerably less than that of C_3 plants and similar to that of C_4 species (Fig. 44). This is expected, as the stomata are closed during malate decarboxylation and fixation of CO_2 by Rubisco. Hence, only a small amount of CO_2 diffuses back from the leaves to the atmosphere, and Rubisco processes the accumulated $^{13}CO_2$ (Sects. 9.3 and 9.4).

Upon a shift from C_3 to CAM photosynthesis in **facultative CAM plants**, the stomata are closed during most of the day and open at night, and the **carbon-isotope fractionation** decreases (Fig. 49). Hence, the carbon-isotope composition of CAM plants can be used as an estimate of the employment of the CAM pathway during past growth.

11. Specialized Mechanisms Associated with Photosynthetic Carbon Acquisition in Aquatic Plants

11.1 Introduction

Contrary to the situation in terrestrial plants, in submerged aquatic plants chloroplasts are frequently located in the **epidermis**. In terrestrial plants, CO_2 diffuses from the air through the stomata to the mesophyll cells. In aquatic plants, where diffusion is directly through the outer epidermal cell walls, the rate of this process is often limiting for photosynthesis. A thick boundary layer around the leaves, and slow diffusion of CO_2 in water limit the rate of CO_2 uptake. How do aquatic plants cope with these problems? To achieve a reasonable rate of photosynthesis and avoid excessive photorepiration, special mechanisms are required to allow sufficient diffusion of CO_2 to match the requirement for photosynthesis. Several specialized mechanisms have evolved in different species adapted to specific environmental conditions. Another feature of the habitat of many submerged aquatics is the low irradiance. Leaves of many aquatics have the traits typical of shade leaves (Sect. 3.2).

11.2 The CO_2 Supply in Water

In fresh water, molecular CO_2 is readily available. Between 10 and 20°C, the partitioning coefficient (that is, the ratio between the molar concentration of CO_2 in air and that in water) is about 1. The equilibrium concentration in water at an atmospheric CO_2 concentration of 380 $\mu\text{mol mol}^{-1}$ is

12 μM (at 25°C, but rapidly decreasing with increasing temperature). Under these conditions, leaves of submerged aquatic macrophytes experience about the same CO_2 concentration as those in air. The **diffusion** of dissolved gasses in water, however, occurs approximately 10^4 times more slowly than in air, leading to rapid depletion of CO_2 inside the leaf during CO_2 assimilation. In addition, the O_2 concentration inside photosynthesizing leaves may increase. Decreasing CO_2 concentrations, especially in combination with increasing O_2 , inexorably lead to conditions that restrict the **carboxylating** activity and favor the **oxygenating** activity of Rubisco (Mommer et al. 2005).

The transport of CO_2 through the unstirred **boundary layer** is only by diffusion. The thickness of the boundary layer is proportional to the square root of the leaf dimension, measured in the direction of the streaming water, and inversely proportional to the flow of the streaming water (Sect. 2.4 of Chapter 4A on the plant's energy balance). It ranges from 10 μm in well stirred media, to 500 μm in nonstirred media. The slow diffusion in the boundary layer is often a major factor limiting an aquatic macrophyte's rate of photosynthesis.

CO_2 dissolved in water interacts as follows:

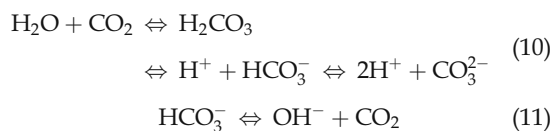

Since the concentration of H_2CO_3 is very low in comparison with that of CO_2 , the two are commonly combined and indicated as $[CO_2]$.

The interconversion between CO_2 and HCO_3^- is slow, at least in the absence of **carbonic anhydrase**. The presence of the dissolved inorganic carbon compounds strongly depends on the pH of the water (Fig. 51). In ocean water, as pH increases from 7.4 to 8.3, the contribution of dissolved inorganic carbon species shifts as follows: CO_2 as a fraction of the total inorganic carbon pool decreases from 4 to 1%, that of HCO_3^- from 96 to 89%, and that of CO_3^{2-} increases from 0.2 to 11%.

During darkness, the CO_2 concentration in ponds and streams is generally high, exceeding the concentration that is in equilibrium with air, due to respiration of aquatic organisms and the slow exchange of CO_2 between water and the air above it. The high CO_2 concentration coincides with a relatively low pH. During the day the CO_2 concentration may decline rapidly due to photosynthetic activity, and the pH rises accordingly. The rise in pH, especially in the boundary layer, represents a crucial problem for

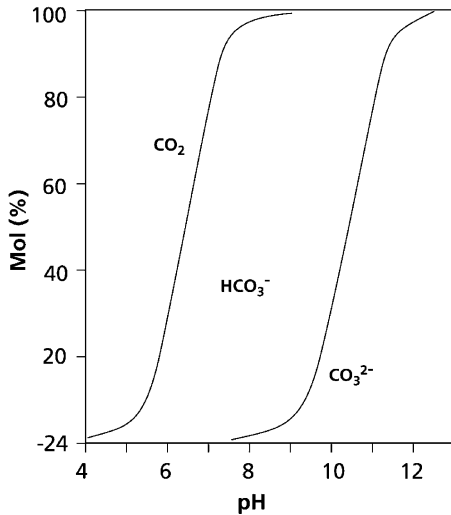

FIGURE 51. The contribution of the different inorganic carbon species as dependent on the pH of the water (Osmond et al. 1982).

CO₂ availability in water at a neutral pH. While the concentration of all dissolved inorganic carbon (i.e., CO₂, HCO₃⁻, and CO₃²⁻) may decline by a few percent only, the CO₂ concentration declines much more, since the high pH shifts the equilibrium from CO₂ to HCO₃⁻ (Fig. 51). This adds to the diffusion problem and further aggravates the limitation by supply of inorganic carbon for assimilation in submerged leaves that only use CO₂ and not HCO₃⁻.

11.3 The Use of Bicarbonate by Aquatic Macrophytes

Many aquatic macrophytes, cyanobacteria, and algae can use HCO₃⁻, in addition to CO₂, as a carbon source for photosynthesis (Maberly & Madsen 2002). This might be achieved either by **active uptake** of HCO₃⁻ itself, or by **proton extrusion**, commonly at the abaxial side of the leaf, thus lowering the pH in the extracellular space and shifting the equilibrium towards CO₂ (Elzenga & Prins 1988). In some species [e.g., *Elodea canadensis* (waterweed)] the conversion of HCO₃⁻ into CO₂ is also catalyzed by an extracellular **carbonic anhydrase**. In *Ranunculus penicillatus* spp. *pseudofluitans* (a stream water crowfoot), the enzyme is closely associated with the epidermal cell wall (Newman & Raven 1993). Active uptake of HCO₃⁻ also requires proton extrusion, to provide a driving force.

Aquatic plants that use HCO₃⁻ in addition to CO₂ have a mechanism to concentrate CO₂ in their chloroplasts. Although this **CO₂-concentrating mechanism** differs from that of C₄ plants (Sect. 9.2), its effect is similar: it suppresses the oxygenating activity of Rubisco and lowers the CO₂-compensation point. In *Elodea canadensis* (common waterweed), *Potamogeton lucens* (ribbonweed), and other aquatic macrophytes, the capacity to acidify the lower side of the leaves, and thus to use HCO₃⁻, is expressed most at high irradiance and low dissolved inorganic carbon concentration in the water (Elzenga & Prins 1989). The capacity of the carbon-concentrating mechanism also depends on the N supply: the higher the supply, the greater the capacity of the photosynthetic apparatus as well as that of the carbon-concentrating mechanism (Madsen & Baatrup-Pedersen 1995). Acidification of the lower side of the leaves is accompanied by an increase in extracellular pH at the upper side of the leaves. The leaves become “polar” when the carbon supply from the water is less than the CO₂-assimilating capacity (Prins & Elzenga 1989). There are also anatomical differences between the upper and lower side of “polar” leaves: the lower epidermal cells are often **transfer cells**, characterized by ingrowths of cell-wall material which increases the surface area of the plasma membrane. They contain numerous mitochondria and chloroplasts. At the upper side of the leaves, the pH increase leads to precipitation of calcium carbonates. This process plays a major role in the geological sedimentation of calcium carbonate (Sect. 11.7).

Due to the use of HCO₃⁻, the internal CO₂ concentration may become much higher than it is in terrestrial C₃ plants. This implies that they do not need a Rubisco enzyme with a high affinity for CO₂. Interestingly, just like C₄ plants (Sect. 9.4), they have a Rubisco with a relatively high K_m for CO₂. The values are approximately twice as high as those of terrestrial C₃ plants (Yeoh et al. 1981). This high K_m is associated with a high maximum catalytic activity (k_{cat}) of Rubisco, as in the HCO₃⁻-using green alga, *Chlamydomonas reinhardtii*, and in C₄ species. For the Rubisco of the cyanobacterium *Synechococcus* that also has a carbon-concentrating mechanism, even higher K_m(CO₂) and k_{cat} values are reported. (Table 9).

Hydrilla verticillata (waterthyme) has an inducible CO₂-concentrating mechanism, even when the pH of the medium is so low that there is no HCO₃⁻ available. This monocotyledonous species predates modern terrestrial C₄ monocots and may represent an ancient form of C₄ photosynthesis (Magnin et al. 1997). The species has an inducible single-cell

C₄-type photosynthetic cycle (Table 7; Sect. 9.5). This mechanism is induced at high temperatures and when the plants are growing in water that contains low concentrations of dissolved inorganic carbon (Reiskind et al. 1997). There appears to be a clear ecological benefit to this CO₂-concentrating mechanism when the canopy becomes dense, the dissolved O₂ concentration is high, and the CO₂ supply is low. Under these conditions photorespiration decreases photosynthesis of a C₃-type plant by at least 35%, whereas in *Hydrilla verticillata* this decrease is only about 4% (Bowes & Salvucci 1989). A carbon-concentrating mechanism in the form of a single-cell C₄-like pathway has also been identified in a marine diatom of common occurrence in the oceans (Reinfelder et al. 2000), indicating that this pathway is more common than thought previously (Sage 2004).

11.4 The Use of CO₂ from the Sediment

Macrophytes like water lilies that have an internal ventilation system assimilate CO₂ arriving from the roots due to pressurized flow (Sect. 4.1.4 of Chapter 2B on plant respiration). The use of CO₂ from the sediment is only minor for most emergent wetland species such as *Scirpus lacustris* (bull rush) and *Cyperus papyrus* (papyrus), where it approximates 0.25% of the total CO₂ uptake in photosynthesis (Farmer 1996). For *Stratiotes aloides* (water soldier),

the sediment is a major source of CO₂, although only after diffusion into the water column (Prins & de Guia 1986). *Stylites andicola* is a vascular land plant without stomata that derives nearly all its carbon through its roots (Keeley et al. 1984).

Submerged macrophytes of the isoetid life form (quillworts) receive a very large portion of their carbon for photosynthesis directly from the sediment via their roots: 60 to 100% (Table 14). This capability is considered an adaptation to growth in low-pH, carbon-poor ("soft-water") lakes, where these plants are common. None of the investigated species from "hard-water" lakes or marine systems show significant CO₂ uptake via their roots (Farmer 1996). In the quillworts, CO₂ diffuses from the sediment, via the lacunal air system to the submerged leaves. These leaves are thick with thick cuticles, have no functional stomata when growing submerged, but large air spaces inside, so that gas exchange with the atmosphere is hampered, but internal exchange is facilitated. Emergent leaves have very few stomata at the leaf base, and normal densities at the leaf tips (Fig. 52). The chloroplasts in isoetid leaves are concentrated around the lacunal system. The air spaces in the leaves are connected with those in stems and roots, thus facilitating the transport of CO₂ from the sediment to the leaves where it is assimilated. At night, only part of the CO₂ coming up from the sediment via the roots through the lacunal system is fixed (Sect. 11.5), the rest being lost to the atmosphere.

TABLE 14. Assimilation of ¹⁴CO₂ derived from the air or from the rhizosphere by leaves and roots of *Littorella uniflora* (quillwort).*

Source:	¹⁴ CO ₂ assimilation [μg C g ⁻¹ (leaf or root DM) h ⁻¹]			
	Leaves		Roots	
	Air	Rhizosphere	Air	Rhizosphere
CO ₂ concentration around the roots (mM)				
0.1	300 (10)	340 (50)	10 (0.3)	60 (70)
0.5	350 (5)	1330 (120)	10 (0.3)	170 (140)
2.5	370 (4)	8340 (1430)	10 (0.3)	570 (300)

Source: Nielsen et al. (1991).

* ¹⁴CO₂ was added to the air around the leaves or to the water around the roots (rhizosphere). Measurements were made in the light and in the dark; values of the dark measurements are given in brackets.

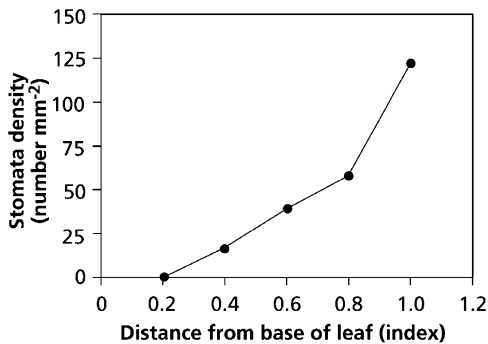

FIGURE 52. The stomatal density along mature leaves of *Littorella uniflora* (shoreweed) from the base to the tip (Nielsen et al. 1991).

11.5 Crassulacean Acid Metabolism (CAM) in Aquatic Plants

Though aquatic plants by no means face the same problems connected with water shortage as desert plants, some of them [*Isoetes* (quillwort) species] have a similar photosynthetic metabolism: Crassulacean Acid Metabolism (CAM) (Keeley 1990). They accumulate **malic acid** during the night and have rates of CO₂ fixation during the night that are similar in magnitude as those during the day, when the CO₂ supply from the water is very low (Fig. 53). The aerial leaves of *Isoetes howellii*, in contrast to the submerged leaves of the same plants, do not show a diurnal fluctuation in the concentration of malic acid.

Why would an aquatic plant have a similar photosynthetic pathway as is common in species from arid habitats? CAM in *Isoetes* is considered an adaptation to very low levels of CO₂ in the water, especially during the day (Fig. 53), and allows the plants to assimilate additional CO₂ at night. This nocturnal CO₂ fixation gives them access to a carbon source that is unavailable to other species. Though some of the carbon fixed in malic acid comes from the surrounding water, where it accumulates due to the respiration of aquatic organisms, some is also derived from the plant's own respiration during the night. A CAM pathway has also been discovered in other genera of aquatic vascular plants (Maberly & Madsen 2002).

11.6 Carbon-Isotope Composition of Aquatic Plants

There is a wide variation in carbon-isotope composition among different aquatic plants, as well as a

large difference between aquatic and terrestrial plants (Fig. 54). A low carbon-isotope fractionation might reflect the employment of the C₄ pathway of photosynthesis, although the typical Kranz anatomy is usually lacking. Only about a dozen aquatic C₄ species have been identified, and very few have submersed leaves with a well developed Kranz anatomy (Bowes et al. 2002). A low carbon-isotope fractionation in aquatic plants might also reflect the CAM pathway of photosynthesis. Isoetids often have rather negative δ¹³C values, due to the isotope composition of the substrate (Table 15). Four factors account for the observed variation in isotope composition of freshwater aquatics (Keeley & Sandquist 1992):

1. The isotope composition of the carbon source varies substantially. It ranges from a δ¹³C value of +1‰, for HCO₃⁻ derived from limestone, to -30‰, for CO₂ derived from respiration. The average δ¹³C value of CO₂ in air is -8‰. The isotope composition also changes with the water depth (Table 16).
2. The species of inorganic carbon fixed by the plant; HCO₃⁻ has a δ¹³C that is 7–11‰ less negative than that of CO₂.
3. Resistance for diffusion across the unstirred boundary layer is generally important (except in rapidly streaming water), thus decreasing carbon-isotope fractionation (Box 2).
4. The photosynthetic pathway (C₃, C₄, and CAM) that represent different degrees of fractionation.

The isotope composition of plant carbon is dominated by that of the source (see 1 and 2 above), because diffusional barriers are strong (see 3). This accounts for most of the variation as described in Fig. 54, rather than biochemical differences in the photosynthetic pathway (Osmond et al. 1982).

11.7 The Role of Aquatic Macrophytes in Carbonate Sedimentation

The capacity of photosynthetic organisms [e.g., *Chara* (musk-grass), *Potamogeton* (pondweed), and *Elodea* (waterweed)] to acidify part of the apoplast and use HCO₃⁻ (Sect. 11.3) plays a major role in the formation of calcium precipitates in fresh water, on both an annual and a geological time scale. Many calcium-rich lake sediments contain plant-induced carbonates, according to:



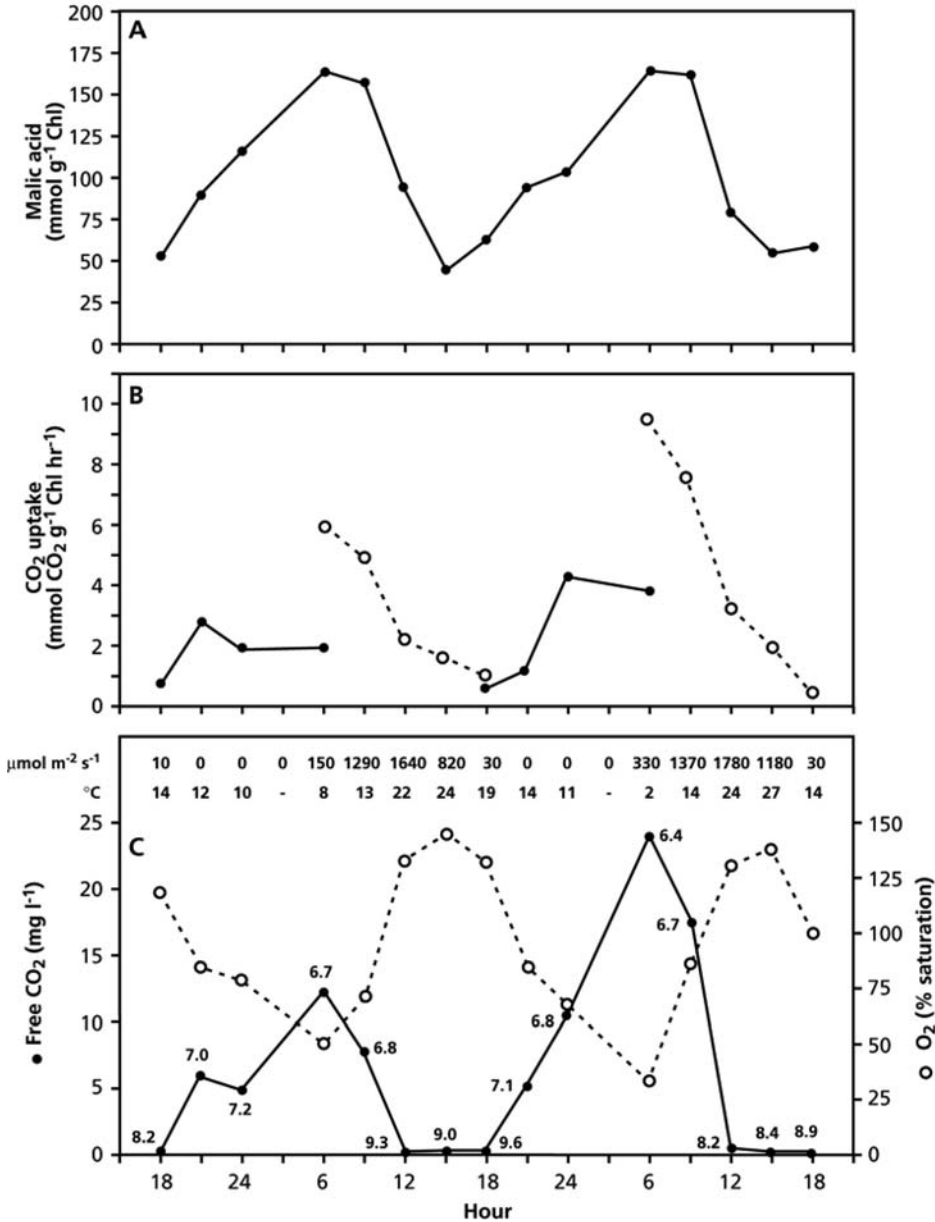

FIGURE 53. CAM photosynthesis in submerged leaves of *Isoetes howellii* (quillwort) in a pool. (A) Malic acid levels, (B) rates of CO₂ uptake, and (C) irradiance at the water surface, water temperatures, and concentrations of CO₂ and O₂; the numbers near the symbols

give the pH values. Open and filled symbols refer to the light and dark period, respectively (after Keeley & Busch 1984). Copyright American Society of Plant Biologists.

This reaction occurs in the alkaline compartment that is provided at the upper side of the polar leaves of aquatic macrophytes (Sect. 11.3). Similar amounts of carbon are assimilated in photosynthesis and precipitated as carbonate. If only part of the CO₂ released in this process is assimilated by the

macrophyte, as may occur under nutrient-deficient conditions, CO₂ is released to the atmosphere. On the other hand, if the alkalinity of the compartment is relatively low, there is a net transfer of atmospheric CO₂ to the water (McConnaughey et al. 1994).

FIGURE 54. Variation in the carbon-isotope composition ($\delta^{13}\text{C}$) of freshwater and marine aquatic species. The observed variation is due to variation in $\delta^{13}\text{C}$ values of the substrate and in the extent of diffusional limitation (Osmond et al. 1982).

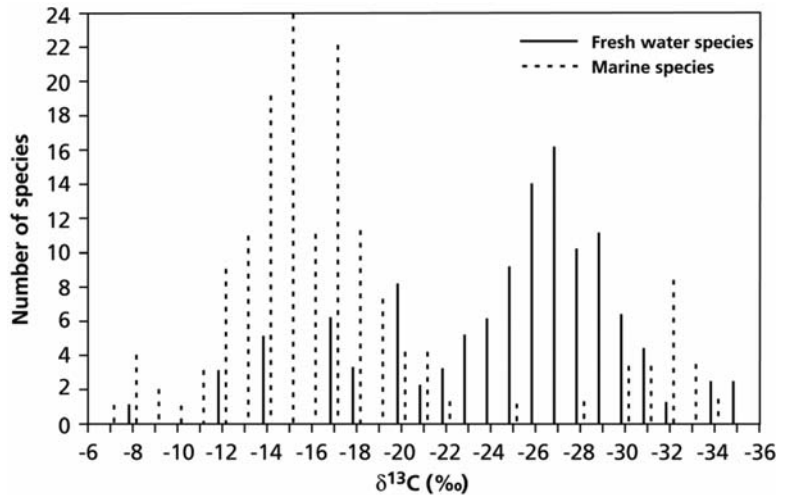

TABLE 15. Carbon-isotope composition ($\delta^{13}\text{C}$ in ‰) of submerged and emergent *Isoetes howellii* plants.*

Pondwater carbonate	-15.5 to -18.6
Submerged	
Leaves	-27.9 to -29.4
Roots	-25.8 to -28.8
Emergent	
Leaves	-29.4 to -30.1
Roots	-29.0 to -29.8

Source: Keeley & Busch (1984).

* Values are given for both leaves and roots and also for the pondwater carbonate.

TABLE 16. Changes in the dissolved carbon isotope composition with depth as reflected in the composition of the organic matter at that depth.

Water depth (m)	$\delta^{13}\text{C}$ (‰)
1	-20.80
2	-20.75
5	-23.40
7	-24.72
9	-26.79
11	-29.91

Source: Osmond et al. (1982).

Equation (12) shows how aquatic photosynthetic organisms play a major role in the global carbon cycle, even on a geological time scale. On the other hand, rising atmospheric CO₂ concentrations have

an acidifying effect and dissolve part of the calcium carbonate precipitates in sediments, and thus contribute to a further rise in atmospheric [CO₂] (Sect. 12).

12. Effects of the Rising CO₂ Concentration in the Atmosphere

Vast amounts of carbon are present in carbonates in the Earth's crust. Also stored in the Earth's crust is another major carbon pool: the organic carbon derived from past photosynthesis; a key factor in the development of the present low CO₂/high O₂ atmosphere. Some CO₂ enters the atmosphere when carbonates are used for making cement, but apart from that, carbonates are only biologically important on a geological time scale. Far more important for the carbon balance of the atmosphere is the burning of fossil fuels (coal, oil, and natural gas) and changes in land-use that represent a CO₂ input into the atmosphere of 8.10¹⁵ g of carbon per year (10¹⁵ g equals 1 petagram, Pg). Compared with the total amount of carbon present in the atmosphere, 720 Pg, such inputs are substantial and inevitably affect the CO₂ concentration in the Earth's atmosphere (Falkowski et al. 2000). CO₂ is, by far, the largest contributor to the anthropogenically enhanced **greenhouse effect** (Houghton 2007).

Since the beginning of the industrial revolution in the late 18th century, the atmospheric CO₂ concentration has increased from about 290 $\mu\text{mol mol}^{-1}$ to the current level of over 385 $\mu\text{mol mol}^{-1}$ (Tans 2007). The concentration continues to rise by about

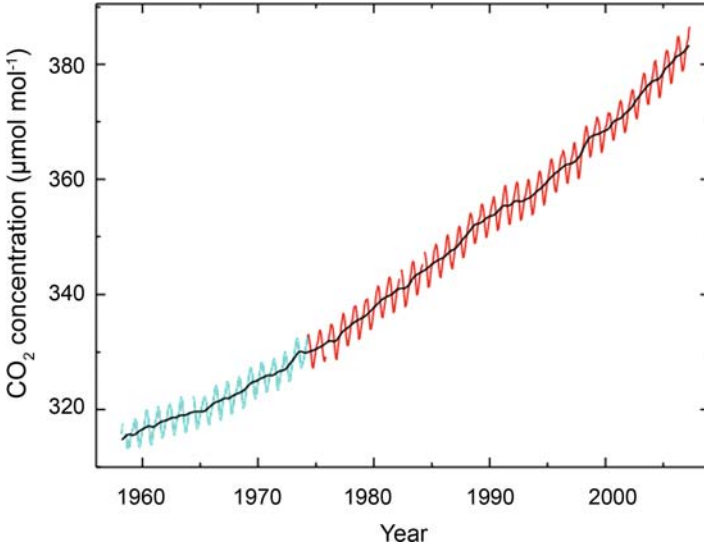

FIGURE 55. The rise in atmospheric CO₂ concentration, as measured at Mauna Loa (Hawaii), accelerated from about 0.7 $\mu\text{mol mol}^{-1} \text{yr}^{-1}$ in the early years to about 2.0 $\mu\text{mol mol}^{-1} \text{yr}^{-1}$ today. The blue line refers to data collected during 1958–1974 at the Scripps Institute of Oceanography; the red line refers to data collected since 1974 by the National Oceanic and Atmospheric Administration, US Department of Commerce (Tans 2007). Reproduced with the author’s permission.

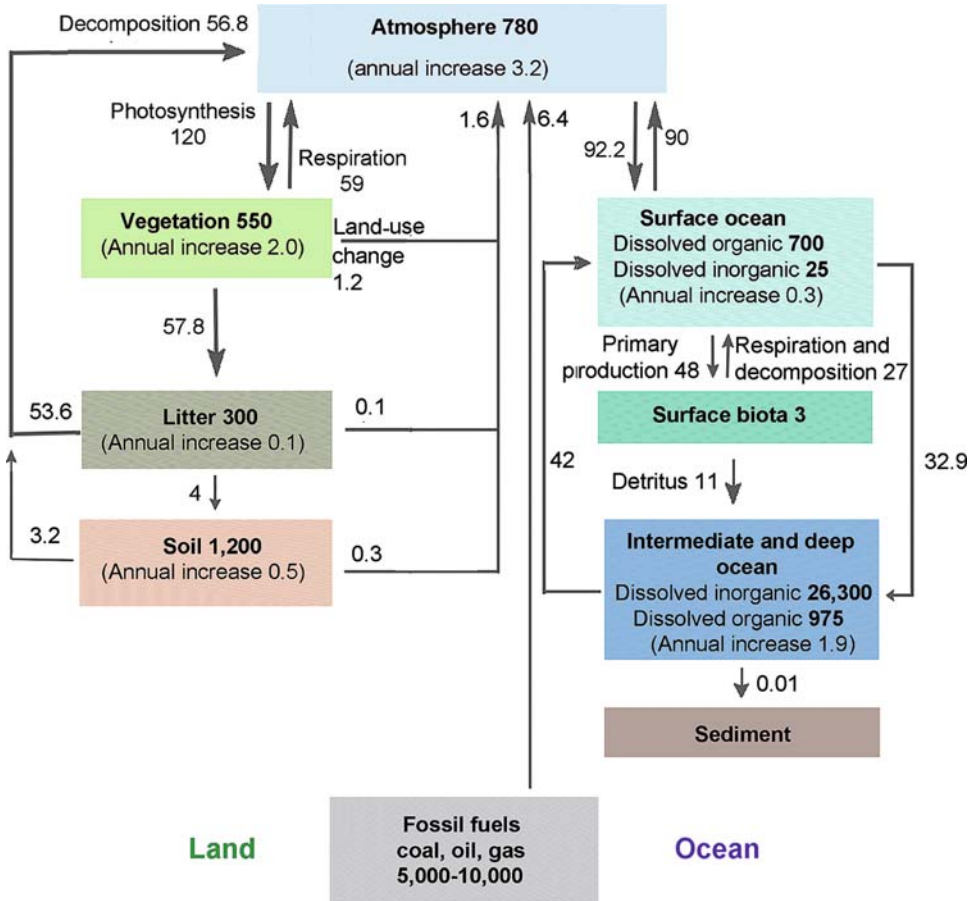

FIGURE 56. The global carbon cycle and global carbon reservoirs. Units are Pg C or Pg C yr⁻¹; 1 petagram = 10¹⁵ g = 10⁹ metric tones (updated following Houghton

2007). Courtesy R.A. Houghton, The Woods Hole Research Center, Falmouth, Massachusetts, USA.

1.5 $\mu\text{mol mol}^{-1}$ per year (Fig. 55). Measurements of CO₂ concentrations in **ice cores** indicate a pre-industrial value of about 280 $\mu\text{mol mol}^{-1}$ during the past 10000 years, and about 205 $\mu\text{mol mol}^{-1}$ some 20000 years ago during the last ice age. Considerable quantities of CO₂ have also been released into the atmosphere as a result of **deforestation, ploughing of prairies, drainage of peats**, and other land-use changes that cause oxidation of organic compounds in soil and, to a lesser extent, biomass. **Combustion of fossil fuel** adds far greater amounts of carbon per year (Fig. 56). Combined anthropogenic fluxes to the atmosphere amount to 8 Pg of carbon per year (Falkowski et al. 2000). Yet, the increase in the atmosphere is only 4.2 Pg of carbon per year (2000–2005). About 2.2 Pg of the “missing” carbon is taken up in the oceans and a similar amount (2.3 Pg) is fixed by terrestrial ecosystems (Grace 2004, Houghton 2007). Analysis of atmospheric CO₂ concentrations and its isotopic composition shows that north-temperate and boreal forests are the most likely sinks for the missing carbon. There is also strong uptake by tropical forests, but this is offset by CO₂ release from deforestation in the tropics. This increased terrestrial uptake of CO₂ has many causes, including stimulation of photosynthesis by elevated [CO₂] (about half of the increased terrestrial uptake) or by N deposition in N-limited ecosystems and regrowth of northern and mid-latitude forests (Houghton 2007).

Since the rate of net CO₂ assimilation is not CO₂-saturated in C₃ plants at 385 $\mu\text{mol mol}^{-1}$ CO₂, the rise in CO₂ concentration is more likely to enhance photosynthesis in C₃ than in C₄ plants, where the rate of CO₂ assimilation is virtually saturated at a CO₂ concentration of 385 $\mu\text{mol mol}^{-1}$ (Bunce 2004). The consequences of an enhanced rate of photosynthesis for plant growth are discussed in Sect. 5.8 of Chapter 7 on growth and allocation.

12.1 Acclimation of Photosynthesis to Elevated CO₂ Concentrations

Upon long-term exposure to 700 $\mu\text{mol mol}^{-1}$, about twice the present atmospheric CO₂ concentration, there may be a reduction of the photosynthetic capacity, associated with reduced levels of Rubisco and organic N per unit leaf area. This **down-regulation** of photosynthesis increases with increasing duration of the exposure to elevated [CO₂] and is most pronounced in plants grown at low N supplies. By contrast, water-stressed plants tend to increase net photosynthesis in

response to elevated [CO₂] (Wullschlegel et al. 2002). Herbaceous plants consistently reduce **stomatal conductance** in response to elevated [CO₂], so that C_i does not increase as much as would be expected from the increase in C_a, but their intrinsic **WUE** tends to be increased (Long et al. 2004). Tree photosynthesis continues to be enhanced by elevated [CO₂], except when seedlings are grown in small pots, inducing nutrient limitation (Norby et al. 1999). The decrease in stomatal conductance of C₃ plants often indirectly stimulates photosynthesis in dry environments by reducing the rate of soil drying and therefore the water limitation of photosynthesis (Hungate et al. 2002). C₃ and C₄ plants, however, benefit equally from increased water-use efficiency and water availability, reducing the relative advantage that C₃ plants gain from their greater CO₂ responsiveness of photosynthesis (Wand et al. 1999, Sage & Kubien 2003).

Why would acclimation of photosynthesis to elevated [CO₂] be more pronounced when N supply is poor? This could be a direct effect of N or an indirect effect by limiting the development of sinks for photoassimilates. This question can be tested by growing *Lolium perenne* (perennial ryegrass) in the field under elevated and current atmospheric CO₂ concentrations at both low and high N supply. Cutting of this herbage crop at regular intervals removes a major part of the canopy, decreasing the ratio of photosynthetic area to **sinks for photoassimilates**. Just before the cut, when the canopy is relatively large, growth at elevated [CO₂] and low N supply decreases in carboxylation capacity and the amount of Rubisco protein. At a high N supply there are no significant decreases in carboxylation capacity or proteins. Elevated [CO₂] results in a marked increase in leaf carbohydrate concentration at low N supply, but not at high N supply. This acclimation at low N supply is absent after a harvest, when the canopy size is small. Acclimation under low N is therefore most likely caused by limitation of sink development rather than being a direct effect of N supply on photosynthesis (Rogers et al. 1998).

How do herbaceous plants sense that they are growing at an elevated CO₂ concentration and then down-regulate their photosynthetic capacity? Acclimation is not due to sensing the CO₂ concentration itself, but sensing the concentration of sugars in the leaf cells, more precisely the soluble hexose sugars (Sect. 4.2), mediated by a specific **hexokinase** (Sect. 4.3). In transgenic plants in which the level of hexokinase is greatly reduced, down-regulation of photosynthesis upon prolonged exposure to high [CO₂] is considerably

TABLE 17. Light-saturated rate of photosynthesis (A_{\max} , measured at the CO_2 concentrations at which the plants were grown), in vitro Rubisco activity, chlorophyll concentration and the concentration of hexose sugars in the fifth leaf of *Solanum lycopersicum* (tomato) at various stages of development.*

Leaf expansion (% of full expansion)	Exposure time (days)	A_{\max} ($\mu\text{mol m}^{-2} \text{s}^{-1}$)		Rubisco activity ($\mu\text{mol m}^{-2} \text{s}^{-1} \text{mg m}^{-2}$)		Chlorophyll (mg m^{-2})		Glucose (mg m^{-2})		Fructose	
		Control	High	Control	High	Control	High	Control	High	Control	High
2	0	16.3	21.3	22.6	–	270	–	750	–	500	–
60	11	18.9	28.7	20.5	25.1	480	520	1000	1200	1400	1400
95	22	15.0	25.1	15.7	12.7	540	500	1100	1250	1800	2100
100	31	9.3	18.0	9.5	4.9	450	310	1100	2100	1800	4200

Source: Van Oosten & Besford (1995), Van Oosten et al. (1995).

* Plants were grown at different atmospheric CO_2 concentrations: control, $350 \mu\text{mol CO}_2 \text{ mol}^{-1}$; high, $700 \mu\text{mol CO}_2 \text{ mol}^{-1}$.

less. Via a signal-transduction pathway, which also involves phytohormones, the **sugar-sensing mechanism** regulates the transcription of nuclear encoded photosynthesis-associated genes (Rolland et al. 2006). Among the first photosynthetic proteins that are affected are the small subunit of Rubisco and Rubisco activase. Upon longer exposure, the level of thylakoid proteins and chlorophyll is also reduced (Table 17).

The down-regulation of photosynthesis at elevated CO_2 has led to the discovery of sugar-sensing in plants, but it has recently become clear that the signaling pathway is intricately involved in a network regulating acclimation to other environmental factors, including light and nutrient availability as well as biotic and abiotic stress (Rolland et al. 2002). Down-regulation of photosynthesis in response to long-term exposure to elevated CO_2 has important global implications. The capacity of terrestrial ecosystems to **sequester carbon** appears to be saturating, leaving a larger proportion of human carbon emissions in the atmosphere, and accelerating the rate of global warming (Canadell et al. 2007).

12.2 Effects of Elevated CO_2 on Transpiration—Differential Effects on C_3 , C_4 , and CAM Plants

Different types of plants respond to varying degrees to elevated CO_2 . For example, C_4 plants, whose rate of photosynthesis is virtually saturated at $385 \mu\text{mol mol}^{-1}$, generally respond less to elevated CO_2 than do C_3 plants.

Also *Opuntia ficus-indica* (prickly pear), a CAM species cultivated worldwide for its fruits and cladodes, responds to the increase in CO_2 concentration in the atmosphere. The rate of CO_2 assimilation is initially enhanced, both at night and during the day, but this disappears upon prolonged exposure to elevated CO_2 (Cui & Nobel 1994). CAM species show, on average, a 35% increase in net daily CO_2 uptake which reflects increases in both Rubisco-mediated CO_2 uptake during the day and PEP carboxylase-mediated CO_2 uptake at night (Drennan & Nobel 2000).

13. Summary: What Can We Gain from Basic Principles and Rates of Single-Leaf Photosynthesis?

Numerous examples have been given on how differences in photosynthetic traits enhance a genotype's survival in a specific environment. These include specific biochemical pathways (C_3 , C_4 , and CAM) as well as more intricate differences between sun and shade plants, aquatic and terrestrial plants, and plants differing in their photosynthetic N-use efficiency and water-use efficiency. Information on photosynthetic traits is also highly relevant when trying to understand effects of global environmental changes in temperature and atmospheric CO_2 concentrations. For a physiological ecologist, a full appreciation of the process of leaf photosynthesis is quintessential.

What we *cannot* derive from measurements on photosynthesis of **single leaves** is what the rate of photosynthesis of an **entire canopy** will be. To

work out these rates, we need to take the approach discussed in Chapter 5, dealing with scaling-up principles. It is also quite clear that short-term measurements on the effect of atmospheric CO₂ concentrations are not going to tell us what will happen in the long term. Acclimation of the photosynthetic apparatus ("down-regulation") may occur, reducing the initial stimulatory effect. Most importantly, we *cannot* derive plant growth rates or crop yields from rates of photosynthesis of a single leaf. Growth rates are not simply determined by rates of single-leaf photosynthesis per unit leaf area, but also by the total leaf area per plant and by the fraction of daily produced photosynthates required for plant respiration, issues that are dealt with in later chapters.

References

- Adams III, W.W., Demmig-Adams, B., Logan, B.A., Barker, D.H., & Osmond, C.B. 1999. Rapid changes in xanthophyll cycle-dependent energy dissipation and photosystem II efficiency in two vines, *Stephania japonica* and *Smilax australis*, growing in the understorey of an open *Eucalyptus* forest. *Plant Cell Environ.* **22**: 125–136.
- Allen, M.T. & Pearcy, R.W. 2000. Stomatal behavior and photosynthetic performance under dynamic light regimes in a seasonally dry tropical rain forest. *Oecologia* **122**: 470–478.
- Atkin, O.K., Scheurwater, I., & Pons, T.L. 2006. High thermal acclimation potential of both photosynthesis and respiration in two lowland *Plantago* species in contrast to an alpine congeneric. *Global Change Biol.* **12**: 500–515.
- Bailey, S., Walters, R.G., Jansson, S., & Horton, P. 2001. Acclimation of *Arabidopsis thaliana* to the light environment: the existence of separate low light and high light responses. *Planta* **213**: 794–801.
- Bastide, B., Sipes, D., Hann, J., & Ting, I.P. 1993. Effect of severe water stress on aspects of crassulacean acid metabolism in *Xerosecyos*. *Plant Physiol.* **103**: 1089–1096.
- Beerling, D.J. & Osborne, C.P. 2006. The origin of the savanna biome. *Global Change Biol.* **12**: 2023–2031.
- Bernacchi, C.J., Pimentel, C., & Long, S.P. 2003. In vivo temperature response functions of parameters required to model RuBP-limited photosynthesis. *Plant Cell Environ.* **26**: 1419–1430.
- Bernacchi, C.J., Singaas, E.L., Pimentel, C., Portis Jr., A.R., & Long, S.P. 2001. Improved temperature response functions for models of Rubisco-limited photosynthesis. *Plant Cell Environ.* **24**: 253–259.
- Bernacchi, C.J., Portis, A.R., Nakano, H., Von Caemmerer, S., & Long, S.P. 2002. Temperature response of mesophyll conductance. Implications for the determination of Rubisco enzyme kinetics and for limitations to photosynthesis *in vivo*. *Plant Physiol.* **130**: 1992–1998.
- Berry, J.A. & Björkman, O. 1980. Photosynthetic response and adaptation to temperature in higher plants. *Annu. Rev. Plant Physiol.* **31**: 491–543.
- Berry, J.A. & Raison, J.K. 1981. Responses of macrophytes to temperature. In: Encyclopedia of plant physiology, Vol. 12A, O.L. Lange, P.S. Nobel, C.B. Osmond, & H. Ziegler (eds.). Springer-Verlag, Berlin, pp. 277–338.
- Björkman, O. 1981. Responses to different quantum flux densities. In: Encyclopedia of plant physiology, N.S., Vol. 12A, O.L. Lange, P.S. Nobel, C.B. Osmond, & H. Ziegler (eds.). Springer-Verlag, Berlin, pp. 57–107.
- Bolhår-Nordenkamp, H.R. & Öquist, G. 1993. Chlorophyll fluorescence as a tool in photosynthesis research. In: Photosynthesis and production in a changing environment, D.O. Hall, J.M.O. Scurlock, H.R. Bolhår-Nordenkamp, R.C. Leegood, & S.P. Long (eds.). Chapman & Hall, London, pp. 193–206.
- Boonman, A., Prinsen, E., Gilmer, F., Schurr, U., Peeters, A.J.M., Voisenek, L.A.C.J., & Pons, T.L. 2007. Cytokinin import rate as a signal for photosynthetic acclimation to canopy light gradients. *Plant Physiol.* **143**: 1841–1852.
- Bowes, G. & Salvucci, M.E. 1989. Plasticity in the photosynthetic carbon metabolism of submersed aquatic macrophytes. *Aquat. Bot.* **34**: 233–286.
- Bowes, G., Rao, S.K., Estavillo, G.M., & Reiskind, J.B. 2002. C₄ mechanisms in aquatic angiosperms: comparisons with terrestrial C₄ systems. *Funct. Plant Biol.* **29**: 379–392.
- Brown, R. & Bouton, J.H. 1993. Physiology and genetics of interspecific hybrids between photosynthetic types. *Annu. Rev. Plant Physiol. Plant Mol. Biol.* **44**: 435–456.
- Brown, R.H. & Hattersley, P.W. 1989. Leaf anatomy of C₃–C₄ species as related to evolution of C₄ photosynthesis. *Plant Physiol.* **91**: 1543–1550.
- Brugnoli, E. & Björkman, O. 1992. Chloroplast movements in leaves: influence on chlorophyll fluorescence and measurements of light-induced absorbance changes related to ΔpH and zeaxanthin formation. *Photosynth. Res.* **32**: 23–35.
- Buchmann, N., Guehl, J.M., Barigah, T.S., & Ehleringer, J.R. 1997. Interseasonal comparison of CO₂ concentrations, isotopic composition, and carbon dynamics in an amazonian rain forest (French Guiana). *Oecologia* **110**: 120–131.
- Bunce, J.A. 2004. Carbon dioxide effects on stomatal responses to the environment and water use by crops under field conditions. *Oecologia* **140**: 1–10.
- Canadell, J.G., Pataki, D.E., Gifford, R., Houghton, R.A., Luo, Y., Raupach, M.R., Smith, P., & Steffen, W. 2007. Saturation of the terrestrial carbon sink. In: Terrestrial ecosystems in a changing world, J.G. Canadell, D. Pataki, & L. Pitelka (eds.). Springer, Berlin, pp. 59–78.
- Cavagnaro, J.B. 1988. Distribution of C₃ and C₄ grasses at different altitudes in a temperate arid region of Argentina. *Oecologia* **76**: 273–277.
- Cen, Y.-P. & Sage, R.F. 2005. The regulation of ribulose-1,5-bisphosphate carboxylase activity in response to variation in temperature and atmospheric CO₂ partial pressure in sweet potato. *Plant Physiol.* **139**: 1–12.
- Cerling, T.E., Harris, J.H., MacFadden, B.J., Leakey, M.G., Quade, J., Eisenmann, V., & Ehleringer, J.R. 1997. Global

- vegetation change through the Miocene/Pliocene boundary. *Nature* **389**: 153–158.
- Chazdon, R.L. & Pearcy, R.W. 1986. Photosynthetic responses to light variation in rainforest species. I. Induction under constant and fluctuating light conditions. *Oecologia* **69**: 517–523.
- Chazdon, R.L. & Pearcy, R.W. 1991. The importance of sunflecks for forest understory plants. *BioSciences* **41**: 760–766.
- Chow, W.S. 2003. Photosynthesis: from natural towards artificial. *J. Biol. Phys.* **29**: 447–459.
- Chow, W.S., Hope, A.B., & Anderson, J.M. 1989. Oxygen per flash from leaf disks quantifies photosystem II. *Biochim. Biophys. Acta* **973**: 105–108.
- Christie, E.K. & Detling, J.K. 1982. Analysis of interference between C₃ and C₄ grasses in relation to temperature and soil nitrogen supply. *Ecology* **63**: 1277–1284.
- Christmann, A., Hoffmann, T., Teplova, I., Grill, E., & Müller, A. 2005. Generation of active pools of abscisic acid revealed by in vivo imaging of water-stressed *Arabidopsis*. *Plant Physiol.* **137**: 209–219.
- Coté, F.X., André, M., Folliot, M., Massimino, D., & Dagueuet, A. 1989. CO₂ and O₂ exchanges in the CAM plant *Ananas comosus* (L.) Merr. determination of total and malate-decarboxylation-dependent CO₂-assimilation rates; study of light O₂-uptake. *Plant Physiol.* **89**: 61–68.
- Coupe, S.A., Palmer, B.G., Lake, J.A., Overy, S.A., Oxborough, K., Woodward, F.I., Gray, J.E., & Quick, W.P. 2006. Systemic signalling of environmental cues in *Arabidopsis* leaves. *J. Exp. Bot.* **57**: 329–341.
- Cui, M. & Nobel, P.S. 1994. Gas exchange and growth responses to elevated CO₂ and light levels in the CAM species *Opuntia ficus-indica*. *Plant Cell Environ.* **17**: 935–944.
- DeLucia, E.H., Nelson, K., Vogelmann, T.C., & Smith, W.K. 1996. Contribution of intercellular reflectance to photosynthesis in shade leaves. *Plant Cell Environ.* **19**: 159–170.
- Demmig-Adams, B. & Adams III, W.W. 1996. The role of xanthophyll cycle carotenoids in the protection of photosynthesis. *Trends Plant Sci.* **1**: 21–26.
- Demmig-Adams, B. & Adams III, W.W. 2006. Photoprotection in an ecological context: the remarkable complexity of thermal energy dissipation. *New Phytol.* **172**: 11–21.
- DeRidder, B.P. & Salvucci, M.E. 2007. Modulation of Rubisco activase gene expression during heat stress in cotton (*Gossypium hirsutum* L.) involves post-transcriptional mechanisms. *Plant Sci.* **172**: 246–254.
- Downton, W.J.S., Loveys, B.R., & Grant, W.J.R. 1988. Stomatal closure fully accounts for the inhibition of photosynthesis by abscisic acid. *New Phytol.* **108**: 263–266.
- Drennan, P.M. & Nobel, P.S. 2000. Responses of CAM species to increasing atmospheric CO₂ concentrations. *Plant Cell Environ.* **23**: 767–781.
- Eckstein, J., Beyschlag, W., Mott, K.A., & Ryell, R.J. 1996. Changes in photon flux can induce stomatal patchiness. *Plant Cell Environ.* **19**: 1066–1074.
- Ehleringer, J., & Björkman, O. 1977. Quantum yields for CO₂ uptake in C₃ and C₄ plants. Dependence on temperature, CO₂, and O₂ concentration. *Plant Physiol.* **59**: 86–90.
- Ehleringer, J.R. & Monson, R. K. 1993. Evolutionary and ecological aspects of photosynthetic pathway variation. *Annu. Rev. Ecol. Syst.* **24**: 411–439.
- Ehleringer, J., Björkman, O., & Mooney, H.A. 1976. Leaf pubescence: effects on absorbance and photosynthesis in a desert shrub. *Science* **192**: 376–377.
- Ehleringer, J.R., Schulze, E.-D., Ziegler, H., Lange, O.L., Farquhar, G.D., & Cowan, I.R. 1985. Xylem-tapping mistletoes: water or nutrient parasites? *Science* **227**: 1479–1481.
- Eller, B.M. & Ferrari, S. 1997. Water use efficiency of two succulents with contrasting CO₂ fixation pathways. *Plant Cell Environ.* **20**: 93–100.
- Ellis, R.P. 1977. Distribution of the Kranz syndrome in the Southern African Eragrostoideae and the Panicoideae according to bundle sheath anatomy and cytology. *Agroplanta* **9**: 73–110.
- Ellis, R.P., Vogel, J.C., & Fuls, A. 1980. Photosynthetic pathways and the geographical distribution of grasses in south west Africa/Namibia. *S. Afr. J. Sci.* **76**: 307–314.
- Elzenga, J.T.M. & Prins, H.B.A. 1988. Adaptation of *Elodea* and *Potamogeton* to different inorganic carbon levels and the mechanism for photosynthetic bicarbonate utilisation. *Aust. J. Plant Physiol.* **15**: 727–735.
- Elzenga, J.T.M. & Prins, H.B.A. 1989. Light-induced polar pH changes in leaves of *Elodea canadensis*. I. Effects of carbon concentration and light intensity. *Plant Physiol.* **91**: 62–67.
- Evans, J.R. 1988. Acclimation by the thylakoid membranes to growth irradiance and the partitioning of nitrogen between soluble and thylakoid proteins. *Aust. J. Plant Physiol.* **15**: 93–106.
- Evans, J.R. 1989. Photosynthesis and nitrogen relationships in leaves of C₃ plants. *Oecologia* **78**: 9–19.
- Evans, J.R. & Loreto, F. 2000. Acquisition and diffusion of CO₂ in higher plant leaves. In: Photosynthesis: physiology and metabolism, R.C. Leegood, T.D. Sharkey, & S. Von Caemmerer (eds.). Kluwer Academic Publishers, Dordrecht, pp. 321–351.
- Evans, J.R. & Seemann, J.R. 1989. The allocation of protein nitrogen in the photosynthetic apparatus: costs, consequences, and control. In: Photosynthesis, W.R. Briggs (ed.). Alan Liss, New York, pp. 183–205.
- Evans, J.R. & Vogelmann, T.C. 2003. Profiles of ¹⁴C fixation through spinach leaves in relation to light absorption and photosynthetic capacity. *Plant Cell Environ.* **26**: 547–560.
- Evans, J.R., Sharkey, T.D., Berry, J.A., & Farquhar, G.D. 1986. Carbon isotope discrimination measured with gas exchange to investigate CO₂ diffusion in leaves of higher plants. *Aust. J. Plant Physiol.* **13**: 281–292.
- Falkowski, P., Scholes, R.J., Boyle, E., Canadell, J., Canfield, D., Elser, J., Gruber, N., Hibbard, K., Höglberg, P., Linder, S., Mackenzie, F.T., Moore III, B., Pedersen, T., Rosenthal, Y., Seitzinger, S., Smetacek, V., & Steffen, W. 2000. The global carbon cycle: a test of our knowledge of Earth as a system. *Science* **290**: 291–296.

- Farmer, A.M. 1996. Carbon uptake by roots. In: Plant roots: the hidden half, Y. Waisel, A. Eshel, & U. Kafkaki (eds.). Marcel Dekker, Inc., New York, pp. 679–687.
- Farquhar, G.D. & Richards, R.A. 1984. Isotopic composition of plant carbon correlates with water-use efficiency of wheat genotypes. *Aust. J. Plant Physiol.* **11**: 539–552.
- Farquhar, G.D., Von Caemmerer, S., & Berry, J.A. 1980. A biochemical model of photosynthetic CO₂ assimilation in leaves of C₃ species. *Planta* **149**: 78–90.
- Farquhar, G.D., O'Leary, M.H., & Berry, J.A. 1982. On the relationship between carbon isotope discrimination and the intercellular carbon dioxide concentration in leaves. *Aust. J. Plant Physiol.* **9**: 131–137.
- Field, C.B., Ball, T., & Berry, J.A. 1989. Photosynthesis: principles and field techniques. In: Plant physiological ecology; field methods and instrumentation, R.W. Pearcy, J.R. Ehleringer, H.A. Mooney, & P.W. Rundel (eds.). Chapman and Hall, London, pp. 209–253.
- Feild, T.S., Lee, D.W., & Holbrook, N.M. 2001. Why leaves turn red in autumn. The role of anthocyanins in senescing leaves of red-osier dogwood. *Plant Physiol.* **127**: 566–574.
- Flexas, J. & Medrano, H. 2002. Drought-inhibition of photosynthesis in C₃ plants: stomatal and non-stomatal limitations revisited. *Ann. Bot.* **89**: 183–189.
- Flexas, J., Bota, J., Loreto, F., Cornic, G., & Sharkey T.D. 2004. Diffusive and metabolic limitations to photosynthesis under drought and salinity in C₃ plants. *Plant Biol.* **6**: 269–279.
- Flexas, J., Ribas-Carbó, M., Hanson, D.T., Bota J., Otto, B., Cifre, J., McDowell, N., Medrano, H., & Kaldenhoff, R. 2006a. Tobacco aquaporin NtAQP1 is involved in mesophyll conductance to CO₂ *in vivo*. *Plant J.* **48**: 427–439.
- Flexas, J., Bota, J., Galmés, J., Medrano, H., & Ribas-Carbó, M. 2006b. Keeping a positive carbon balance under adverse conditions: responses of photosynthesis and respiration to water stress. *Physiol. Plant.* **127**: 343–352.
- Flexas, J., Diaz-Espejo, Galmés, J., Kaldenhoff, R., Medrano, H. & Ribas-Carbó, M. 2007a. Rapid variations of mesophyll conductance in response to changes in CO₂ concentration around leaves. *Plant Cell Environ.* **30**: 1284–1298.
- Flexas, J., Diaz-Espejo, A., Berry, J.A., Cifre, J., Galmés, J., Kaldenhoff, R., Medrano, H. & Ribas-Carbo, M. 2007b. Analysis of leakage in IRGA's leaf chambers of open gas exchange systems: quantification and its effects in photosynthesis parameterization. *J. Exp. Bot.* **58**: 1533–1543.
- Flexas, J., Ribas-Carbó, M., Diaz-Espejo, A., Galmés, J., & Medrano, H. 2008. Mesophyll conductance to CO₂: current knowledge and future prospects. *Plant Cell Environ.* **31**: 602–621.
- Flügge, U.I., Stitt, M., & Heldt, H.W. 1985. Light-driven uptake or pyruvate into mesophyll chloroplasts from maize. *FEBS Lett.* **183**: 335–339.
- Fredeen, A.L., Gamon, J.A., & Field, C.B. 1991. Responses of photosynthesis and carbohydrate partitioning to limitations in nitrogen and water availability in field grown sunflower. *Plant Cell Environ.* **14**: 969–970.
- Galmés, J., Flexas, J., Keys, A.J., Cifre, J., Mitchell, R.A.C., Madgwick, P.J., Haslam R.P., Medrano, H., & Parry, M.A.J. 2005. Rubisco specificity factor tends to be larger in plant species from drier habitats and in species with persistent leaves. *Plant Cell Environ.* **28**: 571–579.
- Galmés, J., Medrano, H., & Flexas, J. 2007. Photosynthetic limitations in response to water stress and recovery in Mediterranean plants with different growth forms. *New Phytol.* **175**: 81–93.
- Genty, B., Briantais, J.-M., & Baker, N.R. 1989. The relationship between the quantum yield of photosynthetic electron transport and quenching of chlorophyll fluorescence. *Biochim. Biophys. Acta* **990**: 87–92.
- Ghannoum, O., Evans, J.R., Chow, W.S., Andrews, T.J., Conroy, J.P., & Von Caemmerer, S. 2005. Faster Rubisco is the key to superior nitrogen-use efficiency in NADP-malic enzyme relative to NAD-Malic enzyme C₄ grasses. *Plant Physiol.* **137**: 638–650.
- Gillon, J.S. & Yakir, D. 2000. Internal conductance to CO₂ diffusion and C¹⁸O discrimination in C₃ leaves. *Plant Physiol.* **123**: 201–214.
- Gilmore, A.M. 1997. Mechanistic aspects of xanthophyll cycle-dependent photoprotection in higher plant chloroplasts and leaves. *Physiol. Plant* **99**: 197–209.
- Goldschmidt, E.E. & Huber, S.C. 1992. Regulation of photosynthesis by end-product accumulation in leaves of plants storing starch, sucrose, and hexose sugars. *Plant Physiol.* **99**: 1443–1448.
- Grace, J. 2004. Understanding and managing the global carbon cycle. *J. Ecol.* **92**: 189–202.
- Grams, E.E., Koziolok, C., Lautner, S., Matyssek, R., & Fromm, J. 2007. Distinct roles of electric and hydraulic signals on the reaction of leaf gas exchange upon re-irrigation in *Zea mays* L. *Plant Cell Environ.* **30**: 79–84.
- Grassi, G. & Magnani, F. 2005. Stomatal, mesophyll conductance and biochemical limitations to photosynthesis as affected by drought and leaf ontogeny in ash and oak trees. *Plant Cell Environ.* **28**: 834–849.
- Gunasekera, D. & Berkowitz, G.A. 1992. Heterogenous stomatal closure in response to leaf water deficits is not a universal phenomenon. *Plant Physiol.* **98**: 660–665.
- Guy, R.D., Fogel, M.L., & Berry, J.A. 1993. Photosynthetic fractionation of the stable isotopes of oxygen and carbon. *Plant Physiol.* **101**: 37–47.
- Hanson, H.C. 1917. Leaf structure as related to environment. *Am. J. Bot.* **4**: 533–560.
- Harris, F.S. & Martin, C.E. 1991. Correlation between CAM-cycling and photosynthetic gas exchange in five species of (*Talinum*) (Portulacaceae) *Plant Physiol.* **96**: 1118–1124.
- Hatch, M.D. & Carnal, N.W. 1992. The role of mitochondria in C₄ photosynthesis. In: Molecular, biochemical and physiological aspects of plant respiration, H. Lambers & L.H.W. Van der Plas (eds.). SPB Academic Publishing, The Hague, pp. 135–148.
- Hatch, M.D. & Slack, C.R. 1966. Photosynthesis by sugar cane leaves A new carboxylation reaction and

- the pathway of sugar formation. *Biochem. J.* **101**: 103–111.
- Hatch, M.D. & Slack, C.R. 1998. C₄ photosynthesis: discovery, resolution, recognition, and significance. In: Discoveries in plant biology, S.-Y. Yang & S.-D. Kung (eds.). World Scientific Publishing, Hong Kong, pp. 175–196.
- Henderson, S.A., Von Caemmerer, S., & Farquhar, G.D. 1992. Short-term measurements of carbon isotope discrimination in several C₄ species. *Aust. J. Plant Physiol.* **19**: 263–285.
- Henderson, S., Hattersley, P., Von Caemmerer, S. & Osmond, C.B. 1995. Are C₄ pathway plants threatened by global climatic change? In: Ecophysiology of photosynthesis, E.-D. Schulze & M.M. Caldwell (eds.). Springer-Verlag, Berlin, pp. 529–549.
- Hibberd, J.M. & Quick, W.P. 2002. Characteristics of C₄ photosynthesis in stems and petioles of C₃ flowering plants. *Nature* **415**: 451–454.
- Hikosaka, K., Ishikawa, K., Borjigidai, A., Muller, O., & Onoda, Y. 2006. Temperature acclimation of photosynthesis: mechanisms involved in the changes in temperature dependence of photosynthetic rate. *J. Exp. Bot.* **57**: 291–302.
- Holbrook, N.M., Shashidhar, V.R., James, R.A., & Munns, R. 2002. Stomatal control in tomato with ABA-deficient roots: response of grafted plants to soil drying. *J. Exp. Bot.* **53**: 1503–1514.
- Houghton, R.A. 2007. Balancing the global carbon budget. *Annu. Rev. Earth Planet. Sci.* **35**: 313–347.
- Huang, Y., Street-Perrott, F.A., Metcalfe, S.E., Brenner, M., Moreland, M., Freeman, K.H. 2001. Climate change as the dominant control on glacial-interglacial variations in C₃ and C₄ plant abundance. *Science* **293**: 1647–1651.
- Hubick, K. 1990. Effects of nitrogen source and water limitation on growth, transpiration efficiency and carbon isotope discrimination in peanut cultivars. *Aust. J. Plant Physiol.* **17**: 413–430.
- Hubick, K. & Farquhar, G.D. 1989. Carbon isotope discrimination and the ratio of carbon gained to water lost in barley cultivars. *Plant Cell Environ.* **12**: 795–804.
- Huner, N.P.A., Öquist, G., & Sarhan, F. 1998. Energy balance and acclimation to light and cold. *Trends Plant Sci.* **3**: 224–230.
- Hungate, B.A., Reichstein, M., Dijkstra, P., Johnson, D., Hymus, G., Tenhunen, J. D., Hinkle, C.R., & Drake, B.G. 2002. Evapotranspiration and soil water content in a scrub-oak woodland under carbon dioxide enrichment. *Global Change Biol.* **8**: 289–298.
- Jahnke, S. & Pieruschka, R. 2006. Air pressure in clamp-on leaf chambers: a neglected issue in gas exchange measurements. *J. Exp. Bot.* **57**: 2553–2561.
- Jones, P.G., Lloyd, J.C., & Raines, C.A. 1996. Glucose feeding of intact wheat plants represses the expression of a number of Calvin cycle genes. *Plant Cell Environ.* **19**: 231–236.
- Jordan, D.B. & Ogren, W.L. 1981. The CO₂/O₂ specificity of ribulose 1,5-bisphosphate carboxylase/oxygenase. *Planta* **161**: 308–313.
- Kalisz, S. & Teeri, J.A. 1986. Population-level variation in photosynthetic metabolism and growth in *Sedum wrightii*. *Ecology* **67**: 20–26.
- Kao, W.-Y. & Forseth, I.N. 1992. Diurnal leaf movement, chlorophyll fluorescence and carbon assimilation in soybean grown under different nitrogen and water availabilities. *Plant Cell Environ.* **15**: 703–710.
- Keeley, J.E. 1990. Photosynthetic pathways in freshwater aquatic plants. *Trends Ecol. Evol.* **5**: 330–333.
- Keeley, J.E. & Busch, G. 1984. Carbon assimilation characteristics of the aquatic CAM plant, *Isoetes howellii*. *Plant Physiol.* **76**: 525–530.
- Keeley, J.E. & Rundel, P.W. 2005. Fire and the Miocene expansion of C₄ grasslands. *Ecol. Lett.* **8**: 683–690.
- Keeley, J.E. & Sandquist, D.R. 1992. Carbon: freshwater aquatics. *Plant Cell Environ.* **15**: 1021–1035.
- Keeley, J.E., Osmond, C.B., & Raven, J.A. 1984. *Stylites*, a vascular land plant without stomata absorbs CO₂ via its roots. *Nature* **310**: 694–695.
- Kirschbaum, M.U.F. & Pearcy, R.W. 1988. Gas exchange analysis of the relative importance of stomatal and biochemical factors in photosynthetic induction in *Alocasia macrorrhiza*. *Plant Physiol.* **86**: 782–785.
- Kluge, M. & Ting, I.P. 1978. Crassulacean acid metabolism. Analysis of an ecological adaptation. Springer-Verlag, Berlin.
- Koch, K.E. & Kennedy, R.A. 1982. Crassulacean acid metabolism in the succulent C₄ dicot, *Portulaca oleracea* L. under natural environmental conditions. *Plant Physiol.* **69**: 757–761.
- Körner, C. & Larcher, W. 1988. Plant life in cold climates. *Symp. Soc. Exp. Biol.* **42**: 25–57.
- Krall, J.P. & Edwards, G.E. 1992. Relationship between photosystem II activity and CO₂ fixation. *Physiol. Plant* **86**: 180–187.
- Krall, J.P., Edwards, G.E. and Andrea, C.S. 1989. Protection of pyruvate, P_i dikinase from maize against cold lability by compatible solutes. *Plant Physiol.* **89**: 280–285.
- Krause, G.H. & Weis, E. 1991. Chlorophyll fluorescence and photosynthesis: The basics. *Annu. Rev. Plant Physiol. Plant Mol. Biol.* **42**: 313–349.
- Kropf, M. 1989. Quantification of SO₂ effects on physiological processes, plant growth and crop production. PhD Thesis, Wageningen Agricultural University, The Netherlands.
- Külheim, C., Agren, J., & Jansson, S. 2002. Rapid regulation of light harvesting and plant fitness in the field. *Science* **297**: 91–93.
- Lake, J.A., Quick, W.P., Beerling, D.J., & Woodward, F.I. 2001. Plant development. Signals from mature to new leaves. *Nature* **411**: 154.
- Lawlor, D.W. 1993. Photosynthesis; molecular, physiological and environmental processes. Longman, London.
- Leverenz, J.W. 1987. Chlorophyll content and the light response curve of shade adapted conifer needles. *Physiol. Plant* **71**: 20–29.
- Li, X.-P., Phippard, A., Pasari, J., & Niyogi, K.K. 2002. Structure-function analysis of photosystem II subunit S (PsbS) *in vivo*. *Funct. Plant Biol.* **29**: 1131–1139.

- Lichtenthaler, H.K. 2007. Biosynthesis, accumulation and emission of carotenoids, α -tocopherol, plastoquinone, and isoprene in leaves under high photosynthetic irradiance. *Photosynth. Res.* **92**: 163–179.
- Lichtenthaler, H.K. & Babani, F. 2004. Light adaptation and senescence of the photosynthetic apparatus. Changes in pigment composition, chlorophyll fluorescence parameters and photosynthetic activity. In: Chlorophyll fluorescence: a signature of photosynthesis, G.C. Papageorgiou & Govindjee (eds.). Springer, Dordrecht, pp. 713–736.
- Logan, B.A., Barker, D.H., Demmig-Adams, B., & Adams III, W.W. 1996. Acclimation of leaf carotenoid composition and ascorbate levels to gradients in the light environment within an Australian rainforest. *Plant Cell Environ.* **19**: 1083–1090.
- Long, S.P. & Bernacchi, C.J. 2003. Gas exchange measurements, what can they tell us about the underlying limitations to photosynthesis? Procedures and sources of error. *J. Exp. Bot.* **54**: 2393–2401.
- Long, S.P. & Hällgren, J.E. 1993. Measurement of CO₂ assimilation by plants in the field and the laboratory. In: Photosynthesis and production in a changing environment, D.O. Hall, J.M.O. Scurlock, H.R. Bolhär-Nordenkamp, R.C. Leegood, & S.P. Long (eds.). Chapman and Hall, London, pp. 129–167.
- Long, S.P., Humphries, S., & Falkowski, P.G. 1994. Photo-inhibition of photosynthesis in nature. *Annu. Rev. Plant Physiol. Plant Mol. Biol.* **45**: 633–662.
- Long, S.P., Ainsworth, E.A., Rogers, A., & Ort, D.R. 2004. Rising atmospheric carbon dioxide: plants FACE the future. *Annu. Rev. Plant Biol.* **55**: 591–628.
- Maberly, S.C. & Madsen, T.V. 2002. Freshwater angiosperm carbon concentrating mechanisms: processes and patterns. *Funct. Plant Biol.* **29**: 393–405.
- Madsen, T.V. & Baattrup-Pedersen, A. 1995. Regulation of growth and photosynthetic performance in *Elodea canadensis* in response to inorganic nitrogen. *Funct. Ecol.* **9**: 239–247.
- Magnin, N.C., Cooley, B.A., Reiskind, J.B., & Bowes, G. 1997. Regulation and localization of key enzymes during the induction of Kranz-less, C₄-type in *Hydrilla verticillata*. *Plant Physiol.* **115**: 1681–1689.
- Martin, B., Tauer, C.G., Lin, R.K. 1999. Carbon isotope discrimination as a tool to improve water-use efficiency in tomato. *Crop Sci.* **39**: 1775–1783.
- Mazen, A.M.A. 1996. Changes in levels of phosphoenolpyruvate carboxylase with induction of Crassulacean acid metabolism (CAM)-like behavior in the C₄ plant *Portulaca oleracea*. *Physiol. Plant.* **98**: 111–116.
- McConnaughey, T.A., LaBaugh, J.W., Rosenberry, D.O., Striegl, R.G., Reddy, M.M., & Schuster, P.F. 1994. Carbon budget for a groundwater-fed lake: calcification supports summer photosynthesis. *Limnol. Oceanogr.* **39**: 1319–1332.
- Medina, E. 1996. CAM and C₄ plants in the humid tropics. In: Tropical forest plant ecophysiology, S.D. Mulkey, R. L. Chazdon, & A.P. Smith (eds.). Chapman & Hall, New York, pp. 56–88.
- Mommer, L., Pons, T.L., Wolters-Arts, M., Venema, J.H., & Visser, E.J.W. 2005. Submergence-induced morphological, anatomical, and biochemical responses in a terrestrial species affect gas diffusion resistance and photosynthetic performance. *Plant Physiol.* **139**: 497–508.
- Monsi, M. & Saeki T. 1953. Über den Lichtfaktor in den Pflanzengesellschaften und sein Bedeutung für die Stoffproduktion. *Jap. J. Bot.* **14**: 22–52.
- Monsi, M. & Saeki T. 2005. On the factor light in plant communities and its importance for matter production. *Ann. Bot.* **95**: 549–567.
- Mooney, H.A. 1986. Photosynthesis. In: Plant ecology, M.J. Crawley (ed.). Blackwell Scientific Publications, Oxford. pp. 345–373.
- Morgan, C.L., Turner, S.R., & Rawsthorne, S. 1992. Cell-specific distribution of glycine decarboxylase in leaves of C₃, C₄ and C₃-C₄ intermediate species. In: Molecular, biochemical and physiological aspects of plant respiration, H. Lambers & L.H.W. Van der Plas (eds.). SPB Academic Publishing, The Hague, pp. 339–343.
- Morgan, P.B., Ainsworth, E.A., & Long, S.P. 2003. How does elevated ozone impact soybean? A meta-analysis of photosynthesis, growth and yield. *Plant Cell Environ.* **26**: 1317–1328.
- Mott, K.A. & Buckley, T.N. 2000. Patchy stomatal conductance: emergent collective behaviour of stomata. *Trends Plant Sci.* **5**: 1380–1385.
- Murchie, E.H. & Horton, P. 1997. Acclimation of photosynthesis to irradiance and spectral quality in British plant species: chlorophyll content, photosynthetic capacity and habitat preference. *Plant Cell Environ.* **20**: 438–448.
- Newman, J.R. & Raven, J.R. 1993. Carbonic anhydrase in *Ranunculus penicillatus* spp. *pseudofluitans*: activity, location and implications for carbon assimilation. *Plant Cell Environ.* **16**: 491–500.
- Nielsen, S.L., Gacia, E., & Sand-Jensen, K. 1991. Land plants or amphibious *Littorella uniflora* (L.) Aschers. maintain utilization of CO₂ from sediment. *Oecologia* **88**: 258–262.
- Niinemets, Ü. 2007. Photosynthesis and resource distribution through plant canopies. *Plant Cell Environ.* **30**: 1052–1071.
- Nimmo, H.G., Fontaine, V., Hartwell, J., Jenkins, G.I., Nimmo, G.A., & Wilkins, M.B. 2001. PEP carboxylase kinase is a novel protein kinase controlled at the level of expression. *New Phytol.* **151**: 91–97.
- Nishiyama, Y., Allakhverdiev, S.I., & Murata, N. 2006. A new paradigm for the action of reactive oxygen species in the photoinhibition of photosystem II. *Biochim. Biophys. Acta* **1757**: 742–749.
- Nishio, J.N., Sun, J., & Vogelmann, T.C. 1993. Carbon fixation gradients across spinach leaves do not follow internal light gradients. *Plant Cell* **5**: 953–961.
- Niyogi, K., Grossman, A.R., & Björkman, O. 1998. *Arabidopsis* mutants define a central role for the xanthophyll cycle in the regulation of photosynthetic energy conversion. *Plant Cell* **10**: 1121–1134.
- Nobel, P.S. & Hartsock, T.L. 1990. Diel patterns of CO₂ exchange for epiphytic cacti differing in succulence. *Physiol. Plant* **78**: 628–634.

- Nobel, P.S., Garcia-Moya, E., & Quero, E. 1992. High annual productivity of certain agaves and cacti under cultivation. *Plant Cell Environ.* **15**: 329–335.
- Norby, R.J., Wullschlegel, S.D., Gunderson, C.A., Johnson, D.W., & Ceulemans, R. 1999. Tree responses to rising CO₂ in field experiments: implications for the future forest. *Plant Cell Environ.* **22**: 683–714.
- Ögren, E. 1993. Convexity of the photosynthetic light-response curve in relation to intensity and direction of light during growth. *Plant Physiol.* **101**: 1013–1019.
- Ogren, W.L. 1984. Photorespiration: pathways, regulation, and modification. *Annu. Rev. Plant Physiol.* **35**: 415–442.
- Oguchi, R., Hikosaka, K., & Hirose, T. 2005. Leaf anatomy as a constraint for photosynthetic acclimation: differential responses in leaf anatomy to increasing growth irradiance among three deciduous trees. *Plant Cell Environ.* **28**: 916–927.
- O'Leary M.H. 1993. Biochemical basis of carbon isotope fractionation. In: Stable isotopes and plant carbon-water relations, J.R. Ehleringer, A.E. Hall, & G.D. Farquhar (eds.). Academic Press, San Diego, pp. 19–28.
- Öquist, G., Brunel, L., & Hällgren, J.E. 1982. Photosynthetic efficiency of *Betula pendula* acclimated to different quantum flux densities. *Plant Cell Environ.* **5**: 9–15.
- Osmond, C.B. 1994. What is photoinhibition? Some insights from comparisons of shade and sun plants. In: Photoinhibition of photosynthesis from molecular mechanisms to the field, N.R. Baker & J.R. Bowyer (eds.). Bios Scientific Publishers, Oxford, pp. 1–24.
- Osmond, C.B. & Holtum, J.A.M. 1981. Crassulacean acid metabolism. In: The biochemistry of plants. A comprehensive treatise, Vol 8, P.K. Stumpf & E.E. Conn (eds.). Academic Press, New York, pp. 283–328.
- Osmond, C.B., Winter, K., & Ziegler, H. 1982. Functional significance of different pathways or CO₂ fixation in photosynthesis. In: Encyclopedia of plant physiology, Vol. 12B, O.L. Lange, P.S. Nobel, C.B. Osmond, & H. Ziegler (eds.). Springer-Verlag, Berlin, pp. 479–548.
- Pascal, A.A., Liu, Z.F., Broess, K., Van Oort, B., Van Amerongen, H., Wang, C., Horton, P., Robert, B., Chang, W.R., & Ruban, A. 2005. Molecular basis of photoprotection and control of photosynthetic light-harvesting. *Nature* **436**: 134–137.
- Patel, A. & Ting, I.P. 1987. Relationship between respiration and CAM-cycling in *Peperomia camptotricha*. *Plant Physiol.* **84**: 640–642.
- Paul, M.J. & Foyer, C.H. 2001. Sink regulation of photosynthesis. *J. Exp. Bot.* **52**: 1383–1400.
- Pearcy, R.W. 1977. Acclimation of photosynthetic and respiratory carbon dioxide exchange to growth temperature in *Atriplex lentiformis* (Torr.) Wats. *Plant Physiol.* **59**: 795–799.
- Pearcy, R.W. 1988. Photosynthetic utilisation of lightflecks by understorey plants. *Aust. J. Plant Physiol.* **15**: 223–238.
- Pearcy, R.W. 1990. Sunflecks and photosynthesis in plant canopies. *Annu. Rev. Plant Physiol. Plant Mol. Biol.* **41**: 421–453.
- Plaut, Z., Mayoral, M.L., & Reinhold, L. 1987. Effect of altered sink:source ratio on photosynthetic metabolism of source leaves. *Plant Physiol.* **85**: 786–791.
- Pons, T.L. & Pearcy, R.W. 1992. Photosynthesis in flashing light in soybean leaves grown in different conditions. II. Lightfleck utilization efficiency. *Plant Cell Environ.* **15**: 577–584.
- Pons, T.L. & Pearcy, R.W. 1994. Nitrogen reallocation and photosynthetic acclimation in response to partial shading in soybean plants. *Physiol. Plant.* **92**: 636–644.
- Pons, T.L. & Welschen, R.A.M. 2002. Overestimation of respiration rates in commercially available clamp-on leaf chambers. Complications with measurement of net photosynthesis. *Plant Cell Environ.* **25**: 1367–1372.
- Pons, T.L., Van der Werf, A., & Lambers, H. 1994. Photosynthetic nitrogen use efficiency of inherently slow and fast-growing species: possible explanations for observed differences. In: A whole-plant perspective of carbon-nitrogen interactions, J. Roy & E. Garnier (eds.). SPB Academic Publishing, The Hague, pp. 61–77.
- Poot, P., Pilon, J., & Pons, T.L. 1996. Photosynthetic characteristics of leaves of male sterile and hermaphroditic sex types of *Plantago lanceolata* grown under conditions of contrasting nitrogen and light availabilities. *Physiol. Plant.* **98**: 780–790.
- Portis, A. 2003. Rubisco activase – Rubisco's catalytic chaperone. *Photosynth. Res.* **75**: 11–27.
- Portis, A.R., Salvucci, M.E., & Ogren, W.L. 1986. Activation of ribulosebiphosphate carboxylase/oxygenase at physiological CO₂ and ribulosebiphosphate concentrations by Rubisco activase. *Plant Physiol.* **82**: 967–971.
- Prins, H.B.A. & Elzenga, J.T.M. 1989. Bicarbonate utilization: function and mechanism. *Aquat. Bot.* **34**: 59–83.
- Pyanikov, V.I. & Kondratchuk, A.V. 1995. Specific features of structural organization of photosynthetic apparatus of the East Pamirs plants. *Proc. Russ. Acad. Sci.* **344**: 712–716.
- Pyanikov, V.I. & Kondratchuk, A.V. 1998. Structure of the photosynthetic apparatus in woody plants from different ecological and altitudinal in Eastern Pamir. *Russ. J. Plant Physiol.* **45**: 567–578.
- Prins, H.B.A. & de Guia, M.B. 1986. Carbon source of the water soldier, *Stratiotes aloides* L. *Aquat. Bot.* **26**: 225–234.
- Raymo, M.E. & Ruddiman, W.F. 1992. Tectonic forcing of late Cenozoic climate. *Nature* **359**: 117–122.
- Reich, P.B. & Schoettle, A.W. 1988. Role of phosphorus and nitrogen in photosynthetic and whole plant carbon gain and nutrient use efficiency in eastern white pine. *Oecologia* **77**: 25–33.
- Reich, P.B., Walters, M.B., & Ellsworth, D.S. 1997. From tropics to tundra: Global convergence in plant functioning. *Proc. Natl. Acad. Sci. USA* **94**: 13730–13734.
- Reinfelder, J.R., Kraepiel, A.M.L., & Morel, F.M.M. 2000. Unicellular C-4 photosynthesis in a marine diatom. *Nature* **407**: 996–999.
- Reiskind, J.B., Madsen, T.V., Van Ginkel, L.C., & Bowes, G. 1997. Evidence that inducible C₄-type photosynthesis is a chloroplastic CO₂-concentrating mechanism in *Hydrilla*, a submersed monocot. *Plant Cell Environ.* **20**: 211–220.
- Rodeghiero, M., Niinemets, Ü. & Cescatti, A. 2007. Major diffusion leaks of clamp-on leaf cuvettes still unaccounted: how erroneous are the estimates of Farquhar

- et al. model parameters? *Plant Cell Environ.* **30**: 1006–1022.
- Rogers, A., Fischer, B.U., Bryant, J., Frehner, M., Blum, H., Raines, C.A., & Long, S.P. 1998. Acclimation of photosynthesis to elevated CO₂ under low-nitrogen nutrition is affected by the capacity for assimilate utilization. Perennial ryegrass under free-air CO₂ enrichment. *Plant Physiol.* **118**: 683–689.
- Rolland, F., Moore, B., & Sheen, J. 2002. Sugar sensing and signaling in plants. *Plant Cell* **14**: S185–S205.
- Rolland, F., Baena-Gonzalez, E., & Sheen, J. 2006. Sugar sensing and signaling in plants: Conserved and novel mechanisms. *Annu. Rev. Plant Biol.* **57**: 675–709.
- Rühle, W. & Wild, A. 1979. Measurements of cytochrome f and P-700 in intact leaves of *Sinapis alba* grown under high-light and low-light conditions. *Planta* **146**: 377–385.
- Rundel, P.W. & Sharifi, M.R. 1993. Carbon isotope discrimination and resource availability in the desert shrub *Larrea tridentata*. In: Stable isotopes and plant carbon-water relations, J.R. Ehleringer, A.E. Hall, & G.D. Farquhar (eds.). Academic Press, San Diego, pp. 173–185.
- Sage, R.F. 2002. C-4 photosynthesis in terrestrial plants does not require Kranz anatomy. *Trends Plant Sci.* **7**: 283–285.
- Sage, R.F. 2004. The evolution of C₄ photosynthesis. *New Phytol.* **161**: 341–370.
- Sage, R.F. & Kubien, D. 2003. Quo vadis C₄? An ecophysiological perspective on global change and the future of C₄ plants. *Photosynth. Res.* **77**: 209–225.
- Sage, R.F. & Sharkey, T.D. 1987. The effect of temperature on the occurrence of O₂ and CO₂ insensitive photosynthesis in field grown plants. *Plant Physiol.* **84**: 658–664.
- Sage, R.F. & Pearcy, R.W. 1987a. The nitrogen use efficiency or C₃ and C₄ plants. I. Leaf nitrogen, growth, and biomass partitioning in *Chenopodium album* (L.) and *Amaranthus retroflexus*. *Plant Physiol.* **84**: 954–958.
- Sage, R.F. & Pearcy, R.W. 1987b. The nitrogen use efficiency or C₃ and C₄ plants. II. Leaf nitrogen effects on the gas exchange characteristics or *Chenopodium album* (L.) and *Amaranthus retroflexus*. *Plant Physiol.* **84**: 959–963.
- Salvucci, M.E. 1989. Regulation of Rubisco activity *in vivo*. *Physiol. Plant.* **77**: 164–171.
- Salvucci, M.E. & Crafts-Brandner, S.J. 2004a. Mechanism for deactivation of Rubisco under moderate heat stress. *Physiol. Plant.* **122**: 513–519.
- Salvucci, M.E. & Crafts-Brandner, S.J. 2004b. Relationship between the heat tolerance of photosynthesis and the thermal stability of Rubisco activase in plants from contrasting thermal environments. *Plant Physiol.* **134**: 1460–1470.
- Sassenrath-Cole, G.F., Pearcy, R.W., & Steinmaus, S. 1994. The role of enzyme activation state in limiting carbon assimilation under variable light conditions. *Photosynth. Res.* **41**: 295–302.
- Schreiber, U., Bilger, W., & Neubauer, C. 1995. Chlorophyll fluorescence as a non-intrusive indicator for rapid assessment of *in vivo* photosynthesis. In: Ecophysiology of photosynthesis, E.-D. Schulze & M.M. Caldwell (eds.). Springer-Verlag, Berlin, pp. 49–70.
- Schulze, E.-D., Kelliher, F.M., Körner, C., Lloyd, J., & Leuning, R. 1994. Relationships among maximum stomatal conductance, ecosystem surface conductance, carbon assimilation rate, and plant nitrogen nutrition: A global ecology scaling exercise. *Annu. Rev. Ecol. Syst.* **25**: 629–660.
- Sharkey, T.D. 2005. Effects of moderate heat stress on photosynthesis: importance of thylakoid reactions, Rubisco deactivation, reactive oxygen species, and thermotolerance provided by isoprene. *Plant Cell Environ.* **28**: 269–277.
- Sharkey, T.D., Seemann, J.R., & Pearcy, R.W. 1986a. Contribution of metabolites of photosynthesis to postillumination CO₂ assimilation in response to lightflecks. *Plant Physiol.* **82**: 1063–1068.
- Sharkey, T.D., Stitt, M., Heineke, D., Gerhardt, R., Raschke, K., & Heldt, H.W. 1986b. Limitation of photosynthesis by carbon metabolism. II. CO₂-insensitive CO₂ uptake results from limitation of triose phosphate utilization. *Plant Physiol.* **81**: 1123–1129.
- Sharkey, T.D., Bernacchi, C.J., Farquhar, G.D., & Singsaas, E.L. 2007. Fitting photosynthetic carbon dioxide response curves for C₃ leaves. *Plant Cell Environ.* **30**: 1035–1040.
- Sims, D.A. & Pearcy, R.W. 1989. Photosynthetic characteristics of a tropical forest understorey herb, *Alocasia macrorrhiza*, and a related crop species, *Colocasia esculenta*, grown in contrasting light environments. *Oecologia* **79**: 53–59.
- Smedley, M.P., Dawson, T.E., Comstock, J.P., Donovan, L.A., Sherrill, D.E., Cook, C.S., & Ehleringer, J.R. 1991. Seasonal carbon isotope discrimination in a grassland community. *Oecologia* **85**: 314–320.
- Smeekeens, S. 2000. Sugar induced signal transduction in plants. *Annu. Rev. Plant Physiol. Plant Mol. Biol.* **51**: 49–81.
- Smeekeens, S. & Rook, F. 1998. Sugar sensing and sugar-mediated signal transduction in plants. *Plant Physiol.* **115**: 7–13.
- Smith, H., Samson, G., & Fork, D.C. 1993. Photosynthetic acclimation to shade: Probing the role of phytochromes using photomorphogenetic mutants of tomato. *Plant Cell Environ.* **16**: 929–937.
- Staiger, C.J., Gibbon, B.C., Kovar, D.R., & Zonia, L.E. 1997. Profilin and actin-depolymerizing factor: Modulators of actin organization in plants. *Trends Plant Sci.* **2**: 275–281.
- Sternberg, L.O., DeNiro, M.J., & Johnson, H.B. 1984. Isotope ratios of cellulose from plants having different photosynthetic pathways. *Plant Physiol.* **74**: 557–561.
- Stitt, M. & Hurry, V. 2002. A plant for all seasons: alterations in photosynthetic carbon metabolism during cold acclimation in *Arabidopsis*. *Curr. Opin. Plant Biol.* **5**: 199–206.
- Surridge, C. 2002. Agricultural biotech: the rice squad. *Nature* **416**: 576–578.
- Tans, P. 2007. NOAA/ESRL (www.esrl.noaa.gov/gmd/ccgg/trends/).
- Terashima, I. & Hikosaka, K. 1995. Comparative ecophysiology of leaf and canopy photosynthesis. *Plant Cell Environ.* **18**: 1111–1128.
- Terashima, I., Wong, S.C., Osmond, C.B., & Farquhar, G.D. 1988. Characterisation of non-uniform photosynthesis

- induced by abscisic acid in leaves having different mesophyll anatomies. *Plant Cell Physiol.* **29**: 385–394.
- Terashima, I., Miyazawa, S.-I., & Hanba, Y.T. 2001. Why are sun leaves thicker than shade leaves? – Consideration based on analyses of CO₂ diffusion in the leaf. *J. Plant Res.* **114**: 93–105.
- Terashima, I., Hanba, Y.T., Tazoe, Y., Vyas, P., & Yano, S. 2006. Irradiance and phenotype: comparative eco-development of sun and shade leaves in relation to photosynthetic CO₂ diffusion. *J. Exp. Bot.* **57**: 343–354.
- Ueno, O. 2001. Environmental regulation of C₃ and C₄ differentiation in the amphibious sedge *Eleocharis vivipara*. *Plant Physiol.* **127**: 1524–1532.
- Ueno, O., Samejima, M., Muto, S., Miyachi, S. 1988. Photosynthetic characteristics of an amphibious plant, *Eleocharis vivipara*: expression of C₄ and C₃ modes in contrasting environments. *Proc. Natl. Acad. Sci. USA* **85**: 6733–6737.
- Van Oosten, J.-J. & Besford, R.T. 1995. Some relationships between the gas exchange, biochemistry and molecular biology of photosynthesis during leaf development of tomato plants after transfer to different carbon dioxide concentrations. *Plant Cell Environ.* **18**: 1253–1266.
- Van Oosten, J.J., Wilkins, D., & Besford, R.T. 1995. Acclimation of tomato to different carbon dioxide concentrations. Relationships between biochemistry and gas exchange during leaf development. *New Phytol.* **130**: 357–367.
- Vernon, D.M., Ostrem, J.A., Schmitt, J.M., & Bohnert, H. 1988. PEPCase transcript levels in *Mesembryanthemum crystallinum* decline rapidly upon relief from salt stress. *Plant Physiol.* **86**: 1002–1004.
- Vogel, J.C., Fuls, A., & Ellis, R.P. 1978. The geographical distribution of Kranz grasses in South Africa. *S. Afr. J. Sci.* **74**: 209–215.
- Vogelmann, T.C. 1993. Plant tissue optics. *Annu. Rev. Plant Physiol. Plant Mol. Biol.* **44**: 231–251.
- Vogelmann, T.C. & Evans, J.R. 2002. Profiles of light absorption and chlorophyll within spinach leaves from chlorophyll fluorescence. *Plant Cell Environ.* **25**: 1313–1323.
- Vogelmann, T.C., Nishio, J.N., & Smith, W.K. 1996. Leaves and light capture: Light propagation and gradients of carbon fixation within leaves. *Trends Plant Sci.* **1**: 65–70.
- Von Caemmerer, S. 1989. A model of photosynthetic CO₂ assimilation and carbon-isotope discrimination in leaves of certain C₃–C₄ intermediates. *Planta* **178**: 463–474.
- Von Caemmerer, S. 2000. Biochemical models of leaf photosynthesis. CSIRO Publishing, Collingwood.
- Von Caemmerer, S. & Farquhar, G.D. 1981. Some relationships between biochemistry of photosynthesis and gas exchange of leaves. *Planta* **153**: 376–387.
- Wakabayashi, K. & Böger, P. 2002. Target sites for herbicides: entering the 21st century. *Pest Manage. Sci.* **58**: 1149–1154.
- Walters, R.G. 2005. Towards an understanding of photosynthetic acclimation. *J. Exp. Bot.* **56**: 435–447.
- Walters, R.G., Rogers, J.J.M., Shephard, F., & Horton, P. 1999. Acclimation of *Arabidopsis thaliana* to the light environment: the role of photoreceptors. *Planta* **209**: 517–527.
- Wand, S.J.E., Midgley, G.F., Jones, M.H., & Curtis, P.S. 1999. Responses of wild C₄ and C₃ grass (Poaceae) species to elevated atmospheric CO₂ concentration: a meta-analytical test of current theories and perceptions. *Global Change Biol.* **5**: 723–741.
- Warren, C.R. 2007. Stand aside stomata, another actor deserves centre stage: the forgotten role of the internal conductance to CO₂ transfer. *J. Exp. Bot.* **59**: 1475–1487.
- Warren, C.R. & Adams, M.A. 2006. Internal conductance does not scale with photosynthetic capacity: implications for carbon isotope discrimination and the economics of water and nitrogen use in photosynthesis. *Plant Cell Environ.* **29**: 192–201.
- Warren, C.R., Low, M., Matysek, R., & Tausz, M. 2007. Internal conductance to CO₂ transfer of adult *Fagus sylvatica*: variation between sun and shade leaves and due to free-air ozone fumigation. *Environ. Exp. Bot.* **59**: 130–138.
- Weger, H.G., Silim, S.N., & Guy, R.D. 1993. Photosynthetic acclimation to low temperature by western red cedar seedlings. *Plant Cell Environ.* **16**: 711–717.
- Weston, D.J., Bauerle, W.L., Swire-Clark, G.A., Moore, B.D., & Baird, W.V. 2007. Characterization of Rubisco activase from thermally contrasting genotypes of *Acer rubrum* (Aceraceae). *Am. J. Bot.* **94**: 926–934.
- Winter, K. & Smith, J.A.C. 1996. An introduction to crassulacean acid metabolism. Biochemical principles and ecological diversity. In: Crassulacean acid metabolism, biochemistry, ecophysiology and evolution. Ecological studies 114, K. Winter & J.A.C. Smith (eds.). Springer-Verlag, Berlin, pp. 1–13.
- Winter, K., Zotz, G., Baur, B., & Dietz, K.-J. 1992. Light and dark CO₂ fixation in *Clusia uvitana* and the effects of plant water status and CO₂ availability. *Oecologia* **91**: 47–51.
- Wright, G.C., Hubick, K.T., & Farquhar, G.D. 1988. Discrimination in carbon isotopes of leaves correlates with water-use efficiency of field-grown peanut cultivars. *Aust. J. Plant Physiol.* **15**: 815–825.
- Wright, I.J., Reich, P.B., & Westoby, M. 2001. Strategy shifts in leaf physiology, structure and nutrient content between species of high- and low-rainfall and high- and low-nutrient habitats. *Funct. Ecol.* **15**: 423–434.
- Wright, I.J., Reich, P.B., Westoby, M., Ackerly, D.D., Baruch, Z., Bongers, F., Cavender-Bares, J., Chapin, T., Cornelissen, J.H.C., Diemer, M., Flexas, J., Garnier, E., Groom, P. K., Gulias, J., Hikosaka, K., Lamont, B.B., Lee, T., Lee, W., Lusk, C., Midgley, J.J., Navas, M.-L., Niinemets, Ü., Oleksyn, J., Osada, N., Poorter, H., Poot, P., Prior, L., Pyankov, V.I., Roumet, C., Thomas, S.C., Tjoelker, M.G., Veneklaas, E.J., & Villar, R. 2004. The worldwide leaf economics spectrum. *Nature* **428**: 821–827.
- Wu, M.-X. & Wedding, R.T. 1987. Temperature effects on phosphoenolpyruvate carboxylase from a CAM and a C₄ plant: a comparative study. *Plant Physiol.* **85**: 497–501.
- Wullschlegel, S.D., Tschaplinski, T.J., & Norby, R.J. 2002. Plant water relations at elevated CO₂ – implications for water-limited environments. *Plant Cell Environ.* **25**: 319–331.
- Yamori, W., Noguchi, K., & Terashima, I. 2005. Temperature acclimation of photosynthesis in spinach leaves: analyses of photosynthetic components and temperature dependencies of photosynthetic partial reactions. *Plant Cell Environ.* **28**: 536–547.

- Yamori, W., Noguchi, K., Hanba, Y.T., & Terashima, I. 2006a. Effects of internal conductance on the temperature dependence of the photosynthetic rate in spinach leaves from contrasting growth temperatures. *Plant Cell Physiol.* **47**: 1069–1080.
- Yamori, W., Suzuki, K., Noguchi, K., Nakai, M., & Terashima, I. 2006b. Effects of Rubisco kinetics and Rubisco activation state on the temperature dependence of the photosynthetic rate in spinach leaves from contrasting growth temperatures. *Plant Cell Environ.* **29**: 1659–1670.
- Yano, S. & Terashima, I. 2001. Separate localization of light signal perception for sun or shade type chloroplast and palisade tissue differentiation on *Chenopodium album*. *Plant Cell Physiol.* **41**: 1303–1310.
- Yeoh, H.-H., Badger, M.R., & Watson, L. 1981. Variations in kinetic properties of ribulose-1,5-bisphosphate carboxylase among plants. *Plant Physiol.* **67**: 1151–1155.

2B. Respiration

1. Introduction

A large portion of the carbohydrates that a plant assimilates each day are expended in respiration in the same period (Table 1). If we seek to explain the carbon balance of a plant and to understand plant performance and growth in different environments, it is imperative to obtain a good understanding of respiration. **Dark respiration** is needed to produce the energy and carbon skeletons to sustain plant growth; however, a significant part of respiration may proceed via a **nonphosphorylating pathway** that is cyanide resistant and generates less ATP than the **cytochrome pathway**, which is the primary energy-producing pathway in both plants and animals. We present several hypotheses in this chapter to explore why plants have a respiratory pathway that is not linked to ATP production.

The types and rates of plant respiration are controlled by a combination of **respiratory capacity**, **energy demand**, **substrate availability**, and **oxygen supply** (Covey-Crump et al. 2002, 2007). At low levels of O₂, respiration cannot proceed by normal aerobic pathways, and fermentation starts to take place, with **ethanol** and **lactate** as major end-products. The ATP yield of fermentation is considerably less than that of normal aerobic respiration. In this chapter, we discuss the control over respiratory processes, the demand for respiratory energy, and the significance of

respiration for the plant's carbon balance, as these are influenced by species and environment.

2. General Characteristics of the Respiratory System

2.1 The Respiratory Quotient

The respiratory pathways in plant tissues include **glycolysis**, which is located both in the cytosol and in the plastids, the **oxidative pentose phosphate pathway**, which is also located both in the plastids and the cytosol, the **tricarboxylic acid (TCA) or Krebs cycle**, in the matrix of mitochondria, and the **electron-transport pathways**, which reside in the inner mitochondrial membrane.

The **respiratory quotient (RQ)**, the ratio between the number of moles of CO₂ released and that of O₂ consumed) is a useful index of the types of substrates used in respiration and the subsequent use of respiratory energy to support biosynthesis. In the absence of biosynthetic processes, the RQ of respiration is expected to be 1.0, if sucrose is the only substrate for respiration and is fully oxidized to CO₂ and H₂O. When **leaves** of *Phaseolus vulgaris* (common bean) are exposed to an extended dark period or to high temperatures, their RQ declines, due to a shift from **carbohydrates** as the main substrate for

TABLE 1. Utilization of photosynthates in plants, as dependent on the nutrient supply.*

Item	Utilization of photosynthates % of C fixed	
	Free nutrient availability	Limiting nutrient supply
Shoot growth	40*–57	15–27*
Root growth	17–18*	33*–35
Shoot respiration	17–24*	19–20*
Root respiration	8–19*	38*–52
– Growth	3.5–4.6*	6*–9
– Maintenance	0.6–2.6*	?
– Ion acquisition	–13*	?
Volatile losses	0–8	0–8
Exudation	<5	<23
N ₂ fixation	Negligible	5–24
Mycorrhiza	Negligible	7–20

Source: Van der Werf et al. (1994).

* inherently slow-growing species; ? no information for nutrient-limited conditions.

respiration to **fatty acids** (Tcherkez et al. 2003). For **roots** of young seedlings, measured in the absence of an N source, values close to 1.0 have been found, but most experimental RQ values differ from unity (Table 2). RQ values for germinating **seeds** depend on the storage compounds in the seeds. For seeds of *Triticum aestivum* (wheat), in which **carbohydrates** are major storage compounds, RQ is close to unity, whereas for the **fat-storing** seeds of *Linum usitatissimum* (flax) RQ values as low as 0.4 are found (Stiles & Leach 1936).

Both the nature of the respiratory substrate and biosynthetic reactions strongly influence RQ. The RQ can be greater than 1, if **organic acids** are an important substrate, because these are more oxidized than sucrose, and, therefore, produce more CO₂ per unit O₂. On the other hand, RQ will be less than 1, if compounds that are more reduced than sucrose (e.g., **lipids** and **protein**) are a major substrate, as occurs during starvation of leaves and excised root tips (Table 2). In **shoots** of *Hordeum vulgare* (barley) that receive NH₄⁺ as their sole N source respiratory fluxes of O₂ equal those of CO₂. By contrast, shoots exposed to NO₃⁻ show a higher CO₂ evolution than O₂ consumption in the dark (RQ = 1.25). These results show that a substantial portion of respiratory electron transport generates reductant for NO₃⁻ assimilation, producing an additional two molecules of CO₂ per molecule of NO₃⁻ reduced to NH₄⁺ (Bloom et al. 1989). Substrates available to support root respiration depend on processes occurring throughout the plant. For

TABLE 2. The respiratory quotient (RQ) of root respiration of a number of herbaceous species.*

Species	RQ	Special Remarks
<i>Allium cepa</i>	1.0	Root tips
	1.3	Basal parts
<i>Dactylis glomerata</i>	1.2	
<i>Festuca ovina</i>	1.0	
<i>Galinsoga parviflora</i>	1.6	
<i>Helianthus annuus</i>	1.5	
<i>Holcus lanatus</i>	1.3	
<i>Hordeum distichum</i>	1.0	
<i>Lupinus albus</i>	1.4	
	1.6	N ₂ -fixing
<i>Oryza sativa</i>	1.0	NH ₄ ⁺ -fed
	1.1	
<i>Pisum sativum</i>	0.8	NH ₄ ⁺ -fed
	1.0	
	1.4	N ₂ -fixing
<i>Zea mays</i>	1.0	Fresh tips
	0.8	Starved tips

Source: Various authors, as summarized in Lambers et al. (2002).

*All plants were grown in nutrient solution, with nitrate as the N-source, unless stated otherwise. The *Pisum sativum* (pea) plants were grown with a limiting supply of combined N, so that their growth matched that of the symbiotically grown plants.

example, organic acids (malate) that are produced during the reduction of NO₃⁻ in leaves can be transported and decarboxylated in the roots, releasing CO₂ and increasing RQ (Ben Zioni et al. 1971). If NO₃⁻ reduction proceeds in the roots, then the RQ is also expected to be greater than 1. Values of RQ are therefore lower in plants that use NH₄⁺ as an N source than in plants grown with NO₃⁻ or, symbiotically, with N₂ (Table 2).

Biosynthesis influences RQ in several ways. Carboxylating reactions consume CO₂, reducing RQ, whereas decarboxylating reactions produce CO₂ and, therefore, increase RQ. In addition, synthesis of oxidized compounds such as organic acids decreases RQ, whereas the production of reduced compounds such as lipids leads to higher RQ values. The average molecular formula of the biochemical compounds typical of plant biomass is more reduced than sucrose, so RQ values influenced by biosynthesis should be greater than 1, as generally observed (Table 2; for further information, see Table 5.11 in Sect. 5.2.2).

RQ values of root respiration increase with increasing potential **growth rate** of a species (Fig. 1). This results from high rates of biosynthesis, relative to rates of ATP production; as explained above, ATP production associated with sucrose breakdown is

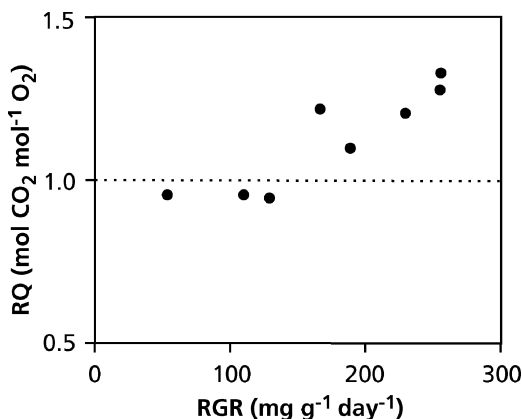

FIGURE 1. The respiratory quotient of a number of fast- and slow-growing grass species, grown with free access to nutrients and with nitrate as the source of N (Scheurwater et al. 1998).

associated with an RQ of 1.0, whereas biosynthesis yields RQ values greater than 1.0 (Scheurwater et al. 2002).

In summary, the patterns of RQ in plants clearly demonstrate that in roots it depends on the plant's growth rate. For all organs, it depends on the predominant respiratory substrate, integrated whole-plant processes, and ecological differences among species.

2.2 Glycolysis, the Pentose Phosphate Pathway, and the Tricarboxylic (TCA) Cycle

The first step in the production of energy for respiration occurs when glucose (or starch or other storage carbohydrates) is metabolized in glycolysis or in the oxidative pentose phosphate pathway (Fig. 2). **Glycolysis** involves the conversion of glucose, via phosphoenolpyruvate (PEP), into malate and pyruvate. In contrast to mammalian cells, where virtually all PEP is converted into pyruvate, in plant cells malate is the major end-product of glycolysis and thus the major substrate for the mitochondria. Key enzymes in glycolysis are controlled by adenylates (AMP, ADP, and ATP), in such a way as to speed up the rate of glycolysis when the demand for metabolic energy (ATP) increases (Plaxton & Podestá 2006).

Oxidation of one glucose molecule in glycolysis produces two **malate** molecules, without a net production of ATP. When **pyruvate** is the end product, there is a net production of two ATP molecules in glycolysis. Despite the production of NADH in one step in glycolysis, there is no net production of NADH when malate is the end product, due to the

need for NADH in the reduction of oxaloacetate, catalyzed by malate dehydrogenase.

Unlike glycolysis, which is predominantly involved in the breakdown of sugars and ultimately in the production of ATP, the **oxidative pentose phosphate pathway** plays a more important role in producing intermediates (e.g., amino acids, nucleotides) and NADPH. There is no evidence for a control of this pathway by the demand for energy.

The malate and pyruvate that are formed in glycolysis in the cytosol are imported into the mitochondria, where they are oxidized in the **tricarboxylic acid (TCA) cycle**. Complete oxidation of one molecule of malate, yields three molecules of CO₂, five molecules of NADH and one molecule of FADH₂, as well as one molecule of ATP (Fig. 2). NADH and FADH₂ subsequently donate their electrons to the electron-transport chain (Sect. 2.3.1).

2.3 Mitochondrial Metabolism

The malate formed in glycolysis in the cytosol is imported into the mitochondria and oxidized partly via **malic enzyme**, which produces pyruvate and CO₂, and partly via **malate dehydrogenase**, which produces oxaloacetate. Pyruvate is then oxidized so that malate is regenerated (Fig. 2). In addition, pyruvate can be produced in the cytosol and imported into the mitochondria. Oxidation of malate, pyruvate, and other NAD-linked substrates is associated with complex I (Sect. 2.3.1). In mitochondria there are four major complexes associated with **electron transfer** and one associated with **oxidative phosphorylation**, all located in the inner mitochondrial membrane. In addition, there are two small redox molecules, **ubiquinone (Q)** and **cytochrome c**, which play a role in electron transfer. In plant mitochondria there is also a cyanide-resistant, nonphosphorylating, **alternative oxidase**, located in the inner membrane (Fig. 3). Finally, there are additional NAD(P)H dehydrogenases in the inner mitochondrial membrane that allow electron transport without ATP formation as well as **uncoupling proteins** that converts energy that could have been used for ATP production into heat.

In the mitochondrial **matrix** the imported substrates are oxidized in a cyclical process (**Krebs** or **TCA cycle**), releasing three CO₂ molecules per pyruvate in each cycle and generating reducing power (NADH and FADH₂) in several reactions (Fig. 2). Pyruvate decarboxylase (PDC), which converts pyruvate into acetylCoA, which then reacts with oxaloacetate to produce citrate, is a major control point for entry of carbon into the TCA cycle.

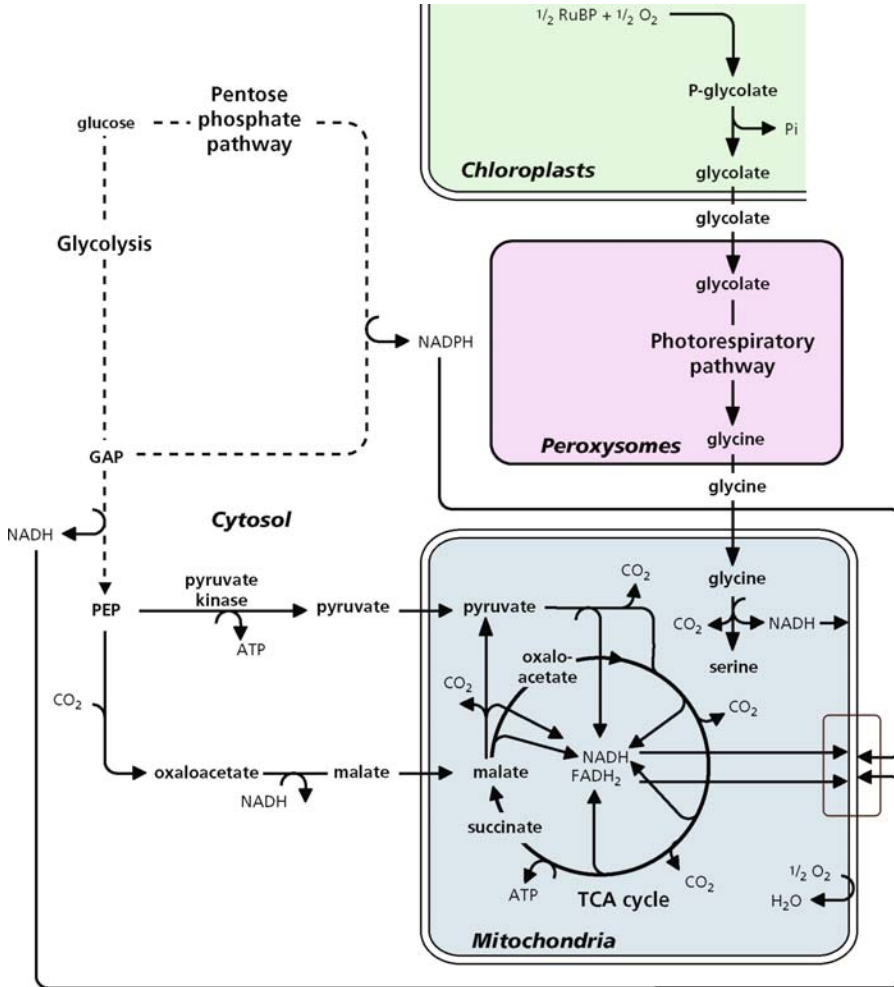

FIGURE 2. The major substrates for the electron transport pathways. Glycine is only a major substrate in

photosynthetically active cells of C_3 plants when photorespiration plays a role.

2.3.1 The Complexes of the Electron-Transport Chain

Complex I is the main entry point of electrons from $NADH$ produced in the TCA cycle or in **photorespiration** (glycine oxidation). Complex I is the **first coupling site** or **site 1** of proton extrusion from the matrix into the intermembrane space which is linked to ATP production. Succinate is the only intermediate of the TCA cycle that is oxidized by a membrane-bound enzyme: succinate dehydrogenase (Fig. 3). Electrons enter the respiratory chain via complex II and are transferred to ubiquinone. $NAD(P)H$ that is produced outside the mitochondria also feeds its electrons into the chain at the level of ubiquinone (Fig. 3). As with complex II, the external

dehydrogenases are not connected with the translocation of H^+ across the inner mitochondrial membrane. Hence less ATP is produced per O_2 when succinate or $NAD(P)H$ are oxidized in comparison with that of glycine, malate, or citrate, which enter at complex I. Complex III transfers electrons from ubiquinone to cytochrome *c*, coupled to the extrusion of protons to the intermembrane space and is therefore **site 2** of proton extrusion from the matrix into the intermembrane space. Complex IV is the terminal oxidase of the cytochrome pathway, accepting electrons from cytochrome *c* and donating these to O_2 . It also generates a proton-motive force (i.e., an electrochemical potential gradient across a membrane), which makes complex IV **site 3** of proton extrusion.

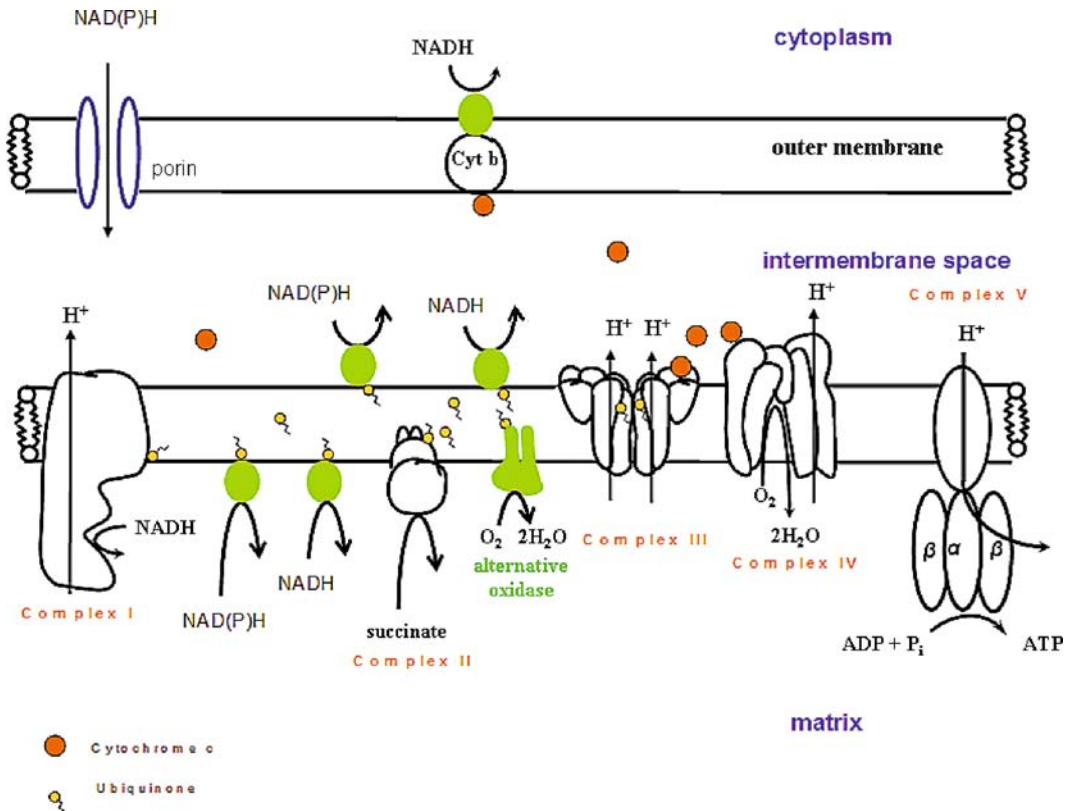

FIGURE 3. The organization of the electron-transporting complexes of the respiratory chain in higher plant mitochondria. All components are located in the inner mitochondrial membrane. Some of the components are membrane spanning, others face the mitochondrial matrix or the space between the inner and the outer mitochondrial membrane. Q (ubiquinone) is a mobile

pool of quinone and quinol molecules. Alternative NAD(P)H dehydrogenases and the alternative oxidase are shown in green (Rasmussen et al. 2004). Reprinted, with permission, from the *Annual Review of Plant Biology*, Volume 55 ©2004 by Annual Reviews www.annualreviews.org.

2.3.2 A Cyanide-Resistant Terminal Oxidase

Mitochondrial respiration of many tissues from higher plants is not fully inhibited by inhibitors of the cytochrome path (e.g., KCN). This is due to the presence of a cyanide-resistant, alternative electron-transport pathway, consisting of one enzyme, the **alternative oxidase**, firmly embedded in the inner mitochondrial membrane. The branching point of the alternative path from the cytochrome path is at the level of ubiquinone, a component common to both pathways. Transfer of electrons from ubiquinone to O₂ via the alternative path is not coupled to the extrusion of protons from the matrix to the intermembrane space. Hence, the transfer of electrons from NADH produced inside the mitochondria to O₂ via the alternative path bypasses two sites of proton extrusion, and therefore yields only one

third of the amount of ATP that is produced when the cytochrome path is used.

2.3.3 Substrates, Inhibitors, and Uncouplers

Figure 2 summarizes the major substrates for mitochondrial O₂ uptake as well as their origin. Oxidation of glycine is of quantitative importance only in tissues exhibiting **photorespiration**. Glycolysis may start with glucose, as depicted here, or with starch, sucrose, or any major transport carbohydrate or sugar alcohol imported via the phloem (Sect. 2 of Chapter 2C on long-distance transport).

A range of respiratory inhibitors have helped to elucidate the organization of the respiratory pathways. To give just one example, **cyanide** effectively blocks complex IV and has been used to demonstrate the presence of the alternative path.

Uncouplers make membranes, including the inner mitochondrial membrane, permeable to protons and hence prevent oxidative phosphorylation. Many compounds that inhibit components of the respiratory chain or have an uncoupling activity occur naturally as **secondary compounds** in plant and fungal tissues; they may protect these tissues from being grazed or infected by other organisms or be released from roots and act as allelochemicals (Sects 2 and 3.1 of Chapter 9B on ecological biochemistry). A more recent addition to the complexity of the plant mitochondrial electron-transport chain is the discovery of **uncoupling protein** (UCP) (Hourton-Cabassa et al. 2004). UCP is a homologue of thermogenin, a protein responsible for thermogenesis in mammalian brown fat cells. Both uncoupling protein and thermogenin allow protons to diffuse down their concentration gradient from the intermembrane space into the matrix, circumventing the ATP synthase complex and thus uncoupling electron transport from ATP production (Plaxton & Podestá 2006).

2.3.4 Respiratory Control

To learn more about the manner in which plant respiration responds to the demand for metabolic energy, we first describe some experiments with **isolated mitochondria**. Freshly isolated intact mitochondria in an appropriate buffer that lacks substrates, a condition referred to as “state 1”, do not consume an appreciable amount of O_2 ; in vivo they rely on a continuous import of respiratory substrate from the cytosol (Fig. 4). Upon addition of a respiratory substrate (“state 2”) there is some, but still not much O_2 uptake; for rapid rates of respiration to occur in vivo, import of additional metabolites is required. As soon as ADP is added, a rapid consumption of O_2 can be measured. This “state” of the mitochondria is called “state 3”. In vivo, rapid supply of ADP will occur when a large amount of ATP is required to drive biosynthetic and transport processes. Upon conversion of all ADP into ATP (“state 4”), the respiration rate of the mitochondria declines again to the rate found before addition of ADP (Fig. 4). Upon addition of

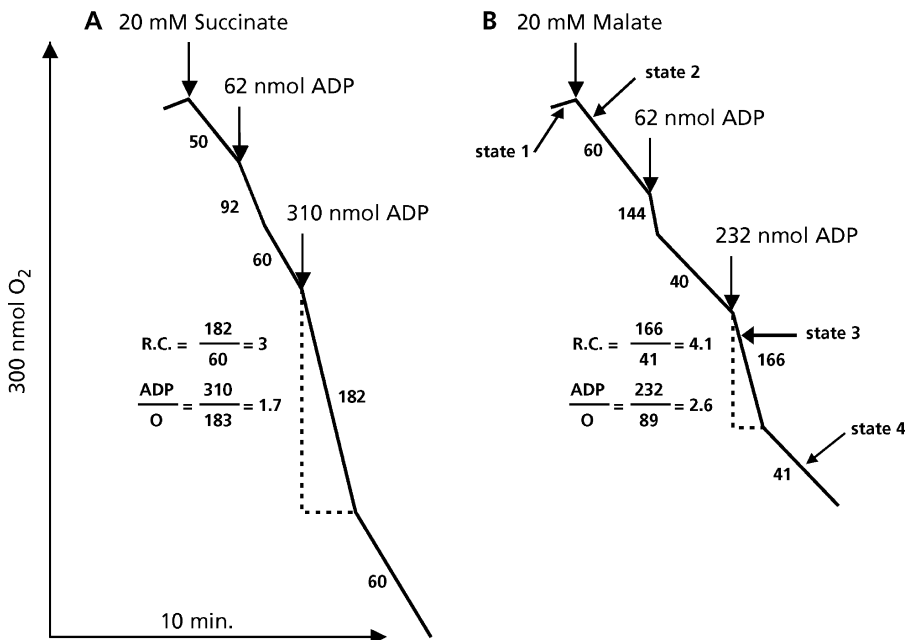

FIGURE 4. The “states” of isolated mitochondria. The ADP:O ratio (also called ATP:O ratio or P:O ratio) is calculated from the O_2 consumption during the phosphorylation of a known amount of added ADP (state 3). The amount of ADP consumed equals the amount that has been added to the cuvette (310 and 232 in A and B, respectively); since the total amount of O_2 in the cuvette is known (300 nmol), the amount consumed during the consumption of the added ADP can be derived (dashed

vertical lines, with values of 183 and 89 nanomoles of O atoms in A and B, respectively). The respiratory control ratio (RC) is the ratio of the rate of O_2 uptake (in nmol O_2 mg^{-1} protein min^{-1} ; values written along the slopes) in state 3 and state 4. State 1 refers to the respiration in the absence of respiratory substrate and ADP, and state 2 is the respiration after addition of respiratory substrate, but before addition of ADP (based on unpublished data from A.M. Wagner, Free University of Amsterdam).

more ADP, the mitochondria go into state 3 again, followed by state 4 upon depletion of ADP. This can be repeated until all O₂ in the cuvette is consumed. Thus the respiratory activity of isolated mitochondria is effectively controlled by the availability of ADP: **respiratory control**, quantified in the “respiratory control ratio” (the ratio of the rate at substrate saturation in the presence of ADP and that under the same conditions, but after ADP has been depleted; Fig. 4). The same respiratory control occurs in intact tissues and is one of the mechanisms ensuring that the rate of respiration is enhanced when the demand for ATP increases.

2.4 A Summary of the Major Points of Control of Plant Respiration

We briefly discussed the control of glycolysis by “energy demand” (Sect. 2.2) and a similar control by “energy demand” of mitochondrial electron transport, termed respiratory control (Sect. 2.3.4). The effects of **energy demand** on dark respiration are a function of the metabolic energy that is required for **growth, maintenance, and transport** processes; therefore, when tissues grow quickly, take up ions rapidly and/or have a fast turnover of proteins, they generally have a high rate of respiration. At low levels of **respiratory substrate supply** (carbohydrates, organic acids), however, the activity of respiratory pathways may be substrate-limited. When substrate levels increase, the respiratory capacity is enhanced and adjusted to the high substrate input, through the transcription of specific genes that encode respiratory enzymes. Figure 5 summarizes these and several other points of control. Plant respiration is clearly quite flexible and responds rapidly to the demand for respiratory energy as well as the supply of respiratory substrate. The production of ATP which is coupled to the oxidation of substrate, may also vary widely, due to the presence of both nonphosphorylating and phosphorylating paths [alternative oxidase and NAD(P) dehydrogenases other than complex I] as well as the activity of an uncoupling protein.

2.5 ATP Production in Isolated Mitochondria and In Vivo

The rate of O₂ consumption during the phosphorylation of ADP can be related to the total ADP that must be added to consume this O₂. This allows calculation of the **ADP:O ratio** in vitro. This ratio is around 2.5 for NAD-linked substrates (e.g.,

malate, citrate) and around 1.5 for succinate and external NAD(P)H. Nuclear Magnetic Resonance (NMR) spectroscopy has been used to estimate ATP production in intact tissues, as outlined in Sect. 2.5.2.

2.5.1 Oxidative Phosphorylation: The Chemiosmotic Model

During the transfer of electrons from various substrates to O₂ via the cytochrome path, protons are extruded into the space between the inner and outer mitochondrial membranes. This generates a **proton-motive force** across the inner mitochondrial membrane which drives the synthesis of ATP. The basic features of this **chemiosmotic model** are (Mitchell 1966, Nicholls & Ferguson 1992):

1. Protons are transported outwards, coupled to the transfer of electrons, thus giving rise to both a **proton gradient** (ΔpH) and a **membrane potential** ($\Delta\Psi$)
2. The inner membrane is **impermeable to protons** and other ions, except by special transport systems
3. There is an **ATP synthetase** (also called ATPase), which transforms the energy of the electrochemical gradient generated by the proton-extruding system into ATP

The pH gradient, ΔpH , and the membrane potential $\Delta\Psi$, are interconvertible. It is the combination of the two which forms the **proton-motive force** (Δp), the driving force for ATP synthesis, catalyzed by an ATPase:

$$\Delta p = \Delta\Psi - 2.3 RT/F\Delta\text{pH} \quad (1)$$

where R is the gas constant ($\text{J mol}^{-1} \text{K}^{-1}$), T is the absolute temperature (K) and F is Faraday’s number (Coulomb). Both components in the equation are expressed in mV. Approximately one ATP is produced per three protons transported.

2.5.2 ATP Production In Vivo

ATP production in vivo can be measured using **NMR spectroscopy**. This technique relies on the fact that certain nuclei, including ³¹P, possess a permanent magnetic moment, because of nuclear spin. Such nuclei can be made “visible” in a strong external magnetic field, in which they orient their nuclear spins in the same direction. It is just like the orientation of a small magnet in response to the presence of a strong one. NMR spectroscopy allows one to monitor the absorption of radiofrequency by the oriented spin population in the strong magnetic

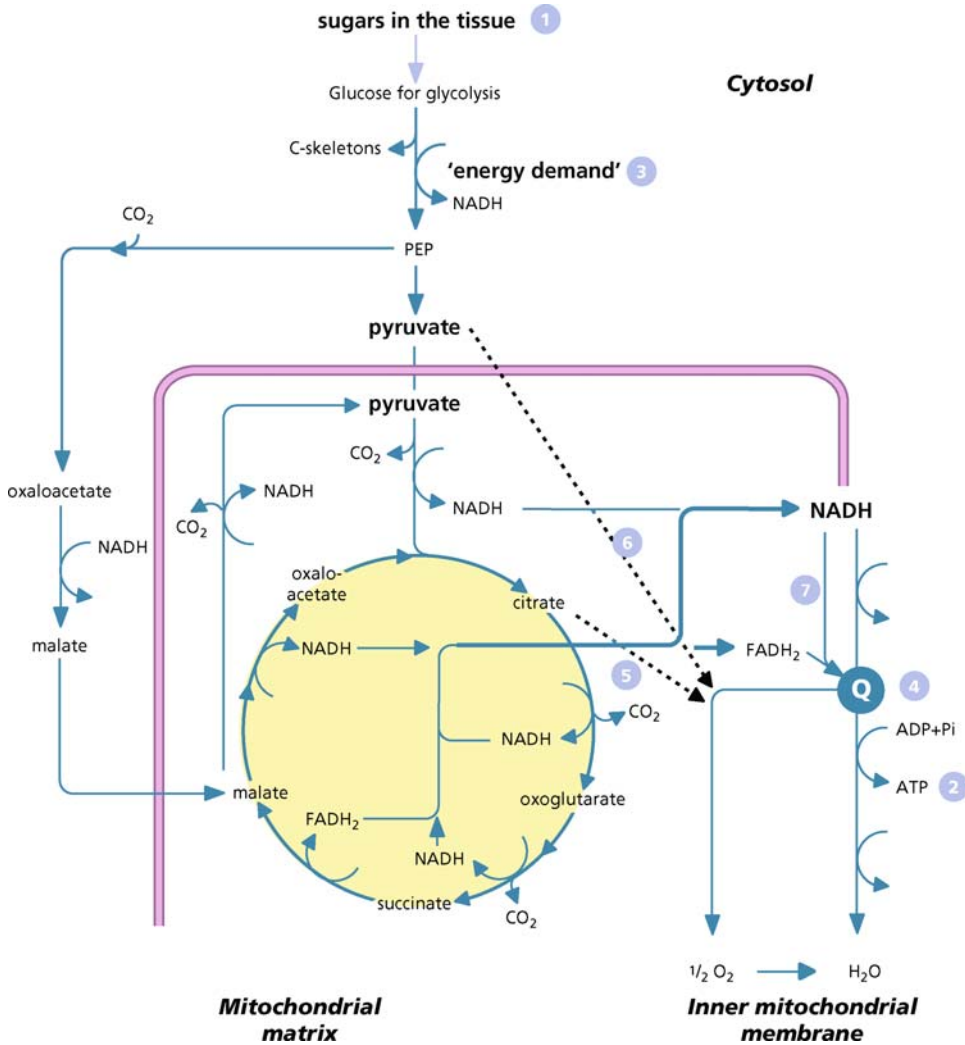

FIGURE 5. A simplified scheme of respiration and its major control points. Controlling factors include the concentration of respiratory substrate [e.g., glucose (1)] and adenylates (2, 3). Adenylates may exert control on electron transport via a constraint on the rate of oxidative phosphorylation (2) as well as on glycolysis, via modulation of the activity of key enzymes in glycolysis, phosphofructokinase and pyruvate kinase (“energy demand”, 3). When the input of electrons into the respiratory chain is very high, a large fraction of ubiquinone becomes reduced and the alternative path becomes more active (4). When the rate of glycolysis is

very high, relative to the activity of the cytochrome path, organic acids may accumulate (5, 6). The accumulation of citric acid may lead to the reduction of the sulfide bonds of the alternative oxidase and thus enhance the capacity of the alternative path (5). Accumulation of pyruvate or other α -keto acids may increase the V_{max} of the alternative oxidase and, hence, allow it to function at a low level of reduced ubiquinone (6). There is increasing evidence that the nonphosphorylating rotenone-insensitive bypass (7) operates in concert with the alternative path, when the concentration of NADH is very high.

field. The location of the peaks in a NMR spectrum depends on the molecule in which the nucleus is present and also on the “environment” of the molecule (e.g., pH). Figure 6 illustrates this point for a range of phosphate – containing molecules (Roberts 1984).

The resonance of specific P – containing compounds can be altered by irradiation with radiofrequency power. If this irradiation is sufficiently strong (“saturating”), then it disorients the nuclear spins of that P – containing compound, so that its peak disappears from the spectrum.

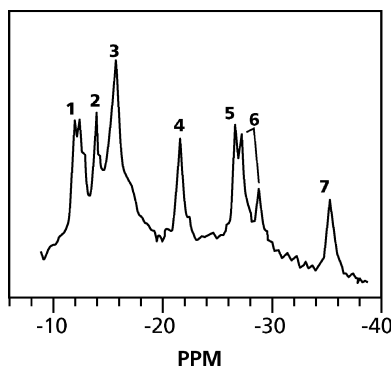

FIGURE 6. NMR spectrum of root tips of *Pisum sativum* (pea), showing peaks of, for example, glucose-6-phosphate (1), (P_i) (2, 3), and ATP (4, 5) in a living plant cell. The exact radiofrequency at which a phosphate-containing compound absorbs depends on the pH. This explains why there are two peaks for P_i : a small one for the cytosol (2), where the pH is approximately 7, and a larger one for the vacuole (3), where the pH is lower (Roberts 1984). Reprinted, with permission, from the *Annual Review of Plant Physiology*, Volume 35 ©1984 by Annual Reviews www.annualreviews.org.

Figure 7A illustrates this for the γ -ATP P-atom, the P atom that is absent in ADP. Upon hydrolysis of ATP, the γ -ATP P atom becomes part of the cytoplasmic inorganic phosphate (P_i) pool. For a brief period, therefore, some of the P_i molecules also contain disoriented nuclear spins; specific irradiation of the γ -ATP peak decreases the P_i peak. This phenomenon is called "saturation transfer" (Fig. 7). Saturation transfer has been used to estimate the rate of ATP hydrolysis to ADP and P_i in vivo.

If the rate of disappearance of the saturation in the absence of biochemical exchange of phosphate between γ -ATP and P_i is known, then the rate of ATP hydrolysis can be derived from the rate of loss of saturation. This has been done for root tips for which the O_2 uptake was measured in parallel experiments. In this manner ADP:O ratios in *Zea mays* (maize) root tips exposed to a range of conditions have been determined (Table 3).

The ADP:O ratios for the root tips supplied with 50 mM glucose are remarkably close to those expected when glycolysis plus TCA cycle are responsible for the complete oxidation of exogenous glucose, provided the alternative path does not contribute to the O_2 uptake (Table 3). KCN decreases the ADP:O ratio of glucose oxidation by two-thirds in a manner to be expected from mitochondrial studies. SHAM, an inhibitor of the alternative path, has no effect on the rate of ATP production. So far, maize root tips are the only

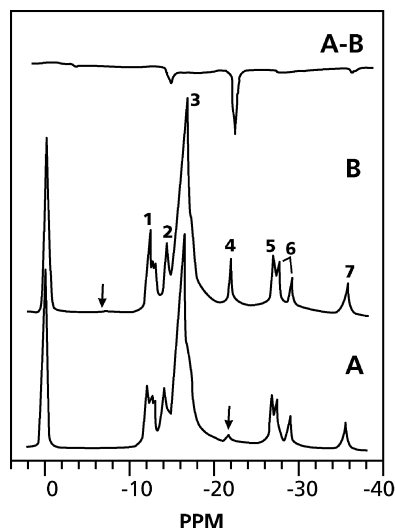

FIGURE 7. Saturation transfer from γ -ATP phosphate to cytosolic P_i in root tips of *Zea mays* (maize). Spectrum A was obtained with selective presaturation of the γ -ATP peak. Spectrum B was obtained with selective presaturation of a point equidistant from the cytosolic P_i peak. Spectrum A-B gives the difference between the two spectra, showing the transfer of saturation from γ -ATP to cytosolic P_i (after Roberts et al. 1984a). Copyright American Society of Plant Biologists.

intact plant material used for the determination of ADP:O ratios in vivo. We cannot assume, therefore, that the ADP:O ratio in vivo is invariably 3. In fact, the ratio under most circumstances is probably far less than 3 (Sect. 2.6.2).

2.6 Regulation of Electron Transport via the Cytochrome and the Alternative Paths

The existence of two respiratory pathways, both transporting electrons to O_2 , in higher plant mitochondria, raises the question if and how the **partitioning of electrons** between the two paths is regulated. This is important because the cytochrome path is coupled to proton extrusion and the production of ATP, whereas transport of electrons via the alternative path is not, at least not beyond the point where both pathways branch to O_2 (Millenaar & Lambers 2003).

2.6.1 Competition or Overflow?

Under specific conditions, the activity of the cytochrome path *in vitro* increases linearly with the

TABLE 3. The in vivo ADP:O ratios in root tips of *Zea mays* (corn) determined with the saturation transfer ^{31}P NMR technique and O_2 uptake measurements.

Exogenous substrate	O_2 concentration	Inhibitor	Rate of O_2 uptake	Rate of ATP production	ADP:O ratio
Glucose	100	None	22	143	3.2
Glucose	0	None	0	<20	–
None	100	None	15	93	3.0
Glucose	100	KCN	14	26	1.0
Glucose	100	KCN+SHAM	4	<20	–
Glucose	100	SHAM	21	137	3.2

Source: Roberts et al. (1984a).

* The O_2 concentration was either that in air (100) or zero. Rates of ATP production and O_2 consumption are expressed as $\text{nmol g}^{-1} \text{FM s}^{-1}$. Exogenous glucose was supplied at 50 mM. The concentration of KCN was 0.5 mM and that of SHAM was 2 mM; this is sufficiently high to fully block the alternative path in maize root tips.

fraction of ubiquinone (Q, the common substrate with the alternative path) that is in its reduced state (Q_r/Q_t). By contrast, the alternative path shows no appreciable activity until a substantial (30–40%) fraction of the Q is in its reduced state, and then the activity increases exponentially (Fig. 8). This would suggest that the alternative path functions as an “energy overflow”; however,

recent experimental results suggest that this is an over-simplification, as outlined below.

2.6.2 The Intricate Regulation of the Alternative Oxidase

Depending on metabolic state, the activity of the alternative pathway changes, so that it competes with the cytochrome pathway for electrons. When embedded in the inner mitochondrial membrane, the alternative oxidase exists as a **dimer**, with the two subunits linked by **disulfide bridges**. These sulfide bridges may be oxidized or reduced. If they are reduced, then the alternative oxidase is in its **higher-activity state**, as opposed to the **lower-activity state** when the disulfide bridges are oxidized. Roots of soybean seedlings (*Glycine max*) initially have a very high respiration rate, and almost all of this respiration occurs *via* the cytochrome path (Fig. 9A). At this stage, the activity of the alternative path is very low and the enzyme is in its oxidized (lower-activity) state. Within a few days, the growth rate and the cytochrome oxidase activity decline about fourfold, and the contribution of the alternative path to root respiration increases to more than 50%. At that stage, all the dimers are in their reduced (higher-activity) state, suggesting that the transition from partly oxidized to fully reduced is responsible for the increased alternative oxidase activity (Millar et al. 1998). A similar change from oxidized to reduced occurs in leaves of *Alocasia odora* (Japanese taro) upon exposure to high-light stress, as discussed in Section 4.4. In intact roots of *Poa annua* (annual meadow-grass) and several other grasses, however, the alternative oxidase is invariably in its reduced, higher-activity configuration (Millenaar et al. 1998, 2000). There is, therefore, no clear evidence that changes in redox state of the alternative

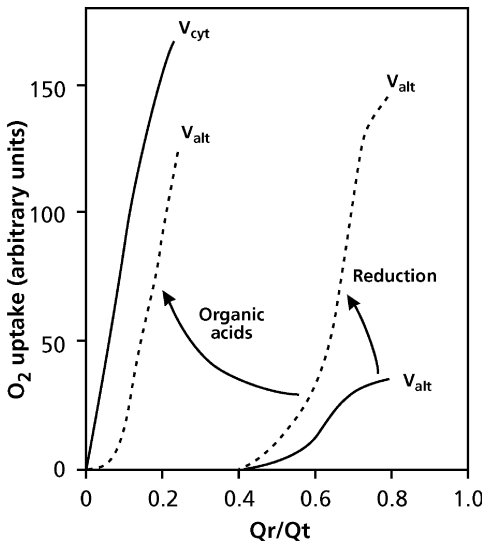

FIGURE 8. Dependence of the activity of the cytochrome path and of the alternative path on the fraction of ubiquinone that is in its reduced state (Q_r/Q_t). When the alternative oxidase is in its “reduced” (higher-activity) configuration, it has a greater capacity to accept electrons. In its reduced state, the alternative oxidase can be affected by α -keto acids, which enhance its activity at low levels of Q_r . [Based on Dry et al. (1989), Umbach et al. (1994), Day et al. (1995), and Hoefnagel et al. (1997)].

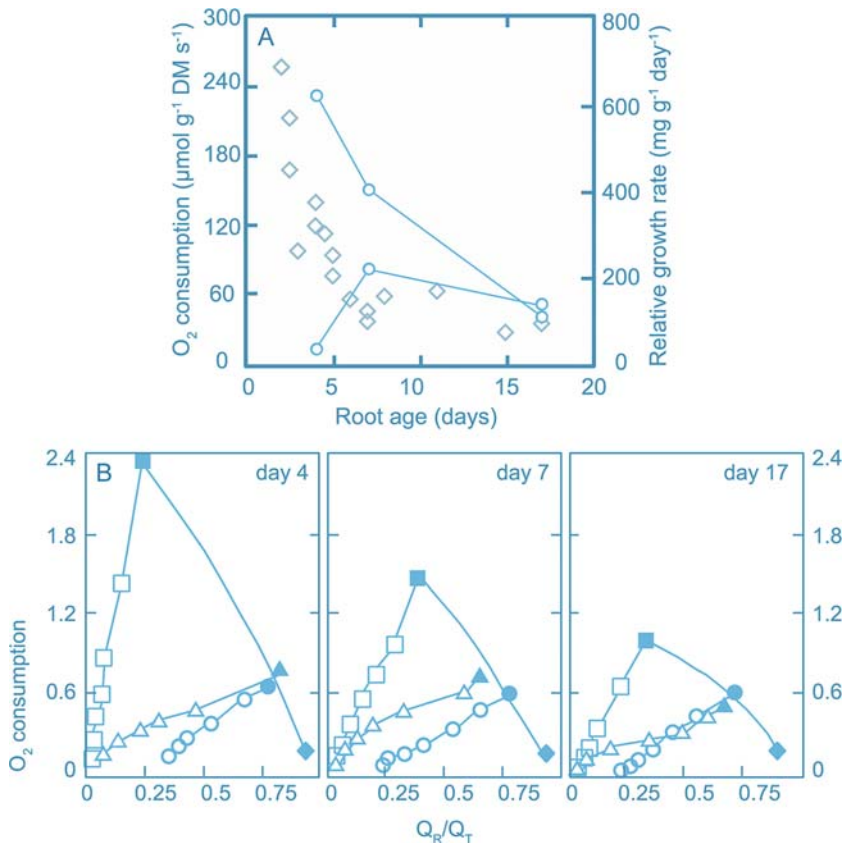

FIGURE 9. Root respiration, growth and the activity of isolated mitochondria for young *Glycine max* (soybean) seedlings. (Top) O₂ consumption via the cytochrome path (circles) and the alternative path (squares), and the relative growth rate (diamonds). (Bottom) Succinate-dependent O₂ consumption and Q_R-pool reduction

state by isolated mitochondria (17-days old seedlings). Succinate was the respiratory substrate (10 mM); myxothiazol was used to inhibit the cytochrome path (2 μM); 1 mM pyruvate was added to activate the alternative oxidase. Modified after Millar et al. (1998). Copyright American Society of Plant Biologists.

oxidase play an important regulatory role in vivo during plant development (Hoefnagel & Wiskich 1998).

The alternative oxidase's capacity to oxidize its substrate (Q_r) also increases in the presence of **pyruvate** and other **α-keto acids** (Millar et al. 1996, Hoefnagel et al. 1997). As a result, in the presence of the potent activator pyruvate the alternative path shows significant activity even when less than 30% of ubiquinone is in its reduced state, when the cytochrome pathway is not fully saturated (Fig. 7). In intact tissues pyruvate levels appear to be sufficiently high to fully activate the alternative oxidase. That is, changes in the level of keto acids probably do not play a regulatory role in vivo (Hoefnagel & Wiskich 1998, Millenaar et al. 1998).

Whenever the alternative oxidase is in its higher activity state and active at low levels of Q_r, there will

be competition for electrons between the two pathways, both in vitro (Hoefnagel et al. 1995, Ribas-Carbó et al. 1995) and in vivo (Atkin et al. 1995). **Competition** for electrons between the two pathways is the rule, rather than an exceptional situation, as was initially thought.

Does competition for electrons between the two pathways really occur at the levels of Q_r that are commonly found in vivo (about 55% reduced; Millar et al. 1998)? In vitro studies with mitochondria isolated from tissues of which we know that the alternative path contributes to respiration can provide the answer (Fig. 8B). In the presence of succinate, but no ADP (state 4; Fig. 4), most of Q is reduced. Upon addition of ADP (state 3; Fig. 4), Q becomes more oxidized, until ADP is depleted. Activation of the alternative oxidase by pyruvate oxidizes Q to a level similar to that found in vivo.

Blocking the cytochrome path leads to Q being more reduced again. Since the alternative oxidase contributes substantially to root respiration at a Q_r level of 55%, the activation mechanisms must operate. Because Q_r levels in vivo are similar to those in state 4, Fig. 8B also suggests that mitochondrial electron transport in roots is probably restricted by ADP (Fig. 5).

2.6.3 Mitochondrial NAD(P)H Dehydrogenases That Are Not Linked to Proton Extrusion

In addition to the alternative oxidase (Sect. 2.3.2) and the uncoupling proteins (Sect. 2.3.3), there are **NAD(P)H dehydrogenases** that allow electron transport without proton extrusion (Møller 2001, Rasmusson et al. 2004; Fig. 3). Addition of NO_3^- to N-limited seedlings of *Arabidopsis thaliana* (thale cress) decreases the transcript abundance of NAD(P)H dehydrogenase and **alternative oxidase** genes, while addition of NH_4^+ decreases the expression of the same gene families. Switching between NO_3^- and NH_4^+ in the absence of N stress leads to very similar results. Corresponding changes in alternative respiratory pathway capacities are exhibited in seedlings supplied with either NO_3^- or NH_4^+ as an N source and in mitochondria purified from the seedlings (Escobar et al. 2006). The parallel changes in both respiratory bypass pathways suggests that the NAD(P) dehydrogenases play a similar role as the alternative oxidase (Sect. 3).

3. The Ecophysiological Function of the Alternative Path

Why should plants produce and maintain a pathway that supports nonphosphorylating electron transport in mitochondria? Do they really differ fundamentally from animals in this respect, or do animals have functional alternatives? Perhaps it is merely a relict or an "error" in the biochemical machinery that has not yet been eliminated by natural selection. On the other hand, there may be situations where respiration in the absence of ATP production could serve important physiological functions. This Section discusses the merits of hypotheses put forward to explain the presence of the alternative path in higher plants. Testing of these hypotheses will require the use of transgenics lacking alternative path activity, some of which are now available.

3.1 Heat Production

An important consequence of the lack of coupling to ATP production in the alternative pathway is that the energy produced by oxidation is released as **heat**. More than 200 years have passed since Lamarck described heat production in *Arum italicum* (Italian arum) and more than 70 years since **thermogenesis** was linked to **cyanide-resistant respiration** (Laties 1998). Thermogenesis has been reported for species in the Annonaceae, Araceae, Araceae, Aristolochiaceae, Cycadaceae, Nymphaeaceae, Winteraceae, Illiciaceae, Magnoliaceae, Rafflesiaceae, and Nelumbonaceae (Seymour, 2001). This **heat production** is ecologically important in, e.g., *Aympllocarpus renifolium* (Asian skunk cabbage), which blooms in early spring when effective pollinators are inactive (Sect. 3.3.5 of Chapter 8 on life cycles). During the female flowering phase, the spadices produce heat 24 hours per day, until the beginning of the male phase. The spadices are visited by small numbers of invertebrate **pollinators** throughout the flowering season, attracted by the stench of **amines** that are volatilized by the elevated spadix temperature (Uemura et al. 1993). During heat production the respiration of the spadix is largely cyanide-resistant. If the alternative pathway is indeed responsible for a major fraction of the spadix respiration, then this would contribute to the heat production, as the lack of proton extrusion coupled to electron flow allows a large fraction of the energy in the substrate to be released as heat. This regulated thermogenic activity in inflorescences is functionally analogous, but differs in biochemical mechanism, to the uncoupled respiration that occurs in thermogenic tissues (brown fat) of some **mammals** under cold conditions.

Heat production also occurs in the flowers of several South American *Annona* species, *Victoria amazonica* (Amazon water lily) and *Nelumbo nucifera* (sacred lotus), clearly linked to activity of the alternative path (Fig. 10). These flowers regulate their temperature with remarkable precision (Seymour et al. 1998). When the air temperature varies between 10 and 30°C, the flowers remain between 30 and 35°C. The stable temperature is a consequence of increasing respiration rates in proportion to decreasing temperatures. Such a phenomenon of thermoregulation in plants is known for only a few species, e.g., *Philodendron selloum* (heart-leaf philodendron), *Symplocarpus foetidus* (skunk cabbage) (Knutson 1974, Seymour 2001). It has been suggested that the heat production in lotus is an energetic reward for **pollinating beetles**. These are trapped overnight, when they

FIGURE 10. (Top) Temperature of the receptacle (T_r) and ambient air (T_a) and (Middle) rates of O_2 consumption throughout the thermogenic phase in *Nelumbo nucifera* (sacred lotus). O_2 consumption is converted to heat production assuming 21.1 J ml^{-1} of O_2 . Shaded areas indicate the night period (Seymour & Schultze-Motel 1996). Reprinted with permission from Nature copyright 1996 MacMillan Magazines Ltd. (Bottom) Total respiratory flux and fluxes through the alternative and cytochrome pathways, in lotus receptacle tissues as a function of the difference between receptacle temperature and temperature of an adjacent nonheating receptacle. Partitioning of electron transport between the two respiratory pathways was determined on the basis of ^{18}O -isotope fractionation of intact tissues, as described in Box 2B.1 (modified after Watling et al. 2006). Copyright American Society of Plant Biologists.

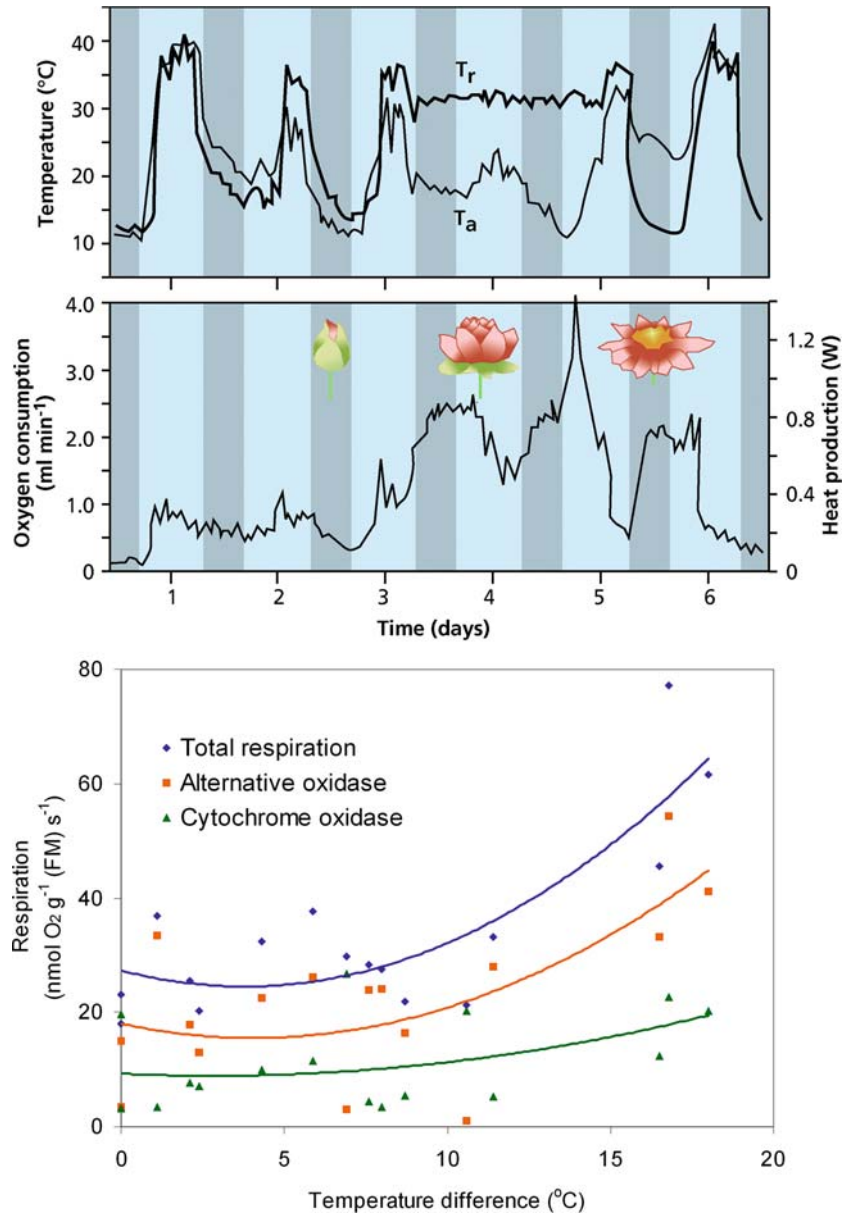

feed and copulate, and then carry the pollen away (Seymour & Schultze-Motel 1996).

Can the alternative oxidase also play a significant role in increasing the temperature of leaves, for example during exposure to low temperature? There is indeed some evidence for increased heat production (7–22% increase) in low-temperature resistant plants (Moynihan et al. 1995). It can readily be calculated, however, using an approach outlined in Chapter 4A on the plant’s energy balance, that such an increase in heat production *cannot* lead to a significant temperature rise in leaves (less than 0.1°C), and hence is

unlikely to play a role in any cold-resistance mechanism. To explain the contribution of the alternative path in respiration of nonthermogenic organs other ecophysiological roles must be invoked.

3.2 Can We Really Measure the Activity of the Alternative Path?

Does the alternative path also play a role in the respiration of “ordinary” tissues, such as roots and leaves? The application of specific inhibitors of the

TABLE 4. A comparison of the KCN resistance of respiration of intact tissues of a number of species and of O₂ uptake by mitochondria isolated from these tissues.*

Species	Tissue	Cyanide-resistance (%)	
		Whole tissue	Mitochondria
<i>Gossypium hirsutum</i>	Roots	36	22
<i>Phaseolus vulgaris</i>	Roots	61	41
<i>Spinacia oleracea</i>	Roots	40	34
<i>Triticum aestivum</i>	Roots	38	35
<i>Zea mays</i>	Roots	47	32
<i>Pisum sativum</i>	Leaves	39	30
<i>Spinacia oleracea</i>	Leaves	40	27

Source: Lambers et al. (1983).

* The percentage KCN resistance of intact tissue respiration was calculated from the rate measured in the presence of 0.2 mM KCN and that measured in the presence of 0.1 μM FCCP, an uncoupler of the oxidative phosphorylation; this was done to obtain a rate of electron transfer through the cytochrome path closer to the state 3 rate (Fig. 4). KCN-resistance of isolated mitochondria was calculated from the rate in the presence and absence of 0.2 mM KCN. Mitochondrial substrates were 10 mM malate plus 10 mM succinate and a saturating amount of ADP. KCN-resistant O₂ uptake by isolated mitochondria was fully inhibited by inhibitors of the alternative path; in the presence of both KCN and SHAM approximately 10% of the control respiration proceeded in some of the tissues ("residual respiration").

alternative path suggests that the alternative path does contribute to the respiration of roots and leaves of at least some species (Tables 4 and 5). The decline in respiration, however, upon addition of an inhibitor of the alternative path tends to underestimate the actual activity of the alternative path. If the two pathways compete for electrons, then the inhibition is less than the activity of the alternative path (Table 5). Thus, any observed inhibition of respiration following the addition of an alternative pathway inhibitor indicates that some alternative pathway activity was present prior to inhibition, but provides no quantitative estimate of its activity (Day et al. 1996).

Stable isotopes can be used to estimate alternative path activity without the complications caused by use of inhibitors, because the alternative oxidase and cytochrome oxidase discriminate to a different extent against the heavy isotope of O₂ (Box 2B.1). The discrimination technique shows that the alternative pathway may account for over 40% of all respiration. The role of the alternative path in roots and leaves cannot be that of heat production. What might be its role in these tissues?

TABLE 5. KCN-resistance, expressing the total respiratory electron flow through the alternative path under the conditions of measurement, and SHAM-inhibition of root respiration.*

Species	KCN resistance	SHAM inhibition
<i>Carex diandra</i>	66	29
<i>Festuca ovina</i>	53	1
<i>Hordeum distichum</i>	34	0
<i>Pisum sativum</i>	40	11
<i>Phaseolus vulgaris</i>	57	4
<i>Plantago lanceolata</i>	53	45
<i>Poa alpina</i>	41	1
<i>Poa costiniana</i>	61	0

Source: Atkin et al. (1995).

* Values are expressed in percentage of the control rate of respiration. KCN and SHAM (salicylhydroxamic acid) are specific inhibitors of the cytochrome path and the alternative path, respectively. Only if the cytochrome path is saturated, SHAM inhibition would equal the activity of the alternative path. Since the cytochrome path is rarely saturated, SHAM-inhibition is usually less than the activity of the alternative path; in fact its activity may be as high as the KCN-resistant component of root respiration. Because the two pathways generally compete for electrons, inhibitors cannot provide information on the actual activity of the two pathways in root respiration.

3.3 The Alternative Path as an Energy Overflow

The activity of the alternative path might increase when the production of organic acids is not matched by their oxidation, so that they accumulate. This observation led to the "energy overflow hypothesis" (Lambers 1982). It states that respiration via the alternative path only proceeds in the presence of high concentrations of respiratory substrate. It considers the alternative path as a **coarse control** of carbohydrate metabolism, but not as an alternative to the finer control by adenylates (Sects. 2.1 and 2.2).

The continuous employment of the alternative oxidase under normal "nonstress" conditions may ensure a rate of carbon delivery to the root that enables the plant to cope with "stress". According to the energy overflow hypothesis, if the carbon demand of a tissue suddenly increases, there is sufficient carbon transport to the tissue to meet these demands, if respiration were to switch entirely to supporting ATP synthesis. For example, a decrease in soil water potential increases the roots' carbon demand for synthesis of compatible solutes for osmotic adjustment. Similarly, attack by parasites

Box 2B.1

Measuring Oxygen-Isotope Fractionation in Respiration

Plants have a cyanide-insensitive respiratory pathway in addition to the cytochrome pathway (Sect. 2.3). Unlike the cytochrome pathway, the transport of electrons from ubiquinol to O_2 through the alternative path is not linked to proton extrusion, and therefore not coupled to energy conservation. The alternative oxidase and cytochrome oxidase discriminate to a different extent against the heavy isotope of oxygen (^{18}O) when reducing O_2 to produce water (Guy et al. 1989). This allows calculation of the partitioning of electron flow between the two pathways in the absence of added inhibitors, also in intact tissues. For many years, studies of electron partitioning between the two respiratory pathways were performed using specific inhibitors of the two pathways [e.g., cyanide for the cytochrome path, and SHAM (salicylhydroxamic acid) for the alternative path]. It was thought that electrons were only available to the alternative pathway when the cytochrome pathway was either saturated or inhibited; however, we now know that both pathways compete for electrons (Sect. 2.6.1). The only reliable technique to study electron partitioning between the cytochrome and alternative pathway is by using oxygen-isotope fractionation (Day et al. 1996). Although the methodology employed has changed dramatically in the last decade, the theoretical basis of the oxygen-isotope fractionation technique remains that described by Guy et al. (1989).

The origin of the oxygen-fractionation methodology can be found in Bigeleisen & Wolfsberg (1959) and Mariotti et al. (1981). Oxygen-isotope fractionation is measured by examining the isotope fractionation of the substrate O_2 as it is consumed in a closed, leak-tight cuvette. The energy needed to break the oxygen-oxygen bond of a molecule containing ^{18}O is greater than that to break the molecule $^{16}O = O^{16}$. Therefore, both terminal oxidases of the plant mitochondrial electron-transport chain react preferentially with $^{32}O_2$, but they produce different isotope effects (Hoefs 1987). This allows determining the relative flux through each terminal oxidase. If α is the ratio of the rate of the reaction with ^{18}O to that with ^{16}O , then:

$$R_p = R\alpha \quad (1)$$

where R_p is the $^{18}O/^{16}O$ ratio of the product (H_2O), and R is that of the substrate (O_2). Since α generally differs from unity by only a few percent, fractionation is usually given by D , where

$$D = (1 - \alpha) \times 1000 \quad (2)$$

and the units of D are parts per mil (%). D is generally obtained directly from Equation (1) by measurements of the isotope ratio of the substrate and product, but since the product of both mitochondrial oxidases is H_2O , which is either the solvent for these reactions (liquid phase) or very difficult to obtain (gas phase), this is not feasible in this case. Instead, changes in the isotope ratio of the O_2 in the substrate pool are measured (Fig. 1). If there is any isotopic fractionation during respiration, the oxygen-isotope ratio (R) of the remaining O_2 increases as the reaction proceeds. The respiratory isotope fractionation can be obtained by measuring R , and the fraction of molecular O_2 remaining at different times during the course of the reaction.

Therefore, if we define the following terms:

$$R_o = \text{initial } ^{18}O/^{16}O$$

$$R = ^{18}O/^{16}O \text{ at time } t$$

$$f = \text{fraction of remaining oxygen at time } t$$

$$t : f = [O_2]/[O_2]_0$$

then the change in R through time is:

$$\delta R/\delta t = \frac{[^{16}O(\delta^{18}O/\delta t - ^{18}O(\delta^{16}O/\delta t)]}{(^{16}O)^2} \quad (3)$$

Since

$$\delta^{18}O/\delta t = R\alpha(\delta^{16}O/\delta t) \quad (4)$$

we obtain:

$$\delta R/R = \delta^{16}O/^{16}O(1 - \alpha) \quad (5)$$

which, upon integration, yields

$$\ln R/R_o = \ln ^{16}O/^{16}O_o(1 - \alpha) \quad (6)$$

Since only 0.4% of the O_2 contains ^{18}O , the ratio $^{16}O/^{16}O_o$ is a good approximation of $[O_2]/[O_2]_0$ (f), and hence we may write

continued

Box 2B.1 Continued

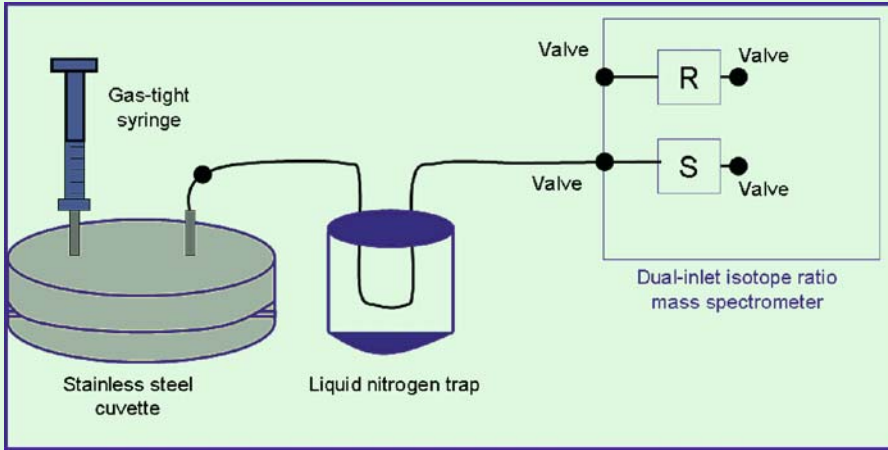

FIGURE 1. Diagram of an on-line oxygen-isotope fractionation system, with a gas-tight syringe, a stainless steel cuvette, a liquid nitrogen trap to remove CO_2

and H_2O , a reference bellow, and a sample bellow (Ribas-Carbó et al. 2005b).

$$D = \ln(R/R_0) / -\ln f \quad (7)$$

and D can be determined by the slope of the linear regression of a plot of $\ln R/R_0$ vs. $-\ln f$, without forcing this line through the origin (Henry et al. 1999). The standard error (SE) of the slope is determined as

$$\text{SE} = \frac{D(1 - r^2)^{1/2}}{r(n - 2)^{1/2}} \quad (8)$$

and indicates the precision of the measurement of isotopic fractionation (D). This error should be less than 0.4%, because the fractionation differential between the cytochrome pathway (18–20%) and the alternative pathway (24–31%) is between 6% and 12%, for roots and green tissues, respectively (Robinson et al. 1995). In most cases, accurate determinations of D can be achieved with experiments comprising six measurements, providing the r^2 of the linear regression is 0.995 or higher (Ribas-Carbó et al. 1995, Henry et al. 1999). Because it is common practice in the plant literature to express isotope

fractionation in “ Δ ” notation, the fractionation factors, D , are converted to Δ :

$$\Delta = \frac{D}{1 - (D/1000)} \quad (9)$$

The partitioning between the cytochrome and the alternative respiratory pathways (τ_a) is (Ribas-Carbó et al. (1997):

$$\tau_a = \frac{\Delta n - \Delta c}{\Delta a - \Delta c}$$

where Δn is the oxygen-isotope fractionation measured in the absence of inhibitors, and Δc and Δa are the fractionation by the cytochrome and alternative pathway, respectively. These “end points” for purely cytochrome or alternative pathway respiration are established for each experimental system using inhibitors of the alternative oxidase and cytochrome oxidase, respectively. The cytochrome oxidase consistently gives a Δc between 18% and 20%, while Δa is more variable, with values ranging from 24 to 25% in roots and nongreen tissues, and 30–32% in cotyledons and green leaves (Ribas-Carbó et al. 2005b).

and pathogens may suddenly increase carbon demands for tissue repair and the mobilization of plant defenses. The alternative oxidase activity may also prevent the production of superoxide and/or

hydrogen peroxide under conditions where electron transport through the cytochrome path is impaired (e.g., due to low temperature or desiccation injury). This is partly due to a reaction of ubisemiquinone

with molecular O₂ (Purvis & Shewfelt 1993, Møller 2001). **Superoxide**, like other **reactive oxygen species (ROS)**, can cause severe metabolic disturbances. So far, the various interpretations of the physiological function of an “energy overflow” remain speculative.

3.4 NADH Oxidation in the Presence of a High Energy Charge

If cells require a large amount of carbon skeletons (e.g., oxoglutarate or succinate) but do not have a high demand for ATP, then the operation of the alternative path could prove useful in oxidizing the NADH that would otherwise accumulate; considering the pool size of NADH, this would then stop respiration within minutes. However, can we envisage such a situation in vivo? Whenever the rate of carbon skeleton production is high, there tends to be a great need for ATP to further metabolize and incorporate these skeletons. When plants are infected by pathogenic microorganisms, however, they tend to produce **phytoalexins** (Sect. 3 of Chapter 9C on effects of microbial pathogens). This generates substantial amounts of NAD(P)H without major ATP requirements, and hence might require engagement of the alternative path (Sect. 4.8).

There are also other circumstances where the production of carbon skeletons does not entail a need for ATP. **Cluster roots** of *Hakea prostrata* (harsh hakea) accumulate large amounts of carboxylates (e.g., citrate), which they subsequently release to mobilize sparingly available P in the rhizosphere (Sect. 2.2.5 of Chapter 6 on mineral nutrition). During the phase of rapid carboxylate synthesis, the alternative path is up-regulated, presumably allowing re-oxidation of NADH that is produced during citrate synthesis (Shane et al. 2004).

There may also be a need for a nonphosphorylating path to allow rapid oxidation of malate in plants exhibiting crassulacean acid metabolism (**CAM plants**) during the day (Sect. 10.2 of Chapter 2A on photosynthesis). Unfortunately, there are no techniques available to assess alternative path activity in the light. If measurements are made in the dark, however, during the normal light period, then malate decarboxylation in CAM plants is indeed associated with increased engagement of the alternative path (Table 6). Malate decarboxylation, however, naturally occurs in the light (Sect. 10.2 of Chapter 2A on photosynthesis). It therefore remains to be confirmed that the alternative path plays a vital role in CAM.

TABLE 6. Respiration, oxygen-isotope discrimination and partitioning of electrons to the cytochrome and the alternative pathway in leaves of *Kalanchoe daigremontiana*.

Parameter	Acidification	De-acidification
Respiration $\mu\text{mol O}_2 \text{ m}^{-2} \text{ s}^{-1}$	1.8	2.6
Discrimination o/oo	22.4	25.0
Cytochrome path $\mu\text{mol O}_2 \text{ m}^{-2} \text{ s}^{-1}$	1.3	1.4
Alternative path $\mu\text{mol O}_2 \text{ m}^{-2} \text{ s}^{-1}$	0.5	1.2

Source: Robinson et al. 1992.

Note: Measurements were made in the dark, during the normal dark period (acidification phase) and the normal light period (de-acidification phase, when rapid decarboxylation occurs).

3.5 NADH Oxidation to Oxidize Excess Redox Equivalents from the Chloroplast

In illuminated leaves, mitochondria are thought to play a role in optimizing photosynthesis. Inhibition of either the cytochrome or the alternative path, using specific inhibitors (Sect. 2.3.3), reduces photosynthetic O₂ evolution and the redox state of the photosynthetic electron transport chain in *Vicia faba* (broad bean) leaves under various light intensities. Under saturating photosynthetic photon flux density, inhibition of either pathway causes a decrease in the steady-state levels of the photosynthetic O₂ evolution rate and the PSII quantum yield. Obviously, both two respiratory pathways are essential for maintenance of high photosynthetic rates at saturating light. At low light intensity, however, only inhibition of the alternative path lowers the photosynthetic rate. This suggests that inhibition of the alternative path causes over-reduction of the photosynthetic electron transport chain, even at low light levels.

It has been suggested that an important function of the alternative oxidase is to prevent chloroplast over-reduction through efficient dissipation of excess reducing equivalents (Noguchi et al. 2005). This hypothesis was tested using *Arabidopsis thaliana* (thale cress) mutants defective in cyclic electron flow around PSI, in which the reducing equivalents accumulate in the chloroplast stroma due to an unbalanced ATP/NADPH production ratio. These mutants show enhanced activities of the enzymes needed to export the reducing equivalents from the

chloroplasts. Interestingly, the amounts of alternative oxidase protein and cyanide-resistant respiration in the mutants are also higher than those in the wild type. After high-light treatment, the alternative oxidase, even in the wild type, is up-regulated concomitant with the accumulation of reducing equivalents in the chloroplasts and an increase in the activities of enzymes needed to export reducing equivalents. These results indicate that the alternative oxidase can dissipate excess reducing equivalents that are exported from the chloroplasts, and that it plays a role in photosynthesis (Yoshida et al. 2007).

3.6 Continuation of Respiration When the Activity of the Cytochrome Path Is Restricted

Naturally occurring **inhibitors** of the cytochrome path (e.g., cyanide, sulfide, carbon dioxide, and nitric oxide) may reach such high concentrations in the tissue that respiration via the cytochrome path is partially or fully inhibited (Palet et al. 1991, Millar & Day 1997). Similarly, mutants that lack **complex I** (Karpova et al. 2002) and hence must use the non-phosphorylating bypass, produce less ATP than the wild type, if respiring at the same rate. Under these circumstances the alternative pathway may be important in providing energy, even though it yields only a third as much ATP as the cytochrome path. This has indeed been shown to be the case for a *Nicotiana sylvestris* (flowering tobacco) mutant that lacks complex I, using the oxygen-isotope fractionation technique (Box 2B.1; Vidal et al. 2007).

Dry seeds, including those of *Cucumis sativus* (cucumber), *Hordeum vulgare* (barley), *Oryza sativa* (rice), and *Xanthium pennsylvanicum* (cocklebur) contain **cyanogenic** compounds, such as cyanohydrin, cyanogenic glycosides, and cyanogenic lipids. Such compounds liberate free HCN after hydrolysis during imbibition. Upon imbibition and triggered by ethylene, seeds containing these cyanogenic compounds produce a mitochondrial β -cyano-alanine synthase that detoxifies HCN (Hagesawa et al. 1995). Despite this detoxifying mechanism, some HCN is likely to be present in the mitochondria of germinating seeds, and hence there is a need for a cyanide-resistant path.

Some plants produce **sulfide** (e.g., species belonging to the Cucurbitaceae) (Rennenberg & Filner 1983). Sulfide is also produced by anaerobic sulfate-reducing microorganisms. It may occur in high concentrations in the phyllosphere of aquatic plants or the rhizosphere of flooded plants. In such flooded soils, **carbon dioxide** levels also increase. Since both sulfide and

high concentration of carbon dioxide inhibit the cytochrome path (Palet et al. 1991), there may be a need for the alternative path under these conditions also.

When the activity of the cytochrome path is restricted by **low temperature**, the alternative path might also increase in activity to provide energy needed for metabolism. In fact, sustained exposure to low temperature enhances the amount of alternative oxidase in mitochondria of *Zea mays* (corn) (Stewart et al. 1990) and *Nicotiana tabacum* (tobacco) (Vanlerberghe & McIntosh 1992). Such an induction also occurs when the activity of the cytochrome path is restricted in other ways [e.g., by application of inhibitors of mitochondrial protein synthesis (Day et al. 1995), or of inhibitors of the cytochrome path (Wagner et al. 1992)]. Interestingly, only those inhibitors of the cytochrome path that enhance superoxide production lead to induction of the alternative oxidase, suggesting that the prevention of damage by reactive oxygen species is a particularly important role of the alternative path. Moreover, superoxide itself can also induce expression of the alternative oxidase. This has led to the suggestion that **reactive oxygen species**, including H_2O_2 , are part of the signal(s) communicating cytochrome path restriction in the mitochondria to the nucleus, thus inducing alternative oxidase synthesis (Rhoads et al. 2006). The key question is, of course, if enhanced *expression* of the alternative oxidase leads to greater *activity* of the alternative path. In *Vigna radiata* (mung bean) this appears to be the case, but such a response is not found in *Glycine max* (soybean) (González-Meler et al. 1999).

In the absence of an alternative oxidase, inhibition or restriction of the activity of the cytochrome path would inexorably lead to the accumulation of fermentation products, as found in transgenic plants lacking the alternative oxidase (Vanlerberghe et al. 1995). In addition, it might cause the ubiquinone pool to become highly reduced which might lead to the formation of reactive oxygen species and concomitant damage to the cell (Purvis & Shewfelt 1993, Møller 2001). Further work with transgenics lacking the alternative path is an essential avenue of future research on the ecophysiological role of the alternative path in plant functioning.

3.7 A Summary of the Various Ecophysiological Roles of the Alternative Oxidase

The alternative oxidase is widespread and can serve a wide variety of physiological functions, ranging from providing ATP when the cytochrome pathway is

restricted (which can occur under a wide variety of circumstances) to acting as an overflow to balancing the physiological rates of a range of processes (e.g., organic acid synthesis and ATP production) to prevent metabolism from getting severely unbalanced. In higher plants, the alternative pathway is just as much entrained in all aspects of metabolism as is the cytochrome path. In addition to the alternative path, plants have a bypass of complex I and uncoupling proteins. The reason why most animals do not have an alternative respiratory path is probably that they entirely depend on uncoupling proteins. In addition, animals may have less need to balance different metabolic functions.

4. Environmental Effects on Respiratory Processes

4.1 Flooded, Hypoxic, and Anoxic Soils

Plants growing in flooded soil are exposed to **hypoxic** (low-O₂) or **anoxic** (no-O₂) conditions in the root environment, and experience a number of conditions, including an insufficient supply of O₂ and accumulation of CO₂ (Sect. 4.7), and changes in plant water relations (Sect. 3 of Chapter 3 on plant water relations).

4.1.1 Inhibition of Aerobic Root Respiration

The most immediate effect of soil **flooding** on plants is a decline in the O₂ concentration in the soil. In water-saturated soils the air that is normally present in the soil pores is almost completely replaced by water. The **diffusion** of gases in water is approximately 10000 times slower than in air. In addition, the **concentration** of O₂ in water is much less than that in air (at 25°C approximately 0.25 mmol O₂ dissolves per liter of water, whereas air contains approximately 10 mmol). The O₂ supply from the soil, therefore, decreases to the extent that aerobic

root respiration, and hence ATP production, is restricted. Under these conditions the synthesis of RNA and proteins is strongly suppressed, but that of specific m-RNAs and **anaerobic polypeptides** is induced. Among these “anaerobic polypeptides” is the fermentative enzyme **alcohol dehydrogenase** (Andrews et al. 1993).

4.1.2 Fermentation

When insufficient O₂ reaches the site of respiration, such as in seeds germinating under water and submerged rhizomes, ATP may be produced through **fermentative processes**. These tissues generate energy in **glycolysis**, producing ethanol, and sometimes lactate. **Lactate** tends to be the product of fermentation immediately after the cells are deprived of O₂. Lactate accumulation decreases the pH in the cytosol (Sect. 4.1.3), which inhibits lactate dehydrogenase and activates the first enzyme of ethanol fermentation: pyruvate decarboxylase. When lactate accumulation does not stop, **cytosolic acidosis** may lead to cell death (Rivoal & Hanson 1994).

It was initially believed that root metabolism cannot continue in flooded conditions, due to the production of toxic levels of **ethanol**. Ethanol, however, does not really inhibit plant growth until concentrations are reached that far exceed those found in flooded plants (Table 7), and hence ethanol plays only a minor role in flooding injury to roots and shoots (Jackson et al. 1982). As long as there is no accumulation of **acetaldehyde**, which is the product of pyruvate decarboxylase and the substrate for alcohol dehydrogenase, which reduces acetaldehyde to ethanol, alcoholic fermentation is unlikely to cause plant injuries. If **acetaldehyde** does accumulate, however, for example upon re-aeration, then this may cause injury, because acetaldehyde is a potent toxin, giving rise to the formation of **reactive oxygen species** (Blokhina et al. 2003). It is the low potential for **ATP production** and its metabolic consequences, rather than the

TABLE 7. The effect of supplying ethanol in aerobic and anaerobic nutrient solutions to the roots of *Pisum sativum* (garden pea) at a concentration close to that found in flooded soil (i.e., 3.9 mM) or greater than that.

	Aerobic control	Aerobic + ethanol	Anaerobic control	Anaerobic + ethanol
Ethanol in xylem sap (mM)	37	540	90	970
Stem extension (mm)	118	108	94	74
Final fresh mass (g)				
shoot	11.9	11.9	10.7	11.4
roots	7.8	9.7	5.7	6.1

Source: Jackson et al. (1982).

toxicity of the products of fermentative metabolism that constrain the functioning of plants under anoxia (Sect. 4.1.3).

Continued fermentation requires the mobilization of a large amount of reserves, such as starch. Seeds of most species fail to germinate under anoxia, but those of *Oryza sativa* (rice) are an exception (Perata & Alpi 1993). In contrast to cereals like *Triticum aestivum* (wheat) and *Hordeum vulgare* (barley), rice seeds produce α -amylase and sucrose-metabolizing enzymes under anoxia; these enzymes allow the degradation and further metabolism of starch, and therefore sustain a rapid fermentative metabolism (Perata et al. 1996).

The **energetic efficiency** of ethanol formation is low, producing only two molecules of ATP in glycolysis ("substrate phosphorylation") per molecule of glucose. This is considerably less than that of aerobic respiration, which produces around 36 molecules of ATP per molecule of glucose, if the most efficient mitochondrial electron-transport pathways are used and not taking into account the costs for transport of metabolites across the inner mitochondrial membrane (Sects. 2.2 and 2.3). Moreover, a large fraction of the **lactate** may be secreted into the rhizosphere [e.g., in some *Limnium* (statice) species]. Although such secretion

prevents acidification of the cytosol, it also represents a substantial carbon loss to the plant (Rivoal & Hanson 1993).

4.1.3 Cytosolic Acidosis

A secondary effect of the decline in root respiration and ATP production in the absence of O_2 is a decrease in the pH of the cytosol (**cytosolic acidosis**), due in part to accumulation of organic acids in fermentation and the TCA cycle. Moreover, in the absence of O_2 as a terminal electron acceptor, ATP production decreases, so there is less energy available to maintain ion gradients within the cell. Acidification of the cytosol reduces the activity of many cytosolic enzymes, whose pH optimum is around 7 and hence severely disturbs the cell's metabolism, so that protons leak from the vacuole to the cytosol. Cytosolic acidosis also reduces the activity of aquaporins (Sect. 5.2 of Chapter 3 on plant water relations). The extent of this cytosolic acidification is less in the presence of NO_3^- (Fig. 11). NO_3^- reduction leads to the formation of hydroxyl ions (Sect. 2.2.6.1 of Chapter 6 on mineral nutrition), which partly neutralize the protons and prevent severe acidosis. Moreover, NO_3^- reduction requires the oxidation of NADH, producing NAD. This allows the continued

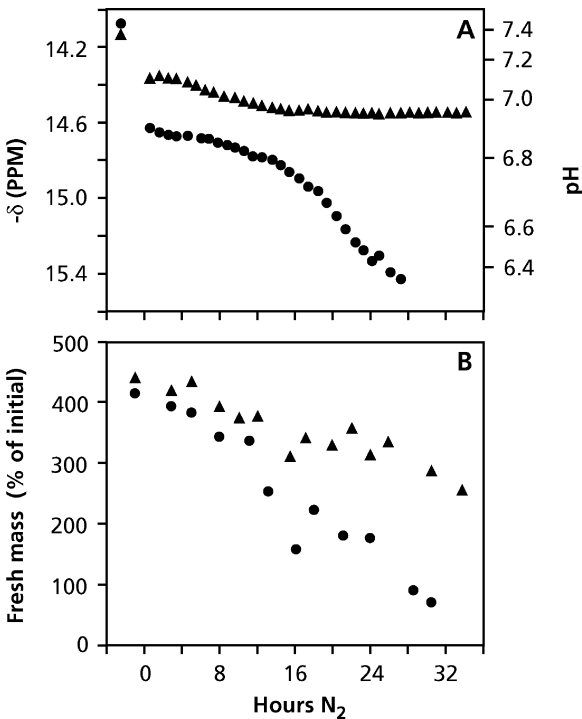

FIGURE 11. The effect of hypoxia on root tips of *Zea mays* (maize), in the presence (triangles) and absence (circles) of nitrate. (A) The effect on the pH of the cytosol, as measured in experiments using ^{31}P -NMR spectroscopy; (B) the increase in fresh mass during 48 hours in air, after the indicated period of hypoxia. The location of the inorganic phosphate (P_i) peaks in an NMR spectrum depends on the "environment" of the molecule (e.g., pH) (Fig. 6 in this chapter). NMR spectroscopy can therefore be used to determine the peak wavelength at which P_i absorbs the magnetic radiation and hence the pH in the cytosol as well as in the vacuole (after Roberts et al. 1985). Copyright American Society of Plant Biologists.

oxidation of organic acids in the TCA cycle, thus preventing their accumulation and associated drop in pH.

4.1.4 Avoiding Hypoxia: Aerenchyma Formation

In wetland plants, including crop species such as *Oryza sativa* (rice), mechanisms have evolved to prevent the problems associated with flooded soils. The most important adaptation to flooded soils is the development of a functional **aerenchyma**, a continuous system of air spaces in the plant that allows diffusion of O₂ from the shoot or the air to the roots (Jackson & Armstrong 1999). Aerenchyma avoids inhibition of respiration due to lack of O₂ which is inevitable for plants that are not adapted to wet soils (Colmer 2003b). In many species, other special structures allow the diffusion of O₂ from the air into the plant: the pneumatophores of mangroves, lenticels in the bark of many wetland trees, and, possibly, the knee roots of *Taxodium distichum* (bald cypress). The mechanisms that maintain the intercellular spaces filled with gas rather than water are not fully understood. Inward radial gradients in water potential created by transpiration in combination with water-impermeable apoplastic barriers such as the exodermis may offer an explanation (Jackson & Armstrong 1999).

Because there is a gradient in partial pressure within the aerenchyma, O₂ will move by **diffusion** to the roots. In aquatic plants, however, like *Nuphar lutea* (yellow water lily) and *Nelumbo nucifera* (sacred lotus) there is also a **pressurized flow-through** system, which forces O₂ from young emergent leaves to the roots and rhizomes buried in the anaerobic sediment (Dacey 1980, 1987). Such a mass flow requires a difference in atmospheric pressure between leaves and roots. The diurnal pattern of the mass flow of air to the roots suggests that the energy to generate the pressure comes from the sun; however, it is not the photosynthetically active component of radiation, but the long-wave region (heat), which increases the atmospheric pressure inside young leaves by as much as 300 Pa. How can these young leaves draw in air against a pressure gradient? To understand this we have to realize that the atmosphere inside the leaf is saturated with water vapor and that movement of gases occurs by **diffusion**, along a gradient in partial pressure, and by **mass flow**, depending on the **porosity** of the pathway. The porosity of the young emergent leaves is such that gas flux by diffusion (i.e., down a concentration gradient) is more important than a mass flux

due to a difference in atmospheric pressure. The concentration gradient is due to the evaporation from the cells inside the leaf, which dilutes the other gases in the intercellular spaces, thus creating a gradient allowing diffusion between the atmosphere and the intercellular spaces. The slightly higher atmospheric pressure inside young leaves forces air, which has been enriched in O₂ by photosynthesis, to move along a pressure gradient from young leaves to roots and rhizomes. Some of the air from roots and rhizomes, which is enriched with CO₂ from respiration, is then forced to older leaves. Isotope studies show that much of this CO₂ is subsequently assimilated in photosynthesis. The reason that only young leaves show this internal ventilation is the higher porosity of the older leaves which does not allow them to draw in more air through diffusion than is lost via mass flow. The quantity of air flow through a single petiole is enormous: as much as 22 liters per day, with peak values as high as 60 ml per minute and rates of 50 cm per minute. The transport of O₂ from the shoot by convective gas flow is also likely to contribute to the flow of O₂ to roots of other species growing in an anaerobic soil (Armstrong et al. 1997). Pressurized flow of O₂ plays a role in the O₂ supply to the roots and rhizosphere of many **emergent macrophytes**. The vital element is that a compartment exists surrounded by walls with sufficiently small pores to allow diffusion to occur at greater rates than mass flow (Colmer 2003a,b).

Aerenchymatous plants often transport more O₂ to the roots than is consumed by root respiration. The **outward diffusion of O₂** into the rhizosphere implies a loss of O₂ for root respiration. Plants adapted to flooded conditions, e.g., *Oryza sativa* (rice), *Phragmites australis* (common reed) and *Glyceria maxima* (reed mannagrass) develop a **flooding-induced O₂ barrier** in basal root zones, thus reducing radial O₂ loss (Colmer 2003a, Soukup et al. 2007). On the other hand, outward diffusion of O₂ also allows the oxidation of potentially harmful compounds (Colmer 2003b). This can readily be seen when excavating a plant from a reduced substrate. The bulk substrate itself is black, due to the presence of FeS, but the soil in the immediate vicinity of the roots of such a plant will be brown or red, indicating the presence of oxidized iron (Fe³⁺, "rust"), which is less soluble than the reduced Fe²⁺.

Aerenchyma and induction of a barrier reducing radial O₂ loss are not unmitigated benefits to plants. Aerenchymatous roots characteristically have a large diameter, and therefore a small surface area per unit biomass. Because plant nutrient

uptake is strongly affected by root diameter and surface area, a likely cost associated with aerenchyma is a reduced rate of nutrient uptake per unit root biomass. The basal O_2 barrier, which involves both quantitative and qualitative differences in **suberin** composition and distribution within exodermal cell walls (Soukup et al. 2007) probably also decreases the roots' capacity for nutrient and water uptake.

Aerenchyma also serves as a conduit of soil gases to the atmosphere, including methane, ethylene, and carbon dioxide. **Methane** (CH_4) is a bacterial product commonly produced in anaerobic soils. In rice paddies and natural wetlands most CH_4 is transported to the atmosphere through plant aerenchyma. Experimental removal of sedges from wetland substantially reduces CH_4 flux and causes CH_4 to accumulate in soils (Fig. 12). CH_4 production and transport to the atmosphere is a topic of current concern, because CH_4 is a "greenhouse gas" that absorbs infrared radiation 20 times more effectively than does CO_2 . Recent increases in atmospheric CH_4 have contributed approximately 20% of the warming potential of the atmosphere that has caused recent global warming (Ramaswamy et al. 2001). The expansion of rice agriculture and associated CH_4 transport via aerenchyma from the soil to the atmosphere is an important contributor to atmospheric CH_4 . There is no firm evidence that plants themselves generate significant amounts of CH_4 , and suggestions in the literature that planting trees might contribute to a major extent to global warming due to their aerobic production of CH_4 have not been substantiated (Dueck et al. 2007, Kirschbaum et al. 2007).

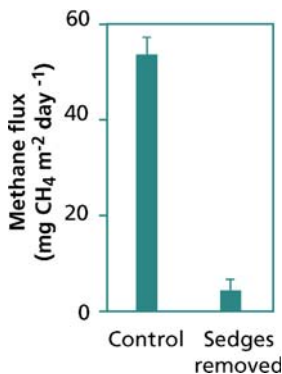

FIGURE 12. Methane flux and soil methane concentration in a tundra wetland in which sedges are present (control) or have been experimentally removed (data from Torn & Chapin 1993).

4.2 Salinity and Water Stress

Sudden exposure of sensitive plants to salinity or water stress often enhances their respiration. For example, the root respiration of *Hordeum vulgare* (barley) increases upon exposure to 10 mM NaCl (Bloom & Epstein 1984). This may either reflect an increased **demand for respiratory energy** or an increased activity of the alternative path, when carbon use for growth is decreased more than carbon gain in photosynthesis (Sect. 5.3 of Chapter 7 on growth and allocation). Long-term exposure of sensitive plants to salinity or desiccation gradually decreases respiration as part of the general decline in carbon assimilation and overall metabolism associated with slow growth under these conditions (Galmés et al. 2007; Sect. 5.3 of Chapter 7 on growth and allocation). Generally, specific rates of leaf respiration at 25°C are highest in plants growing in hot, dry habitats, reflecting acclimation and/or adaptation to such habitats (Wright et al. 2006). Additional declines in root respiration of *Triticum aestivum* (wheat) plants upon exposure to dry soil may reflect a specific decline in the alternative path. The decline correlates with the accumulation of **osmotic solutes**, reducing the availability of sugars and hence providing less "grist for the mill" of the alternative path.

Leaves also show a decline in respiration, as leaf water potential declines. The decline is most likely associated with a decrease in the energy requirement for growth or the export of photoassimilates. In *Glycine max* (soybean) net photosynthesis decreases by 40% under mild and by 70% under severe water stress, whereas the total respiratory O_2 uptake is not significantly different at any water-stress level. However, severe water stress causes a significant shift of electrons from the cytochrome to the alternative pathway. The electron partitioning through the alternative pathway increases from about 11% under well watered or mild water-stress conditions to near 40% under severe water stress (Fig. 13). Consequently, the calculated rate of mitochondrial ATP synthesis decreases by 32% under severe water stress (Ribas-Carbó et al. 2005a).

Species differ in their respiratory response to water stress, primarily due to differences in sensitivity of growth to desiccation. When salt-adapted plants are exposed to mild salinity stress, they accumulate **compatible solutes**, such as sorbitol (Sect. 3 of Chapter 3 on plant water relations). Accumulation of these sugar alcohols requires glucose as a substrate but does not directly affect the concentration of carbohydrates or interfere with growth.

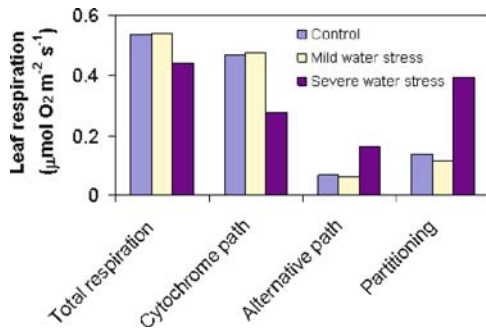

FIGURE 13. Effect of different levels of water stress on total respiration (V_t), the activities of the cytochrome (v_{cyt}), and alternative (v_{alt}) pathways and the partitioning through the alternative pathway (τ_a) (after Ribas-Carbó et al. 2005a). Copyright American Society of Plant Biologists.

Studies of root respiration, using an inhibitor of the alternative path, suggested that sorbitol accumulation is associated with a reduction in activity of the nonphosphorylating alternative respiratory pathway. However, further experimentation using the oxygen-isotope fractionation technique (Box 2B.1) is required to confirm this. Interestingly, the amount of sugars that are “saved” by the decline in respiration is the same as that used as the substrate for the synthesis of sorbitol, suggesting that accumulation of compatible solutes by drought-adapted plants may have a minimal energetic cost (Lambers et al. 1981).

Prolonged exposure of salinity-adapted species (**halophytes**) to salt concentrations sufficiently low not to affect their growth has no effect on the rate of root respiration. This similarity in growth and respiratory pattern under saline and nonsaline conditions suggests that the respiratory costs of coping with mild salinity levels are negligible in salt-adapted species. The respiratory costs of functioning in a saline environment for adapted species that accumulate NaCl are also likely to be relatively small, because of the low respiratory costs of absorbing and compartmentalizing salt when grown in saline soils. For salt-excluding **glycophytes**, however, there may be a large respiratory cost associated with salt exclusion.

4.3 Nutrient Supply

Root respiration generally increases when roots are suddenly exposed to increased ion concentrations in

their environment, a phenomenon known as **salt respiration**. The stimulation of respiration is at least partly due to the increased **demand for respiratory energy** for ion transport. The added respiration may also reflect a replacement of osmotically active sugars by inorganic ions, leaving a large amount of sugars to be respired via the **alternative path**.

When plants are grown at a low supply of N, their rate of **root respiration** is lower than that of plants well supplied with mineral nutrients (Atkinson et al. 2007). This is expected because their rates of growth and ion uptake are greatly reduced (Fig. 14). Rates of root respiration, however, per ion absorbed or per unit root biomass produced at a low NO_3^- supply are relatively high, if we compare these rates with those of plants that grow and take up ions at a *much* higher rate. This suggests that **specific costs** of growth (that is cost per unit biomass produced), maintenance (cost per unit biomass to be maintained), or ion transport (cost per unit nutrient absorbed) must increase in plants grown at a limiting nutrient supply (Sect. 5.2.4).

There is also a correlation between **leaf respiration** and leaf N concentration (Loveys et al. 2003, Noguchi & Terashima 2006). Although the correlation between leaf respiration and leaf N concentration tends to be general, irrespective of the natural habitat of the species (Tjoelker et al. 1999, Reich et al. 2006), environment-mediated changes in the relationship between leaf respiration and leaf N can occur. For example, in a comparison of 70 Australian perennial species, the slope of leaf respiration (on a dry mass basis) vs. leaf N concentration is constant across sites, but there are differences in the intercept for sites differing in nutrient availability and rainfall (Wright et al. 2001). The physiological basis for such a difference in intercept remains to be explored.

4.4 Irradiance

The respiratory response of plants to light and assimilate supply depends strongly on time scale. The immediate effect of low light is to reduce the **carbohydrate status** of the plant and, therefore, the supply of substrate available for respiration (Fig. 15A). Interestingly, in the shade species *Alocasia odora* (Asian taro) addition of sucrose does not increase the rate of leaf respiration of plants transferred to the shade (Fig. 15B), but addition of an uncoupler does increase respiration to a major extent (Fig. 15C) (Noguchi et al. 2001a). This shows that respiration is controlled by **energy**

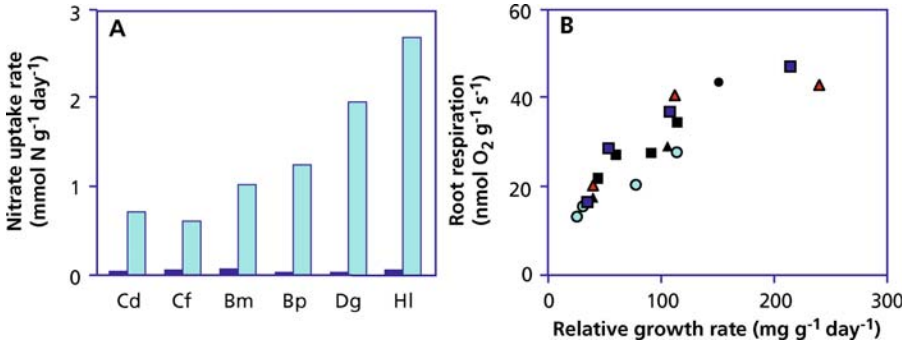

FIGURE 14. (A) Rates of net inflow of nitrate of six grass species grown at two nitrogen addition rates, allowing a near-maximum relative growth rate (open columns) or a RGR well below RGR_{max} (black columns). (B) Root respiration of the same inherently fast- and slow-growing grasses as shown in A, now compared at a range of nitrogen addition rates allowing a near-maximum relative growth rate or a relative growth rate below RGR_{max} , the lowest RGR being $38 \text{ mg g}^{-1} \text{ day}^{-1}$. Cd,

Carex diandra (lesser paniced sedge) (open circles); Cf, *Carex flacca* (blue sedge) (filled triangle); Bm, *Briza media* (quacking grass) (filled squares); BP, *Brachypodium pinnatum* (Tor grass) (filled circles); DG, *Dactylis glomerata* (cocksfoot) (open squares); Hl, *Holcus lanatus* (common velvet grass) (open triangles) (Van der Werf et al. 1992a). Copyright SPB Academic Publishing.

demand, rather than substrate supply (Sect. 2.4, Fig. 5), and that the energy demand is down-regulated in shade conditions. In the leaves of *Alocasia odora*, the contribution of the alternative path is less than 10% of the total respiratory rate, irrespective of growth irradiance. For the sun species *Spinacia oleracea* (spinach) and *Phaseolus vulgaris* (common bean) grown at high light intensity, the contribution of the alternative path in the leaves is about 40% early in the night, but decreases dramatically late in the night. When spinach is grown at low light intensity, however, the contribution of the alternative path in the leaves declines. The low activity of the alternative path in the leaves of the understory species *Alocasia odora* shows that the efficiency of ATP production (ADP:O ratio) of this species is high. This may be especially important in shade environments. In the leaves of sun species, the ADP:O ratio changes depending on conditions (Noguchi et al. 2001a).

To further investigate why the understory species *Alocasia odora* (Asian taro) consistently shows low alternative path activity, Noguchi et al. (2005) grew *Alocasia odora* and *Spinacia oleracea* (spinach) plants under both high and low light intensities. On a mitochondrial protein basis, *Spinacia oleracea* leaves show a higher capacity of the cytochrome pathway than do *Alocasia odora* leaves. Despite a low in vivo activity of the alternative path, *Alocasia odora* has a higher capacity of the alternative oxidase on a mitochondrial protein basis. In the low-light environment, most of the alternative oxidase

protein in *Alocasia odora* leaves is in its inactive, oxidized dimer form (Sect. 2.6.2), but it is converted to its reduced, active form when plants are grown under high light (Fig. 16). This shift may prevent over-reduction of the respiratory chain under photo-oxidative conditions.

Roots and leaves that are subjected to an increased or decreased carbohydrate supply gradually acclimate over several hours by adjusting their respiratory capacity. Upon transfer of *Poa annua* (annual meadow-grass) from high-light to low-light conditions, and at the same time from long-day to short-day conditions, the sugar concentration in the roots decreases by 90%. Both the rate of root respiration and the *in vitro* cytochrome oxidase capacity decrease by about 45%, relative to control values. The absolute rate of O_2 uptake via the alternative pathway, as determined using the isotope fractionation technique (Box 2B.1), does not change, but the cytochrome pathway activity decreases. Interestingly, there is no change in the concentration of the alternative oxidase protein or in the reduction state of the protein. Also, there is no change in the reduction state of the ubiquinone pool. These results show that neither the amount nor the activity of the alternative oxidase change under severe light deprivation (Millenaar et al. 2000), suggesting an important role for this apparently wasteful pathway; this role is most likely avoiding production of reactive oxygen species, as discussed in Sect. 3.3. The results also point to acclimation of respiration as a result of changes in

FIGURE 15. Leaf respiration in the shade species *Alocasia odora* (Asian taro) as dependent on light availability. (A) Changes in the rate of O_2 uptake. Effects of (B) the addition of an uncoupler (FCCP) and (C) a respiratory substrate (sucrose) on the rate of O_2 uptake. Plants that were originally grown in high light (open green symbols) or low light (filled green triangles) were subsequently transferred to high light (filled circles) or low light (open triangles) on day 0 (redrawn after Noguchi et al. 2001a).

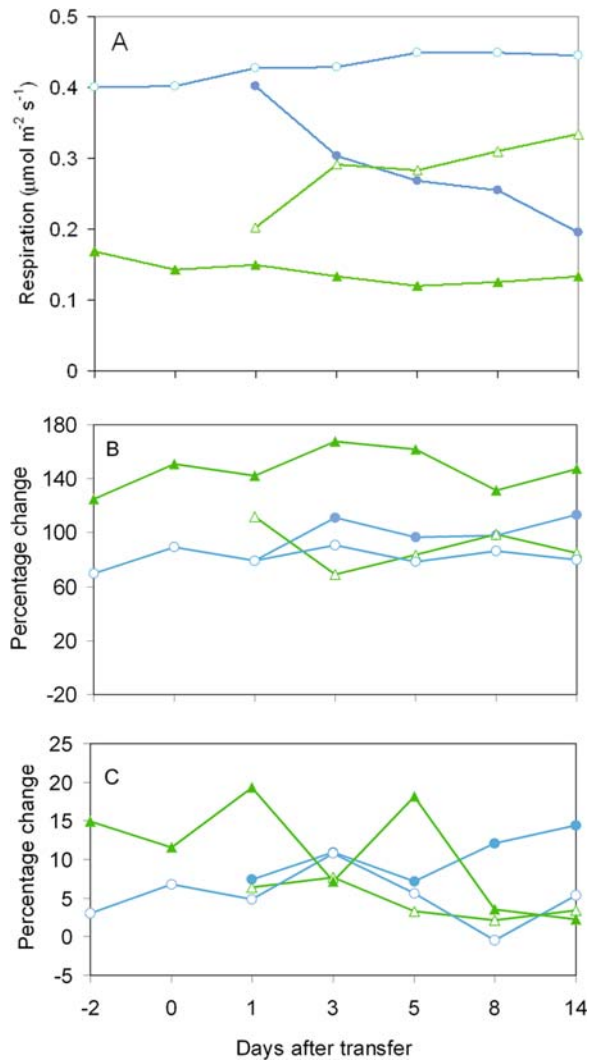

gene expression. Also, after pruning of the shoot to one leaf blade, both the soluble sugar concentration and the respiration of the seminal roots decrease. These effects on respiration reflect the **coarse control** of the respiratory capacity upon pruning or sucrose feeding (Bingham & Farrar 1988, Williams & Farrar 1990). This illustrates the adjustment of the respiratory capacity to the root's carbohydrate level.

Changes in respiratory capacity induced by changes in **carbohydrate status** reflect acclimation of the respiratory machinery. The protein pattern of the roots of pruned plants is affected within 24 h (McDonnel & Farrar 1992, Williams et al. 1992). Glucose feeding to leaves enhances the activity of several glycolytic enzymes in these leaves, due to

regulation of **gene expression** by carbohydrate levels (Krapp & Stitt 1994). Clearly, the capacity to use carbohydrates in respiration is enhanced when the respiratory substrate supply increases, and declines with decreasing substrate supply. The plant's potential to adjust its respiratory capacity to environmental conditions is ecologically significant. Individual plants acclimated to low light generally have low leaf respiration rates. Thus acclimation accentuates the short-term declines in respiration due to substrate depletion.

As with acclimation, species that are **adapted** to low light generally exhibit lower respiration rates than high-light adapted species. For example, the rainforests understory species of *Alocasia odora* (Asian taro) has lower rates of both photosynthesis

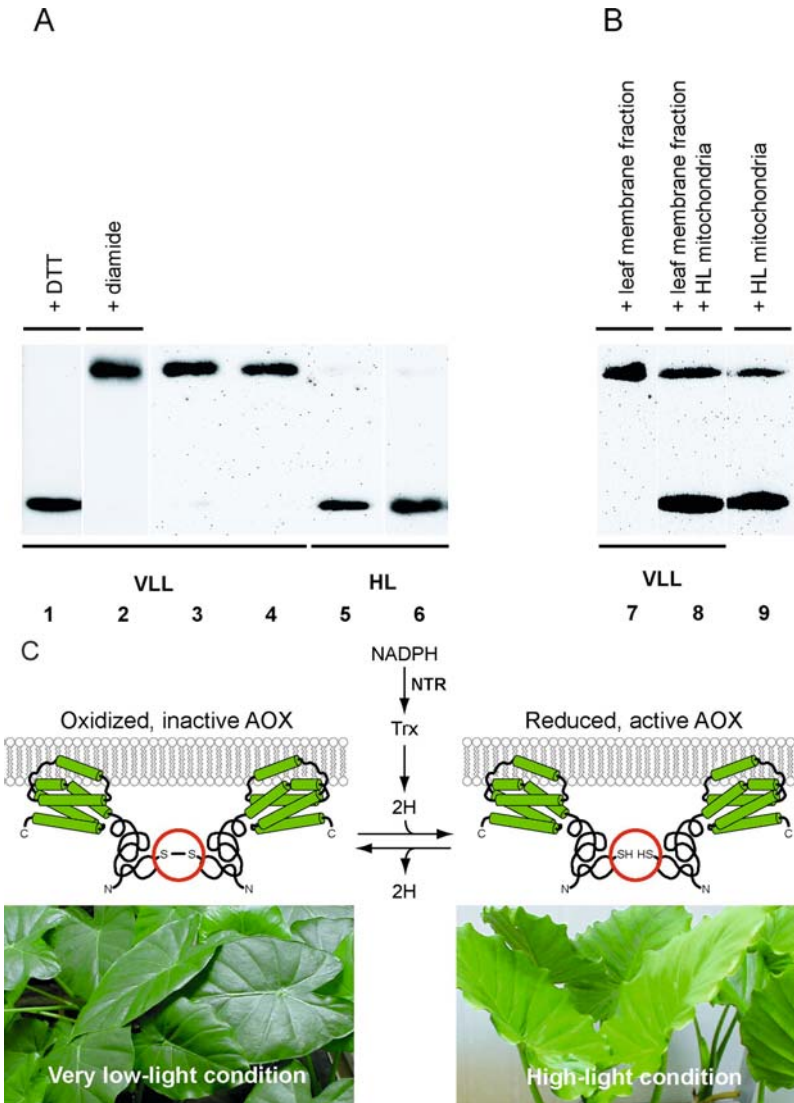

FIGURE 16. (A) Immunoblots of the alternative oxidase (AOX) in extracted membrane fractions isolated from *Alocasia odora* (Asian taro) leaves. Extractions were made very rapidly, so as to maintain the activation state of AOX and determine its *in vivo* state. Lane 1, a sample of leaves of plants grown at very low light intensities (VLL) treated in the presence of 50 mM DTT (dithiothreitol, which renders AOX in its reduced and active state, irrespective of its state *in vivo*). Lane 2, a sample of VLL leaves treated in the presence of 5 mM diamide (which oxidizes and inactivates the AOX dimer, irrespective of its state *in vivo*). Lanes 3 and 4, samples consisted of only VLL leaf membrane fractions; the immunoblots show that AOX was in its oxidized, inactive state in leaves of plants grown at very low light intensity. Lanes 5 and 6, samples consisted of only high-light grown (HL) leaf membrane fractions; these immunoblots show that AOX was in its reduced, active state in leaves of plants grown at high light intensity. (B)

Immunoblots of AOX in rapidly extracted membrane fractions and/or mitochondria isolated from *Alocasia odora* leaves. Lane 7, a sample consisted of only VLL leaf membrane fractions; AOX was in its oxidized, inactive state. Lane 8, a sample of VLL leaf membrane fractions, added with a mitochondrial extract from HL leaves just before the extraction; Lane 9, mitochondrial sample isolated from HL leaves; during isolation some AOX is reduced and activated (Noguchi et al. 2005). (C) Under very low light conditions, the alternative oxidase is in its inactive, oxidized form (left). It is converted to its reduced, active form (right) when plants are exposed to high-light conditions. This shift may prevent over-reduction of the respiratory chain under photo-oxidative conditions. The structural model for AOX has been deduced from derived amino acid sequences and is reprinted with permission of the American Society of Plant Biologists. Photographs by K. Noguchi. Copyright Blackwell Science Ltd.

TABLE 8. The daily carbon budget ($\text{mmol g}^{-1} \text{day}^{-1}$) of the leaves of *Spinacia oleracea* (spinach), a sun species, and *Alocasia odora* (giant upright elephant ear), a shade species, when grown in different light environments.*

Irradiance	Photosynthesis		Leaf respiration		Net leaf carbon gain	
	<i>Spinacia oleracea</i>	<i>Alocasia odora</i>	<i>Spinacia oleracea</i>	<i>Alocasia odora</i>	<i>Spinacia oleracea</i>	<i>Alocasia odora</i>
500	26	nd	3.4 (13)	nd	23 (87)	nd
320	21	11	2.4 (12)	1.1 (10)	18 (88)	9.4 (90)
160	15	9	1.7 (11)	0.82 (9)	14 (89)	8.2 (91)
40	nd	4.5	nd	0.76 (17)	nd	3.7 (83)

Source: Noguchi et al. (1996), K. Noguchi, pers. comm.

* Irradiance is expressed in $\mu\text{mol m}^{-2} \text{s}^{-1}$. Percentages of the photosynthetic carbon gains have been indicated in brackets; nd is not determined; in the original paper the species name is erroneously given as *Alocasia macrorrhiza*.

and respiration than does the sun species *Spinacia oleracea* (spinach), when the two species are compared under the same growth conditions (Table 8). The net daily carbon gain of the leaves (photosynthesis minus respiration) is rather similar for the two species, when expressed as a proportion of photosynthesis. Similarly, understory species of *Piper* (pepper) have lower respiration rates than species from shaded and exposed habitats, when both are grown in the same environment (Fredeen & Field 1991). Because rates of photosynthesis and respiration show parallel differences between sun and shade species (both lower in the shade species), differences in the carbon balance between sun and shade species probably reflect different patterns of biomass allocation rather than differences in photosynthesis and respiration.

Respiration rates tend to be higher in plants grown at higher light intensity. Acclimation to higher levels of irradiance involves up-regulation of genes involved in the metabolism of carbohydrates and in energy-requiring processes (**coarse control**). In the short term, respiration may respond to irradiance because this affects the availability of respiratory substrate (**control by supply**). Sudden exposure of shade plants to a high light intensity may require a change in activation state of the alternative oxidase, associated with accumulation of reactive oxygen species (**stress response**).

Acclimation of respiration is relatively fast (hours to days), when compared with that of photosynthesis (days to weeks). This is largely accounted for by the fact that some aspects of photosynthetic acclimation require the production of new leaves with a different structure, whereas acclimation of respiration requires only production of new proteins.

4.5 Temperature

Respiration increases as a function of temperature, with the magnitude of increase depending on the **temperature coefficient** (Q_{10}) of respiration. This temperature effect on respiration is characteristic of most heterothermic organisms and is a logical consequence of the temperature sensitivity of the enzymatically catalyzed reactions involved in respiration. The temperature stimulation of respiration also reflects the increased demand for energy to support the increased rates of biosynthesis, transport, and protein turnover that occur at high temperatures (Sect. 5.2).

Temperature-mediated changes in plant respiration are an important component of the biosphere's response to global climate change. The Q_{10} is often modeled to be 2 (i.e., respiration doubles per 10°C rise in temperature). However, upon longer-term exposure to a different temperature, the initial temperature effect of a Q_{10} of 2 may diminish, and the long-term Q_{10} declines predictably with increasing temperature across diverse plant taxa and biomes (Fig. 17A). This is due to **thermal acclimation**, i.e., the adjustment of respiration rates to compensate for a change in temperature. The temperature dependence of Q_{10} is linked to shifts in the control by maximum **enzyme activity** at low temperature and **substrate limitations** at high temperature (Fig. 17B). In the long term, acclimation of respiration to temperature is common, reducing the temperature sensitivity of respiration to changes in thermal environment. Temperature acclimation results in a tendency toward **homeostasis** of respiration, such that warm-acclimated (temperate, lowland) and cold-acclimated alpine or high-arctic plants display similar rates of respiration when measured at their

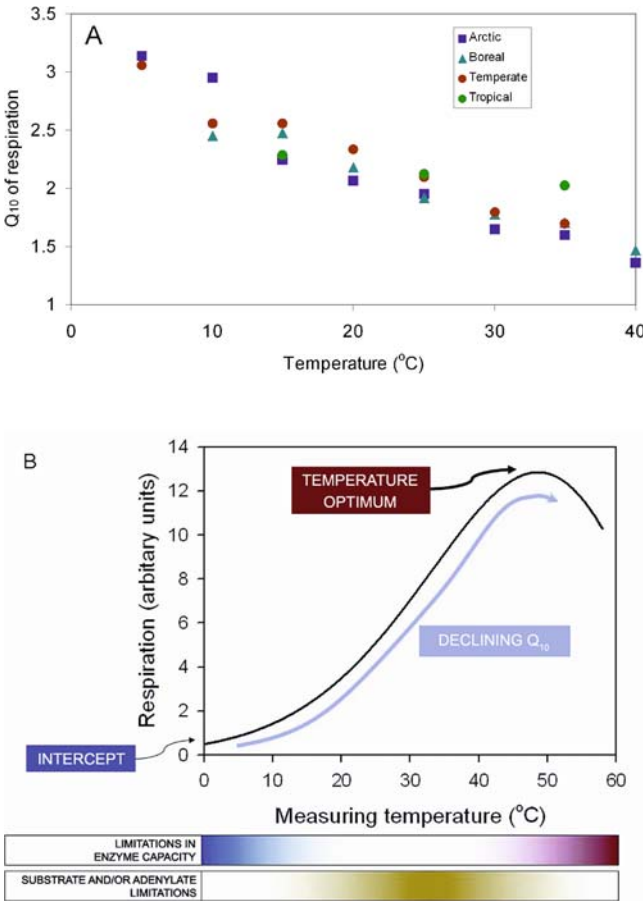

FIGURE 17. Effects of temperature on plant respiration. (A) Q_{10} of foliar respiration rates in relation to short-term measurement temperature. Symbols are the mean Q_{10} of species of arctic, indicated in blue (49 species), boreal, indicated in green (24 species), temperate, indicated in brown (50 species), and tropical, indicated in orange (3 species). (B) Assuming a rate of respiration of 0.5 at 0°C (arbitrary units), respiration at other temperatures was predicted using the linear decline in Q_{10} with increasing temperature (shown in A). Both the intercept (i.e., R at 0°C) and the temperature optimum of respiration (i.e., temperature where respiration rates are maximal) are shown. The lower panels indicate the degree to which respiratory flux is likely limited by enzyme capacity vs. substrate supply and adenylates. The temperatures where respiratory flux is likely limited by maximum catalytic enzyme activity (i.e., V_{max}) are indicated in blue (limitations in the cold) and red (limitations at supra-optimal temperatures). At moderate temperatures, respiratory flux is likely regulated by the availability of substrate and/or adenylates (i.e., the absolute concentration of ADP and the ratio of ATP:ADP) (after Atkin & Tjoelker 2003; copyright Elsevier Science, Ltd.).

respective growth temperatures; however, complete homeostasis is uncommon. Acclimation can play an important role in weakening positive feedback through the warming-respiration-atmospheric CO₂ concentration connection (Atkin & Tjoelker 2003). **Acclimation** of leaf respiration to temperature is larger in conifers than in broad-leaved species (Tjoelker et al. 1999); other than that, there are no major systematic differences in the degree of acclimation among contrasting plant species (Loveys et al. 2003).

The mechanism of temperature acclimation of respiration is not yet fully understood. At low measurement temperatures (e.g., 5°C), respiratory flux is probably limited by the V_{max} (Covey-Crump et al. 2002) (lower panels in Fig. 17) of the respiratory apparatus [i.e., glycolysis, the TCA cycle, and mitochondrial electron transport (Sects. 2.2 and 2.3)]. At moderately high temperatures (e.g., 25°C), respiratory flux is less limited by enzymatic capacity because of increases in the V_{max} of enzymes in soluble and membrane-bound compartments; here, respiration is likely limited by substrate availability

and/or adenylates. Increased leakiness of membranes at high temperatures may further contribute to substrate limitations. The net result of temperature-mediated shifts in control from **capacity** (at low temperatures) to **substrate** or **adenylate** limitation (at moderately high temperatures) (Fig. 17) is that a rise in measurement temperature has less impact on respiratory flux at moderate-high temperatures than it does in the cold. As a result, the calculated Q_{10} is lower when calculated across a high measurement temperature range than at a range of low measurement temperatures. To firmly establish if respiratory enzyme capacity limits respiratory flux in the cold, data are needed on the maximum potential flux of the respiratory apparatus in intact tissues at low temperatures. These can be obtained via measurements of respiration in isolated mitochondria, in the presence of saturating substrates and ADP (Fig. 4). Mitochondrial rates can then be scaled up to the whole-plant level (Atkin & Tjoelker 2003). Thermal acclimation may require changes in the expression of genes that encode respiratory

enzymes or levels of substrates (Sect. 4.4). Acclimation of leaf respiration in field-grown *Eucalyptus pauciflora* (snow gum) occurs without changes in carbohydrate concentrations in leaves (Atkin et al. 2000). Temperature acclimation may also be associated with changes in leaf N concentration, which may affect photosynthesis (Sect. 6.1 of Chapter 2A on photosynthesis) and, consequently, the respiratory energy requirement for phloem loading (Sect. 5) (Tjoelker et al. 1999). Thermal acclimation in leaves of *Arabidopsis thaliana* (thale cress) is associated with an increase in rates of O₂ uptake per unit mitochondrial protein in mesophyll cells (Armstrong et al. 2006).

In addition to the acclimation potential of total respiration, acclimation may also change the partitioning of electrons between the cytochrome and alternative pathways as well as the activity of uncoupling proteins. Using roots of *Triticum aestivum* (wheat) and *Oryza sativa* (rice) cultivars with different degrees of respiratory homeostasis, shows that high-homeostasis cultivars maintain shoot and root growth at low temperature (Kurimoto et al. 2004a). Irrespective of a cultivar's capacity to maintain homeostasis, **cytochrome path capacity** of intact roots and isolated root mitochondria are larger for plants grown at low temperature, and the maximal activity of cytochrome oxidase show a similar trend. In contrast, **cyanide-resistant respiration** of intact roots and relative amounts of alternative oxidase protein in mitochondria isolated from those roots, are lower in high-homeostasis plants grown at low temperature. In the roots of low-homeostasis cultivars, relative amounts of alternative oxidase protein are higher at low growth temperature. Relative amounts of **uncoupling protein** show similar trends. Maintenance of growth rates in high-homeostasis plants grown at low temperature is obviously associated with both respiratory homeostasis and a high efficiency of respiratory ATP production (Kurimoto et al. 2004b).

Needles or leaves of cold-hardened plants that maintain relatively low rates of respiration when exposed to higher temperatures maintain higher concentrations of soluble sugars which confers greater **frost tolerance**. During a 5°C warmer-than-average winter in north-eastern Sweden, *Vaccinium myrtillus* (bilberry) may suffer lethal injuries due to the progressive respiratory loss of **cryoprotective sugars** from their leaves. Initial leaf carbohydrate reserves last 4 months only if tissue water content remains high due to frequent misty and rainy days; when dehydrated, the leaves' cold tolerance increases (Ögren 1996). Climate warming may impact significantly on cold hardiness of some

northern European woody plants such as *Picea abies* (Norway spruce), *Pinus sylvestris* (Scots pine), and *Pinus contorta* (lodgepole pine). In lodgepole pine seedlings, needle sugar concentrations may decrease by 15% which makes them more sensitive to frost. If the seedlings contain unusually large carbohydrate reserves, as found for Scots pine, these may buffer respiratory expenditure of sugars, and thus avoid frost damage. A strong, linear relationship exists between levels of cold hardiness and sugars (Ögren 2001).

4.6 Low pH and High Aluminum Concentrations

Root respiration rate increases as the **pH** in the rhizosphere decreases to a level below that at which growth is no longer possible (Fig. 18). Net H⁺ release from roots by H⁺-ATPase activity is a prerequisite for continued root growth and limits root growth at very low pH values (Schubert et al. 1990). One way of coping with excess H⁺ uptake at a low pH is to increase active H⁺ pumping by plasma-membrane ATPases. This increases the **demand for respiratory energy** (Fig. 18). Increased respiration rates can, therefore, allow plants to maintain root growth at noncritical low pH values, by increasing the supply of ATP for H⁺ pumping by plasma-membrane ATPases.

At very low pH values, root growth, net H⁺ release, and respiration rates decline (relative to rates at pH 7.0). The increased entry of H⁺ into the roots under these circumstances appears to be responsible for these effects (Yan et al. 1992). Such increased uptake of H⁺ tends to disturb cytosolic pH and ultimately root growth. The decrease in root respiration at very low pH might, therefore, result from the decreased respiratory demand for growth.

A low pH may also increase respiration due to the increased solubility of **aluminum** (Sect. 3.1 of Chapter 6 on mineral nutrition). Respiration of intact roots increases in response to aluminum in both aluminum-resistant and sensitive cultivars of *Triticum aestivum* (wheat) (Collier et al. 1993). Root growth and respiration decline at much higher aluminum concentrations in the resistant than in sensitive cultivars (of *Sorghum bicolor* (sorghum) Tan & Keltjens 1990a,b).

The increase in respiration of intact roots suggests that root functioning in the presence of aluminum imposes a demand for additional respiratory energy. These increased costs have little to do with the mechanism explaining resistance (i.e., excretion of chelating carboxylates) because such excretion

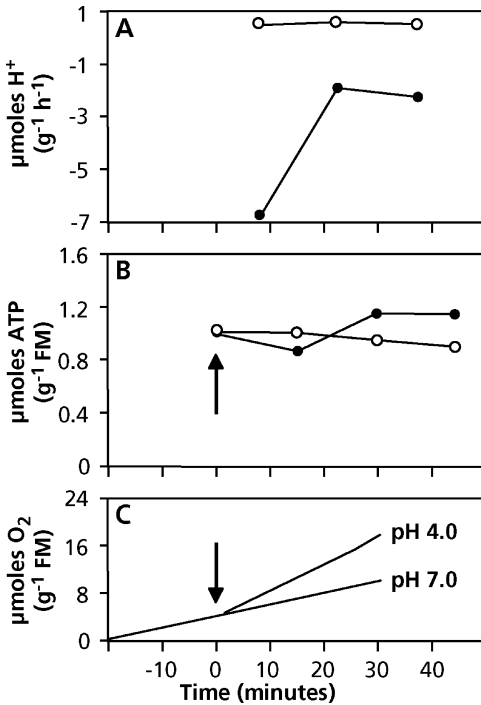

FIGURE 18. Effect of the pH in the rhizosphere on (A) net H⁺ release, (B) ATP concentration, and (C) respiration of *Zea mays* (maize) roots. Seedlings were grown at pH 7.0, and either kept at pH 7.0 (open symbols) or exposed to a pH of 4.0 (filled symbols) at the time indicated by the arrow. Note that the slopes in A and C give the rate of H⁺ release and respiration (after Yan et al. 1992). Copyright American Society of Plant Biologists.

does not occur to any major extent in the sensitive cultivar (Sect. 3.1 of Chapter 6 on mineral nutrition).

4.7 Partial Pressures of CO₂

CO₂ concentrations in air pockets in soil are up to 30-fold higher than those in the atmosphere. Although respiration rates are highest in superficial layers of soil where root biomass is concentrated, the CO₂ concentration increases with increasing profile depth, due to the restricted diffusion of gases in soil pores (Richter & Markewitz 1995).

The CO₂ concentration in the soil may increase substantially upon **flooding** of the soil. Values of 2.4 and 4.2 mmol CO₂ mol⁻¹ (0.24 and 0.42%, respectively) occur in flooded soils supporting the growth of desert succulents, as opposed to 0.54 and 1.1 mmol mol⁻¹ in the same soils, when well-drained (Nobel & Palta 1989). Good & Patrick (1987) found CO₂ concentrations of 5.6 and 3.8% in

silt loam, supporting the growth of *Fraxinus pennsylvanica* (green ash) and *Quercus nigra* (water oak), respectively. Do such high CO₂ concentrations affect root respiration?

Root respiration is reversibly inhibited by 5 mmol CO₂ mol⁻¹ in two cacti [*Opuntia ficus-indica* (prickly pear) and *Ferocactus acanthodes* (compass barrel cactus)] (Nobel & Palta 1989). Full inhibition occurs at 20 mmol CO₂ mol⁻¹ (2%) which is irreversible if lasting for 4 hours. Root respiration of *Pseudotsuga menziessii* (Douglas fir) and *Acer saccharum* (sugar maple) is also inhibited at soil CO₂ levels in a range normally found in soil (Qi et al. 1994, Burton 1997), whereas no such inhibition occurs for a range of other species (e.g., Bouma et al. 1997, Scheurwater et al. 1998). Because respiration is only affected by CO₂, and *not* by **bicarbonate** (Palet et al. 1992), the pH of the root environment will greatly affect experimental results (Fig. 51 in Chapter 2A on photosynthesis).

How can we account for effects of very high CO₂ concentration on respiration? The effects of soil CO₂ concentrations on root respiration is probably *indirect*, due to inhibition of energy-requiring processes. There may also be *direct* effects of a high concentration of CO₂ on respiration (i.e., inhibition of **cytochrome oxidase**) (Sect. 3.6). Other mitochondrial enzymes are also affected by high concentrations of inorganic carbon (González-Meler et al. 1996, Bruhn et al. 2007). Malic enzyme, which oxidizes malate to form pyruvate and CO₂, is rather strongly inhibited by HCO₃⁻ in a range that may well account for inhibition of respiration by CO₂ as found for some tissues (Chapman & Hatch 1977, Neuberger & Douce 1980). Some of the effects in vitro for several mitochondrial enzymes, however, only appear at CO₂ concentrations that are much higher than expected to occur in intact roots.

The information in the literature is still too scanty to draw the robust conclusion that CO₂ levels that normally occur in well drained soil have a *direct* inhibitory effect on root respiration (Lambers et al. 2002). After much discussion on inhibition of **leaf respiration** by elevated atmospheric CO₂ concentrations due to **global change**, there is now wide consensus that these are mostly artifacts of the methodology (Jahnke & Krewitt 2002, Davey et al. 2004). However, there are *indirect* effects of long-term exposure of plants to elevated [CO₂]. These effects are due to changes in, e.g., allocation, plant growth rate, chemical composition of the biomass, rather than accounted for by *direct* effects (Tjoelker et al. 1999, Griffin et al. 2001, Davey et al. 2004). Across all studies, mass-based leaf dark respiration is reduced by 18%, while area-based leaf respiration

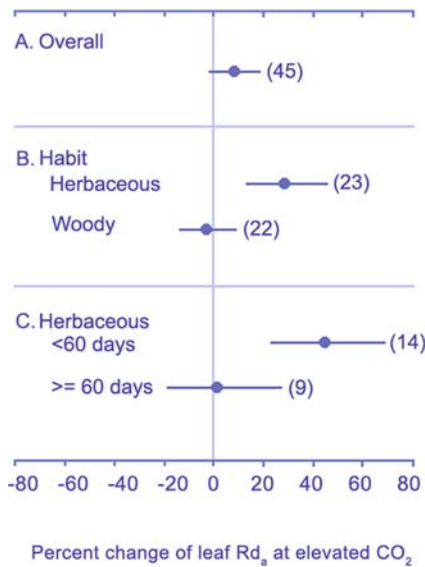

FIGURE 19. Long-term effects of elevated atmospheric CO_2 on leaf dark respiration expressed on a leaf area basis (R_{da}) across 45 independent observations. Effects of growth habit (herbaceous vs. woody species) on leaf R_{da} response and time (length of CO_2 exposure) on herbaceous species leaf R_{da} response to elevated CO_2 are also shown. Mean values \pm 95% confidence interval; the number of observations is shown in brackets (Wang & Curtis 2002).

is marginally increased (8%), under elevated atmospheric CO_2 concentrations. Area-based leaf respiration of **herbaceous** species increases by 28%, but is unaffected in **woody** species (Fig. 19). Mass-based reductions in leaf respiration tend to increase with prolonged exposure to elevated $[\text{CO}_2]$. In cladodes of *Opuntia ficus-indica* (prickly pear), reductions in respiration are associated with a decrease in **mitochondrial number** and cytochrome path activity, and an increase in activity of the alternative path (Gomez-Casanovas et al. 2007). A **meta-analysis** of published results suggests that the amount of carbon use in leaf dark respiration will increase in a higher- $[\text{CO}_2]$ environment, because of higher area-based leaf respiration rates and a proportionally greater leaf biomass increase than reductions in mass-based leaf respiration (Wang & Curtis 2002).

4.8 Effects of Plant Pathogens

Pathogen attack on roots or leaves causes an increase in respiration, but the pattern of this respiratory response may differ between sensitive

and resistant varieties of plants. For example, **nematode** infection of roots of a susceptible variety of *Solanum lycopersicum* (tomato) causes root respiration first to increase, but then to return to the level of uninfested plants. By contrast, the resistant variety shows no initial change in root respiration in response to nematode attack, but after 8 days the respiration rate exceeds that of control plants (Zacheo & Molinari 1987).

Just as with tomato roots, leaves of a susceptible variety of *Hordeum distichum* (barley) show a large increase in respiration when infected with the **fungus** causing powdery mildew. This is expected, as both fungus and host have high demands for energy (the fungus for growth, the host for defense). In the case of barley, most of the respiration is accounted for by host respiration (Farrar & Ryans 1987).

Both **mRNA levels** that encode the alternative oxidase and the amount of **alternative oxidase protein** strongly increase in leaves of *Arabidopsis thaliana* (thale cress) that are infiltrated with the leaf-spotting bacterium *Pseudomonas syringae* (Simons et al. 1999). What could be the functional significance for an increase of this pathway? Pathogenic fungi may produce **ethylene** and enhance the concentration of **salicylic acid** and **reactive oxygen species** in the plant (Overmyer et al. 2003). These compounds may trigger the increased activity of the alternative path. In ripening fruits ethylene enhances alternative respiration; salicylic acid induces the large increase in respiration in the spadix of thermogenic *Arum* species (Sect. 3.1) and in vegetative organs of nonthermogenic plants; reactive oxygen species trigger expression of the alternative oxidase in a range of species (Purvis & Shewfelt 1993, Considine et al. 2002). Quite likely, the enhanced synthesis of defense-related compounds (phytoalexins and other phenolics; Sect. 3 of Chapter 9C on effects of microbial pathogens) requires a large production of NADPH in the **oxidative pentose phosphate** pathway (Fig. 2) (Shaw & Samborski 1957). This pathway, unlike glycolysis (Fig. 3), is not regulated by the demand for metabolic energy. Products of the oxidative pentose phosphate pathway can enter glycolysis, bypassing the steps controlled by energy demand. Additional NADPH can be produced by cytosolic **NADP-malic enzyme**, which oxidizes malate, producing pyruvate and CO_2 . This enzyme is induced upon addition of "elicitors" (i.e., chemical components of a microorganism that induces the synthesis of defense compounds in plant cells) (Sect. 3 of Chapter 9C on effects of microbial pathogens) (Schaaf et al. 1995). The increased activity of the oxidative pentose pathway and of NADP-malic enzyme probably leads to

the delivery of a large amount of pyruvate and malate to the mitochondria, without there being a large need for ATP. As a result, the cytochrome path becomes saturated with electrons, the alternative oxidase is activated (Sect. 2.6.2), and much of the electrons are transported via the alternative pathway (Sect. 3.3) (Simons & Lambers 1999).

4.9 Leaf Dark Respiration as Affected by Photosynthesis

Both photosynthesis and mitochondrial respiration ("dark" respiration, as opposed to photorespiration) produce ATP and NAD(P)H to meet demands for plant growth and maintenance. The light reaction in photosynthesis provides ATP and NAD(P)H for biosynthesis in a leaf cell during illumination, but mitochondrial respiration in the light is necessary for biosynthetic reactions in the cytosol, such as sucrose synthesis (Krömer 1995). Respiratory activity in the light can be considered part of the photosynthetic process, because it is needed to regulate the redox state of the stroma in the chloroplast during photosynthesis (Foyer & Noctor 2000) and to maintain the cytosolic ATP pool (Krömer 1995). The rate of mitochondrial respiration during photosynthesis is therefore determined by the need for this process to provide energy and carbon skeletons in the light. Light inhibits leaf "dark" respiration, but the extent of inhibition depends on species and environmental conditions. In leaves of *Eucalyptus pauciflora* (snow gum), respiration is inhibited most at very low light intensities and moderate temperatures, and considerably less at higher irradiance. The irradiance necessary to maximally inhibit R at 6 to 10°C is lower than that at 15 to 30°C (Atkin et al. 2000). In leaves of *Xanthium strumarium* (common cocklebur) respiration is inhibited at both ambient and elevated CO₂ concentrations, but to a lesser degree for plants grown at elevated (17–24%) than for those grown at ambient (29–35%) CO₂ concentrations, presumably because elevated CO₂-grown plants have a higher demand for energy and carbon skeletons (Wang et al. 2001). Variations in light inhibition of leaf respiration can have a substantial impact on the proportion of carbon fixed in photosynthesis that is respired.

The metabolic origin of the CO₂ production in leaf "dark" respiration during photosynthesis can be analyzed by feeding ¹³C-enriched glucose or pyruvate to intact leaves. Using metabolites that are ¹³C-enriched in different positions, reveals that in leaves of *Phaseolus vulgaris* (common bean) the activity of the TCA cycle is reduced by 95% in the light; pyruvate dehydrogenase activity, however, is much

less reduced (27%). Glucose molecules are scarcely metabolized to liberate CO₂ in the light, because glycolysis is down-regulated. Instead, glucose is mainly used for sucrose synthesis. Several metabolic processes (glycolysis, TCA cycle) are down-regulated, leading to a light-dependent inhibition of mitochondrial respiration (Tcherkez et al. 2005).

5. The Role of Respiration in Plant Carbon Balance

5.1 Carbon Balance

Approximately half of all the photosynthates produced per day are respired in the same period, the exact fraction depending on species and environmental conditions (Table 1). Globally rising temperatures tend to increase the proportion of carbon gained in photosynthesis that is subsequently used in respiration (Atkin et al. 2007). The level of irradiance and the photoperiod appear to affect the carbon balance of acclimated plants to a relatively small extent, but factors such as inadequate nutrient supply and water stress may greatly increase the proportion of photosynthates used in respiration. This is accounted for by a much stronger effect of nutrients on biomass allocation, when compared to that of irradiance and photoperiod (Chapter 7 on growth and allocation). Root temperature is also likely to affect plant carbon balance because this has a major effect on biomass allocation (Sect. 5.2.2 of Chapter 7 on growth and allocation).

5.1.1 Root Respiration

Root respiration accounts for approximately 10–50% of the total carbon assimilated each day in photosynthesis (Table 1) and is a major proportion of the plant's carbon budget (Fig. 20). This percentage is much higher in slow-growing than in fast-growing plants. This is true for a comparison of species that vary in their **potential growth rate** (Poorter et al. 1991) and for plants of the same species that vary in growth rate, due to variation in the **nutrient supply** (Van der Werf et al. 1992a). Root temperatures that enhance biomass allocation to roots (Sect. 5.2.2 of Chapter 7 on growth and allocation) probably also increase the proportion of carbon required for root respiration. When slow growth is due to exposure to low light levels, however, no greater respiratory burden is incurred (Sect. 4.4). To some extent the proportionally greater carbon use in slow-growing plants is accounted for by their

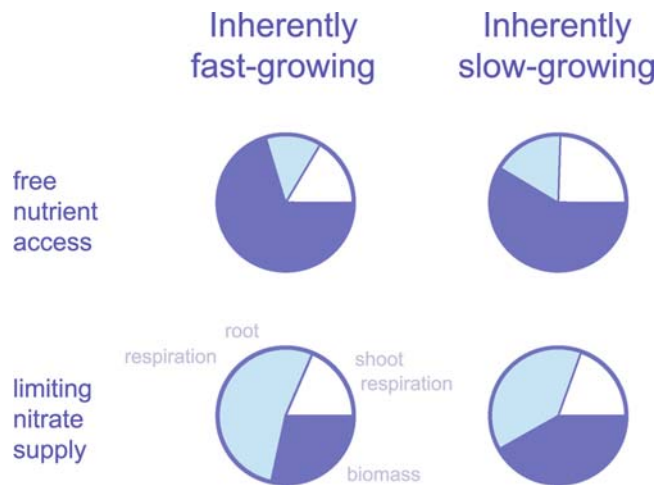

FIGURE 20. The fraction of all carbohydrates produced in photosynthesis per day that is consumed in respiration as dependent on species and the nitrogen supply. Measurements were made on inherently fast-growing (pies on the left) and slow-growing (pies on the right) grass species grown with free nutrient availability (pies at the top) and at a N supply that allowed a relative growth rate of approximately $40 \text{ mg g}^{-1} \text{ day}^{-1}$ (pies at the bottom). The percentages at each

pie indicate the carbon gain in photosynthesis per unit plant mass, relative to that of the fast-growing species grown with free access to nutrients. The black section of the pie refers to carbon invested in growth; the other two sections refer to carbon used in shoot respiration (white sector), and with root respiration depicted as the loose section of the pie (Van der Werf et al. 1992a). Copyright SPB Academic Publishing.

relatively low carbon gain per unit plant mass (Sect. 3 of Chapter 7 on growth and allocation) (Poorter et al. 1995). This does not explain the entire difference, however; variation in respiratory efficiency and/or respiratory costs for processes like ion transport may play an additional role (Sect. 5.2.3).

Root respiration provides the driving force for root growth and maintenance and for ion absorption and transport into the xylem. The percentage of total assimilates that are used in root respiration tends to decrease as plants age. Such a decrease may be due to a decrease in the demand for respiratory energy, when the energy required for root growth and ion uptake decreases with increasing age. Furthermore, the root mass ratio tends to decrease with increasing age, thus decreasing the respiratory burden of roots.

The fraction of carbohydrates used in root respiration, including the respiration of symbionts, if present, is affected by both abiotic and biotic environmental factors (Table 1). Root respiration is higher in the presence of an N_2 -fixing symbiont than when nonnodulated roots are supplied with NO_3^- as a N source. This reflects the greater energy requirement for N-assimilation during N_2 -fixation compared with NO_3^- -assimilation (Sect. 3 of Chapter 9A on symbiotic associations). The fraction of carbohydrates used in root respiration is also greater

in the presence of a symbiotic **mycorrhizal fungus** than in nonsymbiotic plants (Table 1).

The *proportion* of the carbohydrates translocated to roots that is used in respiration, rather than root biomass accumulation, increases with plant age. This is primarily due to the increasing role of maintenance respiration, as root growth slows down and as the *quantity* of assimilates translocated to roots declines (Sect. 5.2). Low nutrient supply also increases the proportion of carbohydrates respired in the roots. At a high supply of nutrients, plants respire approximately 40% of the carbon imported into the roots. This fraction increases to 60% at very low nutrient supply (Van der Werf et al. 1992a). This increase is largely accounted for by a relatively high carbon requirement for maintenance processes compared with that in growth processes. An additional factor is the proportionally low requirement for root growth (relative to maintenance) under these low-nutrient conditions. Finally, specific costs for maintenance or ion uptake might increase when nutrients are in short supply (Van der Werf et al. 1994) (Sect. 5.2).

5.1.2 Respiration of Other Plant Parts

Leaf respiration provides some of the metabolic energy for leaf growth and maintenance, for ion

transport from the xylem and export of solutes to the phloem. Leaf respiration, expressed as a fraction of the carbon gain in photosynthesis, however, varies much less than root respiration, because photosynthesis, leaf respiration and biomass allocation are affected similarly by changes in nutrient supply. This differs from the situation for roots, where a major cause of the large variation found for root respiration (Table 1) is the effect of nutrient supply and genotype on **biomass allocation** to roots.

Rates of photosynthesis and leaf respiration often vary in a similar manner with changes in environment (e.g., N supply and growth irradiance) (Reich et al. 1998). This may be explained by greater respiratory costs of export of photosynthates from leaves which vary with the carbon gained in photosynthesis. There may also be greater maintenance costs in leaves with high rates of photosynthesis and high protein concentrations. Specific costs for major energy-requiring processes (e.g., for transport of assimilates from the mesophyll to the sieve tubes) may also vary among species and environmental conditions (Cannell & Thornley 2000).

The respiration of other plant parts (e.g., fruits) is largely accounted for by their growth rate and the respiratory costs per unit of growth. The maintenance component also plays a role. In green fruits, a substantial proportion of this energetic requirement may be met by photosynthesis in the fruit (De Jong & Walton 1989, Blanke & Whaley 1995). Respiration of the flowers of *Citrus paradisi* (grapefruit) shows a distinct peak about 42 days after emergence. This peak occurs after a peak in respiration that is associated with growth of the flower. A major part of the respiration of the grapefruit flowers is probably accounted for by the alternative path (Bustan & Goldschmidt 1998, Considine et al. 2001).

5.2 Respiration Associated with Growth, Maintenance, and Ion Uptake

The rate of respiration depends on three major energy-requiring processes: **maintenance** of biomass, **growth**, and (ion) **transport**, as summarized in the following overall equation:

$$r = r_m + c_g \text{ RGR} + c_t \text{ TR} \quad (2)$$

where r is the rate of respiration (normally expressed as nmol O_2 or $\text{CO}_2 \text{ g}^{-1} \text{ s}^{-1}$, but to comply with the units in which RGR is expressed, we use here $\mu\text{mol g}^{-1} \text{ day}^{-1}$); r_m is the rate of respiration to produce ATP for the maintenance of biomass; c_g (mmol O_2 or $\text{CO}_2 \text{ g}^{-1}$) is the respiration to produce

ATP for the synthesis of cell material; RGR is the relative growth rate of the roots ($\text{mg g}^{-1} \text{ day}^{-1}$); c_t (mol O_2 or $\text{CO}_2 \text{ mol}^{-1}$) is the rate of respiration required to support TR, the transport rate ($\mu\text{mol g}^{-1} \text{ day}^{-1}$). In roots TR, equals the net ion uptake rate and the rate of xylem loading; in photosynthesizing leaves TR equals the rate of export of the products of photosynthesis (from mesophyll to sieve tubes). Although respiration can be measured as either O_2 uptake or as CO_2 release, the measurements do not yield exactly the same values. First, RQ may not equal 1.0 (Sect. 2.1); second, the rate of CO_2 release varies with the rate of NO_3^- reduction, whereas rates of O_2 consumption do not. For this reason **O_2 consumption** is preferred as a basis to compare plants when we are interested in **respiratory efficiency**, whereas **CO_2 release** is preferred when comparing the **carbon budgets** of different plants.

By examining these three requirements for respiratory energy, we can estimate how the ATP produced in respiration is used for major plant functions. This equation assumes a tight correlation between the rate of respiration and the rates of major energy-requiring processes; there is no implicit assumption that respiration controls the rate of the energy-requiring processes, or vice versa.

5.2.1 Maintenance Respiration

Once biomass is produced, energy must be expended for repair and maintenance. Estimates of the costs of maintaining biomass range from 35 to 80% of the photosynthates produced per day (Amthor 2000), higher values pertaining to plants that grow very slowly (Lambers et al. 2002) and lower values to shade-adapted species (Noguchi et al. 2001b). The energy demands of the individual maintenance processes *in vivo* are not well known and reliable estimates of individual maintenance costs are scarce. A major part of the maintenance energy costs is supposed to be associated with **protein turnover** and with the maintenance of **solute gradients** across membranes. These costs of maintenance have been estimated from basic biochemical principles (Penning de Vries 1975, Amthor 2000, Bouma 2005).

In higher plants approximately 2–5% of all the proteins are replaced daily, with extreme estimates being as high as 20% (Van der Werf et al. 1992b, Bouma et al. 1994). It is quite likely that **protein turnover** rates vary among plant organs, species and with growth conditions, but the data are too scanty to make firm statements. The cost of

synthesizing proteins from amino acids is estimated at 4.7–7.9 ATP, and possibly double that, per peptide bond, or approximately 0.26 (possibly 0.52) g glucose g^{-1} protein (Amthor 2000). Approximately 75% of amino acids from degraded proteins are recycled (Davies 1979). The remaining 25% must be synthesized from basic carbon skeletons, at a cost of 0.43 g glucose g^{-1} protein. The total cost of protein turnover is about 28–53 mg glucose $g^{-1} day^{-1}$, or 3–5% of dry mass per day. Similar calculations for lipids suggest that membrane turnover constitutes a much lower energy requirement, approximately 1.7 mg glucose $g^{-1} day^{-1}$, or 0.2% of dry mass per day. Based on an experimentally determined protein half-life of 5 days, the respiratory energy requirement to sustain protein turnover is approximately 1 mmol ATP g^{-1} (dry mass) day^{-1} [i.e., 7% of the total respiratory energy produced in roots of *Dactylis glomerata* (cocksfoot)]. Expressed as a fraction of the total maintenance requirement as derived from a multiple regression analysis (Sect. 5.2) [i.e., 2.7 mmol ATP g^{-1} (dry mass) day^{-1} for *Carex* (sedge) species], the maintenance requirement for protein turnover is quite substantial (Van der Werf et al. 1992b).

Maintenance of **solute gradients** is also an important maintenance process. Some estimates suggest that the cost of maintaining solute gradients are up to 30% of the respiratory costs involved in ion uptake, or approximately 20% of the total respiratory costs of young roots (Bouma & De Visser 1993).

Other processes (e.g., cytoplasmic streaming and turnover of other cellular constituents) are generally assumed to have a relatively small cost. Based on these many (largely unproven) assumptions, the total estimated maintenance respiration is approximately 30–60 mg glucose $g^{-1} day^{-1}$ (3 to 6% of dry mass day^{-1}). Measured values of maintenance respiration (8–60 mg glucose $g^{-1} day^{-1}$) suggest that these rough estimates are reasonable.

These experimental values for maintenance respiration suggest that protein turnover and the maintenance of solute gradients are by far the largest costs of maintenance in plant tissues. If true, then this conclusion has important implications for plant carbon balance because it suggests that any factor that increases protein concentration or turnover or the leakiness of membranes will increase maintenance respiration.

The positive correlation of respiration rate with N concentration (Reich et al. 2006) is consistent with the prediction that maintenance respiration depends on protein concentration. Thus, leaves that have a high N investment in Rubisco and other photosynthetic enzymes have a correspondingly high maintenance respiration. Whether this is a general phenomena

remains to be investigated (Van der Werf et al. 1992b). Higher respiration rates might also reflect greater costs for the loading of photosynthates in the phloem, which is an ATP-requiring process (Sect. 3.3 of Chapter 2C on long-distance transport). Whatever the explanation for the higher leaf respiration rates, they do contribute to their higher light-compensation point (Sect. 3.2.1 of Chapter 2A on photosynthesis) and, therefore, place a higher limit on the irradiance level at which these leaves can maintain a positive carbon balance. Thus, there is a **trade-off** between high metabolic activity (requiring high protein concentrations and rapid loading of the phloem) and the associated increase in cost of maintenance and transport.

The stimulation of maintenance respiration by temperature is a logical consequence of the increased leakage and of protein turnover that occurs at high temperature (Rachmilevitch et al. 2006). This provides a conceptual framework for studies that seek to explain why different tissues and species differ in their Q_{10} of respiration. Perhaps this reflects differences in membrane properties upon prolonged exposure to higher temperatures or in thermal stability of proteins, with corresponding differences in protein turnover (Criddle et al. 1994). It might also reflect a difference in contribution of the cytochrome and the alternative pathways.

Increased maintenance respiration is often assumed to be the cause of declines in forest productivity in late succession (e.g., Waring & Schlesinger 1985). Maintenance respiration remains relatively constant through succession, however, while growth respiration declines (Fig. 21). The more likely cause of

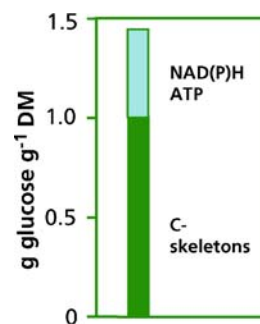

FIGURE 21. Construction costs of leaf biomass. Most of the glucose required for biomass production ends up in the carbon compounds in the biomass. Because the average carbon compound biomass is more reduced than the carbohydrates from which it is produced, some glucose is required to produce NADPH. Some of the glucose is required to produce ATP, that drives many energy-requiring biosynthetic reactions in the cell. The data are for an “average” leaf.

reduced growth in old forest stands is a reduced carbon gain caused by loss of leaf area and loss of photosynthetic capacity associated with reduced hydraulic conductance and in some cases with reduced nutrient availability (Ryan et al. 1997).

5.2.2 Growth Respiration

Production of biomass (**biosynthesis**) requires the input of carbohydrates, partly to generate ATP and NAD(P)H for biosynthetic reactions and partly to provide the carbon skeletons present in biomass (Fig. 22; Table 9). Plant tissue is, in general, more reduced than the carbohydrates from which it is produced, and the cost of biosynthesis from primary substrates must therefore include the carbohydrates necessary to supply reducing power, for example for the reduction of NO_3^- . If a more reduced source of N is absorbed instead (e.g., NH_4^+ or amino acids) (Sect. 2.2 of Chapter 6 on mineral nutrition), then biosynthetic costs are less. When a tissue senesces, most of the chemical constituents are lost to the plant, but some are resorbed and can be used in the production of new tissues. The **final cost** of producing a tissue is the **initial cost** minus **resorption** (Fig. 23).

In photosynthetically active leaves, some of the metabolic energy (ATP and NAD(P)H) may come directly from photosynthesis. In heterotrophic tissues such as roots, and in leaves in the dark, respiration provides the required energy. The amount of respiratory energy that is required for biosynthesis can be calculated from the composition of the biomass in several ways, as discussed in this section.

First, costs for biosynthesis can be derived from detailed information on the **biochemical**

composition, combined with biochemical data on the costs of synthesis of all the major compounds: protein, total nonstructural carbohydrates (i.e., sucrose, starch, fructans), total structural carbohydrates (i.e., cellulose, hemicellulose), lignin, lipid, organic acids, minerals. This can be extended to include various other compounds, e.g., soluble amino acids, nucleic acids, tannins, lipophilic defense compounds, alkaloids, but these are mostly ignored and generally combined with the major ones. Taking glucose as the standard substrate for biosynthesis, one can estimate the amount of glucose required to provide the carbon skeletons, reducing equivalents and ATP for the biosynthesis of plant compounds in tissues (Table 9; Poorter & Villar 1997).

Note that the amount of product produced per unit carbon substrate (production value, PV) varies nearly threefold among chemical constituents (Table 10), with lipid and lignin being "most expensive" (i.e., requiring greatest glucose investment per gram of product), and organic acids "least expensive". Compounds like proteins and lipids are very costly in terms of ATP required for their biosynthesis, whereas carbohydrates and cellulose are not. There are both expensive and cheap ways to produce structure in plants (lignin and cellulose/hemicellulose, respectively) and to store energy (lipid and sugars/starch, respectively) (Chapin 1989). Plants generally use energetically cheap structural components (cellulose/hemicellulose) and energy stores (sugars and starch). By contrast, mobile animals and small seeds, where mass is an important issue, often use lipids as their energy store. Immobile animals, like plants, use carbohydrate (glycogen) as their primary energy store. Knowing the costs and concentrations of the major compounds

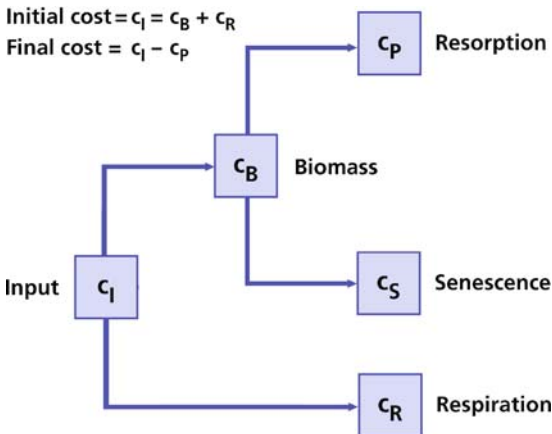

FIGURE 22. Fate of carbon that is initially invested (c_i) in synthesizing a structure. Some of the carbon is retained in the biomass (c_B), the remainder is required for respiration (c_R). Of the carbon in the biomass (c_B), most is lost or respired when a plant part is shed (c_S) but some is resorbed (c_P) for subsequent use (after Chapin 1989).

TABLE 9. Values for characterizing the conversion of substrates to products during biosynthesis, excluding costs of substrate uptake from the environment.*

Compound	PV'	ORF'	CPF'	RQ'	HRF	ERF
Amino acids with NH ₄ ⁺	700	169	5772	34	-11.2	-1.4
Amino acids with NO ₃ ⁻	700	169	5772	34	26.7	39.0
Protein with NH ₄ ⁺	604	163	5727	35	-12.9	34.9
Protein with NO ₃ ⁻	604	163	5727	35	31.4	82.0
Carbohydrates	853	0	1295	-	-3.6	12.2
Lipids	351	0	10705	-	-10.1	51.0
Lignin	483	1388	5545	4	-4.3	18.7
Organic acids	1104	0	-1136	-	16.9	-4.5

Source: De Visser et al. (1992).

* Production Value, PV': mg of the end product per g of substrate required for carbon skeletons and energy production, without taking into account the fate of excess or shortage of NAD(P)H and ATP (the term Production Value, PV, is used when PV' is corrected for this component); Oxygen Requirement Factor, ORF': μmol of O₂ consumed per gram of substrate required for carbon skeletons and energy production, without taking into account the fate of excess or shortage of NAD(P)H and ATP; Carbon dioxide Production Factor, CPF': μmol of CO₂ produced per g of substrate required for carbon skeletons and energy production, without taking into account the fate of excess or shortage of NAD(P)H and ATP (the term Carbon dioxide Production Factor, CPF, is used when CPF' is corrected for this component); RQ' is the ratio of CPF' and ORF'; Hydrogen Requirement Factor, HRF: moles of NAD(P)H required (-) or produced (+) per gram of end product; Energy Requirement Factor, ERF: moles of ATP required (-) or produced (+) per gram of end product (Penning de Vries et al. 1974). More recent findings, for example on the importance of targeting sequences of proteins which are required to "direct" the synthesized proteins to a specific compartment in the cell, indicate that the costs for protein synthesis are likely to be substantially, possibly even double the value as presented in this table.

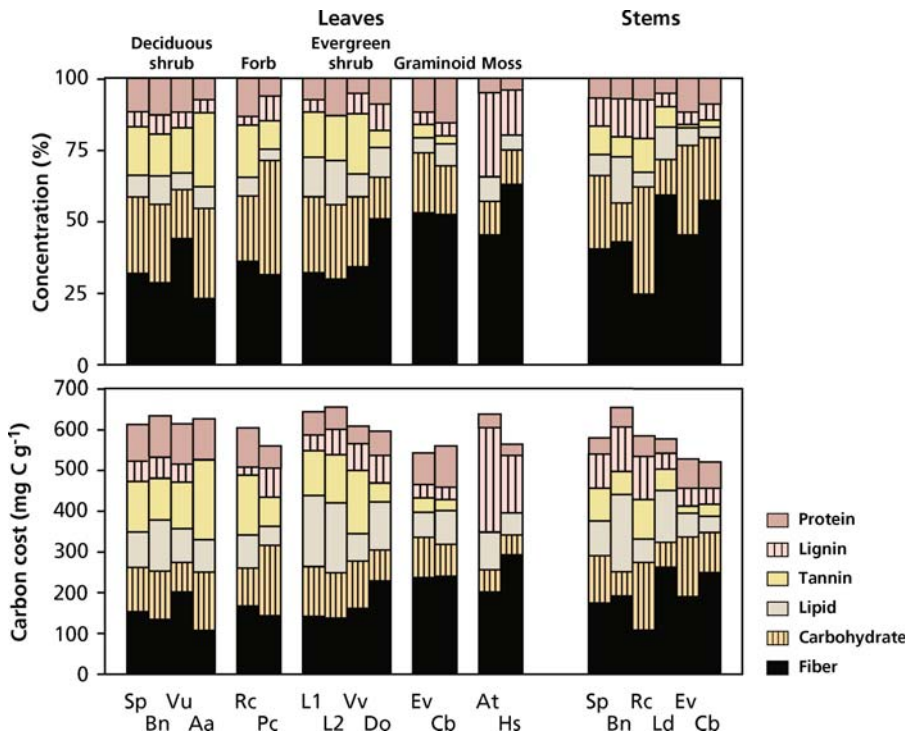

FIGURE 23. The chemical composition and carbon cost of producing leaves and stems of 13 species of tundra plants. Species shown are *Salix pulchra* (willow, Sp), *Betula nana* (dwarf birch, Bn), *Vaccinium uliginosum* (blueberry, Vu), *Arctostaphylos alpina* (bearberry, Aa), *Rubus chamaemorus* (cloudberry, Rc), *Pedicularis capitata* (wooly lousewort, Pc), *Ledum decumbens*

(Labrador tea, Ld, including 1-year old, L1, and 2-year old, L2, leaves), *Vaccinium vitis-idaea* (low-bush cranberry, Vv), *Dryas octopetala* (mountain avens, Do), *Eriophorum vaginatum* (tussock cottongrass, Ev), *Carex bigelowii* (Bigelow sedge, Cb), *Aulacomnium turgidum* (turgid aulacomnium moss, At), and *Hylocomium splendens* (feathermoss, Hs) (after Chapin 1989).

TABLE 10. An example of a simplified calculation of the variables characterizing biosynthesis of biomass from glucose, nitrate and minerals.

Compound	Concentration in biomass required (mg g ⁻¹ dry mass)	Glucose for synthesis	O ₂ required for synthesis (μmol)	CO ₂ production during synthesis (mmol)	NAD(P)H required for synthesis (mmol)	ATP required for synthesis (mmol)
N-compounds	230	371	65	2100	7.14	17.83
Carbohydrates	565	662	0	857	-2.03	6.92
Lipids	25	71	0	807	0.25	1.27
Lignin	80	166	230	918	-0.34	1.50
Organic acids	50	45	0	-52	-0.84	-0.23
Minerals	50	0	0	0	0	0
Total	1000	1315	295	4630	3.68	27.29

Source: Penning de Vries et al. (1974).

in plant biomass, we can calculate the costs for a gram of biomass. As for individual compounds, these costs can be expressed in terms of glucose, O₂ requirement, CO₂ release, requirement for reducing power and ATP (Table 10).

The major assumption underlying the approach based on the biochemical composition of the biomass is that glucose is the sole substrate for all ATP, reductant, and carbon skeletons. When some of these resources are derived directly from photosynthesis, costs may be lower. Costs may be higher when the alternative path, rather than the cytochrome path plays a predominant role in respiration. If we restrict this approach to nonphotosynthetic tissues in which the contribution of the cytochrome and alternative respiratory pathway is known, then there is still a source of error, if these tissues import compounds other than glucose, for example amino acids, as a substrate for biosynthesis.

A second method for estimating the construction cost is based on information on the **elemental composition** of tissues: C, H, O, N, and S (McDermitt & Loomis 1981). The construction costs that are not covered by this equation include costs of mineral uptake and transport of various compounds in the plant, costs for providing ATP for biosynthetic reactions, and reductant required to reduce molecular oxygen in some biosynthetic reactions. This method is less laborious than the first method, which requires detailed chemical analysis; however, it is based on the observations of the first method (i.e., that expensive compounds are generally more reduced than glucose, whereas cheap compounds are more oxidized) (Poorter 1994). Although this method, based on elemental analysis of plant biomass, may seem a crude approach, the approach is

surprisingly effective. First, this is because two thirds of the construction costs are costs to provide carbon skeletons rather than for respiration. Second, most of the carbon that does not end up in the carbon skeletons of biomass is required to reduce carbon skeletons, and not for the production of ATP. So, even in the absence of detailed information on respiratory pathways, construction costs can be estimated rather accurately. In fact, the second method can be simplified even further, taking into account only the **carbon and ash content** of biomass and ignoring minor constituents that have only a small effect on the production value (Vertregt & Penning de Vries 1987).

The level of reduction of plant biomass is approximately linearly related to its **heat of combustion** as well as its costs of construction (McDermitt & Loomis 1981). For example, lipids are highly reduced compounds and have a high heat of combustion. A third method, therefore, uses this approximation to arrive at costs for providing carbon skeletons and reductant for biosynthesis (Williams et al. 1987).

Given the three-fold range in the cost of producing different organic constituents in plants and the large range in concentrations of these constituents among plant parts and species [often 2-10-fold (Fig. 24)], we might expect large differences in costs of synthesizing tissues of differing chemical composition. A given tissue, however, tends to have *either* a high concentration of proteins and tannins (allowing high metabolic activity and chemical defense of these tissues) *or* a high concentration of lignin and lipophilic secondary metabolites (Chapin 1989). The negative correlation between the concentrations of these two groups of

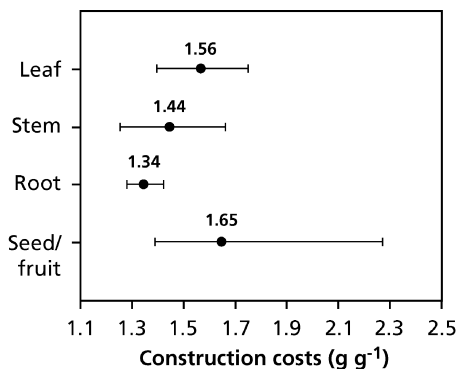

FIGURE 24. Range of construction costs for a survey of leaves ($n = 123$), stems ($n = 38$), roots ($n = 35$), and fruits/seeds ($n = 31$). Values are means and 10th and 90th percentiles (Poorter 1994). Copyright SPB Academic Publishing.

expensive constituents is seen in the comparison of leaves *vs.* stems or in the comparison of leaves of rapidly growing species (e.g., forbs) and slowly growing species (evergreen shrubs) (Fig. 24). The net result of this trade-off between expensive components allowing rapid metabolic activity (proteins) *vs.* those allowing persistence (lignin and lipophilic defensive compounds) is that the cost of all plant species and plant parts are remarkably similar: approximately 1.5 g glucose per gram of biomass (Figs. 23 and 24). Another important correlation that explains the similarity of construction costs across species and tissues is that tissues of fast-growing species that have high protein concentrations (an expensive constituent) also have high concentrations of minerals (cheap constituents) (Poorter 1994, Villar et al. 2006). This explains why extremely simple relationships are excellent predictors of costs of synthesis. The similarity of

cost of synthesis across species, plant parts and environments (Chapin 1989, Villar et al. 2006) differs from early conclusions that emphasized the high costs associated with lipids and lignin in evergreen leaves (Miller & Stoner 1979).

Small seeds are an exception to the generalization that all plant biomass has a similar cost of synthesis, because seed lipids are primarily an energy store (rather than an antiherbivore defense) and are positively associated with protein concentration (Fig. 25), leading to a high carbon cost. The similarity among species and tissues in carbon cost of synthesis has the practical consequence that biomass is an excellent predictor of carbon cost. One possible ecological explanation for this pattern is that carbon is such a valuable resource that natural selection has led to the same minimal carbon cost for the construction of most plant parts. An alternative, and more probable, explanation is that the negative correlations among expensive constituents and the positive correlation between protein and minerals have a basic physiological significance that, by coincidence, leads to a similar carbon cost of synthesis in most structures. For example, lignin and protein concentrations may be negatively correlated because young expanding cells have a high protein concentration, but cell expansion would be prevented by lignin, or that heavy lignification might render cell walls less permeable to water and solutes which would be disadvantageous in tissues with high metabolic activity (as gauged by high protein concentration). In general, currently available data suggest that costs of synthesis differ much less within (10–20%) and among (25%) ecosystems than do other causes of variation in carbon balance, such as respiration and allocation (Chapin 1989, Villar et al. 2006).

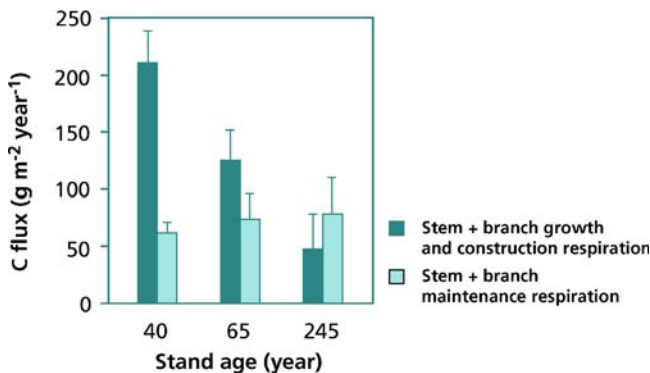

FIGURE 25. Annual carbon use for stem and branch growth (growth costs) and for stem and branch maintenance respiration in a lodgepole pine (*Pinus contorta*) successional sequence. Error bars show 95% confidence intervals (Ryan & Waring 1992). Copyright Ecological Society of America.

5.2.3 Respiration Associated with Ion Transport

Ion transport across membranes may occur via ion channels, if transport is down an electrochemical potential gradient, or via ion carriers, which allow transport against an electrochemical potential gradient (Sect. 2.2.2 of Chapter 6 on mineral nutrition). Because cation **transport from the rhizosphere** into the symplast mostly occurs down an electrochemical potential gradient, cation channels are often involved in this transport. This requires respiratory energy to extrude protons into the apoplast and create an **electrochemical potential gradient**. Transport of anions from the rhizosphere into the symplast almost invariably occurs against an electrochemical gradient and hence requires respiratory energy, mostly because such anion transport is coupled to proton re-entry into the cells (Sect. 2.2.2 of Chapter 6 on mineral nutrition).

The situation is exactly the opposite for the transport of ions from the symplast to the xylem (**xylem loading**). Anions might enter the xylem via channels, as this transport is mostly down an electrochemical gradient; however, we know little about such a mechanism (De Boer & Wegner 1997). The transport of most cations is against an electrochemical gradient, and hence the transport of cations to the xylem depends directly on metabolic energy. Release of anions into the xylem may be passive, but it still depends on the presence of an electrochemical potential gradient, which is maintained by the expenditure of metabolic energy. On the other hand, resorption of anions must be active (involving carriers) whereas that of cations may occur via channels (Wegner & Raschke 1994, De Boer & Wegner 1997).

When NO_3^- is the major source of N, this will be the major anion absorbed, because only 10% and 1%, respectively, as much P and S compared with N are required to produce biomass (Fig. 33 in Sect. 4.1.1 of Chapter 6 on mineral nutrition). Uptake of amino acids will also be against an electrochemical potential gradient and hence require a proton-cotransport mechanism similar to that described for NO_3^- . Like the uptake of NO_3^- and amino acids, P uptake also occurs via a proton symport mechanism (Sect. 2.2.2 of Chapter 6 on mineral nutrition). When P availability is low, however, P acquisition may require exudation of carboxylates (Sect. 2.2.5 of Chapter 6 on mineral nutrition) which will incur additional carbon expenditure. Similarly, P acquisition through a symbiotic association with mycorrhizal fungi

requires additional carbon (Sect. 2.6 of Chapter 9A on symbiotic associations).

As long as there is an electrochemical potential gradient, which is a prerequisite for the uptake of anions, cations can enter the symplast passively. In fact, plants may well need mechanisms to excrete cations that have entered the symplast passively, to avoid excessive uptake of some cation (e.g., Na^+) (Sect. 3.4.2 of Chapter 6 on mineral nutrition). When NH_4^+ is the predominant N source for the plant, such as in acid soils where rates of nitrification are low, this can enter the symplast via a cation channel. Rapid uptake of NH_4^+ , however, must be balanced by excretion of H^+ , so as to maintain a negative membrane potential. Hence, NH_4^+ uptake also occurs with expenditure of respiratory energy.

When NO_3^- is the predominant N-source, rather than NH_4^+ or amino acids, there are additional costs for its reduction. These show up with carbon costs and CO_2 release, but not in O_2 uptake (Table 9), because some of the NADH generated in respiration is used for the reduction of NO_3^- rather than for the reduction of O_2 . As a result, the RQ strongly depends on the source of N (NH_4^+ or NO_3^- ; Table 2) and on the rate of NO_3^- reduction. Costs associated with NO_3^- acquisition are less when the reduction of NO_3^- occurs in leaves exposed to relatively high light intensities, as opposed to reduction in the roots, because the reducing power generated in the light reactions exceeds that needed for the reduction of CO_2 in the Calvin cycle under these conditions (Sect. 3.2.1 of Chapter 2A on photosynthesis).

Given that N is a major component of plant biomass, most of the respiratory energy associated with nutrient acquisition in plants with free access to nutrients will be required for the uptake of this nutrient.

5.2.4 Experimental Evidence

Measurements made with roots provide an opportunity to test the concepts of maintenance respiration, growth respiration, and respiration associated with transport. We assume that the rate of respiration for maintenance of root biomass is linearly related to the root biomass to be maintained. Second, we assume that the rate of respiration for ion transport is proportional to the amount of ions taken up, whereas that for root growth is proportional to the relative growth rate of the roots, provided the chemical composition of the root biomass does not change in a manner that affects the

specific costs of biomass synthesis; superimposed is the maintenance respiration. Third, we assume that the contribution of the alternative path to total respiration is constant. Based on these assumptions, which are largely untested, the rate of ATP production per gram of roots and per day can be related to the relative growth rate of the roots and the rate of anion uptake by the roots. We can improve the approach by assessing the contribution of the **alternative path** (Box 2B.1), and correct for any changes during plant development (Florez-Sarasa et al. 2007). The costs of the three processes can then be estimated by **multiple regression analysis**, presented graphically in a three-dimensional plot (Fig. 26, left). If a plant's relative growth rate and rate of anion uptake are very closely correlated, which is common, then a multiple regression analysis cannot separate the costs of growth from those of ion uptake (Fig. 26, right).

Using the analysis as depicted in Fig. 26A, respiratory costs for growth, maintenance, and ion uptake have been obtained for a limited number of species (Table 11A). Quite often, the correlation between relative growth rate and nutrient uptake is so tight, that a linear regression analysis, as depicted in Fig. 26B, is the only approach possible (Table 11B). There is quite a large variation

in experimental values among species. This may reflect real differences between species; however, the variation may also indicate that the statistical analysis "explained" part of respiration by ion uptake in one experiment and by maintenance in another. For example, a costly process like ion leakage from roots, followed by re-uptake, may show up in the slope or in the y-intercept in the graph, and suggest large costs for ion uptake or for maintenance, respectively. At the highest rates of growth and ion uptake (young plants, fast-growing species) these data suggest that respiration for growth and ion uptake together account for about 60% of root respiration, and that maintenance respiration is relatively small. With increasing age, when growth and ion uptake slow down, maintenance respiration accounts for an increasing proportion of total respiration (over 85%).

The specific costs for *Carex* (sedge) species (Table 11A) were used to calculate the rate of root respiration of 24 other herbaceous species of differing potential growth rate whose rates of growth and ion uptake were known. These calculations greatly over-estimate the rate of root respiration of fast-growing species, when compared with measured values (Fig. 27). This suggests that

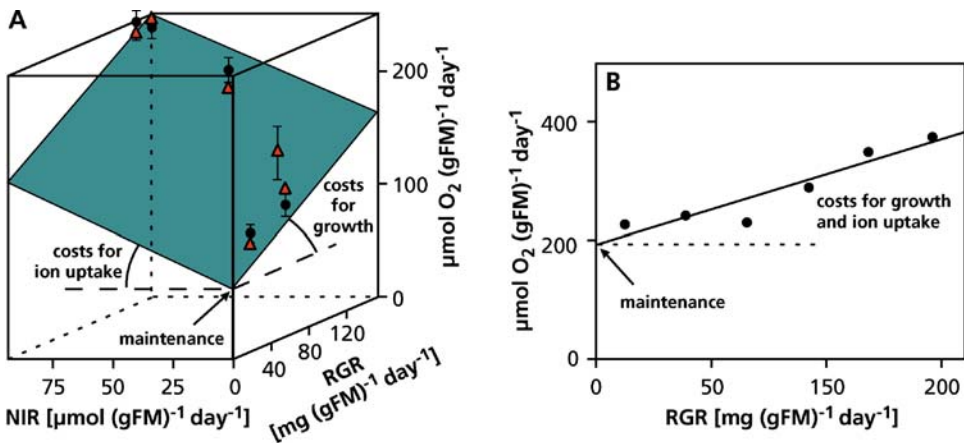

FIGURE 26. (A) Rate of O₂ consumption per unit fresh mass (FM) in roots as related to both the relative growth rate (RGR) of the roots and their net rate of anion uptake (NIR). (B) Rate of O₂ consumption per unit fresh mass in roots as related to the relative growth rate of the roots. The plane in (A) and line in (B) give the predicted mean rate of O₂ consumption. The intercept of the plane in (A) and the line in (B) with the y-axis

gives the rate of O₂ consumption in the roots which is required for maintenance. The slope of the projection of the line on the y-z plane gives the O₂ consumption required to produce one gram of biomass. When projected on the x-y plane, the slope gives the specific respiratory costs for ion transport. In (B) the slope gives costs for growth including ion uptake (after Lambers et al. 2002).

TABLE 11. (A) Specific respiratory energy costs for the maintenance of root biomass, for root growth and for ion uptake. (B) Specific respiratory energy costs for the maintenance of root biomass and for root growth including costs for ion uptake.

	<i>Carex</i> species	<i>Solanum tuberosum</i>	<i>Zea mays</i>	
A.				
Growth, mmol O ₂ (g dry mass) ⁻¹	6.3	10.9	9.9	
Maintenance, nmol O ₂ (g dry mass) ⁻¹ s ⁻¹	5.7	4.0	12.5	
Anion uptake, mol O ₂ (mol ions) ⁻¹	1.0	1.2	0.53	
B.				
	<i>Dactylis glomerata</i>	<i>Festuca ovina</i>	<i>Quercus suber</i>	<i>Triticum aestivum</i>
Growth + ion uptake, mmol O ₂ (g dry mass) ⁻¹	11	19	12	18
Maintenance, nmol (g dry mass) ⁻¹ s ⁻¹	26	21	6	22

Sources: (A) The values were obtained using a multiple regression analysis, as explained in Figure 25A [Van der Werf et al. 1988: average values for *Carex acutiformis* (pond sedge) and *Carex diandra* (lesser paniced sedge); Bouma et al. 1996: *Solanum tuberosum* (white potato); Veen 1980: *Zea mays* (corn)]. (B) The values were obtained using a linear regression analysis, as explained in Figure 25B [Scheurwater et al. 1998: *Dactylis glomerata* (cocksfoot) and *Festuca ovina* (sheep's fescue); Mata et al. 1996: *Quercus suber* (cork oak); Van den Boogaard, as cited in Lambers et al. 2002: *Triticum aestivum* (wheat)].

either the efficiency of respiration is greater (e.g., relatively more cytochrome path and less alternative path activity) in fast-growing species, or that the specific costs for growth, maintenance or ion

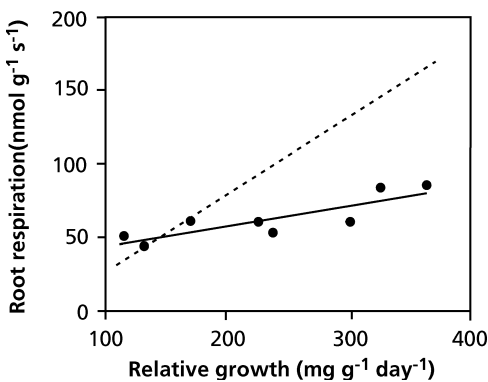

FIGURE 27. The rate of root respiration of fast-growing and slow-growing herbaceous C₃ species. The broken line gives the calculated respiration rate, assuming that specific costs for growth, maintenance, and ion uptake are the same as those given in Table 11 and identical for all investigated species (Poorter et al. 1991). Copyright Physiologia Plantarum.

uptake are lower for fast-growing species. Is there any evidence to support either hypothesis?

Roots of fast-growing grass species exhibit higher rates of alternative path activity than slow-growing grasses (Millenaar et al. 2001), and hence there is no evidence for a more efficient respiration in roots of fast-growing species. Specific respiratory costs for root growth are somewhat higher for fast-growing species (Fig. 28A), and maintenance costs, if anything, are higher, rather than lower, for roots of fast-growing species, possibly be due to their higher protein concentrations and associated turnover costs (Scheurwater et al. 1998, 2000). If neither a low respiratory efficiency nor higher costs for growth or maintenance can account for unexpectedly fast respiration rates of slow-growing plants, then the discrepancy between the expected and measured rates of root respiration (Fig. 27) must be based on higher **specific costs** for ion uptake in the inherently slow-growing species (Fig. 28B). These higher specific costs when plants are grown with free access to NO₃⁻ are accounted for by a large **efflux of NO₃⁻** (Sect. 2.2.2 of Chapter 6 on mineral nutrition; Scheurwater et al. 1999). It should be noted that many slow-growing species naturally grow in a low-NO₃⁻

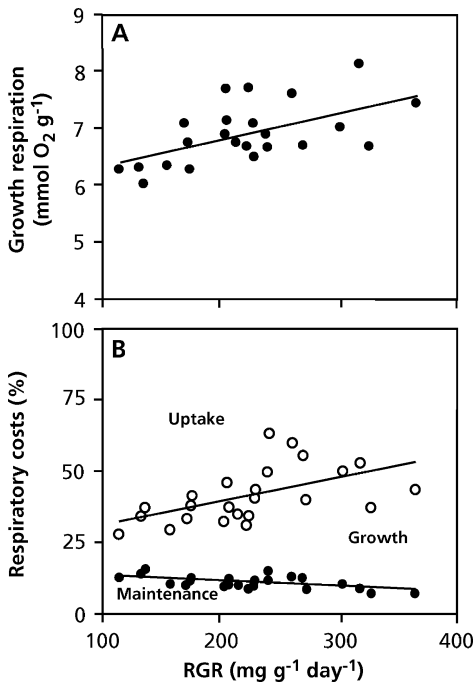

FIGURE 28. Characteristics of root respiration of inherently fast- and slow-growing herbaceous species, grown at free nutrient availability. (A) Respiratory cost for growth, as derived from an analysis of the roots' chemical composition and known cost for the synthesis of the various plant compounds. (B) Assuming similar respiratory efficiencies and maintenance costs for all species and using the costs for growth as given in (A), the specific costs for ion uptake were calculated. It is suggested that these costs are substantially higher for slow-growing herbaceous species than for fast-growing ones (Poorter et al. 1991). Copyright Physiologia Plantarum.

environment, and hence would rarely be exposed to the experimental conditions as used referred to here. The question that remains to be addressed is whether NO_3^- efflux also plays a role when NO_3^- availability limits plant growth. Given that root respiration rates are also unexpectedly high for plants grown at a severely limiting NO_3^- supply (Fig. 14), this is certainly a likely possibility.

The rate of root respiration of plants grown with a limiting nutrient supply is lower than that of plants grown with free access to nutrients, but not nearly as low as expected from their low rates of growth and nutrient acquisition (Sect. 4.3). This again suggests increased specific costs, possibly for ion uptake. Further experimental evidence is needed to address this important question concerning the carbon balance and growth of slow-growing plants.

In summary, experimental data suggest that the concept of respiration associated with growth, maintenance, and ion uptake is a valuable tool in understanding the carbon balance of plants and that the partitioning of respiration among these functions may differ substantially with environment and the type of plant species.

6. Plant Respiration: Why Should It Concern Us from an Ecological Point of View?

A large number of measurements have been made on the gas exchange (i.e., rates of photosynthesis, respiration, and transpiration) of different plants growing under contrasting conditions. Those measurements have yielded fascinating experimental results, some of which have been discussed in Chapter 2A on photosynthesis. There is often the (implicit) assumption, however, that rates of photosynthesis provide us with vital information on plant growth and productivity. Certainly, photosynthesis is essential for most of the gain in plant biomass; however, can we really derive essential information on growth rate and yield from measurements on photosynthesis alone?

Rates of photosynthesis per unit leaf area are poorly correlated with rates of growth, let alone final yield (Evans 1980). One of the reasons that have emerged in this chapter on plant respiration is that the fraction of all carbohydrates that are gained in photosynthesis and subsequently used in respiration varies considerably. First, slow-growing genotypes require relatively more of their photoassimilates for respiration. Secondly, many environmental variables affect respiration more than photosynthesis. This is true both because respiration rate is sensitive to environment and because the size of nonphotosynthetic plant parts, relative to that of the photosynthetically active leaves depends on the environment, as discussed in Chapter 7 on growth and allocation. Clearly, an important message from this chapter on plant respiration should be that measurements of leaf photosynthesis by themselves cannot provide us with sound information on a plant's growth rate or productivity.

A second message worth emphasizing here is that respiration and the use of respiratory energy [NAD(P)H, ATP] are not as tightly linked as long believed. Respiration may proceed via pathways that do not yield the respiratory products needed

for growth, but produces heat instead. These components of respiration can be substantial, at least in some plants under some conditions. In specific tissues the production of heat may be of use to the plant, but the ecophysiological significance of it in other tissues is different.

A challenge for the future will be to explore to what extent respiration scales with other plants traits, as has been done for photosynthesis (Sect. 6 of Chapter 2A). There is clear evidence that specific respiration rates scale with tissue N concentration, just like photosynthesis does, but we have yet to explore scaling patterns with a range of other traits.

References

- Amthor, J.S. 2000. The McCree-de Wit-Penning de Vries-Thornley respiration paradigms: 30 years later. *Ann. Bot.* **86**: 1–20.
- Andrews, D.L., Cobb, B.G., Johnson, J.R., & Drew, M.C. 1993. Hypoxic and anoxic induction of alcohol dehydrogenase in roots and shoots of seedlings of *Zea mays*. *Adh* transcripts and enzyme activity. *Plant Physiol.* **101**: 407–414.
- Armstrong, A.F., Logan, D.C., Tobin, A.K., O'Toole, P., & Atkin, O.K. 2006. Heterogeneity of plant mitochondrial responses underpinning respiratory acclimation to the cold in *Arabidopsis thaliana* leaves. *Plant Cell Environ.* **29**: 940–949.
- Armstrong, J., Lemos, E.E.P., Zobayed, S.M.A., Justin, S.H.F.W., & Armstrong, W. 1997. A humidity-induced convective throughflow ventilation system benefits *Annona squamosa* L. explants and coconut calloid. *Ann. Bot.* **79**: 31–40.
- Atkin, O.K. & Tjoelker, M.G. 2003. Thermal acclimation and the dynamic response of plant respiration to temperature. *Trends Plant Sci.* **8**: 343–351.
- Atkin, O.K., Villar, R., & Lambers, H. 1995. Partitioning of electrons between the cytochrome and the alternative pathways in intact roots. *Plant Physiol.* **108**: 1179–1183.
- Atkin, O.K., Evans, J.R., Ball, M.C., Lambers, H., & Pons, T.L. 2000. Leaf respiration of snow gum in the light and dark. interactions between temperature and irradiance. *Plant Physiol.* **122**: 915–924.
- Atkin, O.K., Scheurwater, I., & Pons, T.L. 2007. Respiration as a percentage of daily photosynthesis in whole plants is homeostatic at moderate, but not high, growth temperatures. *New Phytol.* **174**: 367–380.
- Atkinson, L.J., Hellicar, M.A., Fitter, A.H., & Atkin, O.K. 2007. Impact of temperature on the relationship between respiration and nitrogen concentration in roots: an analysis of scaling relationships, Q10 values and thermal acclimation ratios. *New Phytol.* **173**: 110–120.
- Ben Zioni, A., Vaadia, Y., & Lips, S.H. 1971. Nitrate uptake by roots as regulated by nitrate reduction products of the shoot. *Physiol. Plant* **24**: 288–290.
- Bigeleisen, J. & Wolfsberg, M. 1959. Theoretical and experimental aspects of isotope effects in chemical kinetics. *Adv. Chem. Phys.* **1**: 15–76.
- Bingham, I.J. & Farrar, J.F. 1988. Regulation of respiration in barley roots. *Physiol. Plant* **73**: 278–285.
- Blanke, M.M. & Whiley, A.W. 1995. Bioenergetics, respiration costs and water relations of developing avocado fruit. *J. Plant Physiol.* **145**: 87–92.
- Blokhina, O., Virolainen, E., & Fagerstedt, K.V. 2003. Antioxidants, oxidative damage and oxygen deprivation stress: a review. *Ann. Bot.* **91**: 179–194.
- Bloom, A. & Epstein, E. 1984. Varietal differences in salt-induced respiration in barley. *Plant Sci. Lett.* **35**: 1–3.
- Bloom, A.J., Caldwell, R.M., Finazzo, J., Warner, R.L., & Weissbart, J. 1989. Oxygen and carbon dioxide fluxes from barley shoots depend on nitrate assimilation. *Plant Physiol.* **91**: 352–356.
- Bouma, T. 2005. Understanding plant respiration: Separating respiratory components *versus* a process-based approach. In: Plant respiration. From cell to ecosystem, H. Lambers & M. Ribas-Carbó (eds.). Springer, Dordrecht, pp. 177–194.
- Bouma, T. & De Visser, R. 1993. Energy requirements for maintenance of ion concentrations in roots. *Physiol. Plant* **89**: 133–142.
- Bouma, T., De Visser, R., Janssen, J.H.J.A., De Kock, M.J., Van Leeuwen, P.H., & Lambers, H. 1994. Respiratory energy requirements and rate of protein turnover *in vivo* determined by the use of an inhibitor of protein synthesis and a probe to assess its effect. *Physiol. Plant* **92**: 585–594.
- Bouma, T., Broekhuysen, A.G.M., & Veen, B.W. 1996. Analysis of root respiration of *Solanum tuberosum* as related to growth, ion uptake and maintenance of biomass: a comparison of different methods. *Plant Physiol. Biochem.* **34**: 795–806.
- Bouma, T., Nielsen, K.L., Eissenstat, D.M., & Lynch, J.P. 1997. Estimating respiration of roots in soil: interactions with soil CO₂, soil temperature and soil water content. *Plant Soil* **195**: 221–232.
- Bruhn, D., Wiskich, J.T., & Atkin, O.K. 2007. Contrasting responses by respiration to elevated CO₂ in intact tissue and isolated mitochondria. *Funct. Plant Biol.* **34**: 112–117.
- Burton, A.J., Zogg, G.P., Pregitzer, K.S., & Zak, D.R. 1997. Effect of measurement CO₂ concentration on sugar maple root respiration. *Tree Physiol.* **17**: 421–427.
- Bustan, A. & Goldschmidt, E.E. 1998. Estimating the cost of flowering in a grapefruit tree. *Plant Cell Environ.* **21**: 217–224.
- Cannell, M.G.R. & Thornley, J.H.M. 2000. Modelling the components of plant respiration: some guiding principles. *Ann. Bot.* **85**: 45–54.
- Chapin III, F.S. 1989. The costs of tundra plant structures: Evaluation of concepts and currencies. *Am. Nat.* **133**: 1–19.
- Chapman, K.S.R. & Hatch, M.D. 1977. Regulation of mitochondrial NAD-malic enzyme involved in C₄ pathway photosynthesis. *Arch. Biochem. Biophys.* **184**: 298–306.
- Collier, D.E., Ackermann, F., Somers, D.J., Cummins, W.R., & Atkin, O.K. 1993. The effect of aluminium exposure on root respiration in an aluminium-sensitive and an aluminium-tolerant cultivar of *Triticum aestivum*. *Physiol. Plant.* **87**: 447–452.

- Colmer, T.D. 2003a. Aerenchyma and an inducible barrier to radial oxygen loss facilitate root aeration in upland, paddy and deep-water rice (*Oryza sativa* L.). *Ann. Bot.* **91**: 301–309.
- Colmer, T.D. 2003b. Long-distance transport of gases in plants: a perspective on internal aeration and radial oxygen loss from roots. *Plant Cell Environ.* **26**: 17–36.
- Considine, M.J., Daley, D.O., & Whelan, J. 2001. The expression of alternative oxidase and uncoupling protein during fruit ripening in mango. *Plant Physiol.* **126**: 1619–1629.
- Considine, M.J., Holtzapffel, R.C., Day, D.A., Whelan, J., & Millar, A.H. 2002. Molecular distinction between alternative oxidase from monocots and dicots. *Plant Physiol.* **129**: 949–953.
- Covey-Crump, E.M., Attwood, R.G., & Atkin, O.K. 2002. Regulation of root respiration in two species of *Plantago* that differ in relative growth rate: the effect of short- and long-term changes in temperature. *Plant Cell Environ.* **25**: 1501–1513.
- Covey-Crump, E.M., Bykova, N.V., Affourtit, C., Hoefnagel, M.H.N., Gardeström, P. & Atkin, O.K. 2007. Temperature-dependent changes in respiration rates and redox poise of the ubiquinone pool in protoplasts and isolated mitochondria of potato leaves. *Physiol. Plant* **129**: 175–184.
- Criddle, R.S., Hopkin, M.S., McArthur, E.D., & Hansen, L.D. 1994. Plant distribution and the temperature coefficient of metabolism. *Plant Cell Environ.* **17**: 233–243.
- Dacey, J.W.A. 1980. Internal winds in water lilies: an adaptation for life in anaerobic sediments. *Science* **210**: 1017–1019.
- Dacey, J.W.A. 1987. Knudsen-transitional flow and gas pressurization in leaves of *Nelumbo*. *Plant Physiol.* **85**: 199–203.
- Davey, P.A., Hunt, S., Hymus, G.J., DeLucia, E.H., Drake, B.G., Karnosky, D.F., & Long, S.P. 2004. Respiratory oxygen uptake is not decreased by an instantaneous elevation of [CO₂], but is increased with long-term growth in the field at elevated [CO₂]. *Plant Physiol* **134**: 520–527.
- Davies, D.D. 1979. Factors affecting protein turnover in plants. In: Nitrogen assimilation of plants, E.J. Hewitt & C.V. Cutting (eds.). Academic Press, London, pp. 369–396.
- Day, D.A., Whelan, J., Millar, A.H., Siedow, J.N., & Wiskich, J.T. 1995. Regulation of the alternative oxidase in plants and fungi. *Aust. J. Plant Physiol.* **22**: 497–509.
- Day, D.A., Krab, K., Lambers, H., Moore, A.L., Siedow, J.N., Wagner, A.M., & Wiskich, J.T. 1996. The cyanide-resistant oxidase: to inhibit or not to inhibit, that is the question. *Plant Physiol.* **110**: 1–2.
- De Boer, A.H. & Wegner, L.H. 1997. Regulatory mechanisms of ion channels in xylem parenchyma cells. *J. Exp. Bot.* **48**: 441–449.
- De Jong, T.M. & Walton, E.F. 1989. Carbohydrate requirements of peach fruits, growth and respiration. *Tree Physiol.* **5**: 329–335.
- De Visser, R., Spitters, C.J.T., & Bouma, T. 1992. Energy costs of protein turnover: theoretical calculation and experimental estimation from regression of respiration on protein concentration of full-grown leaves. In: Molecular, biochemical and physiological aspects of plant respiration, H. Lambers & L.H.W. Van der Plas (eds.). SPB Academic Publishing, The Hague, pp. 493–508.
- Dry, I.B., Moore, A.L., Day, D.A., & Wiskich, J.T. 1989. Regulation of alternative pathway activity in plant mitochondria. Non-linear relationship between electron flux and the redox poise of the quinone pool. *Arch. Biochem. Biophys.* **273**: 148–157.
- Dueck, T.A., De Visser, R., Poorter, H., Persijn, S., Gorissen, A., de Visser, W., Schapendonk, A., Verhagen, J., Snel, J., Harren, F.J.M., Ngai, A.K.Y., Verstappen, F., Bouwmeester, H., Voesenek, L.A.C.J., & Van der Werf, A. 2007. No evidence for substantial aerobic methane emission by terrestrial plants: a ¹³C labelling approach. *New Phytol.* **175**: 29–35.
- Escobar, M.A., Geisler, D.A., & Rasmusson, A.G. 2006. Reorganization of the alternative pathways of the Arabidopsis respiratory chain by nitrogen supply: opposing effects of ammonium and nitrate. *Plant J.* **45**: 775–788.
- Evans, L.T. 1980. The natural history of crop yield. *Am. Sci.* **68**: 388–397.
- Farrar, J.F. & Rayns, F.W. 1987. Respiration of leaves of barley infected with powdery mildew: increased engagement of the alternative oxidase. *New Phytol.* **107**: 119–125.
- Florez-Sarasa, I.D., Bouma, T.J., Medrano, H., Azcón-Bieto, J. & Ribas-Carbó, M. 2007. Contribution of the cytochrome and alternative pathways to growth respiration and maintenance respiration in *Arabidopsis thaliana*. *Physiol. Plant.* **129**: 143–151.
- Foyer, C.H. & Noctor, G. 2000. Oxygen processing in photosynthesis: regulation and signalling. *New Phytol.* **146**: 359–388.
- Fredeen, A.L. & Field, C.B. 1991. Leaf respiration in *Piper* species native to a Mexican rainforest. *Physiol. Plant.* **82**: 85–92.
- Galmés, J., Ribas-Carbó, M., Medrano, H., & Flexas, J. 2007. Response of leaf respiration to water stress in Mediterranean species with different growth forms. *J. Arid Environ.* **68**: 206–222.
- Gomez-Casanovas, N., Blanc-Betes, E., González-Meler, M. A., & Azcón-Bieto, J. 2007. Changes in respiratory mitochondrial machinery and cytochrome and alternative pathway activities in response to energy demand underlie the acclimation of respiration to elevated CO₂ in the invasive *Opuntia ficus-indica*. *Plant Physiol.* **145**: 49–61.
- González-Meler, Ribas-Carbó, M., Siedow, J.N., & Drake, B. G. 1996. Direct inhibition of plant respiration by elevated CO₂. *Plant Physiol.* **112**: 1349–1355.
- González-Meler, Ribas-Carbó, M., Giles, L., & Siedow, J.N. 1999. The effect of growth and measurement temperature on the activity of the alternative respiratory pathway. *Plant Physiol.* **120**: 765–772.
- Good, B.J. & Patrick, W.H. 1987. Gas composition and respiration of water oak (*Quercus nigra* L.) and green ash (*Fraxinus pennsylvanica* Marsh.) roots after prolonged flooding. *Plant Soil* **97**: 419–427.
- Griffin, K.L., Anderson, O.R., Gastrich, M.D., Lewis, J.D., Lin, G., Schuster, W., Seemann, J.R., Tissue, D.T., Turnbull, M.H., & Whitehead, D. 2001. Plant growth in

- elevated CO₂ alters mitochondrial number and chloroplast fine structure. *Proc. Natl. Acad. Sci. USA* **98**: 2473–2478.
- Guy, R.D., Berry, J.A., Fogel, M.L., & Hoering, T.C. 1989. Differential fractionation of oxygen isotopes by cyanide-resistant and cyanide-sensitive respiration in plants. *Planta* **177**: 483–491.
- Hagesawa, R., Muruyama, A., Nakaya, M., & Esashi, Y. 1995. The presence of two types of β -cyanoalanine synthase in germinating seeds and their response to ethylene. *Physiol. Plant.* **93**: 713–718.
- Henry, B.K., Atkin, O.K., Farquhar, G.D., Day, D.A., Millar, A.H., & Menz, R.I. 1999. Calculation of the oxygen isotope discrimination factor for studying plant respiration. *Aust. J. Plant Physiol.* **26**: 773–780.
- Hoefnagel, M.H.N. & Wiskich, J.T. 1998. Activation of the plant alternative oxidase by high reduction levels of the Q-pool and pyruvate. *Arch. Biochem. Biophys.* **355**: 262–270.
- Hoefnagel, M.H.N., Millar, A.H., Wiskich, J.T., & Day, D.A. 1995. Cytochrome and alternative respiratory pathways compete for electrons in the presence of pyruvate in soybean mitochondria. *Arch. Biochem. Biophys.* **318**: 394–400.
- Hoefnagel, M.H.N., Rich, P.R., Zhang, Q., & Wiskich, J.T. 1997. Substrate kinetics of the plant mitochondrial alternative oxidase and the effects of pyruvate. *Plant Physiol.* **115**: 1145–1153.
- Hoefs, J. 1987. Stable isotope geochemistry. Springer-Verlag, Berlin.
- Hourton-Cabassa, C., Matos, A.R., Zachowski, A., & Moreau, F. 2004. The plant uncoupling protein homologues: a new family of energy-dissipating proteins in plant mitochondria. *Plant Physiol. Biochem.* **42**: 283–290.
- Jackson, M.B. & Armstrong, W. 1999. Formation of aerenchyma and the processes of plant ventilation in relation to soil flooding and submergence. *Plant Biol.* **1**: 274–287.
- Jackson, M.B., Herman, B., & Goodenough, A. 1982. An examination of the importance of ethanol in causing injury to flooded plants. *Plant Cell Environ.* **5**: 163–172.
- Jahnke, S. & Krewitt, M. 2002. Atmospheric CO₂ concentration may directly affect leaf respiration measurement in tobacco, but not respiration itself. *Plant Cell Environ.* **25**: 641–651.
- Karpova, O.V., Kuzmin, E.V., Elthon, T.E., & Newton and K.J. 2002. Differential expression of alternative oxidase genes in maize mitochondrial mutants. *Plant Cell* **14**: 3271–3284.
- Kirschbaum, M.U.F., Niinemets, Ü., Bruhn, D., & Winters, A.J. 2007. How important is aerobic methane release by plants? *Funct. Plant Sci. Biotechnol.* **1**: 138–145.
- Knutson, R. M. 1974. Heat production and temperature regulation in eastern skunk cabbage. *Science* **186**: 746–747.
- Krapp, A. & Stütt, M. 1994. Influence of high carbohydrate content on the activity of plastidic and cytosolic isozyme pairs in photosynthetic tissues. *Plant Cell Environ.* **17**: 861–866.
- Krömer, S. 1985. Respiration during photosynthesis. *Annu. Rev. Plant Physiol. Plant Mol. Biol.* **46**: 45–70.
- Kurimoto, K., Day, D.A., Lambers, H. & Noguchi, K. 2004a. Effect of respiratory homeostasis on plant growth in cultivars of wheat and rice. *Plant Cell Environ.* **27**: 853–862.
- Kurimoto, K., Millar, A.H., Lambers, H., Day, D.A., Noguchi, K. 2004b. Maintenance of growth rate at low temperature in rice and wheat cultivars with a high degree of respiratory homeostasis is associated with a high efficiency of respiratory ATP production. *Plant Cell Physiol.* **45**: 1015–1022.
- Lambers, H. 1982. Cyanide-resistant respiration: A non-phosphorylating electron transport pathway acting as an energy overflow. *Physiol. Plant.* **55**: 478–485.
- Lambers, H., Blacquièrre, T., & Stuiver, C.E.E. 1981. Interactions between osmoregulation and the alternative respiratory pathway in *Plantago coronopus* as affected by salinity. *Physiol. Plant.* **51**: 63–68.
- Lambers, H., Atkin, O.K. & Millenaar, F.F. 2002. Respiratory patterns in roots in relation to their functioning. In: *Plant roots: the hidden half*, 3rd edition, Y. Waisel, A. Eshel, & U. Kafkaki (eds.). Marcel Dekker, Inc. New York, pp. 521–552.
- Laties, G.G. 1998. The discovery of the cyanide-resistant alternative path: and its aftermath. In: *Discoveries in plant biology*, S.-Y. Yang & S.-D. Kung (eds.). World Scientific Publishing Co., Hong Kong, pp. 233–256.
- Loveys, B.R., Atkinson, L.J., Sherlock, D.J., Roberts, R.L., Fitter, A.H., & Atkin, O.K. 2003. Thermal acclimation of leaf and root respiration: an investigation comparing inherently fast- and slow-growing plant species. *Global Change Biol.* **9**: 895–910.
- Mariotti, A., Germon, J.C., Hubert, P., Kaiser, P., Letolle, R., Tardieux, A., & Tardieux, P. 1981. Experimental determination of nitrogen kinetic isotope fractionation: Some principles; Illustration for the denitrification and nitrification processes. *Plant Soil* **62**: 413–430.
- Mata, C., Scheurwater, I., Martins-Loucao, M.-A., & Lambers, H. 1996. Root respiration, growth and nitrogen uptake of *Quercus suber* L. seedlings. *Plant Physiol. Biochem.* **34**: 727–734.
- McDermitt, D.K. & Loomis, R.S. 1981. Elemental composition of biomass and its relation to energy content, growth efficiency and growth yield. *Ann. Bot.* **48**: 275–290.
- McDonnell, E. & Farrar, J.F. 1992. Substrate supply and its effect on mitochondrial and whole tissue respiration in barley roots. In: *Molecular, biochemical and physiological aspects plant respiration*, H. Lambers & L.H.W. Van der Plas (eds.). SPB Academic Publishing, The Hague, pp. 455–462.
- Millar, A.H. & Day, D.A. 1997. Nitric oxide inhibits the cytochrome oxidase but not the alternative oxidase of plant mitochondria. *FEBS Lett.* **398**: 155–158.
- Millar, A.H., Hoefnagel, M.H.N., Day, D.A., & Wiskich, J.T. 1996. Specificity of the organic acid activation of the alternative oxidase in plant mitochondria. *Plant Physiol.* **111**: 613–618.
- Millar, A.H., Atkin, O.K., Menz, R.I., Henry, B., Farquhar, G., & Day, D.A. 1998. Analysis of respiratory chain

- regulation in roots of soybean seedlings. *Plant Physiol.* **117**: 1083–1093.
- Millenaar, F.F. & Lambers, H. 2003. The alternative oxidase; *in vivo* regulation and function. *Plant Biol.* **5**: 2–15.
- Millenaar, F.F., Benschop, J., Wagner, A.M., & Lambers, H. 1998. The role of the alternative oxidase in stabilizing the *in vivo* reduction state of the ubiquinone pool; and the activation state of the alternative oxidase. *Plant Physiol.* **118**: 599–607.
- Millenaar, F.F., Roelofs, R., González-Meler, M.A., Siedow, J.N., Wagner, A.M. & Lambers, H. 2000. The alternative oxidase in roots of *Poa annua* after transfer from high-light to low-light conditions. *Plant J.* **23**: 623–632.
- Millenaar, F.F., González-Meler, M., Fiorani, F., Welschen, R., Ribas-Carbó, M., Siedow, J.N., Wagner, A.M. & Lambers, H. 2001. Regulation of alternative oxidase activity in six wild monocotyledonous species; an *in vivo* study at the whole root level. *Plant Physiol.* **126**: 376–387.
- Miller, P.C. & Stoner, W.A. 1979. Canopy structure and environmental interactions. In: Topics in plant population biology, O.T. Solbrig, S. Jain, G.B. Johnson, & P.H. Raven (eds.). Columbia University Press, New York, pp. 428–458.
- Mitchell, P. 1966. Chemiosmotic coupling in oxidative and photosynthetic phosphorylation. *Biol. Rev.* **41**: 445–502.
- Møller, I.M. 2001. Plant mitochondria and oxidative stress: electron transport, NADPH turnover, and metabolism of reactive oxygen species. *Annu. Rev. Plant Physiol. Plant Mol. Biol.* **52**: 561–591.
- Moynihan, M.R., Ordentlich, A., & Raskin, I. 1995. Chilling-induced heat evolution in plants. *Plant Physiol.* **108**: 995–999.
- Neuberger, M. & Douce, R. 1980. Effect of bicarbonate and oxaloacetate on malate oxidation by spinach leaf mitochondria. *Biochim. Biophys. Acta* **589**: 176–189.
- Nicholls, D.G. & Ferguson, S.J. 1992. Bioenergetics 2. Academic Press, London.
- Nobel, P.S. & Palta, J.A. 1989. Soil O₂ and CO₂ effects on root respiration of cacti. *Plant Soil* **120**: 263–271.
- Noguchi, K. & Terashima, I. 2006. Responses of spinach leaf mitochondria to low N availability. *Plant Cell Environ.* **29**: 710–719.
- Noguchi, K., Sonoike, K., & Terashima, I. 1996. Acclimation of respiratory properties of leaves of *Spinacia oleracea* (L.), a sun species, and of *Alocasia macrorrhiza* (L.) G. Don., a shade species, to changes in growth irradiance. *Plant Cell Physiol.* **37**: 377–384.
- Noguchi, K., Nakajima, N., & Terashima, I. 2001a. Acclimation of leaf respiratory properties in *Alocasia odora* following reciprocal transfers of plants between high- and low-light environments. *Plant Cell Environ.* **24**: 831–839.
- Noguchi, K., Go, C.-S., Terashima, I., Ueda, S., Yoshinari, T. 2001b. Activities of the cyanide-resistant respiratory pathway in leaves of sun and shade species. *Funct. Plant Biol.* **28**: 27–35.
- Noguchi, K., Taylor, N.L., Millar, A.H., Lambers, H., & Day, D.A. 2005. Responses of mitochondria to light intensity in the leaves of sun and shade species. *Plant Cell Environ.* **28**: 760–771.
- Overmyer, K., Brosche, M., & Kangasjarvi, J. 2003. Reactive oxygen species and hormonal control of cell death. *Trends Plant Sci.* **8**: 335–342.
- Ögren, E. 1996. Premature dehardening in *Vaccinium myrtillus* during a mild winter: a cause for winter dieback? *Funct. Ecol.* **10**: 724–732.
- Ögren, E. 2001. Effects of climatic warming on cold hardiness of some northern woody plants assessed from simulation experiments. *Physiol. Plant.* **112**: 71–77.
- Palet, A., Ribas-Carbó, M., Argiles, J.M., & Azcón-Bieto, J. 1991. Short-term effects of carbon dioxide on carnation callus cell respiration. *Plant Physiol.* **96**: 467–472.
- Palet, A., Ribas-Carbó, M., González-Meler, M.A., Aranda, X., & Azcón-Bieto, J. 1992. Short-term effects of CO₂/bicarbonate on plant respiration. In: Molecular, biochemical and physiological aspects of plant respiration, H. Lambers & L.H.W. Van der Plas (eds.). SPB Academic Publishing, The Hague, pp. 597–602.
- Penning de Vries, F.W.T. 1975. The cost of maintenance processes in plant cells. *Ann. Bot.* **39**: 77–92.
- Penning de Vries, F.W.T., Brunsting, A.H.M., & Van Laar, H. H. 1974. Products, requirements and efficiency of biosynthesis: a quantitative approach. *J. Theor. Biol.* **45**: 339–377.
- Perata, P. & Alpi, A. 1993. Plant responses to anaerobiosis. *Plant Sci.* **93**: 1–17.
- Perata, P., Guglielminetti, L., & Alpi, A. 1996. Anaerobic carbohydrate metabolism in wheat and barley, two anoxia-intolerant cereal seeds. *J. Exp. Bot.* **47**: 999–1006.
- Plaxton, W.C. & Podestá, F.E. 2006. The functional organization and control of plant respiration. *Crit. Rev. Plant Sci.* **25**: 159–198.
- Poorter, H. 1994. Construction costs and payback time of biomass: A whole plant perspective. In: A whole plant perspective on carbon-nitrogen interactions, J. Roy & E. Garnier (eds.). SPB Academic Publishing, The Hague, pp. 111–127.
- Poorter, H. & Villar, R. 1997. Chemical composition of plants: Causes and consequences of variation in allocation of C to different plant compounds. In: Resource allocation in plants, Physiological ecology series, F. Bazzaz & J. Grace (eds.). Academic Press, San Diego, pp. 39–72.
- Poorter, H., Van der Werf, A., Atkin, O.K., & Lambers, H. 1991. Respiratory energy requirements of roots vary with the potential growth rate of a plant species. *Physiol. Plant* **83**: 469–475.
- Poorter, H., Van de Vijver, C.A.D.M., Boot, R.G.A., & Lambers, H. 1995. Growth and carbon economy of a fast-growing and a slow-growing grass species as dependent on nitrate supply. *Plant Soil* **171**: 217–227.
- Purvis, A.C. & Shewfelt, R.L. 1993. Does the alternative pathway ameliorate chilling injury in sensitive plant tissues? *Physiol. Plant* **88**: 712–718.
- Qi, J., Marshall, J.D., & Mattson, K.G. 1994. High soil carbon dioxide concentrations inhibit root respiration of Douglas fir. *New Phytol.* **128**: 435–442.
- Rachmilevitch, S., Lambers, H., & Huang, B. 2006. Root respiratory characteristics associated with plant adaptation to high soil temperature for geothermal and turf-type *Agrostis* species. *J. Exp. Bot.* **57**: 623–631.

- Ramaswamy, V., Boucher, O., Haigh, J., Hauglustaine, D., Haywood, J., Myhre, G., Nakajima, T., Shi, G.Y., & Solomon, S. 2001. Radiative forcing of climate change. In: Climate change 2001: the scientific basis, contribution of working group I to the third assessment report of the intergovernmental panel on climate change, J.T. Houghton, Y. Ding, D.J. Griggs, M. Noguer, P.J. Van der Linden, X. Dai, K. Maskell, & C.A. Johnson (eds.). Cambridge University Press, Cambridge, pp. 349–416.
- Rasmusson, A.G., Soole, K.L., & Elthon, T.E. 2004. Alternative NAD(P)H dehydrogenases of plant mitochondria. *Annu. Rev. Plant Biol.* **55**: 23–39.
- Reich, P.B., Walters, M.B., Tjoelker, M.G., Vanderklein, D., & Buschena, C. 1998. Photosynthesis and respiration rates depend on leaf and root morphology and nitrogen concentration in nine boreal tree species differing in relative growth rate. *Funct. Ecol.* **12**: 395–405.
- Reich, P.B., Tjoelker, M.G., Machado, J.-L., & Oleksyn, J. 2006. Universal scaling of respiratory metabolism, size and nitrogen in plants. *Nature* **439**: 457–461.
- Rennenberg, H. & Filner, P. 1983. Developmental changes in the potential for H₂S emission in cucurbit plants. *Plant Physiol.* **71**: 269–275.
- Rhoads, D.M., Umbach, A.L., Subbaiah, C.C., & Siedow, J.N. 2006. Mitochondria reactive oxygen species. Contribution of oxidative stress and interorganellar signaling. *Plant Physiol.* **141**: 357–366.
- Ribas-Carbó, M., Berry, J.A., Yakir, D., Giles, L., Robinson, S.A., Lennon, A.M., & Siedow, J.N. 1995. Electron partitioning between the cytochrome and alternative pathways in plant mitochondria. *Plant Physiol.* **109**: 829–837.
- Ribas-Carbó, M., Lennon, A.M., Robinson, S.A., Giles, L., Berry, J., & Siedow, J.N. 1997. The regulation of the electron partitioning between the cytochrome and alternative pathways in soybean cotyledon and root mitochondria. *Plant Physiol.* **113**: 903–911.
- Ribas-Carbó, M., Taylor, N.L., Giles, L., Busquets, S., Finnegan, P., Day, D., Lambers, H., Medrano, H., Berry, J.A., & Flexas, J. 2005a. Effects of water stress on respiration in soybean (*Glycine max.* L.) leaves. *Plant Physiol.* **139**: 466–473.
- Ribas-Carbó, M., Robinson, S.A., & Giles, L. 2005b. The application of the oxygen-isotope technique to assess respiratory pathway partitioning. In: Plant respiration. From cell to ecosystem, H. Lambers & M. Ribas-Carbó (eds.). Springer, Dordrecht, pp. 177–194.
- Richter, D.D. & Markewitz, D. 1995. How deep is soil? *BioScience* **45**: 600–609.
- Rivoal, J. & Hanson, A.D. 1993. Evidence for a large and sustained glycolytic flux to lactate in anoxic roots of some members of the halophytic genus *Limonium*. *Plant Physiol.* **101**: 553–560.
- Rivoal, J. & Hanson, A.D. 1994. Metabolic control of anaerobic glycolysis. Overexpression of lactate dehydrogenase in transgenic tomato roots supports the Davies-Roberts hypothesis and points to a critical role for lactate secretion. *Plant Physiol.* **106**: 1179–1185.
- Roberts, J.K.M. 1984. Study of plant metabolism *in vivo* using NMR spectroscopy. *Annu. Rev. Plant Physiol.* **35**: 375–386.
- Roberts, J.K.M., Wemmer, D., & Jardetzky, O. 1984a. Measurements of mitochondrial ATP-ase activity in maize root tips by saturation transfer ³¹P nuclear magnetic resonance. *Plant Physiol.* **74**: 632–639.
- Roberts, J.K.M., Andrade, J.H., & Anderson, I.C. 1985. Further evidence that cytoplasmic acidosis is a determinant of flooding intolerance in plants. *Plant Physiol.* **77**: 492–494.
- Robinson, S.A., Ribas-Carbó, M., Yakir, D., Giles, L., Reuveni, Y., & Berry, J.A. 1995. Beyond SHAM and cyanide: opportunities for studying the alternative oxidase in plant respiration using oxygen isotope discrimination. *Aust. J. Plant Physiol.* **22**: 487–496.
- Ryan, M.G. & Waring, R.H. 1992. Maintenance respiration and stand development in a subalpine lodgepole pine forest. *Ecology* **73**: 2100–2108.
- Ryan, M.G., Binkley, D., & Fownes, J.H. 1997. Age-related decline in forest productivity: pattern and process. *Adv. Ecol. Res.* **27**: 213–262.
- Schaaf, J., Walter, M.H., & Hess, D. 1995. Primary metabolism in plant defense. Regulation of bean malic enzyme gene promoter in transgenic tobacco by development and environmental cues. *Plant Physiol.* **108**: 949–960.
- Scheurwater, I., Cornelissen, C., Dictus, F., Welschen, R., & Lambers, H. 1998. Why do fast- and slow-growing grass species differ so little in their rate of root respiration, considering the large differences in rate of growth and ion uptake? *Plant Cell Environ.* **21**: 995–1005.
- Scheurwater, I., Clarkson, D.T., Purves, J.V., Van Rijt, G., Saker, L.R., Welschen, R., & Lambers, H. 1999. Relatively large nitrate efflux can account for the high specific respiratory costs for nitrate transport in slow-growing grass species. *Plant Soil* **215**: 123–134.
- Scheurwater, I., Dünnebacke, M., Eising, R. & Lambers, H. 2000. Respiratory costs and rate of protein turnover in the roots of a fast-growing (*Dactylis glomerata* L.) and a slow-growing (*Festuca ovina* L.) grass species. *J. Exp. Bot.* **51**: 1089–1097.
- Scheurwater, I., Koren, M., Lambers, H., & Atkin, O.K. 2002. The contribution of roots and shoots to whole plant nitrate reduction in fast- and slow-growing grass species. *J. Exp. Bot.* **53**: 1635–1642.
- Schubert, S., Schubert, E., & Mengel, K. 1990. Effect of low pH of the root medium on proton release, growth, and nutrient uptake of field beans (*Vicia faba*). *Plant Soil* **124**: 239–244.
- Seymour, R.S. 2001. Biophysics and physiology of temperature regulation in thermogenic flowers. *Biosci. Rep.* **21**: 223–236.
- Seymour, R.S. & Schultze-Motel, P. 1996. Thermoregulating lotus flowers. *Nature* **383**: 305.
- Seymour, R.S., Schultze-Motel, P., & Lamprecht, I. 1998. Heat production by sacred lotus flowers depends on ambient temperature, not light cycle. *J. Exp. Bot.* **49**: 1213–1217.

- Shane, M.W., Cramer, M.D., Funayama-Noguchi, S., Millar, A.H., Day, D.A., & Lambers, H. 2004. Developmental physiology of cluster-root carboxylate synthesis and exudation in harsh hakea: expression of phosphoenolpyruvate carboxylase and the alternative oxidase. *Plant Physiol.* **135**: 549–560.
- Shaw, M. & Samborski, D.J. 1957. The physiology of host-parasite relations. III. The pattern of respiration in rusted and mildewed cereal leaves. *Can. J. Bot.* **35**: 389–407.
- Simons, B.H. & Lambers, H. 1999. The alternative oxidase: is it a respiratory pathway allowing a plant to cope with stress? In: Plant responses to environmental stresses: from phytohormones to genome reorganization, H.R. Lerner (ed.). Plenum Press, New York, pp. 265–286.
- Simons, B.H., Millenaar, F.F., Mulder, L., Van Loon, L.C., & Lambers, H. 1999. Enhanced expression and activation of the alternative oxidase during infection of Arabidopsis with *Pseudomonas syringae* pv. tomato. *Plant Physiol.* **120**: 529–538.
- Soukup, A., Armstrong, W., Schreiber, L., Franke, R., Votrubová, O. 2007. Apoplastic barriers to radial oxygen loss and solute penetration: a chemical and functional comparison of the exodermis of two wetland species, *Phragmites australis* and *Glyceria maxima*. *New Phytol.* **173**: 264–278.
- Stewart, C.R., Martin, B.A., Reding, L., & Cerwick, S. 1990. Respiration and alternative oxidase in corn seedlings tissues during germination at different temperatures. *Plant Physiol.* **92**: 755–760.
- Stiles, W. & Leach, W. 1936. Respiration in plants. Methuen & Co., London.
- Tan, K. & Keltjens, W.G. 1990a. Interaction between aluminium and phosphorus in sorghum plants. I. Studies with the aluminium sensitive sorghum genotype TAM428. *Plant Soil* **124**: 15–23.
- Tan, K. & Keltjens, W.G. 1990b. Interaction between aluminium and phosphorus in sorghum plants. II. Studies with the aluminium tolerant sorghum genotype SC0 283. *Plant Soil* **124**: 25–32.
- Tcherkez, G., Nogués, S., Bleton, J., Cornic, G., Badeck, F., & Ghashghaie, J. 2003. Metabolic origin of carbon isotope composition of leaf dark-respired CO₂ in French bean. *Plant Physiol.* **131**: 237–244.
- Tcherkez, G., Cornic, G., Blligny, R., Gout, E., & Ghashghaie, J. 2005. In vivo respiratory metabolism of illuminated leaves. *Plant Physiol.* **138**: 1596–1606.
- Torn, M.S. & Chapin III, F.S. 1993. Environmental and biotic controls over methane flux from arctic tundra. *Chemosphere* **26**: 357–368.
- Tjoelker, M.G., Reich, P.B., & Oleksyn, J. 1999. Changes in leaf nitrogen and carbohydrates underlie temperature and CO₂ acclimation of dark respiration in five boreal tree species. *Plant Cell Environ.* **22**: 767–778.
- Uemura, S., Ohkawara, K., Kudo, G., Wada, N., & Higashi, S. 1993. Heat-production and cross-pollination of the Asian skunk cabbage *Symplocarpus renifolius* (Araceae). *Am. J. Bot.* **80**: 635–640.
- Umbach, A.L., Wiskich, J.T., & Siedow, J.N. 1994. Regulation of alternative oxidase kinetics by pyruvate and intermolecular disulfide bond redox status in soybean seedling mitochondria. *FEBS Lett.* **348**: 181–184.
- Van der Werf, A., Kooijman, A., Welschen, R., & Lambers, H. 1988. Respiratory costs for the maintenance of biomass, for growth and for ion uptake in roots of *Carex diandra* and *Carex acutiformis*. *Physiol. Plant* **72**: 483–491.
- Van der Werf, A., Welschen, R., & Lambers, H. 1992a. Respiratory losses increase with decreasing inherent growth rate of a species and with decreasing nitrate supply: a search for explanations for these observations. In: Molecular, biochemical and physiological aspects of plant respiration, H. Lambers & L.H.W. Van der Plas (eds.). SPB Academic Publishing, The Hague, pp. 421–432.
- Van der Werf, A., Van den Berg, G., Ravenstein, H.J.L., Lambers, H., & Eising, R. 1992b. Protein turnover: A significant component of maintenance respiration in roots? In: Molecular, biochemical and physiological aspects of plant respiration, H. Lambers & L.H.W. Van der Plas (eds.). SPB Academic Publishing, The Hague, pp. 483–492.
- Van der Werf, A., Poorter, H., & Lambers, H. 1994. Respiration as dependent on a species' inherent growth rate and on the nitrogen supply to the plant. In: A whole-plant perspective of carbon-nitrogen interactions, J. Roy & E. Garnier (eds.). SPB Academic Publishing, The Hague, pp. 61–77.
- Vanlerberghe, G.C. & McIntosh, L. 1992. Lower growth temperature increases alternative pathway capacity and alternative oxidase protein in tobacco callus. *Plant Physiol.* **100**: 115–119.
- Vanlerberghe, G.C., Day, D.A., Wiskich, J.T., Vanlerberghe, A.E., & McIntosh, L. 1995. Alternative oxidase activity in tobacco leaf mitochondria. Dependence on tricarboxylic acid cycle-mediated redox regulation and pyruvate activation. *Plant Physiol.* **109**: 353–361.
- Veen, B.W. 1980. Energy costs of ion transport. In: Genetic engineering of osmoregulation. Impact on plant productivity for food, chemicals and energy, D.W. Rains, R.C. Valentine & C. Hlaender (eds.). Plenum Press, New York, pp. 187–195.
- Vertregt, N. & Penning de Vries, F.W.T. 1987. A rapid method for determining the efficiency of biosynthesis of plant biomass. *J. Theor. Biol.* **128**: 109–119.
- Vidal, G., Ribas-Carbó, M., Garmier, M., Dubertret, G., Rasmusson, A.G., Mathieu, C., Foyer, C.H., & De Paepe, R. 2007. Lack of respiratory chain complex I impairs alternative oxidase engagement and modulates redox signaling during elicitor-induced cell death in tobacco. *Plant Cell* **19**: 640–655.
- Villar, R., Robledo, J.R., De Jong, Y., & Poorter, H. 2006. Differences in construction costs and chemical composition between deciduous and evergreen woody species are small as compared to differences among families. *Plant Cell Environ.* **29**: 1629–1643.
- Wagner, A.M., Van Emmerik, W.A.M., Zwiers, J.H., & Kaagman, H.M.C.M. 1992. Energy metabolism of *Petunia hybrida* cell suspensions growing in the presence of antimycin A. In: Molecular, biochemical and physiological aspects of plant respiration, H. Lambers & L.H.W. Van der Plas (eds.). SPB Academic Publishing, The Hague, pp. 609–614.

- Wang, X. & Curtis, P. 2002. A meta-analytical test of elevated CO₂ effects on plant respiration. *Plant Ecol.* **161**: 251–261.
- Wang, X., Lewis, J.D., Tissue, D.T., Seemann, J.R., & Griffin, K.L. 2001. Effects of elevated atmospheric CO₂ concentration on leaf dark respiration of *Xanthium strumarium* in light and in darkness. *Proc. Natl. Acad. Sci. USA* **98**: 2479–2484.
- Waring R.H. & Schlesinger, W. H. 1985. Forest ecosystems: concepts and management. Academic Press, Orlando.
- Watling, J.R., Robinson, S.A., & Seymour, R.S. 2006. Contribution of the alternative pathway to respiration during thermogenesis in flowers of the sacred lotus. *Plant Physiol.* **140**: 1367–1373.
- Wegner, L.H. & Raschke, K. 1994. Ion channels in the xylem parenchyma of barley roots. A procedure to isolate protoplasts from this tissue and a patch-clamp exploration of salt passageways into xylem vessels. *Plant Physiol.* **105**: 799–813.
- Williams, J.H.H. & Farrar, J.F. 1990. Control of barley root respiration. *Physiol. Plant.* **79**: 259–266.
- Williams, K., Percival, F., Merino, J., & Mooney, H.A. 1987. Estimation of tissue construction cost from heat of combustion and organic nitrogen content. *Plant Cell Environ.* **10**: 725–734.
- Williams, J.H.H., Winters, A.L., & Farrar, J.F. 1992. Sucrose: a novel plant growth regulator. In: Molecular, biochemical and physiological aspects of plant respiration, H. Lambers & L.H.W. Van der Plas (eds.). SPB Academic Publishing, The Hague, pp. 463–469.
- Wright, I.J., Reich, P.B., & Westoby, M. 2001. Strategy shifts in leaf physiology, structure and nutrient content between species of high- and low-rainfall and high- and low-nutrient habitats. *Funct. Ecol.* **15**: 423–434.
- Wright, I.J., Reich, P.B., Atkin, O.K., Lusk, C.H., Tjoelker, M.G., & Westoby, M. 2006. Irradiance, temperature and rainfall influence leaf dark respiration in woody plants: evidence from comparisons across 20 sites. *New Phytol.* **169**: 309–319.
- Yan, F., Schubert, S., & Mengel, K. 1992. Effect of low root medium pH on net proton release, root respiration, and root growth of corn (*Zea mays* L.) and broad bean (*Vicia faba* L.). *Plant Physiol.* **99**: 415–421.
- Yoshida, K., Terashima, I., & Noguchi, K. 2007. Up-regulation of mitochondrial alternative oxidase concomitant with chloroplast over-reduction by excess light. *Plant Cell Physiol.* **48**: 606–614.
- Zacheo, G. & Molinari, S. 1987. Relationship between root respiration and seedling age in tomato cultivars infested by *Meloidogyne incognita*. *Ann. Appl. Biol.* **111**: 589–595.

2C. Long-Distance Transport of Assimilates

1. Introduction

The evolution of cell walls allowed plants to solve the problem of osmoregulation in freshwater environments; however, cell walls restrict motility and place constraints on the evolution of long-distance transport systems. Tissues are too rigid for a heart-pump mechanism; instead, higher plants have two systems for long-distance transport. The dead elements of the xylem allow transport of water and solutes between sites of different water potentials. That transport system is dealt with in Chapter 3 on plant water relations. The other transport system, the phloem, allows the mass flow of carbohydrates and other solutes from a **source** region, where the **hydrostatic pressure** in the phloem is relatively high, to a **sink** region with lower pressure.

Plants differ markedly in the manner in which the products of photosynthesis pass from the mesophyll cells to the sieve tubes (**phloem loading**) through which they are then transported to a site where they are unloaded and metabolized (Fig. 1). Plants also differ with respect to the major carbon-containing compounds that occur in the sieve tubes, which is the complex consisting of sieve elements and companion cells. For reasons that are explained in this chapter, there is a close association between the type of phloem loading (symplastic or apoplastic) and the type of major carbon compound (sucrose or oligosaccharides) transported in the

phloem. Sucrose is a sugar composed of two hexose units, whereas an oligosaccharide comprises more than two units. In addition, there appears to be an association between the pattern of phloem loading (symplastic vs. apoplastic) and the ecological distribution of species and between phloem structure and plant habit (vine vs. tree or shrub). It is this association between phloem transport and ecological adaptation that we explore in this chapter.

2. Major Transport Compounds in the Phloem: Why Not Glucose?

In animals, glucose is the predominant transport sugar, albeit at much lower concentrations than those of predominant sugars in the sieve tubes of higher plants. In plants, **sucrose** is a major constituent of phloem sap, whereas glucose and other monosaccharides are found only in trace concentrations. Why not glucose?

A comparison of the physical properties of glucose and sucrose does not provide a compelling reason for the predominance of sucrose. A good long-distance transport compound, however, should be **nonreducing**, so as to avoid a nonenzymatic reaction with proteins or other compounds during its transport. This excludes compounds

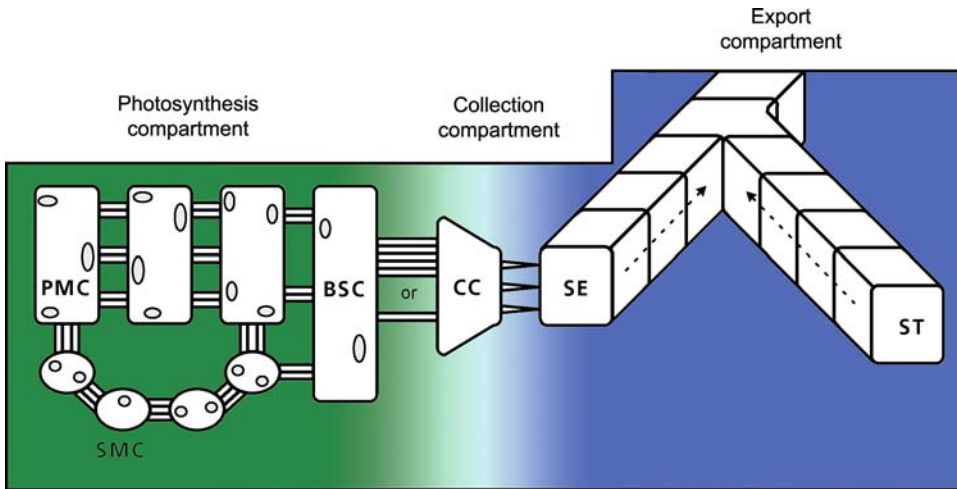

FIGURE 1. Sucrose and other products of photosynthesis (photosynthates) are generated in palisade (PMC) and spongy (SMC) mesophyll cells. They are either symplastically (top) or apoplastically (bottom) moved to the companion cells (CC) and/or sieve elements (SE) of the minor vein phloem and are subsequently exported to sink regions of the plant. Plasmodesmata connect all cell types, but the roles they play in the various transport steps differ in different species. In particular, the number of plasmodesmata connecting bundle sheath cells (BSC) to companion cells varies greatly. In some plants there are many, as depicted at the top. In others there

are relatively few, as shown at the bottom. The ultrastructure and biochemistry of the companion cells in minor veins also differs considerably in different plants, an indication of different loading strategies (as discussed in the text). The plasmodesmata between companion cells and sieve elements are especially wide and accommodate the passage of much larger molecules. Once inside the sieve elements, photosynthates are carried away in the export stream. The minor veins merge to create larger veins with connected sieve tubes (ST). Though not depicted here, all sieve elements have adjoining companion cells.

such as glucose and fructose, which contain an aldehyde group, which is readily oxidized to a carboxylic acid group; hence they are known as **reducing sugars**. A good transport compound should also be protected from enzymatic attack until it arrives at its destination. In this way the flow of carbon in plants can be controlled by the presence of key hydrolyzing enzymes in appropriate sink tissues. Thus, **sucrose** appears to be a preferred compound because it is “**protected**”.

Other “protected” sugars include the oligosaccharides of the raffinose family: raffinose, stachyose, verbascose. These sugars are formed by the addition of one, two or three galactose molecules to a sucrose molecule (Fig. 2). They are major transport sugars in a wide range of species. Other transport compounds are the sugar alcohols (sorbitol, mannitol, dulcitol) (Fig. 2), e.g., in Apiaceae [e.g., *Apium graveolens* (celery)], Rosaceae [e.g., *Prunus persica* (peach)], Combretaceae, Celastraceae, and Plantaginaceae, and oligofructans [e.g., in *Agave deserti* (century plant)] (Wang & Nobel 1998). Despite the diversity in composition of the phloem transport fluid among species, nearly all species are similar in their very

low concentrations of monosaccharides (glucose, fructose) (Turgeon 1995).

In addition to sugars, phloem sap contains a range of organic acids, amino acids, and inorganic ions. Concentrations of Ca, Fe, and Mn in the phloem sap are invariably low; this may be related to the fact that these nutrients tend to precipitate at the relatively **high pH** that characterizes phloem sap (Fig. 6.1B in Chapter 6 on mineral nutrition). As a result, growing leaves and fruits must predominantly import these nutrients via the xylem. If the Ca concentrations in the xylem sap and the transpiration rates are low, some fruits [e.g., of *Solanum lycopersicum* (tomato) and *Capsicum annuum* (capsicum)] may show Ca-deficiency symptoms (Marschner 1995). Similarly, legume seeds may show seed disorders when the import of Mn becomes too low, and calcifuge species show yellowing of their youngest leaves, due to a restricted uptake of Fe at high soil pH (Sect. 2.2.6 of Chapter 6 on mineral nutrition). That is, plant organs that predominantly import specific nutrients via the xylem may show **deficiency symptoms** when transpiration rates are low, when the concentration of

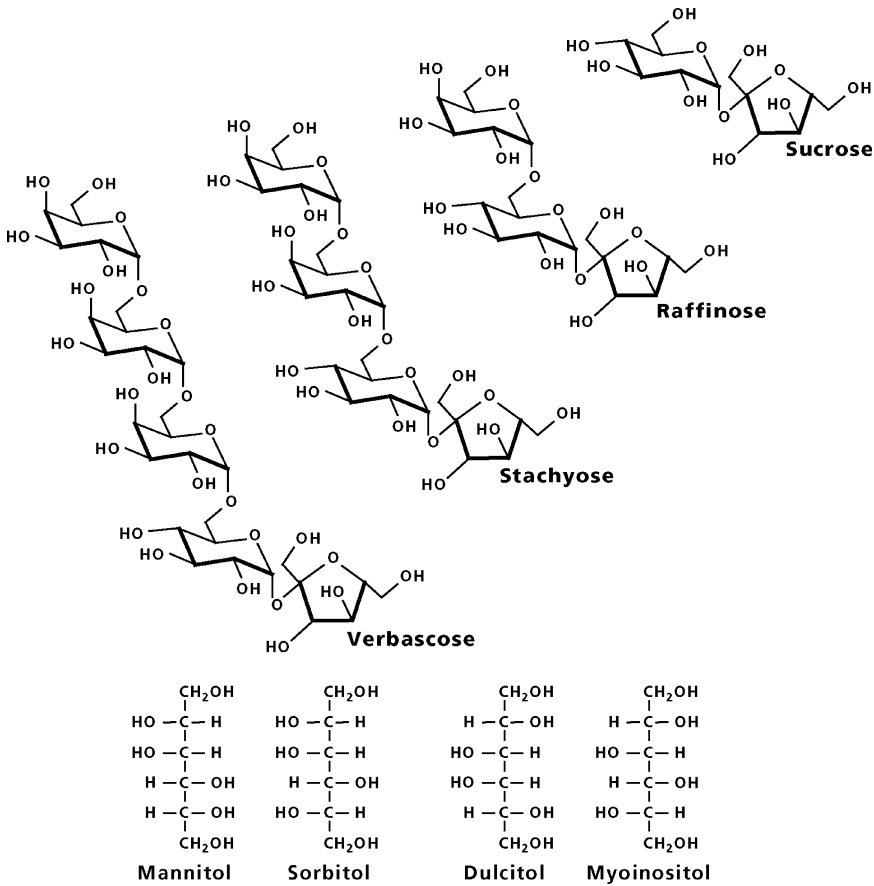

FIGURE 2. The chemical structure of the major sugars and some sugar alcohols transported in sieve tubes. Note that not all of these compounds occur in the phloem sap of every species.

these specific nutrients in the xylem is very low, due to restricted uptake, or both.

Most plant viruses can also move over long distances in the phloem (e.g., Roberts et al. 1997). Moreover, alarm signals involved in induced systemic resistance, hormones, and microRNA (miRNA) molecules, which are a class of developmental signaling molecules, are also transported via the phloem (Van Bel 2003, Juarez et al. 2004, Lough & Lucas 2006).

3. Phloem Structure and Function

In the process of transporting assimilates from the site of their synthesis (the **source**) to the site where they are used (the **sink**), the products of photosynthesis must move from the mesophyll cells to the transport system: the **sieve elements**. Sieve elements are living cells with characteristic sieve

areas in their cell walls. When pores connect adjacent cells, they are commonly differentiated into **sieve plates**, with pores ranging in diameter from 1–15 μm.

In the gymnosperm *Sequoiadendron giganteum* (giant redwood) the source-sink distance of the phloem path can be as much as 110 m, due to the enormous height of the tree. This example is extreme, because sinks mostly receive assimilates from adjacent source leaves, but it illustrates the point that transport sometimes occurs over vast distances, for example to growing root tips far removed from source leaves. Long-distance transport in the phloem occurs by **mass flow**, driven by a difference in **hydrostatic pressure**, created by phloem loading in source leaves and unloading processes in sink tissues.

When sieve tubes are damaged and the pressure declines, sieve plates tend to be blocked. Short-term sealing mechanisms are triggered by Ca and involve

proteins, e.g., **forisomes** in legumes (Furch et al. 2007). Long-term sealing involves blocking with a glucose polymer, **callose**.

3.1 Symplastic and Apoplastic Transport

How are the products of photosynthesis in the mesophyll loaded into the sieve tubes? There are two ways in which solutes can pass from one plant cell to another. One is through **plasmodesmata**. This is known as symplastic (or symplasmic) transport. (The **symplast** is the internal space of cells, surrounded by plasma membranes. Since plasmodesmata are lined by the plasma membrane, cells connected by plasmodesmata form a symplastic continuum.) Solute passage through plasmodesmatal channels is passive, unassisted by proteins that mediate active transport. Therefore, symplastic transport cannot, by itself, establish a solute concentration gradient.

The second route available for solute movement from one cell to another is through the apoplast. (The **apoplast** is the space outside the plasma membranes, including the cell walls and the xylem conduits.) If solute molecules originate inside cells, as photosynthates do, then apoplastic (or apoplasmic) transport involves release of the solute from the symplast into the cell wall space, followed by uptake into recipient cells. The uptake step may involve specific transporters located in the plasma membrane, and often occurs against a concentration

gradient. In some cells that are responsible for high solute flux the walls are invaginated to increase the surface area of the plasma membrane and uptake capacity. These are known as **transfer cells** (Offler et al. 2003). Uptake may also occur nonselectively by endocytosis (Samaj et al. 2004).

Since the solute concentration of the phloem is often much higher than that of the mesophyll tissue, it is not surprising that, in many plants, sucrose is loaded into the phloem from the apoplast. However, in other plants, photoassimilate molecules follow an entirely symplastic pathway into the phloem (Sect. 3.3).

3.2 Minor Vein Anatomy

The veins in leaves of dicotyledonous species branch progressively to form a reticulate network. Up to six or seven branching classes (orders) can be recognized in some species. The largest vein is the **midrib** (class I) and the smallest few classes are called **minor veins**. Minor veins are much more extensive than the major veins, and thoroughly permeate the mesophyll tissue. Few mesophyll cells are more than 6 or 8 cells away from a minor vein. Clearly, the minor venation is responsible for most, if not all, phloem loading of photoassimilates.

Since structure is often a meaningful guide to function, the comparative anatomy of the minor veins should provide clues to the mechanisms of

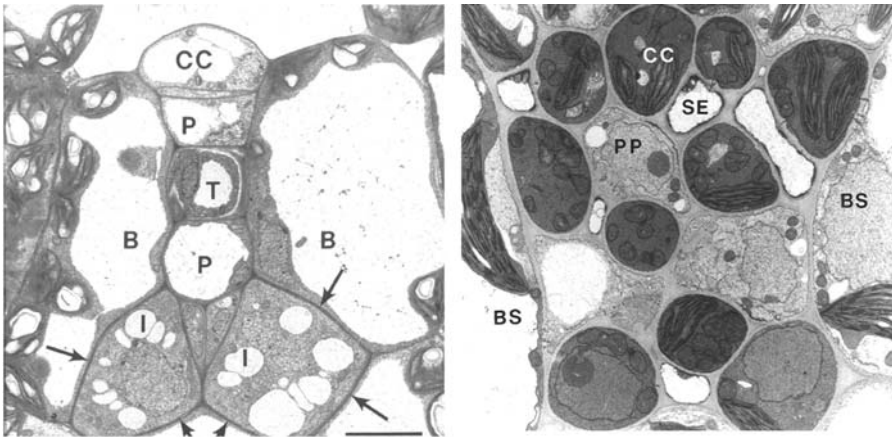

FIGURE 3. (Left) Minor vein from sink-source transition region of a leaf of *Cucumis melo* (melon). Abaxial phloem contains two intermediary cells (I) and immature sieve elements (not labeled) adjacent to a parenchyma cell (P). The interface of intermediary cells and bundle-sheath cells is indicated by arrows. A developing tracheid (T) and adaxial companion cell (CC) with its

immature sieve element (not labeled) are also present. Bar = 5 μm (Volk et al. 1996). (Right) Transverse section of a typical *Arabidopsis thaliana* (thale cress) minor vein, with five sieve elements. BS, bundle sheath cell; CC, companion cell; PP, phloem parenchyma cell; SE, sieve element; T, tracheary element; VP, vascular parenchyma cell. Bar = 2 μm (Haritatos et al. 2000).

the loading process in different species. Gamalei (1989, 1991) studied the minor-vein anatomy of over 1000 higher plant species. He recognized different degrees of **plasmodesmatal connectivity** between the mesophyll cells and the minor vein phloem in different species. In the herb *Senecio vernalis* (eastern groundsel) the frequency is around 0.03 plasmodesmata μm^{-2} interface area, against 60 in the tree *Fraxinus ornus* (manna ash). Gamalei grouped plants into arbitrarily defined types. **Type 1** plants exhibit about three orders of magnitude more plasmodesmatal contacts than **type 2**, while intermediates between the two extremes (types 1-2a) differ by about one to two orders of magnitude in plasmodesmatal frequency. Within Gamalei's types there are subgroups. Type 1 plants with the highest plasmodesmatal counts have specialized **companion cells** known as **intermediary cells** (Fig. 3). Intermediary cells are especially large, with many small vacuoles and extremely large numbers of asymmetrically branched plasmodesmata connecting them to bundle sheath cells. They are so different in many respects from the rest of the type 1 plants that they should probably be treated as a separate group. Type 2 is also heterogeneous. Type 2a **companion cells** have smooth cell walls, whereas those of type 2b have **transfer cells** with highly invaginated plasma membranes (Fig. 3).

Plasmodesmatal frequency is often a strong family characteristic; for example, all studied species in the Magnoliaceae (magnolia family) are

type 1, those in the Aceraceae (maple family) are type 1-2a; and those in the Liliaceae (lily family) are type 2. The minor veins of most monocots have low plasmodesmatal frequencies. Trees tend to have more plasmodesmata in the loading pathway than herbaceous plants, but this is not a strict correlation, because both herbaceous and tree species are found in some families. For example, *Fragaria* (strawberry) and *Malus* (apple) are both in the Rosaceae (rose family) and both are type 1-2a plants.

3.3 Sugar Transport against a Concentration Gradient

As noted in Sect. 1, one of the characteristics of the phloem is that the solute concentration, and thus the **hydrostatic pressure**, is high (Fig. 4). How is this high solute concentration generated? In many species, sucrose is actively loaded into the phloem from the apoplast by specific **transporters** located in the plasma membranes of the **companion cells** and/or **sieve elements** (Fig. 5A). By taking advantage of the steep **proton gradient** between the apoplast and the cytosol of the sieve elements, with pH values of approximately 5 and 9, respectively, sucrose is continually pumped into the phloem by secondary active transport, maintaining a concentration several times that found in mesophyll cells. Since sucrose-proton co-transporters are found in the plasma membranes of most plant cells, it is

FIGURE 4. Phloem transport. Cell walls are shown in gray. Sucrose molecules (double circles) are produced in mesophyll cells by photosynthesis and diffuse into bundle sheath cells of the minor veins through plasmodesmata. In the minor veins they enter the companion cells and sieve elements by one of several mechanisms, either through plasmodesmata, or across the apoplast (see Fig. 4). Water enters the phloem due to the low water potential, keeping the hydrostatic pressure above that in the sink phloem. Bulk flow of water carries sucrose, and other solutes, from the source leaf to sink tissues where it unloads into sink cells, either through plasmodesmata or via the apoplast. In some sinks, such as embryos of developing seeds, sucrose enters the apoplast after it is unloaded from the phloem and is actively pumped into the sink cells. Courtesy R. Turgeon, Cornell University, Ithaca, U.S.A.

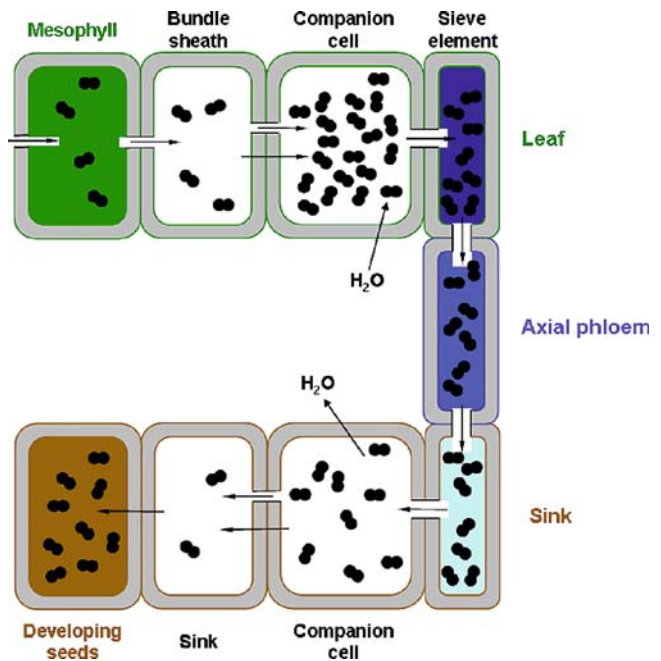

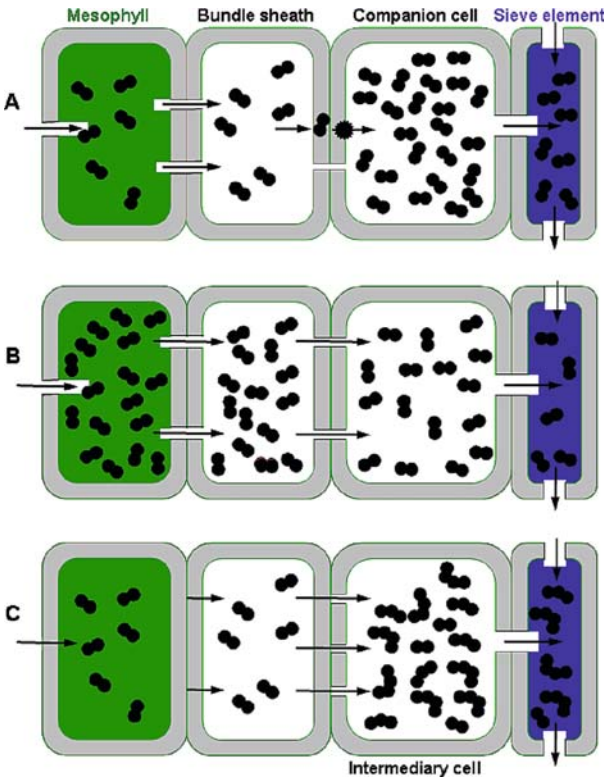

FIGURE 5. Phloem-loading pathways and mechanisms. (A) Apoplastic loading. Sucrose from mesophyll cells (M) diffuses through plasmodesmata to bundle sheath cells (BS) and into the minor veins. Inside the veins, it enters the cell-wall space (apoplast, in grey) near the phloem, and is loaded into the companion cells (CC) and/or sieve elements (SE) by secondary active transport. A sucrose transporter is shown as a star. Phloem parenchyma cells (not shown) are part of the pathway in the vein, and may be the most important site of sucrose efflux into the apoplast. Apoplastic loading is the most common strategy in flowering plants. (B) Diffusion. A downhill sucrose concentration gradient allows diffusion from the cytosol of mesophyll cells, through the bundle sheath and companion cells, and into the sieve elements. Sucrose is carried away in the sieve tubes to the sinks, resulting in continued diffusion. Phloem parenchyma cells are not shown here, but may also be part of the diffusion pathway in the vein. (C) Polymer trapping. Sucrose diffuses through numerous, narrow plasmodesmata from bundle sheath cells into specialized companion cells called intermediary cells (IC), where it is converted to raffinose (trisaccharide) and stachyose (tetrasaccharide). This keeps the sucrose concentration in the intermediary cells low and prevents back diffusion to the mesophyll. The sugars pass from intermediary cells into the sieve elements through larger plasmodesmata. Courtesy R. Turgeon, Cornell University, Ithaca, U.S.A.

reasonable to assume that **apoplastic phloem loading** evolved from a general retrieval mechanism that returns to the cytoplasm sucrose that has leaked out of cells.

If sucrose is loaded into the phloem from the apoplast, one would expect little symplastic continuity with the mesophyll; otherwise the loaded sucrose would leak back through the plasmodesmata to the cells it came from, creating a futile pump/leak system. Indeed, all type 2 plants (those with a low plasmodesmatal frequency) that have been studied load from the apoplast. Many of these plants have highly invaginated plasma membranes (type 2b **transfer cells**) that maximize surface area for this transport. What about the plants with **intermediary cells** (Fig. 5A) that have numerous **plasmodesmata** between the mesophyll and minor vein phloem (Gamalei's type 1 and type 1-2a)? One possibility is that, in these species, sucrose simply diffuses along an entirely symplastic pathway from the mesophyll, without creating an uphill gradient into the phloem (Fig. 5B). If so, the concentration of sucrose must be higher in the mesophyll than in the phloem. This appears to be the case in *Salix babylonica* [(weeping willow), a type 1 species with

numerous plasmodesmata], which has a high concentration of sucrose in the leaves, but a lower concentration in the phloem of the stem (Turgeon & Medville 1998).

In species with **intermediary cells**, yet another strategy prevails (Fig. 5C). All plants with intermediary cells transport their photoassimilates primarily as **raffinose** and **stachyose** which suggests that the synthesis of these sugars (tri- and tetra-saccharides, respectively; Fig. 2) is somehow part of the phloem-loading mechanism. A model put forward to explain this is known as **polymer trapping** (Turgeon 1991, 1996). Sucrose supposedly diffuses into the intermediary cells from the bundle sheath through the numerous plasmodesmata that connect these two cell types. Inside the intermediary cells, most of the sucrose is converted to raffinose and stachyose, which accumulate to high concentrations, because these sugars are too large to diffuse backward through the plasmodesmata. This keeps the sucrose concentration lower in the intermediary cell than in the mesophyll, and allows continued diffusion. Thus, the plasmodesmata between bundle sheath cells and intermediary cells act as valves. The plasmodesmata between the intermediary cells

and the sieve elements are larger, which permits entry of the sugars into the long-distance transport stream.

Most effort in this field has been devoted to sucrose loading, since sucrose is the major transport compound in most plants. We know less about the loading of sugar alcohols, in the species that transport them, and even less about the loading of other organic compounds and ions. Unraveling these mechanisms is an ongoing research effort.

4. Evolution and Ecology of Phloem Loading Mechanisms

The ancestral mechanism of phloem loading in flowering plants is not known for certain because we cannot be sure that “basal” groups (those that diverged early in the evolution of the angiosperms) have retained their ancestral characteristics (Fig. 6). However, most basal plants have numerous minor vein plasmodesmata (type 1) (Gamalei 1989, Turgeon et al. 2001). Type 2 plants, and plants with intermediary cells, are more phylogenetically derived; these traits having evolved independently on a number of occasions (Turgeon et al. 2001). The strategies employed by other vascular plants, including the gymnosperms, are not known.

What are the selective pressures that have led to the emergence of the different forms of phloem loading? There is no clear answer to this question, but we can make a start by studying the growth characteristics and habitats of existing plants. Families with **intermediary cells** are heavily represented in the **tropics** [e.g., Cucurbitaceae (gourd family)] although a few are cosmopolitan [Scrophulariaceae (figwort family)] and some individual species occur in the arctic. There appears to be no correlation of intermediary cells with growth rate or with the woody or herbaceous growth habit. The rest of the type 1 species are essentially all woody (trees or shrubs) and can be found in all climates, except the arctic. Type 2 plants can have many forms, but they tend to be herbaceous and are more heavily represented in temperate and colder regions.

What do the differences between phloem-loading types signify? An early hypothesis that symplastic loading is somehow more sensitive to the cold than apoplastic loading does not appear to be valid. The absence of type 1 plants in the arctic is probably due to the fact that there are very few woody species of any kind in those extremely cold environments, for reasons that have nothing to do with phloem

loading. In addition, laboratory experiments do not support the concept of cold sensitivity in type 1 species with intermediary cells (Schrier et al. 2000). Although plants with intermediary cells seem to be favored in the tropics, it should not be assumed that this has anything directly to do with temperature. There are many other correlates of life in the tropics that need to be considered.

Sugar alcohols present another problem. Plants from many families produce **sugar alcohols** in their leaves, though only a few appear to transport significant amounts of these compounds in the phloem. There is convincing evidence that sugar alcohols confer tolerance to **boron** deficiency because they complex and solubilize this otherwise insoluble mineral and allow it to be transported in the phloem from leaves to meristematic regions, where it is needed for growth (Hu et al. 1997). It has also been suggested that sugar alcohol synthesis and export may channel away excess reducing energy from photosynthesis in times of stress (Loescher & Everard 2000).

5. Phloem Unloading

When considering how sugars and other materials unload from the phloem, it is useful to make the distinction between **axial sinks** (tissues adjacent to the axial, long-distance transport phloem in shoots and roots) and **terminal sinks** (tissues that are either actively growing or storing large quantities of photoassimilates, such as shoot and root tips, growing leaves, and growing fruits) (Fig. 7).

In terminal sinks, where the unloading rate is generally high, solutes unload from the phloem through **plasmodesmata**. Water must follow through **aquaporins**, which are strongly expressed in sink tissues such as the seed coat of *Phaseolus vulgaris* (common bean) (Zhou et al. 2007). The unloading rate is apparently controlled by the radii of the plasmodesmata and by solute concentration and/or hydrostatic pressure differences between the phloem and surrounding cells. In some terminal sinks, the unloaded solute passes **symplastically** through a number of sink cells. It is subsequently released into the apoplast, from which it is actively retrieved by recipient cells. This is the route necessarily taken by sugars in **seeds** since the maternal plant and embryo are different generations and have no connecting plasmodesmata. In this case, sucrose exits the phloem of the seed coat via plasmodesmata, passes symplastically through a layer of cells, and is released into the apoplast

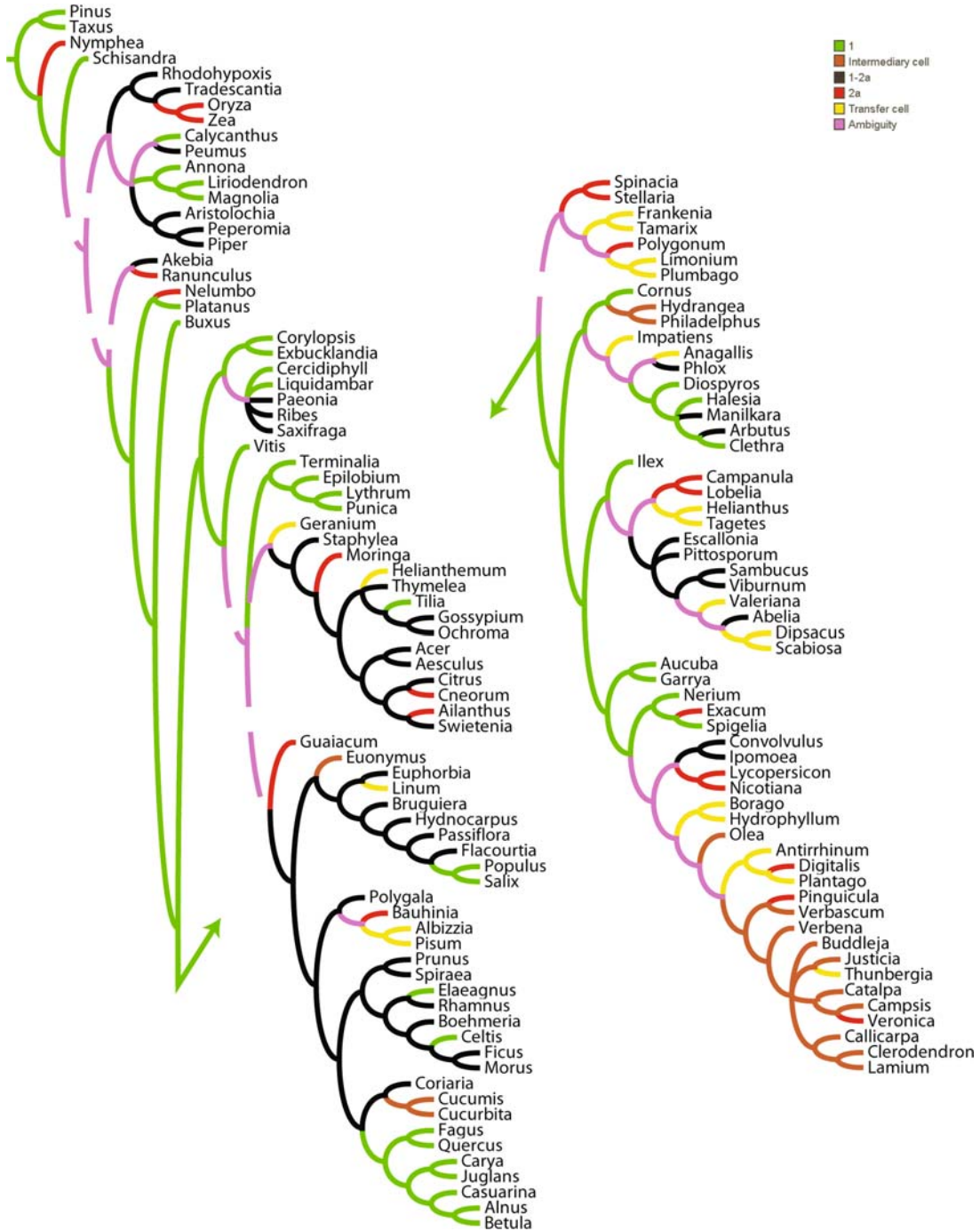

FIGURE 6. Minor vein companion cell characteristics for 137 taxa mapped onto a phylogenetic tree. Wherever possible, genera for which phloem anatomy is known are coded directly in the matrix, but for some representatives there is no equivalent genus in the molecular matrix. In some of these cases, a closely related congeneric genus is coded for the phloem character. All taxa

scored as missing for the phloem loading character are automatically pruned from the consensus tree, producing a tree topology that is a fully congruent subset of the topology with all taxa. The tree has been split at the point indicated by the arrows, with the more ancestral taxa at the left (Turgeon et al. 2001). Copyright The Botanical Society of America.

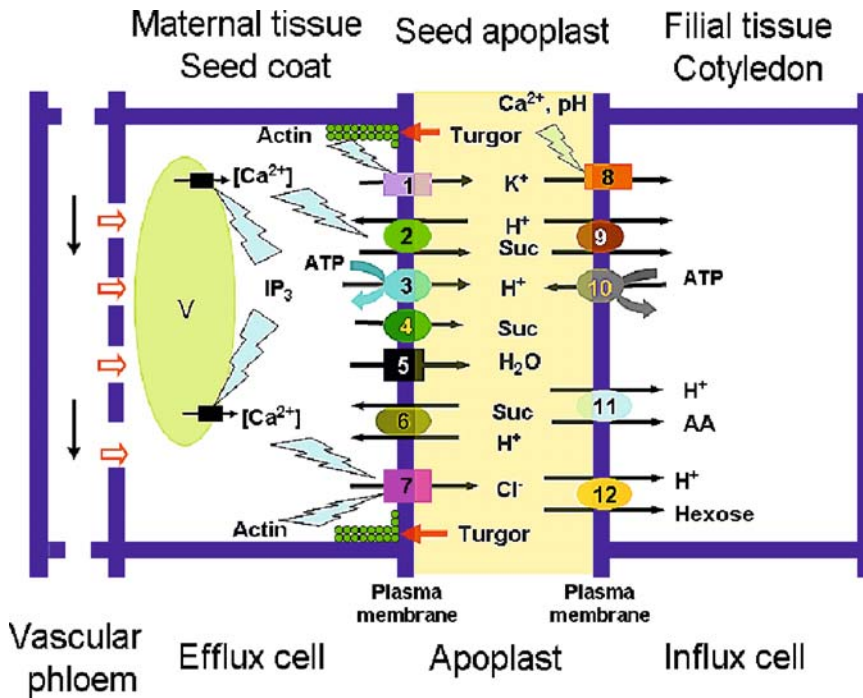

FIGURE 7. Phloem unloading, followed by transport into developing seeds. The diagram shows membrane transporters involved in transferring phloem-imported nutrients from seed coats to cotyledons of developing grain legume seeds. Phloem-imported nutrients are transported through plasmodesmata to the seed coat efflux cells. Here, membrane transporters in plasma membranes lining the efflux cells release nutrients to the seed apoplast. Currently known transporters are: (1) nonselective channels; (2) sucrose/H⁺ antiporters; (3) H⁺-ATPases; (4) sucrose facilitators; (5) aquaporins; (6) sucrose/H⁺ symporters; (7) pulsing Cl⁻ channels. Nutrients are taken up from the seed apoplast by

membrane transporters located in plasma membranes of cotyledon cell complexes. Currently known transporters include: (8) nonselective cation channels; (9) sucrose/H⁺ symporters; (10) H⁺-ATPases; (11) amino acid/H⁺ symporters; (12) hexose/H⁺ symporters. An elevated cell turgor (arrow), due to enhanced uptake of nutrients from the seed apoplast, activates Cl⁻ and nonselective channels, and possibly also activates Ca²⁺ release, leading to an increase in the cytosolic Ca²⁺ concentration, which serves as a signal to activate sucrose/H⁺ antiporters and Cl⁻ channels (Zhang et al. 2007, *Functional Plant Biology* 34: 314–331, Copyright CSIRO Australia).

surrounding the embryo. The embryo then scavenges the sucrose by active transporters in the plasma membranes of the cotyledons.

Unloading in axial sinks follows either the **symplastic** or **apoplastic** routes, depending on the species, the specific sink, and the stage of development. When the path of small fluorescent dyes is followed down a root, the dye does not exit the axial phloem, indicating that the plasmodesmata are too narrow to accommodate even small solute molecules (Oparka et al. 1994). Therefore, sugars and other solutes must be released into the **apoplast**. However, as indicated above, when the dye in the phloem reaches the meristematic tissue at the tip of the root, it rapidly unloads through **plasmodesmata**.

Unloading into cotton fibers provides an example of a shift in unloading routes during development. Cotton fibers (single cells of the seed coat epidermis) grow extremely rapidly. Initially, unloading from the phloem and post-phloem transport into the fiber cell is entirely **symplastic**. However, during the most rapid growth phase the plasmodesmata in the wall of the fiber close for about 6 days, and sucrose instead enters the **apoplast**. This allows active sucrose transporters in the plasma membrane of the fiber to drive up osmotic and turgor potentials to the high values needed for rapid cell expansion (Ruan et al. 2001). Once this active growth phase is over, the plasmodesmata open again.

Phloem unloading in sink leaves illustrates the need to consider anatomy, physiology, and development to assemble a complete picture of events (Turgeon 2006). Very young leaves are sinks: they obtain most of their carbohydrate from older leaves. As this photoassimilate enters a young leaf in the phloem it unloads from relatively large veins; the smaller veins are not yet mature (Turgeon 1987, Roberts et al. 1997). As the leaf grows, it reaches a positive carbon balance and then begins to export. Just before it does so, the small veins mature. These **minor veins** are used for photoassimilate **loading**. Therefore, there is a division of labor between veins of different size classes, large ones for **unloading** in young leaves, small ones for loading in mature leaves.

In some organisms structures have evolved to parasitize the phloem-transport system. Rapid phloem unloading occurs when a **phloem-feeding organism** (e.g., an aphid) injects its stylet into a sieve tube. The hydrostatic pressure in the sieve pushes the contents of the sieve tube into the aphid. The aphid absorbs predominantly nitrogenous compounds and excretes much of the carbohydrate as "**honeydew**". The aphids ingest phloem sap without eliciting the sieve tubes' normal response to injury (Sect. 3). Sealing mechanisms are prevented by chemical constituents in aphid saliva injected into sieve tubes before and during feeding (Will et al. 2007). Another special site where phloem unloading occurs is the **haustoria of holoparasites** that depend on their host for their carbon supply. The release of solutes from the phloem of the host is strongly stimulated by the presence of such a parasite, by an as yet unidentified mechanism (Sect. 4 of Chapter 9D on parasitic associations). In some species, e.g., *Lupinus albus* (white lupin) the phloem bleeds spontaneously upon cutting (Pate & Hocking 1978). Phloem sap collected in this way or as honeydew has provided valuable information on the composition of phloem sap (Sect. 2).

Phloem unloading is affected in a rather special manner by **root nematodes** (e.g., the parasitic nematodes *Meloidogyne incognita* and *Heterodera schachtii*), which can act as major sinks (Dorhout et al. 1993). Unloading from the sieve element companion cell complexes occurs specifically into the "syncytium", the nematode-induced feeding structure within the vascular cylinder of the root. The infective juvenile nematode selects a procambial or cambial cell as an initial syncytial cell, from which a syncytium develops by integration of neighboring cells. The developing nematode depends entirely on the expanding syncytium, withdrawing nutrients from it through a

feeding tube. Unlike in the root tip, the transport of sugars from the phloem to the syncytium in this host-pathogen relationship is apoplastic. The syncytium is not connected via plasmodesmata with the normal root cells. In an as yet unidentified manner, the nematode induces massive leakage from the phloem, thus reducing the transport of phloem solutes to the rest of the roots (Böckenhoff et al. 1996).

6. The Transport Problems of Climbing Plants

Vines can be viewed as "mechanical parasites". They invest too little in wood to support themselves, and thus depend on other plants for mechanical support. Xylem (wood) tissue has both a transport and a mechanical support function. As discussed in Sect. 5.3.5 of Chapter 3 on plant water relations, vines have fewer but longer and wider xylem vessels in their stem per unit stem cross-sectional area. They also have fewer lignified phloem fibers than do trees and shrubs and less phloem tissue per unit of distal area (Fig. 8). How do vines achieve sufficient phloem transport capacity?

Compared with trees and shrubs, vines have **wider sieve tubes** (Fig. 8). Since the hydraulic conductance, by Hagen-Poiseuille's law for ideal capillaries, is proportional to the fourth power of the conduit radius (Sect. 5.3.1 of Chapter 3 on plant water relations), the larger diameter compensates for the smaller total area. The obvious advantage of fewer sieve tubes with a larger diameter is that relatively few resources need to be allocated to producing phloem in the stem, which is therefore light, preventing the supporting plant from toppling over. For a similar investment in stem, the climbing plant will reach a greater height than a nonclimbing plant. If few sieve tubes with large diameters are so advantageous for climbing plants, why do not *all* plants have such wide tubes in their phloem? There is likely a disadvantage in having large-diameter sieve tubes, in that physical damage to a small number of sieve tubes causes a larger proportional loss of transport capacity. Such damage may be mechanical or due to phloem-sucking arthropods or pathogens. As in the xylem of plants with contrasting strategy (Sect. 5.3.5 of Chapter 3 on plant water relations), there may be a trade-off between transport **capacity** and **safety**.

FIGURE 8. Phloem area (A) and maximum diameters of sieve tubes (B) of contrasting *Bauhinia* species. Values are plotted as a function of the leaf area distal to the investigated stem section for stems of lianas (dashed line, open symbols) and congeneric trees and shrubs (solid line, closed symbols) (Ewers & Fisher 1991).

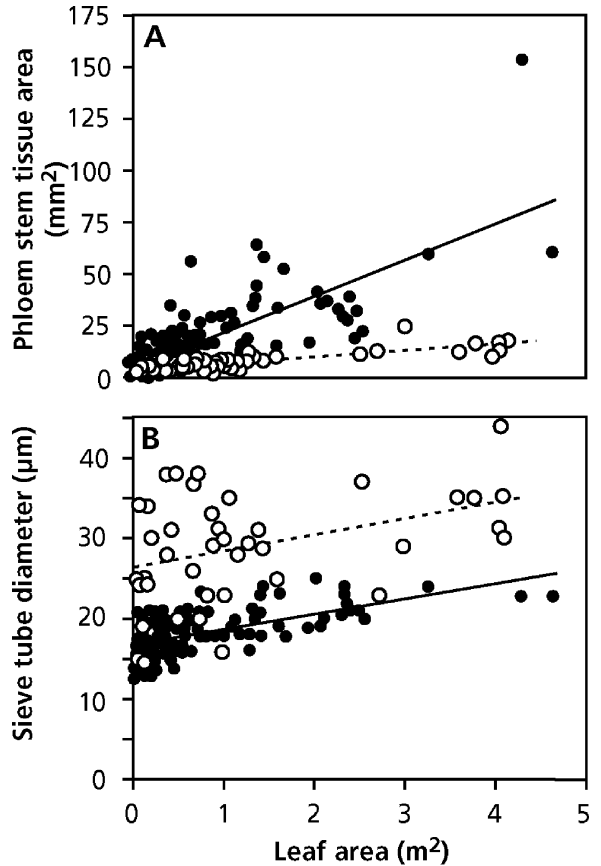

7. Phloem Transport: Where to Move from Here?

After several years of debate on whether phloem loading occurs via an apoplastic or a symplastic pathway, it is now agreed that both pathways occur, depending on species. Are there disadvantages and disadvantages associated with the apoplastic or symplastic pathway? The proton-pumping activity of the transfer cells involved in apoplastic loading requires a substantial amount of metabolic energy. It remains to be demonstrated, however, that this energy requirement is greater than that for the polymerization that occurs in the intermediary cells of plants with symplastic phloem loading. Disadvantages associated with the apoplastic pathway are not immediately obvious.

Phloem unloading can also occur either apoplastically or symplastically, depending on the kind of sink and on species. Phloem unloading in sinks is an important aspect of crop yield, since increases in

yield in newer varieties are often determined by the amount of resources transported to harvestable sinks, rather than by the total amount of resources acquired. It is therefore important to develop a good understanding of phloem transport. Unraveling both loading and unloading mechanisms continues to offer major challenges.

References

- Böckenhoff, A., Prior, D.A.M., Grudler, F.M.W., & Oparka, K.J. 1996. Induction of phloem unloading in *Arabidopsis thaliana* roots by the parasitic nematode *Heterodera schachtii*. *Plant Physiol.* **112**: 1421–1427.
- Dorhout, R., Gommers, F.J., & Kollöffel, C. 1993. Phloem transport of carboxyfluorescein through tomato roots infected with *Meloidogyne incognita*. *Physiol. Mol. Plant Pathol.* **43**: 1–10.
- Ewers, F.W. & Fisher, J.B. 1991. Why vines have narrow stems: Histological trends in *Bauhinia fassoglensis* (Fabaceae). *Oecologia* **88**: 233–237.

- Furch, A.C.U., Hafke, J.B., Schulz, A., & Van Bel, A.J.E. 2007. Ca^{2+} -mediated remote control of reversible sieve tube occlusion in *Vicia faba*. *J. Exp. Bot.* **58**: 2827–2838.
- Gamalei, Y.V. 1989. Structure and function of leaf minor veins in trees and herbs. A taxonomic review. *Trees* **3**: 96–110.
- Gamalei, Y.V. 1991. Phloem loading and its development related to plant evolution from trees to herbs. *Trees* **5**: 50–64.
- Haritatos, E., Medville, R., & Turgeon, R. 2000. Minor vein structure and sugar transport in *Arabidopsis thaliana*. *Planta* **211**: 105–111.
- Hu, H., Penn, S.G., Lebrilla, C.B., & Brown, P.H. 1997. Isolation and characterization of soluble boron complexes in higher plants: the mechanism of phloem mobility of boron. *Plant Physiol.* **113**: 649–655.
- Juarez, M.T., Kui, J.S., Thomas, J., Heller, B.A., & Timmermans, M.C.P. 2004. microRNA-mediated repression of rolled leaf1 specifies maize leaf polarity. *Nature* **428**: 84–88.
- Loescher, W.H. & Everard, J.D. 2000. Regulation of sugar alcohol biosynthesis. In: Photosynthesis: physiology and metabolism, R.C. Leegood, T.D. Sharkey, & S. Von Caemmerer (eds.). Kluwer Academic Publishers, Dordrecht, pp. 275–299.
- Lough, T.J. & Lucas, W.J. 2006. Integrative plant biology: role of phloem long-distance molecular trafficking. *Annu. Rev. Plant Biol.* **57**: 203–232.
- Marschner, H. 1995. Mineral nutrition of higher plants, 2nd edition. Academic Press, London.
- Offler, C.E., McCurdy, D.W., Patrick, J.W., & Talbot, M.J. 2003. Transfer cells: cells specialized for a special purpose. *Annu. Rev. Plant Biol.* **54**: 431–454.
- Oparka, K.J., Duckett, C.M., Prior, D.A.M., & Fisher, D.B. 1994. Real time imaging of phloem unloading in the root tip of *Arabidopsis*. *Plant J.* **6**: 759–766.
- Pate, J.S. & Hocking, P.J. 1978. Phloem and xylem transport in the supply of minerals to a developing legume (*Lupinus albus* L.) fruit. *Ann. Bot.* **42**: 911–21.
- Roberts, A.G., Santa Cruz, S., Roberts, I.M., Prior, D.A.M., Turgeon, R., & Oparka, K.J. 1997. Phloem unloading in sink leaves of *Nicotiana benthamiana*: comparison of a fluorescent solute with a fluorescent virus. *Plant Cell* **9**: 1381–1396.
- Ruan, Y.-L., Llewellyn, D.J., & Furbank, R.T. 2001. The control of single-celled cotton fiber elongation by developmentally reversible gating of plasmodesmata and coordinated expression of sucrose and K^+ transporters and expansin. *Plant Cell* **13**: 47–60.
- Samaj, J., Baluska, F., Voigt, B., Schlicht, M., Volkmann, D., & Menzel, D. 2004. Endocytosis, actin cytoskeleton, and signaling. *Plant Physiol.* **135**: 1150–1161.
- Schrier, A.A., Hoffmann-Thoma, G., & Van Bel, A.J.E. 2000. Temperature effects on symplasmic and apoplasmic phloem loading and loading-associated carbohydrate processing. *Aust. J. Plant Physiol.* **27**: 769–778.
- Turgeon, R. 1987. Phloem unloading in tobacco sink leaves: insensitivity to anoxia indicates a symplastic pathway. *Planta* **171**: 73–81.
- Turgeon, R. 1991. Symplasmic phloem loading and the sink-source transition in leaves: A model. In: Recent advances in phloem transport and assimilate compartmentation, J.L. Bonnemain, S. Delrot, W.J. Lucas, & J. Dainty (eds.). Ouest Edition, Nantes, pp. 18–22.
- Turgeon, R. 1995. The selection of raffinose family oligosaccharides as translocates in higher plants. In: Carbon partitioning and source-sink interactions in plants, M.A. Madore & W.J. Lucas (eds.). American Society of Plant Physiologists, Rockville, pp. 195–203.
- Turgeon, R. 1996. Phloem loading and plasmodesmata. *Trends Plant Sci.* **1**: 418–423.
- Turgeon, R. 2006. Phloem loading: how leaves gain their independence. *BioScience* **56**: 15–24.
- Turgeon, R. & Medville, R. 1998. The absence of phloem loading in willow leaves. *Proc. Natl. Acad. Sci. USA* **95**: 12055–12060.
- Turgeon, R., Medville, R., & Nixon, K.C. 2001. The evolution of minor vein phloem and phloem loading. *Am. J. Bot.* **88**: 1331–1339.
- Van Bel, A.J.E. 2003. The phloem, a miracle of ingenuity. *Plant Cell Environ.* **26**: 125–149.
- Volk, G.M., Turgeon, R., & Beebe, D.U. 1996. Secondary plasmodesmata formation in the minor-vein phloem of *Cucumis melo* L. and *Cucurbita pepo* L. *Planta* **199**: 425–432.
- Wang, N. & Nobel, P.S. 1998. Phloem transport of fructans in the crassulacean acid metabolism species *Agave deserti*. *Plant Physiol.* **116**: 709–714.
- Will, T., Tjallingii, W.F., Thonnessen, A., & van Bel, A.J.E. 2007. Molecular sabotage of plant defense by aphid saliva. *Proc. Natl. Acad. Sci. USA* **104**: 10536–10541.
- Zhang, W.-H., Zhou, Y., Dibley, K.E., Tyerman, S.D., Furbank, R.T., & Patrick, J.W. 2007. Nutrient loading of developing seeds. *Funct. Plant Biol.* **34**: 314–331.
- Zhou, Y., Setz, N., Niemiets, C., Qu., H., Offler, C.E., Tyerman, S.D., & Patrick, J.W. 2007. Aquaporins and unloading of phloem-imported water in coats of developing bean seeds. *Plant Cell Environ.* **30**: 1566–1577.

3

Plant Water Relations

1. Introduction

Although water is the most abundant molecule on the Earth's surface, the availability of water is the factor that most strongly restricts terrestrial plant production on a global scale. Low water availability limits the productivity of many natural ecosystems, particularly in dry climates (Fig. 1). In addition, losses in crop yield due to water stress exceed losses due to all other biotic and environmental factors combined (Boyer 1985). Regions where rainfall is abundant and fairly evenly distributed over the growing season, such as in the wet tropics, have lush vegetation. Where summer droughts are frequent and severe, forests are replaced by grasslands, as in the Asian steppes and North American prairies. Further decrease in rainfall results in semidesert, with scattered shrubs, and finally deserts. Even the effects of temperature are partly exerted through water relations because rates of evaporation and transpiration are correlated with temperature. Thus, if we want to explain natural patterns of productivity or to increase productivity of agriculture or forestry, it is crucial that we understand the controls over plant water relations and the consequences for plant growth of an inadequate water supply.

1.1 The Role of Water in Plant Functioning

Water is important to the physiology of plants because of its crucial role in all physiological

processes and because of the large quantities that are required. Water typically comprises 70–95% of the biomass of nonwoody tissues such as leaves and roots. At the cellular level, water is the major medium for transporting metabolites through the cell. Because of its highly polar structure, water readily dissolves large quantities of ions and polar organic metabolites like sugars, amino acids, and proteins that are critical to metabolism and life. At the whole-plant level, water is the medium that transports the raw materials (carbohydrates and nutrients) as well as the phytohormones that are required for growth and development from one plant organ to another. Unlike most animals, plants lack a well-developed skeletal system; especially herbaceous plants depend largely on water for their overall structure and support. Due to their high concentrations of solutes, plant cells exert a positive pressure (**turgor**) against their cell walls, which is the basic support mechanism in plants. Turgor pressures are typically of the order of 1.0–5.0 MPa, similar to the pressure in nuclear steam turbines. Large plants gain additional structural support from the lignified cell walls of woody tissues. When plants lose turgor (**wilt**), they no longer carry out certain physiological functions, in particular cell expansion and to a lesser extent photosynthesis. Prolonged periods of wilting usually kill the plant.

A second general reason for the importance of water relations to the physiological ecology of plants is that plants require vast quantities of water. Whereas plants incorporate more than 90% of

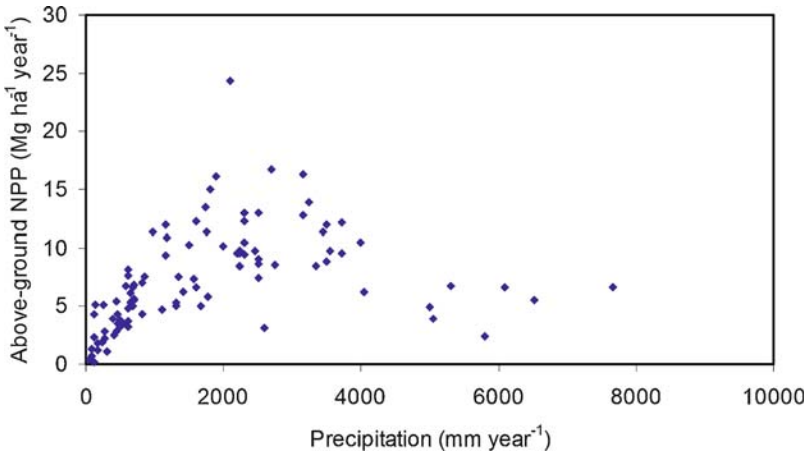

FIGURE 1. Correlation of above-ground net primary production (NPP, in units of biomass) with precipitation. NPP declines at extremely high precipitation ($>3 \text{ m yr}^{-1}$) due to indirect effects of excess moisture, such as low soil oxygen and nutrient loss by leaching (Schoor 2003). Copyright Ecological Society of America.

TABLE 1. Concentration of major constituents in a hypothetical herbaceous plant and the amount of each constituent that must be absorbed to produce a gram of dry biomass. The values only give a rough approximation and vary widely among species and with growing conditions, indicated in Sect. 4.3 of Chapter 6 on mineral nutrition for nutrients, and in Sect. 6 for water.

Resource	Concentration (% of fresh mass)	Quantity required (mg g^{-1})
Water	90	500,000
Carbon	4	40
Nitrogen	0.3	3
Potassium	0.2	2
Phosphorus	0.02	0.2

absorbed N, P, and K, and about 10–70% of photosynthetically fixed C into new tissues (depending on respiratory demands for carbon), less than 1% of the water absorbed by plants is retained in biomass (Table 1). The remainder is lost by **transpiration**, which is the evaporation of water from plants. The inefficient use of water by terrestrial plants is an unavoidable consequence of photosynthesis. The stomates, which allow CO_2 to enter the leaf, also provide a pathway for water loss. CO_2 that enters the leaf must first dissolve in water on the wet walls of the mesophyll cells before diffusing to the site of carboxylation. This moist surface area of mesophyll cells exposed to the internal air spaces of the leaf is about 7–80 times the external leaf area, depending on species and plant growth conditions (Table 2). This causes the air inside the leaf to be saturated with water vapor (almost 100% relative humidity) which

TABLE 2. The ratio of the surface area of mesophyll cells and that of the leaf (A_{mes}/A) as dependent on species and growing conditions.*

Leaf morphology/habitat	A_{mes}/A
Shade leaves	7
Mesomorphic leaves	12–19
Xeromorphic sun leaves	17–31
Low altitude (600 m)	37
High altitude (3000 m)	47
Species	A_{mes}/A
<i>Plectranthus parviflorus</i>	
High light	39
Low light	11
<i>Alternanthera philoxeroides</i>	
High light	78
Low light	50

*The data on leaves of species with different morphologies are from Turrel (1936), those on low-altitude and high-altitude species from Körner et al. (1989), those on *Plectranthus parviflorus* from Nobel et al. (1975), and those on *Alternanthera philoxeroides* (alligator weed) from Longstreth et al. (1985).

creates a strong gradient in water vapor concentration from the inside to the outside of the leaf.

1.2 Transpiration as an Inevitable Consequence of Photosynthesis

Transpiration is an inevitable consequence of photosynthesis; however, it also has important direct effects on the plant because it is a major component of the leaf's energy balance. As water evaporates from mesophyll cell surfaces, it cools the leaf. In the absence of transpiration, the temperature of large leaves can rapidly rise to lethal levels. We

further discuss this effect of transpiration in Chapter 4A on the plant's energy balance. The transpiration stream also allows transport of nutrients from the bulk soil to the root surface and of solutes, such as inorganic nutrients, amino acids, and phytohormones, from the root to transpiring organs. As will be discussed later, however, such transport in the xylem also occurs in the absence of transpiration, so that the movement of materials in the transpiration stream is not strongly affected by transpiration rate.

In this chapter, we describe the environmental factors that govern water availability and loss, the movement of water into and through the plant, and the physiological adjustments that plants make to variation in water supply over diverse timescales. We emphasize the mechanisms by which individual plants adjust water relations in response to variation in water supply and the adaptations that have evolved in dry environments.

2. Water Potential

The status of water in soils, plants, and the atmosphere is commonly described in terms of **water potential** (ψ_w) [i.e., the chemical potential of water in a specified part of the system, compared with the chemical potential of pure water at the same temperature and atmospheric pressure; it is measured in units of pressure (MPa)]. The water potential of pure, free water at atmospheric pressure and at a temperature of 298 K is 0 MPa (by definition) (Box 3.1).

In an isothermal two-compartment system, in which the two compartments are separated by a **semipermeable membrane**, water will move from a high to a low water potential. If we know the water potential in the two compartments, then we can predict the direction of water movement. It is certainly *not* true, however, that water invariably moves down a gradient in water potential. For example, in the **phloem** of a source leaf, the water potential is typically more negative than it is in the phloem of the sink. In this case, water transport is driven by a difference in hydrostatic pressure, and water moves up a gradient in water potential. Similarly, when dealing with a nonisothermal system, such as a warm atmosphere and a cold leaf, water vapor may condense on the leaf even though the water potential of the air is more negative than that of the leaf.

Water potential in any part of the system is the algebraic sum of the **osmotic potential**, ψ_π , and the **hydrostatic pressure**, ψ_p (the component of the water potential determined by gravity is mostly ignored):

$$\psi_w = \psi_\pi + \psi_p \quad (1)$$

where water potential is the overall pressure on water in the system. The **osmotic potential** is the chemical potential of water in a solution due to the presence of dissolved materials. The osmotic potential always has a negative value because water tends to move across a semipermeable membrane from pure water (the standard against which water potential is defined) into water containing solutes (Box 3.1). The higher the concentration of solutes, the lower (more negative) is the osmotic potential. The **hydrostatic pressure**, which can be positive or negative, refers to the physical pressure exerted on water in the system. For example, water in the turgid root cortical cells or leaf mesophyll cells is under positive **turgor pressure** exerted against the cell walls, whereas water in the dead xylem vessels of a rapidly transpiring plant is typically under **suction tension** (negative pressure). Large negative hydrostatic pressures arise because of capillary effects, i.e., the attraction between water and hydrophilic surfaces at an air–water interface (Box 3.2). Total water potential can have a positive or negative value, depending on the algebraic sum of its components. When dealing with the water potential in soils, an additional term is used: the **matric potential**, ψ_m . The matric potential refers to the force with which water is adsorbed onto surfaces such as cell walls, soil particles, or colloids, similar to the forces in xylem vessels. As such it is actually a convenient *alternative* to hydrostatic pressure for characterizing the water status of a porous solid. The hydrostatic pressure and the matric potential should therefore never be added! The matric potential always has a negative value because the forces tend to hold water in place, relative to pure water in the absence of adsorptive surfaces. The matric potential becomes more negative as the water film becomes thinner (smaller cells or thinner water film in soil).

Now that we have defined the components of water potential, we show how these components vary along the gradient from soil to plant to atmosphere.

3. Water Availability in Soil

The availability of soil water to plants depends primarily on the quantity of water stored in the soil and its relationship to soil water potential. Clay and organic soils, which have small soil particles, have more small soil pores; these small capillaries generate very negative pressures (large suction tensions)

Box 3.1

The Water Potential of Osmotic Solutes and the Air

We are quite familiar with the fact that water can have a potential: we know that water at the top of a falls or in a tap has a higher potential than that at the bottom of the falls or outside the tap. Transport of water, however, occurs not invariably as a result of differences in hydrostatic pressure, but also due to differences in vapor pressure (Sect. 2.2.2 of Chapter 2A on photosynthesis) or due to differences in the amount of dissolved osmotic solutes in two compartments separated by a semipermeable membrane. In fact, in all these cases, there is a difference in water potential, which drives the transport of water. For a full appreciation of many aspects of plant water relations, we first introduce the concept of the chemical potential of water, for which we use the symbol μ_w .

By definition, the chemical potential of pure water under standard conditions (298 K and standard pressure), for which the symbol μ_w^0 is used, is zero. We can also calculate the chemical potential of water under pressure, of water that contains osmotic solutes, or of water in air. This can best be explained using a simple example, comparing the chemical potential of water in two sealed containers of similar size (Fig. 1). One of these containers (A) contains pure water under standard conditions: $\mu_w = \mu_w^0 = 0$. Of course, the gas phase is in equilibrium with the liquid pure water, and the vapor pressure is p_0 . The second container (B) contains a 1 M sucrose solution in water. The gas phase will again be in equilibrium with the liquid phase; the vapor pressure is p . The vapor pressure, however, will be less than p_0 because the sucrose molecules interact with the water molecules via hydrogen bonds, so that the water molecules cannot move into the gas phase as readily as in the situation of pure water. How large is the difference between p and p_0 ?

To answer this question, we use Raoult's law, which states that

$$p/p_0 = N_w \quad (1)$$

where N_w is the mol fraction [i.e., the number of moles of water divided by the total number of moles in container B; in the case of 1 mole of sucrose in 1 L water (55.6 moles of water), $N_w =$

$55.6/56.6 = 0.982$]; p_0 is the vapor pressure (in Pa) above pure water, at standard pressure and temperature. We can calculate the difference in potential between the two containers ($\mu_w - \mu_w^0$) by considering the amount of work needed to obtain the same (higher) pressure in container B as in container A. To achieve this, we need to compress the gas in container B until the pressure equals p_0 :

$$\mu_w - \mu_w^0 = \int_{p_0}^p V \, dp = RT \ln\left(\frac{p}{p_0}\right) \quad (2)$$

where V is the volume (m^3) of container B, which is compressed until p_0 is reached, R is the gas constant ($\text{J mol}^{-1} \text{K}^{-1}$), and T is the absolute temperature (K).

Combination of Equations (1) and (2) yields

$$\mu_w - \mu_w^0 = RT \ln(1 - N_s) \quad (3)$$

Because N_w is the mole fraction of water and N_s is the mole fraction of the solute (in our example, $1/56.6 = 0.018$), we can write Equation (3) as

$$\mu_w - \mu_w^0 = RT \ln(1 - N_s) \quad (4)$$

As long as we consider solutions in a physiologically relevant range (i.e., not exceeding a few molar) Equation (4) approximates

$$\mu_w - \mu_w^0 = RT N_s \quad (5)$$

[as can readily be calculated for our example of a 1 M solution of sucrose, N_s is 0.018 and $\ln(1 - N_s) = -0.018$].

Dividing N_s by the molar volume of pure water ($V_w^0 \text{ m}^3 \text{ mol}^{-1}$), we arrive at the concentration of the solute, c_s (in mol m^{-3}):

$$N_s/V_w^0 = c_s \quad (6)$$

We make one further change, by introducing the molar volume of pure water ($\text{m}^3 \text{ mol}^{-1}$; at 273 K) in Equation (5):

$$\frac{\mu_w - \mu_w^0}{V_w^0} = -RTc_s = \Psi \quad (7)$$

continued

Box 3.1. Continued

Ψ is the water potential. Because we are dealing with the water potential of a solution in this example, we refer to this potential as the osmotic potential of water (Ψ_{π}). The dimension is Pascal (Pa). It is often more convenient, however, to use megapascal (MPa = 10^6 Pa) instead (1 MPa = 10 bars, a unit used in the literature, or 10 atm, a unit that is no longer used).

We can therefore calculate that our 1 M sucrose solution has an osmotic potential of -2.4 MPa, which approximates a pressure of a water column of about 250 m! In equilibrium, the water potential of the gas phase above the 1 M sucrose solution also equals -2.4 MPa. In the case of electrolytes, the calculation is slightly more complicated in that the dissociation of the solute has to be taken into account.

By modifying Equation (7), we can also calculate the water potential of air that is not in equilibrium with pure water [i.e., with a relative humidity (RH) of less than 100%]:

$$\frac{\mu_w - \mu_w^o}{V_w^o} = \frac{RT}{V_w^o} \ln\left(\frac{p}{p_o}\right) \quad (8)$$

For air of 293 K and a RH of 75%, Ψ equals -39 MPa [to calculate this, you need to know that the molar volume of water (molecular mass = 18) at 293 K is $18.10^{-6} \text{ m}^3 \text{ mol}^{-1}$]. Values for Ψ of air of different RH are presented in Table 1. Note that

even when the water vapor pressure is only marginally lower than the saturated water vapor pressure $\text{RH} = 100\%$, the water potential is rather negative.

TABLE 1. The water potential (MPa) of air at a range of relative humidities and temperatures. *

Relative humidity (%)	$-\Psi$ (MPa) at different temperatures ($^{\circ}\text{C}$)				
	10	15	20	25	30
100	0	0	0	0	0
99.5	0.65	0.67	0.68	0.69	0.70
99	1.31	1.33	1.36	1.38	1.40
98	2.64	2.68	2.73	2.77	2.81
95	6.69	6.81	6.92	7.04	7.14
90	13.75	13.99	14.22	14.45	14.66
80	29.13	29.63	30.11	30.61	31.06
70	46.56	47.36	48.14	48.94	49.65
50	90.50	92.04	93.55	95.11	96.50
30	157.2	159.9	162.5	165.2	167.6
10	300.6	305.8	310.8	316.0	320.6
RT/V_w	130.6	132.8	135.0	137.3	139.2

Note: The values were calculated using the formula: $\Psi = -RT/V_w^o \ln(\% \text{ relative humidity}/100)$.

* Note that all values for Ψ are *negative* and that the effect of temperature is exclusively due to the appearance of temperature in the equation given in the last line of this table, rather than to any effect of temperature on p_o .

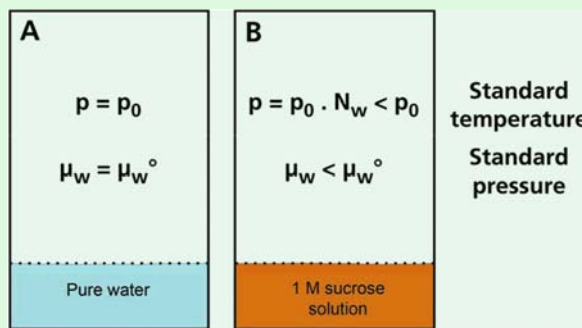

FIGURE 1. The difference in water potential between two systems. The system at the left is a sealed container with pure water at standard temperature and pressure; the partial water vapor pressure in this container is p_o and the chemical potential of water in this system is μ_w^o . The system at the right is a container with a solution of 1 M sucrose at the

same temperature and pressure; the water vapor pressure can be calculated according to Raoult's law ($p = p_o \cdot N_w$) and the chemical potential of water in this system is μ_w . The difference in chemical potential between the two systems can be calculated as explained in the text.

Box 3.2

Positive and Negative Hydrostatic Pressures

Positive values of hydrostatic pressure in plants are typically found in living cells and are accounted for by high concentrations of osmotic solutes. Large negative values arise because of capillary effects (i.e., the attraction between water and hydrophilic surfaces at an air–water interface). It is this attraction that explains the negative matric potential in soil and the negative hydrostatic pressure in the xylem of a transpiring plant.

The impact of the attraction between water and hydrophilic surfaces on the pressure in the adjacent water can be understood by imagining a glass capillary tube, with radius a (m), placed vertically with one end immersed in water. Water will rise in the tube, against the gravitational force, until the mass of the water in the tube equals the force of attraction between the water and the glass wall. A fully developed meniscus will exist (i.e., one with a radius of curvature equal to that of the tube). The meniscus of the water in the glass tube is curved because it supports the mass of the water.

The upward acting force in the water column equals the perimeter of contact between water and glass ($2\pi a$) multiplied by the surface tension, γ (N m^{-1}), of water; namely, $2\pi a\gamma$ (provided the glass is perfectly hydrophilic, when the contact angle between the glass and the water is zero; otherwise, this expression has to be multiplied by the cosine of the angle of contact). When in equilibrium, there must be a difference in pressure, ΔP (Pa) across the meniscus, equal to the force of attraction between the water and the capillary wall (i.e., the pressure in the water is less than that of the air). The downward acting

force (N) on the meniscus is the difference in pressure multiplied by the cross-sectional area of the capillary tube (i.e., $\pi a^2\gamma P$). Thus, because these forces are equal in equilibrium, we have

$$\pi a^2 \Delta P = 2\pi a\gamma \quad (1)$$

and

$$\Delta P = 2\pi a\gamma / \pi a^2 = 2\gamma / a \quad (2)$$

The surface tension of water is 0.075 N m^{-1} at about 20°C , so $\Delta P = 0.15/a$ (Pa). Thus a fully developed meniscus in a cylindrical pore of radius, say $1.5 \mu\text{m}$, would have a pressure drop across it of 1.0 MPa ; the pressure, P , in the water would therefore be -0.1 MPa if referenced to normal atmospheric pressure, or -0.9 MPa absolute pressure (given that standard atmospheric pressure is approximately 0.1 MPa).

This reasoning also pertains to pores that are not cylindrical. It is the radius of curvature of the meniscus that determines the pressure difference across the meniscus, and this curvature is uniform over a meniscus that occupies a pore of any arbitrary shape. It is such capillary action that generates the large negative pressures (large suction tension) in the cell walls of leaves that drive the long-distance transport of water from the soil through a plant to sites of evaporation. The pores in cell walls are especially small (approximately 5 nm) and are therefore able to develop very large suction tensions, as they do in severely water-stressed plants.

(Box 3.2). Pores larger than $30 \mu\text{m}$ hold the water only rather loosely, so the water drains out following a rain. Pores smaller than $0.2 \mu\text{m}$ hold water so tightly to surrounding soil particles that the drainage rate often becomes very small once the large pores have been drained. As a result, most plants cannot extract water from these pores at sufficiently high rates to meet their water needs. It is thus the intermediate—sized pores ($0.2\text{--}30 \mu\text{m}$ diameter) that hold most of the water that is tapped by plants.

In friable soil, roots can explore a large fraction of the soil volume; hence, the volume of water that is available to the roots is relatively large. Upon soil compaction, roots are unable to explore as large a fraction of the soil volume; the roots then tend to be clumped into sparse pores and water uptake is restricted. Compacted soils, however, are not uniformly hard and usually contain structural cracks and biopores (i.e., continuous large pores formed by soil fauna and roots). Roots grow best in soil with an intermediate density, which is soft enough to allow

good root growth but sufficiently compact to give good root–soil contact (Stirzaker et al. 1996).

Water movement between root and soil can be limited by incomplete root–soil contact, such as that caused by air gaps due to root shrinkage during drought. It can also be influenced by a **rhizosheath** (i.e., the soil particles bound together by root exudates and root hairs) (McCully & Canny 1988). Rhizosheaths are limited to distal root regions, which generally have a higher water content than do the more proximal regions (Huang et al. 1993) in part due to the immaturity of the xylem in the distal region (Wang et al. 1991). The rhizosheath virtually eliminates root–soil air gaps, thus facilitating water uptake in moist soil. On the other hand, bare roots restrict water loss from roots to a drier soil (North & Nobel 1997).

3.1 The Field Capacity of Different Soils

Field capacity is defined as the water content after the soil becomes saturated, followed by complete gravitational drainage. The water potential of nonsaline soils at field capacity is close to zero (–0.01 to –0.03 MPa). There is a higher soil water content at field capacity in fine-textured soils with a high clay

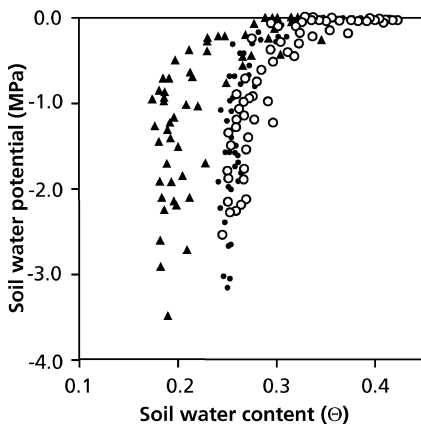

FIGURE 2. Relationship between soil water potential and volumetric soil water content (ratio of volume taken up by water and total soil volume, θ) at different soil depths: 25 cm, *solid triangles*; 50–80 cm, *open circles*; 110–140 cm, *filled circles*. The top horizon was a silty clay loam; the middle layer was enriched with clay, and in the deepest soil layer, the clay content decreased again. Soil water potential was measured with tensiometers and micropsychrometers, and soil water content with a neutron probe. Data were obtained over 1 year while water content fell during drought (Bréda et al. 1995).

TABLE 3. Typical pore-size distribution and soil water contents of different soil types.

Parameter	Soil type		
	Sand	Loam	Clay
Pore space (% of total)			
>30 μ m particles	75	18	6
0.2–30 μ m	22	48	40
<0.2 μ m	3	34	53
Water content (% of volume)			
Field capacity	10	20	40
Permanent wilting point	5	10	20

or organic matter content (Fig. 2). The lowest water potential at which a plant can access water from soil is the **permanent wilting point**. Although species differ in the extent to which they can draw down soil water (e.g., from –1.0 to –8.0 MPa), as discussed later, a permanent wilting point of –1.5 MPa is common for many herbaceous species. The **available water** is the difference in the amount of soil water between field capacity and permanent wilting point, –1.5 MPa (by definition). The amount of available water is higher in clay than it is in sandy soils (Fig. 2, Table 3).

In a moist soil, the smallest soil pores are completely filled with water and only the largest pores have air spaces. As soil moisture declines, the thickness of the water film surrounding soil particles declines, and remaining water is held more tightly to soil particles, giving a low (negative) matric potential. Finally, the hydrostatic pressure (reflecting gravity or the mass of the water column) is generally negligible in soils. In nonsaline soils, the matric potential is the most important component of soil water potential.

In **saline soils**, the osmotic potential adds an additional important component. If plants are well watered with a saline solution of 100 mM NaCl, then the soil water potential is –0.48 MPa. As the soil dries out, the salts become more concentrated and further add to the negative value of the soil water potential. When half of the water available at field capacity has been absorbed, the osmotic component of the soil water potential will have dropped to almost –1 MPa. Under such situations, the osmotic component of the soil water potential, clearly, cannot be ignored.

Soil **organic matter** affects water retention because of its hydrophilic character and its influence on soil structure. Increasing the organic matter content from 0.2 to 5.4% more than doubles the water-holding capacity of a sandy soil—from 0.05 to 0.12

(v/v). In silty soils, which have a larger water-holding capacity, the absolute effect of organic matter is similar, but less dramatic when expressed as a percentage; it increases from about 0.20 to less than 0.30 (v/v). Effects on plant-available water content are smaller because the water content at field capacity as well as that at the permanent wilting point is enhanced (Kern 1995). Roots, especially mycorrhizal roots (Sect. 2.5 of Chapter 9A on symbiotic associations), may promote the development of soil aggregates, through the release of organic matter, and thus affect soil hydraulic properties. **Organic matter** may also have the effect of **repelling** water, if it is highly hydrophobic. Such situations may arise when plant-derived waxy compounds accumulate on the soil surface. These reduce the rate at which water penetrates the soil so that much of the precipitation from a small shower may be lost through runoff or evaporation rather than becoming available for the plant. Some roots release surfactants, which may counteract the effect of water-repelling compounds in soil (Read et al. 2003).

3.2 Water Movement Toward the Roots

Water moves relatively easily through soil to the roots of a transpiring plant by flowing down a gradient in hydrostatic pressure. If the soil is especially dry (with a water potential less than -1.5 MPa), then there may be significant movement as water vapor. Under those conditions, however, transpiration rates are very low. Gradients in osmotic potential move little water because the transport coefficients for diffusion are typically orders of magnitude smaller than for flow down a hydrostatic gradient. Movement across the interface between root and soil is more complicated. There may be a mucilaginous layer that contains pores so small that the flow of water across it is greatly hindered. There may also be a lack of hydraulic

continuity between root and soil if the root is growing in a pore wider than itself or if the root has shrunk. A root has, generally, access to all available water within 6 mm of the root. As the soil dries and the matric forces holding water to soil particles increases, movement of liquid water through soils declines (Fig. 3).

In a situation where the soil is relatively dry and the flow of water through it limits water uptake by the roots, the following equation approximates water uptake by the roots:

$$d\theta'/dt = D(\theta' - \theta_a)/2b^2 \quad (2)$$

where $d\theta'/dt$ is the rate of fall of mean soil water content, θ' , with time, t ; D is the diffusivity of soil water, which is approximately constant with a value of $2 \times 10^{-4} \text{ m}^2 \text{ day}^{-1}$ ($0.2 \times 10^{-8} \text{ m}^2 \text{ s}^{-1}$), during the extraction of about the last third of the available water in the soil (Fig. 3), when the flow is likely limiting the rate of water uptake; θ_a is the soil water content at the surface of the root; and b is the radius of a putative cylinder of soil surrounding the root, to which that root effectively has sole access, and can be calculated as $b = (\pi L)^{-1/2}$, where L (m m^{-3}), the rooting density, is the length of root per unit volume of soil (m^3) (Passioura 1991).

Under the reasonable assumption that θ_a is constant, as it would be if the root were maintaining a constant water potential of, say, -1.5 MPa at its surface (Fig. 3), the equation can be integrated to give

$$(\theta' - \theta_a)_d = (\theta' - \theta_a)_0 \exp(-Dt/2b^2) = \theta_{a0} \exp(-t/t^*) \quad (3)$$

where $(\theta' - \theta_a)_0$ is $(\theta' - \theta_a)$ when $t = 0$, and t^* (equal to $2b^2/D$) is the time constant for the system: the time taken for the mean soil water content to fall to $1/e$ (i.e., 0.37) of its initial value. If D is $2 \times 10^{-4} \text{ m}^2 \text{ day}^{-1}$, then t^* is simply $b^2 \times 10^{-4}$ days. If the roots are evenly distributed in the soil, then, even at a low rooting density, L , of 0.1 m m^{-3} , t^* (calculated from

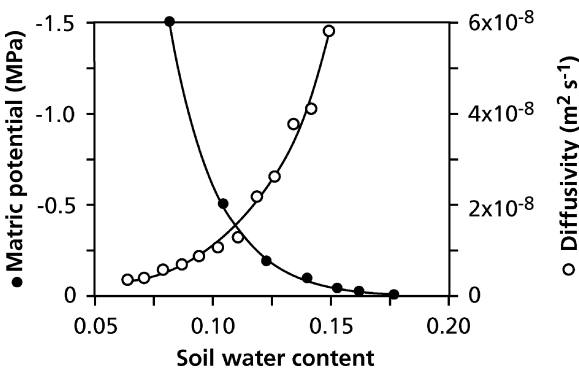

FIGURE 3. The matric potential and diffusivity of soil water as a function of the volumetric water content (ratio of volume taken up by water and total soil volume) of a sandy loam soil (55% coarse sand, 19% fine sand, 12% silt, and 14% clay) (after Stirzaker & Passioura 1996).

$b^2 = 1/[\pi L])$ is only about 3 days. Roots, therefore, should readily be able to extract all the available water from the soil. When the soil is compacted, roots are not distributed so evenly through the soil (Sect. 5.5 of Chapter 7 on growth and allocation), and Equations (2) and (3) are no longer applicable. Under those conditions, t^* could become of the order of weeks. The parameter t^* changes with soil type and soil depth, but is not strongly affected by the nature of the plant extracting the water (Passioura 1991).

If a plant does not absorb all the ions arriving at the surface of its roots, the osmotic potential will drop locally, either only in the apoplast of the roots or possibly in the rhizosphere as well. This is more pronounced in fertilized or saline soils than in nutrient-poor, nonsaline soils. The effect is that plants have greater difficulty in extracting water from soil than expected from the average soil water potential (Stirzaker & Passioura 1996).

3.3 Rooting Profiles as Dependent on Soil Moisture Content

As long as the upper soil is fairly moist, plants tend to absorb most of their water from shallower soil regions, which is where roots are concentrated. As the soil dries out, relatively more water is absorbed from deeper layers. Water from the deepest layers, even from those where no roots penetrate, may become available through capillary rise (Fig. 4; Bréda et al. 1995). The actual **rooting depth** varies greatly among species, with some chaparral shrubs

[*Adenostoma fasciculatum* (chamise), *Quercus dumosa* (California scrub oak), and *Quercus chrysolepis* (canyon live oak)] growing in the San Gabriel and San Bernardino mountains in southern California reaching depths of 8 m in fractured rock structures (Hellmers et al. 1955). Maximum rooting depths are found in deserts and tropical grasslands and savannas (Canadell et al. 1996). On the Edwards Plateau of central Texas, United States, rooting depths of a range of species were determined by using DNA sequence variation to identify roots from caves 5 to 65 m deep. At least six tree species in the system produced roots deeper than 5 m, but only the evergreen oak, *Quercus fusiformis*, was found below 10 m. The maximum rooting depth for the ecosystem was approximately 25 m (Jackson et al. 1999). In the Kalahari Desert, well drillers must bore to great depths in very dry sand to reach water, and drillers reported some of the deepest roots thus far recorded in the world at 68 m. In the Kalahari sands, the annual precipitation of less than 300 mm can only penetrate a couple of meters at most. Below this wetting front, roots must grow in very dry sand for tens of meters before they can reach deep geologic water (Jennings 1974, as cited in Schulze et al. 1988). A potential mechanism that would facilitate this growth in very dry sand is through hydraulic redistribution (Sect. 5.2; Schulze et al. 1988).

The root-trench method, in combination with measurements of volumetric soil water content (Fig. 4), is a laborious and expensive method to obtain information on where most of the water comes from that a tree transpires. If the **isotope signature** of water differs among soil layers, then

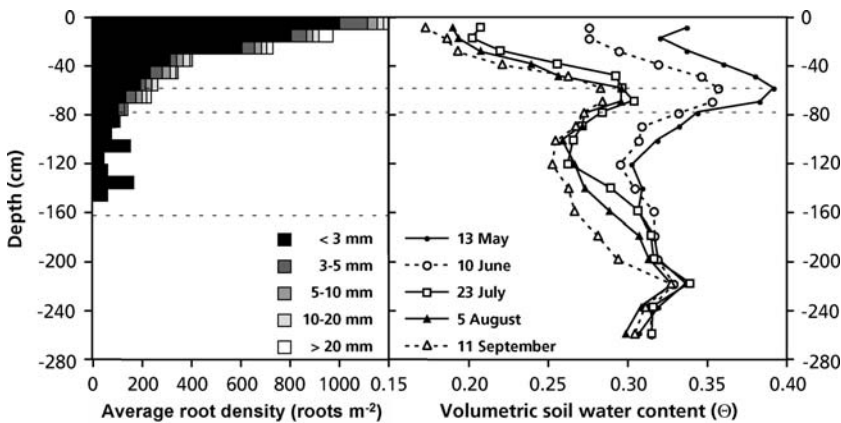

FIGURE 4. (Left) Rooting profile of *Quercus petraea* (sessile oak) as dependent on soil depth. Roots are divided in different diameter classes. (Right) Volumetric water content of the soil in which the oak tree was growing, as dependent on depth and time

of the year. A clay-enriched horizon at around 50 cm depth is indicated by the two broken lines. The third broken line at 160 cm depth indicates the depth of the trench that was dug to make the measurements (Bréda et al. 1995).

this value can be used to obtain information on which soil layers and associated roots provide the water that is transpired (Box 3.3). This technique has shown that perennial groundwater sources can be important (Thorburn & Ehleringer 1995, Boutton et al. 1999). For example, in a Utah desert scrub

community, most plants use a water source derived from winter storm recharge for their early spring growth (Ehleringer et al. 1991). As this water source is depleted, however, only the deep-rooted woody perennials continue to tap this source, and more shallow-rooted species such as annuals, herbaceous

Box 3.3 Oxygen and Hydrogen Stable Isotopes

Small fractions of the elements H and O occur as their heavy stable isotopes ^2H (also called deuterium; D) and ^{18}O (0.156 and 1.2‰, respectively). Their abundances in water (and CO_2) in the immediate environment of the plant, and in water, metabolites, and macromolecules in the plant itself vary as a result of fractionation processes operating in these two compartments. Isotopic composition, which can be measured with high precision, provides information about environmental and physiological parameters that is otherwise difficult to obtain. Isotopes in xylem water, for instance, can yield information on the source of water tapped by a plant, and isotopes in leaf water are influenced by stomatal conductance and humidity. Isotopes in plant dry matter can give a time-integrated and time-resolved historical record of environmental and physiological processes, as in tree rings (Dawson et al. 2002). A problem, however, with interpreting isotopic composition of plant dry matter or of specific compounds (e.g., cellulose) in field studies is that it is simultaneously influenced by many factors. Models have been developed to resolve these problems as much as possible (Farquhar et al. 1998, Roden et al. 2000, Gessler et al. 2007).

Isotopes are measured as atomic ratios (R = rare isotope/common isotope) using mass spectrometers and are expressed relative to a standard (Standard Mean Ocean Water; SMOW; see also Box 2A.2 and Box 2B.1):

$$\delta^2\text{H or } \delta^{18}\text{O}(\text{‰}) = (R_{\text{sample}}/R_{\text{standard}} - 1) \times 1000 \quad (1)$$

The $\delta^2\text{H}$ and $\delta^{18}\text{O}$ of precipitation water and other water bodies that are regularly involved in the global water cycle (meteoric waters) vary as a result of fractionation during evaporation and condensation in a temperature-dependent manner. Tropical regions are characterized by δ -values close to ocean water, and these values decrease toward the poles, particularly in winter.

Depleted values are also found at higher altitudes and further inland on continents. Fractionation processes in meteoric water operates similarly for ^2H and ^{18}O , and the δ -values are linearly related. This is known as the global meteoric water line [$\delta^{18}\text{O} = (\delta^2\text{H} - 10)/8$]. Fractionation processes in more closed compartments result in deviations from this line.

Soil moisture in surface layers is typically isotopically enriched as a result of evaporation (Fig. 1). Different isotopic compositions of precipitation events can further add to a profile of $\delta^2\text{H}$ and $\delta^{18}\text{O}$ in the soil (Midwood et al. 1998). Since fractionation does not normally occur during uptake of water, the δ -value of xylem water may contain information about the depth of water uptake or source of water (e.g., ground or stream water). Once in the leaf, the water is isotopically enriched as a result of transpiration. The ultimate $\delta^2\text{H}$ and $\delta^{18}\text{O}$ of leaf water is influenced by stomatal and boundary layer conductances, vapor pressure difference, transpiration rate and the δ -values of water vapor around the leaf.

The H in photoassimilates stems from water and carries its isotopic composition during assimilation. That is also the case with O, although in an indirect manner. Assimilated O is derived from CO_2 , but its O is exchanged with H_2O in the reaction $\text{CO}_2 \leftrightarrow \text{HCO}_3^-$ catalyzed by carbonic anhydrase. Assimilates thus carry the isotopic signal of leaf water. During CO_2 assimilation, substantial fractionation occurs for ^2H (-117‰), whereas fractionation during further metabolism works in the opposite direction (+158‰). There is also isotopic enrichment of ^{18}O during assimilation and metabolism (+27‰). However, the environmental effect on these fractionation processes is limited. During synthesis of macromolecules from assimilates exchange of H and O with water occurs (Fig. 1). This applies only for part of the atoms. The

continued

Box 3.3 *Continued*

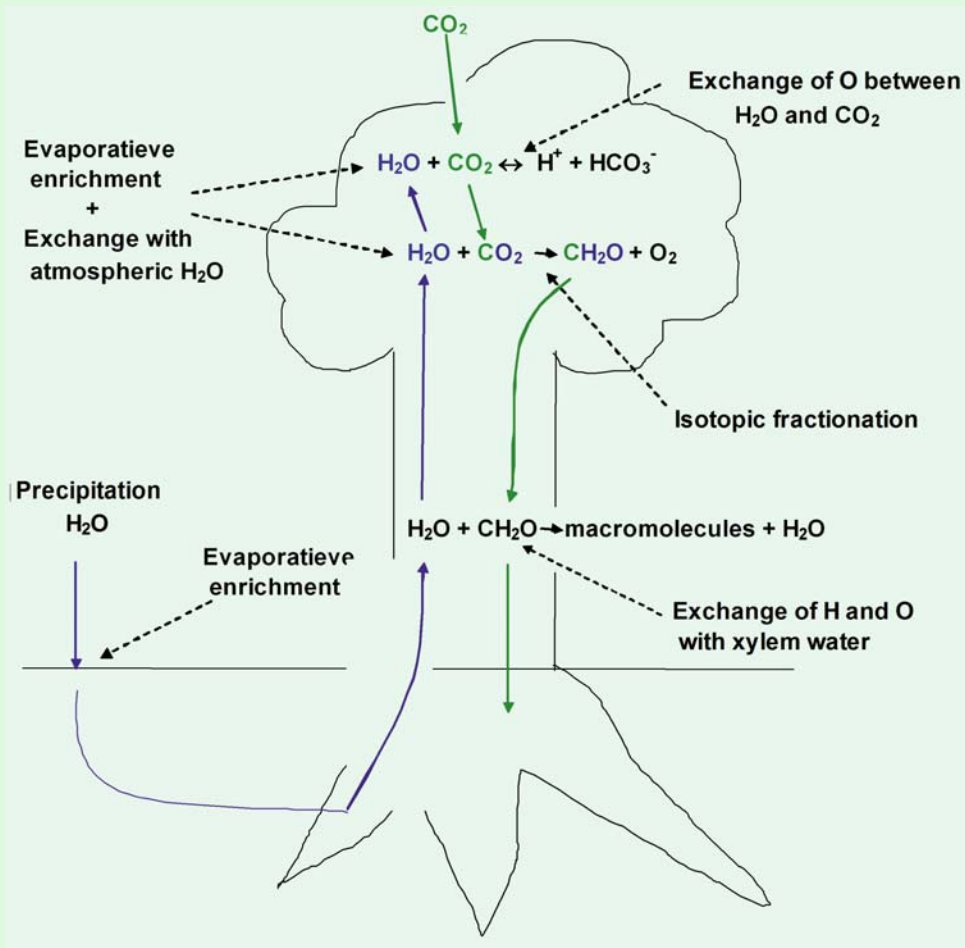

FIGURE 1. Isotopic fractionation and exchange processes of H and O in a tree and its environment.

fraction of exchange during cellulose synthesis in tree rings was estimated at 0.36 for H and 0.42 for O (Roden et al. 2000). Intramolecular positions have different degrees of exchange (Sternberg et al. 2006) which can be used for specific purposes.

The above qualitatively described reactions have been formalized in quantitative models that give good predictions of measured values. When information is available about sufficient environmental variables, unknowns can be calculated on the basis of δ -values.

perennials, and succulent perennials depend on summer rains (Fig. 5). Plants that have an isotopic composition of their xylem water that is representative of deep water are less water stressed and have higher transpiration rates and lower **water-use efficiency** (Sect. 6) than do species with a shallow-water isotopic signature.

3.4 Roots Sense Moisture Gradients and Grow Toward Moist Patches

As with so many other fascinating phenomena in plants, Darwin (1880) already noticed that roots have the amazing ability to grow away from dry sites and toward wetter pockets in the soil: They

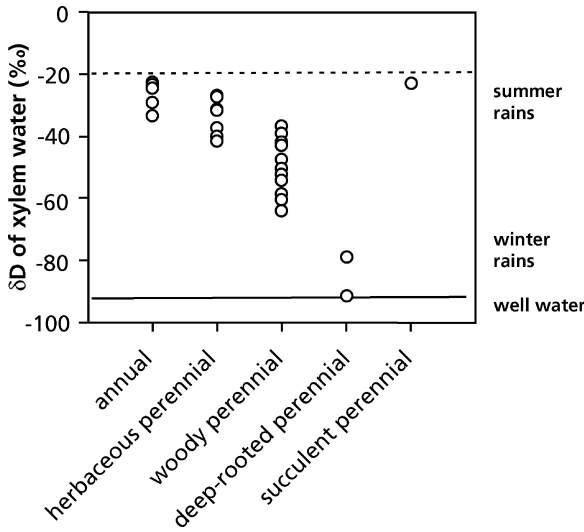

FIGURE 5. Hydrogen isotope ratios (δD) of xylem water during the summer from plants of different growth forms in a Utah desert scrub community. The mean winter precipitation δD was -88‰ , whereas summer precipitation δD ranged from -22 to -80‰ (Ehleringer et al. 1991).

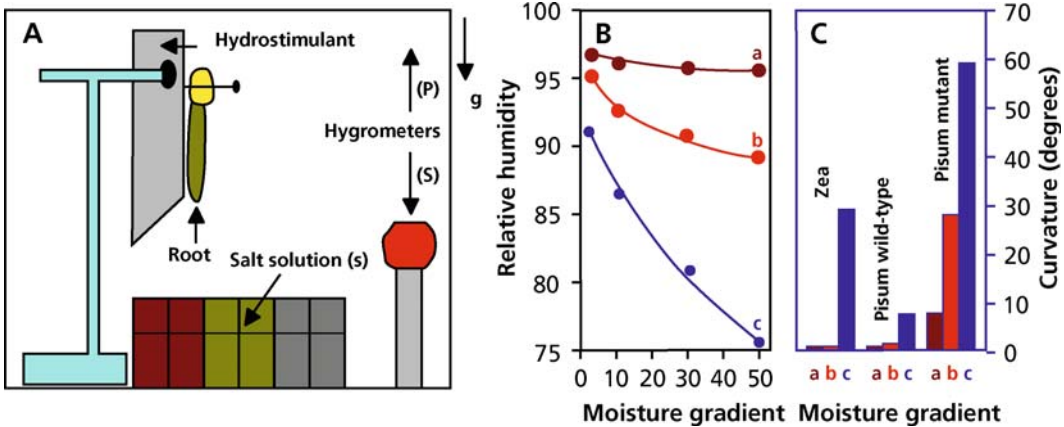

FIGURE 6. Hydrotropism in roots of *Zea mays* (corn) and of the wild type and the ageotropic mutant (*ageotropum*) of *Pisum sativum* (pea). (A) Diagram showing the humidity-controlled chamber. Roots were placed 2–3 mm from the “hydrostimulant” (wet cheesecloth). Saturated solutions of salts create the humidity gradient. Different salts (KCl, K₂CO₃) give different gradients. The relative humidity and temperature was measured with a

thermohygrometer (P). A stationary hygrometer (S) measured the relative humidity in the chamber. The arrow and letter g indicate the direction of gravitational force. (B) Moisture gradients, between 0 and 50 mm from the hydrostimulant, created by using no salt (a), KCl (b), or K₂CO₃ (c). (C) Root curvature 10 hours after the beginning of hydrostimulation by the three moisture gradients shown in (B) (after Takahashi & Scott 1993).

are **hydrotropic**. Positive hydrotropism occurs due to inhibition of root cell elongation at the humid side of the root. The elongation at the dry side is either unaffected or slightly stimulated, resulting in a curvature of the root and growth toward a moist patch (Takahashi 1994, Tsuda et al. 2003). The root cap is most likely the site of **hydrosensing** (Takahashi & Scott 1993), but the exact mechanism of **hydrotropism** is not known. It involves an increase in cell-wall extensibility of the root cells that face the dry side (Sect. 2.2 of Chapter 7 on growth and allocation; Hirasawa et al. 1997). The hydrotropic response is

stronger in roots of *Zea mays* (corn), which is a species that tolerates relatively dry soils, than it is in those of *Pisum sativum* (pea), and it shows a strong interaction with the root’s gravitropic response (Fig. 6).

4. Water Relations of Cells

There are major constraints that limit the mechanisms by which plants can adjust cellular water potential. Adjustment of the water potential must come through variation in hydrostatic pressure or

osmotic potential. Live cells must maintain a positive hydrostatic pressure (i.e., remain turgid) to be physiologically active; in most plants, osmotic potential of the cell or apoplast is the only component that live cells can adjust to modify water potential within hours (Korolev et al. 2000). In the long term, plants can also adjust by changing the elasticity of their cell walls. By contrast with living cells, dead xylem cells have very dilute solutes, so their water potential can change only through changes in hydrostatic pressure.

Within a tissue, the water relations of individual cells may differ widely. This accounts for phenomena such as stomatal opening and closure (Sect. 5.4.2), leaf rolling and movements (Sect. 6.2), and **tissue tension**. Tissue tension plays a role in herbaceous stems (e.g., of Asteraceae), where the outer layers of the stem tissue are held in a state of longitudinal tension by more internal tissues that are held in a reciprocal state of compression (Niklas & Paolillo 1998). This can readily be demonstrated by cutting a stem of celery (*Apium graveolens*) parallel to its axis. Upon cutting, the stem halves curl outward, illustrating that the inner cells were restrained by outer cells and unable to reach their fully expanded size before the cut. Tissue tension plays a major role in the closing mechanism of the carnivorous plant *Dionaea muscipula* (Venus' fly trap) (Sect. 3.1 of Chapter 9F on carnivory).

4.1 Osmotic Adjustment

As the soil dries, causing soil water potential to decline, live cells may adjust their water potential by accumulating osmotically active compounds which reduce the osmotic potential (ψ_{π}), and, therefore, their water potential (ψ_w). As a result of an increased concentration of osmotic solutes, cells have a higher turgor (ψ_p) when fully hydrated, provided the cell walls maintain their original rigidity (Sects. 4.2 and 4.3). In addition, they lose their turgor at a more negative water potential compared with the turgor-loss point of nonacclimated plants (Rodriguez et al. 1993, Nabil & Coudret 1995), thereby enabling the plant to continue to acquire water from soil at low soil water potentials. The osmotic solutes in the vacuole, which constitutes most of the volume of the plant cell, are often inorganic ions and organic acids. Such compounds reduce the activity of cytoplasmic enzymes, and plants tend to synthesize other **compatible solutes** in the cytoplasm (i.e., solutes that do not have a negative effect on cell metabolism). Such compatible solutes include glycinebetaine, sorbitol, and proline. These compounds are not highly charged,

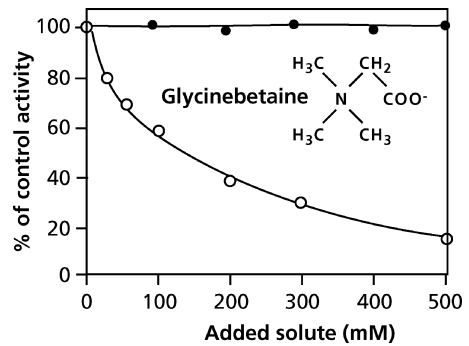

FIGURE 7. The effect of NaCl (open symbols) and glycinebetaine (filled symbols) on the activity of malate dehydrogenase from barley leaves (Pollard & Wyn Jones 1979). The chemical structure of glycinebetaine, a compatible solute in many higher plant species, is also given.

and they are polar, highly soluble, and have a larger hydration shell (the layer of water molecules surrounding each molecule) than denaturing molecules, like NaCl. Compatible solutes do not interfere with the activity of enzymes at a concentration where NaCl strongly inhibits them (Fig. 7). Transgenic *Nicotiana tabacum* (tobacco) plants that accumulate *D*-ononitol, because of insertion of the gene encoding *myo*-inositol *O*-methyltransferase, show less inhibition of photosynthesis by water stress and salinity than do wild-type plants (Sheveleva et al. 1997). Some compatible solutes (e.g., sorbitol, mannitol, and proline) are effective as hydroxyl radical scavengers in vitro, but this is not the case for glycinebetaine (Smirnoff & Cumbes 1989). A role as radical scavenger in vivo has been established for mannitol, using transgenic *Nicotiana tabacum* (tobacco) plants that accumulate mannitol in their chloroplasts (Shen et al. 1997a). Polyols probably shield susceptible thiol-regulated enzymes from inactivation by hydroxyl radicals (Shen et al. 1997b).

Some plants accumulate fructans (i.e., one glucose molecule linked to two or more fructose molecules), when exposed to water stress. Fructan accumulation confers greater drought resistance, partly because these solutes play a role in osmotic adjustment, but presumably also because fructans protect membranes. Transgenic tobacco plants (*Nicotiana tabacum*) that contain the genetic information that enables them to accumulate fructans show greater desiccation resistance than wild-type plants (Pilon-Smits et al. 1995).

4.2 Cell-Wall Elasticity

When cells lose water, they decrease in volume until the turgor is completely lost. The extent to which the

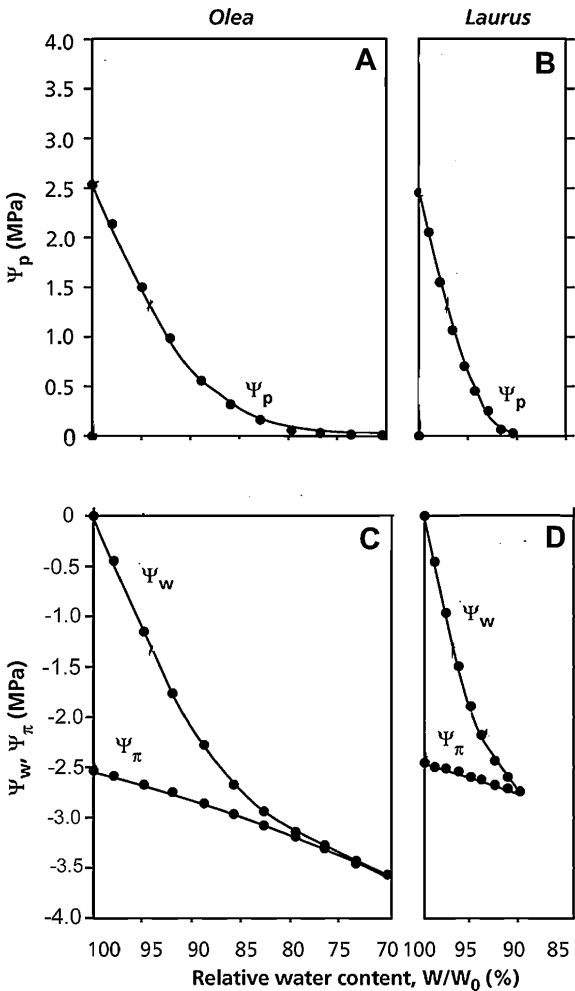

FIGURE 8. Höfler diagrams, relating turgor pressure (Ψ_p), osmotic potential (Ψ_π), and water potential (Ψ_w), to relative water content for leaves of two Mediterranean tree species. (A) *Olea oleaster* (olive) and (B) *Laurus nobilis* (laurel). The bulk elastic modulus, ϵ , is the initial slope of Ψ_p with relative water content (Lo Gullo & Salleo 1988). Copyright Trustees of The New Phytologist.

cells can decrease in volume and hence the extent to which their water potential can decrease until the turgor-loss point is reached depends on the **elasticity** of their cell walls. Cells with highly elastic walls contain more water at full turgor; hence, their volume can decrease more, before the turgor-loss point is reached. The elasticity of the cell walls depends on chemical interactions between the various cell-wall components. Cells with elastic walls can therefore store water that they accumulate during the night and gradually lose again during the day due to the leaf's transpiration. In this way, they can afford to lose more water temporarily than is imported from the root environment.

A greater elasticity of cell walls is expressed as a smaller **elastic modulus**, ϵ (MPa), which describes the amount by which a small change in volume (ΔV , m^3) brings about a change in turgor, $\Delta\psi_p$ (MPa) at a certain initial cell volume:

$$\Delta\Psi_p = \epsilon\Delta V/V, \text{ or } \epsilon = d\Psi_p/dV.V \quad (4)$$

The **bulk elastic modulus** (ϵ) can be derived from **Höfler diagrams** (Fig. 8); they refer to an entire leaf, rather than individual cells. More commonly, ϵ is calculated from plots of $-1/\Psi_p$ vs. the relative water content (Schulte & Hinckley 1985). [Relative water content (RWC) is defined as the water content of the tissue, relative to that at full hydration.] At full turgor (RWC = 100%), the change in turgor for a change in volume is much greater for *Laurus nobilis* (sweet bay) than for *Olea oleaster* (olive) (i.e., ϵ is greater for *Laurus nobilis*) (Table 4). The greater elasticity of the leaf cell walls of *Olea oleaster* from drier sites, in comparison with species from moister sites, implies that its cells can lose more water before they reach the **turgor-loss point** (Table 4); they have cells that can shrink more during periods of water shortage without damage to the cytoplasm. In other words, they have a greater capacity to store water.

TABLE 4. The elastic modulus of 1-year-old leaves of three Mediterranean evergreen, sclerophyllous trees, growing in the same Mediterranean environment, but at locations differing in water availability*

Species	Elastic modulus, at full turgor (MPa)	
	Wet season	Dry season
<i>Olea oleaster</i>	19.5	19.3
<i>Ceratonia siliqua</i>	20.5	24.5
<i>Laurus nobilis</i>	28.1	40.7

Source: Lo Gullo & Salleo (1988).

**Olea oleaster* (olive) is the most desiccation-tolerant, followed by *Ceratonia siliqua* (carob); *Laurus nobilis* (laurel) grows at somewhat wetter locations, near river banks. The elastic modulus was determined at full turgor, in both May (wet season) and September (dry season). Additional information about these trees is included in Figs. 8 and 28.

The elastic modulus can also be determined for individual cells, by using a **pressure probe** (Tomos & Leigh 1999). It involves the insertion in a cell of a small glass microcapillary. The fluid in the capillary will then be pushed back by the turgor pressure. The force to push back the meniscus of the fluid to its position before insertion is then measured, using a sensitive pressure transducer. In this way, the pressure in individual cells, such as stomatal guard cells, can be measured very accurately (Sect. 5.4.2).

4.3 Osmotic and Elastic Adjustment as Alternative Strategies

Osmotic and elastic adjustment are alternative strategies for a species to acclimate to water stress. Osmotic adjustment and simultaneous increases in

elasticity are not an option, because accumulation of solutes would cause cells to swell, and not lead to the same decrease in water potential (Fig. 9; White et al. 2000, Ngugi et al. 2003, Mitchell et al. 2008). An increase in elasticity (a lower elastic modulus) thus contributes to turgor maintenance in much the same way as a decrease in osmotic potential (greater osmotic adjustment).

In nonadapted species, leaves lose turgor ($\psi_p = 0$) at higher relative water content and higher leaf water potential (Table 4; Nabil & Coudret 1995). The protoplasm of the leaf cells of adapted species [e.g., *Olea oleaster* (olive), *Eucalyptus wandoo* (wandoo)] must have the capacity to tolerate more negative water potentials to survive the greater loss of water from their cells with more elastic cell walls (Lo Gullo & Salleo 1988, Mitchell et al. 2008).

Comparing hemiepiphytic *Ficus* (fig) species, which start their life as epiphyte and subsequently establish root connections with the ground, leaf cells have a less negative osmotic potential at full turgor (less osmotic adjustment) and lower bulk elastic modulus (more elastic cells) in the epiphytic stage than they do as terrestrial trees. Lower osmotic potentials (in the tree stage) should allow leaves to withstand greater evaporative demand without wilting, in order to mobilize water from deeper and/or drier soil layers. This strategy, however, requires that there be some substrate moisture in the first place. Given the substrate of the epiphyte which dries rapidly, frequently, and uniformly, a more favorable strategy is to gather water from the aerial rooting medium when it is readily available for storage in highly elastic leaf cells (Holbrook & Putz 1996).

FIGURE 9. Osmotic potential at full turgor ($\Psi_{\pi 100}$, MPa) vs. maximum bulk tissue elasticity (ϵ_{max} , MPa) for spring and summer for 20 species in their natural habitat, in the southwest of Australia, which is characterized by a Mediterranean climate (after Mitchell et al. 2008).

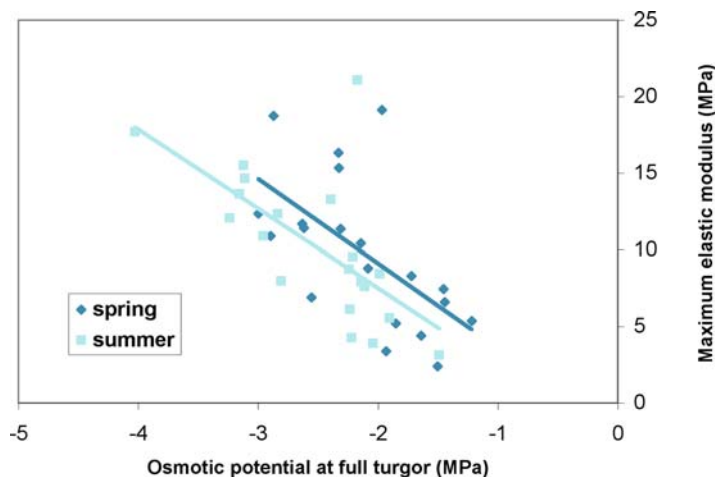

4.4 Evolutionary Aspects

The capacity to adjust the concentration of **osmotic solutes** and the **elasticity** of the leaves' cell walls are both under genetic control. There is a wide range of species of the genus *Dubautia* (Asteraceae), some of which are restricted to dry habitats and others to moister sites. They are therefore ideally suited to an analysis of the survival value of specific traits related to plant water relations. Individuals of the species *Dubautia scabra*, which is restricted to a relatively moist 1935 lava flow in Hawaii, have less negative water potentials, lower turgor, and a higher elastic modulus (less elastic cells) than those of *Dubautia ciliolata*, which is restricted to an older drier lava flow (Robichaux 1984). These differences in tissue elastic properties have a marked influence on diurnal turgor maintenance. Diurnal water potentials of *Dubautia ciliolata* from drier sites are more negative than those of *Dubautia scabra*, but the turgor pressures are very similar throughout the entire day.

A wider comparison of six other *Dubautia* species from Hawaii confirms the results obtained with *Dubautia scabra* and *Dubautia ciliolata* (Robichaux & Canfield 1985). The species from a wet forest (12300 mm rainfall per year) have larger leaves with a higher elastic modulus (lower cell-wall elasticity) than the ones from a dry scrub habitat (400 mm per year). The species in between these extremes show values for leaf size and wall elasticity that are intermediate. Cell-wall elasticity obviously allows maintenance of turgor without a major adjustment in osmotic potential.

As discussed in Sect. 4.1, **fructan accumulation** confers greater desiccation resistance. Some prominent fructan-accumulating families include Poaceae [*Triticum aestivum* (wheat), *Hordeum vulgare* (barley)], Liliaceae [*Allium cepa* (onion)], and Asteraceae [*Helianthus tuberosus* (Jerusalem artichoke), *Cichorium intybus* (chicory)]. In plants, the synthesis of fructans involves at least two enzymes. The first catalyzes the formation of a trisaccharide (one molecule of glucose and two fructose molecules); the second extends this trisaccharide with fructose residues (Pollock & Cairns 1991). Fructan-accumulating taxa increased some 30–15 million years ago, when the climate shifted toward seasonal droughts. The distribution of present-day fructan-accumulating species corresponds with regions of seasonal droughts. The appearance of the genes coding for fructan-synthesizing enzymes probably allowed the fructan flora to cope with seasonal droughts (Hendrey 1993). The deduced amino acid sequence of key enzymes in the formation of fructans shows a high homology with plant **invertases**, which

are ubiquitous enzymes that hydrolyze sucrose, producing glucose and fructose (Sprenger et al. 1995, Vijn et al. 1997). Therefore, the genes in fructan-producing taxa may have emerged as a result of duplication of the invertase gene, followed by slight modification.

5. Water Movement Through Plants

5.1 The Soil—Plant—Air Continuum

Water transport from the soil, through the plant, to the atmosphere, takes place in a soil–plant–air continuum that is interconnected by a continuous film of liquid water (Fig. 10). Water moves through the plant along a **gradient**, either from high to low **water potential** (if transport occurs across a selectively permeable membrane), from high to low **hydrostatic pressure** (if no such membrane is involved), or from a high to a low **water vapor concentration**. The low concentration of water vapor in the air, compared with that inside the leaves, is the major driving force for water loss from leaves which, in turn, drives water transport along the gradient in hydrostatic pressure between the xylem in roots and leaves, and down a gradient in water potential between the soil and the cells in the roots (Fig. 10). As soils dry out, there are parallel decreases in soil water potential and plant water potential, both immediately before dawn (when water stress is minimal, and the water potentials of soil and plant are thought to be in equilibrium) and at midday (when water stress is maximal) (Fig. 11). The passive movement of water along a gradient differs strikingly from plant acquisition of carbon and nutrients which occurs through the expenditure of metabolic energy. The steepest gradient in the soil–plant–atmosphere continuum occurs at the leaf surface which indicates that the stomata are the major control point for plant water relations. There are substantial resistances to water movement in soil, roots, and stems, however, so short-term stomatal controls are constrained by supply from the soil and resistances to transfer through the plant. An appreciation of these controls that operate at different timescales is essential to a solid understanding of plant water relations.

Water flux, J ($\text{mm}^3 \text{s}^{-1}$) (i.e., the rate of water movement) between two points in the soil–plant–atmosphere system, is determined by both the gradient between two points and the resistance to flow between these points. The **conductance**, L_p ($\text{mm}^3 \text{s}^{-1} \text{MPa}^{-1}$) (i.e., the inverse of resistance), is often a more convenient property to measure. As pointed out

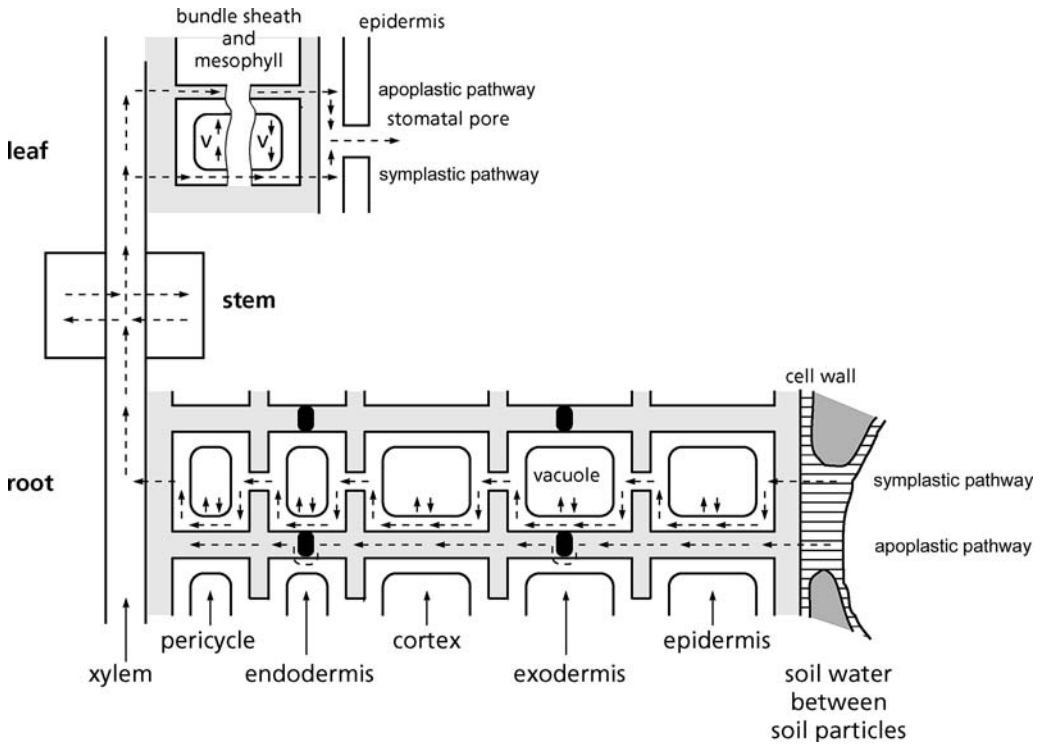

FIGURE 10. Water transport in the soil–plant–air continuum. Water can move through the cell walls (apoplast), or cross the plasma membrane and move through the cytoplasm and plasmodesmata (symplast). Water cannot move through the suberized Casparian

bands in the wall of all endodermal and exodermal cells, including passage cells. Note that the exodermis is absent in some species, in which case water can move from the soil through the apoplast as far as the endodermis.

earlier, the gradient along which water moves is *not* invariably a gradient in water potential ($\Delta\psi_w$ MPa), but it may be a gradient in hydrostatic pressure ($\Delta\psi_p$ MPa), or in water vapor concentration (Δw , the difference in mole or volume fraction of water vapor in air in the intercellular spaces and in air; Equation (2) in Chapter 2A on photosynthesis). In the case of a gradient in water potential, we can write

$$J = L_p \Delta\Psi_w \quad (5)$$

During the day, the water potential of leaves often declines, when the conductance of the roots or stems is too low to supply sufficient water to the leaves to meet their transpirational water loss. This is not invariably found, however, because roots in drying soil send signals to the leaves which reduce the stomatal conductance and hence water loss (Sect. 5.4.1).

5.2 Water in Roots

When plants are growing in moist soils, cell membranes are the major resistance to water flow

through the roots. Water travels along three pathways from the outside to the inside of the root. If there is no **exodermis** (an outermost layer of root cortical cells adjacent to the epidermis with suberized cell walls; Fig. 12A), then water may move through the **apoplast** (i.e., the cell walls and other water-filled spaces outside of living cells), or through the **symplast** (i.e., the space comprising all the cells of a plant’s tissues connected by plasmodesmata and surrounded by a plasma membrane) (Fig. 10), or through the cells by crossing through the walls, cytoplasm, and vacuoles (and plasma membranes and tonoplasts). The latter is termed the **transcellular path** and, under normal conditions, is the main pathway used by water. Water must eventually enter the **symplast** at the **endodermis**, which is the innermost cortical layer of cells and has **Casparian bands**. The radial and transverse walls of the endodermal and exodermal cells are rich in cell-wall proteins, and impregnated with lignin, suberin, and wax (Zeier et al. 1999, Ma & Peterson 2003), which forms a **Casparian band** (Fig. 12A). These hydrophobic bands completely encircle each

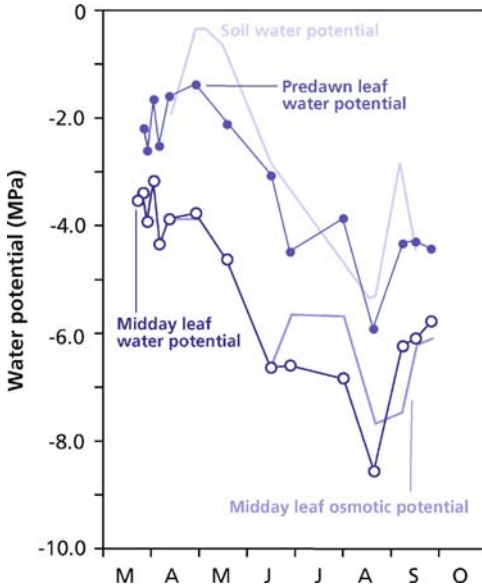

FIGURE 11. Seasonal changes in soil water potential, predawn leaf water potential, midday leaf water potential, and midday leaf osmotic potential in the C_4 plant *Hammada scoparia* (after Schulze 1991).

endodermal cell and prevent further transport of water through the apoplast. Even when the neighboring cortical and pericycle cells plasmolyze, the plasma membrane of the endodermal cells remains attached to the Casparian band. **Plasmodesmata**, which connect the endodermis with the central cortex and pericycle, remain intact and functional during the deposition of suberin lamellae. More importantly for the passage of water, the Casparian bands do not occur in the tangential walls of the endodermal cells, so water may pass through the plasma membranes lining these walls. **Passage cells** frequently occur in both the endodermis and the exodermis; in the endodermis, they are typically located in close proximity to the xylem (Fig. 12B). Passage cells have Casparian bands, but the suberin lamellae and thick cellulosic (often lignified) walls that characterize other endodermal and exodermal cells in some species are either absent or are formed at a much later stage of development. The passage cells become the only cells that present a plasma membrane surface to the soil solution once the epidermal and cortical cells die which occurs naturally in some herbaceous and woody species. Passage cells then provide areas of low resistance to water flow (Peterson & Enstone 1996).

In most plants, water entry into the symplast must occur at the **exodermis**, which has cell properties similar to the endodermis. Only 9% of all

investigated species have either no exodermis or have a hypodermis without Casparian bands and suberin lamellae (Enstone et al. 2003). At the endodermis or exodermis, water must enter the cells, passing at least the plasma membrane, before it can arrive in the xylem tracheary elements (vessels or tracheids). Like other organisms, plants have a family of **water-channel proteins**, usually called "**aquaporins**", which are inserted into membranes and allow passage of water in a single file. Water-channel proteins in the plasma membrane play a vital role in water uptake by plants by reducing the resistance to water flow along the transcellular path (Daniels et al. 1994, Maggio & Joly 1995). The number of water-channel proteins decreases during the night and starts to increase again just before dawn which suggests rapid turnover. Water-channel proteins are also "gated", and affected by phosphorylation, cytosolic pH, Ca^{2+} , pressure, solute gradients, and temperature (Tyerman et al. 2002, Tournaire-Roux et al. 2003, Chaumont et al. 2005). Environmental factors that affect the roots' hydraulic conductance affect either the number or the status of the water channels.

At **low temperature**, when membrane lipids are less fluid and membrane proteins are somewhat immobilized, the resistance of the plasma membrane to water flow is high. Adaptation and acclimation to low temperature generally involves a shift to more unsaturated fatty acids which increases the fluidity of these membranes at low temperature. The resistance to water flow is also high in plants exposed to soil **flooding**, which results in a low oxygen concentration in the soil, followed by inhibition of the normal aerobic respiration and cytosol acidosis. This decreased pH reduces the activity of the water-channel proteins and hence the roots' hydraulic conductance (Sect. 5.6 of Chapter 7 on growth and allocation; Zhang & Tyerman 1999, Chaumont et al. 2005). An excess of water in the soil may, paradoxically, cause symptoms that also occur in water-stressed plants: wilting, accumulation of ABA, and stomatal closure (Sect. 5.6.2 of Chapter 7 on growth and allocation).

As the soil dries, roots and soils shrink which reduces the contact between roots and the soil water films, as well as the conductance of water flow into the root. In dry environments, the contact between roots and soil is the greatest resistance to water flux from soil to leaves. Plants increase root conductance primarily by increasing allocation to production of new roots. Root hairs may be important in that they maintain contact between roots and soil. The role of mycorrhizal associations in water transport is discussed in Sect. 2.7 of Chapter 9A on

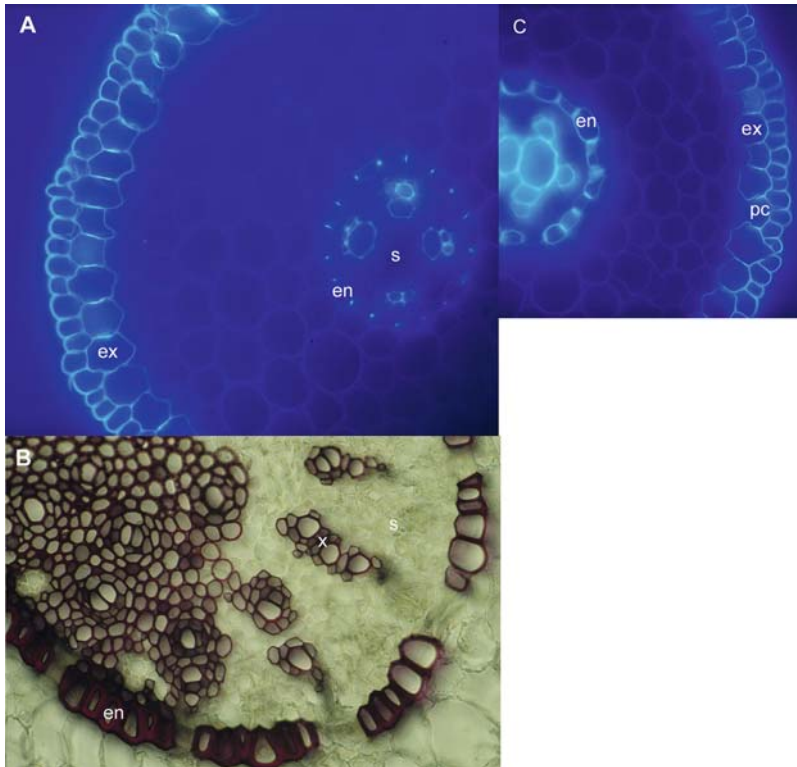

FIGURE 12. (A) Transverse section of an adventitious root of *Allium cepa* (onion). The endodermis (en) and exodermis (ex) both have a Casparian band. The cells of the exodermis also have suberin lamellae. The section has been stained with berberine-aniline blue and viewed with UV light. (B) Cross-section of an orchid (*Phalenopsis* sp.) aerial root showing the endodermis (en), several passage cells (pc), and the xylem (x) within the stele (s). Except for the passage cells, the endodermal cells have

thick, lignified, tertiary walls. Application of phloroglucinol-HCl has stained lignified walls red. (C) Cross-section of an onion root (*Allium cepa*), stained with berberine-aniline blue and viewed with UV light, to show the walls of the epidermis and exodermis. Note the passage cell (pc) in the exodermis; it lacks fluorescence on its inner tangential wall (courtesy D.E. Enstone, Biology Department, University of Waterloo, Canada).

TABLE 5. Above-ground and below-ground biomass and the root mass ratio in various forest ecosystems, partly grouped by climate, climatic forest type, and species. *

Ecosystem	Above-ground biomass (g m ⁻²)	Below-ground biomass (g m ⁻²)	Root mass ratio (g g ⁻¹)
Boreal			
Broadleaf deciduous	50	25	0.32
Needle-leaf evergreen	30–140	7–33	0.20–0.30
Cold-temperate			
Broadleaf deciduous	175–220	25–50	0.13–0.19
Needle-leaf deciduous	170	40	0.18
Needle-leaf evergreen	210–550	50–110	0.14–0.28
Warm-temperate			
Broadleaf deciduous	140–200	40	0.21
Needle-leaf evergreen	60–230	30–35	0.15

Source: Vogt et al. (1996).

* RMR, ratio of root mass, and total plant mass.

symbiotic associations. A high root mass ratio (RMR, root mass as a fraction of total plant mass) is typical of any plant grown under dry conditions, and drought-adapted C_3 species typically have higher root mass ratios than do nonadapted C_3 species. The very few studies that compare the root mass ratio of C_3 and C_4 species suggest that RMR is lower in C_4 which correlates with their higher water-use efficiency (Sect. 9.4 of Chapter 2A on photosynthesis; e.g., Kalapos et al. 1996). When these adaptations and acclimations to low temperature or low water supply are combined in natural vegetation patterns, above-ground biomass declines dramatically along a gradient of increasing aridity, but root biomass often remains relatively constant (Table 5), as a result of an increased root mass ratio.

In extremely dry soils, where the soil water potential is lower than that of plants, and roots can no longer extract water from soil, it may be advantageous to increase root resistance. For example, cacti shed fine roots in summer and so prevent water loss to soil. The Sonoran Desert plant *Agave deserti* quickly produces new roots (**rain roots**) within 24 hour after a shower to exploit new sources of soil moisture (Nobel et al. 1990). Some plants have **contractile roots**. These decrease in length and increase in width, and so maintain hydraulic contact with the surrounding soil. During root contraction in *Hyacinthus orientalis* (hyacinth), mature cortical cells increase in diameter while decreasing in length, suggesting a change in wall extensibility in one or more directions (Sect. 2.2 of Chapter 7 on growth and allocation; Pritchard 1994). [Contractile roots also offer the explanation for why geophytes tend to pull themselves into the ground over the years (Pütz 1996).]

Many of the dominant woody species growing in arid and semi-arid conditions have **dual** or **dimorphic root systems**. Shallow, superficial roots operate during the wet season, and the deep-penetrating part of the root, which is usually located in relatively unweathered bedrock or deep sands, operates during the dry season. Because most of the nutrients tend to be in the superficial soil layers, most of the nutrients will be taken up by the shallow roots. Plants that grow on shallow soil or even bare rock in the Israeli maquis continue to transpire during the entire summer by growing roots in rock fissures. On such sites with shallow soil in semi-arid climate conditions, roots of some plants [e.g., *Arctostaphylos viscida* (whiteleaf manzanita) and *Arbutus menziesii* (Pacific madrone)] of the Pacific Northwest in the United States, can utilize water from the bedrock. Roots of such plants occupy rock fissures as small as 100 μm . The cortex of such roots

may become flat, with wing-like structures on the sides of the stele (Zwieniecki & Newton 1995).

Water in the xylem vessels of the roots is normally under tension (negative hydrostatic pressure). At night under moist conditions and low transpiration, however, the hydrostatic pressure may become positive. The widely held view is that under these conditions the loading of solutes into the xylem is sufficiently rapid to produce a very negative osmotic potential in the xylem. Water may then move osmotically into the xylem vessels and create a positive hydrostatic pressure, forcing water up through the xylem into the stem. This phenomenon is known as **root pressure**. Recent measurements, using cryo-analytical microscopy *in situ*, have shown that solute concentrations in the xylem sap of primary roots of *Zea mays* (corn) are fairly low, also when the hydrostatic pressure in the xylem is high (Enns et al. 1998). This suggests that the simple explanation for root pressure outlined above might not be correct. As an alternative, a mechanism similar to the putative mechanism for stem pressure (Sect. 5.3.4) has been suggested (McCully et al. 1998).

Whatever the exact mechanism that accounts for root pressure is, it can push xylem sap out through the leaf tips of short-statured plants: **guttation**, which is a phenomenon that contributes to the formation of "dew" on leaves. Root pressure is important in reestablishing continuous water columns in stems, after these columns break (see later). Using Equation (7) in Box 3.1, we can calculate that xylem sap containing 10–100 mM solutes can be "pushed" up the stem as high as 2.6–26 m. The liquid exuding from tree stumps and wounds in stems may also result from root pressure [e.g., in *Vitis vinifera* (grapevine) and *Betula nigra* (river birch)]; however, the xylem sap exuded by palms and several maples [e.g., *Acer saccharum* (sugar maple) and *Acer nigrum* (black sugar maple)] which is often tapped commercially to make sugar or syrup, results from stem pressure, and *not* from root pressure (Kramer 1969).

Hydraulic lift is the movement of water from deep moist soils to drier surface soils through the root system. In C_3 and C_4 species, this occurs primarily at night, when stomates are closed, so that the plant is at equilibrium with root water potential. In the CAM plant *Yucca schidigera* in the Mojave Desert, however, hydraulic lift occurs during the day (Yoder & Nowak 1999). This agrees with maximum stomatal conductance at night in CAM plants (Sect. 10.2 of Chapter 2A on photosynthesis). Under these circumstances, water will move from deep moist soils with a high water potential into the root and out into dry surface soils of low water potential. Although hydraulic lift was first

observed in dry grasslands (Caldwell & Richards 1989), it also occurs during dry periods in temperate forests, when high leaf area and high transpiration rates deplete water from upper soil horizons. For example, adult sugar maples (*Acer saccharum*) derive all transpirational water from deep roots. Between 3 and 60% of water transpired by shallow-rooted species without direct access to deep water, however, comes from water that is hydraulically lifted by sugar maple (Dawson 1993). Deep groundwater often has a different isotopic signature than does surface water, making it possible to determine the original source of water transpired by plants (Sect. 3.3).

Because water in soil can be redistributed via the roots from moist regions in either deep or shallow soil layers, the term **hydraulic redistribution** is now widely used (Burgess et al. 1998). Hydraulic redistribution can be measured using sap-flow sensors (Box 3.4). In large trees, this redistribution may also involve the stem, where, at night, water can flow upward in one sector of the stem, and downward in another (Burgess & Bleby 2006). This is due to the much greater axial conductance compared with the radial conductance for water movement in the stem.

Hydraulic redistribution occurs in Amazonian trees, and it has a major impact on climate over the Amazon. Model results show that hydraulic redistribution enhances photosynthesis and evapotranspiration significantly during the dry season. The water subsidy from hydraulic redistribution sustains transpiration at rates that deep roots alone cannot accomplish. The water used for dry-season transpiration is from the deep storage layers in the soil, recharged during the previous wet season. Hydraulic redistribution in the Amazon may increase dry season transpiration by 40%. Such an increase in transpiration over drought-stressed regions affects the seasonal cycles of temperature through changes in latent heat, thereby establishing a direct link between root functioning and climate (Lee et al. 2005).

Hydraulic redistribution can modify competitive interactions among plants in unexpected ways by resupplying water to shallow-rooted species during dry periods, thereby modifying both water supply and the conditions for nitrogen mineralization and diffusion in dry soils. For example, 20–50% of the water used by shallow-rooted *Agropyron desertorum* (crested wheatgrass) comes from water that is hydraulically lifted by neighboring sage brush (*Artemisia tridentata*) in the Great Basin desert of western North America (Richards & Caldwell 1987). We discuss hydraulic lift in this context in Sect. 5.2 of Chapter 9E on interactions among plants. Water flow into deeper soil layers via **hydraulic redistribution** has

been demonstrated for several perennial grass species in the Kalahari Desert. Deuterium labeling shows that water acquired by roots from moist sand in the upper profile can be transported through the root system to roots deeper in the profile, and there released into the dry sand at these depths. This may serve as an important mechanism to facilitate root growth through the dry soil layers below the upper profile where precipitation penetrates, and allow roots to reach deep sources of moisture in water-limited ecosystems (Schulze et al. 1998). The same mechanism accounts for hydraulic redistribution, when water can be transported through roots at the break of the dry season. This phenomenon is probably significant to plant establishment and the reduction of waterlogging in certain soil types (Burgess et al. 1998, 2001a).

Fog can be an important source of moisture in many fog-inundated coastal ecosystems, for example in *Sequoia sempervirens* (coastal redwood) and species in the understory of coastal redwood forests of northern California. In summer, one fifth of the water in the trees and two-thirds of that in understory plants comes from inputs from fog. Fog water accounts for 13–45% of the trees' annual transpiration (Dawson 1998). It can also be a significant component for perennial grasses in northern California, where fog-water inputs can mitigate the summer drought for many species, likely giving an advantage to species that can use it over species that cannot (Corbin et al. 2005). The exact pathway via which water enters the leaf is not entirely clear, but it is unlikely to be via the stomata. **Hydathodes** on the leaf epidermis are probably involved in foliar water uptake in *Crassula* species in the Namib Desert in Southern Africa (Martin & Von Willert 2000).

5.3 Water in Stems

Ever since the phenomenon of atmospheric pressure was recognized, it has been evident that even a perfect vacuum pump cannot lift water any higher than 10 m. In addition, even a relatively small xylem vessel with a radius of 20 mm only accounts for about 0.75 m of sap ascent by capillary action; however, plants can pull water well beyond this limit. Some of them, like the giant redwood (*Sequoia gigantea*) in California or karri (*Eucalyptus diversicolor*) in Western Australia, lift substantial quantities of water close to 100 m daily. If a vacuum pump cannot lift water higher than 10 m, then the pressure in the xylem must be lower than that delivered by such a pump (i.e., it must be negative!).

Box 3.4

Methods to Measure Sap Flow in Intact Plants

Xylem sap-flow rates of whole plants, individual branches, or roots can be measured using a technique that uses heat as a tracer (Fig. 1). The stem, branch, or root is heated electrically, and the heat balance is solved for the amount of heat taken up by the moving sap stream which is then used to calculate the mass flow of sap in the stem. In the heat-pulse method, rather than using continuous heating, short pulses of heat are applied, and the mass flow of sap is determined from the velocity of the heat pulses moving along the stem. Alternatively, rates of sap flow can be determined from the temperature of sapwood near a continuously powered heater implanted in the stem (Smith & Allen 1996). Heat-based sap-flow techniques play a leading role in the study of transpiration and water relations of woody plants (e.g., Čermák et al. 1973, 2004, Wullschleger et al. 1998, Nadezhdina and Čermák 2003, Sakuratani).

Two of the techniques currently available to researchers are the compensation heat-pulse method and the heat-ratio method. Both use the heat-pulse principle, where the mass flow of sap is determined from the velocity of a short pulse of heat moving along xylem tissue through conduction and convection. The heat-ratio method was developed recently by Burgess et al. (2001b), whereas the compensation heat-pulse method has a long history. The theory of the compensation heat-pulse method is described in detail by Marshall (1958), Swanson & Whitfield (1981), and Smith & Allen (1996). Briefly, two temperature sensors are inserted to equal depths into the sapwood, and positioned above and below a similarly inserted line heater probe. The temperature probes are spaced asymmetrically from the heater such that the mid-point of the two probes is located at a fixed distance downstream (i.e., toward the crown) from the heater and all probes are in line with the axis of the plant stem. Following the release of a pulse of heat into the sap stream, heat moves toward the downstream temperature probe. Movement of the heat pulse to the mid-point between the temperature probes is indicated when both temperature sensors have warmed to the same degree. The time taken for the heat pulse to move this distance is used to calculate heat-pulse velocity:

$$v_h = \frac{x_d + x_u}{2ft} 3600 \quad (1)$$

where v_h is heat-pulse velocity (cm h^{-1}), t_0 is the time to thermal equilibrium of the downstream and upstream temperature of the downstream and upstream temperature sensors, x_d and x_u are the distances (cm) from the heater probe of the downstream and upstream temperature sensors, respectively. A negative value is assigned to x_u because it is located on the opposite side of the heater from x_d (Bleby et al. 2004).

The theory of the heat-ratio method is described in detail by Burgess et al. (2001b). Briefly, temperature and heater probes are inserted into the sapwood in a similar manner to the compensation heat-pulse method, except that the heater probe is located at a point equidistant from the upstream and downstream temperature sensors (Fig. 1). Instead of a "distance-traveled-over time" approach to measuring v_h , the heat-ratio method measures the ratio of the increase in temperature at points equidistant upstream and downstream from a line heater, following the release of a heat pulse. Heat-pulse velocity is calculated as (Marshall 1958):

$$v = \frac{k \ln(v_1/v_2)}{x} 3600 \quad (2)$$

where k is thermal diffusivity of wet (fresh) wood, x is the distance from the heater probe of either temperature probe, and v_1 and v_2 are increases in temperature at equidistant points (x cm) downstream and upstream, respectively (in relation to initial temperatures). Thermal diffusivity (k) is assigned a nominal value during measurements and is resolved empirically at a later stage using estimates of thermal conductivity, density, and specific heat capacity of fresh sapwood; variables are derived from simple measurements of the water content and density of sapwood (Bleby et al. 2004).

Heat-pulse methods can be used for accurate measurements of sap flow, provided a reliable calibration procedure is used to relate

continued

Box 3.4 *Continued*

the measured heat-pulse velocity to the actual sap flow. Correction factors are based on comparisons of heat-pulse measurements against actual rates of transpiration determined from measured weight loss of the trees growing in large lysimeters. The compensation heat-pulse method accurately measures flows down to a

few cm h^{-1} (Green et al. 2003), but this method is unable to measure low rates of sap flow, due to its inability to distinguish heat-pulse velocities below a threshold velocity of 0.1 kg h^{-1} ($3\text{--}4 \text{ cm h}^{-1}$). On the other hand, the heat-ratio method accurately describes sap flow at night when rates of flow are low ($< 0.1 \text{ kg h}^{-1}$) or near zero (Bleby et al. 2004).

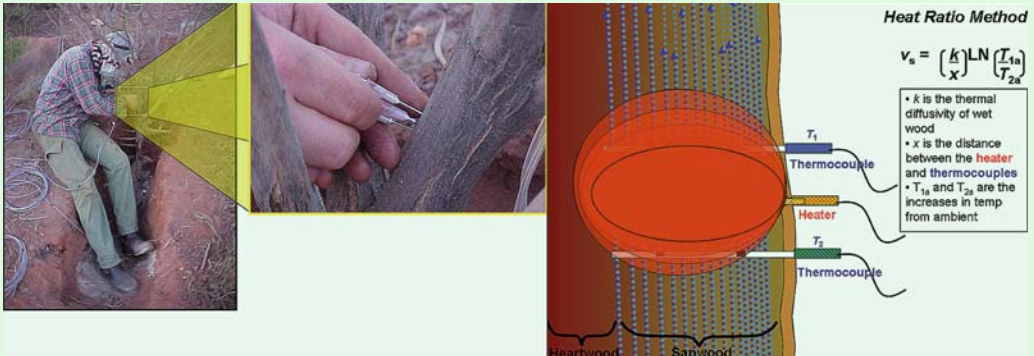

FIGURE 1. Sap-flow measurements using the heat-ratio method require insertion of probes in a stem, root, or branch (*left*). The middle probe is a heater, the other ones are thermocouples. If sap moves upward, then the heat pulse will reach the upper

thermocouple before it reaches the lower one. The equation given in the figure (*right*) is used to calculate flow rates. Courtesy A. Grigg, School of Plant Biology, The University of Western Australia, Crawley, Australia.

Water in the xylem of the stem, in contrast to that in the live cells of the roots and stem, is under **tension** (negative hydrostatic pressure) in transpiring plants. As explained in Box 3.2, these suction tensions are due to interactions of water molecules with the capillaries in the cell walls of transport vessels. In fact, the water column in a 100 m tall tree is held in place by the enormous **capillary forces** in the xylem at the top of the tree. Due to the **cohesion** among water molecules from hydrogen bonding, the water column in the stem is “sucked upward” to replace water that is transpired from leaves. [This **cohesion theory** of water movement is generally ascribed to Böhm and Dixon and Joly (Böhm 1893, Dixon & Joly 1894, Dixon 1914, Steudle 1995), whereas, in fact, all of the elements of this theory were already described in 1727 by the English clergyman Stephen Hales (Floto 1999).] What is our evidence for such **suction tensions** or negative hydrostatic pressures and what exactly do they mean?

5.3.1 Can We Measure Negative Xylem Pressures?

Evidence for negative pressure in the xylem has been obtained using the **pressure chamber** (Scholander et al. 1965). A cut stem is placed in the chamber and sealed from the atmosphere, with the cut stem extending out (Fig. 13). A pressure is then applied just high enough to make the xylem sap in the stem appear at the cut surface. The positive pressure applied (“balancing pressure”) is equal to the negative pressure in the xylem when the plant was still intact. Although there are problems using this technique when using plants with a low relative water content, the pressure chamber is widely used to assess the water potential in plants.

For a full appreciation of the ascent of sap in plants, we need to consider carefully the exact site the water is coming from that is pushed back into the xylem when pressure is applied to the pressure chamber (Box 3.2). This water is pushed out of the

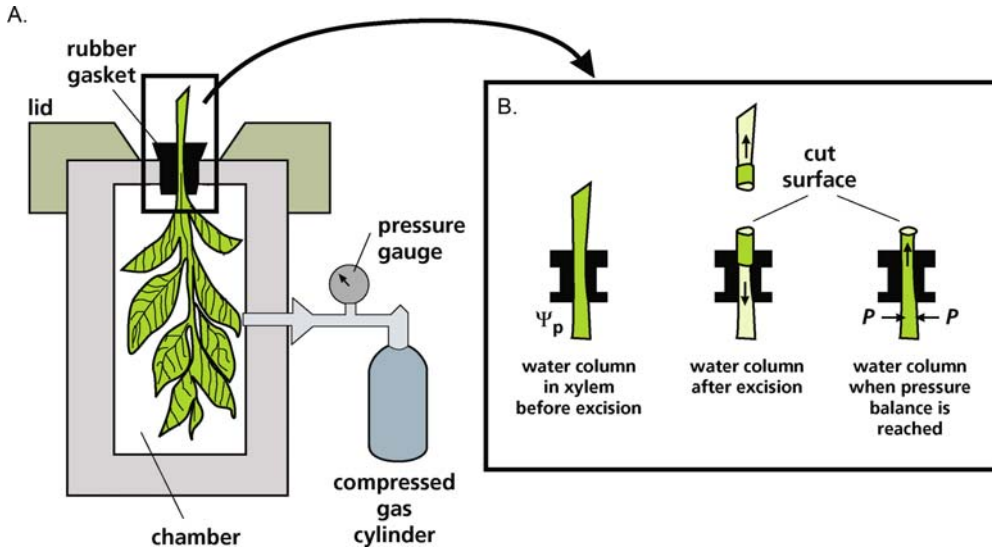

FIGURE 13. (Left) Schematic representation of the Scholander pressure chamber that is used for the measurement of negative hydrostatic pressures in the xylem (Ψ_p). A cut shoot, twig, root, or leaf is excised, and the negative Ψ_p in the xylem causes the water column to be drawn into, e.g., the leaf. (Right) A leaf (or other plant part) is mounted in a gasket and placed in the pressure chamber with the cut end protruding through the lid.

The pressure in the chamber is increased, causing the xylem water column to be pushed upward in the xylem until it protrudes at the cut surface. At that point, the pressure inside the chamber (P) equals $-\Psi_p$. The osmotic potential of the xylem fluid is usually ignored, but can be determined by collecting sufficient xylem sap, avoiding contamination from surrounding cells.

many capillaries in the **walls** of the xylem vessels and adjacent cells, where it was held in place by strong **capillary forces** between the water molecules and the cell walls (Fig. 14). In a transpiring plant, water continuously moves from these capillaries to the intercellular spaces in leaves where the water potential is more negative, as long as the water vapor pressure is not saturated (Box 3.1). Due to the strong capillary forces, this water is replaced by water in the lumen of the xylem vessels. These strong capillary forces keep the entire water column in the xylem vessels in place and prevent it from retreating, such as that happens when the stem is cut. At physiological temperatures, the **cohesive forces** between the water molecules are so strong that the water column in the xylem will not break (but see Sect. 5.3.3).

The most compelling evidence in favor of the cohesion theory for the ascent of sap comes from measurements using a device that involves spinning a length of branch about its center to create a known tension based on centrifugal forces. Results of such experiments agree perfectly with those obtained with the pressure chamber (Holbrook et al. 1995). Tensions can, therefore, be created in xylem vessels and measured accurately by the pressure chamber;

but what do these tensions really represent? When stating that the xylem is under tension, we do not actually mean the xylem conduit itself. Rather the suction tension, or negative hydrostatic pressure, refers to the **adhesive forces** that tightly hold the water in the small **capillaries** in the wall of the xylem conduits (Wei et al. 1999, Steudle 2001).

5.3.2 The Flow of Water in the Xylem

Hydraulic resistance in the shoot xylem accounts for 20–60% of the total pressure difference between the soil and the air in transpiring trees and crop plants (Sperry 1995). In woody plants, most of this pressure difference occurs in small twigs and branches, where the cross-sectional area of xylem is small (Gartner 1995). The water flow (J_v , $\text{mm}^3 \text{mm}^{-2} \text{s}^{-1} = \text{mm s}^{-1}$) in xylem vessels is approximated by the **Hagen-Poiseuille equation**, which describes transport of fluids in ideal capillaries:

$$J_v = (\pi R_4 \Delta \Psi) / 8 \eta L \quad (6)$$

where $\Delta \psi_p$ (MPa) is the difference in hydrostatic pressure, R (mm) is the radius of the single element with length L (mm) through which transport takes

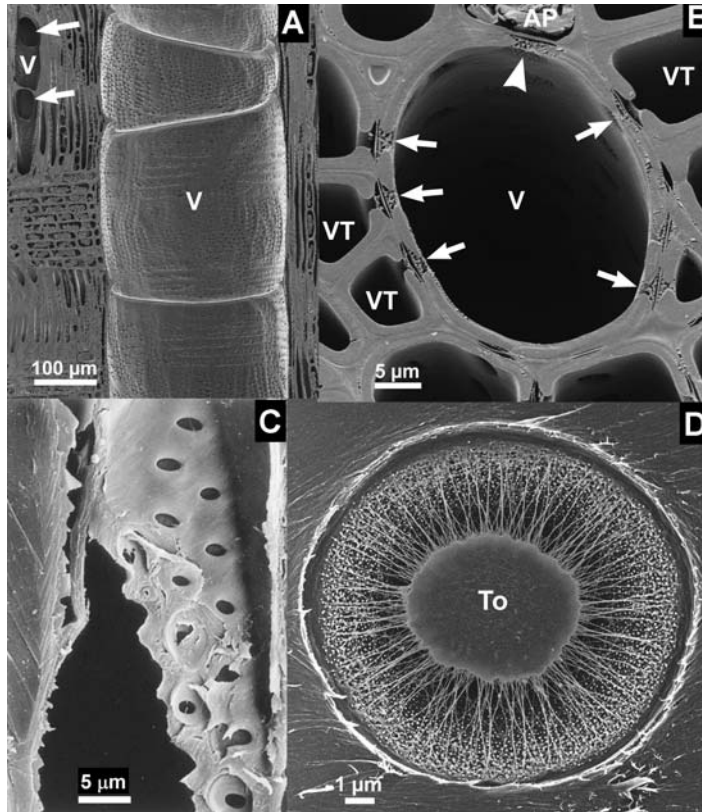

FIGURE 14. Field-emission scanning electron micrographs showing details of the xylem. (A) Radial section of the xylem of *Quercus crispula* (Mongolian oak), showing a wide vessel with numerous pits, and narrow vessel elements that are connected with simple perforations. (B) Transverse section of the xylem of *Eucalyptus camaldulensis* (river red gum), showing several vessel-to-vasicentric tracheid pits and vessel-to-axial parenchyma pits. (C) A scanning electron micrograph of the sapwood of *Populus nigra* (Lombardy poplar) hand-sectioned tangentially and slightly oblique. Bordered pits are shown between two adjacent vessels. Ray parenchyma cells are cut transversely in a vertical row to the right and left. Several pit apertures are seen (top central) in face view, with pit membranes visible through them. Lower down, the blade has removed the top borders of four pits, showing the interiors of the lower bordered pit chambers without any pit membranes. A pit can be seen centrally, half-closed by a torn pit membrane: The blade has folded

the upper chamber above it revealing the inner cavity (indicated by arrow). The delicate pit membrane capillaries are sufficiently fine to filter fine carbon suspensions from Indian ink. They are normally supported from mechanical disruption by the borders if subjected to powerful pressure flow from liquids or gases. Gases can pass when the membranes are physically torn; alternatively, the suction may be so great that air bubbles are pulled through the capillaries in the membranes initiating cavitation in the conduits in which the air bubble enters. (D) Intertracheary pit membrane of *Abies sachalinensis* (Sakhalin fir), a typical torus-bearing pit membrane of a gymnosperm. V, vessels; VT, vasicentric tracheids; AP, axial parenchyma; To, torus; arrows in A point to simple perforations; arrows in B point to vessel-to-vasicentric tracheid pits; the arrow head in B points to vessel-to-axial parenchyma pits (A, B, and D: courtesy Y. Sano, Hokkaido University, Sapporo, Japan; C: courtesy J.A. Milburn, University of New England, Australia).

place, and η ($\text{mm}^2 \text{MPa s}$) is the viscosity constant. This equation shows that the **hydraulic conductance** is proportional to the fourth power of the vessel diameter. The hydraulic conductance of a stem with only a few xylem vessels with a large diameter is, therefore, much higher than that of a stem with many more vessels with a small diameter,

but the same total xylem area. In addition, the **pits** in the connecting walls of the tracheids impose a substantial resistance to water flow (Nobel 1991). Pits are narrow channels through the thick secondary walls of vessel elements (Fig. 14).

Plants differ widely with respect to the diameter and length of their xylem vessels (Table 6). Vessel

TABLE 6. Hydraulic conductance of xylem conduits, maximum velocity of water transport through the conduits and xylem diameter for stems of different types of plants.

	Hydraulic conductivity of xylem lumina ($\text{m}^2 \text{s}^{-1} \text{MPa}^{-1}$)	Maximum velocity (mm s^{-1})	Vessel diameter (m)
Evergreen conifers	5–10	0.3–0.6	<30
Mediterranean sclerophylls	2–10	0.1–0.4	5–70
Deciduous diffuse porous	5–50	0.2–1.7	5–60
Deciduous ring porous	50–300	1.1–12.1	5–150
Herbs	30–60	3–17	
Lianas	300–500	42	200–300

Source: Milburn (1979), Zimmermann & Milburn (1982).

length in trees varies from less than 0.1 m to well over 10 m or as long as the whole stem. There is no obvious advantage associated with either short or long vessels; it might be the accidental result of other variables of tree growth, such as mechanical requirement for fiber length (Zimmermann & Milburn 1982), or that small vessels are less prone to **freezing-induced cavitation**, the breakage of the water column in a transport vessel (Sect. 5.3.3). Vessel length tends to correlate with vessel diameter. In deciduous trees, xylem vessels produced early in the season tend to be longer and wider than the ones produced later in the year. The difference in xylem diameter between early and late wood shows up as **annual tree rings** of the trunk of these **ring-porous** trees. **Diffuse-porous** trees, on the other hand, with a random distribution of wide and narrow vessels throughout the year, such occur as in many tropical trees, do not always show distinct annual rings (Zimmermann 1983).

Vines, which have relatively narrow stems, have long vessels with a large diameter, compared with related species or with the species in which they climb (Sect. 5.3.6). Because the hydraulic conductance is proportional to the fourth power of the vessel diameter (Equation 6), the larger diameter compensates for the smaller total area. For example, the stem of the liana *Bauhinia fassoglensis* (creeping bauhinia) has a conductance equal to the tree *Thuja occidentalis* (white cedar) with a tenfold greater sapwood area (Ewers & Fisher 1991). Xylem vessels with a narrow diameter have the disadvantage of a low **hydraulic conductance**. Because more of the total xylem area is taken up by the xylem walls, they provide greater **mechanical strength**. The narrow xylem vessels, however,

are also less vulnerable to freezing-induced cavitation (Sect. 5.3.6).

5.3.3 Cavitation or Embolism: The Breakage of the Xylem Water Column

Cavitation is not caused simply by breakage of capillary water columns which, at moderate temperatures, does not occur except at considerably higher tensions than ever occur in the xylem (i.e., in excess of 100 MPa) (Tyree & Sperry 1989). **Cavitation**, or **embolism**, however, does occur and leads to the filling of the xylem with water vapor and/or air, rather than water. Under water stress, when the tensions in the xylem become very high, cavitation is nucleated by the **entry of air** through the largest pores in the walls of the transport vessels, located in primary walls of the inter-conduit pits, the **pit membrane** (Figs. 14C,D and 15). Water then begins to evaporate explosively into the air bubble. Short acoustic pulses are registered during cavitation induced by water stress, allowing sound recordings to document cavitation rate. The bubble expands and interrupts the water column. Entry of air into the xylem conduit depends on the size of the pores in the pit membrane (Fig. 14C,D). The thin, porous areas in conduit walls allow passage of water between conduits, but not a gas–water meniscus. This minimizes the spread of air bubbles into neighboring conduits. The tension required to cause cavitation is a function of the permeability of the inter-conduit pits to an air–water interface, which depends on pore diameters (Pockman et al. 1995, Sperry 1995). Pore diameters range from less than 0.05 to more than 0.4 μm (as opposed to <0.01 μm in the cell wall proper), depending on species and location in the plant. Embolism reduces the ability to conduct water and, if severe enough, will limit growth.

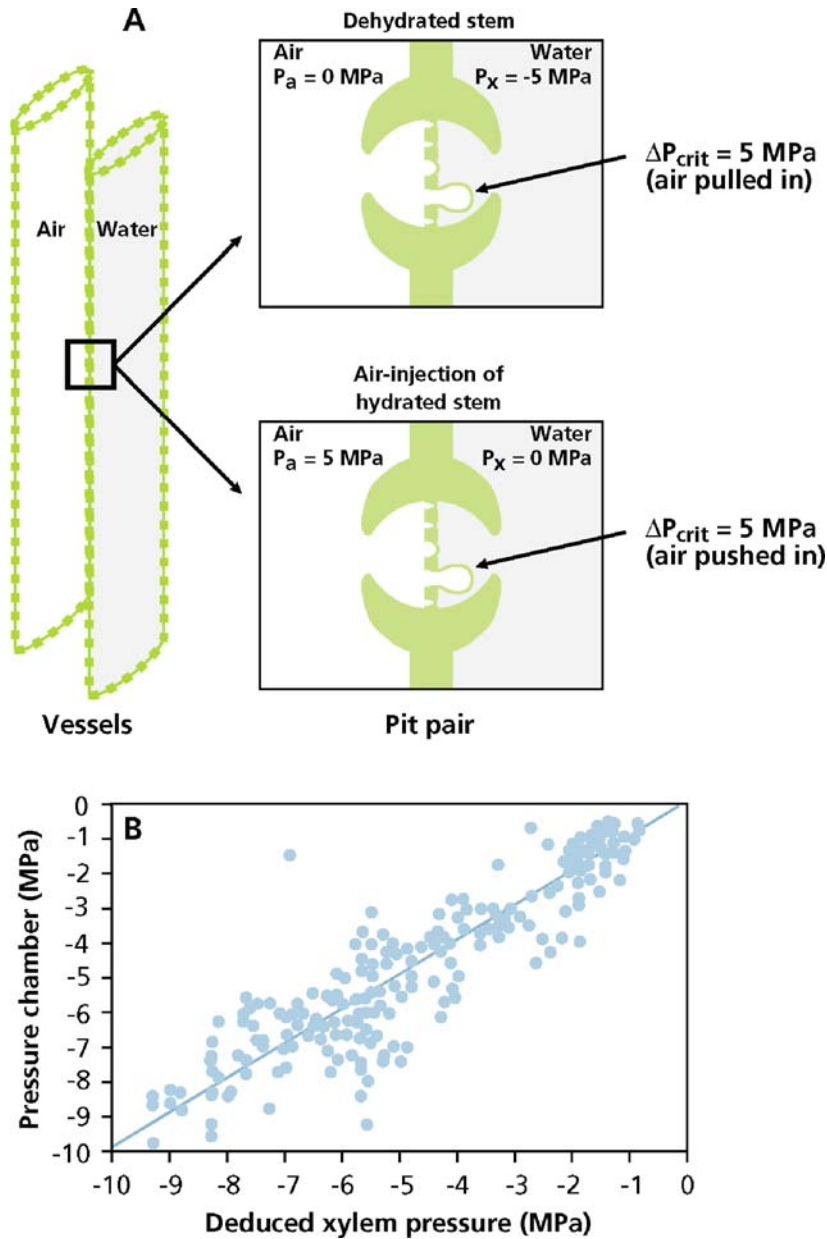

FIGURE 15. (A) Cavitation in dehydrating stems as affected by “air seeding”. Two adjacent xylem vessels are shown. The one on the right is filled with xylem fluid; the one on the left has cavitated and is therefore filled with water vapor at a very low pressure, near vacuum: 0 MPa. Pits between the vessels allow water flow and prevent passage of an air–water meniscus in the event that one vessel becomes air-filled. The top part of the illustration shows how a small air bubble is pulled in through the pit membrane pores when the pressure difference between the two vessels exceeds the pressure threshold. In the example shown, this occurs at a xylem pressure of -5 MPa. In the experimental design

shown in the lower part of the illustration, the critical pressure difference is exceeded by pressurizing the air in the embolized vessel, while the fluid in the other vessel is at atmospheric pressure. Now an air bubble is pushed in. The top part illustrates what is happening in a real plant. (B) There is a very close agreement between pressure differences at which cavitation occurs in real plants, using the pressure chamber to determine the negative pressure in the xylem, and those achieved as illustrated in the bottom part of the top figure. This confirms that negative pressures occur in the xylem (after Sperry et al. 1996).

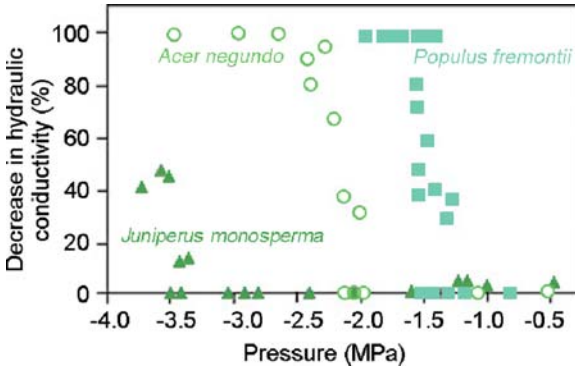

FIGURE 16. Decrease in hydraulic conductivity in the xylem of stems of *Populus fremontii* (poplar), *Acer negundo* (boxelder), and *Juniperus monosperma* (juniper) against xylem hydrostatic pressure. The hydrostatic pressure in the xylem was varied by centrifuging stems that were cut and then recut under water to a length of 260–400 mm (Pockman et al. 1995). Reprinted with permission from *Nature* 378: 715–716; copyright (1995) MacMillan Magazines Ltd.

Species differ considerably in their vulnerability to cavitation, with the less vulnerable species tending to be more **desiccation-tolerant** (Tyree & Sperry 1989). For example, stems of *Populus fremontii* (Fremont cottonwood) show complete cavitation at -1.6 MPa, whereas those of *Salix gooddingii* (Gooding's willow), *Acer negundo* (boxelder), *Abies lasiocarpa* (subalpine fir), and *Juniperus monosperma* (one-seed juniper) have a threshold at -1.4 , -1.9 , -3.1 , and less than -3.5 MPa, respectively (Fig. 16). There are also phenotypic differences in vulnerability to cavitation which may be of similar magnitude as the differences between species. Root xylem in *Acer grandidentatum* (bigtooth maple) is more vulnerable when plants grow in wetter sites (Alder et al. 1996). Sun-exposed branches of *Fagus sylvatica* (beech) are less vulnerable than branches of the same tree that grow in the shade (Cochard et al. 1999). Because xylem conduits can only acclimate to new environmental conditions over prolonged periods, beech trees that are suddenly exposed to full light (e.g., after forest thinning) may experience xylem embolism if transpiration rates are not efficiently controlled.

The diameter of pores in pit membranes (Fig. 14A,B) determines the vulnerability of species

to cavitation in response to water stress by determining the xylem tension at which an air bubble is sucked into the xylem lumen. It is not known whether pore diameter of the pit membrane also determines phenotypic differences in xylem vulnerability, but this is plausible. Because even the widest vessels in ring-porous trees are sufficiently narrow to prevent breaking of a water column other than by the mechanisms accounted for, conduit diameter has no relationship to the vulnerability to cavitation in response to drought stress (Fig. 17; Sperry 1995, Cochard et al. 1999).

Cavitation may also be caused by **freezing and thawing** of the xylem sap when it is under tension (Fig. 17). In this case, cavitation occurs at much lower tension and is induced by a different mechanism: dissolved gases in the sap are insoluble in ice and freeze out as bubbles. If these bubbles are large enough when tension develops during thawing, then they will grow and cause cavitation. When cavitation is caused by freeze-thaw cycles, we can predict that wide and long vessels will be more vulnerable than small ones. Differences in conduit diameter are the main factors that account for species differences in vulnerability to cavitation from

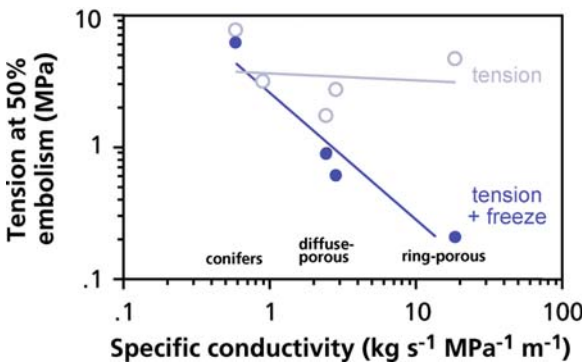

FIGURE 17. Tension at the time of 50% embolism as dependent on the size of the tracheids or vessels. The experiment was carried out with trees exposed to water stress (tension, open circles) and with trees exposed to a freeze-thaw cycle (tension + freeze, solid circles) (after Sperry & Sullivan 1992). Copyright American Society of Plant Biologists.

freeze-thaw events (Fig. 17). If the air freezes out as one large bubble, rather than a number of smaller ones, then the greater dissolved air content in larger conduits will give rise to larger bubbles that cause embolism at lower tensions (Sperry & Sullivan 1992). Most embolisms in temperate woody plants occur in response to freeze-thaw events during winter and during the growing season rather than in response to drought. Embolism correlates more closely with the number of freeze-thaw episodes than it does with degree of frost (Sperry 1995).

The capacity of xylem to withstand freeze-thaw embolisms has important consequences for the evolution and distribution of woody plants. Evergreen trees from cold climates are more likely to be actively transpiring (and therefore developing negative xylem potentials) when freeze-thaw events occur. It is probable for this reason that they have small tracheids that are less likely to cavitate and easier to refill (see later). The disadvantage of narrow conduits is a low conductance. Among deciduous woody plants there are ring-porous trees that produce large vessels during rapid growth in early spring and diffuse-porous species that have smaller diameter conduits. Ring-porous species cannot refill overwintering xylem, so their transpiration is entirely supported by current year's xylem, which therefore requires large-diameter vessels with high conductance. These species leaf out at least 2 weeks later than co-occurring diffuse-porous species, presumably because of their greater vulnerability to spring frosts (Sperry 1995). Some diffuse-porous species can refill embolized, overwinter conduits and are particularly successful in cold climates, whereas other diffuse-porous species cannot.

Embolism can also be induced by **pathogens**. Although it has been known for quite some time that vascular diseases induce water stress in their host by reducing the hydraulic conductivity of the xylem, embolism as a cause for this has received very little attention. In the case of Dutch elm disease, however, embolism precedes any occlusion of vessels by other means. The exact cause of embolism remains unclear. It might be due to a pathogen-induced increase in stomatal conductance or decrease of water uptake by the roots. Pathogens might also change the xylem sap chemistry. For example, millimolar concentrations of oxalic acid, which is produced by many pathogenic fungi, lower the surface tension of the xylem sap. In *Acer saccharum* (sugar maple) and *Abies balsamea* (balsam fir), **oxalic acid** reduces the tension at which air can enter the xylem (Tyree & Sperry 1989). Xylem conductivity can also change in response to the concentration of **cations** in the xylem fluid (Van Ieperen 2007).

Can embolism also be brought about by xylem-feeding **spittlebug nymphs** (*Philaenus spumarius*)? Frothy white "spittle" deposits of feeding spittlebug nymphs are familiar to all who have walked through fields and gardens in late spring and early summer. The water of the spittle comes from the xylem sap that is sucked up through the insect's stylet that is inserted into a single xylem conduit. Because the concentration of nutrients in the xylem sap is very low, these tiny insects pump huge quantities of liquid against a strong pressure gradient, and excrete up to 280 times their body mass in 24 h. How does the spittlebug avoid inducing cavitation? Saliva secreted by the insect forms a hardened lining between the stylet bundle and the plant tissues. This **salivary sheath** is continuous through the hole made by the stylet as it enters a vessel, and it extends into the vessel along the periphery beyond the breach. It allows the insects to feed from functioning vessels, without embolizing them. Embolized vessels, which are basically filled with water vapor, would be of no use for the spittlebug nymphs (Crews et al. 1998).

5.3.4 Can Embolized Conduits Resume Their Function?

Cavitated conduits can refill by **dissolution** of the bubble which can occur at moderately negative xylem pressures. Dissolution of bubbles under tension may require narrow conduits (Sperry 1995) which perhaps explains the tendency of desert plants and plants from cold environments to have narrow conduits (Sect. 5.3.5). When such a moderately negative water potential cannot be reached, the xylem remains filled with water vapor and the conduit no longer functions in water transport (Yang & Tyree 1992). Failure to refill cavitated vessels can sometimes be advantageous. For example, conduits of cactus xylem cavitate when soil gets extremely dry, preventing water from being lost from the body of the plant to the soil.

Functioning of the embolized vessels can be resumed upon refilling the vessel with water. This can occur at night under moist conditions, when **root pressure** builds up a positive xylem pressure. In more extreme cases, this may not occur until it rains (Fig. 18). When roots grow in wet soil, a solute concentration in the xylem sap of 100 mM exerts just enough positive pressure to balance a water column of about 35 m (0.25 MPa plus 0.1 MPa of ambient pressure; Sect. 5.2); therefore, it is unlikely that cavitated conduits in the top of a tall tree are ever refilled by root pressure. In *Fraxinus americana* (white ash),

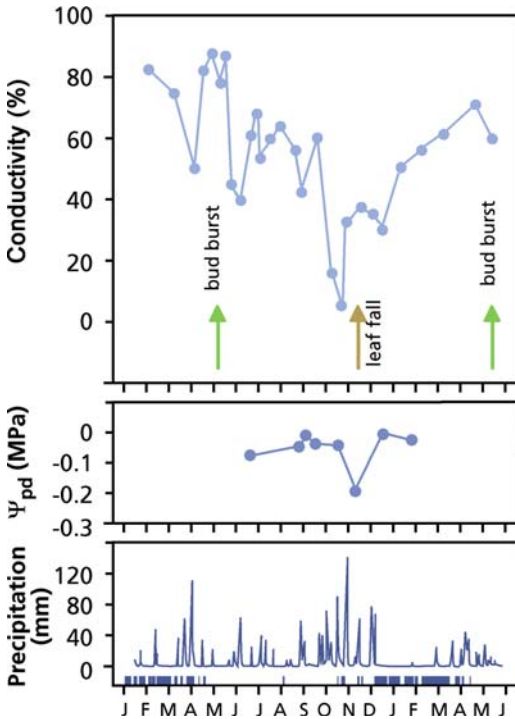

FIGURE 18. Seasonal changes of xylem embolism in apical twigs, expressed as percentage of hydraulic conductivity (top); predawn water potential (middle); precipitation at the site of the studied tree *Fagus sylvatica* (beech). The occurrence of subzero temperatures is marked by bars at the bottom of the lower graph. Arrows in the top figure indicate bud burst and leaf fall (after Magnani & Borghetti 1995).

Acer rubrum (red maple), and *Picea rubens* (red spruce) embolisms are repaired at night, however, despite the existence of tension in the xylem (Zwieniecki & Holbrook 1998).

Trees can also build up **stem pressure**. It is quite possible that stem pressure can also restore cavitated xylem conduits in stems. The exact mechanism that accounts for stem pressure is unknown. Canny (1997) has found evidence for **refilling** of embolized vessels in petioles of *Helianthus annuus* (sunflower) during the day, when transpiration rates are high. Refilling concurrent with transpiration appears to be quite common, raising the question of how embolized vessels can be refilled while the majority of the water in the xylem remains under tension (Tyree et al. 1999). Refilling of embolized conduits requires that water enter the vessel lumen while pressurizing the gas phase until it is forced back into solution (Fig. 19). This requires a local input of energy that may come from the activities of living cells adjacent to the xylem. It is

hypothesized that water is released into the vessel lumen from these adjacent living cells in a manner similar to the process that leads to root exudation (Sect. 5.2). Water will move from living cells to the embolized vessel if an adequate driving gradient is present, e.g., involving active secretion of solutes by the living cells. Measurements of the osmotic concentration within repairing vessels, however, suggest that osmotic forces may not be adequate to explain the observed exudation (Canny 1997, Tyree et al. 1999). Further studies of water exudation from living cells and the potential involvement of aquaporins are needed to understand exactly how water enters embolized conduits (Holbrook & Zwieniecki 1999).

5.3.5 Trade-off Between Conductance and Safety

Species differences in xylem anatomy and function reflect the **trade-off** between a large xylem diameter, which maximizes **conductance**, and a small diameter, which increases the **strength** of the wood and minimizes the chances of **cavitation** due to freeze-thaw events. For example, **vines**, which have a small stem diameter, have large vessels with a high conductance and rapid water movement through the vessels, compared with other species (Table 6). Their stem does not have the strength of that of a tree with similar leaf area, however. Many plants, including herbs and crop plants, function close to the water potential where cavitation occurs. This suggests that the investment in transport conduits is such that it is only just sufficient to allow the required rate of water transport during the growing season (Tyree & Sperry 1989).

Woody species function close to the theoretical limit of the hydraulic conductance of their xylem conduits, and loss of xylem conductance due to embolism is a regular event. Species differ enormously in their vulnerability with respect to water-stress induced cavitation (Fig. 16). In general, the vulnerability of a species correlates negatively with the xylem tensions it experiences in the natural habitat (Fig. 20). The risk of cavitation plays a major role in the differentiation between drought-adapted and mesic species. On the one hand smaller inter-conduit pores confer resistance to cavitation. On the other hand, they may reduce the hydraulic conductivity of the xylem. The **safer** the xylem, the **less efficient** it may be in water conduction.

Cavitation induced by freezing stress occurs at less negative water potential in wide and long xylem conduits than it does in shorter and narrower

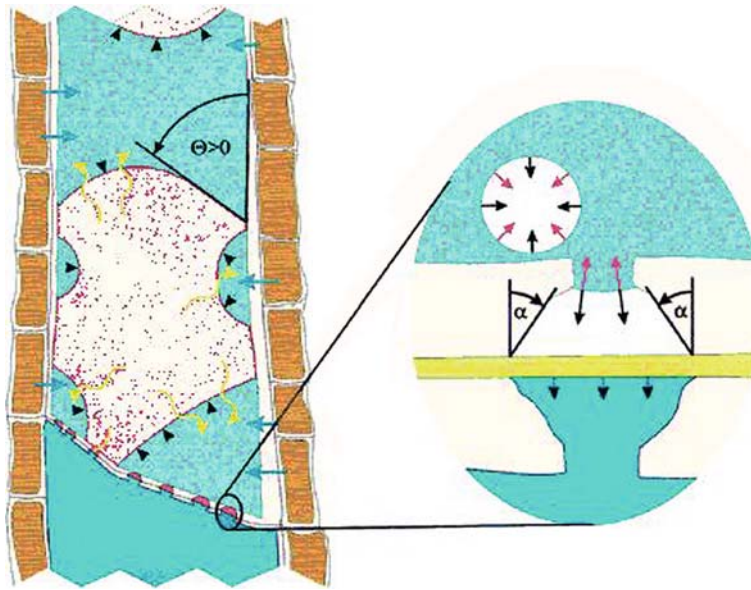

FIGURE 19. Hydraulic compartmentalization of hypothesized vessel refilling. (A) Living cells adjacent to the embolized vessel create a driving gradient that draws water into the vessel lumen (blue arrows). Droplets are retained on the wall due to the nonzero contact angle (Θ). Low permeability of the secondary wall prevents tension in adjacent vessels from being transmitted. Influx of water into the lumen compresses the gas phase (black arrows), forcing it into solution (yellow arrows). The dissolved gas then diffuses away from the

refilling vessel, where it may be carried off by the transpiration stream. (B) Bordered pit geometry (inverted funnel with angle α) prevents water from entering the pit channel before the lumen is entirely filled. The upper conduit is actively refilling and the water is under positive pressure; the lower vessel is under tension. Arrows indicate the effects of hydrostatic pressure (black) and surface tension force (red) on the gas/liquid interface. After Holbrook & Zwieniecki (1999). Copyright American Society of Plant Biologists.

ones (Fig. 17). This may explain why xylem diameters are less in species from high latitude or altitude (Baas 1986). It may also account for the rarity of woody vines at high altitude (Ewers et al. 1990); however, if, as discussed above, the breaking of the

water column in the xylem at moderate temperatures is *not* related to conduit size (Fig. 17), then why do **desert plants** tend to have narrow vessels? Conduits with a small diameter also tend to have smaller pit membrane pores than do wide ones, and this

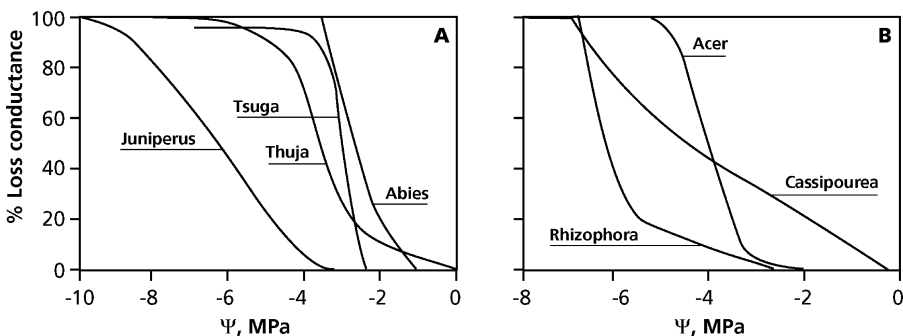

FIGURE 20. Vulnerability of various species to embolism, measured as the loss of hydraulic conductance vs. water potential in the xylem. (A) Coniferous species (*Juniperus virginiana*, *Thuja occidentalis*, *Tsuga canadensis*); (B) hardwood species (*Rhizophora mangle*, *Acer*

saccharum, *Cassipourea elliptica*) (Tyree & Sperry 1989). With kind permission, from the Annual Review of Plant Physiology and Plant Molecular Biology, Vol. 40, copyright 1989, by Annual Reviews Inc.

probably explains why desert plants have small xylem diameters. That is, the correlation does *not* reflect a direct causal relation. Pits may differ widely in different species, however, and the correlation between pit membrane pore size and xylem diameter

is not very strict which accounts for the generally poor correlation between xylem diameter and vulnerability to cavitation in different taxa (Sperry 1995). The length of the xylem conduit is also important, and this is often correlated with conduit diameter. Many short and narrow xylem conduits (such as those concentrated in the nodes or junctions of a stem segment) may be of ecological significance in that they prevent emboli from traveling from one internode to the next or from a young twig to an older one, thus acting as "safety zones" (Lo Gullo et al. 1995).

TABLE 7. Typical ratios of foliage area (A_f) to sapwood area (A_s) of conifers.

Species	Common name	A_f/A_s ($m^2 m^{-2}$)
Mesic environments		
<i>Abies balsamea</i>	Balsam fir	6700–7100
<i>A. amabilis</i>	Pacific silver fir	6300
<i>A. grandis</i>	Grand fir	5100
<i>A. lasiocarpa</i>	Subalpine fir	7500
<i>Larix occidentalis</i>	Western larch	5000
<i>Picea abies</i>	Norway spruce	4600
<i>P. engelmanni</i>	Engelmann spruce	2900–3400
<i>P. sitchensis</i>	Sitka spruce	4500
<i>Pseudotsuga menziesii</i>	Douglas fir	3800–7000
<i>Tsuga heterophylla</i>	Western hemlock	4600
<i>T. mertensiana</i>	Mountain hemlock	1600
Average		5000 ± 500
Xeric environments		
<i>Juniperus monosperma</i>	One-seeded juniper	800
<i>J. occidentalis</i>	Western juniper	1800
<i>Pinus contorta</i>	Lodgepole pine	1100–3000
<i>P. edulis</i>	Pinyon pine	2500
<i>P. nigra</i>	Austrian pine	1500
<i>P. ponderosa</i>	Ponderosa pine	1900
<i>P. sylvestris</i>	Scotch pine	1400
<i>P. taeda</i>	Loblolly pine	1300–3000
Average		1800 ± 200

Source: Margolis et al. (1995).

5.3.6 Transport Capacity of the Xylem and Leaf Area

In a given stand of trees, there is a strong linear relationship between the cross-sectional area of **sapwood** (A_s), that part of the xylem that functions in water transport, and the foliage area (A_f) supported by that xylem. Given that hydraulic conductance of stems differs among species and environments, however, it is not surprising that the ratio of foliage area to sapwood area (A_f/A_s) differs substantially among species and environments (Table 7). Desiccation-resistant species generally support much less leaf area per unit of sapwood than desiccation-sensitive species (Table 7). This is logical because vessels are narrower in species from dry habitats; hence more sapwood is needed for a similar transport capacity (Zimmermann & Milburn 1982). Any factor that speeds the growth of a stand (i.e., higher "site quality") generally increases A_f/A_s because it increases vessel diameter (Fig. 21A). For example, nutrient

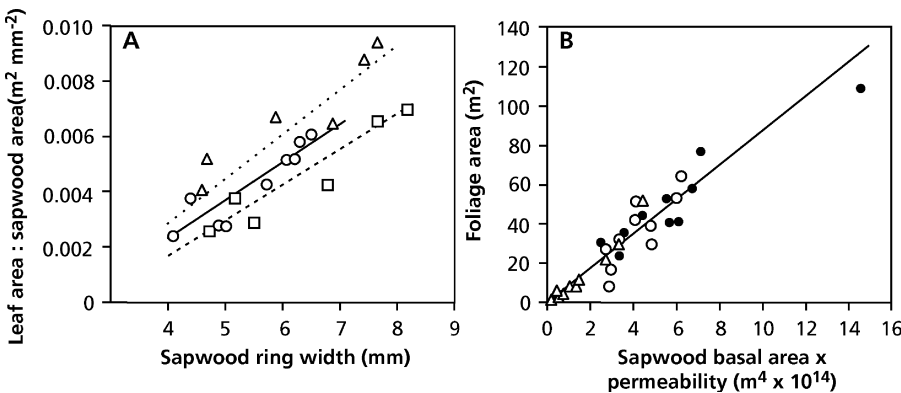

FIGURE 21. (A) Leaf area:sapwood area ratio (A_f/A_s) in relation to sapwood ring width (a measure of growth rate) in Douglas fir (*Pseudotsuga menziesii*) growing in plantations of slow (squares), medium (circles), and fast (triangles) growth rate. (B) Relationship of foliage area

to sapwood area adjusted for permeability (unit area conductance) in fertilized (solid circles) and control (open circles) trees of *Picea sitchensis* (Sitka spruce) and control trees of *Pinus contorta* (lodgepole pine) (open triangles) (after Margolis et al. 1995).

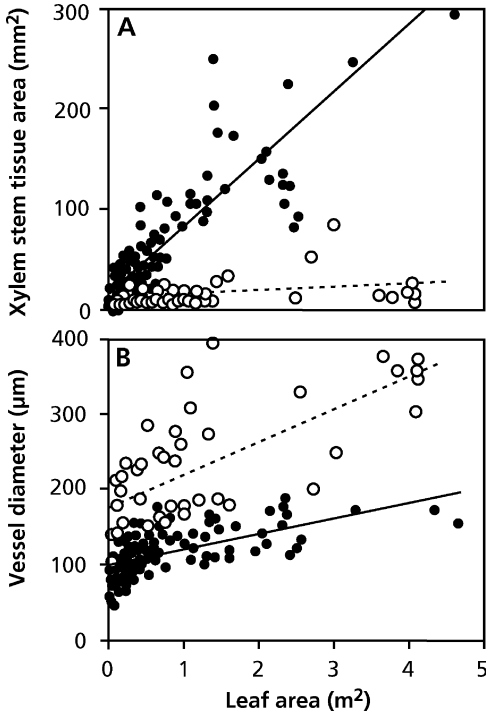

FIGURE 22. Xylem area (A) and maximum diameters of vessels (B) of contrasting *Bauhinia* species. Values are plotted as a function of the leaf area distal to the investigated stem section for stems of lianas (dashed line, open symbols) and congeneric trees and shrubs (solid line, closed symbols) (Ewers & Fisher 1991).

addition and favorable moisture status enhance $A_f:A_s$, and dominant trees have greater $A_f:A_s$ than do subdominants (Margolis et al. 1995). When conductance per unit sapwood is also considered, there is a much

more consistent relationship between foliage area and sapwood area (Fig. 21B).

Vines have less xylem tissue area per unit of distal leaf area (i.e., per unit leaf area for which they provide water). Their stems are thin relative to the distal leaf area, when compared with plants that support themselves. Vines compensate for this by having vessels with a large diameter (Fig. 22). It is interesting that the correlation between sapwood area and distal leaf area also holds when the leaf area is that of a **mistletoe** tapping the xylem, even when there is no host foliage on the branch (Sect. 2.3 of Chapter 9D on parasitic associations). Because there are no phloem connections between the xylem-tapping mistletoe and its host tree, the correlation cannot be accounted for by signals leaving the leaves and traveling through the phloem. This raises the intriguing question on how leaf area controls sapwood area (or vice versa).

5.3.7 Storage of Water in Stems

Plants store some water in stems, which can temporarily supply the water for transpiration. For example, water uptake and stem flow in many trees lags behind transpirational water loss by about 2 hours (Fig. 23) because the water initially supplied to leaves comes from parenchyma cells in the stem. [Stem flow can be measured using sap-flow equipment (Box 3.4).] Withdrawal of stem water during the day causes stem diameter to fluctuate diurnally, being greatest in the early morning and smallest in late afternoon. Most **stem shrinkage** occurs in living tissues external to the xylem, where cells have more elastic walls and cells decrease in volume when water is withdrawn. In trees, the stem

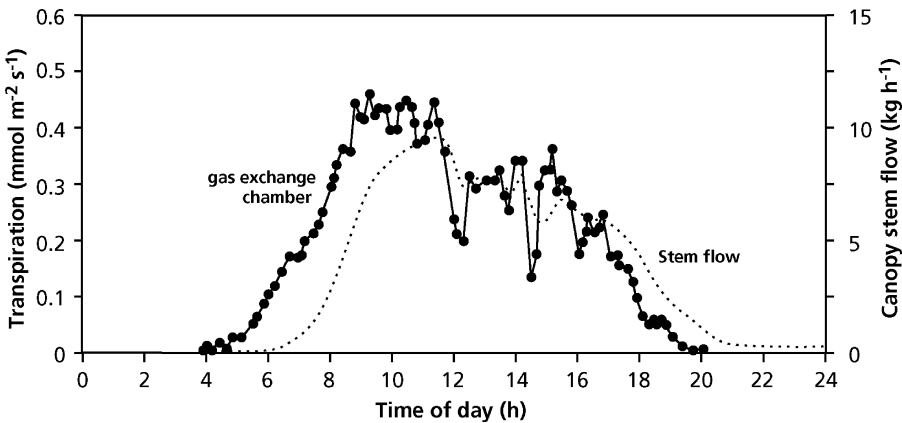

FIGURE 23. Diurnal pattern of water flow in the stem and water loss from transpiring leaves of a *Larix decidua* x *leptolepis* (larch) tree. The difference between the two lines represents stem storage (Schulze et al. 1985).

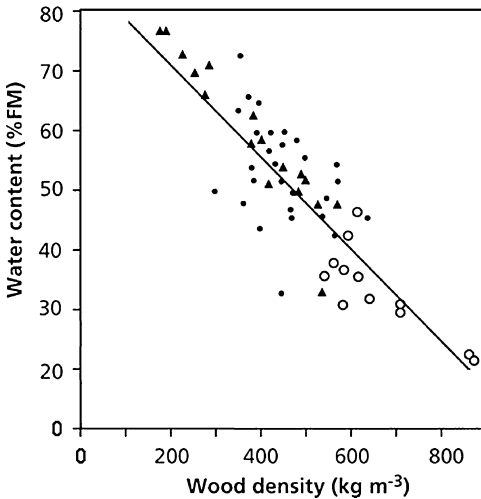

FIGURE 24. Relationship between stem water content and wood density in 32 species of deciduous trees from a dry tropical forest in Costa Rica (after Borchert 1994). Copyright Ecological Society of America.

water provides less than 10–20% of the daily water transpired in most plants, so it forms an extremely small buffer. In addition, if this water becomes available as a result of cavitation, which stops the functioning of the cavitated conduit, then the benefit of such a store is questionable.

Under some circumstances, however, stem water storage is clearly important. For example, in tropical dry forests, the loss of leaves in the dry season by drought-deciduous trees eliminates transpirational water loss. Stem water storage makes an important contribution to the water required for flowering and leaf flushing by these species during the dry season (Borchert 1994). Water storage in these trees is inversely related to wood density (Fig. 24). Early successional, shade-intolerant species grow rapidly, have low wood density, and, therefore, high water storage that enables them to flower during the dry season and to reflush leaves late in the dry season. By contrast, slow-growing deciduous trees with high wood density and low water storage remain bare to the end of the dry season (Borchert 1994). Storage of water in stems is also important in reducing winter desiccation [e.g., of the needles of *Picea engelmannii* (Engelmann spruce) that grow at the timberline]. Water in the stem may become available when the soil is frozen and air temperatures are above -4°C (Sowell et al. 1996).

In herbaceous plants and succulents, which have more elastic cell walls than those of the sapwood in trees, storage in the stem is more important. Small herbaceous plants also transpire water made

available by cavitation of some of the conduits in the stem. They refill the xylem by root pressure during the following night. *Hylocereus undatus* (red pitaya), a hemiepiphytic cactus, has fleshy stems whose water storage is crucial for surviving drought. Under wet conditions, the turgor pressure is 0.45 MPa in its **chlorenchyma**, but only 0–10 MPa in its water-storage parenchyma. During 6 weeks of drought, the stems lose one-third of their water content, predominantly from cells in the **water-storage parenchyma** (hydrenchyma), which decrease by 44% in length and volume, whereas cells in the adjacent chlorenchyma decrease by only 6%; the osmotic pressure concomitantly increases by only 10% in the chlorenchyma, but by 75% in the water-storage parenchyma (Nobel 2006).

5.4 Water in Leaves and Water Loss from Leaves

The earliest known measurements of stomata were made in 1660 by Mariotte, a French mathematician and physicist who earned his living as a clergyman in Dijon. Fifteen years later, Malpighi, who was a professor of medicine at Bologna and Pisa, mentioned porelike structures on leaf surfaces (Meidner 1987). It is now an established fact that leaves inexorably lose water through their stomatal pores, as a consequence of the photosynthetic activity of the mesophyll leaf cells. Stomates exert the greatest short-term control over plant water relations because of the steep gradient in water potential between leaf and air. There are two major interacting determinants of plant water potential: soil moisture, which governs water supply, and transpiration, which governs water loss. Both of these factors exert their control primarily by regulating stomatal conductance. Stomatal conductance depends both on the availability of moisture in the soil and on vapor pressure in the air, as will be outlined shortly.

5.4.1 Effects of Soil Drying on Leaf Conductance

Leaves of “isohydric” species, which control gas exchange in such a way that daytime leaf water status is unaffected by soil water deficits, must control stomatal conductance by messages arriving from the root. This is an example of **feedforward control**. That is, stomatal conductance declines before any adverse effects of water shortage arise in the leaves. Isohydric species include *Zea mays* (corn) and *Vigna sinensis* (cowpea). The

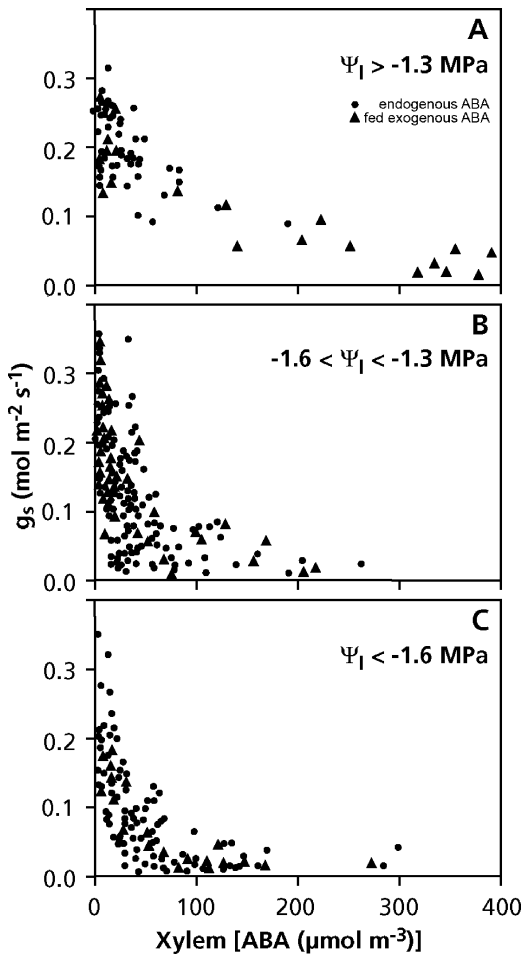

FIGURE 25. Leaf conductance (g_s) as a function of the concentration of ABA in the xylem sap of field-grown *Zea mays* (corn) plants. Measurements were made over three ranges of leaf water potential (Ψ_l). ABA concentrations varied either due to variation in plants producing different amounts of ABA, or because ABA was injected into the stem (after Davies et al. 1994). Copyright American Society of Plant Biologists.

phytohormone abscisic acid (ABA) is the predominant chemical message arriving from roots in contact with drying soil (Schurr et al. 1992, Dodd 2005). Soil drying enhances the concentration of this hormone in the xylem sap as well as in the leaves (Tardieu et al. 1992, Correia et al. 1995). Another chemical change related to soil drying is an increase in the pH of the xylem sap flowing from the roots (Gollan et al. 1992, Wilkinson et al. 1998). Injection of ABA in the stem of corn plants has fairly similar effects on the ABA concentration in the xylem sap and on stomatal conductance as exposure to a

drying soil. The stomata of desiccated plants become more “sensitized” to the ABA signal, however, possibly by a combination of other chemical signals (e.g., pH) transported in the xylem and the low water potential of the leaf itself (Fig. 25). The mechanism by which a high pH in the xylem sap affects the stomata is that the mesophyll and epidermal cells have a greatly reduced ability to sequester ABA away from the apoplast when the pH in that compartment is increased by the incoming xylem sap. This follows from the fact that weak acids such as ABA accumulate in more alkaline compartments (Wilkinson & Davies 1997, Jia & Davies 2007). Among trees, isohydric species are those that generally occur in mesic habitats and operate at water potentials extremely close to potentials causing complete cavitation (Sect. 5.3.3; Sperry 1995). These species seldom experience more than 10% loss in conductance due to cavitation because their effective control of stomatal conductance minimizes diurnal variation in leaf water potential.

In “anisohydric” species, such as *Helianthus annuus* (sunflower), both the leaf water potential and stomatal conductance decline with decreasing soil water potential. In these species, both root-derived ABA and leaf water status regulate stomatal conductance. A controlling influence of leaf water status on stomatal conductance need not be invoked. Rather leaf water status is likely to vary as a consequence of water flux through the plant which is controlled by stomatal conductance. Correlations between stomatal conductance and leaf water status are only observed in plants where leaf water status has no controlling action on the stomata (Tardieu et al. 1996).

The spectrum in stomatal “strategy” between isohydric and anisohydric plants is determined by the degree of influence of leaf water status on stomatal control for a given concentration of ABA in the xylem. There are also effects that are not triggered by ABA arriving from the roots, mediated via ABA produced in the leaf. In addition, both electrical and hydraulic signals control stomatal conductance in response to soil moisture availability (Sect. 5.1 of Chapter 2A on photosynthesis).

The mechanism by which roots sense dry soil is not clear. ABA, like any other acid, crosses membranes in its undissociated form. It therefore accumulates in soil, especially when the rhizosphere is alkaline. Because the concentration of ABA in soil increases when water is limiting for plant growth, it has been speculated that roots may sense drying soils through ABA released into the soil. Because the presence of NaCl inhibits the microbial degradation of ABA, the concentration of ABA also tends to be

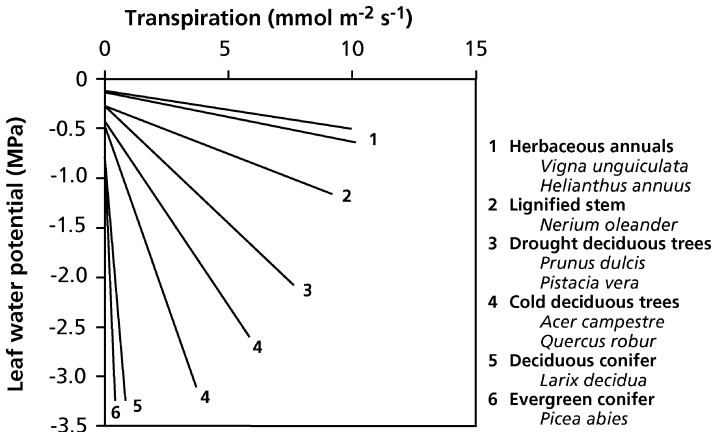

FIGURE 26. The leaf water potential reached at different transpiration rates in various life forms, when exposed to the same water supply (after Schulze 1991).

higher in saline soils. This might offer a mechanism for the roots to sense a low osmotic potential in the soil (Hartung et al. 1996). On the other hand, roots might also sense a decrease in turgor using **osmosensors** that measure the change in concentration of osmotic solutes; such osmosensors have been extensively studied in yeasts (Shinozaki & Yamaguchi-Shinozaki 1997). More recently, it has been discovered that the activity of a specific plant response to cytokinin is also regulated by changes in turgor pressure (Reiser et al. 2003, Bartels & Sunkar 2005). The topic of sensing dry soil is further discussed in Sect. 5.3.1 of Chapter 7 on growth and allocation.

The relationship between stomatal conductance (and hence transpiration) and leaf water potential differs strikingly among growth forms (Fig. 26). Because the difference in leaf water potential and soil water potential is the driving force for water transport in the plant, the relationship in Fig. 26 gives the conductance for water transport of the entire system. This conductance is greatest in herbaceous annuals and smallest in evergreen conifers. Herbaceous species like *Helianthus annuus* (sunflower) change stomatal conductance and transpiration dramatically in response to small changes in leaf water potential. By contrast, stomatal conductance and transpiration are insensitive to progressively larger changes in water potential as we go from herbaceous annuals to woody shrubs to deciduous trees to conifers. There is a corresponding decrease in conduit diameter and increase in the margin of safety against cavitation (Sect. 5.3.3). These patterns demonstrate the close integration of various parameters that determine “strategies” of water relations.

Among trees, anisohydric species maintain a larger safety margin against cavitation, but they also experience more cavitation (up to 50% loss of conductance), compared with isohydric species.

In anisohydric species, the closure of stomates in response to declines in leaf water potential is essential; otherwise, effects of declines in soil water potential would be augmented by those of cavitation which would cause further declines in leaf water potential, and lead to runaway cavitation (Sperry 1995).

How do we know that the decreased stomatal conductance is really accounted for by signals from the roots in contact with drying soil, rather than by the low water potential in the leaf itself? To address this question, Passioura (1988) used a pressure chamber placed around the roots of a *Triticum aestivum* (wheat) seedling growing in drying soil. As the soil dried out, the hydrostatic pressure on the roots was increased so as to maintain shoot water potential similar to that of well-watered plants. Despite having the same leaf water status as the control plants, the treated wheat plants showed reductions in stomatal conductance similar to those of plants in drying soil outside a pressure chamber. Additional evidence has come from experiments with small apple trees (*Malus x domestica*) growing in two containers (split-root design). Soil drying in one container, while keeping water availability high in the other, restricts leaf expansion and initiation, with no obvious effect on shoot water relations. These effects on leaves of wheat seedlings and apple trees must therefore be attributed to effects of soil drying that do not require a change in shoot water status (Davies et al. 1994). They are a clear example of **feedforward** control. In other species [e.g., *Pseudotsuga menziesii* (Douglas fir) and *Alnus rubra* (red alder)], however, stomata do not respond to soil drying according to a feedforward model. When their leaf water status is manipulated in a pressure chamber, stomatal conductance responds to turgor in the leaves within minutes. In these species,

stomatal control is hydraulic and no chemical signal from the roots appears to be involved (Fuchs & Livingston 1996).

5.4.2 The Control of Stomatal Movements and Stomatal Conductance

How do signals discussed in Sects. 5.4.1 and 5.1 of Chapter 2A on photosynthesis affect stomatal conductance? To answer this question, we first need to explore the mechanism of opening and closing of the stomata.

Although the anatomy of stomata differs among species, there are a number of traits in common. First, there are two **guard cells** above a **stomatal cavity** (Fig. 27A1–3). Because the cell walls of these adjacent cells are only linked at their distal end, they form a pore whose aperture can vary because of the swelling or shrinking of the guard cells (Fig. 27A,B). Next to the guard cells, there are often a number of lateral and distal **subsidiary cells** (Outlaw 2003, Franks and Farquhar 2007). Stomatal closure occurs when solutes are transported from the guard cells, via the apoplast, to the subsidiary cells, followed by water movement along an osmotic gradient. Stomatal opening occurs by the transport of solutes and water in the opposite direction, from subsidiary cells, via the apoplast, to the guard cells (Fig. 27C).

The stomatal pore becomes wider when the guard cells take up solutes and water due to the special structure of the cells, which are attached at their distal ends, and the ultrastructure of their cell walls. The **ultrastructural features** include the radial orientation of rigid microfibrils in the walls which allow the cells to increase in volume only in a longitudinal direction. In addition, the guard cells of some species show some thickening of the cell wall bordering the pore. This may help to explain the movement of the guard cells, but the radial orientation of the microfibrils is the most important feature. The combination of the structural and ultrastructural characteristics forces the stomata to open when the guard cells increase in volume. This can happen in minutes and requires rapid and massive transport of solutes across the plasma membrane of the guard cells (Nilson & Assmann 2007).

Which solutes are transported and how is such transport brought about? The major ion that is transported is K^+ , which is accompanied, immediately or with some delay, by Cl^- . On a cell volume, basis KCl transport represents a change which is equivalent to 300 mM in osmotically active solutes. As an alternative to the transport of Cl^- , the charge may be (temporarily) balanced by

negative charges that are produced inside the guard cells, the major one being malate produced from carbohydrate inside the guard cell (Blatt 2000). Guard cells also accumulate sucrose during stomatal opening (Nilson & Assmann 2007). A H^+ -ATPase and several **ion-selective channels** play a role in the transport of both K^+ and Cl^- , in the opening as well as the closing reaction. The channels responsible for the entry of K^+ are open only when the membrane potential is very negative (Fig. 27C). A very negative membrane potential results from the activation of the H^+ -pumping ATPase in the plasma membrane of the guard cells. Activation may be due to **light**, involving a blue-light receptor (Sect. 5.4.4). The ion-selective channels responsible for the release of K^+ open when the membrane potential becomes less negative (Hedrich & Schroeder 1989).

ABA affects some of the K^+ - and Cl^- -selective channels, either directly or indirectly, via the cytosolic Ca concentration or pH; the decrease in stomatal conductance as affected by ABA involves both an inhibition of the opening response and a stimulation of the closing reaction. Stomatal closure is a consequence of the stimulation, possibly by ABA directly, of the channel that allows the release of Cl^- , which depolarizes the membrane and generates a driving force for K^+ efflux. ABA inactivates the channel that normally mediates K^+ entry and activates the channel that determines K^+ release. This picture of events pertains to the plasma membrane; however, since much of the solute lost during stomatal closing originates from the vacuole, equivalent events must occur at the tonoplast. Ca plays a role as “second messenger” in the inhibition of the inward-directed K^+ -channel and stimulation of the outward-directed Cl^- channel. ABA enhances the Ca concentration in the cytosol which in its turn inhibits the inward K^+ -selective channel and stimulates the outward Cl^- -selective channel. The outward K^+ -selective channel is unaffected by $[Ca^{2+}]$. The Ca that accumulates in the cytosol arrives there via Ca^{2+} -selective channels in the tonoplast and, probably, the plasma membrane (Fig. 27C; Mansfield & McAinsh 1995, Blatt 2000).

Irradiance, the **CO_2 concentration** and **humidity** of the air as well as **water stress** affect stomatal aperture. There are **photoreceptors** in stomatal cells that perceive certain wavelengths, thus affecting stomatal movements. We know little about the exact mechanisms and the transduction pathways between perception of the environmental signal and the ultimate effect: stomatal opening and closing, and diurnal variation in stomatal conductance. Even within a single species, there can be drastically

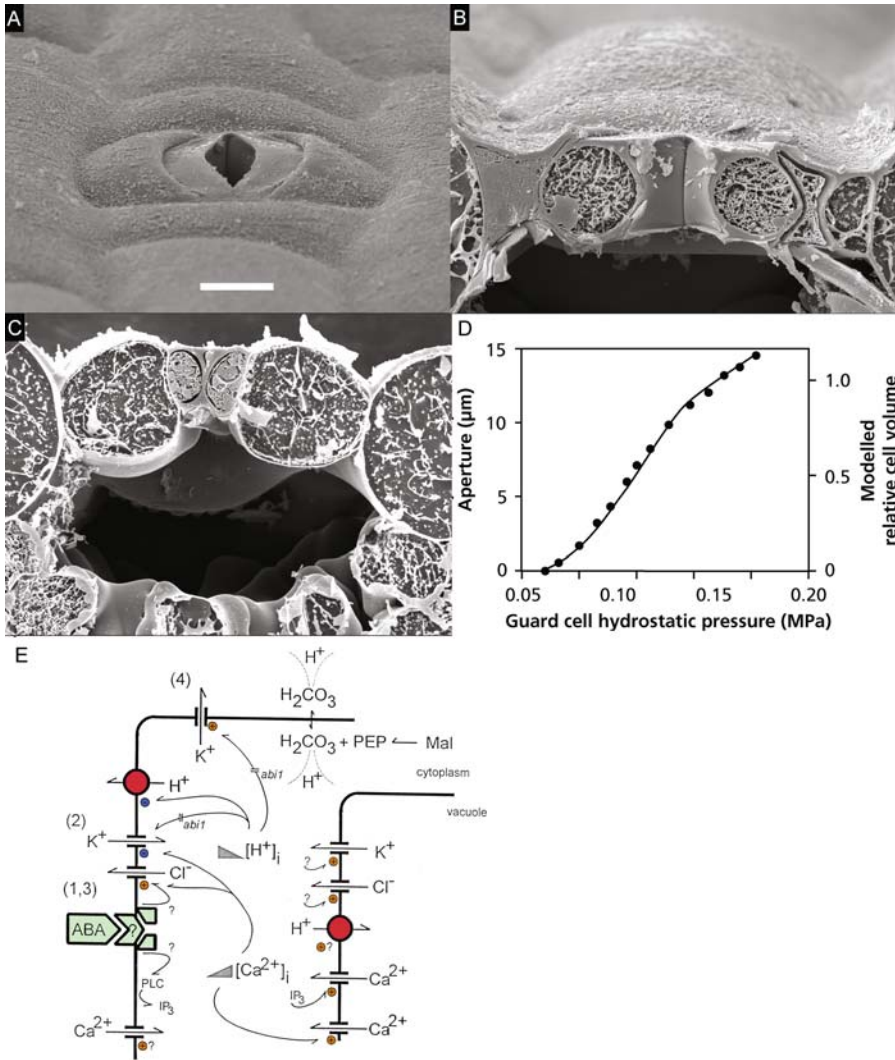

FIGURE 27. (A) Stomata of *Tradescantia virginiana* (Virginia spiderwort) sampled by snap freezing an intact leaf. 1. View of an open stoma from the top, showing the stomatal pore, two guard cells, and two adjacent subsidiary cells. 2. Cross-section showing an open stoma, large guard cells, small subsidiary cells, a stomatal pore, and a substomatal cavity. 3. Cross-section showing a closed stoma, small guard cells, large subsidiary cells, no stomatal pore, and a substomatal cavity (courtesy P.J. Franks, School of Tropical Biology, James Cook University, Australia). (B) Stomatal aperture and cell volume as a function of the guard cell hydrostatic pressure. The pressure in the cells of *Tradescantia virginiana* was controlled with a pressure probe after the guard cells had been filled with silicon oil (after

Franks et al. 1995). (C) Effects of ABA on ion fluxes in guard cells. ABA leads to a concerted modulation [(+) = increase or activation, (-) = decrease or inactivation] of at least three subsets of plasma-membrane ion channels. ABA first binds to a plasma-membrane receptor, possibly both from the outside and from the inside (not shown). This triggers the formation of inositol 1,4,5-triphosphate (IP_3), catalyzed by phospholipase C (PLC). IP_3 facilitates the release of Ca^{2+} from intracellular stores, and the consequent rise in cytosolic $[Ca^{2+}]_i$ affects a number of channels and, possibly, the plasma-membrane H^+ -ATPase. ABA also triggers a rise in pH, which affects a number of channels and depletes the substrate for the H^+ -ATPase. Modified after Blatt & Grabov (1997).

different diurnal courses of stomatal conductance at different times of year (associated with very different relative water contents and leaf water potentials). In addition, the leaf water potential at which leaf cells start to lose turgor can change through a season (Fig. 28). Such a change in **turgor-loss point** must be associated with changes in elastic modulus (Table 4, Fig. 8; Sect. 5.4.6).

greater vapor pressure difference between the leaf and the air. Such a treatment, however, may also decrease stomatal conductance and hence affect transpiration. These effects on transpiration are readily appreciated when considering the Equation introduced in Sect. 2.2.2 of Chapter 2A on photosynthesis:

$$E = g_w(w_i - w_a) \tag{7}$$

5.4.3 Effects of Vapor Pressure Difference or Transpiration Rate on Stomatal Conductance

Exposure of a single leaf or a whole plant to dry air is expected to increase transpiration because of the

where g_w is the leaf conductance for water vapor transport, and w_i and w_a are the mole or volume fractions of water vapor in the leaf and air, respectively. Which environmental factors affect Δw , the

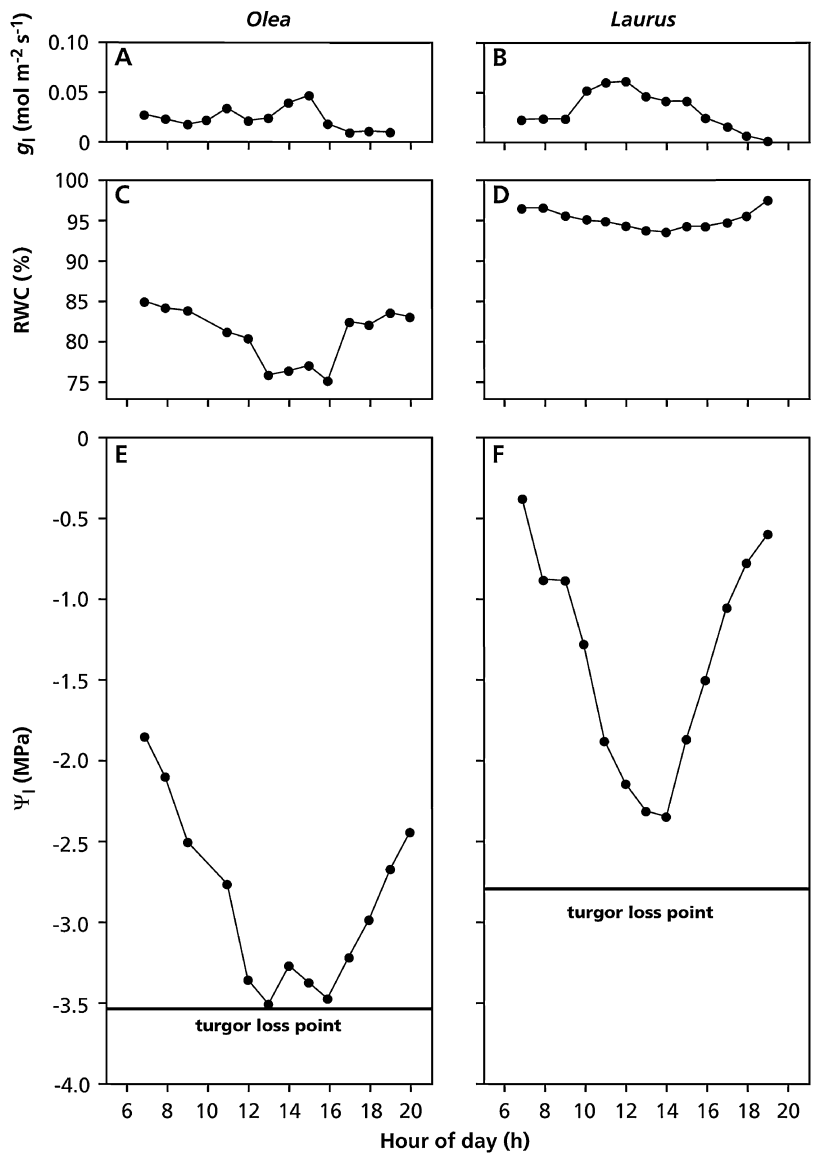

FIGURE 28. Time course of the leaf conductance to water vapor (A, B), the relative water content (RWC) of the leaves (C, D), and the leaf water potential (E, F) for two Mediterranean tree species, the relatively drought-tolerant *Olea oleaster* (olive) and the less tolerant *Laurus nobilis* (laurel). RWC is defined as the amount of water per unit plant mass relative to the amount when the tissue is fully hydrated. Measurements were made in September (dry season) (after Lo Gullo & Salleo 1988). Additional information about these trees is presented in Table 4 and Fig. 8. Copyright Trustees of The New Phytologist.

difference in water vapor concentration between leaf and air and how can stomata respond to humidity?

The water vapor concentration inside the leaf changes with leaf temperature. As temperature rises, the air can contain more water vapor, and evaporation from the wet surfaces of the leaf cells raises the water vapor concentration to saturation. This is true for leaves of both well-watered and water-stressed plants. The air that surrounds the plant can also contain more humidity with rising temperature, but water vapor content of the air typically rises less rapidly than that of the leaf. If the water vapor concentration outside the leaf remains the same, then Δw increases. This enhances the leaves' transpiration in proportion to the increased Δw , as a result of increasing vapor pressure deficit (VPD), unless stomatal conductance declines. However, as VPD increases, stomata generally respond by partial closure (Lange et al. 1971). The stomatal closure response to increasing VPD generally results in a nonlinear increase in transpiration rate to a plateau and in some cases a decrease at high VPD. By avoiding high transpiration rates that would otherwise be caused by increasing Δw , stomatal closure avoids the corresponding decline in plant water potential. The closure response presumably evolved to prevent excessive dehydration and physiological damage. Responses of stomatal conductance to increasing VPD generally follow an exponential decrease, but the magnitude of the decrease, the **stomatal sensitivity**, varies considerably both within and among species. Stomatal sensitivity at low VPD (≤ 1 kPa) is proportional to the magnitude of stomatal conductance (Fig. 29). Individuals, species, and stands with high stomatal conductance at low VPD show a greater sensitivity to VPD, as required by the role of stomata in regulating leaf water potential (Oren et al. 1999).

Note that as in Sect. 2.3 of Chapter 2A on photosynthesis, we use absolute values of water vapor in

the air, rather than relative humidity or water potential. The relative humidity of the air is the absolute amount of water vapor (partial pressure is p) in the air as a proportion of the maximum amount of water vapor that can be held at that temperature (partial pressure is p_o). The water potential of the air relates to the relative humidity as (Box 3.1):

$$\Psi_{\text{air}} = RT/V_w^o \cdot \ln p/p_o \quad (8)$$

where V_w^o is the molar volume of water. For air with a temperature of 293 K and a relative humidity of 75%, the water potential $\psi_{\text{air}} = -39$ MPa (using the value for the molar volume of water at 293 K of $18 \times 10^{-6} \text{ m}^3 \text{ mol}^{-1}$). Air with a lower RH has an even more negative water potential. This shows that water potentials of air that contains less water vapor than the maximum amount are extremely negative (Box 3.1). This negative water potential of the air is the driving force for transpiration. When describing the transport of water in different parts of the soil–plant–atmosphere continuum, it is essential to use the concept of water potential. For an analysis of leaf gas exchange, however, it tends to be more convenient to express the driving force for transpiration in terms of Δw , the difference in water vapor concentration between leaf and air, as is done for the diffusion of CO_2 from air to the intercellular spaces inside the leaf (Sect. 2.2.2 of the Chapter 2A on photosynthesis).

To further elucidate the mechanism that accounts for stomatal responses to humidity, transpiration was measured in several species using normal air and a helium:oxygen mixture (79:21 v/v, with CO_2 and water vapor added) (Mott & Parkhurst 1991). Because water vapor diffuses 2.33 times faster in the helium/oxygen mixture than it does in air, Δw between the leaf and the air at the leaf surface can be varied independently of the transpiration rate, and vice versa. The results of these experiments are consistent with a mechanism for stomatal responses to humidity that is based on the rate of water loss

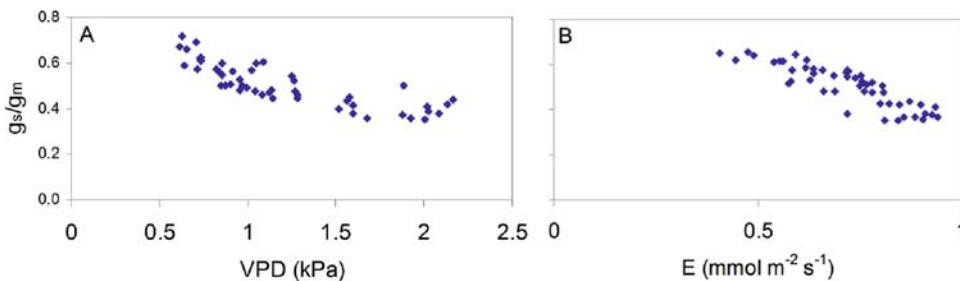

FIGURE 29. Average canopy stomatal conductance relative to the maximum value in relation to (A) vapor

pressure deficit (VPD) and (B) canopy transpiration per unit of leaf area (after Oren et al. 1999).

from the leaf. It suggests that stomata do not directly sense and respond to either the water vapor concentration at the leaf surface or Δw .

The mechanism that accounts for the stomatal response to humidity of the air or transpiration rate is unknown (Eamus & Shanahan 2002), but it does not involve ABA because both ABA-deficient and ABA-insensitive mutants of *Arabidopsis thaliana* (thale cress) respond the same as wild-type plants (Assmann et al. 2000). It can even be demonstrated in epidermal strips, isolated from the mesophyll. It is not universal, however, and it may even vary for one plant throughout a day (Franks et al. 1997). The consequence of this phenomenon is that a decrease in water vapor concentration of the air has less effect on the leaf's water potential and relative water content than expected from the increase in Δw . Stomatal response to humidity therefore allows an apparent **feedforward response** (Cowan 1977, Franks et al. 1997). It enables a plant to restrict excessive water loss before it develops severe water deficits and may enhance the ability of plants to use soil water supplies efficiently. The stomatal response to humidity inevitably reduces the intercellular CO_2 pressure in the leaf, C_i , in response to low humidity, and hence the rate of CO_2 assimilation. A compromise, somehow, has to be reached, as discussed in Sect. 5.4.7.

5.4.4 Effects of Irradiance and CO_2 on Stomatal Conductance

About a century ago, Francis Darwin (1898) already noted that the surface of a leaf facing a bright window had open stomata, whereas the stomata on surface away from the window were closed. When he turned the leaf around, the stomata, which were closed before, opened. The ones that were open, then closed. Since Darwin's observation, an overwhelming amount of evidence accumulated showing that stomata respond to light (Assmann & Shimazaki 1999). In Sect. 4.2 of Chapter 2A on photosynthesis, we discussed the rapid response of stomata in plants exposed to sunflecks. The response to light ensures that stomata are only open when there is the possibility to assimilate CO_2 . In this way, water loss through transpiration is minimized.

How do stomata perceive the light and how is this subsequently translated into a change in stomatal aperture? There are basically two mechanisms by which stomata respond to light. The *direct* response involves specific pigments in the guard cells. In addition, guard cells respond to C_i , which will be reduced by an increased rate of photosynthesis. This is the *indirect* response.

The light response of guard cells is largely to **blue light** (with a peak at 436 nm) mediated by **phototropin** (Shimazaki et al. 2007). Stomata also open in response to **red light** (with a peak at 681 nm). Since *Paphiopedilum harrisianum*, an orchid species that lacks chlorophyll, has guard cell sensitivity only to blue light, the red-light response is most likely mediated by chlorophyll (Kinoshita & Shimazaki 1999). The blue-light receptor (phototropin) affects biochemical events, such as an enhancement of PEP carboxylase, which catalyzes malate formation. Blue light also affects K^+ channels in the plasma membrane of the guard cells, allowing massive and rapid entry of K^+ into the guard cells which is the first step in the train of events that lead to stomatal opening (Blatt & Grabov 1997, Blatt 2000).

Stomata can respond to CO_2 , even when isolated or in epidermal peels, but the sensitivity varies greatly among species and depends on environmental conditions. If stomata do respond, then the response is found in both light and dark conditions. Mott (1988) used leaves of amphistomatous species (i.e., with stomata on both the upper and lower leaf surface) in a gas-exchange system that allows manipulation of C_i , while keeping the CO_2 concentration at one surface of the leaf constant (Sect. 5.4.3). In this way, it was shown that stomata sense the **intercellular CO_2 concentration** (C_i), rather than that at the leaf surface. Although the mechanism that accounts for the stomatal response remains unclear, it does play a major role in plant response to elevated atmospheric CO_2 concentrations (Assmann 1999). Under these conditions, stomatal conductance is less than it is under present atmospheric conditions, enhancing the plant's photosynthetic water-use efficiency (Sect. 10.2 of Chapter 2A on photosynthesis).

5.4.5 The Cuticular Conductance and the Boundary Layer Conductance

In this chapter, we have so far mainly dealt with stomatal conductance (Sect. 2.2.2 of Chapter 2A on photosynthesis). The **cuticular conductance** for CO_2 and water vapor is so low that it can be ignored in most cases, except when the stomatal conductance is extremely low. It is widely believed that thick cuticles are better water barriers than thin ones, but all the experimental evidence shows this to be wrong. Cuticles are formed of three main constituents: waxes, polysaccharide microfibrils, and cutin, which is a three-dimensional polymer network of esterified fatty acids. The main barrier for diffusion is located within a waxy band, called the "skin", whose thickness is much less than 1 μm (Kerstiens 1996).

In the continuum from the cell walls in the leaf, where evaporation takes place, to the atmosphere, there is one more step that cannot be ignored under many conditions. This is the leaf **boundary layer conductance**. We have already dealt with this in Sect. 2.2 of Chapter 2A on photosynthesis and will come back to it in Chapter 4A on the plant's energy balance. A special case where boundary layer conductance is expected to be very low is that of **sunken stomata**, where stomata are concealed in a **stomatal crypt**, rather than be exposed at the leaf surface (Fig. 30). Sunken stomata are relatively common in scleromorphic leaves of plants on nutrient-poor soils in (semi-)arid climates (Grieve & Hellmuth 1970, Sobrado & Medina 1980). Because of their effect on boundary layer conductance, sunken stomata will reduce transpiration, but they will have a similar effect on photosynthesis, and hence water-use efficiency is expected to be the same as that of plants with stomata on the leaf surface, instead of in stomatal crypts. The ecophysiological significance of sunken stomata is therefore not immediately obvious. Perhaps the sunken stomata are protected, e.g., against the abrasive effects of sand blown in strong winds, which might damage epidermal cells and hence interfere with stomatal opening. Or sunken stomata may be exposed to more humid air than that above the leaf, allowing them to remain open despite the high VPD (Sect. 5.4.2). This topic clearly needs further investigation.

5.4.6 Stomatal Control: A Compromise Between Carbon Gain and Water Loss

As first discussed in Sect. 5 of Chapter 2A on photosynthesis, leaves are faced with the problem of a compromise between maximization of photosynthesis (A) and minimization of transpiration (E). At a relatively high leaf conductance (g_l ; note that leaf conductance includes stomatal conductance, mesophyll conductance as well as boundary layer and cuticular conductance), A no longer increases linearly with C_i (Figs. 6 and 28; Sects. 2.2.1 and 4.1 of Chapter 2A on photosynthesis). On the other hand, E continues to increase with increasing g_l because it depends on the gradient in water vapor, and not on the biochemical machinery of photosynthesis (Fig. 29, Sect. 5.1 of Chapter 2A on photosynthesis). As explained, the intrinsic water-use efficiency (A/g_l) declines with increasing g_l . As can be seen from Fig. 29 of Chapter 2A, the ratio of the *change* in E and the *change* in A (termed λ) also increases with increasing leaf conductance (Cowan 1977).

Figure 31 gives the rate of transpiration as a function of the rate of assimilation and the time of the day, assuming different values for leaf conductance or for λ . If we assume that stomata are regulated only to *maximize* carbon gain, then this produces a transpiration curve with one diurnal peak on the contour of the surface. The peak is due to the high difference in water vapor concentration between the leaf and the atmosphere when the radiation level is high

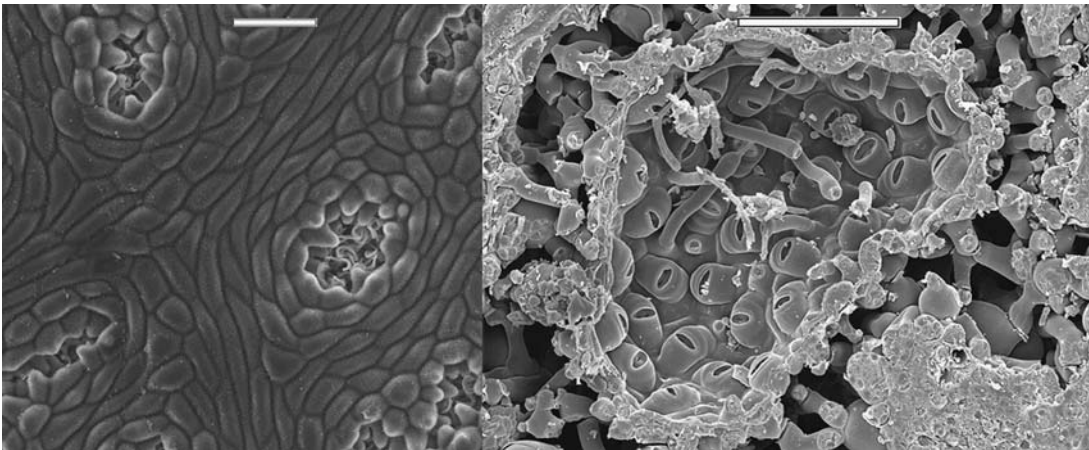

FIGURE 30. Sunken stomata and stomatal crypts in leaves of *Banksia* species. (left) Abaxial leaf surface of *Banksia quercifolia* (oak-leaved banksia) showing stomatal crypts with trichomes. Scanning electron micrograph; scale bar 100 μ m (courtesy F. Hassiotou, School of Plant Biology, The University of Western Australia, Australia). (right) Paradermal section of abaxial leaf surface of *Banksia*

elderiana (swordfish banksia) showing a stomatal crypt with a few trichomes and many stomata. Stomata are restricted to the stomatal crypt. Cryoscanning electron micrograph; scale bar 100 μ m (courtesy F. Hassiotou, School of Plant Biology, The University of Western Australia, Australia, and C. Huang, Research School of Biological Sciences, Australian National University, Australia).

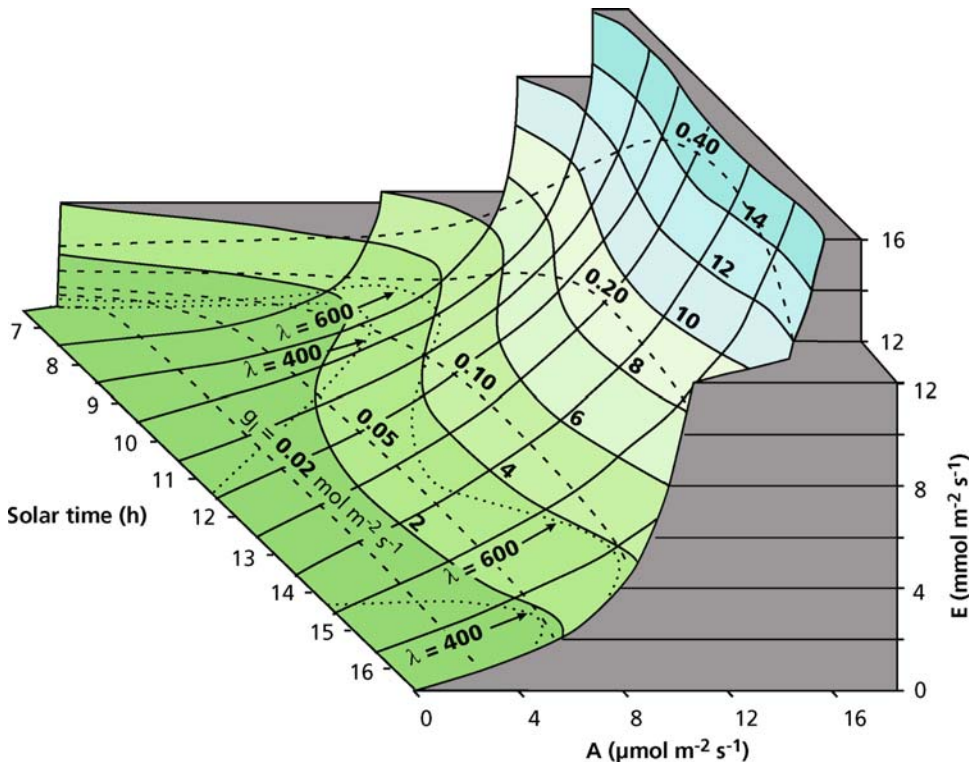

FIGURE 31. Calculated rates of transpiration (E), as a function of the rate of photosynthesis (A), and time of the day, assuming certain characteristics of leaf metabolism and environment. The magnitudes for E are given on the contours of the surface. The broken lines are diurnal trajectories on the surface giving the diurnal

variation in E and A for particular constant magnitudes of leaf conductance (g_l ; 0.02, 0.05, 0.10, 0.20, or 0.40 $\text{mol m}^{-2} \text{s}^{-1}$). The broken lines are diurnal trajectories for which is constant (400 or 600) (Cowan 1977). Copyright Australian Academy of Science.

during the middle of the day. Assuming **optimization** of stomatal regulation (i.e., constant λ) gives a curve with two peaks, when λ is small (i.e., when carbon assimilation is an important criterion for optimization). When rates of transpiration change to a lot, relative to assimilation, i.e., λ is large (greater than in the two examples in Fig. 31, but stomatal conductance is regulated to optimize carbon gain and water loss), a curve with only one diurnal peak is found. In summary, the optimization model predicts that plants in a water-limited environment should show morning and late-afternoon peaks in transpiration rate and **midday stomatal closure**, whereas plants well supplied with water would perform optimally with a single **midday peak in transpiration**. The two-peak curve may be achieved by (partial) closure of the stomata during that time of the day when the evaporative demand is highest, due to a large difference in water vapor concentration between the leaf and the air.

How should stomata be regulated so as to maximize the fixation of CO_2 with a minimum loss of water? The optimization theory for stomatal action is based on the following assumption: stomatal action is such that for each amount of CO_2 absorbed, the smallest possible amount of water is lost. The mathematics to solve such a problem requires a sophisticated approach, which will not be included here (Cowan 1977). The solution, however, can be presented very briefly: For each infinitesimally small change of E at a certain E , the change in A is constant, λ (Fig. 31).

The theoretical curves of Fig. 31 agree with observations on both C_3 and C_4 plants in dry environments, where curves with two peaks are quite common. When the water supply is favorable and VPD is moderate, however, curves with only one peak are found (i.e., there is no partial midday stomatal closure) (Fig. 32). This has led to the conclusion that stomatal conductance is regulated so as to optimize carbon gain and water loss. It should be kept in mind, however, that this optimization

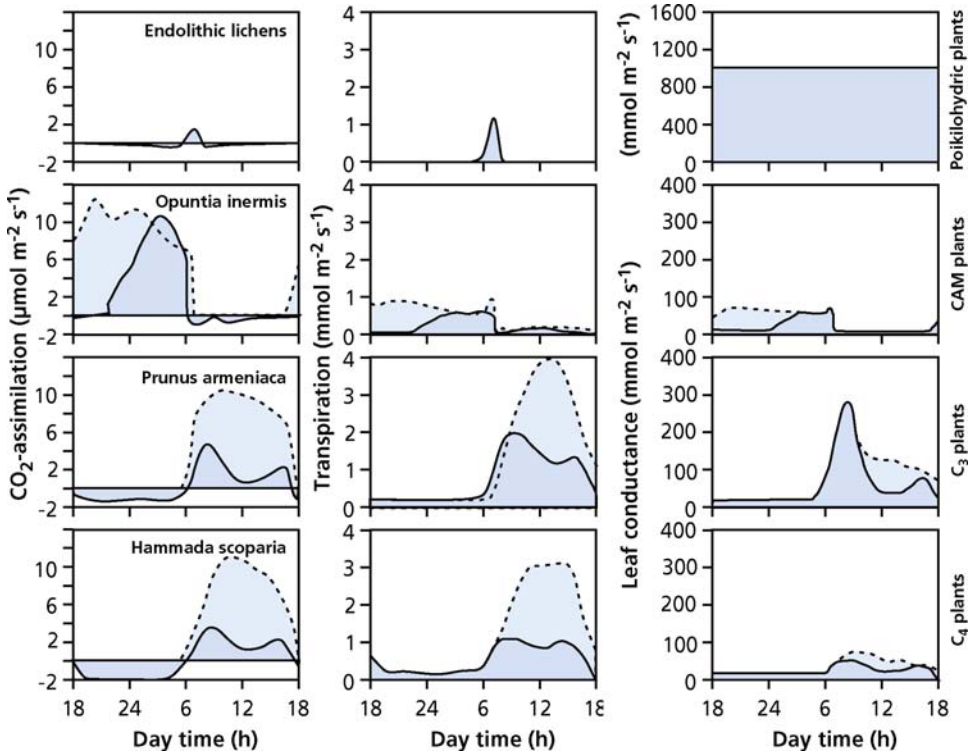

FIGURE 32. Diurnal variation in the rate of CO_2 assimilation (left), transpiration (middle), and leaf conductance (right) for four different plant types. Light shading (dashed

line) shows wet season; dark shading (solid line) shows dry season (Schulze & Hall 1982).

approach, while very attractive for explanation of stomatal behavior, is teleological in nature; it has no mechanistic basis and is not easily used for predictive purposes.

Constancy of λ does not have to be the result of the action of stomata, but it may also be achieved by a specific leaf orientation. For example, vertical leaves absorb least radiation during the middle of the day as opposed to horizontal ones. A vertical orientation of leaves is typically associated with hot and dry places close to the equator. A horizontal leaf orientation is common in temperate regions, further away from the equator. Some leaves have the ability to orientate their leaves in response to environmental factors, including the angle of the incident radiation and leaf temperature. Such **heliotropic leaf movements** may also lead to the constancy of λ (Sect. 2.2 of Chapter 4A on leaf energy balance).

6. Water-Use Efficiency

Water-use efficiency (WUE) refers to the amount of water lost during the production of biomass or the fixation of CO_2 in photosynthesis. It is defined in

two ways. First, the **water-use efficiency of productivity** is the ratio between (above-ground) gain in biomass and loss of water during the production of that biomass; the water loss may refer to total transpiration only, or include soil evaporation. Second, as explained in Sect. 5.2 of Chapter 2A on photosynthesis, the **photosynthetic water-use efficiency** is the ratio between carbon gain in photosynthesis and water loss in transpiration, A/E . Instead of the ratio of the rates of photosynthesis and transpiration, the ratio of photosynthesis (A) and leaf conductance for water vapor A/g_w can be used (**intrinsic water-use efficiency**) (Comstock & Ehleringer 1992). As expected, there is generally a good correlation between the WUE of productivity and the photosynthetic WUE. Variation in intrinsic WUE is due the way stomata are controlled, as discussed in Sect. 5.4.6.

6.1 Water-Use Efficiency and Carbon-Isotope Discrimination

As explained in Box 2A.2, the carbon-isotope composition of plant biomass is largely determined

by the biochemical fractionation of Rubisco and the fractionation during diffusion of CO_2 from the atmosphere to the intercellular spaces. The higher the stomatal conductance, relative to the activity of Rubisco, the less ^{13}C ends up in the photosynthates and hence in plant biomass. This is the basis of the generally observed correlation between $\delta^{13}\text{C}$ -values and both the intercellular CO_2 concentration (C_i) and photosynthetic WUE (Fig. 30 in Chapter 2A on photosynthesis). As a result, $\delta^{13}\text{C}$ -values can be used to assess a plant's WUE; however, differences in WUE determined at the leaf level may be reduced substantially at the canopy level, as further explained in Sect. 4 of Chapter 5 on scaling-up.

A plant's WUE depends both on stomatal conductance and on the difference in water vapor pressure in the leaf's intercellular air spaces and that in the air. Because temperature affects the water vapor concentration in the leaf, temperature also has a pronounced effect on plant WUE, A/E . Therefore, the intrinsic water-use efficiency, A/g_w , is a better indicator for a plant's physiological WUE (Comstock & Ehleringer 1992).

There are major differences in photosynthetic WUE (A/g_w) between C_3 , C_4 , and CAM plants, as well as smaller differences among species of the same photosynthetic pathway (Sect. 5.2 of Chapter 2A on photosynthesis). Xylem-tapping hemiparasitic plants have the lowest WUE, as discussed in Sect. 3 of Chapter 9 on parasitic associations (Table 8).

TABLE 8. The photosynthetic water-use efficiency* of plants with different photosynthetic pathwayand belonging to different functional groups. *****

Functional group	Water-use efficiency (mmol mol^{-1})
CAM plants	4–20
C_4 plants	4–12
Woody C_3 plants	2–11
Herbaceous C_3 plants	2–5
Hemiparasitic C_3 plants	0.3–2.5

Source: Kluge & Ting (1978), Osmond et al. (1982), Shah et al. (1987), Ehleringer & Cooper (1988), Morison (1987), Marshall & Zhang (1994), and Yu et al. (2005).

*Because A/g_w (intrinsic water-use efficiency) is difficult to compare between CAM plants and other plants, A/E (photosynthetic water-use efficiency) was used instead.

** C_3 , C_4 , and CAM; for CAM plants, the high values refer to gas exchange during the night and the low values to the light period.

***All species are nonparasitic, unless stated otherwise, grown at an ambient CO_2 concentration of around 350 mol mol^{-1} and not exposed to severe water stress.

6.2 Leaf Traits That Affect Leaf Temperature and Leaf Water Loss

As discussed in Sect. 5.4.3, leaf temperature affects the water vapor concentration inside the leaf; therefore, it is expected to affect transpiration. At increasing irradiance, leaf temperatures may rise and enhance transpiration enormously. Plants have mechanisms to minimize these effects, however. For example, water stress may cause **wilting** in large-leaved dicots even in moist soils (Chiariello et al. 1987) or **leaf rolling** in many Gramineae (Arber 1923). The latter is associated with the presence of **bulliform** or **hygroscopic** cells in grasses and sedges which are large epidermal cells with thin anticlinal walls (Beal 1886). A decline in relative water content reduces the volume of these cells to a greater extent than that of the surrounding cells, so that the leaves roll up. As a result, less radiation is absorbed, the boundary layer conductance of the adaxial surface is decreased, and further development of water stress symptoms is reduced (Sect. 2 of Chapter 4A on the plant's energy balance). Leaf rolling is probably a consequence of the relatively large elasticity of the cell walls and associated water relations of the bulliform cells compared with other epidermal leaf cells.

Leaf movements (heliotropisms) may also reduce the radiation load, as discussed in Sect. 2.2 of Chapter 4A on the plant's energy balance. Such leaf movements require a leaf joint, or **pulvinus** at the base of the petiole or leaf sheath (Satter & Galston 1981). Solutes, especially K^+ , are actively transported from one side of the pulvinus to the other (Fig. 33). Water follows passively, through **aquaporins** (Uhlein & Kaldenhoff 2008), and the turgor is increased which causes movement of the petiole or leaf sheath.

Leaf movements have been studied in detail in *Glycine max* (soybean) (Oosterhuis et al. 1985) and in *Melilotus indicus* (annual yellow sweetclover) (Schwartz et al. 1987). In these plants, as in some other Fabaceae and in *Mimosa* species, the (blue) light stimulus that gives rise to leaf movement is perceived in the pulvinus itself (Vogelmann 1984). In *Crotalaria pallida* (smooth rattlebox) (Schmalstieg 1997) and in species belonging to the Malvaceae (Schwartz et al. 1987), perception occurs in the leaf lamina. In *Crotalaria pallida* the signal is transported to the pulvinus at a rate of $30\text{--}120 \text{ mm h}^{-1}$. Both the adaxial (upper) and the abaxial (lower) side of the pulvinus of *Melilotus indicus* perceive the light stimulus. Light perception at the adaxial side causes the pulvinus to move upward, whereas perception of light at the abaxial side induces the pulvinus to cause a downward movement (Fig. 34).

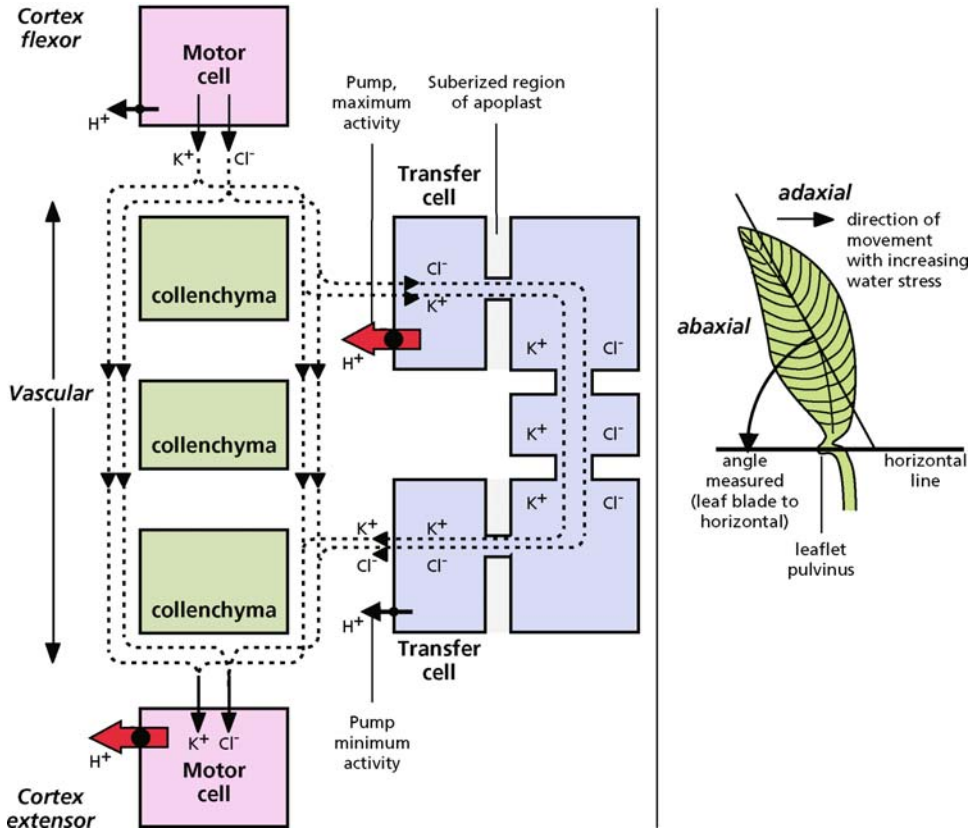

FIGURE 33. A flow diagram of the direction and pathways of net K^+ , Cl^- , and H^+ movements in a pulvinus during leaflet opening (after Satter & Galston 1981; with kind permission, from the *Annual Review of Plant*

Physiology, Vol. 32, copyright 1981, by Annual Reviews Inc.) and the location of the pulvinus in *Glycine max* (soybean) (after Oosterhuis et al. 1985).

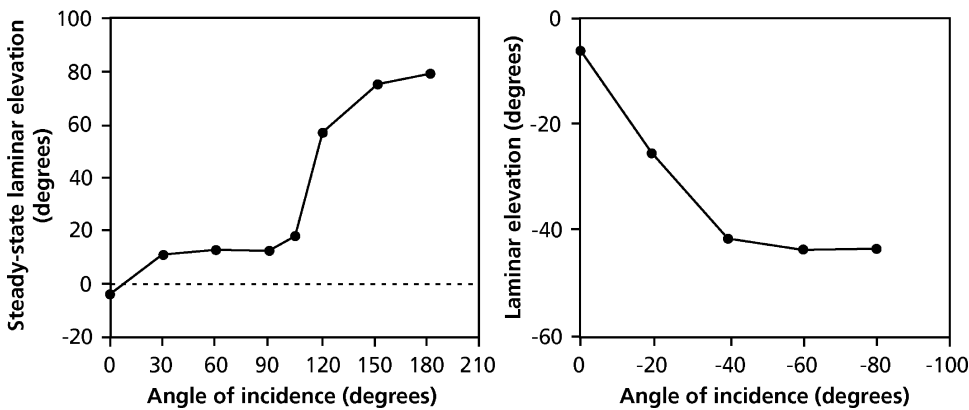

FIGURE 34. The orientation of the terminal leaf of a composite leaf of *Melilotus indicus* (annual yellow sweet-clover), as dependent on the angle of the incident radiation. An angle of 0° and $+180^\circ$ of the light refers to light in the horizontal plane, from the tip to the base of the leaf, and from the base to the tip, respectively. An

angle of $+90^\circ$ and -90° refers to light in the vertical plane, coming from above and below, respectively. For the leaf orientation, the same terminology is followed. (Left) The pulvinus is irradiated from above. (Right) The pulvinus is irradiated from below (after Schwartz et al. 1987). Copyright American Society of Plant Biologists.

Leaf movements of *Phaseolus vulgaris* (common bean) depend on air temperature (Fu & Ehleringer 1989). The effect of these leaf movements is that at a low air temperature the leaf is oriented in such a way as to enhance the incident radiation, whereas the opposite occurs at a high air temperature. As a result, the leaf temperature is closer to the optimum for photosynthesis (Fig. 35). The air temperature that induces the leaf movements in bean is perceived in the pulvinus, rather than in the leaf itself.

Other acclimations and adaptations that affect plant transpiration are discussed in Sect. 2.2 of Chapter 2A on the plant's energy balance.

6.3 Water Storage in Leaves

Many **succulents** store water in their leaves, often in specialized cells. For example, in the epiphytic *Peperomia magnoliaefolia* (desert privet), water storage occurs in a multiple epidermis (**hydrenchyma**), just under the upper epidermis which may account for 60% of the leaf volume (Fig. 36). The water-storage tissue of the epiphytic Bromeliad, *Guzmania monostachia* (strap-leaved guzmania), may amount to as much as 67% of the total leaf volume on exposed sites (Maxwell et al. 1992). The hydrenchyma in *Peperomia magnoliaefolia* consists of large cells with large vacuoles, but lacking chloroplasts. Their radial walls are thin and "collapse" when the cells lose water. Beneath the hydrenchyma is a layer of smaller cells that contain many chloroplasts: the

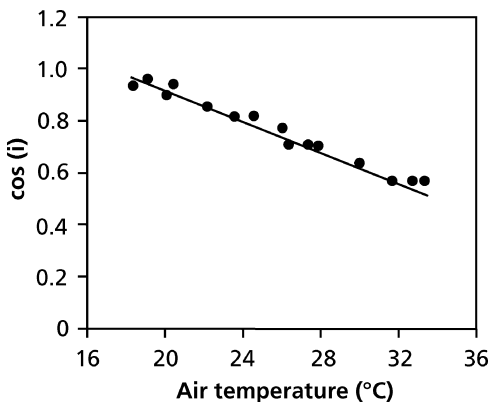

FIGURE 35. The correlation between the cosine of the angle between the incident light beam and the vector normal to the leaf lamina of *Phaseolus vulgaris* (common bean) as dependent on air temperature. Irradiance, atmospheric CO₂ concentration, and vapor pressure deficit were constant (after Fu & Ehleringer 1989). Copyright American Society of Plant Biologists.

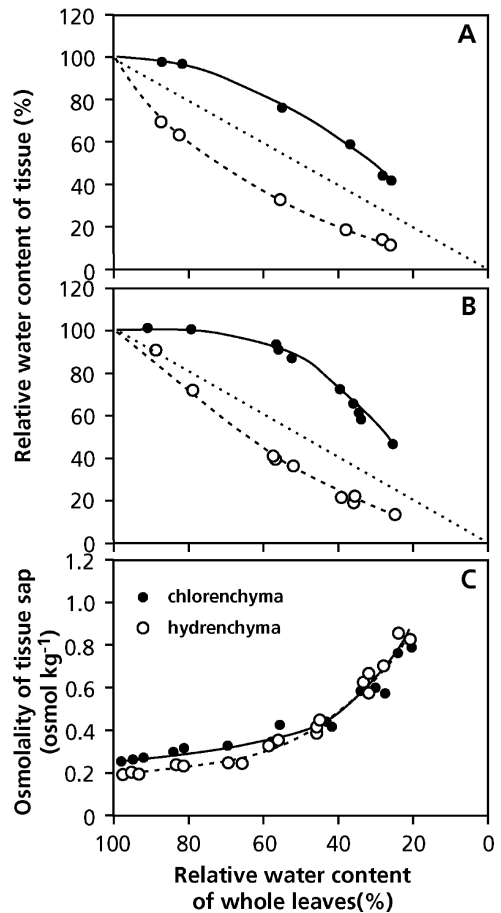

FIGURE 36. The relative water content (A, B) and the osmolality (C) of the hydrenchyma and chlorenchyma sap of *Peperomia magnoliaefolia* (desert privet) as dependent on the relative water content of whole leaves. The data in A and B refer to results obtained with detached and attached leaves, respectively; the *broken line* gives the relative water content if both tissues would lose water at the same rate (after Schmidt & Kaiser 1987). Copyright American Society of Plant Biologists.

chlorenchyma. Like in the stems of the hemiepiphytic cactus discussed in Sect. 5.3.7, when the leaves lose water, the dehydration of the chlorenchyma is much less than that of the hydrenchyma. The hydrenchyma functions as a reservoir for water lost through transpiration. This allows the chlorenchyma to remain photosynthetically active. During water loss, both solutes and water move from the hydrenchyma to the chlorenchyma. The total amount of water in the hydrenchyma of *Peperomia magnoliaefolia* exceeds 1 kg m⁻² leaves. At an average transpiration rate of 0.2 mmol H₂O m⁻² s⁻¹ during 12 hours of the day, this stored water allows the plant

to continue to transpire at the same rate for about 1 week. The stored water allows the plant to maintain a positive carbon balance in the absence of water uptake from the environment for several days.

In a South African succulent, the facultative CAM plant *Prenia sladeniana*, during desiccation, water shifts from older leaves to younger ones. If this shift of water is prevented because the older leaves are removed, then the quantum yield of photosynthesis, as determined from fluorescence parameters (Box 2A.4), declines more during a 12-day drought period than it does when older leaves are present (Tüffers et al. 1996).

7. Water Availability and Growth

During incipient water-stress, specific genes are induced (Fig. 37). Some water-stress-induced gene products protect cellular structures from the effects of water loss, whereas others are involved in the regulation of genes for signal transduction in the water-stress response. The protective proteins include **water-channel** proteins (**aquaporins**) (Sect. 5.2), enzymes required for the biosynthesis of various **compatible solutes** (Sect. 4.1), proteins that may **protect** macromolecules and membranes, **proteases** for protein turnover, **detoxification enzymes** (e.g., catalase and superoxide dismutase) (Zhu 2002, Bray 2004). The protective proteins are predominantly hydrophilic and they are probably located in the cytoplasm where they are involved in the sequestration of ions, which become concentrated during

cellular dehydration. They are amphiphilic α -helices (i.e., they contain both hydrophilic and hydrophobic parts). The hydrophilic part binds ions, thus preventing damage, whereas the hydrophobic part is associated with membranes. Other proteins have many charged amino acids and are thought to have a large water-binding capacity. Some of the proteins may protect other proteins, by replacing water, be involved in renaturation of unfolded proteins, or have a chaperon function (i.e., allow the transport of proteins across a membrane, on their way to a target organelle) (Bray 1993).

At a low soil water potential, the rate of photosynthesis decreases, largely due to a decline in stomatal conductance (Sec. 5.1 of Chapter 2A on photosynthesis). As pointed out in Sect. 5.3 of Chapter 7 on growth and allocation, however, effects of water stress on growth are largely accounted for by physiological processes other than photosynthesis. Many processes in the plant are far more sensitive to a low water potential than are stomatal conductance and photosynthesis. The growth reduction at a low soil water potential is therefore more likely due to inhibition of more sensitive processes such as **cell elongation** and **protein synthesis**; these processes are, at least partly, also controlled by **ABA** (Box 7.1).

Above-ground plant parts respond more strongly to a decreased soil water potential than do roots. Is this perhaps due to a much greater effect of the low water potential on growth of leaves, as compared with that of the roots, simply because they are closer to the source of water? Do roots and leaves, on the other hand, have a different

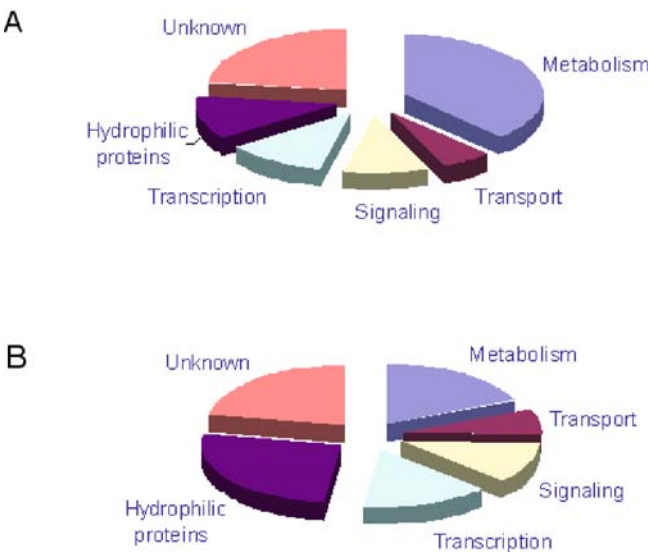

FIGURE 37. Functional categories of the genes induced in water-deficit experiments of *Arabidopsis thaliana* (thale cress), as observed in microarray experiments using different methods to impose water stress (A and B). The microarray technology allows the study of expression patterns of thousands of genes simultaneously, proving a comprehensive understanding of the types and quantities of RNAs that are present in a cell, in this example in response to water-deficit stress. There are 27 genes commonly induced and three commonly repressed (after Bray 2004).

sensitivity for the water potential? In *Zea mays* (corn), the soil water potential causing growth reduction is indeed lower (more negative) for roots than it is for leaves, but this does not provide a conclusive answer to our question. In Sect. 5.3 of Chapter 7 on growth and allocation, this problem is addressed more elaborately. Lowering the water potential enhances the transport of assimilates to the roots which is probably due to the growth reduction of the leaves. Because photosynthesis is less affected than leaf growth is, sugar import as well as root growth may be enhanced, with the overall effect that the leaf area ratio decreases in response to a decrease in soil water potential. That is, the evaporative surface is reduced, relative to the water-absorbing surface.

Aquatic angiosperms are perhaps comparable to whales: they returned to the water, taking with them some features of terrestrial organisms. In perennially submerged angiosperms, where the pressure in the xylem is never negative, the xylem is somewhat “reduced”. The structure is like that of resin ducts. The xylem ducts in submerged aquatics often have thin walls, whereas “conventionally” thick-walled xylem cells are found in aquatics whose tops are able to emerge from the water.

It is well established that water transport from roots to leaves is possible in submerged aquatic angiosperms, and that it is important in the transport of nutrients and root-produced phytohormones to the stem and leaves. The roots of most aquatics serve the same role as those of terrestrial plants as the major site of nutrient uptake and in the synthesis of some phytohormones. In submerged angiosperms, the driving force for xylem transport cannot be the transpiration, and root pressure is the most likely mechanism (Pedersen & Sand-Jensen 1997).

8. Adaptations to Drought

Plants have adapted to a lack of water in the environment either by avoiding drought or by tolerating it. **Desert annuals** and drought-deciduous species **avoid** drought by remaining dormant until water arrives. Other plants in dry environments avoid drought by producing roots with access to deep groundwater (**phreatophytes**). The alternative strategy is to **tolerate** drought. Tolerance mechanisms are found in evergreen shrubs and in plants that can dry out in the absence of water and “resurrect” upon exposure to water. Many plants in dry habitats exhibit intermediate strategies. For example, succulents, especially those with the CAM pathway (Sect.

10 of Chapter 2A on photosynthesis), minimize effects of drought by opening their stomates at night and concentrating their activity in wet seasons, but they also have many characteristics typical of drought-tolerant species.

8.1 Desiccation Avoidance: Annuals and Drought-Deciduous Species

A large proportion of the plants in deserts are annuals with no specific physiological tolerance of desiccation. As is further discussed in Sect. 2.2 of Chapter 8 on life cycles, seeds of these species may germinate only after heavy rain. These species grow very fast following germination, often completing their life cycle in 6 weeks or less. These plants typically have high rates of photosynthesis and transpiration as well as a high leaf area ratio to support their rapid growth (Mooney et al. 1976).

The most obvious mechanism of acclimation to drought is perhaps a decrease in canopy leaf area. This can be rapid, through **leaf shedding**, or more slowly, through adjustments in allocation pattern (Sect. 5.3 of Chapter 7 on growth and allocation). In general, drought-deciduous species have high stomatal conductance and high rates of photosynthesis and transpiration when water is available, but lose their leaves and enter **dormancy** under conditions of low water potential. As with desert annuals, their leaves exhibit no physiological adaptations for drought tolerance or water conservation. The advantages of a drought-deciduous strategy (high rates of photosynthesis and growth under favorable conditions) are offset by the cost of producing new leaves in each new growth period. Some species [e.g., *Fouquieria splendens* (ocotillo) in the deserts of North America] produce and lose leaves as many as six times per year. There is typically a 2–4 week lag between onset of rains and full canopy development of drought-deciduous species. It is, therefore, not surprising that drought-tolerant evergreens displace drought-deciduous species as rains become more frequent and water availability increases (Fig. 38).

Some desert plants, known as **phreatophytes**, produce extremely deep roots that tap the water table. Like the desert annuals and drought-deciduous shrubs, these plants generally have high rates of photosynthesis and transpiration with little capacity to restrict water loss or withstand drought. For example, honey mesquite (*Prosopis glandulosa*) commonly occupies desert washes in the south-eastern United States, where there is little surface water but where groundwater is close enough to the surface that seedlings can occasionally produce deep

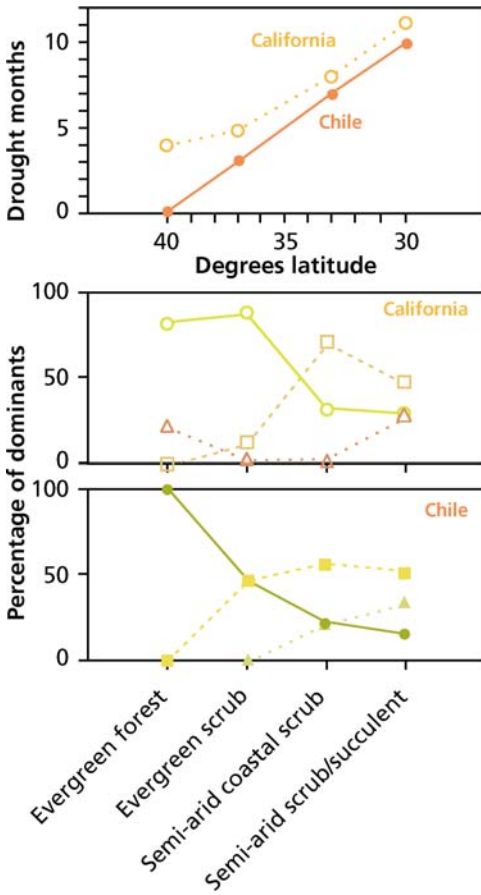

FIGURE 38. Leaf types of the dominant plants in major vegetation types along a latitudinal drought gradient in California and Chile. Leaf types are evergreen (circles), deciduous (squares), and succulent (triangles) (after Mooney & Dunn 1970).

enough roots to reach this groundwater in wet years. In the same area, *Tamarix chinensis* (saltcedar), which is an exotic phreatophyte, has lowered the water table sufficiently through its high transpiration rate that other species of intermediate rooting depth are being eliminated (Van Hylckama 1974).

8.2 Dessication Tolerance: Evergreen Shrubs

Most evergreen shrubs are exposed to water stress during part of the year, whether during the summer in a Mediterranean climate, or in winter in cooler climates.

Relatively drought-tolerant species [e.g., *Olea oleaster* (olive) in Fig. 28] withstand lower water

potentials before stomatal closure and before loss of turgor because they have relatively elastic cell walls (low elastic modulus, ϵ) and a high resistance to cavitation of xylem. Natural selection leading to scleromorphic and evergreen growth habits is complex. Low P availability is a major environmental factor driving the evolution of evergreen, scleromorphic leaves (Loveless 1961, 1962).

Mediterranean shrubs are also characterized by **dual** or **dimorphic root systems**, having both deep taproots and shallow feeder roots. This architecture allows access to semi-permanent groundwater supplies as well as to surface precipitation (Rundel 1995). A large number of woody shrub and tree species [e.g., *Banksia prionotes* (acorn banksia) and *Banksia ilicifolia* (holly-leaved banksia)] of the nutrient-impooverished sandplains of southwest Australia possess dimorphic root systems. Superficial lateral roots exploit nutrient-enriched surface layers during the wet winter season (Sect. 2.2.5.2 of Chapter 5 on mineral nutrition), and a deeply penetrating sinker taps underground sources of water throughout the year, and especially during the prolonged dry summer. Sinkers may reach the water table at 2.5–2.9 m depth. They have xylem vessels with diameters ranging from 55 to 120 μm , as opposed to 30–70 μm for lateral roots. As a result, the hydraulic conductance (on the basis of organ transectional area) of sinker roots ranges from 30 to $780 \times 10^{-3} \text{ m}^2 \text{ MPa}^{-1} \text{ s}^{-1}$, which is consistently greater than that of associated laterals ($2\text{--}50 \times 10^{-3} \text{ m}^2 \text{ MPa}^{-1} \text{ s}^{-1}$) or trunks ($0.5\text{--}9 \times 10^{-3} \text{ m}^2 \text{ MPa}^{-1} \text{ s}^{-1}$) (Pate et al. 1995).

8.3 Resurrection Plants

An extreme case of desiccation tolerance of whole plants is that of **resurrection plants** or “poikilohydric plants”. Even after their protoplasm has dried out to the extent that the water potential of the cells is in equilibrium with dry air (with a relative humidity of 20–40%), they can almost fully restore their physiological activity (Gaff 1981). Their dry, shriveled, and seemingly dead leaves regain turgor in less than 24 hour after a shower which makes the term “resurrection” most appropriate. Many mosses and ferns and some angiosperms, including woody species [e.g., *Myrothamnus flabellifolius* (resurrection bush)] are characterized as resurrection plants. They are mostly found in Southern Africa, North America, Brazil, and Australia in environments where droughts occur regularly (e.g., on rocky substrates); there are only two

European genera of angiosperm resurrection plants, *Ramonda* and *Haberla* (Gesneriaceae).

There are two strategies among resurrection angiosperms:

1. Those that lose chlorophyll and break down their chloroplasts upon drying (**poikilochlorophyllous**)
2. Those that retain some or all of their chlorophyll and chloroplast ultrastructure (**homoiochlorophyllous**).

The poikilochlorophyllous species tend to take longer to recover than do the homoiochlorophyllous ones because they must reconstitute their chloroplasts (Sherwin & Farrant 1996). All poikilochlorophyllous species are monocots, but some of the grasses are homoiochlorophyllous. The two strategies may have evolved in response to light stress, which is exacerbated during dehydration and rehydration. While the leaf tissue is dehydrating, dry, or rehydrating, light absorption should be minimal and the energy that is absorbed must be dissipated. The leaves of homoiochlorophyllous plants tend to roll or curl and produce protective pigments (e.g., anthocyanins), which act as screens. The poikilochlorophyllous plants tend to have elongate leaves that can only fold, thus leaving a greater surface exposed to light (Sherwin & Farrant 1998).

The exact nature of the reactivation of the physiological processes is not yet fully understood. The following must generally hold

1. Any damage incurred during the drying phase is not lethal
2. Some of the metabolic functions are maintained in the dry state, to an extent that they can be deployed upon rewetting
3. Any damage incurred is repaired during or after rehydration

Even though the dehydrated homoiochlorophyllous resurrection plants may have lost most of their green color, their thylakoid membranes, chlorophyll complexes, mitochondria, and other membrane systems remain intact. Elements of the protein-synthesizing machinery, including mRNA, tRNA, and ribosomes, also remain functional. Using inhibitors of transcription and translation show that membrane protection and repair does not require transcription of new gene products or translation of existing transcripts. Full recovery of the photosynthetic apparatus in the homoiochlorophyllous *Craterostigma wilmsii* requires protein synthesis, but not gene transcription. On the other hand, for the poikilochlorophyllous *Xerophyta humilis* both transcription and translation are

required for full recovery (Dace et al. 1998). *Myrothamnus flabellifolius* (resurrection bush) is a South African resurrection plant with a woody stem. Transpiration rates in well-watered plants are moderate, generating xylem water potentials of -1 to -2 MPa. Acoustic emissions indicate extensive cavitation events at xylem water potentials of -2 to -3 MPa. On re-watering, the root pressures are low (0.0024 MPa), but capillary forces are adequate to account for the refilling of xylem vessels and re-establishment of hydraulic continuity even when water was under a mild tension of -0.008 MPa (Sherwin et al. 1998). *Vellozia flavicans* in the cerrado in central Brazil takes up water via its shoot, as evidenced by sap-flow measurements (Oliveira et al. 2005).

A large number of enzymes associated with carbon metabolism remain intact in the dry state, as found for *Selaginella lepidophylla* (resurrection plant) from the Chihuahuan Desert in Texas (Table 9). About 24 hours after rewetting, the plants have regained their green appearance, and rates of photosynthesis and respiration are again close to those of normal wet plants. At that time, the activity of many enzymes has increased, compared with that in dehydrated plants. On average, 74% of the enzyme activity remains in the dry phase; however, this value is only 27% for the NADPH-dependent triose-phosphate dehydrogenase in *Selaginella lepidophylla*. In addition, in a bryophyte, *Acrocladium cuspidatum*, the activity of this photosynthetic enzyme is reduced more than that of all other enzymes tested. It appears that enzymes involved in respiratory metabolism are conserved better than are those associated with photosynthesis. The increase in activity of the enzymes that are not fully conserved in the dry phase may involve de novo protein synthesis (NADP-dependent triose-phosphate dehydrogenase, Rubisco). Rapid de novo synthesis, in addition to the maintenance of functional enzymes, is clearly important in the reactivation phase after rewetting. Maintenance of the protein-synthesizing machinery, therefore, appears to be of vital importance.

During dehydration of the resurrection plants, as in "ordinary" plants, the phytohormone **ABA** accumulates. In resurrection plants, ABA induces the **transcription** of a number of genes, which code for proteins that are closely related to those that are abundantly induced during embryo maturation in the seeds of many higher plants or to some extent in water-stressed seedlings (Bartels & Salamini 2001). In the small, herbaceous, homoiochlorophyllous *Craterostigma plantagineum*, **sucrose** accumulates to high concentrations (up to 40% of the dry

TABLE 9. The activity of three enzymes associated with photosynthesis and three involved in respiration.*

Enzyme	Enzyme activity enzyme units g ⁻¹ DM		Conservation
	Desiccated	Hydrated	%
Photosynthetic enzymes:			
Ribose-5-phosphate isomerase	7.56	9.24	82
Rubisco	0.60	0.96	62
(NADPH)Triose-phosphate dehydrogenase	0.48	1.80	27
Respiratory enzymes:			
Citrate synthase	1.76	2.05	86
Malate dehydrogenase	2.89	2.97	97
(NADH)Triose-phosphate dehydrogenase	1.13	1.40	81

Source: Harten & Eickmeier (1986).

* They were isolated from the resurrection plant *Selaginella lepidophylla*, both from dehydrated plants and 24 hours after rehydration.

mass), while the concentration of the C8-sugar octulose declines; upon rehydration, sucrose is converted back into octulose (Bartels & Salamini 2001). In the European *Ramonda* and *Haberlea* species, sucrose is also the predominant sugar that accumulates upon desiccation (Müller et al. 1997). Sucrose and other solutes play a major role in stabilizing subcellular components, including membranes and proteins. The sugars ensure that the small amount of water left in the tissue occurs in a “glassy” state, like the glass in our windows, which is actually a fluid. Some of the gene products are proteins with both hydrophobic and hydrophilic zones; they may bind ions and be membrane-associated (Bartels & Salamini 2001). These probably have an “osmoprotective” function, reducing potential damage by high solute concentrations. Other gene products are likely involved in carotenoid biosynthesis (Alamillo & Bartels 1996).

The genes expressed upon dehydration of resurrection plants are similar to those expressed at the end of the ripening of the embryo in **ripening seeds**, described as **late embryogenesis abundant** genes, or *lea* genes. The proteins involved in the survival of dehydrated embryos in dry seeds are similar to those that protect resurrection plants in their dehydrated state (**LEA proteins** or **dehydrins**). Dehydrins are rich in polar and charged amino acids; their expression is induced by environmental stresses or the application of ABA (Bartels & Salamini 2001, Neale et al. 2000). Some of the genes that are expressed in resurrection plants during dehydration are also expressed in water-stressed leaves, and more so in the more desiccation-resistant *Populus popularis*

(poplar) than in the less resistant *Populus tomentosa* (Chinese white poplar) (Pelah et al. 1997).

9. Winter Water Relations and Freezing Tolerance

As discussed in Sect. 5.3.2, subzero temperatures may lead to the formation of air bubbles in xylem conduits, hence to **embolism**. The water in the xylem generally freezes between 0 and -2°C. Some water transport may still continue after embolism has occurred, although at a very low rate (around 3% of normal rates). This slow movement probably occurs either through late-wood tracheids or through cell-wall cavities (Tranquillini 1982).

Frost damage is also associated with the formation of extracellular **ice crystals** that cause severe dehydration of the cytoplasm and the formation of crystals inside the cells, both being associated with damage to membranes and organelles. The cells become leaky and their water potential declines sharply. Resistance mechanisms predominantly involve the prevention of the formation of intracellular ice crystals, by restricting freezing to the extracellular compartment or by biochemical mechanisms to withstand dehydration (Thomashow 1999, Xiong et al. 2002, Shinozaki & Yamaguchi-Shinozaki 2000, Shinozaki et al. 2003). During cold acclimation, leaves of *Secale cereale* (rye) produce “**antifreeze proteins**” in their apoplast. These proteins interact directly with ice *in planta* and reduce freezing injury by slowing the growth and recrystallization of ice, but have no

specific cryoprotective activity (Griffith et al. 2005). At a molecular level, the responses to low temperature share major elements with plant responses to dehydration (Yamaguchi-Shinozaki & Shinozaki 2006).

Changes in the composition of cell walls play a major role in preventing ice formation. For example, deposition of **pectin** in the cell wall reduces the size of the microcapillaries in the walls, allowing a more negative water potential. Pectin formation in the pits between xylem and xylem-parenchyma cells (Fig. 14) closes these pores, so that water remains in the cells (Fig. 39). In spring, pectin is enzymatically removed again, coinciding with the loss of the capacity to tolerate deep supercooling (Wisniewski et al. 1991). Deep supercooling is only possible to temperatures around -40°C ; below that

temperature ice formation occurs in the absence of crystallization nuclei.

In subarctic trees, which tolerate temperatures below -40°C , supercooling does not play a role. Ice formation starts around -2 to -5°C , but only in the cell wall. The cold acclimation that occurs in autumn is triggered by photoperiod and exposure to cool temperatures. It involves synthesis of membrane lipids with less saturated fatty acids, so they remain flexible at low temperatures, and the production of osmotically active solutes. Cells that would freeze at -3 to -5°C in summer remain unfrozen to -40°C in winter. At subfreezing temperatures, ice forms first in cell walls, reducing the concentration of extracellular liquid water. Water moves out of cells along this water-potential gradient, increasing the

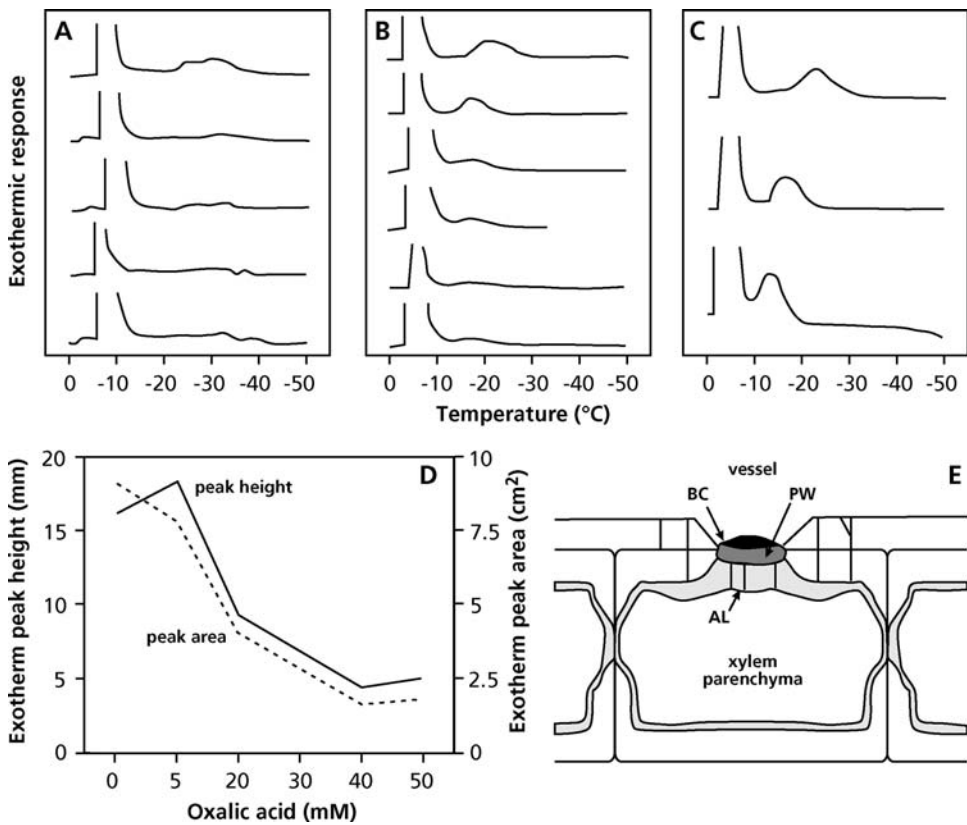

FIGURE 39. (A-C) The effect of macerase (an enzyme that hydrolyzes pectin), oxalic acid, and EGTA (both bind Ca^{2+} , responsible for “cross-linking” in pectin) on the exothermal response. The left peak (which is not relevant in the present context) is due to freezing of extracellular water. The peak to the right decreases, or shifts to lower temperatures, upon removal of pectin. The data in (B) have been replotted in (D), both as peak height and as peak area vs. the concentration of oxalic acid. (E)

The structure of a pit between the xylem and a xylem-parenchyma cell of *Prunus persica* (peach). The pit membrane consists of three layers: an outermost black cap (BC) or toruslike layer, a primary wall (PM), and an amorphous layer (AL). The channels are meant to diagrammatically illustrate how pore size or continuity would affect the ability of a cell to exhibit deep supercooling (after Wisniewski et al. 1991). Copyright American Society of Plant Biologists.

intracellular solute concentration, which prevents intracellular freezing. The biochemical mechanisms to withstand this winter desiccation are identical to those caused by lack of water in deserts. It is therefore not surprising that species that tolerate extremely low temperatures are also highly desiccation-tolerant.

10. Salt Tolerance

Halophytes are species that typically grow in soils with high levels of NaCl and, hence, a low water potential. They accumulate NaCl in their vacuoles. By contrast, **glycophytes** have a limited capacity to transport NaCl into their vacuoles and are unable to tolerate high salinity levels. Cytoplasmic enzymes of glycophytes and halophytes are very similar with respect to their sensitivity to high concentrations of inorganic solutes (Fig. 6). Tolerance mechanisms of halophytes are discussed in Sect. 3.4 of Chapter 6 on mineral nutrition.

11. Final Remarks: The Message That Transpires

What have we finally learned from this chapter on water relations? First, that water is a major factor limiting plant growth in many ecosystems, and also that in different species fascinating mechanisms have evolved to cope with this limiting factor, ranging from **avoidance** to **tolerance**. Tolerance at one level (e.g., of the roots) may allow drought

avoidance at another (e.g., of the leaves). Plants have adapted to a limiting supply of water in their environment, but all plants, to varying degrees, can also acclimate to an environment where water is scarce.

The characteristics that enable plants to tolerate drought are highly interdependent (Table 10). To appreciate these mechanisms, a full understanding of the biophysical, physiological, and molecular aspects of plant water relations is essential. Such an appreciation is pivotal, if we aim to improve the performance of crops in dry environments. This is not to say that other ecophysiological aspects are not of equal, or even greater, importance. In fact, vigorous early growth and early flowering may also greatly contribute to a greater water-use efficiency over the entire season, when evaporative demands are considerably less.

Resurrection plants offer one of the most remarkable examples of how plants cope with a shortage of water in their environment. At one stage, it may have been considered esoteric to study these peculiar plants, which would seem useless from an economic point of view. It now becomes increasingly clear, however, that resurrection plants show many similarities to ripening seeds and leaves that are able to cope with water stress. As such, resurrection plants offer a model system to study water-stress resistance, and they may also be a source of genes to be used to improve the performance of new crop varieties in dry environments. As so often in science, possibilities for applications emerge that are based on fascinating discoveries on fundamental aspects of plant biology.

TABLE 10. Summary of characteristics of drought-sensitive and drought-tolerant evergreen species.

Characteristic	Drought-sensitive species	Drought-tolerant species
Maximum transpiration rate	High	Low
Maximum photosynthetic rate	High	Low
Maximum stomatal conductance	High	Low
Specific leaf area	High	Low
Leaf size	Large	Small
Leaf longevity	Low	High
Potential growth rate	High	Low
Root mass ratio	Low	High
Leaf compatible solute concentration	Low	High
Water potential at turgor loss	High	Low
Stomatal regulation	Iso/anisohydric	Anisohydric
Safety margin for cavitation	Small	Large

References

- Alamillo, J.M. & Bartels, D. 1996. Light and stage of development influence the expression of desiccation-induced genes in the resurrection plant *Craterostigma plantagineum*. *Plant Cell Environ.* **19**: 300–310.
- Alder, N.N., Sperry, J.S., & Pockman, W.T. 1996. Root and stem xylem embolism, stomatal conductance, and leaf turgor in *Acer grandidentatum* populations along soil moisture gradient. *Oecologia* **105**: 293–301.
- Arber, A. 1923. Leaves of the Gramineae. *Bot. Gaz.*, **76**: 374–388.
- Assmann, S.M. 1999. The cellular basis of guard cell sensing of rising CO₂. *Plant Cell Environ.* **22**: 629–637.
- Assmann, S.M. & Shimazaki, K. 1999. The multisensory guard cell. Stomatal responses to blue light and abscisic acid. *Plant Physiol.* **119**: 809–815.
- Assmann, S.M., Snyder, J.A., & Lee, Y.H. J. 2000. ABA-deficient (*aba1*) and ABA-insensitive (*abi1-1*, *abi2-1*) mutants of *Arabidopsis* have a wild-type stomatal response to humidity. *Plant Cell Environ.* **23**: 387–395.
- Baas, P. 1986. Ecological patterns in xylem anatomy. In: On the economy of plant form and function, T.J. Givnish (ed.). Cambridge University Press, Cambridge, pp. 327–352.
- Bartels, D. & Salamini, F. 2001. Desiccation tolerance in the resurrection plant *Craterostigma plantagineum*. A contribution to the study of drought tolerance at the molecular level. *Plant Physiol.* **127**: 1346–1353.
- Bartels, D. & Sunkar, R. 2005. Drought and salt tolerance in plants. *Crit. Rev. Plant Sci.* **24**: 23–58.
- Beal, W.J. 1886. The bulliform or hygroscopic cells of grasses and sedges compared. *Bot. Gaz.* **11**: 321–326.
- Blatt, M.R. 2000. Cellular signaling and volume control in stomatal movements in plants. *Annu. Rev. Cell Dev. Biol.* **16**: 221–241.
- Blatt, M.R. & Grabov, A. 1997. Signalling gates in abscisic acid-mediated control of guard cell ion channels. *Physiol. Plant.* **100**: 481–490.
- Bleby, T.M., Burgess, S.S.O., & Adams, M.A. 2004. A validation, comparison and error analysis of two heat-pulse methods for measuring sap flow in *Eucalyptus marginata* saplings. *Funct. Plant Biol.* **31**: 645–658.
- Böhm, J. 1893. Capillarität und Saftsteigen. *Ber. Dtsch. Bot. Ges.* **11**: 203–212.
- Boyer, J.S. 1985. Water transport. *Annu. Rev. Plant Physiol.* **36**: 473–516.
- Borchert, R. 1994. Soil and stem water storage determine phenology and distribution of tropical dry forest trees. *Ecology* **75**: 1437–1449.
- Boutton, T.W., Archer, S.R., & Midwood, A.J. 1999. Stable isotopes in ecosystem science: Structure, function and dynamics of a subtropical savanna. *Rapid Comm. Mass Spectrom.* **13**: 1263–1277.
- Bray, E.A. 1993. Molecular responses to water deficit. *Plant Physiol.* **103**: 1035–1040.
- Bray, E.A. 2004. Genes commonly regulated by water-deficit stress in *Arabidopsis thaliana*. *J. Exp. Bot.* **55**: 2331–2341.
- Bréda, N., Granier, A., Barataud, F., & Moyne, C. 1995. Soil water dynamics in an oak stand. I. Soil moisture, water potential and water uptake by roots. *Plant Soil* **172**: 17–27.
- Burgess, S. & Bleby, T. 2006. Redistribution of soil water by lateral roots mediated by stem tissues. *J. Exp. Bot.* **57**: 3283–3291.
- Burgess, S.S.O., Adams, M.A., Turner, N.C., & Ong, C.K. 1998. The redistribution of soil water by tree root systems. *Oecologia* **115**: 306–311.
- Burgess, S.S.O., Adams, M.A., Turner, N.C., White, D.A., & Ong, C.K. 2001a. Tree roots: Conduits for deep recharge of soil water. *Oecologia* **126**: 158–165.
- Burgess, S.S.O., Adams, M.A., Turner, N.C., Beverly, C.R., Ong C.K., Khan, A.A.H., & Bleby, T.M. 2001b. An improved heat pulse method to measure low and reverse rates of sap flow in woody plants. *Tree Physiol.* **21**: 589–598.
- Caldwell, M.M. & Richards, J.H. 1989. Hydraulic lift: Water efflux from upper roots improves effectiveness of water uptake by deep roots. *Oecologia* **79**: 1–5.
- Canadell, J., Jackson, R.B., Ehleringer, J.R., Mooney, H.A., Sala, O.E., & Schulze, E-D. 1996. Maximum rooting depth of vegetation types at the global scale. *Oecologia* **108**: 583–595.
- Canny, M.J. 1997. Vessel contents during transpiration – Embolism and refilling. *Am. J. Bot.* **84**: 1223–1230.
- Čermák, J., Demi, M., & Penka M. 1973. A new method of sap flow rate determination in trees. *Biol. Plant.* **15**: 171–178.
- Čermák, J., Kučera, J., & Nadezhdina, N. 2004. Sap flow measurements with some thermodynamic methods, flow integration within trees and scaling up from sample trees to entire forest stands. *Trees - Struc. Funct.* **18**: 529–546.
- Chaumont, F., Moshelion, M., & Daniels, M.J. 2005. Regulation of plant aquaporin activity. *Biol. Cell.* **97**: 749–764.
- Chiariello, N.R., Field, C.B., & Mooney, H.A. 1987. Midday wilting in a tropical pioneer tree. *Funct. Ecol.* **1**: 3–11.
- Cochard, H., Lemoine, D., & Dreyer, E. 1999. The effects of acclimation to sunlight on the xylem vulnerability to embolism in *Fagus sylvatica*. *Plant Cell Environ.* **22**: 101–108.
- Comstock, J., & Ehleringer, J. 1992. Correlating genetic variation in carbon isotopic composition with complex climatic gradients. *Proc. Natl. Acad. Sci. USA* **89**: 7747–7751.
- Corbin, J.D., Thomsen, M.A., Dawson, T.E., & D'Antonia, C.M. 2005. Summer water use by California coastal prairie grasses: Fog, drought, and community composition. *Oecologia* **145**: 511–521.
- Correia, M.J., Pereira, J.S., Chaves, M.M., Rodrigues, M.L., & Pacheo, C.A. 1995. ABA xylem concentrations determine maximum daily leaf conductance of field-grown *Vitis vinifera* L. plants. *Plant Cell Environ.* **18**: 511–521.
- Cowan, I.R. 1977. Water use in higher plants. In: Water. Planets, plants and people, A.K. McIntyre (ed.). Australian Academy of Science, Canberra, pp. 71–107.
- Crews, L.J., McCully, M.E., Canny, M.J., Huang, C.X., & Ling, L.E. 1998. Xylem feeding by spittlebug nymphs: Some observations by optical and cryo-scanning electron microscopy. *Am. J. Bot.* **85**: 449–460.

- Dace, H., Sherwin, H.W., Illing, N., & Farrant, J.M. 1998. Use of metabolic inhibitors to elucidate mechanisms of recovery from desiccation stress in the resurrection plant *Xerophyta humilis*. *Plant Growth Regul.* **24**: 171–177.
- Daniels, M.J., Mirkov, T.E., & Chrispeels, M.J. 1994. The plasma membrane of *Arabidopsis thaliana* contains a mercury-insensitive aquaporin that is a homolog of the tonoplast water channel protein TIP. *Plant Physiol.* **106**: 1325–1333.
- Darwin, C. 1880. The power of movement in plants. John Murray, London.
- Darwin, F. 1898. Observations on stomata. *Phil Trans. Royal Soc., Ser. B* **190**: 531–621.
- Davies, W.J., Tardieu, F., & Trejo, C.L. 1994. How do chemical signals work in plants that grow in drying soil? *Plant Physiol.* **104**: 309–314.
- Dawson, T.E. 1993. Hydraulic lift and water use by plants: Implications for water balance, performance and plant-plant interactions. *Oecologia* **95**: 565–574.
- Dawson, T.E. 1998. Fog in the California redwood forest: Ecosystem inputs and use by plants. *Oecologia* **117**: 476–485.
- Dawson, T.E., Mambelli, S., Plamboeck, A.H., Templer, P. H., & Tu, K.P. 2002. Stable isotopes in plant ecology. *Annu. Rev. Ecol. Syst.* **33**: 507–559.
- Dixon, H.H. 1914. Transpiration and the ascent of sap in plants. Macmillan, London.
- Dixon, H.H. & Joly, J. 1894. On the ascent of sap. *Ann. Bot.* **8**: 468–470.
- Dodd, I.C. 2005. Root-to-shoot signalling: Assessing the roles “up” in the up and down world of long-distance signalling in *planta*. *Plant Soil* **274**: 251–270.
- Eamus D. & Shanahan S.T. 2002. A rate equation model of stomatal responses to vapour pressure deficit and drought. *BMC Ecology* **2**: 1–14.
- Ehleringer, J.R. & Cooper, T.A. 1988. Correlations between carbon isotope ratio and microhabitat in desert plants. *Oecologia* **76**: 562–566.
- Ehleringer, J.R., Phillips, S.L., Schuster, W.S.F., & Sandquist, D.R. 1991. Differential utilization of summer rains by desert plants *Oecologia* **75**: 1–7.
- Enns, L.C., McCully, M.E., & Canny, M.J. 1998. Solute concentrations in xylem sap along vessels of maize primary roots at high root pressure. *J. Exp. Bot.* **49**: 1539–1544.
- Enstone, D.E., Peterson, C.A., & Ma, F. 2003. Root endodermis and exodermis: Structure, function, and responses to the environment. *J. Plant Growth Regul.* **21**: 335–351.
- Ewers, F.W. & Fisher, J.B. 1991. Why vines have narrow stems: Histological trends in *Bauhinia fassoglensis* (Fabaceae). *Oecologia* **88**: 233–237.
- Ewers, F.W., Fisher, J.B., & Chiu, S.T. 1990. A survey of vessel dimensions in stems of tropical lianas and other growth forms. *Oecologia* **84**: 544–552.
- Farquhar, G.D., Barbour, M.M., & Henny, B.K. 1998. Interpretation of oxygen isotope composition of leaf material. In: Stable isotopes, H. Griffiths (ed.). BIOS Scientific Publishers, Oxford, pp. 27–62.
- Floto, F. 1999. Stephen Hales and the cohesion theory. *Trends Plant Sci.* **6**: 209.
- Franks, P.J., Cowan, I.R., Tyerman, S.D., Cleary, A.L., Lloyd, J., & Farquhar, G.D. 1995. Guard cell pressure/aperture characteristics measured with the pressure probe. *Plant Cell Environ.* **18**: 795–800.
- Franks, P.J., Cowan, I.R., & Farquhar, G.D. 1997. The apparent feedforward response of stomata to air vapour pressure deficit: Information revealed by different experimental procedures with two rainforest species. *Plant Cell Environ.* **20**: 142–145.
- Franks, P.J. & Farquhar, G.D. 2007. The mechanical diversity of stomata and its significance in gas-exchange control. *Plant Physiol.* **143**: 78–87.
- Fu, Q.A. & Ehleringer, J.R. 1989. Heliotropic leaf movements in common beans controlled by air temperature. *Plant Physiol.* **91**: 1162–1167.
- Fuchs, E.E. & Livingston, N.J. 1996. Hydraulic control of stomatal conductance in Douglas fir [*Pseudotsuga menziesii* (Mirb.) Franco] and alder [*Alnus rubra* (Bong)] seedlings. *Plant Cell Environ.* **19**: 1091–1098.
- Gaff, D.F. 1981. The biology of resurrection plants. In: The Biology of Australian plants, J.S. Pate & A.J. McComb (eds.). University of Western Australia Press, Nedlands, pp. 115–146.
- Gartner, B.L. 1995. Patterns of xylem variation within a tree and their hydraulic and mechanical consequences. In: Plant stems. Physiology and functional morphology, B. L. Gartner (ed.), Academic Press, San Diego, pp. 125–149.
- Gessler, A., Peuke, A.D., Keitel, C., & Farquhar G.D. 2007. Oxygen isotope enrichment of organic matter in *Ricinus communis* during the diel course and as affected by assimilate transport. *New Phytol.* **174**: 600–613.
- Gollan, T., Schurr, U., & Schulze, E.-D. 1992. Stomatal response to drying soil in relation to changes in the xylem sap composition of *Helianthus annuus*. I. The concentrations of cations, anions, amino acids in, and pH of, the xylem sap. *Plant Cell Environ.* **15**: 551–559.
- Green, S., Clothier, B., & Jardine, B. 2003. Theory and practical application of heat pulse to measure sap flow. *Agron. J.* **95**: 1371–1379.
- Grieve, B.J. & Hellmuth, E.O. 1970. Eco-physiology of Western Australian plants. *Oecol. Plant.* **5**: 34–67.
- Griffith, M., Lumb, C., Wiseman, S.B., Wisniewski, M., Johnson, R.W., & Marangoni, A.G. 2005. Antifreeze proteins modify the freezing process in *planta*. *Plant Physiol.* **138**: 330–340.
- Harten, J.B. & Eickmeier, W.G. 1986. Enzyme dynamics of the resurrection plant *Selaginella lepidophylla* (Hook. & Grev.) spring during rehydration. *Plant Physiol.* **82**: 61–64.
- Hartung, W., Sauter, A., Turner, N.C., Fillery, I., & Heilmeyer, H. 1996. Abscisic acid in soils: What is its function and which mechanisms influence its concentration? *Plant Soil* **184**: 105–110.
- Hedrich, R. & Schroeder, J.I. 1989. The physiology of ion channels and electrogenic pumps in higher plants. *Annu. Rev. Plant Physiol.* **40**: 539–569.
- Hellmers, H., Horton, J.S., Juhren, G., & O’Keefe, J. 1955. Root systems of some chaparral plants in southern California. *Ecology* **36**: 667–678.

- Hendrey, G.A.F. 1993. Evolutionary origins and natural functions of fructans – a climatological, biogeographic and mechanistic appraisal. *New Phytol.* **123**: 3–14.
- Hirasawa, T., Takahashi, H., Suge, H., & Ishihara, K. 1997. Water potential, turgor and cell wall properties in elongating tissues of the hydrotropically bending roots of pea (*Pisum sativum* L.). *Plant Cell Environ.* **20**: 381–386.
- Holbrook, N.M. & Putz, F.E. 1996. From epiphyte to tree: Differences in leaf structure and leaf water relations associated with the transition in growth form in eight species of hemiepiphytes. *Plant Cell Environ.* **19**: 631–642.
- Holbrook, N.M. & Zwieniecki, M.A. 1999. Embolism repair and xylem tension: Do we need a miracle? *Plant Physiol.* **120**: 7–10.
- Holbrook, N.M., Burns, M.J., & Field, C.B. 1995. Negative xylem pressures in plants: A test of the balancing-pressure technique. *Science* **270**: 1193–1194.
- Huang, B., North, G.B., & Nobel, P.S. 1993. Soil sheath, photosynthate distribution to roots, and rhizosphere water relations of *Opuntia ficus-indica*. *Int. J. Plant Sci.* **154**: 425–431.
- Jackson, R.B., Moore, L.A., Hoffmann, W.A., Pockman, W. T., & Linder, C.R. 1999. Ecosystem rooting depth determined with caves and DNA. *Proc. Natl. Acad. Sci. USA* **96**: 11387–11392.
- Jia, W. & Davies, W.J. 2007. Modification of leaf apoplastic pH in relation to stomatal sensitivity to root-sourced abscisic acid signals. *Plant Physiol.* **143**: 68–77.
- Kalapos, T., Van den Boogaard, R., & Lambers, H. 1996. Effect of soil drying on growth, biomass allocation and leaf gas exchange of two annual grass species. *Plant Soil* **185**: 137–149.
- Kern, J.S. 1995. Evaluation of soil water retention models based on basic soil physical properties. *Soil Sci. Soc. Am. J.* **59**: 1134–1141.
- Kerstiens, G. 1996. Signalling across the divide: A wider perspective of cuticular structure-function relationships. *Trends Plant Sci.* **1**: 125–129.
- Kinoshita T. & Shimazaki K. 1999. Blue light activates the plasma membrane H⁺-ATPase by phosphorylation of the C-terminus in stomatal guard cells. *EMBO J.* **18**: 5548–5558.
- Kluge, M. & Ting, I.P. 1978 Crassulacean acid metabolisms. Analysis of an ecological adaptation. Ecological studies, Vol. 30. Springer-Verlag, New York.
- Körner, C., Neumayer M., Pelaez Menendez-Riedl, S., & Smeets-Scheel, A. 1989. Functional morphology of mountain plants. *Flora* **182**: 353–383.
- Korolev, A.V., Tomos, A.D., Bowtell, R., & Farrar, J.F. 2000. Spatial and temporal distribution of solutes in the developing carrot taproot measured at single-cell resolution. *J. Exp. Bot.* **51**: 567–577.
- Kramer, P.J. 1969. Plant & soil water relationships. McGraw-Hill, New York.
- Lange, O.L., Lösch, R., Schulze, E.-D., & Kappen, L. 1971. Responses of stomata to changes in humidity. *Planta* **100**: 76–86.
- Lee, J.-E., Oliveira, R.S., Dawson, T.E., & Fung, I. 2005. Root functioning modifies seasonal climate. *Proc. Natl. Acad. Sci. USA* **102**: 17576–17581.
- Lo Gullo, M.A. & Salleo, S. 1988. Different strategies of drought resistance in three Mediterranean sclerophyllous trees growing in the same environmental conditions. *New Phytol.* **108**: 267–276.
- Lo Gullo, M.A., Salleo, S. Piaceri, E.C., & Rosso, R. 1995. Relations between vulnerability to xylem embolism and xylem conduit dimensions in young trees of *Quercus cerris*. *Plant Cell Environ.* **18**: 661–669.
- Longstreth, D.J., Bolanos, J.A., Goddard, R.H. 1985. Photosynthetic rate and mesophyll surface area in expanding leaves of *Alternanthera philoxeroides* grown at two light intensities. *Am. J. Bot.* **72**: 14–19.
- Loveless, A.R. 1961. A nutritional interpretation of sclerophyllous and mesophytic leaves. *Ann. Bot.* **25**: 169–184.
- Loveless, A.R. 1962. Further evidence to support a nutritional interpretation of sclerophylly. *Ann. Bot.* **26**: 551–561.
- Ma, F. & Peterson, C.A. 2003. Current insights into the development, structure, and chemistry of the endodermis and exodermis of roots. *Can. J. Bot.* **81**: 405–421.
- Maggio, A. & Joly, R.J. 1995. Effects of mercuric chloride on the hydraulic conductivity of tomato root systems. Evidence for a channel-mediated water pathway. *Plant Physiol.* **109**: 331–335.
- Magnani, F. & Borghetti, M. 1995. Interpretation of seasonal changes of xylem embolism and plant hydraulic resistance in *Fagus sylvatica*. *Plant Cell Environ.* **18**: 689–696.
- Mansfield, T.A. & McAinsh, M.R. 1995. Hormones as regulators of water balance. In: Plant hormones, P.J. Davies (ed.). Kluwer Academic Publishers, Dordrecht.
- Margolis, H., Oren, R., Whitehead, D., & Kaufmann, M.R. 1995. Leaf area dynamics of conifer forests. In: Ecophysiology of coniferous forests, W.K. Smith & T.M. Hinckley (eds.). Academic Press, San Diego, pp. 181–223.
- Marshall, D.C. 1958. Measurement of sap flow in conifers by heat transport. *Plant Physiol.* **33**: 385–396.
- Marshall, J.D. & Zhang, J. 1994. Carbon isotope discrimination and water use efficiency in native plants of the north-central Rockies. *Ecology* **75**: 1887–1895.
- Martin, C.E. & Von Willert, D.J. 2000. Leaf epidermal hydathodes and the ecophysiological consequences of foliar water uptake in species of *Crassula* from the Namib desert in Southern Africa. *Plant Biol.* **2**: 229–242.
- Maxwell, C., Griffiths, H., Borland, A.M., Broadmeadow, M.S.J., & McDavid, C.R. 1992. Photoinhibitory responses of the epiphytic bromeliad *Guzmania monostachia* during the dry season in Trinidad maintain photochemical integrity under adverse conditions. *Plant Cell Environ.* **15**: 37–47.
- McCully, M.E. & Canny, M.J. 1988. Pathways and processes of water and nutrient movement in roots. *Plant Soil* **111**: 159–170.
- McCully, M.E., Huang, C.X., & Ling, L.E.C. 1998. Daily embolism and refilling of xylem vessels in the roots of field-grown maize. *New Phytol.* **138**: 327–342.
- Meidner, H. 1987. Three hundred years of research into stomata. In: Stomatal function, E. Zeiger, G.D. Farquhar, & I.R. Cowan (eds.). Stanford University Press, Stanford, pp. 7–27.

- Midwood, A.J., Boutton, T.W., Archer, S.R., & Watts, S.E. 1998. Water use by woody plants on contrasting soils in a savanna parkland: Assessment with $\delta^2\text{H}$ and $\delta^{18}\text{O}$. *Plant Soil* **205**: 13–24.
- Milburn, J.A. 1979. Water flow in plants. Longman, London.
- Mitchell, P., Veneklaas, E.J., Lambers, H., & Burgess, S.S.O. 2008. Maintaining leaf water balance during summer water deficit: Differential responses in turgor maintenance and variation in leaf structure among plant functional types in southern-western Australia. *Plant Cell Environ.*
- Mooney, H.A. & Dunn, E.L. 1970. Photosynthetic systems of Mediterranean climate shrubs and trees of California and Chile. *Am. Nat.* **194**: 447–453.
- Mooney, H.A., Ehleringer, J., & Berry, J.A. 1976. High photosynthetic capacity of a winter annual in Death Valley. *Science* **194**: 322–324.
- Morison, J.I.L. 1987. Intercellular CO_2 concentration and stomatal response to CO_2 . In: Stomatal function, E. Zeiger, G.D. Farquhar, & I.R. Cowan (eds.). Stanford University Press, Stanford, pp. 229–251.
- Mott, K.A. 1988. Do stomata respond to CO_2 concentrations other than intercellular? *Plant Physiol.* **86**: 200–203.
- Mott, K.A. & Parkhurst, D.F. 1991. Stomatal responses to humidity in air and helox. *Plant Cell Environ.* **14**: 509–516.
- Müller, J., Sprenger, N., Bortlik, K., Boller, T., & Wiemken, A. 1997. Desiccation increases sucrose levels in *Ramonda* and *Haberlea*, two genera of resurrection plants in the Gesneriaceae. *Physiol. Plant.* **100**: 153–158.
- Nabil, M. & Coudret, A. 1995. Effects of sodium chloride on growth, tissue elasticity and solute adjustments in two *Acacia nilotica* subspecies. *Physiol. Plant.* **93**: 217–224.
- Nadezhdina, N. & Čermák, J. 2003. Instrumental methods for studies of structure and function of root systems of large trees. *J. Exp. Bot.* **54**: 1511–1521.
- Neale, A.D., Blomstedt, C.K., Bronson, P., Le, T.-N., Guthridge, K., Evans, J., Gaff, D.F., & Hamill, J.D. 2000. The isolation of genes from the resurrection grass *Sporobolus stapfianus* which are induced during severe drought stress. *Plant Cell Environ.* **23**: 265–277.
- Ngugi M., Doley D., Hunt M., Dart P., & Ryan, P. 2003. Leaf water relations of *Eucalyptus cloeziana* and *Eucalyptus argophloia* in response to water deficit. *Tree Physiol.* **23**: 335–343.
- Niklas, K.J. & Paolillo, D.J., Jr. 1998. Preferential states of longitudinal tension in the outer tissues of *Taraxacum officinale* (Asteraceae) peduncles. *Am. J. Bot.* **85**: 1068–1081.
- Nilson, S.E. & Assmann, S.M. 2007. The control of transpiration. Insights from *Arabidopsis*. *Plant Physiol.* **143**: 19–27.
- Nobel, P.S. 1991. Physicochemical and environmental plant physiology. Academic Press, San Diego.
- Nobel, P.S. 2006. Parenchyma-chlorenchyma water movement during drought for the hemiepiphytic cactus *Hylocereus undatus*. *Ann. Bot.* **97**: 469–474.
- Nobel, P.S., Zaragoza, L.J., & Smith, W.K. 1975. Relationship between mesophyll surface area, photosynthetic rate, and illumination level during development for leaves of *Plectranthus parviflorus*. *Plant Physiol.* **55**: 1067–1070.
- Nobel, P.S., Schulte, P.J., & North, G.B. 1990. Water influx characteristics and hydraulic conductivity for roots of *Agave deserti* Engelm. *J. Exp. Bot.* **41**: 409–415.
- North, G.B. & Nobel, P.S. 1997. Drought-induced changes in soil contact and hydraulic conductivity for roots of *Opuntia ficus-indica* with and without rhizosheaths. *Plant Soil* **191**: 249–258.
- Oliveira, R.S., Dawson, T.E., & Burgess, S.S.O. 2005. Evidence for direct water absorption by the shoot of the desiccation-tolerant plant *Vellozia flavicans* in the savannas of central Brazil. *J. Trop. Ecol.* **21**: 585–588.
- Oosterhuis, D.M., Walker, S., & Eastman, J. 1985. Soybean leaflet movement as an indicator of crop water stress. *Crop Sci.* **25**: 1101–1106.
- Oren, R., Sperry, J.S., Katul, G.G., Pataki, D.E., Ewers, B.E., Phillips, N., & Schäfer, K.V.R. 1999. Survey and synthesis of intra- and interspecific variation in stomatal sensitivity to vapour pressure deficit. *Plant Cell Environ.* **22**: 1515–1526.
- Osmond, C.B., Winter, K., & Ziegler, H. 1982. Functional significance of different pathways of CO_2 fixation in photosynthesis. In: Encyclopedia of plant physiology, N.S. Vol. 12B, O.L. Lange, P.S. Nobel, C.B. Osmond, & H. Ziegler (eds.). Springer-Verlag, Berlin, pp. 479–547.
- Outlaw, W.H., Jr. 2003. Integration of cellular and physiological functions of guard cells. *Crit. Rev. Plant Sci.* **22**: 503–529.
- Passioura, J.B. 1988. Root signals control leaf expansion in wheat seedlings growing in drying soil. *Aust. J. Plant Physiol.* **15**: 687–693.
- Passioura, J.B. 1991. Soil structure and plant growth. *Aust. J. Soil Res.* **29**: 717–728.
- Pate, J.S., Jeschke, W.D., & Aylward, M.J. 1995. Hydraulic architecture and xylem structure of the dimorphic root systems of south-west Australian species of Proteaceae. *J. Exp. Bot.* **46**: 907–915.
- Pedersen, O. & Sand-Jensen, K. 1997. Transpiration does not control growth and nutrient supply in the amphibious plant *Mentha aquatica*. *Plant Cell Environ.* **20**: 117–123.
- Pelah, D., Wang, W., Altman, A., Shoseyov, O., & Bartels, D. 1997. Differential accumulation of water stress-related proteins, sucrose synthase and soluble sugars in *Populus* species that differ in their water stress response. *Physiol. Plant.* **99**: 153–159.
- Peterson, C.A. & Enstone, D.E. 1996. Functions of passage cells in the endodermis and exodermis of roots. *Physiol. Plant.* **97**: 592–598.
- Pilon-Smits, E.A.H., Ebskamp, M.J.M., Paul, M.J., Jeuken, M.J.W., Weisbeek, P.J., & Smeeckens, S.J.M. 1995. Improved performance of transgenic fructan-accumulating tobacco under drought stress. *Plant Physiol.* **107**: 125–130.
- Pockman, W.T., Sperry, J.S., & O'Leary, J.W. 1995. Sustained and significant negative water pressure in xylem. *Nature* **378**: 715–716.
- Pollard, A. & Wyn Jones, R.G. 1979. Enzyme activities in concentrated solutions of glycinebetaine and other solutes. *Planta* **144**: 291–298.

- Pollock, C.J. & Cairns, A.J. 1991. Fructan metabolism in grasses and cereals. *Annu. Rev. Plant Physiol. Plant. Mol. Biol.* **42**: 77–101.
- Pritchard, J. 1994. The control of cell expansion in roots. *New Phytol.* **127**: 3–26.
- Pütz, N. 1996. Development and function of contractile roots. In: Plant roots: The hidden half, Y. Waisel, A. Eshel, & U. Kafkaki (eds.). Marcel Decker, New York, pp. 859–894.
- Read, D.B., Bengough, A.G., Gregory, P.J., Crawford, J.W., Robinson, D., Scrimgeour, C.M., Young, I.M., Zhang, K., & Zhang, X. 2003. Plant roots release phospholipid surfactants that modify the physical and chemical properties of soil. *New Phytol.* **157**: 315–326.
- Reiser, V., Raitt, D.C., & Saito, H. 2003. Yeast osmosensor Sln1 and plant cytokinin receptor Cre1 respond to changes in turgor pressure. *J. Cell Biol.* **161**: 1035–1040.
- Richards, J.H. & Caldwell, M.M. 1987. Hydraulic lift: Substantial nocturnal water transport between soil layers by *Artemisia tridentata* roots. *Oecologia* **73**: 486–489.
- Roden, J.S., Lin, G.G., & Ehleringer, J.R. 2000. A mechanistic model for interpretation of hydrogen and oxygen isotope ratios in tree ring cellulose. *Geochim. Cosmochim. Acta* **64**: 21–35.
- Robichaux, R.H. 1984. Variation in the tissue water relations of two sympatric Hawaiian *Dubautia* species and their natural hybrid. *Oecologia* **65**: 75–81.
- Robichaux, R.H. & Canfield, J.E. 1985. Tissue elastic properties of eight Hawaiian *Dubautia* species that differ in habitat and diploid chromosome number. *Oecologia* **66**: 77–80.
- Rodriguez, M.L., Chaves, M.M., Wendler, R., David, M.M., Quick, W.P., Leegood, R.C., Stitt, M., & Pereira, J.S. 1993. Osmotic adjustment in water stressed grapevine leaves in relation to carbon assimilation. *Aust. J. Plant Physiol.* **20**: 309–321.
- Rundel, P.W. 1995. Adaptive significance of some morphological and physiological characteristics in Mediterranean plants: Facts and fallacies. In: Timescales of biological responses to water constraints. The case of Mediterranean biota, J. Roy, J. Aronson, & F. di Castri (eds.). SPB Academic Publishing, Amsterdam, pp. 119–139.
- Sakuratani, T. 1981. A heat balance method for measuring water flux in the stem of intact plants. *J. Agric. Meteorol.* **37**: 9–17.
- Satter, R.L. & Galston, A.W. 1981. Mechanism of control of leaf movements. *Annu. Rev. Plant Physiol.* **32**: 83–110.
- Schmalstig, J.G. 1997. Light perception for sun-tracking is on the lamina in *Crotalaria pallida* (Fabaceae). *Am. J. Bot.* **84**: 308–314.
- Schmidt, J.E. & Kaiser, W.M. 1987. Response of the succulent leaves of *Peperomia magnoliaefolia* to dehydration. *Plant Physiol.* **83**: 190–194.
- Scholander, P.F., Bradstreet, E.D., & Hemmingsen, E.A. 1965. Sap pressures in vascular plants. *Science* **148**: 339–346.
- Schulze, E.-D. 1991. Water and nutrient interactions with plant water stress. In: Response of plants to multiple stresses, H.A. Mooney, W.E. Winner, & E.J. Pell (eds.). Academic Press, San Diego, pp. 89–101.
- Schulze, P.J. & Hincley, A.R. 1985. A comparison of pressure-volume curve data analysis techniques. *J. Exp. Bot.* **36**: 1590–1602.
- Schulze, E.-D., Čermák, J., Matyssek, R., Penka, M., Zimmermann, R., Vasicek, F., Gries, W., & Kucera, J. 1985. Canopy transpiration and water fluxes in the xylem of the trunk of *Larix* and *Picea* trees – A comparison of xylem flow, porometer and cuvette measurements. *Oecologia* **66**: 475–483.
- Schulze, E.-D., Caldwell, M.M., Canadell, J., Mooney, H.A., Jackson, R.B., Parson, D., Scholes, R., Sala, O.E., & Trimbom, P. 1988. Downward flux of water through roots (i.e. inverse hydraulic lift) in dry Kalahari sands. *Oecologia* **115**: 460–462.
- Schulze, E.D., Caldwell, M.M., Canadell, J., Mooney, H.A., Jackson, R.B., Parson, D., Scholes, R., Sala, O.E., & Trimbom, P. 1998. Downward flux of water through roots (i.e. inverse hydraulic lift) in dry Kalahari sands. *Oecologia* **115**: 460–462.
- Schuur, E.A.G. 2003. Productivity and global climate revisited: The sensitivity of tropical forest growth to precipitation. *Ecology* **84**: 1165–1170.
- Schurr, U., Gollan, T., & Schulze, E.-D. 1992. Stomatal response to drying soil in relation to changes in the xylem sap composition of *Helianthus annuus*. II. Stomatal sensitivity to abscisic acid imported from the xylem sap. *Plant Cell Environ.* **15**: 561–567.
- Schwartz, A., Gilboa, S., & Koller, D. 1987. Photonastic control of leaflet orientation in *Melilotus indicus* (Fabaceae). *Plant Physiol.* **84**: 318–323.
- Shah, N., Smirnov, N., & Stewart, G.R. 1987. Photosynthesis and stomatal characteristics of *Striga hermonthica* in relation to its parasitic habit. *Physiol. Plant.* **69**: 699–703.
- Sheveleva, E., Chmara, W., Bohnert, H.J., & Jensen, R.G. 1997. Increased salt and drought tolerance by D-ononitol production in transgenic *Nicotiana tabacum* L. *Plant Physiol.* **115**: 1211–1219.
- Sherwin, H.W. & Farrant, H.W. 1996. Differences in rehydration of three desiccation-tolerant angiosperm species. *Ann. Bot.* **78**: 703–710.
- Sherwin, H.W. & Farrant, H.W. 1998. Protection mechanisms against excess light in the resurrection plants *Craterostigma wilmsii* and *Xerophyta viscosa*. *Plant Growth Regul.* **24**: 203–210.
- Sherwin, H.W., Pammenter, N.W., February, E., Vander Willigen, C., & Farrant, J.M. 1998. Xylem hydraulic characteristics, water relations and wood anatomy of the resurrection plant *Myrothamnus flabellifolius* Welw. *Ann. Bot.* **81**: 567–575.
- Shen, B., Jensen, R.G., & Bohnert, H.J. 1997a. Increased resistance to oxidative stress in transgenic plants by targeting mannitol biosynthesis to chloroplasts. *Plant Physiol.* **113**: 1177–1183.
- Shen, B., Jensen, R.G., & Bohnert, H.J. 1997b. Mannitol protects against oxidation by hydroxyl radicals. *Plant Physiol.* **115**: 527–532.
- Shinozaki, K. & Yamaguchi-Shinozaki, K. 1997. Gene expression and signal transduction in water-stress response. *Plant Physiol.* **115**: 327–334.

- Shinozaki, K. & Yamaguchi-Shinozaki, K. 2000. Molecular responses to dehydration and low temperature: Differences and cross-talk between two stress signaling pathways. *Curr. Opin. Plant Biol.* **3**: 217–223.
- Shinozaki, K., Yamaguchi-Shinozaki, K. & Seki, M. 2003. Regulatory network of gene expression in the drought and cold stress responses. *Curr. Opin. Plant Biol.* **6**: 410–417.
- Shimazaki, K.-I., Doi, M., Assmann, S.M., & Kinoshita, T. 2007. Light regulation of stomatal movement. *Annu. Rev. Plant Biol.* **58**: 219–247.
- Smirnoff, N. & Cumbes, Q.J. 1989. Hydroxyl radical scavenging activity of compatible solutes. *Phytochemistry* **28**: 1057–1060.
- Smith, D.M. & Allen, S.J. 1996. Measurement of sap flow in plant stems. *J. Exp. Bot.* **47**: 1833–1844.
- Sobrado, M.A. & Medina, E. 1980. General morphology, anatomical structure, and nutrient content of sclerophyllous leaves of the “bana” vegetation of amazonas. *Oecologia* **45**: 341–345.
- Sowell, J.B., McNulty, S.P., & Schilling, B.K. 1996. The role of stem recharge in reducing the winter desiccation of *Picea engelmannii* (Pinaceae) needles at alpine timberline. *Am. J. Bot.* **83**: 1351–1355.
- Sperry, J.S. 1995. Limitations on stem water transport and their consequences. In: Plant stems. Physiology and functional morphology, B.L. Gartner (ed.). Academic Press, San Diego, pp. 105–124.
- Sperry, J.S. & Sullivan, J.E. 1992. Xylem embolism in response to freeze-thaw cycles and water stress in ring-porous, diffuse-porous, and conifer species. *Plant Physiol.* **100**: 605–613.
- Sperry, J.S., Saliendra, N.Z., Pockman, W.T., Cochard, H., Cuizat, P., Davis, S.D., Ewers, F.W., & Tyree, M.T. 1996. New evidence for large negative xylem pressures and their measurement by the pressure chamber technique. *Plant Cell Environ.* **19**: 427–436.
- Sprenger, N., Bortlik, K., Brandt, A., Boller, T., & Wiemken, A. 1995. Purification, cloning, and functional expression of scucrose:fructan 6-fructosyltransferase, a key enzyme of fructan synthesis in barley. *Proc. Natl. Acad. Sci. USA* **92**: 11652–11656.
- Sternberg, L., Pinzon, M.C., Anderson, W.T., & Jahren, A. H. 2006. Variation in oxygen isotope fractionation during cellulose synthesis: Intramolecular and biosynthetic effects. *Plant Cell Environ.* **29**: 1881–1889.
- Stedle, E. 1995. Trees under tension. *Nature* **378**: 663–664.
- Stedle, E. 2001. The cohesion-tension mechanism and the acquisition of water in plant roots. *Annu. Rev. Plant Physiol. Plant Mol. Biol.* **52**: 847–875.
- Stirzaker, R.J. & Passioura, J.B. 1996. The water relations of the root–soil interface. *Plant Cell Environ.* **19**: 201–208.
- Stirzaker, R.J., Passioura, J.B., & Wilms, Y. 1996. Soil structure and plant growth: Impact of bulk density and biopores. *Plant Soil* **185**: 151–162.
- Swanson, R.H. & Whitfield, D.A.W. 1981. A numerical analysis of heat pulse velocity theory. *J. Exp. Bot.* **32**: 221–239.
- Takahashi, H. 1994. Hydrotropism and its interaction with gravitropism in roots. *Plant Soil* **165**: 301–308.
- Takahashi, H. & Scott, T.K. 1993. Intensity of hydrostimulation for the induction of root hydrotropism and its sensing by the root cap. *Plant Cell Environ.* **16**: 99–103.
- Tardieu, F., Zhang, J., Katerji, N., Bethenod, O., Palmer, S., & Davies, W.J. 1992. Xylem ABA controls the stomatal conductance of field-grown maize subjected to soil compaction or soil drying. *Plant Cell Environ.* **15**: 193–197.
- Tardieu, F., Lafarge, T., & Simonneau, T. 1996. Stomatal control by fed or endogenous xylem ABA in sunflower: Interpretation of correlations between leaf water potential and stomatal conductance in anisohydric species. *Plant Cell Environ.* **19**: 75–84.
- Thomashow, M.F. 1999. Plant cold acclimation: Freezing tolerance genes and regulatory mechanisms. *Annu. Rev. Plant Physiol. Plant Mol. Biol.* **50**: 571–599.
- Thorburn, P.J. & Ehleringer, J.R. 1995. Root water uptake of field-growing plants indicated by measurements of natural-abundance deuterium. *Plant Soil* **177**: 225–233.
- Tomos, A.D. & Leigh, R.A. 1999. The pressure probe: A versatile tool in plant cell physiology. *Annu. Rev. Plant Physiol. Plant Mol. Biol.* **50**: 447–472.
- Tournaire-Roux, C., Sutka, M., Javot, H., Gout, E., Gerbeau, P., Luu, D.-T., Bligny, R., & Maurel, C. 2003. Cytosolic pH regulates root water transport during anoxic stress through gating of aquaporins. *Nature* **425**: 393–397.
- Tranquillini, W. 1982. Frost-drought and its ecological significance. In: Encyclopedia of plant physiology, N.S. Vol 12B, O.L. Lange, P.S. Nobel, C.B. Osmond, & H. Ziegler (eds.). Springer-Verlag, Berlin, pp. 379–400.
- Tsuda, S., Mmiyamoto, N., Takahashi, H., Ishihara, K., & Hirasawa, T. 2003. Roots of *Pisum sativum* L. exhibit hydrotropism in response to a water potential gradient in vermiculite. *Ann. Bot.* **92**: 767–770.
- Tüffers, A.V., Martin, C.E., & Von Willert, D.J. 1996. Possible water movement from older to younger leaves and photosynthesis during drought stress in two succulent species from South Africa, *Delosperma tradescantioides* Bgr. and *Prenia sladeniana* L. Bol. (Mesembryanthemaceae). *J. Plant Physiol.* **146**: 177–182.
- Turrel, F.M. 1936. The area of the internal exposed surface of dicotyledon leaves. *Am. J. Bot.* **23**: 255–264.
- Tyerman, S.D., Niemietz, C.M., & Bramley, H. 2002. Plant aquaporins: Multifunctional water and solute channels with expanding roles. *Plant Cell Environ.* **25**: 173–194.
- Tyree, M.T. & Sperry, J.S. 1989. Vulnerability of xylem to cavitation and embolism. *Annu. Rev. Plant Physiol. Mol. Biol.* **40**: 19–38.
- Tyree, M.T., Salleo, S., Nardini, A., Lo Gullo, M.A., & Mosca, R. 1999. Refilling of embolized vessels in young stems of laurel. Do we need a new paradigm. *Plant Physiol.* **120**: 11–21.
- Uhlein, N. & Kaldenhoff, R. 2008. Aquaporins and plant leaf movements. *Ann. Bot.* **101**: 1–4.
- Van Hylckama, T.E.A. 1974. Water use by salt cedar as measured by the water budget method. U.S. geological survey papers, 491-E.

- Van Ieperen, W. 2007. Ion-mediated changes of xylem hydraulic resistance in *planta*: Fact or fiction? *Trends Plant Sci.* **12**: 137–142.
- Vijn, I., Van Dijken, A., Sprenger, N., Van Dun, K., Weisbeek, P., Wiemken, A., & Smeeckens, S. 1997. Fructan of the inulin neoseris is synthesized in transgenic chicory plants (*Cichorium intybus* L.) harbouring onion (*Allium cepa* L.) fructan-fructan 6G-fructosyltransferase. *Plant J.* **11**: 387–398.
- Vogelmann, T.C. 1984. Site of light perception and motor cells in a sun-tracking lupine (*Lupinus succulentus*). *Physiol. Plant.* **62**: 335–340.
- Vogt, K.A., Vogt, D.A., Palmiotto, P.A., Boon, P., O'Hara, J., & Asbjornson, H. 1996. Review of root dynamics in forest ecosystems grouped by climate, climatic forest type and species. *Plant Soil* **187**: 159–219.
- Wang, X.-L., Canny, M.J., & McCully, M.E. 1991. The water status of the roots of soil-grown maize in relation to the maturity of their xylem. *Physiol. Plant.* **82**: 157–162.
- Wei, C., Steudle, E., & Tyree, M.Y. 1999. Water ascent in plants: Do ongoing controversies have a sound basis? *Trend Plant Sci.* **4**: 372–375.
- White D.A., Turner N.C., & Galbraith J.H. 2000. Leaf water relations and stomatal behaviour of four allopatric *Eucalyptus* species planted in Mediterranean southwestern Australia. *Tree Physiol.* **20**: 1157–1165.
- Wilkinson, S. & Davies, W.J. 1997. Xylem sap pH increase: A drought signal received at the apoplastic face of the guard cell that involves the suppression of a saturable abscisic acid uptake by the epidermal symplast. *Plant Physiol.* **113**: 559–573.
- Wilkinson, S., Corlett, J.E., Oger, L., & Davies, W.J. 1998. Effects of xylem pH on transpiration from wild-type and *flacca* tomato leaves. *Plant Physiol.* **117**: 703–709.
- Wisniewski, M., Davis, G., & Arora, R. 1991. Effect of macerage, oxalic acid, and EGTA on deep supercooling and pit membrane structure of xylem parenchyma of peach. *Plant Physiol.* **96**: 1354–1359.
- Wullschleger, S.D., Meinzer, F.C., & Vertessy, R.A. 1998. A review of whole-plant water use studies in trees. *Tree Physiol.* **18**: 499–512.
- Xiong, L., Schumaker, K.S., & Zhu, J.-K. 2002. Cell signaling during cold, drought, and salt stress. *Plant Cell* **14**: S165–S183.
- Yamaguchi-Shinozaki, K. & Shinozaki, K. 2006. Transcriptional regulatory networks in cellular responses and tolerance to dehydration and cold stresses. *Annu. Rev. Plant Biol.* **57**: 781–803.
- Yang, S. & Tyree, M.T. 1992. A theoretical model of hydraulic conductivity recovery from embolism with comparison to experimental data on *Acer saccharum*. *Plant Cell Environ.* **15**: 633–643.
- Yoder, C.K. & Nowak, R.S. 1999. Hydraulic lift among native plant species in the Mojave Desert. *Plant Soil* **215**: 93–102.
- Yu, M., Xie, Y., Zhang, X. 2005. Quantification of intrinsic water use efficiency along a moisture gradient in north-eastern China. *J. Environ. Qual.* **34**: 1311–1318.
- Zeier, J., Goll, A., Yokoyama, M., Karahara, I., & Schreiber, L. 1999. Structure and chemical composition of endodermal and rhizodermal/hypodermal walls of several species. *Plant Cell Environ.* **22**: 271–279.
- Zhang, W.-H. & Tyerman, S.D. 1999. Inhibition of water channels by HgCl₂ in intact wheat root cells. *Plant Physiol.* **120**: 849–857.
- Zhu, J.-K. 2002. Salt and drought stress signal transduction in plants. *Annu. Rev. Plant Biol.* **53**: 247–273.
- Zimmermann, M.H. 1983. Xylem structure and the ascent of sap. Springer-Verlag, Berlin.
- Zimmermann, M.H. & Milburn, J.A. 1982. Transport and storage of water. In: Encyclopedia of plant physiology, N.S. Vol. 12B, O.L. Lange, P.S. Nobel, C.B. Osmond, & H. Ziegler (eds.). Springer-Verlag, Berlin, pp. 135–151.
- Zwieniecki, M.A. & Holbrook, N. M. 1998. Diurnal variation in xylem hydraulic conductivity in white ash (*Fraxinus americana* L.), red maple (*Acer rubrum* L.) and red spruce (*Picea rubens* Sarg.). *Plant Cell Environ.* **21**: 1173–1180.
- Zwieniecki, M.A. & Newton, M. 1995. Roots growing in rock fissures: Their morphological adaptation. *Plant Soil* **172**: 181–187.

4

Leaf Energy Budgets: Effects of Radiation and Temperature

4A. The Plant's Energy Balance

1. Introduction

Temperature is a major environmental factor that determines plant distribution. Temperature affects virtually all plant processes, ranging from enzymatically catalyzed reactions and membrane transport to physical processes such as transpiration and the volatilization of specific compounds. Species differ in the activation energy of particular reactions and, consequently, in the temperature responses of most physiological process (e.g., photosynthesis, respiration, biosynthesis). Given the pivotal role of temperature in the ecophysiology of plants, it is critical to understand the factors that determine plant temperature. Air temperature in the habitat provides a gross approximation of plant temperature. Air temperature in a plant's **microclimate**, however, may differ substantially from air temperature measured by standard meteorological methods. The actual temperature of a plant organ often deviates substantially from that of the surrounding air. We can only understand the temperature regime of plants and, therefore, the physiological responses of plants to their thermal environment through study of microclimate and the plant's energy balance.

2. Energy Inputs and Outputs

2.1 Short Overview of a Leaf's Energy Balance

Most leaves effectively absorb the **short-wave radiation** (SR) emitted by the sun. A relatively small

fraction of incident solar radiation is **reflected, transmitted**, or utilized for processes other than just heating. In bright sunlight, the net absorption of solar radiation (SR_{net}) is the main energy input to a leaf. If such a leaf had no means to dissipate this energy, then its temperature would reach 100°C in less than 1 minute. Thus, processes that govern heat loss by a plant are critical for maintaining a suitable temperature for physiological functioning.

Heat loss occurs by several processes (Fig. 1). A leaf emits long-wave infrared radiation (LR). At the same time, however, it absorbs LR emitted by surrounding objects and the sky. The net effect of **emission and absorption** (LR_{net}) may be negative or positive, depending on whether it constitutes an export or import of energy, respectively. When there is a temperature difference between leaf and air, **convective heat transfer** (C) takes place in the direction of the temperature gradient. Another major component of the energy balance is cooling caused by **transpiration** (λE ; where λ is the energy required per unit evaporation and E is the rate of evaporation). This is called transpiration when it concerns the surface of a living plant). In addition, **metabolic processes** are involved in the energy balance. Respiration and other metabolic processes (M) generate heat, and energy is consumed when absorbed SR is used in photosynthesis (A), but this is typically small compared with other components of the energy balance, and usually ignored. When the temperature rises in response to sunlight, most components of the energy balance that contribute to cooling increase in magnitude until energy gain and

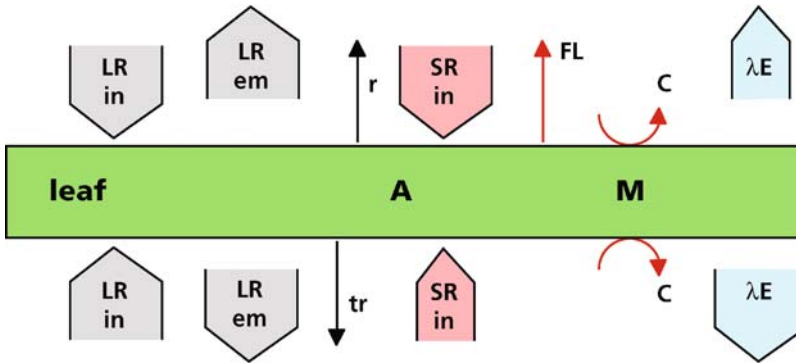

FIGURE 1. Schematic representation of the components of the energy balance of a leaf consisting of short-wave radiation (SR), long-wave radiation (LR), both incident (in) and emitted (em), convective heat transfer (C), and evaporative heat loss (λE). Reflection (r), transmission

(tr), and fluorescent emission (FL) are only given for SR incident on the upper side of the leaf. A and M are CO_2 assimilation and heat-producing metabolic processes, respectively.

loss are in balance. At this point, the leaf has reached an equilibrium temperature (steady state), and the sum of all components of the energy balance must equal zero:

$$\text{SR}_{\text{net}} + \text{LR}_{\text{net}} + C + \lambda E + M = 0 \quad (1)$$

Any change in the components of the energy balance will alter leaf temperature. For a correct description of the time course of change, a **heat storage** term must be included; however, storage capacity is low in most leaves, and response times of leaf temperature to changing conditions are typically minutes or less. Exceptions are more bulky plant parts such as succulent leaves, stems (particularly the watery stems of cacti), and tree trunks and branches, but these are not dealt with here.

2.2 Short-Wave Solar Radiation

Absorption of solar radiation normally dominates the input side of the energy balance of sunlit leaves during the light. About 98% of the radiation emitted by the sun is in the range of 300–3000 nm (short-wave radiation, SR). Ultraviolet radiation (UV; 300–400 nm) has the highest energy content per quantum (shortest wavelength); it constitutes approximately 7% of solar radiation and is potentially damaging to a plant (Sect. 2.2 of Chapter 4B on effects of radiation and temperature). Plants absorb about 97% of incoming UV radiation (Fig. 2). About half of the energy content of solar radiation is in the waveband of 400–700 nm (photosynthetically active radiation, PAR), which can be used to drive photochemical processes (SR_A); most green leaves absorb

around 85% of the incident radiation in this region, depending on the chlorophyll concentration (Fig. 2). Short-wave (solar) infrared radiation (IR_s ; 700–3000 nm) is absorbed to a much lesser extent. This wavelength region can be divided into two parts: 700 to about 1200 nm, which is largely **reflected** or **transmitted** by a leaf and represents the largest part of IR_s in terms of energy content, and 1200–3000 nm, which is largely absorbed by water in the leaf (Fig. 2). The result is that about 50% of IR_s is absorbed.

Leaves have mechanisms that can modify the magnitude of the components that make up the amount of absorbed solar radiation (SR_{abs}): **incident** (SR_{in}), **reflected** (SR_r), and **transmitted** (SR_{tr}) **radiation**. Changes in SR_{in} can be brought about by changes in leaf orientation with respect to the sun (**heliotropisms** or **solar tracking**) (Sect. 5.4.6 of Chapter 3 on plant water relations; Jurik et al. 1990). These leaf movements can be active and may orient the leaf perpendicularly to the incident radiation (**diaheliotropism**), thus maximizing SR_{in} under conditions of low temperature and adequate soil moisture (Fig. 3). A most dramatic example of heliotropic movements is found in flowers of many arctic and alpine plants [e.g., *Dryas octopetala* (mountain avens) and *Ranunculus adoneus* (snow buttercup)] that move diurnally to continually face the sun, thus maximizing radiation gain. The parabolic shape of these heliotropic flowers reflects radiation toward the ovary. Thus, the shape and orientation of flowers maximize rate of ovule development and attract pollinators (Sect. 3.3.5 of Chapter 8 on life cycles; Kjellberg et al. 1982). Floral heliotropic movements are mainly restricted to Asteraceae,

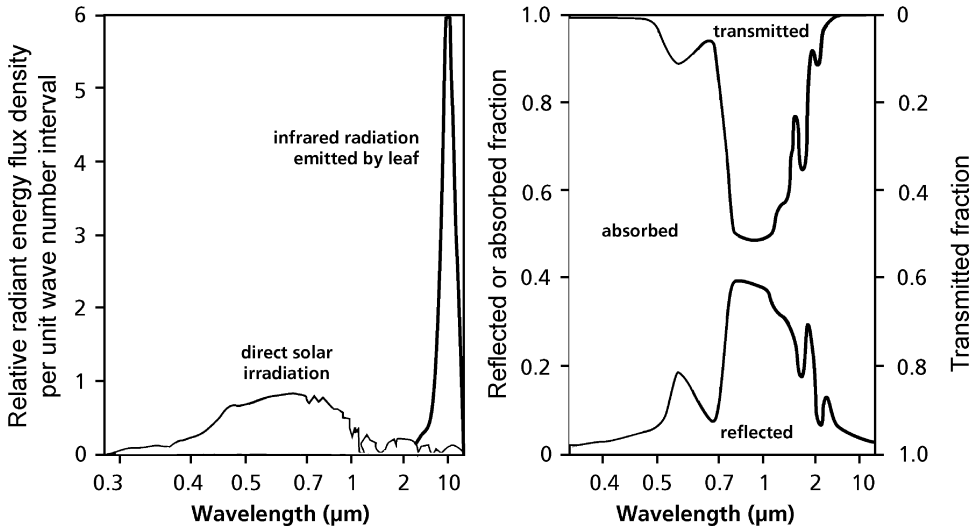

FIGURE 2. (Left) Wavelength spectrum of skylight (60 W m^{-2}), direct solar irradiance (840 W m^{-2}), and infrared radiation emitted by a leaf (900 W m^{-2}) at 25°C . (Right)

Wavelength spectrum of absorbed, transmitted, and reflected irradiance (% of total) by a leaf.

Papaveraceae, Ranunculaceae, and Rosaceae. The mechanism is similar to the more widely studied phenomenon of seedling **phototropism** (Sect. 2.2.2 of Chapter 7 on growth and allocation), rather than the more common heliotropic leaf movements (Sect. 5.4.6 of Chapter 3 on plant water relations; Sherry & Galen 1998). Another example of a mechanism that increases temperature of a specific part of a plant is

that of *copiapoa* species (barrel cactus) that increase SR_{in} by leaning toward the north in Chile (Ehleringer et al. 1980). The effect of this orientation is that tissue temperatures of the meristematic and floral regions on the tip of the cactus receive high solar radiation loads, which result in high temperatures ($30\text{--}40^\circ\text{C}$) relative to air temperatures ($15\text{--}20^\circ\text{C}$) during winter and spring months when adequate soil moisture for growth is available. Second, absorption of solar radiation by the sides of the cactus is minimized which reduces the potential detrimental effects of light and heat load on the cactus, and probably balances daily quanta absorbed for photosynthesis with nighttime CO_2 uptake rates during drought stress periods.

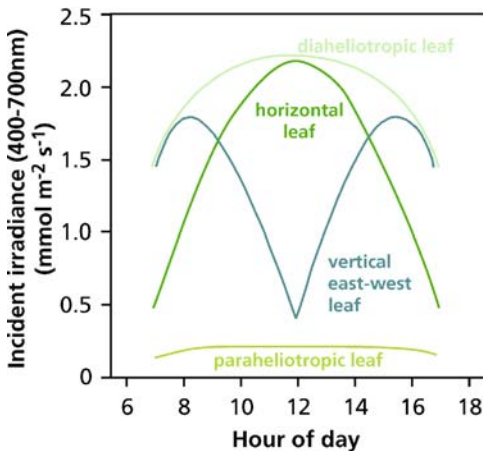

FIGURE 3. Photosynthetically active radiation incident on four leaf types over the course of a midsummer day: a horizontal leaf, a diaheliotropic leaf (cosine of incidence = 1.0), a vertical east-west-facing leaf, and a paraheliotropic leaf (cosine of incidence = 0.1) (modified after Ehleringer & Forseth 1980).

When exposed to high temperature and water deficit, leaves may become **paraheliotropic** (i.e., the leaf orientation is parallel to the incident radiation), thus minimizing SR_{in} (Fig. 3; Kao & Forseth 1992). Many desert shrubs exhibit steep leaf angles relative to the sun (Smith et al. 1998). This reduces midday SR_{in} when temperatures are warmest, and increases SR_{in} in the mornings and afternoons, when irradiance is less and temperatures are cooler. Angles can become progressively more horizontal in wetter communities which increases SR_{in} at midday (Ehleringer 1988). This regulation of leaf angle keeps leaf temperatures within limits, thereby reducing transpiration and photoinhibition and maximizing the rate of CO_2 assimilation (Gamon & Pearcy 1989). In three wild *glycine* (soybean) species, paraheliotropic leaf movements respond in concert with

photosynthetic characteristics such that **water-use efficiency** is enhanced and the risk of **photoinhibition** under water deficit is reduced (Kao & Tsai 1998). Wilting and leaf rolling are additional mechanisms by which leaves reduce incident radiation under conditions of water stress.

The **reflection** component of incident radiation (SR_r) is typically small (approximately 5–10%; Fig. 2) and comprises reflection from the surface which is largely independent of wavelength, and internal reflection, which is wavelength-specific because of absorption by pigments along the internal pathway (Sect. 2.1.1 of Chapter 2A on photosynthesis). In some plants, surface reflection can be high due to the presence of reflecting **wax** layers, short **white hairs**, or **salt crystals**. Reflection can change seasonally as in the desert shrub *Encelia farinosa* (brittlebush) that produces new leaves during winter with sparse hairs resulting in 80% absorption of incident radiation raising leaf temperature several degrees above ambient temperature (Fig. 4). Leaves produced in summer, however, when water is scarce, have dense reflective hairs that reduce absorptance to 30–40% of incident radiation, and reduce leaf temperature below ambient temperature. The sympatric *Encelia californica* (bush sunflower) from cooler and more humid coastal habitats has glabrous leaves that increase absorptance and raises leaf temperature by 5–10°C (Fig. 2 in Chapter 2A on photosynthesis). The variation in leaf hair formation throughout the year might be controlled by photoperiod and gibberellins, as it is in *Arabidopsis thaliana* (thale cress) (Chien & Sussex 1996). Because *Encelia farinosa* (brittlebush) has an optimum temperature for photosynthesis that is below summer daytime temperature, this reduction in absorptance is critical to leaf carbon balance (Ehleringer & Björkman 1978). Presence of leaf hairs in summer increases carbon gain and reduces water loss by 20–25% through

amelioration of leaf temperature (Fig. 4). A white layer of salt excreted by salt glands on the leaves of *Atriplex hymenelytra* (desert holly) (Sect. 3.4.3. of Chapter 6 on mineral nutrition), similarly, reduces the absorptance and leaf temperature; it enhances CO_2 assimilation and water-use efficiency because of a more favorable leaf temperature for photosynthesis (Mooney et al. 1977).

The components of solar radiation relevant for the energy balance of a leaf are summarized below.

- SR** Short-wave (solar) radiation (300–3000 nm)
 SR_{in} incident radiation (UV + PAR + IR_s)
 UV ultraviolet (300–400 nm)
 PAR photosynthetically active radiation (400–700 nm)
 IR_s short-wave infrared radiation (700–3000 nm)

$$SR_{in} = PAR + IR_s + UV$$

$$SR_r \quad \text{reflected} \quad (2)$$

$$SR_{tr} \quad \text{transmitted}$$

$$SR_{abs} \quad \text{absorbed}$$

$$SR_{abs} = SR_{in} - SR_r - SR_{tr}$$

$$SR_A \quad \text{used in photosynthesis} \quad (3)$$

$$SR_{FL} \quad \text{emitted as fluorescence}$$

$$SR_{net} = SR_{abs} - SR_A - SR_{FL} \quad (4)$$

Typical values of the energy balance of leaves are given in Fig. 5 (and more in Figs. 8 and 10, in Sect. 2.4).

A few percent of SR_{abs} is emitted as fluorescence (SR_{FL}) (Box 2A.4) and the same is true for the part of SR_{abs} used in photosynthesis (SR_A) in high-light conditions. For the sake of simplicity, SR_A and SR_{FL} are generally ignored in energy-balance calculations; however, this may represent a significant

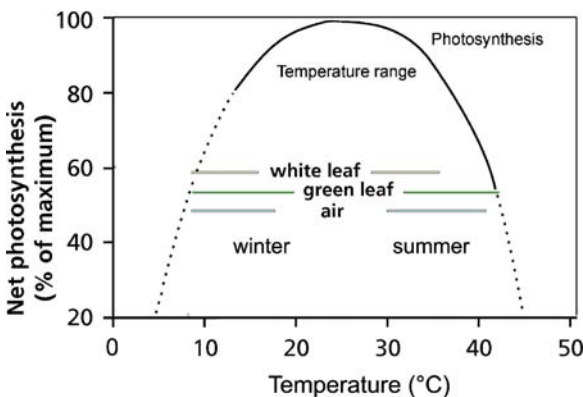
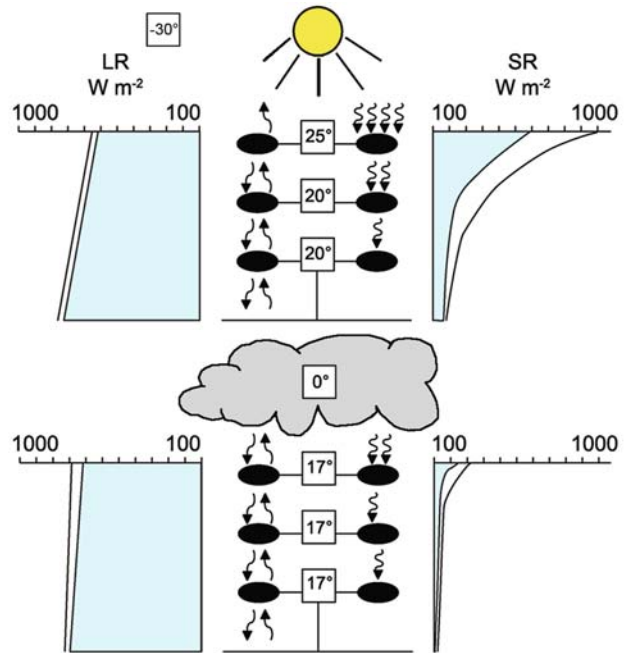

FIGURE 4. Daily ranges of air temperatures and leaf temperatures of glabrous green winter leaves and pubescent white summer leaves of *Encelia farinosa* (brittlebush). Temperature ranges were measured on a typical winter day for winter leaves and on a summer day for summer leaves; calculated values are shown for the reciprocal conditions. The temperature dependence of photosynthesis is identical in winter and summer (Ehleringer & Mooney 1978).

FIGURE 5. Schematic representation of the long-wave radiation (LR) and short-wave radiation (SR) inputs and outputs for a sunny (left) and cloudy (right) day. Graphs show the vertical profile of incident radiation (solid line) and net radiation (blue). The lower three are leaf temperatures and the upper is the effective sky radiation temperature. Assumed is a global incident irradiance of 833 W m^{-2} , reflectance by the surroundings of 20%, leaf absorbance of 0.6, photosynthetic rate of $8 \mu\text{mol m}^{-2} \text{ s}^{-1}$ at the top of the canopy on a sunny day, leaf temperature of 25°C (top), 20°C (middle and bottom) on a sunny day, and of 17°C on a cloudy day. Total incoming radiation (SR_{in}) exceeds the global irradiance due to reflectance from surrounding leaves and twigs. Abbreviations as defined in text.



Component	Cloudless day			Cloudy day		
	Top	Middle	Bottom	Top	Middle	Bottom
SR_{in}	1000	200	40	200	80	10
SR_{abs}	600	100	20	100	40	5
SR_{A}	7	2	0.4	2	0.8	0.1
SR_{net}	593	198	19.6	98	39.2	4.9
LR_{in}	650	750	833	792	800	802
LR_{abs}	624	720	800	760	768	770
LR_{em}	859	800	800	770	770	770
LR_{net}	-235	-80	0	-10	-2	0
TR_{abs}	1224	820	820	860	808	775
TR_{net}	358	118	19.6	88	37.2	4.9

error in the case of SR_{A} under conditions that are favorable for photosynthesis or where light intensity is low.

2.3 Long-Wave Terrestrial Radiation

All objects above 0 K emit energy by radiation. Long-wave radiation (LR) is the infrared radiation that is emitted by objects at temperatures commonly occurring at the Earth’s surface of around 290 K. Its wavelength range ($>3 \mu\text{m}$) is much longer than that emitted by the sun (Fig. 1). A leaf loses heat by **emission** of LR (LR_{em}). LR_{em} is proportional to the fourth power of the absolute temperature (T) and

the **emissivity** of the leaf (ϵ). The proportionality constant (σ , Stefan–Boltzmann constant) is $5.57 \cdot 10^{-8} \text{ W m}^{-2} \text{ K}^{-4}$:

$$\text{LR}_{\text{em}} = \epsilon \cdot \sigma \cdot T^4 \tag{5}$$

For a perfect radiator (“black body”), $\epsilon = 1$; real objects have lower values. Values for ϵ range from 0 to 1, with leaves having long-wave emissivities typically between 0.94 and 0.99. The leaf’s emissivity equals 1 minus the reflection coefficient and is determined by such traits as leaf “roughness” (e.g., presence of hairs) and leaf color. Heat loss through long-wave infrared radiation is a major component of a leaf’s energy balance. This may be balanced, however, by an equally large absorption

of LR emitted by surrounding objects and the sky. The high ϵ of leaves causes almost total absorption of incident LR. LR_{abs} is low under a clear sky, which may have an effective radiation temperature around -30°C , but is high when plants grow widely spaced in dry sand or rocks that can reach temperatures of more than 70°C in full sun (Stoutjesdijk & Barkman 1987). LR_{abs} often accounts for half the total energy gain of a leaf in a canopy exposed to the sun (Fig. 5). A negative total radiation (TR) balance of a leaf can occur under a clear sky at night which causes its temperature to drop below air temperature (negative ΔT). Such conditions can also be found during daytime in leaves shaded from the sun but exposed to a blue sky, as on the north side of objects (rocks, walls, trees) at higher latitudes in the northern hemisphere (Nobel 1983, Stoutjesdijk & Barkman 1987).

The components of the long-wave radiation balance are summarized below, with values typical of a green leaf exposed to full sun at sea level on a cloudless day presented in Fig. 5 (Nobel 1983):

LR Long-wave (terrestrial) radiation ($>3 \mu\text{m}$)

LR_{in} incident radiation

LR_{r} reflected

LR_{abs} absorbed

$$LR_{\text{abs}} = LR_{\text{in}} - LR_{\text{r}} \quad (6)$$

LR_{em} emitted

$$LR_{\text{net}} = LR_{\text{abs}} - LR_{\text{em}} \quad (7)$$

TR Total radiation

$$TR_{\text{abs}} = SR_{\text{abs}} + LR_{\text{abs}} \quad (8)$$

$$TR_{\text{net}} = SR_{\text{net}} + LR_{\text{net}} \quad (9)$$

The amount of energy gained by a leaf changes dramatically through a leaf canopy, and the extent of this change depends on cloud conditions (Fig. 5). In full sun, the short-wave radiation incident on a leaf exceeds that of incoming solar short-wave radiation because of reflection from surrounding leaves and other surfaces, and the total radiation (TR) absorbed by a leaf (1224 W m^{-2} in Fig. 5.1) approaches that of the solar constant (1360 W m^{-2}) (i.e., the solar energy input above the atmosphere) (Nobel 1983). TR_{abs} declines dramatically in the absence of direct solar irradiance, whether this is due to clouds or to canopy shading. Even leaves in full sun absorb more than half their energy as long-wave radiation, and leaves in cloudy or shaded conditions receive most energy as long-wave radiation emitted by objects in their surroundings. There is a sharp decline in total net radiation gained (and therefore energy that must be dissipated) through

the canopy under both sunny and cloudy conditions (Fig. 5).

2.4 Convective Heat Transfer

Leaf temperature is further determined by **convective (sensible) heat exchange** (C), which is proportional to the temperature difference (ΔT) between leaf (T_L) and air (T_a). The contribution of C to the energy balance of the leaf is negative or positive when leaf temperature is higher or lower than air temperature, respectively, which is typically the case in the light in the sun and at night or in shaded conditions, respectively (Figs. 5, 8, and 10, but see the exception in Fig. 4). The magnitude of C depends further on the boundary layer conductance for heat transport (g_{ah}), which is proportional to the conductance for diffusion of CO_2 and H_2O (Fig. 6):

$$C = g_{\text{ah}}(T_a - T_L) \quad (10)$$

The **boundary layer** is the layer of air close to a leaf (or any other surface) whose gas concentrations (e.g., CO_2 and H_2O), temperature, and pattern of air flow are modified by the leaf (Sect. 2.2.2 of Chapter 2A on photosynthesis). As air moves across a leaf, it becomes increasingly influenced by the leaf surface, primarily by diffusion of heat and gases close to the leaf surface (conductive transfer) and by turbulent movement of air (convective transfer) at greater distance from the leaf surface (Fig. 7). Boundary layer conductance (g_{ah}) is inversely related to the **boundary layer thickness** (δ), which in turn depends on **wind speed** (u) and **leaf**

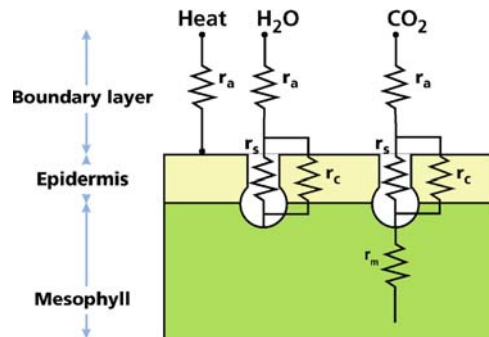

FIGURE 6. Resistances for the exchange of heat and gas between a leaf and the atmosphere. For CO_2 , apart from the cuticular resistance (r_c), three resistances play a role (mesophyll or internal, r_m , stomatal, r_s , boundary layer, r_a), whereas there are only two for H_2O and one for heat exchange. Note that conductance is the inverse of resistance, $g = 1/r$.

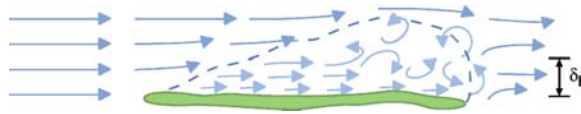

FIGURE 7. Schematic representation of the flow of non-turbulent air across a leaf. The arrows indicate the relative speed and direction of air movement. As air moves across a leaf, there is a laminar sublayer (*short straight arrows*), followed by a turbulent region. The effective

boundary layer thickness (δ_b) averages across these regions. The exchange of the lower surface of the leaf will be a mirror image of the upper surface (Nobel 1983).

dimension (d ; leaf width measured in the direction of the wind):

$$\delta = 4\sqrt{d/u} \tag{11}$$

Equation (8) shows that small leaves have higher g_{abv} and thus tends to have temperatures closer to air temperature, than do large leaves. Compound or highly dissected leaves are functionally similar to small leaves in this respect. Under hot, dry conditions, most plants have small leaves, because they cannot support high transpiration rates and must rely largely on convective cooling to dissipate absorbed short-wave and long-wave radiations. Another mechanism that reduces boundary layer thickness is the increase of effective wind speed across leaves with thin flattened petioles that cause leaves to flutter at low wind speeds, as in some *Populus* species [*Populus tremula* (European aspen) and *Populus tremuloides* (quaking aspen)].

Some plants do not “obey the rules”. *Welwitschia mirabilis* (two-leafed-cannot-die) is an African long-

lived desert plant with extremely large leaves (0.5–1.0 m wide and 1–2 m long) (Schulze et al. 1980). Those parts of the leaves not in contact with the ground, however, are only 4–6°C above air temperature. A high reflectivity of leaves (56%) minimizes SR_{abs} , and relatively cool shaded soils beneath leaves minimize LR_{in} (Fig. 8). There is negligible transpiration in summer, so it is primarily through these two mechanisms of minimizing energy gain that the plant avoids serious overheating. Parts of the leaves that touch the ground have substantially higher temperatures because heat exchange at the lower surface is hampered (Fig. 8).

It may be advantageous in cold environments to increase boundary layer thickness in order to raise leaf temperature at high irradiance. Some prostrate growth forms such as **cushion plants** in alpine habitats maximize boundary layer thickness by keeping leaves closely packed. They are also close to the ground, where they are in the boundary layer of the ground surface where temperatures are higher

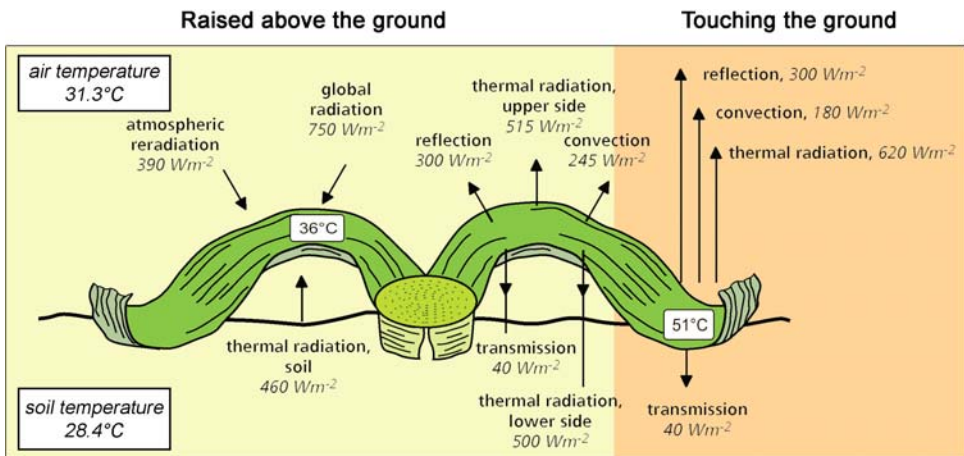

FIGURE 8. Major components of the energy balance of two parts of leaves of *Welwitschia mirabilis* (two-leafed-cannot-die) in a coastal desert area of Namibia. Leaf tips are in contact with the ground and have a higher temperature (T_l) due to reduced convective transfer (C) and

absence of emitted long-wave radiation (LR_{em}) at the underside of the leaf. The leaf parts raised above the ground that shades it have lower temperatures as a result of the increased C and LR_{net} (Schulze et al. 1980).

during daytime and wind speeds are lower. The plant's sensible heat loss is reduced, as is possibly also its transpiration. Thus, it is possible that some prostrate alpine plants uncouple their microenvironment from ambient to an extent that temperatures of 27°C, relative humidities of 99%, and calm conditions occur around leaves, while the hiker may experience 10°C, a relative humidity of 50%, and a wind speed of 4 m s⁻¹. This has been measured under clear sky conditions for *Celmisia longifolia* (snow daisy), *Verbascum thapsus* (common mullein),

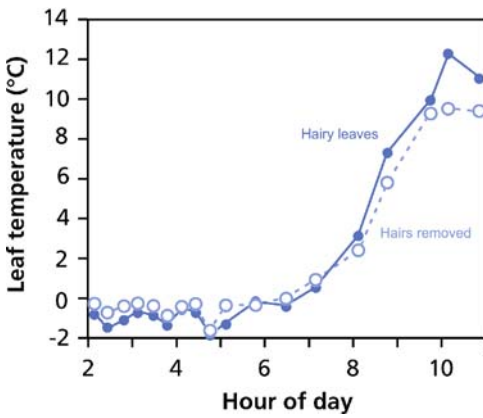

FIGURE 9. Leaf temperature of *Espeletia timotensis*, a giant rosette plant that occurs in the Venezuelan Andes at elevations up to 4500 m. Measurements were made on plants growing in their natural environment, at different times of the day, both on intact hairy leaves and on adjacent leaves of which the hairs were partly removed. Sunrise occurred around 6:45 am. The temperature of the intact leaf becomes higher than that of the shaved leaf when global radiation exceeds 300 W m⁻²; the thick leaf pubescence (up to 30 mm) increases boundary layer thickness and resistance to convective and latent heat transfer; effects of the pubescence on solar radiation absorption are minor. At night, the temperature of the intact leaves is somewhat lower than that of shaved leaves, due to reduced convective heat transfer from air to leaf (Meinzer & Goldstein 1985). Copyright Ecological Society of America.

and other rosette plants with sessile leaves (Körner 1983). The resulting higher plant temperatures are more favorable for many physiological processes. Leaf hairs are another mechanism by which plants in cold environments can increase boundary layer thickness, and, therefore, leaf temperature. Plants from high altitudes, for example, a giant Andean paramo rosette plant, *Espeletia timotensis*, have **long hairs**. These increase reflection to a minor extent, but they do reduce the boundary layer conductance considerably so that the leaf temperature becomes substantially higher than that of air when the incident radiation is high (Fig. 9). Hence, depending on their structure, leaf hairs can have different functions with respect to the energy balance. Highly reflective hairs reduce absorption, and thus T_L and nonreflective hairs reduce boundary layer conductance, and thus increase T_L .

2.5 Evaporative Energy Exchange

Heat loss associated with evaporation of water is the result of the energy demand for that process. Its contribution to the energy balance is typically negative during daytime when a leaf transpires, but it can be positive during nighttime when water condenses on the leaf. The rate of transpiration depends on leaf conductance for diffusion of water vapor (g_w) which consists of the **stomatal conductance** (g_s) and the **boundary layer conductance** (g_a) (Fig. 6) and the difference in vapor pressure between leaf and air ($\Delta w = e_i - e_a$), where e_i is determined by leaf temperature because it represents the saturated vapor pressure at the leaf temperature (Sect. 2.3 of Chapter 2A on photosynthesis). Heat loss through transpiration is the product of the rate of transpiration (E) and the latent heat of the vaporization of water (λ , 2450 J g⁻¹ at 20°C):

$$\lambda E = -\lambda g_w (e_i - e_a) \quad (12)$$

A popular but incorrect idea is that plants control their leaf temperature by regulating transpiration.

FIGURE 10. Results of energy-balance model calculations for leaves in different conditions (model provided by F. Schieving, Utrecht University, the Netherlands). The parameter values used for the calculations are shown below the figure. The difference in temperature between leaf and air (ΔT ; left Y-axis) and the components of the energy-balance long-wave radiation (LR), convective heat exchange (C), and evaporative heat

exchange (E) (right Y-axis) are plotted as a function of the leaf dimension (a, b, c), stomatal conductance (d, e), and wind speed (f) for conditions pertaining to a clear day in moist conditions (a, d, f) and in a desert environment (c), a clear night (b), and an overcast day (e). Parameter values used for the calculations are shown below, with letters in brackets referring to the calculated scenarios and the panels in the figure.

	Clear day (a, d, f)	Clear night (b)	Desert (c)	Overcast day (e)
Air temperature, °C	20	10	30	20
Soil temperature, °C	20	20	60	20
Sky temperature, °C	-20	-20	-20	20
Short-wave radiation (SR_m), $W m^{-2}$	800	0	800	100
Leaf dimension, mm	100	-	-	100
Wind speed, $m s^{-1}$	1	1	1	1
Relative humidity, %	65	100	30	80
Stomatal conductance, $mmol m^{-2} s^{-1}$	400	0	30	-

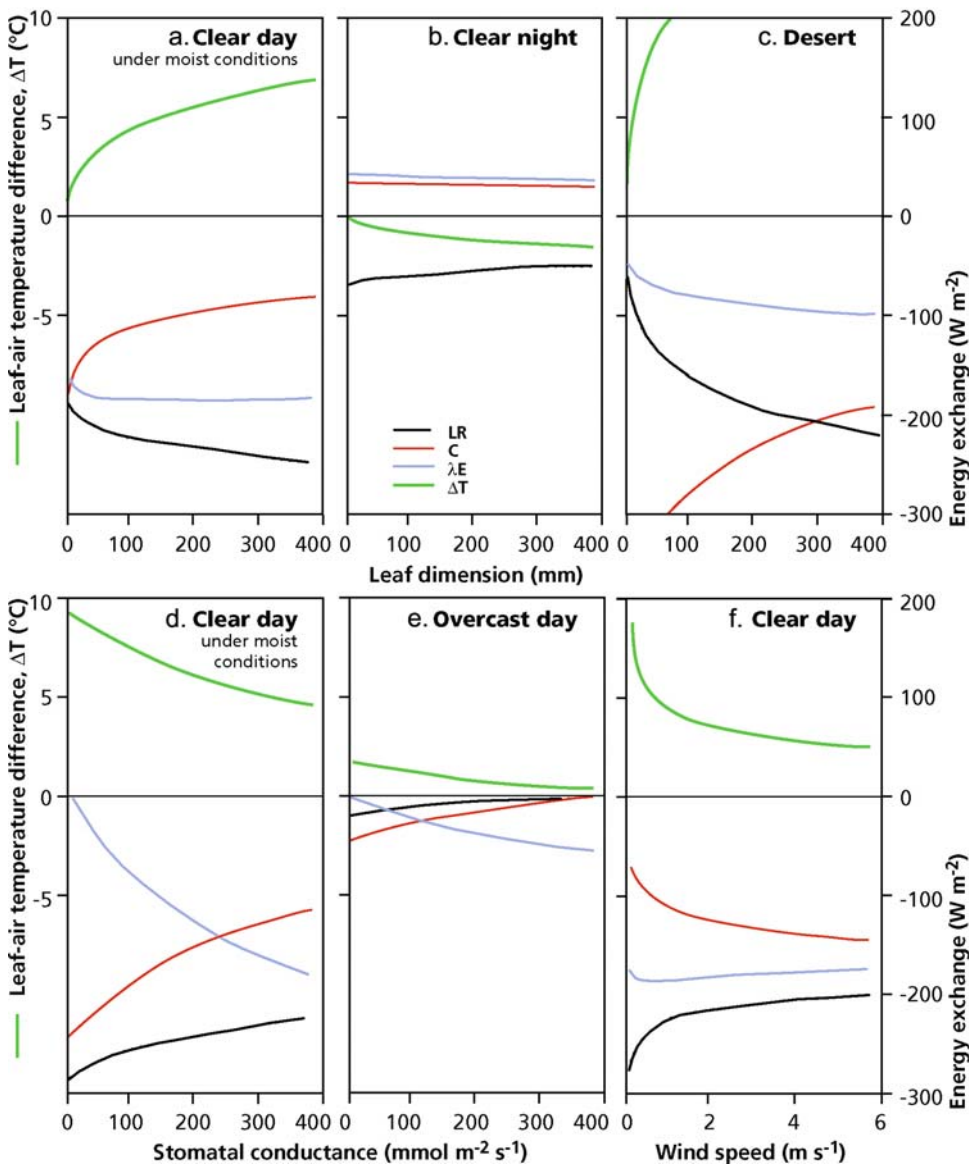

There is no evidence for such a regulatory mechanism. Leaf cooling through transpiration is only beneficial at high temperatures, but then high transpiration rates may create problems for the plant if water loss is not matched by water uptake; limited water supply often coincides with high temperatures (Chapter 3 on plant water relations). Leaf cooling by transpiration also occurs at suboptimal temperatures, because stomata are open during photosynthesis which leads to an even less favorable temperature. Hence, leaf cooling must be considered a *consequence* of transpirational water loss that is inexorably associated with the stomatal opening required to sustain photosynthesis, rather than a mechanism to control leaf temperature, as is the case for some animals.

In many situations, there is an inverse relationship between convective and evaporative heat exchange at any given irradiance. When stomatal conductance (g_s) and thus evaporative heat loss decline, leaf temperature increases, which causes an increase in convective heat exchange (by increasing the temperature gradient between leaf and air). Transpiration increases also as a consequence of the higher leaf temperature and thus leaf-to-air vapor pressure difference, but that only partly compensates for the effect of the lower g_s (Fig. 10).

A negative radiation balance of a leaf under a clear sky at night causes its temperature to drop below air temperature (negative ΔT), causing condensation of water (dew) on the leaf (positive λE); however, not all water on a leaf in early morning is dew; it may also originate from guttation (Sect. 5.2 of Chapter 3 on plant water relations). Guttation water appears as drops on leaf margins (dicots and broad-leaved monocots) or leaf tips (grasses) as opposed to dew that covers the leaf surface.

2.6 Metabolic Heat Generation

The metabolic component (M) refers to heat production in **biochemical** reactions. Its contribution in leaves is very small under most circumstances and is generally ignored in calculation of the energy balance. In some plant organs, however, the contribution of metabolism to the energy balance may be substantial. In inflorescences such as the spadix of Araceae and flowers of, e.g., Cycadaceae and Nymphaeaceae, temperatures may rise several degrees above air temperature, due to their extremely high **respiration** rates, which largely proceeds through the alternative pathway (Sect. 2.6.1 of Chapter 2B on plant respiration).

3. Modeling the Effect of Components of the Energy Balance on Leaf Temperature

The analysis of the exact contribution of the different components of the energy balance to leaf temperature is difficult when based on measurements only. The physical relationships as described earlier can be used to calculate leaf temperature from input parameters relevant for the energy balance of a leaf. By varying parameter values, the influence of a single parameter or combination of parameters on the final leaf temperature and components of the energy balance can be analyzed in a model. Although such a model uses simplifying assumptions, the outcome of the calculations appears to describe the real situation in a satisfactory manner (Campbell 1981, Campbell & Norman 1998). In Sects. 2.2 and 2.4, two examples were shown where energy-balance calculations were used (Figs. 4, 5, and 8). Here we develop a sensitivity analysis, investigating the effect of changes in one variable on the energy balance while keeping other variables constant.

Figure 10 illustrates the result of model calculations on the basis of input parameter values provided. We use realistic values for a clear day under moist conditions, an overcast day, a clear night, and a clear day in a desert. The daytime scenarios have a positive short-wave radiation input (SR_{in}). The other components contribute to the required loss of energy at a stable leaf temperature and are negative. SR_{in} is zero for the nighttime scenario. Components of the energy balance and leaf-to-air temperature difference (ΔT) are calculated in relation to leaf dimension (d), stomatal conductance (g_s), and wind speed (u) for a total of six scenarios (Fig. 10).

The calculations show that the difference in leaf–air temperature (ΔT) increases with increasing leaf width, because the boundary layer conductance decreases which results in a decrease in convective heat exchange (C) in scenarios a, b, and c. On a clear day in cool humid conditions (a), net emission of long-wave radiation (LR) increases with leaf width as a result of the increasing leaf temperature (T_L). Evaporative cooling (λE) is rather constant, because the high boundary layer conductance (g_{ah}) increases E in small leaves, whereas the higher T_L , and thus larger ($w_i - w_a$), compensates for the lower g_{ah} in larger leaves. At night, (b) leaf temperature (T_L) drops below air temperature (T_a) because of the negative total radiation balance (TR_{net}) causing condensation at the prevailing high humidity. This

makes the evaporative heat exchange (λE) positive. C is also positive as a result of the lower T_L than T_a which causes less cooling of the leaf below T_a , than would be expected on the basis of the negative radiation balance alone. In a warm, dry desert environment (c), with a sparse vegetation cover, the radiation load is increased enormously due to the high soil surface temperature. Evaporative cooling is restricted due to stomatal closure (Fig. 10). Leaf temperatures only remain within tolerable limits in small leaves that have large convective heat exchange (C). Such conditions occur in deserts as well as on sand dunes in temperate climates on a sunny day.

An increasing stomatal conductance (d) causes a decrease in leaf temperature (T_L) as a result of increasing evaporative cooling (λE) and LR and C decrease, due to the reduced T_L and ΔT , respectively. On a cloudy day (e), the increasing E with increasing g_s compensates for the small influx of short-wave radiation (SR_{in}) and reduces the leaf temperature to approximately air temperature at higher stomatal conductances (g_s). This reduces LR and C to negligible values at high g_s . Wind (f) reduces T_L , due to an increase in convective cooling (C), but transpiration is, again, hardly affected, because the increase in boundary layer conductance (g_{ah}) with increasing wind speed is offset by a decrease in leaf-to-air vapor pressure difference ($e_i - e_a$) due to the decrease in leaf temperature. The largest effects on leaf temperature are found at the lower ranges of wind speeds, which are reflected in the emission of long-wave radiation (LR_{em}).

4. A Summary of Hot and Cool Topics

We have a sound understanding of the leaf energy budget as affected by leaf traits and environment. What remains to be tested experimentally, however, is whether, indeed, larger-leaved species actually operate at warmer leaf temperatures, under field conditions. If they do, there must be costs associated with wider leaves, e.g., costs associated with tissue tolerance of higher temperatures, or higher rates of leaf respiration. If they do not operate at higher leaf temperatures, then costs of wider leaves might be incurred through avoiding radiation, e.g., by growing in shaded habitats, or having leaves with steeper angles or reflective leaf surfaces. Alternatively, there may be costs associated with greater allocation to

roots, to ensure sufficient acquisition of water to sustain higher transpiration rates. A close interaction between modeling and experimental approaches should provide answers for many of the remaining ecophysiological questions.

References

- Campbell, G.S. 1981. Fundamentals of radiation and temperature relations. In: Encyclopedia of plant physiology, Vol 12A, O.L. Lange, P.S. Nobel, C.B. Osmond, & H. Ziegler (eds.). Springer-Verlag, Berlin, pp. 11–40.
- Campbell, G.S. & Norman, J.M. 1998. An introduction to environmental biophysics. 2nd ed. Springer-Verlag, New York.
- Chien, J.C. & Sussex, I.M. 1996. Differential regulation of trichome formation on the adaxial and abaxial leaf surfaces by gibberellins and photoperiod in *Arabidopsis thaliana* (L.) Heynh. *Plant Physiol.* **111**: 1321–1328.
- Ehleringer, J.R. 1988. Changes in leaf characteristics of species along elevational gradients on the wasatch front, Utah. *Am. J. Bot.* **75**: 680–689.
- Ehleringer, J.R. & Björkman, O. 1978. Pubescence and leaf spectral characteristics in a desert shrub, *Encelia farinosa*. *Oecologia* **36**: 151–162.
- Ehleringer, J.R. & Forseth, I. 1980. Solar tracking by plants. *Science* **210**: 1094–1098.
- Ehleringer, J.R. & Mooney, H.A. 1978. Leaf hairs: Effects on physiological activity and adaptive value to a desert shrub. *Oecologia* **37**: 183–200.
- Ehleringer, J. Mooney, H.A. Gulmon, S.L., & Rundel, P. 1980. Orientation and its consequences for *Copiapoa* (Cactaceae) in the Atacama desert. *Oecologia* **46**: 63–67.
- Gamon, J.A. & Pearcy, R.W. 1989. Leaf movement, stress avoidance and photosynthesis in *Vitis californica*. *Oecologia* **79**: 475–481.
- Jurik, T.W., Zhang, H., & Pleasants, J.M. 1990. Ecophysiological consequences of non-random leaf orientation in the prairie compass plant, *Silphium laciniatum*. *Oecologia* **82**: 180–186.
- Kao, W.-Y. & Forseth, I.N. 1992. Diurnal leaf movement, chlorophyll fluorescence and carbon assimilation in soybean grown under different nitrogen and water availabilities. *Plant Cell Environ.* **15**: 703–710.
- Kao, W.-Y. & Tsai, T.-T. 1998. Tropic leaf movements, photosynthetic gas exchange, $\delta^{13}C$ and chlorophyll *a* fluorescence of three soybean species in response to water availability. *Plant Cell Environ.* **21**: 1055–1062.
- Kjellberg, B., Karlsson, S., & Kerstensson, I. 1982. Effects of heliotropic movements of flowers of *Dryas octopetala* L. on gynoecium temperature and seed development. *Oecologia* **54**: 10–13.
- Körner, C. 1983. Influence of plant physiognomie on leaf temperature on clear midsummer days in the Snowy Mountains, south-eastern Australia. *Acta Oecol.* **4**: 117–124.
- Meinzer, F. & Goldstein, G. 1985. Some consequences of leaf pubescence in the Andean giant rosette plant *Espeltia timotensis*. *Ecology* **66**: 512–520.

- Mooney, H.A., Ehleringer, J.R., & Björkman, O. 1977. The energy balance of leaves of the evergreen shrub *Atriplex hymenelytra*. *Oecologia* **29**: 301–310.
- Nobel, P.S. 1983. Biophysical plant physiology and ecology. W.H. Freeman and Co., San Francisco.
- Schulze, E.-D., Eller, B.M., Thomas, D.A., Von Willert, D.J., & Brinckmann, E. 1980. Leaf temperatures and energy balance of *Welwitschia mirabilis* in its natural habitat. *Oecologia* **44**: 258–262.
- Smith, W.K., Bell, D.T., & Shepherd, K.A. 1998. Associations between leaf structure, orientation, and sunlight exposure in five Western Australian communities. *Am. J. Bot.* **85**: 56–63.
- Stoutjesdijk, P. & Barkman, J.J. 1987. Microclimate, vegetation and fauna. Opulus Press, Upsala.
- Sherry, R.A. & Galen, C. 1998. The mechanism of floral heliotropism in the snow buttercup, *Ranunculus adoneus*. *Plant Cell Environ.* **21**: 983–993.

4B. Effects of Radiation and Temperature

1. Introduction

In Chapter 4A on the plant's energy balance, we discussed traits that reflect radiation or otherwise avoid high radiation loads in high-light environments. Many plants lack these adaptations and absorb potentially damaging levels of radiation. In this chapter, we discuss some of the negative effects of excess radiation and the physiological mechanisms by which some plants avoid damage (Sect. 2.1). Effects of ultraviolet radiation and plant mechanisms to avoid or repair damage are treated in Sect. 2.2. Finally, some effects of both high and low temperatures are addressed in Sect. 3.

2. Radiation

2.1 Effects of Excess Irradiance

Species that are adapted to shade often have a restricted capacity to acclimate to a high irradiance. Unacclimated plants have a low capacity to use the products of the light reactions for carbon fixation, and tend to be damaged by high irradiance levels, because the energy absorbed by the photosystems exceeds the energy that can be used by carbon-fixation reactions. The excess energy can give rise to the production of reactive oxygen species (ROS) (i.e., toxic, reactive oxygen-containing molecules that

rapidly lose an electron) and radicals (molecules with unpaired electrons) that break down membranes and chlorophyll (**photodamage**) (Sect. 3.3 of Chapter 2A on photosynthesis). Acclimated plants have protective mechanisms that avoid this photodamage. For example, the energy absorbed by the light-harvesting complex may be lost as heat through reactions associated with the **xanthophyll cycle**. When the cycle converts violaxanthin to zeaxanthin or antheraxanthin, nonradiative mechanisms dissipate energy by a mechanism that is not yet fully known (Sect. 3.3.1 of Chapter 2A on photosynthesis). This mechanism is induced by acidification of the thylakoid lumen that results from the formation of a proton-motive force. The strong acidification of the lumen induces an enzymatic conversion of the carotenoid violaxanthin into zeaxanthin. When both zeaxanthin is present and the thylakoid lumen is acidic, excess light energy is lost as heat by a mechanism not yet fully known. **Chlorophyll fluorescence** analysis can detect this nonphotochemical quenching of excess light energy (Box 2A.4 and Sect. 3.1 of Chapter 2A on photosynthesis).

2.2 Effects of Ultraviolet Radiation

Effects of ultraviolet (UV) radiation on plants have been studied for more than a century. The finding that the stratospheric UV-screening

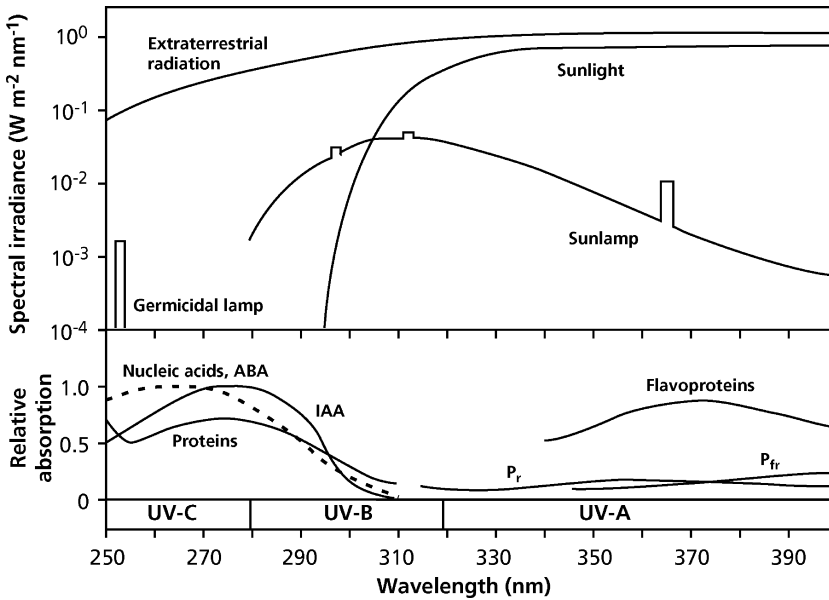

FIGURE 1. Spectral irradiance at 30 cm from common UV lamps, solar spectral irradiance before attenuation by the Earth's atmosphere (extraterrestrial), and as would be received at sea level at midday in summer at temperate latitudes. The absorption spectra of a number of plant compounds are also shown; ABA (abscisic acid)

and nucleic acids are represented by the same curve; IAA (indole acetic acid) and the two forms of phytochrome (P_r and P_{fr}) are represented by the same curve as protein. Major subdivisions of the UV spectrum are indicated at the bottom; UV-B is ultraviolet light in the region 280–320 nm (Caldwell 1981).

ozone layer has been substantially depleted due to human activities, however, has increased interest in this topic. Ozone in the Earth's atmosphere prevents all of the UV-C (< 280 nm) and most of the UV-B (280–320 nm) radiation from reaching the Earth's surface (Fig. 1). Due to differences in optical density of the atmosphere, the UV radiation reaching the Earth is least at sea level in polar regions and greatest at high altitude and low latitude (e.g., the Andes). Cloud cover greatly reduces solar UV irradiance.

2.2.1 Damage by UV

Many compounds in plant cells absorb photons in the ultraviolet region (Fig. 1); the most destructive actions of UV include effects on nucleic acids. DNA is by far the most sensitive nucleic acid. Upon absorption of UV radiation, polymers of pyrimidine bases, termed **cyclobutane-pyrimidine dimers**, are formed which leads to loss of biological activity. Although RNA and proteins also absorb UV radiation, much higher doses are required for inactivation to occur, possibly due to their higher concentration in the cell compared with DNA. ROS play a role in mediating effects of UV-B:

membranes are damaged, due to lipid peroxidation (Jansen et al. 1998).

Algae and bacteria are considerably more sensitive to UV-B radiation than are leaves of higher plants, due to less shielding of their DNA. Higher plants that are sensitive to solar UV show a reduction in photosynthetic capacity, leaf expansion, and height; they tend to have thicker leaves, which are often curled, and increased axillary branching. Although part of the reduced leaf expansion may be the result of reduced photosynthesis, it also involves direct effects on cell division (Fig. 2), with both effects leading to reductions in plant growth and productivity. There may be additional effects on plant development, e.g., on leaf epidermal cell size and leaf elongation in *Deschampsia antarctica* (Antarctic hair-grass) (Ruhland & Day 2000).

2.2.2 Protection Against UV: Repair or Prevention

Damage incurred by nucleic acids due to UV absorption can be repaired at the molecular level by splitting the **pyrimidine dimers**. Identification, followed by excision of the lesions from a DNA molecule and replacement by an undamaged patch

FIGURE 2. The damaging effect of UV on the dichlorophenol-indophenol reduction of chloroplasts isolated from *Spinacia oleracea* (spinach) (“photosynthetic inhibition”) and on DNA in microorganisms (“DNA damage”). The same data are plotted on a linear (left) and an exponential (right) scale, showing that DNA is very sensitive to UV radiation, compared with photosynthesis (Jones & Kok 1966, as cited in Caldwell 1981, and Sewtlow 1974).

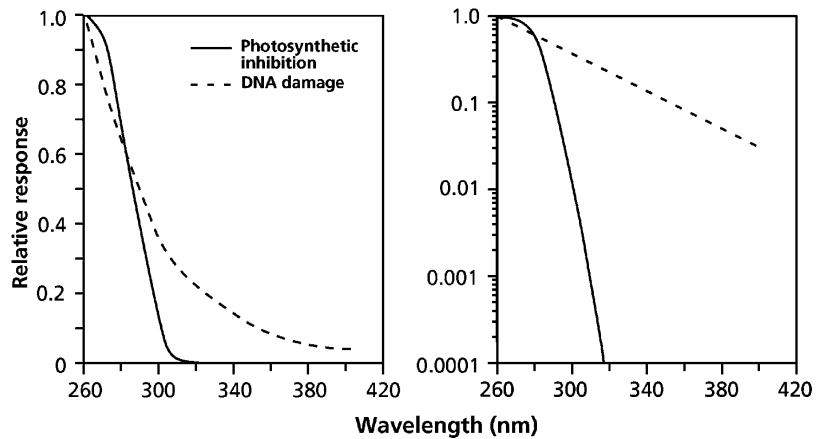

using the other strand as a template, has also been demonstrated. Genotypes of *Oryza sativa* (rice) that lack the capacity to repair damaged DNA show a high sensitivity to UV (Hidema et al. 1997). Plants have effective mechanisms to repair damage in all cells and organelles that contain DNA (Stapleton et al. 1997). Scavenging of ROS can also alleviate UV-B stress; levels of key anti-oxidants (glutathione and ascorbate) and of enzymes that detoxify ROS [e.g., superoxide dismutase (SOD) and ascorbate peroxidase] are up-regulated in response to UV-B (Jansen et al. 1998).

Plants can minimize UV exposure by having **steeply inclined leaves**, especially at lower latitudes, and by **reflecting** or **absorbing** UV in the **epidermis**. Epidermal cells may selectively absorb UV because of the presence of **phenolic compounds** (specific flavonoids) (Stapleton & Walbot 1994 Martz et al. 2007). Next to flavonoids, sinapate esters of phenolics provide some protection against UV in Brassicaceae [e.g., *Arabidopsis thaliana* (thale cress)] (Sheahan 1996). The phenolic compounds sometimes occur in leaf hairs (Karabourniotis et al. 1992, 1998). Both adaptation and acclimation to UV occur via the production of phenolic compounds (Burchard et al. 2000, Mazza et al. 2000). The most effective location for phenolics to screen UV is in the cell walls of epidermal cells, rather than in their vacuoles, where phenolics may also accumulate. The epidermis of evergreens transmits, on average, approximately 4% of the incident UV, and it does not allow penetration beyond 32 μm , as opposed to, on average, 28% and 75 μm , respectively, for leaves of deciduous plants (Day 1993). Conifer needles screen UV-B far more effectively because the absorbing compounds are located in the cell walls as well as inside their epidermal cells. The epidermis of herbaceous species is relatively ineffective at UV-B

screening because UV-B may still penetrate through the epidermal cell walls, even if their vacuoles contain large amounts of UV-absorbing phenolics (Fig. 3; Day et al. 1994).

Polyamines, waxes, and specific **alkaloids** may also contribute to UV tolerance, either because they absorb UV or because they act as scavengers of ROS (Frohnmeyer & Staiger 2003).

3. Effects of Extreme Temperatures

3.1 How Do Plants Avoid Damage by Free Radicals at Low Temperature?

Variation in growth potential at different temperatures may reflect the rate of photosynthesis per unit leaf area, as discussed in Sect. 7 of Chapter 2A on photosynthesis. A frequently observed effect of chilling is **photooxidation**, which occurs because the biophysical reactions of photosynthesis are far less temperature sensitive than are the biochemical ones. Chlorophyll continues to absorb light at low temperatures, but the energy cannot be transferred to the normal electron-accepting components with sufficient speed to avoid **photoinhibition**. One mechanism by which cold-acclimated plants avoid photooxidation is to increase the components of the **xanthophyll cycle** (Williams et al. 2003), just as observed at excess radiation (Sect. 3.3.1 of Chapter 2A on photosynthesis). This prevents the formation of **ROS**; radicals may form when oxygen is reduced to superoxide (Apel & Hirt 2004). The xanthophyll cycle is widespread among plants, however, and other mechanisms probably also protect the photosynthetic apparatus of cold-adapted species,

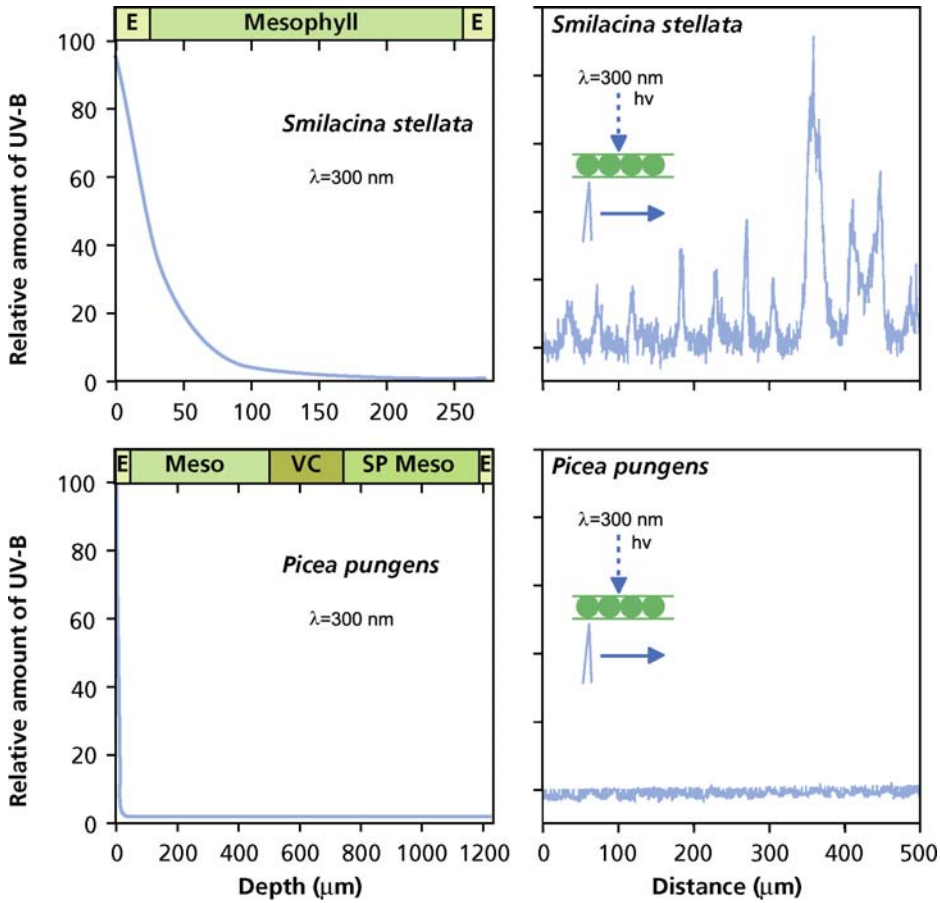

FIGURE 3. (Left) Relative amount of UV-B (300 nm) as a function of depth in intact foliage of an herbaceous species [*Smilacina stellata* (false Solomon's seal)] and a conifer [*Picea pungens* (Colorado spruce)]. Measurements were made with a fiberoptic microprobe. E, epidermis; Meso, mesophyll; VC, vascular cylinder; SP Meso, spongy mesophyll. Note that UV-B penetrates into the mesophyll of the herbaceous leaf, whereas it is quickly attenuated in the epidermis of the conifer needle. (Right) Pattern of UV-B transmission under an epidermal peel, removed from the rest of the leaf, of *Smilacina stellata* (false Solomon's seal) and *Picea*

pungens (Colorado spruce). Measurements were made by running a microscopic fiberoptic sensor along the underside of irradiated peels, parallel to the leaf axis, as illustrated by the image in the figures. UV-B penetrates (the spikes) through cell walls between cells of the epidermis in the herbaceous species, where UV-absorbing compounds are located in the vacuole. In the conifer species, minimal transmission occurs, because UV-absorbing compounds are present in the cell wall (after Day et al. 1993).

especially if low temperatures coincide with high levels of irradiance, such as at high altitude.

Once ROS are formed, they must be scavenged to avoid their damaging effect. Upon exposure to oxidative stress some ROS are produced in nonacclimated plants which induce the expression of genes coding for enzymes like chalcone synthase, which is involved in the synthesis of phenolic anti-oxidants (Henkov et al. 1996). High-alpine species contain higher concentrations of a range of **anti-oxidants**, such as ascorbic acid (vitamin C), α -tocopherol

(vitamin E), and the tripeptide glutathione. Their concentrations increase with increasing altitude (Fig. 4). The alpine site and the lowland environments from which the plants shown in Fig. 4 were collected receive a similar daily quantum input (Körner & Diemer 1987). The higher level of anti-oxidants in the high-altitude plants enables them to cope with multiple stresses, including lower, early-morning temperature, higher level of irradiance at peak times, or higher levels of UV-B. The concentrations of anti-oxidants also show a diurnal pattern,

FIGURE 4. The concentration of various antioxidants in leaves of (a) *Homogyne alpina* (alpine coltsfoot) and (b) *Soldanella pusilla* (alpine snowbell) measured in plants growing at 1000 m (Wank) and at 2000 m (Oberburgl). Note the different scales on the y-axis (after Wildi & Lütz 1996).

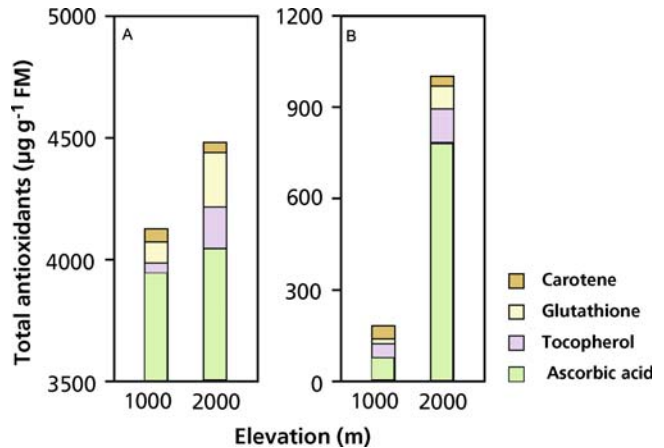

with highest values at midday and lower ones at night (Wildi & Lütz 1996). **Superoxide dismutase** (SOD) and **catalase** are major enzymes that are involved in avoiding damage by ROS. SOD catalyzes the conversion of superoxide to hydrogen peroxide (H_2O_2), and catalase converts H_2O_2 to water and oxygen.

Acclimation to low temperature in *Zea mays* (corn) is enhanced by exposure to a low soil water potential (Irigoyen et al. 1996). Both stresses enhance the level of the phytohormone ABA (Box 7.1), which is involved in acclimation to both a low soil water potential and a low temperature, although through separate signal-transduction pathways. In addition, there are ABA-independent stress-signaling pathways that “cross-talk” with the ABA-dependent pathways (Ishitani et al. 1997).

3.2 Heat-Shock Proteins

A sudden rise in temperature, close to the lethal temperature, induces the formation of mRNAs coding for **heat-shock proteins** (Parcellier et al. 2003). Some of the genes coding for heat-shock proteins are homologous with those from animals; in fact, heat-shock proteins were first discovered in *Drosophila*. Although the precise role of heat-shock proteins is not yet known, they do increase the plant’s heat tolerance. Some of these proteins are only produced after exposure to high temperatures; others are also found after exposure to other extreme environmental conditions (e.g., low temperature, water stress, high light, and drought). There is some evidence that an increase in **membrane fluidity** specifically enhances the expression of genes encoding heat-shock proteins; however, the mechanisms of the

perception of changes in membrane fluidity are unknown (Xiong et al. 2002).

Heat-shock proteins may be involved in the protection of the photosynthetic apparatus and prevent photooxidation. Other heat-shock proteins belong to the class of the **chaperones**, which also occur in plant cells that are not exposed to high temperatures, but in smaller quantities. Chaperones are involved in arranging the tertiary structure of proteins. Heat-shock proteins are formed both after a sudden increase in temperature and upon a more gradual and moderate rise in temperature, although not to the same extent. This class of proteins is, therefore, probably also involved in the tolerance of milder degrees of heat stress (Parcellier et al. 2003).

3.3 Are Isoprene and Monoterpene Emissions an Adaptation to High Temperatures?

There is increasing evidence that plants, especially some tree species and ferns, can cope with rapidly changing leaf temperatures through the production of the low-molecular-mass hydrocarbon: **isoprene** and **monoterpenes** (Peñuelas & Munné-Bosch 2005). Around Sydney in Australia, these hydrocarbons account for the haze in the Blue Mountains. Isoprene (2-methyl-1,3-butadiene) is the single most abundant biogenic, nonmethane hydrocarbon entering the atmosphere due to emission by plants in both temperate and tropical ecosystems, and the reason for these high emission rates has puzzled scientists for a long time (Sharkey & Yeh 2001). Many isoprene-emitting species lose about 15% of fixed carbon as isoprene emissions, with extreme values up to 50%. Global isoprene emissions from

plants to the atmosphere amount to $180\text{--}450 \times 10^{12}$ g carbon per year, more than any other volatile organic carbon lost from plants (Lichtenthaler 2007). There should be sufficient evolutionary pressure to eliminate this process, if it serves no function. The finding that emissions increase at high temperature and under water stress has stimulated research into a role in coping with high leaf temperatures. The change in **isoprene emission** capacity through the canopy is similar to the change in **xanthophyll cycle** intermediates, which suggests that isoprene and monoterpene emission may be the plant's protection against excess heat, just as the xanthophyll cycle protects against excess light (Loreto et al. 1998, Loreto & Velikova 2001) (Sect.3.3.1 of Chapter 2A on photosynthesis). In the presence of realistic concentrations of isoprene or monoterpenes, leaves are, indeed, protected against high-temperature damage of photosynthesis (Fig. 5; Sharkey et al. 2008).

How hot do leaves normally get? Leaf temperatures of *Quercus alba* (white oak) at the top of the canopy can increase by as much as 14°C above air temperature, and the leaf temperature may drop by 8°C within minutes (Singsaas & Sharkey 1998). Using isoprene may be an effective way of changing membrane properties rapidly enough to track leaf temperature. In plants that are not subject to such high temperatures or changes in leaf temperature, slower and less wasteful methods may be more effective.

3.4 Chilling Injury and Chilling Tolerance

Many (sub)tropical plants grow poorly at or are damaged by temperatures between 10 and 20°C . This type of damage is quite different from frost damage, which occurs at subzero temperatures, and is generally described as **chilling injury**.

Different parts of the plant may well differ in their sensitivity to low temperatures, and this sensitivity may vary with age. For example, germinating seeds and young seedlings of *Gossypium herbaceum* (Levant cotton) and *Glycine max* (soybean) are far more chilling sensitive than are mature plants. For *Oryza sativa* (rice) and *Sorghum bicolor* (millet), processes that occur in the phase just prior to flower initiation are most sensitive. Low temperatures may disturb the formation of pollen mother cells, and thus cause sterility. Ripening fruits of (sub)tropical crops are also rapidly damaged by low temperatures.

The physiological cause of low-temperature damage varies among species and plant organs. The following factors play a role:

1. Changes in membrane fluidity
2. Changes in the activity of membrane-bound enzymes and processes, such as electron transport in chloroplasts and mitochondria, and in compartmentation
3. Loss of activity of low-temperature-sensitive enzymes

Chilling resistance may involve **membrane properties**, which are affected by the composition of the membranes. Both the proteins and the lipids in the membrane may play a role. When plants are exposed to low temperatures, the desaturation of fatty acids occurs mainly from 18:2 to 18:3. **Chilling tolerance** correlates with a high proportion of *cis*-unsaturated fatty acids in the phosphatidylglycerol molecules of chloroplast membranes. Evidence for this comes from work with *Nicotiana tabacum* (tobacco) plants transformed with glycerol-3-phosphate acyltransferase from either a cold-tolerant species or a cold-sensitive one. Over-expression of the enzyme from the cold-tolerant species increases cold tolerance, whereas the tobacco plants become more sensitive to cold stress

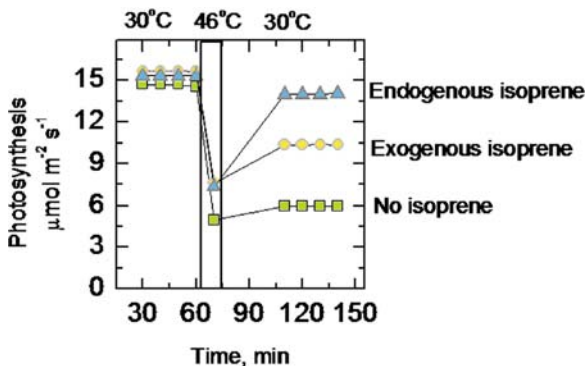

FIGURE 5. Thermoprotection of photosynthetic capacity by isoprene. Photosynthesis of detached leaves of *Pueraria lobata* (kudzu) was measured at the indicated temperatures. One leaf was fed water, and so made isoprene from endogenous sources. Two other leaves were fed $4 \mu\text{M}$ fosmidomycin, and inhibitor of the pathway leading to isoprene, and isoprene emission was monitored until $>90\%$ of the isoprene emission capacity was lost. One of these leaves was then provided with $2 \mu\text{L L}^{-1}$ isoprene in the air stream (exogenous isoprene treatment). Modified after Sharkey et al. (2008).

when over-expressing the enzyme from cold-sensitive plants. Cold sensitivity of the transgenic tobacco plants correlates with the extent of fatty acid unsaturation in phosphatidyl-glycerol which is due to different selectivities for the saturated and *cis*-unsaturated fatty acids of the enzyme from contrasting sources (Bartels & Nelson 1994, Murata & Los 1997).

The degree of saturation of the fatty acid affects the **membrane's fluidity**, as shown for mitochondria: the ratio between unsaturated and saturated fatty acids is about 2 for chilling-sensitive species and about 4 for resistant species. It is likely that the mitochondrial membranes of sensitive species tend to "solidify" at a relatively high temperature, hampering membrane-associated processes and causing "leakage" of solutes out of various compartments or out of the cells.

Heat-shock proteins are expressed at low temperatures (Sabehat et al. 1998), and these probably function in much the same way as discussed in Sect. 3.2.

There is some evidence that the low temperature is **perceived** through changes in **fluidity** of the plasma membrane, which then activates cold-inducible genes. For example, partial desaturation of membrane lipids *in vivo*, by using a water-soluble palladium complex as a catalyst, enhances the level of transcript of a gene that is also up-regulated at low temperature (Xiong et al. 2002).

3.5 Carbohydrates and Proteins Conferring Frost Tolerance

As outlined in Sect. 9 of Chapter 3 on plant water relations, frost damage only occurs at subzero temperatures, when the formation of **ice crystals** within cells causes damage to membranes and organelles and dehydration of cells; ice crystals that form outside of cells (e.g., in cell walls) generally cause little damage. Cold tolerance is correlated with the concentration of **soluble carbohydrates** in the cells (Fig. 6; Sakai & Larcher 1987). These carbohydrates play a role in **cryoprotection** (Crowe et al. 1990). Differences in cold tolerance between *Picea abies* (Norway spruce), *Pinus contorta* (lodgepole pine), and *Pinus sylvestris* (Scots pine), following exposure of hardened needles to 5.5°C, are closely correlated with their carbohydrate concentration. *Picea abies* maintains high sugar concentrations by having larger reserves to start with and lower rates of respiration, which decline more rapidly when sugars are depleted (Ögren et al. 1997).

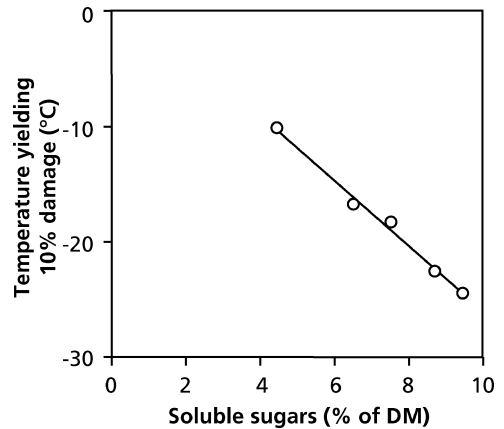

FIGURE 6. Temperature causing 10% damage of the needles of *Pinus sylvestris* (Scots pine) as dependent on the concentration of soluble carbohydrates in the needles. Variation in sugar concentration was obtained by exposure of intact plants to temperatures ranging from -8.5 to +5.5°C for 16 weeks in midwinter (Ögren 1997). Copyright Heron Publishing.

Cold stress leads to differential **gene expression**, and a wide range of cold-inducible genes have been isolated. Several of these genes occur in a wide range of plant species and contain conserved structural elements, which are probably vital for functional reasons. Their role in low-temperature acclimation, however, is not yet clear. A group of low-temperature-induced genes are homologous to the genes preferentially expressed during embryo maturation and encode mainly **hydrophilic proteins**. These genes may be involved in the osmotic stress response that is common to cold, water, and salt stress (Bartels & Nelson 1994).

Many plants that naturally occur in temperate climates go through an annual cycle of frost **hardening** and **dehardening**, with maximum freezing tolerance occurring during winter. In many woody plants, short days signal the initiation of cold acclimation, which is mediated by ABA. Freezing tolerance is accompanied by bud dormancy, which is also induced by short days, but the role of ABA in this induction is less direct (Welling et al. 1997). In herbaceous plants, frost hardening occurs by exposure to low, nonfreezing temperatures. Upon exposure to 5/2 (day/night) °C, specific mRNAs increase in abundance. It has yet to be established, however, which of the changes in gene expression are acclimations to growth at low temperature and which have a role in subsequent resistance to freeze-thaw damage. Specific **anti-freeze proteins** accumulate in the apoplast of *Secale cereale* (winter rye) and other frost-

resistant species (Hinch et al. 1997, Moffatt et al. 2006). These proteins are similar to the pathogenesis-related proteins that are induced by microbial pathogens (Sect. 3 of Chapter 9C on effects of microbial pathogens) (Griffith & Yaish 2004). They confer greater frost tolerance, as evidenced by less ion leakage from the leaves when exposed to subzero temperatures. Anti-freeze proteins that accumulate in several places in the apoplast of rye form oligomeric complexes and have the unique ability to absorb onto the surface of ice and inhibit its growth (Griffith et al. 1997, Yu & Griffith 1999). When the anti-freeze proteins are experimentally removed from the apoplast, the plant's cold tolerance is lost (Marentes et al. 1993). Hence, the accumulation of these proteins is causally linked to the increased frost tolerance; they may have an effect on the growth of ice in the cell walls (Hon et al. 1994). Exposure of *Triticum aestivum* (wheat) to low temperature induces a **dehydrin**; dehydrins are a class of proteins that are related to the products of late embryogenesis abundant genes, which we discussed in Sect. 8.3 of Chapter 3 on plant water relations. The dehydrins are found near the plasma membrane, where they may function in cryoprotection (Danyluk et al. 1998). Upon cold acclimation, a specific glycoprotein (**cryoprotectin**) accumulates in leaves of *Brassica oleracea* (cabbage) which protects thylakoids from non-acclimated leaves, both of cabbage and of other species such as *Spinacia oleracea* (spinach) (Sieg et al. 1996). Exposure to low temperature induces a specific class of proteins: lipid-transfer proteins. Although the name of these proteins suggests otherwise, they are unlikely to be involved in lipid transfer in vivo. The relationship between the putative protective role of lipid-transfer proteins and cold tolerance still needs to be determined (Doxey et al. 2006, Moffatt et al. 2006).

4. Global Change and Future Crops

Plants are frequently exposed to potential harmful radiation and adverse temperatures. Some of the protective mechanisms in plants are universal (e.g., the carotenoids of the xanthophyll cycle that protect against excess radiation). All plants also have mechanisms to avoid effects of UV radiation and repair UV damage. There is a wide variation among species, however, in the extent of the avoidance and probably also in the capacity to repair the damage. The rapid depletion of the stratospheric UV-screening ozone layer, due to human activities, imposes a selective force on plants to cope with UV.

Toxic ROS are produced when the dark reactions of photosynthesis cannot cope with the high activity of the light reactions. This may occur under high-light conditions, in combination with extreme temperatures. The xanthophyll cycle can prevent some of the potential damage by funneling off excess energy, acting as a lightning rod, at both high and low temperatures. Isoprene production possibly provides additional protection of leaves at high temperatures. Specific proteins and carbohydrates offer protection against temperature extremes. Further ecophysiological research on these compounds and on the regulation of genes that code for their production may help us to develop crop varieties that have a greater capacity to cope with extreme temperatures. Such plants will be highly desirable for agriculture in those parts of the world where extreme temperatures are a major factor limiting crop productivity.

References

- Apel, K. & Hirt, H. 2004. Reactive oxygen species: metabolism, oxidative stress, and signal transduction. *Annu. Rev. Plant Biol.* **55**: 373–399.
- Bartels, D. & Nelson, D. 1994. Approaches to improve stress tolerance using molecular genetics. *Plant Cell Environ.* **17**: 659–667.
- Burchard, P., Bilger, W., & Weissenböck, G. 2000. Contribution of hydroxycinnamates and flavonoids to epidermal shielding of UV-A and UV-B radiation in developing rye primary leaves as assessed by ultraviolet-induced chlorophyll fluorescence measurements. *Plant Cell Environ.* **23**: 1373–1380.
- Caldwell, M.M. 1981. Plant responses to solar ultraviolet radiation. In: Encyclopedia of plant physiology, N.S., Vol. 12A, O.L. Lange, P.S. Nobel, C.B. Osmond & H. Ziegler (eds). Springer-Verlag, Berlin, pp. 169–197.
- Crowe, J.H., Carpenter, J.F., Crowe, L.M., & Anchordoguy, T.J. 1990. Are freezing and dehydration similar stress factors? A comparison of modes of interaction of different biomolecules. *Cryobiol.* **27**: 219–231.
- Danyluk, J., Perron, A., Houde, M., Limin, A., Fowler, B., Benhamou, N., & Sarhan, F. 1998. Accumulation of an acidic dehydrin in the vicinity of the plasma membrane during cold acclimation of wheat. *Plant Cell* **10**: 623–638.
- Day, T.A. 1993. Relating UV-B radiation screening effectiveness of foliage to absorbing-compound concentration and anatomical characteristics in a diverse group of plants. *Oecologia* **95**: 542–550.
- Day, T.A., Martin, G., & Vogelmann, T.C. 1993. Penetration of UV-B radiation in foliage: evidence that the epidermis behaves as a non-uniform filter. *Plant Cell Environ.* **16**: 735–741.
- Day, T.A., Howells, B.W., & Rice, W.J. 1994. Ultraviolet absorption and epidermal-transmittance in foliage. *Physiol. Plant.* **92**: 207–218.

- Doxey, A.C., Yaish, M.W., Griffith, M., & McConkey, B.J. 2006. Ordered surface carbons distinguish antifreeze proteins and their ice-binding regions. *Nature* **24**: 852–855.
- Frohnmeier, H. & Staiger, D. 2003. Ultraviolet-B radiation-mediated responses in plants. Balancing damage and protection. *Plant Physiol.* **133**: 1420–1428.
- Griffith, M. & Yaish, M.W.F. 2004. Antifreeze proteins in overwintering plants: a tale of two activities. *Trends Plant Sci.* **9**: 399–405.
- Griffith, M., Antikainen, M., Hon, W.-C., Pihakaski-Maunschbach, K., Yu, X., Chun, J.U., & Yang, D.S. 1997. Antifreeze proteins in winter rye. *Physiol. Plant.* **100**: 327–332.
- Henkov, L., Strid, A., Berglund, T., Rydstrom, J., & Ohlsson, A.B. 1996. Alteration of gene expression in *Pisum sativum* tissue cultures caused by the free radical-generating agent 2,2'-azobis (2-aminopropane) dihydrochloride. *Physiol. Plant.* **96**: 6–12.
- Hidema, J., Kumagai, T., Sutherland, J.C., & Sutherland, B.M. 1997. Ultraviolet B-sensitive rice cultivar deficient in cyclobutyl pyrimidine dimer repair. *Plant Physiol.* **113**: 39–44.
- Hincha, D.K., Meins, F., & Schmidt, J.M. 1997. β -1,3-glucanase is cryoprotective in vitro and is accumulated in leaves during cold acclimation. *Plant Physiol.* **114**: 1077–1083.
- Hon, W.-C., Griffith, M., Chong, P., & Yang, D.S.C. 1994. Extraction and isolation of antifreeze proteins from winter rye (*Secale cereale* L.) leaves. *Plant Physiol.* **104**: 971–980.
- Irigoyen, J.J., Perez de Juan, J., & Sanchez-Diaz, M. 1996. Drought enhances chilling tolerance in a chilling-sensitive maize (*Zea mays*) variety. *New Phytol.* **134**: 53–59.
- Ishitani, M., Xiong, L., Stevenson, B., Zhu, J.-K. 1997. Genetic analysis of osmotic and cold stress signal transduction in *Arabidopsis*: Interactions and convergence of abscisic acid-dependent and abscisic acid-independent pathways. *Plant Cell* **9**: 1935–1949.
- Jansen, A.K., Gaba, V., & Greenberg, B.M. 1998. Higher plants and UV-B radiation: balancing damage, repair and acclimation. *Trends Plant Sci* **3**: 131–135.
- Karabourniotis, G., Papadopoulos, K., Papamarkou, M & Manetas, Y. 1992. Ultraviolet-B radiation absorbing capacity of leaf hairs. *Physiol. Plant.* **86**: 414–418.
- Karabourniotis, G., Kofidis, G., Fasseas, C., Liakoura, V., & Drossopoulos, I. 1998. Polyphenol deposition in leaf hairs of *Olea europaea* (Oleaceae) and *Quercus ilex* (Fagaceae). *Am. J. Bot.* **85**: 1007–1012.
- Körner, C. & Diemer, M. 1987. In situ photosynthetic responses to light, temperature and carbon dioxide in herbaceous plants from low and high altitude. *Funct. Ecol.* **1**: 179–194.
- Lichtenthaler, H.K. 2007. Biosynthesis, accumulation and emission of carotenoids, α -tocopherol, plastoquinone, and isoprene in leaves under high photosynthetic irradiance. *Photosynth. Res.* **92**: 163–179.
- Loreto, F. & Velikova, V. 2001. Isoprene produced by leaves protects the photosynthetic apparatus against ozone damage, quenches ozone products, and reduces lipid peroxidation of cellular membranes. *Plant Physiol.* **127**: 1781–1787.
- Loreto, F., Förster, A., Dürr, M., Csiky, O., & Seufert, G. 1998. On the monoterpene emission under heat stress and on the increased thermotolerance of leaves of *Quercus ilex* L. fumigated with selected monoterpenes. *Plant Cell Environ.* **21**: 101–107.
- Marentes, E., Griffiths, M., Mlynarz, A., & Brush, R.A. 1993. Proteins accumulate in the apoplast of winter rye leaves during cold acclimation. *Physiol. Plant.* **87**: 499–507.
- Martz, F., Sutinen, M.-L., Derome, K., Wingsle, G., Julkunen-Tiito, R., & Turunen, M. 2007. Effects of ultraviolet (UV) exclusion on the seasonal concentration of photosynthetic and UV-screening pigments in Scots pine needles. *Global Change Biol.* **13**: 252–265.
- Mazza, C.A., Boccacandro, H.E., Giordano, C.V., Battista, D., Scopel, A.L., & Ballaré, C.L. 2000. Functional significance and induction by solar radiation of ultraviolet-absorbing sunscreens in field-grown soybean crops. *Plant Physiol.* **122**: 117–126.
- Moffatt, B., Ewart, V., & Eastman, A. 2006. Cold comfort: plant antifreeze proteins. *Physiol. Plant.* **126**: 5–16.
- Murata, N. & Los, D.A. 1997. Membrane fluidity and temperature perception. *Plant Physiol.* **115**: 875–879.
- Ögren, E. 1997. Relationship between temperature, respiratory loss of sugar and premature dehardening in dormant Scots pine seedlings. *Tree Physiol.* **17**: 47–51.
- Ögren, E., Nilsson, T., & Sundblad, L.-G. 1997. Relationships between respiratory depletion of sugars and loss of cold hardiness in coniferous seedlings over-wintering at raised temperatures: indications of different sensitivities of spruce and pine. *Plant Cell Environ.* **20**: 247–253.
- Parcellier, A., Gurbuxani, S., Schmitt, E., Solary, E., & Garrido, C. 2003. Heat shock proteins, cellular chaperones that modulate mitochondrial cell death pathways. *Biochem. Biophys. Res. Comm.* **304**: 505–512.
- Peñuelas, J. & Munné-Bosch, S. 2005. Isoprenoids: an evolutionary pool for photoprotection. *Trends Plant Sci.* **10**: 166–169.
- Ruhland, C.T. & Day, T.A. 2000. Effects of ultraviolet-B radiation on leaf elongation, production and phenylpropanoid concentrations of *Deschampsia antarctica* and *Colobanthus quitensis* in Antarctica. *Physiol. Plant.* **109**: 244–251.
- Sabehat, A., Lurie, S., & Weiss, D. 1998. Expression of small heat-shock proteins at low temperatures. a possible role in protecting against chilling injuries. *Plant Physiol.* **117**: 651–658.
- Sakai, A. & Larcher, W. 1987. Frost survival of plants. Responses and adaptation to freezing stress. Springer-Verlag, Berlin.
- Sharkey, T.D. & Yeh, S. 2001. Isoprene emission from plants. *Annu. Rev. Plant Physiol. Plant Mol. Biol.* **52**: 407–436.
- Sharkey, T.D., Wiberley, A.E., & Donohue, A.R. S. 2008. Isoprene emission from plants: why and how? *Ann. Bot.* **101**: 5–18.
- Sheahan, J.J. 1996. Sinapate esters provide greater UV-B attenuation than flavonoids in *Arabidopsis thaliana* (Brassicaceae). *Am. J. Bot.* **83**: 679–686.
- Sieg, F., Schröder, W., Schmitt, J.M., & Hincha, D.K. 1996. Purification and characterization of a cryoprotective

- protein (cryoprotectin) from the leaves of cold-acclimated cabbage. *Plant Physiol.* **111**: 215–221.
- Singsaas, E.L. & Sharkey, T.D. 1998. The regulation of isoprene emission responses to rapid leaf temperatures fluctuations. *Plant Cell Environ.* **21**: 1181–1188.
- Stapleton, A.E. & Walbot, V. 1994. Flavonoids protect maize DNA from the induction of ultraviolet radiation damage. *Plant Physiol.* **105**: 881–889.
- Stapleton, A.E., Thornber, C.S., & Walbot, V. 1997. UV-B component of sunlight causes measurable damage in field-grown maize (*Zea mays* L.): Developmental and cellular heterogeneity of damage and repair. *Plant Cell Environ.* **20**: 279–290.
- Welling, A., Kaikuranta, P., & Rinne, P. 1997. Photoperiodic induction of dormancy and freezing tolerance in *Betula pubescens*. Involvement of ABA and dehydrins. *Physiol. Plant.* **100**: 119–125.
- Wildi, B. & Lütz, C. 1996. Antioxidant composition of selected high alpine plant species from different altitudes. *Plant Cell Environ.* **19**: 138–146.
- Williams, E.L., Hovenden, M.J., & Close, D.C. 2003. Strategies of light energy utilisation, dissipation and attenuation in six co-occurring alpine heath species in Tasmania. *Funct. Plant Biol.* **30**: 1205–1218.
- Xiong, L., Schumaker, K.S., & Zhu, J.-K. 2002. Cell signaling during cold, drought, and salt stress. *Plant Cell* **14**: S165–183.
- Yu, X.-M. & Griffith, M. 1999. Antifreeze proteins in winter rye leaves form oligomeric complexes. *Plant Physiol.* **119**: 1361–1369.

5

Scaling-Up Gas Exchange and Energy Balance from the Leaf to the Canopy Level

1. Introduction

Having discussed the gas exchange and energy balance of individual leaves in previous chapters, we are now in a position to “scale up” to the canopy level. In moving between scales, it is important to determine which interactions are strong enough to be considered and which can be ignored. The water relations of plant canopies differ distinctly from what would be predicted from the study of individual leaves, because each leaf modifies the environment of adjacent leaves by reducing irradiance and wind speed, and either decreasing or increasing vapor pressure deficit, depending on transpiration rates. These changes within the canopy reduce transpiration from each leaf more than would be predicted from an individual leaf model, based on the atmospheric conditions above the canopy. For example, **irradiance** declines more or less exponentially with leaf area index within the canopy (Box 5.1), reducing the energy that each leaf absorbs. Friction from the canopy causes **wind speed** to decline close to the canopy, just as it declines close to the ground surface. Wind speed, generally, declines exponentially within the canopy, and individual leaves within a canopy have lower boundary layer conductance than expected from leaf dimensions and the meteorological conditions of the bulk air. Finally, transpiration by each leaf increases the **water vapor concentration** around adjacent leaves, as does

evaporation from a wet soil surface. As stomatal conductance increases, the increasing water vapor concentration within the canopy reduces the driving force for transpiration, so that transpiration increases less than expected from the increase in stomatal conductance alone (Jarvis & McNaughton 1986).

Mathematical functions can be used to describe the effects of variables and their interactions in a model of the system. A good model for scaling will be based on mechanistic processes at a lower scale. Can we treat the canopy simply as one big leaf to arrive at the gas exchange and energy balance of a canopy, or do we need to sum up the gas exchange and energy balance of each leaf and its individual microclimate? These questions will be addressed in the following sections.

2. Canopy Water Use

In Sect. 2.2 of Chapter 2A on photosynthesis, we discussed leaf transpiration as measured on a single leaf in a well ventilated and environmentally controlled gas-exchange cuvette. In such cuvettes, the boundary layer is minimal, and transpiration has little effect on the conditions inside and around the leaf. For leaves in a canopy, however, boundary layers significantly affect the transpiration rate, and the air in the boundary layer contains more water

Box 5.1

Optimization of Nitrogen Allocation to Leaves in Plants Growing in Dense Canopies

A theoretical optimum distribution of N over the leaves of a plant that maximizes whole plant photosynthesis per unit leaf N can be calculated (Field 1983, Hirose & Werger 1987, Pons et al. 1989, Evans 1993, Anten et al. 1995). Such an optimum distribution pattern depends on the distribution of light over the leaves of a plant growing in a dense canopy. The approach chosen here is for plant stands consisting of one species of even-sized individuals. Hence, the performance of the stand is identical to the performance of individual plants growing in the stand. The calculations consist of five parts that describe mathematically: (1) the distribution of irradiance in the leaf canopy where the plant is growing, (2) the dependence of photosynthetic rate on irradiance of leaves, (3) the relationships with leaf N of the parameters of the photosynthesis-irradiance relationship, (4) canopy photosynthesis by summation of photosynthetic rates in different canopy layers, and (5) the distribution of leaf N at maximum canopy photosynthesis per unit leaf N.

Following the approach discussed in Box 2A.3 on gradients in leaves, we can use the Lambert-Beer law to calculate the light absorption profile in the canopy. An extension of that equation gives the mean irradiance (I_L , $\mu\text{mol m}^{-2} \text{s}^{-1}$) incident on a leaf at a certain depth in the canopy expressed as cumulative leaf area index from the top of the canopy [F , m^2 (leaf area) m^{-2} (ground surface)]:

$$I_L = \frac{I_o K_L}{1-t} \exp(-K_L F) \quad (1)$$

where I_o ($\mu\text{mol m}^{-2} \text{s}^{-1}$) is the irradiance above the canopy, and the dimensionless parameters K_L , t , and F are the canopy extinction coefficient, leaf transmission coefficient, and leaf area index, respectively (Hirose & Werger 1987). I_o is multiplied by K_L to account for the deviation of leaf angle from horizontal transmission of light by leaves.

Again following the approach in Box 2A.3, we calculate the photosynthetic rate in each canopy layer by using the light-response curve. For this purpose, we use the equation introduced in Sect. 3.2.1 of Chapter 2A on photosynthesis:

$$A = \frac{\Phi I + A_{\max} - \sqrt{(\Phi I + A_{\max})^2 - 4\Theta I \phi A_{\max}}}{2\Theta} - R_{\text{day}} \quad (2)$$

where A_n ($\mu\text{mol CO}_2 \text{m}^{-2} \text{s}^{-1}$) is the actual rate of net photosynthesis, ϕ is the apparent quantum yield at low irradiance [$\text{mol CO}_2 \text{mol}^{-1}$ (quanta)], I is irradiance ($\mu\text{mol quanta m}^{-2} \text{s}^{-1}$), A_{\max} ($\mu\text{mol CO}_2 \text{m}^{-2} \text{s}^{-1}$) is the light-saturated rate of (gross) photosynthesis, and Θ (dimensionless) describes the curvature on the A - I relationship.

Parameters of the light-response curve (Equation 2) can be related to leaf N per unit leaf area (N_{LA}). Linear relationships give a satisfactory description of the increase of A_{\max} and R_{day} with N_{LA} :

$$A_{\max} = a_a (N_{\text{LA}} - N_b) \quad (3)$$

$$R_{\text{day}} = a_r (N_{\text{LA}} - N_b) + R_b \quad (4)$$

where a_a and N_b are the slope and intercept of the A_{\max} - N_{LA} relation. N_b is the amount of N still present in leaves that have no photosynthetic capacity left. R_b is R_{day} in leaves with $N_{\text{LA}} = N_b$. The quantum yield, ϕ , depends on chlorophyll concentration which may also be true for the curvature, Θ . These two parameters may thus also depend on the leaf N concentration, N_{LA} , for which mathematical relationships can be formulated.

Canopy photosynthesis can now be calculated using Equations 1-4 and the leaf N distribution in the canopy. For that purpose distribution functions may be used (Hirose & Werger 1987). Photosynthetic rates are summed over the different canopy layers and over a day or other time interval with varying irradiance. Daily course of irradiance may be described by a sinusoidal curve, or in any other way.

Maximum canopy photosynthesis at constant total leaf N of the plant is reached when at every-depth in the canopy a change in leaf N (δN_{LA}) will result in the same change in daily photosynthesis (δA_{day}) (Field 1983):

$$\frac{\delta A_{\text{day}}}{\delta N_{\text{LA}}} = \lambda \quad (5)$$

continued

Box 5.1 Continued

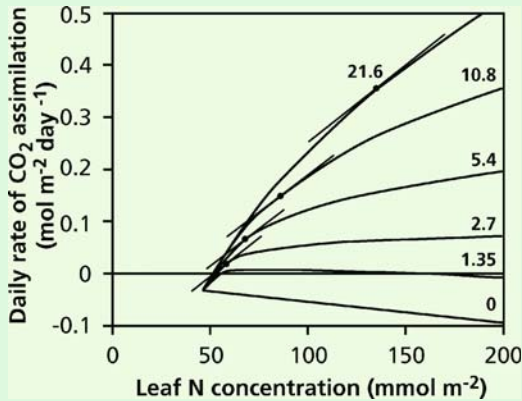

FIGURE 1. Calculated daily photosynthesis as a function of leaf N for different depths in a canopy with concomitantly different levels of irradiance (expressed as $\text{mol m}^{-2} \text{day}^{-1}$). The points of contact of the parallel tangents to the curves represent the optimal distribution pattern of N at a given total amount of leaf N (after Hirose & Werger 1987).

The constant λ is called the *Lagrange multiplier*. This is illustrated in Fig. 1, where the points of contact of the tangents to the lines for daily photosynthesis at different canopy depths as a function of N_{LA} represent the optimal distribution of leaf N. Different total amounts of leaf N will result in different values for λ . In this way optimal leaf N distribution for maximum canopy photosynthesis of a plant per unit leaf N

(photosynthetic nitrogen-use efficiency, PNUE) can be calculated. Photosynthetic rates at actual distribution of leaf N in plants growing in leaf canopies have been compared with theoretically derived ones as described earlier, and with plants that have a uniform distribution. For instance, in the study of Pons et al. (1989), the performance of *Lysimachia vulgaris* (yellow loosestrife) at uniform and optimal distribution was 73 and 112%, respectively, of that at actual distribution. Hence, plants tend to distribute their leaf N optimally over leaf area.

A submodel of the model developed above is a canopy photosynthesis model. This is a simplified one because both the light distribution and leaf photosynthesis use simplifications that are valid for the purpose of the above calculations, but not when we are interested in the quantitative outcome of canopy photosynthesis itself. The distribution of light as described here gives the average irradiance incident on leaves at a particular depth in a canopy with unidirectional light coming from straight overhead. It provides a reasonable approximation for diffuse light, but not for directional sunlight because spatial variation due to sunflecks and varying angle of incident sunlight are not accounted for. For the leaf photosynthesis module, the Farquhar et al. (1980) model could be used which accounts not only for varying conditions of irradiance, as in this model, but also for variation in temperature and stomatal conductance. This model is described in Box 2A.1.

vapor than the bulk ambient air. In a canopy, more than in leaves measured in a leaf cuvette, transpiration is therefore affected by both stomatal and **boundary layer conductance**. In effect, the boundary layer provides a **negative feedback** to transpiration. As a result, stomatal conductance has much less effect on canopy water loss than would be expected from study of single leaves (Jarvis & McNaughton 1986).

While transpiration from individual leaves in a leaf cuvette can be adequately described by the diffusion equation, transpiration from leaves in a canopy requires consideration of both diffusion and the leaf energy balance. The dual processes of **vaporization** and **diffusion** were first considered in an evaporation model by Penman (1948). This work was extended to include evaporation from vegetation by incorporation of a canopy

conductance (Monteith 1963, 1965). This line of thinking, which leads to “**single-layer**” models, is to determine the evaporation if the plant canopy were simply a partially wet plane at the lower boundary of the atmosphere. This conceptual plane, which is often referred to as a “**big leaf**”, is ascribed a physiological and aerodynamic resistance to water vapor transfer (Fig. 1). In an analogy with an individual leaf, a **canopy conductance** is introduced which implicitly assumes that the conductances of individual leaves act in parallel, so that this canopy conductance can be determined by the leaf-area-weighted sum of leaf conductances (Monteith 1973). This approach ignores details of the canopy profile and simplifies the canopy to one single layer (“**big leaf**”; Field 1991). The “**big-leaf**” models are applicable only in circumstances where the detailed and complete spatial structure of the

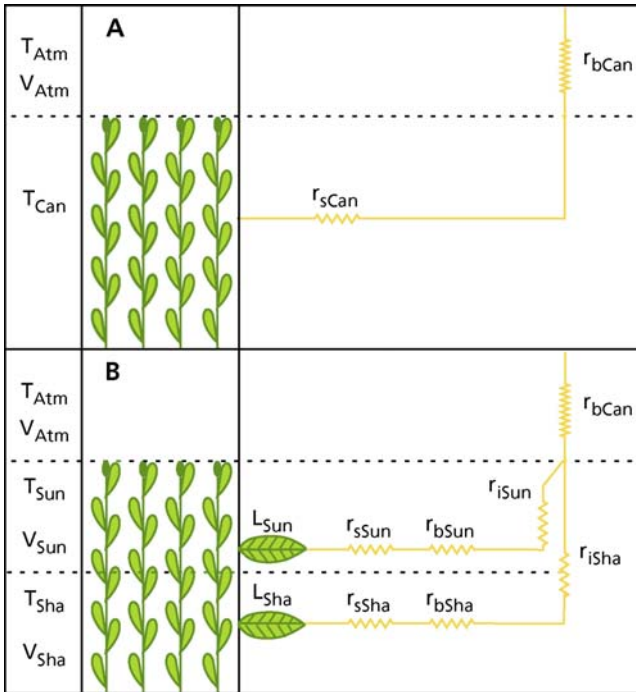

FIGURE 1. Schematic representation of (A) a single-layer (“big-leaf”) model and (B) a multi-layer model used for calculation of canopy evapotranspiration [modified after Raupach & Finnigan (1988)]. The model includes temperatures (T), vapor pressures (V), and resistances (r). Subscripts refer to the canopy (Can), the atmosphere (Atm), sunlit leaves (Sun), and shaded leaves (Sha). Resistances are stomatal (s), boundary layer (b), and in the air within the canopy (i).

actual canopy microclimate and difference in light-response curves of individual leaves that make up the canopy are irrelevant (Fig. 1).

Whenever details within the canopy (e.g., the interaction between microclimate and physiology) are important to estimate canopy gas-exchange, big-leaf models are insufficient. “**Multilayer**” models have therefore been developed (Cowan 1968, 1988). These models describe both the evaporation of the entire canopy and the partitioning of evaporation among various components (e.g., soil, understory, and crown) together with other aspects of the canopy microclimate, such as profiles of leaf and air temperature and humidity of the air (Fig. 1).

Single-layer models are appropriate when one is concerned with vegetation essentially as a permeable lower boundary of the atmosphere or upper boundary of the soil, in systems with a length scale much larger than that of the vegetation itself. They are useful in hydrological modeling of large-scale or medium-scale catchments (e.g., areas where water is collected for urban use). On the other hand, multi-layer models are appropriate when necessary to resolve details within the canopy, either because the detail is important in its own right or because the height scale is comparable with that of the system under investigation. They are relevant when

dealing with interactions between microclimate and plant physiology or with hydrology in small catchments (Raupach & Finnigan 1988).

Water loss from communities includes both transpiration of leaves and evaporation directly from the soil. Evaporation from the soil accounts for about 40% of the water used by a wheat crop in a Mediterranean environment (Siddique et al. 1990). The soil component is affected by the level of radiation that penetrates through the canopy to the soil surface and hence by the canopy leaf area index (LAI). Evaporation from the soil is also affected by wetness of the soil surface, hydraulic conductivity of the soil, and wind speed beneath the canopy. The rate of soil evaporation is high when the surface is wet. As the soil dries out, the point of evaporation moves deeper into the soil and the surface layer offers a greater impedance, thus dramatically reducing soil evaporation. When the canopy intercepts most of the incident radiation, soil evaporation is probably a minor component of the total evaporation. If rain is infrequent and the soil surface dry, then soil evaporation tends to be insignificant. When the canopy is sparse, with a projected foliage cover of less than 1, as occurs on 70% of terrestrial vegetation (Graetz 1991), soil evaporation cannot be ignored, and it should be included in multilayer evaporation models.

Canopies differ in the extent to which the behavior of individual leaves is “coupled” to the atmosphere. In **rough canopies**, such as those of forest trees or of small plants in complex terrain, the complex surface structure creates large eddies of air that penetrate the canopies. As a result, the air that surrounds each leaf has a temperature and humidity similar to that of bulk air, so that single-leaf models predict the behavior of leaves in canopies. On the other hand, individual leaves in **smooth canopies** such as in crops or grasslands, are poorly coupled to the atmosphere. Because of the dimensions of their leaves, their higher stomatal conductances, and their tendency to form smooth canopy surfaces, broad-leaf canopies are less coupled than coniferous forests, and considerable vertical gradients of temperature and humidity can develop over just a few meters. Leaf resistances are in series with the canopy boundary layer resistance (Fig. 1). Therefore, where boundary layer resistance is high, such as in smooth canopies, particularly at low wind speeds, variation in leaf resistance does not play a critical role in determining canopy evaporation.

3. Canopy CO₂ Fluxes

Carbon accumulation in communities involves exchanges of carbon with both the atmosphere and the soil (i.e., photosynthesis, plant respiration, and microbial respiration). **Photosynthesis** of the entire canopy can be approached as discussed in Sect. 2 for water use, using single-layer or multilayer models. Models of canopy gas exchange based on equations developed for single leaves (**big-leaf** approach) are relatively simple but can introduce major errors when averaging gradients of light and photosynthetic capacity. Photosynthesis can also be modeled in a “multilayer” approach (Box 2A.1 and Box 5.1). In big-leaf models of canopy photosynthesis, the Rubisco activity and electron-transport capacity per unit ground area are taken as the sums of activities per unit leaf area within the canopy. These models over-estimate rates of photosynthesis unless they incorporate empirical factors that adjust the response of photosynthesis to irradiance (Mercado et al. 2007).

Canopy photosynthesis can also be measured using large cuvettes that enclose entire plants or several plants in the canopy, or by **eddy covariance**, which is a micrometeorological approach that compares the concentrations of water vapor, CO₂, and heat in upward-moving vs. downward-moving parcels of air. Figure 2 shows the rate of canopy CO₂

assimilation and total stomatal conductance of an entire macadamia tree (*Macadamia integrifolia*). Net CO₂ assimilation and stomatal conductance are related to photon irradiance, but the relationships differ for overcast conditions and clear sky.

The heterogeneity of the canopy complicates model estimates of canopy photosynthesis because the light environment and leaf physiological properties are highly variable (Sect. 3 of Chapter 2A on photosynthesis). The resulting variation in photosynthesis and transpiration modifies the air within the canopy, creating gradients in humidity, temperature, and CO₂ concentration. Errors associated with big-leaf models can be avoided in **multilayer models** that treat the canopy in terms of a number of layers. Thus, by combining a model of **leaf photosynthesis** with a model on **penetration of light** and on transport processes within the canopy, the flux from each canopy layer can be estimated. Such models are essential for analyzing the significance of within-canopy variation in leaf traits. For example, the **allocation of nitrogen** to different leaves within a canopy is determined by the light gradient in a canopy in both single-species and multispecies canopies, but the gradient in leaf N is always less than that in irradiance (Field 1983, Hirose & Werger 1987) (Box 5.1) which is why big-leaf models do not work. When sunlit and shaded leaf fractions of the canopy are modeled separately, such a **single-layer sun/shade model** is much simpler than a multilayer canopy model (de Pury & Farquhar 1997).

There are important interactions among environmental gradients and physiological processes within a canopy. For example, under moist conditions, the leaves at the top of the canopy which have the highest N concentrations and experience the highest light availability account for most of photosynthesis. As the soil dries, particularly for vegetation with tall canopies, the leaves at the top of the canopy may have significantly reduced stomatal conductances compared with those lower down, and the zone of maximum photosynthesis shifts farther down in the canopy (Ryan et al. 2006).

It has been consistently more difficult to model **canopy dark respiration** using simple canopy scaling rules because growth and respiration within the canopy are not a simple function of photosynthesis within the canopy (Sects. 1 and 4 of Chapter 2B on respiration). Complications arise because respiration depends on metabolic activity as well as on carbohydrate status, in a manner that is not readily modeled. Thermal acclimation (Sect. 4.5 in Chapter 2B on respiration) and the extent to which dark respiration continues during photosynthesis (Sect. 4.9 in Chapter 2B on respiration; Mercado

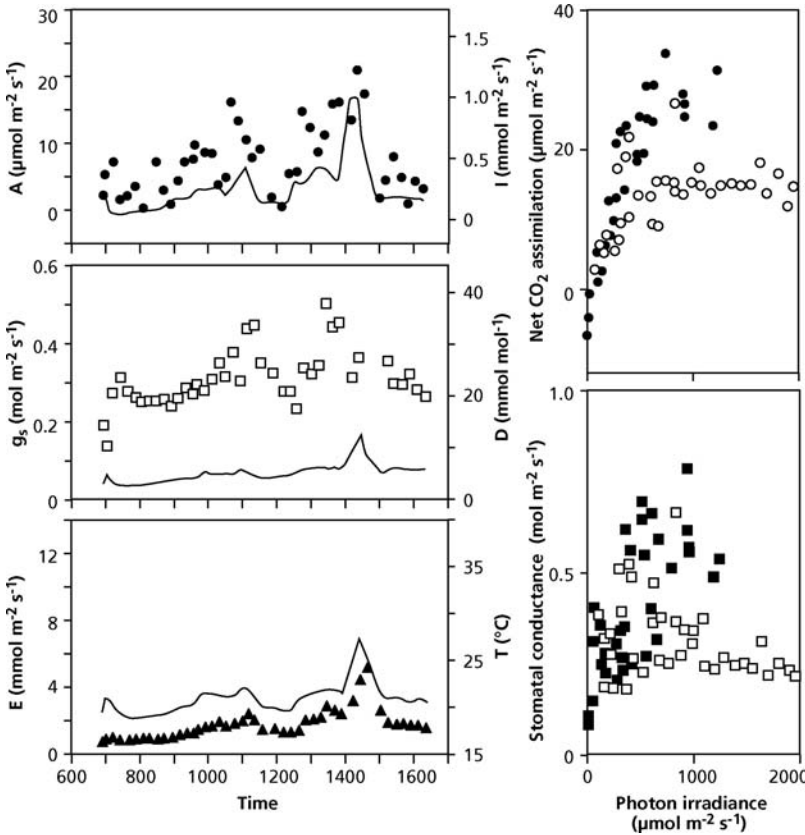

FIGURE 2. (Left) The rate of CO_2 assimilation, stomatal conductance, and transpiration (all expressed on a ground area basis) of an entire tree of *Macadamia integrifolia* (macadamia), throughout an entire day. Diurnal changes in irradiance (I), leaf-to-air vapor pressure difference (D) and air temperature (T) are also shown (solid lines). (Right) The rate of net CO_2 assimilation and stomatal conductance (expressed on a ground area basis) of an entire tree of *Macadamia integrifolia* (macadamia), as dependent on photon irradiance. The solid and open symbols refer to overcast and clear-sky conditions, respectively (Lloyd et al. 1995), *Australian Journal of Plant Physiol.* 22: 987–1000, Copyright CSIRO, Australia).

et al. 2007) represent further uncertainties, with major variation among species. This remains an area of plant physiology where more information is needed to allow scaling from the leaf's CO_2 flux to that of the canopy, especially if canopy scaling is going to be used to address global issues.

4. Canopy Water-Use Efficiency

If canopies affect the gas-exchange properties of individual leaves, then the water-use efficiency (WUE) of the canopy cannot be deduced simply from that of individual leaves measured under the prevailing bulk air conditions. Does this imply that genotypic differences in WUE at the leaf level (Sect. 6 of Chapter 3 on plant water relations) disappear when studied at an ecologically more relevant scale? When dealing with a **rough canopy** (Sect. 2), the differences certainly persist. In a **smooth canopy**, however, such as that of a wheat crop, the differences in conductance are diminished when scaling from the leaf to the canopy level (Fig. 3). For example, a leaf-level difference in photosynthetic water-use efficiency of 24% is

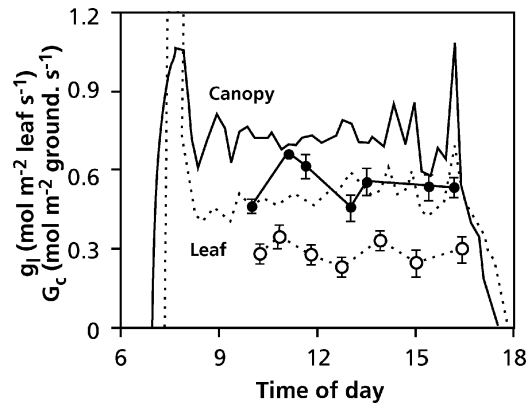

FIGURE 3. Comparison of the diurnal variation of leaf conductance, g_l (circles connected by lines) and canopy conductance, G_c (lines only) for two cultivars of *Triticum aestivum* (wheat), selected on the basis of their contrasting photosynthetic water-use efficiency at the leaf level (de Pury 1995). Reproduced with the author's permission.

only 5% at the canopy level. This decrease in the effect of genotype on WUE, when scaling from a single leaf to the canopy, reflects both the dominance of the **canopy boundary layer conductance** in the total canopy conductance (Sect. 2) and the greater leaf area of the cultivar with lower WUE. This greater leaf area reduces the canopy boundary layer conductance, which counteracts the greater stomatal conductance. In addition, much of the gain made by decreasing stomatal conductance and transpiration can be offset by greater evaporation from the soil when the rate of leaf area development decreases simultaneously.

Wheat genotypes with a low WUE tend to develop their leaf area faster and have a higher leaf area ratio (LAR), in comparison with ones that have a higher WUE, with two important consequences. First, genotypes with a lower WUE transpire more of the available water early in the growing season, when the vapor pressure deficit of the air is relatively low due to low temperatures such as in Mediterranean climates, and, consequently, the WUE is high. Second, transpiration represents a greater fraction of the total crop water use of low-WUE genotypes due to the reduced evaporation from the soil, as mentioned earlier (Condon et al. 1993). A high leaf area ratio (LAR) and vigorous early growth is clearly a major trait determining a crop's water use (Van den Boogaard et al. 1997). This calls for a line of plant breeding, which combines a high WUE (low $\delta^{13}\text{C}$ -value) with vigorous early growth to reduce soil evaporation.

5. Canopy Effects on Microclimate: A Case Study

As pointed out above, individual leaves in smooth canopies, such as in crops or grasslands, are poorly coupled to the atmosphere. When stomatal conductance declines to low levels, leaves dissipate most heat through convective exchange, warming the air within the canopy. This creates turbulence within the canopy which brings new dry air into the canopy to increase transpiration.

The net loss of radiative energy from a surface exposed to the sky at night is balanced by the flow of heat from the overlying air and the underlying soil. During nights of radiation frost, temperatures of *Eucalyptus* (gum tree) leaves exposed to clear skies may be 1–3°C below those of the air. The resistance to heat transfer between air and grass is less than between air and soil because of the canopy's greater aerodynamic roughness. Because the thermal

resistance of air within the grass sward is rather high, air temperatures immediately above the grass are lower than that above bare soil, which conducts heat more easily to the surface. As a result, leaf temperatures of seedlings above grass tend to be lower than those above dry soil which are lower than those above moist soil. This affects the performance of plants growing above a grass canopy, as compared with those above bare patches (Sect. 2 of Chapter 9E on interactions among plants).

6. Aiming for a Higher Level

Scaling of processes from a single leaf to an entire canopy or community is complicated because of complex environmental and physiological gradients and interactions within the canopy. "Big-leaf" models are often a useful simple starting point, especially for estimates of process rates over large geographic areas. However, an understanding of the role of physiology in mediating the exchanges of water, carbon, and heat often benefits from a "multilayer" approach that uses information about these environmental and physiological gradients to model the gas exchange of the entire canopy (Mercado et al. 2007).

When dealing with canopies, we often find that differences (e.g., in water-use efficiency) that are relatively large when studied at the leaf level become smaller or disappear at the canopy level. Scaling from single leaves to communities will become increasingly important when ecophysiologicals model effects of global change in temperature and atmospheric CO₂ concentration on primary productivity. Difficulties arise when dealing with the time factor; short-term effects of temperature on rates of processes may differ widely from those in acclimated plants. Temporal and spatial scaling are therefore an important research area for ecophysiologicals seeking to develop more effective crops or predict the performance of plants under future conditions.

References

- Anten, N.P.R., Schieving, F., & Werger, M.J.A. 1995. Patterns of light and nitrogen distribution in relation to whole canopy gain in C₃ and C₄ mono- and dicotyledonous species. *Oecologia* **101**: 504–513.
- Condon, A.G., Richards, R.A., & Farquhar, G.D. 1993. Relationships between carbon isotope discrimination, water use efficiency and transpiration efficiency for dryland wheat. *Aust. J. Agric. Res.* **44**: 1693–1711.

- Cowan, I.R. 1968. Mass, heat and momentum exchange between stands of plants and their atmospheric environment. *Q. J. R. Meteor. Soc.* **94**: 523–544.
- Cowan, I.R. 1988. Stomatal physiology and gas exchange in the field. In: Flow and Transport in the natural environment: advances and applications, W.L. Steffen & O.T. Denmead (eds). Springer-Verlag, Berlin, pp. 160–172.
- de Pury, D.G.G. 1995. Scaling photosynthesis and water use from leaves to paddocks. PhD Thesis, Australian National University, Canberra, Australia.
- de Pury, D.G.G. & Farquhar, G.D. 1997. Simple scaling of photosynthesis from leaves to canopies without the errors of big-leaf models. *Plant Cell Environ.* **20**: 537–557.
- Evans, J.R. 1993. Photosynthetic acclimation and nitrogen partitioning within a lucerne canopy. II. Stability through time and comparison with a theoretical optimum. *Aust. J. Plant Physiol.* **20**: 69–82.
- Farquhar, G.D., Von Caemmerer, S., & Berry, J.A. 1980. A Biochemical model of photosynthetic CO₂ assimilation in leaves of C₃ species. *Planta* **149**: 78–90.
- Field, C. 1983. Allocating leaf nitrogen for the maximization of carbon gain: leaf age as a control on the allocation programme. *Oecologia* **56**: 341–347.
- Field, C.B. 1991. Ecological scaling of carbon gain to stress and resource availability. In: Response of plants to multiple stress, H.A. Mooney, W.E. Winner, & E.J. Pell (eds). Academic Press, San Diego, pp. 35–65.
- Graetz, R.D. 1991. The nature and significance of the feedback of change in terrestrial vegetation on global atmospheric and climatic change. *Climatic Change* **18**: 147–173.
- Hirose, T. & Werger, M.J.A. 1987. Maximising daily canopy photosynthesis with respect to the leaf nitrogen allocation pattern in the canopy. *Oecologia* **72**: 520–526.
- Jarvis, P.G. & McNaughton, K.G. 1986. Stomatal control of transpiration: scaling up from leaf to region. *Adv. Ecol. Res.* **15**: 1–49.
- Lloyd, J., Grace, J.B., Wong, S.C., Styles, J.M., Batten, D., Priddle, R., Turnbull, C., & McConchie, C.A. 1995a. Measuring and modelling whole-tree gas exchange. *Aust. J. Plant Physiol.* **22**: 987–1000.
- Mercado, L.M., Huntingford, C., Gash, J.H.C., Cox, P.M., Jogireddy, V. 2007. Improving the representation of radiation interception and photosynthesis for climate model applications. *Tellus B* **59**, 553–565.
- Monteith, J.L. 1963. Gas exchange in plant communities. In: Environmental control of plant growth, L.T. Evans (ed). Academic Press, New York, pp. 95–112.
- Monteith, J.L. 1965. Evaporation and environment. *Symp. Soc. Exp. Biol.* **19**: 205–234.
- Monteith, J.L. 1973. Principles of environmental physics. Edward Arnold, London.
- Penman, H.L. 1948. Natural evaporation from open water, bare soil and grass. *Proc. R. Soc. London Series A* **193**: 120–145.
- Pons, T.L., Schieving, F., Hirose, T., & Werger, M.J.A. 1989. Optimization of leaf nitrogen allocation for canopy photosynthesis in *Lysimachia vulgaris*. In: Causes and consequences of variation in growth rate and productivity of higher plants, H. Lambers, M.L. Cambridge, H. Konings, & T.L. Pons (eds). SPB Academic Publishing, The Hague, pp. 175–186.
- Raupach, M.R. & Finnigan, J.J. 1988. “Single-layer” models of evaporation from plant canopies are incorrect but useful, whereas multilayer models are correct but useless. *Aust. J. Plant Physiol.* **15**: 705–716.
- Ryan, M.G., Phillips, N., & Bond, B.J. 2006. The hydraulic limitation hypothesis revisited. *Plant Cell Environ.* **29**: 367–381.
- Siddique, K.H.M., Belford, R.K., & Tennant, D. 1990. Root: shoot ratios of old and modern, tall and semi-dwarf wheats in a mediterranean environment. *Plant Soil* **121**: 89–98.
- Van den Boogaard, R., Alewijnse, D., Veneklaas, E.J., & Lambers, H. 1997. Growth and water use efficiency of ten *Triticum aestivum* L. cultivars at different water availability in relation to allocation of biomass. *Plant Cell Environ.* **20**: 200–210.

6

Mineral Nutrition

1. Introduction

Next to water, nutrients are the environmental factor that most strongly constrains terrestrial productivity. The productivity of virtually all natural ecosystems, even arid ecosystems, responds to addition of one or more nutrients, indicating widespread nutrient limitation. Species differ widely in their capacity to acquire nutrients from soil. Some plants can take up Fe, P, or other ions from a calcareous soil from which others cannot extract enough nutrients to persist. In other soils, the concentrations of aluminum, heavy metals, or sodium chloride may reach toxic levels, whereas some species have genetic adaptations that enable them to survive in such environments. This does not mean that metallophytes *need* high concentrations of heavy metals or that halophytes *require* high salt concentrations to survive. These species perform well in the absence of these adverse conditions. Their distribution is restricted to these extreme habitats because, on one hand, these plants resist the adverse conditions, whereas most other plants do not. On the other hand, metallophytes and halophytes generally perform less well than most other plants in habitats without toxic levels of minerals or salts. Terms like metallophytes, halophytes, and others that we will encounter later in this chapter therefore refer to the **ecological amplitude** of the species rather than to their physiological requirements (Fig. 2 in Chapter 1 on assumptions and approaches).

This chapter deals with the acquisition and the use of nutrients by plants, focusing on terrestrial plants that absorb nutrients predominantly via their roots from soil. Leaves are also capable of

acquiring nutrients. For example, volatile nitrogenous and sulfurous compounds, which may occur either naturally or as air pollutants in the atmosphere, can be taken up through the stomata. Nutrients in the water on wet leaves are also available for absorption by leaves. This may be of special importance for aquatic and epiphytic plants as well as for mosses and even *Sequoia sempervirens* (coast redwood) (Burgess & Dawson 2004). Other mechanisms to acquire nutrients include those found in carnivorous plants, which acquire nutrients from their prey, symbiotic associations with microorganisms, and parasitic associations with host plants. These will be treated in separate chapters.

2. Acquisition of Nutrients

Most terrestrial plants absorb the inorganic nutrients required for growth via their roots from soil. For the uptake into the root cells, transport proteins (“carriers”, “channels”, and “transporters”) are used (Sect. 2.2.1). Before describing mechanisms associated with transport across the plasma membrane, we discuss the movement of nutrients in soil.

2.1 Nutrients in the Soil

2.1.1 Nutrient Availability as Dependent on Soil Age

In relatively young landscapes, following recent volcanic activity or glaciation, phosphorus (P) availability is relatively high, and nitrogen (N) tends to

be the key nutrient that limits plant productivity. In ancient, highly weathered soils that characterize much of Australia and the Cape region in South Africa, P is the key-limiting nutrient. **Chronosequences** (gradients of soil age) over various geological time scales up to 4 million years constitute natural experiments that allow the study of causes

of variation in availability and forms of N and P (Walker & Syers 1976, Vitousek 2004) (Fig. 1A) and of plant strategies for accessing different forms of nutrients (Lambers et al. 2008). These strategies broaden the options for uptake of resources from soils that differ in chemical composition. Individual strategies such as mycorrhizas, N₂-fixing symbioses

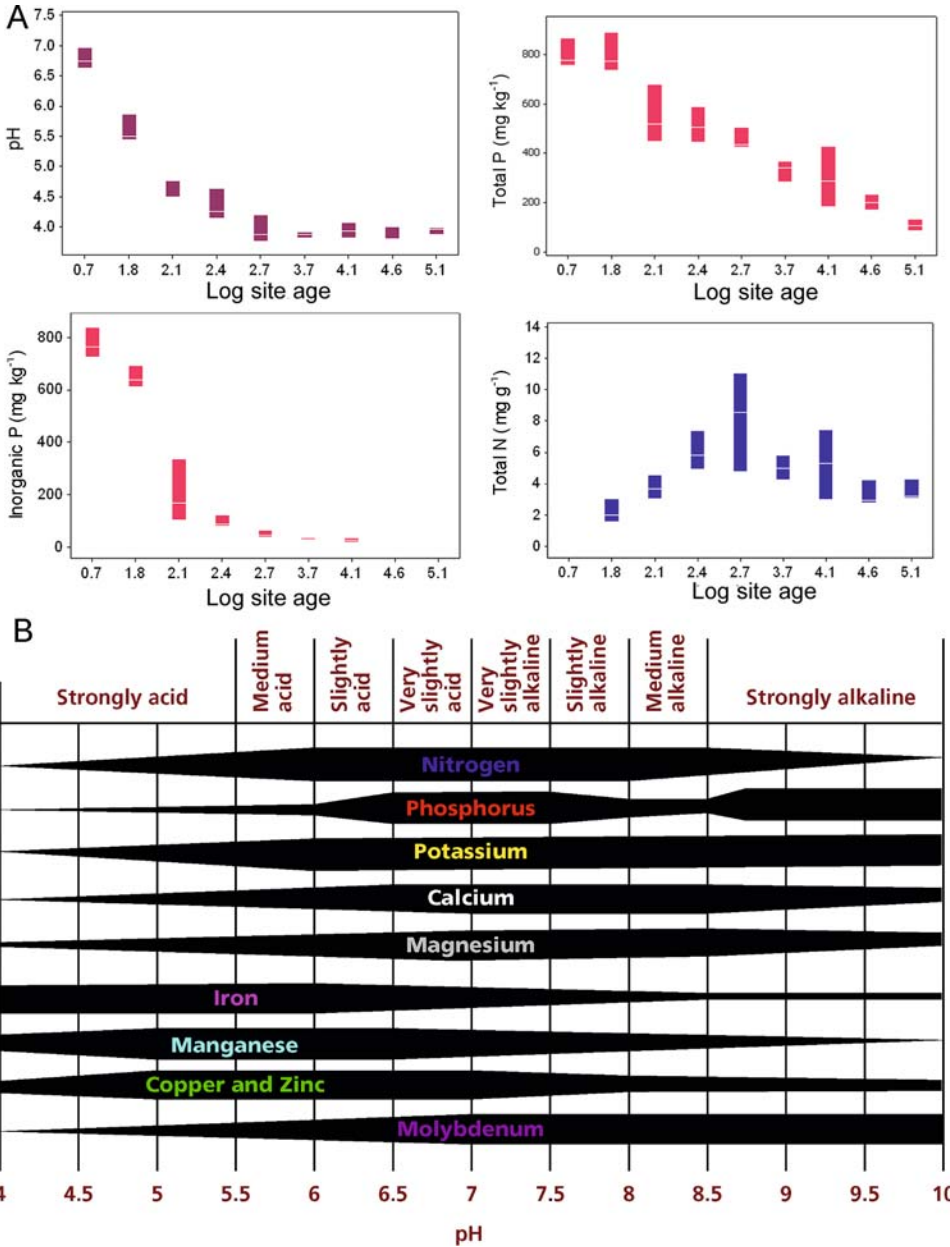

FIGURE 1. (A) Summary of mineral soil properties along the Franz Josef soil chronosequence. Box plot symbols: horizontal lines are the median; shaded bars give 25 and

75% percentiles, based on Richardson et al. (2004). (B) The availability of a number of essential nutrients in the soil as dependent on soil pH.

(Chapter 9A), and P-absorbing cluster roots (Sect. 2.2.5) may augment each other's activities. Together, these strategies allow plants to grow and compete under a wide range of conditions, including extremely nutrient-impooverished soils, such as those in ancient landscapes.

2.1.2 Nutrient Supply Rate

Nutrient supply rates in the soil ultimately govern the rates of nutrient acquisition by plants. **Parent material**, the rocks or sediments that give rise to soil, determines the proportions of minerals that are potentially available to plants. For example, granite is resistant to weathering and generally has lower concentrations of P and cations required by plants than does limestone. Other parent materials such as serpentine rock have high concentrations of heavy metals that are either not required by plants or are required in such low concentrations that their high concentrations in serpentine soils can cause toxic accumulations in plants. Various ecological factors (climate, vegetation, topography, and surface age) strongly influence weathering rates and rates of leaching loss and, therefore, the relationship between parent material and nutrient availability (Jenny 1980).

The **atmosphere** is the major source of N, through both biotic N_2 fixation (Sect. 2 of Chapter 9A on symbiotic associations) and deposition of nitrate and ammonium in precipitation. Atmospheric deposition of P is considerably less but can be important in extremely P-impooverished biomes, such as ocean basins downwind from deserts (Brown et al. 1984, Soderberg & Compton 2007). There is also substantial input from wet and dry deposition. Some cations [e.g., sodium (Na)] may come primarily from sea salt, particularly in coastal regions, but other nutrients [calcium (Ca), magnesium (Mg), phosphorus (P), and potassium (K)] come predominantly from dust (from deserts, agricultural areas, and unpaved roads) and from industrial pollution. These atmospheric inputs can be substantial. For example, atmospheric inputs of Ca are equivalent to 62, 42, and 154% of uptake by forests in the eastern United States, Sweden, and the Netherlands, respectively (Hedin et al. 1994), which is considerably higher than annual inputs by weathering. In ecosystems receiving aeolian dust, atmospheric deposition may contribute a substantial proportion of the P requirement of natural vegetation (Gressel & McColl 1997), especially in nutrient-impooverished landscapes (Soderberg & Compton 2007). Thus, atmospheric inputs may

determine external mineral supply to ecosystems much more than generally appreciated.

Soil pH is a major factor in determining the **availability** of nutrients in soils. High concentrations of hydrogen ions (low pH) cause modest increases in nutrient input by increasing weathering rate (Johnson et al. 1972), but even greater loss of base cations by leaching. Acid rain is a recent source of soil acidity caused by atmospheric deposition of nitric and sulfuric acid in precipitation. Protons first displace cations from the exchange complex on clay minerals and soil organic matter. Sulfate anions can then leach below the root zone, carrying with them mobile mineral cations (e.g., K, Ca, and Mg) and leaving behind a predominance of hydrogen and Al ions (Fig. 1B) (Driscoll et al. 2001). The availability of other ions is strongly affected by pH because this affects their oxidation state and solubility (e.g., P, S, and Al) or the biological processes that control production and consumption (e.g., N) (Fig. 1B).

In the short term, recycling of nutrients from dead organic matter is the major direct source of soluble nutrients to soils (Table 1). Soluble cations like K and Ca are leached from dead organic matter, whereas organically bound nutrients like N and P must be released by **decomposition**. Plants can only take up inorganic phosphate (P_i), predominantly as $H_2PO_4^-$, which is released by plant or microbial enzymes that release P_i from organic P forms (**phosphatases**). N is released from dead organic matter yielding soluble organic N, which may be further decomposed to NH_4^+ (**N mineralization**). NH_4^+ may then be oxidized, via NO_2^- , to NO_3^- (**nitrification**), and NO_3^- may be converted to gaseous N_2 or N_2O (**denitrification**) (Fig. 2A). The rates of these steps depend on temperature and soil conditions (e.g., pH and redox potential); however, nitrification may also be affected by inhibitors released from

TABLE 1. Major sources of available nutrients that enter the soil.

Nutrient	Source of nutrient (% of total)		
	Atmosphere	Weathering	Recycling
Temperate forest			
N	7	0	93
P	1	<10?	>89
K	2	10	88
Ca	4	31	65
Arctic tundra			
N	4	0	96
P	4	<1	96

Source: Chapin 1991.

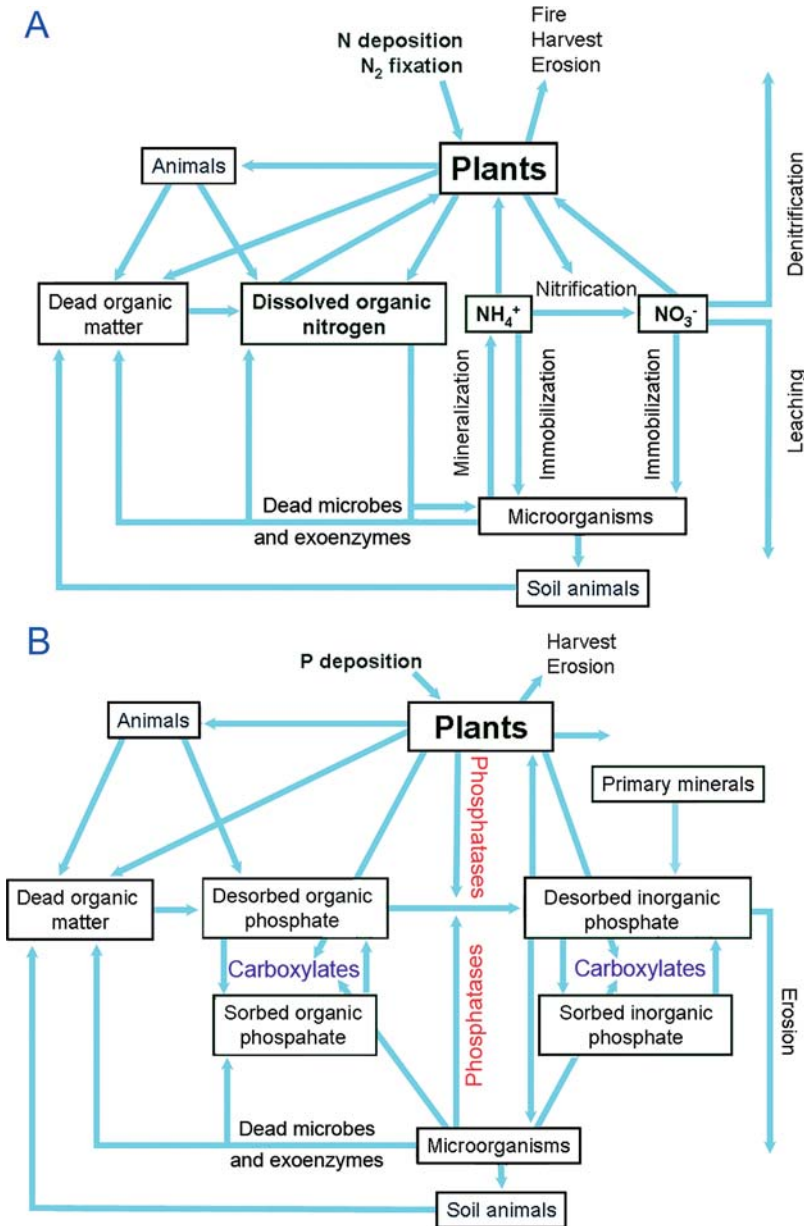

FIGURE 2. (A) A simplified view of the terrestrial N cycle. All N pools (boxes) and transformations (arrows) are affected by both plants and microorganisms. Dead plants, animals, and microorganisms are decomposed, releasing dead organic matter and then dissolved organic N (e.g., amino acids, urea). Some of the dissolved organic N in soils originate from living organisms. Both plants and microorganisms are capable of using dissolved organic N. Microorganisms use the dissolved organic N as a carbon source, releasing N that is in excess of their requirement as NH₄⁺. Both plants and microorganisms can use NH₄⁺ as a source of N. Incorporation of NH₄⁺ into soil microorganisms leads to

N-immobilization; the reverse transformation is called mineralization. Immobilization predominates at high availability of a carbon source, whereas mineralization is favored by a shortage of a source of carbon for microorganisms. Under aerobic conditions, some NH₄⁺ is transformed into NO₃⁻, in a process called nitrification. In alkaline soil, nitrification predominantly results from autotrophic microorganisms, whereas in acid soil heterotrophic microorganisms are probably most important. NO₃⁻ is available for both plants and microorganisms; as with NH₄⁺, some of the NO₃⁻ may be immobilized, or lost from the system through leaching or denitrification; denitrification can be inhibited by

roots (Lata et al. 2004), as is further discussed in Chapter 9E on interactions among plants. At each step, plants or soil microorganisms can take up soluble N, or N can be leached from the system, reducing the substrate available for the next N transformation. Therefore, the supply rates of the different forms of “available N” to plants and microbes must follow this same sequence: dissolved organic N \geq NH_4^+ \geq NO_3^- (Eviner & Chapin 1997). If N supply rate always follows the same sequence in all soils, why do the quantities and relative concentrations of these soluble forms of N differ among ecosystems?

First, microbes generally release P_i or NH_4^+ to the soil solution when their growth is more strongly limited by carbon than by nutrients (Schimel & Bennett 2004). On the other hand, they **immobilize** nutrients when decomposing plant litter with low nutrient concentrations and/or high concentrations of labile carbon (e.g., inputs of straw). Second, environmental conditions further modify rates of specific N transformations. For example, cold anaerobic soils in arctic Alaska limit N mineralization and nitrification (an aerobic process), so amino acid N concentrations are relatively high and NO_3^- concentrations low (Kielland 1994). On the other hand, in many arid and agricultural soils, high temperatures promote rapid mineralization and nitrification, and denitrification (an anaerobic process) occurs slowly, so NO_3^- is the most abundant form of soluble N. Finally, N-uptake rates by plants and microorganisms modify availability of each N form to other organisms. For example, low concentrations of NO_3^- in acidic conifer forest soils may be caused by rapid microbial NO_3^- uptake (Stark & Hart 1997), and not only by slow nitrification rates (Lodhi & Killingbeck 1980). Plant species in a N-limited, arctic tundra community are differentiated in timing, depth, and chemical form of N uptake, and species dominance is strongly correlated with uptake of the most available soil N forms (Jones et al. 2005, McKane et al. 2002).

The activity of **phosphatases** that release P_i from organic P sources (Sect. 2.2.5.1) implies that organic phosphate is hydrolyzed independently of the utilization of organic matter by microorganisms (Fig. 2B). In addition, root exudates can greatly

enhance weathering of primary minerals and mobilize phosphate **sorbed** to soil particles (Sect. 2.2.5.2); “sorption” refers to both adsorption (precipitation) onto soil particles and absorption inside such particles (Barrow 1984). When compared with the N cycle (Fig. 2A), the **P cycle** is, therefore, considerably less dependent on microbial decomposition of organic matter than the **N cycle**, on both biological and geological time scales (Fig. 2B; Gressel & McColl 1997, Johnson et al. 2003).

In summary, each nutrient is returned from dead organic matter to plant-available forms through distinct processes that occur at different rates in response to quite different environmental controls. Consequently, nutrients in the soil are seldom available in the proportions required by plants.

2.1.3 Nutrient Movement to the Root Surface

As roots grow through the soil, they **intercept** some nutrients. This amount, however, is often less than the amount contained in the growing root, and therefore cannot serve as a net source of nutrients to the rest of the plant. That is, roots do not move toward the nutrients; rather the nutrients must move to the roots by mass flow or diffusion (Table 2).

Rapid transpiration in plants may result in substantial nutrient transport from the bulk soil to the root surface via **mass flow**. The extent to which mass flow is responsible for ion transport to the roots depends on the concentration of the different ions in the bulk solution relative to the requirement for plant growth (Table 2; Prenzel 1979).

If less nutrients arrive at the root surface than are required to sustain plant growth, the concentration at the root surface drops, due to absorption by the roots. This creates a concentration gradient that drives ion **diffusion** toward the root (e.g., for P_i and K^+). Other ions are delivered more rapidly by mass flow than they are required by the roots (e.g., Ca^{2+}), which causes precipitation on the root surface (often as CaSO_4) (Barber & Ozanne 1970). Diffusion from the bulk soil to the root surface depends both on the **concentration gradient** and on the **diffusion coefficient**. This coefficient, which varies among soil types, differs by three orders of

FIGURE 2. (continued) specific compounds released from living roots or litter. (B) A simplified representation of the major processes and components of the terrestrial P cycle in plant–soil systems. Several processes explained for the N cycle (e.g., mineralization, immobilization)

play a similar role in the P cycle; however, leaching of P tends to be negligible, due to the low mobility of P in soil. Note that plants have considerably greater control over the P cycle than over the N cycle, e.g., via the release of phosphatases and carboxylates.

TABLE 2. The significance of root interception, mass flow, and diffusion in supplying *Zea mays* (corn) and a sedge tundra ecosystem with nutrients.*

Nutrient	Amount taken up by the crop	Approximate amounts supplied by		
		Root interception	Mass flow	Diffusion
<i>Zea mays</i>				
Nitrogen	190	2	150	38
Phosphorus	40	1	2	37
Potassium	195	4	35	156
Calcium*	40	60	165	0
Magnesium*	45	15	110	0
Sulfur	22	1	21	0
Copper*	0.1	–	0.4	–
Zinc	0.3	–	0.1	–
Boron*	0.2	–	0.7	–
Iron	1.9	–	1.0	–
Manganese*	0.3	–	0.4	–
Molybdenum*	0.01	–	0.02	–
<i>Sedge tundra ecosystem</i>				
Nitrogen	22	–	0.1	21.9
Phosphorus	1.4	–	0.01	1.4
Potassium	9.7	–	0.6	9.1
Calcium	20.9	–	52	0
Magnesium	47.1	–	39.1	8.0

Source: Clarkson 1981, Barber 1995, Jungk 1991; tundra data calculated from Shaver & Chapin 1991 and Chapin, unpublished.

* All data in kg ha^{-1} . The corn data pertain to a typical fertile silt loam and a crop yield of 9500 kg ha^{-1} and the tundra data a wet sedge meadow with a low-nutrient peat soil. The amount supplied by mass flow was calculated from the concentration of the nutrients in the bulk soil solution and the rate of transpiration. The amount supplied by diffusion is calculated by difference; other forms of transport to the root (e.g., mycorrhizas) may also be important but are not included in these estimates. The elements marked * are potentially supplied in excess by mass flow; they may accumulate at the soil/root interface and diffuse back into the bulk soil.

magnitude among common ions. It is large for NO_3^- , which therefore moves quickly to the root surface in moist soils, even when there is little water uptake. The diffusion coefficient is also fairly large for K^+ so that most plants can acquire sufficient K to sustain growth. Diffusion coefficients are very low for zinc (Zn^{2+}) and P_i (Table 3), due to specific interactions with the clay minerals of the soil cation-exchange complex. Hence, variation in soil clay content is one of the factors that affect the diffusion coefficient. N and P, which are the two macronutrients that most frequently limit plant growth, are seldom supplied in sufficient quantities by mass flow to meet the plant requirement; therefore, diffusion generally limits their supply to the plant, particularly in natural ecosystems. When soil solution concentrations are much higher, as they are in agricultural soils, mass flow delivers a major fraction of all N required for plant growth (Table 2; Yanai et al. 1998).

Most estimates of the importance of mass flow consider only water movement associated with transpiration. Bulk movement of soil solution, however, also occurs as a "wetting front" after rain. The wetting front carries ions with it and replenishes "diffusion shells" where plant uptake has reduced

TABLE 3. Typical values for diffusion coefficients for ions in moist soil.*

Ion	Diffusion coefficient ($\text{m}^2 \text{s}^{-1}$)
Cl^-	$2-9 \times 10^{-10}$
NO_3^-	1×10^{-10}
SO_4^{2-}	$1-2 \times 10^{-10}$
H_2PO_4^-	$0.3-3.3 \times 10^{-13}$
K^+	$1-28 \times 10^{-12}$

Source: Clarkson 1981.

* The range of values represents values for different soil types.

nutrient concentrations around individual roots. In arctic tundra, where permafrost causes substantial lateral movement of water, bulk water flow accounts for 90% of the nutrient delivery to deep-rooted species (Chapin et al. 1988). Bulk water movement may have a large (but currently unknown) influence on nutrient supply in other wet ecosystems. Soil heterogeneity may influence the importance of bulk water flow for nutrient supply to roots. Roots and rainwater both move preferentially through soil cracks created by small animals or soil drying. These effects of soil heterogeneity may increase the importance of bulk water movement as a mechanism of nutrient supply more than is currently appreciated.

Mass flow and diffusion cannot always account for the nutrient transport to the root surface. Mass flow delivers very little P_i to the roots, and the diffusion coefficient for P_i in soil is too low to allow much P_i to move by diffusion (Table 3). Some organic phosphate molecules may diffuse more rapidly and become available for the roots, but generally diffusion of organic phosphate is also slow (Sect. 2.2.5.1). If plants do not have access to this source of P, then special adaptations or acclimations are required to acquire P_i when its concentration in the soil solution is low (Sect. 2.2.2). Mycorrhizas are an additional important mechanism of nutrient transport to the root (Sect. 2 of Chapter 9A on symbiotic associations).

Because NO_3^- moves more readily to the roots' surface, it would appear to be available in larger quantities than NH_4^+ . Is NO_3^- really the predominant source of N for any plant? That depends to a large extent on environmental conditions. Where both NO_3^- and NH_4^+ are present, NH_4^+ is the preferred source (Garnett & Smethurst 1999, Kronzucker et al. 1999a). When amino acids are available, these can also represent a major source of N (Kielland 1994, Warren 2006). When the soil pH is low, the rate of nitrification, i.e., the oxidation of NH_4^+ to NO_2^- and then to NO_3^- by NH_4^+ -oxidizing and NO_2^- -oxidizing autotrophic bacteria, respectively, tends to be slow (Lodhi & Killingbeck 1980). Under these conditions NO_3^- will not be a major source of N. The same is true for anaerobic soils, since nitrification is an aerobic process. When soils are cold, such as in arctic Alaska, mineralization is slow, very little NH_4^+ is made available, and a large fraction of the total pool of soil N is present as amino acids (Kielland 1994, Lipson & Näsholm 2001). Under such conditions, amino acids tend to be a major source of N (Henry & Jefferies 2003), but arctic plants will also absorb NO_3^- or NH_4^+ and assimilate it, if supplied in sufficient amounts. Most plants from acid soils, similarly, appear to be

capable of absorbing and assimilating NO_3^- and very few species appear to be incapable of using NO_3^- as a source of N (Atkin 1996, Min et al. 1999). The potential to utilize amino acids as N sources is, however, common in most plant communities, regardless of soil fertility (Schmidt & Stewart 1999, Kielland et al. 2006).

Low water availability reduces diffusion rates below values in moist soils, because air replaces water in pores of dry soil, greatly lengthening the path from the bulk soil to the root surface (increased "tortuosity"). Ion mobility in soil can decrease by two orders of magnitude between a soil water potential of -0.01 and -1.0 MPa, which is a range that does not strongly restrict water uptake by most plants (Fig. 3). Because diffusion is the rate-limiting step in uptake of the most strongly limiting nutrients (Table 2), reduction in water availability can greatly reduce plant growth. Two lines of evidence suggest that this may be a major causal mechanism by which low water supply restricts plant growth (Chapin 1991):

- (1) Tissue concentrations of growth-limiting nutrients often decline with water stress (Fig. 4), whereas one would expect tissue concentrations to increase if water restricted growth more than nutrient uptake.
- (2) Nutrient addition enhances growth of some desert annuals more than does water addition (Gutierrez & Whitford 1987).

The implication of this is that, with current predictions of climate change, plant growth in Mediterranean regions will become more limited by P (Sardans et al. 2007).

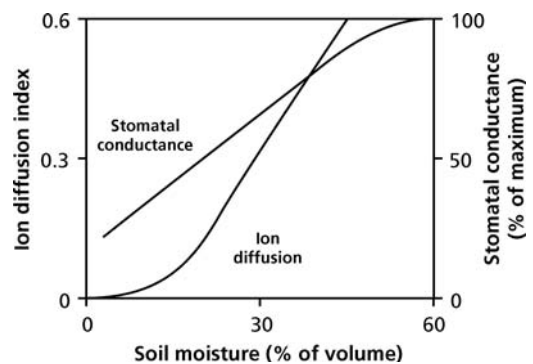

FIGURE 3. The rate of ion diffusion (deduced from the diffusion impedance factor for Cl^-) and leaf conductance to water vapor as dependent on soil moisture for *Nerium oleander* (oleander) grown in a sandy loam (after Chapin 1991).

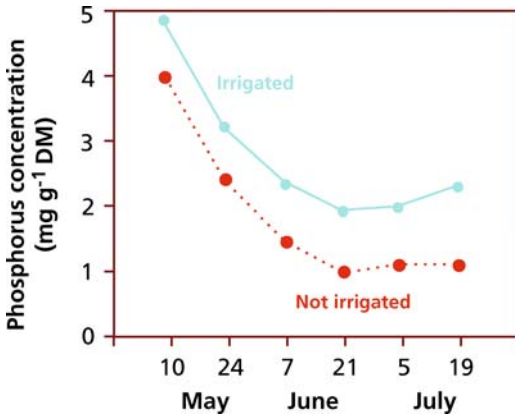

FIGURE 4. P concentration in the shoots of *Hordeum vulgare* (barley) grown with or without irrigation (after Chapin 1991).

For soil-mobile ions, such as NO_3^- , tissue concentrations vary with soil moisture availability in exactly the opposite manner as found for immobile ions. That is, in plants of Australian semi-arid mulga woodlands, the NO_3^- concentration in the tissue tends to be high and the rate of NO_3^- assimilation tends to be low, when the availability of soil moisture is low. After a shower, the NO_3^- concentration in the soil rises rapidly, and the rate of NO_3^- assimilation in the tissue increases, whereas the concentration of NO_3^- in the tissue declines (Erskine et al. 1996).

2.2 Root Traits That Determine Nutrient Acquisition

Rates of nutrient uptake depend on the quantity of root surface area and the uptake properties of this surface. Once nutrients arrive at the root surface, they must pass the plasma membrane of the root cells. As with carbon uptake by photosynthesis (Sect. 2.2 of Chapter 2A on photosynthesis), the rate of nutrient uptake depends on both the concentration in the environment and the **demand** by the plant as well as on the inherent capacity of a plant to take up certain nutrients. The plant's demand is determined by its growth rate and the concentration of the nutrient in the tissues. At a high internal concentration, the capacity for uptake of that nutrient tends to be **down-regulated** so as to avoid nutrient toxicity. Despite this feedback mechanism, plants may show **luxury consumption** of specific nutrients (i.e., absorption at a higher rate than

required to sustain growth), leading to the accumulation of that nutrient. Many species from N-rich sites [e.g., *Urtica dioica* (stinging nettle), *Spinacia oleracea* (spinach), and *Lactuca sativa* (lettuce)] show luxury consumption of NO_3^- and accumulate NO_3^- in their vacuoles (Martinoia et al. 1981). Some species from severely P-impooverished habitats [e.g., *Hakea prostrata* (harsh hakea), *Banksia grandis* (bull banksia), and *Protea compacta* (bot river sugarbush)] exhibit **P toxicity** when exposed to slightly higher P levels than that occurring in their natural habitat, because they fail to sufficiently down-regulate P uptake as internal P concentration increases (Lambers et al. 2008).

2.2.1 Increasing the Roots' Absorptive Surface

Because diffusion is the major process that delivers growth-limiting nutrients to plant roots (Table 2), the major way in which plants can augment nutrient acquisition is by increasing the size of the root system. The relative size, expressed as the **root mass ratio** (root mass as a fraction of total plant mass), is enhanced by growth at a low nutrient supply (**acclimation**) (Brouwer 1962). Similarly, plants **adapted** to low nutrient supply typically have a high root mass ratio. Increased root allocation is particularly important for those ions that diffuse slowly in soil (e.g., P_i). In a heterogeneous soil, roots tend to proliferate in those zones with highest availability of N or P, rather than in depleted zones, thus maximizing the effectiveness of each unit of root production (but see Sect. 2.2.5).

The effective absorbing root surface can be enlarged by **root hairs** (Table 4). These root hairs vary in length from 0.2 to 2 mm, depending on species. Root hair length may increase from 0.1 to 0.8 mm, due to reduced supply of NO_3^- or P_i (Bates & Lynch 1996). The diameter of most roots involved in ion uptake is between 0.15 and 1.0 mm, so the presence of root hairs allows a considerably larger cylinder of the soil to be exploited by the root than could be achieved by a root without root hairs. Root hairs have greatest effect on absorption of those ions that diffuse slowly into soil; they are probably not important for the uptake of Si, since mutants of *Oryza sativa* (rice) that lack root hairs take up Si at the same rates as the wild type, and Si transporters involved in Si uptake are not expressed in root hairs (J.F. Ma et al. 2001b, 2006). In low-P soils root hairs may be responsible for as much as 90% of total P_i uptake (Föhse et al. 1991). Total root hair length in cereals may be 20–50 m m⁻¹ (of roots from which they emerge); the higher values are

TABLE 4. Phosphorus uptake of seven plant species in relation to morphological root properties (root radius and root hairs).

Species	P_i uptake (10^{-12} mol m^{-1} s^{-1})	Root radius (μm)	Root hairs		
			Number per mm	Average length (mm)	Surface area of root hairs ($m^2 m^{-2}$)
<i>Allium cepa</i>	84	2290	1	0.05	6.5×10^{-3}
<i>Lolium perenne</i>	69	660	45	0.34	1.2
<i>Triticum aestivum</i>	91	770	46	0.33	1.2
<i>Brassica napus</i>	320	730	44	0.31	1.3
<i>Solanum lycopersicum</i>	186	1000	58	0.17	0.6
<i>Spinacia oleracea</i>	485	1070	71	0.62	1.9
<i>Phaseolus vulgaris</i>	60	1450	49	0.20	0.4

Source: Föhse et al. 1991.

typical for P-efficient cultivars (Gahoonia & Nielsen 2004). Species with a high frequency of long root hairs yield relatively more when P is limiting, in comparison with those with less frequent or shorter root hairs which need a high P_i supply for good growth. Increasing the root mass ratio or production of root hairs must incur costs, in terms of investment of carbon, N, and other resources. To achieve a 200% expansion of the root surface by root hairs incurs less than 2% of the costs associated with a similar increase realized by a greater investment in roots (Clarkson 1996). **Mycorrhizal associations** are even more effective in terms of enlarging the P_i -absorbing surface per unit cost, even if we consider that the fungus requires additional plant-derived carbohydrates for its functioning (Sect. 2.6 of Chapter 9A on symbiotic associations).

2.2.2 Transport Proteins: Ion Channels and Carriers

Roots transport nutrients across their plasma membrane either by **diffusion** down an electrochemical potential gradient or by **active transport** against an electrochemical potential gradient. The electrochemical potential gradient is caused by the extrusion of protons by a **proton-pumping ATPase** that pumps H^+ from the cytosol across the plasma membrane. This creates an electrical potential difference of approximately 80–150 mV (negative inside) across the plasma membrane (Fig. 5A); however, values outside this range have also been measured (Cheeseman & Hanson 1979, Szczerba et al. 2006a). The proton pump functions like the ATPase in the thylakoid membrane of the chloroplast (Sect. 2.1.3 of Chapter 2A on photosynthesis) and the inner membrane of mitochondria (Sect.

2.5.1 of Chapter 2B on plant respiration); however, here the ATPase acts in reverse: it uses ATP and extrudes protons. Cations tend to move inward and anions outward along this electrochemical potential gradient. The **Nernst equation** allows us to calculate that monovalent cations are at electrochemical equilibrium (no driving force for movement) if the concentration of the cation is 40- to 150-fold lower outside than inside the cell. For monovalent anions, the reverse can be calculated: the concentration of an anion at electrochemical equilibrium is 40- to 150-fold lower inside than outside the cell. When concentration gradients are less than this, ions may move in the direction predicted by the electrochemical gradient; when the concentration gradients exceed these values, ions may move in the opposite direction (Fig. 5B).

For most ions, diffusion across the lipid bilayer of the plasma membranes is a very slow process, unless facilitated by special transport proteins. Such transport proteins include **ion-specific channels** (i.e., “pores” in the membrane through which ions can move single file) (Roberts 2006). These channels function in a similar way as the water-channel proteins discussed in Sect. 5.2 of Chapter 3 on plant water relations. The ion channels are either open or closed, depending on the membrane potential or the concentration of specific effectors (Fig. 5A). Ion channels have the advantage that they allow massive transport, albeit only down an electrochemical potential gradient. If such a gradient does not exist or when the gradient is in the opposite direction, channels cannot be used for net transport. In that case, transport may require, first, the extrusion of protons via a H^+ -pumping ATPase (Fig. 5A). The proton gradient can then be used for uptake of ions, in a proton-cotransport mechanism via **carrier proteins** (Fig. 5A). Such carriers are like enzymes: they bind their substrates, followed

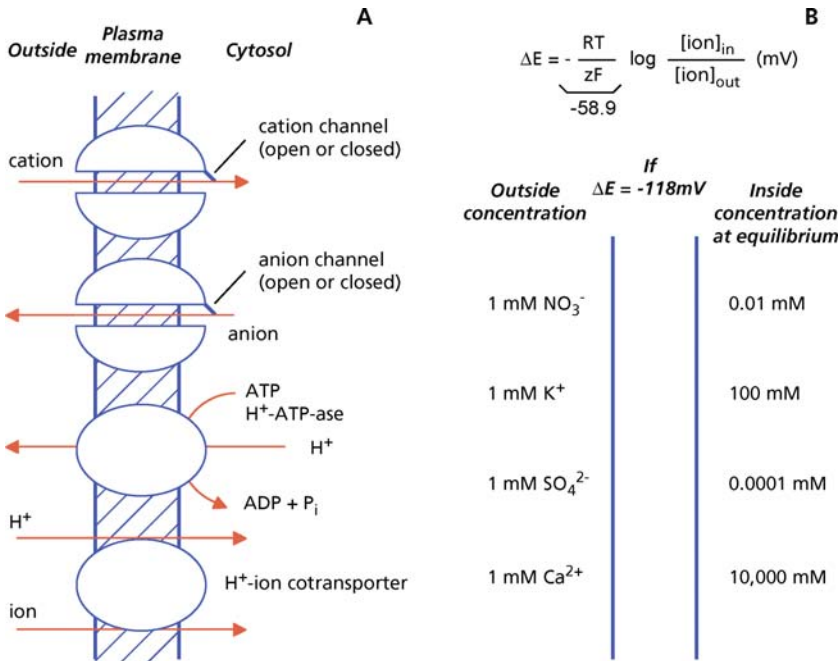

FIGURE 5. (A) Ion transport across the plasma membrane. The membrane potential is negative (i.e., there is a negative charge inside and a positive charge outside). Cations can enter via a cation channel, down an electrochemical potential gradient. Anions (e.g., NO₃⁻) can only leave the cytosol via an anion channel, down an electrochemical potential gradient. An H⁺-ATPase ("proton pump") extrudes protons from the cytosol, thus creating a proton-motive force. Protons can be used to drive ion uptake against an electrochemical potential gradient. For further explanation, see the

text. (B) Schematic representation of the concentration of monovalent and divalent anions and cations that is expected if the plasma membrane is perfectly permeable for these ions in the absence of energy-requiring mechanisms at a membrane potential of 118 mV. The Nernst equation gives the relationship between the membrane potential ΔE and the outside and inside ion concentrations. R is the gas constant; T is the absolute temperature; z is the valency of the ion for which the equilibrium concentration is calculated; and F is Faraday's number. For further explanation, see the text.

by a specific reaction (release of the substrate at the other side of a membrane), and may be allosterically regulated. Carriers tend to have a much lower transport capacity than channels. Both types of proteins are subject to turnover so that continuous protein synthesis is required to maintain ion transport.

Although ions can move via a channel down an electrochemical potential gradient across the plasma membrane, it should be noted that also ion transport via channels is eventually an **active process**, because charge balance must be accomplished, by the H⁺-pumping ATPase, at the expense of ATP; otherwise, membranes subjected to, say, NH₄⁺ or Na⁺ uniport would electrically supercharge and "combust" very quickly (Gerendás & Schurr 1999, Britto & Kronzucker 2006).

Both channels and carriers are, in principle, ion specific, but other ions with similar structure might occasionally enter the cell via these transport proteins. This may account for the entry of some Na⁺,

heavy metals, and Al in plant roots. Transport proteins are involved in the **influx** of nutrients from the rhizosphere, as well as in the transport of some of the acquired nutrients into the **vacuoles** and the release into the **xylem vessels** (De Boer & Wegner 1997). Channels and carriers are also involved in ion **efflux**, sometimes spectacularly so, as during stomatal movements (Sect. 5.4.2 of Chapter 3 on plant water relations), or they may be responsible for efflux of nutrients, which may occur simultaneously with nutrient influx. Uptake of Na⁺ ions from a saline soil occurs down an electrochemical potential gradient, in which case the ions may be extruded with an energy-dependent carrier mechanism (Sect. 3.4.1; Davenport & Tester 2000). Silicon (as silicic acid) is transported into the root cells by a passive channel, but out of the cells by an active transporter (Ma et al. 2006, 2007).

Transport from the rhizosphere across the plasma membrane into the cytosol (influx) is mostly

against an electrochemical potential gradient for all anions and sometimes also for some cations. Such transport must involve an active component (i.e., it requires **metabolic energy**); however, transport mediated by channels also requires metabolic energy, although indirectly to generate the electrochemical potential gradient. This requires respiratory energy: ATP is used to extrude protons, catalyzed by an H^+ -ATPase, so that a membrane potential is created (inside negative). **Efflux** of ions, from the cytosol to the rhizosphere, is mostly down an electrochemical potential gradient for anions; the efflux of NO_3^- may be very low in some circumstances, but it may also be of similar magnitude as the influx (Kronzucker et al. 1999b), especially in slow-growing plants grown with a high nutrient supply (Scheurwater et al. 1999). Like the NO_3^- -uptake system, the NO_3^- -efflux system is NO_3^- inducible, and it strongly increases with increasing internal NO_3^- concentrations. The efflux system requires both RNA and protein synthesis, but has a much lower turnover rate than the uptake system (Aslam et al. 1996). NO_3^- efflux may contribute significantly to the respiratory costs associated with nutrient acquisition (Sect. 5.2.3 of Chapter 2B on plant respiration). NO_3^- efflux may reflect a fine control of net uptake, compared with the coarse control of gene expression. Ion efflux from roots is not restricted to Na^+ and NO_3^- , but is quite common for a range of other cations and anions (Demidchik et al. 2002, Roberts 2006).

2.2.3 Acclimation and Adaptation of Uptake Kinetics

2.2.3.1 Response to Nutrient Supply

Nutrient uptake by roots increases in response to increasing nutrient supply up to some maximum uptake rate, where a plateau is reached (Fig. 6A) which is very similar to the CO_2 or light-response curves of photosynthesis (Sect. 2.2 of Chapter 2A on photosynthesis; Epstein & Hagen 1952). If nutrient uptake is not limited by diffusion of the nutrient to the root surface, then the shape of this curve is also similar to that obtained with enzymes in solution (Michaelis–Menten kinetics). This leads to the suggestion that the **maximum inflow rate** (I_{max}) may be determined largely by the abundance or specific activity of transport proteins in the plasma membrane; the K_m describes the **affinity** of the transport protein for its ion. This analogy may not be entirely accurate, however, because the access of ions to carriers and ion channels in plasma membranes of a structurally complex cortex is probably quite

different from the access of substrates to an enzyme in a stirred solution. Nonetheless, I_{max} is a useful description of the capacity of the root for ion uptake, and K_m describes the capability of the root to utilize low concentrations of substrate (low K_m confers high affinity). Affinities and transporter abundance may be reasonably inferred, provided influx is properly measured, and this can be difficult at high nutrient concentrations (Szczerba et al. 2006b). C_{min} is the minimum ion concentration at which net uptake occurs (analogous to the light- and CO_2 -compensation points of photosynthesis). C_{min} , the minimum ion concentration at which net uptake occurs (Fig. 6A), is determined by the balance of influx by ion-transport proteins and efflux along an electrochemical potential gradient. The experimental determination of C_{min} is difficult. For instance, in nonsterile conditions much of the nutrient remaining in solution is in microorganisms. If these are filtered out, then the C_{min} is often spectacularly lower than is usually determined in this critical experiment.

For many nutrients, roots have both a **high-affinity uptake system**, which functions well at low external concentration but has a low I_{max} , and a **low-affinity system**, which is slow at low external concentrations but has a high I_{max} (Forde 2002, Bucher 2007). The high-affinity system is most probably carrier mediated, whereas the low-affinity system may reflect the activity of a channel, at least for K^+ . However, there are also “**dual-affinity transporters**”, e.g., for NO_3^- (Liu & Tsay 2003). Switching between the two modes of action is regulated by **phosphorylation**; when phosphorylated, the transporter functions as a high-affinity NO_3^- transporter, whereas, it functions as a low-affinity NO_3^- transporter when dephosphorylated. This regulatory mechanism allows plants to change rapidly between high- and low-affinity NO_3^- uptakes. The ecophysiological significance of low-affinity systems for NO_3^- , which only allow significant uptake at NO_3^- concentrations well above that in most natural soils, still remains to be demonstrated (Sect. 2.2.3.2).

When nutrients are in **short supply**, plants tend to show a **compensatory** response in that the I_{max} is increased and a high-affinity transport system is sometimes induced. For example, plants exhibit a high capacity (i.e., high I_{max}) to absorb P_i when grown at a very low supply of P_i , a high potential to absorb NO_3^- and NH_4^+ under conditions when N is in short supply, a high potential to absorb K^+ or SO_4^{2-} when K or S are limiting (Table 5). Information about other nutrients is sparse, but it suggests that there is little stimulation of the inflow of Ca, Mg, and Mn (Robinson 1996). The compensatory increase in

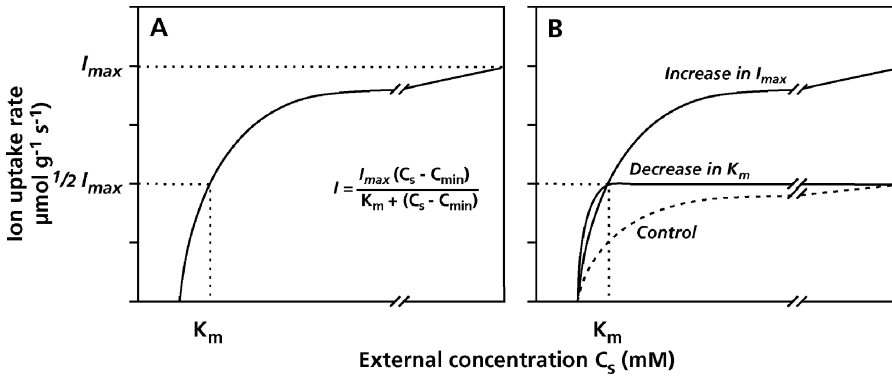

FIGURE 6. (A) The relationships between uptake rates (net inflow = I) of ions and their external concentrations (C_s). At C_{min} the net uptake is zero (influx = efflux). (B) Uptake kinetics in control plants and in plants grown with a shortage of nutrients. Note that both

induction of a different high-affinity system and up-regulation of the same low-affinity system enhance the capacity for nutrient uptake at low external concentration.

I_{max} for P, N, and K in response to a shortage of these nutrients occurs over a 2- to 15-day period, but can be as fast as hours (Siddiqi et al. 1990). It is specific to the nutrient that limits growth: N limitation increases the capacity to absorb both NH_4^+ and NO_3^- , but it decreases the capacity to absorb other nonlimiting nutrients (Table 5). The appearance of a high-affinity system (low K_m) is especially strong for K, and happens within an hour (Smart et al. 1996).

TABLE 5. Effect of a shortage of one nutrient or of water and exposure to a low irradiance on the maximum rate of nutrient uptake (I_{max})*.

Limiting factor	Ion absorbed	Uptake rate by stressed plants (% of control)
Nitrogen	Ammonium	209
	Nitrate	206
	Phosphate	56
	Sulfate	56
Phosphorus	Phosphate	400
	Nitrate	35
	Sulfate	70
Sulfur	Sulfate	895
	Nitrate	69
	Phosphate	32
Water	Phosphate	13
Light	Nitrate	73

Source: Chapin 1991.

*Values for *Hordeum vulgare* (barley), except for water stress [*Solanum lycopersicum* (tomato)]. Stress is due to low availability of the resource listed in the left-hand column.

Compensatory changes in I_{max} involve synthesis of additional transport proteins for the growth-limiting nutrient, and an up-regulation of mRNA levels coding for a high-affinity uptake system (Sect. 2.2.3.2). A decrease in K_m could be due to induction of a high-affinity system, or to allosteric effects on or phosphorylation of existing transporters (Smart et al. 1996, Liu & Tsay 2003). Both an increase in capacity (I_{max}) of a low-affinity system and induction of a high-affinity system may enhance the uptake capacity at a low nutrient supply (Fig. 6B).

An increase in I_{max} or a decrease in K_m is functionally important if processes at the root surface limit nutrient uptake, as would be the case for NO_3^- . The significance of the up-regulation of the uptake system for the plant is that the concentration of the limiting nutrient at the root surface is decreased which increases the concentration gradient and the diffusion of the limiting nutrient from the bulk soil to the root surface. The significance of such up-regulation for plants growing in soil is relatively small for immobile ions such as P_i , when compared with that for mobile ions such as NO_3^- . For immobile ions, it is the mobility in the soil, rather than the I_{max} of the roots, that determines the rate at which roots can acquire this nutrient from the rhizosphere (Sects. 2.1.2 and 2.3). Rather than considering an up-regulation of I_{max} for P uptake at a low P availability uptake as being functionally important, a down-regulation at higher P supply is probably important in avoiding P toxicity (Shane et al. 2004a, b).

2.2.3.2 Response to Nutrient Demand

Any factor that increases plant **demand** for a specific nutrient appears to cause an increase in I_{\max} for that nutrient. Up-regulation of the system for NO_3^- uptake upon an increased demand involves the NO_3^- concentration in the root itself as well as **systemic signals** from the shoot, imported via the phloem (King et al. 1993). The signals that arrive via the phloem probably include a low concentration of amino acids and/or an increased concentration of organic acids (Touraine et al. 1994). In experiments on effects of the demand for P_i , K^+ , or SO_4^{2-} , effects of demand can be simulated by a period of starvation, as discussed in 2.2.3.1. For example, in *Arabidopsis thaliana* (thale cress) the expression of genes that encode a P_i transporter and the capacity to take up P_i increases with decreasing internal P concentration (Dong et al. 1999). The same happens with genes that encode NH_4^+ transporters and the capacity to take up NH_4^+ when the external NH_4^+ supply increases (Rawat et al. 1999). The influence of demand and starvation on NO_3^- transport, however, is more complex (Fig. 7).

For NO_3^- , as is the case for many other ions, there are two inducible uptake systems: a **high-affinity transport system (HATS)** and a **low-affinity transport system (LATS)**; other genes encoding NO_3^- -uptake systems are constitutively expressed (Miller & Cramer 2005). In the complete absence of external NO_3^- (rather than low external concentrations as described in Table 5), the uptake capacity is very low. In *Hordeum vulgare* (barley) and *Lotus japonicum*

(birdsfoot-trefoil), the mRNA for the HATS is almost absent after 72 hours of NO_3^- deprivation. Upon re-exposure of the roots to NO_3^- , this is first taken up by the constitutive HATS. After 30 minutes, there is a huge rise in mRNA encoding the HATS, and after 2–4 hours the inducible HATS is reassembled in the plasma membrane (Trueman et al. 1996a), and the rate of NO_3^- uptake increases (Siddiqi et al. 1990). The general experience, however, is that plants receiving NO_3^- , but in amounts inadequate for supporting maximum growth, de-repress their NO_3^- -transport activity (Table 5), so net NO_3^- uptake increases in experimental conditions where the plants are given a sudden dose of NO_3^- (Fig. 7).

The significance of the low-affinity uptake systems, which only function at external NO_3^- concentrations well above that normally found in soil, is puzzling. Concentrations in the range of 5–20 mM, however, do occur in the rhizosphere of crop plants and ruderals (i.e., species that occupy disturbed sites where nitrification rates are generally high) (Wolt 1994). In *Arabidopsis thaliana* (thale cress), the gene that encodes the inducible low-affinity system is expressed in epidermal cells close to the root tip, and in cells beyond the epidermis and even the endodermis further away from the tip; but it is never expressed in the vascular cylinder (Huang et al. 1996). The low-affinity NO_3^- -uptake systems cannot be passive, because transport occurs against an electrochemical potential gradient even at an external NO_3^- concentration of 1 mM (Siddiqi et al. 1991). The constitutive system may serve as a **NO_3^- -sensing system**, because it is associated with a plasma membrane-bound nitrate reductase. The

FIGURE 7. Regulation of the inducible high-affinity NO_3^- uptake system (HATS) by NO_3^- . The HATS is affected both by external NO_3^- supply and by internal demand. **Situation 1:** If *no nitrate* is present in the rhizosphere, there is no positive effector. The gene encoding the NO_3^- transporter is repressed and the system cannot respond immediately to the addition of NO_3^- . **Situation 2:** If there is an *inadequate nitrate* concentration in the rhizosphere, NO_3^- is sensed (probably by the constitutive HATS) and the gene encoding the NO_3^- transporter is transcribed and the system responds to the addition of NO_3^- . Products of the reduction and assimilation of NO_3^- (amino acids, organic acids) have a negative effect on the transcription of the gene encoding the HATS.

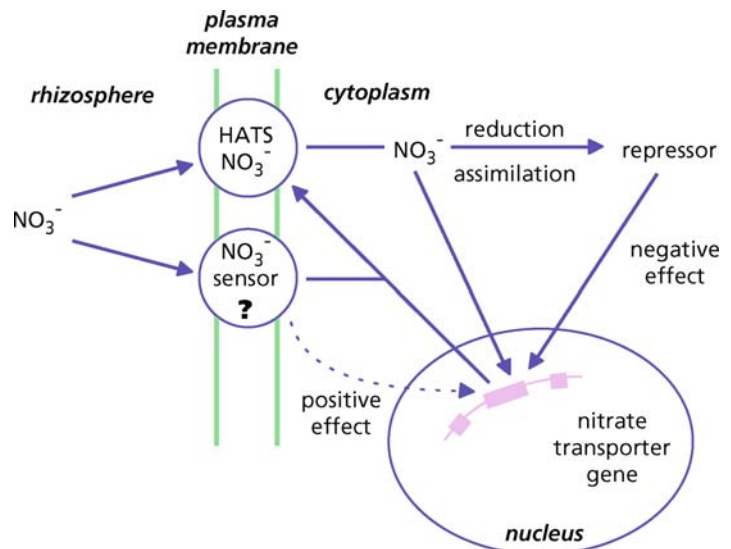

concerted action of the constitutive system and its associated nitrate reductase may lead to the production of intermediates that induce both the inducible high-affinity system and cytosolic nitrate reductase. Both the constitutive and the inducible systems are carrier-mediated proton-cotransport systems, requiring the entry of two protons for every NO_3^- taken up (Mistrik & Ullrich 1996, Trueman et al. 1996b).

C_{\min} for a given ion decreases in minutes to hours in response to decreases in supply of that ion, due to decreases in its cytoplasmic concentration, which reduce leakage across the plasma membrane and therefore efflux rates (Kronzucker et al. 1997). The increase in I_{\max} when plants acclimate to low availability of a given nutrient increases the plant's capacity to absorb nutrients from solutions of low concentration (Fig. 8). This compensation, however, is always less than 100%, so tissue concentrations increase under conditions of high nutrient supply (**luxury consumption**) and decrease under conditions of low nutrient supply (high nutrient-use efficiency) (Sect. 4). A low capacity to down-regulate I_{\max} for P_i uptake is typically associated with species occurring on severely P-impooverished soils (Fig. 8).

A plant's response to nutrient stress, e.g., a short supply of P, requires a capacity to sense the internal nutrient status, e.g., leaf [P]. Recent studies have demonstrated the novel functions of **micro-RNAs** (miRNAs) in regulating adaptive responses to nutrient stresses. Plant miRNAs usually down-regulate the abundance of their target mRNAs by post-transcriptional cleavage of the targeted mRNA. For example, miR399 is up-regulated during P_i deficiency which results in down-regulation of *UBC24*, a gene involved in **targeted protein degradation**. Plants over-expressing miR399 or defective in the gene involved in targeted protein degradation (*UBC24*) display P toxicity because of increased P uptake, enhanced root-to-shoot translocation, and retention of P in their old leaves. This suggests that the miR399-mediated regulation of *UBC24* expression is critical in **P homeostasis**. Similar results have been found for plants that are deprived of S. The existence and conservation of miRNAs and their target genes involved in P and S uptake among many plant species point to the evolutionary importance of these miRNA-mediated nutrient-stress responses (Chiou 2007).

The nature of genetic adaptation to infertile soils differs among ions. Plants adapted to infertile soils typically have a low capacity to absorb immobile ions like P which follows from their relatively low growth rate and hence a low demand for nutrients.

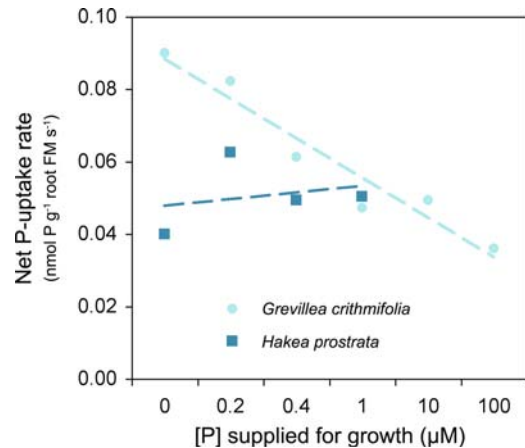

FIGURE 8. Net P_i -uptake rates for intact whole root systems, calculated from P_i -depletion curves. The nutrient solution for the uptake studies contained $5 \mu\text{M P}$. Uptake rates are plotted against the external P concentration during plant growth, for *Grevillea crithmifolia* and *Hakea prostrata* (harsh hakea). Note down-regulation of net P-uptake rates (the common response) in *Grevillea crithmifolia*, and a lack of down-regulation of net P-uptake rates in *Hakea prostrata* (which accounts for this species showing signs of P toxicity upon fertilization with P). After Shane et al. (2004b) and Shane & Lambers (2006).

2.2.3.3 Response to Other Environmental and Biotic Factors

The responses of nutrient-uptake kinetics to changes in water, light, and other factors are readily predicted from changes in plant demand for nutrients. **Water stress** may reduce the capacity of roots to absorb nutrients, if it reduces growth, and therefore plant demand for nutrients (Table 5, Fig. 9A). Similarly, plants adapted to dry environments typically have low relative growth rates (Chapter 7 on growth and allocation), and, consequently, low capacities to absorb nutrients. The effect of **irradiance** on nutrient-uptake kinetics depends on nutrient supply. With adequate nutrition, low light availability reduces nutrient uptake (Table 5, Fig. 9B). By contrast, nutrient uptake by nutrient-limited plants is not strongly affected by light availability.

Low temperature directly reduces nutrient uptake by plants, as expected for any physiological process that is dependent on respiratory energy (Fig. 10A; Macduff et al. 1987). Plants compensate through both acclimation and adaptation for this temperature inhibition of uptake by increasing their capacity for nutrient uptake (Fig. 10B,C). In contrast to plants from dry and infertile environments, arctic and alpine plants often grow quite rapidly and so

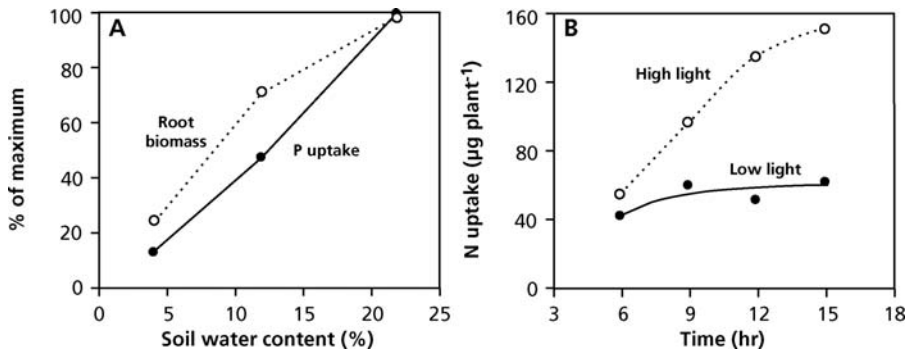

FIGURE 9. Effect of soil water content on root biomass and P_i uptake per unit root biomass in *Solanum lycopersicum* (tomato) (A) and of growth irradiance on

ammonium uptake per plant in *Oryza sativa* (rice) (B) (after Chapin 1991).

exploit the short growing season; therefore, they have a substantial demand for nutrients.

When plants are grown with an adequate nutrient supply and store nutrients, **grazing** of leaves reduces plant nutrient demand and therefore reduces nutrient-uptake capacity (Clement et al. 1978). By contrast, grazing of nutrient-stressed plants can deplete plant nutrient stores, so that plants respond by increasing nutrient-uptake capacity (Chapin & Slack 1979). Plants that are adapted to frequent grazing, such as grasses from the Serengeti Plains of Africa, similarly increase their capacity to absorb P_i when clipped to simulate grazing (McNaughton & Chapin 1985).

2.2.4 Acquisition of Nitrogen

N can be absorbed by plants in three distinct forms: NO₃⁻, NH₄⁺, and **amino acids**. N assimilation (i.e.,

the conversion of inorganic to organic N) has a substantial carbon cost: NO₃⁻ must first be reduced to NH₄⁺, which must then be attached to a carbon skeleton before it can be used in biosynthesis. Thus, the carbon cost of assimilation which is generally large is NO₃⁻ >> NH₄⁺ > amino acids (Zerihun et al. 1998). Depending on the species, NO₃⁻ is reduced either in the roots or transported to the leaves, where it is reduced in the light. The first step in the reduction is catalyzed by **nitrate reductase**, which is an inducible enzyme; the gene encoding nitrate reductase is transcribed in response to NO₃⁻ application (Campbell 1996). The protein is rather short lived, being degraded with a half-time of a few hours (Miller & Cramer 2005). In addition, the activity of the enzyme is controlled by phosphorylation. In the leaf, the enzyme is turned off at night by **phosphorylation**, which allows inactivation of nitrate reductase by an inhibitor protein.

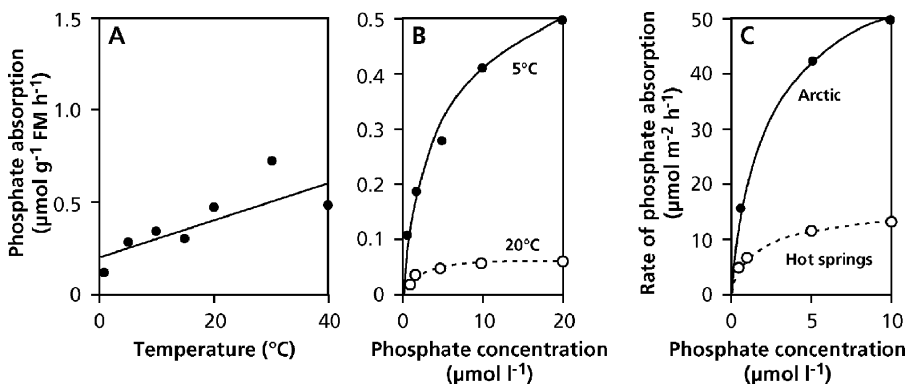

FIGURE 10. Response of P_i uptake by *Carex aquatilis* (a tundra sedge) to temperature at different time scales: (A) immediate response, (B) response following

acclimation, and (C) response of adapted genotypes (measured at 5°C) (after Chapin 1974; copyright Ecological Society of America, and Chapin & Bloom 1976).

A protein phosphatase reactivates the enzyme when irradiance increases (Kaiser & Huber 2001). NO_3^- assimilation is energetically expensive because of the costs of NO_3^- reduction. NH_4^+ is toxic to plant cells, and therefore must be assimilated rapidly to amino acids. NO_3^- reduction to NH_4^+ requires approximately 15% of plant-available energy when it occurs in the roots (2% in plants that reduce NO_3^- in leaves) with an additional 25% of available energy for NH_4^+ assimilation (Bloom et al. 1992). One might think that the lower costs when NH_4^+ , rather than NO_3^- , is used as the source of N by the plant would allow for a higher growth rate. This does not always occur, however, because of either adjustments in leaf area ratio (Sect. 2.1.1 of Chapter 7 on growth and allocation) or possibly a lower efficiency of root respiration (Sect. 2.6 of Chapter 2B on plant respiration).

The distribution of nitrate reductase activity and the presence/absence of NO_3^- in xylem sap suggest the following ecological patterns (Andrews 1986):

1. All species increase the proportion of NO_3^- reduced in the shoot as NO_3^- supply increases which suggests a limited capacity for NO_3^- reduction in the root system.
2. Temperate perennials and annual legumes reduce most NO_3^- in the roots under low NO_3^- supply.
3. Temperate nonlegume annuals vary considerably among species in the proportion of NO_3^- reduced in roots under low NO_3^- supply.
4. Tropical and subtropical species, both annuals and perennials, reduce a substantial proportion of their NO_3^- in the shoot, even when growing at a low NO_3^- supply.

Despite these general patterns, some NO_3^- reduction occurs in leaves of most plants, particularly in ruderals. Leaf nitrate reductase activity is typically highest at midday in association with high light intensities. Some plants, particularly those in the Ericaceae, show low levels of nitrate reductase (Smirnoff et al. 1984), presumably because NO_3^- availability is generally low in habitats occupied by these species. Leaves of most Gymnospermae and Proteaceae reduce NO_3^- only after induction by feeding leaves with NO_3^- which suggests that these species also reduce most NO_3^- in the roots (Smirnoff et al. 1984).

Plant species differ in their preferred forms of N absorbed, depending on the forms available in the soil. For example, arctic plants, which experience high amino acid concentrations in soil, preferentially absorb and grow on amino acids, whereas *Hordeum vulgare* (barley) preferentially absorbs

inorganic N (Chapin et al. 1993); *Picea glauca* (white spruce) preferentially absorbs NH_4^+ (Kronzucker et al. 1997). Much of the early work on NO_3^- and NH_4^+ preference is difficult to interpret because of inadequate pH control (Sect. 2.2.6) or low light intensity. Species from habitats with high NO_3^- availability (e.g., calcareous grasslands), however, often show preference for NO_3^- and have higher nitrate reductase activities than do species from low- NO_3^- habitats. Most plants are capable of absorbing any form of soluble N, however, especially if acclimated to its presence (Atkin 1996).

Plants can also acquire N from the air. This is an important avenue of N uptake by N-limited forests exposed to rain that has high NO_3^- due to fossil fuel combustion or high NH_4^+ due to volatilization from agricultural lands and stockyards (Clarkson et al. 1986). Natural and agricultural vegetation acts as a major "sink" for atmospheric pollutants in terrestrial ecosystems. When the needles of *Picea abies* (Norway spruce) are exposed to NO_2 , they rapidly induce nitrate reductase and assimilate the N (Von Ballmoos et al. 1998). It has been estimated that the total emissions of NO_x (i.e., a combination of NO and NO_2) are around 150 million tons per year, and that more than half of this is from a natural origin. In metropolitan areas, however, 75% of the NO_x may be due to road traffic. The capacity to assimilate NO_2 from the air varies greatly among species. Some species [e.g., *Magnolia kobus* (kobus magnolia), *Eucalyptus viminalis* (manna gum), and *Nicotiana tabacum* (tobacco)] may derive more than 10% of their N from NO_2 . Information about the species that can assimilate a lot of NO_x may be useful in choosing street trees in polluted areas (Morikawa et al. 1998).

2.2.5 Acquisition of Phosphorus

There are numerous traits involved in acquiring sufficient quantities of P_i from soil. Some of these traits are specific for P_i (e.g., root phosphatases); other traits (e.g., root hairs and root mass ratio) promote uptake of all ions, but are most critical for P_i because of the low diffusion coefficient of P_i in soil (Table 3) and therefore the small volume of soil that each root can exploit. The specialized association with a mycorrhizal fungus will be discussed in Sect. 2.3 of Chapter 9A on symbiotic associations.

2.2.5.1 Plants Can Also Use Some Organic Phosphate Compounds

In agricultural soils, 30–70% of all P is present in an **organic** form; in nutrient-poor grasslands, peat soils, and forest soils this may be as much as

80–95% (Macklon et al. 1994, Turner 2006), or 99% in organic tundra soils (Kielland 1994). A major form of soil P is **inositol phosphate**, which consists of esters containing four, five, or six P molecules, or stereo-isomers thereof (Turner & Richardson 2004). Many species [e.g., *Lupinus albus* (white lupin) (Adams & Pate 1992), *Carex acutiformis* (pond sedge) (Pérez Corona et al. 1996), *Trifolium subterraneum* (subclover) (Hayes et al. 2000), *Triticum aestivum* (wheat) (Richardson et al. 2000)] can use nucleic acids, phospholipids, glucose 1-phosphate, and glycerophosphate (all present in the soil), in addition to P_i , due to the activity of **phosphatases** in the soil. Production of phosphatases by the roots provides an additional source of P_i ; these enzymes hydrolyze organic P-containing compounds, releasing P_i that is absorbed by roots (Richardson et al. 2007). Phosphatase production is enhanced by a low P_i supply to the plants. Phosphatases cannot hydrolyze **phytate** (the calcium salt of *myo*-inositol hexakisphosphate), the major form of organic P in seeds; **phytase** is required to release P_i from this source. Some plants may release phytate into the rhizosphere, but for many plants phytate is a poor source of P (Hayes et al. 2000, Richardson et al. 2000). Roots may, however, exude organic substances that act as substrates for microorganisms, which produce enzymes that hydrolyze organic phosphate, including phytate (Richardson 1994). Whatever the exact mechanism by which organic P is hydrolyzed, the concentration of organic P near the root surface may decrease by as much as 65% in *Trifolium alexandrinum* (berseem clover) and 86% in *Triticum aestivum* (wheat) (Tarafdar & Jungk 1987). This shows that these roots do have access to organic forms of P in the soil (Fig. 11).

The capacity to use organic P varies among species and also depends on soil conditions. It may range from almost none to a capacity similar to that of the rate of P_i uptake (Hübel & Beck 1993).

2.2.5.2 Excretion of Phosphate-Solubilizing Compounds

Some plants that are adapted to low-P soils excrete **acidifying** and/or **chelating** compounds (e.g., citric acid and malic acid). Acidification enhances the solubility of P_i in alkaline soils; however, in acid soils, when phosphate is bound to Al or Fe, phosphate solubility is not enhanced by a pH decrease in the rhizosphere (Fig. 1B). Chelating compounds, including citrate and malate, occupy sites that bind phosphate (ligand exchange), and thus solubilize phosphate **sorbed** to soil particles. Both acidification (in alkaline soils) and chelation (all soils) processes enhance the concentration gradient for P_i between the bulk soil and the root surface (Lambers et al. 2006). Crop species vary widely in their capacity to access sparingly available P (Pearse et al. 2006), and such variation offers potential for improving crops for specific soils, intercropping, and crop rotations (Kamh et al. 1999, 2002, Nuruzzaman et al. 2005, Li et al. 2007).

The capacity to excrete carboxylates is very pronounced in members of the Proteaceae, which do not form a mycorrhizal association, but have **proteoid roots** (Fig. 12). The term “proteoid roots” was given because the structures were first discovered in the family of the Proteaceae (Purnell 1960). Similar structures have since been found in many other families, and now the term **cluster roots** is used more commonly. Proteoid cluster roots consist of clusters of longitudinal rows of extremely hairy

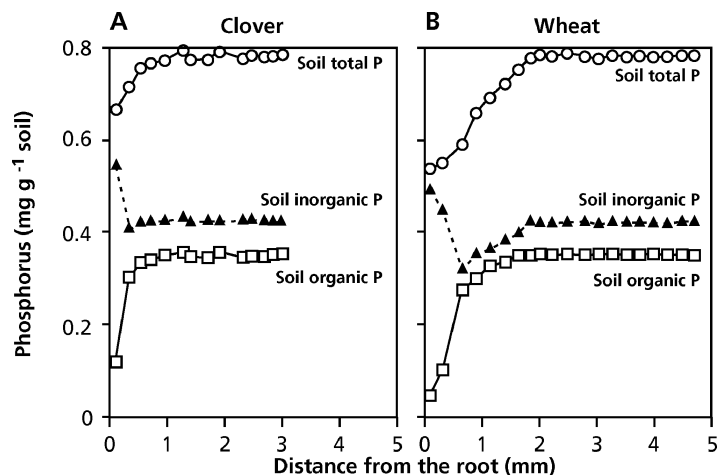

FIGURE 11. Distribution of total, inorganic and organic P in the rhizosphere of *Trifolium alexandrinum* (clover, 10 days old) and *Triticum aestivum* (wheat, 15 days old) grown in a silt loam (Tarafdar & Jungk 1987).



FIGURE 12. Root-cluster morphology of Proteaceae and Cyperaceae species. In A–F plants were grown hydroponically at very low P supply ($\leq 1 \mu\text{M}$). (A) *Dryandra sessilis* (parrot bush) root system with “compound” “proteoid” root clusters; bar is 20 mm. (B) *Hakea prostrata* (harsh hakea) root system with “simple” proteoid-

root clusters; bar is 30 mm. (C) *Tetraria* (sedge) species root system with “dauciform” root clusters; bar is 20 mm. (D) Young, compound proteoid-root cluster of *Banksia grandis* (bull banksia) terminates with third-order determinate, branch rootlets; bar is 3 mm. (E) Simple proteoid-root clusters of *Hakea sericea* (silky

rootlets, which originate during root development, 1–3 cm from the root tip. One lateral branch may contain one, two, or several clusters, centimeters apart from each other. Clusters may consist of unbranched rootlets [simple cluster roots, as in *Hakea* species (Proteaceae) and *Lupinus albus* (white lupin, Fabaceae) (Fig. 12B,E)], or they may have branched rootlets [compound cluster roots, as in *Banksia* species (Proteaceae) (Fig. 12A,D) (Shane & Lambers 2005)]. The cluster roots excrete carboxylates, phenolics, and phosphatases (Lambers et al. 2006), but this process takes place during only a few days after their formation (Neumann et al. 2000). Many sedges (Cyperaceae) produce **dauciform roots**, carrot-shaped roots with long root hairs (Fig. 12C,F), which are physiologically similar to the cluster roots in Proteaceae and Fabaceae (Shane et al. 2005). A third type of root clusters, **capillaroid roots**, is restricted to some species in the Restionaceae (Lambers et al. 2006).

Root clusters are almost universal in the Proteaceae; they also occur in species belonging to the Betulaceae, Casuarinaceae, Cucurbitaceae, Cyperaceae, Elaeagnaceae, Fabaceae, Moraceae, Myricaceae, and Restionaceae. Many species that form cluster roots are nonmycorrhizal or weakly mycorrhizal (e.g., Cyperaceae, some Fabaceae, Proteaceae, Restionaceae), but this is not universal (e.g., Betulaceae, Casuarinaceae, Elaeagnaceae, some Fabaceae) (Lambers et al. 2006).

In Australia and South Africa, nonmycorrhizal cluster-bearing species of the Proteaceae occur on the most heavily leached and P-impooverished soils. Mycorrhizal species of the Myrtaceae, on the other hand, are found on soil with higher P levels. Species of the Casuarinaceae, which are both mycorrhizal and cluster bearing, occupy an intermediate position (Lambers et al. 2006). This distribution pattern is explained by the fact that cluster roots are very effective at acquiring P from soils in which phosphate is largely **sorbed** to soil particles; they effectively “**mine**” the soil for P_i . Arbuscular mycorrhizal associations, on the other hand, act as “**scavengers**” for P_i (Sect. 2.2 of Chapter 9A); they are more effective when the P_i concentration in solution is

somewhat higher than that in soils where Proteaceae are more abundant (Fig. 13A).

The development of root clusters is suppressed by an increased supply of P_i (Fig. 9A.9 in Sect. 2.3.2 of Chapter 9A on symbiotic associations; Reddell et al. 1997, Keerthisinghe et al. 1998, Shane & Lambers 2006). Because the formation of cluster roots is suppressed by foliar application of P_i , the induction must be controlled systemically by the internal P concentration, rather than by that in the soil (Gilbert et al. 1998).

Proteoid roots of *Lupinus albus* release 40, 20, and 5 times more citric, malic, and succinic acid, respectively, than lupin roots in which the development of proteoid roots is suppressed by P. The mechanism that allows the massive and rapid release of carboxylates is not yet known, but we know that it is mediated by anion channels (Zhang et al. 2004). Although the excretion of citrate is highest close to the root tip, the capacity to absorb P from the medium is equally high close to, and further away from, the tip. In situ, however, most of the P_i in the soil will be depleted by root cells close to the tip, leaving little to be absorbed by the older zones. The mechanism by which citrate and other chelating substances enhance P uptake is by **solubilizing** P_i that is **sorbed** to soil particles; both inorganic and organic P compounds are solubilized, the latter then becoming available for hydrolysis by **phosphatases** (Fig. 13B).

The capacity to excrete acidifying and/or chelating compounds is not restricted to species with morphological structures such as cluster roots. Species in the Brassicaceae also excrete citric acid, thus enhancing the capacity to solubilize rock phosphate (Hoffland et al. 1989). Some species induce a dissolution of poorly soluble phosphate at a faster rate than that of P_i uptake, leading to accumulation in the rhizosphere (Hinsinger 1998). Neighboring plants may profit from the capacity to release inorganic P from sparingly soluble sources. Intercropping, i.e., growing at least two crop species on the same plot of land at the same time, can enhance plant productivity. *Zea mays* (corn) yields 43% more and *Vicia faba* (faba bean) yields 26% more when the species are intercropped on a low-P soil, instead of grown as a monoculture on the same soil (Table 6). Using permeable and

FIGURE 12. (continued) *hakea* at various stages of development terminate with second-order determinate branch rootlets (white root clusters are young-mature, whereas brown ones are senescent or dead). (F) Higher magnification of dauciform-root clusters of *Tetaria* species in C. Root hair density is extremely high on individual dauciform roots; bar is 10 mm. (F) *Tetaria* species.

In G and E, simple proteoid-root clusters of *Hakea ceratophylla* that tightly bind the sand excavated at the University of Western Australia's Alyson Baird Reserve at Yule Brook (Western Australia) (courtesy M.W. Shane, School of Plant Biology, the University of Western Australia, Perth, Australia). A-F: copyright Elsevier Science, Ltd.

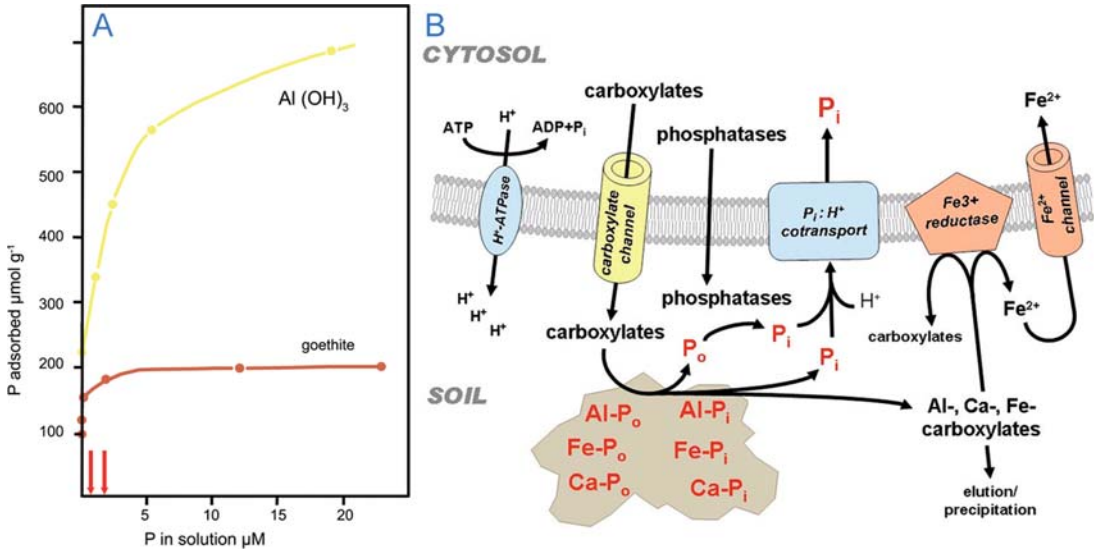

FIGURE 13. (A) P_i-sorption isotherms on goethite (at pH 6.3) and Al(OH)₃ (at pH 5.8), using Ca(H₂PO₄)₂. Goethite is a common, Fe-containing compound in soil. Al(OH)₃ was used for the sake of comparison, since no reduction of the metal was possible. Note that P_i is “not readily available” for *Lolium perenne* (perennial ryegrass) until about 40% of all the goethite is “covered”. P availability then increases, reaching a maximum at 2 μM in solution, when 75% of the goethite is covered by sorbed P_i. Mycorrhizas increase the availability for ryegrass in the range 0.5–2 μM, marked by the arrows, when 60–70% of the goethite surface is “covered by sorbed P_i. Modified after Parfitt (1979). (B)

Effects of carboxylates (and other exudates) on inorganic (P_i) and organic P (P_o) mobilization in soil. Carboxylates are released via an anion channel. The exact way in which phosphatases are released is not known. Carboxylates mobilize both inorganic and organic P, which both sorb to soil particles. Phosphatases hydrolyze organic P compounds, once these have been mobilized by carboxylates. Carboxylates will also mobilize some of the cations that bind P. Some of these cations (especially Fe) move to the root surface for uptake by the roots. Others move down the soil profile. Modified after Lambers et al. (2006).

TABLE 6. Average biomass and grain yield of *Zea mays* (corn) and *Vicia faba* (faba bean) grown in continuous monoculture, in a continuous intercropping system, or in a continuous rotational system for 4 years in a low-P, high-N soil in China.

	Crop	Cropping system	Average for 2003–2006 kg ha ⁻¹	% Increase
Grain yield	Corn	Continuous monoculture	12810	–
		Intercropped with faba bean	18910	49
		Rotated with faba bean	17360	37
	Faba bean	Monoculture	4290	–
		Intercropped with corn	5240	22
		Rotated with corn	5720	29
Above-ground biomass	Corn	Monoculture	26920	–
		Intercropped with faba bean	39990	49
		Rotated with faba bean	36990	38
	Faba bean	Monoculture	10380	–
		Intercropped with corn	12660	22
		Rotated with corn	13000	21

Source: Li et al. 2007.

impermeable root barriers, the positive effects on corn can be ascribed to rhizosphere acidification by faba bean. The positive effect on faba bean is due to exploration of a different rooting depth (Li et al. 2007). P-solubilizing effects may also benefit the following crop (Table 6). When *Triticum aestivum* (wheat) is grown in rotation with *Lupinus albus* (white lupin) on a low-P soil in northern Nigeria, wheat benefits from the P-solubilizing activity of white lupin as the preceding crop (Kamh et al. 2002).

2.2.6 Changing the Chemistry in the Rhizosphere

The availability of several **micronutrients** in the rhizosphere is greatly affected by physiological processes of the roots (Table 7). For example, **proton extrusion** by roots may reduce rhizosphere pH by more than 2 units from that in the bulk soil (Hinsinger et al. 2003); the capacity to affect the pH is strongest at a soil pH of 5–6. Roots also have the capacity to **reduce** compounds in the rhizosphere or at the plasma membrane which is particularly important for the acquisition of Fe, when available in its less mobile oxidized state in soil. On the other hand, roots in flooded soils can **oxidize** compounds in the rhizosphere, largely by the release of oxygen (Sect. 3.5). This can reduce the solubility of potentially toxic ions like aluminum and sulfide. Roots

often excrete exudates that **mobilize** sparingly soluble micronutrients, or stimulate the activity of rhizosphere microorganisms and therefore the mineralization of N and P.

2.2.6.1 Changing the Rhizosphere pH

The pH in the rhizosphere is greatly affected by the **source of N** used by the plant, because N is the nutrient required in largest quantities by plants and can be absorbed as either a cation (NH_4^+) or an anion (NO_3^-). Roots must remain electrically neutral, so when plants absorb more cations than anions, as when NH_4^+ is the major N source, more **protons** must be extruded (reducing rhizosphere pH) than when NO_3^- is the major N source, in which case the pH tends to rise slightly. An additional cause of the decline in rhizosphere pH when NH_4^+ is the source of N is that, for each N that is incorporated into amino acids, one H^+ is produced. Because NH_4^+ is assimilated exclusively in the roots, whereas NO_3^- is assimilated partly in the roots and partly in the leaves, the production of H^+ is greatest with NH_4^+ . A somewhat smaller decrease in pH also occurs when atmospheric N_2 is the sole source of N for legumes or other **N_2 -fixing** systems (Sect. 3 of Chapter 9A on symbiotic associations). The drop in pH with NH_4^+ as N source is due to exchange of NH_4^+ for H^+ (or uptake of NH_3 , leaving H^+ behind). The rise in pH with NO_3^- as the source of N is thought to be associated with the generation of hydroxyl ions during its reduction according to the overall equation: $\text{NO}_3^- + 8 e^- + 1.5 \text{H}_2\text{O} \rightarrow \text{NH}_3 + 3 \text{OH}^-$. A more comprehensive analysis, however, which also accounts for primary transport at the plasma membrane and N metabolism subsequent to NO_3^- reduction shows that NO_3^- entry does not raise the pH intracellularly (Britto & Kronzucker 2005). To compensate for an increase in pH associated with NO_3^- accumulation, protons are taken up; some hydroxyl ions are neutralized by the formation of organic acids (mainly malic acid) from neutral sugars. As a result, plants grown with NO_3^- contain more organic acids (mainly malate) than those using NH_4^+ or N_2 .

Application of ammonium or urea as fertilizers can create major agricultural problems, since both the pH in the rhizosphere and that of the bulk soil will decline in the longer term. This may mobilize potentially toxic ions, including Al and Mn, and reduce the availability of required nutrients (Fig. 1 and Sect. 3.1).

Rhizosphere pH affects the availability of both soil micronutrients and potentially toxic elements that are not essential for plant growth (Al)

TABLE 7. The availability of a number of micronutrients, aluminum, and toxic heavy metals for plants when the pH decreases, and the reason for the change in availability.

Microelement	Effect of decreased pH on availability of the microelement	Cause of the effect
Aluminum	Increase	Increased solubility
Boron	Increase	Desorption
Cadmium	Increase	Cadmium-organic ligand complexation
Copper	No effect	
Iron	Increase	Reduction, increased solubility
Manganese	Increase	Desorption, reduction
Molybdenum	Decrease	Adsorption
Zinc	Increase	Desorption

Source: Marschner & Römheld 1996, Krishnamurti et al. 1997.

(Table 7). The solubility of iron (Fe) decreases a 1000-fold for each unit increase in soil pH in the range 4–9; that of manganese (Mn), copper (Cu), and zinc (Zn) decreases a 100-fold. Mn and Fe also become more available when they are reduced (to Mn^{2+} and Fe^{2+} , respectively). Although Fe is abundant in the Earth's crust, it predominates as insoluble Fe^{3+} precipitates, which are largely unavailable to plants, especially at neutral or alkaline pH. **Fe-deficiency** symptoms in calcareous soils can be prevented by supplying NH_4^+ , which acidifies the rhizosphere, rather than NO_3^- , which tends to further increase the pH around the roots; however, it is only effective in the presence of nitrification inhibitors that prevent the microbial transformation of NH_4^+ to NO_3^- (Marschner 1991). Net nitrification is often favored by a high pH, which increases nitrification more than NO_3^- immobilization by soil microbes. In practice, supplying Fe in a chelated or reduced form is more effective (Table 8).

The availability of molybdenum (Mo) decreases with a decreasing pH, and that of Cu, which tends to be complexed in the soil, is unaffected by pH. As a result, when grown in soil with $(NH_4)_2SO_4$, the concentrations of Fe, Mn, Zn, and B are higher in plant biomass than those in plants given $Ca(NO_3)_2$ (Table 8).

Plants can strongly reduce rhizosphere pH by excreting organic acids (Sect. 2.2.6) or by excreting protons which occur when the uptake of major cations (e.g., K^+) exceeds that of anions (Hinsinger et al. 2003). In calcareous soils, this acid excretion occurs to an extent that bulk soil pH is lowered.

Some nutrient deficiencies cause plants to reduce **rhizosphere pH**. When the Fe supply is insufficient, *Helianthus annuus* (sunflower) plants lower the pH

of the root solution from approximately 7 to 4. Similar responses have been found for *Zea mays* (corn) and *Glycine max* (soybean) genotypes with a low susceptibility to Fe deficiency ("lime-induced chlorosis"). Fe deficiency-induced acidification of the rhizosphere is mediated by the proton-pumping ATPase at the plasma membrane, with cations being exchanged for H^+ (Fig. 14). Zn deficiency can also cause a lowering of the rhizosphere pH (Römheld 1987). Organic acid-mediated dissolution of Fe plays a significant role in elevating the concentration of Fe complexes in the rhizosphere, especially when Fe occurs as $Fe(OH)_3$, but less so when it is present as Fe oxides (Fe_2O_3 and Fe_3O_4) (Jones et al. 1996a).

Lowering the pH in response to Fe deficiency may coincide with an increased capacity to reduce Fe at the root surface, due to the activity of a specific **Fe reductase** in the plasma membrane (Schmidt 2003). Reducing and chelating compounds (phenolics) may be excreted, solubilizing and reducing Fe^{3+} (Deiana et al. 1992). This is the typical response of Fe-efficient dicots and monocots other than grasses ("strategy I" in Fig. 15). Excretion of reducing and chelating compounds also enhances the availability and uptake of Mn. In calcareous soils with a low concentration of Fe and a high concentration of Mn, this strategy may lead to Mn toxicity. When the buffering capacity of the soil is large and the pH is fairly high, "strategy I" is not very effective.

2.2.6.2 Excretion of Organic Chelates

Grasses exude very effective chelating compounds, particularly when Fe or Zn are in short supply

TABLE 8. The effect of the form of nitrogen applied to a sandy loam [*Triticum aestivum* (wheat) and *Brassica oleracea* var. *botrytis* (cauliflower)] or a calcareous soil [*Arachis hypogaea* (peanut)] on concentrations of micronutrients or chlorophyll.*

N-source	Micronutrient concentration (mg kg ⁻¹ DM)				Chlorophyll concentration [mg (g ⁻¹ FM ⁻¹)]
	Fe	Mn	Zn	B	
Nitrate	55	23	18	3.5	0.89
Ammonium	68	45	24	12.9	0.85
Ammonium + nitrification inhibitor					1.76
Nitrate + FeEDDHA					2.96

Source: Marschner 1991.

* Chlorophyll concentration is a good indicator for the availability of Fe in the rhizosphere. To inhibit the transformation of ammonium into NO_3^- by nitrifying bacteria, a nitrification inhibitor (nitrapyrin) was added. FeEDDHA is a chelated form of Fe, which is readily available to the plant. Concentrations were measured in mature leaves (B), young leaves (chlorophyll), or the entire shoot (other micronutrients).

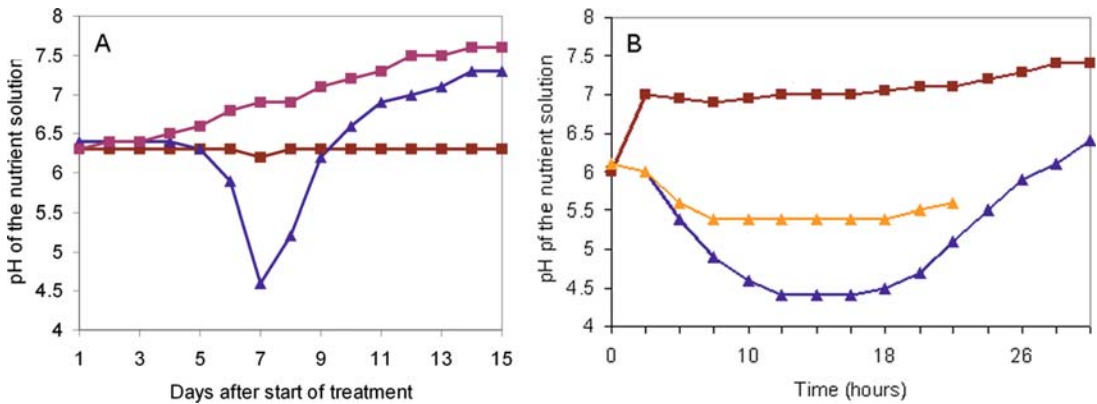

FIGURE 14. Changes in pH in the root environment of *Cicer arietinum* (chickpea) as affected by Fe supply. (A) Effects of Fe supply in the absence and presence of an organic buffer (MES, 4-morpholineethanesulfonic acid)

on the acidification of the nutrient solution. (B) Effects of an inhibitor of the plasma membrane ATPase (vanadate) on the acidification of the nutrient solution (Ohwaki & Sugahara 1997).

(Fig. 15). These chelators are called **phytosiderophores**, because of their role in the acquisition of Fe. However, these chelators are also important for the uptake of metals like Zn, when these are in short supply, and hence the term phytometallophore is also used (Cakmak et al. 1996). Phytosiderophores are probably released through an anion channel; concomitant K⁺ uptake ensures charge balance (Sakaguchi et al. 1999). Fe diffuses in the form of an Fe-phytosiderophore chelate to the root surface, and is absorbed as such by root cells (“strategy II”; Fig. 17). The system responsible for uptake of the Fe chelate is induced by **Fe deficiency**. In strategy II, Fe reduction takes place after uptake into the root cells, rather than prior to uptake as in strategy I. The capacity of a genotype to release phytosiderophores is inversely related to its sensitivity to Fe or Zn

deficiency. For example, *Hordeum vulgare* (barley) is less sensitive to Fe deficiency and excretes more phytosiderophores than sorghum (*Sorghum bicolor*) and corn (*Zea mays*) (Marschner & Römheld 1996). Genotypes of wheat [*Triticum aestivum* (bread wheat) and *Triticum durum* (durum wheat)] that are more resistant to Zn deficiency exude more phytosiderophores than do more sensitive genotypes (Cakmak et al. 1996, Rengel & Römheld 2000).

Phytosiderophores are similar to and sometimes derived from nicotinamine (Fig. 16). Nicotinamine itself is also an effective chelator and probably plays a role in chelating Fe inside the cell, in both strategies I and II (Scholz et al. 1992). Phytosiderophores are specific for each species and are more effective in chelating Fe than are many synthetic chelators used in nutrient solutions. They also form

FIGURE 15. The response to Fe deficiency of species following two contrasting “strategies”. Strategy II is restricted to grasses. Strategy I is found in monocots, with the exception of grasses, and in dicots. Plants are grown with or without Fe and then supplied with ⁵⁹FeEDDHA or ⁵⁹Fe hydroxide (Römheld 1987). Copyright Physiologia Plantarum.

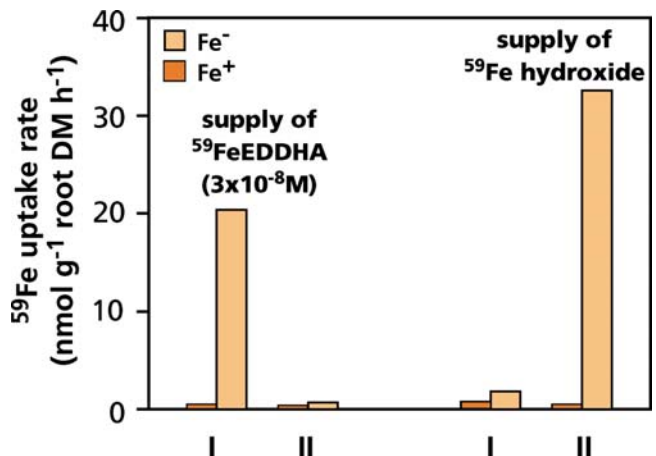

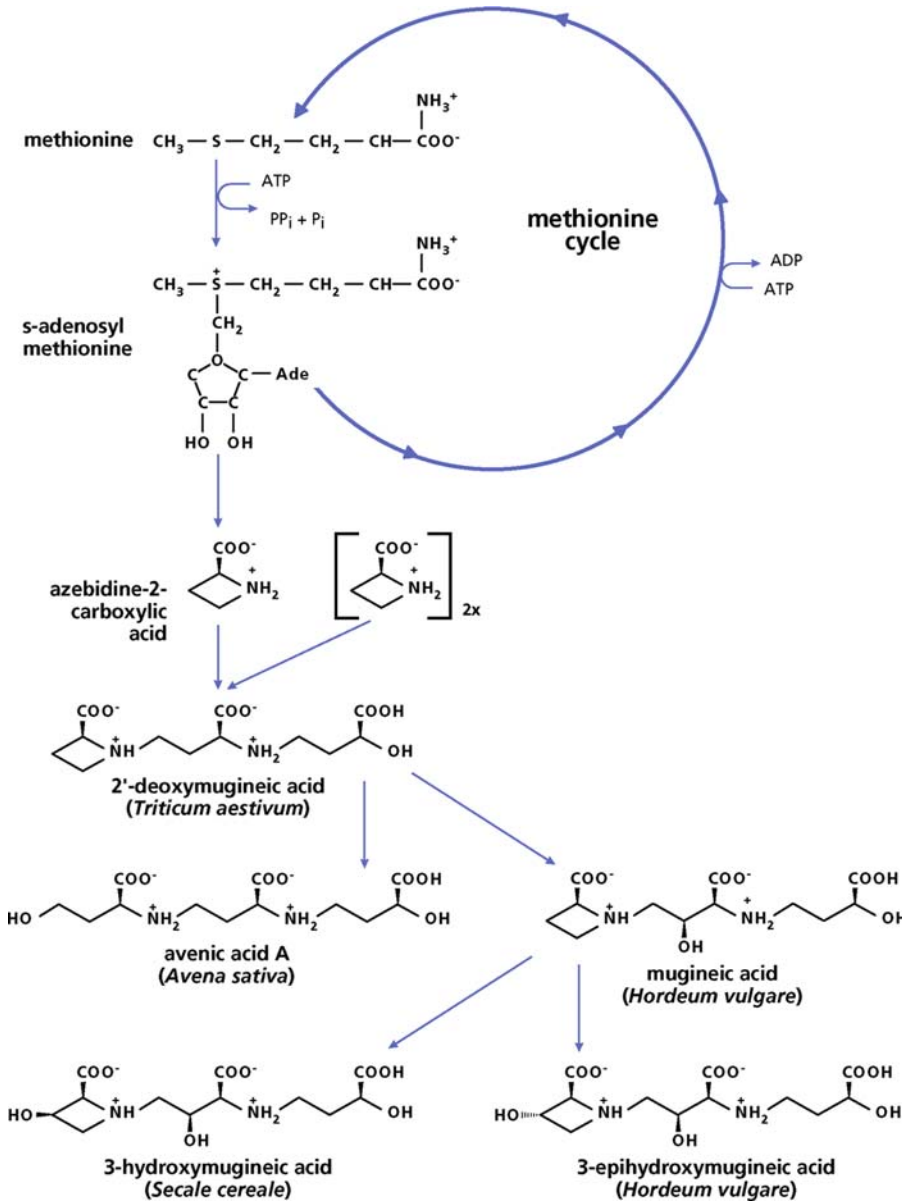

FIGURE 16. Scheme for the biosynthesis of phytosiderophores, which are hydroxy- and amino-substituted imino-carboxylic acids exuded by graminaceous

monocotyledonous plants (Ueno et al. 2007). Copyright Trustees of The New Phytologist.

stable chelates with Cu, Zn, and, to a lesser extent, Mn and enhance the availability of these nutrients in calcareous soils. Fe-efficient species belonging to strategy I or II show an enhanced capacity to absorb Fe upon withdrawal of Fe from the nutrient solution (Fig. 17).

Phytosiderophores that are excreted by Fe-efficient grasses can also enhance the Fe status

of some Fe-inefficient dicotyledonous neighboring plants, both in nutrient solution and in pot experiments. This mechanism offers an explanation for the success of **intercropping** *Arachis hypogaea* (peanut) with *Zea mays* (corn) in northern China (Zuo et al. 2000) and for the re-greening of fruit trees when grown in combination with *Festuca rubra* (red fescue) (Ma et al. 2003).

FIGURE 17. Induction of the capacity to absorb Fe as affected by Fe deficiency in dicotyledonous and non-graminaceous dicotyledonous species (strategy I) and in graminaceous species (strategy II) (Ma 2005).

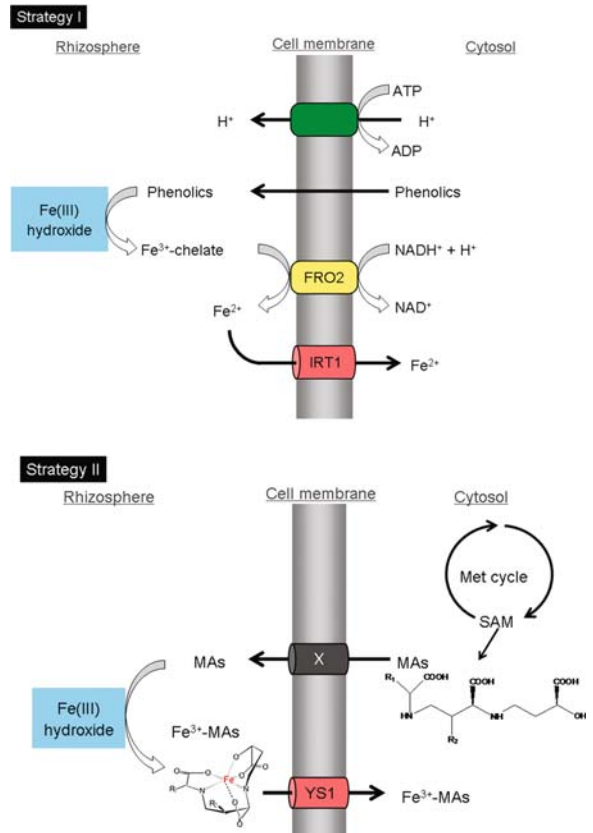

Carboxylates are a common component of root exudates. They are excreted in response to a shortage of P, Fe, K, and some other cations (Jones 1998, Neumann & Römheld 1999). Depending on the dissociation properties and number of carboxylic groups, carboxylates can carry varying negative charges, thereby allowing the complexation of metal cations in solution and the displacement of anions from the soil matrix. For this reason, carboxylates play a role in many soil processes, including the mobilization and acquisition of nutrients by plants (e.g., P_i and Fe) and the detoxification of metals (e.g., Al, Pb), microbial proliferation in the rhizosphere, and the dissolution of soil minerals, leading to **pedogenesis** (e.g., laterite formation and podzolization) (Pate et al. 2001). Organic acids transform high-molecular-mass humus compounds into smaller ones (molecular mass less than 10000). Upon transformation of the humus complex, Ca, Mg, Fe, and Zn are released from the humus complex. Organic acids are far more effective than their K⁺-salts or inorganic acids; their action is likely a combination of acidification and chelation (Albuzzio & Ferrari 1989).

2.2.7 Rhizosphere Mineralization

Root exudation of organic acids, carbohydrates, and amino acids, and the sloughing of polysaccharides from growing root tips, usually accounts for less than 5% of total carbon assimilation, but it may increase substantially when P availability is low (Table 2 in Chapter 2B on respiration). Root exudates have major effects on microbial processes in soils which are often carbon limited (Chapter 10A on decomposition). The densities and activity of microorganisms, especially bacteria, and microbial predators are much greater in the rhizosphere than they are in bulk soil, and they are enhanced by factors, such as elevated atmospheric CO₂ concentrations, that increase root exudation (Cheng & Johnson 1998). The effects of root exudates depend on soil fertility (Sect. 3.2 of Chapter 10A on decomposition). In infertile soils, stimulation of root exudation by elevated CO₂ concentrations tends to increase N immobilization by rhizosphere microbes and reduces plant uptake (Diaz et al. 1993). By contrast, in more fertile soils, where microbes are more carbon limited, the stimulation of root exudation by

elevated $[\text{CO}_2]$ increases N mineralization and plant uptake (Zak et al. 1993). Annual N uptake by vegetation is often twice the N mineralization estimated from incubation of soils in the absence of roots (Chapin et al. 1988). Much of this discrepancy could involve the more rapid nutrient cycling that occurs in the rhizosphere, as fueled by root exudation.

2.2.8 Root Proliferation in Nutrient-Rich Patches: Is It Adaptive?

When N, K, or P are limiting for plant growth and only available in localized root zones, roots tend to **proliferate** in these zones more than they do in microsites with low nutrient availability. Roots experiencing nutrient-rich patches can also enhance their physiological ion-uptake capacities compared

with roots of the same plant outside the patch zone (Hodge 2004). Local proliferation, however, is found only if the elongating tip of the axis from which the laterals emerge has experienced these favorable local conditions while elongating. If it has not, or if the plant as a whole does not experience nutrient deficiency, then no laterals emerge in favorable zones (Drew et al. 1973; Drew 1975). Local root proliferation occurs similarly in species from nutrient-rich [*Holcus lanatus* (common velvetgrass), *Lolium perenne* (perennial ryegrass)] and nutrient-poor habitats [*Anthoxanthum odoratum* (sweet vernalgrass), *Festuca rubra* (red fescue)] (Franken et al. 1999). Recent discoveries on molecular aspects of plant responses to N-rich patches are discussed in Box 6.1.

It would seem that the proliferation of roots in response to a localized nutrient supply is functional, but is it really? When *Triticum aestivum* (wheat)

Box 6.1

Molecular Control of Local Root Proliferation

Local root proliferation in response to patches enriched in N, P, or K is well documented (Sect. 2.2.8; Zhang & Forde 1998). In roots of *Arabidopsis thaliana* (thale cress), NO_3^- induces a gene (*ANR1*) that codes for a NO_3^- -specific transcription factor; this gene is not affected by K or P (Zhang & Forde 1998, Forde 2002). Transgenics in which expression of this key gene is repressed no longer respond to NO_3^- -rich zones by lateral-root proliferation. When NO_3^- is supplied to the entire root system, lateral-root growth is unaffected by NO_3^- in the range of 0.01–1 mM, whereas it is inhibited in the transgenic plants. A mutant that has only 0.5% of the nitrate reductase activity of the wild type exhibits a response that is similar to that of the wild type. This shows that NO_3^- itself, rather than an assimilation product, is responsible for the effects on localized root proliferation.

Root proliferation corresponds with an increased rate of cell production in the lateral-root meristem (Sect. 2.2.5 in Chapter 7 on growth and allocation). An auxin-resistant mutant does not respond to the NO_3^- signal, suggesting involvement of the phytohormone auxin (Box 7.1 in Chapter 7) in the NO_3^- -stimulated lateral-root expansion (Zhang et al. 1999). Lateral-root primordia originate from pericycle founder cells. Sophisticated mass-spectroscopy-based techniques have

been used to determine the exact map of the sites of biosynthesis of auxin and its distribution in *Arabidopsis thaliana*. This has highlighted the importance of the phytohormone during lateral-root initiation and emergence (Casimiro et al. 2003).

The systemic inhibitory effect (i.e., the suppression of root proliferation when a high NO_3^- concentration is supplied to the entire root system) acts by suppressing the development of lateral-root primordia at a stage just after emergence through the epidermis. Mature laterals are insensitive to NO_3^- , and the stunted lateral roots that are produced in 50 mM NO_3^- grow out as normal after plants have been transferred to 1 mM NO_3^- . Therefore, the post-emergence stage is specifically susceptible to the systemic, inhibitory signal (Zhang et al. 1999).

To explain the manner in which down-regulation of *ANR1* leads to suppression of the growth of lateral roots in well-fed plants and to the absence of a response to a local NO_3^- supply, the following model has been suggested. First, there is the localized stimulatory effect that requires the presence of NO_3^- at the lateral-root tip and *ANR1* expression. Second, there is a systemic inhibitory effect that results from the influence of NO_3^- supply on

continued

Box 6.1. Continued

the N status of the shoot; this effect does not depend on expression of *ANR1* and might involve cytokinins (Box 7.1 and Sect. 5.4.4 in Chapter 7 on growth and allocation). This model is consistent with a response of the lateral roots of wild-type plants in NO_3^- -rich patches, and with the lack of a response in the transgenics. It is also consistent with the inhibition of lateral-root growth of the transgenics when NO_3^- is supplied to the entire root system; the positive effect of *ANR1* is blocked, and there is only the inhibitory effect of the N status of the entire plant (Fig. 1).

The localized stimulatory effect begins with perception of the NO_3^- signal by a NO_3^- sensor, involving a specific NO_3^- transporter, *NRT1.1* (Fig. 7; Remans et al. 2006). The signal is then transduced through a pathway that involves the products of *ANR1*. The transcription factor encoded by this gene activates a set of genes that modulate meristematic activity in the lateral-root tip. An auxin-sensitivity gene (*AXR4*) interacts with *ANR1*, but it is not yet clear how the two genes interact.

The systemic inhibitory effect requires the uptake of NO_3^- ; the more NO_3^- is taken up, the stronger the inhibition. Evidence from experiments with a mutant deficient in nitrate reductase suggests that the plant senses the internal NO_3^- pool. The nature of the inhibitory signal is unknown, but it probably originates in the shoot, because applying 50 mM KNO_3 to one half of a split-root system leads to the suppression of lateral-root development in both halves. The inhibitory signal appears to be sensed specifically during a critical phase of lateral-root development after emergence from the parent root and just prior to the point at which the cells of the newly differentiated lateral-root meristem become activated and elongation of the mature lateral root begins.

The two opposing effects of NO_3^- provide a regulatory system that enables root branching to respond to both the plant's N status and the local availability of NO_3^- . In this way, the intensity of the response to a localized NO_3^- source (i.e., the foraging response) can be adjusted according to the plant's demand for N, so that resource allocation within the plant as a whole can be optimized (Zhang & Forde 2002).

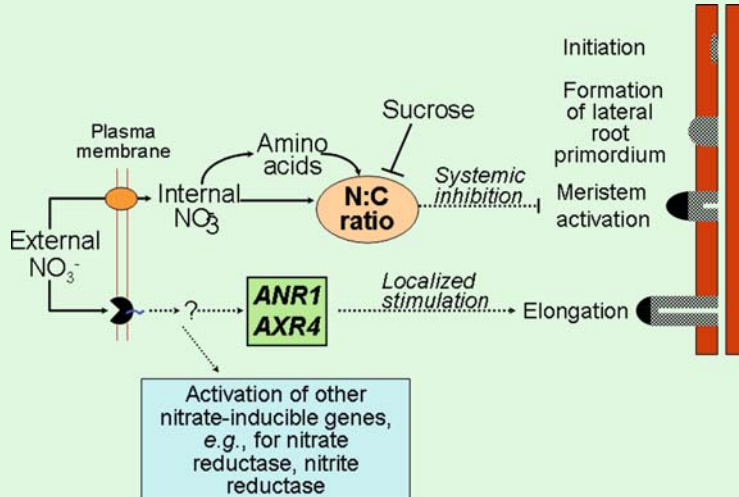

FIGURE 1. Dual-pathway model for regulation of lateral-root growth and development by NO_3^- in *Arabidopsis thaliana* (thale cress). Broken lines indicate signaling steps; solid arrows indicate transport or metabolic steps. The localized stimulatory effect depends on the external NO_3^- concentration and acts on the mature lateral-root tip to increase meristematic activity. The systemic inhibitory effect

depends on the internal N status of the plant and acts on a critical stage of lateral-root development prior to activation of the lateral-root meristem. Both effects are specific to the lateral roots, and growth of the primary root is largely insensitive to the supply of NO_3^- (Forde 2000). With permission from Oxford University Press.

plants are grown with a localized ^{15}N -labeled organic residue in soil, rates of N uptake per unit root length greatly increase during growth through the localized source of N. Plants obtain only 8% of the N that they ultimately absorb during the first 5 days of exploitation of the localized source. Only after this initial absorption do the roots proliferate in the residue; over the next 7 days they absorb 63% of the total N obtained from the local source. After that time, massive proliferation occurs in the residue, but relatively little further N is captured (Fig. 18). This suggests that local proliferation is of only limited importance for the capture of the N released from locally decomposing organic matter. When plants are competing for nutrients, however, local proliferation is advantageous. For example, when *Lolium perenne* (perennial ryegrass) grows together with *Poa pratensis* (smooth meadowgrass), *L. perenne* produces greater root densities in the patch than does *Poa pratensis*, and it also captures more N from the patch (Hodge et al. 1999). Proliferation, triggered by the local source of N, might also be advantageous in the longer term to take up nutrients other than N.

The extent of the response to a localized supply depends on the overall nutrient status of the plant. Thus, if one half of the roots receives no nutrients at all, then the response is considerably stronger than if that half is supplied with a moderate amount (Table 9; Robinson 1994). The development of an individual root obviously depends both on the nutrient availability in its own environment and on other roots of the same plant.

2.3 Sensitivity Analysis of Parameters Involved in Phosphate Acquisition

The contribution of different parameters involved in the uptake of P_i can be assessed using **simulation models**. Such models are increasingly used to analyze ecophysiological problems.

Nye and co-workers (Bhat & Nye 1973, Nye & Tinker 1977, Tinker & Nye 2000) analyzed the significance of root hairs using an experimental and a mathematical approach. They measured the (labeled) P_i concentration at the root surface of an oil seed root with dense root hairs. In addition, they simulated the P_i concentration under one of the following two assumptions: (1) root hairs are not involved in P_i uptake, and (2) root hairs effectively increase the cylinder intercepted by the root. There was good agreement between the simulated and the experimental data, only when they assumed that

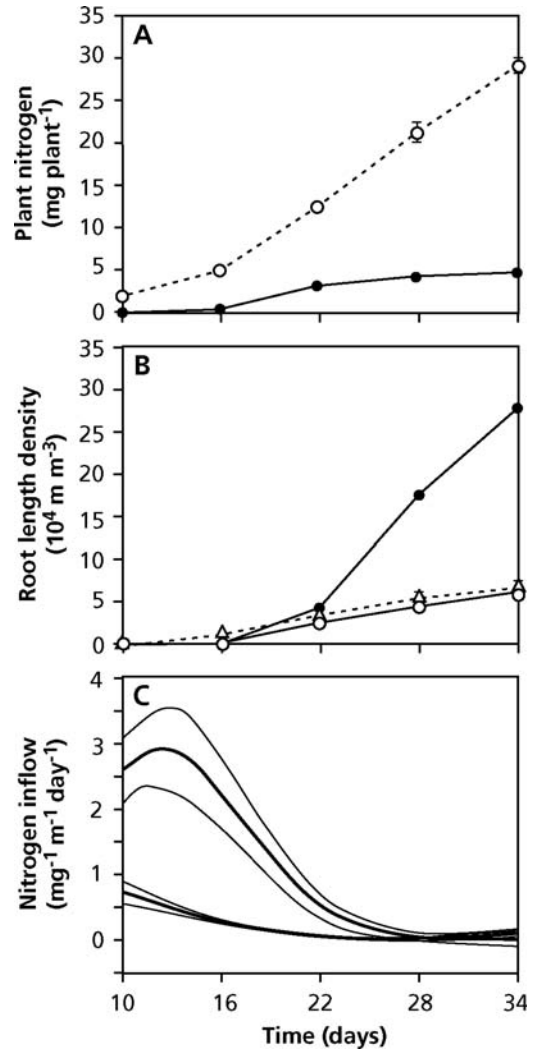

FIGURE 18. The response of *Triticum aestivum* to a localized organic residue, enriched with ^{15}N . (A) Total N in the plant (open symbols) and N in the plant derived from the organic residue. (B) Total root length density in the residue (filled symbols) and in the soil above (triangles) and below (triangles) the residue; (C) N uptake for the whole root system (lower curve) and for the part of the roots that proliferated in the localized residue (upper curve) (Van Vuuren et al. 1996).

root hairs are effective (Fig. 19). This work corroborated earlier ideas based on the significance of root hairs for the acquisition of immobile ions, including P_i (Table 4).

Barber and co-workers (Silberbush & Barber 1983, Barber 1995) analyzed the sensitivity of P_i uptake by pot-grown soybean plants to various soil and root factors (Fig. 20). The simulated

TABLE 9. Root development of *Pisum sativum* (garden pea) in a split-root design, in which root halves were grown in different pots and supplied with different nutrient concentrations from the time they were 24 mm long.*

Nutrient strength pot 1–pot 2	Root dry mass (mg)				Shoot dry mass (mg)
	Pot 1	Pot 2	Total	Ratio pot 1/pot 2	
0–50	51	450	501	0.11	806
1–50	60	427	487	0.14	847
10–50	142	370	512	0.38	874
25–50	194	269	463	0.72	935
50–50	300	283	582	1.05	1032
10–0	225	61	286	3.77	463
25–0	343	52	394	6.76	670

Source: Gersani & Sachs 1992.

* Plants were harvested when they were 3 weeks old.

FIGURE 19. Calculated and measured P_i concentration profiles around a *Brassica napus* (oil seed) root. P_i profiles are calculated under the assumption that root hairs do (ii, outer broken lines) or do not (i, inner broken lines) play a role in P_i uptake. The solid line gives the experimentally determined profile. The radii given are the radius of the root axis only (a_r) and that of the root plus root hairs (a_e) (Bhat & Nye 1973 and Nye & Tinker 1977).

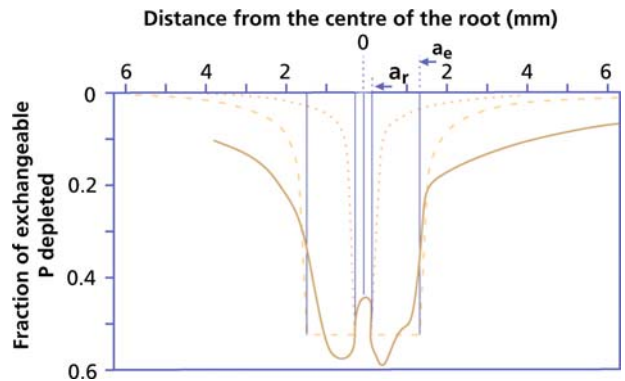
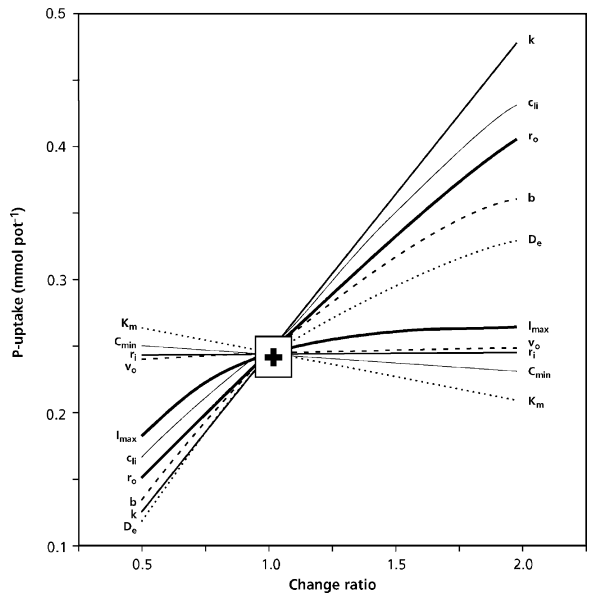

FIGURE 20. Effects of changing parameter values (from 0.5 to 2.0 times the standard value) on simulated P_i uptake by roots of *Glycine max* (soybean). k is the rate of root elongation, C_{ii} is the initial P_i concentration in solution, r_o is the root diameter, b is the buffer power of the soil, D_e is the diffusion coefficient of P_i in the soil, I_{max} is the maximum P_i inflow rate, v_o is the rate of transpiration, r_i is the spacing between individual roots, C_{min} is the lowest concentration at which P_i uptake is possible, and K_m is the P_i concentration at which the rate of P_i uptake is half of that of I_{max} (Silberbush & Barber 1983). With kind permission, from the Annual Review of Plant Physiology, Vol. 36, copyright 1985, by Annual Reviews Inc.



uptake agreed well with their experimental results. Their results demonstrated that P_i uptake is much more responsive to changes in the rate of **root elongation** (kin Fig. 20) and **root diameter** (r_o) than to changes in **kinetic properties** of the uptake system: K_m , I_{max} , and C_{min} . Soil factors such as **diffusion coefficient** (D_e) and **buffer power** (b) have greater effects if their values are decreased than if they are increased. **Transpiration** (v_o) has no effect at all on the rate of P_i uptake. The spacing between roots (r_i) was such that there was no inter-root competition; hence, changes in the value for this parameter had no effect. It is clear that, for a relatively immobile nutrient such as P, kinetic parameters are considerably less important than are root traits such as the rate of elongation and root diameter. This is consistent with the generalization that diffusion to the root surface rather than uptake kinetics is the major factor determining P_i acquisition. For more mobile ions, such as NO_3^- , kinetic properties play a somewhat more important role (Kirk & Kronzucker 2005).

This example shows how simulation models can be helpful to explore our intuitive ideas elegantly, if they are used in combination with experimental approaches.

3. Nutrient Acquisition from “Toxic” or “Extreme” Soils

The term *toxic* or *extreme* soil is clearly anthropomorphic. For example, a soil of a rather high or low pH may be toxic for some species, but a favorable habitat for others. Similarly, the presence of high concentrations of “heavy metals” may prevent the establishment of one species, but allow completion of the life cycle of another. As pointed out in Sect. 1, the occurrence of species in sites that we tend to call “toxic” does not necessarily mean that adapted plants grow better in such sites. We use terms like **halophytes** and **calcifuges** to refer to the **ecological amplitude** of the species. The **physiological amplitude** of a species is usually much broader than its ecological amplitude (Sect. 3 of Chapter 1 on assumptions and approaches). The restriction of a species to extreme soils might indicate that adapted plants are the only ones that can survive in these soils, due to their specialized mechanisms and that they are outcompeted on soils that we consider less extreme.

The following sections discuss specialized plant traits associated with phenotypic **acclimation** and

genotypic **adaptation** to extreme soils and their consequences for species distribution.

3.1 Acid Soils

Soils naturally tend to become acid with age (Fig. 1), as a result of several processes (Bolan et al. 1991):

1. **Decomposition of minerals** by weathering, followed by leaching of cations, such as K^+ , Ca^{2+} , and Mg^{2+} by rain. This is particularly important in humid regions.
2. **Production of acids** in soils (e.g., due to hydration and dissociation of CO_2 , formation of organic acids, oxidation of sulfide to sulfuric acid and nitrification of ammonia).
3. Plant-induced production of acidity, when an **excess of cations** over anions is taken up (e.g., when N_2 or NH_4^+ , rather than NO_3^- , is used as N source for plant growth).

Soils may also acidify due to human activities such as input of nitric and sulfuric acids from “acid rain”; the addition of acidic fertilizer, such as ammonium sulfate or urea, or the exposure of acidic mine tailings.

Soil acidity modifies the availability of many mineral nutrients (Fig. 1) as well as the solubility of Al. Although a **low soil pH** per se may limit the growth of plants, **Al toxicity** is considered a major yield-limiting factor in many acid soils, especially in the tropics and subtropics (Kochian et al. 2005). In acid soils, concentrations of Mn may also increase to toxic levels, generally at a somewhat higher pH than that which causes Al toxicity. P, Ca, Mg, K, and Mo may decline to an extent that deficiency symptoms arise (Table 7 in Sect. 2.2.6).

3.1.1 Aluminum Toxicity

Aluminum is of the most abundant metal in the Earth’s crust and the third most abundant element. Like all trivalent cations, it is toxic to plants. Aluminum hydrolyzes in solution, such that the trivalent cation dominates at **low pH** (Fig. 21). In addition, at low pH aluminum is released from chelating compounds (J.F. Ma et al. 2001a). Many species have a distinct preference for a soil with a particular pH. **Calcifuge** (“chalk-escaping”; also called “acidophilous”, acid-loving) species resist higher levels of soluble Al^{3+} in the root environment. There are several potential sites for injury due to Al (Fig. 22):

1. the cell wall
2. the plasma membrane

FIGURE 21. Calculated distribution of total inorganic Al concentration over various monomeric and polymeric forms as a function of pH. Calculations are based on parameters given by Nair & Prenzel (1978).

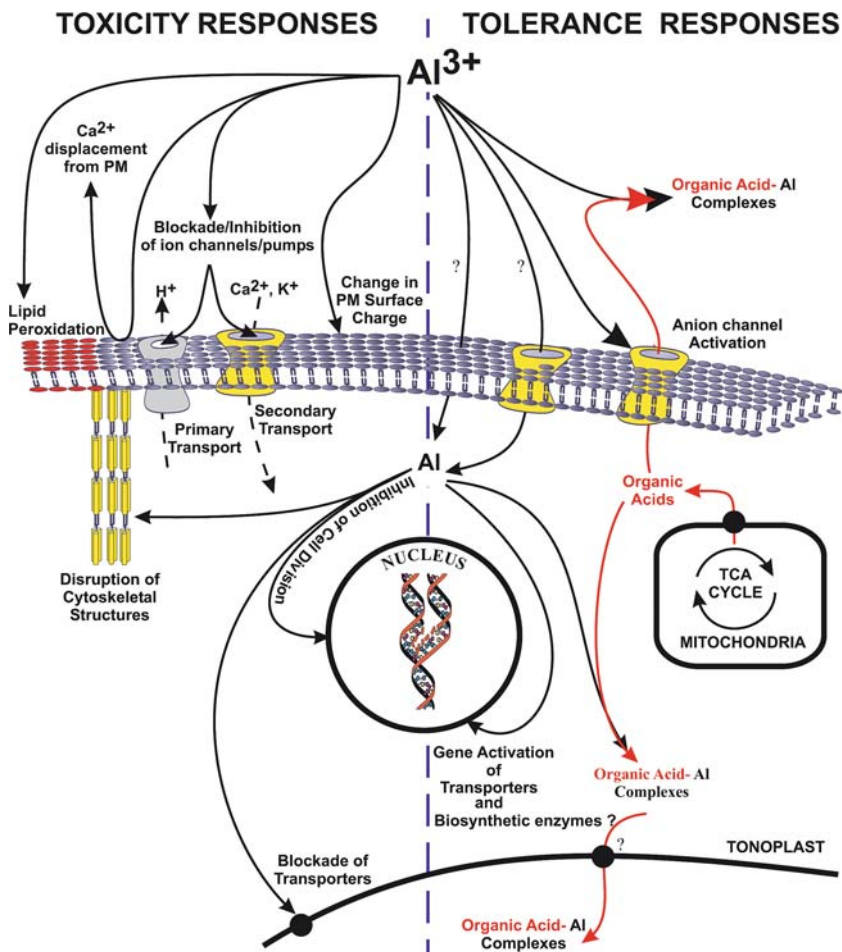
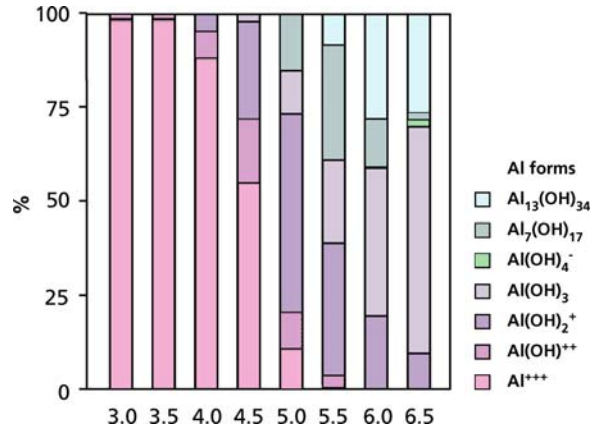

FIGURE 22. Possible mechanisms of Al toxicity and Al resistance in plants. Al toxicity targets are illustrated on the left side of the diagram. For clarity, the interactions of Al with the cell wall are not shown. On the right side, Al-resistance mechanisms (Al exclusion and internal Al detoxification) are based on the formation of Al complexes with

carboxylates. The Al-exclusion mechanism involves the release of carboxylate anions via an Al-gated anion channel at the plasma membrane. The internal Al-detoxification mechanism involves chelation of cytosolic Al by carboxylate anions with the subsequent sequestration into the vacuole via unknown transporters (Kochian et al. 2005).

3. signal-transduction pathways
4. the root cytoskeleton
5. DNA/nuclei

The **root apex** appears to be the most sensitive region for Al toxicity. When most of the roots are exposed to Al, but root tips are in a solution without Al, plant growth is not affected. On the other hand, when only the root tips are exposed to Al, toxicity symptoms are readily visible (Kochian 1995). Inhibition of root elongation is the primary Al-toxicity symptom (Ryan et al. 1994). Inhibition of root elongation in the root tip is due to interference with the formation of **cell walls**, decreasing cell-wall elasticity by cross-linking with pectin (Kochian et al. 2005, Ma et al. 2005). Root cells become shorter and wider. As a consequence, root elongation is impaired and the roots have a “stubby” appearance (Fig. 23) and a low specific root length, when grown in the presence of Al (Table 10; Delhaize & Ryan 1995).

Important toxic effects of Al occur at the **plasma membrane**. These are partly due to the inhibition of the uptake of Ca and Mg (Table 11), due to blockage of ion channels in the plasma membrane (Kochian et al. 2005). Some of the symptoms of Al toxicity are very similar to those of a deficiency of other ions. This may be due to competition for the same site in the cell walls (some cations), precipitation of Al complexes (with P_i), or inhibition of root elongation, which reduce the absorption capacity (Kochian et al. 2005). Inhibition by Al of the uptake of Ca and Mg

TABLE 10. The effects of aluminum concentration on various root parameters of *Mucuna pruriens* (velvet bean).*

[Al ³⁺] (mg L ⁻¹)	DM (g)	FM (g)	D (mm)	L (m)	SRL (m g ⁻¹)
0	6.4	126	0.37	1160	175
0.1	6.6	155	0.44	1100	166
0.2	6.6	126	0.46	931	141
0.4	3.3	55	0.51	253	76

Source: Hairiah et al. 1990.

* DM, dry mass; FM, fresh mass; D, diameter; L, root length per plant; SRL, specific root length (per gram dry mass of roots).

Note: The increase in root dry mass was not statistically significant.

decreases the concentration of these cations in the cell, causing Ca- and/or Mg-deficiency symptoms. Ca is required during cell division for spindle formation and to initiate metaphase/anaphase transition. Hence, the presence of Al prevents cell division and root development (Kochian et al. 2005). Interference with Mg uptake causes Mg deficiency symptoms (i.e., chlorotic leaves with brown spots), and stubby discolored roots (Kochian et al. 2005). Al toxicity also resembles boron deficiency, but the reason for this is not clear (LeNoble et al. 1996a).

Some Al is rapidly taken up in the symplast as well, possibly via carriers whose function is to take up Mg or Fe, or via endocytosis (Kochian 1995). In

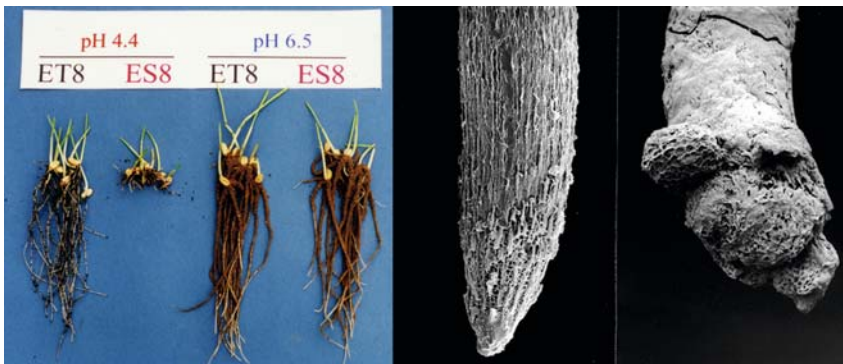

FIGURE 23. (Left) Seedlings of an Al-sensitive (ES8, right) and a near-isogenic Al-resistant (ET8, left) line of *Triticum aestivum* (wheat) grown in soil at pH 6.5, where Al is harmless for roots, and at pH 4.4, where aluminum is toxic if not chelated (courtesy J.F. Ma, Plant Stress Physiology Group, Research Institute for Bioresources, Okayama University, Kurashiki, Japan; Ma 2000, by permission of Oxford University Press). (Right) Scanning electron micrograph of the root tips

of the two near-isogenic lines shown in the top panel; the photo on the right shows a root tip of the Al-sensitive line, and the one on the left a root tip of the Al-resistant line. The seedlings were grown for 4 days in a solution containing 5 mM AlCl₃ in 200 mM CaCl₂ at pH 4.3 (courtesy E. Delhaize, CSIRO, Canberra, Australia; Delhaize & Ryan 1995). Copyright American Society of Plant Biologists.

TABLE 11. Aluminum, phosphorus, calcium, and magnesium concentration [mmol (kg dry mass)⁻¹] in roots and shoot of *Sorghum bicolor* (sorghum), grown for 35 days at three levels of Al (zero, low: 0.4 mg L⁻¹, high 1.6 mg L⁻¹) and P [low, medium, and high: 285, 570, and 1140 mmol plant⁻¹ (35 days)⁻¹].*

P level	Al level	Shoot				Root			
		Al	P	Ca	Mg	Al	P	Ca	Mg
Low	Zero	–	26	171	69	–	29	28	22
Medium	Zero	–	30	151	63	–	34	21	20
High	Zero	–	38	139	63	–	39	19	23
Low	Medium	1	27	127	36	7(29)	30	20	16
Medium	Medium	1	29	108	37	5(40)	34	18	16
High	Medium	1	40	85	36	5(40)	46	20	19
Low	High	1	93	61	23	11(36)	70	16	14
Medium	High	1	108	51	21	13(31)	76	15	15
High	High	1	335	65	25	131(45)	263	16	16

Source: Tan & Keltjens 1990.

* Values in brackets indicate the percentage removable with 0.05 M H₂SO₄ (i.e., the fraction in the apoplast).

the cytosol, with a neutral pH, it is no longer soluble, and the Al³⁺ concentration is less than 10⁻¹⁰ M, due to the formation of nontoxic forms of Al, e.g., Al(OH)₃. Al may also displace Ca and/or Mg from sites where they have a vital function in activation of enzymes; interference with calmodulin (a major component of **signal-transduction pathways** in plants) and the **cytoskeleton** may be particularly harmful.

Because of the very high affinity of Al for proteins and P-containing compounds, including ATP, phospholipids, and DNA, these very low Al concentrations are potentially phytotoxic (Ma et al. 1998). Most of these effects occur *after* the very rapid (1–2 hours) inhibition of root elongation. They are, therefore, not the primary cause of inhibition of plant growth (Kochian 1995). Cell division is also inhibited; mitosis appears to be arrested in the S-phase of DNA replication.

Leaf disorders (e.g., Fe-deficiency symptoms) occur several days after exposure to Al. In *Triticum aestivum* (wheat), which exhibits Fe uptake according to strategy II (Sect. 2.2.6), Fe deficiency is due to inhibition of the biosynthesis and release of phyto-siderophores (Chang et al. 1998).

3.1.2 Alleviation of the Toxicity Symptoms by Soil Amendment

Al toxicity symptoms can be diminished by addition of extra **magnesium** or **calcium**. **Phosphate** addition also has a positive effect, because it precipitates Al, either outside or in the roots. There is some evidence that the toxicity symptoms can be alleviated by Mg (especially in **monocotyledons**)

and Ca (especially in **dicotyledons**) (Keltjens & Tan 1993, Silva et al. 2001a). This pattern is consistent with the higher requirement for Ca in dicots (Sect. 4). Cation amelioration of Al toxicity is probably caused by a reduction of Al accumulation (Ryan et al. 1997). In *Glycine max* (soybean), adding 50 μM Mg to a nutrient solution containing toxic levels of Al increases exudation of citrate (which chelates Al) by the tap root tips several fold. This suggests that alleviation of Al toxicity by Mg is due to increased production and exudation of citrate (Silva et al. 2001b).

The ability of high-molecular-mass organic acids, such as **humic acid** and **fulvic acid**, to bind Al is well documented. These substances form much more stable complexes with Al than do citrate, malate, and oxalate, which are excreted by roots of Al-resistant plants (Sect. 3.1.3). Fulvic acid and humic acid are constituents of humus, peat, and leaf litter, which can be added to alleviate toxic effects of Al (Harper et al. 1995).

Some of the symptoms of Al toxicity [e.g., inhibition of root elongation of *Cucurbita pepo* (squash) growing in nutrient solution] are relieved by the addition of boron (LeNoble et al. 1996a). Incorporation of boron in an acidic high-Al subsoil promotes the depth of rooting and total root growth in *Medicago sativa* (alfalfa) (LeNoble et al. 1996b).

3.1.3 Aluminum Resistance

Recent progress in several laboratories has set the stage for identification and characterization of the genes and associated physiological mechanisms

that contribute to Al resistance in important crop species grown on acid soils. This provides the necessary molecular tools to address a major, worldwide agronomic problem (Kochian et al. 2005). Different mechanisms can be discerned to account for a plant's resistance to potentially toxic levels of Al:

1. Al exclusion from the root apex (avoidance)
2. Al tolerance

There is clear evidence for both **exclusion** mechanisms (Kochian 1995) that confer Al resistance and for **internal detoxification** in species that accumulate Al, such as *Hydrangea macrophylla* (hydrangea), *Camellia sinensis* (tea), *Richeria grandis* (a tropical cloud-forest tree) (Ma et al. 1997), and *Fagopyrum esculentum* (buckwheat) (Zheng et al. 1998). Internal detoxification of Al in Al-accumulating species is probably based on binding of Al to **citrate** or **oxalate** in leaf cells (Ma et al. 1997, Zheng et al. 1998).

Work on the aluminum-resistant species *Fagopyrum esculentum* (buckwheat) and comparisons of resistant and sensitive genotypes of *Phaseolus vulgaris* (common bean), *Triticum aestivum* (wheat), *Zea mays* (corn), and *Arabidopsis thaliana* (thale cress) highlight the importance of **carboxylates** (**citrate**, **malate**, and **oxalate**) release by roots, especially by root tips (Figs. 23 and 25; Zheng et al. 1998). Some species, e.g., *Lupinus albus* (white lupin) release carboxylates in response to both Al supply and P deficiency, but the response differs in the exact part of the root system from which the carboxylates are released (Wang et al. 2007).

In resistant wheat genotypes, Al activates a channel that allows the exudation of carboxylates. Transporters responsible for Al-activated release of carboxylates have been identified in several species (Delhaize et al. 2007, Furukawa et al. 2007, Magalhaes et al. 2007). Higher rates of exudation reflect higher rates of carboxylate synthesis, rather than higher concentrations in the root tips. The excretion of carboxylates is accompanied by K^+ efflux, so the positive effect of the chelator is not negated by lowering the pH. Mucilage exuded by the root cap may allow the malate concentration to remain sufficiently high over extended periods to protect the root tip (Delhaize & Ryan 1995). Wheat genotypes that excrete both malate and **phosphate** at the root tip show a threefold greater resistance to Al. Contrary to the inducible release of malate, the release of phosphate is constitutive (Pellet et al. 1996). Microbial degradation of the malate released by the roots of Al-resistant plants could potentially limit the effectiveness of these compounds in

sequestering Al because the half-life of the released organic acids is less than 2 hours. For rapidly growing roots ($> 15 \text{ mm day}^{-1}$), however, the residence time of the malate-releasing root tips in any zone of soil is around 5 hours, because root tips and their carbon release to the rhizosphere move quickly enough, so that the size of the microbial biomass in the rhizosphere of the root tip does not change much from the time the tip enters a zone. Electron microscopy and physiological studies confirm that there is little microbial proliferation at the root apex. Carboxylate release protects the root tip from the toxic effects of Al, despite some microbial breakdown of malate in the rhizosphere (Jones et al. 1996b).

Al resistance may be based not only on the release of carboxylates and phosphate, but also on an Al-induced root-mediated elevation of the pH in the rhizosphere adjacent to the root tip (Degenhardt et al. 1998, Larsen et al. 1998). Because the solubility of Al is pH dependent, increases in rhizosphere pH reduce the concentration of Al^{3+} (Fig. 21).

At a high pH, calcifuge species may show **Fe-deficiency** symptoms. This is probably associated with their Al-resistance mechanism, which may immobilize other ions as well, including Fe. Root growth of calcifuge species may be stimulated by low Al concentrations. This growth-enhancing effect of Al is most pronounced at low pH (high H^+ concentration). It is probably associated with the alleviation of the toxic effects of a low pH which is a general effect of cations; trivalent cations have the strongest effect, followed by divalent and then monovalent ones (Kinraide 1993). The growth of **calcicole** ("chalk-loving"; also called acidifuge, "acid-escaping") species, which naturally occur on soils with a high pH (Sect. 3.2), may also be stimulated by Al, but the optimum Al concentration for such species is about $5 \mu\text{M}$, as opposed to $20\text{--}30 \mu\text{M}$ for calcifuge species, such as *Nardus stricta* (mat-grass) and *Ulex europaeus* (gorse).

3.2 Calcareous Soils

Calcifuge ("chalk-escaping") species have a distinct preference for a soil with a low pH. They tend to have a very low ability to solubilize the **P**, **Fe**, and **Zn** and in limestone, but resist higher levels of soluble Al^{3+} in the root environment (Sect. 3.1); NO_3^- availability will be low, and NH_4^+ will be a more important source of N (Sect. 2.1.2). Carbonate-rich soils may contain high levels of Fe and this may arrive at the root surface, but calcifuge species are unable to acquire sufficient Fe to sustain

rapid growth. The lack of a high capacity to utilize the forms of Fe, Zn, and other trace elements that prevail in alkaline soils (Sect. 2.2.6) leads to “**lime chlorosis**” and may be the cause of failure of establishment of calcifuge species in such soils. Some calcifuge plants [e.g., *Carex pilulifera* (pill sedge)] are unable to translocate sufficient Fe to their leaves when grown in calcareous soil; Fe may accumulate in or precipitate on their roots. Others [e.g., *Veronica officinalis* (heath speedwell)] may increase the amount of Fe that is transported to their leaves, but accumulate this Fe in a form that is not metabolically active (Table 12; Zohlen & Tyler 1997, 2000). In addition, calcifuges tend to lack the capacity to access the prevalent poorly soluble P sources in alkaline substrates (Sect. 2.2.5). **Calcifuges** have very low leaf P concentrations to support physiological functions and consequently low biomass production, when grown in calcareous soil (Zohlen & Tyler 2004).

Calcicole species are associated with soils of high pH. Their growth may be stimulated by high Ca concentrations, which are saturating for calcifuge species; however, this is not the major factor explaining their distribution. More importantly, calcicole species do not resist **Al** in their root environment (Sec. 3.1).

The solubilization of P_i and Fe by carboxylate exudation in calcicoles inevitably also enhances the concentration of Ca. Indeed, high Ca concentrations may be found in the xylem sap of calcicole species. Because Ca is an important “**second messenger**” (e.g., in the regulation of stomatal conductance) (Sect. 5.4.2 of Chapter 3 on plant water relations), how does a calcicole plant avoid being poisoned by Ca? Calcicoles store excess Ca as crystals, sometimes in leaf trichomes (De Silva et al. 1996). Calcifuge herbs are unable to avoid excessive uptake of **calcium** from calcareous soil (Zohlen & Tyler 2004).

3.3 Soils with High Levels of Heavy Metals

Heavy metals are characterized by their high density, which is greater than 5 g mL⁻¹. Their biological activity, however, is due to **ligand properties**. Moreover, some of the “heavy metals” (e.g., arsenate) do not quite fit the above definition, and hence the term “heavy metal” is a bit of a misnomer (Duffus 2002); it will be used in this chapter, as it is a term that is common in the ecophysiological literature. Some heavy metals [cobalt (Co), copper (Cu), iron (Fe), manganese (Mn), molybdenum (Mo), nickel (Ni), and zinc (Zn)] are essential micronutrients for plants but become toxic at elevated concentrations. Their role as an essential micronutrient may be as a cofactor or activator of specific enzymes or to stabilize organic molecules. Other heavy metals [e.g., cadmium (Cd), lead (Pb), chromium (Cr), mercury (Hg), silver (Ag), uranium (U), and gold (Au)] are not essential for plant functioning.

3.3.1 Why Are the Concentrations of Heavy Metals in Soil High?

High levels of heavy metals in soils may have a geological or anthropogenic origin. In 1865 the first reference to heavy metal **hyperaccumulation** in plants was made when *Thlaspi caerulescens* (alpine pennycress) growing on Zn-rich soils near the German–Belgium border was reported to contain 17% of Zn in its ash. However, it was the discovery in 1948 by Minguzzi and Vergnano of extreme Ni accumulation in *Alyssum bertolonii* from serpentine hills in Italy, reaching 10 mg Ni g⁻¹ dry mass, that marks the beginning of an increasing interest in this subject (Assunção et al. 2003). Brooks et al. (1977) first coined the term **hyperaccumulator** to define plants with Ni concentrations higher than 1000 µg g⁻¹ dry mass. There is increasing

TABLE 12. Total, “metabolically active”, and “HCl-soluble” Fe in freshly sampled leaf tissue of two calcifuge species, grown in acid silicate soil, calcareous soil, and calcareous soil amended with calcium phosphate.*

Species	Soil	Total	Metabolically active	HCl soluble
<i>Carex pilulifera</i>	Acid	781	283	691
	Calcareous	491	163	272
	Calcareous + P	360	115	202
<i>Veronica officinalis</i>	Acid	1148	689	818
	Calcareous	1588	399	654
	Calcareous + P	1311	480	593

Source: Zohlen & Tyler 1997.

* Expressed as nmol g⁻¹ dry mass.

Note: The “metabolically active” fraction was extracted with 1,10-phenantroline, an Fe-complexing reagent considered to extract mainly Fe²⁺; the HCl-soluble fraction is considered the fraction that is important in chlorophyll synthesis.

evidence that hyperaccumulation confers protection against herbivores and microbial pathogens (Chapters 9A and 9B; Poschenrieder et al. 2006).

Serpentine soils have naturally high levels of nickel (Ni), chromium (Cr), cobalt (Co), and magnesium (Mg), but low concentrations of Ca, N, and P. The flora associated with these soils is rich in specially adapted **endemic species** (Arianoutsou et al. 1993). It has been known in Europe for centuries that rock formations containing high levels of certain metals (e.g., Cu) are characterized by certain plant species associated with these sites (**metallophytes**). This is also true for southern Africa, where only certain herbaceous species [e.g., *Senecio coronatus* (woolly grassland senecio)] establish in metal-rich sites (Przybylowicz et al. 1995). Such **metal-hyperaccumulating** plants may contain very high levels of heavy metals. Hyperaccumulators of Co, Cr, Cu, Pb, or Ni have concentrations $>1 \text{ mg g}^{-1}$ dry mass, and hyperaccumulators of Mn or Zn contain up to 10 mg g^{-1} dry mass. Recently a fern, *Pteris vittata* (Chinese brake fern) was found to hyperaccumulate arsenate (As). In As-spiked soils, it accumulates 23 mg g^{-1} dry mass of As in its above-ground biomass (fronds) (L. Ma et al. 2001c). Metal-resistant species can be used as indicators to identify potential mining sites (e.g., *Hybanthus floribundus*, from the Eastern Goldfields area of Western Australia, to find Ni) (Brooks 1998).

In sites close to mines, where the remains of the mining activity have enriched the soil with heavy metals, or under electricity pylons, which cause zinc contamination due to corrosion of their galvanized surfaces, metal-resistant genotypes emerge [e.g., of *Agrostis capillaris* (colonial bentgrass), *Agrostis stolonifera* (creeping bentgrass), *Anthoxanthum odoratum* (sweet vernalgrass), *Deschampsia caespitosa* (tufted hair-grass), and *Festuca ovina* (sheep's fescue) (Al-Hiyaly et al. 1990)]. The shoots of such plants may contain as much as 1.5 mg g^{-1} Zn on a dry mass basis, a level that is highly toxic to other plants (Brown & Brinkmann 1992). Along roadsides, which are often enriched in lead (Pb) from automobile exhaust, Pb-resistant genotypes occur. Some *Agrostis tenuis* (common bentgrass) genotypes grow even better in soils that contain as much as 10 mg g^{-1} Pb than in unpolluted control soil (McNeilly 1968). Resistant genotypes are usually resistant only to one metal, unless more than one heavy metal is present in high level at such a site.

Cadmium (Cd) pollution has increased drastically in recent decades as a result of combustion of fossil fuel, disposal of pigments and stabilizers for plastics, application of sewage sludge, and the use of phosphate fertilizers. This has led to concern

about possible health and ecosystem effects. A comparison of several cultivars of two *Lupinus* species [*Lupinus albus* (white lupin), and *Lupinus angustifolius* (narrow-leaved lupin)] with *Lolium multiflorum* (Italian ryegrass) showed much greater uptake by the grass. Because the lupins release considerably more **carboxylates** (citrate, malate, and succinate) into the rhizosphere than the grass does, cadmium is possibly chelated by root exudates which would reduce its availability for uptake (Römer et al. 2000).

3.3.2 Using Plants to Clean or Extract Polluted Water and Soil: Phytoremediation and Phytomining

Some metal-accumulating species have been used to remove heavy metals from polluted water [e.g., *Eichhornia crassipes* (water hyacinth)]. Terrestrial metallophytic species are also potentially useful to remove heavy metals from polluted sites, a process termed **phytoremediation** (Chaney et al. 1997, Krämer 2005). It requires plants that show both a high biomass production and metal accumulation to such high levels that extraction is economically viable. For example, *Brassica juncea* (Indian mustard) accumulates high levels of Cd, even when the Cd level in solution is as low as 0.1 mg L^{-1} (Salt et al. 1995), *Thlaspi montanum* (Fendler's pennycress) and *Thlaspi goesingense* (tiny wild mustard) accumulate high levels of Ni (Krämer et al. 1997, Boyd & Martens 1998), and *Thlaspi caerulescens* (alpine pennycress) accumulates Zn and Cd (Robinson et al. 1998, Frey et al. 2000). The combination of high biomass production and hyperaccumulation is often found in Brassicaceae (cabbage family). After accumulation of heavy metals from the polluted soil, the plants have to be removed and destroyed, taking care that the toxic metal is removed from the environment. Phytoremediation technologies are currently available for only a small subset of pollution problems, such as As. As removal employs naturally selected hyperaccumulator plants [e.g., *Pteris vittata* (brake fern)], which accumulate very high concentrations of arsenic specifically in above-ground tissues (Krämer 2005).

Metal-accumulating plants can also be used as a "green" alternative to environmentally destructive opencast mining practices. Such production of a crop of high-biomass plants that accumulate high metal concentrations is termed **phytomining** (Brooks et al. 1998, Robinson et al. 1999). Phytomining also offers the potential to exploit ore bodies that are uneconomic to mine by conventional methods. Promising results have been obtained using a

number of hyperaccumulating species to extract gold; **ammonium thiocyanate** is added to soil, because this is commonly used for making gold soluble in mining operations. In the presence of this compound, *Brassica juncea* (Indian mustard) accumulates nearly $60 \mu\text{g g}^{-1}$ dry mass, whereas these plants typically contain only $1 \mu\text{g g}^{-1}$ plant (Anderson et al. 1998).

3.3.3 Why Are Heavy Metals So Toxic to Plants?

The biochemical basis of metal toxicity is not always clear. Heavy metals are "Lewis acids", which can accept a pair of electrons from a coordinate covalent bond; that is, they react with naturally occurring "Lewis bases" in the cell, such as S^- groups, OH^- groups, amino groups, and carboxylic acid termini. Cd, Pb, and Hg, which are nonessential, affect **sulfhydryl groups** and **N atoms** in proteins and thus inactivate these. For a redox-active metal, an excess supply may result in uncontrolled redox reactions, giving rise to the formation of toxic **free radicals**. For example, $\text{Fe}^{2+} + \text{H}_2\text{O}_2 \rightarrow \text{Fe}^{3+} + \text{OH}\cdot + \text{OH}^-$, followed by $\text{Fe}^{3+} + \text{H}_2\text{O}_2 \rightarrow \text{Fe}^{2+} + \text{OOH}\cdot + \text{H}^+$. Free radicals may lead to **lipid peroxidation** and membrane leakage (Clemens 2001). Other heavy metals may inactivate major enzymes by **replacing the activating cation**. For example, Zn may replace Mg in Rubisco, reducing the activity of this enzyme and hence the photosynthetic capacity (Clijsters & Van Assche 1985). Like Zn, Cd also affects photosynthesis. Fluorescence measurements indicate that the Calvin cycle is the primary process affected, and this subsequently leads to a "down-regulation" of photosystem II (Krupa et al. 1993). Cd affects the mineral composition even in Cd-resistant species such as *Brassica juncea* (Indian mustard). It reduces the concentration of Mn, Cu, and chlorophyll in the leaves, even at a concentration in solution that has no effect on biomass production (Salt et al. 1995).

Most primary effects of heavy metals occur in the **roots**, which show reduced elongation upon exposure. Metal resistance can be quantitatively assessed by determining the effect of the metal on root elongation (Table 13). The increment in root dry mass tends to be affected less than that in root length, leading to "stubby" roots (Brune et al. 1994). Zn inhibition of water uptake may be due to binding of the metal to water-channel proteins (Sect. 5.2 of Chapter 3 on plant water relations). Mn toxicity leads to interveinal chlorosis and reduced photosynthesis (Macfie & Taylor 1992).

TABLE 13. The effect of zinc on root elongation of a Zn-sensitive and a Zn-resistant ecotype of *Deschampsia caespitosa*.

Zn sensitive		Zn resistant	
Zn concentration (μM)	Root elongation rate (%)	Zn concentration (μM)	Root elongation rate (%)
1	100	1	100
25	82	250	82
50	78	500	64
100	62	1000	53

Source: Godbold et al. 1983.

Note: The plants were exposed to different Zn concentrations in solution for 10 hours.

3.3.4 Heavy-Metal-Resistant Plants

Resistance in higher plants has been demonstrated for the following heavy metals: Cd, Cu, Fe, Hg, Mn, Ni, Pb, and Zn. **Metal resistance** is sometimes partly based on **tolerance**. For example, damage by Pb outside the plasma membrane can be prevented by modification of extracellular enzymes so that they are no longer affected by Pb. This has been shown for extracellular phosphatases in Pb-resistant genotypes of *Agrostis tenuis* (common bentgrass). **Avoidance** mechanisms generally account for resistance in a range of species. At a cellular level, these mechanisms include (Fig. 24) the following:

1. **Exclusion** of the metal:
 - a. binding by mycorrhizal fungi;
 - b. binding to root cell walls;
 - c. chelation by root exudates;
 - d. reduced net uptake: decreased influx or increased efflux.
2. Uptake followed by storage, typically occurring in **hyperaccumulators**:
 - a. chelation of metals in the cytosol;
 - b. repair of metal-damaged proteins;
 - c. compartmentation of metals in specific compartments, e.g., vacuoles or trichomes.

In addition, mechanisms that are expressed at the level of whole plants play a role. These include differences in the proportion of absorbed metals that are either retained in the roots or loaded in the xylem for export to the shoot (Assunção et al. 2003).

Some mycorrhizal fungi (predominantly ectomycorrhizal fungi; Sect. 2 of Chapter 9A on symbiotic associations) can retain Zn and thus reduce the Zn

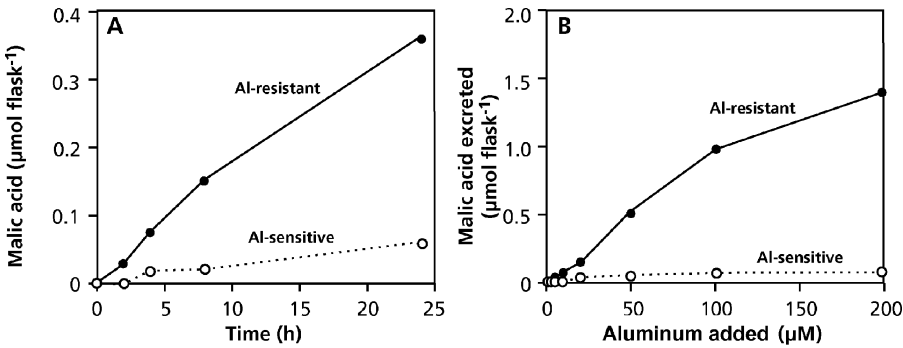

FIGURE 24. (A) Malate release from the roots of seedlings of an Al-resistant and an Al-sensitive genotype of *Triticum aestivum* (wheat) incubated in nutrient solution containing 50 mM Al. (B) Effect of Al concentration in

the nutrient solution on malate release of the same genotypes as shown in (A) (after Delhaize et al. 1993). Copyright American Society of Plant Biologists.

content of their host, *Pinus sylvestris* (Scots pine). Although the root cell walls are in direct contact with heavy metals in the soil solution, adsorption onto these must be of limited capacity and be of little consequence for resistance.

As with Al (Sect. 3.1.3), heavy metals can be chelated by exudates released from roots of resistant plants. For example, Ni-resistant plants of *Thlaspi arvense* (field pennycress) exude histidine and citrate, which chelate Ni and thus reduce its uptake by roots (Nian et al. 2002, Salt et al. 2000). Pb-resistant varieties of *Oryza sativa* (rice) release oxalate into the rhizosphere to detoxify Pb (Yang et al. 2000). Cu induces release of malate and citrate from roots of *Triticum aestivum* (wheat). Therefore, although not as widely explored as carboxylate release as a mechanism to reduce uptake of Al, a similar mechanism does appear to play a role in preventing entry of heavy metals (Fig. 25).

The clearest example of reduced uptake as a resistance mechanism is for As, first discovered in *Holcus lanatus* (common velvetgrass). Arsenate, which is structurally similar to phosphate, is taken up by the same transport system as P_i , and the As-resistant plants exhibit an absence of the high-affinity P_i -uptake system (Meharg & Macnair 1992). Enhanced efflux plays a role in bacteria and fungi, but has not yet been found in higher plants (Sharples et al. 2000, Hall 2002).

Chelation of heavy metals following their uptake involves several SH-containing compounds. Cd resistance is associated with the presence of SH-containing phytochelatins (PCs) (Fig. 26A,B). PCs are poly(γ -glutamyl-cysteinyl)-glycines, which bind metals. Unlike other peptides, with an α -carboxyl peptide bond, they are not made on ribosomes, but via a specific pathway from glutathione (which can

also bind metals on its own). Upon exposure of tobacco [*Nicotiana rustica* (Aztech tobacco)] plants to Cd in the root environment, Cd-binding peptides, [γ -(Glu-Cys)₃-Gly and γ -(Glu-Cys)₄-Gly] are produced. Inhibition of PC synthesis leads to loss of the cadmium-detoxification mechanism. Together with Cd, some of the PCs are almost exclusively located in the vacuole (Vögeli-Lange & Wagner 1990), and an ATP-dependent mechanism transporting the Cd-PC complex has been identified in tonoplasts of *Avena sativa* (oat) (Salt & Rauser 1995). The formation of PCs, followed by uptake of the Cd-PC complex in the vacuole, probably plays a crucial role in Cd resistance. Cu resistance in *Arabidopsis thaliana* (thale cress) correlates with the level of expression of genes that encode metallothioneins, a group of cysteine-rich metal-binding proteins. Metallothioneins also have a high affinity for Cd and Zn. They were first discovered as the substances that are responsible for Cd accumulation in mammalian kidney. Like other proteins, but unlike phytochelatins, metallothioneins are synthesized on ribosomes (Robinson et al. 1993, Murphy & Taiz 1995).

Evidence for protection against heavy-metal-induced damage comes from enhanced expression of heat-shock proteins (HSPs). These proteins characteristically show increased expression in response to exposure of plants to stress, including heavy metals as well as high temperature (Sect. 3.2 of Chapter 4B on effects of radiation and temperature).

Compartmentation of accumulated metals may occur in the vacuole or in the apoplastic space (e.g., for Zn, Cd, Ni, and Cu) (Krämer et al. 2000). Epidermal cells, with the exception of stomatal cells, may also be used for storage of the metals (Brune et al. 1994, Frey et al. 2000). Cd, Mn, Zn, and Pb are

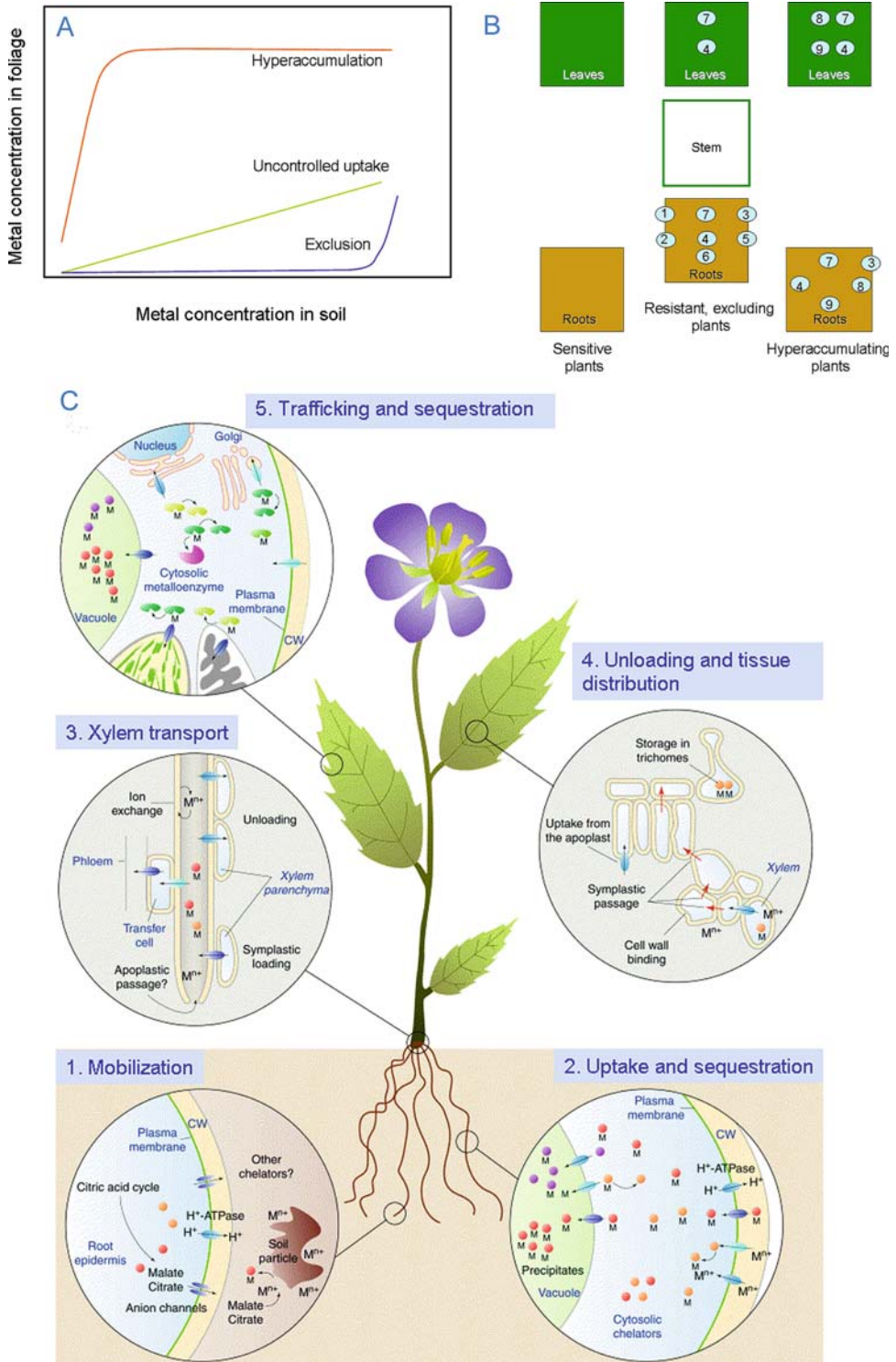

FIGURE 25. Summary of potential responses of higher plants to heavy metals. (A) Typical responses of sensitive plants, plants that exclude heavy metals from their

foliage, and hyperaccumulating plants. For further explanation, see text (Callahan et al. 2005). (B) Mechanisms of metal toxicity and resistance in higher plants.

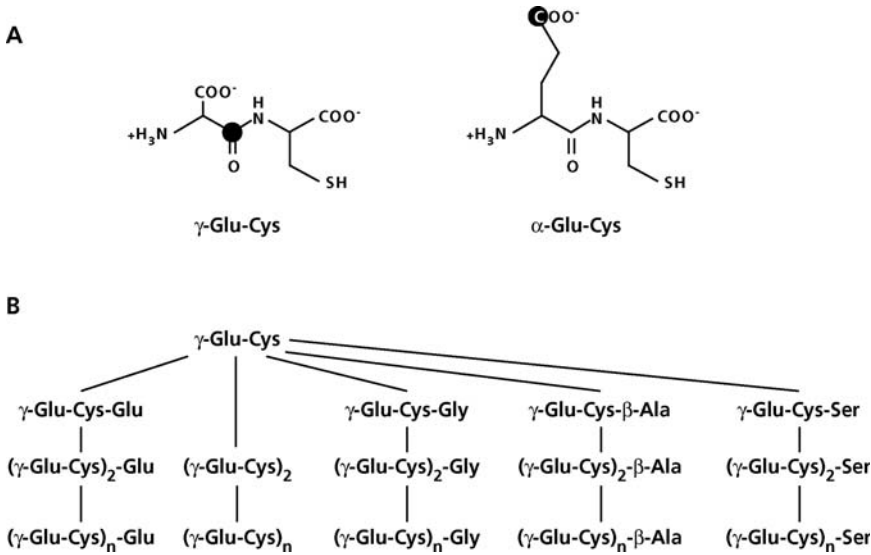

FIGURE 26. (A) The structure of γ (Glu-Cys) peptides. The γ -carboxyl-C of Glu is highlighted to indicate the difference between α - and γ -carboxyamide linkages. (B) A model summarizing the five families of γ (Glu-Cys)

peptides involved in metal immobilization in plants and yeasts; the lines indicate family relationships and do not necessarily specify biosynthetic sequences (Rausser 1995).

preferentially accumulated in leaf trichomes [e.g., in *Brassica juncea* (Indian mustard) and *Arabidopsis halleri*(meadow rock-cress)] (Salt et al. 1995, Zhao et al. 2000).

Cu resistance in *Silene cucubalus* (bladder campion) is based on **exclusion**, which is at least partly based on ATP-dependent Cu efflux (Van Hoof et al. 2001). Upon exposure to Cu, both resistant and sensitive *Silene vulgaris* plants accumulate

phytochelatin (Fig. 27). When compared at tissue Cu concentrations that give a similar physiological effect, the phytochelatin concentrations in sensitive and resistant genotypes are fairly similar (Table 14). Phytochelatin synthesis is likely to be essential to bind the toxic Cu, but because phytochelatin is produced in both Cu-resistant and sensitive plants, it is apparently not the basis for Cu resistance in *Silene vulgaris*.

FIGURE 25. (continued) 1. Restriction of metal movement to roots by mycorrhizal fungi. 2. Binding to cell walls. 3. Chelation by root exudates. 4. Reduced influx across the plasma membrane. 5. Efflux into the apoplast. 6. Chelation in the cytosol by various ligands, including organic acids, phytochelatin (PC), and metallothioneins (MT). 7. Repair and protection of plasma membranes, e.g., by heat-shock proteins (HSP) and metallothioneins. 8. Transport of PC-Cd complex into the vacuole. 9. Transport and accumulation of metals in the vacuole (Hall 2002). (C) Molecular mechanisms involved in heavy metal hyperaccumulation. (1) Metal ions are mobilized by secretion of chelators and acidification of the rhizosphere. (2) Uptake of hydrated metal ions or metal-chelate complexes is mediated by various uptake systems in the plasma membrane. Inside the cell, metals are chelated, and excess metals are sequestered by transport into the vacuole. (3) From the roots, transition

metals are transported to the shoot via the xylem. Presumably, the larger portion reaches the xylem via the root symplast. Apoplastic passage might occur at the root tip. Inside the xylem, metals are present as hydrated ions or as metal-chelate complexes. (4) After reaching the apoplast of the leaf, metals are differentially captured by different leaf cell types and move cell to cell through plasmodesmata. Storage appears to occur preferentially in trichomes. (5) Uptake into the leaf cells again is catalyzed by various transporters [not depicted in (5)]. Intracellular distribution of essential heavy metals (= trafficking) is mediated by specific metallo-chaperones and transporters localized in endomembranes (note that these processes function in every cell). Abbreviations and symbols: CW, cell wall; M, metal; filled circles, chelators; filled ovals, transporters; bean-shaped structures, metallo-chaperones (Clemens et al. 2002); copyright Elsevier Science, Ltd.

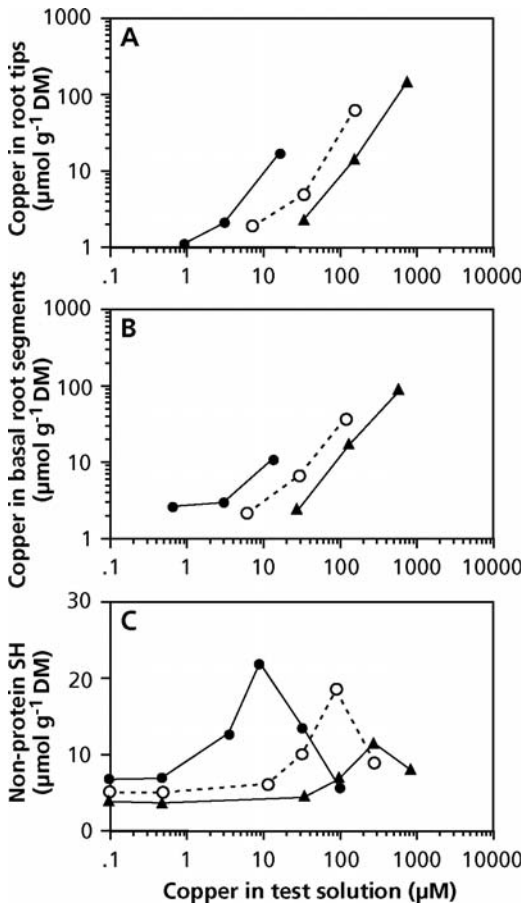

FIGURE 27. Copper (A, B) and phytochelatin sulfhydryl concentration (lowest panel) in the roots of one Cu-sensitive (filled circles) and two Cu-resistant (open circles and filled triangles) ecotypes of *Silene cucubalus*(bladder campion). Cu was measured in the apical 10 mm (A) and the adjacent 10 mm (B). Phytochelatin was measured for the entire roots (after Schat & Kalff 1992).

When compared at the same external Zn concentration (100 µM), a **Zn-resistant** ecotype of *Deschampsia caespitosa* (tufted hair-grass) accumulates less Zn in the apical parts of its roots (especially the 0–10 mm zone, but also in the 10–50 mm zone), but more in the basal parts (further than 50 mm from the apex) (Godbold et al. 1983). At the same external Zn concentration, whole roots of both ecotypes of *Deschampsia flexuosa* absorb Zn at the same rate. When compared at an external Zn concentration that has a similar effect on root growth (Table 13), the resistant ecotype accumulates more Zn than does the sensitive one (Fig. 28). As found for other Zn-resistant genotypes, it also binds a greater

TABLE 14. Phytochelatin sulfhydryl concentration [µmol (g dry mass)⁻¹] and molar ratio of phytochelatin to Cu in the roots of a Cu-sensitive and a Cu-resistant ecotype of *Silene cucubalus*(bladder campion).

Cu exposure level	Phytochelatin concentration		Phytochelatin/Cu ratio	
	Sensitive	Resistant	Sensitive	Resistant
Highest concentration without any effect	3.7	2.9	3.7	1.6
Concentration giving 50% inhibition of root growth	7.6	7.5	3.7	1.7
Concentration giving 100% inhibition of root growth	19.0	16.0	1.2	0.3

Source: Schat & Kalff 1992.

Note: The same data were used as given in Figure 27 for the apical 10 mm.

fraction of the Zn to its cell walls than does the sensitive one. Inside the cell, Zn is probably stored in the vacuole (as a complex with oxalate or citrate). There is very little transport of Zn to the shoot, especially in the resistant ecotypes. Zn-resistant ecotypes of *Silene vulgaris* (bladder campion) also accumulate more Zn than sensitive ones. Zn accumulates in vacuoles because of a greater capacity to transport Zn across the tonoplast (Chardonnens et al. 1999). As with Al (Sect. 3.1.1), many heavy metals are largely complexed or precipitated at cytosolic pH.

Typical Zn-hyperaccumulating species [e.g., *Thlaspi caerulescens* (alpine pennycress)] accumulate and tolerate up to 40 mg Zn g⁻¹ dry mass in their shoots. When exposed to Zn levels that are toxic for most plants, *Thlaspi caerulescens* shows both enhanced Zn influx into the roots and increased transport to the shoots which makes it a promising species to be used for **phytoremediation** (Lasat et al. 1996).

After the discovery of extreme Ni hyperaccumulation in *Alyssum bertolonii* (Brassicaceae) from Italian serpentine soil in 1948, nearly 200 species have been identified as Ni hyperaccumulators. **Ni resistance** in *Alyssum lesbiacum* is associated with the presence of high concentrations of the amino acid **histidine**. Histidine plays a role in the detoxification of absorbed Ni and transport of a Ni-

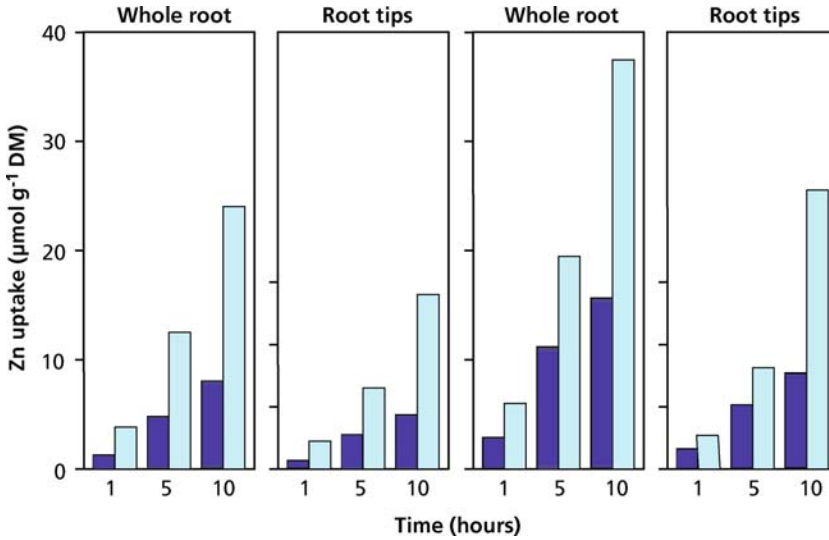

FIGURE 28. Uptake of ^{65}Zn by roots of a Zn-sensitive (filled bars) and a Zn-resistant (open bars) ecotype of *Deschampsia caespitosa*. The plants are compared at low and high external Zn concentrations, which give the same effect on root elongation (Table 14). The low Zn concentrations (panels at left) are 25 and 250 mM, and the high Zn concentrations (panels at right) are 100

and 500 mM for the sensitive and resistant ecotype, respectively. At the end of the experiment, desorption into a nonlabeled Zn solution was allowed for 30 minutes. The data therefore show uptake into the root cells only, rather than a combination of uptake and binding of labeled Zn to the cell walls (after Godbold et al. 1983).

histidine complex in the xylem to the leaves. In some *Alyssum* species Ni may accumulate to 30 mg g⁻¹ leaf dry mass (Krämer et al. 1996).

3.3.5 Biomass Production of Sensitive and Resistant Plants

The biomass production of metal-resistant ecotypes tends to be less than that of sensitive ones, even when compared at a concentration of the heavy metal that is optimal for the plants (i.e., a higher concentration for the resistant plants) (Table 15). This might be due to the costs associated with the resistance mechanism. Alternatively, the low productivity of the resistant ecotypes may be associated with the typically low nutrient supply in their natural environment, which selects for inherently slow-growing species (Sect. 3 of Chapter 7 on growth and allocation).

When grown in nontoxic soil, Cu-resistant and Cu-sensitive ecotypes of *Agrostis tenuis* (common bentgrass) have a similar yield in monoculture. In mixtures, the yield of the resistant ecotype is reduced (McNeilly 1968). This explains why resistant ecotypes are exclusively found in environments containing high levels of heavy metals. If resistance were based on reduced uptake capacity, as for As-resistant

TABLE 15. Dry mass (mg per two plants) of roots and shoot of a Cu-sensitive and a Cu-resistant ecotype of *Silene cucubalus* (= *S. vulgaris*, bladder campion), after growth in nutrient solution with two Cu concentrations.

Ecotype		0.5 µM	40.5 µM
Sensitive	Roots	64	8
	Shoot	523	169
	Total	587	173
Resistant	Roots	22	33
	Shoot	146	237
	Total	168	270

Source: Lolkema et al. 1986.

Note: The different ecotypes were grown separately.

ecotypes that are characterized by an absence of the high-affinity P_i-uptake system (Sect. 3.3.4), this would offer an explanation for this observation.

3.4 Saline Soils: An Ever-Increasing Problem in Agriculture

The presence of high concentrations of Na⁺, Cl⁻, Mg²⁺, and SO₄²⁻ ions in saline soils inhibits growth

of many plants. On a global scale, production is severely restricted by salinity on about 380 million hectares that is potentially usable for agriculture. These areas occur predominantly in regions where evaporation exceeds precipitation (as in southern Australia) and in low-lying areas (such as the Mekong delta and many coastal stretches) where infiltration of seawater is common. The problem of saline soils is ever increasing, due to poor irrigation and drainage practices, expansion of irrigated agriculture into arid zones with high evapotranspiration rates, or clearing land which leads to rising saline water tables ("dryland salinity") (Munns 2002, 2005).

3.4.1 Glycophytes and Halophytes

Most crop species are relatively salt sensitive (**glycophytes**). A notable exception is sugar beet (*Beta vulgaris*). In saline areas, such as salt marshes, species occur with a high resistance to salt in their root environment (**halophytes**). The problems associated with high salinity are threefold:

1. A high salinity is associated with a low soil **water potential**, giving rise to symptoms similar to those of water stress;
2. Specific ions, especially Na^+ and Cl^- , may be **toxic**;
3. High levels of NaCl may give rise to an **ion imbalance** (predominantly Ca) and lead to deficiency symptoms.

Plant adaptation and acclimation to salinity involve all these aspects; we discussed acclimation associated with the low water potential in Sect. 3 of Chapter 3 on plant water relations.

Toxicity effects may include competition of Na^+ with K^+ in biochemical processes and inhibition of NO_3^- uptake by Cl^- , possibly because both anions

are transported across the plasma membrane by the same carrier. The toxic effect of Na^+ far exceeds that of Cl^- (Tester & Davenport 2003). High Na^+ may replace Ca^{2+} on root cell membranes, which may give rise to leakage of K^+ from the root cells. It may also reduce the influx and enhance the efflux of Ca^{2+} . The decreased influx of Ca probably results from competition for binding sites in the cell wall which decreases the concentration at the protein in the plasma membrane responsible for Ca^{2+} influx. The toxicity of specific ions may subsequently lead to an ion imbalance and ion deficiency, especially Ca deficiency (Munns 2002). On the other hand, Ca^{2+} reduces the influx of Na^+ , due to the inhibition by Ca^{2+} of a voltage-insensitive monovalent channel that allows Na^+ entry into roots (White 1999). However, confirmation of this effect using intact plants is necessary to firmly establish that Ca^{2+} does, indeed, affect influx. The addition of Ca^{2+} has often been proposed as a strategy to reduce Na^+ toxicity to crops.

At a moderate NaCl concentration in the root environment, Na^+ uptake occurs down an electrochemical potential gradient and higher Na^+ concentrations are expected inside than outside (Table 16). Roots of some **glycophytes**, however, maintain a low Na^+ concentration in the presence of 1 mM Na^+ in their medium. This indicates that either their plasma membranes are highly impermeable for this ion or Na^+ is actively excreted from these roots.

3.4.2 Energy-Dependent Salt Exclusion from Roots

The low Na^+ concentration inside the cells of glycophytes is mostly due to energy-dependent transport. At an external NaCl concentration of 1 mM,

TABLE 16. Experimentally determined concentrations of Na^+ and K^+ ions in *Avena sativa* (oat) and *Pisum sativum* (pea) roots, compared with values predicted on the basis of the Nernst equation.*

Ion	Oat		Pea	
	Predicted	Experimentally determined	Predicted	Experimentally determined
K^+	27	66	73	75
Na^+	27	3	73	8

Source: Higginbotham et al. 1967.

*The latter values assume that no metabolic energy-dependent mechanism is involved in the transport of these cations. The membrane potential of oat and pea was -84 and -110 mV, respectively.

TABLE 17. Net uptake of labeled Na^+ in a glycophyte, *Plantago media* (hoary plantain), and a halophyte, *Plantago maritima* (sea plantain), in the presence and absence of DES (diethylstilboestrol, an inhibitor of the plasma membrane ATPase).*

NaCl (mM)	<i>Plantago media</i>		<i>Plantago maritima</i>	
	-DES	+DES	-DES	+DES
1	0.5	2.8	5.9	2.7
10	6	27.7	21.6	25.5
50	37.3	121.1	68.1	82.5

Source: De Boer 1985.

* The uptake was measured at three levels of NaCl in the nutrient solution and are expressed as ($\mu\text{mol (g root dry mass)}^{-1} \text{ hour}^{-1}$). Values printed in bold are significantly different from those to their immediate left.

inhibition of the plasma membrane H^+ -ATPase increases net Na^+ uptake in the glycophyte *Plantago media* (hoary plantain), but decreases it in the halophyte *Plantago maritima* (sea plantain). This illustrates that both **ATP-dependent Na^+ excretion and uptake** occur in these *Plantago* species (Table 17). At higher (10, 50 mM) NaCl concentrations, the roots of the glycophyte continue to excrete Na^+ , but not to the extent that accumulation in the plant is avoided. At 10 mM, there is no evidence for ATPase-mediated uptake in the halophyte, and at 50 mM there is excretion (Table 17).

3.4.3 Energy-Dependent Salt Exclusion from the Xylem

At 10 and 50 mM NaCl, when an inhibitor of the plasma membrane ATPase has no positive effect on the Na^+ concentration in the roots, the inhibitor enhances the Na^+ concentration in the leaves of *Plantago* (Fig. 29). This indicates ATP-dependent exclusion from the xylem in both the glycophyte [*Plantago media* (hoary plantain)] and the halophyte [*Plantago maritima* (sea plantain)]. Glycophytes, therefore, maintain a lower Na^+ concentration in their leaves, partly due to excretion by their roots as well as because of energy-dependent **exclusion from the xylem** (Cheeseman 1988). In *Arabidopsis thaliana* (thale cress), such exclusion is based on reabsorption of Na^+ from the xylem by surrounding xylem-parenchyma cells involving a specific Na^+ transporter (Sunarpi et al. 2005, Davenport et al. 2007).

Using labeled Na^+ , it has been shown for *Glycine max* (soybean) that salt that leaks into the xylem can be reabsorbed and excreted back into the root environment; however, the extent to which this happens

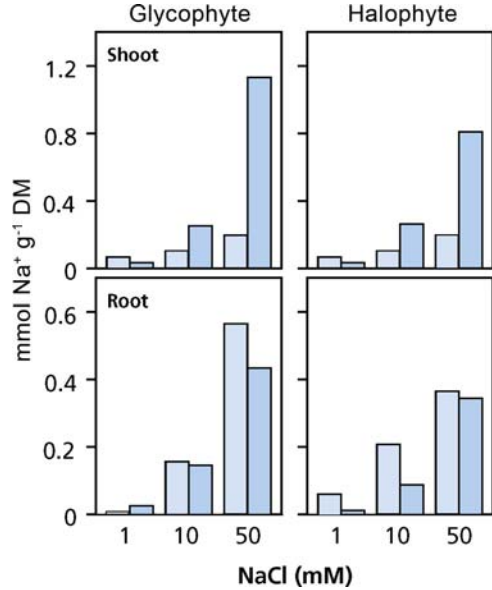

FIGURE 29. The effect of an inhibitor of the plasma membrane ATPase (DES, diethylstilboestrol; open bars) on the accumulation of labeled Na^+ in roots and shoots of a glycophyte (*Plantago media*) and a halophyte (*P. maritima*). Results for control plants are shown with filled bars (De Boer 1985). Reproduced with the author's permission.

in this glycophyte is rather small (Lacan & Durand 1994).

3.4.4 Transport of Na^+ from the Leaves to the Roots and Excretion via Salt Glands

Salt transported to the shoot via the transpiration stream may be exported again, via the phloem, to the roots. Using $^{22}\text{NaCl}$, this was shown for *Capsicum annuum* (sweet pepper) (Blom-Zandstra et al. 1998). For another glycophyte [*Lupinus albus* (white lupin)] this was determined by analyzing phloem sap, which exudes spontaneously from white lupin stems upon cutting (Sect. 5 in Chapter 2C on long-distance transport). Export of Na^+ to the roots may be followed by excretion, as shown for *Plantago media* (hoary plantain) (Table 17).

True halophytes may have **salt glands**, which excrete salt from their leaves. These may remove a major part of the salt arriving in the shoot via the transpiration stream, as shown for *Cynodon* (bermudagrass) turf cultivars (Fig. 30). **Salt exclusion** in the roots can be estimated from the difference in net Cl^- uptake and the product of the transpiration rate and

FIGURE 30. (A) Leaf salt gland Na-excretion rate and (B) leaf sap Na concentration plotted against relative salinity tolerance of 35 *Cynodon* (bermudagrass) turfgrass cultivars. Relative salinity tolerance is the salinity level resulting in 50% shoot dry weight relative to that of control; a broad range in salinity tolerance exists within the *Cynodon* genus (Marcum & Pessaraki 2006). Copyright Crop Science Society of America.

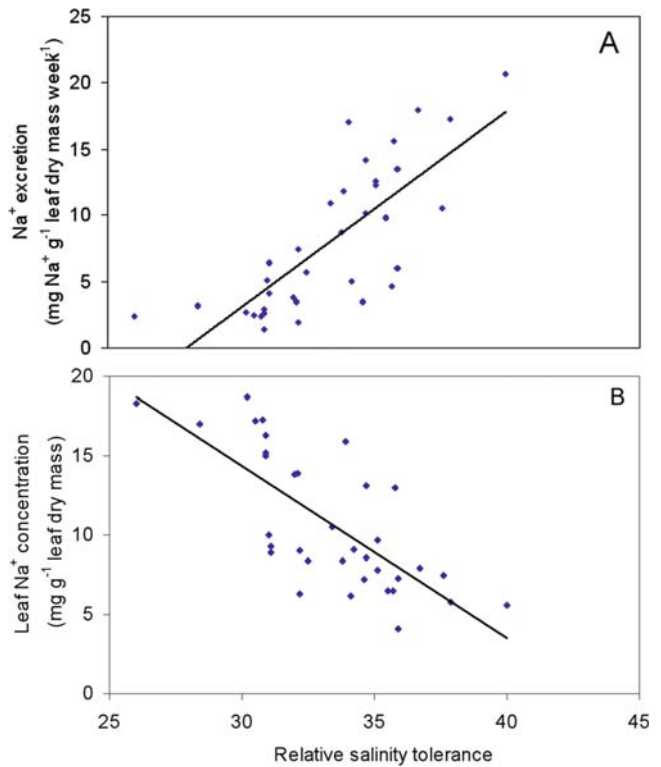

the Cl^- concentration in the root environment. It is substantial in *Avicennia marina* (gray mangrove), increasing from 90% at the lowest salinity level to 97% at 500 mM NaCl (Ball 1998). Exclusion may be due to active excretion from the roots, as in *Plantago* species (Table 17), or be associated with highly impermeable membranes. Active excretion must incur respiratory costs, as discussed in Sect. 4.2 of Chapter 2B on plant respiration.

Salt removal from the leaves involves specialized structures, specialized **trichomes (salt bladders)** (Schirmer & Breckle 1982) or **salt glands** (Wiehe & Breckle 1990). In *Atriplex* species, salt that arrives in the transpiration stream is transported via plasmodesmata to the cytosol of epidermal cells and then to bladder-like cells on stalks (special trichomes) on the epidermal surface (Fig. 31). The salt is pumped into the large vacuole of this bladder cell. In the end, the bladder may collapse and the salt is deposited on the leaf surface, where it gives the leaves a white appearance until washed away by rain. The salt may also be **excreted** in such a way that concentrated droplets fall from the leaves, as in some *Tamarix* species. True salt glands, as opposed to the trichomes of *Atriplex*, are found in *Tamarix aphylla* (Fig. 31). The salt glands of *Tamarix aphylla* consist

of eight cells, six of which are involved in pumping the salt to the leaf surface. Salt is transported from mesophyll cells via plasmodesmata to two basal collecting cells that transport it to the secreting cells. The secreting cells are surrounded by a lipophilic layer, except where they are connected to the basal cells via plasmodesmata. In these secreting cells, salt is pumped into microvacuoles. These merge with the plasma membrane and the salt is then exported to the apoplast. The invaginations in these cells suggest that active membrane transport is involved as well. The salt diffuses via the apoplast to a pore in the cuticle, where it is deposited on the leaf surface. The waxy layer that surrounds the secreting cells prevents back diffusion to the mesophyll cells (Popp 1995).

What might be the advantage of salt excretion from the leaves over salt excretion from the roots? If all the salt that arrives via mass flow at the root surface were excluded, then the salt concentration in the rhizosphere would rapidly rise to very high levels. In the absence of a substantial removal from the rhizosphere by bulk flow of less saline water, the local accumulation of salt would continue to reduce water potential and aggravate the problems associated with water uptake (Passioura et al. 1992).

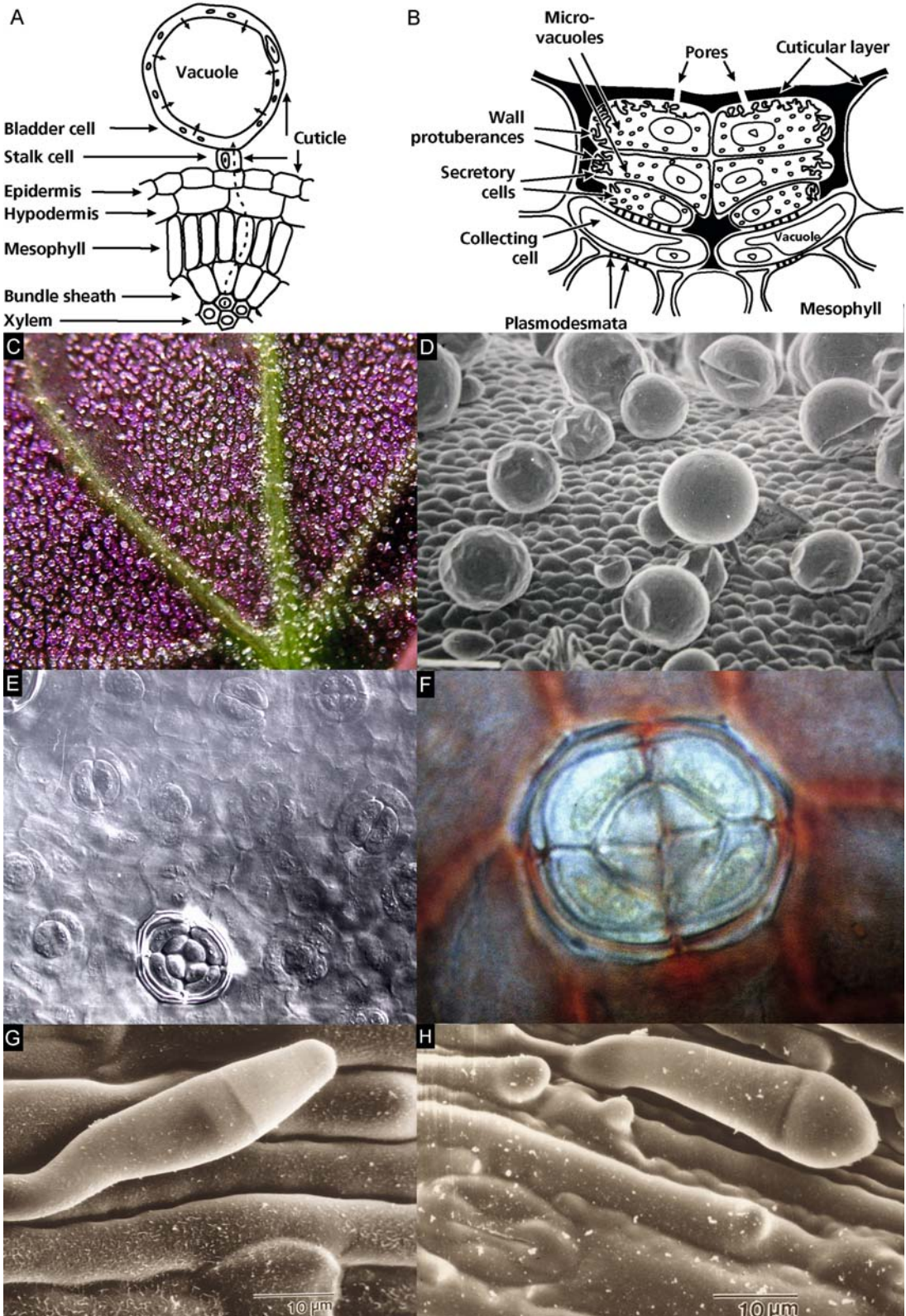

A high water-use efficiency in combination with salt exclusion therefore has advantages over active or passive exclusion only. Mangrove species with the highest water-use efficiency are also the most salt-resistant ones (Ball 1988).

3.4.5 Compartmentation of Salt Within the Cell and Accumulation of Compatible Solutes

Salt resistance also involves the **compartmentation** of the potentially toxic ions in the vacuole and the capacity to produce nontoxic, **compatible solutes** in the cytoplasm (Sect. 3 of Chapter 3 on plant water relations). Compartmentation in the **vacuole** is achieved by an active mechanism that is induced in halophytes such as *Plantago maritima* (sea plantain) (Fig. 32) and *Mesembryanthemum crystallinum* (common iceplant) (Barkla et al. 1995), but not in glycophytes, such as *Plantago media* (hoary plantain), in the presence of NaCl in the root medium. A specific Na⁺ transporter is involved in compartmentalizing Na⁺ in the vacuole (Apse & Blumwald 2007).

Some moderately salt-resistant glycophytes, for example, *Hordeum vulgare* (barley) cultivars, also accumulate some salt in their leaves. Using X-ray diffraction, it can be shown that Cl⁻ predominantly accumulates in the vacuoles of the epidermis cells of leaf blades and sheaths. To a smaller extent Cl⁻ is also found in the mesophyll cells of the leaf sheath, whereas the concentration remains low in the mesophyll cells of the leaf blade, even after exposure to 50 mM NaCl in the root environment for 4 days (Huang & Van Steveninck 1989).

3.5 Flooded Soils

The absence of oxygen in the soil causes a drop in redox potential, due to microbial activity. At a low

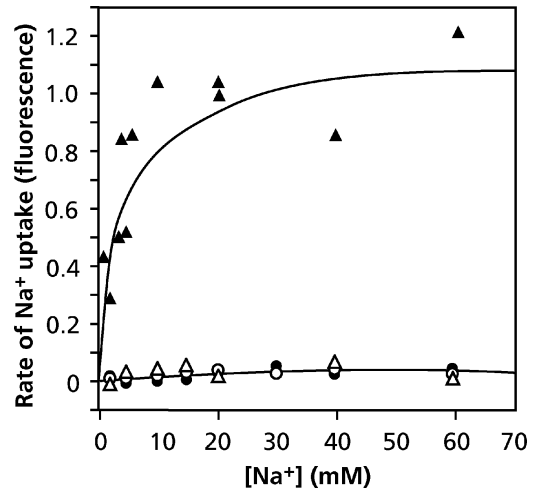

FIGURE 32. Uptake of Na⁺ in tonoplast vesicles of the glycophyte *Plantago media* (hoary plantain, circles) and the halophyte *Plantago maritima* (sea plantain, triangles). Tonoplast vesicles were isolated from plants grown in the absence (open symbols) or in the presence (filled symbols) of 50 mM NaCl (Staal et al. 1991). Copyright Physiologia Plantarum.

redox potential, NO₃⁻ rapidly disappears due to its use as an electron acceptor by **denitrifying bacteria**, and NH₄⁺ is the predominant source of inorganic N for the plant. Fe and Mn are similarly reduced. These reduced forms are much more soluble and potentially toxic to the plant. SO₄²⁻ is also used as an alternative electron acceptor by specialized bacteria, leading to the formation of S²⁻, which is an inhibitor of cytochrome oxidase (Sect. 3.6 of Chapter 2B on plant respiration). Thus, the availability of many ions is affected by the redox potential which leads to shortage of some nutrients and potentially toxic levels of others.

FIGURE 31. Two schematic diagrams of structures involved in the excretion of salt to the leaf surface. (A) Diagram of a trichome of a leaf of an *Atriplex* (saltbush) species. (B) Diagram of a salt-excreting gland of *Tamarix aphylla* (tamarisk) (after Esau 1977; reprinted with permission from John Wiley & Sons, Inc.). (C) Lower leaf surface of fresh leaves of *Atriplex pratovii* with dense cover of salt bladders. Courtesy M. Wennemann & S.-W. Breckle, Department of Ecology, University of Bielefeld, Bielefeld, Germany. (D) Scanning electron micrograph showing salt bladders on a leaf of *Atriplex hortensis*. Courtesy U. Schirmer & S.-W. Breckle, Department of Ecology, University of Bielefeld, Bielefeld, Germany. (E)

Stages of development of salt glands on a leaf of *Limonium ramossissimum*. Courtesy W. Wiehe & S.-W. Breckle, Department of Ecology, University of Bielefeld, Bielefeld, Germany. (F) Salt gland on upper leaf surface *Acantholimon ulicinum* var. *creticum*, stained with Sudan red. Courtesy W. Wiehe & S.-W. Breckle, Department of Ecology, University of Bielefeld, Bielefeld, Germany. (G) Scanning electron micrograph showing a salt hair on a leaf of *Bouteloua eriopoda* (black grama). (H) Scanning electron micrograph showing a salt hair on a leaf of *Buchloe dactyloides* (buffalograss). G and H: courtesy K.B. Marcum, Department of Applied Biological Sciences, Arizona State University, Mesa, USA.

Toxicity is largely prevented by oxidation, possibly followed by precipitation of these ions in the oxygenated rhizosphere. **Oxygenation of the rhizosphere** of flooding-resistant species is due to the presence of an **aerenchyma**, which allows root respiration to continue and leads to detoxification of potentially toxic ions in the rhizosphere (Sect. 4.1.4 of Chapter 2B on plant respiration and Sect. 5.6.1 of Chapter 7 on growth and allocation; Kirk & Kronzucker 2005).

4. Plant Nutrient-Use Efficiency

Plants differ both in their capacity to acquire nutrients from the soil (Sect. 3) and in the amount of nutrients they need per unit growth, the nutrient concentrations in their tissue, and the time and extent to which they withdraw nutrients during leaf senescence before leaf abscission. In this section, we discuss several approaches for analyzing the efficiency with which plants utilize nutrients to produce new biomass. Whole-plant nutrient-use efficiency (NUE) addresses processes related to carbon gain and loss, whereas photosynthetic nitrogen-use efficiency (Sect. 6 of Chapter 2A on photosynthesis) addresses only the instantaneous use of N for photosynthetic carbon gain.

4.1 Variation in Nutrient Concentration

4.1.1 Tissue Nutrient Concentration

Plants differ in the concentration of mineral nutrients in their tissue, depending on environment, allocation to woody and herbaceous tissues, developmental stage, and species (Fig. 33). N, P, and K are the nutrients that most frequently limit plant growth. However, as explained in Sect. 2.1.1 and Fig. 1A, N tends to limit plant productivity on young soils, whereas P becomes increasingly limiting as soils age. The presence of a specific mineral in plant tissues does not imply that the plant needs this mineral for growth. For example, Cd is found in tissues of plants growing on Cd-polluted soil, but it is *not* an essential nutrient for any plant. Similarly, high Na concentrations are not required for growth.

Nutrient concentrations change predictably with plant development. In especially woody plants, the **C:N ratio** increases with increase in plant age, as the ratio of woody mass to active mass increases. Nutrients associated with **metabolism** (e.g., N, P, and K) have highest concentrations when a leaf or other organ is first produced, then concentrations decline, first as the concentration becomes diluted by increasing quantities of cell-wall material during leaf expansion, then by resorption of nutrients during senescence (Fig. 34). **Ca**, which is largely associated with cell walls and is phloem immobile

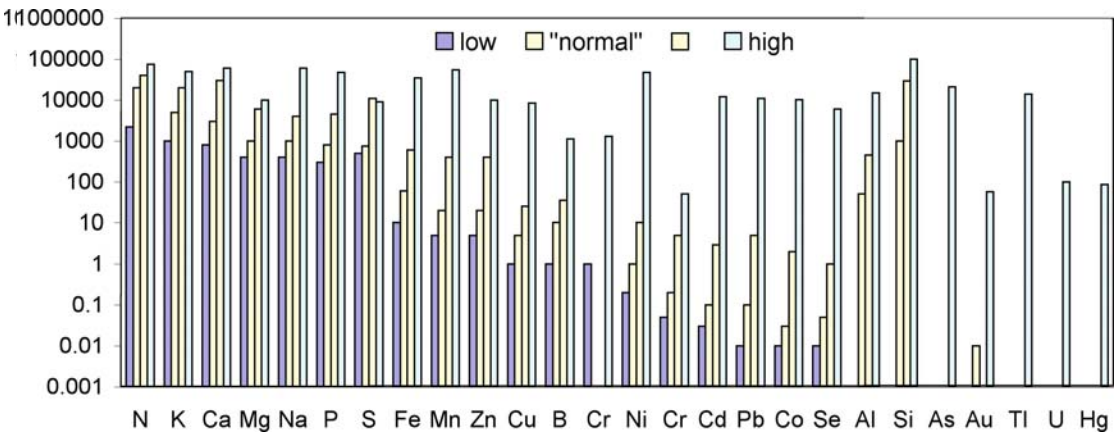

FIGURE 33. The range of concentrations of minerals as determined in plant dry matter. The two middle bars refer to concentrations commonly observed in healthy plants; the bar at the left refers to either plants that are very efficient at using a specific nutrient or plants that exhibit a low concentration because their leaves are severely deficient or senescent, or because the plants

exclude certain elements; the bar at the right refers to plants exhibiting exceptionally high concentrations of an element, e.g., in halophytes or metallophytes. Based on numerous references, including Biddulph et al. (1956), Foulds (1993), Bell (1997), Anderson et al. (1998), Baker et al. (2000), Reeves & Baker (2000), Broadley et al. (2003) and Osaki et al. (2003a,b).

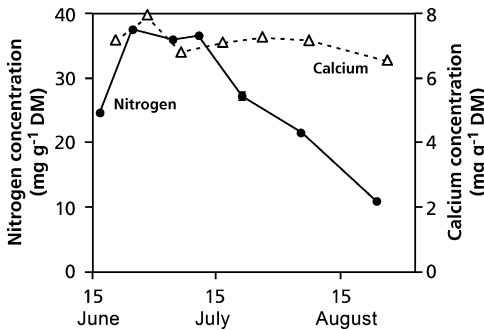

FIGURE 34. Typical seasonal pattern of leaf N and Ca concentrations of leaves of *Salix pulchra* (willow) from an Alaskan arctic tundra meadow (Chapin et al. 1980).

(Sect. 2 in Chapter 3 on long-distance transport) and therefore not resorbed (Sect. 4.3), increases continuously through leaf development.

Tissues differ predictably in nutrient concentrations: leaves have higher concentrations of nutrients associated with **metabolism** (N, P, and K) and lower concentrations of Ca than do **woody stems**; roots have intermediate concentrations. Whole-plant nutrient concentrations, therefore, differ among species and environments, depending on relative allocation to these tissues.

Environment strongly affects plant nutrient concentration by changing both allocation among organs and the composition of individual tissues. The major environmental effect on tissue nutrient composition is to alter the concentration of nutrients associated with **metabolism**. Plants have high concentrations of N, P, and K when conditions are favorable for growth (e.g., with adequate water and nutrients) (Niklas et al. 2005). The balance of available nutrients in the environment then alters the proportions of these nutrients. Whole-plant biomass **N:P ratios** [g N (g P)^{-1}] may vary up to 50-fold, due to differences in root allocation, nutrient uptake, biomass turnover, and reproductive output (Aerts & Chapin 2000). At the vegetation level, N:P ratios $<10:1$ and $>20:1$ tend to correspond with N- and P-limited biomass production, respectively, as evidenced by short-term fertilization experiments. N:P ratios are, on average, higher in graminoids than in forbs and higher in stress-tolerant species than in ruderals; they correlate negatively with the maximum relative growth rates of species and with their N-indicator values (Sect. 3 of Chapter 7 on growth and allocation). At the vegetation level, N:P ratios tend to correlate negatively with biomass production; high N:P ratios promote graminoids and stress-tolerating species, relative to other

species (Güsewell 2004). In general, leaf N and P concentrations decline, and the N:P ratio increases toward the equator as average temperature and growing season length increase (Reich & Oleksyn 2004). This trend persists across taxonomic groups, and presumably reflects both acclimation and adaptation. Higher leaf N and P concentrations compensate for reduced metabolic rates at low temperatures, and soils may differ in relative N and P supply across tropical to temperate regions (Hedin 2004).

There are no striking differences among species in biochemical allocation of N and P among classes of chemical compounds (e.g., protein N, nucleic acid N, lipid N) (Chapin 1988). The major differences among species relate to accumulation of certain compounds in the cytoplasm for osmotic functions (N-containing compatible solutes) and in vacuoles for storage functions (e.g., P_i , NO_3^- , and vegetative storage proteins; Sect. 4.3 of Chapter 7 on growth and allocation) or chemical defense (e.g., alkaloids and cyanogenic glycosides; Sect. 3 of Chapter 9B on ecological biochemistry).

When nutrient supply declines relative to plant demand, most plants show the following sequence of events (Chapin 1980): (1) decrease in vacuolar reserves with little effect on growth; (2) continued reduction in tissue nutrient concentrations, especially in older leaves and stems, reduced rates of leaf growth and photosynthesis (in that order), increased nonstructural carbohydrate concentrations, senescence of older leaves, and reallocation of reserves to compensate for reduced nutrient status (increased root mass ratio and increased root absorption capacity); (3) greatly reduced photosynthesis and nutrient absorption, dormancy, or death of meristems.

4.1.2 Tissue Nutrient Requirement

Species differ in their nutrient requirement for maximum growth, but the physiological mechanisms for this are not always known. For example, the tissue **calcium concentration** at which 90% of the maximum yield is achieved is about twice as high for **dicots** as for **monocots** (Table 18). In addition, when comparing graminoids and forbs at similar sites, the forbs invariably have higher concentrations of both Ca and Mg (Meerts 1997). The reason for this difference is likely the greater cation exchange capacity of the cell walls of dicotyledonous species (i.e., the amount of free Ca-binding carboxylic acid groups in pectins) (Woodward et al. 1984). The tissue **P concentration** at which 90% of the maximum yield

TABLE 18. Effect of the calcium concentration in the nutrient solution on the growth and the calcium concentration in the shoots of a monocotyledonous [*Lolium perenne* (perennial ryegrass)] and a dicotyledonous [*Solanum lycopersicum* (tomato)] species.

Species	Calcium supply (μM)				
	0.8	2.5	10	100	1000
Growth rate (% of maximum value)					
<i>Lolium perenne</i>	42	100	94	94	93
<i>Solanum lycopersicum</i>	3	19	52	100	80
Calcium concentration ($\mu\text{mol g}^{-1}$ dry mass)					
<i>Lolium perenne</i>	15.0	17.5	37.4	92.3	269.5
<i>Solanum lycopersicum</i>	49.9	32.4	74.9	321.9	621.3

Source: Loneragan 1968 and Loneragan & Snowball 1969, as cited in Marschner 1983.

occurs is greater for many **crop legumes** than for **nonlegumes** (Fig. 5 in Chapter 9A on symbiotic associations). The physiological basis of this difference is not quite clear, but it is likely associated with the fast-growing strategy of many legumes, as well as with the high energetic requirement and use of phosphorylated intermediates to fix N_2 in legume nodules (Sprent 1999).

Some slow-growing species from severely P-impoorished soils maintain relatively high rates of photosynthesis at extremely low leaf P concentrations (Wright et al. 2004, Denton et al. 2007), presumably because they contain very little P in their vacuoles. From a biochemical point of view, all species will need similar amounts of N, P, S, and so on, to make a unit of growth, simply because they are constructed in a similar manner (Sterner and Elser 2002). Thus, the idea that there are different *metabolic* requirements is erroneous, except that specific enzymes may require a specific ion. For instance, Ni is an essential element for **urease**, which hydrolyzes urea to CO_2 and H_2O . Urease is required in all plants, but in greater amounts in those legumes that produce ureides when grown symbiotically with rhizobia (Sect. 3.4 of Chapter 9A on symbiotic associations) (Walker et al. 1985). Apart from these exceptional differences, variation in nutrient requirement and nutrient productivity (Sect. 4.2.1) depends much more on the balance

between requirements for protein synthesis for new growth and N storage (Sect. 4 of Chapter 7 on growth and allocation).

4.2 Nutrient Productivity and Mean Residence Time

4.2.1 Nutrient Productivity

A useful measure of the efficiency of nutrient use to produce new biomass is **nutrient productivity** (Ingestad 1979), the ratio of relative growth rate (RGR, $\text{mg g}^{-1} \text{day}^{-1}$) to whole-plant nutrient concentration in the plant tissue (NP, mol g^{-1}). For example, N productivity (NP, $\text{mg mol}^{-1} \text{N day}^{-1}$) is

$$\text{NP} = \text{RGR}/\text{PNC} \quad (1)$$

where PNC is the plant N concentration (i.e., total plant N per total plant mass). When grown at an optimum nutrient supply, plants differ widely in their N productivity (Fig. 35). A higher N productivity is associated with rapid growth, a relatively large investment of N in photosynthesizing tissue, an efficient use of the N invested in the leaves for the process of photosynthesis, and a relatively small use of carbon in respiration (Fig. 35). C_4 species also have a high N productivity under optimal N supply which is apparently a result of their lower N requirement for photosynthesis (high PNUE) (Sect. 6.1 of Chapter 2A on photosynthesis).

N productivity shows saturation and sometimes an optimum curve, when plotted as a function of the N supply to the plant (Fig. 36). The decrease in NP above the maximum value for NP is due to a decrease in the rate of photosynthesis per unit of N in the leaf at high leaf N which reflects increased allocation of N to storage (Sect. 4 of Chapter 7 on growth and allocation). The decrease when the N supply is less than that at the maximum value for NP is largely due to greater investment of N in nonphotosynthetic tissue (Sect. 5.4 of Chapter 7 on growth and allocation).

4.2.2 The Mean Residence Time of Nutrients in the Plant

Although the nutrient productivity gives a good indication of a plant's **instantaneous** NUE, it does not provide insight into a plant's **long-term performance** in a natural habitat. To develop such insight, we expand the concept of **nutrient-use efficiency** to consider the time during which nutrients remain in the plant to support productivity. Plant NUE ($\text{g g}^{-1} \text{N}$), which is defined in this way,

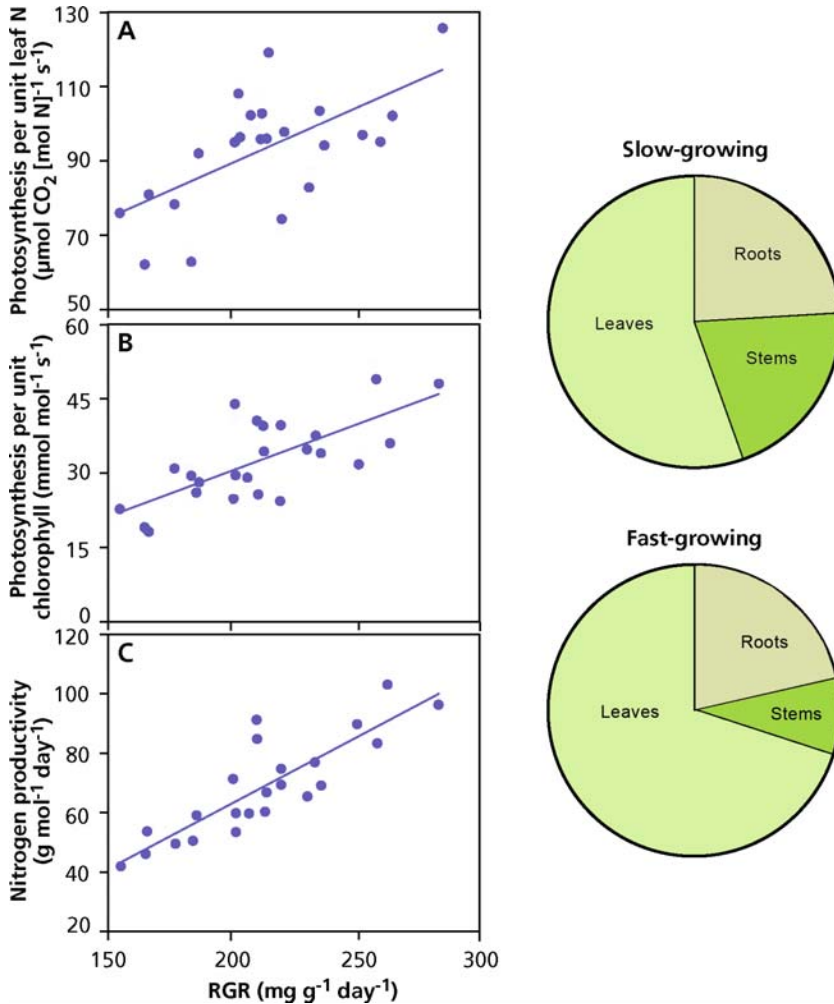

FIGURE 35. The N productivity (*bottom panel*) of fast- and slow-growing herbaceous plant species, grown with free access to nutrients in a growth room. The physiological background of the higher N productivity of fast-growing species is their greater investment of N in leaves, as opposed to roots and stems (*circles* at the right), and their higher rate of photosynthesis per

unit N in the leaves (photosynthetic N-use efficiency, PNUE) (*top panel*). The rate of photosynthesis per unit chlorophyll in the leaves is also higher for the fast-growing herbaceous species (*middle panel*) (after Poorter et al. 1990). Copyright American Society of Plant Biologists.

is the product of the NP ($\text{g g}^{-1} \text{N yr}^{-1}$) (as defined earlier, but is now determined over much longer periods; say 1 year), and the **mean residence time** (MRT; yr) of that nutrient in the plant (Berendse & Aerts 1987):

$$\text{NUE} = \text{NP} \cdot \text{MRT} \quad (2)$$

The mean residence time is the average time the nutrient remains in the plants, before it is lost due to leaf shedding, herbivory, root death, and so on.

The N-use efficiencies of evergreen heathland shrub species and that of a co-occurring deciduous grass species are remarkably similar, but the underlying components differ (Table 19). **Evergreen** species achieve their NUE with a low N productivity and a high mean residence time, whereas **deciduous** species have a considerably higher N productivity, but a lower mean residence time. In competition experiments with the species from Table 19, the grass wins at a relatively high N supply, because of its higher N productivity. At a low N supply, the

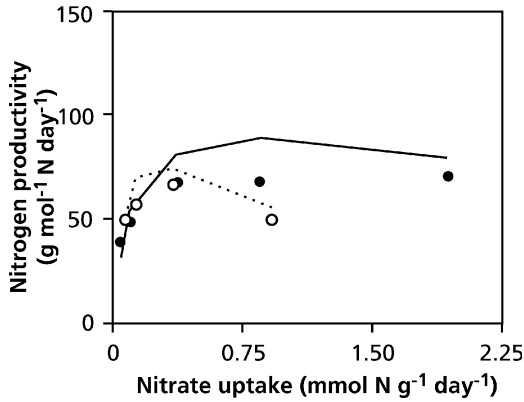

FIGURE 36. The N productivity of *Briza media* (quacking grass, open symbols and broken line) and *Dactylis glomerata* (cocksfoot, filled symbols and continuous line), as a function of the rate of NO_3^- uptake. The NO_3^- uptake was varied through different exponential rates of N addition in order to maintain a constant RGR at each rate of NO_3^- supply. The symbols give the actual experimental data and the lines refer to results of a simulation model (Van der Werf et al. 1993). Copyright Blackwell Science Ltd.

competitive ability of the evergreen shrub is higher, because of its long mean residence time of N in the plant. A high mean residence time is the most important mechanism for nutrient conservation in infertile sites (Eckstein et al. 1999). Both adaptation and acclimation contribute to the greater mean residence time in infertile sites. These sites are typically dominated by evergreen shrubs and trees, and both grasses and evergreen trees and shrubs adapt to low nutrient supply through increases in leaf longevity (Westoby et al. 2002).

TABLE 19. The long-term nitrogen productivity (NP), the mean residence time of nitrogen (MRT), and the nitrogen-use efficiency (NUE) of an evergreen heathland shrub species [*Erica tetralix* (crossleaf heath)] and a co-occurring deciduous grass species [*Molinia caerulea* (purple moorgrass)].

	<i>Erica tetralix</i>	<i>Molinia caerulea</i>
Nitrogen productivity (g g ⁻¹ N yr ⁻¹)	77	110
Mean residence time (yr)	1.2	0.8
Nitrogen-use efficiency (g g ⁻¹ N)	90	89

Source: Aerts 1990.

It is interesting that the plant features that favor a low rate of nutrient loss (high mean residence time) also decrease the rate of **decomposition** of the leaf litter. This tends to aggravate the low availability of nutrients in the already nutrient-poor environments (Sect. 3.2 of Chapter 10A on decomposition). As will be discussed in Sect. 2.4 of Chapter 9A on symbiotic associations and in Chapter 10A on decomposition, however, some species can make use of nutrients in leaf litter even before it is fully decomposed.

4.3 Nutrient Loss from Plants

Nutrient loss is just as important as nutrient uptake in determining the **nutrient budgets** of perennial plants; however, much less is known about the controls over nutrient loss.

4.3.1 Leaching Loss

Leaching accounts for about 15% of the N and P and half the K returned from above-ground plant parts to soil (Table 20), with the remainder coming from senesced leaves and stems. Use of experimental “mini-umbrellas” to prevent rain from contacting leaves suggests that leaching losses can be an even larger proportion (25–55% of nutrient loss from leaves) (Chapin & Moilanen 1991). Leaching occurs most readily when there are high concentrations of soluble nutrients in the intercellular spaces of leaves, for example, during rapid leaf production or senescence and when plants grow under conditions of high **nutrient availability**. Leaching rate is highest when rain first hits a leaf, then declines exponentially with continued exposure to rain (Tukey 1970). The frequency of rainfall is, therefore, more important than its intensity in determining

TABLE 20. Nutrients leached from the canopy (throughfall) as a percentage of the total above-ground nutrient return from plants to the soil for 12 deciduous and 12 evergreen forests.

Nutrient	Throughfall (% of annual return)	
	Evergreen forests	Deciduous forests
N	1	15
P	15	15
K	59	48
Ca	27	24
Mg	33	38

Source: Chapin 1991.

leaching loss. **Deciduous** leaves have a higher rate of leaching loss than do **evergreens** because of their higher tissue nutrient concentrations. This is compensated, however, by the greater time of exposure to leaching in evergreen plants (Thomas & Grigal 1976), so that leaching constitutes a similar proportion of above-ground nutrient loss by evergreen and deciduous forests (Table 20).

The magnitude of nutrient loss by leaching decreases in the order $K > Ca > N = P$ which reflects the greater mobility of monovalent than divalent cations, and the greater susceptibility to loss of inorganic than of organically bound nutrients. It was initially thought that one explanation for the scleromorphic leaves with thick cuticles in nutrient-poor sites was prevention of leaching loss (Loveless 1961); however, there is no clear relationship between cuticle thickness or scleromorphy and the susceptibility of leaves to leaching loss (Sects. 5.4.5 and 8.2 of Chapter 3 on plant water relations). These leaf traits are more likely selected for their importance in withstanding unfavorable conditions during the nongrowing season and reducing leaf loss to herbivores and pathogens (Sect. 3.2 of Chapter 9B on ecological biochemistry; Read et al. 2006).

Acid rain increases leaching of cations, particularly of Ca (Fig. 37), because hydrogen ions in the rain exchange with cations held on the cuticular exchange surface and because acidity alters the chemical nature of the cuticle so that it is more susceptible to diffusion and mass flow of nutrients to the leaf surface (Shriner & Johnston 1985, Reuss & Johnson 1986).

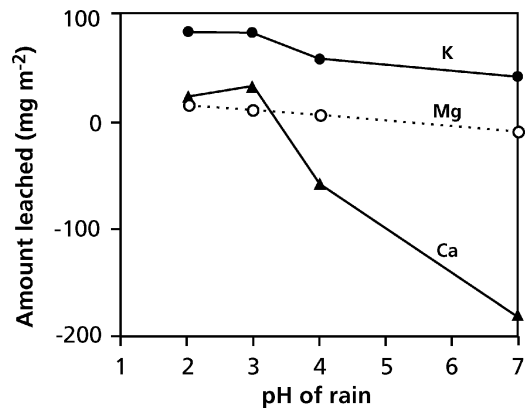

FIGURE 37. Effects of pH of simulated rain (containing 315, 35, and 35 mg m⁻² of Ca, Mg, and K, respectively) on the leaching of Ca, K, and Mg from spruce crowns. At high pH, spruce needles absorb Ca, and to a lesser extent Mg, from the rain (after Chapin 1991).

4.3.2 Nutrient Loss by Senescence

Approximately half of the N and P content of **leaves** is resorbed during senescence and is used to support further plant growth (Aerts 1996, Killingbeck 1996). By contrast, Ca, which is immobile in the phloem (Sect. 2 of Chapter 2C on long-distance transport), is not resorbed and reutilized. N- and P-**resorption efficiency** (proportion of maximum nutrient pool resorbed) ranges from 0 to 80% among species and environmental conditions (Reich et al. 1995, Killingbeck 1996) (Table 21).

TABLE 21. Nutrient withdrawal from senescing leaves of trees growing on nutrient-poor sandy sites.*

Species	Location	Leaf longevity	Resorption (%)	
			P	N
<i>Goupia glabra</i>	Guyana	Lower	53	0
<i>Cecropia obtusa</i>	Guyana	Lower	63	0
<i>Dicymbe altsonii</i>	Guyana	Higher	60	33
<i>Chlorocardium rodiei</i>	Guyana	Higher	51	0
<i>Banksia menziesii</i>	Australia	Higher	82	73
<i>Eucalyptus gomphocephala</i>	Australia	Lower	55	61
<i>Larix laricina</i>	Minnesota, USA	Lower	0	48
<i>Populus tremuloides</i>	Minnesota, USA	Lower	42	65

* For the tree species from a rainforest in Guyana, nitrogen was not a factor limiting growth. Phosphorus was available in critically low amounts which may have been limiting for growth; however, productivity may also have been limited by other nutrients or the low pH of the soil. For the Australian tree species from an open sclerophyll nutrient-poor woodland, where bushfires regularly remove large amounts of nitrogen from the ecosystem, growth of the investigated trees was limited by nitrogen (Raaimakers 1995). In Minnesota, nitrogen was the growth-limiting nutrient (Tilton 1977, Verry & Timmons 1976). In addition most other nutrients were also scarcely available. Nutrient resorption was calculated from the amount of P or N present in senesced leaves and the peak amount found in the leaves of each species.

Similar variation occurs with respect to the terminal nutrient concentration in senesced leaves (**resorption proficiency**). Concentrations of 3 mg N g⁻¹ dry mass and 100 µg P g⁻¹ dry mass in senesced leaves are considered the ultimate potential resorption of these nutrients in woody perennials; however, some Western Australian *Banksia* species from the world's most severely P-impooverished habitats show even greater resorption proficiency, down to 27 µg P g⁻¹ dry mass (Denton et al. 2007). Resorption efficiency of both N and P is highest in graminoids; N-resorption efficiency is higher in deciduous shrubs and trees than it is in evergreens, although the differences are small compared with differences in mean residence time (Aerts 1996) (Table 22). Evergreen species have a greater ability to reduce the mass-based P concentration in senescing leaves than do deciduous species (greater P-resorption proficiency) (Table 23). In spite of the large range observed in nutrient resorption and the importance of resorption to plant nutrient budgets, no clear patterns of physiological and ecological controls over nutrient resorption have emerged. About 60% of studies show no relationship of resorption efficiency to nutrient availability, with most of the remaining studies showing small decreases in resorption efficiency in fertile sites (Aerts 1996, Demars & Boerner 1997). In nutrient-rich sites, larger quantities of nutrients are generally withdrawn from the leaves and larger quantities remain in senesced leaves, compared with leaves of plants growing in infertile sites (Killingbeck 1996, Richardson et al. 2005), but the proportion of N and P resorbed is similar across sites (Aerts 1996, Wright & Westoby 2003). Thus, the nutrient concentration of litter is higher in more

fertile sites, which has important consequences for decomposition (Chapter 10A on decomposition).

Resorption is the net result of several processes: enzymatic breakdown of N- and P-containing compounds in the leaves, phloem loading and transport, and the formation of an abscission layer that cuts off the transport path and causes the leaf to fall. Resorption is positively correlated with leaf mass loss during senescence which suggests a link with export via the phloem (Chapin & Kedrowski 1983). Leaves that are darkened during senescence to reduce source strength have low resorption, whereas leaves with strong sinks (e.g., nearby developing fruits or new leaf growth) have high resorption which again suggests a role for source-sink interactions and phloem transport in explaining proportional resorption (Nambiar & Fife 1987, Chapin & Moilanen 1991). Both graminoids (Aerts 1996) and evergreens (Nambiar & Fife 1987) that have active growth of new leaves (a strong sink) at the time of leaf senescence have high resorption efficiency. Comparing different species, all major N and P chemical fractions are broken down to the same extent during autumn senescence (Chapin & Kedrowski 1983). It is therefore unlikely that there is some recalcitrant nutrient fraction that limits resorption efficiency in some species more than in others. Strong winds, water stress, and frosts can reduce resorption efficiency, but leaves typically abscise only after resorption has ceased (Boerner 1985, Chapin & Moilanen 1991). Species with gradual leaf fall may have low resorption efficiencies (del Arco et al. 1991).

There is very little information on nutrient resorption from senescing stems and **roots**. In the few studies of roots, no resorption has been reported (Nambiar 1987, Aerts 1990), again with a distinct exception for the Western Australian *Hakea prostrata* (harsh hakea) from a severely P-impooverished habitat which efficiently mobilizes P from peak concentrations of 2500 µg P g⁻¹ root dry mass down to 96 µg P g⁻¹ root dry mass (Shane et al. 2004c).

TABLE 22. N- and P-resorption efficiency of different growth forms (mean values, with number of species in parentheses).

Growth form	Resorption efficiency (% of maximum pool)	
	N	P
All data	50 (287)	52 (226)
Evergreen trees and shrubs	47 (108)	51 (88)
Deciduous trees and shrubs	54 (115)	50 (98)
Forbs	41 (33)	42 (18)
Graminoids	59 (31)	72 (22)

Source: Aerts 1996.

Note: Results are mean values, with the number of species in parentheses.

4.4 Ecosystem Nutrient-Use Efficiency

Our definitions of **nutrient-use efficiency** (NUE) have so far been based on individual plants. The same concept has been applied to ecosystems that are approximately in steady state [i.e., where above-ground production is approximately equal to litterfall (leaves, twigs, small branches, and reproductive parts)]. Ecosystem NUE is the ratio of litterfall mass to litterfall nutrient content (i.e., the inverse of the

TABLE 23. Ranges of N and P concentrations representing complete and incomplete resorption, which are synonymous with high and low resorption proficiency, respectively.

Resorption proficiency	
Complete resorption	Incomplete resorption
<i>Based on nutrient concentrations per unit mass in senescent leaves</i>	
<7 mg N g ⁻¹ dry weight	>10 mg N g ⁻¹ dry weight
<0.5 mg P g ⁻¹ dry weight (deciduous species)	>0.8 mg P g ⁻¹ dry weight (deciduous species)
<0.4 mg P g ⁻¹ dry weight (evergreen species)	>0.5 mg P g ⁻¹ dry weight (evergreen species)
<i>Based on nutrient concentrations per unit area in senescent leaves</i>	
<0.5 µg N mm ⁻² leaf area	>0.75 µg N mm ⁻² leaf area
<0.3 µg P mm ⁻² leaf area	>0.8 µg P mm ⁻² leaf area

Source: Killingbeck 1996.

Note: Mass-based P concentrations are segregated between deciduous and evergreen species because of the large difference between these life forms with ability to reduce P in senescing leaves.

nutrient concentration of litterfall) (Vitousek 1982). This is equivalent to the biomass produced per unit of nutrient gained or lost. Defined in this way, ecosystem NUE is generally greater in sites with low availability of nutrients (particularly for N, which is the element that most strongly limits productivity in most terrestrial ecosystems in young landscapes). The data for ecosystem NUE, however, must be interpreted with care: NUE and nutrient concentration in the litter are inversely and negatively correlated and are not independent. All else being equal, a high nutrient concentration of the litter (i.e., a low dry mass: N ratio) is associated with a high N loss in litterfall.

The three processes that might cause differences in ecosystem NUE are

- (1) photosynthesis per unit nutrient (PNUE)
- (2) mean residence time (MRT) during which the nutrient contributed to production
- (3) proportion of nutrients resorbed prior to senescence

PNUE is low in slow-growing plants from low N environments (Fig. 2A.34, Sect. 6 of Chapter 2A on photosynthesis; Reich et al. 1992, 1995). This is offset to an unknown extent by greater mean residence time of N in infertile sites (Westoby et al. 2002). Resorption is similar across sites or slightly higher in infertile sites (Sect. 4.3). Although these patterns are well documented at the scale of individual plants or leaves, we have insufficient information to quantify their net effect on NUE at the ecosystem scale. It is therefore currently impossible to provide an independent confirmation from

physiological measurements of Vitousek's (1982) conclusion that NUE is greatest in infertile sites. Current uncertainties include (1) the effect of herbivory on nutrient loss (which is greater in fertile sites and removes nutrient-rich tissues, leading to an over-estimate of NUE in fertile sites), (2) leaching losses (which are generally similar between fertile and infertile sites), and (3) the omission of below-ground dynamics, for which few data are available.

In summary, plants vary in their capacity for nutrient uptake and efficiency of nutrient use. Genetic adaptation and acclimation, however, vary in their relative importance to different processes. Acclimation is probably the major factor that accounts for the high root mass ratio in infertile sites. Due to low availability, rates of nutrient acquisition are low for plants in infertile sites. These plants generally have low leaf N concentrations and a low photosynthetic N-use efficiency (Table 22), due primarily to effects of environment on tissue concentration and to both genetic and phenotypic differences in PNUE. Plants on infertile sites generally keep their nutrients for a longer period; for example, the mean residence time of nutrients is higher for evergreens than it is for deciduous leaves, and any given species retains its leaves longer on infertile sites. Plants also differ in the extent to which they withdraw nutrients from senescing leaves, but the variation in the extent to which nutrients are withdrawn shows a less consistent difference between fertile and infertile sites. The high ecosystem NUE in infertile sites reflects low tissue N concentrations and high mean residence time.

5. Mineral Nutrition: A Vast Array of Adaptations and Acclimations

Nutrients move in the soil to root surfaces by mass flow and diffusion, but selective systems (channels, carriers) are then needed to transport the nutrients into the symplast. Because anion transport mostly occurs up an electrochemical potential gradient, metabolic energy is required to import these nutrients from the rhizosphere. Although cation transport may occur down an electrochemical potential gradient, metabolic energy is also required to import these nutrients from the rhizosphere, because the maintenance of the electrochemical potential gradient requires ATP. When essential nutrients move too slowly to the roots' surface, adaptive mechanisms are required, especially for the acquisition of P, Fe, and Zn.

Species have adapted to adverse or favorable soil conditions, and individual plants have some capacity to acclimate to a range of soil conditions. Some of these acclimations are physiological (e.g., an induction of ion-uptake systems when nutrients are in short supply, and excretion of phosphate-hydrolyzing enzymes). Others are anatomical (e.g., the formation of more or longer root hairs when P_i is in short supply), or morphological (e.g., the increase in root mass ratio when N is limiting for growth). These anatomical and morphological acclimations also have a physiological basis, however, and often require induction of specific genes, after a shortage of nutrients has been sensed.

Plants need many macronutrients and micronutrients, but the concentration of the various elements in plant tissues does not necessarily give us a correct estimate of a plant's requirements. Rather, elements may accumulate because the plant lacks mechanisms to keep these out and stores these elements in compartments where they are least harmful. In this chapter, we have encountered numerous species that occupy sites that are practically inaccessible to others. These adapted plants include halophytes, metallophytes, calcifuges, and calcicoles. Halophytes and metallophytes do not need high concentrations of NaCl and heavy metals, respectively, for maximum growth, but they are among the few species that can cope with such adverse soil conditions; that is, their ecological amplitude is much narrower than their physiological amplitude. Calcifuges are largely restricted to acid soils, because they lack the capacity to acquire some nutrients from alkaline soils. On the other hand, calcicoles are restricted to alkaline soils, because they are adversely affected by toxic compounds in acid soils (Al). Understanding

plant distribution as dependent on soil type clearly requires an appreciation for a breadth of physiological mechanisms.

Plants differ in the mechanisms employed to acquire nutrients from various soils, as well as in the requirement for these nutrients and in their long-term nutrient-use efficiency. Plants from nutrient-rich sites tend to produce more biomass per unit nutrient in the plant, whereas plants from nutrient-poor sites tend to keep the nutrients they have acquired for a longer time. There is less variation among species in the extent to which they resorb nutrients from senescing leaves, but some species from severely nutrient-impooverished habitats show remarkable resorption proficiency. Variation in nutrient availability sometimes influences resorption (i.e., a smaller proportion of the N invested in leaf mass tends to be remobilized on N-rich sites than on N-poor sites).

Knowledge of a plant's mineral nutrition is pivotal to understanding the distribution of plant species and the high diversity of plant species in nutrient-impooverished soils. It is also essential for modern agriculture and forestry (e.g., to avoid nutrient deficiency disorders or to breed for plants that can acquire nutrients from soils of low nutrient availability). It is also important to resolve environmental problems (e.g., through phytoremediation). Mixed cultures and crop rotations can be highly beneficial in cropping situations. Intercrop species (i.e., plants that are used because of their favorable effect on the actual crop that is of agronomic interest), can be selected on the basis of ecophysiological information presented in this chapter. For example, if the intercrop plant solubilizes Fe or rock phosphate that becomes available to the crop, then it might prevent chlorosis or reduce the need for phosphate fertilization, respectively. This chapter should inspire us to think of traits that might be exploited in future agriculture.

References

- Adams, M.A. & Pate, J.S. 1992. Availability of organic and inorganic forms of phosphorus to lupins (*Lupinus* spp.). *Plant Soil* **145**: 107-113.
- Aerts, R. 1990. Nutrient use efficiency in evergreen and deciduous species from heathlands. *Oecologia* **84**: 391-397.
- Aerts, R. 1996. Nutrient resorption from senescing leaves of perennials: are there general patterns? *J. Ecol.* **84**: 597-608.
- Aerts R, & Chapin III, F.S. 2000. The mineral nutrition of wild plants revisited: a re-evaluation of processes and patterns. *Adv. Ecol. Res.* **30**: 1-67.

- Albuzio, A. & Ferrari, G. 1989. Modulation of the molecular size of humic substances by organic acids of the root exudates. *Plant Soil* **113**: 237–241.
- Al-Hiyaly, S.A.K., McNeilly, T., & Bradshaw, A.D. 1990. The effect of zinc contamination from electricity pylons. Contrasting patterns of evolution in five grass species. *New Phytol.* **114**: 183–190.
- Anderson, C.W.N., Brooks, R.R., Stewart, R.B., & Simcock, R. 1998. Harvesting a crop of gold in plants. *Nature* **395**: 553–554.
- Andrews, M. 1986. The partitioning of nitrate assimilation between root and shoot of higher plants. *Plant Cell Environ.* **9**: 511–519.
- Ape, M.P. & Blumwald, E. 2007. Na⁺ transport in plants. *FEBS Lett.* **581**: 2247–2254.
- Arianoutsou, M., Rundel, P.W., & Berry, W.L. 1993. Serpentine endemics as biological indicators of soil elemental concentrations. In: *Plants as biomonitors*, B. Markert (ed). VCH Weinheim, New York, pp. 179–189.
- Aslam, M., Travis, R.L., & Rains, D.W. 1996. Evidence for substrate induction of a nitrate efflux system in barley roots. *Plant Physiol.* **112**: 1167–1175.
- Assunção, A.G.L., Schat, H., & Aarts, M. 2003. *Thlaspi caerulescens*, an attractive an attractive model species to study heavy metal hyperaccumulation in plants. *New Phytol.* **159**: 351–360.
- Atkin, O.K. 1996. Reassessing the nitrogen relations of arctic plants: a mini-review. *Plant Cell Environ.* **19**: 695–704.
- Baker, A.J.M., McGrath, S.P., Reeves, R.D., & Smith, J.A.C. 2000. Metal hyperaccumulator plants: a review of the ecology and physiology of a biological resource for phytoremediation of metal-polluted soil. In: *Phytoremediation of contaminated soil and water*, N. Terry & G.S. Banuelos (eds). CRC Press Inc., Boca Raton, pp. 85–107.
- Ball, M.C. 1988. Ecophysiology of mangroves. *Trees* **2**: 129–142.
- Barber, S.A. 1995. Soil nutrient bioavailability, 2nd edition. Wiley, New York.
- Barber, S.A. & Ozanne, O.G. 1970. Autoradiographic evidence for the differential effect of four plant species in altering the calcium content of the rhizosphere soil. *Soil Sci. Soc. Am. Proc.* **34**: 635–637.
- Barkla, B.J., Zingarelli, L., Blumwald, E., Smith, A.C. 1995. Tonoplast Na⁺/H⁺ antiport activity and its energization by the vacuolar H⁺-ATPase in the halophytic plant *Mesembryanthemum crystallinum*. *Plant Physiol.* **109**: 549–556.
- Barrow, N.J. 1984. Modeling the effect of pH on phosphate sorption by soils. *J. Soil Sci.* **35**: 283–297.
- Bates, T.R. & Lynch, J.P. 1996. Stimulation of root hair elongation in *Arabidopsis thaliana* by low phosphorus availability. *Plant Cell Environ.* **19**: 529–538.
- Bell, R.W. 1997. Diagnosis and prediction of boron deficiency for plant production. *Plant Soil* **193**: 149–168.
- Berendse, F. & Aerts, R. 1987. Nitrogen-use efficiency: a biologically meaningful definition? *Funct. Ecol.* **1**: 293–296.
- Bhat, K.K.S. & Nye, P.H. 1973. Diffusion of phosphate to plant roots in soil. I. Quantitative autoradiography of the depletion zone. *Plant Soil* **38**: 161–175.
- Biddulph, O., Cory, R. & Biddulph, S. 1956. The absorption and translocation of sulfur in red kidney bean. *Plant Physiol.* **33**: 293–300.
- Blom-Zandstra, M., Vogelzang, S., & Veen, B. 1998. Sodium fluxes in sweet pepper exposed to varying sodium concentrations. *J. Exp. Bot.* **49**, 1863–1868.
- Bloom, A.J., Sukrapanna, S.S., & Warner, R.L. 1992. Root respiration associated with ammonium and nitrate absorption and assimilation by barley. *Plant Physiol.* **99**: 1294–1301.
- Boerner, R.E.J. 1985. Foliar nutrient dynamics, growth, and nutrient use efficiency of *Hamamelis virginiana* in three forest microsites. *Can. J. Bot.* **63**: 1476–1481.
- Bolan, N.S., Hedley, M.J., & White, R.E. 1991. Processes of soil acidification during nitrogen cycling with emphasis on legume based pastures. *Plant Soil* **134**: 53–63.
- Boyd, R.S. & Martens, S.N. 1998. Nickel hyperaccumulation by *Thlaspi montanum* var. *montanum* (Brassicaceae): a constitutive trait. *Am. J. Bot.* **85**: 259–265.
- Britto, D.T. & Kronzucker, H.J. 2005. Nitrogen acquisition, PEP carboxylase, and cellular pH homeostasis: new views on old paradigms. *Plant Cell Environ.* **28**: 1396–1409.
- Britto, D.T. & Kronzucker, H.J. 2006. Futile cycling at the plasma membrane: a hallmark of low-affinity nutrient transport. *Trends Plant Sci.* **11**: 529–534.
- Broadley, M.R., Bowen, H. C., Cotterill, H.L., Hammond, J.P., Meacham, M.C., Mead, A., & White, P.J. 2003. Variation in the shoot calcium content of angiosperms. *J. Exp. Bot.* **54**: 1431–1446.
- Brooks, R.R. (ed.) 1998. Plants that hyperaccumulate heavy metals. Their role in phytoremediation, microbiology, archaeology, mineral exploitation and phytomining. CAB International, Wallingford.
- Brooks, R.R., Lee, J., Reeves, R.D. & Jaffrè, T. 1977. Detection of nickeliferous rocks by analysis of herbarium specimens of indicator plants. *J. Geochem. Explor.* **7**: 49–57.
- Brooks, R.R., Chambers, M.F., Nicks, L.J., & Robinson, B.H. 1998. Phytomining. *Trends Plant Sci.* **3**: 359–362.
- Brouwer, R. 1962. Nutritive influences on the distribution of dry matter in the plant. *Neth. J. Agric. Sci.* **10**: 399–408.
- Brown, G. & Brinkmann, K. 1992. Heavy metal tolerance in *Festuca ovina* L. from contaminated sites in the Eifel Mountains, Germany. *Plant Soil* **143**: 239–247.
- Brown, G., Mitchell, D.T., & Stock, W.D. 1984. Atmospheric deposition of phosphorus in a coastal fynbos ecosystem if the south-western Cape, South Africa. *J. Ecol.* **72**: 547–551.
- Brune, A., Urbach, W., Dietz, K.-J. 1994. Compartmentation and transport of zinc in barley primary leaves as basic mechanisms involved in zinc tolerance. *Plant Cell Environ.* **17**: 153–162.
- Bucher, M. 2007. Functional biology of plant phosphate uptake at root and mycorrhiza interfaces. *New Phytol.* **173**: 11–26.
- Burgess, S.S.O. & Dawson, T.E. 2004. The contribution of fog to the water relations of *Sequoia sempervirens*

- (D. Don): foliar uptake and prevention of dehydration. *Plant Cell Environ.* **27**: 1023–1034.
- Cakmak, I., Sari, N., Marschner, H., Ekiz, H., Kalayci, M., Yilmaz, A., & Braun, H.J. 1996. Phytosiderophore release in bread wheat genotypes differing in zinc efficiency. *Plant Soil* **180**: 183–189.
- Callahan, D.L., Baker, A.J.M., Kolev, S.D., & Wedd, A.G. 2005. Metal ion ligands in hyperaccumulating plants. *J. Biol. Inorg. Chem.* **11**: 2–12.
- Campbell, W.H. 1996. Nitrate reductase biochemistry comes of age. *Plant Physiol.* **111**: 355–361.
- Casimiro, I., Beeckman, T., Graham, N., Bhalerao, R., Zhang, H., Casero, P., Sandberg, G., & Bennett, M.J. 2003. Dissecting *Arabidopsis* lateral root development. *Trends Plant Sci.* **8**: 165–171.
- Chang, Y.-C., Ma, J.F., & Matsumoto, H. 1998. Mechanism of Al-induced iron chlorosis in wheat (*Triticum aestivum*). Al-inhibited biosynthesis and secretion of phytosiderophores. *Physiol. Plant.* **102**: 9–15.
- Chaney, R.L., Malik, M., Li, Y.M., Brown, S.L., Angle, J.S., & Baker A.J.M. 1997. Phytoremediation of soil metals. *Curr. Opin. Biotech.* **8**: 279–284.
- Chapin III, F.S. 1974. Morphological and physiological mechanisms of temperature compensation in phosphate absorption along a latitudinal gradient. *Ecology* **55**: 1180–1198.
- Chapin III, F.S. 1980. The mineral nutrition of wild plants. *Annu. Rev. Ecol. Syst.* **11**: 233–260.
- Chapin III, F.S. 1988. Ecological aspects of plant mineral nutrition. *Adv. Min. Nutr.* **3**: 161–191.
- Chapin III, F.S. 1991. Effects of multiple environmental stresses on nutrient availability and use. In: Response of plants to multiple stresses, H.A. Mooney, W.E. Winner, & E.J. Pell (eds). Academic Press, San Diego, pp. 67–88.
- Chapin III, F.S. & Bloom, A. 1976. Phosphate absorption: adaptation of tundra graminoids to a low temperature, low phosphorus environment. *Oikos* **26**: 111–121.
- Chapin III, F.S. & Kedrowski, R.A. 1983. Seasonal changes in nitrogen and phosphorus fractions and autumn retranslocation in evergreen and deciduous taiga trees. *Ecology* **64**: 376–391.
- Chapin III, F.S. & Moilanen, L. 1991. Nutritional controls over nitrogen and phosphorus resorption from Alaskan birch leaves. *Ecology* **72**: 709–715.
- Chapin III, F.S. & Slack, M. 1979. Effect of defoliation upon root growth, phosphate absorption, and respiration in nutrient-limited tundra graminoids. *Oecologia* **42**: 67–79.
- Chapin III, F.S., Johnson, D.A., & McKendrick, J.D. 1980. Seasonal movement of nutrients in plants of differing growth form in an Alaskan tundra ecosystem: Implications for herbivory. *J. Ecol.* **68**: 189–209.
- Chapin III, F.S., Fetcher, N., Kielland, K., Everett, K.R., & Linkins, A.E. 1988. Productivity and nutrient cycling of Alaskan tundra: enhancement by flowing soil water. *Ecology* **69**: 693–702.
- Chapin III, F.S., Moilanen, L., & Kielland, K. 1993. Preferential use of organic nitrogen for growth by non-mycorrhizal arctic sedge. *Nature* **361**: 150–153.
- Chardonens, A.N., Koevoets, P.L.M., Van Zanten, A., Schat, H., & Verkleij, J.A.C. 1999. Properties of enhanced tonoplast zinc transport in naturally selected zinc-tolerant *Silene vulgaris*. *Plant Physiol.* **120**: 779–785.
- Cheeseman, J.M. 1988. Mechanisms of salinity tolerance in plants. *Plant Physiol.* **87**: 547–550.
- Cheeseman, J.M. & Hanson, J.B. 1979. Energy-linked potassium influx as related to cell potential in corn roots. *Plant Physiol.* **64**: 842–845.
- Cheng, W. & Johnson, D.W. 1998. Elevated CO₂, rhizosphere processes, and soil organic matter decomposition. *Plant Soil* **202**: 167–174.
- Chiou, T.-J. 2007. The role of microRNAs in sensing nutrient stress. *Plant Cell Environ.* **30**: 323–332.
- Clarkson, D.T. 1981. Nutrient interception and transport by root systems. In: Physiological factors limiting plant productivity, C.B. Johnson (ed). Butterworths, London, pp. 307–314.
- Clarkson, D.T. 1996. Root structure and sites of ion uptake. In: Plant roots: the hidden half, 3rd edition, Y. Waisel, A. Eshel, & U. Kafkaki (eds). Marcel Dekker, Inc., New York, pp. 483–510.
- Clarkson, D.T., Lüttge, U., & Kuiper, P.J.C. 1986. Mineral nutrition: sources of nutrients for land plants from outside the pedosphere. *Progr. Bot.* **48**: 80–96.
- Clemens, S. 2001. Molecular mechanisms of plant metal tolerance and homeostasis. *Planta* **212**: 475–486.
- Clemens, S., Palmgren, M.G., Kramer, U. 2002. A long way ahead: understanding and engineering plant metal accumulation. *Trends Plant Sci.* **7**, 309–315.
- Clement, C.R., Hopper, M.J., Jones, L.H.P., & Leafe, E.L. 1978. The uptake of nitrate by *Lolium perenne* from flowing nutrient solution. II. Effect of light, defoliation, and relationship to CO₂ flux. *J. Exp. Bot.* **29**: 1173–1183.
- Clijsters, H. & Van Assche, F. 1985. Inhibition of photosynthesis by heavy metals. *Photosynth. Res.* **7**: 31–40.
- Davenport, R.J. & Tester, M. 2000. A weakly voltage-dependent, nonselective cation channel mediates toxic sodium influx in wheat. *Plant Physiol.* **122**: 823–834.
- Davenport, R.J., Muñoz-Mayor, A., Jha, D., Essah, P.A., Rus, A., & Tester, M. 2007. The Na⁺ transporter AtHKT1; 1 controls retrieval of Na⁺ from the xylem in *Arabidopsis*. *Plant Cell Environ.* **30**: 497–507.
- De Boer, A.H. 1985. Xylem/symplast ion exchange: Mechanism and function in salt-tolerance and growth. PhD Thesis, University of Groningen, Groningen, the Netherlands.
- De Boer, A.H. & Wegner, L.H. 1997. Regulatory mechanisms of ion channels in xylem parenchyma cells. *J. Exp. Bot.* **48**: 441–449.
- Degenhardt, J., Larsen, P.B., Howell, S.H., & Kochian, L.V. 1998. Aluminum resistance in the *Arabidopsis* mutant *alr-104* is caused by an aluminum-induced increase in rhizosphere pH. *Plant Physiol.* **117**: 19–27.
- Deiana, S., Gessa, C., Manunza, B., Marchetti, M., & Usai, M. 1992. Mechanism and stoichiometry of the redox reaction between iron (III) and caffeic acid. *Plant Soil* **145**: 287–294.

- del Arco, J.M., Escudero, A., & Garrido, M.V. 1991. Effects of site characteristics on nitrogen retranslocation from senescing leaves. *Ecology* **72**: 701–708.
- Delhaize, E. & Ryan, P.R. 1995. Aluminum toxicity and tolerance in plants. *Plant Physiol.* **107**: 315–321.
- Delhaize, E., Ryan, P.R., & Randall, P.J. 1993. Aluminum tolerance in wheat (*Triticum aestivum* L.). II. Aluminum-stimulated excretion of malic acid from root apices. *Plant Physiol.* **103**: 695–702.
- Delhaize, E., Gruber, B.D., & Ryan P.R. 2007. The roles of organic anion permeases in aluminium resistance and mineral nutrition. *FEBS Lett.* **581**: 2255–2262.
- Demars, B.G. & Boerner, R.E.J. 1997. Foliar nutrient dynamics and resorption in naturalized *Lonicera maackii* (Caprifoliaceae) populations in Ohio, USA. *Am. J. Bot.* **84**: 112–117.
- Demidchik, V., Davenport, R.J. & Tester, M. 2002. Nonselective cation channels in plants. *Annu. Rev. Plant Biol.* **53**: 67–107.
- Denton, M.D., Veneklaas, E.J., Freimoser, F.M., & Lambers, H. 2007. *Banksia* species (Proteaceae) from severely phosphorus-impooverished soils exhibit extreme efficiency in the use and re-mobilisation of phosphorus. *Plant Cell Environ.* **30**: 1557–1565.
- De Silva, D.L.R., Hetherington, A.M., & Mansfield, T.A. 1996. Where does all the calcium go? Evidence of an important regulatory role for trichomes in two calcicoles. *Plant Cell Environ.* **19**: 880–886.
- Diaz, S.A., Grime, J.P., Harris, J., & McPherson, E. 1993. Evidence of a feedback mechanism limiting plant response to elevated carbon dioxide. *Nature* **364**: 616–617.
- Dong, B., Ryan, P.R., Rengel, Z., & Delhaize, E. 1999. Phosphate uptake in *Arabidopsis thaliana*: dependence of uptake on the expression of transporter genes and internal phosphate concentration. *Plant Cell Environ.* **22**: 1455–1461.
- Drew, M.C. 1975. Comparison of the effects of a localized supply of phosphate, nitrate, ammonium and potassium on the growth of the seminal root system, and the shoot, in barley. *New Phytol.* **75**: 479–490.
- Drew, M.C., Saker, L.R., & Ashley, T.W. 1973. Nutrient supply and the growth of the seminal root system in barley. I. The effect of nitrate concentration on the growth of axes and laterals. *J. Exp. Bot.* **24**: 1189–1202.
- Driscoll, C.T., Lawrence, G.B., Bulger, A.J., Butler, T.J., Cronan, C.S., Eagar, C., Lambert, K.F., Likens, G.E., Stoddard, J.L. & Weathers, K.C. 2001. Acidic deposition in the northeastern United States: sources and inputs, ecosystem effects and management strategies. *BioSci.* **51**: 180–198.
- Duffus, J.H. 2002. “Heavy metals”—a meaningless term? *Pure Appl. Chem.* **74**: 793–807.
- Eckstein, R.L., Karlsson, P.S., & Weih, M. 1999. Leaf life span and nutrient resorption as determinants of plant nutrient conservation in temperate-arctic regions. *New Phytol.* **143**: 177–189.
- Epstein, E. & Hagen, C.E. 1952. A kinetic study of the absorption of alkali cations by barley roots. *Plant Physiol.* **27**: 457–474.
- Erskine, P.D., Stewart, G.R., Schmidt, S., Turnbull, M.H., Unkovich, M.H., & Pate, J.S. 1996. Water availability—a physiological constraint on nitrate utilization in plants of Australian semi-arid mulga woodlands. *Plant Cell Environ.* **19**: 1149–1159.
- Esau, K. 1977. Anatomy of seed plants, 2nd edition. John Wiley & Sons, New York.
- Eviner, V.T. & Chapin III, F.S. 1997. Plant-microbial interactions. *Nature* **385**: 26–27.
- Föhse, D., Claassen, N., & Jungk, A. 1991. Phosphorus efficiency of plants. *Plant Soil* **132**: 261–272.
- Forde, B.G. 2002. Local and long-range signaling pathways regulating plant responses to nitrate. *Annu. Rev. Plant Biol.* **53**: 203–224.
- Foulds W. 1993. Nutrient Concentrations of foliage and soil in south-western Australia. *New Phytol.* **125**: 529–546.
- Franken, B., Blijenberg, J., & De Kroon, H. 1999. Root morphological and physiological plasticity of perennial grass species and the exploitation of spatial and temporal heterogeneous nutrient patches. *Plant Soil* **211**: 179–189.
- Frey, B., Keller, C., Zierold, K., & Schulin, R. 2000. Distribution of Zn in functionally different leaf epidermal cells of the hyperaccumulator *Thlaspi caerulescens*. *Plant Cell Environ.* **23**: 675–687.
- Furukawa, J., Yamaji, N., Wang, H., Mitani, N., Murata Y., Sato, K., Katsuhara, M., Takeda, K., & Ma, J.F. 2007. An aluminum-activated citrate transporter in barley. *Plant Cell Physiol.* **48**: 1081–1091.
- Gahoonia, T.S. & Nielsen, N.E. 2004. Barley genotypes with long root hairs sustain high grain yields in low-P field. *Plant Soil* **262**: 55–62.
- Garnett, T.V. & Smethurst, P.J. 1999. Ammonium and nitrate uptake by *Eucalyptus nitens*: effects of pH and temperature. *Plant Soil* **214**: 133–140.
- Gerendás J. & Schurr, U. 1999. Physicochemical aspects of ion relations and pH regulation in plants—a quantitative approach. *J. Exp. Bot.* **50**: 1101–1114.
- Gersani, M. & Sachs, T. 1992. Development correlations between roots in heterogeneous environments. *Plant Cell Environ.* **15**: 463–469.
- Gilbert, G.A., Allan, D.A., & Vance, C.P. 1998. Phosphorus deficiency in white lupin alters root development and metabolism. In: Radical biology: advances and perspectives in the function of plant roots, H.E. Flores, J.P. Lynch, & D.M. Eissenstat (eds). Current topics in plant physiology, Vol. 17. American Society of Plant Physiology, Rockville, MD, pp. 92–103.
- Godbold, D.L., Horst, W.J., Marschner, H., & Collins, J.C. 1983. Effect of high zinc concentrations on root growth and zinc uptake in two ecotypes of *Deschampsia caespitosa* differing in zinc tolerance. In: Root ecology and its practical application, W. Böhm, L. Kutschera, & E. Lichtenegger (eds). Bundesanstalt für alpenländische Landwirtschaft, Gumpenstein, pp. 165–172.
- Gressel, N. & McColl, J.G. 1997. Phosphorus mineralization and organic matter decomposition: A critical review. In: Driven by nature: plant litter quality and decomposition, G. Cadisch & K.E. Giller (eds). CAB International, Wallingford.

- Güsewell, S. 2004. N:P ratios in terrestrial plants: variation and functional significance. *New Phytol.* **164**: 243–266.
- Gutierrez, F.R. & Whitford, W.G. 1987. Chihuahuan desert annuals: importance of water and nitrogen. *Ecology* **68**: 2032–2045.
- Hairiah, K., Stulen, I., & Kuiper, P.J.C. 1990. Aluminium tolerance of the velvet beans *Mucuna pruriens* var. *utilis* and *M. deeringiana*. I. Effects of aluminium on growth and mineral composition. In: Plant nutrition—physiology and applications, M.L. Van Beusichem (ed). Kluwer Academic Publishers, Dordrecht, pp. 365–374.
- Hall, J.L. 2002. Cellular mechanisms for heavy metal detoxification and tolerance. *J. Exp. Bot.* **53**: 1–11.
- Harper, S.M., Edwards, D.G., Kerven, G.L., & Asher, C.J. 1995. Effects of organic acid fractions extracted from *Eucalyptus camaldulensis* leaves on root elongation of maize (*Zea mays*) in the presence and absence of aluminium. *Plant Soil* **171**: 189–192.
- Hayes, J.E., Simpson, R.J., & Richardson, A.E. 2000. The growth and phosphorus utilisation of plants in sterile media when supplied with inositol hexaphosphate, glucose 1-phosphate or inorganic phosphate. *Plant Soil* **220**: 165–174.
- Hedin, L.O. 2004. Global organization of terrestrial plant-nutrient interactions. *Proc. Natl. Acad. Sci. USA* **101**: 10849–10850.
- Hedin, L.O., Granat, L., Likens, G.E., Buishand, A., Galloway, J.N., Butler, T.J., & Rodhe, H. 1994. Steep declines in atmospheric base cations in regions of Europe and North America. *Nature* **367**: 351–354.
- Henry, H.A.L. & Jefferies, R.L. 2003. Plant amino acid uptake, soluble N turnover and microbial N capture in soils of a grazed arctic salt marsh. *J. Ecol.* **91**: 627–636.
- Higginbotham, N., Etherton, B., & Foster, R.J. 1967. Mineral ion contents and cell transmembrane electro-potentials of pea and oat seedling tissue. *Plant Physiol.* **42**: 37–46.
- Hinsinger, P. 1998. How do plant roots acquire mineral nutrients? Chemical processes involved in the rhizosphere. *Adv. Agron.* **64**: 225–265.
- Hinsinger, P., Plassard, C., Tang, C., & Jaillard, B. 2003. Origins of root-mediated pH changes in the rhizosphere and their responses to environmental constraints: A review. *Plant Soil* **248**: 43–59.
- Hodge, A. 2004. The plastic plant: root responses to heterogeneous supplies of nutrients. *New Phytol.* **162**: 9–24.
- Hodge, A., Robinson, D., Griffiths, B.S., & Fitter, A.H. 1999. Why plants bother: Root proliferation results in increased nitrogen capture from an organic patch when two grasses compete. *Plant Cell Environ.* **22**: 811–820.
- Hoffland, E., Findenegg, G.R., & Nelemans, J.A. 1989. Solubilization of rock phosphate by rape. II. Local root exudation of organic acids as a response to P-starvation. *Plant Soil* **113**: 161–165.
- Huang, C.X. & Van Steveninck, R.F.M. 1989. Maintenance of low Cl-concentrations in mesophyll cells of leaf blades of barley seedlings exposed to salt stress. *Plant Physiol.* **90**: 1440–1443.
- Huang, N.-C., Chiang, C.-S., Crawford, N.M., & Tsay, Y.F. 1996. *Chl1* encodes a component of the low-affinity nitrate uptake system in *Arabidopsis* and shows cell type-specific expression in roots. *Plant Cell* **8**: 2183–2191.
- Hübel, F. & Beck, F. 1993. In-situ determination of the P-relations around the primary root of maize with respect to inorganic and phytate-P. *Plant Soil* **157**: 1–9.
- Ingestad, T. 1979. Nitrogen stress in birch seedlings II. N, P, Ca and Mg nutrition. *Physiol. Plant.* **52**: 454–466.
- Jenny, H. 1980. The soil resources. Origin and behavior. Springer-Verlag, New York.
- Johnson, M.N., Reynolds, R.C., & Likens, G.E. 1972. Atmospheric sulfur: Its effect on the chemical weathering of New England. *Science* **177**: 514–515.
- Johnson, A.H., Frizano, J., & Vann, D.R. 2003. Biogeochemical implications of labile phosphorus in forest soils determined by the Hedley fractionation procedure. *Oecologia* **135**: 487–499.
- Jones, D.L. 1998. Organic acids in the rhizosphere—a critical review. *Plant Soil* **205**: 25–44.
- Jones, D.L., Darrah, P.R., & Kochian, L.V. 1996a. Critical evaluation of organic acid mediated iron dissolution in the rhizosphere and its potential role in iron uptake. *Plant Soil* **180**: 57–66.
- Jones, D.L., Prabowo, A.M., & Kochian, L.V. 1996b. Kinetics of malate transport and decomposition in acid soils and isolated bacterial populations: The effects of microorganisms on root exudation of malate under Al stress. *Plant Soil* **182**: 239–247.
- Jones, D.L., Healey, J.R., Willett, V.B., Farrar, J.F., & Hodge, A. 2005. Dissolved organic nitrogen uptake by plants—an important N uptake pathway? *Soil Biol. Biochem.* **37**: 413–423.
- Kaiser, W.M. & Huber, S.C. 2001. Post-translational regulation of nitrate reductase: mechanism, physiological relevance and environmental triggers. *J. Exp. Bot.* **52**: 1981–1989.
- Kamh, M., Horst, W.J., Amer, F., Mostafa, H., & Maier, P. 1999. Mobilization of soil and fertilizer phosphate by cover crops. *Plant Soil* **211**: 19–27.
- Kamh, M., Abdou, M., Chude, V., Wiesler, F., & Horst, W.J. 2002. Mobilization of phosphorus contributes to positive rotational effects of leguminous cover crops on maize grown on soils from northern Nigeria. *J. Plant Nutr. Soil Sci.* **165**: 566–572.
- Keerthisinghe, G., Hocking, P., Ryan, P.R., & Delhaize, E. 1998. Proteoid roots of lupin (*Lupinus albus* L.): Effect of phosphorus supply on formation and spatial variation in citrate efflux and enzyme activity. *Plant Cell Environ.* **21**: 467–478.
- Keltjens, W.G. & Tan, K. 1993. Interactions between aluminium, magnesium and calcium with different monocotyledonous and dicotyledonous plant species. *Plant Soil* **155/156**: 485–488.
- Kielland, K. 1994. Amino acid absorption by arctic plants: Implications for plant nutrition and nitrogen cycling. *Ecology* **75**: 2373–2383.
- Kielland, K., McFarland, J., & Olson, K. 2006. Amino acid uptake in deciduous and coniferous taiga ecosystems. *Plant Soil* **288**: 297–307.

- Killingbeck, K.T. 1996. Nutrients in senesced leaves: keys to the search for potential resorption and resorption proficiency. *Ecology* **77**: 1716–1727.
- King, B.J., Siddiqui, N.Y., Ruth, T.J., Warner, R.L., & Glass, A.D.M. 1993. Feedback regulation of nitrate influx in barley roots by nitrate, nitrite, and ammonium. *Plant Physiol.* **102**: 1279–1286.
- Kinraide, T.B. 1993. Aluminium enhancement of plant growth in acid rooting media. A case of reciprocal alleviation of toxicity by two toxic cations. *Physiol. Plant.* **88**: 619–625.
- Kirk, G.J.D. & Kronzucker, H.J. 2005. The potential for nitrification and nitrate uptake in the rhizosphere of wetland plants: a modelling study. *Ann Bot* **96**: 639–646.
- Kochian, L. 1995. Cellular mechanisms of aluminum toxicity and resistance in plants. *Annu. Rev. Plant Physiol. Plant Mol. Biol.* **46**: 237–260.
- Kochian, L.V., Piñeros, M.A., & Hoekenga, O.A. 2005. The physiology, genetics and molecular biology of plant aluminum resistance and toxicity. *Plant Soil* **274**: 175–195.
- Krämer, U. 2005. Phytoremediation: novel approaches to cleaning up polluted soils. *Curr. Opin. Biotechnol.* **16**: 133–141.
- Krämer, U., Cotter-Howels, J.D., Charnock, J.M., Baker, A.J.M., & Smith, J.A. 1996. Free histidine as a metal chelator in plants that accumulate nickel. *Nature* **379**: 635–638.
- Krämer, U., Smith, R.D., Wenzel, W.W., Raskin, I., & Salt, D.E. 1997. The role of metal transport and tolerance in nickel hyperaccumulation by *Thlaspi goesingense* Halacsy. *Plant Physiol.* **115**: 1641–1650.
- Krämer, U., Pickering, I.J., Prince, R.C., Raskin, I., & Salt, D.E. 2000. Subcellular localization and speciation of nickel in hyperaccumulator and non-accumulator *Thlaspi* species. *Plant Physiol.* **122**: 1343–1354.
- Krishnamurti, G.S.R., Cieslinski, G., Huang, P.M., & Van Rees, K.C.J. 1997. Kinetics of cadmium release from soils as influenced by organic acids: Implications in cadmium availability. *J. Environ. Qual.* **26**: 271–277.
- Kronzucker, H.J., Siddiqui, M.Y., & Glass, A.D.M. 1997. Conifer root discrimination against soil nitrate and the ecology of forest succession. *Nature* **385**: 59–61.
- Kronzucker, H.J., Siddiqui, M.Y., Glass, A.D.M., & Kirk, G.J.D. 1999a. Nitrate-ammonium synergism in rice. A subcellular flux analysis. *Plant Physiol.* **119**: 1041–1046.
- Kronzucker, H.J., Glass, A.D.M. & Siddiqui, M.Y. 1999b. Inhibition of nitrate uptake by ammonium in barley. Analysis of component fluxes. *Plant Physiol.* **120**: 283–292.
- Krupa, Z., Oquist, G., & Huner, N.P.A. 1993. The effect of cadmium on photosynthesis of *Phaseolus vulgaris*—a fluorescence analysis. *Physiol. Plant.* **88**: 626–630.
- Lacan, D. & Durand, N. 1994. Na⁺ and K⁺ transport in excised soybean roots. *Physiol. Plant.* **93**: 132–138.
- Lambers, H., Shane, M.W., Cramer, M.D., Pearse, S.J., & Veneklaas, E.J. 2006. Root structure and functioning for efficient acquisition of phosphorus: matching morphological and physiological traits. *Ann. Bot.* **98**: 693–713.
- Lambers, H., Shaver, G., Raven, J.A., & Smith, S.E. 2008. N- and P-acquisition change as soils age. *Trends Ecol. Evol.* **23**: 95–103.
- Larsen, P.B., Degenhardt, J., Tai, C.-Y., Stenzler, L.M., Howell, S.H., & Kochian, L.V. 1998. Aluminum resistance *Arabidopsis* mutants that exhibit altered patterns of aluminum accumulation and organic acid release from roots. *Plant Physiol.* **117**: 7–18.
- Lasat, M.M., Baker, A.J.M., & Kochian, L.V. 1996. Physiological characterization of root Zn²⁺ absorption and translocation to shoots in Zn hyperaccumulator and nonaccumulator species of *Thlaspi*. *Plant Physiol.* **112**: 1715–1722.
- Lata, J.-C., Degrange, V., Raynaud, X., Maron, P.-A., Lensi, R., & Abbadié, L. 2004. Grass populations control nitrification in savanna soils. *Funct. Ecol.* **18**: 605–611.
- LeNoble, M.E. Blevins, D.G., Sharp, R.E., & Cumbie, B.G. 1996a. Prevention of aluminium toxicity with supplemental boron. I. Maintenance of root elongation and cellular structure. *Plant Cell Environ.* **19**: 1132–1142.
- LeNoble, M.E. Blevins, D.G., & Miles, R.J. 1996b. Prevention of aluminium toxicity with supplemental boron. II. Stimulation of root growth in an acidic, high-aluminium subsoil. *Plant Cell Environ.* **19**: 1143–1148.
- Li, L., Li, S.-M., Sun, J.-H., Zhou, L.-L., Bao, X.-G., Zhang, H.-G., & Zhang, F.-S. 2007. Diversity enhances agricultural productivity via rhizosphere phosphorus facilitation on phosphorus-deficient soils. *Proc. Natl. Acad. Sci. USA* **104**: 11192–11196.
- Lipson, D. & Näsholm, T. 2001. The unexpected versatility of plants: Organic nitrogen use and availability in terrestrial ecosystems. *Oecologia* **128**: 305–316.
- Liu, K.-H. & Tsay, Y.-F. 2003. Switching between the two action modes of the dual-affinity nitrate transporter CHL1 by phosphorylation. *EMBO J.* **22**: 1005–1013.
- Lodhi, M.A.K. & Killingbeck, K.T. 1980. Allelopathic inhibition of nitrification and nitrifying bacteria in a ponderosa pine (*Pinus ponderosa* Dougl.) community. *Am. J. Bot.* **67**: 1423–1429.
- Lolkema, P.C., Doornhof, M., & Ernst, W.H.O. 1986. Interaction between a copper-tolerant and a copper-sensitive population of *Silene cucubalus*. *Physiol. Plant.* **67**: 654–658.
- Loneragan, J.F. 1968. Nutrient requirements of plants. *Nature* **220**: 1307–1308.
- Loveless, A.R. 1961. A nutritional interpretation of sclerophylly based on differences in chemical composition of sclerophyllous and mesophytic leaves. *Ann. Bot.* **25**: 168–184.
- Ma, J.F. 2000. Role of organic acids in detoxification of aluminum in higher plants. *Plant Cell Physiol.* **41**: 383–390.
- Ma, J.F. 2005. Plant root responses to three abundant soil minerals: silicon, aluminum and iron. *Crit. Rev. Plant Sci.* **24**: 267–281.
- Ma, J.F., Hiradate, S., Nomoto, K., Iwashita, T., & Matsumoto, H. 1997. Internal detoxification mechanisms of Al in hydrangea. Identification of Al forms in the leaves. *Plant Physiol.* **113**: 1033–1039.

- Ma, J.F., Hiradata, S., & Matsumoto, H. 1998. High aluminum resistance in buckwheat. II. Oxalic acid detoxifies aluminum internally. *Plant Physiol.* **117**: 753–759.
- Ma, J.F., Ryan, P.R., & Delhaize, E. 2001a. Aluminium tolerance in plants and the complexing role of organic acids. *Trends Plant Sci.* **6**: 273–278.
- Ma, J.F., Goto, S., Tamai, K., & Ichii, M. 2001b. Role of root hairs and lateral roots in silicon uptake by rice. *Plant Physiol.* **127**: 1773–1780.
- Ma, L., Komar, K.M., Tu, C., Zhang, W., Cai, Y., & Kennelley E.D. 2001c. A fern that hyperaccumulating arsenic. *Nature* **409**: 579.
- Ma, J.F., Ueno, H., Ueno, D., Rombola, A.D., Iwashita, T. 2003. Characterization of phytosiderophore secretion under Fe deficiency stress in *Festuca rubra*. *Plant Soil* **256**: 131–137.
- Ma, J.F., Nagao, S., Huang, C.F., & Nishimura, M. 2005. Isolation and characterization of a rice mutant hypersensitive to Al. *Plant Cell Physiol.* **46**: 1054–1061.
- Ma, J.F., Tamai, K., Yamaji, N., Mitani, N., Konishi, S., Katsuhara, M., Ishiguro, M., Murata, Y., Yano, M. 2006. A silicon transporter in rice. *Nature* **440**: 688–691.
- Ma, J.F., Yamaji, N., Mitani, N., Tamai, K., Konishi, S., Fujiwara, T., Katsuhara, M., Yano, M. 2007. An efflux transporter of silicon in rice. *Nature* **448**: 209–212.
- Macduff, J.H., Hopper, M.J., & Wild, A. 1987. The effect of root temperature on growth and uptake of ammonium and nitrate by *Brassica napus* L. cv. bien venu in flowing solution culture: II. uptake from solutions containing NH_4NO_3 . *J. Exp. Bot.* **38**: 53–66.
- Macklon, A.E.S., Mackie-Dawson, L.A., Sim, A., Shand, C.A., & Lilly, A. 1994. Soil P resources, plant growth and rooting characteristics in nutrient poor upland grasslands. *Plant Soil* **163**: 257–266.
- Macfie, S.M. & Taylor, G.J. 1992. The effect of excess manganese on photosynthetic rate and concentration of chlorophyll in *Triticum aestivum* grown in solution culture. *Physiol. Plant.* **85**: 467–475.
- Magalhaes, J.V., Liu, J., Guimaraes, C.T., Lana, U.G.P., Alves, V.M.C., Wang, Y.-H., Schaffert, R.E., Hoekenga, O.A., Pineros, M.A., Shaff, J.E., Klein, P.E., Carneiro, N.P., Coelho, C.M., Trick, H.N., & Kochian, L.V. 2007. A gene in the multidrug and toxic compound extrusion (MATE) family confers aluminum tolerance in sorghum. *Nature Genetics* **39**: 1156–1161.
- Marcum, K.B. & Pessaraki, M. 2006. Salinity tolerance and salt gland excretion efficiency of bermudagrass turf cultivars. *Crop Sci.* **46**: 2571–2574.
- Marschner, H. 1983. General introduction to the mineral nutrition of plants. In: Encyclopedia of plant physiology, N.S., Vol 15A, A. Läuchli & R.L. Bielecki (eds). Springer-Verlag, Berlin, pp. 5–60.
- Marschner, H. 1991a. Root-induced changes in the availability of micronutrients in the rhizosphere. In: Plant roots: the hidden half, 3rd edition, Y. Waisel, A. Eshel, & U. Kafkaki (eds). Marcel Decker, Inc., New York, pp. 503–528.
- Marschner, H. & Römheld, V. 1996. Root-induced changes in the availability of micronutrients in the rhizosphere. In: Plant roots: the hidden half, 3rd edition, Y. Waisel, A. Eshel, & U. Kafkaki (eds). Marcel Decker, Inc., New York, pp. 557–580.
- Martinoia, E., Heck, U., & Wiemken, A. 1981. Vacuoles as storage compartments for nitrate in barley leaves. *Nature* **289**: 292–294.
- McKane, R.B., Johnson, L.C., Shaver, G.R., Nadelhoffer, K.J., Rastetter, E.B., Fry, B., Giblin, A.E., Kielland, K., Kwiatkowski, B.L., Laundre, J.A. & Murray, G. 2002. Resource-based niches provide a basis for plant species diversity and dominance in arctic tundra. *Nature* **415**: 68–71.
- McNaughton, S.J., & Chapin III, F.S. 1985. Effects of phosphorus nutrition and defoliation on C_4 graminoids from the Serengeti Plains. *Ecology* **66**: 1617–1629.
- McNeilly, T. 1968. Evolution in closely adjacent plant populations III. *Agrostis tenuis* on a small copper mine. *Heredity* **23**: 99–108.
- Meerts, P. 1997. Foliar macronutrient concentrations of forest understorey species in relation to Ellenberg's indices and potential relative growth rate. *Plant Soil* **189**: 257–265.
- Meharg, A.A. & Macnair, M.R. 1992. Suppression of the high affinity phosphate uptake system: a mechanism of arsenate tolerance in *Holcus lanatus* L. *J. Exp. Bot.* **43**: 519–524.
- Miller, A.J. & Cramer, M.D. 2005. Root nitrogen acquisition and assimilation. *Plant Soil* **274**: 1–36.
- Min, X., Siddiqi, M.Y., Guy, R.D., Glass, A.D.M., & Kronzucker, H.J. 1999. A comparative study of fluxes and compartmentation of nitrate and ammonium in early-successional tree species. *Plant Cell Environ.* **22**: 821–830.
- Mistrik, I. & Ullrich, C.I. 1996. Mechanism of anion uptake in plant roots: Quantitative evaluation of H^+/NO_3^- and $\text{H}^+/\text{H}_2\text{PO}_4^-$ stoichiometries. *Plant Physiol. Biochem.* **34**: 621–627.
- Morikawa, H., Higaki, A., Nohno, M., Takahashi, M., Kamada, M., Nakata, M., Toyohara, G., Okamura, Y., Matsui, K., Kitani, S., Fujita, K., Irifune, K., & Goshima, N. 1998. More than 600-fold variation in nitrogen dioxide assimilation among 217 plant taxa. *Plant Cell Environ.* **21**: 180–190.
- Munns, R. 2002. Comparative physiology of salt and water stress. *Plant Cell Environ.* **25**: 239–250.
- Munns, R. 2005. Genes and salt tolerance: bringing them together *New Phytol.* **167**: 645–663.
- Murphy, A. & Taiz, L. 1995. Comparison of metallothionein gene expression and nonprotein thiols in ten *Arabidopsis* ecotypes. *Plant Physiol.* **109**: 945–954.
- Nair, V.D. & Prenzel, J. 1978. Calculations of equilibrium concentration of mono- and polynuclear hydroxyaluminium species at different pH and total aluminium concentrations. *Z. Pflanzenernähr. Bodenkd.* **141**: 741–751.
- Nambiar, I.K.S. 1987. Do nutrients retranslocate from fine roots? *Can. J. For. Res.* **17**: 913–918.
- Nambiar, I.K.S. & Fife, D.N. 1987. Growth and nutrient retranslocation in needles of radiata pine in relation to nitrogen supply. *Ann. Bot.* **60**: 147–156.

- Neumann, G. & Römheld, V. 1999. Root excretion of carboxylic acids and protons in phosphorus-deficient plants. *Plant Soil* **211**: 121–130.
- Neumann, G., Massonneau, A., Langlade, N., Dinkelaker, B., Hengeler, C., Römheld, V., & Martinoia, E. 2000. Physiological aspects of cluster root function and development in phosphorus-deficient white lupin (*Lupinus albus* L.). *Ann. Bot.* **85**: 909–919.
- Nian, H., Yang, Z.M., Ahn, S.J., Cheng, Z.J., & Matsumoto, H. 2002. A comparative study on the aluminium- and copper-induced organic acid exudation from wheat roots. *Physiol. Plant.* **116**: 328–335.
- Niklas, K.J., Owens, T., Reich, P.B., & Cobb, E.D. 2005. Nitrogen/phosphorus leaf stoichiometry and the scaling of plant growth. *Ecol. Lett.* **8**: 636–642.
- Nuruzzaman, M., Lambers, H., Bolland, M.D.A., & Veneklaas, E.J. 2005. Phosphorus benefits of different legume crops to subsequent wheat grown in different soils of Western Australia. *Plant Soil* **271**: 175–187.
- Nye, P.H. & Tinker, P.B. 1977. Solute movement in the soil-root system. Blackwell, Oxford.
- Ohwaki, Y. & Sugahara, K. 1997. Active extrusion of protons and exudation of carboxylic acids in response to iron deficiency by roots of chickpea (*Cicer arietinum* L.). *Plant Soil* **189**: 49–55.
- Osaki, M., Yamada, S., Ishizawa, T., Watanabe, T. & Shinano, T. 2003a. Mineral characteristics of leaves of plants from different phylogeny grown in various soil types in the temperate region. *Plant Foods Human Nutr.* **58**: 117–137.
- Osaki, M., Yamada, S., Ishizawa, T., Watanabe, T. & Shinano, T. 2003b. Mineral characteristics of the leaves of 166 plant species with different phylogeny in the temperate region. *Plant Foods Human Nutr.* **58**: 139–152.
- Parfitt, R.L. 1979. The availability of P from phosphate-goethite bridging complexes. Desorption and uptake by ryegrass. *Plant Soil* **53**: 55–65.
- Passioura, J.B., Ball, M.C., Knight, J.H. 1992. Mangroves may salinize the soil and in so doing limit their transpiration rate. *Funct. Ecol.* **6**: 476–481.
- Pate, J.S. Verboom, W.H., & Galloway, P.D. 2001. Co-occurrence of Proteaceae, laterite and related oligotrophic soils: coincidental associations or causative inter-relationships? *Aust. J. Bot.* **49**: 529–560.
- Pearse, S.J., Veneklaas, E.J., Cawthray, G.R., Bolland, M.D.A. & Lambers, H. 2006. Carboxylate release and other root traits of wheat, canola and 11 grain legume species as affected by P status. *Plant Soil* **288**: 127–139.
- Pellet, D.M., Papernik, L.A., & Kochian, L.V. 1996. Multiple aluminum-resistance mechanisms in wheat (roles of root apical phosphate and malate exudation). *Plant Physiol.* **112**: 591–597.
- Pérez Corona, M.E., Van der Klundert, I., & Verhoeven, J.T.A. 1996. Availability of organic and inorganic phosphorus compounds as phosphorus sources for *Carex* species. *New Phytol.* **133**: 225–231.
- Poorter, H., Remkes, C., & Lambers, H. 1990. Carbon and nitrogen economy of 24 wild species differing in relative growth rate. *Plant Physiol* **94**: 621–627.
- Popp, M. 1995. Salt resistance in herbaceous halophytes and mangroves. *Progr. Bot.* **56**: 416–429.
- Poschenrieder, C., Tolra, R., & Barceló, J. 2006. Can metals defend plants against biotic stress? *Trends Plant Sci.* **11**: 88–295.
- Prenzel, J. 1979. Mass flow to the root system and mineral uptake of a beech stand calculated from 3-year field data. *Plant Soil* **51**: 39–49.
- Przybylowicz, J., Pineda, C.A., Prozesky, V.M., & Mesjasz-Przybylowicz, J. 1995. Investigation of Ni hyperaccumulation by true elemental imaging. *Nucl. Instr. Meth.* **B104**: 176–181.
- Purnell, H.M. 1960. Studies of the family Proteaceae. I. Anatomy and morphology of the roots of some Victorian species. *Aust. J. Bot.* **8**: 38–50.
- Raaimakers, T.H.M.J. 1995. Growth of tropical rainforest trees as dependent on P-availability. Tree saplings differing in regeneration strategy and their adaptations to a low phosphorus environment in Guyana. PhD Thesis, Utrecht University, Utrecht, the Netherlands.
- Rausser, W.E. 1995. Phytochelatin and related peptides. Structure, biosynthesis, and function. *Plant Physiol.* **109**: 1141–1149.
- Rawat, S.R., Silim, S.N., Kronzucker, H.J. Siddiqi, M.Y., & Glass, A.D.M. 1999. AtAMT1 gene expression and NH₄⁺ uptake in roots of *Arabidopsis thaliana*: evidence for regulation by root glutamine levels. *Plant J.* **19**: 143–152.
- Read, J., Sanson, G.D., Garine-Wichatitsky, M.d., & Jaffre, T. 2006. Sclerophylly in two contrasting tropical environments: low nutrients vs. low rainfall. *Am. J. Bot.* **93**: 1601–1614.
- Reddell, P., Yun, Y., & Shipton, W.A. 1997. Cluster roots and mycorrhizae in *Casuarina cunninghamiana*: their occurrence and formation in relation to phosphorus supply. *Aust. J. Bot.* **45**: 41–51.
- Reeves, R.D. & Baker, A.J.M. 2000. Metal-accumulating plants. In: Phytoremediation of toxic metals: using plants to clean up the environment, I. Raskin & B.D. Ensley (eds). John Wiley & Sons, New York, pp. 193–229.
- Reich, P.B. & Oleksyn, J. 2004. Global patterns of plant leaf N and P in relation to temperature and latitude. *Proc. Natl. Acad. Sci. USA* **101**: 11001–11006.
- Reich, P.B., Walters, M.B., & Ellsworth, D.S. 1992. Leaf life-span in relation to leaf, plant and stand characteristics among diverse ecosystems. *Ecol. Monogr.* **62**: 365–392.
- Reich, P.B., Ellsworth, D.S., & Uhl, C. 1995. Leaf carbon and nutrient assimilation and conservation in species of differing succession status in an oligotrophic Amazonian forest. *Funct. Ecol.* **9**: 65–76.
- Remans, T., Nacry, P., Pervent, M., Filleur, S., Diatloff, E., Mounier, E., Tillard, P., Forde, B.G., & Gojon, A. 2006. The *Arabidopsis* NRT1.1 transporter participates in the signaling pathway triggering root colonization of nitrate-rich patches. *Proc. Natl. Acad. Sci. USA* **103**: 19206–19211.
- Rengel, Z. & Römheld, V. 2000. Root exudation and Fe uptake and transport in wheat genotypes differing in tolerance to Zn deficiency. *Plant Soil* **222**: 25–34.
- Reuss, J.O. & Johnson, D.W. 1986. Acid deposition and the acidification of soils and waters. Springer-Verlag, New York.

- Richardson, A.E. 1994. Soil microorganisms and phosphorus availability. In: Soil biota. Management in sustainable farming systems, C.E. Pankhurst, B.M. Doube, V.V.S.R. Gupta, & P.R. Grace (eds). CSIRO, East Melbourne, pp. 50–62.
- Richardson, A.E., Hadobas, P.A., & Hayes, J.E. 2000. Acid phosphomonoesterases and phytase activities of wheat (*Triticum aestivum*) roots and utilization of organic phosphorus substrates by seedlings grown in sterile culture. *Plant Cell Environ.* **23**: 397–405.
- Richardson, S.J., Peltzer, D.A., Allen, R.B., McGlone, M.S., & Parfitt, R.L. 2004. *Oecologia* **139**: 267–276.
- Richardson, S.J., Peltzer, D.A., Allen, R.B., & McGlone, M.S. 2005. Resorption proficiency along a chronosequence: responses among communities and within species. *Ecology* **86**: 20–25.
- Richardson, A.E., George, T.S., Jakobsen, I., & Simpson, R.J. 2007. Plant utilization of inositol phosphates. In: Inositol phosphates: linking agriculture and the environment, B.L. Turner, A.E. Richardson, & E.J. Mullaney (eds). CABI Publishing, Wallingford. pp. 242–260.
- Roberts, S.K. 2006. Plasma membrane anion channels in higher plants and their putative functions in roots. *New Phytol.* **169**: 647–666.
- Robinson, D. 1994. The responses of plants to non-uniform supplies of nutrients. *New Phytol.* **127**: 635–674.
- Robinson, D. 1996. Variation, co-ordination and compensation in root systems in relation to soil variability. *Plant Soil* **187**: 57–66.
- Robinson, N.J., Tommey, A.M., Kuske, C., & Jackson, P.J. 1993. Plant metallothioneins. *Biochem. J.* **295**: 1–10.
- Robinson, B.H., Leblanc, M., Petit, D., Brooks, R.B., Kirkman, J.H., & Gregg, P.E.H. 1998. The potential of *Thlaspi caerulescens* for phytoremediation of contaminated spoils. *Plant Soil* **203**: 47–56.
- Robinson, B.H., Brooks, R.R., & Clothier, B.E. 1999. Soil amendments affecting nickel and cobalt uptake by *Berkheya coddii*: potential use for phytomining and phytoremediation. *Ann. Bot.* **84**: 689–694.
- Römer, W., Kang, D.-K., Egle, K., Gerke, J., & Keller, H. 2000. The acquisition of cadmium by *Lupinus albus* L., *Lupinus angustifolius* L., and *Lolium multiflorum* Lam. *J. Plant Nutr. Soil Sci.* **163**: 623–628.
- Römheld, V. 1987. Different strategies for iron acquisition in higher plants. *Physiol. Plant.* **70**: 231–234.
- Ryan, P.R., Kinraide, T.B., & Kochian, L.V. 1994. Al³⁺-Ca²⁺ interactions in aluminium rhizotoxicity. I. Inhibition of root growth is not caused by reduction of calcium uptake. *Planta* **192**: 98–103.
- Ryan, P.R., Reid, R.J., & Smith, F.A. 1997. Direct evaluation of the Ca²⁺-displacement hypothesis for Al toxicity. *Plant Physiol.* **113**: 1351–1357.
- Sakaguchi, T., Nishizawa, N.K., Nakanishi, H., Yoshimura, E., & Mori, S. 1999. The role of potassium in the secretion of mugineic acids family phytosiderophores from iron-deficient barley roots. *Plant Soil* **215**: 221–227.
- Salt, D.E. & Rauser, W.E. 1995. MgATP-dependent transport of phytochelatin across the tonoplast of oat roots. *Plant Physiol.* **107**: 1293–1301.
- Salt, D.E., Prince, R.C., Pickering, I.J., & Raskin, I. 1995. Mechanisms of cadmium mobility and accumulation in Indian mustard. *Plant Physiol.* **109**: 1427–1433.
- Salt, D.E., Kato, N., Krämer, U., Smith, R.D., & Raskin, I. 2000. The role of root exudates in nickel hyperaccumulation and tolerance in accumulator and non-accumulator species of *Thlaspi*. In: Phytoremediation of contaminated soil and water, N. Terry & G.S. Bañuelos (eds). CRC Press, Boca Raton, pp. 191–202.
- Sardans, J., Peñuelas, J., & Estiarte, M. 2007. Seasonal patterns of root-surface phosphatase activities in a Mediterranean shrubland. Responses to experimental warming and drought. *Biol. Fertil. Soils* **43**: 779–786.
- Scheurwater, I., Clarkson, D.T., Purves, J., Van Rijn, G., Saker, L., Welschen, R., & Lambers, H. 1999. Relatively large nitrate efflux can account for the high specific respiratory costs for nitrate transport in slow-growing grass species. *Plant Soil* **215**: 123–134.
- Schimel, J. P. & Bennett, J. 2004. Nitrogen mineralization: challenges of a changing paradigm. *Ecology* **85**: 591–602.
- Schirmer, U. & Breckle, S.-W. 1982. The role of bladders for salt removal in some Chenopodiaceae (mainly *Atriplex* species). In: Tasks for vegetation science, Vol. 2, D.N. Sen & K.S. Rajpurokit (eds). Dr W. Junk Publishers, The Hague, pp. 215–231.
- Schmidt, W. 2003. Iron solutions: acquisition strategies and signaling pathways in plants. *Trends Plant Sci.* **8**: 188–193.
- Schmidt, S. & Stewart, G.R. 1999. Glycine metabolism by plant roots and its occurrence in Australian plant communities. *Aust. J. Plant Physiol.* **26**: 253–264.
- Scholz, G., Becker, R., Pich, A., & Stephan, U.W. 1992. Nicotinamine—a common constituent of strategies I and II of iron acquisition by plants: a review. *J. Plant Nutr.* **15**: 1647–1665.
- Shane, M.W. & Lambers, H. 2005. Cluster roots: A curiosity in context. *Plant Soil* **274**: 99–123.
- Shane, M.W. & Lambers, H. 2006. Systemic suppression of cluster-root formation and net P-uptake rates in *Grevillea crithmifolia* at elevated P supply: a Proteaceae with resistance for developing symptoms of “P toxicity”. *J. Exp. Bot.* **57**: 413–423.
- Shane, M.W., McCully, M., & Lambers, H. 2004a. Tissue and cellular phosphorus storage during development of “phosphorus toxicity” in *Hakea prostrata* (Proteaceae). *J. Exp. Bot.* **55**: 1033–1044.
- Shane, M.W., Szota, C. & Lambers, H. 2004b. A root trait accounting for the extreme phosphorus sensitivity of *Hakea prostrata* (Proteaceae). *Plant Cell Environ.* **27**: 991–1004.
- Shane, M.W., Cramer, M.D., Funayama-Noguchi, S., Millar, A.H., Day, D.A., & Lambers, H. 2004c. Developmental physiology of cluster-root carboxylate synthesis and exudation in harsh hakea: expression of phosphoenolpyruvate carboxylase and the alternative oxidase. *Plant Physiol.* **135**: 549–560.
- Shane, M.W., Dixon, K.W. & Lambers, H. 2005. The occurrence of dauciform roots amongst Western Australian reeds, rushes and sedges, and the impact of P supply on dauciform-root development in *Schoenus unispiculatus* (Cyperaceae). *New Phytol.* **165**: 887–898.

- Sharples, J.M., Meharg, A.M., Chambers, S.M., & Cairney, J.W.G. 2000. Mechanism of arsenate resistance in the ericoid mycorrhizal fungus *Hymenoscyphus ericae*. *Plant Physiol.* **124**: 1327–1334.
- Shaver, G.R. & Chapin III, F.S. 1991. Production:biomass relationships and element cycling in contrasting arctic vegetation types. *Ecol. Monogr.* **61**: 1–31.
- Shriner, D.S. and Johnston Jr., J.W. 1985. Acid rain interactions with leaf surfaces: a review. In: Acid deposition: environmental, economic, and policy issues, D.D. Adams & W.P Page (eds). Plenum Publishing Corporation, New York, pp. 241–253.
- Siddiqi, M.Y., Glass, A.D.M., & Ruth, T.J., & Ruffy, T.W. 1990. Studies of the nitrate uptake system in barley. I. Kinetics of $^{13}\text{NO}_3^-$ influx. *Plant Physiol.* **93**: 1426–1432.
- Siddiqi, M.Y., Glass, A.D.M., & Ruth, T.J. 1991. Studies of the uptake of nitrate in barley. III. Compartmentation of NO_3^- . *J. Exp. Bot.* **42**: 1455–1463.
- Silberbush, M. & Barber, S.A. 1983. Sensitivity of simulated phosphorus uptake to parameters used by a mechanistic-mathematical model. *Plant Soil* **74**: 93–100.
- Silva, I.R., Smyth, T.J., Israel, D.W., Raper, C.D. & Ruffy, T.W. 2001a. Altered aluminum inhibition of soybean root elongation in the presence of magnesium. *Plant Soil* **230**: 223–230.
- Silva, I.R., Smyth, T.J., Israel, D.W., & Ruffy, T.W. 2001b. Magnesium ameliorates aluminum rhizotoxicity in soybean by increasing citric acid production and exudation by roots. *Plant Cell Physiol.* **42**: 546–554.
- Smart, C.J., Garvin, D.F., Prince, J.P., Lucas, W.J., & Kochian, L.V. 1996. The molecular basis of potassium nutrition. *Plant Soil* **187**: 81–89.
- Smirnov, N., Todd, P., & Stewart, G.R. 1984. The occurrence of nitrate reduction in the leaves of woody plants. *Ann. Bot.* **54**: 363–374.
- Soderberg, K. & Compton, J. 2007. Dust as a nutrient source for fynbos ecosystems, South Africa. *Ecosystems* **10**: 550–561.
- Sprent, J.I. 1999. Nitrogen fixation and growth of non-crop legume species in diverse environments. *Perspect. Plant Ecol. Evol. Syst.* **2**: 149–162.
- Staal, M., Maathuis, F.J.M., Elzenga, T.J.M., Overbeek, J.H.M., & Prins, H.B.A. 1991. Na^+/H^+ antiport activity in tonoplast vesicles from roots of the salt-tolerant *Plantago maritima* and the salt-sensitive *Plantago media*. *Physiol. Plant.* **82**: 179–184.
- Stark, J.M. & Hart, S.C. 1997. High rates of nitrification and nitrate turnover in undisturbed coniferous ecosystems. *Nature* **385**: 61–64.
- Sterner, R.W. and J.J. Elser. 2002. Ecological Stoichiometry: the biology of elements from molecules to the biosphere. Princeton University Press, Princeton.
- Sunardi, Horie, T., Motado, J., Kubo, M., Yang, H., Yoda, K., Horie, R., Chan, W.-Y., Hattori, K., Osumi, M., Yamagami, M., Schroeder, J., & Uozumi, N. 2005. Enhanced salt tolerance mediated by AtHKT1 transporter-induced Na^+ unloading from xylem vessels to xylem parenchyma cells. *Plant J.* **44**: 928–938.
- Szczerba, M.W., Britto, D.T., & Kronzucker, H.J. 2006a. Rapid, futile K^+ cycling and pool-size define low-affinity potassium transport in barley. *Plant Physiol.* **141**: 1494–1507.
- Szczerba M W, Britto D T and Kronzucker H J 2006b. The face value of ion fluxes: the challenge of determining influx in the low-affinity transport range. *J. Exp. Bot.* **57**: 3293–3300.
- Tarafdar, J.C. & Jungk, A. 1987. Phosphatase activity in the rhizosphere and its relation to the depletion of soil organic phosphorus. *Biol. Fert. Soils* **3**: 199–204.
- Tester, M. & Davenport, R. 2003. Na^+ tolerance and Na^+ transport in higher plants. *Ann. Bot.* **91**: 503–527.
- Thomas, W.A. & Grigal, D.F. 1976. Phosphorus conservation by evergreenness of mountain laurel. *Oikos* **27**: 19–26.
- Tilton, D.L. 1977. Seasonal growth and foliar nutrients of *Larix laricina* in three wetland ecosystems. *Can. J. Bot.* **55**: 1291–1298.
- Tinker, P.B.H. & Nye, P.H. 2000. Solute transport in the rhizosphere. Oxford University Press, Oxford.
- Touraine, B., Clarkson, D.T., & Muller, B. 1994. Regulation of nitrate uptake at the whole plant level. In: A whole-plant perspective on carbon-nitrogen interactions, J. Roy & E. Garnier (eds). SPB Academic Publishing, The Hague pp. 11–30.
- Trueman, L.J., Richardson, A., & Forde, B.G. 1996a. Molecular cloning of higher plant homologues of the high-affinity nitrate transporters of *Chlamydomonas reinhardtii* and *Aspergillus nidulans*. *Gene* **175**: 223–231.
- Trueman, L.J., Onyeocha, I., & Forde, B.G. 1996b. Recent advances in the molecular biology of a family of eukaryotic high affinity nitrate transporters. *Plant Physiol. Biochem.* **34**: 621–627.
- Tukey Jr., H.B. 1970. The leaching of substances from plants. *Annu. Rev. Plant Physiol.* **21**: 305–324.
- Turner B.L. (2006) Inositol phosphates in soil: amounts, forms and significance of the phosphorylated inositol stereoisomers. In: Inositol phosphates: linking agriculture and the environment, B.L. Turner, A.E. Richardson, & E.J. Mullaney (eds). CABI Publishing, Wallingford, pp. 186–206.
- Turner, B.L. & Richardson, A.E. 2004. Identification of scyllo-inositol phosphates in soil by solution phosphorus-31 nuclear magnetic resonance spectroscopy. *Soil Sci. Soc. Am. J.* **68**: 802–808.
- Ueno, D., Rombola, A.D., Iwashita, T., Nomoto, K., Ma, J.F. 2007. Identification of two novel phytosiderophores secreted by perennial grasses. *New Phytol.* **174**: 304–310.
- Van der Werf, A., Visser, A.J., Schieving, F., & Lambers, H. 1993. Evidence for optimal partitioning of biomass and nitrogen at a range of nitrogen availabilities for a fast- and slow-growing species. *Funct. Ecol.* **7**: 63–74.
- Van Hoof, N.A.L.M., Koevoets, P.L.M., Hakvoort, H.W.J., Ten Bookum, W. M., Schat, H., Verkleij, J.A.C. & Ernst, W.H.O. 2001. Enhanced ATP-dependent copper efflux across the root cell plasma membrane in copper-tolerant *Silene vulgaris*. *Physiol. Plant.* **113**: 225–232.
- Van Vuuren, M.M.I., Robinson, D., & Griffiths, B.S. 1996. Nutrient inflow and root proliferation during the

- exploitation of a temporally and spatially discrete source of nitrogen in the soil. *Plant Soil* **178**: 185–192.
- Verry, E.S. & Timmons, D.R. 1976. Elements in leaves of a trembling aspen clone by crown position and season. *Can. J. For. Res.* **6**: 436–440.
- Vitousek, P. 1982. Nutrient cycling and nutrient use efficiency. *Am. Nat.* **119**: 553–572.
- Vitousek, P.M. 2004. Nutrient cycling and limitation: Hawaii as a model system. Princeton University Press, Princeton.
- Von Ballmoos, P., Amman, M., Egger, A., Suter, M., & Brunold, C. 1998. NO₂-induced nitrate reductase activity in needles of Norway spruce (*Picea abies*) under laboratory and field conditions. *Physiol. Plant.* **102**: 596–604.
- Vögeli-Lange, R. & Wagner, G.J. 1990. Subcellular localization of cadmium and cadmium-binding peptides in tobacco leaves. *Plant Physiol.* **92**: 1086–1093.
- Walker, T.W. & Syers, J.K. 1976. The fate of phosphorus during pedogenesis. *Geoderma* **15**: 1–9.
- Walker, C.D., Graham, R.D., Madison, J.T., Cary, E.E., & Welch, R.M. 1985. Effects of Ni deficiency on some nitrogen metabolites in cowpea (*Vigna unguiculata* L. Walp). *Plant Physiol.* **79**: 474–479.
- Wang, B.L., Shen, J.B., Zhang, W.H., Zhang, F.S., & Neumann, G. 2007. Citrate exudation from white lupin induced by phosphorus deficiency differs from that induced by aluminum. *New Phytol.* **176**: 581–589.
- Warren, C.R. 2006. Potential organic and inorganic N uptake by six *Eucalyptus* species. *Funct. Plant Biol.* **33**: 653–660.
- Westoby, M., Falster, D.S., Moles, A.T., Vesk, P.A., & Wright, I.J. 2002. Plant ecological strategies: some leading dimensions of variation between species. *Annu. Rev. Ecol. Syst.* **33**: 125–159.
- White, P.J. 1999. The molecular mechanism of sodium influx to root cells. *Trends Plant Sci.* **4**: 277–278.
- Wiehe, W. & Breckle, S.-W. 1990. The ontogenesis of the salt glands of *Limonium* (Plumbaginaceae). *Bot. Acta* **103**: 107–110.
- Wolt, J.D. 1994. Soil solution chemistry. John Wiley & Sons, New York.
- Woodward, R.A., Harper, K.T., & Tiedemann, A.R. 1984. An ecological consideration of the significance of cation-exchange capacity of roots of some Utah range plants. *Plant Soil* **79**: 169–180.
- Wright, I.J. & Westoby, M. 2003. Nutrient concentration, resorption and lifespan: leaf traits of Australian sclerophyll species. *Funct. Ecol.* **17**: 10–19.
- Wright, I.J., Reich, P.B., Westoby, M., Ackerly, D.D., Baruch, Z., Bongers, F., Cavender-Bares, J., Chapin, T., Cornelissen, J.H.C., Diemer, M., Flexas, J., Garnier, E., Groom, P.K., Gulias, J., Hikosaka, K., Lamont, B.B., Lee, T., Lee, W., Lusk, C., Midgley, J.J., Navas, M.-L., Niinemets, Ü., Oleksyn, J., Osada, N., Poorter, H., Poot, P., Prior, L., Pyankov, V.I., Roumet, C., Thomas, S.C., Tjoelker, M.G., Veneklaas, E.J., & Villar, R. 2004. The worldwide leaf economics spectrum. *Nature* **428**: 821–827.
- Yanai, J., Robinson, D., Young, I.M., Kyuma, K., & Kosaki, T. 1998. Effects of the chemical form of inorganic nitrogen fertilizers on the dynamics of the soil solution composition and on nutrient uptake by wheat. *Plant Soil* **202**: 263–270.
- Yang, Y.-Y., Jung, J.-Y., Song, W.-Y., Suh, H.-S., & Lee, Y. 2000. Identification of rice varieties with high tolerance or sensitivity to lead and characterization of the mechanism of tolerance. *Plant Physiol.* **124**: 1019–1026.
- Zak, D.R., Pregitzer, K.S., Curtis, P.S., Teeri, J.A., Fogel, R., & Randlett, D.A. 1993. Elevated CO₂ and feedback between carbon and nitrogen cycles. *Plant Soil* **151**: 105–117.
- Zerihun, A., McKenzie, B.A., & Morton, J.D. 1998. Photosynthate costs associated with the utilization of different nitrogen-forms: influence on the carbon balance of plants and shoot-root biomass partitioning. *New Phytol.* **138**: 1–11.
- Zhang, H. & Forde, B.G. 1998. An *Arabidopsis* MADS box gene that controls nutrient-induced changes in root architecture. *Science* **279**: 407–409.
- Zhang, H. & Forde, B.G. 2000. Regulation of *Arabidopsis* root development by nitrate availability. *J. Exp. Bot.* **51**: 51–59.
- Zhang, H., Jennings, A., Barlow, P.W., & Forde, B.G. 1999. Dual pathways for regulation of root branching by nitrate. *Proc. Natl. Acad. Sci. USA* **96**: 6259–62534.
- Zhang, W.-H., Ryan, P.R., & Tyerman, S.D. 2004. Citrate-permeable channels in the plasma membrane of cluster roots from white lupin. *Plant Physiol.* **136**: 3771–3783.
- Zhao, F.J., Lombi, E., Breedon, T., & McGrath, S.P. 2000. Zinc hyperaccumulation and cellular distribution in *Arabidopsis halleri*. *Plant Cell Environ.* **5**: 507–514.
- Zheng, S.J., Ma, J.F., & Matsumoto, H. 1998. High aluminum resistance in buckwheat. I. Al-induced specific secretion of oxalic acid from root tips. *Plant Physiol.* **117**: 745–751.
- Zohlen, A. & Tyler, G. 1997. Differences in iron nutrition of two calcifuges, *Carex pilulifera* L. and *Veronica officinalis* L. *Ann. Bot.* **80**: 553–559.
- Zohlen, A. & Tyler, G. 2000. Immobilisation of tissue iron on calcareous soil—differences between calcicole and calcifuge plants. *Oikos* **89**: 95–106.
- Zohlen, A. & Tyler, G. 2004. Soluble inorganic tissue phosphorus and calcicole–calcifuge behaviour of plants. *Ann. Bot.* **94**: 427–432.
- Zuo, Y., Zhang, F., Li, X., & Cao, Y. 2000. Studies on the improvement in iron nutrition of peanut by intercropping with maize on a calcareous soil. *Plant Soil* **220**: 13–25.

7

Growth and Allocation

1. Introduction: What Is Growth?

Plant growth results from interactions among all the processes discussed in previous chapters: 2 (photosynthesis, respiration, and long-distance transport), 3 (plant water relations), and 6 (mineral nutrition). By the same token, growth rate may control these physiological processes through its effect on plant demands for carbon, water, and nutrients, as discussed in the preceding chapters. What exactly do we mean by plant growth? **Growth** is the increment in dry mass, volume, length, or area that results from the **division, expansion, and differentiation** of cells. Increment in dry mass may not, however, coincide with changes in each of these components of growth. For example, leaves often expand and roots elongate at night, when the entire plant is decreasing in dry mass because of carbon use in respiration. On the other hand, a tuber may gain dry mass without concomitant change in volume, as starch accumulates. Discussion of “growth” therefore requires careful attention to context and the role of different processes at different times. For example, although cell divisions often initiate growth, this process by itself is insufficient to cause growth. In addition, growth requires cell elongation and the deposition of mass in the cytoplasm and cell walls which determine the increment in volume or mass. To appreciate ecophysiological aspects of plant growth, we must understand its cellular basis. Although this is a fascinating and rapidly moving

field, many questions remain unanswered, as will be revealed in this chapter.

This chapter also deals with the question of why some plants grow more rapidly than others. A plant’s growth rate is the result of both its genetic background and the environment in which it grows. Plants are the product of natural selection, resulting in genotypes with different **suites of traits** that allow them to perform in specific habitats. Such a suite of traits constitutes a “strategy”. The term is used here, as well as elsewhere in this text, to indicate the capacity of a plant to perform effectively in a specific ecological and evolutionary context (Box 9E.1). In this chapter we discuss how genetic and environmental factors affect the growth of plants.

2. Growth of Whole Plants and Individual Organs

Plant growth can be analyzed in terms of an increase in total plant dry mass and its distribution (**allocation**) among organs involved in acquisition of above-ground or below-ground resources. In such an approach, the pattern of biomass allocation plays a pivotal role in determining a plant’s access to resources and therefore its growth rate. Plant growth can also be studied at the level of individual organs or cells. Using this approach we can ask why the leaves of one plant grow faster or bigger than

those of another. The two approaches are complementary and should be integrated to highlight traits that determine a plant's growth potential.

2.1 Growth of Whole Plants

Growth analysis provides considerable insight into the functioning of a plant as dependent on genotype or environment. Different growth analyses can be carried out, depending on what is considered a key factor for growth (Lambers et al. 1989). Leaf area and net assimilation rate are most commonly treated as the "driving variables". As discussed in Sect. 4.2 of Chapter 6 on mineral nutrition, however, we can also consider the plant's nutrient concentration and nutrient productivity as driving variables. In either case, "driving variables" represent aspects of a plant's suite of traits (Sect. 3.7), rather than offering a mechanistic explanation for differences in growth rate.

2.1.1 A High Leaf Area Ratio Enables Plants to Grow Fast

We first concentrate on the plant's leaf area as the driving variable for the **relative growth rate (RGR)**, the rate of increase in plant mass per unit of plant mass already present (Evans 1972). According to this approach, RGR is factored into two components: the **leaf area ratio (LAR)**, which is the amount of leaf area per unit total plant mass, and the **net assimilation rate (NAR)**, which is the rate of increase in plant mass per unit leaf area (see Table 1 for a list of abbreviations and the units in which they are expressed):

$$\text{RGR} = \text{LAR} \cdot \text{NAR} \quad (1)$$

LAR and NAR, in turn, can each be subdivided into additional components. The LAR is the product of the **specific leaf area (SLA)**, which is the amount of leaf area per unit leaf mass, and the **leaf mass ratio (LMR)**, which is the fraction of the total plant biomass allocated to leaves:

$$\text{LAR} = \text{SLA} \cdot \text{LMR} \quad (2)$$

The NAR, which is the rate of dry mass gain per unit leaf area, is largely the net result of the rate of carbon gain in **photosynthesis** per unit leaf area (A) and that of carbon use in **respiration** of leaves, stems, and roots (LR, SR, and RR) which, in this case, is also expressed per unit leaf area. If these physiological processes are expressed in moles of carbon, the net balance of photosynthesis and respiration has to be divided by the carbon

concentration of the newly formed material, $[C]$, to obtain the increase in dry mass. The balance can be completed by subtracting losses due to volatilization and exudation per unit time, again expressed on a leaf area basis. For simplicity's sake, volatilization and exudation will be ignored here, although these processes can be ecologically important to the plant's carbon budget under some circumstances. We already discussed volatile losses (Sect. 3.3 of Chapter 4B on effects of radiation and temperature) and discuss this further in Sect. 5.2; the process of exudation has been treated in Sects. 2.2.5, 2.2.6, 3.1.3, and 3.2 of Chapter 6 on mineral nutrition. The simplified equation for the net assimilation rate is

$$\text{NAR} = \frac{\{A_a - \text{LR}_a - (\text{SR} \cdot \text{SMR})/(\text{LAR}) - (\text{RR} \cdot \text{RMR})/(\text{LAR})\}}{[C]} \quad (3)$$

The subscript a indicates that the rates are expressed on a leaf area basis. This is a common way to express rates of CO_2 assimilation (Chapter 2A on photosynthesis). Of course, stem and root respirations are not directly related to leaf area, but rather to the biomass of the different organs. This has been resolved by multiplying the rate of stem respiration (SR) and root respiration (RR) by SMR/LAR and RMR/LAR, respectively; SMR and RMR are the stem mass ratio and the root mass ratio, i.e., the fraction of plant biomass allocated to stems and roots, respectively (Table 1). Although the net assimilation rate is relatively easy to estimate from harvest data, it is not really an appropriate parameter to gain insight into the relation between physiology and growth. Rather, we should concentrate on the underlying processes: **photosynthesis, respiration, and allocation**.

For the relative growth rate, we can now derive the following equation:

$$\text{RGR} = \frac{A_a \cdot \text{SLA} \cdot \text{LMR} - \text{LR}_m - \text{SR} \cdot \text{SMR} - \text{RR} \cdot \text{RMR}}{[C]} \quad (4)$$

This equation has been widely used to identify traits that are associated with genetic variation in a plant's RGR at an optimum nutrient supply as well as variation caused by environmental factors, such as light intensity, temperature, or nutrient supply.

2.1.2 Plants with High Nutrient Concentrations Can Grow Faster

In an alternative approach, the plant's nutrient concentration (mostly **plant N concentration, PNC**) is assumed to be a driving variable, as discussed in Sect. 4 of Chapter 6 on mineral nutrition. PNC, in combination with the nutrient productivity (mostly

TABLE 1. Abbreviations related to plant growth analysis and the units in which they are expressed.

Abbreviation	Meaning	Preferred units
A_a	Rate of CO ₂ assimilation per unit leaf area	$\mu\text{mol CO}_2 \text{ m}^{-2} \text{ s}^{-1}$
[C]	Carbon concentration	mmol C g^{-1}
LAR	Leaf area ratio	$\text{m}^2 \text{ kg}^{-1}$
LMA	Leaf mass per unit leaf area	kg m^{-2}
LMR	Leaf mass ratio	g g^{-1}
LR_a (LR_m)	Rate of leaf respiration per unit leaf area or mass	$\mu\text{mol CO}_2 \text{ m}^{-2}$ (leaf area) s^{-1} [$\text{nmol CO}_2 \text{ g}^{-1}$ (leaf mass) s^{-1}]
NAR	Net assimilation rate	$\text{g m}^{-2} \text{ day}^{-1}$
NP	Nutrient productivity	$\text{g (plant mass) mol}^{-1}$ (plant nutrient) day^{-1}
PNC	Plant nutrient concentration	$\text{mol (nutrient) g}^{-1}$ (plant mass)
RGR	Relative growth rate	$\text{mg g}^{-1} \text{ day}^{-1}$
RMR	Root mass ratio	g g^{-1}
RR	Rate of root respiration	$\text{nmol CO}_2 \text{ g}^{-1}$ (root mass) s^{-1}
SLA	Specific leaf area	$\text{m}^2 \text{ kg}^{-1}$
SR	Rate of stem respiration	$\text{nmol CO}_2 \text{ g}^{-1}$ (stem mass) s^{-1}
SRL	Specific root length	m g^{-1}
SMR	Stem mass ratio	g g^{-1}

N productivity, NP), determines plant growth. Thus, we arrive at

$$\text{RGR} = \text{NP} \cdot \text{PNC} \quad (5)$$

As pointed out in Sect. 4.2 of Chapter 6 on mineral nutrition, plants differ widely in their N productivity, when grown with free access to nutrients. A high N productivity is associated with a relatively large investment of N in photosynthesizing tissue, an efficient use of the N invested in the leaves for the process of photosynthesis, and a relatively low carbon use in respiration (Poorter et al. 1990, Garnier et al. 1995).

2.2 Growth of Cells

Insights into the cellular basis of growth analysis come from studying the actual processes of growth (cell division, cell expansion, mass deposition) in greater detail.

2.2.1 Cell Division and Cell Expansion: The Lockhart Equation

Growth of leaves and roots, like that of other organs, is determined by **cell division**, **cell expansion**, and **deposition** of cell material. Cell division cannot cause an increase in volume, however, and therefore does not drive growth by itself. Rather, it provides the structural framework for subsequent cell expansion (Green 1976).

The processes of cell division and cell expansion are not mutually independent. Cells probably divide when they reach a certain size (i.e., they elongate after division and then divide again, before they have elongated substantially). This limits the developmental phase at which cell division can occur and implies that any process that slows down cell expansion inevitably leads to fewer cells per leaf or root and hence smaller leaves or roots. For example, consider a newly formed meristematic leaf cell that differentiates to produce epidermal leaf cells. Suppose this cell divides only after it doubles in cell volume, and that it has 240 hours left to undergo repeated mitoses at the point of determination. If the cell doubled in volume every 10 hours, then cell divisions will occur 24 times, which produce 2^{24} cells. If an environmental factor slows the rate of cell expansion such that the cells now take 12 hours to double in volume, however, then only 20 division cycles will occur which give rise to 2^{20} cells. Such a reduction in cell number could substantially reduce leaf surface area (Van Volkenburgh 1994).

Once a cell has divided, it can elongate and expand, provided the turgor pressure (Ψ_p , MPa) exceeds a certain **yield threshold** (Y , MPa). In cells capable of expansion, this threshold value is around 15–50% of the turgor pressure under normal conditions (no stress) (Pritchard 1994). The proportional growth rate (r , s^{-1}) is measured as the rate of increase in volume (dV , m^3) per unit volume (V , m^3); r is proportional to the difference between **turgor** and **yield threshold**. The proportional rate of

expansion ($dV/V \cdot dt, s^{-1}$) is described by the simplified **Lockhart equation**:

$$R = dV/(V \cdot dt) = \phi(\Psi_p - Y) \quad (6)$$

where ϕ is the cell-wall **yield coefficient** ($\text{MPa}^{-1} \text{s}^{-1}$), which is a proportionality constant that depends on biochemical and biophysical properties of the cell wall. Plant cell expansion is, therefore, a **turgor-driven** process believed to be controlled, both in extent and in direction, by the physical properties of the primary (growing) cell wall. If cells expand more in one direction than in another, the cell walls are more **extensible** (looser) in the direction in which they expand most. This simple analysis using the Lockhart equation assumes that neither water flow nor solute influx is limiting. This assumption appears to be met when plants are growing under favorable conditions. In later sections of this chapter we will discuss whether this assumption still applies under conditions of environmental stress.

Because cell expansion and cell division are closely linked, the increase in length or volume of entire leaves and other organs can be analyzed with a similar equation (Passioura & Fry 1992). Both the cell-wall yield coefficient, ϕ , and the yield threshold, Y , reflect the **extensibility** of the cell walls, as determined by their biochemical and biophysical properties. The turgor pressure, Ψ_p , or, more precisely, the difference between Ψ_p and Y , allows cell expansion. Uptake of ions into the cell maintains the turgor pressure, which tends to drop as the cell volume increases.

Turgor tends to be **tightly regulated**, particularly in growing cells (Pritchard 1994). This tight regulation of cell turgor is most likely due to modification of the activity ("gating") of **aquaporins** in the plasma membrane and tonoplast which are highly expressed in zones of rapid division and expansion (Tyerman et al. 2002, Siefritz et al. 2004). There are several examples, however, where a step-change in turgor does *not* lead to (full) readjustment to the original turgor pressure (Zhu & Boyer 1992, Passioura 1994). This probably reflects differences in original water status (Hsiao et al. 1998) or between-species and/or tissue-specific behavior. These results also point out that growth is not really controlled by turgor in the simple manner suggested by the Lockhart equation. Above the turgor threshold, the rate of cell enlargement is controlled by metabolic reactions, which cause synthesis and/or extension of wall polymers. Inside the cell, sufficient solutes must be generated to maintain turgor above the threshold.

2.2.2 Cell-Wall Acidification and Removal of Calcium Reduce Cell-Wall Rigidity

The fundamental structure of the primary (growing) cell wall is very similar in all land plants: Cellulose microfibrils are embedded in a hydrated matrix composed mostly of neutral and acidic polysaccharides and a small amount of structural proteins (Cosgrove 1999). The polysaccharides include the negatively charged cation-binding **polygalacturonic acids**. **Cellulose microfibrils**, which consist of bundles of around 50 cellulose molecules, provide the tensile strength of the cell wall. In expanding cells, the microfibrils tend to be arranged transversely, which favors expansion in a longitudinal, rather than in a radial direction. **Glycoproteins** add further strength to the cell walls. **Hemicelluloses** (i.e., polysaccharides with a glucan or similar backbone) probably bind to cellulose microfibrils and to each other by means of hydrogen bonds. Because there are many hemicellulose molecules per cellulose microfibril, the microfibrils are completely coated, making a three-dimensional net. Finally, there are several enzymes that can cleave covalent bonds that link the sugar residues of the noncellulosic polymers in the walls, and other enzymes that can join loose ends of similar polymers (Carpita & Gibeau 1993). The growing wall possesses a remarkable combination of strength and pliancy, enabling it to withstand the large mechanical forces that arise from cell turgor pressure, while at the same time permitting a controlled polymer "creep" that distends the wall and creates space for the enlarging protoplast. Cellulose microfibrils themselves are effectively inextensible; wall expansion occurs by slippage or rearrangement of the matrix polymers that coat the microfibrils and hold them in place. Until recently this was thought to occur primarily by hydrolysis of matrix polysaccharides, but the discovery of **expansins** (enzymes involved in loosening of cell walls) has uncovered another mechanism of wall enlargement (Cosgrove 1999, 2000).

Hormonal and environmental stimuli promote growth of plant cells by inducing polymer rearrangement and loosening of the primary (growing) cell wall. Expansin's unique physical effects on plant cell walls include rapid induction of wall extension and stimulation of stress relaxation. Expansins do not progressively weaken the cell wall, nor do they cause a lasting change in wall structure, except that the wall is longer and thinner after it extends. No ligands or cofactors are necessary for expansin action. Normally, expansin is a very minor component of the cell wall; binding and activity both saturate at an expansin-protein-to-wall ratio of about 1:1000. From an architectural perspective, one might expect

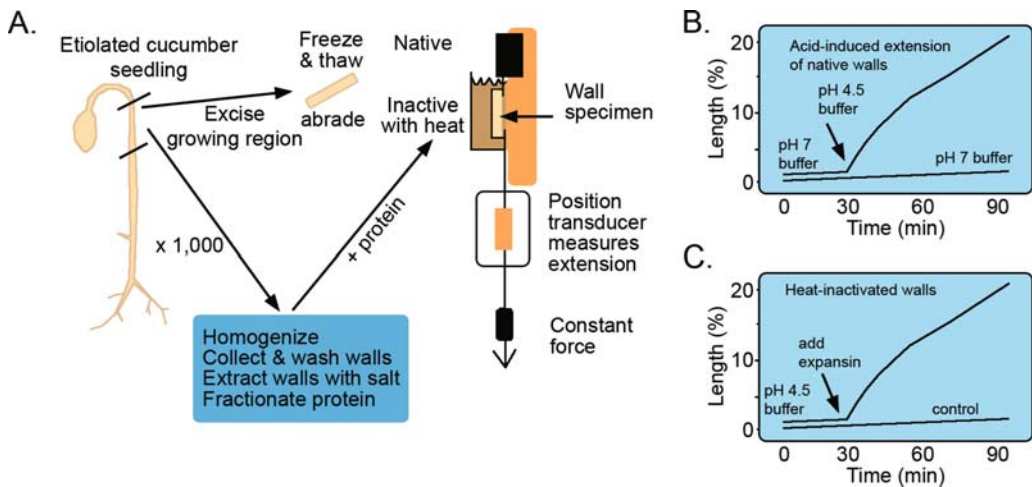

FIGURE 1. Diagram of extensometer assays. (A) The growing hypocotyl of a seedling is cut and frozen to kill the cells. The wall specimen is either directly clamped in a constant-force extensometer (“native walls”) or first inactivated with a brief heat treatment before being clamped in the extensometer (“heat-inactivated walls”). Expansin protein is prepared by extraction from native

walls, followed by fractionation and addition to the wall. (B) Native walls extend very little at neutral pH, but rapidly extend in acidic pH. (C) Heat-inactivated walls lack acid-induced extension, which can be restored by addition of expansin to the walls (modified after Cosgrove 2000). Reprinted with permission from *Nature* copyright 1996 Macmillan Magazines Ltd.

expansin’s loosening action to result from hydrolysis of the matrix polymers that hold the cellulose microfibrils in place, but none of the available evidence supports this. The current thinking is that expansins weaken the noncovalent binding (hydrogen bonding) between wall polysaccharides, thereby allowing turgor-driven polymer creep (Cosgrove 2000).

Expansins are encoded by a gene family; expression of individual genes may be differentially regulated at various developmental stages and by diverse environmental stimuli (Sects. 5.3 and 5.6.1). Loosening of primary and secondary walls can be modulated in various ways (e.g., by changes in wall pH, secretion of molecules that affect the activity of wall enzymes, and secretion of substrates). Additionally, the wall can be modified by other enzymes that change the structure in such a way that they can no longer be affected by the wall-loosening agents: **wall stiffening** (Cosgrove 1999).

Calcium enhances cell-wall stiffening by binding to pectin components, forming **Ca-pectate complexes** (Pritchard 1994). For example, shade enhances stem elongation as a result of the removal of Ca from the cell walls. Protons also play an important role in the breaking of cross-linkages. For example, the light-induced growth of leaves (phototropism) is preceded by extrusion of protons from the cytosol into the cell wall. A low pH in the cell wall, through activation of **expansins**, induces disruption of hydrogen bonding between cellulose microfibrils and matrix polymers

(Fig. 1). Hydrolytic enzymes, especially **xyloglucan endotransglycosylases**, catalyze breakage of some of the hemicellulose cross-links between cellulose molecules (Fry 2004).

The **light-induced enhancement of leaf growth**, which is preceded by the perception of light by both a red-light receptor (phytochrome) and a blue-light receptor, is due to **cell-wall acidification**, which enhances expansin activity (Fig. 1) and increases the extensibility of the cell walls (Sect. 5.1.1). Cells of stems may also respond to light, which is perceived by phytochrome, i.e., red light suppresses stem elongation and far-red light enhances it. Gibberellins enhance cell elongation, but through a different mechanism. In *Lactuca sativa* (lettuce) hypocotyls this effect of gibberellin is associated with the removal of **Ca** from the cell walls rather than with cell-wall acidification. **Cytokinins** promote and **abscisic acid** reduces the rate of **leaf expansion**, but, as with gibberellins, this is unlikely to be due to cell-wall acidification. Cytokinins and abscisic acid have either no effect or the opposite effect on **root elongation** (i.e., cytokinins tend to inhibit and ABA tends to promote root growth); in the case of ABA that may depend on the level of water stress (Sect. 5.3.2).

Phototropic reactions, which allow coleoptiles to grow toward the light, are based on greater **acidification** of the walls of cells furthest away from the light source as compared with the more proximal cells.

Box 7.1 Phytohormones

Many aspects of plant growth and development are controlled by internal messengers: phytohormones (Davies 2004). In the animal literature, the term hormone refers to a molecule that is produced in cells of a specific organ (gland) and that has specific effects on other cells (target cells). Phytohormones are not produced in specific glands, but in organs and tissues that serve other functions as well. The effect of phytohormones is also less specific than that of their animal counterparts. They may mediate among several environmental factors and lead to several plant responses.

Phytohormones are characterized as

1. organic molecules produced by the plant itself
2. compounds that affect growth and development (either positively or negatively) at very low concentrations
3. compounds that act primarily in a part of the plant that differs from the site they are produced
4. compounds whose action depends on their chemical structure, rather than on the elements they contain

There are six groups of phytohormones (Fig. 1). The first phytohormone was discovered in the 1920s by F.W. Went (1926), who was doing a PhD with his father, F.A.F.C. Went, at Utrecht University, where the structure of **auxin** was identified. It is indoleacetic acid (IAA), termed auxin, because of its involvement in the growth of *Avena sativa* (oat) coleoptiles toward the light (auxin comes from the Greek verb to grow). It is involved in the promotion of cell growth, differentiation in the root and shoot meristem, and apical dominance. Auxin is produced in leaves and transported to the site of action through specific carrier proteins located in the plasma membrane. Localized effects, such as tropisms and tissue polarity, depend on this highly regulated transport.

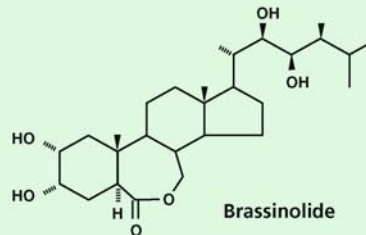
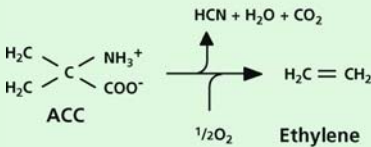
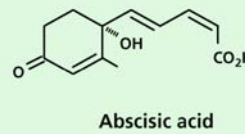
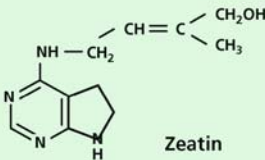
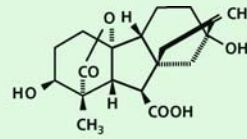
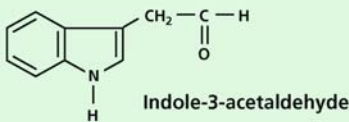

FIGURE 7.1.1. The chemical structure of a representative of the six groups of phytohormones: indole-3-acetaldehyde (IAA, an auxin), gibberellin A₁ (GA₁, one of many gibberellins, of which only a small number is physiologically active; GA₁ is the gibberellin that usually induces stem elongation), zeatin [a

common bioactive cytokinin first identified in *Zea mays* (corn)], abscisic acid (ABA), ethylene (the only gaseous phytohormone) and its water-soluble precursor: 1-amino-cyclopropane-1-carboxylic acid (ACC), and brassinolide, which is the most biologically active brassinosteroid.

continued

Box 7.1 Continued

The **gibberellins** or gibberellic acids (GAs) derived their name from the fungus *Gibberella fujikori*, which turns dwarf rice cultivars into tall ones. It is a complex class of phytohormones of which the active compounds strongly stimulate elongation growth through an effect on both cell division and cell elongation. GA has also a key role in the first steps leading to germination of seeds.

Cytokinins were discovered in a search for a medium suitable for tissue culture, where they stimulate cell division. The bioactive members of this family of phytohormones are also involved in chloroplast maturation, the delay of senescence, leaf expansion, and several other morphogenetic processes. Root tips are a major site of cytokinin production, and the primary transport path to the site of action is in the transpiration stream.

Absciscic acid (ABA) derives its name from its stimulation of leaf abscission. This phytohormone is, however, involved in a wide range of regulatory processes. ABA plays a key role in stress responses (e.g., desiccation, salinity). ABA causes stomatal closure, inhibits extension growth, and induces senescence. ABA also induces dormancy of buds and seeds.

Ethylene is the only gaseous hormone. It is produced from the water-soluble precursor 1-amino-cyclopropane-1-carboxylic acid (ACC) in an oxygen-requiring step, catalyzed by ACC oxidase. It induces senescence and inhibits cell growth at higher concentrations in most plants, but it stimulates growth in flooding-resistant plants (Sect. 7.5.7).

The hormonal status of **brassinosteroids** has been established more recently (Yokota 1997).

They were first isolated in 1974 from *Brassica napus* (oilseed rape) pollen and have since been found in many species. This group of hormones stimulates growth, as evidenced by mutants with defects in brassinosteroid biosynthesis or sensitivity which are all dwarfs. They stimulate senescence, stress tolerance, and germination of seeds.

Hormonal status is also claimed for other compounds such as jasmonate, salicylic acid, and several small peptides, but this is not generally accepted (Reski 2006). These compounds play, among others, a role in plant defense against pathogens and herbivores (Chapter 9B on ecological biochemistry).

Phytohormones are important both to internally coordinate the growth and development of different organs and as chemical messengers whose synthesis may be affected when plants are exposed to certain environmental factors. Many, if not all, developmental processes in plants depend on a coordinated action of several hormones. External or internal factors need to be sensed first, which is the first step in a signal-transduction pathway, ultimately leading to the plant's response. The plant's response is not necessarily due to an effect on the rate of production of the phytohormone, but it may involve its rate of breakdown or the sensitivity of the target cells to the hormone. At a molecular level, a plant's response may involve up-regulation or down-regulation of genes coding for enzymes involved in synthesis or breakdown of the phytohormone, or genes encoding a receptor of the phytohormone. Most of these receptor proteins have recently been identified in *Arabidopsis thaliana* (thale cress).

Such a difference in acidification is based on a difference in **auxin activity** in the distal and proximal cells (Box 7.1). These examples show that cells respond to light and hormones, sometimes in interaction, by changes in cell-wall properties that, in turn, affect growth of leaf, stem, or root cells. Genetic or environmental factors that affect the cell-wall cross-linkages, and hence φ or Y , affect the rate of cell expansion and the extent to which an organ will grow. Environmental factors such as hypoxia, water stress, and light affect leaf or stem growth exactly in this manner (Sect. 5).

Cell-wall extensibility declines with age of the cells, so that the walls of older cells no longer respond to cell-wall acidification. This is associated with changes in chemical composition (e.g., incorporation of more

galactose). Formation of **phenolic cross-links** between wall components might also play a role, as do **extensins**, which are rigid cell-wall glycoproteins that are particularly abundant in secondary cell walls. A wide range of environmental factors, including water stress, flooding, and soil compaction, affect leaf growth through their effect on cell-wall extensibility, as discussed later in this chapter (Pritchard 1994).

2.2.3 Cell Expansion in Meristems Is Controlled by Cell-Wall Extensibility and Not by Turgor

The growth rate of individual cells along a growing root tip varies considerably. A pressure probe that

measures the **turgor pressure** in individual growing root cells shows that the turgor varies little along the growing root. Changes in **cell-wall mechanical properties**, rather than in turgor, must therefore be responsible for the immediate control of the expansion rate of roots (Pritchard 1994).

Removal of minute quantities of sap from expanding cells shows that the **osmotic component of the water potential** becomes less negative by approximately 15% during cell expansion. This change is small, compared with that in cell volume during expansion, and it results from the drop in concentration of K^+ by about 50%. The concentration of other solutes is constant, showing that solute uptake into the expanding cells occurs at just about the same rate as that of water. There is little information to indicate which processes affect the cell-wall properties of roots. It may be similar to the situation in leaves, where cell-wall acidification plays a major role. On the other hand, Ca might play a role, as it does in hypocotyls.

As the cells expand, more cell-wall material is deposited, so that the cell-wall thickness remains approximately the same during the expansion phase. Further **deposition of cell-wall material** may occur after the cells have reached their final size which causes the cell walls to become thicker.

2.2.4 The Physical and Biochemical Basis of Yield Threshold and Cell-Wall Yield Coefficient

From a physical point of view, the parameters ϕ , the cell-wall yield coefficient, and Y , the yield threshold, in the Lockhart equation make intuitive sense. They can also be demonstrated experimentally, by using a pressure probe to determine turgor in the growing zone. The Lockhart “parameters” often behave as “variables”, however (i.e., the relationship between r and P is often nonlinear) (Passioura 1994). What exactly do these “parameters” mean?

In hypocotyl segments of *Vigna unguiculata* (cowpea) the cell-wall mechanical properties are affected by the phytohormones auxin and gibberellin (Box 7.2). In segments that are deficient in endogenous gibberellin, **auxin** only affects the **yield threshold**, but not the yield coefficient. As a result the effect of auxin is only half that in segments with normal gibberellin levels. After pretreatment with **gibberellin**, auxin does affect the **yield coefficient**. These results suggest that auxin decreases the yield threshold independently of gibberellin, but that it increases the yield coefficient only in the presence of gibberellin (Okamoto et al. 1995). In the same tissue, both the yield coefficient and the yield threshold are affected

by the **pH** in the cell wall. Both parameters are also affected by exposure to high temperature and proteinase, but not in the same manner. That is, a brief exposure to 80°C affects the yield threshold, but not the yield coefficient. Exposure to proteinase affects the yield coefficient, but not the yield threshold. These results suggest that the two cell-wall mechanical properties are controlled by two different proteins, both of which are activated by low pH (Okamoto & Okamoto 1995).

2.2.5 The Importance of Meristem Size

As discussed in previous sections, cell elongation depends on an increase in cell-wall extensibility. A more rapid rate of cell elongation may lead to a higher rate of leaf expansion or root elongation. A higher rate of leaf expansion or root elongation, however, is not invariably due to greater cell-wall extensibility. If more cells in the meristem divide and elongate at the same rate, this also results in higher rates of expansion. Indeed, variation in growth can be associated with variation in **meristem size** (i.e., the number of cells that divide and elongate at the same time). In a comparison of the growth of *Festuca arundinacea* (tall fescue) at high and low N supply, the major factor contributing to variation in leaf elongation is the size of the meristem (Fig. 2A). Along these lines, two genotypes of *Festuca arundinacea* that differ in their rate of leaf elongation by 50% when grown at high nutrient supply differ in the number of cells that elongate at the same time, whereas the rate of elongation of the expanding cells is fairly similar (Fig. 2B). Similarly, the number of meristems can be an important determinant of whole-plant growth rate.

3. The Physiological Basis of Variation in RGR—Plants Grown with Free Access to Nutrients

Plant species characteristic of **favorable environments** often have inherently higher maximum relative growth rates (RGR_{max}) than do species from less favorable environments (Parsons 1968, Grime & Hunt 1975). For example, inherently slow growth has been observed in species characteristic of nutrient-poor (Grime & Hunt 1975), saline (Ball & Pidsley 1995), and alpine (Atkin et al. 1996) environments. It is clear from Equations (1) and (2) that a high RGR could be associated with a high NAR (reflecting high photosynthesis and/or

Box 7.2 Phytochrome

Plants monitor various aspects of the light climate, and they use this information to adjust their growth and reproduction to environmental conditions. Phytochrome is one of the systems in plants that allow them to gain information about their light environment. It was discovered by Butler et al. (1959) as the photoreceptor involved in red to far-red reversible reactions. Other photoreceptors have been identified more recently (cryptochromes and phototropins; Jiao et al. 2007). In vivo the phytochrome chromophore exists in two different photoconvertible forms (Fig. 1): the red-light (R) absorbing form (P_r) and the active far-red (FR) light-absorbing form (P_{fr}). Other transformation processes are the synthesis of phytochrome as P_r and its breakdown as P_{fr} . Conversion of P_{fr} to P_r can also take place independent of light, as the process of dark reversion (Fig. 1). The main function of phytochrome is the detection of the presence of competing neighbors and mediation of a response known as shade avoidance (Sect. 5.1.1). This is achieved by the perception of the presence of light per se, its spectral composition, its irradiance level, and its direction (Ballaré 1999). Phytochrome is also involved in the perception of daylength. It plays a key role throughout the life cycle of plants, from seed maturation, dormancy, and germination, seedling development, during vegetative growth, and on to the control of flowering and senescence.

In *Arabidopsis thaliana* (thale cress) five genes encoding different apoproteins of phytochrome have been identified: *PHYA*–*PHYE*. They have

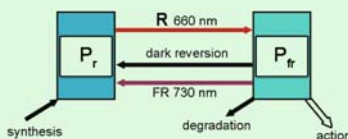

FIGURE 1. Conversion of phytochrome between the red (R) and far-red (FR) absorbing forms of phytochrome (P_r and P_{fr} , respectively). Phytochromes are synthesized in the P_r form and broken down in the P_{fr} form. Absorption of R (peak sensitivity 660 nm) and FR (peak sensitivity 730 nm) generates photoconversions of the chromophore. P_{fr} is the biologically active form that migrates to the nucleus where it promotes transcription.

different and partly overlapping functions during the various developmental stages. PhyA is easily degraded in the P_{fr} form, but phyB is more stable and can be subject to repeated photoconversions. The use of mutants lacking one or more phytochromes has been a powerful tool in unraveling their functions. *Arabidopsis thaliana* has an extreme shade-avoiding phenotype when all phytochrome is absent due to a mutation in the synthesis of the chromophore, even to the extent that the plant no longer has a rosette habit. The presence of phytochromes in the P_{fr} form is apparently necessary for attaining a normal light-grown phenotype (Smith 2000).

The more abundant phyB is the principal regulator of the classical R–FR reversibility of seed germination in the so-called low fluence response (LFR; Sect. 2.5 of Chapter 8 on life cycles). A similar role has been identified for phyE. Buried seeds can detect extremely low quantities of light in the so-called very low fluence response (VLFR) where phyA is the actor. Exposures to a light dose of $0.1 \mu\text{mol photons m}^{-2}$ are effective in these sensitized seeds, whereas the LFR operates in the $100\text{--}1000 \mu\text{mol m}^{-2}$ range (Sect. 2.5 of Chapter 8 on life cycles). Phytochrome A is also important for the high-irradiance response (HIR) that inhibits germination under prolonged exposure to light of high irradiance (Fig. 2A; Franklin & Whitelam 2004).

After germination, the etiolated seedling is highly sensitive to light due to the accumulation of phyA. De-etiolation starts after exposure to light, even before the seedling breaks through the soil surface. Subsequent hypocotyl extension is under control of the R:FR ratio (and thus canopy density), where phyB is the principal actor in inhibition of hypocotyl extension in normal daylight together with phyD, and possibly phyC, whereas phyA has a unique role, because it reduces the extension at low R:FR (Fig. 2B) (Quail et al. 1995).

A vegetative non-shade-tolerant herbaceous plant, such as *Arabidopsis thaliana* (thale cress), exposed to canopy shade develops a shade-avoiding phenotype characterized by erect growth and

continued

Box 7.2 Continued

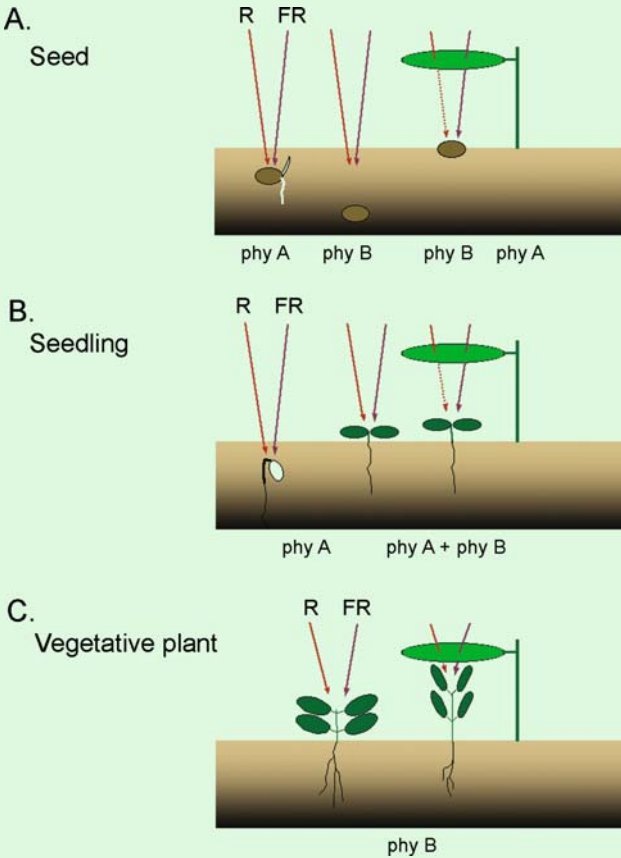

FIGURE 2. Simplified scheme to show the role of phytochromes in three developmental stages. Only phyA and phyB are depicted; for the roles of the other phytochromes see text. (A) Seed. Darkness keeps seeds in a dormant state. Daylight that is not modified by canopy filtration may break dormancy via the low (LFR; phyB) or the very low fluence response (VLFR; phyA), but canopy-filtered light with a low R:FR ratio maintains dormancy via the high-irradiance response (HIR; phyA) and the LFR (phyB). (B) Seedling. De-etiolation is initiated when the emerging seedling perceives light via the VLFR and the LFR (phyA and phyB, respectively), irrespective of canopy shade. Once emerged, hypocotyl extension is regulated via the HIR, where phyA and phyB have antagonistic effects under the low R:FR of canopy shade. (C) Vegetative plant. Shade avoidance, i.e., vertical orientation of leaves and petioles, and extension of leaves, petioles, and internodes are regulated mainly by phyB with respect to the degree of canopy shade.

an elongated shoot (Sect. 5.1.1). Mutants lacking phyB have a constitutive shade-avoiding phenotype, indicating that this phytochrome plays a major role in that response (Fig. 2C). However, the fact that these mutants still show a further

shade-avoidance response in low R:FR indicates that other phytochromes are also involved. These appear to be phyD and phyE. The remaining phyA and phyC modulate the effects of the other photoreceptors (Franklin & Whitelam 2004).

low whole-plant respiration), a high SLA (i.e., high leaf area per unit leaf mass), and/or a high LMR (high allocation to leaf mass). Which of these traits is most strongly correlated with a high RGR?

3.1 SLA Is a Major Factor Associated with Variation in RGR

Several extensive surveys have shown that the main trait associated with inherently **slow growth** in temperate lowland species from nutrient-poor habitats is their **low SLA**, both in monocotyledonous and in dicotyledonous species (Poorter &

Remkes 1990, Garnier 1992, Marañón & Grub 1993). The same conclusion holds for a wide range of both deciduous and evergreen tree species (Antúnez et al. 2001). Low SLA values decrease the amount of leaf area available for light interception and hence photosynthetic carbon gain, therefore reducing RGR. Although this conclusion follows logically from Equation (4), it may not provide insight into the exact **mechanisms** that account for slow growth. A further understanding of these mechanisms requires a thorough analysis of the processes discussed in Sect. 2.2.

Numerous surveys of herbaceous C_3 species show significant positive correlations of RGR with

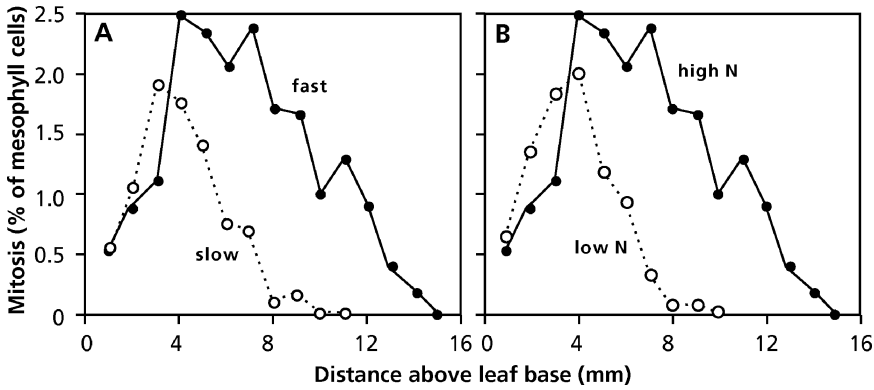

FIGURE 2. Percentage of mesophyll cells that are in mitosis as observed in longitudinal sections from the basal 40 mm of elongating leaf blades of *Festuca arundinacea* (tall fescue). A greater area under the curves indicates a larger meristem. (A) A comparison

of meristem size of a fast-elongating and slow-elongating genotype. (B) Effects of N supply on leaf meristem size in the fast-elongating genotype (after MacAdam et al. 1989). Copyright American Society of Plant Biologists.

LAR, LMR, and SLA, but not with NAR (Fig. 3). For example, in a broad comparison using 80 woody species from the British Isles and Northern Spain, ranging widely in leaf habit and life form, RGR is also tightly correlated with LAR (Cornelissen et al. 1996). When comparing more productive cultivars of tree species with less productive ones, SLA, rather than photosynthesis, is the main factor that accounts for variation in RGR (Ceulemans 1989). In addition, leaf and twig architecture of the more productive

trees is such that more of the light is harvested throughout the entire day (Leverenz 1992).

LMR does not correlate with RGR in monocotyledons, but it may account for some of the variation in RGR among dicotyledonous species. This reflects the phylogenetic constraints on a plant: a change in LMR appears to require a greater genetic change than that allowed by the genetic variation within a species, genus, or perhaps even family (Marañón & Grub 1993).

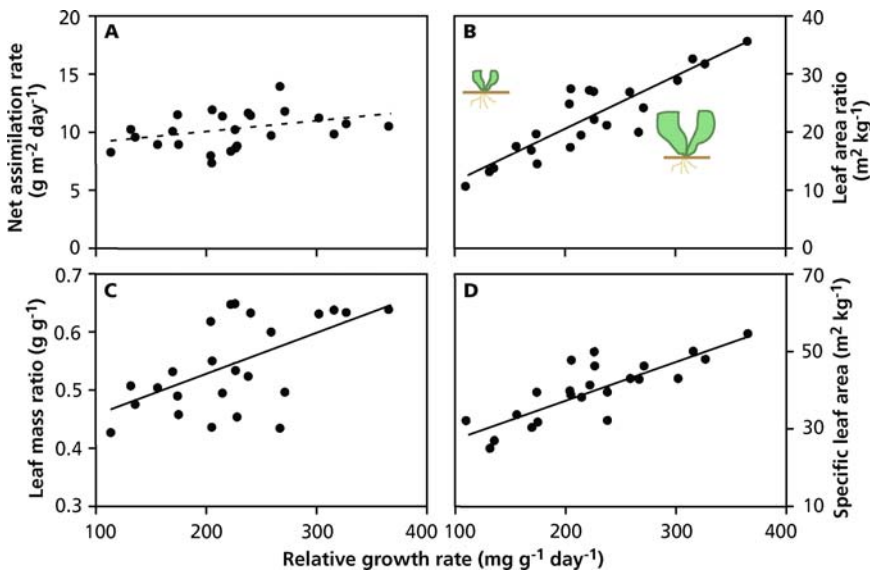

FIGURE 3. A comparison of the NAR, LAR, LMR, and SLA of 24 herbaceous C_3 species that differ in their RGR as determined on plants grown with free access to

nutrients. The *broken line* indicates a nonsignificant regression; *solid lines* indicate significant regressions (Poorter & Remkes 1990).

Fast-growing species allocate relatively less to their stems, both in terms of biomass and N, when compared with slower-growing ones. Similarly, high-yielding crop varieties generally have a low allocation to stems (Evans 1980). A high allocation to stem growth reflects a diversion of resources from growth to storage in slower-growing species (Sect. 4).

In broad comparison, **NAR** is often not correlated with RGR in dicots, whereas it is in monocots. The effect of variation in SLA on the RGR of monocots is invariably stronger than that in NAR. When pairs of annual and perennial grass species that belong to the same genus are compared, the highest RGR is invariably associated with the **annual life form**. Because annuals are thought to have descended from perennial ancestors, it has been suggested that the same morphological changes that enhance a genotype's RGR have occurred repeatedly in different genera (**convergent evolution**) and that a high RGR is the more recent development (Garnier 1992, Garnier & Vancaeyzeele 1994).

3.2 Leaf Thickness and Leaf Mass Density

Variation in **SLA**, or its inverse [leaf mass per unit leaf area (**LMA**, kg m^{-2})] must be due to variation in **leaf thickness** (m) or in **leaf mass density** (kg m^{-3}) (Witkowski & Lamont 1991):

$$\text{LMA} = (\text{leaf thickness}) \cdot (\text{leaf mass density}) \quad (7)$$

When **shade leaves** and **sun leaves** are compared, leaf thickness is a major parameter in determining variation in LMA, and it reflects increased **thickness of palisade parenchyma** in sun leaves (Sect. 3.2.2 of Chapter 2A on photosynthesis). In addition, comparing alpine species, which are characteristically exposed to high light, and congeneric lowland species, variation in LMA is associated with that in leaf thickness. In comparisons of closely related species from nutrient-poor and nutrient-rich sites, however, variation in LMA is due to differences in leaf mass density (Garnier & Laurent 1994, Van Arendonk & Poorter 1994). In addition, leaf mass density also accounts for a part of the variation in LMA between shade leaves and sun leaves, between widely contrasting woody species (Cornelissen et al. 1996), and especially when comparing congeneric lowland and alpine species (Atkin et al. 1996). Comparing 53 European woody species yields a strong, positive correlation of LMA with leaf mass density, but no correlation with leaf thickness; in fact leaf mass density and leaf thickness are negatively correlated (Fig. 4). In summary,

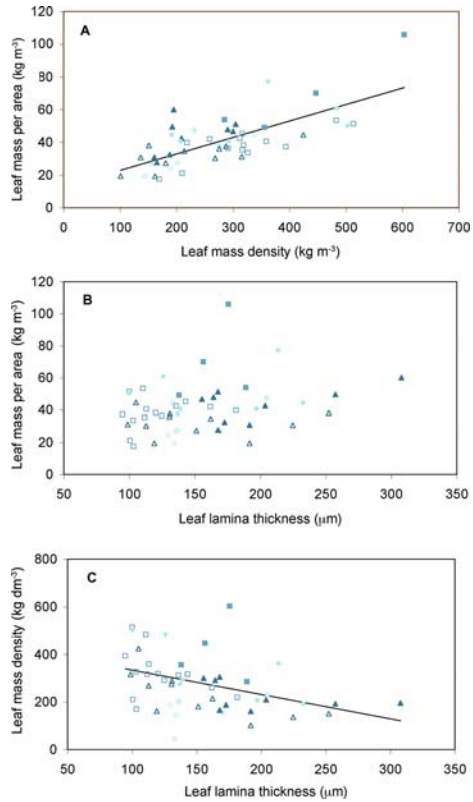

FIGURE 4. Regressions between leaf mass per area (LMA), lamina thickness, and leaf mass density. Graphs represent natural values of the variables, but regression coefficients were calculated using natural-logarithm transformations of leaf lamina thickness and leaf mass density; *open symbols* deciduous species, *closed symbols* evergreens, *squares* trees, *triangles* shrubs, *circles* subshrubs, *diamonds* climbers-scramblers (Castro-Diez et al. 2000).

differences in leaf mass density are generally the primary factor explaining differences in LMA (and its inverse: SLA), except in sun-shade comparisons, where number of cell layers (leaf thickness) is also important.

Fast-growing herbaceous species tend to have a lower tissue density in their roots as well as in their leaves (Wahl & Ryser 2000), but this pattern does not appear in woody species (Comas & Eissenstat 2004).

3.3 Anatomical and Chemical Differences Associated with Leaf Mass Density

The inherent variation in LMA and **leaf mass density** (Fig. 4) is associated with differences in both leaf

anatomy and **chemical composition** (Cunningham et al. 1999). Fast-growing species with a low LMA have relatively **large epidermal leaf cells**. Because these cells lack chloroplasts, which are a major component of the mass in the cytoplasm of mesophyll cells, they have a low density which contributes to the low leaf mass density of the fast-growing species. Slow-growing plants with a high LMA have **thicker cell walls** and contain more **sclerenchymatic cells**. These cells are small and characterized by very thick cell walls; therefore, they have a high mass density. Associated with these and other anatomical differences, the leaves of slow-growing species have more **lignin** and **cell-wall components** per unit leaf mass or area (Van Arendonk & Poorter 1994).

3.4 Net Assimilation Rate, Photosynthesis, and Respiration

As explained in Sect. 2.1.1, the **net assimilation rate (NAR)** is related to the balance of carbon gain in **photosynthesis** and carbon use in whole-plant **respiration**. Variation in NAR may, therefore, be due to variation in photosynthesis, respiration, or a combination of the two. In a broad comparison of herbaceous species (Fig. 3), there is no clear trend of NAR with RGR. Rate of photosynthesis per unit leaf area also shows no correlation with RGR (Fig. 5). **Slow-growing species**, however, use relatively more of their carbon for **respiration**, especially in their roots (Fig. 5), whereas **fast-growing species** invest a relatively greater proportion of assimilated carbon in **new growth**,

especially **leaf growth**. Next to the variation in LAR (SLA and LMR), this difference in the amount of carbon required for respiration is the second-most important factor that is associated with inherent variation in RGR.

If widely different **tree species** are compared, rates of **photosynthesis** per unit leaf area are higher in **fast-growing pioneer species** than in **slower-growing climax species** (Evans 1989). SLA and allocation, however, also differ strikingly among these taxa. The lack of a correlation between photosynthesis and RGR among closely related taxa or among morphologically similar taxa (Fig. 3) indicates that these broad differences in photosynthetic rate are not a major cause of differences in RGR.

3.5 RGR and the Rate of Leaf Elongation and Leaf Appearance

The higher RGR and SLA of fast-growing grass species is associated with a more **rapid leaf elongation** (Fig. 6). The extent to which this difference in leaf expansion is associated with variation in cell-wall properties of the elongating cells is not known. Does cell-wall acidification or the removal of Ca from the cell walls play a role? Are the cells of rapidly elongating leaves more responsive to changes in pH or Ca? Does it reflect a difference in meristem size, as shown in Fig. 2? Answers to these basic questions provide rich opportunities for research to improve our basic understanding of plant growth. It is also apparent that in the fast-growing grass [*Holcus lanatus* (common velvet

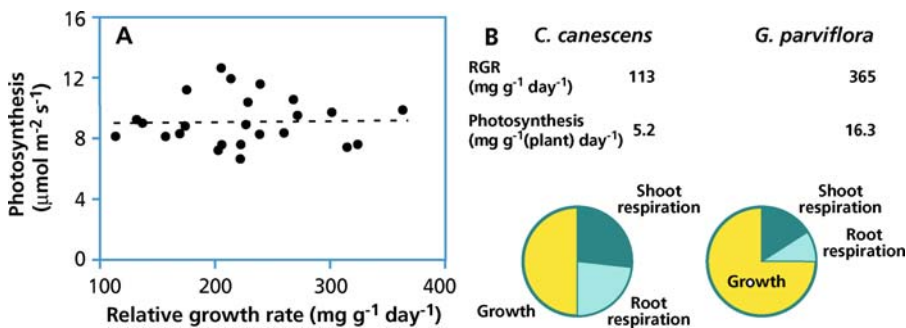

FIGURE 5. (A) The rate of photosynthesis per unit leaf area in fast- and slow-growing herbaceous species (after Poorter et al. 1990; copyright American Society of Plant Biologists). (B) The carbon budget of a slow-growing species [*Corynephorus canescens*

(grey hair-grass)] and a fast-growing species [*Galinsoga parviflora* (gallant soldier)]. RGR and daily gross CO₂ fixation of these species are also shown (Lambers & Poorter 2004; Copyright Elsevier Science Ltd.)

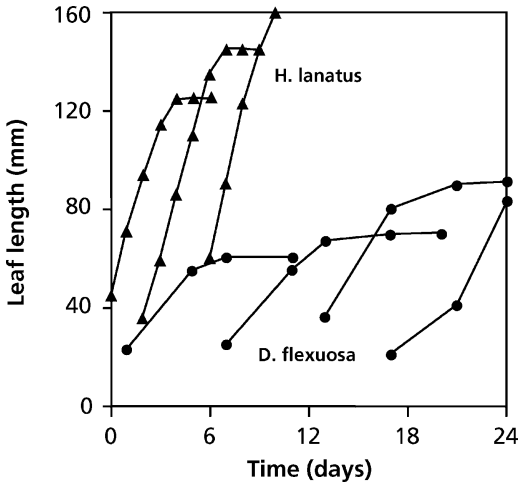

FIGURE 6. The rate of leaf elongation of a slow-growing grass species [*Deschampsia flexuosa* (tufted hair-grass), circles] and a fast-growing grass [*Holcus lanatus* (common velvet grass), triangles] (after Groeneveld & Bergkotte 1996). Copyright Blackwell Science Ltd.

grass]) the next leaf starts to grow just before the previous one has reached its final size. This typically contrasts with the pattern in slow-growing grasses [e.g., *Deschampsia flexuosa* (tufted hair-grass)], where the next leaf does not start elongating until well after the previous one has stopped (Fig. 6).

3.6 RGR and Activities per Unit Mass

The growth analysis discussed in Sect. 3.2 shows that SLA “explains” much more of the variation in RGR than do area-based measures of NAR and photosynthesis. This area-based measure is the most logical way to describe the environmental controls over capture of light and CO₂. **Economic analyses of plant growth** (the return on a given biomass investment in leaves or roots), however, more logically express resource capture (photosynthesis or nutrient uptake) per unit plant mass. This is achieved by multiplying the area-based measures of carbon gain by SLA, for example:

$$\text{NAR}_m = \text{NAR}_a \cdot \text{SLA} \quad (8)$$

Because of the strong correlation between SLA and RGR, RGR also has a strong positive correlation with NAR_m (Fig. 7A). The low NAR_m of slow-growing species in part reflects their high carbon requirement for root respiration (Fig. 5; Sect. 5.2.3 of Chapter 2B on plant respiration). Both the V_{max} for

NO₃⁻ uptake and the net rate of NO₃⁻ inflow show a strong correlation with RGR_{max} (Fig. 7B,C). This correlation is probably a result, rather than the cause of variation in growth rates (Sect. 2.2.3.2 of Chapter 6 on mineral nutrition; Touraine et al. 1994). The positive correlations between RGR_{max} and mass-based activity of both roots and leaves hold for monocots and dicots (Fig. 7A–C). By contrast, there is no correlation of RGR_{max} with biomass allocation to roots and leaves for monocotyledonous species (Fig. 7D), whereas RGR_{max} decreases with increasing biomass allocation to roots in dicotyledonous species (Fig. 7E).

These correlations result from **rapidly growing plants** producing leaves and roots with relatively large allocation to metabolically active components, rather than to cell walls and storage (Fig. 4). As a result, they have leaves with a high mass-based photosynthetic capacity and roots with a high mass-based capacity for N inflow. It is the balance of net mass-based carbon gain (leaf photosynthesis minus total plant respiration, NAR_m) and mass-based maximum rate of NO₃⁻ inflow (NIR_m) in combination with the pattern of root:leaf allocation (Fig. 7E,F) that accounts for differences in RGR_{max}. The limited data available suggest that NIR_m has a stronger correlation with RGR_{max} than does NAR_m. This is evident from the positive correlation between RGR_{max} and the ratio of mass-based specific ion uptake rate and mass-based net assimilation rate (Fig. 7D).

3.7 RGR and Suites of Plant Traits

Our analysis of the correlations of RGR_{max} with plant traits suggests that SLA is the key trait because it enables the plant to expose a large leaf area to light and CO₂ per given biomass invested in leaves. Certain other traits, however, also correlate positively with RGR_{max} (e.g., mass-based measures of photosynthesis and nutrient uptake), whereas some traits are negatively associated with RGR_{max} (e.g., leaf mass density due to support tissues and root respiration). These observations suggest that there is a **suite of plant traits** associated with rapid growth (high SLA, high mass-based rates of photosynthesis, and nutrient uptake), whereas other traits are typically associated with slow growth (greater investment in cell walls and fiber) (Lambers & Poorter 2004). These dichotomies suggest a **trade-off** between traits that promote rapid growth and those that promote persistence.

Due to their greater investment in carbon-rich compounds, such as lignin, and less accumulation of minerals, the carbon concentration of the slow-

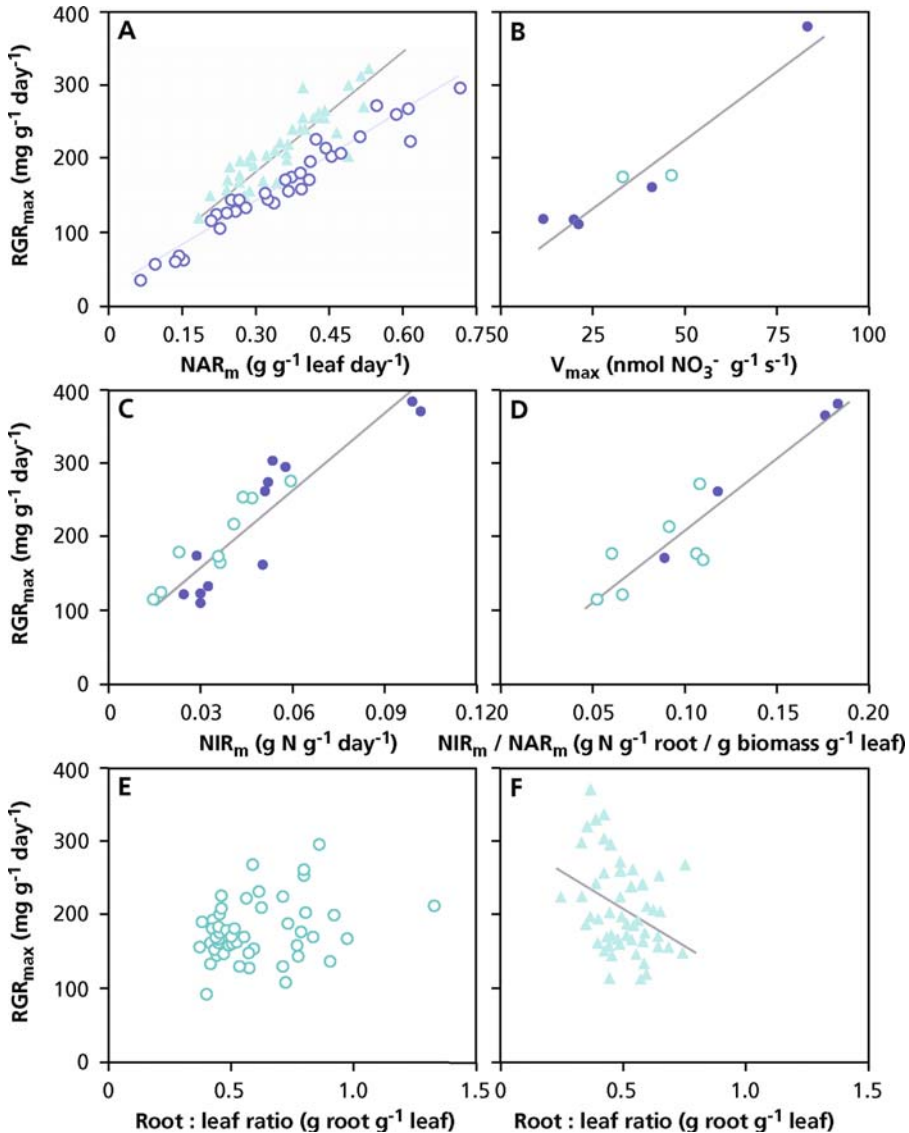

FIGURE 7. Correlation between maximum relative growth rate (RGR_{max}) and (A) mass-based net assimilation rate (NAR_m), (B) mass-based maximum rate of NO_3^- uptake (V_{max}), (C) mass-based specific NO_3^- inflow rate (NIR_m), (D) the ratio of NIR_m/NAR_m , and (E, F) the ratio of biomass allocation to roots and

leaves for 51 monocotyledonous (E) and 53 dicotyledonous (F) species. Each point represents a separate species of monocot (*open symbols*) or dicot (*closed symbols*) grown with free access to nutrients (redrawn after data synthesized by Garnier 1991).

growing species is higher than that of fast-growing ones. This is an additional, albeit minor, factor that contributes to their low growth potential. There may well be differences in exudation and volatilization, but their quantitative significance in explaining variation in RGR is generally small, except for species with cluster roots (Sect. 2.2.5.2 of Chapter 6 on mineral nutrition).

4. Allocation to Storage

Up to now in this chapter, we have only dealt with allocation of resources to structural components of the plant, during vegetative growth. Plants, however, also channel some of their resources to storage compartments, where the stored

resources are available for future growth. Plants store both carbon and nutrients, but there is a wide variation in the amount and kind of resources that are stored and in the organ where the storage predominantly takes place: leaves, stems, roots, or specialized storage organs. We will first discuss the concept of storage and its chemical nature and then describe differences in the role of storage in annuals, biennials, and perennials.

4.1 The Concept of Storage

We define **storage** as resources that build up in the plant and can be mobilized in the future to support biosynthesis (Chapin et al. 1990). There are three general categories of storage:

1. **Accumulation** is the increase in compounds that do not directly promote growth. Accumulation occurs when **resource acquisition** exceeds **demands** for growth and maintenance (Millard 1988).
2. **Reserve formation** involves the metabolically regulated synthesis of storage compounds that might otherwise directly promote growth. Reserve formation may compete for resources with growth and defense (Rappoport & Loomis 1985).
3. **Recycling** is the reutilization of compounds whose immediate physiological function contributes to growth or defense, but which can subsequently be broken down to support future growth (Chapin et al. 1990).

Accumulation, also termed "interim deposition" (Heilmeier & Monson 1994), accounts for much of the short-term fluctuations in chemical composition of plants [e.g., the daily fluctuation of starch in chloroplasts (Sect. 2.1.4 of Chapter 2A on photosynthesis) or of NO_3^- in vacuoles (Sect. 2.2 of Chapter 6 on mineral nutrition)]. Accumulation allows a relatively constant export rate of carbohydrates from source leaves throughout the 24-hour cycle, despite the obvious diurnal pattern of photosynthetic carbon gain (Fondy & Geiger 1985). Carbohydrate accumulation also occurs when conditions favor photosynthesis more than nutrient acquisition (Heilmeier & Monson 1994). This accounts for accumulation of starch during sunny weather and its depletion under cloudy conditions. On the other hand, N accumulation, also termed "luxury consumption", occurs after pulses of N

availability or when N supply exceeds the capacity of the plant to utilize N in growth. In a Mediterranean climate, nutrient uptake predominantly occurs in the wet season, whereas growth occurs later in the year (Mooney & Rundel 1979); this obviously requires nutrients to be stored. Although accumulation may explain many of the short-term changes in storage, it is less important over time scales of weeks to years. Over these longer time scales, capacities for photosynthesis and nutrient uptake adjust to plant demand, thus minimizing large long-term imbalance between carbon and nutrient stores.

Reserve formation diverts newly acquired carbon and nutrients from growth or respiration into storage. This can occur when rates of acquisition are high and vegetative growth is slow and during periods of rapid vegetative growth, often in competition with it. Grafting experiments clearly demonstrate this competition between storage and growth. For example, roots of sugar beet (*Beta vulgaris*), which allocate strongly to storage in a taproot, decrease shoot growth when grafted to shoots of a leafy variety of the same species (chard). On the other hand, chard roots, which have a small capacity for storage, cause grafted sugar beet shoots to grow larger than normal (Rappoport & Loomis 1985). Stored reserves make a plant less dependent on current photosynthesis or nutrient uptake from the soil and provide resources at times when growth demands are large, but when there are few leaves or roots present to acquire these resources, such as in early spring in cold climates. Stored reserves also enable plants to recover following catastrophic loss of leaves or roots to fire, herbivores, or other disturbances. Finally, stored reserves enable plants to shift rapidly from a vegetative to a reproductive mode, even at times of year when conditions are not favorable for resource acquisition.

Recycling of nutrients following **leaf senescence** allows reutilization of about half of the N and P originally contained in the leaf (Sect. 4 of Chapter 6 on mineral nutrition), but it is a relatively unimportant source of carbon for growth (Chapin et al. 1990). These stored nutrients are then a nutrient source for developing leaves. For example, in arctic and alpine plants 30–60% of the N and P requirement for new growth comes from retranslocated nutrients. Reserve formation and recycling allow plants to achieve rapid growth following snowmelt, despite low soil temperatures that may limit nutrient uptake from the soil (Chapin et al. 1986, Atkin 1996).

4.2 Chemical Forms of Stores

In Sect. 4.1 we demonstrated that there are several types of controls over carbon and nutrient stores (accumulation, reserve formation, and recycling). The chemistry and location of stored reserves, however, may be similar for each of these processes.

Carbohydrates are stored as **soluble sugars** (predominantly sucrose), **starch**, or **fructans** (polyfructosylsucrose) are only found in some taxa: Asterales, Poales, and Liliales. Storage of carbohydrates as sucrose [e.g., in the taproot of *Beta vulgaris* (sugar beet)] coincides with the accumulation of KCl in the apoplast, so that cell turgor is maintained, despite the accumulation of vast amounts of osmotic solutes inside the storage cells (Leigh & Tomos 1983). Stored carbohydrates in (tap)roots, e.g., of *Medicago sativa* (alfalfa) and *Lolium perenne* (perennial ryegrass), are predominantly used to support root respiration, rather than export to the shoot (Avice et al. 1996b, Schnyder & De Visser 1999). The capacity for storage depends on the presence of a specific organ, such as a stem, rhizome, tuber, bulb, or taproot. Thus, an important cost of storage is production of the storage structure, in addition to the stores themselves. In a comparison of 92 species (15 genera) of Ericaceae in a fire-dominated Australian habitat, species that regenerate from seeds (“**seeder species**”) have low starch levels in their roots (2 mg g⁻¹ dry mass) when compared with “**resprouter species**” (14 mg g⁻¹ dry mass), whereas no differences occur in their shoots (Bell et al. 1996). The rate of root respiration decreases greatly when the capacity to store carbohydrates in the taproot increases with increasing plant age (Steingröver 1981). This indicates that storage of carbohydrates does not invariably occur at the expense of vegetative growth, but may involve a decline in carbon expenditure in respiration.

N is stored as **NO₃⁻** (especially in petioles and shoot axes of fast-growing species), when plants are supplied with rather high levels of NO₃⁻ from soil. At a moderate or low N availability, N is stored as **amino acids** (often of a kind not found in proteins), **amides** (asparagine and glutamine), or **protein** (enzymes such as **Rubisco**, often special **vegetative storage proteins**) (Chapin et al. 1986, Heilmeyer & Monson 1994, Meuriot et al. 2004). Storage as protein involves the additional costs of protein synthesis, but has no effects on the cell's osmotic potential. In addition, proteins may serve a catalytic or structural function as well as being a store of N. Leaves contain

vast amounts of Rubisco, of which some may be inactivated and not contribute to photosynthesis (Sect. 4.2 of Chapter 6 on mineral nutrition). Rubisco is not a storage protein in a strict sense, but it is nonetheless available as a source of amino acids that are exported to other parts of the plant (Chapin et al. 1990). Storage of nitrogenous compounds is sometimes considered an indication of “luxury consumption”. This is misleading, however, because N-deficient plants also store some N, which they later use to support reproductive growth (Millard 1988).

P is stored as **inorganic phosphate** (orthophosphate or polyphosphate) as well as in **organic phosphate-containing compounds** (e.g., inositol phosphate) (Sect. 2.2.5.1 of Chapter 6 on mineral nutrition; Chapin et al. 1982, Hübel & Beck 1996). In vivo NMR (Sects. 2.5.2 and 4.1.3 of Chapter 2B on respiration) has been used to determine the P_i concentration in the cytoplasm and vacuoles of the root tips of *Pinus serotina* (pond pine). In P-starved plants, the P_i concentration is 0.75 mM, as compared with 1.5 mM in plants that are grown with abundant P. In the vacuoles of the root tips, on the other hand, the concentration drops from 3.4 mM to a level that is too low to determine (Ayling & Topa 1998). This shows that the vacuoles are the major storage site for P_i, and that the concentration of P_i in the cytoplasm is relatively constant over a wide range of P_i concentrations in the root environment (Lee et al. 1990).

4.3 Storage and Remobilization in Annuals

Annuals allocate relatively little of their acquired resources (carbon and nutrients) to storage which contributes to their high growth rate (Schulze & Chapin 1987). Annuals are generally short-lived, and the rapid formation of a large seed biomass ensures survival of the population and avoids periods of low resource supply.

During seed filling, carbohydrate reserves in stems are depleted, and the N invested in the photosynthetic apparatus is exported, after hydrolysis of the proteins to amino acids, which are exported via the phloem. The gradual breakdown and export of resources invested in leaves occurs during leaf **senescence**. This is a **controlled process** in plants, and it is rather different from the uncontrolled collapse with increase in age of animal cells. It ensures remobilization of resources previously invested in vegetative structures to developing reproductive

TABLE 2. Net export of N (mainly as amino acids and amides after protein hydrolysis) from senescing glumes, leaves, stem, and roots, and accumulation of the same amount in the grains of *Triticum aestivum* (wheat), between 9 and 15 days after flowering.

Plant part	Change in nitrogen content [$\mu\text{g (plant part)}^{-1} \text{ day}^{-1}$]
Glumes	-192
Leaves	-335
Stem	-193
Roots	-132
Total	-852
Grains	+850

Source: Simpson et al. (1983).

structures. Roots and some parts of the reproductive structures also show a net loss of N and a decrease in nutrient uptake during some stages of seed filling (Table 2).

In addition to the use of proteins that first function in the plant's primary metabolism during vegetative growth, *Glycine max* (soybean) also has specific **vegetative storage proteins**. These vacuolar glycoproteins accumulate abundantly in bundle sheath and associated mesophyll cells and in the upper epidermis of leaves (Staswick 1990). In hypocotyls, the storage proteins accumulate in epidermal and vascular tissues. As these organs mature, the storage proteins are hydrolyzed, and the amino acids are exported (Staswick 1988, 1990). In soybean, the amount of vegetative storage proteins and the level of mRNA encoding these depend on the N supply to the plants. Wounding, water deficit, blockage of export via the phloem, and exposure to jasmonic acid (a molecule signaling stress in plants; Sect. 4.3 of Chapter 9B on ecological biochemistry) all enhance the accumulation of the proteins in leaves of soybean (Staswick et al. 1991) and *Arabidopsis thaliana* (thale cress) (Berger et al. 1995).

4.4 The Storage Strategy of Biennials

Biennials represent a specialized life history that enables them to exploit habitats where resources are available intermittently and where a small change in these environmental conditions may tip the balance toward either annuals or perennials (Hart 1977). In their first year, biennials develop a storage organ, as do perennials. In their second year, they invest all available resources into reproduction, in a manner similar to annuals.

The storage organ contains both **carbohydrates** and N. Do the stored reserves of C or N add significantly to seed yield? In the biannual thistle, *Arctium tomentosum* (woolly burdock), the carbohydrates stored in the taproot are important to sustaining **root respiration**, but they contribute less than 0.5% to the formation of new leaves. Carbohydrate storage only primes the growth of the first leaves, after which the next leaves grow independently of stored carbon. Of all the N invested into growth of new leaves, however, about half originates from the N that is remobilized from the storage root. The N stored in roots contributes 20% to the total N requirement during the second season. Under shaded conditions, this fraction is as high as 30%. Seed yield is most significantly correlated with total plant N content early in the second year. In shaded plants, the amount of N in the seeds is very similar to the amount stored after the first year, whereas in plants grown at normal levels of irradiance the amount of N in the seeds is about twice that which was stored (Fig. 8).

4.5 Storage in Perennials

Perennials have a large capacity for storage of both nutrients and carbohydrates which reduces their growth potential in the early vegetative stage (Rosnitschek-Schimmel 1983). Once storage of resources has been achieved, however, it enables these plants to start growth early in a seasonal climate and to survive conditions that are unfavorable for CO₂ assimilation or nutrient absorption. The stored products allow rapid leaf development when annuals depend on recently acquired carbon and nutrients (Bausenwein et al. 2001).

In the tundra sedge, *Eriophorum vaginatum* (cotton grass), amino-acid N and organic P reserves vary nearly fourfold during the growing season and provide all the nutrients required to support leaf growth in early summer, when the arctic soil is largely frozen (Chapin et al. 1986). Plants whose roots are experimentally isolated from the soil are able to grow just as rapidly as plants rooted in soil for an entire growing season, based on stored nutrient reserves (Jonasson & Chapin 1985).

As in the annual *Glycine max* (soybean) (Sect. 4.1), some perennial herbaceous species also accumulate specific **storage proteins** [e.g., in the taproots of *Taraxacum officinale* (dandelion) and *Cichorium intybus* (chicory) (Cyr & Bewley 1990)]. Accumulation of vegetative storage proteins in

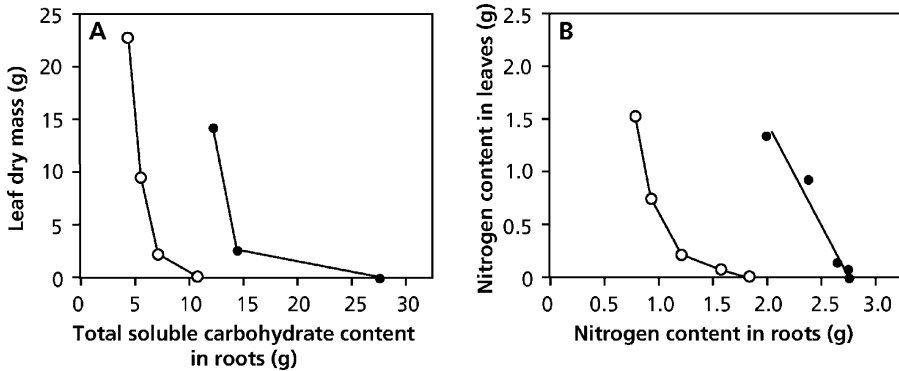

FIGURE 8. The relation between (A) the decrease with time of the content of total soluble carbohydrates in the taproot and the increase with time of leaf dry mass and (B) the decrease with time of the N content of the taproot and the increase with time of the N content of the leaves, at the beginning of the second season in

the biennial herbaceous thistle, *Arctium tomentosum* (woolly burdock). *Filled circles* refer to control plants, grown under natural light in the field, and *open circles* to plants growing in shade, 20% of the irradiance of control plants (Heilmeier et al. 1986).

stolons of *Trifolium repens* (white clover) during autumn and winter is encoded by a cold-induced gene (Goulas et al. 2007). Storage proteins have the advantage over amino acids and amides as storage products in that they allow storage at a lower cellular water content and thereby reduce the danger of freezing damage. Upon defoliation, the storage proteins are remobilized during regrowth of the foliage [e.g., in the taproot of *Medicago sativa* (alfalfa)] where they constitute approximately 28% of the soluble protein pool. Several weeks after defoliation, the storage proteins may again comprise more than 30% of the soluble protein pool (Avicé et al. 1996a).

Storage proteins also occur in woody plants, especially in structural roots, bark, and wood tissue of trees, where they may constitute 25–30% of the total extractable proteins. In *Populus canadensis* (Canada poplar), **storage glycoproteins** accumulate in protein bodies in ray parenchyma cells of the wood in autumn and

disappear again in spring (Sauter & Cleve 1990). In *Populus trichocarpa* (black cottonwood) the synthesis of storage proteins is induced by exposure to short-day conditions (Fig. 9), most likely under the control of **phytochrome** (Coleman et al. 1992).

The persistence of grassland species such as *Lolium perenne* (perennial ryegrass) greatly depends on their capacity to grow after cutting or grazing. After defoliation, the carbohydrate reserves in the stubble (mainly fructans) are rapidly depleted during regrowth. The carbohydrate content of the roots also declines after defoliation, but the roots remain a net sink for carbon, even immediately after defoliation. Morvan-Bertrand et al. (1999) showed that after a regrowth period of 28 days, 45% of all carbon fixed before defoliation is still present in the root and leaf tissue, and only 1% is incorporated in entirely new tissue, demonstrating the importance of recently fixed carbon for regrowth.

FIGURE 9. The effect of exposure to short days (8-hour light) following growth under long-day conditions (16-hour light) on the protein concentration in bark (*triangles*) and leaves (*filled circles*) and on the NO₃⁻ concentration (*open circles*) in leaves of *Populus trichocarpa* (black cottonwood). The plants were grown in a full nutrient solution in a growth chamber under a temperature regime of 22°C during the day and 18°C at night, both before and after exposure to short days (after Langheinrich & Tischner 1991). Copyright American Society of Plant Biologists.

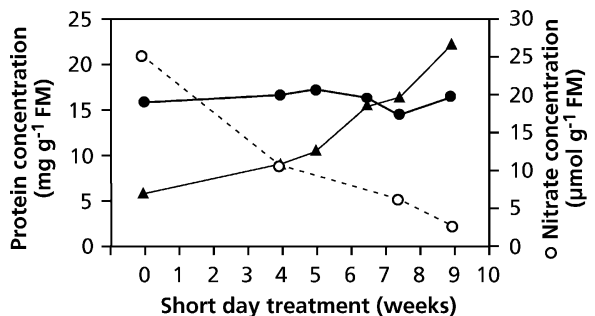

4.6 Costs of Growth and Storage: Optimization

Costs of storage include **direct costs** for **translocation** of storage compounds to and from storage sites, **chemical conversions** to specific storage compounds, and **construction of special cells, tissues, or organs** for storage as well as their protection. There are also **opportunity costs** (i.e., diminished growth as a result of diverting metabolites from resources that might have been used for structural growth) (Bloom et al. 1985). The construction of storage cells and tissue does not necessarily occur at the same time as the accumulation of the stored products which makes it difficult to assess whether vegetative growth and storage are competing processes. If the storage compounds are derived from recycling of leaf proteins (e.g., Rubisco), which functioned in metabolism during the growing season, then storage does not compete with vegetative growth. Use of accumulated stores similarly does not compete with growth and has negligible opportunity cost. If carbohydrates accumulate during the period of most vigorous vegetative growth, particularly when plants are light-limited, then there is no competition between storage and vegetative growth (Heilmeyer & Monson 1994).

5. Environmental Influences

In earlier sections we discussed the causes of inherent differences among species in growth rate under favorable conditions. Natural conditions, however, are seldom optimal for plant growth, so it is critical to understand the patterns and mechanisms by which growth responds to variation in environmental factors, including water and nutrient supply, irradiance, oxygen availability, and temperature. Plants may acclimate to different environmental conditions, or they may differ genetically in their programmed response to the environment. Aspects of both acclimation and adaptation are discussed in this section.

Plants generally respond to suboptimal conditions through reductions in growth rate and changes in allocation to minimize the limitation of growth by any single factor. Arguments based on economic analogies suggest that plants can minimize the cost of growth (and therefore maximize growth rate) if allocation is adjusted such that all resources are equally limiting to growth (Bloom et al. 1985). Thus, we might expect greater allocation to leaves when light strongly limits growth and greater

allocation to roots in response to water or nutrient limitation (Brouwer 1963). The net result of these adjustments, through both adaptation and acclimation, should be a functional balance between the activity of roots and shoots in which below-ground resources are acquired in approximate balance with above-ground resources (Garnier 1991):

$$\text{root mass} \cdot \text{NIR}_m = k \cdot \text{leaf mass} \cdot \text{NAR}_m \quad (9)$$

where NIR_m is the net inflow of N per unit root mass; NAR_m is the net assimilation rate, which is now expressed per unit leaf mass rather than leaf area; and k is the concentration of N; instead of N, the net inflow and concentration of other nutrients can be used in this equation. The accumulation of nutrients under conditions of carbon limitation and of carbohydrates under conditions of nutrient or water limitation (Sect. 4) shows that plants never achieve perfect functional balance.

Growth is arguably the most important process to understand in predicting plant **responses to environment**, and we therefore need to understand the **basic mechanisms** by which growth responds to environment. Does growth decline in direct response to reductions in resource supply and acquisition or does the plant anticipate and respond to specific signals before any single resource becomes overwhelmingly limiting to all physiological processes? In other words, is growth **source-controlled** or do specific signals modulate sink activity (growth), which then governs rates of resource acquisition (**feedforward control**)? For example, if growth responds directly to reduced source strength, low availability of light or CO_2 would act primarily on photosynthesis which would reduce the carbon supply for growth; similarly, water or N shortage would restrict acquisition of these resources such that water potential or N supply would directly determine growth rate. On the other hand, if unfavorable environmental conditions are sensed and trigger signals that reduce growth rate directly, this would lead to a feedforward response that would reduce rates of acquisition of nonlimiting resources before the plant experiences severe resource imbalance.

Unfavorable environmental conditions tend to reduce growth. For example, unfavorable conditions below ground often trigger changes in the balance among abscisic acid, cytokinins, and gibberellins which lead to changes in growth rate that precede any direct detrimental effects of these changes in environment. This **feedforward response** minimizes the physiological impact of the unfavorable environment on plant growth. In

the following sections, we describe the evidence for the relative importance of direct environmental effects on resource acquisition (source control) vs. those mediated by feedforward responses. Current computer simulation models of plant growth in agriculture and ecology assume that source control is the major mechanism of plant response to environment. If this is incorrect, it is important to know whether the feedforward responses of plants lead to qualitatively different predictions of how plants respond to their environment.

5.1 Growth as Affected by Irradiance

Light is one of the most important environmental factors, providing plants with both a source of energy and **informational signals** that control their growth and development. Plants contain an array of **photoreceptors** that track almost all parameters of incoming light signals, including presence, absence, colors, intensity, direction, and duration. These effects of light are the topics of this section, whereas effects of UV radiation are discussed in Sect. 2.2 of Chapter 4B on effects of radiation and temperature. Effects of daylength (photoperiod) on flowering are treated in Sect. 3.3.1 of Chapter 7 on life cycles. N allocation to different leaves as dependent on incident irradiance is discussed in Sect. 5.4.6, after discussing the involvement of cytokinins in N allocation (Sect. 5.4.4).

5.1.1 Growth in Shade

Shade caused by a leaf canopy reduces the irradiance predominantly in the photosynthetically active region of the spectrum (400–700 nm), causing a shift in both the quantity and the spectral composition of light (Box 7.2).

5.1.1.1 Effects on Growth Rate, Net Assimilation Rate, and Specific Leaf Area

Plants that grow in a shady environment invest relatively more of the products of photosynthesis and other resources in leaf area: they have a **high LAR**. Their leaves are relatively thin: they have a **high SLA** (Sect. 3.2.2 of Chapter 2A on photosynthesis) and **low leaf mass density**. This is associated with relatively few, small **palisade mesophyll** cells per unit area. The leaves have a high **chlorophyll concentration** per unit fresh mass which results in a rather similar chlorophyll concentration per unit leaf area as that in sun leaves, but relatively

less protein per unit chlorophyll (Sect. 3.2.3 of Chapter 2A on photosynthesis).

Trees, e.g., ecotypes of *Fagus crenata* (Japanese beech), produce sun leaves with thick palisade tissue comprising two cell layers. The number of cell layers in the palisade tissue is determined in the **winter buds**, by early winter of the year prior to leaf unfolding. When sun-exposed branches with young expanding leaves are shaded, the resultant leaves show intermediate characteristics: they have palisade tissue with two cell layers but the height of the palisade tissue is lower than that in the fully exposed sun leaves (Terashima et al. 2006). This suggests that several different signals are used for the determination of characteristics of sun leaves. When plants of the annual herb *Chenopodium album* (lambsquarters) are shaded in various ways, the developing leaves, irrespective of their own light environments, form palisade tissue with two cell layers if mature leaves are exposed to high light. On the other hand, when mature leaves are shaded, palisade tissue with one cell layer is formed. These results show that the light environment of mature leaves determines the number of cell layers in the palisade tissue of new leaves and suggest a signal-transduction system that conveys a signal from the mature leaves to the developing leaves (Yano & Terashima 2001). The signal from the mature leaves regulates the direction of cell division. In the future sun leaves, the signal probably induces periclinal division in addition to anticlinal division, while the signal from the shaded mature leaves only allows the cells to divide anticlinally (Yano & Terashima 2004). This signal might be the abundance of photosynthates (Terashima et al. 2006).

Table 3 summarizes the results of morphological acclimation and adaptation to a low irradiance. The RGR of the **shade-tolerant** *Dactylis glomerata* (cocksfoot) is reduced less by growth in shade as compared with full sun, when compared with *Dactylis polygama* (slender cocksfoot), which is a **shade-avoiding** species. This is due to a stronger increase of the LAR in the shade in *Dactylis polygama*, which is due to a large increase in SLA and a small increase in LMR (the various abbreviations used in growth analysis are explained in Table 1 and Sect. 2.1). The regulation of the increase in LAR may involve signaling as discussed in this section for *Chenopodium album*; it serves to capture more of the growth-limiting resource in the shade. Table 3 also shows trade-offs between resource allocation to leaves and roots. The overall patterns indicate that changes in allocation and leaf morphology in response to shade maximize capture of the growth-limiting resource (light), and

TABLE 3. Effects of the irradiance level on growth parameters of a sun-adapted species, *Dactylis glomerata* (cocksfoot), and a shade-adapted species, *Dactylis polygama* (slender cocksfoot). Daily irradiances (100% values) were full sunlight for both species

Growth parameter	Relative irradiance level			
	100	30	20	5.5
Relative growth rate ($\text{mg g}^{-1} \text{day}^{-1}$)				
<i>Dactylis glomerata</i>	98	88	88	56
<i>Dactylis polygama</i>	98	88	100	29
Net assimilation rate ($\text{g m}^{-2} \text{day}^{-1}$)				
<i>Dactylis glomerata</i>	13.2	5	6.9	1.5
<i>Dactylis polygama</i>	8.8	5.9	5.9	0.7
Leaf area ratio ($\text{m}^2 \text{kg}^{-1}$ dry mass)				
<i>Dactylis glomerata</i>	4	11.7	12.7	38.0
<i>Dactylis polygama</i>	11.2	15.0	10	38.5
Specific leaf area ($\text{m}^2 \text{kg}^{-1}$ dry mass)				
<i>Dactylis glomerata</i>	28.5	36.4	33.7	66.6
<i>Dactylis polygama</i>	31.7	36.4	40.4	74.9
Leaf mass ratio (g g^{-1})				
<i>Dactylis glomerata</i>	0.26	0.34	0.37	0.57
<i>Dactylis polygama</i>	0.36	0.41	0.42	0.52
Leaf mass density ($\text{kg dry mass m}^{-3}$)				
<i>Dactylis glomerata</i>	217	217	217	142
<i>Dactylis polygama</i>	247	248	244	155
Root length ratio (m g^{-1} dry mass)				
<i>Dactylis glomerata</i>	141	105	102	59
<i>Dactylis polygama</i>	110	92	88	96
Specific root length (m g^{-1} dry mass)				
<i>Dactylis glomerata</i>	287	282	303	416
<i>Dactylis polygama</i>	278	277	279	407

Source: Ryser & Eek (2000).

that this shade acclimation is more extreme in shade-adapted species (Fig. 10).

At a very low irradiance, such as under a dense canopy, many shade-avoiding plants do not survive, even though they may exhibit a positive RGR in short-term growth experiments (Table 3). Thus, there must be additional factors that account for the distribution of sun-adapted and shade-adapted species. First, **leaf longevity** appears to be important. Shade-tolerant species tend to keep their leaves for a longer time and so increase the potential photosynthetic return (Reich et al. 1991, 1992a,b). When grown in shade, fast-growing tropical trees show a higher LAR and lower RMR, as well as a greater mortality than do slower-growing ones (Kitajima 1994). Shade-tolerant plants also minimize leaf loss through their greater allocation to chemical defenses against pathogens and herbivores than in shade-avoiding species (Chapter 9B on ecological biochemistry). In addition, the enhanced rate of stem

elongation (Sect. 5.1.1.3) may weaken the shade-avoiding plants.

5.1.1.2 Adaptations to Shade

In addition to **acclimation** to a specific light environment, there are also specific **adaptations**. That is, there are species with a genetic constitution that restricts their distribution to an environment with a specific light climate. To put it simply, three “plant strategies” are discerned:

1. Plants avoiding shade, or obligate sun plants
2. Plants tolerating shade, or facultative sun or shade plants
3. Plants requiring shade, or obligate shade plants

Many weedy species and most crop species are **obligate sun species**. **Obligate shade plants** include some mosses, ferns, club mosses, and a few higher plant species in tropical rainforests

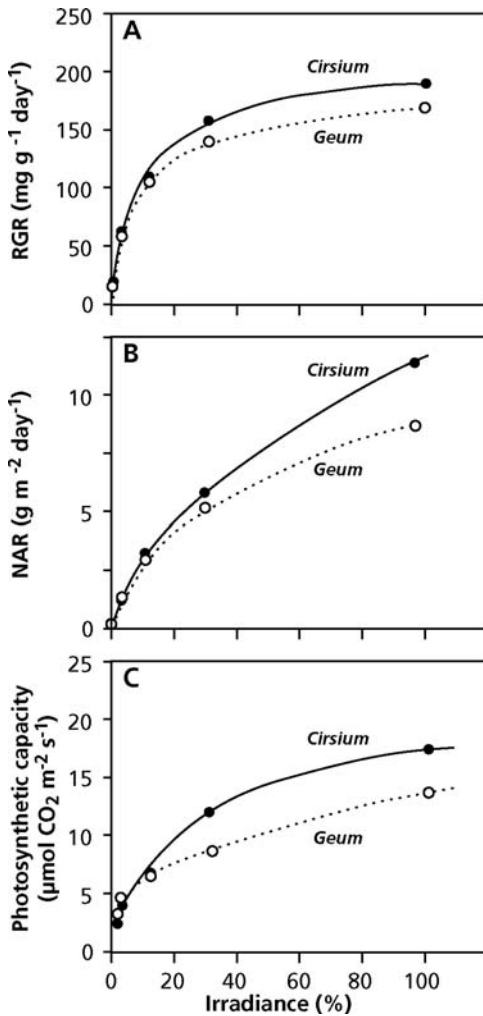

FIGURE 10. The relative growth rate (RGR), net assimilation rate (NAR), and photosynthetic capacity of the shade-avoiding *Cirsium palustre* (marsh thistle) and the shade-tolerant *Geum urbanum* (avens), grown at a range of light intensities. Full daylight is 100% (after Pons 1977).

(e.g., young individuals of *Monstera* and *Philodendron* species). Among higher plants, obligate shade species are rare in temperate regions and will not be discussed here. Most understory species are **facultative** rather than obligate shade plants.

5.1.1.3 Stem and Petiole Elongation: The Search for Light

Stem and petiole elongation of shade-avoiding plants growing in the shade are greatly enhanced, branching is reduced (increased apical dominance),

total leaf area and **leaf thickness** are less, and **SLA** is increased. The effects of leaf canopy shade can be separated into those due to **reduced irradiance** and those affected by the **red/far-red ratio**.

Plants that tolerate shade do not respond with increased stem elongation; instead, they increase their leaf area. Their leaf thickness is reduced to a smaller extent than it is in shade-avoiding species, and their chlorophyll concentration per unit leaf area often increases. The increased chlorophyll concentration gives these plants [e.g., *Hedera* spp. (ivy) and species from the understory of tropical rain forests] their dark-green color. Less extreme shade-tolerant species [e.g., *Geum urbanum* (avens)] also enhance their chlorophyll concentration per unit fresh mass. Because their SLA is increased at the same time, however, the chlorophyll concentration per unit area is not enhanced (sometimes even less), and they do not appear dark-green.

The **red/far-red ratio** (R/FR) is the ratio of the irradiance at 655–665 nm and that at 725–735 nm. Comparison of a number of species from open habitats [e.g., *Chamaenerion angustifolium* (fireweed), *Sinapis alba* (white mustard), *Senecio vulgaris* (groundsel)], from intermediate habitats [*Urtica dioica* (stinging nettle)], and from closed habitats (shade in forest understory) [*Geum urbanum* (avens), *Oxalis acetosella* (soursop), *Silene dioica* (red campion)] shows that the stem elongation of sun-adapted species responds much more strongly to R/FR than does that of shade species. The effect of a change in R/FR on stem elongation can be recorded within 10–15 min, e.g., in *Sinapis alba* (white mustard) (Fig. 11).

5.1.1.4 The Role of Phytochrome

Perception of R/FR involves the **phytochrome** system (Box 7.2 and Sect. 2.2.2). In *Vigna sinensis* (cowpea) the response of **stem elongation** to R/FR is similar to that of **gibberellins** (GAs). In fact, inhibition of stem elongation by light is associated with a decrease in tissue responsiveness to GAs (Olszewski et al. 2002). *Arabidopsis thaliana* (thale cress) plants that have mutations affecting GA-and/or phytochrome action show that a fully functional GA system is necessary for full expression of the phytochrome response (Peng & Harberd 1997). The phytochrome responses clearly demonstrate that many of the light responses of shade plants are hormonally mediated (sink-controlled) rather than direct responses to irradiance level.

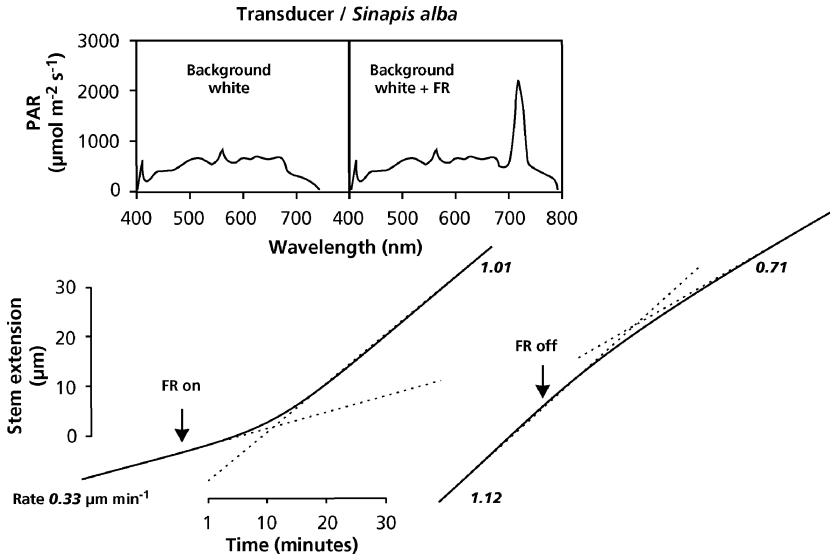

FIGURE 11. Continuous measurements of stem extension rate by a position-sensitive transducer. A seedling attached to the transducer and exposed to background white fluorescent light was given far-red (FR) light via a fiberoptic probe. The FR source was switched on and off as indicated. *Solid lines* show the observed stem

extension, and the *dotted lines* show the best-fit initial and final extension rates, the values of which are presented next to the lines. The *insets* show the spectral composition of the irradiance of the background white light with and without FR (data of D.C. Morgan, as presented in Smith 1981).

5.1.1.5 Phytochrome and Cryptochrome: Effects on Cell-Wall Elasticity Parameters

Both red light and **blue light** inhibit stem elongation. A blue photoreceptor (**cryptochrome**) is involved in the perception of blue light. Both red light and blue light affect cell-wall properties rather than the osmotic or turgor potential of the cells (Table 4). As explained in Sect. 2.2, stem elongation is the result of cell expansion ($dV/V \cdot t$), which is related to the cell-wall yield coefficient, the turgor pressure, and the yield threshold. Red light inhibits elongation mainly by lowering the **cell-wall yield coefficient** (ϕ), whereas blue light predominantly acts by enhancing the **yield threshold** (γ) (Table 4). This indicates

that shade affects growth through **feedforward responses** rather than through direct supply of photosynthate.

5.1.1.6 Effects of Total Level of Irradiance

The total level of irradiance is the major factor that determines the LAR and SLA of shade-avoiding species, but the spectral composition of the irradiance also has an effect in some species. Shade-avoiding species respond to the spectral composition in the shade primarily with enhanced stem elongation, at the expense of their leaf mass ratio. Shade-tolerant species tend to invest relatively more resources in

TABLE 4. Effects of darkness, red light, and blue light on in vivo cell wall properties of stems of etiolated pea (*Pisum sativum*) seedlings. *

	Dark	Red light	Blue light
Elongation rate ($\mu\text{m m}^{-1} \text{s}^{-1}$)	9.2	3.3	3.0
Turgor potential (MPa)	0.53	0.59	0.58
Osmotic potential (MPa)	0.84	0.82	0.83
Yield threshold, γ (MPa)	0.05	0.16	0.33
Yield coefficient, ϕ ($\text{Pa}^{-1} \text{s}^{-1}$)	19.1	8	15.6

Source: Kigel & Cosgrove (1991).

* In darkness the P_{fr} configuration of phytochrome reverts to the P_r configuration.

their leaves when exposed to shade, primarily as a response to the level of irradiance (Smith 1981).

These responses to the level of irradiance are most likely mediated through **sugar-sensing systems** (Sects. 4.3 and 12.1 of Chapter 2A on photosynthesis and Sect. 4.4 of Chapter 2B on plant respiration).

5.1.2 Effects of the Photoperiod

The length of the photoperiod affects the flowering response of long-day and short-day plants (Sect. 3.3.1 of Chapter 8 on life cycles), tuber formation [e.g., in *Solanum tuberosum* (potato)], as well as aspects of vegetative plant development that are not directly related to reproduction. These effects are mediated by the **phytochrome** system and differ from those that result from changes in the total level of irradiance received by the plants. It is interesting that a leaf from a tobacco plant (*Nicotiana tabacum*) that is induced to flower induces a potato plant (*Solanum tuberosum*) to tuberize when the tobacco leaf is grafted on the potato plant. Antisense phytochrome B potato plants have provided evidence for the role of phytochrome B (Box 7.2) in tuberization (Jackson et al. 1998).

For temperate species, the length of the photoperiod is an important signal for acclimation to low temperatures (cold hardening), especially in woody species (Sect. 3.5 of Chapter 4B on effects of radiation and temperature). In a Norwegian ecotype of *Dactylis glomerata* (cocksfoot) dry matter production is enhanced under long days at low temperature, compared with short days at the same low temperature (Fig. 12). In a Portuguese ecotype at higher temperatures, photoperiod has little effect. The greater production at a low temperature and long days in the Norwegian ecotype reflects a higher RGR, because of a higher SLA. The net assimilation rate is reduced in long days, at all temperatures and in both ecotypes (Fig. 12). Leaves tend to be thinner in long days and their cells are longer. It is common for populations of a species from different latitudes to differ in their photoperiodic cues, indicating that changes in photoperiodic requirement are a relatively easy evolutionary adjustment that is differentially selected at different latitudes.

Increased levels of endogenous **gibberellins**, possibly in combination with an enhanced sensitivity to these hormones, are involved in the growth response of *Poa pratensis* (Kentucky bluegrass) to

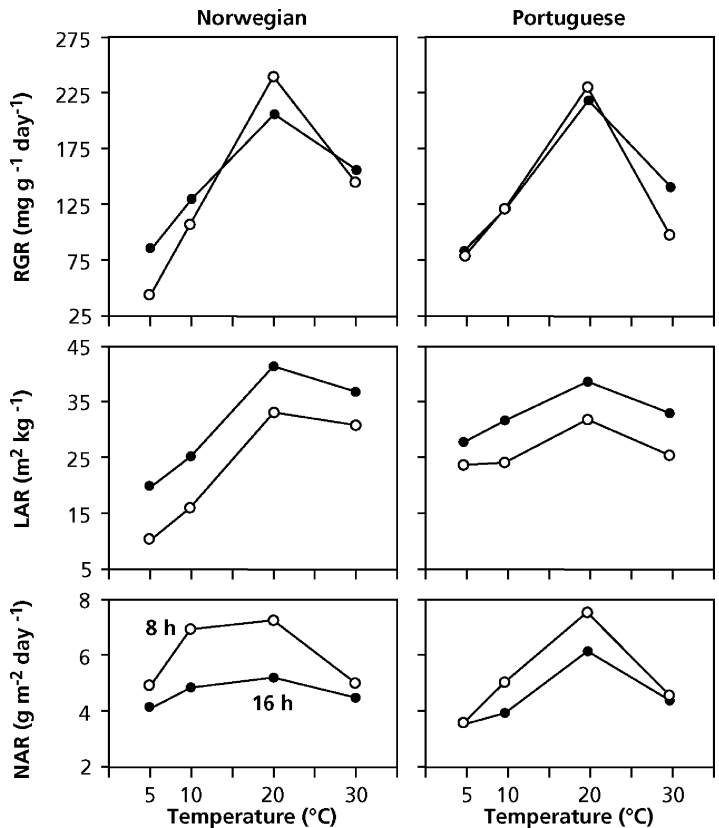

FIGURE 12. Results of a growth analysis of seedlings of *Dactylis glomerata* (cocksfoot) from two different origins at four temperatures and two daylengths (Eagles 1971, as cited in Hay 1990). Copyright Trustees of The New Phytologist.

long days (Juntilla et al. 1997). The photoperiod also affects the plant's chemical composition, again independent of the total level of irradiance received by the plant. The percentage of total N in dry matter declines with increasing photoperiod, which is the likely cause for a decrease in NAR at long days (Fig. 12).

5.2 Growth as Affected by Temperature

Temperature affects a range of enzymatically catalyzed and membrane-associated processes in the plant and is a major factor affecting plant distribution. The **activation energy** of different reactions may differ widely. Growth, development, and allocation are affected in different ways in different species. Effects of temperature on plant development are commonly related to **degree days**, computed as the integral of a function of time that varies with temperature. The number of degree days accumulated over a period of time is often related to the phenological development of plants. Degree days are used to predict the date a flower will bloom or a crop will reach maturity (Leon et al. 2001).

The temperature optimum of root growth tends to be lower than that of the shoot. In spring, therefore, roots start growing before the leaves do. Temperature also affects the uptake of nutrients and water by the roots. The optimum temperature for root growth of plants from temperate regions is between 10 and 30°C, but growth may continue around 0°C. Subtropical species have a higher optimum temperature for root growth, and growth may cease below 10–15°C (Bowen 1991). In tropical species damage may occur at temperatures of 12°C or less. How exactly does a low temperature affect root and leaf growth and the pattern of allocation to roots and leaves? This is a highly relevant question, in view of the current rise in global temperature.

5.2.1 Effects of Low Temperature on Root Functioning

Exposure to a low temperature reduces **root extension**, without an effect on turgor in the elongation zone. In *Zea mays* (corn) the reduction in elongation rate is associated with a decrease in cell-wall extensibility, more specifically in the **cell-wall yield coefficient**. Reduced elongation may lead to an increased number of rather small cells, immediately behind the root tip. These resume expansion upon

exposure of the roots to a more favorable temperature (Pritchard 1994).

For a proper functioning of roots at low temperature, their membranes must remain fluid and semi-permeable. The **lipid composition** of the membranes in the roots affects membrane fluidity and interactions with membrane-bound proteins and, therefore, the transport of both ions and water. Cold-acclimated plants tend to have a higher degree of unsaturation of phospholipids, which causes their membranes to remain fluid at lower temperatures.

The major resistances for **water flow** in the roots are in the **exodermis**, if present, and the **endodermis**. At the exodermis or endodermis, water must enter the **symplast** before it can arrive in the xylem vessels. Water passes the membranes in a single file through specific water-channel proteins (**aquaporins**) (Sect. 5.2 of Chapter 3 on plant water relations). The effect of temperature on the rate of water uptake by roots, therefore, possibly reflects direct effects on these water-channel proteins and indirect effects on membrane fluidity.

The effects of temperature on the roots' capacity to absorb water largely account for temperature effects on plant growth. Increasing the root temperature of *Glycine max* (soybean) in the range that is suboptimal for growth, while maintaining a constant shoot temperature, increases the water potential of the whole plant (Kuo & Boersma 1971). It is likely that the effects of temperature on the relative investment of biomass in roots and leaves reflect the roots' capacity to take up water, at least in the range of temperatures around the optimum (Li et al. 1994). Capacity to take up water is, in turn, probably influenced by plant hormones (Sect. 5.3).

Does this imply that effects of temperature on the allocation pattern are accounted for by an effect of root temperature on the roots' capacity to transport water and that temperature effects on nutrient uptake are not a cause for changes in the allocation pattern? Current evidence does indeed support this contention. Whereas growth at a low root temperature does affect the rate of absorption of both NO_3^- and NH_4^+ , this appears to be a response to the decline in growth rate (Clarkson et al. 1992). That is, the decline in the rate of nutrient absorption at low root temperatures is, in part, a response to the decreased nutrient demand of the plant (Sect. 2.2.3.2 of Chapter 6 on mineral nutrition).

5.2.2 Changes in the Allocation Pattern

Variation in growth rate with temperature is associated with changes in plant carbon balance. A

positive carbon balance can be maintained at adverse temperatures by changes in the pattern of resource allocation to leaves and nonphotosynthetic plant parts. Acclimation to different temperatures, therefore, may affect the rate of photosynthesis per unit leaf area (Fig. 2A.25 in Chapter 2A on photosynthesis) or the plant's allocation pattern. In very general terms, the effect of temperature on biomass allocation in the vegetative stage is that the relative investment of biomass in roots is lowest at a certain optimum temperature, and that it increases at both higher and lower temperatures. This is found both when the temperature of the entire plant is varied and when only root temperature is changed (constant shoot temperature) (Bowen 1991).

It has been suggested that an increase in root temperature in the suboptimal range increases the demand for respiratory substrate in roots, which results in lower carbohydrate concentrations in the whole plant or in the shoots. These effects of root temperature on root respiration are often only transient, however, with values returning to control rates within a day (Sect. 4.5 of Chapter 2B on respiration).

Temperature strongly affects the uptake of both nutrients and water by the roots. Although **nutrient uptake** does depend on root temperature, at least in short-term experiments, it is unlikely that long-term temperature effects on biomass partitioning are due to effects on nutrient uptake. Upon prolonged exposure to low root temperature, the uptake system acclimates (Sect. 2.2.3.3 of Chapter 6 on mineral nutrition); there is compelling evidence that, at a low root temperature, **growth controls the rate of nutrient uptake**, rather than being controlled by it (Clarkson et al. 1988). Effects of root temperature, through the plant's water relations, are probably mediated by **ABA** (Sect. 5.3), but further evidence is needed to support this contention.

There are also indirect effects of temperature on nutrient availability, in that rates of mineralization decline at low temperatures (e.g., in arctic and alpine environments).

5.3 Growth as Affected by Soil Water Potential and Salinity

Many processes in the plant are far more sensitive to a low water potential than are stomatal conductance and photosynthesis (Sect. 5.2 of Chapter 2A on photosynthesis). The growth reduction at a low soil water potential is largely due to inhibition of more sensitive processes, such as **leaf cell elongation** and **protein synthesis**. At a low soil water potential, the

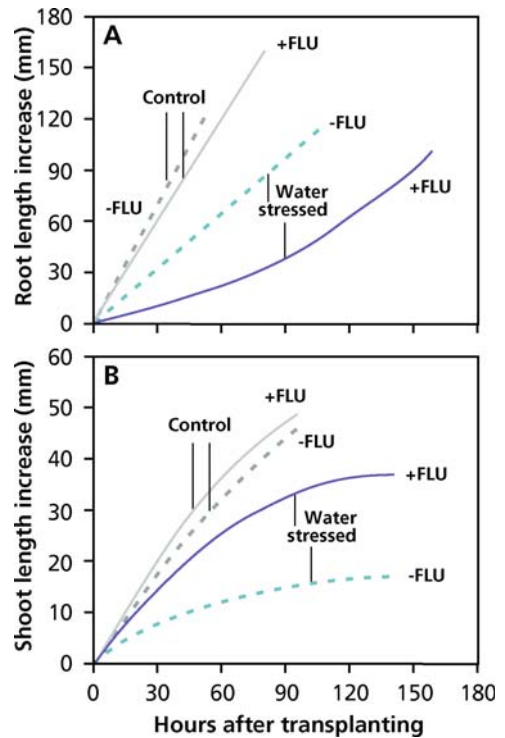

FIGURE 13. Elongation of the primary root and shoot of *Zea mays* (corn) seedlings that were well watered or grown at a low water potential. Also shown is the effect of fluridone, which is an inhibitor of the synthesis of ABA. (Top) Root growth of seedlings soaked in water for 36 hours and then transplanted to -1.6 MPa; (Bottom) shoot growth of seedlings soaked in water for 60 hours and then transplanted to -0.3 MPa (after Saab et al. 1990). Copyright American Society of Plant Biologists.

rate of leaf expansion decreases, whereas the rate of **root elongation** is much less affected (Fig. 13). In glycophytes [e.g., *Zea mays* (corn)] root elongation is inhibited by exposure to high concentrations of NaCl. This inhibition is not associated with a loss of turgor of the growing tip, but with an **increased yield threshold pressure** (Neumann et al. 1994).

Maintenance of root elongation at a low soil water potential may occur despite a (transient) decline in turgor of the root cells, suggesting that the yielding capacity of the elongating cells has increased due to an increase in the **amount and activity of expansins** in the root tip of plants grown at low soil water potential and an increase in the sensitivity of the cell wall to expansins (Wu et al. 1996).

Although it is tempting to think that the reduction in leaf expansion (Fig. 13) is due to a loss in turgor of the leaf cells, such a turgor loss usually

does not occur, and the reduction in leaf growth is due primarily to leaf cell-wall stiffening (Van Volkenburgh & Boyer 1985) in response to (**chemical signals**) arriving from the roots in contact with the drying soil (Davies & Zhang 1991). How do we know that chemical signals play a role?

5.3.1 Do Roots Sense Dry Soil and Then Send Signals to the Leaves?

To answer this question, Passioura (1988) used a pressure vessel placed around the roots of a *Triticum aestivum* (wheat) seedling growing in drying soil. As the soil dries, the hydrostatic pressure in the vessel is increased to maintain shoot water relations similar to those of well watered plants. The treated wheat plants show reductions in leaf growth similar to those of plants in drying soil without a pressure chamber. Additional evidence comes from experiments with small apple trees (*Malus × domestica*) with their roots growing in two separate containers, one with moist and one with dry soil. Soil drying in one container restricts leaf expansion and initiation, although the roots in the moist soil continue to maintain shoot water relations similar to those of control plants. Leaf growth recovers upon severing the roots in contact with the drying soil (Gowing et al. 1990). These effects on leaves of wheat seedlings and apple trees must therefore be attributed to effects of soil drying that do not require a change in shoot water status (Davies et al. 1994).

As with effects of soil drying on stomatal conductance (Sect. 5.1 of Chapter 2A on photosynthesis and Sect. 5.4.1 of Chapter 3 on plant water relations), **hydraulic and electric signals**, in addition to **chemical messengers** from the roots, possibly play a role in effects of drying soils on leaf growth (Dodd & Davies 1996, Dodd 2005). Thus, there are multiple signal-transduction pathways by which water shortage reduces plant growth.

5.3.2 ABA and Leaf Cell-Wall Stiffening

The effect of water stress on leaf elongation is mediated by the phytohormone abscisic acid (**ABA**) (Dodd 2005). Soil drying and salinity enhance the concentration of this hormone in the leaves (Tardieu et al. 1992, He & Cramer 1996). The **pH of the xylem sap** also affects leaf elongation, and this effect is, again, mediated via ABA (Bacon et al. 1998).

Above-ground plant parts respond more strongly to a decreased soil water potential than do roots. This is due to a greater **inhibition by ABA of leaf growth**, as compared with that of the roots (Saab et al. 1990),

at least during the initial phase of imposed water stress. At a later stage, ABA acts to maintain leaf growth, albeit at a slower rate than in well-watered plants (Sharp 2002). If, and to what extent, ABA is responsible for the decline in cell-wall acidification upon water stress (Van Volkenburgh & Boyer 1985) and acid-induced wall loosening (Cleland 1967) remains to be investigated (Munns & Sharp 1993). We do know that leaves tend to have stiffer walls when the plants are exposed to water stress (Chimenti & Hall 1994). The leaves also show higher endogenous ABA concentrations and reduced leaf growth. ABA most likely affects the growth of roots and leaves through its inhibitory effect on **ethylene biosynthesis** (Sharp 2002, Dodd 2005).

Salt-sensitive species respond more strongly, both in terms of ABA level and in leaf expansion, than do resistant species (He & Cramer 1996). ABA seems to harden the cell wall of leaf cells by increasing the yield threshold, Y , and decreasing wall extensibility, ϕ . Both the carbohydrate and the protein component of cell walls are affected (Munns & Cramer 1996).

5.3.3 Effects on Root Elongation

Roots that experience a moderate water stress may loosen their walls and increase their extension growth rate. **Wall loosening** is probably due to an increase in activity of **expansins** (Sect. 2.2.4; Cosgrove 2000). An increase in expansin proteins and wall-loosening capacity in the root apex in response to water stress is widespread and presumably an adaptation to growth in drying soils that allows exploitation of a falling water table. The size of the root meristem is also reduced under water stress, so fewer root cells contribute to the elongation process (Sharp et al. 2004). As in leaves, osmotic stress has no effect on the **turgor** of *Zea mays* (corn) root cells; however, it increases the **concentration of osmotic solutes** to the extent that the difference in cell water potential and that of the root environment is restored (Pritchard et al. 1996).

Lowering the water potential around the roots also enhances sugar transport to the roots, probably due to the growth reduction of the leaves. Because photosynthesis is less affected than leaf growth, sugar transport as well as root growth may be enhanced in both a relative and an absolute sense, at least in the early stages of the stress. The unresolved question remains, however: how does an increased concentration of sugars affect the growth of roots? This probably requires a sugar-sensing mechanism similar to the one discussed for leaves

where a specific hexokinase senses hexose levels and affects the repression of genes that encode photosynthetic enzymes (Sect. 4.3 of Chapter 2A on photosynthesis). Gene transcription in roots is indeed affected by sugar levels, as discussed for respiratory enzymes (Sect. 4.4 of Chapter 2B on plant respiration), but the search continues for genes that affect root elongation. We are still far from understanding the entire signal-transduction pathway from elevated sugar levels in roots cells on the one hand to stimulation of root elongation on the other. This is clearly a major challenge for molecular ecophysiologicals!

5.3.4 A Hypothetical Model That Accounts for Effects of Water Stress on Biomass Allocation

The effects of water stress on phytohormone production in the roots, leaf expansion, and root growth are summarized in Fig. 14. Whatever the exact signal-transduction pathway, the overall effect of inhibition of leaf area expansion while root elongation is inhibited less, or even stimulated, is that the LAR and/or the LMR decrease, and that the RMR increases in response to a decrease in soil water potential. The increased respiratory costs of such an increase in RMR may contribute to reduced growth of desiccated plants; they also reduce the dry mass gain per unit of water lost in transpiration (Van den Boogaard et al. 1996).

5.4 Growth at a Limiting Nutrient Supply

Plants allocate relatively less biomass to leaves and more to their roots when N or P is in short supply

(e.g., Brouwer 1963, 1983). Like the response to water stress (Sect. 5.3), the response to nutrient shortage is also functional. In both situations the investment in plant parts that acquire the limiting resource is favored, at the expense of allocation to plant parts that have a high requirement for the limiting resource. The opposite and equally functional response is found when plants are growing at a low irradiance (Sect. 5.1).

In this section we focus on the response to N shortage because the effect of N shortage on biomass allocation is stronger than that of other nutrients. P may have similar effects, possibly acting through an effect on N acquisition (Kuiper et al. 1989). This may also be the case for S, whereas the pattern is less clear for other nutrients. Leaf expansion rates are decreased at a low N supply (Gastal et al. 1992). Leaves of plants grown with a limiting N supply are smaller, compared with those of plants grown with an optimum nutrient supply, predominantly due to an effect on **meristem size** and **cell number** (Fig. 2B) (Terry 1970). How are the changes in biomass allocation pattern brought about?

5.4.1 Cycling of Nitrogen Between Roots and Leaves

NO_3^- can act as a signaling molecule that affects local root proliferation (Sect. 2.2.8 of Chapter 6 on mineral nutrition). NO_3^- probably also plays a signaling role in the control of biomass partitioning between roots and leaves (Scheible et al. 1997). Since plants respond to NH_4^+ supply in much the same way as they do to NO_3^- , however, additional signals must be involved. In vegetative plants, whether grown with an

FIGURE 14. Hypothetical model to account for the effects of water stress on plant growth and biomass allocation. Roots sensing dry soil enhance the production of ABA, which is exported in the xylem and moves to the leaves. Here, ABA reduces stomatal conductance and wall extensibility of growing cells. The effects are a reduction in the rate of transpiration and photosynthesis as well as in leaf expansion. As long as photosynthesis is affected less than leaf expansion, the export of assimilates to the roots is enhanced. The increased import of assimilates in combination with ABA-enhanced wall loosening of growing roots cell may enhance the rate of root growth.

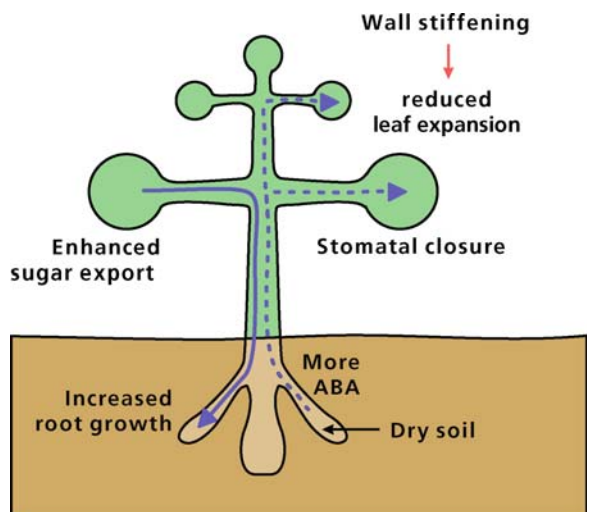

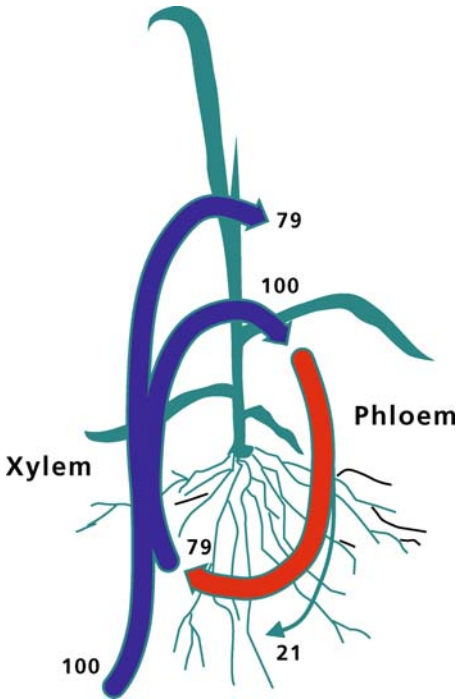

FIGURE 15. “Cycling” of nitrogen in a vegetative wheat plant (*Triticum aestivum*). Much of the N (NO_3^- , amino acids, and amides) that arrives in the leaves via the xylem is exported again in the phloem (amino acids and amides). Upon arrival in the roots, some of the nitrogen may be used for root growth, whereas the remainder cycles back to the shoot (Simpson et al. 1982a). Copyright *Physiologia Plantarum*.

optimum or a limiting N supply, much of the N transported from the roots via the xylem to the leaves is exported back to the roots, as amino acids and amides, via the phloem (Fig. 15). Such a process of continuous N **cycling** between roots and leaves makes it highly unlikely that the transport of N to the leaves itself is a controlling factor. Rather, we should search for signals, in addition to NO_3^- , that change concomitantly with the N supply.

5.4.2 Hormonal Signals That Travel via the Xylem to the Leaves

The response of plants to a low N or P supply is akin to that to a limiting supply of water: reduced leaf growth while root growth is maintained or enhanced. This response is generally described in terms of a **functional equilibrium** between leaves and roots (Brouwer 1963, 1983). That is, when resources that are acquired by the roots are in short

supply, the growth of the roots is favored over that of the leaves so that the RMR is increased. Transgenics that have a very low nitrate reductase activity (1–5% of wild-type levels) also exhibit an increased RMR when NO_3^- is in short supply, which shows that NO_3^- itself, rather than a product of its assimilation, is the primary signal that induces this response (Scheible et al. 1997). We have encountered a similar **signaling role of NO_3^-** in the proliferation of roots in response to a local NO_3^- supply (Sect. 2.2.8 of Chapter 6 on mineral nutrition). We know less about the signaling pathways in plants from environments with low nitrification potential. It is interesting that N deficiency reduces the roots’ **hydraulic conductivity**; it is very likely that this is controlled by a decreased expression or activity of **aquaporins**, water-channel proteins involved in water uptake by the roots (Sect. 5.2 of Chapter 3 on plant water relations; Clarkson et al. 2000). The rapid decline (within hours) in leaf growth of *Zea mays* (corn) upon transfer to a low-nutrient solution is associated with a decreased extensibility of the cell walls of expanding leaf cells. Transfer to high-nutrient conditions enhances this extensibility. The transfer has no effect on the osmotic potential of the leaf cells or on cell production (Snir & Neumann 1997).

Contrary to what has been found for plants exposed to water stress, there is no evidence that ABA plays a role as a signal between roots and leaves of plants exposed to a nutrient supply that is limiting to plant growth (Munns & Cramer 1996). Rather, a reduced nutrient supply to the roots reduces the synthesis of **cytokinins** in the root tips and their subsequent export to the leaves (Fetene & Beck 1993, Van der Werf & Nagel 1996). N appears to be the predominant nutrient that leads to this response (Kuiper et al. 1989). Due to the lower cytokinin import into leaves of plants grown with a limiting N supply, growth of the leaves is reduced (Simpson et al. 1982b). Cytokinins affect the growth of leaves and roots in an opposite manner (Sect. 2.2.2); root growth is either stimulated or unaffected by a low N supply.

In plants grown with a limiting supply of nutrients, the level of cytokinin can be maintained, by the addition of benzyladenine, a synthetic **cytokinin**, to the roots (Table 5). This maintains the RGR of the leaves of plants transferred to a low nutrient supply to a rate close to that in plants grown with a full nutrient supply; this effect can only last for a few days, after which the plants start to collapse. On the other hand, addition of cytokinin reduces the root growth to the level of plants well supplied with nutrients.

What kind of effects do cytokinins have on leaf metabolism? First, cytokinins promote the synthesis of

TABLE 5. Cytokinin (zeatin) concentrations (pmol g^{-1} FM) and the relative growth rate (RGR, $\text{mg g}^{-1} \text{day}^{-1}$) of *Plantago major* (common plantain) plants, exposed to a full-nutrient solution or transferred to a diluted solution, plus or minus 10^{-8} M benzyladenine (BA), a synthetic cytokinin.

Treatment	Cytokinin concentration		Growth (RGR)	
	Shoot	Roots	Shoot	Roots
Full nutrients	110	160	220	160
Diluted solution				
Without BA	25	23	150	180
With BA	100	140	190	160

Source: Kuiper & Staal (1987) and Kuiper et al. (1989).

several proteins that are involved in photosynthesis. Cytokinins also have a specific effect on a gene encoding a protein involved in the cell cycle and promote cell division and cell expansion (Sect. 2.2.2). To put it simply, cytokinins promote leaf cell division and leaf cell expansion, increase the photosynthetic capacity, delay leaf senescence, and enhance leaf expansion. Thus, as with water and temperature, nutrient supply governs growth through hormonal signals (feedforward control) rather than through a direct effect on the availability of substrates for protein synthesis (source control). The hormonal signals that regulate growth in response to nutrient shortage (cytokinins), however, differ from those associated with water and

salinity stress (ABA) and light shortage (phytochrome-induced changes in gibberellins).

5.4.3 Signals That Travel from the Leaves to the Roots

Leaves that experience a low import of nutrients probably send signals back to the roots, which account for their enhanced growth. What is the nature of these signals? The signal might well be the amount of carbohydrates exported via the phloem (Van der Werf & Nagel 1996). When the low nutrient supply reduces leaf growth, products of photosynthesis accumulate. These probably affect the sugar-sensing mechanism (Sect. 4.3 of Chapter 2A on photosynthesis). Genes encoding photosynthetic enzymes are subsequently suppressed, leading to down-regulation of photosynthesis. The increased level of carbohydrates in the leaves, however, implies that more photosynthate is available for translocation to the roots. There it may act as a signal and affect sugar-sensing mechanisms. Rather than suppressing genes, it is likely to de-repress genes encoding respiratory enzymes (Sect. 4.4 of Chapter 2B on plant respiration) and possibly others (Farrar 1996).

5.4.4 Integrating Signals from the Leaves and the Roots

The results presented in Sect. 5.4.2 lead to the model depicted in Fig. 16 (Van der Werf & Nagel 1996). An

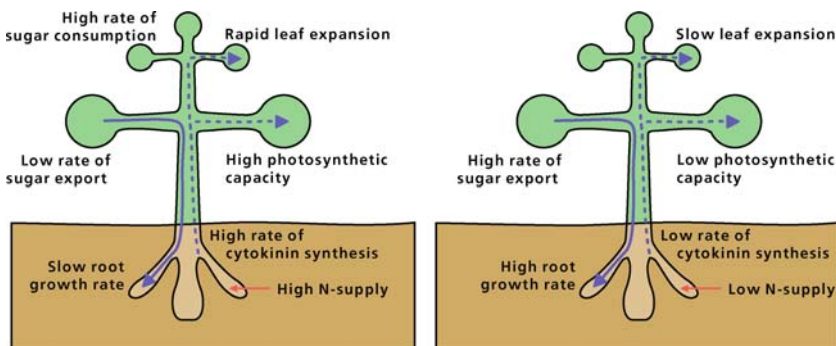

FIGURE 16. Hypothetical model to account for the effects of N supply on plant growth and biomass allocation. (Left) Roots sensing a high N availability produce large amounts of cytokinins, which are exported via the xylem to the leaves. Here the cytokinins enhance the photosynthetic capacity and leaf expansion. Hence, a large fraction of the photosynthates are consumed in the leaves, and a relatively small fraction is available for export to the roots. (Right) Roots sensing a low N availability produce only small amounts of cytokinins.

The import of cytokinins into leaves is small, so that their photosynthetic capacity and rate of leaf expansion are reduced. Only a small fraction of the photosynthates are consumed in the leaves, so that the concentration of sugars in the leaves is high and a relatively large fraction is available for export to the roots. The high level of sugars in leaves suppresses genes encoding photosynthetic enzymes. In roots, high sugar levels induce genes encoding respiratory and possibly other enzymes.

early response of a plant to a decline in the N supply is the decrease in synthesis and export of **cytokinins**. This reduces the rate of protein synthesis, cell division, and expansion in the growing leaves. Carbohydrates accumulate, leading to suppression of photosynthetic genes and down-regulation of photosynthesis. Plenty of carbohydrates are available for export to the roots. In the roots they depress genes that encode respiratory and possibly other enzymes. The roots may either grow at the same rate as those of control plants or their growth may be increased (Van der Werf 1996).

It appears that the relative increase in biomass allocation to roots with N shortage is largely accounted for by the decrease in production of **cytokinins** in the roots. This phytohormone then sets the change in biomass partitioning in motion which leads to a new **functional equilibrium** between roots and leaves. Roots appear to have very little *direct* control over the rate of carbon import from the leaves. They do exert *indirect* control, however, via their effect on leaf growth, which depends on the supply of cytokinins from the roots.

5.4.5 Effects of Nitrogen Supply on Leaf Anatomy and Chemistry

In a comparison of four congeneric grass species [*Poa annua* (annua meadow-grass), *Poa trivialis* (rough bluegrass), *Poa compressa* (Canada bluegrass), and *Poa pratensis* (Kentucky bluegrass)] grown at both an optimum and a limiting N supply, RGR and N concentrations decrease with low N supply (Van Arendonk et al. 1997). The decrease in RGR is accounted for by the decrease in **LAR** (both **SLA** and **LMR**). The changes are largest in the fastest-growing *Poa annua*. N shortage invariably enhances the proportion of leaf tissue that is occupied by **sclerenchymatic cells**, from about 0.5 to 6%, predominantly due to an increase in the number of these sclerenchymatic cells. The area occupied by **veinal tissue** doubles, from approximately 4.5 to 9%, whereas that occupied by epidermal cells is more or less constant (25%), despite a substantial decrease in **size of the epidermal cells**, especially in *Poa annua*. Mesophyll + intercellular spaces occupy a variable area of about 60% in all species and treatments. N stress decreases the concentration of protein and enhances that of (hemi)cellulose and lignin.

It is not known whether cytokinins are involved in the control of these anatomical and chemical features by nutrient supply. The anatomical changes are probably ecologically important, however, in that the

increase in sclerenchymatic and veinal tissue likely gives better protection of leaves from herbivores and desiccation (Lambers & Poorter 2004).

N shortage also has a major effect on allocation to nonstructural secondary metabolites such as **lignin and tannins** (Sect. 4.1 of Chapter 9B on ecological biochemistry). Because these compounds slow down the rate of litter decomposition, this response aggravates the N shortage in the environment (Sects. 2 and 3 of Chapter 10A on decomposition).

5.4.6 Nitrogen Allocation to Different Leaves, as Dependent on Incident Irradiance

Different leaves of a plant may differ widely with respect to their N concentration, perhaps due to **N withdrawal** from older, senescing leaves (Sect. 4). Leaves also adjust their N concentration to the **level of incident irradiance**; leaves at the top of the canopy that are exposed to full daylight have higher N concentrations per unit leaf area than leaves near the ground surface, where they are shaded by higher leaves (Hirose & Werger 1987a).

Most of the leaf N is associated with the photosynthetic apparatus (Sect. 3.2.3 of Chapter 2A on photosynthesis). Because light intensity is higher for the top leaves than for the bottom ones, the observed **gradient in leaf N concentration** enables the plant to optimize its use of N to fix C (Hirose & Werger 1987b, Pons et al. 1989, Field 1991). Mathematical models have been developed to assess the significance of a gradient in leaf N concentration, as opposed to a uniform distribution (Box 5.1).

What might be the physiological mechanism to achieve a N gradient that tends to follow the gradient of irradiance in the canopy? Leaves exposed to higher levels of irradiance, high in the canopy, will have higher rates of transpiration than the shaded ones lower in the canopy. This occurs partly because stomata respond to the level of irradiance (Sect. 5.4.4 of Chapter 3 on plant water relations), partly because of the greater vapor pressure difference between leaf and air higher in the canopy, and possibly also because the temperature of the top leaves is higher which increases the partial pressure of water vapor inside the leaf. The higher rate of transpiration causes a greater influx of solutes imported via the xylem, including amino acids and root-produced phytohormones. The greater N influx is probably not the immediate cause of enhanced incorporation of N into the photosynthetic apparatus, because far more N is imported via the xylem in leaves than is required for biosynthesis (Fig. 15). It is more likely that other xylem-transported compounds

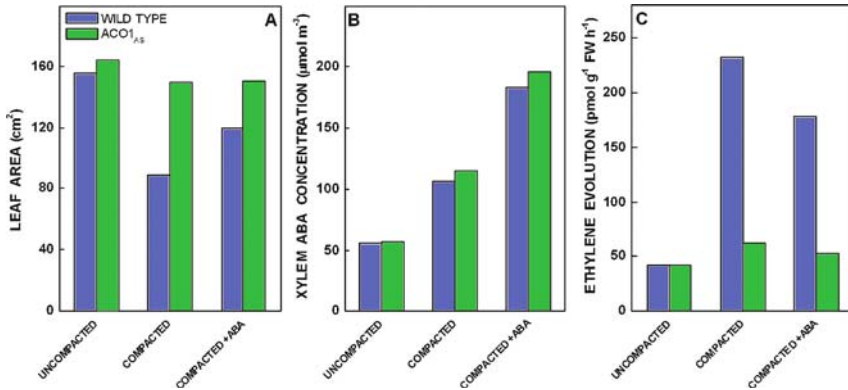

FIGURE 17. Effects of soil compaction on leaf growth, xylem ABA concentration, and ethylene production in wild type and a transgenic with a low capacity to produce ethylene of *Solanum lycopersicum* (tomato). (A) Total leaf area; (B) xylem sap ABA concentration; (C) leaf ethylene evolution at 21 days after emergence. Plants were well watered and grown in a split-pot

system in which either both compartments contained uncompact soil or one compartment contained uncompact soil and the other contained compacted soil. The compartment containing compacted soil was supplied either with water or with 100 nM ABA (compact +ABA) twice daily from day 5 (modified from Hussain et al. 2000).

control the differential incorporation of N in the leaves. **Cytokinins** are probably transported in greater amounts to rapidly transpiring leaves that are exposed to high levels of irradiance, compared with slowly transpiring leaves that are lower in the canopy (Fig. 16). In the top leaves, the greater inflow of cytokinins enhances the net incorporation of N into the photosynthetic apparatus (Sect. 5.4.4, Fig. 17). Other factors likely play an additional role, especially in trees where leaves in the outer canopy

may have an extra layer of palisade parenchyma (Sect. 3.2.2 of Chapter 2A on photosynthesis), which may be programmed well before the leaf has developed and begins to transpire (Sect. 5.1.1.1) (Fig. 18).

The mechanism depicted in Fig. 17 leads us to the following question: to what extent does the plant achieve its N allocation to different leaves so as to maximize its rate of photosynthesis? To answer this question, ecophysiological experiments have to be combined with a modeling approach.

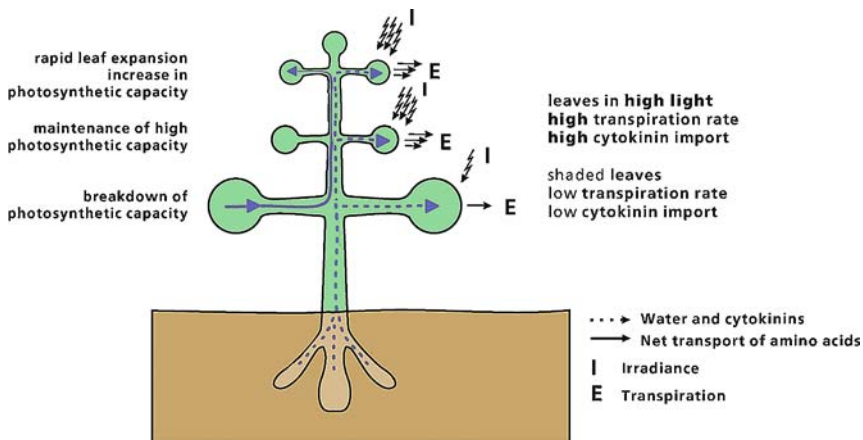

FIGURE 18. A hypothetical model to account for the differential allocation of N to leaves exposed to high or low levels of irradiance. Cytokinins are imported in greater amounts by rapidly transpiring leaves high in the canopy than by leaves lower in the canopy, which have lower rates of transpiration. Cytokinins then

promote N incorporation into the photosynthetic apparatus. In the absence of a large inflow of cytokinins, much of the nitrogenous compounds imported via the xylem are exported again via the phloem. Based on information in Pons & Bergkotte (1996).

To assess whether plants optimize the allocation of N to the different leaves, we need to know (1) the gradient of light within the canopy, (2) the relationship between photosynthesis and the level of irradiance, and (3) the relationship between photosynthesis and leaf N concentration. The optimal pattern of N distribution is the one that maximizes the rate of photosynthesis of the entire plant (Box 5.1). The outcome can be summarized as follows. Although plants do not quite achieve the pattern of N allocation to their leaves that would yield the highest possible rate of canopy photosynthesis, both monocotyledons and dicotyledons, and both C₃ and C₄ plants, have a N allocation pattern that approaches the optimal pattern. In this way the plants have a higher rate of canopy photosynthesis than could have been achieved with a uniform N allocation pattern (Hirose & Werger 1987a,b, Pons et al. 1989, Anten et al. 1995).

5.5 Plant Growth as Affected by Soil Compaction

Soil structure affects plant performance in many ways, both reducing leaf growth and changing root morphology. Roots are smooth and cylindrical in friable soil, but they become **stubby** and **gnarled** with soil compaction and explore less soil, with potentially deleterious effects on the supply of water and nutrients (Bengough & Mullins 1990a,b).

5.5.1 Effects on Biomass Allocation: Is ABA Involved?

Plants that grow in compacted soil have a **reduced LMR**, even in the presence of adequate nutrients and water. Soil compaction tends to enhance the concentration of ABA in the xylem sap (Sharp 2002). ABA is probably responsible for a reduced stomatal conductance (Hussain et al. 1999), but is it also the cause of the reduction in leaf growth, as it is under water stress? This is unlikely, because ABA-deficient mutants of both *Solanum lycopersicum* (tomato) and *Zea mays* (corn) show exactly the same response as wild-type plants (Munns & Cramer 1996).

Hussain et al. (2000) compared a wild-type tomato (*Solanum lycopersicum*), an ABA-deficient mutant, and a transgenic genotype with a reduced capacity to produce **ethylene**. They grew their plants in pots with soil that was noncompacted, compacted, or layered in such a way that the plants first encountered noncompacted and then compacted soil. The wild type and the transgenic with a low capacity to

produce ethylene show a similar increase in ABA concentration in the xylem sap. Because the leaf area expansion of the wild-type tomatoes is reduced to a greater extent than that of the transgenics, ABA can be discounted as the root-produced signal that affects leaf growth in compacted soil. Leaf expansion is invariably less in the ABA-deficient mutant. Reductions in leaf area expansion in wild-type and ABA-deficient mutants are associated with increased ethylene production. Application of ABA enhances the leaf expansion of the ABA-deficient mutant, and to a lesser extent that in the wild type. These results suggest that antagonistic interactions between ABA and ethylene regulate leaf expansion in tomato when the roots simultaneously encounter uncompacted and compacted soil (Fig. 17).

The responses of plants that grow in compacted soil are similar to those of plants that are **pot-bound** (i.e., grown in pots that are too small for their roots). The roots somehow sense the walls of the pots to be “impenetrable soil”. Leaf area expansion is reduced, even when sufficient water and nutrients are provided. The xylem sap of pot-bound sunflower (*Helianthus annuus*) plants contains far more ABA than does the sap of control plants (Table 6), but in bean (*Phaseolus vulgaris*) no such effect is observed (Munns & Cramer 1996). These responses can also be expected in plants that encounter rocks or a hardpan. However, root growth of *Hakea* species adapted to ironstone soils and a Mediterranean climate in Western Australia, typically do not show inhibition of root growth when reaching the hard surface. Instead, they continue growth and thus maximize chances to reach cracks in the rocks which are essential for survival in their natural habitat (Poot & Lambers 2003, 2008).

5.5.2 Changes in Root Length and Diameter: A Modification of the Lockhart Equation

Mechanical resistance (impedance) of the soil can be an important factor that limits root growth in cropping as well as natural systems (Hamza & Anderson 2005). The resulting increase in the rate of **ethylene** production is the most likely cause for the observed reduction in root elongation and an increase in root diameter and (sometimes) number of cortical cells (Harpham et al. 1991). There is also a change in the branching pattern. When ethylene production is inhibited, however, soil compaction still induces the same root morphology. The effects of soil compaction on root morphology may therefore also be accounted for by physical effects.

TABLE 6. Effects of root confinement on yield and physiology of 14-day-old *Helianthus annuus* (sunflower) plants.*

Treatment	Fresh mass (mg)						
	Shoot	Root	RMR	Transpiration (mm day ⁻¹)	K ⁺ transport (pmol g ⁻¹ s ⁻¹)	Plant water potential (MPa)	[ABA] in xylem (nM)
Control	163	9.5	0.055	0.054	97	-0.51	10
Confined	112	3	0.061	0.053	136	-0.51	70

Source: Ternesi et al. (1994).

* The root mass ratio (RMR) is the root fresh mass as a fraction of total plant mass; K⁺ transport (expressed per unit root fresh mass) was calculated from the concentration of K⁺ in the xylem exudate and the rate of exudation. Plants were grown in such a way as to ensure that water and nutrients were supplied at an optimum level.

For the roots to be able to elongate, the mechanical impedance of the soil matrix acting against the cross-section of the root tip must be less than the pressure exerted by the root itself. To expand on Equation (6) (Sect. 2.2), the proportional root elongation (r) is the result of cell expansion, which is related to the cell-wall yield coefficient (ϕ , MPa⁻¹ s⁻¹), the turgor pressure (Ψ_P , Pa), the yield threshold of the root (Ψ_r , MPa), and the yield threshold of the soil (Ψ_s , MPa) (Pritchard 1994):

$$r = \phi(\Psi_P - Y_r - Y_s) \quad (10)$$

Maximum axial and radial root growth pressures range from 0.24 to 1.45 and from 0.51 to 0.90 MPa, respectively, and vary with plant species. Because it is impractical to measure the mechanical impedance of the soil directly by using actively growing roots, a **penetrometer** has been developed that measures the pressure required to force a steel probe, with a 60° or 30° conical tip (i.e., 30° or 15° semiangle), into the soil.

Root elongation is primarily determined by the rate at which files of cells are produced and by the cell elongation rate in the apex. Root elongation and total root length are reduced by mechanical impedance (Fig. 19), due to inhibition of cell elongation. The root diameter commonly increases because of radial cell expansion of cortical cells (Fig. 20) and the solute concentration of the root cells is enhanced (Atwell 1989). Thicker and more rigid roots which result from radial root expansion are thought to exert higher pressure on the surrounding soil and deform the soil ahead of the root which facilitates subsequent penetration (Pritchard 1994). Turgor measurements show **turgor pressures** of 0.78 MPa in impeded root tips of *Pisum sativum* (pea), as compared with 0.55 MPa in unimpeded root tip cells (Clark et al. 1996).

The smaller root system under conditions of soil compaction may be detrimental for the uptake of

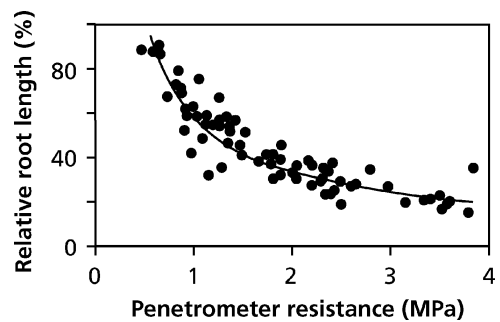

FIGURE 19. The relative root length of 70-day-old plants of *Zea mays* (corn), *Gossypium hirsutum* (cotton), *Triticum aestivum* (wheat), and *Arachis hypogaea* (groundnut) as dependent on mechanical impedance of the soil, as determined with a penetrometer (after Bennie 1996).

nutrients and water, and hence reduce the plant's growth rate and productivity. There are also effects on leaf expansion, however, that are not accounted for by the plant's water or nutrient status. Roots perceive soil compaction as such, and they send inhibitory signals to the leaves which cause a **feed-forward response** (Stirzaker et al. 1996). There is no conclusive evidence that species differ in their capacity to grow in compacted soil. Rather, they differ in their capacity to find less compacted sites in the same soil (Sect. 5.5.1; Bennie 1996). They may also differ in the size of their root system and hence in the extent to which they explore the soil, including the compacted part (Materchera et al. 1993).

5.6 Growth as Affected by Soil Flooding

Flooding or inundation of the soil leads to filling with water of the soil pores that are normally filled with air. This reduces the supply of soil O₂ which may reduce aerobic respiration (Sect. 4.1 of Chapter

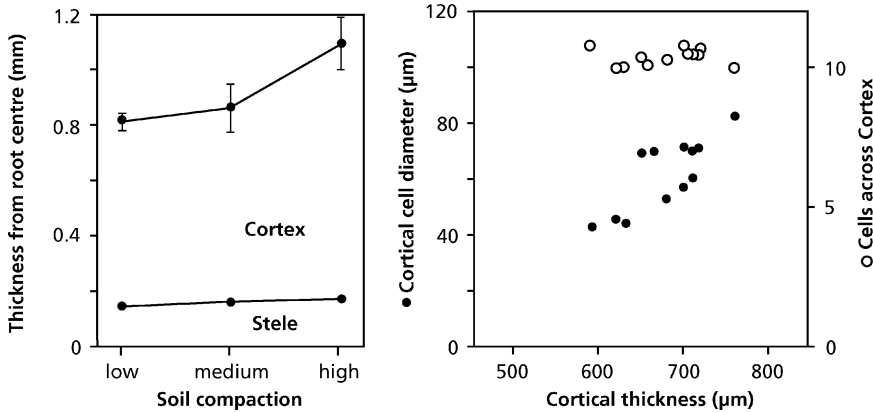

FIGURE 20. The radius of the stele and cortex in roots of *Lupinus angustifolius* (narrow-leaved lupin), (left) grown at three levels of soil compaction and (right) the diameter and number of cortical cells and mean cortical

cell diameter of the same plants. Increasing cortical thickness on the abscissa in the right-hand figure is the result of increased soil compaction, as illustrated in the left-hand figure (Atwell 1989).

2B on plant respiration). Flooding also affects the roots' hormone metabolism. Concentrations of **ethylene** in the roots increase, largely because this gas diffuses more slowly in a flooded soil than it does in a well aerated soil, so that it gets trapped in the roots, and partly because of an enhanced production of this hormone (Colmer 2003).

5.6.1 The Pivotal Role of Ethylene

Ethylene inhibits root elongation and induces the formation of **aerenchyma** in roots (Fig. 21). **Lysigenous aerenchyma** formation, which involves death and dissolution of cortical cells, is preceded by enhanced transcription of a gene that encodes a **xyloglucan endotransglycosylase**, which is a cell-wall loosening enzyme involved in the hydrolysis of cell walls (Sect. 2.2) and ultimately in the **lysis** of some **cortical cells** (Saab & Sachs 1996): **programmed cell death**. The ethylene-induced aerenchyma facilitates **gas diffusion** between roots and aerial parts (Sect. 4.1.4 of Chapter 2B on plant respiration), because the large cross-sectional area of gas space reduces the physical resistance to gas movement. Many hydrophytes such as *Oryza sativa* (rice) and *Senecio congestus* (marsh fleabane) possess extensive aerenchyma even when growing in well-drained conditions. In mesophytes such as *Zea mays* (corn) and *Helianthus annuus* (sunflower), however, cortical aerenchyma formation by cell breakdown is minimal in well-aerated conditions and is promoted by poor aeration (Colmer 2003).

Ethylene also increases the **elongation of the coleoptile** in seedlings of *Oryza sativa* (rice), and, at

later growth stages, stem internodes, so that shoots reach the surface of the water more rapidly. In the flood plains of Bangladesh, internodal growth rates of up to 25 cm day⁻¹ have been recorded. Submergence induces accumulation of mRNA that encodes **expansins** before the rate of growth starts to increase (Cho & Kende 1997c). The "snorkeling" response is characteristic of most flood-tolerant species. A similar response has been found for petioles and lamina in the flood-tolerant *Rumex palustris* (marsh dock) during submergence of entire plants. The flood-sensitive *Rumex acetosa* (sorrel), on the other hand, responds to flooding with enhanced ethylene concentrations in the shoot, but not with enhanced elongation rates (Peeters et al. 2002). This indicates that it is the greater **responsiveness to ethylene**, and not the enhanced ethylene production, that increases petiole elongation in the flood-tolerant *Rumex* species (Banga et al. 1996). The increased responsiveness of the flood-tolerant *Rumex* species is associated with an increased transcription of the gene encoding for an ethylene receptor upon submergence. High concentrations of ethylene and exposure to high concentrations of CO₂ and low concentrations of ethylene increase the levels of transcripts encoding for the ethylene receptor. Therefore, flood-tolerant *Rumex* species respond to flooding stress by increasing their number of **ethylene receptors** which subsequently enhances their responsiveness to ethylene, leading to leaf elongation (Vriezen et al. 1997). The interaction of three hormones (ethylene, ABA, and GA) determines the growth rate of the shoot. Ethylene renders the internode more responsive to GA by

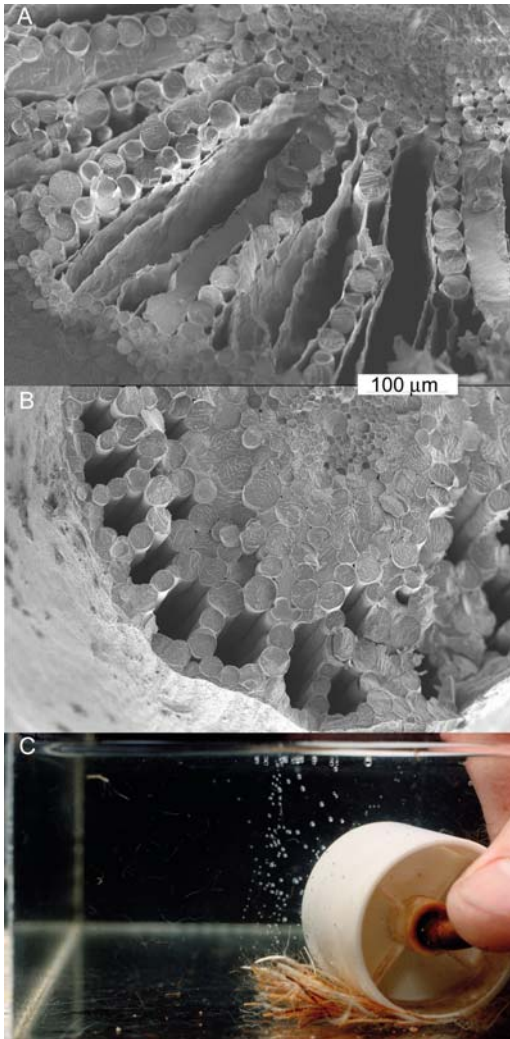

FIGURE 21. Aerenchyma in roots. Scanning electron micrograph of (A) constitutive, lysigenous aerenchyma of *Juncus effusus* (soft rush) and (B) constitutive, schyzogenously aerenchyma of *Rumex palustris* (marsh dock). The horizontal bars indicate a length of 100 μm (courtesy L. Mommer, Department of Ecology, Radboud University Nijmegen, the Netherlands). (C) Evidence of air-filled aerenchyma in roots of *Oryza sativa* (rice) is provided by bubbles coming from cut ends of roots squeezed gently with a roller under water. The rice plants were grown in waterlogged soil [courtesy T. L. Setter, Department of Agriculture and Food Western Australia, Perth, Australia; Setter & Belford (1990)].

lowering the level of endogenous ABA. GA is the immediate growth-promoting hormone and acts by enhancing cell elongation and, probably indirectly, by increasing cell-division activity in the intercalary

meristem. Rice internodes contain two **expansins** that may mediate acid-induced wall extension (Cho & Kende 1997a,b).

In *Potamogeton pectinatus* (water chestnut) it is the root that shows a “snorkeling” response to flooding; it reaches the surface of the water by growing upward, rather than showing the normal positive gravitropism (Summers & Jackson 1994).

5.6.2 Effects on Water Uptake and Leaf Growth

The responses of leaf growth and metabolism to soil inundation are similar to those of water-stressed plants. Flooding delays the normal daily increase in root **hydraulic conductance** in flooding-sensitive *Solanum lycopersicum* (tomato) plants (Else et al. 1995). This is probably due to **cytosol acidosis** and the inhibitory effect of a low pH on **aquaporins** (Sect. 5.2 of Chapter 3 on plant water relations). **Stomatal conductance** declines and the rate of **leaf elongation** is reduced (Fig. 22). If the lower hydraulic conductance is compensated by

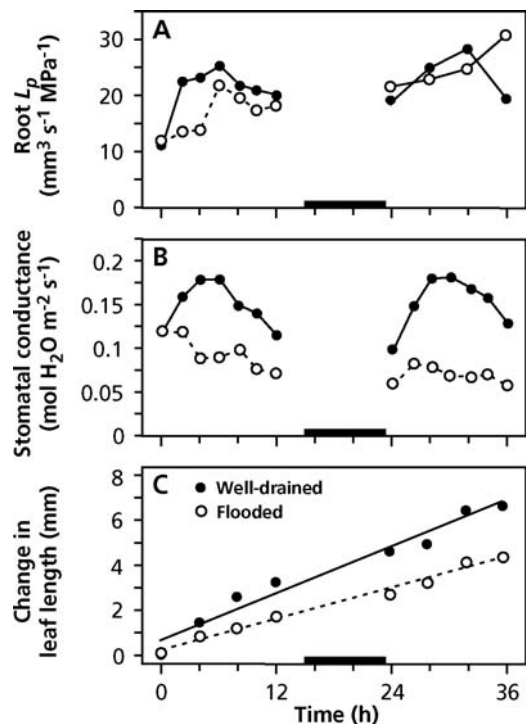

FIGURE 22. Effects of soil flooding for 24–36 hours on (A) root hydraulic conductance, (B) stomatal conductance, and (C) leaf elongation of *Solanum lycopersicum* (tomato) (after Else et al. 1995). Copyright American Society of Plant Biologists.

pressurizing the roots (Sect. 5.3), however, both the stomatal conductance and the rate of leaf expansion remain low. As in plants exposed to water shortage, **chemical signals** are responsible for the early responses to flooding in sensitive plants. **ABA** is one of the chemical signals arriving from the roots that cause stomatal closure (Else et al. 1996). Exposure of roots to hypoxia also reduces leaf **cell-wall extensibility**, and it is paralleled by a decreased capacity to **acidify leaf cell walls** (Van Volkenburgh 1994).

5.6.3 Effects on Adventitious Root Formation

When the effects of soil flooding become too severe, plants with some degree of flooding tolerance make new, aerenchymatous adventitious roots with air channels to the shoot that permit O₂ diffusion to the new roots (Colmer 2003). Endogenous **auxin** is the phytohormone that is generally responsible for adventitious root formation, even in flooding-sensitive plants. Auxin accumulates at the base of the shoot, possibly due to inhibition of the energy-dependent transport of auxin to the roots. In the flood-tolerant *Rumex palustris* (marsh dock) both **ethylene** and **auxin** enhance the formation of new adventitious roots (Table 7). Because ethylene has no effect in the presence of an inhibitor of auxin transport, it must exert its effect through auxin. Because the concentration of auxin is not increased, ethylene, which accumulates upon flooding the plants, must enhance the tissue's sensitivity for endogenous auxin, allowing root primordia to develop where they would otherwise remain dormant (Visser et al. 1996).

TABLE 7. The effect of exposure to hypoxia and treatment with auxin, ethylene, or a combination of ethylene and an inhibitor of auxin transport on the formation of adventitious roots in the flooding-tolerant *Rumex palustris* (marsh dock).

Treatment	Number of adventitious roots
Aerobic control	4
Anaerobic control	43
Auxin	45
Ethylene	44
Ethylene + inhibitor	8

Source: Visser et al. (1996).

5.6.4 Effects on Radial Oxygen Loss

Aerenchyma provides a low-resistance internal pathway for the exchange of gases between the atmosphere and the submerged plant parts. Respiration by tissues along the pathway in aerenchymatous roots decreases the amount of O₂ that is available for the growing root apex, eventually restricting the maximum length of these roots in an O₂-free environment. A potentially greater sink for O₂ along the pathway is the **radial loss of O₂** to the soil. Many wetland species prevent excessive O₂ loss from the basal root zones by forming a complete or partial **barrier to radial O₂ loss** (Armstrong 1971, 1979). Radial O₂ loss tends to be less in species that are adapted to waterlogging than in waterlogging-sensitive species (McDonald et al. 2002, Garthwaite et al. 2003). The barrier for radial O₂ loss may be constitutive [e.g., in *Carex acuta* (slender tufted sedge) and *Juncus effusus* (common rush)] or inducible [e.g., in *Caltha palustris* (marsh marigold) and *Oryza sativa* (rice)] (Colmer et al. 1998, Visser et al. 2000).

5.7 Growth as Affected by Submergence

Flooding of terrestrial plants may also submerge aerial parts, restricting gas exchange not only of the roots but also of the leaves. Two alternative responses can be observed under different flooding regimes: (1) dormancy, characterized by tolerance of the stress and reduced metabolic activity; (2) escape, due to shoot elongation, which establishes aerial contact. The **elongation response** requires energy expenditure, which is only "paid back" when aerial contact is established. Under conditions of deep or short-lasting floods tolerance of **hypoxia** and reduced metabolic activity are favored (Setter & Laureles 1996, Voesenek et al. 2004).

Plants that escape **submergence** occur in habitats that are temporarily and shallowly flooded and where the water table rises gradually. Plants with a rosette habit typically show hyponastic growth (upward curving) of petioles and leaves and increased extension of petioles (Fig. 23). When a stem is present, internodes elongate strongly upon submergence. The increased growth toward the surface re-establishes or maintains aerial contact that facilitates gas exchange and increases survival (Voesenek et al. 2004). Flood-prone environments with long-lasting submergence periods are found in river floodplains where depressions and embankments can trap water, causing continued submergence after the flood has receded. *Rumex palustris* (marsh dock) is a typical example of a species that

FIGURE 23. Submergence-induced hyponastic growth and petiole elongation in *Rumex palustris* (marsh dock). At the start of the submergence treatment plants had an age of 28 days. Plants were submerged up to 54 hours (Voeselek et al. 2003). Courtesy M.C.H. Cox & L.A.C.J. Voeselek, Department of Biology, Utrecht University, Utrecht, the Netherlands.

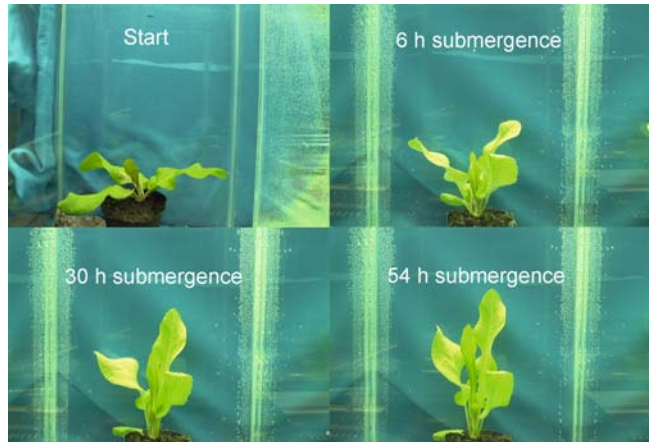

shows the above-mentioned “snorkeling” behavior, whereas the closely related *Rumex acetosa* (sorrel) from higher, better-drained sites does not show such a response to submergence (Voeselek et al. 2004). Deepwater rice (*Oryza sativa*) is also adapted to seasonal floods; its internodes elongate to such an extent that the shoots keep pace with the rising water levels in the monsoon season in river deltas in south-east Asia. Leaves and panicles can thus be in contact with air above water of several meters deep (Kende et al. 1998).

Tolerance of the conditions after the water level drops is part of the **suite of traits** that allow survival in occasionally flooded areas. Protection against desiccation and damage as a result of the sudden exposure to O_2 after a prolonged period of hypoxia is an important aspect.

5.7.1 Gas Exchange

Net photosynthetic CO_2 uptake essentially stops upon submergence of terrestrial plants at the low ambient CO_2 concentrations in water (Vervuren et al. 2003). Only higher CO_2 concentrations allow net CO_2 assimilation (and thus net O_2 production). The capability of CO_2 exchange is improved after a period of acclimation under water. Leaves of *Rumex palustris* (marsh dock) that develop under water are thinner with a thin cuticle. Furthermore, chloroplasts in the mesophyll cells orient toward the epidermis, indicating that **diffusion of CO_2** takes place predominantly through the **cuticle**, rather than through the stomata that are closed under water. Although net photosynthetic CO_2 uptake may be absent under water, photosynthetic electron transport continues, as evidenced by **chlorophyll fluorescence** (Mommer et al. 2005). There is apparently

recycling of CO_2 derived from (photo)respiration in photosynthesis which may produce some ATP and help dissipate excess energy in strong light.

Although photosynthetic O_2 evolution may be restricted under low ambient CO_2 conditions, it can be substantial at elevated CO_2 in flood water. Moreover, O_2 can diffuse into the leaf at sufficiently high concentrations (Mommer et al. 2004). Hence, provided the water is sufficiently clear and gas concentrations are suitable, the internal O_2 can facilitate aerobic respiration. Internal diffusion through aerenchyma to below-ground parts can further improve O_2 conditions and contribute to long-term survival of submergence-tolerant plants.

5.7.2 Perception of Submergence and Regulation of Shoot Elongation

Ethylene accumulates under submergence conditions (Sect. 5.6). Normal internal concentrations are in the range of $0.02\text{--}0.05 \mu\text{mol mol}^{-1}$, but they can increase to $1 \mu\text{mol mol}^{-1}$ within an hour after submergence (Bailey-Serres & Voeselek 2008) and enhance further by increased ethylene production (Kende et al. 1998). Exposure of a responsive plant to a high ethylene concentration without submergence is sufficient to initiate shoot elongation. Reduced internal O_2 levels further promote the submergence-avoidance response and increased CO_2 concentrations also contribute to the signal in deepwater rice (*Oryza sativa*). Ethylene accumulates also upon submergence in *Rumex acetosa* (sorrel), but this flood-intolerant species does not respond to submergence or high ethylene concentration with enhanced shoot elongation.

The first reaction of *Rumex palustris* (marsh dock) upon submergence is **hyponastic growth**, i.e., a more vertical orientation of the petiole and leaf

blade (Fig. 23) which is a condition for further petiole extension. Ethylene-stimulated petiole and internode elongation in *Rumex palustris* and *Oryza sativa* (rice) depends on a reduced level of the inhibitor ABA relative to the stimulator of extension growth GA (Kende et al. 1998, Voesenek et al. 2006). The ABA:GA ratio quickly changes upon submergence by increased breakdown of ABA and de novo synthesis of GA. A further essential step is that cell-wall extensibility is enhanced both by increased expression of specific **expansins** and **acidification** of the cell wall. These events downstream of the signal perception allow the rapid (within a few hours) onset of extension growth toward the water surface.

5.8 Growth as Affected by Touch and Wind

Some plants can “move” when touched. Unless *Mimosa pudica* (touch-me-not) has just been assaulted by a classroom of school children, its petioles and pinnate leaves will respond to touch, due to the movement of ions in the pulvinus (Sect. 5.4.6 of Chapter 3 on plant water relations). These movements in response to touch are *not* related to growth. The growth of some plant organs, however, does respond to touch (e.g., the **tendrils** of climbing plants like *Clematis* or *Lathyrus*). Upon contact, these tendrils enhance their growth at the side away from the point of contact, sometimes in combination with a growth reduction at the side where contact occurred. Another response of the tendril to contact may be a strong reduction in the rate of elongation, as in the tendrils of *Cucumis sativus* (cucumber) (Ballaré et al. 1995). Susceptibility of plants to contact was already recognized by Theophrastus, around 300 BC, and by Darwin (1880), who described this phenomenon for the apex of the radicle of *Vicia faba* (broad bean). Since then, it has been shown that wind, vibrations, rain, and turbulent water flow affect a plant’s physiology and morphology which is a phenomenon generally termed **thigmomorphogenesis** (Esmon et al. 2005). Wind exposure may make plants less susceptible to other forms of stress. Mechanical stimulation of young internodes of *Bryonia dioica* (Cretan bryony) reduces their elongation and increases their radial expansion. This is associated with an acceleration of lignification and a transient increase in **ethylene** production, preceded by a redistribution of Ca^{2+} within the cell and expression of specific proteins (Thonat et al. 1997). An extreme form of thigmomorphogenesis is found in trees at high altitude, which show the typical “**Krumholz**” sculpture (i.e., a

wind-induced deformation). Trees at the edge of a plantation or forest tend to be hardened by wind and have thicker and shorter trunks. Whenever these trees are removed, the weaker, slender trees are easily knocked over (Jaffe & Forbes 1993).

Plant growth may decline in response to careful touching or stroking of leaves, much to the disappointment of some students who have tried to carry out a **nondestructive growth analysis**. Although not all species or genotypes of a species show thigmomorphogenesis to the same extent, it is a common and often underestimated phenomenon, generally associated with a reduction in plant growth. Canopy effects on stem growth are usually ascribed to shading, but reduced mechanical stress also plays a role. This canopy effect on *Nicotiana tabacum* (tobacco) is that plants produce shorter but thicker and more flexible stems (Table 8). Touching the leaves may also affect leaf respiration, in some species by as much as 56% (Todd et al. 1972), transpiration, and chemical composition, even in plants whose growth may not be reduced by such a treatment (Kraus et al. 1994). Roots show thigmotropic reactions when encountering obstacles in soil and grow around these (Fasano et al. 2002).

Exposure of the grasses *Lolium perenne* (perennial ryegrass) and *Festuca arundinacea* (tall fescue) to a high wind speed of 8.4 m s^{-1} , as compared with 1.0 m s^{-1} for control plants, reduces their rate of leaf elongation by about 25% which is partially reversible. The wind-exposed plants are shorter and less leafy. Although wind speed reduces leaf temperature of these grasses, this effect is small and cannot account for the large effects on leaf elongation. Wind speed reduces the LAR, mainly due to a decrease in SLA. The RGR of the grasses is also reduced, although not to the same extent, due to a 15% increase in NAR by this wind treatment (Russel & Grace 1978, 1979).

Thigmomorphogenetic effects may vary among genotypes of the same species (Table 8). An alpine ecotype of *Stellaria longipes* (longstalk starwort), which is characterized by a short erect habit, produces substantial amounts of **ethylene** in response to wind, and stem growth is inhibited by ethylene (Emery et al. 1994). By contrast, the prairie ecotype produces substantial amounts of ethylene even in the absence of wind stress, but stem growth is not inhibited by ethylene. This demonstrates that ethylene dwarfs stems in alpine *Stellaria longipes* primarily as a result of increased sensitivity to the ethylene produced during wind stress. To an alpine plant, wind is an important selective force, whereas in the prairie habitat it is important that stems elongate rapidly, in order to avoid being overtopped by

TABLE 8. Stem characteristics measured on control and flexed *Nicotiana tobac* (tobacco) plants grown either in isolation or in a mixed stand.*

	Isolated plants		Mixed stand	
	Control	Flexed	Control	Flexed
Mechanical properties				
Height (cm)	84	67	61	27
Diameter	13.3	14.8	8.4	1
σ_b	10.7	9.3	10.1	4.3
E	1.6	0.9	1.1	0.1
Growth data				
Leaf mass ratio	0.47	0.49	0.49	0.54
Stem mass ratio	0.38	0.35	0.38	0.34
Root mass ratio	0.15	0.16	0.13	0.11

Source: Anten et al. (2005).

* In the mixed stand, flexed and control plants were mixed together. The properties σ_b and E are the breaking stress and Young's modulus (a measure for stiffness) of the stem, respectively; both σ_b and E are expressed in N m^{-2} .

competitors. Such genetic differentiation likely affects a genotype's success in contrasting environments, as further discussed in Chapter 9E on interactions among plants.

Exposure of *Arabidopsis thaliana* (thale cress) to wind, rain, or touch led to the serendipitous discovery that these stimuli rapidly (within 10 min) induce several **touch-specific (TCH) genes**, three of which encode **calmodulin**, which is a Ca-binding protein that turns on several cellular processes, or calmodulin-related proteins (Braam & Davis 1990). The gene *TCH4* encodes XET (**xyloglucan endotransglycolase**, an enzyme that breaks cross-links among cell-wall carbohydrates and promotes wall loosening) (Braam et al. 1996). It is interesting that overall XET levels decline after wind stimulation, whereas *TCH4* (i.e., the product of the gene *TCH4*) increases (Antosiewicz et al. 1997). Using *in planta* expression of the jellyfish apoaequorin gene, which encodes a Ca-dependent luminescent protein, Knight et al. (1991, 1992) showed that touch immediately increases cytosolic free Ca levels. Calcium has therefore been implicated as the **second messenger** that induces the expression of the *TCH* genes (Esmon et al. 2005). The increased production of calmodulin and calmodulin-related proteins probably starts many Ca-regulated events. For example, wind-induced production of calmodulin reduces the rate of elongation of petioles and of bolting in *Arabidopsis thaliana*, modifies callose deposition, and induces auxin-enhanced growth and mitosis. Up-regulation of the XET-encoding

gene may play a critical role in determining properties of the cell wall, including extensibility (Sect. 2.2).

5.9 Growth as Affected by Elevated Concentrations of CO_2 in the Atmosphere

On average, the final mass of C_3 plants, grown at high nutrient supply without shading by neighboring plants, increases by 47% when the atmospheric CO_2 concentration is doubled to $700 \mu\text{mol mol}^{-1}$ (70 Pa) (Poorter et al. 1996). When plants have **numerous sinks**, such as tillers or side shoots, this stimulation can be even higher (several hundred percent). The average enhancement is, however, much less than the extent of the stimulation of the rate of **photosynthesis** in short-term experiments (Fig. 6, Sect. 2.2.1 of Chapter 2A on photosynthesis). To explain why growth is less sensitive to CO_2 than is photosynthesis, it is helpful to examine the impact of elevated $[\text{CO}_2]$ on each growth parameter (Sect. 2.1.1):

$$\text{RGR} = \frac{(A_a \cdot \text{SLA} \cdot \text{LMR} - \text{LR}_m \cdot \text{LMR} - \text{SR}_m \cdot \text{SMR} - \text{RR}_m \cdot \text{RMR})}{[\text{C}]} \quad (11)$$

where A_a is the rate of photosynthesis per unit leaf area; RGR is the plant's relative growth rate; SLA is the specific leaf area; LMR, SMR, and RMR are the leaf mass ratio, stem mass ratio, and root mass ratio, respectively; LR_m , SR_m , and RR_m are the rate of respiration per unit mass of the leaves, stems, and

roots, respectively; $[C]$ is the carbon concentration of the plant biomass. If the RGR and final mass of the plants are enhanced less than expected from the increase in rate of photosynthesis, one or more of the parameters in the equation must have been affected by elevated atmospheric CO_2 concentrations. In other words, growth at $700 \mu\text{mol mol}^{-1} \text{CO}_2$ leads to a number of changes in the plant that may compensate for the higher rate of photosynthesis as found in A vs. C_c curves. Photosynthetic **acclimation** to high CO_2 concentrations was addressed in Sect. 12.1 of Chapter 2A on photosynthesis. Here we discuss some additional changes that counteract the initial stimulation of photosynthesis.

There are numerous examples where exposure of plants to a high atmospheric CO_2 concentration transiently enhances the plant's RGR, followed by a return to the RGR found in control plants (e.g., Wong 1993, Fonseca et al. 1996). The **transient increase in RGR** may account entirely for the increase in final mass of the plants grown at elevated $[\text{CO}_2]$ (Fig. 24). Some species show a sustained enhancement of RGR, but some degree of acclimation is common. Which component(s) of the growth equation accounts for such acclimation?

A **decrease in SLA** is the major adjustment found upon prolonged exposure to $700 \mu\text{mol mol}^{-1} \text{CO}_2$. This is partly due to the accumulation of nonstructural carbohydrates (Sect. 3.4 of Chapter 2C on long-distance transport). LMR, SMR, and

RMR are not, or are only marginally, affected (Stulen & Den Hertog 1993). If they are affected, then it is due to the more rapid depletion of nutrients in the soil of the faster-growing plants exposed to elevated $[\text{CO}_2]$.

Leaf respiration is increased by long-term exposure to high $[\text{CO}_2]$ (Sect. 4.7 of Chapter 2B on plant respiration). The carbon concentration varies with CO_2 concentration, but without a distinct trend (Poorter et al. 1992). Results from short-term measurements on single leaves clearly cannot simply be extrapolated to the growth of whole plants over a long period. About two-thirds of all studies show enhanced biomass production at elevated $[\text{CO}_2]$ (Luo et al. 2006).

Different types of plants may respond to varying degrees to elevated $[\text{CO}_2]$. For example, **C_4 plants**, whose rate of photosynthesis is virtually saturated at $350 \mu\text{mol mol}^{-1} \text{CO}_2$, respond to a smaller extent (Poorter et al. 1996). Elevated $[\text{CO}_2]$ does not consistently affect the **competitive balance between C_3 and C_4 plants** (Sect. 5.4 of Chapter 9E on interactions among plants).

6. Adaptations Associated with Inherent Variation in Growth Rate

6.1 Fast- and Slow-Growing Species

In **unpredictable but productive environments**, where "catastrophes" like fire, inundation, or other forms of disturbance occur, **fast-growing short-lived species** are common. In more **predictable environments** with a low incidence of disturbance, **longer-lived slow-growing species** predominate. Apart from their life span, these short- and long-lived species differ in many other traits and, broadly generalizing, have been termed **r-species** and **K-species**, where r and K are constants in a logistic growth curve (McArthur & Wilson 1967, Pianka 1970). Such a classification, once proposed for both plants and animals, has been questioned, but it provides a useful context in which to understand the ecological performance of vastly different species (Table 9).

Grime (1979) extended this concept by suggesting that there are two major categories of selective factors: **stress**, which is an environmental factor that reduces the growth rate of plants, and **disturbance**, which is a factor that destroys plant biomass. High-stress environments include those with low availability of water, nutrients, and light or where other conditions are unfavorable for growth (low

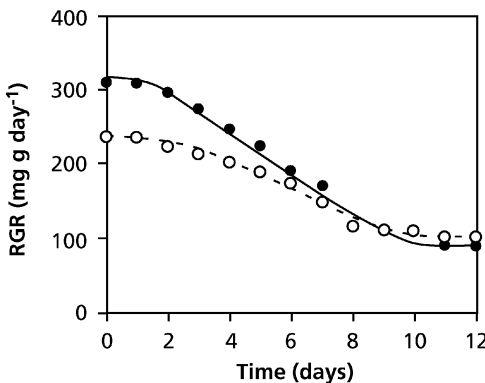

FIGURE 24. The relative growth rate (expressed on a fresh mass basis) of *Plantago major* (common plantain) grown at $350 \mu\text{mol mol}^{-1} \text{CO}_2$ (open symbols) or at $700 \mu\text{mol mol}^{-1} \text{CO}_2$ from day zero onward, when the plants were 4 weeks old (Fonseca et al. 1996). Copyright Trustees of *The New Phytologist*.

TABLE 9. Some of the characteristics of r- and K-species and the habitats in which they occur.

	r selection	K selection
Climate	Variable and/or unpredictable; uncertain	Fairly constant and/or predictable; more certain
Mortality	Often catastrophic; density independent	Density dependent
Population size	Variable; usually well below carrying capacity; frequent recolonization	Fairly constant; at or near carrying capacity; no recolonization required
Intra- and interspecific competition	Variable; often minor	Usually severe
Traits favored by selection	Rapid development High growth rate Early reproduction Single reproduction	Slower development Competitive ability Delayed reproduction Repeated reproductions
Life span	Relatively short	Longer

temperature, high salinity, low oxygen, heavy metal contamination). Disturbance can result from herbivory or from environmental factors like fire or wind. Grime describes three extreme types of plant strategies: **competitors**, which exist under conditions of low stress and low disturbance; **stress-tolerant** species, which occupy habitats with high stress and low disturbance; and **ruderals** (=weeds), which occur in highly disturbed nonstressful environments. There is no viable plant strategy that can deal with the combination of high stress and high disturbance. Most plants actually fall at intermediate points along these continua of stress and disturbance, so it is most useful to use the scheme in a comparative sense, with some species being more stress-tolerant than others, some species more tolerant of disturbance than others. Although this classification has also been seriously questioned, it has led to the recognition that plants characteristic of low-resource and stressful environments consistently have a lower RGR than do plants from more favorable environments (Box 9E.1).

The close association between a species' growth potential and the quality of its natural habitat (Fig. 25) raises two questions. First, how are the differences in growth rate between species brought about? Second, what ecological advantage is conferred by a plant's growth potential? These two questions are in fact closely related. Before evaluating the **ecological significance** of the inherent RGR of a species, it is important to analyze the **physiological basis** of the genetic variation in RGR (Lambers & Poorter 2004). Numerous plant characteristics contribute to a plant's absolute growth rate in its natural habitat (e.g., seed size, germination time, or plant size after overwintering). In view of the close correlation between a

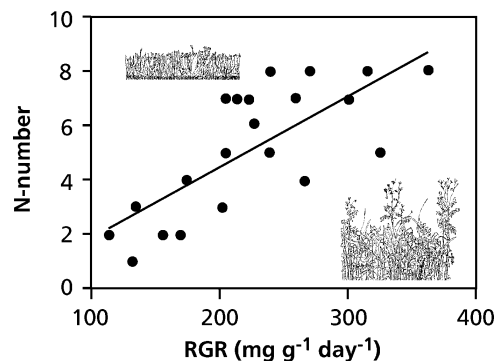

FIGURE 25. The relationship between the relative growth rate (RGR) of 24 herbaceous C_3 species and the "N-number" of the species' habitat (high values correspond to habitats of high N availability). The RGR was determined under identical conditions for all species: free access to nutrients and an irradiance of $320 \mu\text{mol m}^{-2} \text{s}^{-1}$ (Poorter & Remkes 1990).

plant's inherent RGR and environmental parameters (Fig. 25), we restrict the present discussion to traits that contribute to variation in RGR. Finally, we discuss the ecological implications of inherent differences in the various traits and in the growth rate itself.

6.2 Growth of Inherently Fast- and Slow-Growing Species Under Resource-Limited Conditions

In Sect. 2.1 we compared plants under conditions favorable for growth. How do fast- and

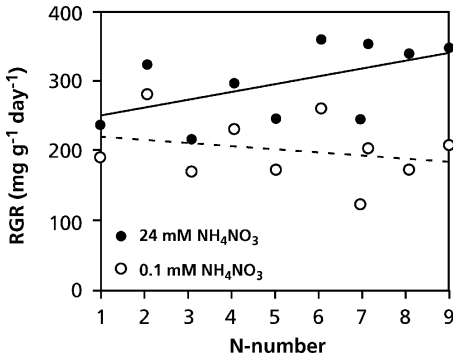

FIGURE 26. The RGR of 10 annual herbaceous C_3 species grown at a high and a low N supply. The 10 species were from habitats differing in “N-number” (higher values indicating a higher N availability as well as an inherently higher RGR_{max}) (Fichtner & Schulze 1992).

slow-growing species perform at a low nutrient concentration?

6.2.1 Growth at a Limiting Nutrient Supply

Although the RGR of potentially fast-growing species is reduced more than that of slow-growing ones, when nutrients are in short supply, the inherently fast-growing species still tend to grow fastest (Fig. 26). Similar results are obtained in a situation where a fast-growing species competes with a slow-growing one under nutrient stress, at least when the duration of the experiment is short, relative to the plant’s life span.

The higher RGR of inherently fast-growing species at a low nutrient supply, in comparison with slow-growing ones, is largely “explained” by differences in LAR (SLA) which is similar to the situation with free access to nutrients (Table 10). (Note that “explained” is used here in a statistical sense and that it does not refer to physiological mechanisms.)

6.2.2 Growth in the Shade

In a comparison of tropical tree species, fast-growing species with a high LAR and low RMR maintain a higher RGR when grown in the shade; however, they also show greater mortality (Kitajima 1994). This trend can be accounted for by greater investment in defense against herbivores and pathogens (dense and tough leaves) in the slower-growing trees, which have a large root system and a high wood density (Kitajima 1996).

6.3 Are There Ecological Advantages Associated with a High or Low RGR?

The ecological advantage of a high RGR seems straightforward: fast growth results in the rapid occupation of space, which is advantageous in a situation of competition for limiting resources. A high RGR may also maximize the reproductive output in plants with a short life span, which is particularly important for ruderals. What is the possible survival value of slow growth? Grime and Hunt (1975) and Chapin (1980, 1988) offered several explanations, which we review in this section.

6.3.1 Various Hypotheses

It has been suggested that slow-growing species make modest demands and are therefore less likely to exhaust the available nutrients (Parsons 1968). This is not a stable evolutionary strategy, however, because a neighboring individual with a faster nutrient uptake could absorb most nutrients (Schulze & Chapin 1987). In addition, these modest demands cannot explain slow growth as an adaptation to saline environments or other situations where conditions are stressful for reasons other than low resource supply.

TABLE 10. The effect of a nutrient solution with a high or a low NO_3^- concentration on some growth parameters of an inherently slow-growing species [*Deschampsia flexuosa* (tufted hair-grass)] and a fast-growing one [*Holcus lanatus* (common velvet grass)]

Parameter	High [NO_3^-]		Low [NO_3^-]	
	<i>Deschampsia</i>	<i>Holcus</i>	<i>Deschampsia</i>	<i>Holcus</i>
RGR	97	172	47	66
NAR	6.9	8.5	5.2	4.6
LAR	13	20	9	14
SLA	28	51	24	44

Source: Poorter et al. (1995).

Slow-growing species have also been suggested to function closer to their optimum than fast-growing ones in an adverse environment (Chapin 1980). This explanation suggests that allocation or some other aspects of the plant's physiology at a low nutrient supply is closer to the optimal pattern for inherently slow-growing species than for fast-growing ones. Information on the pattern of allocation, however, indicates that both fast- and slow-growing species allocate their carbon and N in a manner that maximizes their RGR (Van der Werf et al. 1993).

Slow-growing species were thought to incorporate less photosynthates and nutrients into structural biomass. This might allow them to form reserves for later growth, thereby enabling them to maintain physiological integrity during periods of low nutrient availability. As we discuss in Sects. 5.3.3 and 5.4.3, however, under such adverse conditions, growth is restricted before photosynthesis is, and sugars tend to accumulate. Hence, it is unlikely that survival during periods of nutrient shortage depends on storage of photosynthates.

There is also no evidence that slow-growing species have a greater capacity to accumulate nutrients, perhaps with the exception of *P*. Finally, it has been suggested that a high growth rate cannot be realized in a low-resource environment; therefore, a high potential RGR is a selectively neutral trait. As discussed in Sect. 6.2, however, potentially fast-growing species still grow faster than potentially slow-growing ones, even in low-resource environments. This indicates that the potential RGR is not a selectively neutral trait. Even in low-resource environments, fast-growing species attain a larger size more rapidly, which has advantages in terms of their competitive ability and fitness. Although a very high RGR is not attainable, a slightly higher RGR might, therefore, still be advantageous.

6.3.2 Selection on RGR_{max} Itself, or on Traits That Are Associated with RGR_{max} ?

Having scrutinized the various hypotheses accounting for variation in growth potential, we conclude that a low potential growth rate per se does not confer ecological advantage. Why, then, do slow-growing species occur more frequently in unfavorable habitats than do fast-growing ones? An alternative explanation for the observed differences in potential growth rate is that one of the **components linked with RGR**, and not RGR itself, has been the target of selection (Lambers & Poorter 2004).

The most likely traits selected for are those that protect the tissue (**quantitative defense**; Sect. 3.2 of

Chapter 9B on ecological biochemistry). In leaves this is associated with a **low SLA**, which is accounted for by variation in **leaf mass density** (i.e., the amount of dry mass per unit fresh mass). Variation in leaf mass density is largely accounted for by variation in cell-wall thickness, number of sclerenchymatic cells, and the concentration of quantitatively important secondary plant compounds (Sects. 3.2 and 3.3). Variation in these traits is closely correlated with that in RGR (Figs. 3 and 4). In a situation where nutrients are limiting, conservation of the scarce resource is at least as important as its capture (Sect. 4 of Chapter 6 on mineral nutrition). Hence, plants growing under severe nutrient limitation are expected to **conserve their nutrients**. Indeed, low-productivity species are more successful due to less leaf turnover; therefore, nutrient losses are restricted (Sects. 4.3 and 4.4 of Chapter 6 on mineral nutrition). Comparing tree seedlings, a close negative correlation exists between relative growth rate and leaf life span (Reich et al. 1992a,b).

How can **leaf longevity** be increased? This depends on the environmental factor that affects leaf longevity. Herbivory can be reduced by increasing leaf toughness and accumulating palatability-reducing compounds (Sect. 3 of Chapter 9B on ecological biochemistry; Wright et al. 2005). The abrasive effects of high wind speeds can be reduced by investment in fiber and sclerenchyma (Sect. 3.3). Trampling resistance may be the result of a large amount of cell-wall material per cell. Transpiration can be decreased and water-use efficiency can be increased by the construction of leaf hairs or epicuticular waxes (Sect. 2 of Chapter 4A on the plant's energy balance). Epicuticular waxes may also confer disease resistance and diminish deleterious effects of salt spray. Each of these additional investments increases the leaf's longevity, but each also decreases SLA, and therefore diminishes the plant's growth potential, but positively influences its fitness under adverse conditions.

There is considerably less information on root turnover than on leaf turnover, and not enough to generalize about inherent differences associated with a plant's growth potential. We do know, however, that the **tissue mass density** tends to be higher in roots of slow-growing grass species, when compared with that in fast-growing ones which is similar to what has been found for leaves (Ryser & Lambers 1995); this higher root mass density is associated with thicker cell walls. The high tissue mass density might be associated with slow root turnover, but this remains speculative.

Is there any indication that plants without the types of leaf and root adjustment discussed in this

section could not survive in unfavorable habitats? This would require introduction of plants that only differ in one specific trait in different environments. Such isogenic genotypes are rarely available, however, and variation in one trait could be expected to affect related traits. The best ecological information available does support the contention that a decrease in SLA enhances the capacity to survive in more stressful environments (Lambers & Poorter 2004).

6.3.3 An Appraisal of Plant Distribution Requires Information on Ecophysiology

A plant's growth potential is part of a strategy that explains the distribution of a species (Sect. 3). Various hypotheses have been proposed to account for the ecological advantage of a high or low RGR_{max} . As

we learned before, however, when discussing the ecology and physiology of C_4 and CAM plants (Sects. 9 and 10 of Chapter 2A on photosynthesis), and of cluster-root-producing species (Sect. 2.2.5.2 of Chapter 6 on mineral nutrition), detailed information on biochemistry and physiology is essential to fully appreciate a plant's functioning in different environments as well as a species' distribution.

In the present context, we conclude that a thorough **ecophysiological analysis** of inherent variation in RGR has led to greater insight in the **ecological significance** of this trait. Rather than RGR per se, one or more underlying components have been the target of natural selection. This natural selection has inevitably led to variation in maximum RGR and an associated **suite of traits** (Table 11). This analysis also serves to illustrate that a thorough ecophysiological analysis is essential for a full appreciation of a species' strategy.

TABLE 11. Typical characteristics of inherently fast-growing and slow-growing herbaceous C_3 species, summarizing information presented in the text.

Characteristic	Fast-growing species	Slow-growing species
Habitat		
Nutrient supply	High	Low
Potential productivity	High	Low
Morphology and allocation		
Leaf area ratio	High	Low
Specific leaf area	High	Low
Leaf mass ratio	Higher	Lower
Root mass ratio	Lower	Higher
Physiology		
Photosynthesis		
(per unit leaf area)	Equal	Equal
(per unit leaf mass)	High	Low
Carbon use in respiration (% of total C fixed)	Low	High
Ion uptake rate (per unit root mass)	High	Low
Chemical composition		
Concentration of quantitative secondary compounds	Low	High
Concentration of qualitative secondary compounds	Variable	Variable
Other aspects		
Leaf mass density	Low	High
Root mass density	Low	High
Leaf turnover	High	Low
Root turnover	High?	Low?
Leaf longevity	Low	High
Root longevity	Low?	Low?

Note: Unless stated otherwise, the differences refer to plants grown with free access to nutrients. A ? indicates that further study is needed.

7. Growth and Allocation: The Messages About Plant Messages

The numerous examples in this chapter provide a wealth of information on how plants cope with their environment. Plant responses to mild stress are not merely the direct effect of resource deprivation on growth rate. Intricate physiological adjustments that minimize major disturbances in plant metabolism take place. Upon sensing water or nutrient shortage in the root environment, signals are sent to the leaves, which respond in such a way as to minimize deleterious effects. This is a **feedforward response**: an anticipating response in which the rate of a process is affected before large deleterious effects of that process have occurred. Low levels of irradiance are similarly detected, both in developing and in mature leaves, and the signals lead to a feed-forward response that minimizes the effect of growth in the shade.

What do all these examples have in common? They demonstrate that a plant is continuously **sensing** its changing **environment** and using this information to control its physiology and allocation pattern. They indicate that, in general, environment affects growth via chemical or hydraulic messages (**sink control**). We may assume that all plants have this capacity to sense their environment. What makes species different from one another is perhaps the manner in which they are able to **respond**, and not so much the variation in their capacity to sense the environments. The typical response of a ruderal species upon sensing nutrient shortage is to slow down leaf expansion and allocate more resources to root growth; it will promote leaf senescence and so withdraw nutrients from older leaves and use these for its newly developing tissues. A species naturally occurring on nutrient-poor sandplains will use the same signal to slow down the production of new tissues, with less dramatic effects on leaf senescence and allocation pattern. Upon sensing water shortage some plants may similarly respond by severely reducing leaf expansion, and others by shedding some leaves, whereas facultative CAM plants switch from the C₃ or C₄ pathway to the CAM mode. Shade is perceived by shade-avoiding and shade-tolerant plants, but the response to promote stem elongation is typical only for shade-avoiding species.

It is the **variation in responses**, rather than the actual sensing mechanism itself, that must be of paramount importance accounting for a species' **ecological amplitude** as well as in such ecological processes as **succession** and **competition** (Aphalo & Ballaré 1995). Ignoring the capacity of plants to

process and respond to environmental information (and assuming that plants grow until they run out of resources) leads to a distorted view of the process of competition (Ballaré 1999). As neighbors interact, how do the continuous changes in plant form and function, elicited by information-sensing systems, contribute to competitive success? To what extent does the capacity of an individual to adjust its allocation and development contribute to the outcome of competition?

It is not our aim to promote the "Panglossian" view, which is referred to in Chapter 1 on assumptions and approaches, that just because a species exhibits certain traits in a particular environment, these traits must be beneficial and have resulted from natural selection in that environment. We do wish to stress, however, that plants are **information-acquiring systems**, rather than passively responding organisms, and that this capability must not be ignored, as we discuss in Chapter 9E on interactions among plants.

If we aim to understand plant functioning in different environments, information at the cellular and molecular level is of vital importance. Perception of the environment by specific molecules (e.g., phytochrome), followed by transduction of the information and effects on cell growth (e.g., through cell-wall acidification), allows the plant to acclimate to its environment (e.g., shade). In the past decade our understanding of numerous intricate processes has increased enormously. It is to be expected that fascinating progress will be made in the next decade that will allow us both to deepen our understanding of plant performance in an ecological context and to apply this information in breeding new varieties for adverse environments.

References

- Anten, N.P.R., Schieving, F., & Werger, M.J.A. 1995. Patterns of light and nitrogen distribution in relation to whole canopy carbon gain in C₃ and C₄ mono- and dicotyledonous species. *Oecologia* **101**: 504–513.
- Anten, N.P.R., Casado-Garcia, R., & Nagashima, H. 2005. Effects of mechanical stress and plant density on mechanical characteristics, growth, and lifetime reproduction of tobacco plants. *Am. Nat.* **166**: 650–660.
- Antosiewicz, D.M., Purugganan, M.M., Polisensky, D.H., & Braam, J. 1997. Cellular localization of *Arabidopsis* xyloglucan endotransglycosylase-related proteins during development and after wind stimulation. *Plant Physiol.* **115**: 1319–1328.
- Antúnez, I., Retamosa, E.C., Villar, R. 2001. Relative growth rate in phylogenetically related deciduous and evergreen woody species. *Oecologia* **128**: 172–180.

- Aphalo, P.J. & Ballaré, C.L. 1995. On the importance of information-acquiring systems in plant-plant interactions. *Funct. Ecol.* **9**: 5-14.
- Armstrong, W. 1971. Radial oxygen losses from intact rice roots as affected by distance from the apex, respiration and waterlogging. *Physiol. Plant.* **25**: 192-19
- Armstrong, W. 1979. Aeration in higher plants. In: *Advances in botanical research*, Vol. 7, H.W. Woolhouse (ed.). Academic Press, London, pp. 225-332.
- Atkin, O.K. 1996. Reassessing the nitrogen relations of arctic plants: A mini-review. *Plant Cell Environ.* **19**: 695-704.
- Atkin, O.K., Botman, B. & Lambers, H. 1996. The causes of inherently slow growth in alpine plants: An analysis based on the underlying carbon economies of alpine and lowland *Poa* species. *Funct. Ecol.* **10**: 698-700.
- Atwell, B.J. 1989. Physiological responses of lupin roots to soil compaction. In: *Structural and functional aspects of transport in roots*, B.C. Loughman, O. Gasparikova, & J. Kolek (eds.). Kluwer Academic Publishers, Dordrecht, pp. 251-255.
- Avice, J.-C., Ourry, A., Volenec, J.J., Lemaire, G., & Boucaud, J. 1996a. Defoliation-induced changes in abundance and immuno-localization of vegetative storage proteins in taproots of *Medicago sativa*. *Plant Physiol. Biochem.* **34**: 561-570.
- Avice, J.-C., Ourry, A., Lemaire, G., & Boucaud, J. 1996b. Nitrogen and carbon flows estimated by ¹⁵n and ¹³c pulse-chase labeling during regrowth of alfalfa. *Plant Physiol.* **112**: 281-290.
- Ayling, S.M. & Topa, M.A. 1998. Phosphorus compartmentation in *Pinus serotina* Michx. (pond pine); observations from in vivo nuclear magnetic resonance spectroscopy. *Plant Cell Environ.* **21**: 723-730.
- Bacon, M.A., Wilkinson, S., & Davies, W.J. 1998. pH-regulated leaf cell expansion in droughted plants is abscisic acid dependent. *Plant Physiol.* **118**: 1507-1515.
- Bailey-Serres, J. & Voeselek, L.A.C.J. 2008. Flooding stress: Acclimations and genetic diversity. *Annu. Rev. Plant Biol.*, **59**: 313-339.
- Ball, M.C. & Pidsley, S.M. 1995. Growth responses to salinity in relation to distribution of two mangrove species, *Sonneratia alba* and *S. lanceolata*, in northern Australia. *Funct. Ecol.* **9**: 77-85.
- Ballaré, C.L. 1999. Keeping up with the neighbours: Phytochrome sensing and other signalling mechanisms. *Trends Plant Sci.* **4**: 97-102.
- Ballaré, C.L., Scopel, A.L., Roush, M.L., & Radosevich, S.R. 1995. How plants find light in patchy canopies. A comparison between wild-type and phytochrome-B-deficient mutant plants of cucumber. *Funct. Ecol.* **9**: 859-868.
- Banga, M., Blom, C.W.P.M., & Voeselek, L.A.C.J. 1996. Sensitivity to ethylene: The key factor in ethylene production by primary roots of *Zea mays* L. in submergence-induced shoot elongation of *Rumex*. *Plant Cell Environ.* **19**: 1423-1430.
- Bausenwein, U., Millard, P., Thornton, B., & Raven, J.A. 2001. Seasonal nitrogen storage and remobilization in the forb *Rumex acetosa*. *Funct. Ecol.* **15**: 370-37
- Bell, T.L., Pate, J.S., & Dixon, K.W. 1996. Relationship between fire response, morphology, root anatomy and starch distribution in south-west Australian Epacridaceae. *Ann. Bot.* **77**: 357-364.
- Bennie, A.T.P. 1996. Growth and mechanical impedance. In: *Plant roots: The hidden half*, 2nd edition, Y. Waisel, A. Eshel, & U. Kafkaki (eds.). Marcel Dekker, New York, pp. 453-470.
- Bengough, A.C. & Mullins, C.E. 1990a. The resistance experienced by roots growing in a pressurized cell. *Plant Soil* **123**: 73-82.
- Bengough, A.C. & Mullins, C.E. 1990b. Mechanical impedance to root growth: A review of experimental techniques and root growth responses. *J. Soil Sci.* **41**: 341-358.
- Berger, S., Bell, E., Sadka, A., & Mullet, J.E. 1995. *Arabidopsis thaliana Atosp* is homologous to soybean *vspA* and *vspB*, genes encoding vegetative storage protein acid phosphatases, and is regulated similarly by methyl jasmonate, wounding, sugars, light and phosphate. *Plant Mol. Biol.* **27**: 933-942.
- Bloom, A.J., Chapin III, F.S., & Mooney, H.A. 1985. Resource limitation in plants - An economic analogy. *Annu. Rev. Ecol. Syst.* **16**: 363-392.
- Bowen, G.D. 1991. Soil temperature, root growth, and plant function. In: *Plant roots: The hidden half*, 1st edition. Y. Waisel, A. Eshel, & U. Kafkaki (eds.). Marcel Dekker, New York, pp. 309-330.
- Braam, J. & Davis, R.W. 1990. Rain-, wind-, and touch-induced expression of calmodulin and calmodulin-related genes in *Arabidopsis*. *Cell* **60**: 357-364.
- Braam, J., Sistrunk, M.L., Polisensky, D.H., Xu, W., Puruganan, M.M., Antosiewicz, D.M., Campbell, P., & Johnson, K.A. 1996. Life in a changing world: *TCH* gene regulation of expression and responses to environmental signals. *Physiol. Plant.* **98**: 909-91
- Brouwer, R. 1963. Some aspects of the equilibrium between overground and underground plant parts. *Meded. Inst. Biol. Scheikd. Onderzoek Landbouwgewassen* **213**: 31-39.
- Brouwer R. 1983. Functional equilibrium: Sense or nonsense? *Neth. J. Agric. Sci.* **31**: 335-348.
- Butler, W.L., Norris, H.W., & Hendricks, S.B. 1959. Detection, assay, and preliminary purification of the pigment controlling photoresponsive developments of plants. *Proc. Natl. Acad. Sci. USA* **45**: 1703-1708.
- Carpita, N.C. & Gibeaut, D.M. 1993. Structural models of primary cell walls in flowering plants: Consistency of molecular structure with the physical properties of the walls during growth. *Plant J.* **3**: 1-30.
- Castro-Diez, P., Puyravaud, J.P., & Cornelissen, J.H.C. 2000. Leaf structure and anatomy as related to leaf mass per area variation in seedlings of a wide range of woody plant species and types. *Oecologia* **124**: 476-486.
- Ceulemans, R. 1989. Genetic variation in functional and structural productivity components in *Populus*. In: *Causes and consequences of variation in growth rate and productivity of higher plants*, H. Lambers, M.L. Cambridge, H. Konings, & T.L. Pons (eds.). SPB Academic Publishing, The Hague, pp. 69-85.

- Chapin III, F.S. 1980. The mineral nutrition of wild plants. *Annu. Rev. Ecol. Syst.* **11**: 233–260.
- Chapin III, F.S. 1988. Ecological aspects of plant nutrition. *Adv. Min. Nutr.* **3**: 161–191.
- Chapin III, F.S., Follet, J.M., & O'Connor, K.F. 1982. Growth, phosphate absorption, and phosphorus chemical fractions in two *Chionochloa* species. *J. Ecol.* **70**: 305–321.
- Chapin III, F.S., Shaver, G.R., & Kedrowski, R.A. 1986. Environmental controls over carbon, nitrogen and phosphorus fractions in *Eriophorum* in Alaskan tussock tundra. *J. Ecol.* **74**: 167–195.
- Chapin III, F.S., Schulze, E.-D., & Mooney, H.A. 1990. The ecology and economics of storage in plants. *Annu. Rev. Ecol. Syst.* **21**: 423–44
- Chimenti, C.A. & Hall, A.J. 1994. Responses to water stress of apoplastic water fraction and bulk elastic modulus of elasticity in sunflower (*Helianthus annuus* L.) genotypes of contrasting capacity for osmotic adjustment. *Plant Soil* **166**: 101–10
- Cho, H.-T. & Kende, H. 1997a. Expansins in deepwater rice internodes. *Plant Physiol.* **113**: 1137–1143.
- Cho, H.-T. & Kende, H. 1997b. Expansins and internodal growth of deepwater rice. *Plant Physiol.* **113**: 1145–1151.
- Cho, H.-T. & Kende, H. 1997c. Expression of expansin genes is correlated with growth in deepwater rice. *Plant Cell* **9**: 1661–1671.
- Clark, L.J., Whalley, W.R., Dexter, A.R., Barraclough, P.B., & Leigh, R.A. 1996. Complete mechanical impedance increases the turgor of cells in the apex of pea roots. *Plant Cell Environ.* **19**: 1099–1102.
- Clarkson, D.T., Earnshaw, M.J., White, P.J., & Cooper, H.D. 1988. Temperature dependent factors influencing nutrient uptake: An analysis of responses at different levels of organization. In: Plants and temperature, S.P. Long & F.I. Woodward (eds). Company of Biologists, Cambridge, pp. 281–309.
- Clarkson, D.T., Jones, L.H.P., & Purves, J.V. 1992. Absorption of nitrate and ammonium ions by *Lolium perenne* from flowing solution cultures at low root temperatures. *Plant Cell Environ.* **15**: 99–106.
- Clarkson, D.T., Carvajal, M., Henzler, T., Waterhouse, R.N., Smyth, A.J., Cooke, D.T., & Steudle, E. 2000. Root hydraulic conductance: Diurnal aquaporin expression and the effects of nutrient stress. *J. Exp. Bot.* **51**: 61–70.
- Cleland, R.E. 1967. Extensibility of isolated cell walls: Measurements and changes during cell elongation. *Planta* **74**: 197–209.
- Coleman, G.D., Chen, T.H.H., & Fuchigami, L.H. 1992. Complementary DNA cloning of poplar bark storage protein and control of its expression by photoperiod. *Plant Physiol.* **98**: 687–693.
- Colmer, T.D. 2003. Long-distance transport of gases in plants: A perspective on internal aeration and radial oxygen loss from roots. *Plant Cell Environ.* **26**: 17–36.
- Colmer, T.D., Gibberd, M.R., Wiengweera, A., & Tinh, T.K. 1998. The barrier to radial oxygen loss from roots of rice (*Oryza sativa* L.) is induced by growth in stagnant solution. *J. Exp. Bot.* **49**: 1431–1436.
- Comas, L.H. & Eissenstat, D.M. 2004. Linking fine root traits to maximum potential growth rate among 11 mature temperate tree species. *Funct. Ecol.* **18**: 388–39
- Cornelissen, J.H.C., Castro-Diez, P., & Hunt, R. 1996. Seedling growth, allocation and leaf attributes in a wide range of woody plant species and types. *J. Ecol.* **84**: 755–765.
- Cosgrove, D.J. 1999. Enzymes and other agents that enhance cell wall extensibility. *Annu. Rev. Plant Physiol. Plant Mol. Biol.* **50**: 391–41
- Cosgrove, D.J. 2000. Loosening of plant cell walls by expansins. *Nature* **407**: 321–326.
- Cunningham, S.A., Summerhaye, B., & Westoby, M. 1999. Evolutionary divergences in leaf structure and chemistry, comparing rainfall and soil nutrient gradients. *Ecology* **69**: 569–588.
- Cyr, D.R. & Bewley, J.D. 1990. Proteins in the roots of perennial weeds chicory (*Cichorium intybus* L.) and dandelion (*Taraxacum officinale* Weber) are associated with overwintering. *Planta* **182**: 370–374.
- Darwin, C. 1880. The power of movement in plants. John Murray, London.
- Davies, P.J. 2004. (ed.). Plant hormones; biosynthesis, signal transduction, action! Kluwer Academic Publishers, Dordrecht.
- Davies, W.J. & Zhang, J. 1991. Root signals and the regulation of growth and development of plants in drying soil. *Annu. Rev. Plant Physiol. Mol. Biol.* **42**: 55–76.
- Davies, W.J., Tardieu, F., & Trejo, C.L. 1994. How do chemical signals work in plants that grow in drying soil? *Plant Physiol.* **104**: 309–314.
- Dodd, I.C. & Davies, W.J. 1996. The relationship between leaf growth and ABA accumulation in the grass leaf elongation zone. *Plant Cell Environ.* **19**: 1047–1056.
- Dodd, I.C. 2005. Root-to-shoot signalling: Assessing the roles of “up” in the up and down world of long-distance signalling in plants. *Plant Soil* **274**: 251–270.
- Else, M.A., Davies, W.J., Malone, M., & Jackson, M.B. 1995. A negative hydraulic message from oxygen-deficient roots of tomato plants? Influence of soil flooding on leaf water potential. Leaf expansion, and synchrony between stomatal conductance and root hydraulic conductivity. *Plant Physiol.* **109**: 1017–1024.
- Else, M.A., Tiekstra, A.E., Croker, S.J., Davies, W.J., & Jackson, M.B. 1996. Stomatal closure in flooded tomato plants involves abscisic acid and a chemically unidentified anti-transpirant in xylem sap. *Plant Physiol.* **1012**: 239–24
- Emery, R.J.N., Reid, D.M., & Chinnappa 1994. Phenotypic plasticity of stem elongation in two ecotypes of *Stellaria longipes*: The role of ethylene and response to wind. *Plant Cell Environ.* **17**: 691–700.
- Esmon, C.A., Pedmale, U.V., & Liscum, E. 2005 Plant tropisms: Providing the power of movement to a sessile organism. *Int. J. Dev. Biol.* **49**: 665–674.
- Evans, G.C. 1972. The quantitative analysis of plant growth. Blackwell Scientific Publications, Oxford.
- Evans, L.T. 1980. The natural history of crop yield. *Am. Sci.* **68**: 388–39

- Evans, J.R. 1989. Photosynthesis and nitrogen relationships in leaves of C_3 plants. *Oecologia* **78**: 9–19.
- Farrar, J.F. 1996. Regulation of root weight ratio is mediated by sucrose. *Plant Soil* **185**: 13–19.
- Fasano, J.M., Massa, G.D., & Gilroy, S. 2002. Ionic signaling in plant responses to gravity and touch. *J. Plant Growth Regul.* **21**: 71–88.
- Fetene, M. & Beck, E. 1993. Reversal of direction of photosynthate allocation in *Urtica dioica* L. plants by increasing cytokinin import into the shoot. *Bot. Acta.* **106**: 235–240.
- Fichtner, K. & Schulze, E.-D. 1992. The effect of nitrogen nutrition on growth and biomass partitioning of annual plants originating from habitats of different nitrogen availability. *Oecologia* **92**: 236–241.
- Field, C.B. 1991. Ecological scaling of carbon gain to stress and resource availability. In: Integrated responses of plants to stress, H.A. Mooney, W.E. Winner, & E.J. Pell (eds.). Academic Press, San Diego, pp. 35–65.
- Fondy, B.R. & Geiger, D.R. 1985. Diurnal changes in allocation of newly fixed carbon in exporting sugar beet leaves. *Plant Physiol.* **78**: 753–757.
- Fonseca, F., Den Hertog, J., & Stulen, I. 1996. The response of *Plantago major* ssp. *pleiosperma* to elevated CO_2 is modulated by the formation of secondary shoots. *New Phytol.* **133**: 627–635.
- Franklin, K.A. & Whitelam, G.C. 2004. Light signals, phytochromes and cross-talk with other environmental cues. *J. Exp. Bot.* **55**: 271–276.
- Fry, S.C. 2004. Primary cell wall metabolism: Tracking the careers of wall polymers in living plant cells. *New Phytol.* **161**: 641–675.
- Garnier, E. 1991. Resource capture, biomass allocation and growth in herbaceous plants. *Trends Ecol. Evol.* **6**: 126–131.
- Garnier, E. 1992. Growth analysis of congeneric annual and perennial grass species. *J. Ecol.* **80**: 665–675.
- Garnier, E. & Laurent, G. 1994. Leaf anatomy, specific leaf mass and water content in congeneric annual and perennial grass species. *New Phytol.* **128**: 725–736.
- Garnier, E. & Vancaeyzeele, S. 1994. Carbon and nitrogen content of congeneric annual and perennial grass species: Relationships with growth. *Plant Cell Environ.* **17**: 399–409.
- Garnier, E., Gobin, O., & Poorter, H. 1995. Interspecific variation in nitrogen productivity depends on photosynthetic nitrogen use efficiency and nitrogen allocation within the plant. *Ann. Bot.* **76**: 667–672.
- Garthwaite, A.J., Von Bothmer, R., & Colmer, T.D. 2003. Diversity in root aeration traits associated with waterlogging tolerance in the genus *Hordeum*. *Funct. Plant Biol.* **30**: 875–889.
- Gastal, F., Belanger, G., & Lemaire, G. 1992. A model of the leaf extension rate of tall fescue in response to nitrogen and temperature. *Ann. Bot.* **70**: 437–442.
- Goulas, E., Richard-Molard, C., Le Dily, F., Le Dantec, C., Ozouf, J., & Ourry, A. 2007. A cytosolic vegetative storage protein (TrVSP) from white clover is encoded by a cold-inducible gene. *Physiol. Plant.* **129**: 567–577.
- Gowing, D.J.G., Davies, W.J., & Jones, H.G. 1990. A positive root-sourced signal as an indicator of soil drying in apple, *Malus x domestica* Borkh. *J. Exp. Bot.* **41**: 1535–1540.
- Green, P.B. 1976. Growth and cell pattern formation on an axis: Critique of concepts, terminology, and mode of study. *Bot. Gaz.* **137**: 187–202.
- Grime, J.P. 1979. Plant strategies and vegetation processes. John Wiley, Chichester.
- Grime, J.P. & Hunt, R. 1975. Relative growth-rate: Its range and adaptive significance in a local flora. *J. Ecol.* **63**: 393–422.
- Groeneveld, H.W. & Bergkotte, M. 1996. Cell wall composition of leaves of an inherently fast- and a slow-growing grass species. *Plant Cell Environ.* **19**: 1389–1398.
- Hamza, M.A. & Anderson, W.K. 2005. Soil compaction in cropping systems: A review of the nature, causes and possible solutions. *Soil & Tillage Research* **82**: 121–145.
- Harpham, N.V.J., Berry, A.W., Knee, E.M., Roveda-Hoyos, G., Raskin, I., Sanders, I.O., Smith, A.R., Wood, C.K. & Hall, M.A. 1991. The effect of ethylene on the growth and development of wild-type and mutant *Arabidopsis thaliana* (L.) Heynh. *Ann. Bot.* **68**: 55–61.
- Hart, R. 1977. Why are biennials so few? *Am. Nat.* **111**: 792–799.
- Hay, R.K.M. 1990. The influence of photoperiod on the dry-matter production of grasses and cereals. *New Phytol.* **116**: 233–254.
- He, T. & Cramer, G.R. 1996. Abscisic acid concentrations are correlated with leaf area reductions in two salt-stressed rapid-cycling *Brassica* species. *Plant Soil* **179**: 25–33.
- Heilmeier, H. & Monson, R.K. 1994. Carbon and nitrogen storage in herbaceous plants. In: A whole-plant perspective on carbon-nitrogen interactions, J. Roy & E. Garnier (eds.) SPB Academic Publishing, The Hague, pp. 149–171.
- Heilmeier, H., Schulze, E.-D., & Whale, D.M. 1986. Carbon and nitrogen partitioning in the biennial monocarp *Arcium tomentosum* Mill. *Oecologia* **70**: 466–474.
- Hirose, T. & Werger, M.J.A. 1987a. Maximizing daily canopy photosynthesis with respect to leaf nitrogen allocation pattern in the canopy. *Oecologia* **72**: 520–526.
- Hirose, T. and Werger, M.J.A. 1987b. Nitrogen use efficiency in instantaneous and daily photosynthesis of leaves in the canopy of a *Solidago altissima* stand. *Physiol. Plant.* **70**: 215–222.
- Hsiao, T.C., French, J., & Rojas-Lara, B.A. 1998. The pressure-jump technique shows maize leaf growth to be enhanced by increases in turgor only when water status is not too high. *Plant Cell Environ.* **21**: 22–42.
- Hübel, F. & Beck, E. 1996. Maize root phytase. Purification, characterization, and localization of enzyme activity and its putative substrate. *Plant Physiol.* **112**: 1429–1436.
- Hussain, A., Black, C.R., Taylor, I.B., Mulholland, B.J., & Roberts, J.A. 1999. Novel approaches for examining the effects of differential soil compaction on xylem sap abscisic acid concentration, stomatal conductance and growth in barley (*Hordeum vulgare* L.). *Plant Cell Environ.* **22**: 1377–1388.
- Hussain, A., Black, C.R., Taylor, I.B., & Roberts, J.A. 2000. Does an antagonistic relationship between ABA and

- ethylene mediate shoot growth when tomato (*Lycopersicon esculentum* Mill.) plants encounter compacted soil? *Plant Cell Environ.* **23**: 1217–1226.
- Jackson, S.D., James, P., Prat, S. & Thomas, B. 1998. Phytochrome B affects the levels of a graft-transmissible signal involved in tuberization. *Plant Physiol.* **117**: 29–32.
- Jaffe, M.J. & Forbes, S. 1993. Thigmomorphogenesis: The effects of mechanical perturbation on plants. *Plant Growth Regul.* **12**: 313–324.
- Jiao, Y., Lau, O.S., & Deng, X.W. 2007. Light-regulated transcriptional networks in higher plants. *Nature* **8**: 217–230.
- Jonasson, S. & Chapin III, F.S. 1985. Significance of sequential leaf development for nutrient balance of the cotton sedge, *Eriophorum vaginatum* L. *Oecologia* **67**: 511–518.
- Juntilla, O., Heide, O.M., Lindgard, B., & Ernstein, A. 1997. Gibberellins and the photoperiodic control of leaf growth in *Poa pratensis*. *Physiol. Plant.* **101**: 599–605.
- Kende H., Van der Knaap, E., & Cho H.T. 1998. Deepwater rice: A model plant to study stem elongation. *Plant Physiol.* **118**: 1105–1110.
- Kigel, J. & Cosgrove, D.J. 1991. Photoinhibition of stem elongation by blue and red light. Effects on hydraulic and cell wall properties. *Plant Physiol.* **95**: 1049–1056.
- Kitajima, K. 1994. Relative importance of photosynthetic traits and allocation patterns as correlates of seedling shade tolerance of 13 tropical trees. *Oecologia* **98**: 419–428.
- Kitajima, K. 1996. Ecophysiology of tropical tree seedling. In: Tropical forest plant ecophysiology, S. Mulkey, R. Chazdon, & A. Smith (eds.). Chapman & Hall, New York, pp. 559–596.
- Knight, M.R., Campbell, A.K., Smith, S.M., & Trewavas, A.J. 1991. Transgenic plant aequorin reports the effects of touch and cold-shock and elicitors on cytoplasmic calcium. *Nature* **352**: 524–526.
- Knight, M.R., Smith, S.M., & Trewavas, A.J. 1992. Wind-induced plant motion immediately increases cytosolic calcium. *Proc. Natl. Acad. Sci. USA* **89**: 4967–4971.
- Kraus, E., Kollöffel, C., & Lambers, H. 1994. The effect of handling on photosynthesis, transpiration, respiration, and nitrogen and carbohydrate content of populations of *Lolium perenne*. *Physiol. Plant.* **91**: 631–638.
- Kuiper, D. & Staal, M. 1987. The effect of exogenously supplied plant growth substances on the physiological plasticity in *Plantago major* ssp. *major*: Responses of growth, shoot to root ratio and respiration. *Physiol. Plant.* **69**: 651–658.
- Kuiper, D., Kuiper, P.J.C., Lambers, H., Schuit, J.T., & Staal, M. 1989. Cytokinin contents in relation to mineral nutrition and benzyladenine addition in *Plantago major* ssp. *pleiosperma*. *Physiol. Plant.* **75**: 511–51
- Kuo, T. & Boersma, L. 1971. Soil water suction and root temperature effects on nitrogen fixation in soybeans. *Agron. J.* **63**: 901–904.
- Lambers, H. & Poorter, H. 2004. Inherent variation in growth rate between higher plant: A search for physiological causes and ecological consequences. *Adv. Ecol. Res.* **34**: 283–362.
- Lambers, H., Cambridge, M.L., Konings, H., & Pons, T.L. (eds.) 1989. Causes and consequences of variation in growth rate and productivity of higher plants. SPB Academic Publishing, The Hague.
- Langheinrich, U. & Tischner, R. 1991. Vegetative storage proteins in poplar. Induction and characterization of a 32- and a 36-kilodalton polypeptide. *Plant Physiol.* **97**: 1017–1025.
- Lee, R.B., Ratcliffe, R.G., & Southon, T.E. 1990. ³¹P NMR measurements of the cytoplasmic and vacuolar P_i content of mature maize roots: Relationships with phosphorus status and phosphate fluxes. *J. Exp. Bot.* **41**: 1063–1078.
- Leigh, R.A. & Tomos, A.D. 1983. An attempt to use isolated vacuoles to determine the distribution of sodium and potassium in cells of storage roots of red beet (*Beta vulgaris* L.). *Planta* **159**: 469–475.
- Leon, A.J., Lee, M., & Andrade, F.H. 2001. Quantitative trait loci for growing degree days to flowering and photoperiod response in sunflower (*Helianthus annuus* L.). *Theor. Appl. Genet.* **102**: 497–503.
- Leverenz, J.W. 1992. Shade shoot structure and productivity of evergreen conifer stands. *Scand. J. For. Res.* **7**: 345–353.
- Li, X., Feng, Y., & Boersma, L. 1994. Partitioning of photosynthates between shoot and root in spring wheat (*Triticum aestivum* L.) as a function of soil water potential and root temperature. *Plant Soil* **164**: 43–50.
- Luo, Y., Hui, D., & Zhang, D. 2006. Elevated CO₂ stimulates net accumulations of carbon and nitrogen in land ecosystems: A meta-analysis. *Ecology* **87**: 53–63.
- MacAdam, J.W., Volenec, J.J., & Nelson, C.J. 1989. Effects of nitrogen supply on mesophyll cell division and epidermal cell elongation in tall fescue leaf blades. *Plant Physiol.* **89**: 549–556.
- McDonald, M.P., Galwey, N.W., & Colmer, T.D. 2002. Similarity and diversity in adventitious root anatomy as related to root aeration among a range of wetland and dryland grass species. *Plant Cell Environ.* **25**: 441–451.
- Maranon, T. & Grub, P.J. 1993. Physiological basis and ecological significance of the seed size and relative growth rate relationship in Mediterranean annuals. *Funct. Ecol.* **7**: 591–599.
- Materechera, S.A., Alston, A.M., Kirby, J.M., & Dexter, A.R. 1993. Field evaluation of laboratory techniques for predicting the ability of roots to penetrate strong soil and of the influence of roots on water absorptivity. *Plant Soil* **149**: 149–158.
- McArthur, R.H. & Wilson, E.O. 1967. The theory of island biogeography. Princeton University Press, Princeton.
- Meuriot, F., Noquet, C., Avicé, J.-C., Volenec, J.J., Cunningham, S.M., Sors, T.G., Caillot, S., & Ourry, A. 2004. Methyl jasmonate alters N partitioning, N reserves accumulation and induces gene expression of a 32-kDa vegetative storage protein that possesses chitinase activity in *Medicago sativa* taproots. *Physiol. Plant.* **120**: 113–123.
- Millard, P. 1988. The accumulation and storage of nitrogen by herbaceous plants. *Plant Cell Environ.* **11**: 1–8.

- Mommer, L., Pedersen, O., & Visser, E.J.W. 2004. Acclimation of a terrestrial plant to submergence facilitates gas exchange under water. *Plant Cell Environ.* **27**: 1281–1288
- Mommer, L., Pons, T.L., Wolters-Arts, M., Venema, J.H., & Visser, E.J.W. 2005. Submergence-induced morphological, anatomical, and biochemical responses in a terrestrial species affect gas diffusion resistance and photosynthetic performance. *Plant Physiol.* **139**: 497–508.
- Mooney, H.A. & Rundel, P.W. 1979. Nutrient relations of the evergreen shrub, *Adenostoma fasciculatum*, in the California chaparral. *Bot. Gaz.* **140**: 109–113.
- Morvan-Bertrand, A., Pavis, N., Boucaud, J., & Prud'homme, M.-P. 1999. Partitioning of reserve and newly assimilated carbon in roots and leaf tissue of *Lolium perenne* during regrowth after defoliation: Assessment by ¹³C steady-state labelling and carbohydrate analysis. *Plant Cell Environ.* **22**: 1097–1108.
- Munns, R. & Cramer, G.R. 1996. Is coordination of leaf and root growth mediated by abscisic acid? *Plant Soil* **185**: 33–49.
- Munns, R. & Sharp, R.E. 1993. Involvement of abscisic acid in controlling plant growth in soil of low water potential. *Aust. J. Plant Physiol.* **20**: 425–43
- Neumann, P.M., Azaizeh, H., & Leon, D. 1994. Hardening of root cell walls: A growth inhibitory response to salinity stress. *Plant Cell Environ.* **17**: 303–309.
- Okamoto, A. & Okamoto, H. 1995. Two proteins regulate the cell-wall extensibility and the yield threshold in glycerinated hollow cylinders of cowpea hypocotyl. *Plant Cell Environ.* **18**: 827–830.
- Okamoto, A., Katsumi, M., & Okamoto, H. 1995. The effects of auxin on the mechanical properties in vivo of cell wall in hypocotyl segments from gibberellin-deficient cowpea seedlings. *Plant Cell Physiol.* **36**: 645–651.
- Olszewski, N., Sun, T., & Gubler, F. 2002. Gibberellin signaling: Biosynthesis, catabolism, and response pathways. *Plant Cell Suppl.* S61–S80.
- Parsons, R.F. 1968. The significance of growth-rate comparisons for plant ecology. *Am. Nat.* **102**: 595–59
- Passioura, J.B. 1988. Root signals control leaf expansion in wheat seedlings growing in drying soil. *Aust. J. Plant Physiol.* **15**: 687–693.
- Passioura, J.B. 1994. The physical chemistry of the primary cell wall: Implications for the control of expansion rate. *J. Exp. Bot.* **45**: 1675–1682.
- Passioura, J.B. & Fry, S.C. 1992. Turgor and cell expansion: Beyond the Lockhart equation. *Aust. J. Plant Physiol.* **19**: 565–576.
- Peeters, A.J.M., Cox, M.C.H., Benschop, J.J., Vreeburg, R.A.M., Bou, J., Voeseek, L.A.C.J. 2002. Submergence research using *Rumex palustris* as a model; looking back and going forward. *J. Exp. Bot.* **53**: 391–398.
- Peng, J. & Harberd, P. 1997. Gibberellin deficiency and response mutations suppress the stem elongation phenotype of phytochrome-deficient mutants of *Arabidopsis*. *Plant Physiol.* **113**: 1051–1058.
- Pianka, E.R. 1970. On r and K selection. *Am. Nat.* **104**: 592–59
- Pons, T.L. 1977. An ecophysiological study in the field layer of ash coppice. II. Experiments with *Geum urbanum* and *Cirsium palustre* in different light intensities. *Acta Bot. Neerl.* **26**: 29–42.
- Pons, T.L. & Bergkotte, M. 1996. Nitrogen allocation in response to partial shading of a plant: Possible mechanisms. *Physiol. Plant.* **98**: 571–57
- Pons, T.L., Schieving, F., Hirose, T., & Werger, M.J.A. 1989. Optimization of leaf nitrogen allocation for canopy photosynthesis in *Lysimachia vulgaris*. In: Causes and consequences of variation in growth rate and productivity of higher plants, H. Lambers, M.L. Cambridge, H. Konings, & T.L. Pons (eds.). SPB Academic Publishing, The Hague, pp. 175–186.
- Poorter, H. & Remkes, C. 1990. Leaf area ratio and net assimilation rate of 24 wild species differing in relative growth rate. *Oecologia* **83**: 553–559.
- Poorter, H. Remkes, C., & Lambers, H. 1990. Carbon and nitrogen economy of 24 wild species differing in relative growth rate. *Plant Physiol.* **94**: 621–72
- Poorter, H., Gifford, R.M., Kriedemann, P.E., & Wong, S.C. 1992. A quantitative analysis of dark respiration and carbon content as factors in the growth response of plants to elevated CO₂. *Aust. J. Bot.* **40**: 501–513.
- Poorter, H., Van de Vijver, C.A.D.M., Boot, R.G.A., & Lambers, H. 1995. Growth and carbon economy of a fast-growing and a slow-growing grass species as dependent on nitrate supply. *Plant Soil* **171**: 217–22
- Poorter, H., Roumet, C., & Campbell, B.D. 1996. Interspecific variation in the growth response of plants to elevated CO₂: A search for functional types. In: Biological diversity in a CO₂-rich world, C. Körner & F.A. Bazzaz (eds.). Physiological ecology series, Academic Press, San Diego, pp. 375–412.
- Poot, P. & Lambers, H. 2003. Are trade-offs in allocation pattern and root morphology related to species abundance? A congeneric comparison between rare and common species in the SW Australian flora. *J. Ecol.* **91**: 58–6
- Poot, P. & Lambers, H. 2008. Shallow-soil endemics: Adaptive advantages and constraints of a specialized root-system morphology. *New Phytol.* **175**: 371–381.
- Pritchard, J. 1994. The control of cell expansion in roots. *New Phytol.* **127**: 3–2
- Pritchard, J., Fricke, W., & Tomos, D. 1996. Turgor-regulation during extension growth and osmotic stress of maize roots. An example of single-cell mapping. *Plant Soil* **187**: 11–21.
- Quail, P.H., Boylan, M.T., Parks, B.M., Short, T.W., Xu, Y., & Wagner, D. 1995. Phytochromes: Photosensory perception and signal transduction. *Science* **268**: 675–680.
- Rappoport, H.F. & Loomis, R.S. 1985. Interaction of storage root and shoot in grafted sugarbeet and chard. *Crop Sci.* **25**: 1079–1084.
- Reich, P.B., Uhl, C., Walters, M.B., & Ellsworth, D.S. 1991. Leaf life-span as a determinant of leaf structure and function among 23 Amazonian tree species. *Oecologia* **86**: 16–24.
- Reich, P.B., Walters, M.B., & Ellsworth, D.S. 1992a. Leaf life-span in relation to leaf, plant and stand characteristics among diverse ecosystems. *Ecol. Monogr.* **62**: 365–392.

- Reich, P.B., Walters, M.B., & Ellsworth, D.S. 1992b. Leaf life-span in relation to leaf, plant and stand characteristics among diverse ecosystems. *Ecol. Monogr.* **62**: 365–392.
- Reski, R. 2006. Small molecules on the move: Homeostasis, crosstalk, and molecular action of phytohormones. *Plant Biol.* **8**: 277–280.
- Rosnitschek-Schimmel, I. 1983. Biomass and nitrogen partitioning in a perennial and an annual nitrophilic species of *Urtica*. *Z. Pflanzensphysiol.* **109**: 215–225.
- Russel, G. & Grace, J. 1978. The effects of wind on grasses. V. Leaf extension, diffusive conductance, and photosynthesis in the wind tunnel. *J. Exp. Bot.* **29**: 1249–1258.
- Russel, G. & Grace, J. 1979. The effects of windspeed on the growth of grasses. *J. Appl. Ecol.* **16**: 507–514.
- Ryser, P. & Lambers, H. 1995. Root and leaf attributes accounting for the performance of fast- and slow-growing grasses at different nutrient supply. *Plant Soil* **170**: 251–265.
- Ryser, P. & Eek, L. 2000. Consequences of phenotypic plasticity vs. interspecific differences in leaf and root traits for acquisition of aboveground and belowground resources. *Am. J. Bot.* **87**: 402–411.
- Saab, I.N. & Sachs, M.N. 1996. A flooding-induced xyloglucan endo-transglycosylase homolog in maize is responsive to ethylene and associated with aerenchyma. *Plant Physiol.* **112**: 385–391.
- Saab, I.N., Sharp, R.R., Pritchard, J., & Voetberg, G.S. 1990. Increased endogenous abscisic acid maintains primary root growth and inhibits shoot growth of maize seedlings at low water potentials. *Plant Physiol.* **93**: 1329–1336.
- Sauter, J.J. & Van Cleve, B. 1990. Biochemical, immunochemical, and ultrastructural studies of protein storage in poplar (*Populus xcanadensis* "robusta" wood. *Planta* **183**: 92–100.
- Scheible, W.-R., Lauerer, M., Schulze, E.-D., Caboche, M., & Stitt, M. 1997. Accumulation of nitrate in the shoot acts as a signal to regulate shoot-root allocation in tobacco. *Plant J.* **11**: 671–691.
- Schnyder, H. & De Visser, R. 1999. Fluxes of reserve-derived and currently assimilated carbon and nitrogen in perennial ryegrass recovering from defoliation. The regrowing tiller and its component functionally distinct zones. *Plant Physiol.* **119**: 1423–1436.
- Schulze, E.-D. & Chapin III, F.S. 1987. Plant specialization to environments of different resource availability. In: Potentials and limitations of ecosystem analysis, E.-D. Schulze & H. Zwölfer (eds.). Springer-Verlag, Berlin. pp. 120–148.
- Setter, T.L. & Belford, B. 1990. Waterlogging: How it reduces plant growth and how plants can overcome its effects. *W.A. J. Agric.* **31**: 51–55
- Setter, T.L. & Laureles, E.V. 1996. The beneficial effect of reduced elongation growth on submergence tolerance of rice. *J. Exp. Bot.* **47**: 1551–1559.
- Sharp, R.E. 2002. Interaction with ethylene: Changing views on the role of abscisic acid in root and shoot growth responses to water stress. *Plant Cell Environ.* **25**: 211–222.
- Sharp, R.E., Poroyko, V., Hejlek, L.G., Spollen, W.G., Springer, G.K., Bohnert, H.J., & Nguyen, H.T. 2004. Root growth maintenance during water deficits: Physiology to functional genomics. *J. Exp. Bot.* **55**: 2343–2351.
- Siefritz, F., Otto, B., Bienert, G.P., Van der Krol, A., & Kaldenhoff, R. 2004. The plasma membrane aquaporin NtAQP1 is a key component of the leaf unfolding mechanism in tobacco. *Plant J.* **37**: 147–155.
- Simpson, R.J., Lambers, H., Beilharz, V.C., & Dalling, M.J. 1982a. Translocation of nitrogen in a vegetative wheat plant (*Triticum aestivum*). *Physiol. Plant.* **56**: 11–1
- Simpson, R.J., Lambers, H., & Dalling, M.J. 1982b. Kinetin application to roots and its effects on uptake, translocation and distribution of nitrogen in wheat (*Triticum aestivum*) grown with a split root system. *Physiol. Plant.* **56**: 430–435.
- Simpson, R.J., Lambers, H., & Dalling, M.J. 1983. Nitrogen redistribution during grain growth in wheat (*Triticum aestivum* L.). IV. development of a quantitative model of the translocation of nitrogen to the grain. *Plant Physiol.* **71**: 7–14.
- Smith, H. 1981. Adaptation to shade. In: Physiological processes limiting plant productivity, C.B. Johnson (ed.). Butterworths, London, pp. 159–173.
- Smith, H. 2000. Phytochromes and light signal perception by plants – An emerging synthesis. *Nature* **407**: 585–591.
- Snir, N. & Neumann, P.M. 1997. Mineral nutrient supply, cell wall adjustment and the control of leaf growth. *Plant Cell Environ.* **20**: 239–246.
- Staswick, P.E. 1988. Soybean vegetative storage protein structure and gene expression. *Plant Physiol.* **87**: 250–254.
- Staswick, P.E. 1990. Novel regulation of vegetative storage protein genes. *Plant Cell* **2**: 1–6.
- Staswick, P.E., Huang, J.-F., & Rhee, Y. 1991. Nitrogen and methyl jasmonate induction of soybean vegetative storage protein genes. *Plant Physiol.* **96**: 130–136.
- Steingröver, E. 1981. The relationship between cyanide-resistant root respiration and the storage of sugars in the taproot in *Daucus carota* L. *J. Exp. Bot.* **32**: 911–919.
- Stirzaker, R.J., Passioura, J.B., & Wilms, Y. 1996. Soil structure and plant growth: Impact of bulk density and biopores. *Plant Soil* **185**: 151–162.
- Stulen, I. & Den Hertog, J. 1993. Root growth and functioning under atmospheric CO₂ enrichment. *Vegetatio* **104/105**: 99–115.
- Summers, J.E., & Jackson, M.B. 1994. Anaerobic conditions strongly promote extension by stems of overwintering tubers of *Potamogeton pectinatus* L. *J. Exp. Bot.* **45**: 1309–1318.
- Tardieu, F., Zhang, J., Katerji, N., Bethenod, O., Palmer, S., & Davies, W.J. 1992. Xylem ABA controls the stomatal conductance of field-grown maize subjected to soil compaction or soil drying. *Plant Cell Environ.* **15**: 193–19
- Terashima, I., Hanba, Y.T., Tazoe, Y., Vyas, P., & Yano, S. 2006. Irradiance and phenotype: Comparative eco-development of sun and shade leaves in relation to photosynthetic CO₂ diffusion. *J. Exp. Bot.* **57**: 343–354.
- Ternesi, M., Andrade, A.P., Jorin, J., & Benlloch, M. 1994. Root-shoot signalling in sunflower plants with confined root systems. *Plant Soil* **166**: 31–36.
- Terry, N. 1970. Developmental physiology of sugar-beet. II. Effect of temperature and nitrogen supply on the

- growth, soluble carbohydrate content and nitrogen content of leaves and roots. *J. Exp. Bot.* **21**: 477–496.
- Thonat, C., Mathieu, C., Crevecoeur, M., Penel, C., Gaspar, T., & Boer, N. 1997. Effects of a mechanical stimulation on localization of annexin-like proteins in *Bryonia dioica* internodes. *Plant Physiol.* **114**: 981–988.
- Todd, G.W., Chadwick, D.L., & Tsai, S.-D. 1972. Effect of wind on plant respiration. *Physiol. Plant.* **27**: 342–346.
- Touraine, B., Clarkson, D.T., & Muller, B. 1994. Regulation of nitrate uptake at the whole plant level. In: A whole-plant perspective on carbon-nitrogen interactions, J. Roy & E. Garnier (eds.), SPB Academic Publishing, The Hague, pp. 11–30.
- Tyerman, S.D., Niemietz, C.M., & Bramley, H. 2002. Plant aquaporins: Multifunctional water and solute channels with expanding roles. *Plant Cell Environ.* **25**: 173–194.
- Van Arendonk, J.J.C.M. & Poorter, H. 1994. The chemical composition and anatomical structure of leaves of grass species differing in relative growth rate. *Plant Cell Environ.* **17**: 963–970.
- Van Arendonk, J.J.C.M., Niemann, G.J., Boon, J.J., & Lambers, H. 1997. Effects of N-supply on anatomy and chemical composition of leaves of four grass species, belonging to the genus *Poa*, as determined by image-processing analysis and pyrolysis-mass spectrometry. *Plant Cell Environ.* **20**: 881–89
- Van den Boogaard, R., Goubitz, S., Veneklaas, E.J., & Lambers, H. 1996. Carbon and nitrogen economy of four *Triticum aestivum* cultivars differing in relative growth rate and water use efficiency. *Plant Cell Environ.* **19**: 998–1004.
- Van der Werf, A. 1996. Growth analysis and photoassimilate partitioning. In: Photoassimilate distribution in plants and crops: Source-sink relationships, E. Zamski & A.A. Schaffer (eds.). Marcel Dekker, New York, pp. 1–20.
- Van der Werf, A. & Nagel, O.W. 1996. Carbon allocation to shoots and roots in relation to nitrogen supply is mediated by cytokinins and sucrose. *Plant Soil* **185**: 21–32.
- Van der Werf, A., Schieving, F. & Lambers, H. 1993. Evidence for optimal partitioning of biomass and nitrogen at a range of nitrogen availabilities for a fast- and slow-growing species. *Funct. Ecol.* **7**: 63–74.
- Van Volkenburgh, E. 1994. Leaf and shoot growth. In: Physiology and determination of crop yield, K.J. Boote, J.M. Bennet, T.R. Sinclair, & G.M. Paulsen (eds.). American Society of Agronomy, Crop Science Society of America, Soil Science Society of America, Madison, pp. 101–120.
- Van Volkenburgh, E. & Boyer, J.S. 1985. Inhibitory effects of water deficit on maize leaf elongation. *Plant Physiol.* **77**: 190–194.
- Vervuren, P.J.A., Blom, C.W.P.M., & De Kroon, H. 2003. Extreme flooding events on the Rhine and the survival and distribution of riparian plant species. *J. Ecol.* **91**: 135–146.
- Visser, E.J.W., Cohen, J.D., Barendse, G.W.M., Blom, C.W.P.M., & Voeselek, L.A.C.J. 1996. An ethylene-mediated increase in sensitivity to auxin induces adventitious root formation in flooded *Rumex palustris* Sm. *Plant Physiol.* **112**: 1687–1692.
- Visser, E.J.W., Colmer, T.D., Blom, C.W.P.M., & Voeselek, L.A.C.J. 2000. Changes in growth, porosity, and radial oxygen loss from adventitious roots of selected mono- and dicotyledonous wetland species with contrasting types of aerenchyma. *Plant Cell Environ.* **23**: 1237–1245.
- Voeselek, L.A.C.J., Benschop, J.J., Bou i Torrent, J., Cox, M. C.H., Groeneveld, H.W., Millenaar, F.F., Vreeburg, R.A. M., Peeters, A.J.M. 2003. Interactions between plant hormones regulate submergence-induced shoot elongation in the flooding tolerant dicot *Rumex palustris*. *Ann. Bot.* **91**: 205–211.
- Voeselek, L.A.C.J., Rijnders, J.H.G.M., Peeters, A.J.M., Van de Steeg, H.M.V., & De Kroon, H. 2004. Plant hormones regulate fast shoot elongation under water: From genes to communities. *Ecology* **85**: 16–2
- Voeselek, L.A.C.J., Colmer, T.D., Pierik, R., Millenaar, F.F., & Peeters, A.J.M. 2006. How plants cope with complete submergence. *New Phytol.* **170**: 213–226.
- Vriezen, W.H., Van Rijn, C.P.E., Voeselek, L.A.C.J., & Mariani, C. 199 A homologue of the *Arabidopsis thaliana* *ERS* gene is actively regulated in *Rumex palustris* upon flooding. *Plant J.* **11**: 1265–1271.
- Went, F.W. 1926. On growth-accelerating substances in the coleoptile of *Avena sativa*. *Proc. Koninkl. Ned. Akad. Wetensch. Ser. C.* **30**: 10–19.
- Wahl, S. & Ryser, P. 2000. Root tissue structure is linked to ecological strategies of grasses. *New Phytol.* **148**: 459–471.
- Wong, S.C. 1993. Interaction between elevated atmospheric concentration of CO₂ and humidity on plant growth: Comparison between cotton and radish. *Vegetatio* **104/5**: 211–221.
- Witkowski, E.T.F. & Lamont, B.B. 1991. Leaf specific mass confounds leaf density and thickness. *Oecologia* **88**: 486–493.
- Wright, I.J., Reich, P.B., Cornelissen, J.H.C., Falster, D.S., Groom, P.K., Hikosaka, K., Lee, W., Lusk, C.H., Niinemets, U., Oleksyn, J., Osada, N., Poorter, H., Warton, D.I., & Westoby, M. 2005. Modulation of leaf economic traits and trait relationships by climate. *Global Ecol. Biogeog.* **14**: 411–421.
- Wu, Y., Sharp, R.E., Durachko, D.M., & Cosgrove, D.J. 1996. Growth maintenance of the maize primary root at low water potentials involves increases in cell-wall extension properties, expansin activity, and wall susceptibility to expansins. *Plant Physiol.* **111**: 765–772.
- Yano, S. & Terashima, I. 2001. Separate localization of light signal perception for sun or shade type chloroplast and palisade tissue differentiation in *Chenopodium album*. *Plant Cell Physiol.* **42**: 1303–1310.
- Yano, S. & Terashima, I. 2004. Developmental process of sun and shade leaves in *Chenopodium album* L. *Plant Cell Environ.* **27**: 781–793.
- Yokota, T. 1997. The structure, biosynthesis and function of brassinosteroids. *Trends Plant Sci.* **2**: 137–143.
- Zhu, G.L. & Boyer, J.S. 1992. Enlargement in *Chara* studied with a turgor clamp. Growth rate is not determined by turgor. *Plant Physiol.* **100**: 2071–2080.

8

Life Cycles: Environmental Influences and Adaptations

1. Introduction

Previous chapters have emphasized the physiological responses of mature plants to their environment. The environmental stresses encountered and optimal physiological solutions, however, can change dramatically as plants develop from the seedling to vegetative and reproductive phases. Following germination, most species pass through several distinctive life phases: **seedling** (loosely defined as the stage during which cotyledons are still present), **vegetative** (sometimes with a juvenile phase preceding the adult phase), and **reproductive**. This chapter addresses the major ecophysiological changes that occur in the life cycles of plants. These involve changes in **development** (i.e., the initiation and occurrence of organs), **phenology** (i.e., the progress of plants through identifiable stages of development), and **allocation of resources** to different plant parts. The pattern and duration of developmental phases depend on environmental conditions and pattern of acclimation to specific conditions. The developmental pattern also varies genetically, which may reflect adaptations to specific abiotic or biotic environments. This chapter discusses plant development and processes associated with transition between developmental stages.

2. Seed Dormancy and Germination

Germination includes those events that commence with **imbibition** of water by the dormant, usually dry, seed and terminate with the elongation of the embryonic axis. It is the event that marks the transition between two developmental stages of a plant: **seed** and **seedling**. The seed has a package of food reserves that makes it largely independent of environmental resources for its survival. This changes dramatically in the photoautotrophic seedling,

which depends on a supply of light, CO₂, water, and inorganic nutrients from its surroundings for autotrophic growth, i.e., the phase when the seedling has become independent of maternal reserves. In this section we discuss the mechanisms by which some seeds sense the suitability of the future seedling's environment. For example, how does a seed acquire information about the expected light, nutrient, and water availabilities?

Germination is the process when part of the embryo, usually the radicle, penetrates the seed coat and may proceed with adequate water and O₂ and at a suitable temperature. **Dormancy** is defined as a state of the seed that does not permit germination, although conditions for germination may be favorable (temperature, water, and O₂). Dormancy thus effectively delays germination. Conditions required to break dormancy and allow subsequent germination are often quite different from those that are favorable for growth or survival of the autotrophic life stage of a plant.

Timing of seed germination can be critical for the survival of natural plant populations, and dormancy mechanisms play a major role in such timing. These mechanisms are pronounced in many **ruderals** and other species from habitats that are subject to disturbance. Many trees, particularly temperate and tropical species from undisturbed forest, lack pronounced dormancy, and their large seeds often do not tolerate desiccation. The germination of these **recalcitrant** seeds typically occurs quickly after dispersal. Recalcitrant seeds rapidly lose viability when dried, and storage of such seeds is notoriously difficult. Some seeds that lack dormancy are **viviparous**; they germinate prior to, or coincident with, abscission from the maternal plant (e.g., seeds of many mangrove and seagrass species).

In a dormant seed, the chain of events that leads to germination of the seed is blocked. This block, and hence dormancy itself, can be relieved by a specific factor or combination of factors (e.g., light, temperature regime, and/or specific compounds).

In some cases environmental factors, such as the absence of light, NO_3^- , and/or a diurnally fluctuating temperature, may keep seeds in a dormant state (**enforced dormancy**). The term dormancy is used here because these environmental factors function as an environmental signal that removes a block leading to germination, rather than being involved in metabolism, as is the case for environmental factors such as water, O_2 , and temperature (Bewley & Black 1994, Finch-Savage & Leubner-Metzger 2006). This form of dormancy is relieved as soon as the signal is present. Enforced dormancy is not always considered as a form of dormancy, but as a mechanism that prevents germination (Vleeshouwers et al. 1995, Baskin & Baskin 2004). Seeds are considered to be in a true (deeply) dormant state when they do not germinate even if given the stimuli for breaking enforced dormancy and favorable conditions for germination. Breaking of this type of dormancy occurs gradually over weeks, months, or even longer. Seeds may be dormant upon release from the mother plant (**primary or innate dormancy**), and dormancy can also be induced in seeds after they have become nondormant (**secondary or induced dormancy**), if conditions become unfavorable for germination. Transitions among the various forms of dormancy are illustrated in Fig. 8.1. As seeds gradually come out of primary dormancy, they pass through a phase of conditional dormancy when seeds germinate only over a narrow range of conditions. Similarly, induction of dormancy is accompanied by a gradual narrowing of the range of conditions that allow germination (Baskin & Baskin 2001).

Baskin & Baskin (2001, 2004) distinguish five classes of primary dormancy. **Physiological dormancy** (PD) refers to physiological mechanisms in the embryo and/or its surrounding structures (endosperm, seed coat) that prevent radicle emergence. Seeds with **morphological dormancy** (MD) have small underdeveloped or even undifferentiated embryos; germination will only occur until

growth and development have proceeded till a predefined stage. Seeds with hard coats that are impermeable to water have **physical dormancy** (PY). Separate classes are reserved for combinations of physiological with morphological dormancy [**morphophysiological dormancy** (MPD)] and physiological with physical dormancy [**combinational dormancy** (PD + PY)]. The most extensive subdivision in levels (from deep to nondeep) and types is given for physiological dormancy (three levels and five types) and morphophysiological dormancy (eight levels but no types). Physical dormancy and combinational dormancy are not subdivided. Physiological dormancy at a nondeep level is the most common kind of dormancy in seed banks in temperate climates and occurs in gymnosperms and in all major clades of angiosperms.

2.1 Hard Seed Coats

The hard **seed coat** of many species (e.g., in Fabaceae, Malvaceae, and Geraniaceae) can prevent germination because it is largely impermeable to water (physical dormancy) (Baskin & Baskin 2001). Water uptake occurs only when the seed coat is sufficiently deteriorated; imbibition increases with the degree of damage to the seed coat, e.g., in *Coronilla varia* (purple crownvetch) seeds (Fig. 2). In *Pelargonium* species with hard seed coats, palisade cells effectively close the site where water will ultimately enter the seed, whereas soft seeds form a wide opening at this site (Meisert et al. 1999).

Hard seed coats that are permeable to water do not represent a real mechanical barrier for outgrowth of the embryo in nondormant seeds (Baskin & Baskin 2001), but merely protect it. In other seeds the seed coat is not hard, but the outer layers such as the endosperm and seed coat can represent a mechanical barrier in combination with the force exerted by the embryo (coat-imposed dormancy). The balance in strength of the two opposing forces

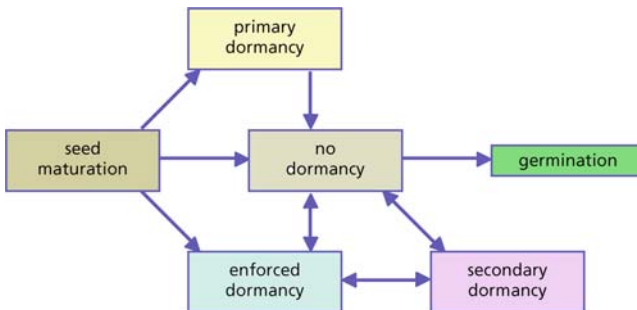
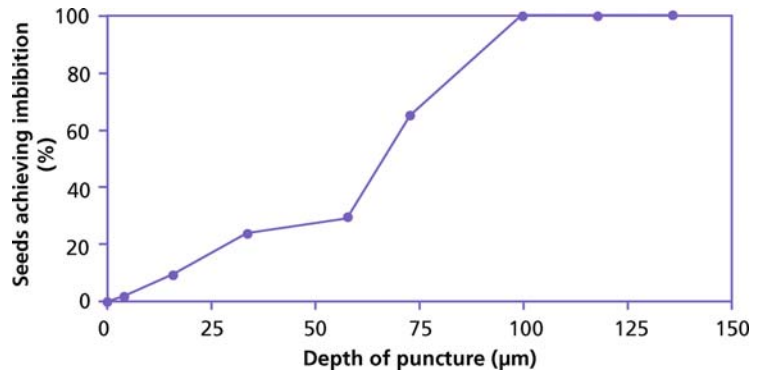

FIGURE 1. Schematic representation of changes in dormancy after seed maturation.

FIGURE 2. Impermeability of the seed coat of *Coronilla varia* (purple crownvetch). The seed coat was pierced to varying depths by a 0.4 mm diameter indenter, after which the seeds were left to imbibe on moist filter paper (after McKee et al. 1977).



determines whether or not the radicle will break through. This balance is subject to regulation and an important mechanism involved in physiological dormancy (Sect. 2.7).

Deterioration of the seed coat may be due to microbial breakdown, when seeds are buried in soil. It may also be due to physical processes, such as exposure to strong temperature fluctuations at the soil surface, as occurs in a desert. In both conditions the breakdown of the seed coat is gradual and, consequently, germination is spread in time. Exposure to short periods of high temperatures, such as during a fire (approximately 100°C), may lead to synchronous breaking of dormancy as a result of increased water permeability or other changes in the seed. However, temperature can easily become lethal in intense fires or when seeds are at the soil surface. Another mechanism that stimulates germination after fire is related to specific chemicals in smoke (Sect. 2.4).

In the seed coat there is a preformed "weak site", e.g., the **strophiole** in Fabaceae, where tissue degradation first occurs and through which water uptake starts. Dormancy associated with constraining tissues often complicates germination for plant cultivation purposes. It can be relieved artificially in hard-coated seeds by boiling, mechanical (sanding or breaking the seed coat), or chemical (concentrated sulfuric acid) treatments.

2.2 Germination Inhibitors in the Seed

Arid climates are characterized by little precipitation, often concentrated in just a few unpredictable showers. After such a shower, massive seed germination of short-lived plants may occur. How can the seeds perceive that the environment has become more favorable for germination and growth? A common trait of many species germinating under such

conditions is the presence of **water-soluble inhibitors** in the pericarp (i.e., the matured ovulatory wall, including seed coat and attached parts of the fruit). Light rain may not fully remove these inhibitors, so germination cannot take place (Fig. 3). Germination occurs only after a major rainfall event or prolonged rain that elutes the inhibitor; in this case the emerged seedling has access to sufficient water to enhance its chances to survive and complete its life cycle. The substance that inhibits germination may be either a specific organic compound or accumulated

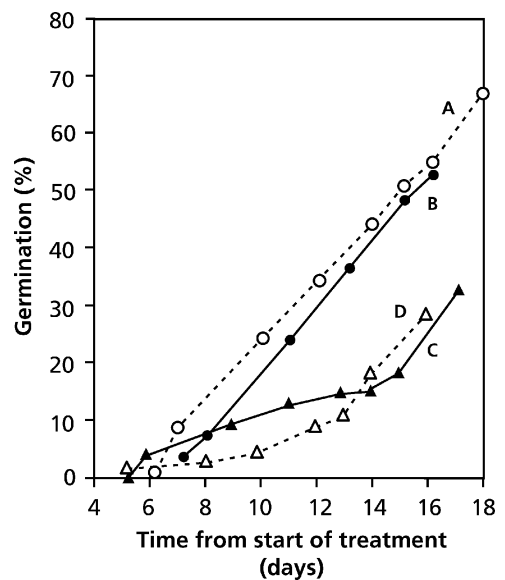

FIGURE 3. Time course of germination of *Oryzopsis miliacea* (smilgrass) as affected by duration of a drip treatment. The origin of the x-axis represents the start of the drip treatment. Curves A, B, C, and D refer to a duration of the treatment of 93, 72, 48, and 24 hours, respectively. Control seeds did not germinate (Koller & Negbi 1959). Copyright Ecological Society of America.

salts. Following moderate rains, those seeds that fail to germinate synthesize additional inhibitors; therefore, subsequent rains must still be substantial to trigger germination.

Germination inhibitors also play an important role in preventing germination of seeds in fleshy fruits. These germination inhibitors can be general (e.g., high solute concentration of many fruits) or highly specific. For example, ABA inhibits the germination of the seeds of *Solanum lycopersicum* (tomato) in combination with osmotic strength, as illustrated by seed germination inside the fruit of ABA-deficient mutants (Karssen & Hillhorst 1992). In a comparison of a range of mangrove and non-mangrove species, ABA levels are consistently lower in embryos of **viviparous** mangrove species than in related nonmangrove, nonviviparous species (Farnsworth & Farrant 1998).

2.3 Effects of Nitrate

Germination of many seeds of **ruderal** species is stimulated by **nitrate** (Fig. 4). This role of NO_3^- as an environmental trigger is not associated with a need for NO_3^- for protein synthesis, because no nitrate reductase activity is detected in seeds (Hilhorst & Karssen 1989). Rather, NO_3^- functions as a **signaling compound** and thus as a factor breaking

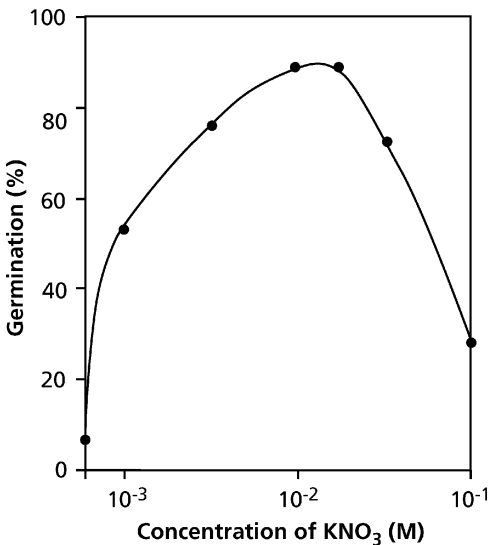

FIGURE 4. The relation between germination percentage of seeds of *Epilobium montanum* (broad-leaved willowherb) and KNO_3 concentration. Germination took place in the dark for 14 days at 16–20°C (redrawn after Hesse 1924).

enforced dormancy, especially in many ruderal species. When the mother plant has grown at a NO_3^- -rich site, seeds may accumulate NO_3^- and then lose the requirement for external NO_3^- to trigger germination. NO_3^- interacts with temperature and light in the regulation of dormancy and germination, and a mechanism has been proposed that accounts for this interaction at the level of a membrane-bound receptor protein (Karssen & Hillhorst 1992). Why would weedy and ruderal species use NO_3^- as an environmental cue?

A **NO_3^- requirement** may function as a mechanism to detect a **gap in the vegetation**, just like the perception of other environmental variables, e.g., light and diurnal temperature fluctuation, which are involved in enforced dormancy. Seeds in soil where a large plant biomass depletes soil NO_3^- experience a low- NO_3^- environment, which enforces dormancy. When the vegetation is destroyed, mineralization and nitrification continue, but absorption by plants is reduced. This increases soil NO_3^- concentrations to levels that can break dormancy as shown for *Plantago lanceolata* (snake plantain) seed buried in grassland in open patches and between the grass (Pons 1989).

2.4 Other External Chemical Signals

Various compounds in the natural environment of seeds may have stimulating or inhibiting effects on seed germination (Karssen & Hillhorst 1992). The inhibition of germination of buried seeds often cannot be explained by the absence of light or alternating temperatures alone. The gaseous environment may play a role (low O_2 and high CO_2), and in some cases specific organic compounds, such as leachates from living or decaying plant material containing **allelochemicals** (Sect. 2 of Chapter 9B), inhibit seed germination, e.g., in *Nicotiana attenuata* (Indian tobacco) in response to *Artemisia tridentata* (sagebush), which releases methyl jasmonate (Preston et al. 2002).

Germination can be stimulated by **smoke** derived from the combustion of plant material; this stimulates seed germination of *Audouinia capitata*, a fire-dependent South African fynbos species (De Lange & Boucher 1990). Exposure of dormant seeds to cold smoke derived from burnt vegetation also promotes seed germination of many species from the English moorlands (Legg et al. 1992), the California chaparral in United States (Keeley 1991), and Western Australian sandplains (Dixon et al. 1995). Chemicals in cold smoke also promote germination of seeds that are normally difficult to germinate, even of species that have not evolved in fire-prone

FIGURE 5. Glasshouse germination studies with Western Australian species. (A) Species for which there is a significant difference in germination between control (open bars) and smoke treatment (filled bars). (B) Species that did not germinate in the absence of smoke but whose germination percentage was increased to as little as 3% and as much as 72% in the presence of smoke (Dixon et al. 1995).

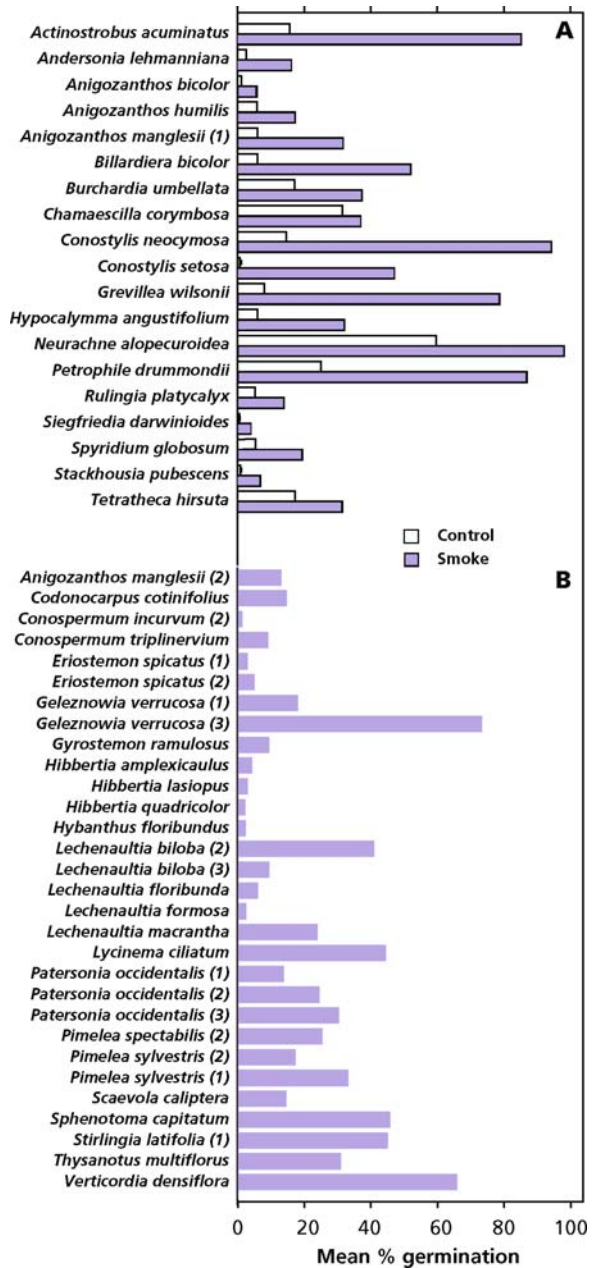

environments (Fig. 5). The main compound that triggers germination in smoke-sensitive seeds is a **butenolide** (Flematti et al. 2004b). However, triggering of germination by the butenolide, now known as karrikinolide, is not restricted to plants in fire-dominated ecosystems, but also includes several crop and weed species that have evolved in ecosystems where fire is not an ecological trigger; this suggests that karrikinolide may also occur in other types of

disturbances (Sect. 2.3; Flematti et al. 2004a). Commercial “smoke” products are available to enhance the germination of seeds that are difficult to germinate and to promote seed germination for mine rehabilitation in Western Australia (Roche et al. 1997). However, any ecological advantage of the capacity to respond to compounds present in smoke for species that do not occur in a fire-dominated system remains to be demonstrated.

2.5 Effects of Light

Light is an important factor determining enforced dormancy in seeds (Pons 2000). A wide variety of light responses have been described. These depend strongly on other environmental conditions, such as temperature, water potential, and nitrate, and on prior conditions, such as temperature regime, and include conditions to which the parent plant was exposed.

The light climate under natural conditions has many components, some of which are used by seeds for regulation of dormancy. Three major types of light responses can be distinguished.

1. A **light requirement** prevents germination of seeds that are buried too deeply in soil. Such seeds germinate only when exposed to **light**, and thus do not germinate below a soil depth where no light penetrates. This prevents "fatal germination" of the predominantly small seeds in which this mechanism is most frequent. Germination occurs only when the soil is turned over or the seeds otherwise reach the soil surface where they are exposed to light. This often coincides with damage or the complete disappearance of the established vegetation. The emergent seedlings thus have a more favorable position with respect to established plants than they would have otherwise.
2. **Light intensity and duration of exposure** (photon dose, integrated over a period of time) determine whether dormancy enforced by darkness is broken. A steep light gradient exists near the soil surface. Seeds of some species [e.g., *Digitalis purpurea* (foxglove)] germinate at the extremely low intensity prevailing at 10 mm depth in sand ($0.026 \mu\text{mol m}^{-2} \text{s}^{-1}$), whereas others [e.g., *Chenopodium album* (lambsquarters)] do not germinate below 2 mm (Bliss and Smith 1985). The very low photon dose required by buried weed seeds is also illustrated by their emergence after soil cultivation in light, but not in darkness, with an estimated exposure time of about 0.2 s (Scopel et al. 1994). Other species, e.g., *Plantago major* (common plantain), require much longer or repeated exposures (Pons 1991b). A high light sensitivity may provide more certainty of germination after a disturbance event, but increases the probability of fatal germination after reburial.
3. The **spectral composition** of daylight as modified by a leaf canopy also influences the **timing of germination after disturbance** of vegetation. Light under a leaf canopy is depleted in red compared with that above the canopy (Fig. 6)

resulting in a low red:far-red ratio. This enforces dormancy in many species (Fig. 7). This is particularly important shortly after seed shedding, when conditions might otherwise be suitable for

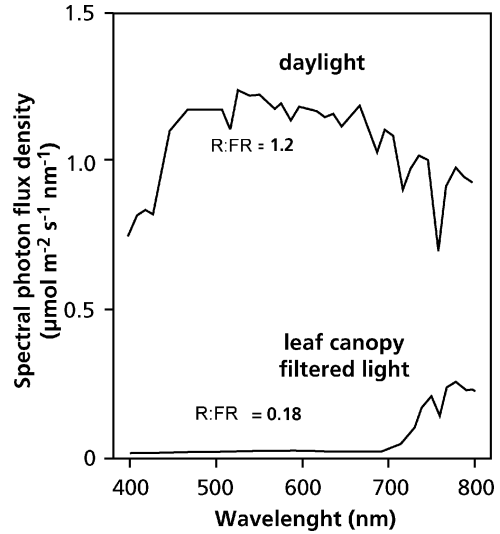

FIGURE 6. The spectral energy distribution of sunlight and light filtered through a leaf canopy. Red:far-red ratios (660:730) are also shown (after Pons 2000).

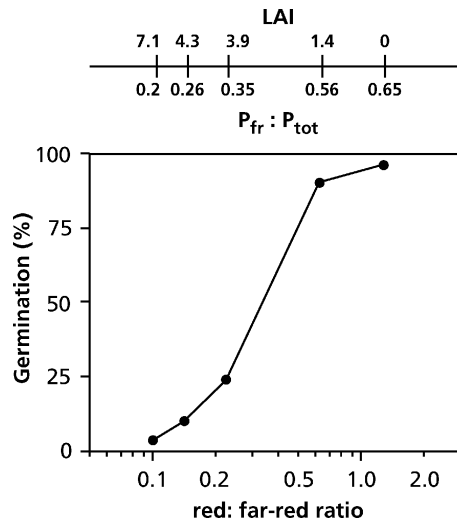

FIGURE 7. Germination of *Plantago major* (common plantain) in daylight under stands of *Sinapis alba* (white mustard) of different densities resulting in different red:far-red photon ratios of the transmitted light. Corresponding leaf area index (LAI) and phytochrome photoequilibria ($P_{fr}:P_{total}$ ratios) are shown (after Pons 2000).

germination. The seeds may subsequently get mixed into the soil, where a light requirement further enforces dormancy and where the risks of predation are smaller than at the soil surface. Litter, especially dry litter, also decreases the red:far-red ratio, which further reduces the probability of germination (Vazquez-Yanes et al. 1990).

Perception of light per se as well as the response to the spectral composition of the light involves the **phytochrome** system (Box 7.2). Seeds with a dormancy mechanism involving phytochrome require a minimum amount of the far-red-absorbing form of phytochrome (P_{fr}) to break dormancy. Light with a high red:far-red ratio enhances the formation of P_{fr} . When the seeds are exposed to light with a low red:far-red ratio, less P_{fr} is formed. The amount of P_{fr} is also determined by photon dose in the non-saturating region. The amount of P_{fr} required for germination depends on environmental conditions and the level of other forms of dormancy; it also differs among species. Hence, a low red:far-red ratio does not enforce dormancy in all light-requiring species and not under all conditions.

If, after exposure to light of appropriate spectral composition, germination is subsequently impaired by some other environmental factor, then a new exposure to light is required to break dormancy. This is due to the decay of P_{fr} in the dark. This mechanism also explains why seeds that are initially not light-requiring upon ripening become so after burial in the soil (Pons 1991b). A requirement for light for breaking dormancy is clearly not a fixed

characteristic of a species. Seeds that are not obviously light-requiring may still have a dormancy mechanism that is regulated by phytochrome. In such seeds there may be sufficient P_{fr} in the ripe seeds, influenced by the chlorophyll content of covering structures during the ripening process, to allow germination in the dark (Cresswell & Grime 1981).

Many light responses of seeds are typically referred to as the **low fluence response** (LFR). That is, a rather low photon dose is required to give the response. Some seeds under certain conditions respond to much lower light doses (three to four orders of magnitude) with the breaking of dormancy. Such a response is called the **very low fluence response** (VLFR). The two responses can be found in the same seeds, depending on pretreatment, e.g., in *Lactuca sativa* (lettuce) (Fig. 8). Transition between LFR and VLFR also varies seasonally during burial of seeds in soil (Derx & Karssen 1993). The VLFR under natural conditions is probably involved in the response to the short exposures to light that occur during soil disturbance as mentioned above (Scopel et al. 1994).

Studies with mutants of *Arabidopsis thaliana* (thale cress) have shown that different forms of phytochrome trigger VLFR and LFR responses. Phytochrome A is required for the VLFR and phytochrome B for the LFR (Casal & Sánchez 1998); both phytochrome A and B are involved in the far-red reversible stimulation of germination by red light (Hennig et al. 2002).

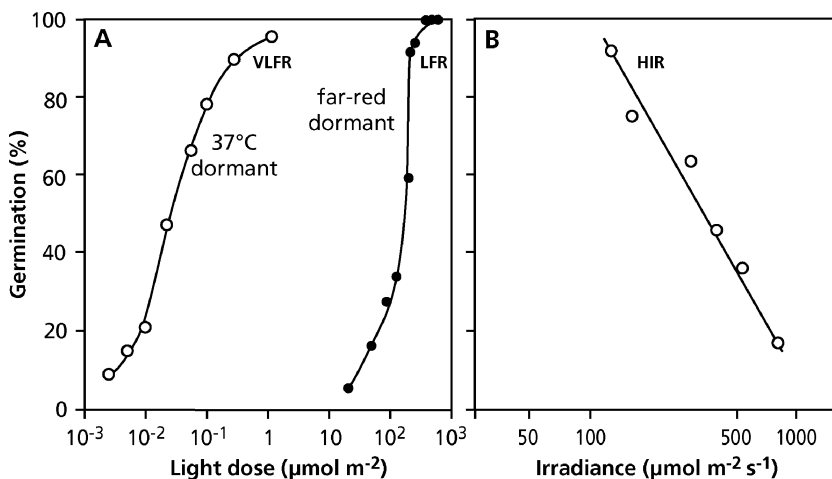

FIGURE 8. The three light responses of seed germination demonstrated in one species *Lactuca sativa* (lettuce). (A) Fluence response to red light of seeds pretreated at 37°C and with far-red showing the very low fluence

response (VLFR) and the low fluence response (LFR), respectively (after Blaauw-Jansen & Blaauw 1975). (B) Irradiance response to daylight showing the high-irradiance response (HIR) (Gorski & Gorska 1979).

Germination of many species [but not of *Arabidopsis thaliana* (thale cress)] can also be inhibited by exposure to light when exposure times are long. The inhibition increases with increasing irradiance (Fig. 8), and the maximum effective wavelength region is 710–720 nm. This response is called the **high-irradiance response** (HIR). The cycling between P_r and P_{fr} and their intermediates is somehow involved in the HIR, but the mechanism is not fully understood. Seeds that are negatively **photoblastic**, i.e., whose germination is prevented by light, have a strongly developed HIR. Short exposures and low irradiances are not inhibitory, and they sometimes even stimulate germination in such seeds. Experiments with mutants of *Solanum lycopersicum* (tomato) that are deficient in different forms of phytochrome show that phytochrome A is the principal form involved in the HIR (Appenroth et al. 2006).

Light responses of seeds have been extensively studied with short exposures to light (LFR and VLFR). Seeds, however, mostly experience long exposure times under natural conditions. For seeds under a leaf canopy, both the photoequilibrium of phytochrome and the HIR are important, because seeds experience many hours of exposure to wavelengths that are effective. Hence, the inhibiting effect of a leaf canopy can be stronger than expected from the spectral composition alone.

Seeds on the surface of bare soil may be inhibited by the HIR due to the prevailing high irradiances. In light-requiring seeds, this may restrict germination to the upper few millimeters of the soil profile where light penetrates, but does not reach a high intensity, and where both light and moisture are available.

2.6 Effects of Temperature

Temperature influences seed dormancy and germination in several ways

1. **Diurnal fluctuation** in temperature controls enforced dormancy of many seeds. The response is independent of the absolute temperature which illustrates that it is the amplitude that causes the response (Fig. 9). This mechanism prevents germination of seeds **buried deep** in the soil, where temperature fluctuations are damped. In addition, seeds in unvegetated soil experience larger temperature fluctuations than seeds under a canopy. Hence, the capacity to perceive temperature fluctuations allows the detection of soil depth and of gaps in the vegetation. Most small-seeded marsh plants also germinate in response to diurnally fluctuating temperature which indicates the absence of deep water over the seed. Hence, in these plants temperature fluctuation functions as a mechanism to detect **water depth** (Fig. 9).
2. The **temperature range** over which germination can occur is an indication of the degree of true dormancy of the seed. If this range is narrow, then the seed is strongly dormant. If it is wider, then the seed is less dormant or nondormant. Variation in this temperature range may occur as a result of a shift in the upper and/or lower critical temperature limits for germination (Baskin & Baskin 2001).
3. The **temperature** to which the seed is exposed when no germination takes place is a major factor in determining release and induction of

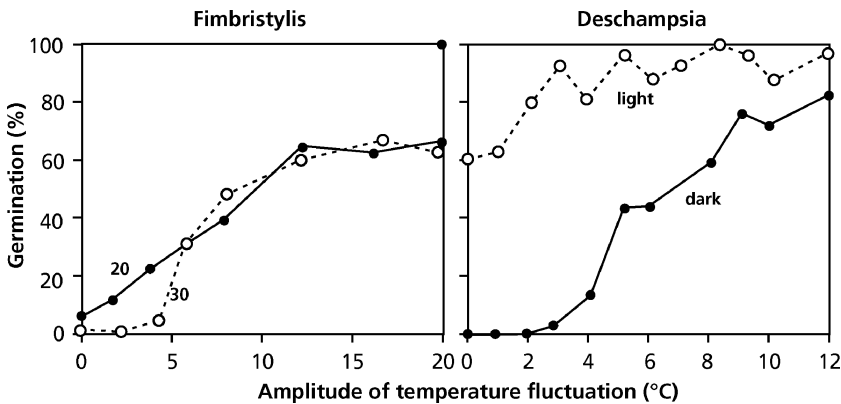

FIGURE 9. Germination responses to various amplitudes of diurnal temperature fluctuations. (Left) The light-requiring rice-field weed *Fimbristylis littoralis* (grass-like fimbry) at mean temperatures of 20 and 30°C (Pons &

Schröder 1986). (Right) The grass species *Deschampsia caespitosa* (tufted hair-grass) in light and darkness (Thompson et al. 1977). Reprinted with permission from *Nature*, copyright 1995 Macmillan Magazines Ltd.

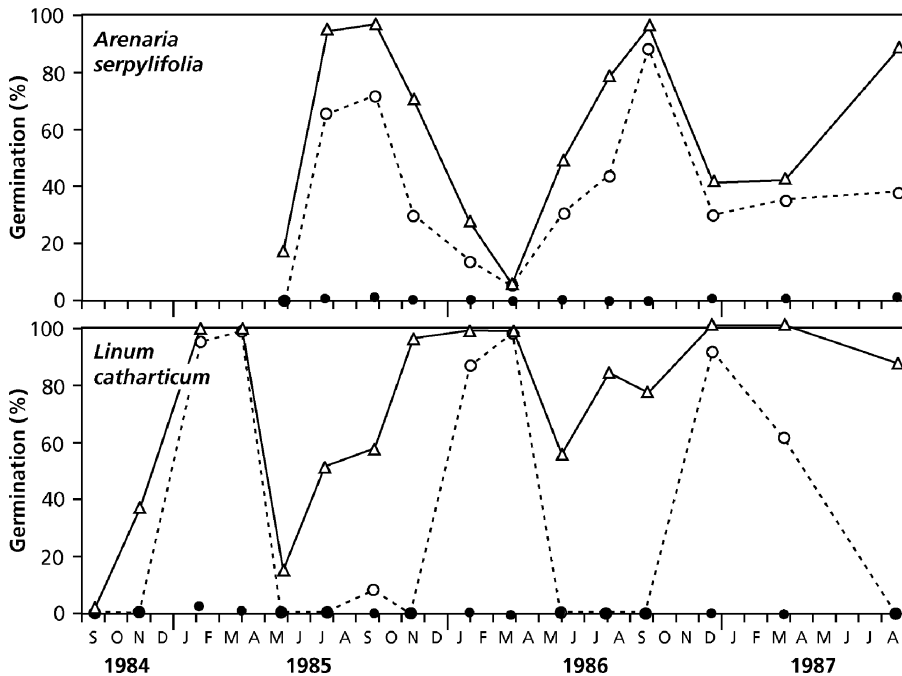

FIGURE 10. Germination of exhumed seeds under laboratory conditions after different burial times in a chalk grassland in South Limburg, the Netherlands: *Arenaria serpyllifolia* (thyme-leaved sandwort), which is a winter annual, and *Linum catharticum* (fairy flax), which is a

biennial that emerges in spring. Germination in darkness (closed symbols) and in light (open symbols), solid line final germination percentage, dashed line germination after 1 week at 22/12°C (Pons 1991a). Copyright Blackwell Science Ltd.

physiological dormancy, mostly at a nondeep level (Baskin & Baskin 2004). Two main types of responses are discerned in climates with seasonally changing temperatures:

- Summer annuals** and other species that produce seeds in autumn and germinate in the spring. A long exposure (1–4 months) of imbibed seeds to low temperature (approximately 4°C; **stratification** or chilling) relieves dormancy by gradually decreasing the minimum temperature for germination (Fig. 11). In many species with a persistent seed bank, secondary dormancy is subsequently induced by exposure to higher summer temperatures (e.g., 20°C) which causes large seasonal changes in the degree of dormancy (Fig. 10). This seasonal change in dormancy restricts germination to spring, the beginning of the most suitable season for growth in temperate climates (Fig. 11).
- Winter annuals** set seed in spring and early summer; they generally germinate in autumn. Exposure to relatively high summer temperatures gradually relieves the dormancy by increasing the maximum temperature that allows germination. This occurs even without

imbibition. In this case, low temperatures induce dormancy (Fig. 10). This seasonal dormancy pattern causes the seeds to germinate in autumn (Fig. 11), which is the beginning of the most suitable season for many species from Mediterranean climates.

Seeds may go through several cycles of induction and release of dormancy if enforced dormancy prevents germination (e.g., by the light requirement of seeds buried in the soil) (Fig. 1).

Water supply is the factor that makes winter the most favorable season for growth of winter annuals and, thus, autumn the best period for germination; however, seed dormancy is controlled by **temperature**. In many seasonal climates, such as the Mediterranean climate, temperature and water supply are closely correlated, but temperature is a better predictor of the beginning of the wet season than is moisture itself. In summer annuals, it is the low temperature in winter that releases dormancy in the seeds and, hence, it is used as a signal; however, the subsequently occurring high temperatures in summer form the suitable conditions for growth of the autotrophic plant.

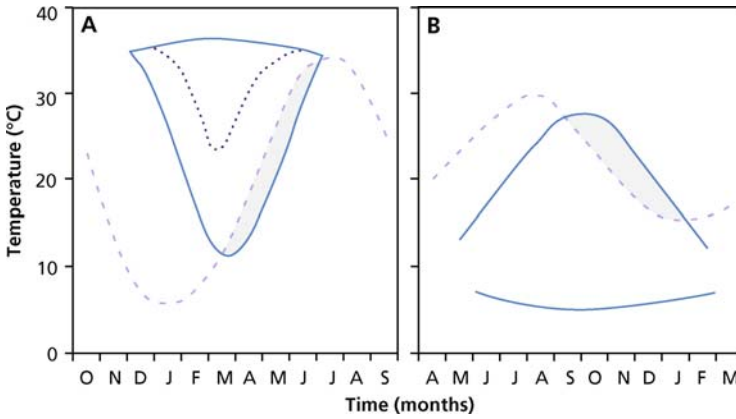

FIGURE 11. Widening and narrowing of the temperature range of germination in relation to the temperature in the natural habitat during the season. The *broken line* gives the mean daily maximum temperature in the field; the *continuous line* gives the temperature range for germination in light; the *dotted line* represents the minimum temperature for germination in darkness. In the *hatched area*, the actual and the required temperatures in light overlap. (A) Summer annual; (B) winter annual (after Karszen 1982).

2.7 Physiological Aspects of Dormancy

Many studies have examined the mechanisms of physiological dormancy, particularly the role of **phytohormones** (Box 7.2). Little progress was made, however, until mutants that are deficient in the synthesis of a phytohormone or that have a reduced sensitivity to a phytohormone [e.g., *Arabidopsis thaliana* (thale cress) and *Solanum lycopersicum* (tomato)] became available. More recently, molecular work using the large variation in accessions of *Arabidopsis thaliana* has further contributed to the understanding of the complex nature of this form of dormancy. On the basis of these studies, a fascinating view has emerged that probably applies to many species where the structures surrounding the embryo restrict radicle outgrowth (Koornneef et al. 2002, Finch-Savage & Leubner-Metzger 2006).

During seed development on the mother plant, there is an increase in **abscisic acid** (ABA) in the embryo. This phytohormone is involved in the prevention of precocious germination, synthesis of reserve proteins, development of desiccation tolerance, and induction of primary dormancy. External ABA is not very effective in inducing dormancy. Induction of and release from primary dormancy involves changes in both the concentration of ABA and the sensitivity to this phytohormone. **Gibberellic acid** (GA) has an effect opposite to that of ABA, and the ABA:GA ratio resulting from synthesis and catabolism and the sensitivities to these hormones regulate the release and induction of physiological dormancy. Release from dormancy is typically accompanied by an increase in sensitivity to GA (Fig. 12), whereas, with release from enforced dormancy, GA is synthesized *de novo*. ABA reduces the growth potential of the embryo, whereas GA can stimulate it. GA is further involved in the induction

of enzymatic hydrolysis of carbohydrates, especially of galactomannan-rich endosperm cell walls. Cell-wall hydrolysis weakens the endosperm layer, so that the radicle of the embryo can penetrate the seed coat, when its growth potential is sufficiently large, leading to the germination event.

Induction of secondary dormancy, as occurs in buried seeds, is accompanied by a decrease in the sensitivity to GA. Phytohormone receptors in the plasma membrane could be affected by the temperature-dependent state of membranes, thus at least partly explaining the effect of temperature on dormancy. The change in sensitivity to GA is reflected in the sensitivity for environmental stimuli that break enforced dormancy, such as light that stimulates GA synthesis, causing the above-mentioned endosperm weakening.

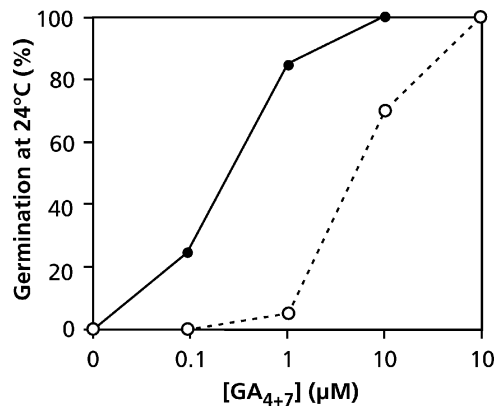

FIGURE 12. The effect of gibberellin concentration on the germination of a GA-deficient mutant of *Arabidopsis thaliana* (thale cress) in darkness at 24°C. Seeds directly sown (*open symbols*) or preincubated at 2°C for 7 days (*filled symbols*) (Hilhorst & Karszen 1992).

TABLE 1. A summary of the possible ecological significance of environmental factors involved in breaking seed dormancy.

Environmental factor	Ecological role
Light	Gap detection
	Sensing depth in soil
Diurnal temperature fluctuation	Increasing longevity in seed bank
	Gap detection
	Sensing depth in soil and water
Nitrate	Gap detection
	Nutrient availability
Rain event in desert	Detection of water availability
Smoke	Response to fire
High temperature	Response to fire
Seasonal temperature regime	Detection of suitable season
	Increasing longevity in soil
Time	Avoidance of unsuitable season
	Spreading risks in time

2.8 Summary of Ecological Aspects of Seed Germination and Dormancy

Section 2 discussed how environmental factors control dormancy. These environmental cues lead to a **timing** of germination which maximizes the chances of seedling survival and subsequent reproductive success. Table 1 summarizes these germination cues. The cues that indicate presence of disturbance (light, diurnal temperature fluctuation, nitrate, and other chemicals) are typically best developed in early-successional species. In the absence of these cues, these species enter long-lasting seed reserves ("seed banks") in the soil, where they can remain for tens or even hundreds of years until the next disturbance occurs. By contrast, late-successional species have short-lived seeds that are produced regularly and have poorly developed seed dormancy mechanisms. As a result, these species are poorly represented in the seed bank. The viability of seeds in the seed bank declines with time, but it is quite common for the seed bank to be a major source of germinants, even when disturbance occurs more than a century after the previous disturbance that gave rise to the seed bank.

3. Developmental Phases

Most species pass through several distinct life phases after germination. Plants grow most rapidly, but are most vulnerable to environmental stress and to the effects of competition, during the seedling phase.

There is then a gradual transition from the seedling to the juvenile phase, where many species allocate significant resources to defense and storage. Finally, there is an abrupt hormonally triggered shift to the reproductive phase, where some shoot meristems produce reproductive rather than vegetative organs. The response of plants to the environment often differs among these developmental phases, and species differ substantially in the timing and triggers for phase shifts. For example, **annuals** rapidly switch to their reproductive phase, whereas **perennials** may remain vegetative for a longer time, sometimes many years. **Biennials** are programmed to complete their life cycle within 2 years, but this may take longer if environmental conditions are less favorable. What are the physiological differences between plants with these contrasting strategies, and how is the program in biennials modified by the environment?

3.1 Seedling Phase

Seedlings are susceptible to many abiotic and biotic stresses after germination. During germination of a dicotyledonous plant, such as *Pisum sativum* (pea), the shoot emerges from the seed with a hook-shaped structure that protects the apical meristem and first leaves while the seedling pushes through the soil. When the seedling reaches the light as perceived by **phytochrome**, the leaves expand, and the photosynthetic apparatus differentiates, a process called **de-etiolation**. Until that time the apical hook is maintained by an inhibition of cell elongation of the inner portion of the hook which is mediated by **ethylene**. Cells on the inner, concave, side of the hook accumulate more mRNA that encodes 1-aminocyclopropane-1-carboxylate oxidase, which is the terminal enzyme in the biosynthesis of ethylene (Box 7.1), than do cells on the outer, convex, side. The cells at the concave side are also more responsive to ethylene. To form a straight stem below the hook, ethylene inhibition is released, and the cells on the inner side expand rapidly to match the length at the outer side (Peck et al. 1998).

Due to their small root systems seedlings are vulnerable to desiccation from minor soil drying events, so there is strong selection for rapid root extension. Where seedling densities are high, there is also strong competition for light, and an advantage of even 1 or 2 days in time of germination is a strong determinant of competitive success (Harper 1977). Most plant mortality occurs in the seedling phase through the interactive effects of environmental stress, competition, pathogens, and herbivory, so there is strong selection for rapid growth at this vulnerable phase to acquire resources (leaves and

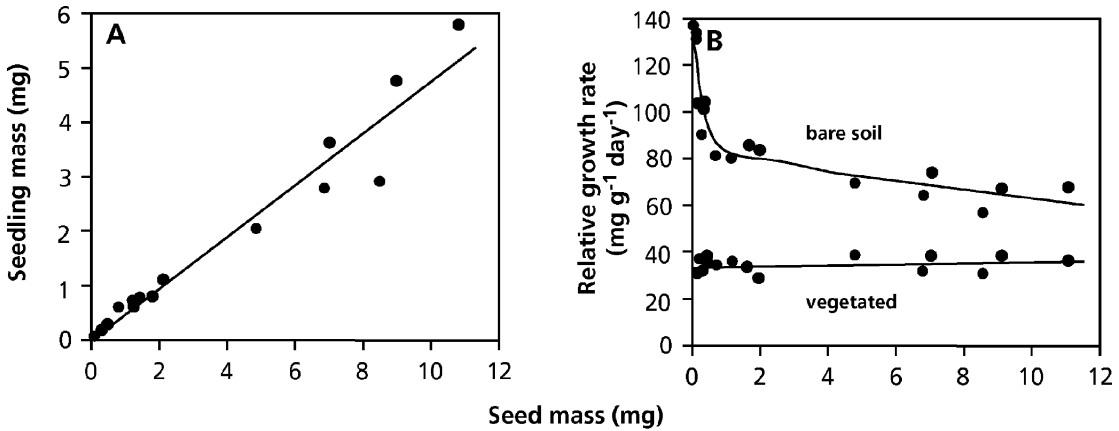

FIGURE 13. Relationship between seed mass of prairie perennials and (A) mass of newly emerged seedlings (<12 hours) or (B) relative growth rate of seedlings on bare soil and in a mat of *Poa pratensis* (Kentucky bluegrasses) in the glasshouse. Absolute plant size increases with increasing seed mass. Relative growth rate decreases with increasing seed size in the

absence of competition, but it increases with increasing seed size in the presence of competition. Species are *Verbascus thapsus* (mullein), *Oenothera biennis* (evening primrose), *Daucus carota* (carrot), *Dipsacus sylvestris* (common teasel), *Tragopogon dubius* (yellow salsify), and *Arctium minus* (lesser burdock) (after Gross 1984).

roots) and to grow above neighbors (stem) (Cook 1979). In most species, this can be achieved only through minimal allocation to storage or defense.

Seed size is a major determinant of initial size and absolute growth rate of seedlings (Leishman et al. 1995) (Fig. 13). Species that colonize disturbed open sites with minimal competition typically produce abundant, small seeds which maximize the probability of a seed encountering a disturbed patch, but minimize the reserves available to support initial growth and survivorship (Fig. 14; Leishman & Westoby 1994). Trees, shrubs, and woodland herbs, which confront stronger competition at the seedling stage, however, often produce a few large seeds (Fenner 1985, Shipley & Dion 1992). Thus, for a given reproductive allocation, there is a clear **trade-off** between seed size and seed number, with seed size generally favored in species that establish in closed vegetation. It is interesting that small seed size is one of the few traits that differentiate rare from common species of grass (Rabinowitz 1978), perhaps because of the longer dispersal distance associated with rare species.

Many tropical trees and some temperate trees produce extremely large nondormant seeds that germinate, grow to a small size, and then cease growth until a branch or tree-fall opens a gap in the canopy. This **seedling bank** is analogous to the seed bank of ruderal species in that it allows new recruits to persist in the environment until disturbance creates an environment favorable for seedling establishment. Large seed reserves to support maintenance respiration are essential to species that form a seedling bank. There is a strong negative relationship

between seed size and death rate in shade (Fig. 15). In contrast to the situation in rapidly growing seedlings, the leaves of seedlings in the seedling bank are extremely well defended against herbivores and pathogens. These seedlings quickly resume growth following disturbance and have a strong initial competitive advantage over species that persist as a seed bank in the soil.

3.2 Juvenile Phase

There is a gradual transition from a seedling phase with minimal storage reserves to a juvenile phase with accumulation of some reserves to buffer the plant against unfavorable environmental conditions. There are striking differences among plants in the length of the juvenile phase and the extent of reserve accumulation, however. At one extreme, *Chenopodium album* (pigweed) can be induced to flower at the cotyledon stage immediately after germination, whereas some trees may grow for decades before switching to reproduction [e.g., 40 years in *Fagus sylvaticus* (beech)]. The switch to reproduction is typically hormonally mediated.

Annuals allocate relatively little of their acquired resources (carbon and nutrients) to storage, whereas perennials are characterized by storage of both nutrients and carbohydrates. The greater resource allocation to storage, rather than to leaf area, partly accounts for the lower growth rate of perennials. The stored reserves, however, allow perennials to start growth early in a seasonal climate and to survive

FIGURE 14. Frequency distribution of seed size in different ecological groups of plants (after Salisbury 1942). Species that establish in closed habitats tend to have larger seeds than open-habitat plants.

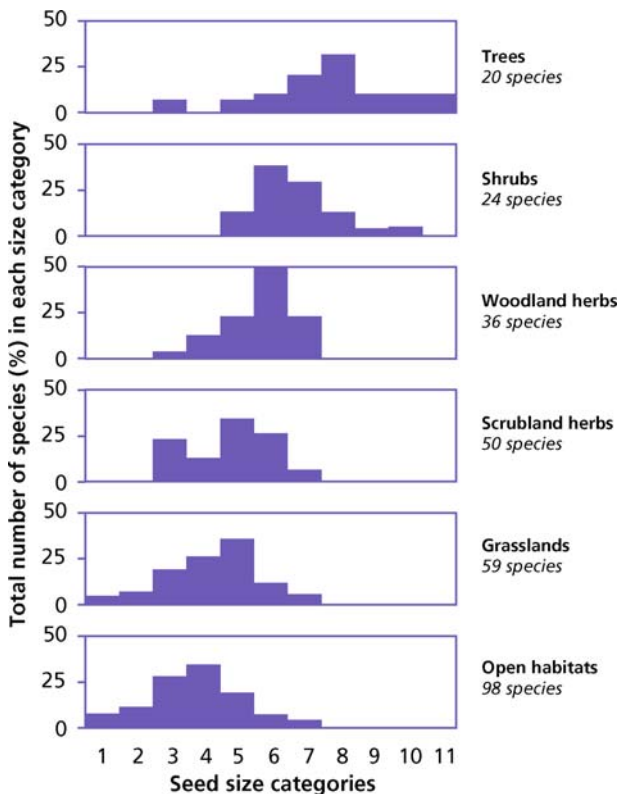

conditions that are unfavorable for photosynthesis or nutrient acquisition.

3.2.1 Delayed Flowering in Biennials

Biennial species typically grow as vegetative rosettes until the storage pools are sufficiently filled to allow a

switch to the reproductive phase; this transition commonly requires **vernalization** (Sect. 3.3.3). Compared with an annual, biennials are able to grow and accumulate nutrients throughout a larger part of the year and are therefore able to produce more seeds (De Jong et al. 1987). Biennials may grow longer than 2 years at a low irradiance (Pons & During 1987) or low nutrient supply if their stores are not filled sufficiently to induce a switch to flowering (Table 2). In general, shifts from one developmental phase to another correlate more closely with plant size than with plant age. Hence, the term **biennial** is

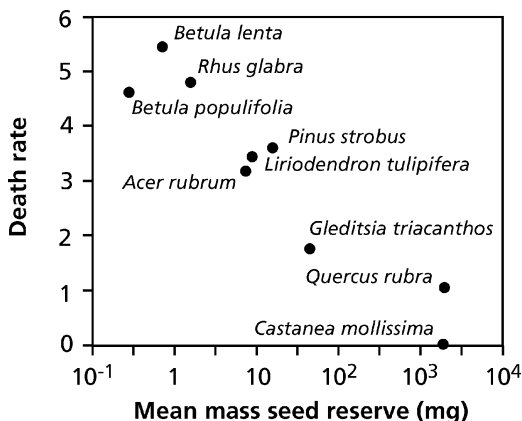

FIGURE 15. Relationship between death rate (mean number of fatalities per container in 12 weeks in shade) and log mean mass of seed reserve in nine North American tree species (after Grime & Jeffrey 1965).

TABLE 2. Probability of flowering in *Cirsium vulgare* (spear thistle) of small rosettes after transfer from the field to a long-day regime in a growth room in February.

Treatment	Probability of flowering (%)	Average time before bolting (days)
Without nutrients	25	45
With nutrients	80	40

Source: Klinkhamer et al. (1986).
 Note: A control group in the field showed 13% flowering.

less appropriate than **monocarpic perennial**, which indicates that the plant terminates its life cycle once the transition to the reproductive stage has been made. Vegetative growth in some monocarpic perennials [e.g., in *Cycas revoluta* (sago palm) and *Agave americana* (century plant) species] can be very long.

3.2.2 Juvenile and Adult Traits

In woody plants there is a distinctive suite of morphological and chemical traits that disappear when the plant becomes reproductively mature. Juvenile plants are typically more strongly defended against herbivores, either by producing spines (e.g., apple or orange trees) or by a variety of chemical defenses (Bryant & Kuropat 1980). Many woody species exhibit a difference in morphology between their **juvenile** and **adult foliage**. For example, the young foliage of many *Acacia* (wattle) species in Australia is characterized by bipinnate leaves, whereas older individuals produce "phyllodes" (i.e., compressed petioles) (New 1984). Phyllodinous species in which the juvenile foliage persists longest are generally native to moist regions, whereas phyllodes that are reduced to small whorled spines are common in *Acacia* species from many (semi)arid zones. *Acacia* species commonly show a mosaic of bipinnate leaves and phyllodes, with the highest frequency of bipinnate leaves under more favorable conditions. In *Acacia pycnantha*, a shade-tolerant forest species, seedlings produce predominantly juvenile foliage for more than 9 months if growing in the shade, and they show a high survival rate and high leaf area ratio (LAR). When grown in full sun, they become entirely

phyllodinous after a few months. Treatment with GA favors production of the bipinnate leaves.

Acacia melanoxylon (blackwood) is another Australian forest species with a mosaic of leaves, like the Hawaiian shade-intolerant *Acacia koa* (koa) that grows at sites characterized by unpredictable drought periods. It has been suggested that the bipinnate *Acacia* leaves function as shade leaves, whereas the phyllodes may be sun leaves. To test this hypothesis, gas-exchange characteristics of the contrasting leaves have been determined (Table 3). The juvenile *Acacia* leaves have higher rates of photosynthesis (on a leaf mass and leaf N basis) and transpiration (leaf area basis), but a lower water-use efficiency and leaf water potential when compared with the adult phyllodes. The traits of the juvenile leaves promote establishment (rapid growth), whereas the phyllodes are more like the leaves of slow-growing stress-tolerant species.

3.2.3 Vegetative Reproduction

Many plants such as grasses or root-sprouting trees have a modular structure composed of units, each of which has a shoot and root system. This "vegetative reproduction" can be viewed simply as a form of growth, as described in the Chapter 7 on growth and allocation, or as a mechanism of producing physiologically independent individuals without going through the bottleneck of reproduction and establishment (Jonsdottir et al. 1996).

Vegetative reproduction is best developed in environments where flowering is infrequent and seedling establishment is a rare event. For example,

TABLE 3. Gas-exchange characteristics, water relations, and aspects of leaf chemical composition and morphology of juvenile bipinnate leaves and adult phyllodes of *Acacia koa* (koa), a shade-intolerant endemic tree from Hawaii.

Parameter	Juvenile bipinnate leaves	Adult phyllodes
Light-saturated rate of CO ₂ assimilation ($\mu\text{mol m}^{-2} \text{s}^{-1}$)	11.1	12.1
Light-saturated rate of CO ₂ assimilation ($\text{nmol g}^{-1} \text{s}^{-1}$)	0.8	0.5
Stomatal conductance (daily mean) ($\text{mol m}^{-2} \text{s}^{-1}$)	0.4	0.3
Transpiration (daily mean) ($\text{mmol m}^{-2} \text{s}^{-1}$)	7.5	6.9
Water-use efficiency (daily mean) [$\text{mmol CO}_2 (\text{mol H}_2\text{O})^{-1}$]	1.3	1.5
Internal CO ₂ concentration ($\mu\text{mol mol}^{-1}$)	282	274
Carbon-isotope fractionation (‰)	19.7	18.0
Leaf water potential (MPa)	-1.2	-0.9
Leaf N concentration (mmol g^{-1})	2.1	1.7
Photosynthetic nitrogen-use efficiency [$\text{mmol CO}_2 (\text{mol N})^{-1} \text{s}^{-1}$]	0.24	0.20
C/N (mol mol^{-1})	19.3	24.6
Leaf mass per unit area (LMA) (kg m^{-2})	0.14/0.10*	0.24/0.51*

Source: Hansen (1986, 1996).

* The values are for open and understory habitats, respectively.

clones of *Carex aquatilis* (water sedge) are estimated to be thousands of years old as a result of continual production of new tillers by vegetative reproduction (Shaver et al. 1979); similarly *Larrea tridentata* (creosote bush) across the Chihuahuan, Sonoran, and Mohave Deserts of western North America is thousands of years old (McAuliffe et al. 2007). In this situation, the carbon cost of producing a new tiller by sexual reproduction is estimated to be 10000-fold greater than the cost of a new tiller by vegetative reproduction, because of very low rates of seedling establishment (Chapin et al. 1980). Aspen (*Populus tremuloides*) clones in the Rocky Mountains of the central United States are similarly estimated to be of Pleistocene age as a result of root sprouting. This is an effective mechanism of maintaining a given genotype under conditions where sexual reproduction is a rare event. The trade-off is that vegetative clones often lack the genetic diversity for long-term evolutionary change.

Clonal growth is one mechanism by which plants can explore **patchy habitats**. For example, daughter ramets (i.e., a unit composed of a shoot and root) of *Fragaria chiloensis* (beach strawberry) draw on reserves of the parental ramet to grow vegetatively. If the daughter ramet encounters a resource-rich patch, it produces additional ramets, whereas ramets that move into resource-poor patches fail to reproduce vegetatively. Resource translocation can also occur between established ramets of clonal plants, supporting damaged or stressed ramets

growing under relatively unfavorable conditions (Chapman et al. 1992, Jonsdottir et al. 1996). When the roots of one ramet of *Trifolium repens* (white clover) are in a dry patch, whereas those of another are well supplied with water, relatively more roots are produced in the wet patch. Similarly, when leaves of one ramet are exposed to high irradiance, whereas those of another are in the shade, the ramet exposed to high irradiance produces relatively more leaf mass (Fig. 16). Note that these environmental responses are opposite to the changes in allocation that occur when an entire plant is exposed to these conditions (Chapter 7, Sect. 5).

The data on *Trifolium repens* (Fig. 16) suggest that ramets can exchange captured resources. To test this in another clonal plant, *Potentilla anserina* (silverweed), phloem transport was interrupted by “steam girdling” which leaves the xylem intact. Under these conditions the shaded ramet produces less shoot and root biomass than does the control, with its phloem connection still intact. This experiment confirms that carbohydrates can be exported from the sun-exposed ramet to the shaded one (Stuefer 1995).

The developmental process by which vegetative reproduction occurs differs among taxonomic groups. These mechanisms include production of new tillers (a new shoot and associated roots) in grasses and sedges, initiation of new shoots from the root system (root suckering) in some shrubs and trees, production of new shoots at the base of the

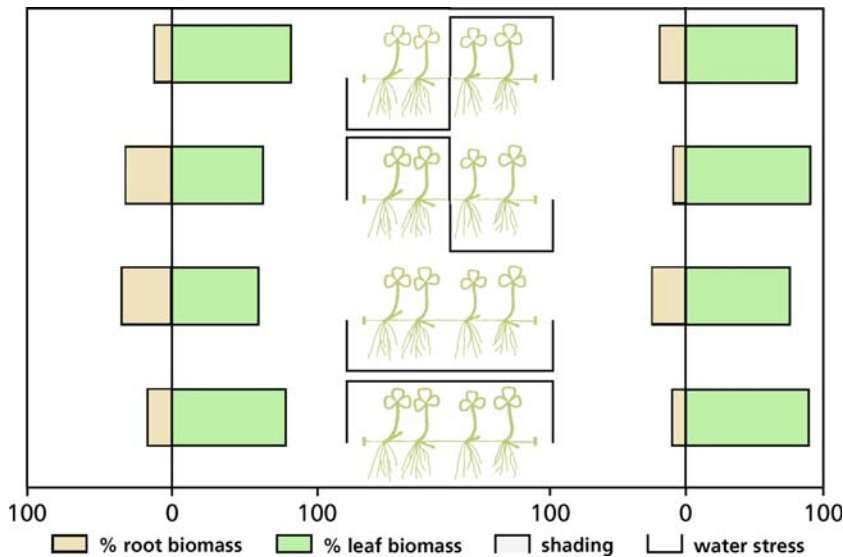

FIGURE 16. Percentage biomass allocation to leaves and roots of two interconnected ramets of *Trifolium repens* (white clover) (after Stuefer et al. 1996).

parental shoot (stump sprouting) in other shrubs and trees, initiation of new shoots from below-ground stems or burls, as in many Mediterranean shrubs, and rooting of lower limbs of trees that become covered by soil organic matter (layering) in many conifers.

3.2.4 Delayed Greening During Leaf Development in Tropical Trees

Many tropical, shade-tolerant rain forest species initiate leaves that are white, red, blue, or light-green, during the stage of leaf expansion which indicates their low chlorophyll concentration. This pattern of **delayed greening** is typical of shade-tolerant species and is less common in gap specialists (Table 4). The pattern of delayed greening is distinctly different from the shift from juvenile to adult foliage, because it is typical of all young leaves, even those on mature plants. Leaves show delayed greening function below the light-compensation point for photosynthesis at saturating light until fully expanded. After full expansion, their rate of dark respiration is very high, presumably due to high rates of metabolism associated with the development of chloroplasts. The completion of this development may take as long as 30 days after the leaves have fully expanded. In contrast, normally greening leaves achieve maximum photosynthetic capacity at the end of leaf expansion (Kursar & Coley 1992b, Woodall et al. 1998).

There is obviously a cost involved in delayed greening: during leaf expansion species showing this pattern of chloroplast development exhibit only 18–25% of the maximum possible photosynthetic rate, compared with 80% for leaves that show a normal developmental pattern. At the irradiance level that is typical of the forest understory,

TABLE 4. The color of young leaves of 175 species, common in a tropical rain forest in Panama.

Leaf color	Gap specialist (%)	Shade tolerant (%)
White	0	8
Red	3	33
Light-green	3	41
Delayed greening	7	82
Green	93	18

Source: Kursar & Coley (1991).

Note: Values are the number of species and families in each category. Percentages are calculated for gap-specialist and shade-tolerant species separately.

TABLE 5. Rates of herbivory of young leaves, measured during the 3 days prior to full expansion (when they lack toughness) and 4–6 days after full expansion (when their toughness has increased substantially).*

Species	Number of leaves	During expansion	After expansion
<i>Ouratea lucens</i>	274	3.08	1.63
<i>Connarus panamensis</i>	179	0.22	0.03
<i>Xylopia micrantha</i>	90	0.57	0.01
<i>Desmopsis panamensis</i>	262	0.75	0.27
<i>Annona spragueii</i>	204	0.37	0.08

Source: Kursar & Coley (1991).

* Values are expressed as the percentage of the leaves which were eaten per day; they were all significant at $p < 0.01$.

the quantum yield of photosynthesis is also less than half that of green leaves, largely due to their low photon absorption (Kursar & Coley 1992a). What might be the advantages of delayed greening?

Delayed greening may be a strategy to reduce herbivory of young leaves. All young leaves lack toughness, which is provided by cell-wall thickening and lignification, which are processes that tend to be incompatible with cell expansion and leaf growth. Because toughness provides protection against both biotic and abiotic factors, young leaves are poorly protected (Table 5). The accumulation of proteins and other nutrients associated with chloroplast development in species without delayed greening presumably makes young unprotected leaves even more attractive to herbivores. Hence, although delayed greening may represent a loss of potential carbon gain, it also reduces carbon losses associated with **herbivory**. In a high-irradiance environment losses incurred by delayed greening could be substantial. In the low-light environment of shade-adapted species, where the irradiance is only about 1% of full sunlight, losses by herbivory could be relatively more important (Table 6).

We have so far discussed the delayed greening in terms of lack of chlorophyll; however, the red or blue appearance also reflects the presence of specific pigments: **anthocyanins**. Early hypotheses that these anthocyanins raise leaf temperature have been rejected. The suggestion that these anthocyanins protect against damage by ultraviolet light (Sect. 2.2.2 of Chapter 4B on effects of radiation and temperature) also seems unlikely, considering the very low irradiance level in understory habitats. Bioassays using leaf-cutter ants, however, suggest that

TABLE 6. Hypothetical carbon budgets for white and green young leaves in sun and shade environments.

Habitat	Leaf color	CO ₂ assimilation (carbon gain)	Herbivory (carbon loss)	Net carbon gain/loss
Sun	Green	High	High	+++
	White	Low	Low	-
Shade	Green	Low	High	--
	White	Low	Low	-

Source: Kursar & Coley (1991).

these anthocyanins may protect the leaves because of their **antifungal** properties. These leaf-cutter ants collect leaves, store them underground as substrate for fungi, which are fed on by ants. Leaves that contain anthocyanins, either naturally or experimentally added, are collected to a lesser extent than leaves with lower anthocyanin concentrations (Coley & Aide 1989).

3.3 Reproductive Phase

We know that some plants **flower** in spring, when days are getting warmer and longer, whereas others flower in autumn, when temperatures are getting lower and days are shortening. Similarly, **tuber formation** also typically occurs either in spring or in autumn. How do plants sense that it is spring or autumn? Depending on the species, plants may use either the **daylength** or the **temperature** as environmental cues. Many plants from temperate regions use a combination of both cues and are thus able to distinguish between spring and autumn (Garner & Allard 1920, Samach & Coupland 2000). Our

understanding of the timing mechanisms of plants has led to greater insight into how plants time their switch from the vegetative to the reproductive phase, as well as to important applications in the glasshouse industry.

3.3.1 Timing by Sensing Daylength: Long-Day and Short-Day Plants

In Chapter 7 on growth and allocation (Sect. 5.1.2) we discuss how vegetative growth can be affected by daylength. This environmental cue is pivotal in triggering **flowering** (Mouradov et al. 2002) and **tuberization** (Martinez-Garcia et al. 2002) in many species. Daylength does not play a role in the so-called **day-neutral plants**, like *Cucumis sativus* (cucumber), *Ilex aquifolium* (sparked holly), *Solanum lycopersicum* (tomato), *Impatiens balsamina* (touch-me-not), and *Poa annua* (annual meadowgrass). It is most important, however, in plants whose flowering is triggered by the short days in autumn (**short-day plants**, which require a photoperiod less than about 10–12 hours) or the long days in spring (**long-day plants**, which require a photoperiod longer than about 12–14 hours).

Examples of short-day plants include *Chrysanthemum* species, *Eupatorium rugosa* (snakeroot), *Euphorbia pulcherrima* (poinsettia), some *Fragaria* species (strawberry), *Glycine max* (soybean), *Nicotiana tabacum* (tobacco), *Oryza sativa* (rice), and *Xanthium strumarium* (cocklebur), which is one of the best-studied short-day species (Fig. 17). Long-day plants include *Arabidopsis thaliana* (thale cress), *Avena sativa* (oat), *Coreopsis verticillata* (tickseed), *Hordeum vulgare* (barley), *Lolium perenne* (perennial ryegrass), *Rudbeckia fulgida* (black-eyed Susan), *Trifolium pratense* (strawberry clover), *Triticum aestivum* (wheat), and

FIGURE 17. Induction of flowering by exposure to short days (= long nights) in *Eupatorium rugosa* (snakeroot). No flowering is observed above a critical daylength of 16 hours. Courtesy B. Fausey and A. Cameron, Department of Horticulture, Michigan State University, USA.

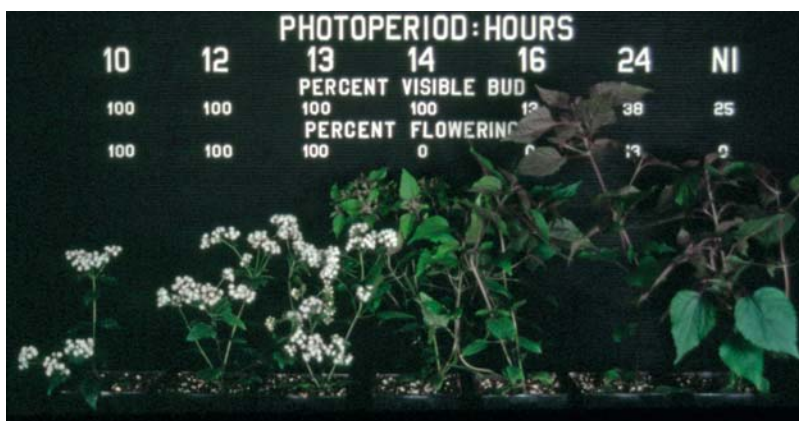

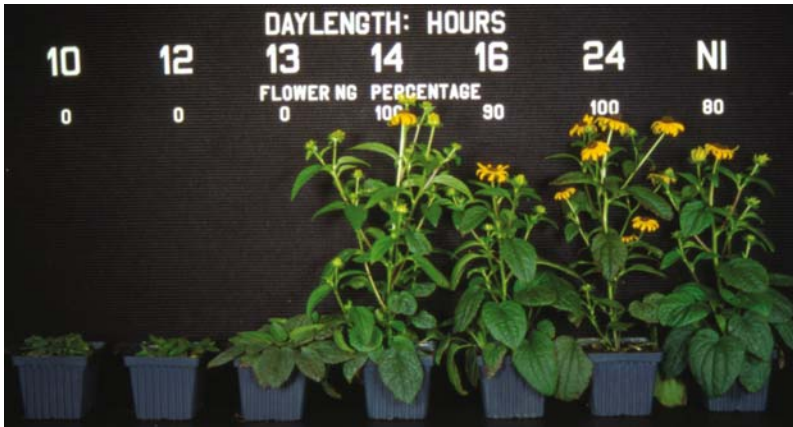

FIGURE 18. Induction of flowering by exposure to long days (= short nights) in *Rudbeckia fulgida* (black-eyed Susan). No flowering is observed below a critical daylength of 14 hours. Courtesy E. Runkle, Royal Heins, and A. Cameron, Department of Horticulture, Michigan State University, USA.

Hyoscyamus niger (black henbane), which is a much-researched long-day species (Fig. 18). Some species [e.g., *Bouteloua curtipendula* (side-oats grama)] have short-day ecotypes at the southern end of their distribution and long-day ecotypes at the northern end (Olmsted 1944). The requirement for a certain daylength may be **qualitative** [e.g., in *Perilla nankinensis* (shiso)] meaning that plants will not flower at all without exposure to at least 1 day of the appropriate photoperiod. It may also be **quantitative** or **facultative** [e.g., in *Arabidopsis thaliana* (thale cress)], which means that flowering will occur more quickly when exposed to the appropriate photoperiod. Do plants really sense the daylength, or is it the duration of the night period that is perceived?

The answer to this question has come from experiments in which the night was interrupted with either **white** or **red light**. A short interruption of the dark period prevents or delays flowering in a short-day plant, whereas the same treatment promotes flowering in long-day plants. Interrupting the light period has no effect on either short-day or long-day plants. The period between two light periods, normally the **night**, clearly must be the **critical time** that is perceived by the plant. *How* do plants perceive the duration of the night?

The answer again has come from experiments in which the night was interrupted, now using light of a specific wavelength: **red** (660 nm) or **far-red** (730 nm). A short flash is generally sufficient to obtain the effect: red light has the same effect as white light, and this effect is reversed by exposure to far-red light. This points to **phytochrome** as the photoreceptor involved in perception of the photoperiod (Box 7.2). In fact, phytochrome was discovered in the first place through these sorts of experiments (Bernier et al. 1981).

Classic grafting experiments have shown that daylength is detected in the leaves that have just matured and that a signal is transmitted from there to the shoot apex where flowering is induced (Piñeiro & Coupland 1998). Exposure of just one leaf to the inducing photoperiod may be enough. Experiments with the short-day plant *Zea mays* (corn) have shown that four to six leaves are required for the shoot meristem to become committed to form flowers. The daylength signal is transmitted to the shoot apical meristem, both in the long-day plant *Arabidopsis thaliana* (thale cress) (Corbesier et al. 2007) and in the short-day plant *Oryza sativa* (rice) (Tamaki et al. 2007).

In *Arabidopsis thaliana* (thale cress) the shoot apical meristem of plants that have been grown for 30 days under short days ceases producing leaf primordia and starts producing flower primordia within a few hours of being shifted. This suggests that the signal from the leaves acts directly on existing primordia to alter their identity (Koornneef et al. 1998). The signal may be a chemical compound or compounds, but the exact nature remains unclear. Gibberellins and ethylene can induce flowering in some long-days plants, whereas ABA inhibits the process. In the short-day plant *Pharbitis nil* (Japanese morning glory) ABA both promotes and inhibits flowering, depending on addition before or after the 14-hour inductive dark period (Takeno & Maeda 1996). Cytokinin levels in the short-day plant *Chenopodium rubrum* (lambsquarters) are also affected by exposure to a photoperiod inductive for flowering (Machackova et al. 1996). The signals may therefore involve the classical phytohormones, although it is not yet possible to account for all the observed effects (Koornneef 1997).

Because interruption of the photoperiod at different times of the night has different effects on

induction or prevention of flowering, a biological clock with a rhythm of about 24 hours (a **circadian clock**) has been postulated in plants. Such a circadian clock also plays a role in plants that fold their leaves at night and in many other processes. The biological clock presumably controls the sensitivity for P_{fr} . If the ability of plants from temperate climates to sense the length of the night is impressive, that of some tropical species is truly astounding. Here the variation in daylength may be very short and a change of 20–30 min may suffice to trigger flowering (Mouradov et al. 2002).

3.3.2 Do Plants Sense the Difference Between a Certain Daylength in Spring and Autumn?

Daylength is a tricky environmental cue, because days of the same length occur in both spring and autumn. How do plants sense the difference between the two seasons? Many long-day and short-day plants from cold climates may never perceive daylength in spring, since there is no appreciable metabolic activity. This would be the case for, e.g., *Eupatorium rugosum* (white snakeroot) and various *Helianthus* (sunflower) species in Michigan, USA. However, that situation is different in warmer environments. It was once thought that plants could sense the **lengthening** or the **shortening** of days; however, experiments have not confirmed the existence of such a mechanism. How, then, do they do it?

In addition to daylength, plants need a second environmental cue (e.g., temperature) (Sect. 3.3.3). Such a combination is required to induce flowering in *Fragaria ananassa* (strawberry) and *Beta vulgaris* (sugar beet). Flower primordia are induced in autumn, when daylength is reduced to a critical level. Further development of the primordia is stopped by low temperature in winter and only continues when the temperature increases in spring (Bernier et al. 1981).

3.3.3 Timing by Sensing Temperature: Vernalization

In temperate climates, changes in daylength coincide with changes in temperature. Many species that flower in spring are not long-day plants; rather, they use **temperature** as an environmental cue (Fig. 18). Exposure of the entire plant or of the moist seed induces flowering. We owe much of the information on effects of temperature on flower induction to the Russian botanist **Lysenko**. He showed that

exposure of moist seeds of winter wheat (*Triticum aestivum*) to low temperatures allowed the plants to flower, without exposure of the seedlings to the harsh Russian winter. The physiological changes triggered by exposure to low temperature are called **vernalization** (from the Latin word for spring, *ver*) (Atkinson & Porter 1996).

Lysenko unfortunately did not place his important findings in the right scientific perspective. Rather than concluding that phenotypic changes in the seeds exposed to low temperature accounted for the flowering of the mature wheat plants, he insisted that the changes were genetic. Inspired and supported by the political flavor of the 1930s in his country, he stuck to his genetic explanation, much to the detriment of genetics and geneticists in the Soviet Union.

Vernalization is essential, both for crop species such as *Triticum aestivum* (winter wheat) and for winter annuals in general which survive during winter as seedlings. Vernalization also triggers flowering in biennials that overwinter as a rosette, such as *Digitalis purpurea* (fox glove), *Lunaria annua* (honesty), *Daucus carota* (carrot), *Beta vulgaris* (beet), and in perennials such as *Primula* (primrose) and *Aster* species, and plants that overwinter as a bulb, tuber, or rhizome. Figure 19 shows the effect of exposure to low temperature for 3–12 weeks on flowering of *Campanula* (harebell).

Vernalization is believed to require perception of low temperature in the vegetative apex. In *Arabidopsis thaliana* (thale cress), the vernalization requirement of late-flowering genotypes is due to up-regulation of a specific gene. In *Triticum aestivum* (wheat) the difference between winter wheat and spring wheat is controlled by a single gene (Yan et al. 2003). After cold treatment, the transcripts of this gene are down-regulated and remain so for the remainder of the plant's life (Michaels & Amasino 2000). Cold treatment supposedly induces the breakdown of a compound that accumulated during exposure to short days in autumn and which inhibits flower induction. At the same time, a chemical compound is produced that promotes flower induction, most likely GA (Mouradov et al. 2002).

The practical applications of our ecophysiological knowledge on environmental cues that trigger flowering are enormous. Many flowers that used to be available during specific seasons only can now be produced all year round. Building on fundamental ecophysiological experiments, in the Netherlands the flower industry has become a flourishing branch of horticulture.

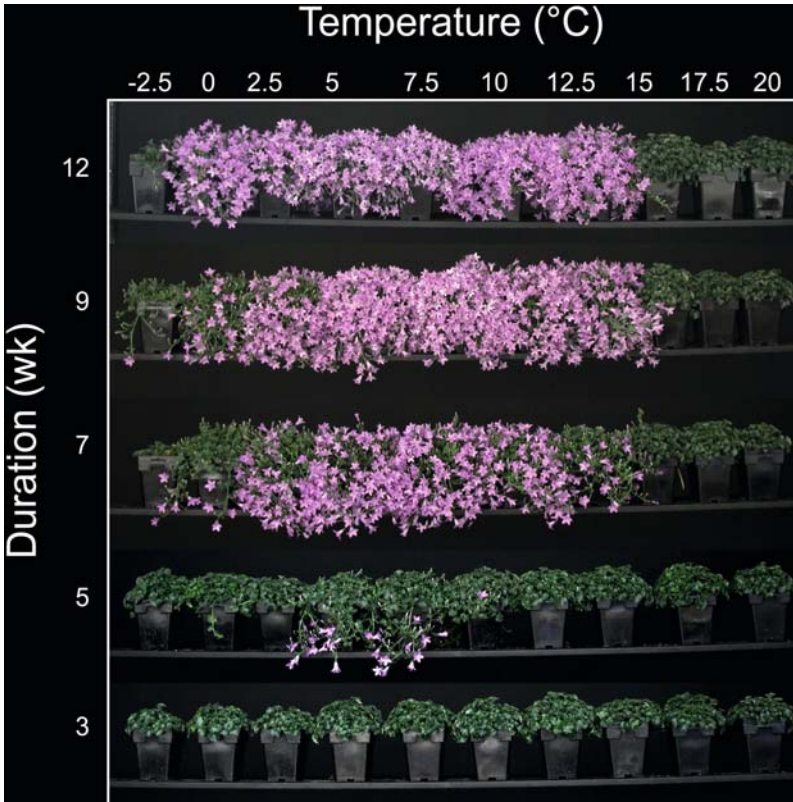

FIGURE 19. The effect of vernalization temperature and duration of flowering of *Campanula birch* hybrid (harebell). No flowering is observed if the vernalization period is less than 5 weeks. Courtesy S. Padhye and A. Cameron, Department of Horticulture, Michigan State University, USA.

3.3.4 Effects of Temperature on Plant Development

Low temperature is a **trigger** for flower induction of biennials (Sect. 3.3.3) and also affects plant **development** (Atkinson & Porter 1996). Reaumur (1735) introduced the concept of a **thermal unit** to predict plant development. This concept assumes that plants need a fixed temperature sum to fulfill a developmental phase. This assumption implies that the rate of development, expressed as the inverse of the duration in days for a given phase, is a linear function of temperature. Although the concept of thermal unit is widely applied, it has no physiological basis (Horie 1994).

3.3.5 Attracting Pollinators

Pollination of flowers by insects, birds, lizards, or bats requires attraction of pollinators. Attraction may occur through secondary phenolic compounds (flavonoids) in the petals (Shirley 1996). These **UV-absorbing compounds** are invisible to the human eye, but they are perceived by pollinating bees. The flowers of many species change color with

pollination, thus guiding potential pollinators to those flowers that are still unpollinated, and provide a nectar reward (Weiss 1991). The change in color may be due to a change of the pH in the vacuole, in which the phenolics compounds are located [e.g., in *Ipomoea caerulea* (morning glory)]. Following pollination, most flowers cease nectar production. Pollinators quickly learn which colors provide a nectar reward.

The quantity of nectar provided by a flower depends on the number of flowers in an inflorescence and the type of pollinator that a flower is “designed” to attract. For example, long-tubed red flowers pollinated by hummingbirds typically produce more nectar than short-tubed flowers pollinated by small insects; this makes sense in view of the 140-fold greater energy requirement of hummingbirds (Heinrich & Raven 1972). Those species that produce many flowers in an inflorescence typically produce less nectar per flower than do species that produce a single flower. In general, plants produce enough nectar to attract pollinators, but not to satiate them, thus forcing pollinators to visit additional flowers to meet their energetic requirements and increasing the probability of effective pollen transfer (Heinrich 1975).

Secondary compounds play a role as **visual** cues for insects. Others, with specific **scents**, are often released only at a specific time of the day or night, associated with thermogenic respiration. These scents may be faint smells or an olfactory delight for humans, e.g., terpenoids released by **thermogenic** cones of *Macrozamia* (cycad) species (Terry et al. 2004). On the other hand, *Heliconia* (*Heliconia muscivora* (dead horse arum) produces an inflorescence that resembles the anal area of a dead mammal and produces a foetid scent during the few hours after sunrise. Flies enter the floral chamber, pollinate the female florets, and become trapped until the next morning, when pollen is shed from the male florets and the flies are released (Seymour et al. 2003). The cyanide-resistant **alternative path** increases in activity prior to heat production and is partly responsible for it (Sect. 3.1 of Chapter 2B on plant respiration). Although this is not the only reason for thermogenesis (high respiration rates per se are also important), it definitely contributes to the **heat production** because the lack of proton extrusion coupled to electron flow allows a large fraction of the energy in the substrate to be released as heat.

The temperature of the flower, compared with that of the ambient air, can also be enhanced by **solar tracking**, which is a common phenomenon in alpine and arctic species that belong to the Asteraceae, Papaveraceae, Ranunculaceae, and Rosaceae and involves the perception of blue light (Stanton & Galen 1993). This may raise flower temperature by several degrees above the ambient temperature, as long as the wind speed is not too high (Sect. 2.2 of Chapter 4A on the plant's energy balance). Solar tracking might therefore affect fitness in many ways. When solar tracking is prevented in *Dryas octopetala* (mountain avens), by tethering the plants, lighter seeds are produced, but the seed set is not affected (Kjellberg et al. 1982). A similar treatment decreases both seed set and seed mass in *Ranunculus adoneus* (snow buttercup) (Stanton & Galen 1989). The flowers of the solar-tracking Norwegian alpine buttercup (*Ranunculus acris*) traverse an arc of about 50°, with speed of movement and solar tracking accuracy being highest at midday (between 11 am and 5 pm). This solar tracking enhances flower temperature by about 3.5°C. Solar tracking decreases with flower aging and stops completely as the petals wither, so that it cannot have effects on post-anthesis events. Tethering the flowers does not affect the attractiveness to pollinating insects, seed:ovule ratio, seed mass, or seed abortion rate (Totland 1996). If solar tracking has any selective advantage in this species, then it is probably only under special

weather conditions (e.g., when pollinator activity is limited by low temperatures).

Orchids more than any other plant family have engaged in complex pollination systems, with species adopting the full spectrum of pollination syndromes from autogamy (a means of self-pollinating), food rewarding, food deception, nest-site deception, to sexual deception (Cozzolino & Widmer 2005). Whereas food-deceptive systems are the most common in orchids, it is sexual-deceptive systems that have attracted most interest where orchid flowers produce insectiform flowers and pheromones (known as **allomones**) that match the calling hormone of female insects, usually wasps and bees. The most extreme cases of sexual deception are found in Australian orchids, where hammer orchids (*Drakaea* and *Chiloglottis*) have almost exclusive one-to-one relationships between male wasps and orchid species. In the case of *Chiloglottis*, the hormone has been characterized and is known as chiloglottine (Schiestl et al. 2003); it precisely matches the pheromone chemistry produced by the female wasp. Such levels of evolutionary specialization present important consequences for conservation management where managing the orchid requires careful consideration of the wasp.

3.3.6 The Cost of Flowering

Some of the most important tropical-subtropical fruit trees produce extremely large numbers of flowers, for unknown reasons. Their respiratory demands are high (Sect. 5.1.2 of Chapter 2B on plant respiration) and the overall daily demand for carbohydrates during bloom may often exceed the daily photosynthate production. Flowering in *Citrus paradisi* (grapefruit) for a tree that bears 20000–50000 flowers requires 166–400 mol C tree⁻¹. In comparison, the amount of carbon required for the growth of the ovaries, the only floral organs that persist after flowering, is only 33–38 mol C tree⁻¹. Together with the abscission of fruitlets, the amount of carbon that is lost at early stages of the reproductive cycle is about 27% of the annual photosynthate production (Bustan & Goldschmidt 1998).

From an evolutionary perspective the advantages that are associated with the production of large numbers of reproductive units must justify the apparent waste of resources. Uncertainties concerning pollination and improvement of fruit/seed quality by selective abscission have been suggested as factors influencing the excessive production of reproductive units. From the grower's point of view the heavy bloom of *Citrus* may seem to be a

waste of resources; preventing it might lead to an increase in yield or fruit quality.

3.4 Fruiting

Allocation to reproduction varies substantially among plants and with environmental conditions, ranging from 1 to 30% of net primary production, with median values of perhaps 10%. This modest allocation to reproduction (the process that most directly governs plant fitness) is less than typical allocation to root exudation under nutrient stress or nutrient uptake under favorable conditions (Table 2 in Chapter 2B on plant respiration) which suggests that the processes of resource acquisition under conditions of environmental stress and competition with neighboring plants often leave relatively few resources for reproduction.

Wild plants generally produce fewer fruits than flowers. Low allocation to reproduction sometimes reflects poor pollination, when weather conditions are bad for pollinators or for appropriate pollen-producing plants. Even when the flowers are artificially pollinated, however, the ratio between fruits and flowers, commonly referred to as **fruit set**, may still be substantially below 1. In addition, increased pollination may have more seeds setting, but at the expense of seed size, which indicates that seed production may be both “pollen-limited” and “resource-limited” (Stanton et al. 1987).

Allocation to reproduction differs substantially among species. In general, annuals and other short-lived species allocate a larger proportion of annual production to reproduction than do long-lived perennials, which suggests a **trade-off** between reproduction and traits that promote survival or growth (Bazzaz et al. 1987). For example, many conifers and other tree species reproduce prolifically once in several years. These “mast years” are correlated with years of low wood production and are often synchronized among individuals in a population. Mast reproduction may be possible only after several years of reserve accumulation. This pattern of reproduction serves to “swamp” seed predators in years of abundant seed production and to limit the population growth of seed predators in intervening years (Eis et al. 1965).

Allocation to female function is generally considered the most costly component of reproduction, because of the large investments of carbon and nutrient required to produce seeds. This may explain why female individuals of dioecious species are generally underrepresented in sites of low water availability (Bazzaz et al. 1987); however, male

function also entails substantial costs. For example, *Phacelia linearis* (threadleaf phacelia) has both female and hermaphroditic individuals. Those individuals that have both male and female function (hermaphrodites) grow more slowly than do females, particularly at low nutrient supply which suggests that it is the nutrient investment in male function that accounts for the slower growth of hermaphrodites (Eckhart 1992a,b). During the vegetative phase, hermaphroditic genotypes of *Plantago lanceolata* (snake plantain) have exactly the same growth rate and photosynthetic characteristics as the ones with only female function. When grown at a nutrient supply that resembles that in their natural environment, however, the female plants have a three- to fivefold higher reproductive output. Female genotypes invest three times more biomass in each flower, with an even greater difference in terms of N investment, because the stamens contain relatively more N than do the female components of flowers (sepals and petals). The female plants use the N saved by not producing pollen for additional vegetative as well as reproductive growth, showing that resource compensation is a primary mechanism that accounts for the persistence of genotypes that are exclusively female (Poot 1997).

Allocation to reproduction is difficult to quantify because the inflorescence can often meet much of its own carbon requirement and because some structures serve both reproductive and nonreproductive roles. A substantial proportion of the energetic costs of reproduction are met by photosynthesis in the inflorescence and associated leaves. For example, photosynthesis by the inflorescence accounts for 2–65% (median 22%) of the carbon required for reproduction of temperate trees (Bazzaz et al. 1979). In cereals, the ear accounts for up to 75% of the photosynthate required for grain production, and the inflorescence plus the closest leaf (the flag leaf) provide all of the photosynthate required for reproduction (Evans & Rawson 1970). When vegetative leaves are removed by herbivores, an increased proportion of flag-leaf photosynthate goes to vegetative organs, whereas damage to the flag leaf increases carbon transport from other leaves to the inflorescence. Thus, the role of each leaf in supporting reproduction depends on the integrated carbon supply and demand of the entire plant. Stem growth often increases during reproduction of herbaceous plants which increases the probability of pollen exchange and the dispersal distance of wind-dispersed fruits. The greatest gains in yield of crop (e.g., cereals, peanuts, sugar beet) have come from breeding for a higher **harvest index** [i.e., the ratio between harvestable biomass and total

(above-ground) biomass]. In cereals this has been achieved by selection for varieties with reduced stem allocation, which is due to a low production of or sensitivity to GA. There has been no increase in photosynthetic capacity during crop breeding for higher grain yield (Evans 1980, Gifford et al. 1984). However, actual yields are now approaching potential crop yields in many areas. Further increases in yield may be possible only by increasing photosynthetic capacity (Mitchell & Sheeny 2006).

3.5 Senescence

After flowering, phloem-mobile nutrients are exported from the senescing leaves and roots to the developing fruits (Sect. 4.3.2 of Chapter 6 on mineral nutrition). Unlike “getting old and wearing out”, senescence in plants is a carefully programmed, hormonally controlled developmental process: **programmed cell death** (Jones & Dangl 1996). It is an integral part of plant development that is affected by environmental factors (e.g., irradiance level, photoperiod, and nutrient supply). It is promoted by **ethylene** and **ABA**, and slowed down or reversed by **cytokinins** and/or **GA**. A number of specific genes are up-regulated during leaf senescence (Smart 1994). An early visible symptom of leaf senescence is leaf yellowing, due to loss of chlorophyll. Rubisco and other chloroplast proteins are hydrolyzed by proteolytic enzymes, and free amino acids are exported via the phloem. Mitochondrial proteins tend to be hydrolyzed in a later phase, and tissues around the vascular system which are required for nutrient export are the last to senesce. The breakdown of the nucleus, whose activity is essential for senescence to proceed, is a relatively late event in the developmental process (Gan & Amasino 1997). Nitrogenous compounds are remobilized, as are most other compounds that can move in the phloem. Unlike phloem-mobile elements, Ca concentrations in phloem sap are very low (Sect. 2 of Chapter 2C on long-distance transport).

Considering the driving force for phloem transport (i.e., a gradient in hydrostatic pressure between source and sink; Sect. 3 of Chapter 2C on long-distance transport), it is not surprising that some of the compounds remobilized from senescing leaves are transported to roots, even though these may show a net export of nutrients (Simpson et al. 1983). The pattern is somewhat similar to that in vegetative plants, which show a continuous cycling of N between leaves and roots, via both phloem and xylem (Sect. 5.4.1 of Chapter 7 on growth and allocation). The rather indirect manner in which N moves

from senescing leaves to developing kernels probably reflects the way the systems for long-distance transport (i.e., xylem and phloem) operate. That is, phloem sap will move in the sieve tubes from a site where the phloem is loaded, thus creating a high pressure, to a site where phloem unloading takes place, thus decreasing the pressure. Xylem sap will move in the xylem conduits, down a gradient in hydrostatic pressure. There is some exchange between the transport pathways, especially in the stem (Fig. 19), but this is obviously not sufficient to stop the need for a continuous cycling process in plants.

4. Seed Dispersal

Seeds are often well protected, either physically, by a hard seed coat (Sect. 2.1), or chemically, due to poisonous compounds, e.g., cyanogenic glycosides or specific inhibitors of digestive enzymes (Sects. 3.1 and 3.2 of Chapter 9B on ecological biochemistry).

Numerous plant attributes are associated with seed dispersal [e.g., floating designs in aquatics, sticky seed parts in mistletoes that ensure deposition on a host branch (Mitich 1991, Amico & Aizen 2000), hooks that facilitate attachment to animal furs, structures that attract animals, “ballistic” structures, plumes and wings that allow transfer through air (Murray 1986)]. Some of these mechanisms involve aspects of the plant’s physiology, of which a few examples will be presented in this section.

4.1 Dispersal Mechanisms

Explosive or **ballistic** seed dispersal occurs in many plant species. Such dispersal mechanisms are highly undesirable in crop plants because they cause “shattering” and loss of seed during harvest [e.g., in *Brassica* (cabbage) species]. In the tropical rain forest legume tree, *Tetradelphinium moreliana*, such a mechanism allows seeds to be launched and transferred over as much as 50 m (Van der Burgt 1997). It is a consequence of drying of the pod walls which creates tension that builds up between the two valves of the pod. Once the tension exceeds a threshold value, the pod explodes and the seed is launched.

Tension in the tissue may also occur without drying of the reproductive structure [e.g., in *Impatiens* (touch-me-not)]. In this case the tissue tension reflects an aspect of tissue water relations, which we alluded to in Sect. 4 of Chapter 3 on plant water relations. That is, within the reproductive tissue,

the water relations of individual cells must differ widely, creating **tissue tension**. Touch or wind may cause a threshold to be exceeded which causes rupture in the reproductive structure and launching of the seeds.

4.2 Life-History Correlates

Plants have an ancient and uneasy relationship with vertebrate animals that eat their fruits and either digest or disperse their seeds. As early as 300 million years ago, Carboniferous progenitors of modern cycads bore fleshy fruits, which were apparently adapted for consumption by primitive reptiles that then dispersed the seeds (Howe 1986).

Many species [e.g., *Acacia* (wattle) species in Australia] produce a lipid-rich morphological structure, termed **aril** or **elaiosome**. Such a structure allows dispersal via ants (Hughes et al. 1994), which transport the seeds to their nest, thus burying the *Acacia* seeds, safe from fire (O'Dowd & Gill 1985). *Cabralea canjerana* (cancharana), on the other hand, is a typical bird-dispersed tree in Atlantic forests in south-east Brazil. Ants treat their seeds in different ways, depending on the species. Some ants remove the arillate seeds to their nest, thus reducing seed predation by insects and rodents. Other ants remove the aril on the spot or cover the seeds before removing the aril. Aril removal greatly facilitates seed germination in some species (Pizo & Oliviera 1998).

5. The Message to Disperse: Perception, Transduction, and Response

Plants continuously **sense** their environment, both as adults and as seeds, before germination starts. Seeds acquire information about the suitability of their environment for seedling growth, and they use this information to germinate or to remain dormant. There are numerous environmental cues, with plants from different environments using different cues. At a later stage plants similarly sense their environment to change from the vegetative to the reproductive stage and to time their flowering. Day-length and low temperature are major cues, with irradiance level and nutrient supply occasionally playing an additional role in the switch to the reproductive phase in biennials.

There are also changes during development that are programmed, with environmental factors playing at most a moderating role. For example, leaf senescence is part of a scenario of programmed cell death that can be hastened by low irradiance and limiting N supply. The switch from juvenile to adult foliage is also programmed, but it can be affected by irradiance, nutrient availability, and plant water status.

Once flowering has started, the plant may require pollinating animals to produce seeds. Olfactory and visual cues are produced to attract these pollinators. The seeds that are subsequently produced may end up close to the mother plant, but there are also numerous mechanisms that ensure dispersal of the seeds over relatively great distances. One of the mechanisms of ecophysiological interest is that of plants that "launch" their seeds. Other dispersal mechanisms require allocation of reserves to elaiosomes (i.e., producing food for dispersing ants). Ants both disperse and bury the seeds; therefore, it is assumed that the seeds are safe during a fire, but this remains to be established. Surviving seeds remain dormant until the right environmental (chemical) cues have been perceived, and the life cycle continues.

Plants sense their environment during their entire life, and the acquired information determines what is going to happen in several steps of the plant's life cycle. We now have a reasonable understanding of important environmental cues and plant responses. Right now, our knowledge of signal-transduction pathways that connect the environmental cue and the plant's response is expanding rapidly.

References

- Amico, G. & Aizen, M.A. 2000. Mistletoe seed dispersal by a marsupial. *Nature* **408**: 929-930.
- Appenroth, K.J., Lenk, G., Goldau, L., & Sharma, R. 2006. Tomato seed germination: Regulation of different response modes by phytochrome B2 and phytochrome A. *Plant Cell Environ.* **29**: 701-709.
- Atkinson, D. & Porter, J.R. 1996. Temperature, plant development and crop yields. *Trends Plant Sci.* **1**: 119-124.
- Baskin, C.C. & Baskin, J.M. 2001. Seeds; ecology, biogeography, and evolution of dormancy and germination. Academic press, San Diego.
- Baskin, J.M. & Baskin, C.C. 2004. A classification system for seed dormancy. *Seed Sci. Res.* **14**: 1-6.
- Bazzaz, F.A., Carlson, R.W., & Harper, J.L. 1979. Contribution to reproductive effort by photosynthesis of flowers and fruits. *Nature* **279**: 554-555.

- Bazzaz, F.A., Chiariello, N.R., Coley, P.D., & Pitelka, L.F. 1987. Allocating resources to reproduction and defense. *BioSci.* **37**: 58–67.
- Bernier, G., Kinet, J.-M., & Sachs, R.M. 1981. The physiology of flowering. Vol. I. CRC Press, Boca Raton.
- Bliss, D. & Smith, H. 1985. Penetration of light into soil and its role in the control of seed germination. *Plant Cell Environ.* **8**: 475–483.
- Bewley, J.D. & Black, M. 1994. Seeds - Physiology of development and germination. Plenum Press, New York.
- Blaauw-Jansen, G. & Blaauw, O.H. 1975. A shift in the response threshold to red irradiation in dormant lettuce seeds. *Acta Bot. Neerl.* **24**: 199–202.
- Bryant, J.P. & Kuropat, P.J. 1980. Selection of winter forage by subarctic browsing vertebrates: The role of plant chemistry. *Annu. Rev. Plant Physiol.* **11**: 261–285.
- Bustan, A. & Goldschmidt, E.E. 1998. Estimating the cost of flowering in a grapefruit tree. *Plant Cell Environ.* **21**: 217–224.
- Casal, J.J. & Sánchez, R.A. 1999. Phytochromes and seed germination. *Seed Sci. Res.* **8**: 317–329.
- Chapin III, F.S., Tieszen, L.L., Lewis, M., Miller, P.C., & McCown, B.H. 1980. Control of tundra plant allocation patterns and growth. In: An arctic ecosystem: The coastal tundra at Barrow, Alaska, J. Brown, P. Miller, L. Tieszen, & F. Bunnell (eds.). Dowden, Hutchinson and Ross, Stroudsburg, pp. 140–185.
- Chapman, D.F., Robson, M.J., & Snaydon, R.W. 1992. Physiological integration in the perennial herb *Trifolium repens* L. *Oecologia* **89**: 338–347.
- Coley, P.D. & Aide, T.M. 1989. Red coloration of tropical young leaves: A possible antifungal defence? *J. Trop. Ecol.* **5**: 293–300.
- Cook, R.E. 1979. Patterns of juvenile mortality and recruitment in plants. In: Topics in plant population biology, O.T. Solbrig, S. Jain, G.B. Johnson, & P.H. Raven (eds.). Columbia University Press, New York, pp. 207–231.
- Corbesier, L., Vincent, C., Jang, S., Fornara, F., Fan, Q., Searle, I., Giakountis, A., Farrona, S., Gissot, L., Turnbull, C., & Coupland, G. 2007. FT protein movement contributes to long-distance signaling in floral induction of *Arabidopsis*. *Science* **316**: 1030–1033.
- Cozzolino, S. & Widmer, A. 2005. Orchid diversity: An evolutionary consequence of deception? *Trends Ecol. Evol.* **20**: 487–494.
- Cresswell, E.G. & Grime, J.P. 1981. Induction of light requirement during seed development and its ecological consequences. *Nature* **291**: 583–585.
- De Jong, T.J., Klinkhamer, P.G.L., Nell, H.W., & Troelstra, S.J. 1987. Growth and nutrient accumulation of the biennials *Cirsium vulgare* and *Cynoglossum officinale* under nutrient-rich conditions. *Oikos* **48**: 62–72.
- De Lange, J.H. & Boucher, C. 1990. Autecological studies on *Audouinia capitata* (Bruniaceae). I. Plant-derived smoke as a seed germination cue. *S. Afr. J. Bot.* **56**: 700–703.
- Derckx, M.P.M. & Karssen, C.M. 1993. Changing sensitivity to light and nitrate but not to gibberellins regulates seasonal dormancy patterns in *Sisymbrium officinale* seeds. *Plant Cell Environ.* **16**: 469–479.
- Dixon, K.W., Roche, S., & Pate, J.S. 1995. The promotive effect of smoke derived from burnt vegetation on seed germination of Western Australian plants. *Oecologia* **101**: 185–192.
- Eckhart, V.M. 1992a. The genetics of gender and the effects of gender on floral characteristics in gynodioecious *Phacelia linearis* (Hydrophyllaceae). *Am. J. Bot.* **79**: 792–800.
- Eckhart, V.M. 1992b. Resource compensation and the evolution of gynodioecy in *Phacelia linearis* (Hydrophyllaceae). *Evolution* **46**: 1313–1322.
- Eis, S. Garman, E.H., & Ebell, L.F. 1965. Relation between cone production and diameter increment of Douglas-fir (*Pseudotsuga menziesii* (Mirb.) Franco), grand fir (*Abies grandis* (Dougl.) Lindl.), and western white pine (*Pinus monitcola* Dougl.). *Can. J. Bot.* **43**: 1553–1559.
- Evans, L.T. 1980. The evolution of crop yield. *Am. Sci.* **68**: 388–397.
- Evans, L.T. & Rawson, H.M. 1970. Photosynthesis and respiration by the flag leaf and components of the ear during grain development in wheat. *Aust. J. Biol. Sci.* **23**: 245–254.
- Farnsworth, E.J. & Farrant, J.M. 1999. Reductions in abscisic acid are linked with viviparous reproduction in mangroves. *Am. J. Bot.* **85**: 760–769.
- Fenner, M. 1985. Seed ecology. Chapman and Hall, London.
- Finch-Savage, W.E. & Leubner-Metzger, G. 2006. Seed dormancy and the control of germination. *New Phytol.* **171**: 501–523.
- Flematti, G.R., Ghisalberti, E.L., Dixon, K.W., & Trengove, R.D. 2004a. Molecular weight of a germination-enhancing compound in smoke. *Plant Soil* **263**: 1–4.
- Flematti, G.R., Ghisalberti, E.L., Dixon, K.W., & Trengove, R.D. 2004b. A compound from smoke that promotes seed germination. *Science* **305**: 977.
- Gan, S. & Amasino, R.M. 1997. Making sense of senescence. *Plant Physiol.* **113**: 313–319.
- Garner, W.W. & Allard, H.A. 1920. Effects of the relative length of night and day and other factors of the environment on growth and reproduction in plants. *J. Agric. Res.* **18**: 553–606.
- Gifford, R.M., Thorne, J.H., Hitz, W.D., & Giaquinta, R.T. 1984. Crop productivity and photoassimilate partitioning. *Science* **225**: 801–80
- Gorski, T & Gorska, K. 1979. Inhibitory effects of full daylight on the germination of *Lactuca sativa*. *Planta* **144**: 121–124.
- Grime, J.P. & Jeffrey, D.W. 1965. Seedling establishment in vertical gradients of sunlight. *J. Ecol.* **53**: 621–642.
- Gross, K.L. 1984. Effects of seed size and growth form on seedling establishment of six monocarpic perennial plants. *J. Ecol.* **72**: 369–387.
- Hansen, D.H. 1986. Water relations of compound leaves and phyllodes in *Acacia koa* var. *latifolia*. *Plant Cell Environ.* **9**: 439–445.
- Hansen, D.H. 1996. Establishment and persistence characteristics in juvenile leaves and phyllodes of *Acacia koa* (Leguminosae) in Hawaii. *Int. J. Plant Sci.* **157**: 123–12

- Harper, J.L. 1977. Population biology of plants. Academic Press, London.
- Heinrich, B. 1975. Energetics of pollination. *Annu. Rev. Ecol. Syst.* **6**: 139–170.
- Heinrich B. & Raven, P.H. 1972. Energetics and pollination ecology. *Science* **176**: 597–602.
- Hennig, L., Stoddart, W.M., Dieterle, M., Whitelam, G.C., & Schafer, E. 2002. Phytochrome E controls light-induced germination of *Arabidopsis*. *Plant Physiol.* **128**: 194–200.
- Hesse, O. 1924. Untersuchungen über die Einwirkung chemischer Stoffe auf die Keimung lichtempfindlicher Samen. *Bot. Arch.* **5**: 133–171.
- Hilhorst, H.W.M. & Karssen, C.M. 1989. Nitrate reductase independent stimulation of seed germination in *Sisymbrium officinale* L. (hedge mustard) by light and nitrate. *Ann. Bot.* **63**: 131–137.
- Hilhorst, H.W.M. & Karssen, C.M. 1992. Seed dormancy and germination: The role of abscisic acid and gibberellins and the importance of hormone mutants. *Plant Growth Regul.* **11**: 225–23
- Horie, T. 1994. Crop ontogeny and development. In: Physiology and determination of crop yield, K.J. Boote, J.M. Bennet, T.R. Sinclair, & G.M. Paulsen (eds.). American Society of Agronomy, Crop Science Society of America, Soil Science Society of America, Madison, pp. 153–180.
- Howe, H.F. 1986. Seed dispersal by fruit-eating birds and mammals. In: Seed Dispersal, D.R. Murray (ed.). Academic Press, Sydney, pp. 123–189.
- Hughes, L., Westoby, M., & Jurado, E. 1994. Convergence of elaiosomes and insect prey: Evidence from ant foraging behaviour and fatty acid composition. *Funct. Ecol.* **8**: 358–365.
- Jones, A.M. & Dangl, J.L. 1996. Logjam at the Styx: Programmed cell death in plants. *Trends Plant Sci.* **1**: 114–119.
- Jonsdottir, I.S., Callaghan, T.V., & Headly, A.D. 1996. Resource dynamics within arctic clonal plants. *Ecol. Bull.* **45**: 53–64.
- Karssen, C.M. 1982. Seasonal patterns of dormancy in weed seeds. In: The physiology and biochemistry of seed development, dormancy and germination, A.A. Kahn (ed.). Elsevier, Amsterdam, pp. 243–270.
- Karssen, C.M. & Hillhorst, H.W.M. 1992. Effect of chemical environment on seed germination. In: Seeds, the ecology of regeneration in plant communities, M. Fenner (ed.). C.A.B. International, Wallingford, pp. 327–34
- Keeley, J.E. 1991. Seed germination and life history syndromes in the Californian chaparral. *Bot. Rev.* **67**: 81–116.
- Kjellberg, B., Karlsson, S., & Kerstensson, I. 1982. Effects of heliotropic movements of flowers of *Dryas octopetala* on gynoecium temperature and seed development. *Oecologia* **70**: 155–160.
- Klinkhamer, P.G.L. & De Jong, T.J., & Meelis, E. 1986. Delay of flowering in spear thistle (*Cirsium vulgare* (Savi. Ten)): Size-effects and devernization. *Oikos* **49**: 303–30
- Koller, D. & Negbi, M. 1959. The regulation of germination in *Oryzopsis miliacea*. *Ecology* **40**: 20–36.
- Koornneef, M. 1997. Plant development: Timing when to flower. *Curr. Biol.* **7**: 651–652.
- Koornneef, M., Alonso-Blanco, C., Peeters, A.J.M., & Soppe, W. 1998. Genetic control of flowering time in *Arabidopsis*. *Annu. Rev. Plant Physiol. Plant Mol. Biol.* **49**: 345–370.
- Koornneef, M., Bentsink, L., & Hilhorst, H. 2002. Seed dormancy and germination. *Curr. Opin. Plant Biol.* **5**: 33–36.
- Kursar, T.A. & Coley, P.D. 1991. Delayed greening in tropical trees: An antiherbivore defense? *Biotropica* **24**: 256–262.
- Kursar, T.A. & Coley, P.D. 1992a. The consequences of delayed greening during leaf development for light absorption and light use efficiency. *Plant Cell Environ.* **15**: 901–909.
- Kursar, T.A. & Coley, P.D. 1992b. Delayed development of the photosynthetic apparatus in tropical rain forest species. *Funct. Ecol.* **6**: 411–422.
- Legg, C.J., Maltby, E., Proctor, C.F. 1992. The ecology of severe moorland fire on the North York Moors: Seed distribution and seedling establishment of *Calluna vulgaris*. *J. Ecol.* **80**: 737–752.
- Leishman, M.R. & Westoby, M. 1994. The role of large seed size in shaded conditions: Experimental evidence. *Funct. Ecol.* **8**: 205–214.
- Leishman, M.R., Westoby, M., & Jurado, E. 1995. Correlates of seed size variation: A comparison among five temperate floras. *J. Ecol.* **83**: 517–530.
- Machackova, I., Eder, J., Motyka, V., Hanus, J., & Krekule, J. 1996. Photoperiodic control of cytokinin transport and metabolism in *Chenopodium rubrum*. *Physiol. Plant.* **98**: 564–570.
- Martinez-Garcia, J.F., Virgos-Soler, A., & Prat, S. 2002. Control of photoperiod-regulated tuberization in potato by the *Arabidopsis* flowering-time gene CONSTANS. *Proc. Natl. Acad. Sci. USA* **99**: 15211–15216.
- McAuliffe, J.R., Hamerlynck, E.P., & Eppes, M.C. 2007. Landscape dynamics fostering the development and persistence of long-lived creosotebush (*Larrea tridentata*) clones in the Mojave Desert. *J. Arid Environ.* **69**: 96–126.
- McKee, G.W., Pfeiffer, R.A., & Mohsenin, N.N. 1977. Seed-coat structure in *Coronilla varia* L. and its relations to hard seed. *Agronomy J.* **69**: 53–5
- Meisert, A., Schulz, D., & Lehmann, H. 1999. Structural features underlying hardseededness in Geraniaceae. *Plant Biol.* **1**: 311–314.
- Michaels, D.D. & Amasino, R.M. 2000. Memories of winter: Vernalization and the competence to flower. *Plant Cell Environ.* **23**: 1145–1153.
- Mitchell, P.L. & Sheehy, J.E. 2006. Supercharging rice photosynthesis to increase yield. *New Phytol.* **171**: 688–693.
- Mitich, L.W. 1991. Intriguing world of weeds. Mistletoe – The Christmas weed. *Weed Technol.* **5**: 692–694.
- Mouradov, A., Cremer, F., & Coupland, G. 2002. Control of flowering time: Interacting pathways as a basis for diversity. *Plant Cell* **S111**–130.
- Murray, D.R. (ed.) 1986. Seed dispersal. Academic Press, Sydney.
- New, T.R. 1984. A biology of acacias. Oxford University Press, Melbourne.
- O'Dowd, D.J. & Gill, A.M. 1985. Seed dispersal syndromes in Australian *Acacia*. In: Seed dispersal, D.R. Murray (ed.). Academic Press, Sydney, pp. 87–121.

- Olsen, J.E., Jensen, E., Junntila, O., & Moritz, T. 1995. Photo-periodic control of endogenous gibberellins in seedlings of *Salix pentandra*. *Physiol. Plant.* **93**: 639–644.
- Olmsted, C.E. 1944. Growth and development in range grasses. IV. Photoperiodic responses in twelve geographic strains of side-oats grama. *Bot. Gaz.* **106**: 46–74.
- Peck, S.C., Pawlowski, K., & Kende, H. 1999. Asymmetric responsiveness to ethylene mediates cell elongation in the apical hook of peas. *Plant Cell* **10**: 713–719.
- Piñeiro, M. & Coupland, G. 1999. The control of flowering time and floral identity in *Arabidopsis*. *Plant Physiol.* **117**: 1–
- Pizo, M. & Oliviera, P.S. 1999. Interactions between ants of a nonmyrmecochorous neotropical tree, *Cabralea canjerana*, (Meliaceae), in the Atlantic forest of south-eastern Brazil. *Am. J. Bot.* **85**: 669–674.
- Pons, T.L. 1989. Breaking of seed dormancy by nitrate as a gap detection mechanism. *Ann. Bot.* **63**: 139–143.
- Pons, T.L. 1991a. Dormancy, germination and mortality of seeds in a chalk-grassland flora. *J. Ecol.* **79**: 765–780.
- Pons, T.L. 1991b. Induction of dark dormancy in seeds: Its importance for the seed bank in the soil. *Funct. Ecol.* **5**: 669–675.
- Pons, T.L. 2000. Seed responses to light. In: *Seeds, the ecology of regeneration in plant communities*, 2nd edition, M. Fenner (ed.). C.A.B. International, Wallingford, pp. 237–260.
- Pons, T.L. & During, H.J. 1987. Biennial behaviour of *Cirsium palustre* in ash coppice. *Holarct. Ecol.* **10**: 40–44.
- Pons, T.L. & Schröder, H.F.J.M. 1986. Significance of temperature fluctuation and oxygen concentration for germination of the rice field weeds *Fimbristylis littoralis* and *Scirpus juncooides*. *Oecologia* **68**: 315–319.
- Poot, P. 1997. Reproductive allocation and resource compensation in male-sterile, partially-male sterile and hermaphroditic plants of *Plantago lanceolata*. *Am. J. Bot.* **84**: 1256–1265.
- Preston, C.A., Betts, H., & Baldwin, I.T. 2002. Methyl jasmonate as an allelopathic agent: Sagebrush inhibits germination of a neighboring tobacco, *Nicotiana attenuata*. *J. Chem. Ecol.* **28**: 2343–2369.
- Rabinowitz, D. 1978. Abundance and diaspore weight in rare and common prairie grasses. *Oecologia* **37**: 213–219.
- Reaumur, R.A.F. 1735. Observations du thermomètre faites à Paris pendant l'année 1735, comparées avec celles qui ont été faites sous la Ligne, à l'Isle de France, à Algeres, & en quelquesunes de nos Isles de l'Amerique. Histoire de l'Academie Royale des Sciences, avec les Mémoires de Mathématique & de Physique pour la même année (Paris). 545–580.
- Roche, S., Dixon, K.W., & Pate, J.S. 1997. Seed ageing and smoke: Partner cues in the amelioration of seed dormancy in selected Australian native species. *Aust. J. Bot.* **45**: 783–815.
- Salisbury, E.J. 1942. The reproductive capacity of plants. Bell, London.
- Samach, A. & Coupland, G. 2000. Time measurement and the control of flowering in plants. *BioEssays* **22**: 38–47.
- Schiestl, F.P., Peakall, R., Mant, J.M., Ibarra, F., Schulz, C., Franke, S., & Francke, W. 2003. The chemistry of sexual deception in an orchid-wasp pollination system. *Science* **302**: 437–43
- Scopel, A.L., Ballaré, C.L., & Radosevich, S.R. 1994. Photostimulation of seed germination during soil tillage. *New Phytol.* **126**: 145–152.
- Seymour, R.S., Gibernau, M., & ITO, K. 2003. Thermogenesis and respiration of inflorescences of the dead horse arum *Heliconia muscivora*, a pseudothermoregulatory aroid associated with fly pollination. *Funct. Ecol.* **17**: 886–894.
- Shaver, G.A., Chapin III, F.S., & Billings, W.D. 1979. Ecotypic differentiation in *Carex aquatilis* on ice-wedge polygons in the Alaskan coastal tundra. *J. Ecol.* **67**: 1025–1046.
- Shibley, B. & Dion, J. 1992. The allometry of seed production in herbaceous angiosperms. *Am. Nat.* **139**: 467–483.
- Shirley, B.W. 1996. Flavonoid biosynthesis: "new" functions for an "old" pathway. *Trends Plant Sci.* **1**: 377–382
- Simpson, R.J., Lambers, H., & Dalling, M.J. 1983. Nitrogen redistribution during grain growth in wheat (*Triticum aestivum* L). IV. Development of a quantitative model of the translocation of nitrogen to the grain. *Plant Physiol.* **71**: 7–14.
- Smart, C. 1994. Gene expression during leaf senescence. *New Phytol.* **126**: 419–44
- Stanton, M. & Galen, C. 1989. Consequences of flower heliotropism for reproduction in an alpine buttercup (*Ranunculus adoneus*). *Oecologia* **78**: 477–485.
- Stanton, M. & Galen, C. 1993. Blue light controls solar tracking by flowers of an alpine plant. *Plant Cell Environ.* **16**: 983–989.
- Stanton, M.L., Berczky, J.K., & Hasbrouck, H.D. 1987. Pollination thoroughness and maternal yield regulation in wild radish, *Raphanus raphanistrum* (Brassicaceae). *Oecologia* **74**: 68–76.
- Steinbach, H.S., Bence-Arnold, R.L., & Sanchez, R.A. 1997. Hormonal regulation of dormancy in developing sorghum seeds. *Plant Physiol.* **113**: 149–154.
- Stuefer, J.F. 1995. Separating the effects of assimilate and water integration in clonal fragments by the use of steam-girdling. *Abstr. Bot.* **19**: 75–81.
- Stuefer, J.F., De Kroon, H., & During, H.J. 1996. Exploitation of environmental heterogeneity by spatial division of labour in a clonal plant. *Funct. Ecol.* **10**: 328–334.
- Takeo, K. & Maeda, T. 1996. Abscisic acid both promotes and inhibits photoperiodic flowering of *Pharbitis nil*. *Physiol. Plant.* **98**: 467–470.
- Tamaki, S., Matsuo, S., Wong, H.L., Yokoi, S., & Shimamoto, K. 2007. Hd3a protein is a mobile flowering signal in rice. *Science* **316**: 1033–1036.
- Terry, I., Moore, C.J., Walter, G.H., Forster, P.I., Roemer, R.B., Donaldson, J.D., & Machin, P.J. 2004. Association of cone thermogenesis and volatiles with pollinator specificity in Macrozamia cycads. *Plant Syst. Evol.* **243**: 233–247.
- Thompson, K., Grime, J.P., & Mason, G. 1977. Seed germination response to diurnal fluctuations of temperature. *Nature* **267**: 147–149.
- Totland, O. 1996. Flower heliotropism in an alpine population of *Ranunculus acris* (Ranunculaceae): Effects on flower temperature, insect visitation, and seed production. *Am. J. Bot.* **83**: 452–45
- Van der Burgt, X.M. 1997. Explosive seed dispersal of the rainforest tree *Tetrabelinia moreliana*

- (Leguminosae – Caesalpinioideae) in Gabon. *J. Trop. Ecol.* **13**: 145–151.
- Vazquez-Yanes, C., Orozco-Segovia, A., Rincón, E., Sánchez-Coronado, M.E., Huante, P., Toledo, J.R., & Barradas, V.L. 1990. Light beneath the litter in a tropical forest: Effect on seed germination. *Ecology* **71**: 1952–195
- Vleeshouwers, L.M., Bouwmeester, H.J., & Karssen, C.M. 1995. Redefining seed dormancy: An attempt to integrate physiology and ecology. *J. Ecol.* **83**: 1031–1037.
- Weiss, M.R. 1991. Floral colour changes as cues for pollinators. *Nature* **354**: 227–229.
- Woodall, G.S., Dodd, I.C. & Stewart, G.R. 1998. Contrasting leaf development within the genus *Syzygium*. *J. Exp. Bot.* **49**: 79–87.
- Yan, L., Loukoianov, L., Tranquilli, G., Helguera, G., Fahima, T., & Dubcovsky, J. 2003. Positional cloning of the wheat vernalization gene *VRN1*. *Proc. Natl. Acad. Sci. USA* **100**: 6263–626

9

Biotic Influences

9A. Symbiotic Associations

1. Introduction

Symbiosis is the “living together” of two or more organisms. In its broadest sense, symbiotic associations include parasitic and commensal as well as mutually beneficial partnerships. As is common in the ecophysiological literature, however, we use the term **symbiosis** in a narrow sense to refer to **mutually beneficial associations** between higher plants and microorganisms. Mutual benefits may not always be easy to determine, particularly for the microsymbiont. In this chapter benefits for the macrosymbiont (“host”) are often expressed in terms of ability to accumulate biomass. In an ecological context, benefits in terms of “fitness” may be more relevant but are rarely documented. In the mutually beneficial associations discussed in this chapter, nutrients or specific products of the partners are shared between two or three partners; the macrosymbiont and the microsymbiont(s). Parasitic associations between higher plants are dealt with in Chapter 9D; parasitic associations between microorganisms and higher plants are discussed briefly in this chapter, and more elaborately in Chapter 9C on effects of microbial pathogens.

In Chapter 6 on mineral nutrition, we discussed numerous special mechanisms that allow some higher plants to acquire sparingly soluble nutrients from soils (e.g., excretion of carboxylates and phyto-siderophores). We also pointed out (Sects. 2.2.5 and 2.2.6 of Chapter 6 on mineral nutrition) that some species are quite capable of growing on soils where

P is sparingly available, without having a large capacity to excrete protons or carboxylates. How do these plants manage to grow? It is also obvious that special mechanisms to take up nutrients (e.g., N) are of little use, if the N is simply not there. Such plants must have alternative ways to acquire N.

This chapter discusses associations between higher plants and microorganisms that are of vital importance for the acquisition of nutrients. Such symbiotic associations play a major role in environments where the supply of P, N, or immobile cations limits plant growth. In the **rhizosphere** (or elsewhere in the plant’s immediate surroundings), mycorrhiza-forming fungi and N₂-fixing bacteria or cyanobacteria may form symbiotic associations. For those species that are capable of such symbioses, it tends to be profitable for both the higher plant (**macrosymbiont**) and the microorganism (**micro-symbiont**). Indeed, it is so profitable for the macrosymbiont that some plants are associated with more than one microsymbiont at the same time.

2. Mycorrhizas

Vast majority of higher plant species can form symbiotic associations with **mycorrhizal fungi**. Mycorrhizas are the structures arising from the association of roots and fungi; except for nonmycorrhizal species (Sect. 2.2), roots in soil should be considered in conjunction with their mycorrhizal symbionts. There are four main types of mycorrhizas (Sect. 2.1; Smith &

TABLE 1. The length of mycorrhizal hyphae per unit colonized root length as measured for a number of plant species, infected with different arbuscular mycorrhiza-forming fungal species.

Fungus	Host	Hyphal length (m cm ⁻¹ root)
<i>Glomus mosseae</i>	<i>Allium cepa</i> (onion)	0.79–2.5
<i>Glomus mosseae</i>	<i>Allium cepa</i>	0.71
<i>Glomus macrocarpum</i>	<i>Allium cepa</i>	0.71
<i>Glomus microcarpum</i>	<i>Allium cepa</i>	0.71
<i>Glomus sp.</i>	<i>Trifolium sp.</i> (clover)	1.29
<i>Glomus sp.</i>	<i>Lolium sp.</i> (ryegrass)	1.36
<i>Glomus fasciculatum</i>	<i>Trifolium sp.</i>	2.50
<i>Glomus tenue</i>	<i>Trifolium sp.</i>	14.20
<i>Gigaspora calospora</i>	<i>Allium cepa</i>	0.71
<i>Gigaspora calospora</i>	<i>Trifolium sp.</i>	12.30
<i>Acaulospora laevis</i>	<i>Trifolium sp.</i>	10.55

Source: Various authors, as cited in Smith & Gianinazzi-Pearson (1988).

Read 2008). The most ancient type dates back to the early Devonian, some 400 million years ago (Nicholson 1975, Cairney 2000). The first bryophyte-like land plants had endophytic associations resembling **arbuscular mycorrhizas (AM)**, even before roots evolved. The **ectomycorrhizal** symbiosis has evolved repeatedly over the last 130–180 million years (Martin et al. 2001). Like root hairs (Sects. 2.2.1 and 2.2.5 of Chapter 6 on mineral nutrition), the mycorrhizal associations enhance the symbiotic plant's below-ground absorbing surface. For some mycorrhizas (Table 1), this is the primary mechanism by which mycorrhizal plants are able to acquire scarcely available, poorly mobile nutrients, especially P (Sect. 2.1). For other mycorrhizas, additional mechanisms, such as excretion of hydrolytic enzymes and carboxylates, may also play a role (Sect. 2.1).

The mycorrhizal associations generally enhance plant growth, especially when P or other immobile nutrients limit plant growth; they may also be beneficial when water is in short supply and suppress infection by parasitic plants (Sect. 2.1 of Chapter 9D on parasitic associations). As such, mycorrhizas are of great ecological and agronomic significance. When the nutrient supply is high, however, they are a potential carbon drain on the plant, providing less benefit in return. Plants, however, may have mechanisms to

suppress the symbiotic association at a high supply of P (Sect. 2.3.1).

Some species never form a mycorrhizal association, even when P is in short supply. Some of these (e.g., Proteaceae; Sect. 2.2.5.2 of Chapter 6 on mineral nutrition) perform well when P is severely limiting; other nonmycorrhizal plants may even be harmed by mycorrhizal fungi (Sect. 7 of Chapter 9E). On the other hand, some nonmycorrhizal plants severely inhibit the growth of mycorrhizal hyphae. Before dealing with these complex interactions (Sect. 2.2), we discuss some general aspects of mycorrhizal associations.

2.1 Mycorrhizal Structures: Are They Beneficial for Plant Growth?

Mycorrhizas occur in 82% of all angiosperm species investigated to date; all gymnosperms are mycorrhizal (Brundrett 2002). A mycorrhizal association consists of three vital parts:

1. The root
2. The fungal structures in close association with the root
3. The external mycelium growing in the soil

FIGURE 1. (A) Schematic structure of an arbuscular mycorrhiza (AM). (B) Arbuscules (A) and a vesicle (V) of *Glomus sp.* colonized on the root of *Tagetes patula* (marigold). (C) Arbuscules (A) and intercellular hyphae (IH) of *Glomus etunicatum* isolated from the root of *Tagetes patula* after enzymatic digestion. (D) Detail of

the intraradical hyphae of *Glomus mosseae* in a root of *Tagetes patula* (marigold), after enzymatic digestion of the root, showing fine branches and trunks of an arbuscule (Ezawa et al. 1995) (courtesy T. Ezawa, Faculty of Horticulture, Nagoya University, Japan).

A

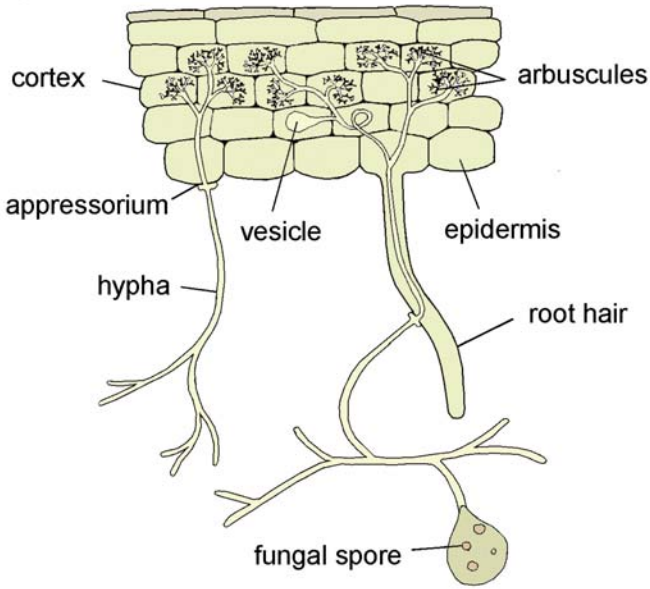

B

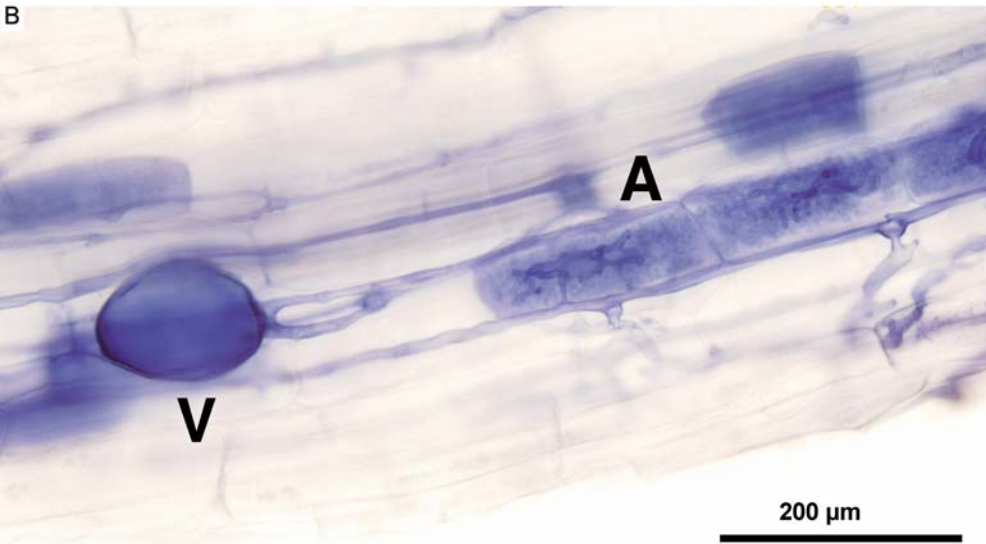

C

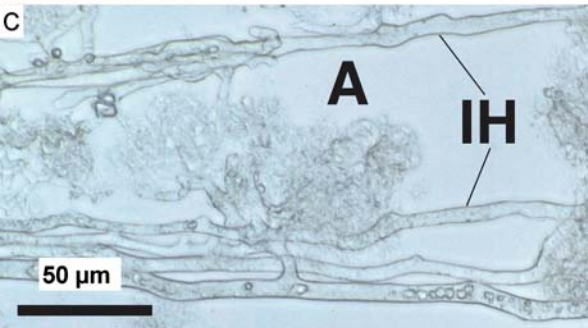

D

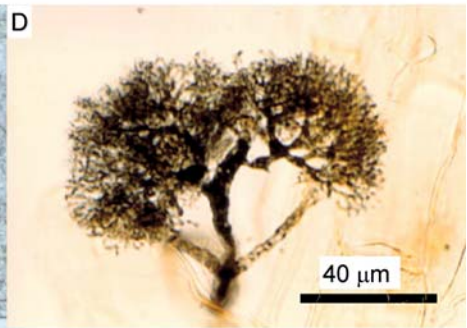

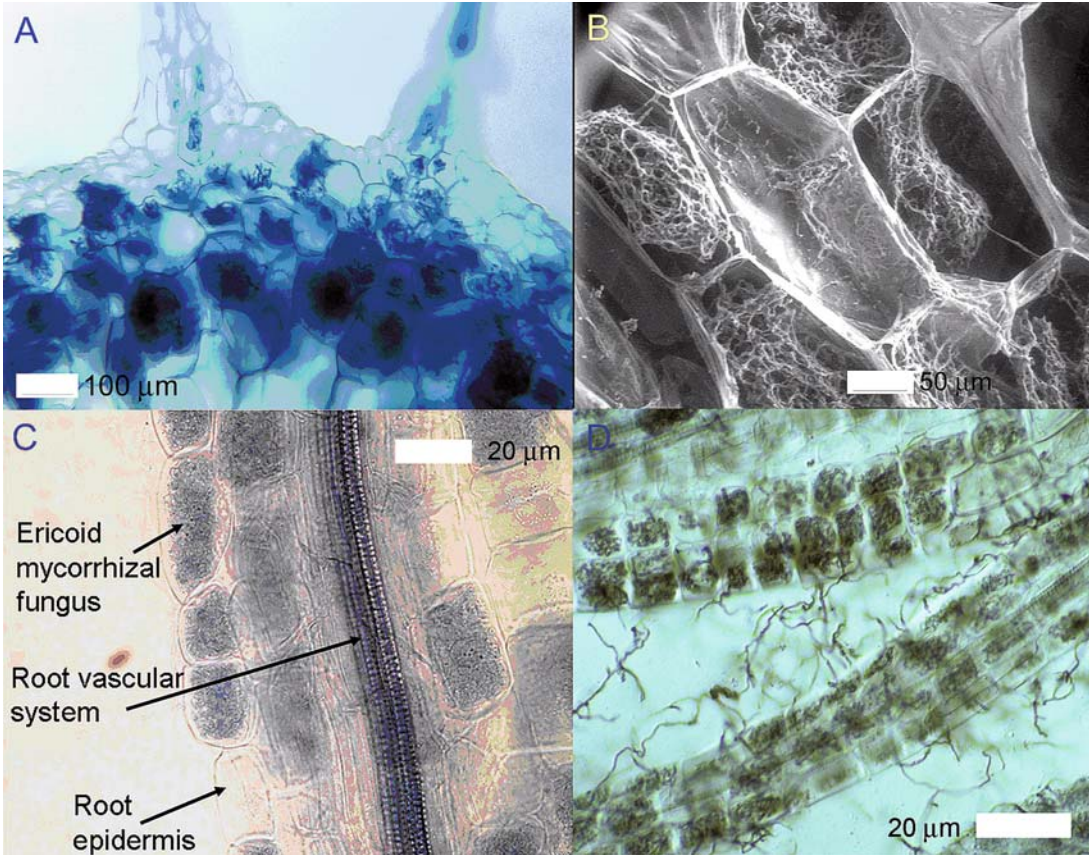

FIGURE 2. (A) Orchidaceous mycorrhizal association in a stem of *Pterostylis sanguinea* (greenhood orchid). (B) Transverse section of a stem of *Caladenia arenicola* (carousel spider orchid) showing intracellular fungal coils (courtesy A.L. Batty and M.C. Brundrett, The University of Western Australia, Australia). (C) Ericoid mycorrhizal association of *Woollisia pungens*, showing epidermal cells colonized by coils of an ericoid

mycorrhizal fungus (stained blue, arrowed) (courtesy S. Chambers and J.W.G. Cairney, Centre for Plant and Food Science, University of Western Sydney, Australia; copyright Elsevier Science, Ltd.). Ericoid mycorrhizal association of *Leucopogon verticillatus* (courtesy M.C. Brundrett, The University of Western Australia, Australia).

Mycorrhizas are classified in different types, but some are very similar (Brundrett 2002). **Arbuscular mycorrhizas (AMs)** are the most widespread. A large fraction of the fungal tissue is within root cortical cells, outside their plasma membrane (Fig. 1). They frequently occur on herbaceous plants, but are also found on trees, especially in tropical

forests. **Ericoid mycorrhizas** in the Ericaceae and **orchid mycorrhizas** in the Orchidaceae have somewhat different structures and functions (Fig. 2). *Alnus* (alder), *Cupressus* (cypress), *Eucalyptus* (eucalypt), *Fraxinus* (ash), *Populus* (poplar), and *Salix* (willow) are genera that have both AMs and **ectomycorrhizas (ECMs)** (Fig. 3; Brundrett 2002).

FIGURE 3. (A) Schematic representation of an ectomycorrhiza, showing the fungal mantle around the root and the hyphae in the cortex, which form the Hartig net. (B–D) Ectomycorrhizal association between *Pinus resinosa* (red pine) and an unknown fungal species. A higher magnification of *Pinus resinosa* and *Pisolithus tinctorius* as the mycobiont, showing thickened branched rootlets,

covered in a fungal mantle, and external hyphae. The highest magnification is of a longitudinal section of a *Pinus resinosa*–*Pisolithus tinctorius* mycorrhizal root showing mantle hyphae on the root surface and Hartig net hyphae surrounding epidermal and cortical cells (courtesy R.L. Peterson, University of Guelph, Canada).

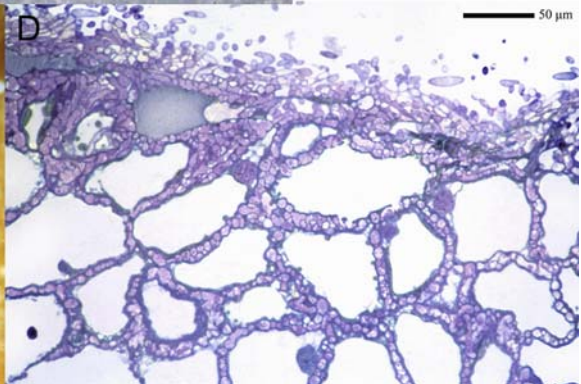
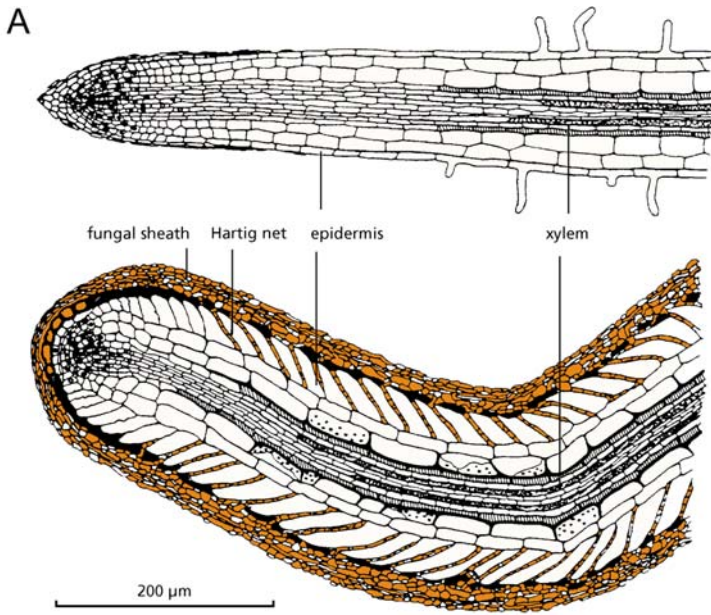

Less than 200 fungal species form AM; they are the most widespread mycorrhizal association (Nicholson 1975, Brundrett 2002). AMs are classified in six genera within the Glomeromycota, with *Glomus* being the largest genus. These fungi are considered to be “primitive” because they have relatively simple spores and they associate with a wide range of plant species. They are not capable of growing without a plant host. The AMs have been named after the **arbuscules** (which are tree-like structures that occur inside root cortical cells; Fig. 1). Although the arbuscule can fill most of the cell space, it does not compromise the integrity of the plant plasma membrane, because cortical cells envelop the arbuscule in a specialized host membrane, the **periarbuscular membrane** (Javot et al. 2007). The roots of 80% of all surveyed plant species and 92% of all families can be infected with AM-forming fungi (Wang & Qiu 2006). Even species that are typically ectomycorrhizal form AM associations in the absence of ectomycorrhizal inoculum.

In ericoid and orchid mycorrhizas, like in AMs, a large fraction of the fungal tissues is within the root cortical cells. In **ectomycorrhizas**, however, most fungal tissue is outside the root. This symbiotic association is frequently found between trees (Dipterocarpaceae: 98%; Pinaceae: 95%; Fagaceae: 94%; Myrtaceae: 90%; Salicaceae: 83%; Betulaceae: 70%; Fabaceae: 16%) and more than 5000 species that belong to the Basidiomycota (agarics, bolets) or Ascomycota (truffles) (Barker et al. 1998, Martin et al. 2001). Fossil ectomycorrhizas have been found among plant remains of *Pinus* (pine) from the Middle Eocene 40 million years ago (LePage et al. 1997). Although ectomycorrhizas occur mostly in woody angiosperms and Pinaceae, they have also been found in some monocotyledons and in ferns. **Ectomycorrhizas** independently evolved many times through **parallel evolution**. Co-evolution between plant and fungal partners in ECM has probably contributed to diversification of both plant hosts and fungal symbionts (Wang & Qiu 2006).

2.1.1 The Infection Process

Root exudates from AM host plants enhance, but are not required for spore germination, whereas exudates from nonhost plants, e.g., *Lupinus* (lupin) or *Brassica* (cabbage) species, do not stimulate germination. Roots of host plants also release a signal or signals that stimulate(s) the directional growth of the AM fungus toward them. CO₂ may be one such signal (Bécard et al. 2004), but there are others, analogous to the signal molecules (flavonoids)

involved in the legume–rhizobium recognition interactions (Sect. 3.3; Scervino et al. 2005, Catford et al. 2006). In fact, flavonoids have been implicated in the recognition between AM hosts and fungi (Harrison 2005, Hause & Fester 2005). However, root exudates of *Zea mays* (corn) mutants deficient in chalcone synthase, which is an enzyme involved in flavonoid synthesis, show similar AM colonization as those of the wild-type (Bécard et al. 1995). This suggests that flavonoids are not the key components in the AM fungus–host recognition (Buee et al. 2000, Harrison 2005). In one of the first stages of AM **host recognition**, the hyphae of AM fungi show extensive branching in the vicinity of host roots in response to signaling molecules (Fig. 4). Root exudates contain a **branching factor** identified as a **strigolactone**, 5-deoxy-strigol (Akiyama et al. 2005, Paszkowski 2006). Strigolactones are a group of sesquiterpene lactones, previously isolated as seed-germination stimulants for the **parasitic weeds** *Striga* and *Orobancha* (Sect. 2.1 of Chapter 9D on parasitic associations). Strigolactones induce extensive **hyphal branching** in germinating spores of the AM fungus *Gigaspora margarita* at very low concentrations (Bouwmeester et al. 2007). They also play a role in monocotyledonous species [e.g., *Sorghum bicolor* (millet)], interacting with AM fungi at concentrations as low as 10⁻¹³ M. Within 1 hour of exposure, the density of mitochondria in the fungal cells increases and their shape and movement changes dramatically which is associated with a rapid increase of mitochondrial density and respiration (Besserer et al. 2006). Isolation and identification of plant symbiotic signals open up new ways for studying the molecular basis of plant–AM fungus interactions. This discovery also provides a clear answer to a long-standing question on the evolutionary origin of the release from host roots of molecules that stimulate seed germination in parasitic plants (Sect. 2.1 of Chapter 9D on parasitic associations; Akiyama & Hayashi 2006). Similar signaling between host and fungus also plays a role in mycorrhizal associations other than AM, but we know much less about this (Martin et al. 2001).

During the establishment of AM, fungal hyphae that grow from spores in the soil or from adjacent plant roots contact the root surface, where they differentiate to form an **appressorium** in response to signals released from the host roots, and initiate the internal colonization phase (Genre & Bonfante 2005). Appressoria form only on epidermal cells, and generally not on the roots of nonhost plants, a further indication of recognition signals (Harrison 2005). Penetration of the root occurs via the appressoria, and the fungus frequently enters by forcing its

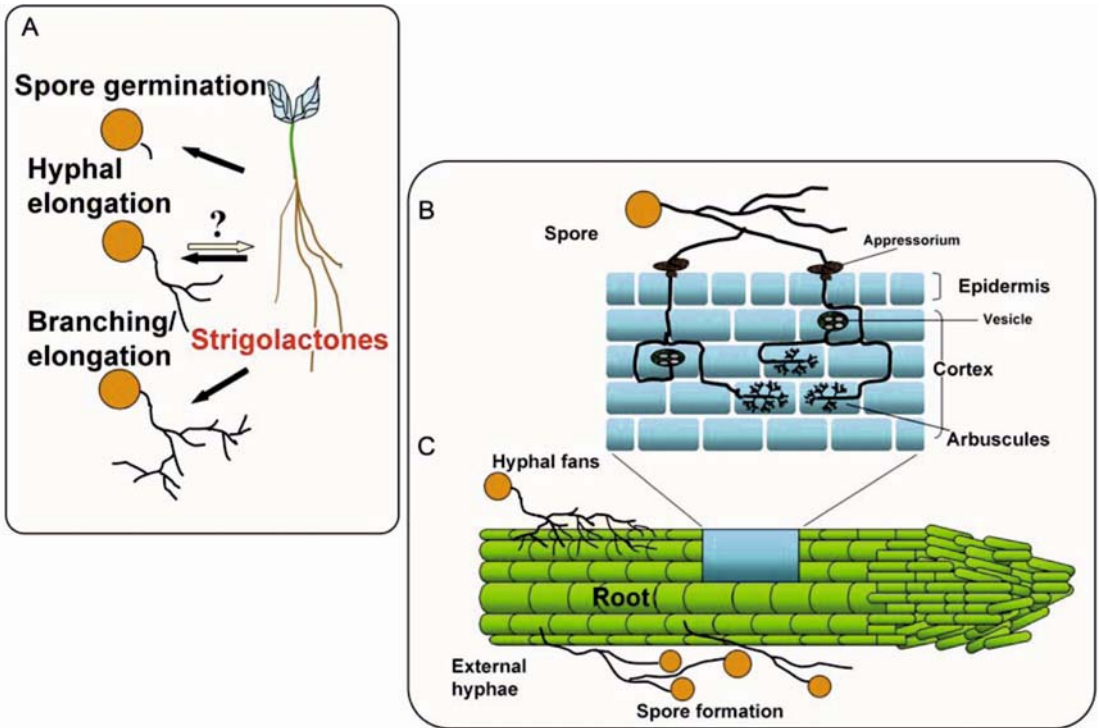

FIGURE 4. The complete life cycle of arbuscular mycorrhizal fungi, involving recognition, communication, and establishment of symbiosis between fungus and host.

The pre-germination stages may be stimulated by the plant root exudates, but may also occur in its absence (after Gadkar et al. 2001).

way between two epidermal cells. Alternatively, a hypha may penetrate the cell wall of an epidermal or root-hair cell and grow through the cell as a result of localized production of hydrolytic enzymes by the fungus.

Once inside the root, the fungus produces intercellular hyphae, coils, and **arbuscules**. The function of the arbuscules is most likely to increase the surface area of membranes over which exchange of metabolites occurs and so to enhance active transport between the plasma membrane of the host and the hyphae of the fungus. The invaginated membranes are highly specialized; they contain mycorrhiza-inducible P_i **transporters** (Rausch et al. 2001, Karandashov & Bucher 2005) and H^+ -**pumping ATPases** (Ferrol et al. 2002, Requena et al. 2003). Arbuscules are short lived and usually degenerate within a week or two. Thus, progression of colonization requires continuous arbuscule formation as the fungus spreads in the roots (Gadkar et al. 2001). The hyphae proliferate both in the cortex and in the soil. **Vesicles**, in which lipids are stored, are sometimes formed at a later stage, either between or within cells. The AM fungus does not penetrate into the endodermis, stele, or meristems; the fungus usually colonizes roots

where the endodermis does not have a complete suberin barrier yet (Brundrett 2002).

The structure of orchid mycorrhizas have also been studied intensively; as with AM, there is extensive intracellular growth with fungi forming intracellular **fungal coils**, rather than arbuscules (Fig. 2). The fungi forming the mycorrhizas are Basidiomycota and many belong to the genus *Rhizoctonia*. As soon as they have germinated, the orchid seedlings, which have very few reserves, depend on organic matter in the soil or from other host plants which is supplied via the mycorrhizal fungus. *Rhizoctonia* species may form associations with both orchids and conifers. The orchids are therefore not saprophytic, but **mycoheterotrophic** (i.e., parasitic on the fungus) (Leake 2004); the association between host and fungus does not appear to be mutually beneficial. Even orchids that have the ability to photosynthesize may form ECM with forest trees, and their stable N- and C-isotope signatures indicate a dependence on ECM. This would explain the success of orchids in low-light environments (Bidartondo et al. 2004). In those orchids that remain nonphotosynthetic during their entire life cycle [e.g., the Western Australian fully

subterranean *Rhizanthella gardneri* (Batty et al. 2004)], the fungus continues to play this role. In all orchids, including those that are green (photosynthetic) as adults, the fungi also absorb mineral nutrients from soil (like AM, see below) (Cameron et al. 2006).

In ericoid mycorrhizas, a large number of infection points are found: up to 200 per mm root in *Calluna*, as opposed to 2–10 per mm in *Festuca ovina* (sheep's fescue), infected by an AM fungus. Up to 80% of the volume of these mycorrhizas may be fungal tissue (not including the external mycelium). The fungi infecting Ericaceae are Ascomycota (e.g., *Hymenoscyphus ericae*) (Cairney & Ashford 2002).

Spores of ectomycorrhizal fungi in the rhizosphere may germinate to form a **monokaryotic mycelium**. This fuses with another hypha, forming a **dikaryotic mycelium**, which can then colonize the root, forming a mantle of fungal hyphae that enclose the root. The hyphae usually penetrate intercellularly into the cortex, where they form the **Hartig net** (Fig. 3; Massicotte et al. 1999). The hyphae always remain apoplastic and can colonize the epidermal (angiosperms) and the cortical (gymnosperms) layers. As hyphae contact the root surface, roots may respond by increasing their diameter and switching from apical growth to precocious branching (Peterson & Bonfante 1994). Fungal biomass constitutes about 40% of ectomycorrhizas. Numerous fungal species have the capacity to form ectomycorrhizas. Most of these belong to the Basidiomycota and Ascomycota, and they are often species that we are familiar with as toadstools. Some of these are edible (e.g., *Boletus*, truffles), whereas others are highly toxic (e.g., *Amanita*).

In contrast to infection by pathogenic fungi, colonization with mycorrhizal fungi never causes disease symptoms. In the presence of mycorrhizal fungi in the rhizosphere, flavonoids accumulate in the roots of *Medicago sativa* (alfalfa) host roots, similar to, but much weaker than, the response to pathogenic fungal attack (Sect. 3 of Chapter 9C on effects of microbial pathogens). AM fungi initiate a transient **host defense response** in the early stages of colonization, followed by suppression to levels well below those of noncolonized plants. The production of defense-related gene products is restricted to arbusculated cells; intercellular hyphae and vesicles elicit no such defense response (Harrison & Dixon 1994, Harrison 1999, Hause & Fester 2005). The rate and location of fungal growth within the root may be controlled through activation of plant defense mechanisms.

Some mutants of *Pisum sativum* (pea) and other legumes are characterized by aborted mycorrhizal infections, after formation of appressoria (Duc et al. 1989, Shirliffe & Vessey 1996). The genes appear to

be linked with genes that control nodulation by rhizobia (Sect. 3.3) which may point to a tight control of two carbon-consuming and potentially competing symbioses (Sect. 2.6).

2.1.2 Mycorrhizal Responsiveness

In soils with low P availability, plants vary widely in the extent to which their growth responds to root colonization by mycorrhizal fungi (Johnson et al. 1997). **Mycorrhizal dependency** is the ratio of the dry mass of mycorrhizal plants to that of nonmycorrhizal plants. Species that depend less on AM fungi for their nutrient acquisition are generally colonized to a lesser extent in the field than more AM-dependent ones. This suggests that species that have root systems with low dependency on mycorrhizas also have mechanisms to suppress mycorrhizal colonization (Sect. 2.3.1). Mycorrhizal dependency of a plant species varies with the AM fungal species involved in the symbiosis (Van der Heijden et al. 1998a). In grassland communities, dominant species tend to have a greater mycorrhizal dependency than subordinate species, so that suppression of the AM symbiosis enhances plant species diversity (Hartnett & Wilson 2002). In other herbaceous communities, mycorrhizas enhance plant species diversity by increasing the establishment and abundance of subordinate species relative to the community dominants, and plant diversity may be positively correlated with the species diversity of mycorrhizal fungi (Van der Heijden et al. 1998b, O'Connor et al. 2002).

Plants that show little responsiveness to AM fungi in terms of growth, may, in fact, acquire significant amounts of P via the fungus (Smith et al. 2003, 2004, Li et al. 2006). Using a compartmented pot system and ³³P-labeled P_i (Fig. 5A), the contribution of the mycorrhizal uptake pathway to total plant P_i uptake can be estimated. The hyphal compartment is capped with 25 μm nylon mesh, which allows hyphae to penetrate, but excludes roots. Unlabeled P can be absorbed directly by roots or via the mycorrhizal pathway. Compared with noninoculated plants without additional P, *Linum usitatissimum* (flax) grows better, but to different extents, depending on the AM fungi tested (*Gigaspora rosea*, *Glomus caledonium*, or *Glomus intraradices*). *Medicago truncatula* (medic) responds positively to the two *Glomus* species in terms of dry weight production, but shows a small growth depression with *Gigaspora rosea*, compared with nonmycorrhizal plants. *Solanum lycopersicum* (tomato) does not respond positively to any of the fungi. P uptake also varies among the different plant–fungus combinations, and **mycorrhizal phosphorus dependencies**

FIGURE 5. (A) Diagrammatic representation (not to scale) of a compartmented pot design to assess P uptake by mycorrhizas and roots. The main root + hyphae compartment is a nondraining pot containing a mixture of sand and soil. For mycorrhizal treatments, this mix includes inoculum of three appropriate fungi: *Gigaspora rosea*, *Glomus caledonium*, and *Glomus intraradices*. Nonmycorrhizal treatments receive no inoculum. The hyphal compartment is a small plastic tube containing the same soil + sand mix, but without inoculum; it is capped with 25 μm nylon mesh, which allows hyphae (shown in red) but not roots (shown in black) to grow into the hyphae compartment. The soil in the hyphae compartment is well mixed with ^{33}P -labeled orthophosphate of high specific activity. (B–D) Mycorrhizal effects on (A) growth, (B) total P uptake, and (C) specific activities of ^{33}P , in *Linum usitatissimum* (flax, blue bars), *Medicago truncatula* (medic, yellow bars), and *Solanum lycopersicum* (tomato, red bars). Mycorrhizal dependencies for growth and P-uptake are calculated as: $100 \times (\text{value for mycorrhizal plant} - \text{mean value for nonmycorrhizal plants}) / \text{value for mycorrhizal plant}$. In the bottom panel, the dotted horizontal line indicates the predicted specific activity of ^{33}P in the plants if 100% of P is derived via the mycorrhizal pathway. This percentage is calculated using values for specific activities of ^{33}P in the plants and bicarbonate-extractable P in the hyphae compartment and the total P available in the pots and in the hyphae compartment. It assumes that the densities of hyphae (meters per gram of soil) are the same in the hyphae compartment and in the hyphae + roots compartment (after Smith et al. 2003). Copyright American Society of Plant Biologists.

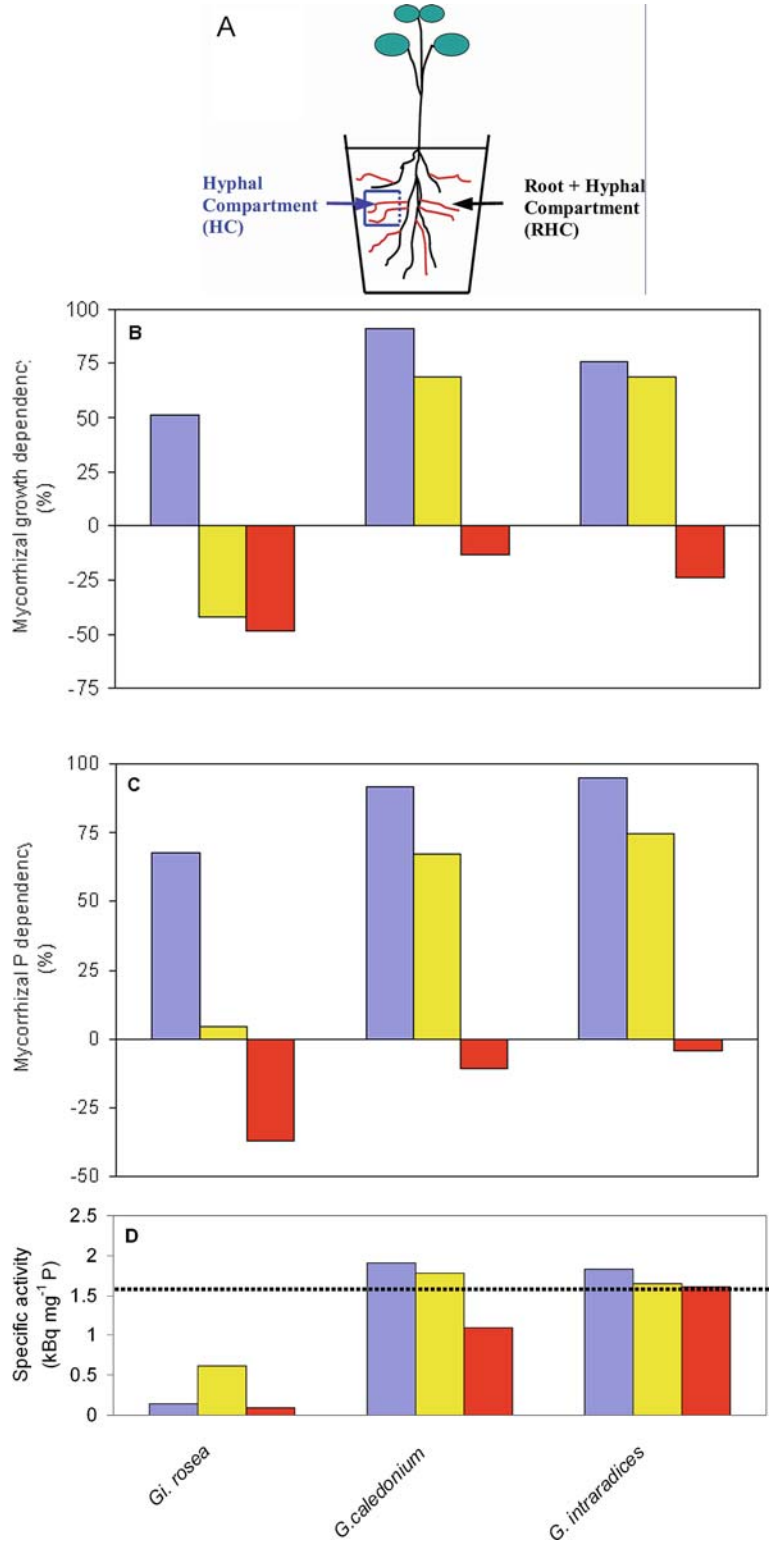

(Fig. 5B, middle) are similar to **mycorrhizal growth dependencies** (Fig. 5B, top). By supplying ^{33}P in a compartment to which only the fungal hyphae have access (Fig. 5A), it is possible to show that the mycorrhizal pathway differs in its contribution to total P uptake, depending on fungal and plant species. P transfer via the mycorrhizal pathway is extremely high in five out of the nine individual plant–fungus combinations, although this is not correlated with mycorrhizal P dependency. With *Glomus intraradices* as the fungal partner, all of the P is delivered via the mycorrhizal pathway to all tested plants (Fig. 5B, bottom). These findings indicate that mycorrhizas may be an important pathway of P_i uptake, even in plants that lack a positive change in growth or P status as a result of AM colonization. It would be interesting to learn more about the conditions that cause down-regulation of P_i transporters responsible for P_i uptake from the root environment (Sect. 2.2.2 of Chapter 6 on mineral nutrition) when AM fungi infect the roots (Karandashov & Bucher 2005).

Mycorrhizal responsiveness is generally assessed using single species in a pot experiment, which poorly reflects the real world. When paired with a near-isogenic nonmycorrhizal genotype, even *Solanum lycopersicum* (tomato) shows a positive growth response (Cavagnaro et al. 2004), when this is not the case when tested singly (Fig. 5B, top). This aspect is further discussed in Sect. 2.2.

Crop cultivars, e.g., of *Zea mays* (corn) that have been developed for high-input systems in Europe have not lost their ability to be colonized, and may be more responsive to inoculation by *Glomus intraradices* than those suited for low-input African systems. However, specific adaptations that allow nonmycorrhizal plants developed for low-input systems to

perform well in low-P soils may limit their ability to respond to higher nutrient supply rates and mycorrhizal infection. High-input cultivars may have traits that are useful for low-input cropping systems where mycorrhizal symbioses are established (Wright et al. 2005). A high mycorrhizal responsiveness is commonly associated with lack of well-developed root hairs and coarse fibrous roots (Sect. 2.2.1 of Chapter 6 on mineral nutrition; Collier et al. 2003).

2.2 Nonmycorrhizal Species and Their Interactions with Mycorrhizal Species

Although mycorrhizal associations are very common, some species cannot be colonized, or only marginally so (Brundrett 2002). These **nonmycorrhizal species** can be broadly categorized as either **ruderal species** that inhabit relatively fertile sites or species that occur on severely P-impoorished soils. The nonmycorrhizal ruderals include many that belong to Brassicaceae, Caryophyllaceae, Chenopodiaceae, and Urticaceae. The species from severely **P-impoorished habitats** include Cyperaceae, Proteaceae, and Restionaceae, as well as carnivorous (Chapter 9F) and parasitic species (Chapter 9D). The “scavenging” strategy of mycorrhizal species, which access P that is in the soil solution, but too far away from roots or inside soil pores that are too small for roots to enter, does not work on severely P-impoorished soils. The little amount of P that is present in these soils is predominantly sorbed to soil particles. Cluster roots, which release large amounts of carboxylates in an exudative burst (Sect. 2.2.5.2 of Chapter 6 on mineral nutrition) effectively “mine” P from these soils (Fig. 6). In younger landscapes, nonmycorrhizal species with cluster roots tend to occur on either

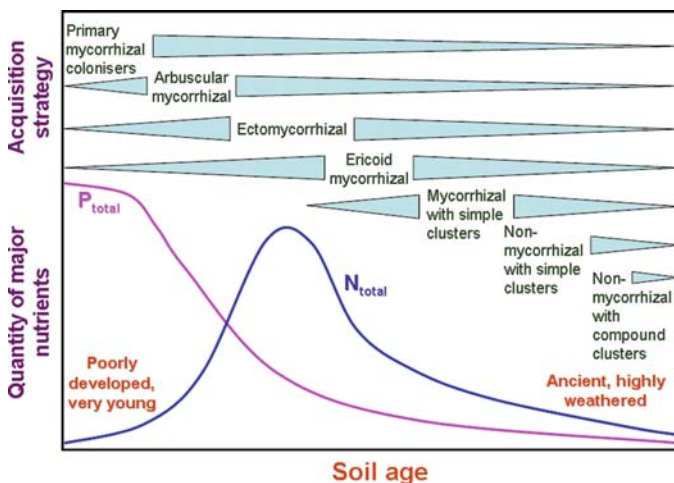

FIGURE 6. Changes in total soil P and N and in plant nutrient-acquisition strategies (green) as dependent on soil age. “Poorly developed, very young soils” refers to soils that result from, e.g., recent volcanic eruptions or glaciation; “ancient, highly weathered soils” refers to soils that have been above sea level and not been glaciated for millions of years. Whilst never becoming dominant in severely P-impoorished soils, some mycorrhizal species do co-occur with nonmycorrhizal, cluster-bearing species. The width of the triangles referring to the different ecological strategies provides a measure of the abundance of these strategies as dependent on soil age (modified after Lambers et al. 2008). Copyright Elsevier Science, Ltd.

calcareous soils, where the availability of P is low due to precipitation as calcium phosphates, or on acids soils, where P precipitates as iron or aluminum phosphates (Fig. 6.1 in Sect. 2.1 of Chapter 6 on mineral nutrition; Lambers et al. 2006, 2008).

Even within typical nonmycorrhizal genera, mycorrhizal infection has been observed in some species (Muthukumar et al. 2004, Boulet & Lambers 2005). It is interesting, as discussed in Sect. 2.2.5.2 of Chapter 6 on mineral nutrition, that many of the nonmycorrhizal species from severely P-impooverished soils have “**cluster roots**” (Cyperaceae, Proteaceae, and Restionaceae). Other nonmycorrhizal species include **carnivorous** species, e.g., *Drosera* (sundew), and **hemiparasitic** species, e.g., *Nuytsia floribunda* (Western Australian Christmas tree).

The mechanisms that prevent colonization in nonmycorrhizal species are not yet fully understood. In some species, the exudation of fungi-toxic compounds, such as **glucosinolates** in Brassicaceae (Koide & Schreiner 1992) or a chitin-binding **agglutinin** in *Urtica dioica* (stinging nettle) (Vierheilig et al. 1996), may prevent infection. More importantly, the correct chemical cues necessary for development after spores have germinated (Sect. 2.2.1) may be lacking (Harrison 2005).

Mycorrhizal fungi may enhance growth of mycorrhizal plants, at least at a low P supply. In some nonmycorrhizal species, however, the opposite is found (Sanders & Koide 1994). In these species, the mycorrhizal fungus may cause localized lesions on the roots around aborted penetration points (Allen et al. 1989), inhibit root-hair elongation, probably via its exudates, and reduce stomatal conductance (Allen & Allen 1984). This mechanism may well explain why nonmycorrhizal species show poor growth in a community dominated by mycorrhizal species, unless the P level is increased (Francis & Read 1994).

2.3 Phosphate Relations

Like root hairs, the external mycelium of mycorrhizas increases the roots' absorptive surface. In fact, the effective root length of the mycorrhizal associations may increase 100-fold or more per unit root length (Table 1).

2.3.1 Mechanisms That Account for Enhanced Phosphate Absorption by Mycorrhizal Plants

Arbuscular mycorrhizal associations enhance P uptake and growth most strongly, when the

availability of P in the soil is fairly low (Sect. 2.2.5.2 of Chapter 6 on mineral nutrition; Bolan et al. 1987, Thingstrup et al. 1998). Experiments using different soil compartments and different labeled sources of P_i show that AM plants do not have access to different chemical pools of P_i in soil (Fig. 7). They are capable, however, of acquiring P outside the depletion zone that surrounds the root, because of the **widely ramified hyphae**. These hyphae allow P transport over as much as 10 cm from the root surface and at rates that far exceed diffusion in soil (Fig. 8). In addition, they may access smaller soil pores and compete effectively with other microorganisms (Joner & Jakobsen 1995); some AM may access organic P, but the ecological significance of this remains to be established (Joner et al. 2000a,b, Koide & Kabir 2000). Ectomycorrhizal hyphae can extend even greater distances, possibly several meters. Ectomycorrhizal and ericoid mycorrhizal roots also have access to additional chemical pools of P; they may release **phosphatases**, which enhance the availability of organic P, or exude **carboxylates**, which increase the availability of sparingly soluble P (Landeweert et al. 2001, Van Leerdam et al. 2001, Van Hees et al. 2006). *Hymenoscyphus ericae*, which forms mycorrhizas with a number of host plants belonging to the Ericaceae, also produces extracellular enzymes that may allow the fungus to decompose components of plant cell walls which facilitates access to mineral nutrients that are sequestered in these walls (Leake & Read 1989, Read 1996, Cairney & Burke 1998). *Laccaria bicolor*, an ectomycorrhizal fungus, is capable of paralyzing, killing, and digesting **springtails**. A significant portion of the organic N that is subsequently hydrolyzed ends up in its macrosymbiont, *Pinus strobus* (eastern white pine) (Klironomos & Hart 2001). Springtails selectively feed on fungi, including mycorrhizal fungi. Should this phenomenon prove to be widespread, forest-nutrient cycling may turn out to be more complicated and tightly linked than is currently recognized. Interestingly, springtails prefer nonmycorrhizal species when given a choice; their fecundity is reduced when fed a diet of less palatable mycorrhizal fungi (Klironomos et al. 1999).

Ectomycorrhizas and ericoid mycorrhizas frequently occur in organic soils, whereas AMs are more typical of mineral soils. Weatherable minerals under many European coniferous forests contain a dense network of tubular micropores with a diameter of 3–10 μm that are formed by carboxylates exuded by mycorrhizal or saprotrophic fungi. Concentrations of succinate, oxalate, formate, citrate, and malate may be in the micromolar to millimolar range. These exuded carboxylates enhance mineral

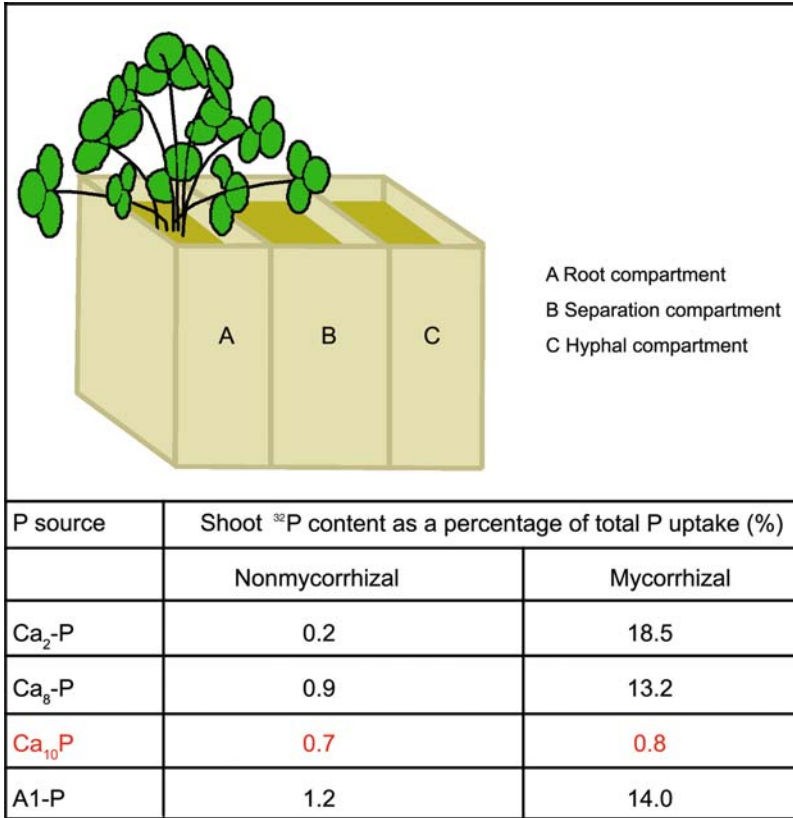

FIGURE 7. Diagram showing the design of the rhizoboxes used to assess which chemical forms of P can be accessed by arbuscular mycorrhizal hyphae. The ³²P-labeled P source is added to the hyphal compartment only. The ³²P content is expressed as a proportion of the total P content of the shoots of *Trifolium pratense* (red clover) (Yao et al. 2001).

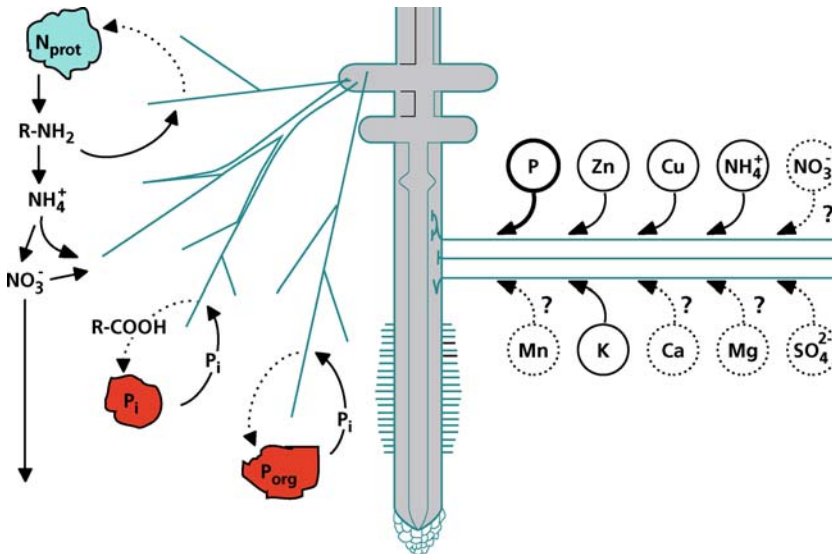

FIGURE 8. Schematic presentation of components of the nutrient acquisition from the soil by arbuscular mycorrhizal roots (right). The thickness of the circle indicates the importance of AM in acquiring this nutrient (? indicates lack of definitive information). Additional components in ectomycorrhizal roots are also shown (left). Note that all mycorrhizas enhance the availability of

soil nutrients by enlarging the soil volume that is exploited, and that this is most relevant for those nutrients that are least mobile (e.g., phosphate). Ectomycorrhizas excrete hydrolytic enzymes, which allow them to use organic forms of both P and N, and chelating organic acids, which allows the use of poorly soluble forms of phosphate (after Marschner & Dell 1994).

weathering by forming complexes with Al and dissolve Ca-rich rock (Wallander 2000). In this way about 10^7 hyphal tips are eating their way through sand grains at any one time, forming 150 km of micropores per m^3 of soil per year. Ectomycorrhizal hyphae of the species *Suillus granulatus* and *Piloderma croceum* are thought to transport the released minerals directly to their hosts, thereby bypassing competition for nutrient uptake by other organisms. This mechanism by which mycorrhizal hyphae bypass the soil to reach minerals might help explain why forest productivity has not decreased, despite recent excessive soil acidification (Jongmans et al. 1997).

The external AM mycelium consists of both large “runner” hyphae and finer hyphae with a role in nutrient absorption. As in roots, P_i uptake by the fine mycorrhizal hyphae occurs via active transport, against an electrochemical potential gradient, with a proton-cotransport mechanism (Sect. 2.2.2 of Chapter 6 on mineral nutrition). Once absorbed by the external hyphae, P is rapidly transported into vacuoles where most of it is polymerized into inorganic **polyphosphate** (poly-P), a linear polymer of three to thousands of inorganic phosphate molecules, connected by high-energy phosphate bonds (Ezawa et al. 2002). This reaction is catalyzed by polyphosphate kinase, which is induced when excess P_i is absorbed. Poly-P accumulated in the vacuole is translocated from the external hyphae to the hyphae inside the roots, possibly via cytoplasmic streaming. This transport of P and that of other immobile ions through the external hyphae to the plant is relatively rapid, bypassing the very slow diffusion of these ions in soil. Once the poly-P has arrived near the plant cells, it is degraded, presumably catalyzed by **phosphatases**. The mechanisms accounting for poly-P production at one end of the hyphae and breakdown at the other are unknown. It might involve sensing a gradient in plant-derived carbohydrates. Transfer of P and other nutrients from fungus to plant is a two-step process over the membranes of the two symbionts, probably involving passive efflux from the fungus and active uptake by the plant (Javot et al. 2007). Some of the plant P_i -transporter genes involved in this process are mycorrhiza-specific and differ genetically from those discussed in Sect. 2.2.2 of Chapter 6 on mineral nutrition (Karandashov & Bucher 2005). These mycorrhiza-inducible P_i -transporter genes are up-regulated in roots that are colonized by AM fungi and expressed at a very low level in noncolonized parts of the same root system. These findings show that in species that form AM associations with members of the Glomeromycota P_i transporters have evolved that are involved in scavenging P from the apoplast between intracellular AM structures and

root cortical cells (Rausch et al. 2001, Glassop et al. 2005).

2.3.2 Suppression of Colonization at High Phosphate Availability

The AM fungus colonizes roots to a greater extent in low-P soils than in soils that are more fertile (Fig. 9; Smith & Read 2008). To some extent this greater

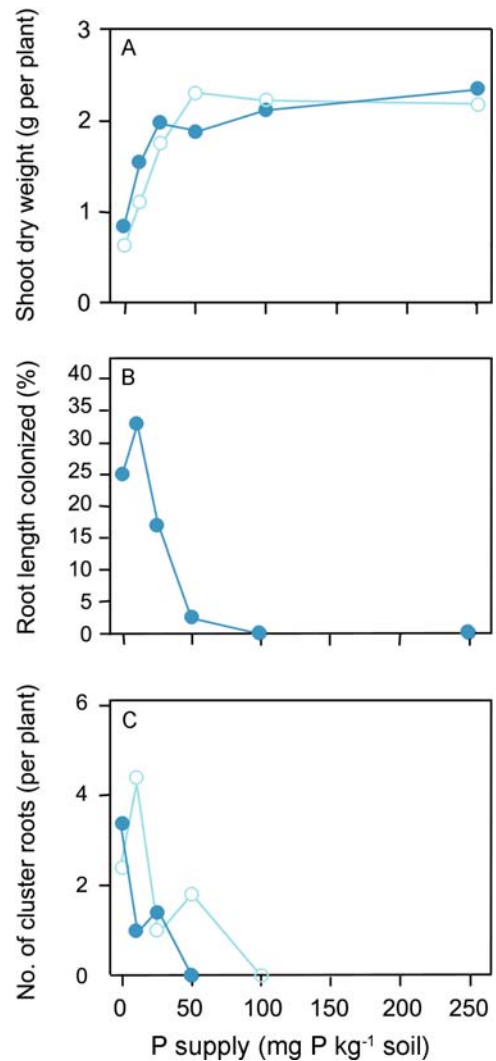

FIGURE 9. Response of *Casuarina cunninghamiana* (sheoak) seedlings to inoculation with an arbuscular mycorrhizal fungus (*Glomus* sp.) over a range of P supplies in sand culture. (A) Shoot dry weight; (B) mycorrhizal colonization of roots; (C) occurrence of cluster roots. Filled symbols: inoculated with *Glomus*; open symbols uninoculated (redrawn after Reddell et al. 1997, *Australian Journal of Botany* 45: 41–51, Copyright CSIRO, Australia).

frequency may be associated with a decreased rate of root elongation so that the colonization by the fungus keeps up with the growth of the root. **Systemic effects** of P are also important, however. An analysis of *Solanum tuberosum* (potato) grown with a divided root system of which only one half is inoculated with the AM fungus *Glomus intraradices* shows that when high P levels are applied to the noncolonized part of the root system, the formation of both arbuscules and vesicles is suppressed in the colonized portion of the root, despite the presence of more internal hyphae. Moreover, a high P_i supply may lead to down-regulation of the expression level of both the mycorrhiza-inducible and other P_i transporters (Rausch et al. 2001, Glassop et al. 2005).

Once a root is infected by an AM fungus, further infection of the roots tends to be suppressed (Vierheilig et al. 2000); this phenomenon is called **autoregulation**. A decreased availability of carbohydrates or an improved P status of the plant has been offered as an explanation for this suppression of further colonization. To test this, plants of *Hordeum vulgare* (barley) were grown with a divided root system, where one half is inoculated with an AM fungus. After extensive root colonization, the other half is inoculated, but colonization is suppressed (Fig. 10). In such plants some of the P acquired by the colonized root part ends up in the roots that are not colonized, as a result of transport via the xylem to the shoot, followed by export via the phloem from the shoot. Because the biomass and the P concentration of both root halves are the same, neither a shortage of carbohydrates nor elevated P concentrations explain the suppression (Fig. 10). A **systemic suppression**, i.e., a response triggered by mycorrhizal colonization followed by signaling to the rest of the plant, is the most likely explanation for the autoregulatory effect of prior mycorrhization on subsequent colonization. This involves signaling molecules such as **strigolactones** (Sect. 2.1.1), whose release from roots of plants that are hosts for AM fungi is promoted by P deficiency (Yoneyama et al. 2007a). By contrast, in roots of nonmycorrhizal species, P deficiency does not affect exudation (Yoneyama et al. 2007b). Interestingly, the systemic autoregulatory effect not only suppresses mycorrhization in *Hordeum vulgare* (barley), but also reduces root **infection** by the take-all **disease** caused by the fungus *Gaeumannomyces graminis* var. *tritici*. This effect is found when barley plants show a high degree of mycorrhizal root colonization, whereas a low mycorrhizal root colonization has no effect on take-all (Khaosaad et al. 2007).

2.4 Effects on Nitrogen Nutrition

Unlike AM, some **ectomycorrhizas** may utilize **organic N**, including proteins. This has been documented in situ, as revealed by a comparison of ^{15}N **fractionation** in plants with and without ectomycorrhiza. Ectomycorrhizal plants may have a 1.0–2.5‰ more positive $\delta^{15}\text{N}$ value than do plants infected with arbuscular mycorrhiza (Table 2), demonstrating that different N sources are used (either different compounds or different regions in the soil). A study on a Tanzanian woodland (Table 2) provides no evidence for a difference in isotope composition in different soil layers. Fractionation of the heavy N isotope (^{15}N) occurs during **mineralization** and **nitrification**; therefore, the organic N becomes enriched with ^{15}N . The data in Table 2 provide evidence that the ectomycorrhizal plants use a significant amount of N from a pool that was not decomposed and nitrified (i.e., organic N). In boreal forest and arctic tundra, ectomycorrhizal plant species also have distinctive ^{15}N signatures, with ^{15}N concentrations that are higher than those of species with ericoid mycorrhizas, but lower than those of AM or nonmycorrhizal species (Schulze et al. 1995, Nadelhoffer et al. 1996). In these studies either rooting depth or the form of N that is utilized could have contributed to the different ^{15}N signatures.

Ericoid mycorrhizas, like ectomycorrhizas, can use quite **complex organic sources of N and P** (Fig. 8; Read 1996). This ability may contribute to the dominance by Ericaceae of many cold and wet soils, where rates of decomposition and mineralization are low (Read & Perez-Moreno 2003). AMs are at the other extreme of the continuum of mycorrhizal associations. They cannot access organic P, because of a very low capacity to release phosphatases into the soil (Joner et al. 2000a). Their predominant significance lies in the acquisition of sparingly available inorganic nutrients, especially P. AMs are relatively unimportant for acquisition of N, if this is available as NO_3^- , but they do enhance N acquisition when mineral N is present as the less mobile NH_4^+ (Johansen et al. 1994, Tanaka & Yano 2005). In the extraradical hyphae, ammonium is assimilated into **arginine**, and then transported toward the arbuscules, where arginine is broken down, followed by transfer of NH_4^+ to the host cells (Govindarajulu et al. 2005, Jin et al. 2005, Chalot et al. 2006). AM may enhance the uptake of NO_3^- from dry soils, when mass flow and diffusion are limited, but not in wet soils (Tobar et al. 1994). Ectomycorrhizas are thought to be intermediate between

FIGURE 10. Diagram showing the experimental design of the rhizo-boxes used to assess the systemic effect of prior infection of *Hordeum vulgare* (barley) by arbuscular mycorrhizal fungi (compartment B) on subsequent infection (in compartment C). Infection takes place by roots of *Phaseolus vulgaris* (common bean) in adjacent compartments (A or D) (modified after Vierheilig et al. 2000).

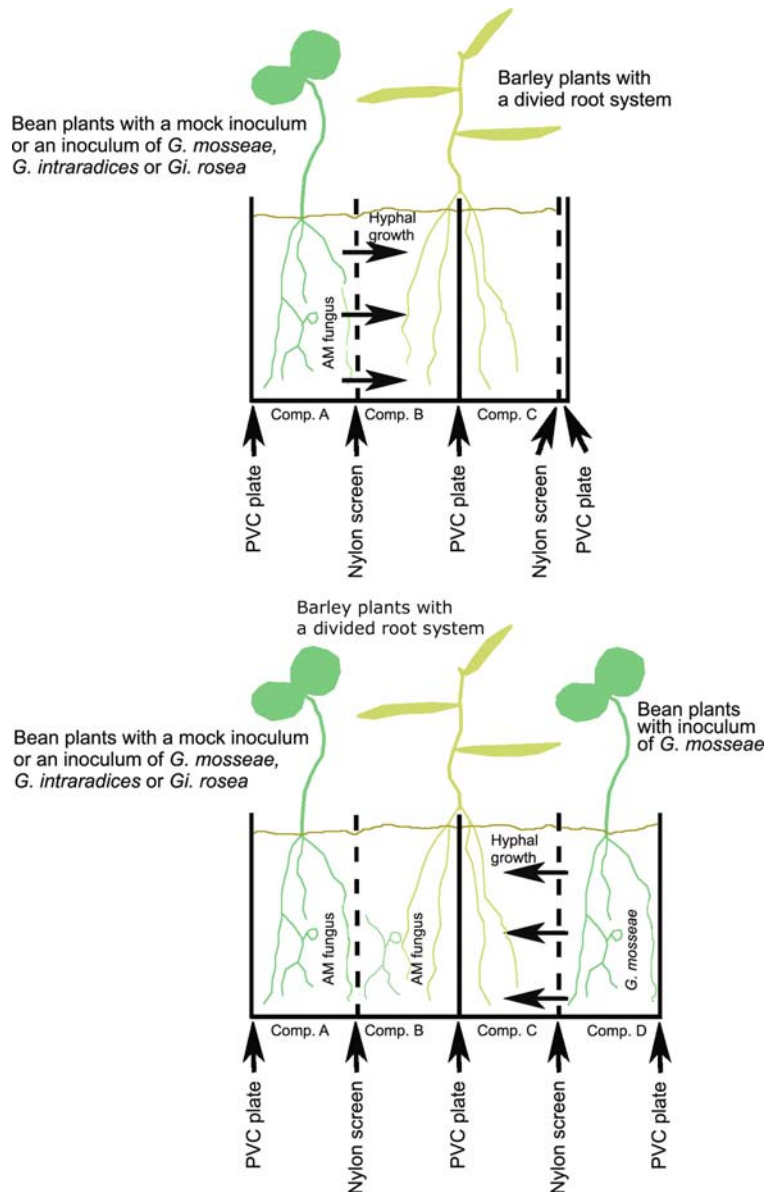

the ericoid and arbuscular mycorrhiza in terms of accessing organic N (Lambers et al. 2008).

2.5 Effects on the Acquisition of Water

Arbuscular mycorrhizal plants may have an enhanced capacity to acquire water from the root environment (Augé 2001). Several hypotheses have been put forward to explain this increased capacity. One suggests an indirect effect via the **improved P status** of the plant which increases the hydraulic

conductance of the roots or affects the plant's hormone metabolism and stomatal conductance. *Lactuca sativa* (lettuce) plants colonized by the AM fungi *Glomus coronatum*, *Glomus intraradices*, *Glomus claroidium*, and *Glomus mosseae* deplete soil water to a greater extent than uninoculated control plants or plants colonized by *Glomus constrictum* or *Glomus geosporum*. The differences in soil-moisture depletion can be ascribed to the activity of AM fungi, but fungi differ in their effectiveness to enhance plant water uptake from soil, probably related to the amount of external mycelium produced by each AM fungus

TABLE 2. ^{15}N abundance of leaf samples collected in different years in Tanzania.*

Species	Symbiotic status	$\delta^{15}\text{N}$		
		1980	1981	1984
<i>Brachystegia boehmii</i>	EC	1.64	1.32	1.23
<i>B. microphylla</i>	EC	1.53	1.51	1.73
<i>Julbernardia globiflora</i>	EC	2.81	1.63	1.60
<i>Pterocarpus angolensis</i>	AM+NO	-0.81	-0.87	-0.93
<i>Diplorynchus condylocarpon</i>	AM	-	-0.36	-0.60
<i>Xeroderris stuhlmannii</i>	AM+NO	-	0.01	0.62
<i>Dichrostachys cinerea</i>	AM+NO	-	0.45	-0.38

Source: Högberg (1990).

* EC = ectomycorrhizal; AM = arbuscular mycorrhizal; NO = nodulated. The experiments summarized here were actually carried out with the aim to determine the extent of symbiotic N_2 fixation of the nodulated plants. Since nodulated plants have access to dinitrogen from the atmosphere, they are expected to have $\delta^{15}\text{N}\text{‰}$ values closer to atmospheric N_2 than do plants that do not fix dinitrogen. The data presented here stress that control plants need to be sampled to allow a proper comparison. This table shows that the choice of the control plants is highly critical (see also Sect. 3 of this chapter).

and to the frequency of root colonization in terms of live and active fungal structures (Marulanda et al. 2003). The multihyphal strands of ectomycorrhizas are thought to have a particularly high capacity to transport water. Alternatively, the improved plant water status may be an effect on effects of mycorrhizas on soil structure (Bearden & Petersen 2000).

2.6 Carbon Costs of the Mycorrhizal Symbiosis

Mycorrhizas provide nutritional benefits, which may enhance **resource allocation to leaves** (Baas & Lambers 1988, Grimoldi et al. 2005) and **photosynthetic carbon gain** of the host (Douds et al. 1988, Wright et al. 1998a), but they also incur **carbon costs** for the host. The amount of carbon that is exuded from intact roots into the apoplast and normally ends up in the rhizosphere is not sufficient to satisfy the demand of the microsymbiont of the mycorrhizal association. It is possible that passive efflux of carbon is increased in mycorrhizal plants; alternatively, the host's active carbon-uptake system may be inhibited. So far there is no molecular information on transport proteins that account for carbon efflux from or carbon re-uptake in mycorrhizal plants (Bago et al. 2000).

Costs associated with the AM symbiosis have been estimated in various ways (e.g., by comparing plants with and without the mycorrhizal symbiont at the same growth rate). This can be achieved by providing more P to the nonmycorrhizal plant, compared with the supply to the mycorrhizal plant. The carbon use for growth and respiration by the roots of

both types of plants can then be used to quantify costs of the mycorrhizal symbiosis (Snellgrove et al. 1982, Grimoldi et al. 2006). The problem with this method is that it assumes steady-state rates of P acquisition and carbon consumption, whereas in fact these may vary following active root colonization. A variation of this approach is to grow nonmycorrhizal plants at a range of P supplies, so that a P-response curve can be constructed with which to compare the mycorrhizal plants (Rousseau & Reid 1991, Eissenstat et al. 1993).

An alternative approach to quantify the costs of the mycorrhizal symbiosis has been to grow plants with a divided root system. That is, part of the root system is grown in one pot, and the remaining part in a separate pot. One part of the divided root is then inoculated with a mycorrhizal fungus, while the other is not and remains nonmycorrhizal. The shoot is then given $^{14}\text{CO}_2$ to assimilate in photosynthesis and the partitioning of the label over the two root parts is measured (Table 3; Koch & Johnson 1984, Douds et al. 1988). It is also possible to calculate carbon costs of the mycorrhizal symbiosis by measuring the flow of ^{14}C -labeled assimilates into soil and external hyphae (Jakobsen & Rosendahl 1990).

The estimates of the carbon costs of the AM symbiosis vary between 4 and 20% of the carbon fixed in photosynthesis (Lambers et al. 2002). Only a minor part (15%) of the increased rate of root respiration is associated with an increased rate of ion uptake by the mycorrhizal roots. The major part (83%) is explained by the respiratory metabolism of the fungus and/or other effects of the fungus on the roots' metabolism (Baas et al. 1989). Construction costs of fibrous roots

TABLE 3. Comparison of accumulated ^{14}C and fresh mass in mycorrhizal and nonmycorrhizal halves of root system of two citrus cultivars.*

Species	^{14}C recovered from below-ground tissue dpm g^{-1}		Fresh mass mg plant^{-1}	
	+	-	+	-
<i>Sour orange</i>	66.4	33.6	1580	1240NS
<i>Carrizo citrange</i>	67.7	32.3	1990	1520NS

Source: Koch & Johnson (1984).

* + and - denote mycorrhizal and nonmycorrhizal plants, respectively; NS indicates that there was no significant difference.

are also higher for mycorrhizal than for nonmycorrhizal roots, because of their higher fatty acid concentration (Sect. 5.2.1 of Chapter 2B on plant respiration; Peng et al. 1993). The costs for the ECM symbiosis are probably higher, but there is little information available (Hobbie 2006).

In addition to a higher carbon expenditure, mycorrhizal plants also tend to have a higher rate of photosynthesis per plant, partly due to higher rates of photosynthesis per unit leaf area and partly due to their greater leaf area (Wright et al. 1998a, b). The higher rate of CO_2 assimilation is most pronounced when the soil water potential is low (Sanchez-Diaz et al. 1990). When P and water are limiting for growth, therefore, benefits outweigh the costs, and mycorrhizal plants usually grow faster, despite the large carbon sink of the symbiotic system. The relatively high costs of the mycorrhizal association, however, may help to explain why mycorrhizal plants sometimes grow less than their nonmycorrhizal counterparts (Thompson et al. 1986, Fredeen & Terry 1988), especially when a second microsymbiont (rhizobium) plays a role (Fig. 11). Under drought, however, mycorrhizal plants may still show more benefit from an association with rhizobium than do nonmycorrhizal control plants (Penas et al. 1988).

2.7 Agricultural and Ecological Perspectives

From an ecological point of view, information on the mycorrhizal status of plants in a community is most important. In a mixed community **nonmycorrhizal species** may profit most from fertilization with P because the mycorrhizal association is often suppressed at a higher P supply, and not necessarily because the growth of nonmycorrhizal species is more severely P-limited (Sect. 2.3). Suppression of the mycorrhizas might then reduce the harmful

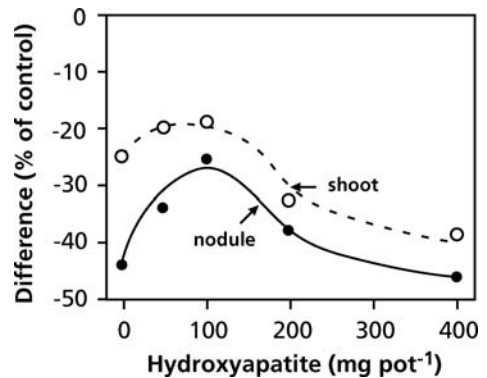

FIGURE 11. The relative host response to mycorrhizal infection as dependent on the supply of hydroxyapatite $[\text{Ca}_{10}(\text{PO}_4)_6(\text{OH})_2]$. *Phaseolus vulgaris* (common bean) plants are infected with *Rhizobium phaseoli*, a nitrogen-fixing bacteria. Half of the plants are also infected with the mycorrhizal fungus *Glomus fasciculatum*. The difference in mass of the parts of the mycorrhizal plants relative to the nonmycorrhizal control plants is calculated as percentage of the difference. Negative values indicate that the shoot or nodule mass is less in the mycorrhizal plants (after Bethlenfalvai et al. 1982). Copyright American Society of Plant Biologists.

effect of the mycorrhizal fungus on nonmycorrhizal species (Sect. 2.2). We should therefore be cautious in interpreting the effects of P fertilization on the growth of certain plants in a community.

Close proximity between the roots of a seedling and those of an established, infected plant may speed up AM infection, but, for unknown reasons, this is not always the case (Newman et al. 1992). AMs may have profound effects on interactions between plants in a community, as discussed in Sect. 7 of Chapter 9E on interactions among plants.

Mycorrhizas can obviously never enhance growth and productivity of crop plants in the absence of any P. Mycorrhizal associations,

however, do have great potential in improving crop production when P or other immobile nutrients are in short supply. Introduction of spores of the best microsymbiont and breeding for genotypes with a

more efficient mycorrhizal symbiosis are tools that can be used to enhance food production in countries where immobile nutrients restrict crop production. As such, mycorrhizas allow good crop growth and

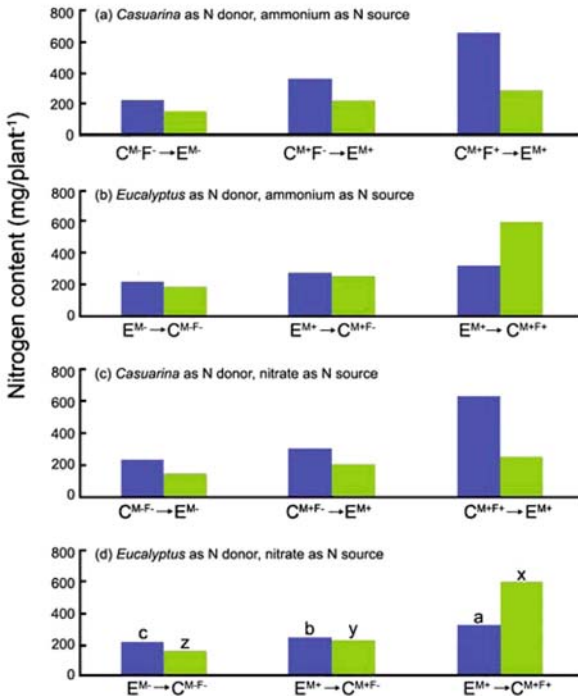
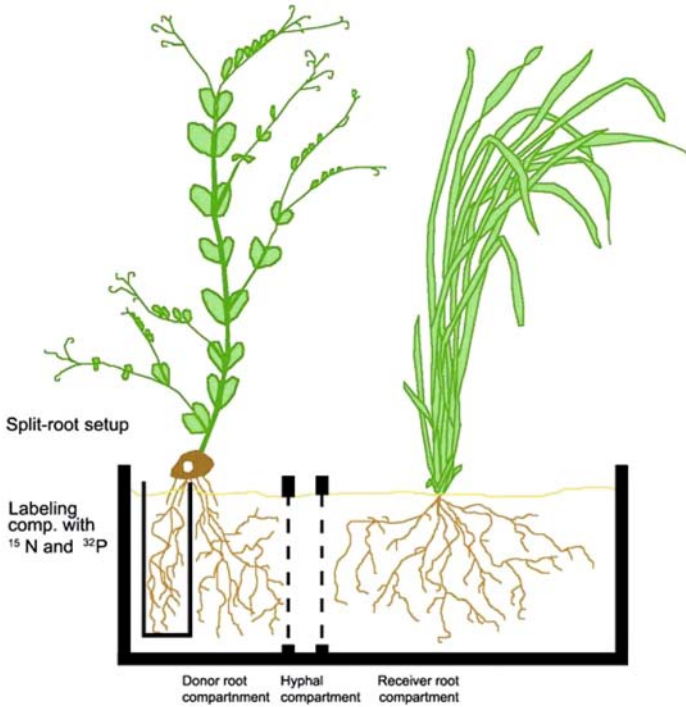

FIGURE 12. (Top) Planting arrangement in a split-root design. (Bottom) N content of *Casuarina cunninghamiana* and *Eucalyptus maculata* seedlings (blue bars for donors and green bars for receivers) as affected by mycorrhizas, nodulation, N source, and identity of the N-donor or N-receiver. Plants were fertilized with ¹⁴N for 5 months and with ¹⁵N (N donor only) for 1 month before harvest. Abbreviations: C, *Casuarina cunninghamiana*; E, *Eucalyptus maculata*; M, mycorrhizal status; F, nodulation status (He et al. 2004). Copyright Trustees of The New Phytologist.

may reduce nutrient losses to the surrounding environment (Tisdall 1994).

Arbuscular and ectomycorrhizal mycorrhizal fungi may infect many plants at the same time, even plants of different species, potentially providing a pathway for transport of carbon or nutrients between roots of different plants. Two-way N transfers mediated by a **common mycorrhizal network** have been examined by growing plants in two-chambered pots separated by nylon mesh, and supplying $^{15}\text{NH}_4^+$ or $^{15}\text{NO}_3^-$; the mesh effectively excludes root contact, but allows movement of water-soluble substances and penetration of fungal hyphae (Johansen & Jensen 1996). Using this method, it can be demonstrated that nitrogenous compounds are transported bidirectionally between N_2 -fixing *Casuarina cunningghamiana* trees (sheoak) and *Eucalyptus maculata* trees (spotted gum), connected via the ectomycorrhizal fungus *Pisolithus* sp. (Fig. 12), especially in the nodulated, ectomycorrhizal treatment. About twice as much N moves from *Eucalyptus maculata* toward *Casuarina cunningghamiana* as in the opposite direction, irrespective of the source of N ($^{15}\text{NH}_4^+$ or $^{15}\text{NO}_3^-$), resulting in increased growth of *Casuarina cunningghamiana* due to interspecific N transfer. Since there is virtually no N transfer in the nonmycorrhizal treatment, but significant N transfer in the mycorrhizal treatment, N transfer between the two tree species is obviously mediated by ectomycorrhizal fungi. The much higher N transfer between nodulated mycorrhizal plants indicates that mycorrhizas and *Frankia* together enhance bidirectional N fluxes between N_2 -fixing *Casuarina cunningghamiana* and non- N_2 -fixing mycorrhizal *Eucalyptus maculata*, contradicting the view that N flows from N_2 -fixing to non- N_2 -fixing plants. However, the fraction of N derived from transfer is similar for both species, because the N concentrations are higher in the N_2 -fixing *Casuarina cunningghamiana* (He et al. 2004, 2005). It remains to be established how significant bidirectional transport of nutrients or carbon is in the field, especially via AM networks (Pfeffer et al. 2004). Using stable carbon isotopes to assess carbon transfer via AM, provides no evidence for carbon transfer from *Festuca idahoensis* (Idaho fescue) to the exotic invasive *Centaurea maculosa* (spotted knapweed). However, *Centaurea maculosa* exploits its mycorrhizal symbiosis more effectively than the native grassland species, probably due to the luxury consumption of P through efficient utilization of extra-radical hyphae. Exploitation of AM networks may be a mechanism by which **invasive weeds** outcompete their neighbors (Zabinsky et al. 2002). Transport of carbon via mycorrhizal hyphae is obviously also important in **mycoheterotrophic** plants, which depends on

carbon supplied by a photosynthetic plant to which they are connected via mycorrhizal hyphae (Sect. 2.1.1; Selosse et al. 2006). However, putatively autotrophic orchids also receive significant amounts of carbon from their fungal associates (Gebauer & Meyer 2003).

Benefits of N nutrition to non- N_2 -fixing plants by neighboring N_2 -fixing plants are well documented (Sect. 3.6). Differences in net N transfer with different nodulation/mycorrhizal combinations could have important ecological implications, both for nutrient cycling and for the structure and function of natural or agricultural plant communities, particularly with respect to those plants that can potentially construct a common mycorrhizal network to transfer nutrients (He et al. 2005). AM colonization can result in resource equalization or sharing, thus reducing dominance of aggressive species and promoting coexistence and biodiversity (Van der Heijden et al. 1998a). In tallgrass prairie, Fischer Walter et al. (1996) documented transfer of (labeled) P over distances of up to 0.5 m. Transfer of label, however, does not imply a net transfer of P. Although tracer experiments do show that interplant transfer does occur, the amount of transfer of ^{32}P between mycorrhizal plants of *Lolium perenne* and *Plantago lanceolata* appears to be much too slow to be ecologically significant (Eissenstat 1990).

3. Associations with Nitrogen-Fixing Organisms

Nitrogen is a major limiting nutrient for the growth of many plants in many environments in young landscapes (Sect. 2.1 of Chapter 6 on mineral nutrition). Terrestrial N is subject to rapid turnover, and is eventually lost as nitrogen gas into the atmosphere or deposited in marine sediments. Its maintenance, therefore, requires a continuous reduction of atmospheric N_2 . Biological reduction of dinitrogen gas to ammonia can be performed only by some prokaryotes and is a highly O_2 -sensitive process. The most efficient N_2 -fixing microorganisms establish a symbiosis with higher plants, in which the energy for N_2 fixation and the O_2 -protection system are provided by the plant partner (Mylona et al. 1995).

Symbiotic associations with microorganisms that fix atmospheric N_2 may be of major importance for a symbiotic plant's N acquisition, especially in environments where N is severely limiting to plant growth. As such, the symbiosis is also of agronomic and environmental importance, because it reduces the need for costly fertilizers and greenhouse gas emissions associated with their production.

A nonsymbiotic association [e.g., with *Azospirillum* in the rhizosphere of tropical grasses or *Gluconacetobacter diazotrophicus* in the apoplast of the stems of *Saccharum officinarum* (sugarcane)] is sometimes found. Contrary to the strictly symbiotic systems, no special morphological structures are induced.

Symbiotic N₂-fixing systems require a carbon input from the host that is far greater than the carbon requirements for the acquisition of N in the combined form (e.g., NO₃⁻, NH₄⁺, or amino acids). Are there mechanisms to suppress the symbiosis when there is plenty of combined N around? How does a plant discriminate between a symbiotic guest

and a pathogenic microorganism? Finally, what is the significance of nonsymbiotic N₂ fixation for plants? To answer these ecological questions we will first provide a basic understanding of some physiological aspects of this symbiotic association.

3.1 Symbiotic N₂ Fixation Is Restricted to a Fairly Limited Number of Plant Species

Because of its overwhelming economic importance, the most widely studied associations between N₂-fixing microorganisms and vascular plants are those



FIGURE 13. N₂-fixing symbiotic systems. (Top, left) Legume–rhizobium symbiosis on the South African *Chamaecrista mimosoides* (fishbone dwarf cassia) (photo H. Lambers). (Bottom, left) Symbiotic structure (rhizothamnia) between the Western Australian *Allocasuarina humilis* and an Actinobacteria (*Frankia*) (courtesy M.W. Shane, School of Plant Biology, The University of Western Australia, Australia). (Right) Symbiotic structure between *Macrozamia riedlii* and cyanobacteria (courtesy M.W. Shane, School of Plant Biology, The University of Western Australia, Crawley, Australia).

that involve a symbiosis between bacteria of the family Rhizobiaceae (genera: *Allorhizobium*, *Azorhizobium*, *Bradyrhizobium*, *Rhizobium*, *Mesorhizobium*, and *Sinorhizobium*, collectively known as **rhizobia**; the numbers of genera are increasing steadily, and they include both alpha and beta Proteobacteria; Sprent & James 2007) and more than 3000 species of **Fabaceae** (Geurts & Bisseling 2002, Vessey et al. 2005). *Parasponia* is the only nonlegume species known to have a symbiotic association with rhizobium [*Bradyrhizobium* and *Rhizobium* (Vessey et al. 2005)]. Invariably, **root nodules** are formed (Figs. 13 and 14), with the exception of *Azorhizobium* and *Bradyrhizobium*, which induces nodules on both stems and roots (of *Sesbania rostrata* and *Aeschynomene* species, respectively). The Fabaceae family comprises three subfamilies; the less specialized subfamily Caesalpinioideae includes far more nonnodulating species than do the other two subfamilies (Van Rhijn & Vanderleyden 1995). The symbiosis between rhizobia and legume crops is of enormous agronomic importance, especially where fertilizer inputs are low.

There are also **nonlegume species** capable of forming a symbiotic association with N_2 -fixing organisms, other than rhizobia. First, there is the

actinorhizal symbiosis between soil bacteria (*Frankia*, Actinobacteria) and more than 200 species from eight nonlegume families of angiosperms [e.g., *Alnus* (alder), *Hippophae* (sea buckthorn), *Myrica* (myrtle), *Elaeagnus* (silverberry), *Dryas* (mountain avens), and *Casuarina* (sheoak)]. In all these symbioses **root nodules** are formed (Figs. 13 and 14; Akkermans & Hirsch 1997, Vessey et al. 2005). Second, there are symbioses between **Cyanobacteria** (*Nostoc*, *Anabaena*) and plant species of the genera *Azolla*, *Macrozamia*, and *Gunnera* (Vessey et al. 2005). Special morphological structures are sometimes formed on the roots (e.g., the **coralloid roots** in *Macrozamia* species) (Figs. 13 and 9.A.14; Pate et al. 1988). The endosymbiont only fixes N_2 , not CO_2 , although cyanobacteria are photosynthetically active when free-living (Lindblad et al. 1991). *Nostoc* in the *Gunnera*-*Nostoc* symbiosis maintains its photosystem II (PS II) units, but their photochemical efficiency is much reduced (Black & Osborne 2004). In the symbiosis between fungi of the genus *Collema* and cyanobacteria (*Nostoc*), the cyanobacteria are photosynthetically active; this symbiosis occurs in **lichens**.

Table 4 gives an overview of major symbiotic associations between plants and microorganisms

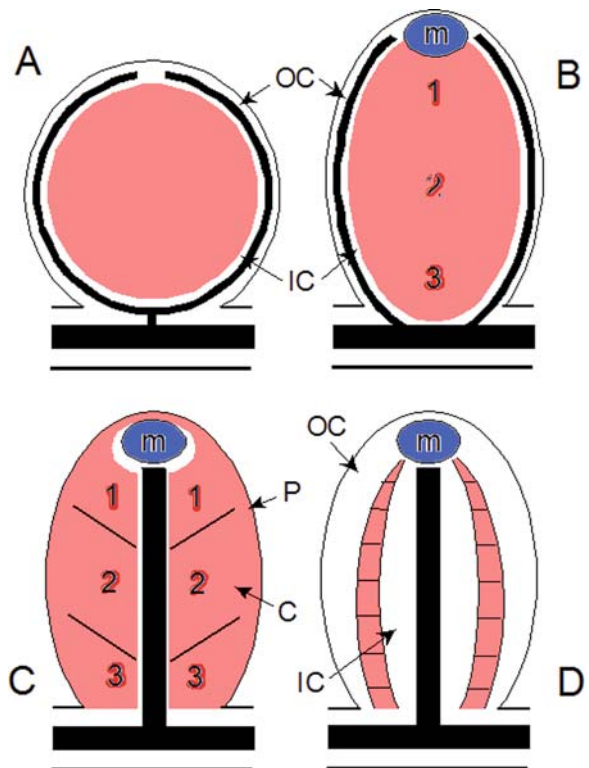

FIGURE 14. Diagrammatic representation of longitudinal sections through (A) an indeterminate legume nodule, (B) a determinate legume nodule, (C) an actinorhizal nodule, and (D) a lobe of a symbiotic coralloid root cluster. The red colored regions represent the infected zones. The dark, thick lines represent vascular tissues. Outer cortical (OC) tissue, inner cortical (IC) tissue, and meristems (m, blue) are indicated. In the indeterminate legume nodule (B) and the actinorhizal nodule (C), the zones of infection (1), N_2 fixation (2), and senescence (3) are indicated (Vessey et al. 2005).

TABLE 4. Symbiotic associations between plants and microorganisms capable of fixing atmospheric N₂.*

Plant type	Genus	Microorganism	Location	Amount of N ₂ fixed (kg N ha ⁻¹ season ⁻¹)
Fabaceae	<i>Pisum</i>	<i>Rhizobium</i>	Root nodules	10–350
	<i>Glycine</i>	<i>Bradyrhizobium</i>	Root nodules	15–250
	<i>Medicago</i>	<i>Sinorhizobium</i>	Root nodules	440–790
	<i>Sesbania</i>	<i>Azorhizobium</i>	Stem nodules	7–324
		<i>Mesorhizobium</i>		
Ulmaceae	<i>Parasponia</i>	<i>Bradyrhizobium</i>	Root nodules	20–70
Betulaceae	<i>Alnus</i>	<i>Frankia</i>	Root nodules	15–300
Casuarinaceae	<i>Casuarina</i>	(<i>Actinobacteria</i>)	Root nodules	9–440
Eleagnaceae	<i>Eleagnus</i>	(<i>Actinobacteria</i>)	Root nodules	nd
Rosaceae	<i>Rubus</i>	(<i>Actinobacteria</i>)	Root nodules	nd
Pteridophytes	<i>Azolla</i>	<i>Anabaena</i>	Heterocysts in cavities of dorsal leaf lobes	40–120
Cycads	<i>Ceratozamia</i>	<i>Nostoc</i>	Coralloid roots	19–60
Lichens	<i>Collema</i>	<i>Nostoc</i>	Interspersed between fungal hyphae	nd

Source: Kwon & Beevers (1992), Gault et al. (1995), Peoples et al. (1995), Vance (2002).

* Only a limited number of species are listed, just to provide an example; nd is not determined.

capable of fixing atmospheric N₂. It shows that N₂-fixing organisms can be very significant for the input of N into natural and agricultural systems.

3.2 Host–Guest Specificity in the Legume–Rhizobium Symbiosis

The associations between legumes and rhizobia have been studied most elaborately. Many are highly specific. For example, *Rhizobium meliloti* will infect *Medicago truncatula* (medic), *Melilotus alba* (honey clover), and *Trigonella coerulea* (fenugreek), but not *Trifolium repens* (white clover) or *Glycine max* (soybean). *Bradyrhizobium japonicum* will nodulate *Glycine max* (soybean), but not *Pisum sativum* (pea) and *Medicago truncatula* (medic). Other rhizobia (e.g., *Rhizobium* strain NGR234) may infect up to 100 host species, from different genera, including *Parasponia andersonii*, a nonlegume, but this is exceptional. What determines the specificity and why does this specificity vary among different rhizobia? To answer these questions, we first discuss the infection process in more detail.

3.3 The Infection Process in the Legume–Rhizobium Association

Nodule formation in legumes such as *Pisum sativum* (pea) and *Glycine max* (soybean) is preceded by the

release of **specific phenolic compounds (flavonoids)**: flavones, flavanones, or isoflavones) and betaines from the legume roots (Phillips et al. 1994). The same or similar flavonoids are induced as antibiotics (phytoalexins) upon infection by pathogenic microorganisms (Sect. 3 of Chapter 9C on effects of microbial pathogens). Subtle differences between host plant species, of which we are only just beginning to understand the details, determine if an interaction between a bacterium and a plant results in symbiosis or pathogenesis. The flavonoids bind with a bacterial gene product, and then interact with a specific promoter in the genome of rhizobium. This promoter is associated with the genes responsible for inducing nodulation (the nodulation, or **nod genes**). As detailed in the following sections, the products of these genes, the **Nod factors**, induce **root-hair curling** on the plant and **cortical cell divisions**, which are among the earliest, microscopically observable events in the nodulation of most legume species. Nod factors are not required for symbiosis in some legumes, e.g., *Aeschynomene* species forming a symbiosis with photosynthetic *Bradyrhizobium* species (Giraud et al. 2007). Rhizobia may also enter through cracks in the epidermis, associated with lateral-root formation, or wounds; for 25% of all legumes this is the only way of entry (Sprent 2007).

The actinorhizal symbiosis between plant species like *Alnus glutinosa* (black alder) and the Actinobacteria *Frankia* also involves the release of specific compounds (flavonols) that enhance the level of

nodulation, but their exact role in the process is unknown (Van Ghelue et al. 1997, Vessey et al. 2005). Very little is known about the chemical nature of attractants from hosts to Cyanobacteria (Vessey et al. 2005).

3.3.1 The Role of Flavonoids

To some extent **specificity** between the host and rhizobium is determined by the type of **flavonoids** released by the host and by the sensitivity of the rhizobium promoter for a given type of flavonoid (Table 5). Rhizobium species that form symbioses with a broad range of plant species respond to a wider range of flavonoids than those that are more specific, but, if the flavonoid concentration is increased, a response may occur, even in those more specific rhizobia. In addition, nonlegumes may also exude flavonoids, and several legumes exude flavonoids that also activate the promoter of rhizobium species that are unable to establish a symbiosis. Other factors must, therefore, also contribute to specificity (Spaink 1995). What ultimate effects do the flavonoids have in rhizobium?

To study the effect of flavonoids on rhizobium an appropriate assay is required that is less elaborate than measuring root-hair curling (Maxwell et al. 1989). A construct has been made, coupling the gene from *Escherichia coli* that encodes β -galactosidase to the promoter of the *nod* genes. The activity of the enzyme β -galactosidase is then measured in a simple spectrophotometric assay. In this way, the relative effect of various flavonoids can be assessed by determining the activity of β -galactosidase,

rather than the extent of root-hair curling. In the following section we examine the kind of products produced by the bacterial *nod* genes.

3.3.2 Rhizobial *nod* Genes

There are three types of rhizobial *nod* genes (Fig. 15). First, all rhizobia have a *nod* gene that is transcribed constitutively and probably confers some host specificity. The product of this gene binds with flavonoids produced by the host plant to activate the common *nod* genes, which are found in all rhizobium species and lead to the production of a bacterial **lipochitooligosaccharide**. The flavonoids also activate the transcription of host-specific *nod* genes, which encode enzymes that “decorate” this lipochitooligosaccharide. The “decorated” lipochitooligosaccharides are known as the **Nod factors**. The lipid component of the Nod factor allows penetration through membranes. Different side groups are added to the backbone of this molecule, and this confers the specificity of a certain rhizobium (Fig. 15). Rhizobial species with a broad specificity produce many different Nod factors, as opposed to ones with a narrow host range. That is, the structure of the lipochitooligosaccharide determines if it will be recognized as a symbiont or as a pathogen by a potential host plant. Because the Nod factor is effective at concentrations as low as 10^{-12} M, a plant **receptor** must be involved, and evidence for this has recently been obtained (Radutoiu et al. 2003, Oldroyd et al. 2005). Rhizobial Nod factors trigger *nod* gene transcription in plant epidermal cells within 1 hour of exposure;

TABLE 5. Comparisons of indeterminate and determinate nodules.

Parameter	Indeterminate	Determinate
Nodule initiation	Inner cortex	Outer cortex
Cell infection through	Infection threads	Infection threads and cell division
Meristem	Persistent (months)	Nonpersistent (days)
Bacteroid size	Larger than bacteria	Variable, although usually not too much larger than bacteria
Peribacteroid membrane	One bacteroid per symbiosome	Several bacteroids per symbiosome
N ₂ fixation products transported	Amides usually	Ureides usually
Infected cells	Vacuolate	Nonvacuolate
Geographical origin	Temperate	Tropical to subtropical
Genera	<i>Medicago</i> , <i>Trifolium</i> , <i>Pisum</i> , <i>Lupinus</i>	Isoflavones
<i>nod</i> Gene inducers	Flavones, isoflavones	<i>Glycine</i> , <i>Phaseolus</i> , <i>Vigna</i>
Ploidy level of bacteroids	Polyploid	Diploid
Viability of bacteroids	Nonviable upon release in soil	Viable upon release in soil

Source: Vance (2002), Vessey et al. (2005), Mergaert et al. (2006).

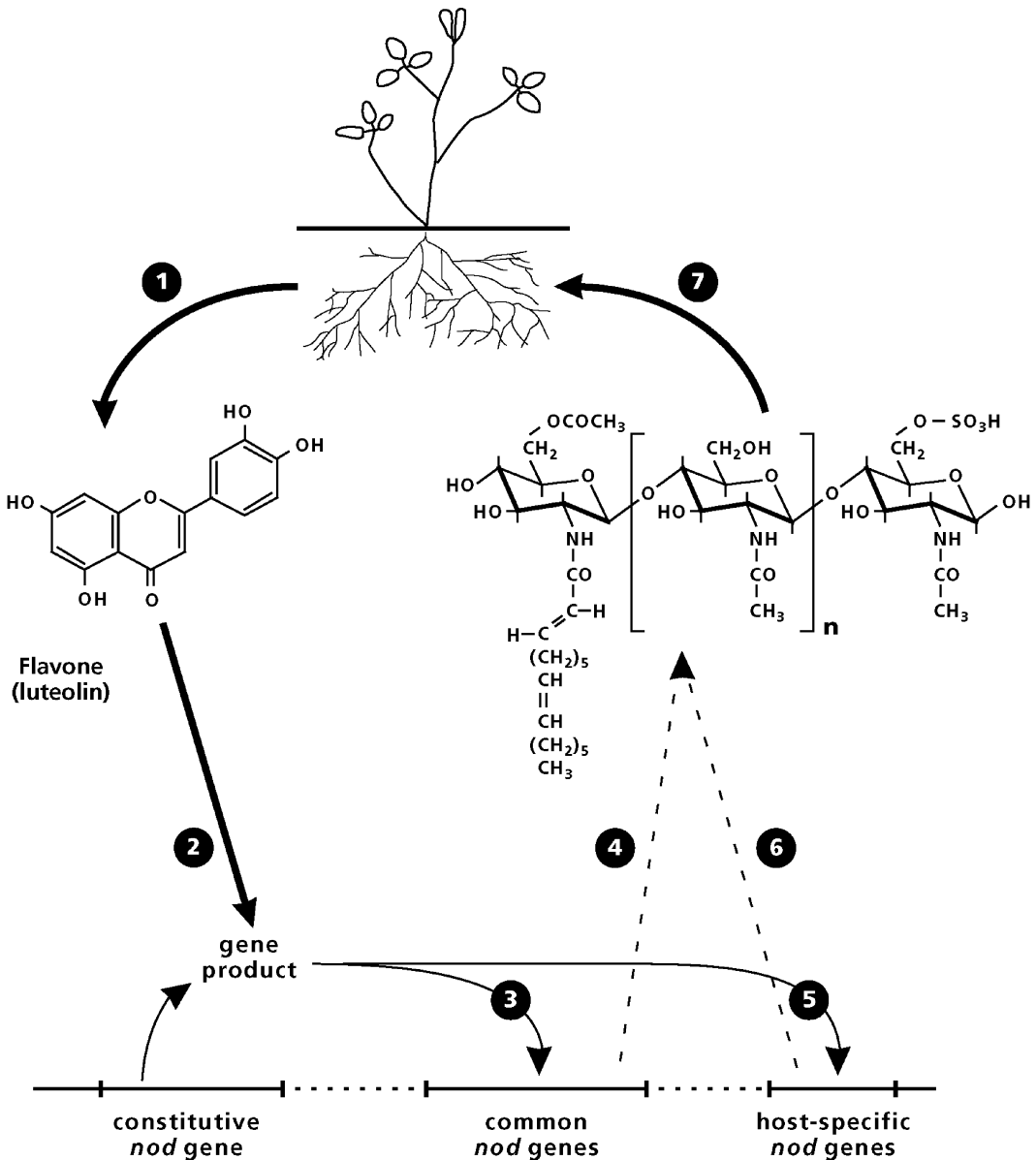

FIGURE 15. Symbiotic signaling between legume plants and rhizobia. (1) Flavonoids are exuded by the legume roots. (2) The flavonoids bind to the gene product of a constitutively expressed nodulation (*nod*) gene. (3) After this binding, common *nod* genes are activated. (4) This leads to the production of a lipochitooligosaccharide. (5)

The flavonoids also activate the transcription of specific *nod* genes. (6) The products of the specific *nod* genes lead to modification of the lipochitooligosaccharides and the formation of nodulation (*nod*) factors, which confer specificity. (7) The Nod factors are recognized by receptors on the surface of the legume-host's roots.

maximum expression is in the differentiating region of the root between the growing root tip and the zone of root-hair emergence, where the nodulation process is initiated. An increase of the cytosolic Ca concentration, which originates from

intracellular sources and from the apoplast, appears to play a role in the signal-transduction pathway that starts with the perception of the Nod factor and leads to *nod* gene expression (Pingret et al. 1998).

Much less is known about plant factors determining if a rhizobium will recognize a plant as an appropriate host. Flavonoids offer only a partial explanation. When rhizobial genes that confer host specificity are transferred to a rhizobium strain with a different specificity, these genes alter the bacterial acidic polysaccharide structure and in situ binding to the host's root hairs. Furthermore, introducing the genes encoding specific root-hair proteins (**lectins**) into *Trifolium repens* (white clover) allows nodulation of clover roots by a *Rhizobium* strain, which is usually specific for *Pisum sativum* (pea). It has therefore been thought that the host-*Rhizobium* specificity involves the interaction of the root hair lectins with specific carbohydrates on the bacterial surface (Diaz et al. 1989).

3.3.3 Entry of the Bacteria

After the release of flavonoids by the host and the release of the Nod factors by rhizobium, the bacteria multiply rapidly in the rhizosphere. The bacteria may adhere to root hairs and affect those that have just stopped growing. Younger and older root hairs are not affected. Alternatively, entry may occur through cracks in the epidermis or wounds. This is the only way of entry for 25% of all legumes (Sprent 2007) as well as for entry into nonlegumes, e.g., *Oryza sativa* (rice), *Triticum aestivum* (wheat), and *Zea mays* (corn) (Webster et al. 1997). However, upon entry into nonlegumes, with the exception of *Parasponia* species, no nodules are formed.

When rhizobia adhere to root hairs, the cell wall of the affected root hair is then partly hydrolyzed at the tip. In this process the root hairs curl, attaching the bacteria to the root hair. On those locations on the root hairs that have become deformed due to the presence of rhizobia, the cell wall is degraded, allowing the bacteria to enter. An **infection thread** is formed by invagination of the cell wall. This thread consists of cell-wall components similar to those that form the normal root-hair cell wall. The infection thread grows down the root hair at a rate of 7–10 $\mu\text{m h}^{-1}$ and provides a conduit for bacteria to reach the root cortex. The tip of the transcellular infection thread appears to be open; sealing of the thread tip results in abortion of the infection thread. The formation of the infection thread may well be analogous to the enlargement of epidermal cell walls, in response to a pathogen's attempted penetration (Vance 2002).

Only 1–5% of all root hairs become infected, and only 20% of these infections result in nodules. Why are most of the infections unsuccessful? This is likely to be due to the production of **chitinases** by the

plant. These enzymes hydrolyze the lipochitooligosaccharide Nod factor (Mellor & Collinge 1995). Legumes contain different chitinases. In an early stage of infection the host produces a chitinase that breaks down the Nod factors of *Rhizobium* species that are not suitable guests. In this way they prevent the entry of bacteria that cannot form a symbiosis. Chitinases are therefore another factor that confers **host-guest specificity**. At a later stage, different chitinases are produced that are effective against the Nod factor of "homologous" rhizobium bacteria, i.e., suitable guests. This is probably a mechanism to control the entry of rhizobium and to prevent more nodules being formed than can be supported by the host. In addition, the breakdown of Nod factors prevents entering bacteria from being erroneously recognized as pathogens. *Rhizobium* strains that overproduce the Nod factor do indeed lead to a defense response. Not only is the Nod factor broken down by plant chitinase activity, but expression of the bacterial *nod* genes is also suppressed at a later stage of infection. Plant phenolics may play a role in this suppression. If the *Rhizobium* fails to recognize the plant-derived suppressor molecule, the bacteria may be recognized as a pathogen and further development stops. This offers another possibility for **host-guest specificity**. The train of events that likely plays a role in the early stages of infection and the role of chitinases is outlined in Fig. 16.

If the infection is successful, then specific genes are activated in the cortex and pericycle which allows the formation of an infection thread through which the bacteria enter (Vessey et al. 2005). Cell divisions start in the inner cortex (indeterminate nodules) or outer cortex (determinate nodules), opposite protoxylem poles, so that a new **meristem** is formed due to the presence of the rhizobia. This meristem gives rise to the **root nodule**. The infection thread grows inward, and, finally, the bacteria are taken up into the cytoplasm of the parenchyma cells of the center of the developing nodule. Inside the infected host plant cell, the bacteria continue to divide for some time, now differentiating into **bacteroids**, which have a diminished ability to grow on laboratory culture media; they may be greatly enlarged with various shapes. In most legumes, bacteroids are enclosed within a **peribacteroid membrane**, to form a **symbiosome** (White et al. 2007). Most symbiosomes are of a similar volume, but in some nodules, each symbiosome contains a single, enlarged pleomorphic bacteroid, whereas there may be several (up to 20) smaller, rod-shaped bacteroids in others. Symbiosomes with a single bacteroid are more typical of elongate, cylindrical nodules of the so-called **indeterminate** class, as

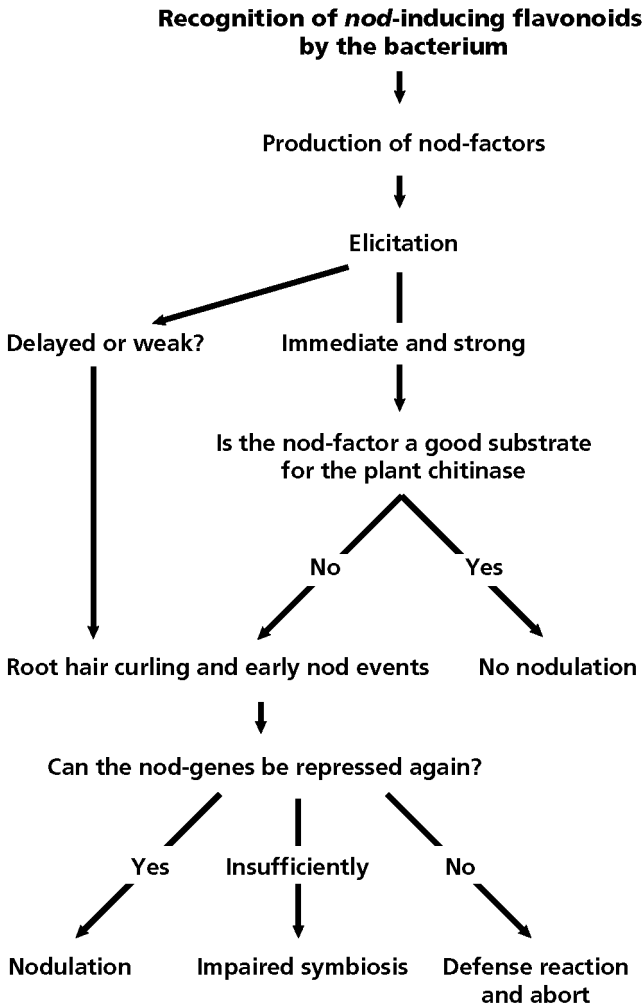

FIGURE 16. Tentative scheme to account for events that determine the establishment of a functional symbiosis (effective nodulation) between rhizobium and a host legume. “Elicitation” is a combination of the elicitor activity of a specific bacterial Nod factor and the sensitivity of the plant to that elicitor (Mellor & Collinge 1995). Reproduced with kind permission of Oxford University Press.

found on *Trifolium repens* (white clover) or *Pisum sativum* (pea) (Table 5). These nodules have a persistent meristem. Bacteroids in indeterminate nodules are polyploid, and have lost their ability to divide; hence they are nonviable when released from nodules (Mergaert et al. 2006). Symbiosomes with several bacteroids are common in spherical, **determinate** nodules (with no meristem), such as those of *Vigna unguiculata* (cowpea) or *Glycine max* (soybean). Bacteroids in determinate nodules are diploid, like free-living rhizobia, and can divide in soil upon release from nodules. The ploidy level of the bacteroids is controlled by the host (Mergaert et al. 2006). A few legumes have nodules in which there are no symbiosomes, the bacteria being retained within multiply branched infection threads. Mature nodules of the determinate and indeterminate types are strikingly different, but their initiation is rather similar (Sprenst 2007).

3.3.4 Final Stages of the Establishment of the Symbiosis

Each **infected cell** may contain many hundreds of symbiosomes. The symbiosome membrane (**peribacteroid membrane**) originates from an invagination and endocytosis of the plasma membrane of the infected cortical cells. This membrane acts as a selective permeability barrier to metabolite exchange between the bacteroids and the cytosol of the infected cells. Interspersed between the infected cells of many nodules are smaller, **uninfected cells**, which occupy about 20% of the total volume of the central zone of the nodules of *Glycine max* (soybean). **Plasmodesmata** connect uninfected with infected cells and with other uninfected cells in the central zone of the nodule. These plasmodesmata allow for the massive transport of carbon from the uninfected cells to the infected ones and of

nitrogenous compounds in the reverse direction (Brown et al. 1995). Both infected and uninfected cells contain numerous plastids and mitochondria. Uninfected and infected cells in nodules have different metabolic roles in symbiotic N₂ fixation (Day & Copeland 1991). The central tissue of some nodules, however, contains no uninfected cells.

In *Glycine max* (soybean) nodules, an outer layer of cortical cells surrounds an endodermal cell layer, which in turn encloses several layers of subcortical cells. The central zone of the nodules contains several thousand infected cells. The nodule is connected with the **vascular tissue** in the stele, due to the proliferation of cells from the pericycle.

The pattern of gene expression in the host cells that are part of the nodules is altered by the presence of the bacteria, resulting in the synthesis of many different proteins, known as **nodulins**. Some of these nodulins have been characterized biochemically, including the O₂ carrier **leghemoglobin** and nodule-specific forms of the enzymes uricase, glutamine synthetase, and sucrose synthase.

3.4 Nitrogenase Activity and Synthesis of Organic Nitrogen

Biological reduction of N₂ to NH₃ is catalyzed by **nitrogenase**, in a highly O₂-sensitive process. This O₂ sensitivity accounts for the pink color of the nodule tissue which is due to the presence of **leghemoglobin** in the cytoplasm of the infected legume cells or **hemoglobin** in nodules of species living symbiotically with *Frankia* (Gualtieri & Bisseling 2000). This heme-protein may comprise 35% of the total nodule soluble protein. Leghemoglobin is related to the myoglobin of mammalian muscle; its protein component is encoded by the DNA of the plant. The enzymes responsible for the synthesis of the O₂-binding heme-group of the protein in legume nodules are encoded both in rhizobium and in the host [e.g., *Pisum sativum* (pea)]. Because the enzymes are up-regulated in the infected host cells in root nodules that synthesize the other component of leghemoglobin, the heme moiety is probably synthesized by the macrosymbiont (Santana et al. 1998). Leghemoglobin plays a role in the **O₂ supply** to the bacteroid. It has a high affinity for O₂ and a relatively fast O₂-dissociation rate, which ensures sufficiently rapid **O₂ supply** for the highly active respiratory processes in the plant and bacteroid compartment while maintaining a low concentration of free O₂ (between 3 and 30 nM). The latter is very important because **nitrogenase**, which is the enzyme responsible for the fixation of atmospheric N₂ to

NH₃, is rapidly damaged by **free O₂** (Arredondo-Peter et al. 1998, Gualtieri & Bisseling 2000).

To control the O₂ supply and O₂ concentration to and within infected cells, **nodule permeability to O₂ diffusion** varies within seconds to hours in response to changes in carbohydrate supply via the phloem, adenylate demand, and O₂ status. This permeability control is associated with the reversible flow of water into or out of intercellular spaces. When nodulated *Glycine max* (soybean) plants are exposed to treatments that decrease the nodules' O₂ permeability, the K⁺ concentration in the nodule cortex increases relative to that in the central zone of the nodules. On the other hand, treatments that increase O₂ permeability have the opposite effect. The energy-dependent coupled movement of ions and water into and out of infected cells offers a possible mechanism for diffusion barrier control in legume nodules (Wei & Layzell 2006).

The bacteroids contain **nitrogenase**, which is an enzyme complex that consists of two proteins. One, nitrogenase-reductase, is an Fe-S-protein that accepts electrons, via an intermediate electron carrier, from NADPH and then binds ATP. At the same time, the other subunit (an Fe-Mo-protein) binds N₂. Reduction of this N₂ occurs if the two subunits have formed an active complex. A minimum of 12, and possibly as many as 16 ATP are required per N₂; therefore the overall equation is:

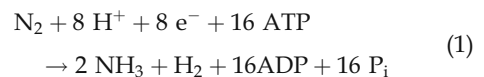

Most of the N₂ fixed by the bacteroids is released as NH₃ to the peribacteroid space and then as NH₄⁺, via a voltage-driven channel across the peribacteroid membrane, to the cytosol of the nodule cells (Fig. 17; Mouritzen & Rosendahl 1997). Alternatively, NH₃ may be converted into alanine, and then exported (Fig. 17; White et al. 2007). A nodule-specific glutamine synthetase is expressed in the cytosol of infected cells. Glutamine 2-oxoglutarate aminotransferase (GOGAT) then catalyses the formation of two molecules of glutamate from one molecule of glutamine. The major N-containing products exported via the xylem are the **amides** asparagine and glutamine in such species as *Pisum sativum* (pea), *Medicago sativa* (alfalfa), and *Trifolium repens* (white clover). These products are typical for nodules that are elongate-cylindrical with **indeterminate** apical meristematic activity (Fig. 18, Table 5). In *Phaseolus vulgaris* (common bean) and *Glycine max* (soybean), the products are predominantly **ureides**: allantoin and allantoic acid (Fig. 18, Table 5). Nodules exporting these compounds are spherical

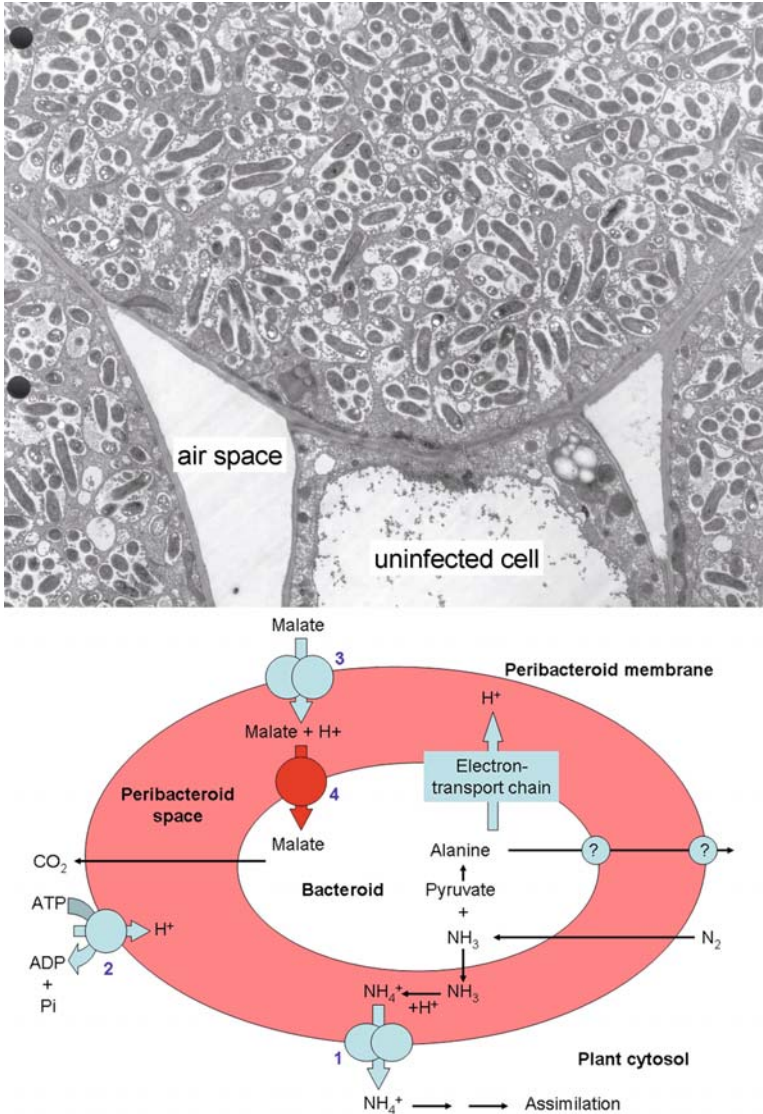
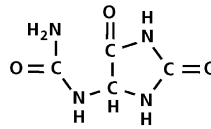

FIGURE 17. (Top) Electron micrograph of a nodule of *Glycine max* (soybean), infected with *Bradyrhizobium japonicum*. Three infected cells and one uninfected cell are shown, with two air spaces in between. Note that the uninfected cell is much smaller than the infected ones, and that the bacteroids are grouped as “symbiosomes”, surrounded by a peribacteroid membrane (courtesy D. Price, Research School of Biological Sciences, Australian National University, Canberra, Australia). (Bottom) Scheme of N_2 -fixation and NH_3 production in bacteroids. NH_3 , being an uncharged molecule, can cross the bacteroid membrane and arrives in the peribacteroid space, where it picks up a proton and becomes NH_4^+ . Subsequently, NH_4^+ leaves

the symbiosome via a monovalent cation channel (1). Alternatively, NH_3 may react with pyruvate, producing alanine. An ATPase in the peribacteroid membrane (2) creates a membrane potential (positive inside of the symbiosome), which drives the passive uptake of negatively charged organic acids (predominantly malate and succinate) into the symbiosome (3). Alternatively, organic acids may arrive symplastically from neighboring uninfected cells. An electron-transport chain in the bacteroid membrane (etc.) creates a proton-motive force, which drives the uptake of malate (and succinate) into the bacteroids via a H^+ -co-transport mechanism (4) [Whitehead et al. (1995), White et al. (2007)].

FIGURE 18. Major nitrogen transport products from legume nodules. The C:N ratio of ureides is 1:1, whereas that of amides is 2:1 (asparagine) or 2.5:1 (glutamine).

Ureides



Allantoin

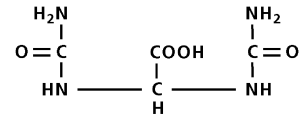

Allantoic acid

Amides

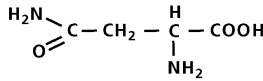

Asparagine

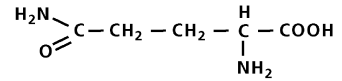

Glutamine

with **determinate** internal meristematic activity (Vessey et al. 2005).

The ureides released to the xylem of plants with **determinate** nodules are products that are only found when the symbiotic plants are fixing N_2 (Peoples et al. 1996). Hence the concentration of these compounds in the xylem sap, relative to the total amount of N transported in the xylem, has been used to estimate the proportion of N derived from N_2 fixation, as opposed to the assimilation of combined N (Peoples et al. 1996). The amides released to the xylem of plants with **indeterminate** nodules are also found when these plants grow nonsymbiotically. In fact, they are not even typical for legumes. Hence, they cannot be used as "markers" for symbiotic N_2 fixation.

3.5 Carbon and Energy Metabolism of the Nodules

Carbohydrates are supplied via the phloem to the nodules, where they are rapidly converted in the

plant compartment to **dicarboxylic acids** (malate, succinate), predominantly in the uninfected cells in the nodules (Lodwig & Poole 2003, White et al. 2007). Malate and succinate are the major substrates for the bacteroids (Fig. 17). How do the infected cells prevent a large part of the organic acids from being oxidized via the nonphosphorylating alternative path in a situation where the demand for organic acids of the bacteroids is very large (Sect. 2.3 of Chapter 2B on plant respiration)? Mitochondria from nodules have very little alternative path capacity; the little capacity they have is restricted to the uninfected cortical cells, rather than to the infected ones (Table 6). There is, therefore, no risk of oxidizing the organic acids destined for the bacteroids.

Apart from N_2 , H^+ is also reduced by nitrogenase [see Equation (1) in Sect. 3.4], leading to the production of H_2 . Most rhizobia, however, contain **hydrogenase**, which is an enzyme that consumes H_2 , using it as an electron donor. The characteristic of nitrogenase to reduce acetylene (ethyne) to ethylene (ethene) is frequently used to assay nitrogenase activity in vivo. Because the assay itself,

TABLE 6. Cyanide-resistant, SHAM-sensitive respiration in infected and uninfected cells isolated from *Glycine max* (soybean).*

Cells from root nodules	O_2 consumption [$nmol\ mg^{-1}\ (protein)\ min^{-1}$]		
	Control	KCN-resistant respiration	KCN resistant respiration (%)
Infected	60	0	0
Uninfected	45	22	49

Source: Kearns et al. (1992).

* Measurements were made on isolated mitochondria from different tissues, as well as on infected and uninfected cells from root nodules.

however, interferes with the process of N_2 fixation, it should only be considered as a *qualitative* to *semi-quantitative* indicator for the occurrence of nitrogenase activity, rather than as a good *quantitative* measure for its actual activity (Hunt & Layzell 1993, Vessey 1994).

3.6 Quantification of N_2 Fixation In Situ

The contribution of symbiotic N_2 fixation to the total accumulation of N in the above-ground biomass of a crop or a plant community can be determined by applying ^{15}N -labeled inorganic N ($^{15}NO_3^-$ or $^{15}NH_4^+$) separately to N_2 -fixing plants and reference plants (i.e., nonfixing species or mutants). For example, it can be given to a plant community that consists of both N_2 -fixing species (e.g., clover) and other species (e.g., grasses) (^{15}N is a nonradioactive isotope of N). The grasses have a $^{15}N/^{14}N$ ratio, which is used as a reference. N_2 fixation in the N_2 -fixing clovers will "dilute" their ^{15}N concentration. The extent of the dilution is used to calculate the contribution of fixation to the total amount of N that accumulates in the clover plants. The contribution of N_2 fixation to the total amount of N that accumulates in the plant may amount to 75 and 86% in *Trifolium repens* (white clover) and *Trifolium pratense* (strawberry clover). Transfer of N is most likely via release of ammonium and amino acids from legume roots (Paynel et al. 2001), but under some conditions N transfer is not detected (McNeill & Wood 1990). The contribution depends on the amount of inorganic combined N that the plants receive from soil and fertilizer, and also varies with the developmental stage of the plant and the time of the year (Fig. 19). The overwhelming importance of symbiotic N_2 fixation in some agricultural systems is illustrated in Table 7.

Sometimes the **natural abundance** of ^{15}N in the soil is used to quantify N_2 fixation (Table 2 in Sect. 2.4). Instead of adding ^{15}N -labeled inorganic combined N, the natural abundance of N in the soil can be used. The natural abundance of soil N is likely to differ from that of N_2 in the atmosphere, due to discrimination against the heavy isotope in various biological processes (e.g., nitrification and denitrification). N in the soil is therefore "enriched" with the heavy isotope, relative to N_2 in the air. To apply this technique in situ, reliable control plants have to be used. As discussed in Sect. 2 (Table 2), this is not always easy, if it is at all possible (Handley et al. 1993).

The ^{15}N technique referred to earlier has also been used to demonstrate a significant transfer of

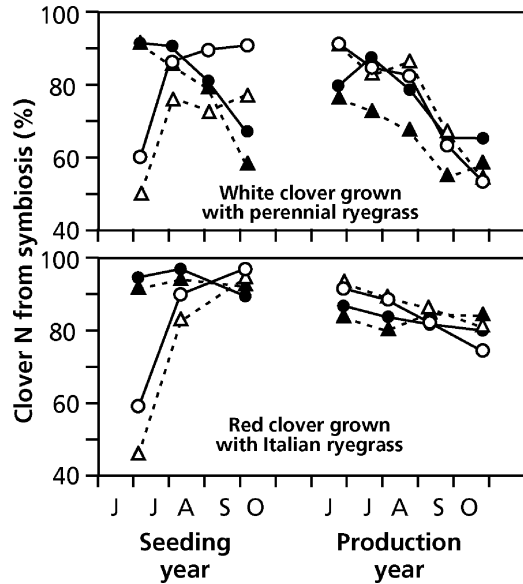

FIGURE 19. The contribution of symbiotic nitrogen fixation to the total N accumulation in the above-ground biomass of *Trifolium repens* (white clover) (top) and *Trifolium pratense* (strawberry clover) (bottom). The white clover plants grew in a mixed culture with *Lolium perenne* (perennial ryegrass) and the strawberry clover with *Lolium multiflorum* (Italian ryegrass). Circles: no N fertilizer; triangles: 30 kg N ha⁻¹ per cut; open and closed symbols refer to different years (Boller & Nösberger 1987).

TABLE 7. Symbiotic N_2 fixation by some legume crops¹ and native species in their natural environment in Brazil².

Species	N_2 fixed kg ha ⁻¹ per season	Plant N absorbed from atmosphere (%)
<i>Medicago sativa</i>	440–780	65–96
<i>Glycine max</i>	120	53
<i>Lotus corniculatus</i>	92	55
<i>Lupinus angustifolius</i>	170	65
<i>Medicago sativa</i>	180	70
<i>Phaseolus vulgaris</i>	65	40
<i>Pisum sativum</i>	72	35
<i>Trifolium pratense</i>	170	59
<i>Vicia faba</i>	151	nd
<i>Vigna angularis</i>	80	70
<i>Chamaecrista</i> species	nd	66–79
Mimosoid legumes	nd	42–63
Papilionoid legumes	nd	68–79

Source: ¹Gault et al. (1995), Vance (2002); ²Sprent et al. (1996).

N from symbiotic plants to neighboring grasses (up to 52 kg N ha⁻¹ year⁻¹; on average a value of 17 kg ha⁻¹ year⁻¹ is found). Conditions favoring N₂ fixation by the legume, such as a high irradiance, a favorable temperature, long days, and a relatively high P_i supply, enhance the transfer of N from the legume to the nonfixing neighbors. This transfer is to some extent the result of the uptake of nitrogenous compounds released after decomposition of parts of the legumes. Some of it is also due, however, to the exudation of nitrogenous compounds by the legumes, followed by absorption by the nonfixing plants. Some transfer of N may occur through mycorrhizal hyphae (Sect. 2.3.1).

The maximum yield of *Lolium rigidum* (annual ryegrass) is reached at a much lower supply of P_i than that of *Trifolium subterraneum* (subclover), at least when both species are grown in monoculture (Bolan et al. 1987). This demand for a higher P is fairly common for nodulated legumes, although it is by no means universal (Koide et al. 1988, Sprent 1999). The high demand for P of many crop legumes may reflect their adaptation to soils with a high availability of P_i, and it points out that a benefit from such legumes can only be expected when these have access to sufficient P_i. Apart from P_i, also Mo and S have to be available to the legume to allow symbiotic N₂ fixation.

What is the role of N₂-fixing species in more biodiverse grasslands? To address this question, test plants ("phytometers") can be planted in plots under investigation, to sample their above-ground biomass at a later stage (both N concentration and natural abundance of ¹⁵N: δ¹⁵N). Phytometers in a recent study belonged to four "plant functional groups" (Chapter 9E): *Festuca pratensis* (meadow fescue), *Plantago lanceolata* (snake plantain), *Knautia arvensis* (field scabious), and *Trifolium pratense* (strawberry clover). Significantly lower δ¹⁵N values and higher N concentrations and N contents were

found in all phytometer species growing with legumes, indicating a facilitative role for legumes in these natural grassland ecosystems. The magnitude of the positive interactions depends on the exact phytometer species, but increased N uptake in communities containing legumes is found in all three nonlegume phytometer species, with a subsequent strong increase in biomass in the grass *Festuca pratensis* across all diversity levels, and a lesser biomass gain in *Plantago lanceolata* and *Knautia arvensis*. In contrast, the legume phytometer species *Trifolium pratense* is negatively affected when other legumes are present in their host communities across all diversity levels (Temperton et al. 2007).

3.7 Ecological Aspects of the Nonsymbiotic Association with N₂-Fixing Microorganisms

Next to the truly symbiotic associations that lead to N₂ fixation, as discussed in Sect. 3.3, a somewhat looser association between *Azospirillum* and higher plants (especially grasses) has been investigated. Inoculation of the soil in which *Zea mays* (corn) plants are grown with *Azospirillum* bacteria significantly enhances the yield of the corn plants, especially when the N supply is relatively low (Table 8). It is by no means certain, however, that this is a direct result of the fixation of N₂ by the *Azospirillum* bacteria. These organisms are more likely to enhance the growth of higher plants in a different manner, such as the production of phytohormones (Dobbelaere et al. 1999). In a comparison of three cultivars of *Triticum aestivum* (wheat), grown with *Azospirillum brasiliense*, most N₂ is fixed in the rhizosphere of Al-resistant cultivars. Because these cultivars also exude more dicarboxylic acids (Sect. 3.1 of Chapter 6 on mineral nutrition), it has been suggested that fixation is enhanced by the excretion of

TABLE 8. The effect of inoculation with *Azospirillum brasiliense* on the production of *Zea mays* (corn) plants as dependent on the N supply.*

N supply (g L ⁻¹)	Shoot dry mass (g)		Root dry mass (g)		Relative increment of total plant mass (%)
	Inoculated	Control	Inoculated	Control	
0	0.49	0.32	0.36	0.27	44
0.04	0.97	0.66	0.76	0.53	45
0.08	1.84	1.23	0.97	0.86	34
0.16	2.93	2.52	1.96	1.70	16

Source: Cohen et al. (1980).

* N was supplied as NH₄NO₃.

these organic molecules (Christiansen-Weniger et al. 1992). Microorganisms might promote plant growth in many other ways, such as **suppression of pathogenic organisms** and the **production of vitamins**.

In some areas in Brazil, *Saccharum officinarum* (sugarcane) has been grown continuously for more than a century without any nitrogenous fertilizer. Although it had long been suspected that substantial N_2 fixation occurs in such systems, none of the N_2 -fixing bacteria isolated from the rhizosphere of *Saccharum officinarum* occur in large enough numbers to account for the high rates of N_2 fixation found in these crops. An acid-tolerant N_2 -fixing bacterium (*Glucoacetobacter diazotrophicus* and a range of others) has been identified in the **intercellular spaces** of sugarcane stem parenchyma (Dong et al. 1994, James et al. 1994). These spaces are filled with a solution that contains 12% sucrose (pH 5.5). *Glucoacetobacter diazotrophicus* has most unusual growth requirements; it shows optimal growth with 10% sucrose and pH 5.5. It will grow in a medium with 10% sucrose and rapidly acidifies its surroundings by the formation of acetic acid. It has been isolated from sugarcane tissues, but was not found in the soil between rows of sugarcane or in grasses from the same location. The apoplastic fluid occupies approximately 3% of the stem volume, which is equivalent to 3 tons of fluid per hectare of the sugarcane crop. It has been suggested that this amount suffices to make the sugarcane independent of N fertilizers.

Enterobacter agglomerans, *Herbaspirillum seropedicae*, and *Klebsiella terrigena* are also believed to be

able to fix atmospheric N_2 in the apoplast of plants that have high apoplastic sugar concentrations. Some of these (e.g., *Herbaspirillum seropedicae*) are pathogens on certain grass species which restricts their potential use as inoculants in agriculture (Palus et al. 1996, Triplett 1996). To date, with the exception of sugarcane, little success has been attained in elucidating which endophyte is really responsible for the observed biological N_2 fixation, and in what site, or sites, within plants the N_2 fixation mainly occurs. Until such important questions are answered, further developments or extension of this novel N_2 -fixing system to other economically important nonlegumes (e.g., cereals) will be seriously hindered (Boddey et al. 2003).

3.8 Carbon Costs of the Legume–Rhizobium Symbiosis

Because all the organic acids required for symbiotic N_2 fixation by rhizobium and for maintenance of the root nodules come from the plant (Fig. 17), there are costs involved in this symbiotic system for the higher plant. These costs exceed those required for assimilation of NO_3^- or NH_4^+ . They have been estimated for an association of *Trifolium repens* (white clover) and rhizobium, in which the clover plants are totally dependent on the microsymbiont for their supply of N (Fig. 20). In this symbiotic system, the N_2 fixation is briefly interrupted by decreasing the O_2 concentration that surrounds the plants, but kept sufficiently high to fully maintain aerobic

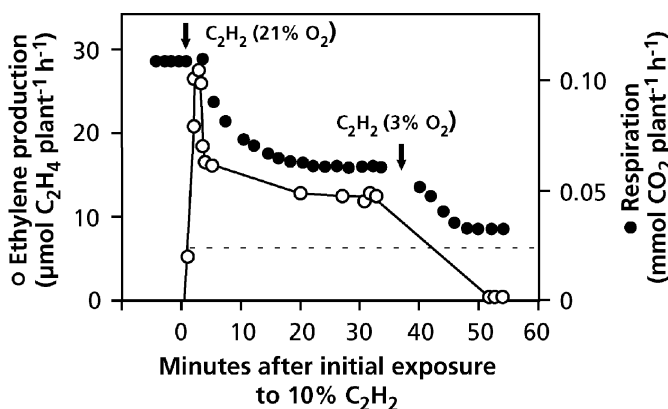

FIGURE 20. Respiration and acetylene reduction (measured as ethylene production) in roots of *Trifolium repens* (white clover) at either high or low O_2 concentration. The low O_2 concentration was sufficiently high to maintain aerobic metabolism of the plant cells, but virtually completely abolished the activity of the N_2 -fixing activity

of the bacteroids. The decline in respiration after adding acetylene reflects the sensitivity of the nodules to "manipulations". It also shows that this technique cannot be used to give reliable quantitative estimates of the rate of N_2 fixation (Ryle et al. 1985). Reproduced with kind permission of Oxford University Press.

metabolism of the plant. It is sufficiently low, however, to completely block the respiration and N_2 fixation by the bacteroids. By relating the decrease in respiration upon blocking the N_2 fixation to the activity of N_2 fixation as determined from the accumulation in the clover plants, **carbon costs** per unit fixed N are calculated. The costs for N_2 fixation amount to approximately 25% of all the carbon fixed in photosynthesis per day. This proportion is rather high when compared with the figures for N acquisition by nonsymbiotic plants given in Table 2 of Chapter 2B on respiration: 4–13% when plants are grown at an optimum nutrient supply. At a limiting nutrient supply, the percentage is likely to be more similar to that of the costs of N_2 fixation.

Because of the high carbon costs of symbiotic N_2 fixation, it has been suggested that **elevated atmospheric CO_2 concentrations** will stimulate this process. However, a meta-analysis shows that symbiotic N_2 fixation is stimulated by elevated atmospheric $[CO_2]$ only when sufficient soil nutrients, other than N, are available (Van Groenigen et al. 2006). Short-term experiments frequently show a positive effect of elevated atmospheric $[CO_2]$ on symbiotic N_2 fixation, but in the long run, a reduced availability of, in particular, Mo, a key component of nitrogenase, leads to rates of N_2 fixation similar to those under ambient $[CO_2]$ (Hungate et al. 2004).

3.9 Suppression of the Legume–Rhizobium Symbiosis at Low pH and in the Presence of a Large Supply of Combined Nitrogen

Once rhizobia have successfully infected legume roots and nodules have been formed, further infection is suppressed. This is called **autoregulation** of root nodule formation, a phenomenon we encountered before in the establishment of a mycorrhizal symbiosis (Sect. 2.3.1). Using plants grown with a divided root system, it can be shown that autoregulation depends on **systemic signals** (Van Brussel et al. 2002). Infection of one root of *Vicia sativa* (common vetch) with *Rhizobium leguminosarum* bacteria inhibits nodulation of a spatially separated root, when this root is inoculated 2 days later with the same bacteria. The mechanism by which nodulation is autoregulated is related to that by which combined N inhibits nodulation (see below). Genes that are involved in Nod-factor signaling may be targets for mechanisms that suppress nodulation (Limpens & Bisseling 2003).

At **low pH**, nodule formation on legumes tends to be inhibited. Because fixation of N_2 lowers soil pH (Sect. 3.1 of Chapter 6 on mineral nutrition), continued use of legumes in agriculture requires **regular liming**. Why is nodulation impaired at a low soil pH? The assay system described in Sect. 3.3.1 has been used to establish that a relatively acid or alkaline, as opposed to a neutral pH of the soil, leads to less effective root exudates. This offers an explanation for the common observation of a poor infection of legumes by rhizobium in acid soils. Survival of rhizobia is also lower in soils with a low pH, but some degree of adaptation of rhizobia strains has been observed.

N_2 fixation is an energetically expensive process, as compared with the assimilation of NO_3^- or NH_4^+ . Reminiscent of the effect of P_i on the formation of the mycorrhizal symbiosis, NO_3^- often inhibits the **infection** of legumes by rhizobia, but this is not invariably found (Sprent 1999). When *Medicago sativa* (alfalfa) plants are grown under N-limiting conditions, the expression of the genes involved in flavonoid biosynthesis and the production of root flavonoids are enhanced. This may account for greater infection by *Rhizobium meliloti* under conditions when N is in short supply, as opposed to suppression of nodulation in the presence of high NO_3^- concentrations (Coronado et al. 1995).

TABLE 9. Apparent nitrogenase activity and the O_2 -limitation coefficient, 2 days after addition of NO_3^- to the root environment of nodulated 21-day-old plants of *Pisum sativum* (pea).*

$[NO_3^-]$ (mM)	Apparent nitrogenase activity [nmol H_2 g^{-1} (nodule dry mass) s^{-1}]	O_2 limitation coefficient
0	45	0.89
5	38	0.64
10	22	0.45
15	24	0.49

Source: Kaiser et al. (1997).

* The apparent nitrogenase activity was measured as the rate of H_2 evolution. As explained in Sect. 3.4, nitrogenase activity leads to the production of H_2 . There is normally no net evolution of H_2 , because rhizobia have a hydrogenase (i.e., an enzyme that uses H_2 as an electron donor). In the present experiment, a rhizobium strain was used that lacks hydrogenase so that the evolution of H_2 could be measured. The O_2 limitation coefficient is calculated as the ratio between total nitrogenase activity (H_2 evolution in the absence of N_2) and potential nitrogenase activity (H_2 evolution in the absence of N_2 at an optimum concentration of O_2).

NO_3^- also inhibits the process of **fixation** itself (Table 9). Several mechanisms have been proposed to account for this inhibition (Hunt & Layzell 1993):

1. Competition for **carbohydrates** between nitrogenase and nitrate reductase, located in leaves, roots, or nodules
2. Inhibitory effects of NO_2^- , the product of nitrate reductase. NO_2^- may inhibit nitrogenase directly, by irreversibly binding to the enzyme, or indirectly, by forming a bond with leghemoglobin, so that it can no longer function in O_2 transport
3. A decrease of the partial pressure of O_2 in the nodule, due to a decrease in the conductance for gas transport in the pathway between the outside air and the infected cells
4. **Feedback inhibition** of nodule metabolism by nitrogenous compounds that arrive via the phloem

There is evidence for a decrease in the conductance for O_2 transport to the infected cells which leads to a more severe limitation of nitrogenase activity by O_2 (Table 9). It is unlikely, however, that this is the only mechanism that accounts for NO_3^- inhibition of nodule activity. Rather, all four mechanisms probably occur at one stage or another in some species.

Several mutants of a number of legumes have been produced, of which neither infection nor N_2 fixation itself is inhibited by nitrate. These mutants

are expected to enhance input of N through the legume-rhizobium symbiosis in agricultural systems.

4. Endosymbionts

Many plants are infected by **fungal endophytes** (family Clavicipitaceae, Ascomycota) that live their entire life cycle within a plant (Bacon & De Battista 1991). The fungi form nonpathogenic and usually intercellular associations in living plant tissue. The endophytes are often transmitted through the plant seed, particularly in grasses and sedges, but seeds may lose their endophytes upon prolonged storage. Infection through germinating spores is an alternative way to enter the macrosymbiont. The association between higher plants and endosymbiotic fungi has been well studied in grasses in which the fungi may produce **alkaloids** in the tissue of their hosts, many of which have a neurotoxic effect, and hence make the infected plants poisonous to domestic mammals and increase their resistance to insect herbivores (Table 10).

In some species, plant growth and seed production can be increased by infection with the endophyte. The symbiotic associations between grasses

TABLE 10. Antiherbivore effects of fungal endophytes that infect grasses.

Animal	Host genus grass	Fungal endophyte genus	Comments
Mammals			
Cattle, horses	<i>Festuca</i>	<i>Acremonium</i>	Reduced mass gain, gangrene, spontaneous abortion
Cattle, sheep, deer	<i>Lolium</i>	<i>Acremonium</i>	Reduced mass gain, tremors, staggers, death
Cattle, goats	<i>Andropogon</i>	<i>Balansia</i>	Reduced milk production, death
Cattle	<i>Paspalum</i>	<i>Myriogenospora</i>	Reduced mass gain, tremors gangrene
Insects			
Fall armyworm	<i>Cenchrus</i>	<i>Balansia</i>	Avoidance, reduced survival, reduced growth, increased development time
	<i>Cyperus</i>	<i>Balansia</i>	
	<i>Festuca</i>	<i>Acremonium</i>	
	<i>Lolium</i>	<i>Acremonium</i>	
	<i>Paspalum</i>	<i>Myriogenospora</i>	
	<i>Stipa</i>	<i>Atkinsonella</i>	
Aphids	<i>Festuca</i>	<i>Acremonium</i>	Avoidance
Billbugs	<i>Lolium</i>	<i>Acremonium</i>	Reduced feeding and oviposition
Crickets	<i>Lolium</i>	<i>Acremonium</i>	Complete mortality
Cutworms	<i>Dactylis</i>	<i>Epichloe</i>	Reduced survival and mass gain
Flour beetles	<i>Lolium</i>	<i>Acremonium</i>	Reduced population growth
Sod webworms	<i>Lolium</i>	<i>Acremonium</i>	Reduced feeding and oviposition
Stem weevils	<i>Lolium</i>	<i>Acremonium</i>	Reduced feeding and oviposition

Source: Clay (1988).

Note: The examples are representative but not exhaustive.

and fungal endophytes may be an association in which the fungi derive carbohydrates from their host and defend their host against herbivory, thereby defending their own resources. Similar to the effect that mycorrhizal fungi have on interactions among mycorrhizal and nonmycorrhizal plants (Sect. 2.2), fungal endophytes may also influence competitive interactions between plants. For example, grass plants infected with fungal endosymbionts are less nutritious (Clay et al. 1993) and preferred less than the uninfected plants of the same species. The presence of endophytes may also affect competition among grasses in interaction with herbivory (Clay et al. 1993) and suppress the fungal take-all disease in *Triticum aestivum* (wheat) (Dewan & Sivasithamparam 1988).

The presence or absence of fungal endophytes is not a specific trait of a plant species; rather, it depends on environmental conditions in an as-yet-unclear manner. For example, in Western Australian heaths (Ericaceae), the number of fungal associates is considerably smaller on a mesic wetland site when compared with a dryland habitat, even when comparing the endophytes associated with the same plant species (*Lysinema ciliatum*). This appears to reflect the response of different fungal endophytes to water stress (Hutton et al. 1996).

Bacteria may also act as endosymbionts. Some plant-growth-promoting endosymbiotic bacteria have already been discussed in Sect. 3.7: *Gluconacetobacter diazotrophicus*, which fixes N₂ in the tissues of *Saccharum officinarum* (sugarcane). Common endophytic bacteria from healthy tubers of *Solanum tuberosum* (potato) belong to six genera (*Pseudomonas*, *Bacillus*, *Xanthomonas*, *Agrobacterium*, *Actinomyces*, and *Acinetobacter*). As discussed in Sect. 3 of Chapter 9C on effects of microbial pathogens, many bacterial endophytes make the host plant more resistant to pathogen attack (induced resistance) or they enhance growth. There are also endophytic bacteria, however, that are plant-growth-neutral or plant-growth-retarding (Sturz 1995).

5. Plant Life Among Microsymbionts

At one stage in the history of plant ecophysiology it may have seemed most appropriate to discuss the mineral nutrition and performance of plants devoid of their microsymbionts. If we wish to unravel basic principles of plant mineral nutrition (e.g., the nature of a NO₃⁻ transporter or the function of a micronutrient), then this remains a valid approach. If the aim is to understand plant functioning in a real

environment, whether a natural ecosystem or an agricultural field, however, then we cannot ignore the existence and overwhelming importance of the microsymbionts that interact with higher plants in an intricate manner. This is most certainly true for mycorrhizal fungi, which affect both mycorrhizal and nonmycorrhizal species, although in a very different manner.

Plant-microbe interactions do not always receive the attention they deserve. Interactions with N₂-fixing symbionts have been the target of plant physiological research for a long time. Why buy N if you can grow your own? In recent years there has been an enormous development in the understanding of signaling between rhizobia and legumes. Similar signaling processes probably exist between other N₂-fixing microsymbionts and their nonlegume hosts, and major progress has been made on signaling between mycorrhizal fungi and their macrosymbiotic partners.

Endophytes other than the “classic” mycorrhizal fungi and N₂-fixing microorganisms include the fascinating N₂-fixing microorganisms in the apoplast of *Saccharum officinarum* (sugarcane) and toxin-producing endophytes in grasses. We are only just beginning to understand the agronomic and ecological significance of these endophytes. Another question that remains to be answered is how symbiotic microorganisms are allowed entry into the plant when we know that plants have a wide array of defense mechanisms to keep microorganisms at bay.

In this chapter we have showcased one of many areas in plant physiological ecology where “established” terms like **ecology** and **molecular plant physiology** have become obsolete. We can only further our basic understanding of interactions between plants and their microsymbionts if we abolish barriers that hinder the developments in this field. Many applications of a basic understanding of symbiotic associations between plants and microorganisms are to be expected.

References

- Akiyama, K. & Hayashi, H. 2006. Strigolactones: chemical signals for fungal symbionts and parasitic weeds in plant roots. *Ann. Bot.* **97**: 925–931.
- Akiyama, K., Matsuzaki, K., & Hayashi, H. 2005. Plant sesquiterpenes induce hyphal branching in arbuscular mycorrhizal fungi. *Nature* **435**: 824–827.
- Akkermans, A.D.L. & Hirsch, A.M. 1997. A reconsideration of terminology in *Frankia* research: A need for congruence. *Physiol. Plant.* **99**: 574–578.

- Allen, E.B. & Allen, M.F. 1984. Competition between plants of different successional stages: mycorrhizae as regulators. *Can J. Bot.* **62**: 2625–2629.
- Allen, M.F., Allen, E.B., & Friese, C.G. 1989. Responses of the non-mycotrophic plant *Salsola kali* to invasion by vesicular-arbuscular mycorrhizal fungi. *New Phytol.* **111**: 45–49.
- Augé, R.M. 2001. Water relations, drought and vesicular-arbuscular mycorrhizal symbiosis. *Mycorrhiza* **11**: 3–42.
- Arredondo-Peter, R., Hargrove, M.S., Moran, J.F., Sarath, G., & Klucas, R.V. 1998. Plant hemoglobins. *Plant Physiol.* **118**: 1121–1125.
- Baas, R., & Lambers, H. 1988. Effects of vesicular-arbuscular mycorrhizal infection and phosphate on *Plantago major* ssp. *pleiosperma* in relation to the internal phosphate concentration. *Physiol. Plant.* **74**: 701–707.
- Baas, R., Van der Werf, A., & Lambers, H. 1989. Root respiration and growth in *Plantago major* as affected by vesicular-arbuscular mycorrhizal infection. *Plant Physiol.* **91**: 227–232.
- Bacon, C.W. & De Battista, J. 1991. Endophytic fungi of grasses. In: Handbook of applied mycology. Vol. 1: Soil and plants, D.K. Arora, B. Rai, K.G. Mukerji, & G.R. Knudsen (eds). Marcel Dekker, New York, pp 231–256.
- Bago, B., Pfeffer, P.E., & Shachar-Hill, Y. 2000. Carbon metabolism and transport in arbuscular mycorrhizas. *Plant Physiol.* **124**: 949–958.
- Barker, S.J., Tagu, D., & Delp, G. 1998. Regulation of root and fungal morphogenesis in mycorrhizal symbioses. *Plant Physiol.* **116**: 1201–1207.
- Batty, A.L., Dixon, K.W., Brundrett, M.C., & Sivasithamparam, K. 2004. Orchid conservation and mycorrhizal associations. In: Microorganisms in plant conservation and biodiversity, K. Sivasithamparam, K.W. Dixon, & R.L. Barrett (eds). (Kluwer Academic Publishers, Dordrecht, pp. 195–226.
- Bearden, B. & Petersen, L. 2000. Influence of arbuscular mycorrhizal fungi on soil structure and aggregate stability of a vertisol. *Plant Soil* **218**: 173–183.
- Bécard, G., Taylor, L.P., Douds, D.D., Pfeffer, P.E., & Donner, L. 1995. Flavonoids are not necessary plant signal compounds in arbuscular mycorrhizal symbiosis. *Mol. Plant-Microbe Interact.* **8**: 252–258.
- Bécard, G., Kosuta, S., Tamasloukht M., Sejalón-Delmas, N., & Roux, C. 2004. Partner communication in the arbuscular mycorrhizal interaction. *Can. J. Bot.* **82**: 1186–1197.
- Besserer, A., Puech-Pagès, V., Kiefer, P., Gomez-Roldán, V., Jauneau, A., Roy, S., Portais, J.-C., Roux, C., Bécard, G., & Séjalón-Delmas, N. 2006. Strigolactones stimulate arbuscular mycorrhizal fungi by activating mitochondria. *PLoS Biol.* **4**: 1239–1247.
- Bethlenfalvay, G.J., Pacovsky, R.S., Bayne, H.G., & Stafford, A.E. 1982. Interactions between nitrogen fixation, mycorrhizal colonization, and host-plant growth in the *Phaseolus-Rhizobium-Glomus* symbiosis. *Plant Physiol.* **70**: 446–450.
- Bidartondo, M.I., Burghardt, B., Gebauer, G., Bruns, T.D., Read, D.J. 2004. Changing partners in the dark: isotopic and molecular evidence of ectomycorrhizal liaisons between forest orchids and trees. *Proc. R. Soc. B: Biol. Sci.* **271**: 1799–1806.
- Black, K. & Osborne, B. 2004. An assessment of photosynthetic down-regulation in cyanobacteria in the *Gunnera-Nostoc* symbiosis. *New Phytol.* **162**: 125–132.
- Boddey, R.M., Urquiaga, S., Alves, B.J.R., & Reis, V. 2003. Endophytic nitrogen fixation in sugarcane: present knowledge and future applications. *Plant Soil* **252**: 139–149.
- Bolan, N.S., Robson, A.D., & Barrow, N.J. 1987. Effect of vesicular-arbuscular mycorrhiza on the availability of iron phosphates to plants. *Plant Soil* **99**: 401–410.
- Boller, B.C. & Nösberger, J. 1987. Symbiotically fixed nitrogen from field-grown white and red clover mixed with ryegrass at low levels of ¹⁵N-fertilization. *Plant Soil* **104**: 219–226.
- Boulet, F. & Lambers, H. 2005. Characterisation of arbuscular mycorrhizal fungi colonisation in cluster roots of shape *Hakea verrucosa* F. Muell (Proteaceae), and its effect on growth and nutrient acquisition in ultramafic soil. *Plant Soil* **269**: 357–367.
- Bouwmeester, H.J., Roux, C., Lopez-Raez, J.A., & Becard, G. 2007. Rhizosphere communication of plants, parasitic plants and AM fungi. *Trends Plant Sci.* **12**: 224–230.
- Brown, S.M., Oparka, K.J., Sprent, J.I., & Walsh, K.N.B. 1995. Symplasmic transport in soybean root nodules. *Soil Biol. Biochem.* **27**: 387–399.
- Brundrett, M.C. 2002. Coevolution of roots and mycorrhizas of land plants. *New Phytol.* **154**: 275–304.
- Buee, M., Rossignol, M., Jauneau, A., Ranjeva, R., & Bécard, G. 2000. The pre-symbiotic growth of arbuscular mycorrhizal fungi is induced by a branching factor partially purified from plant root exudates. *Mol. Plant-Microbe Interact.* **13**: 693–698.
- Cairney, J.W.G. 2000. Evolution of mycorrhiza systems. *Naturwissenschaften.* **87**: 467–475.
- Cairney, J.W.G. & Ashford, A.E. 2002 Biology of mycorrhizal associations of epacrids (Ericaceae). *New Phytol.* **154**: 305–326.
- Cairney, J.W.G. & Burke, R.M. 1998. Extracellular enzyme activities of the ericoid mycorrhizal endophyte *Hymenoscyphus ericae* (Read) Korf & Kernan: their likely roles in decomposition of dead plant tissue in soil. *Plant Soil* **205**: 181–192.
- Cameron, D.D., Leake, J.R., & Read, D.J. 2006. Mutualistic mycorrhiza in orchids: evidence from plant-fungus carbon and nitrogen transfers in the green-leaved terrestrial orchid *Goodyera repens*. *New Phytol.* **171**: 405–416.
- Catford, J.G., Staehelin, C., Larose, G., Piché, Y., & Vierheilig, H. 2006. Systemically suppressed isoflavonoids and their stimulating effects on nodulation and mycorrhization in alfalfa split-root systems. *Plant Soil* **285**: 257–266.
- Cavagnaro, T.R., Smith, F.A., Hay, G., Carne-Cavagnaro, V.L., & Smith, S.E. 2004. Inoculum type does not affect overall resistance of an arbuscular mycorrhiza-defective tomato mutant to colonisation but inoculation does change competitive interactions with wild-type tomato. *New Phytol.* **161**: 485–494.
- Chalot, M., Blaudez, D., & Brun, A. 2006. Ammonia: a candidate for nitrogen transfer at the mycorrhizal interface. *Trends Plant Sci.* **11**: 263–266.
- Christiansen-Weniger, C., Groneman, A.F., & Van Veen, J.A. 1992. Associative N₂ fixation and root exudation of

- organic acids from wheat cultivars of different aluminium tolerance. *Plant Soil* **139**: 167–174.
- Clay, K. 1988. Fungal endophytes of grasses: a defensive mutualism between plants and fungi. *Ecology* **69**: 10–16.
- Clay, K., Marks, S., & Cheplick, G.P. 1993. Effects of insect herbivory and fungal endophyte infection on competitive interactions among grasses. *Ecology* **74**: 1767–1777.
- Cohen, E., Okon, Y., Kigel, J., Nur, I., & Henis, Y. 1980. Increase in dry weight and total nitrogen content in *Zea mays* and *Setaria italica* associated with nitrogen-fixing *Azospirillum*. *Plant Physiol.* **66**: 746–749.
- Collier, S.C., Yarnes, C.T., & Herman, R.P. 2003. Mycorrhizal dependency of Chihuahuan Desert plants is influenced by life history strategy and root morphology. *J. Arid Environ.* **55**: 223–229.
- Coronado, C., Zuanazzi, J.A.S., Sallaud, C., Quirion, J.-C., Esnault, R., Husson, H.-P., Kondorosi, A., & Ratet, P. 1995. Alfalfa root flavonoid production is nitrogen regulated. *Plant Physiol.* **108**: 533–542.
- Day, D.A. & Copeland, L. 1991. Carbon metabolism and compartmentation in nitrogen-fixing legume nodules. *Plant Physiol. Biochem.* **29**: 185–201.
- Dewan, M.M. & Sivasithamparam, K. 1988. A plant-growth-promoting sterile fungus from wheat and rye-grass roots with potential for suppressing take-all. *New Phytol.* **91**: 687–692.
- Diaz, C.L., Melchers, L.S., Hooykaas, P.J.J., Lugtenberg, B.J.J., & Kijne, J.W. 1989. Root lectin as a determinant of host-plant specificity in the *Rhizobium*-legume symbiosis. *Nature* **338**: 579–581.
- Dobbelaere, S., Croonenbosch, A., Thys, A., Vande Broek, A., Vanderleyden, J. 1999. Phytostimulatory effect of *Azospirillum brasiliense* wild type and mutant strains altered in IAA production on wheat. *Plant Soil* **212**: 155–164.
- Dong, Z., Canny, M.J., McCully, M.E., Roboredo, M.R., Cabadilla, C.F., Ortega, E., & Rodes, R. 1994. A nitrogen-fixing endophyte of sugarcane stems. A new role for the apoplast. *Plant Physiol.* **105**: 1139–1147.
- Douds, D.D., Johnson, C.R., & Koch, K.E. 1988. Carbon cost of the fungal symbiont relative to net leaf P accumulation in a split-root VA mycorrhizal symbiosis. *Plant Physiol.* **86**: 491–496.
- Duc, G., Trouvelot, A., Gianinazzi-Pearson, V., & Gianinazzi, S. 1989. First report of non-mycorrhizal plant mutants (Myc⁻) obtained in pea (*Pisum sativum*) and fababean (*Vicia faba* L.). *Plant Sci.* **60**: 215–222.
- Eissenstat, D.M. 1990. A comparison of phosphorus and nitrogen transfer between plants of different phosphorus status. *Oecologia* **82**: 342–347.
- Eissenstat, D.M., Graham, J.H., Syvertsen, J.P., & Drouillard, D.L. 1993. Carbon economy of sour orange in relation to mycorrhizal colonization and phosphorus status. *Ann. Bot.* **71**: 1–10.
- Ezawa, T., Saito, M., & Yoshida, T. 1995. Comparison of phosphatase localization in the intraradical hyphae of arbuscular mycorrhizal fungi, *Glomus* spp. and *Gigaspora* spp. *Plant Soil* **176**: 57–63.
- Ezawa, T., Smith, S.E., & Smith, F.A. 2002. P metabolism and transport in AM fungi. *Plant Soil* **244**: 221–230.
- Ferrol, N., Pozo, M., Antelo, M., & Azcón-Aguilar, C. 2002. Arbuscular mycorrhizal symbiosis regulates plasma membrane H⁺-ATPase gene expression in tomato plants. *J. Exp. Bot.* **53**: 1683–1687.
- Fischer Walter, L.E., Hartnett, D.C., Hetrick, B.A.D., & Schwab, A.P. 1996. Interspecific nutrient transfer in a tallgrass prairie plant community. *Am. J. Bot.* **83**: 180–184.
- Francis, R. & Read, D.J. 1994. The contribution of mycorrhizal fungi to the determination of plant community structure. *Plant Soil* **159**: 11–25.
- Fredeen, A.L. & Terry, N. 1988. Influence of vesicular-arbuscular mycorrhizal infection and soil phosphorus level on growth and carbon metabolism of soybean. *Can. J. Bot.* **66**: 2311–2316.
- Gadkar, V., David-Schwartz, R., Kunik, T., and Kapulnik, Y. 2001. Arbuscular mycorrhizal fungal colonization. Factors involved in host recognition. *Plant Physiol.* **127**: 1493–1499.
- Gault, R.R., Peoples, M.B., Turner, G.L., Lilley, D.M., Brockwell, J., & Bergersen, F.J. 1995. Nitrogen fixation by irrigated lucerne during the first three years after establishment. *Aust. J. Agric. Res.* **56**: 1401–1425.
- Gebauer, G. & Meyer, M. 2003. ¹⁵N and ¹³C natural abundance of autotrophic and mycoheterotrophic orchids provides insight into nitrogen and carbon gain from fungal association. *New Phytol.* **160**: 2209–2223.
- Genre, A. & Bonfante, P. 2005. Building a mycorrhizal cell: How to reach compatibility between plants and arbuscular mycorrhizal fungi. *J. Plant Interact.* **1**: 3–13.
- Geurts, R. & Bisseling, T. 2002. *Rhizobium* Nod factor perception and signalling. *Plant Cell* **14**: 239–249.
- Giraud, E., Moulin, L., Vallenet, D., Barbe, V., Cytryn, E., Avarre, J.-C., Jaubert, M., Simon, D., Cartieaux, F., Prin, Y., Bena, G., Hannibal, L., Fardoux, J., Kojadinovic, M., Vuillet, L., Lajus, A., Cruveiller, S., Rouy, Z., Mangenot, S., Segurens, B., Dossat, C., Franck, W.L., Chang, W.-S., Saunders, E., Bruce, D., Richardson, P., Normand, P., Dreyfus, B., Pignol, D., Stacey, G., Emerich, D., Vermeglio, A., Medigue, C., & Sadowsky, M. 2007. Legumes symbioses: absence of Nod genes in photosynthetic bradyrhizobia. *Science* **316**: 1307–1312.
- Glassop, D., Smith, S.E., & Smith, F.W. 2005. Cereal phosphate transporters associated with the mycorrhizal pathway of phosphate uptake into roots. *Planta* **222**: 688–698.
- Govindarajulu, M., Pfeffer, P., Jin, H., Abubaker, J., Douds, D., Allen, J.W., Bucking, H., Lammers, P., & Shachar Hill, Y. 2005. Nitrogen transfer in the arbuscular mycorrhizal symbiosis. *Nature* **435**: 819–823.
- Grimoldi, A.A., Kavanová, M., Lattanzi, F.A., & Schnyder, H. 2005. Phosphorus nutrition-mediated effects of arbuscular mycorrhiza on leaf morphology and carbon allocation in perennial ryegrass. *New Phytol.* **168**: 435–444.
- Grimoldi, A.A., Kavanová, M., Lattanzi, F.A., Schaefe, R., & Schnyder, H. 2006. Arbuscular mycorrhizal colonization on carbon economy in perennial ryegrass:

- quantification by $^{13}\text{CO}_2/^{12}\text{CO}_2$ steady-state labelling and gas exchange. *New Phytol.* **172**: 544–553.
- Gualtieri, G. & Bisseling, T. 2000. The evolution of nodulation. *Plant Mol. Biol.* **42**: 181–194.
- Handley, L.L., Daft, M.J., Wilson, J., Scrimgeour, C.M., Ingelby, K., & Sattar, M.A. 1993. Effects of the ectoand VA-mycorrhizal fungi *Hydnagium carneum* and *Glomus clarum* on the $\delta^{15}\text{N}$ and $\delta^{13}\text{C}$ values of *Eucalyptus globulus* and *Ricinus communis*. *Plant Cell Environ.* **16**: 375–382.
- Harrison, M.J. 1999. Molecular and cellular aspects of the arbuscular mycorrhizal symbiosis. *Annu. Rev. Plant Physiol. Plant Mol. Biol.* **50**: 361–389.
- Harrison, M.J. 2005. Signaling in the arbuscular mycorrhizal symbiosis. *Annu. Rev. Microbiol.* **59**: 19–42.
- Harrison, M., & Dixon, R. 1994. Spatial patterns of expression of flavonoid/isoflavonoid pathway genes during interactions between roots of *Medicago truncatula* and the mycorrhizal fungus *Glomus versiforme*. *Plant J.* **6**: 9–20.
- Hartnett, D.C. & Wilson, G.W.T. 2002. The role of mycorrhizas in plant community structure and dynamics: lessons from grasslands. *Plant Soil* **244**: 319–331.
- Hause, B. & Fester, T. 2005. Molecular and cell biology of arbuscular mycorrhizal symbiosis. *Planta* **221**: 184–196.
- He, X., Critchley, C., Ng, H., & Bledsoe, C. 2004. Reciprocal N ($^{15}\text{NH}_4^+$ or $^{15}\text{NO}_3^-$) transfer between non- N_2 -fixing *Eucalyptus maculata* and N_2 -fixing *Casuarina cunninghamiana* linked by the ectomycorrhizal fungus *Pisolithus* sp. *New Phytol.* **163**: 692–640.
- He, X., Critchley, C., Ng, H., & Bledsoe, C. 2005. Nodulated N_2 -fixing *Casuarina cunninghamiana* is the sink for net N transfer from non- N_2 -fixing *Eucalyptus maculata* via an ectomycorrhizal fungus *Pisolithus* sp. using $^{15}\text{NH}_4^+$ or $^{15}\text{NO}_3^-$ supplied as ammonium nitrate. *New Phytol.* **167**: 897–912.
- Hobbie, E.A. 2006. Carbon allocation to ectomycorrhizal fungi correlates with belowground allocation in culture studies. *Ecology* **87**: 563–569.
- Högberg, P. 1990. ^{15}N natural abundance as a possible marker of the ectomycorrhizal habit of trees in mixed African woodlands. *New Phytol.* **115**: 483–486.
- Hungate, B.A., Stiling, P.D., Dijkstra, P., Johnson, D.W., Ketterer, M.E., Hymus, G.J., Hinkle, C.R., & Drake, B.G. 2004. CO_2 elicits long-term decline in nitrogen fixation. *Science* **304**: 1291.
- Hunt, S., & Layzell, D.B. 1993. Gas exchange of legume nodules and the regulation of nitrogenase activity. *Annu. Rev. Plant Physiol. Plant Mol. Biol.* **44**: 483–511.
- Hutton, B.J., Sivasithamparan, K., Dixon, K.W., & Pate, J.S. 1996. Pectic zymograms and water stress tolerance of endophytic fungi isolated from Western Australian heaths (Epacridaceae). *Ann. Bot.* **77**: 399–404.
- Jakobsen, I. & Rosendahl, L. 1990. Carbon flow into soil and external hyphae from roots of mycorrhizal cucumber plants. *New Phytol.* **115**: 77–83.
- James, E.K., Reis, V.M., Olivars, F.L., Baldani, J.I., & Döbereiner, J. 1994. Infection of sugar cane by the nitrogen-fixing bacterium *Acetobacter diazotrophicus*. *J. Exp. Bot.* **45**: 757–766.
- Javot, H., Pumplin, N., & Harrison, M.J. 2007. Phosphate in the arbuscular mycorrhizal symbiosis: transport properties and regulatory roles. *Plant Cell Environ.* **30**: 310–322.
- Jin, H., Pfeffer, P.E., Douds, D.D., Piotrowski, E., Lammers, P.J., Shachar-Hill, Y. 2005. The uptake, metabolism, transport and transfer of nitrogen in an arbuscular mycorrhizal symbiosis. *New Phytol.* **168**: 687–696.
- Johansen, A. & Jensen, E.S. 1996. Transfer of N and P from intact or decomposing roots of pea to barley interconnected by an arbuscular mycorrhizal fungus. *Soil Biol. Biochem.* **28**: 73–81.
- Johansen, A., Jakobsen, I., & Jensen, E.S. 1994. Hyphal N transport by a vesicular-arbuscular fungus associated with cucumber grown at three nitrogen levels. *Plant Soil* **160**: 1–9.
- Johnson, N.C., Graham, J.H., & Smith, F.A. 1997. Functioning of mycorrhizal associations along the mutualism-parasitism continuum. *New Phytol.* **135**: 575–585.
- Joner, E.J. & Jakobsen, I. 1995. Uptake of ^{32}P from labelled organic matter by mycorrhizal and non-mycorrhizal subterranean clover (*Trifolium subterraneum* L.). *Plant Soil* **172**: 221–227.
- Joner, E.J., Van Aarle, I.M., & Vosatka, M. 2000a. Phosphatase activity of extra-radical arbuscular mycorrhizal hyphae: a review. *Plant Soil* **226**: 199–210.
- Joner, E.J., Ravnskov, S., & Jakobsen, I. 200b. Arbuscular mycorrhizal phosphate transport under monoxenic conditions using radio-labelled inorganic and organic phosphate. *Biotechnol. Lett.* **22**: 1705–1708.
- Jongmans, A.G., Van Breemen, N., Lundström, U., Van Hees, P.A.W., Finlay, R.D., Srinivasan, M., Unestam, T., Giesler, R., Melkerud, P.-A., & Olsen, M. 1997. Rock-eating fungi. *Nature* **389**: 682–683.
- Kaiser, B.N., Layzell, D.B., & Shelp, B.J. 1997. Role of oxygen limitation and nitrate metabolism in the nitrate inhibition of nitrogen fixation by pea. *Physiol. Plant.* **101**: 45–50.
- Karandashov, V. & Bucher, M. 2005. Symbiotic phosphate transport in arbuscular mycorrhizas. *Trends Plant Sci.* **10**: 22–29.
- Kearns, A., Whelan, J., Young, S., Elthon, T.E., & Day, D.A. 1992. Tissue-specific expression of the alternative oxidase in soybean and siratro. *Plant Physiol.* **99**: 712–717.
- Khaosaad, T., Garcia-Garrido, J.M., Steinkellner, S., & Vierheilig, H. 2007. Take-all disease is systemically reduced in roots of mycorrhizal barley plants. *Soil Biol. Biochem.* **39**: 727–734.
- Klironomos, J.N. & Hart, M.M. 2001. Animal nitrogen swap for plant carbon. *Nature* **410**: 651–652.
- Klironomos, J.N., Bednarczuk E. M., & Neville J. 1999. Reproductive significance of feeding on saprobic and arbuscular mycorrhizal fungi by the collembolan, *Folsomia candida* *Funct. Ecol.* **13**: 756–761.
- Koch, K.E. & Johnson, C.R. 1984. Photosynthetic partitioning in split-root citrus seedlings with mycorrhizal and nonmycorrhizal root systems. *Plant Physiol.* **75**: 26–30.
- Koide, R.T. & Kabir, Z. 2000. Extraradical hyphae of the mycorrhizal fungus *Glomus intraradices* can hydrolyse organic phosphate. *New Phytol.* **2000** **148**: 511–517.
- Koide, R.T. & Schreiner, R.P. 1992. Regulation of the vesicular-arbuscular mycorrhizal symbiosis. *Annu. Rev. Plant Physiol. Plant Mol. Biol.* **43**: 557–581.

- Koide, R.T., Huenneke, L.F., Hamburg, S.P., & Mooney, H.A. 1988. Effects of applications of fungicide, phosphorus and nitrogen on the structure and productivity of an annual serpentine plant community. *Funct. Ecol.* **2**: 335–344.
- Kwon, D.-K. & Beevers, H. 1992. Growth of *Sesbania rostrata* (Brem) with stem nodules under controlled conditions. *Plant Cell Environ.* **15**: 939–945.
- Lambers, H., Atkin, O.K., & Millenaar, F.F. 2002. Respiratory patterns in roots in relation to their functioning. In: Plant roots: the hidden half, 3rd edition. Y. Waisel, A. Eshel, & U. Kafkaki (eds). Marcel Dekker, New York, pp. 521–552.
- Lambers, H., Shane, M.W., Cramer, M.D., Pearse, S.J., & Veneklaas, E.J. 2006. Root structure and functioning for efficient acquisition of phosphorus: matching morphological and physiological traits. *Ann. Bot.* **98**: 693–713.
- Lambers, H., Shaver, G., Raven, J.A., & Smith, S.E. 2008. N- and P-acquisition change as soils age. *Trends Ecol. Evol.* **23**: 95–103.
- Landeweert, R., Hoffland, E., Finlay, R.D., Kuypers, T.W., & Van Breemen, N. 2001. *Trends Ecol. Evol.* **16**: 248–253.
- Leake, J.R. 2004. Myco-heterotroph/epiparasitic plant interactions with ectomycorrhizal and arbuscular mycorrhizal fungi. *Curr. Opin. Plant Biol.* **7**: 422–428.
- Leake, J.R. & Read, D.J. 1989. The biology of mycorrhiza in the Ericaceae. *New Phytol.* **112**: 69–76.
- LePage, B.A., Currah, R.S., Stockey, R.A., & Rothwell, G.W. 1997. Fossil ectomycorrhizae from the middle Eocene. *Am. J. Bot.* **84**: 410–412.
- Li, H.-Y., Smith, S.E., Holloway, R.E., Zhu, Y.-G., & Smith, F.A. 2006. Arbuscular mycorrhizal (AM) fungi contribute to phosphorus uptake by wheat grown in a phosphorus-fixing soil even in the absence of positive growth responses. *New Phytol.* **172**: 536–543.
- Limpens, E. & Bisseling, T. 2003. Signaling in symbiosis. *Curr. Opin. Plant Sci.* **6**: 343–350.
- Lindblad, P., Atkins, C.A., & Pate, J.S. 1991. N₂-fixation by freshly isolated *Nostoc* from coralloid roots of the cycad *Macrozamia riedlei* (Fisch. ex Gaud.) Gardn. *Plant Physiol.* **95**: 753–759.
- Lodwig, E. & Poole, P. 2003. Metabolism of *Rhizobium* bacteroids. *Crit. Rev. Plant Sci.* **22**: 37–78.
- Martin, F., Duplessis, S., Ditengou, F., Lagrange, H., Voiblet, C., & Lapeyrie, F. 2001. Developmental cross talking in the ectomycorrhizal symbiosis: signals and communication genes. *New Phytol.* **152**: 145–154.
- Marschner, H. & Dell, B. 1994. Nutrient uptake in mycorrhizal symbiosis. *Plant Soil* **159**: 89–102.
- Marulanda, A., Azcon, R., & Ruiz-Lozano, J.M. 2003. Contribution of six arbuscular mycorrhizal fungal isolates to water uptake by *Lactuca sativa* plants under drought stress. *Physiol. Plant.* **119**: 526–533.
- Massicotte, H.B., Melville, L.H., Peterson, R.L., Unestam, T. 1999. Comparative studies of ectomycorrhiza formation in *Alnus glutinosa* and *Pinus resinosa* with *Paxillus involutus*. *Mycorrhiza* **8**: 229–240.
- Maxwell, C.A., Hartwig, U.A., Joseph, C.M., & Phillips, D.A. 1989. A chalcone and two related flavonoids released from alfalfa roots induce *nod* genes of *Rhizobium meliloti*. *Plant Physiol.* **91**: 842–847.
- McNeill, A.M. & Wood, M. 1990. Fixation and transfer of nitrogen by white clover to ryegrass. *Soil Use Manage.* **6**: 84–86.
- Mellor, R.B. & Collinge, D.B. 1995. A simple model based on known plant defence reactions is sufficient to explain most aspects of nodulation. *J. Exp. Bot.* **46**: 1–18.
- Mergaert, P., Uchiumi, T., Uchiumi, Alunni, B., Evanno, G., Cheron, A., Catrice, O., Mausset, A.-E., Barloy-Hubler, F., Galibert, F., Kondorosi, A., & Kondorosi, E. 2006. Eukaryotic control on bacterial cell cycle and differentiation in the rhizobium-legume symbiosis. *Proc. Natl. Acad. Sci. USA* **103**: 5230–5235.
- Mouritzen, P. & Rosendahl, L. 1997. Identification of a transport mechanism for NH₄⁺ in the symbiosome membrane of pea root nodules. *Plant Physiol.* **115**: 519–526.
- Muthukumar, T., Udaiyan, K., & Shanmughavel, P. 2004. Mycorrhiza in sedges—an overview. *Mycorrhiza* **14**: 65–77.
- Mylona, P., Pawlowski, K., & Bisseling, T. 1995. Symbiotic nitrogen fixation. *Plant Cell* **7**: 869–885.
- Nadelhoffer, K., Shaver, G., Fry, B., Giblin, A., Johnson, L., & McKane, R. 1996. ¹⁵N natural abundances and N use by tundra plants. *Oecologia* **107**: 386–394.
- Newman, E.I., Eason, W.R., Eissenstat, D.M., & Ramos, M.I.F.R. 1992. Interactions between plants: the role of mycorrhizae. *Mycorrhiza* **1**: 47–53.
- Nicholson, T. 1975. Evolution of vesicular-arbuscular mycorrhizas. In: Endomycorrhizas, F.E. Sanders, B. Mosse, & P.B. Tinker (eds). Academic Press, London, pp. 25–34.
- O'Connor, P.J., Smith, S.E., & Smith, F.A. 2002. Arbuscular mycorrhizas influence plant diversity and community structure in a semi-arid herbland. *New Phytol.* **154**: 209–218.
- Oldroyd, G.E.D., Harrison, M.J., & Udvardi, M. 2005. Peace talks and trade deals. Keys to long-term harmony in legume-microbe symbioses. *Plant Physiol.* **137**: 1205–1210.
- Palus, J.A., Borneman, J., Ludden, P.W., & Triplett, E.W. 1996. A diazotrophic bacterial endophyte isolated from stems of *Zea mays* L. and *Zea luxurians* Iltis and Doebley. *Plant Soil* **186**: 135–142.
- Paszkowski, U. 2006. Mutualism and parasitism: the yin and yang of plant symbioses. *Curr. Opin. Plant Biol.* **9**: 364–370.
- Pate, J.S., Lindblad, P., & Atkins, C.A. 1988. Pathway of assimilation and transfer of fixed nitrogen in coralloid roots of cycad-*Nostoc* symbioses. *Planta* **176**: 461–471.
- Paynel, F., Murray, P.J., & Cliquet, J.B. 2001. Root exudates: a pathway for short-term N transfer from clover and ryegrass. *Plant Soil* **229**: 235–243.
- Penas, J.I., Sanchez-Diaz, M., Aguirreola, J., & Becana, M. 1988. Increased stress tolerance of nodule activity in *Medicago-Rhizobium-Glomus* symbiosis under drought. *J. Plant Physiol.* **79**: 79–83.
- Peng, S., Eissenstat, D.M., Graham, J.H., Williams, K., & Hodge, N.C. 1993. Growth depression in mycorrhizal citrus at high-phosphorus supply. Analysis of carbon costs. *Plant Physiol.* **101**: 1063–1071.
- Peoples, M.B., Herridge, D.F., & Ladha, J.K. 1995. Biological nitrogen fixation: an efficient source of nitrogen for sustainable agricultural production? *Plant Soil* **174**: 3–28.

- Peoples, M.B., Palmer, B., Lilley, D.M., Duc, L.M., & Herdridge, D.F. 1996. Application of ^{15}N and xylem ureide methods for assessing N_2 fixation of three shrub legumes periodically pruned for forage. *Plant Soil* **182**: 125–137.
- Peterson, R.L. & Bonfante, P. 1994. Comparative structure of vesicular-arbuscular mycorrhizas and ectomycorrhizas. *Plant Soil* **159**: 79–88.
- Pfeffer, P.E., Douds, D.D. Jr, Bücking, H., Schwartz, D.P., & Shachar-Hill, Y. 2004. The fungus does not transfer carbon to or between roots in an arbuscular mycorrhizal symbiosis. *New Phytol.* **163**: 617–627.
- Phillips, D.A., Dakora, F.D., Sande, E., Joseph, C.M., & Zon, J. 1994. Synthesis, release, and transmission of alfalfa signal to rhizobial symbionts. *Plant Soil*. **161**: 69–80.
- Pingret, J.-L., Journet, E.-P., & Barker, D.G. 1998. *Rhizobium* Nod factor signaling: Evidence for a G protein-mediated transduction mechanism. *Plant Cell* **10**: 659–671.
- Radutoiu, S., Madsen, Madsen, E.B., Felle, H.H., Umehara, Y., Gronlund, M., Sato, S., Nakamura, Y., Tabata, S., Dandal, N., & Stougaard, J. 2003. Plant recognition of symbiotic bacteria requires two LysM receptor-like kinases. *Nature* **425**: 585–592.
- Rausch, C., Daram, P., Brunner, S., Jansa, J., Laloi, M., Leggewie, G., Amrhein, N., & Bucher, M. 2001. A phosphate transporter expressed in arbuscule-containing cells in potato. *Nature* **414**: 462–466.
- Read, D.J. 1996. The structure and function of the ericoid mycorrhizal root. *Ann. Bot.* **77**: 365–374.
- Read, D.J. & Perez-Moreno, J. 2003. Mycorrhizas and nutrient cycling in ecosystems – a journey towards relevance? *New Phytol.* **157**: 475–492.
- Reddell, P., Yun, Y., & Shipton, W.A. 1997. Cluster roots and mycorrhizae in *Casuarina cunninghamiana*: their occurrence and formation in relation to phosphorus supply. *Aust. J. Bot.* **45**: 41–51.
- Requena, N., Breuninger, M., Franken, P., & Ocon, A. 2003. Symbiotic status, phosphate, and sucrose regulate the expression of two plasma membrane H^+ -ATPase genes from the mycorrhizal fungus *Glomus mosseae*. *Plant Physiol.* **132**: 1540–1549.
- Rousseau, J.V.D. & Reid, C.P.P. 1991. Effects of phosphorus fertilization and mycorrhizal development on phosphorus nutrition and carbon balance of loblolly pine. *New Phytol.* **92**: 75–87.
- Ryle, G.J.A. Powell, C.E., & Gordon, A.J. 1985. Short-term changes in CO_2 -evolution associated with nitrogenase activity in white clover in response to defoliation and photosynthesis. *J. Exp. Bot.* **36**: 634–643.
- Sanchez-Diaz, M., Pardo, M., Antolin, M., Pena, J., & Aguirreola, J. 1990. Effect of water stress on photosynthetic activity in the *Medicago-Rhizobium-Glomus* symbiosis. *Plant. Sci.* **71**: 215–221.
- Sanders, I.R. & Koide, R.T. 1994. Nutrient acquisition and community structure in co-occurring mycotrophic and non-mycotrophic old-field annuals. *Funct. Ecol.* **8**: 77–84.
- Santana, M.A., Pihakaski-Maunschbach, K., Sandal, N., Marcker, K.A., & Smith, A.G. 1998. Evidence that the plant host synthesizes the heme moiety of leghemoglobin in root nodules. *Plant Physiol.* **116**: 1259–1269.
- Scervino, J.M., Ponce, M.A., Erra-Bassells, R., Vierheilig, H., Ocampo, J.A., & Godeas, A. 2005. Flavonoids exclusively present in mycorrhizal roots of white clover exhibit a different effect on arbuscular mycorrhizal fungi than flavonoids exclusively present in non-mycorrhizal roots of white clover. *J. Plant Interact.* **1**: 15–22.
- Schulze, E.-D., Chapin III, F.S., & Gebauer, G. 1995. Nitrogen nutrition and isotope differences among life forms at the northern treeline of Alaska. *Oecologia* **100**: 406–412.
- Selosse, M.-A., Richard, F., He, X., & Simard, S.W. 2006. Mycorrhizal networks: des liaisons dangereuses? *Trends Ecol Evol.* **21**: 621–628.
- Shirlcliffe, S.J. & Vessey J.K. 1996. A nodulation (Nod⁺/Fix⁻) mutant of *Phaseolus vulgaris* L. has nodules lacking peripheral vascular bundles (Pvb⁻) and is resistant to mycorrhizal infection (Myc⁻). *Plant Sci.* **118**: 209–220.
- Smith, S.E. & Gianinazzi-Pearson, V. 1988. Physiological interactions between symbionts in vesicular-arbuscular mycorrhizal plants. *Annu. Rev. Plant Physiol. Mol. Biol.* **39**: 221–244.
- Smith, S.E. & Read, D.J. 2008. Mycorrhizal symbiosis, 3rd edition. Elsevier, City.
- Smith, S.E., Smith, F.A., & Jakobsen, I. 2003. Mycorrhizal fungi can dominate phosphate supply to plants irrespective of growth responses. *Plant Physiol.* **133**: 16–20.
- Smith, S.E., Smith, F.A., & Jakobsen, I. 2004. Functional diversity in arbuscular mycorrhizal (AM) symbioses: the contribution of the mycorrhizal P uptake pathway is not correlated with mycorrhizal responses in growth or total P uptake. *New Phytol.* **162**: 511–524.
- Snellgrove, R.C., Splittstoesser, W.E., Stribley, D.P., & Tinker, P.B. 1982. The distribution of carbon and the demand of the fungal symbiont in leek plants with vesicular-arbuscular mycorrhizas. *New Phytol.* **92**: 75–87.
- Spaink, H.P. 1995. The molecular basis of infection and nodulation by rhizobia: the ins and outs of symbiogenesis. *Annu. Rev. Phytopathol.* **33**: 345–368.
- Sprent, J.I. 1999. Nitrogen fixation and growth of n-pn-crop legume species in diverse environments. *Persp. Plant Ecol. Evol. Syst.* **2**: 149–162.
- Sprent, J.I. 2007. Evolving ideas of legume evolution and diversity: a taxonomic perspective on the occurrence of nodulation. *New Phytol.* **174**: 11–25.
- Sprent, J.I. & James, E.K. 2007. Legume evolution: where do nodules and mycorrhizas fit in? *Plant Physiol.* **144**: 575–581.
- Sprent, J.I., Geoghegan, I.E., Whitty, P.W., & James, E.K. 1996. Natural abundance of ^{15}N and ^{13}C in nodulated legumes and other plants in the cerrado and neighbouring regions of Brazil. *Oecologia* **105**: 440–446.
- Sturz, A.V. 1995. The role of endophytic bacteria during seed piece decay and potato tuberization. *Plant Soil* **172**: 257–263.
- Tanaka, Y. & Yano, K. 2005. Nitrogen delivery to maize via mycorrhizal hyphae depends on the form of N supplied. *Plant, Cell Environ.* **28**: 1247–1254.
- Temperton, V.M., Mwangi, P.N., Scherer-Lorenzen, M., Schmid, B., & Buchmann, N. 2007. Positive interactions between nitrogen-fixing legumes and four different

- neighbouring species in a biodiversity experiment. *Oecologia* **151**: 190–205.
- Thingstrup, I., Rubaek, G., Sibbesen, E., & Jakobsen, I. 1998. Flax (*Linum usitatissimum* L.) depends on arbuscular mycorrhizal fungi for growth and P uptake at intermediate but not high soil P levels. *Plant Soil* **203**: 37–46.
- Thompson, B.D., Robson, A.D., & Abbott, L.K. 1986. Effects of phosphorus on the formation of mycorrhizas by *Gigaspora calospora* and *Glomus fasciculatum* in relation to root carbohydrates. *New Phytol.* **103**: 751–765.
- Tisdall, J.M. 1994. Possible role of soil microorganisms in aggregation in soils. *Plant Soil* **159**: 115–121.
- Tobar, R., Azcón, R., & Barea, J.-M. 1994. Improved nitrogen uptake and transport from ¹⁵N-labelled nitrate by external hyphae of arbuscular mycorrhiza under water-stressed conditions. *New Phytol.* **126**: 119–122.
- Triplett, E.W. 1996. Diazotrophic endophytes: progress and prospects for nitrogen fixation in monocots. *Plant Soil* **186**: 29–38.
- Van Brussel, A.A.N., Tak, T., Boot, K.J.M., & Kijne, J.W. 2002. Autoregulation of root nodule formation: signals of both symbiotic partners studied in a split-root system of *Vicia sativa* subsp. *nigra*. *Mol. Plant-Microbe Interact.* **15**: 341–349.
- Van Groenigen, K.-J., Six, J., Hungate, B.A., De Graaff, M.-A., Van Breemen, N., & Van Kessel, C. 2006. Element interactions limit soil carbon storage. *Proc. Natl. Acad. Sci. USA* **103**: 6571–6574.
- Vance, C.P. 2002. Root-bacteria interactions. Symbiotic nitrogen fixation. In: Plant roots: the hidden half, 3rd edition, Y. Waisel, A. Eshel, & U. Kafkaki (eds). Marcel Dekker, New York, pp. 839–868.
- Van der Heijden, M.G.A., Klironomos, J.N., Ursic, M., Moutoglou, P., Streitwolf-Engel, R., Boller, T., Wiemken, A., & Sanders, I.R. 1998a. Mycorrhizal fungal diversity determines plant diversity, ecosystem variability and productivity. *Nature* **396**: 69–72.
- Van der Heijden, M.G.A., Boller, T., Wiemken, A., & Sanders, I.R. 1998b. Different arbuscular mycorrhizal fungal species are potential determinants of plant community structure. *Ecology* **79**: 2082–2091.
- Van Ghelue, M., Løvaas, E., Ringø, E. & Solheim, B. 1997. Early interactions between *Alnus glutinosa* and *Frankia* strain ArI3. Production and specificity of root hair deformation factor(s). *Physiol. Plant.* **99**: 579–587.
- Van Hees, P.A.W., Rosling, A., Essén, S., Godbold D.L., Jones, D.L., & Finlay R.D. 2006. Oxalate and ferricrocin exudation by the extramatrical mycelium of an ectomycorrhizal fungus in symbiosis with *Pinus sylvestris*. *New Phytol.* **169**: 367–378.
- Van Leerdam, D. M., Williams, P. A., & Cairne, J. W. G. 2001. Phosphate-solubilising abilities of ericoid mycorrhizal endophytes of *Woolisia pungens* (Epacridaceae). *Aust. J. Bot.* **49**: 75–80.
- Van Rhijn, P & Vanderleyden, J. 1995. The *Rhizobium*-plant symbiosis. *Microbiol. Rev.* **59**: 124–142.
- Vessey, J.K. 1994. Measurement of nitrogenase activity in legume root nodules: in defence of the acetylene reduction assay. *Plant Soil* **158**: 151–162.
- Vessey, J.K., Pawlowski, K., & Bergman, B. 2005. N₂-fixing symbiosis: legumes, actinorhizal plants, and cycads. *Plant Soil* **274**: 51–78.
- Vierheilig, H., Iseli, B., Alt, M., Raikhel, N., Wiemken, A., & Boller, T. 1996. Resistance of *Urtica dioica* to mycorrhizal colonization: a possible involvement of *Urtica dioica* agglutinin. *Plant Soil* **183**: 131–136.
- Vierheilig, H. Garcia-Garrido, J.M., Wyss, U., & Piché, Y. 2000. Systemic suppression of mycorrhizal colonization of barley roots already colonized by AM fungi. *Soil Biol. Biochem.* **32**: 589–595.
- Wallander, H. 2000. Uptake of P from apatite by *Pinus sylvestris* seedlings colonised by different ectomycorrhizal fungi. *Plant Soil* **218**: 249–256.
- Wang, B. & Qiu, Y.-L. 2006. Phylogenetic distribution and evolution of mycorrhizas in land plants. *Mycorrhiza* **16**: 299–363.
- Webster, G., Gough, C., Vasse, J., Batchelor, C.A., O'Callaghan, K.J., Kothari, S.L., Davey, M.R., Dénarié, J., Cocking, E.C. 1997. Interactions of rhizobia with rice and wheat. *Plant Soil* **194**: 115–122.
- Wei, H. & Layzell, D.B. 2006. Adenylate-coupled ion movement. A mechanism for the control of nodule permeability to O₂ diffusion. *Plant Physiol.* **141**: 280–287.
- White, J., Prell, J., James, E.K., Poole, P. 2007. Nutrient sharing between symbionts. *Plant Physiol.* **144**: 604–614.
- Whitehead, L.F., Tyerman, S.D., Salom, C.L., & Day, D.A. 1995. Transport of fixed nitrogen across symbiotic membranes of legume nodules. *Symbiosis* **19**: 141–154.
- Wright, D.P., Scholes, J.D., & Read, D.J. 1998a. Effects of VA mycorrhizal colonization on photosynthesis and biomass production of *Trifolium repens* L. *Plant Cell Environ.* **21**: 209–216.
- Wright, D.P., Read, D.J., & Scholes, J.D. 1998b. Mycorrhizal sink strength influences whole plant carbon balance of *Trifolium repens* L. *Plant Cell Environ.* **21**: 881–891.
- Wright, D.P., Scholes, J.D., Read, D.J., Rolfe, S.A. 2005. European and African maize cultivars differ in their physiological and molecular responses to mycorrhizal infection. *New Phytol.* **167**: 881–896.
- Yao, Q., Li, X., Feng, G., & Christie, P. 2001. Mobilization of sparingly soluble inorganic phosphates by the external mycelium of an arbuscular mycorrhizal fungus. *Plant Soil* **230**: 279–285.
- Yoneyama, K., Yoneyama, K., Takeuchi, Y., & Sekimoto, H. 2007a. Phosphorus deficiency in red clover promotes exudation of orobanchol, the signal for mycorrhizal symbionts and germination stimulant for root parasites. *Planta* **225**: 1031–1038.
- Yoneyama, K., Sekimoto, H., Takeuchi, Y., & Yoneyama, K. 2007b. Regulation of strigolactone exudation by plant nutrients. Abstract 19th Annual Meeting International Plant Growth Substances Association, Puerto Rico, Mexico.
- Zabinsky, C.A., Quinn, L., & Callaway, R.M. 2002. Phosphorus uptake, not carbon transfer, explains arbuscular mycorrhizal enhancement of *Centaurea maculosa* in the presence of native grassland species. *Funct. Ecol.* **16**: 758–765.

9B. Ecological Biochemistry: Allelopathy and Defense Against Herbivores

1. Introduction

Plants contain a vast array of compounds referred to as **secondary metabolites** that play no role in primary catabolic or biosynthetic pathways. Many of these metabolites influence important ecological interactions (e.g., deterring herbivores, protection against pathogens, allelopathy, symbiotic associations, seed germination of parasites, or interactions with pollinators). Others provide protection against ultraviolet radiation or high temperatures. Some of these roles have already been discussed. This chapter discusses the role of secondary compounds in allelopathic and plant–herbivore interactions. Plant–pathogen interactions are discussed in Chapter 9C.

2. Allelopathy (Interference Competition)

Some plants harm the growth or development of surrounding plants by the release of chemical compounds: **allelopathic compounds** or **allelochemicals**. These **allelopathic** effects are invariably negative, and the compounds may come from living roots or leaves or from decomposing plant remains (Fig. 1). Other released compounds may have positive effects, such as the carboxylates that solubilize

phosphate in the rhizosphere or chelate Al metals and avoid Al toxicity (Sects. 2.2.5 and 3.1.2 of Chapter 6 on mineral nutrition). These positive effects are *not* referred to as **interference competition** or **allelopathy** [the word allelopathy is derived from two Greek words: *allelon* (of each other) and *pathos* (to suffer)]. The chemicals involved in positive interactions, however, may still be referred to as allelochemicals.

Many allegedly allelopathic interactions can be explained in other ways. For example, the absence of seedlings near aromatic shrubs that produce volatile growth inhibitors suggested that allelopathy might be involved (Muller et al. 1964), but closer investigation showed that seed-eating animals prefer to graze in the shelter of the shrub, where they are in less danger from predatory birds (Bartholomew 1970). There is general agreement in the literature, however, that allelopathic interactions do exist and can be ecologically important. Both water-soluble compounds (mainly of a phenolic nature) and volatiles (mainly terpenoids) can have an allelopathic effect (Birkett et al. 2001, Bais et al. 2006).

Activated carbon, which adsorbs allelochemicals, has been used to assess the significance of allelopathic interactions in natural ecosystems, for example to study the allelopathic potential of an **invasive weed**, *Centaurea maculosa* (spotted knapweed) in western North America. Root elongation and biomass production of *Festuca idahoensis* (Idaho fescue) plants that were grown together with this

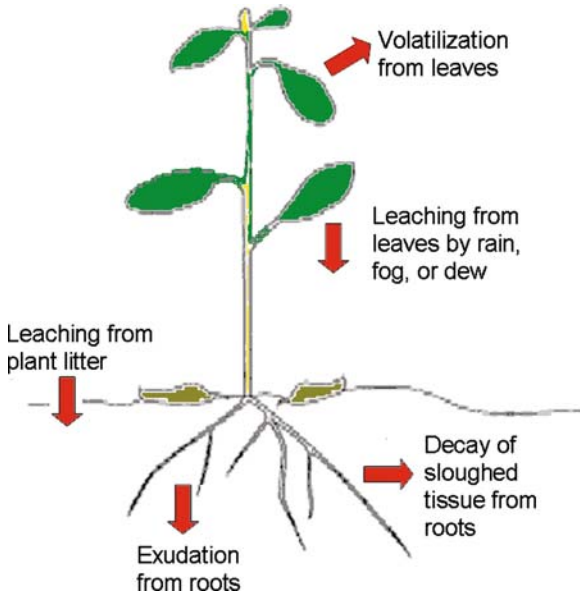

FIGURE 1. Routes of entry of allelochemicals from plants into the rhizosphere.

invasive weed was enhanced in the presence of activated carbon in the root environment (Fig. 2). Using activated carbon, it can be shown that allelopathy accounts for a substantial proportion of the total interference of *Centaurea maculosa* on *Festuca idahoensis*, shifting the balance of competition in favor of the invasive weed. However, *Centaurea maculosa* outperforms *Festuca idahoensis* even in the absence of activated carbon, which shows the combined roles of **resource competition** and allelopathy. Some species, e.g., *Lupinus sericeus* (silky lupine)

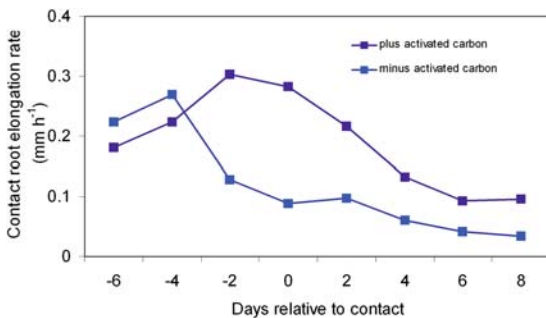

FIGURE 2. Elongation rates of *Festuca idahoensis* (Idaho fescue) roots that made physical contact with *Centaurea maculosa* (spotted knapweed) roots in root observation chambers, with or without activated carbon, from 6 days before until 8 days after contact. Elongation rates of all roots were converted to mm h⁻¹ and standardized in time by aligning their days of contact at “day 0” (Ridennour & Callaway 2001).

and *Gaillardia grandiflora* (blanketflower) are resistant to the allelochemical [(+)-catechin] released by *Centaurea maculosa*, because they release increased amounts of **oxalate** upon exposure to catechin. Oxalate blocks generation of **reactive oxygen species** and reduces oxidative damage generated in response to catechin (Weir et al. 2006).

Genotypes of one species, e.g., *Triticum aestivum* (wheat) differ substantially in the rate at which they release allelochemical phenolics (Wu et al. 2000a). This characteristic has potential in integrated weed management, because the wheat genotypes that release most phenolics tend to have the greatest capacity to suppress the weedy grass *Lolium rigidum* (annual ryegrass) (Wu et al. 2000b). Benzoxazinoids (cyclic hydroxamic acids) are common allelochemicals in root exudates from *Triticum aestivum* (wheat), *Zea mays* (corn), and *Secale cereale* (rye) (Understrup et al. 2005). In soil, the exudates may be converted into other benzoxazinoids, many with a similar phytotoxic effect (Macías et al. 2005).

Allelopathic compounds may have originally evolved as compounds that deter pathogens or herbivores and subsequently become involved in interactions between higher plants. Secretory glands were well developed in the early gymnosperms and angiosperms of the Paleozoic before there were terrestrial herbivores, but after the evolution of terrestrial fungi which suggests that early defense systems may have been directed at pathogens (Chapter 9C on microbial pathogens; Bais et al. 2004).

The mode of action of most allelopathic compounds is unknown. Many phenolic compounds inhibit seed germination of grasses and herbs, and they may inhibit ion uptake or respiration. Volatile terpenoids can inhibit cell division. Potentially allelopathic compounds can be **detoxified** by some species through mechanisms discussed in Sect. 5.

The allelopathic effects of *Juglans nigra* (black walnut) illustrate the multiplicity of ecological effects. In a zone up to 27 m from the tree trunk, many plants [e.g., *Solanum lycopersicum* (tomato), *Medicago sativa* (alfalfa)] die. The toxic effects are due to the leaching from the leaves, stems, branches, and roots of a bound phenolic compound, which undergoes hydrolysis and oxidation in the soil. The bound compound, which is nontoxic itself, is the 4-glucoside of 1,4,5-trihydroxy-naphthalene. It is converted to the toxic compound juglone (5-hydroxynaphthoquinone). Some species are resistant to juglone [e.g., *Poa pratensis* (Kentucky bluegrass)], probably because they detoxify this allelochemical (Sect. 5). Juglone severely inhibits the relative growth rate, photosynthesis, stomatal conductance, and respiration of *Zea mays* (corn) and *Glycine max* (soybean), when applied at a concentration of 10 μM or more. This concentration can be found in soil under black walnut when it is used in alley cropping (Jose & Gillespie 1998a,b).

Sorghum species have a reputation for suppressing weed growth, due to the exudation of allelochemicals. One of these is a dihydroxyquinone (sorgoleone), which inhibits mitochondrial respiration (Rasmussen et al. 1992) and electron transport in photosystem II (Nimbal et al. 1996), presumably due to the structural similarity between sorgoleone and both ubiquinone and plastoquinone (Sect. 2.1 of Chapter 9D on parasitic associations). Similarly, very few weeds occur under trees of *Leucaena leucocephala* (white leadtree) plantations in Taiwan. This has been ascribed to the presence of high concentrations of mimosine (a toxic nonprotein amino acid) as well as a range of phenolic compounds, which originate from the tree leaves and inhibit germination and growth of many forest species (Table 1).

Allelopathic interactions also appear to play a major role in desert plants [e.g., between *Encelia farinosa* (brittlebush) and its surrounding plants in the Mojave desert in California, USA]. In many of these plants, a simple benzene derivative is produced, primarily in the leaves (Fig. 3). It is released when the leaves fall to the ground and decompose.

An example of growth inhibition by a toxin produced in roots, rather than leaves, is that of the rubber plant guayule (*Parthenium argentatum*). The aromatic compound (Fig. 3), remarkably, causes inhibition of plants of the same species (**autotoxicity**). Similar examples of autotoxicity have been found for cultivars of *Triticum aestivum* (wheat) in bioassays under laboratory conditions; this suggests that cultivars may have to be selected carefully if wheat is to be used in a continuous cropping system (Wu et al. 2007). In several cucurbit crops [e.g., *Citrullus lanatus* (watermelon), *Cucumis melo* (melon), and *Cucumis sativus* (cucumber)], autotoxicity contributes to "soil sickness"; that is, a reduction in yield when crops are grown on the same plot without rotation (Yu et al. 2000). Cinnamic acid is one of the autotoxic compounds in cucumber; it induces formation of **reactive oxygen species** (ROS) (Ding et al. 2007).

Allelopathic and autotoxic effects probably play a role in many environments; however, it is hard to estimate their ecological significance. Some of the released compounds are probably decomposed rather rapidly by microorganisms, thus diminishing their potential effects. Other allelopathic compounds decompose rather slowly, including a group of phenolic compounds mostly referred to as tannins (Sect. 3.1). The consequences of this slow decomposition for nutrient cycling are discussed in Chapter 10A on decomposition.

Allelochemicals may also affect soil microorganisms and thus indirectly affect surrounding plants. For example, monoterpenes from *Picea abies* (Norway spruce) inhibit **nitrification**, either directly or indirectly due to immobilization of mineral nitrogen (Sect. 2.1.1 in Chapter 6 on mineral nutrition) (Paavolainen et al. 1998). Allelochemicals released

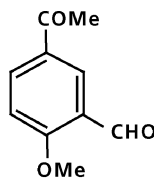

3-acetyl-6-methoxybenzaldehyde
Encelia farinosa

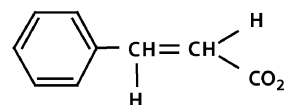

trans-cinnamic acid
Parthenium argentatum

FIGURE 3. Two examples of toxins produced in desert shrubs (Harborne 1988).

TABLE 1. The effects of *Leucaena leucocephala* (white leadtree) leaves mixed with 150 g of soil or mulched and spread on the soil surface on survival of seedlings of a number of plant species.*

Species	Survival (% of the control)		
	Leaves mixed with soil	2 g	Leaf mulch added
	1 g	2 g	5 g
<i>Leucaena leucocephala</i>	100	100	87
<i>Alnus formosana</i>	72	44	37
<i>Acacia confuse</i>	30	19	14
<i>Liquidamber formosana</i>	5	9	31
<i>Casuarina glauca</i>	0	0	0
<i>Mimosa pudica</i>	0	0	0

Source: Chou & Kuo (1986).

* The data are expressed as percent survival relative to that in the soil alone.

from grass roots may also inhibit **nitrification** (Lata et al. 2004, Subbarao et al. 2006, 2007a). Since NO_3^- is far more prone to losses by denitrification and leaching, the biological nitrification inhibitors may enhance the efficiency of N use at the ecosystem level, both in natural and in managed systems. This is why their potential is currently being explored in wild relatives of *Triticum aestivum* (wheat) (Subbarao et al. 2007b).

Exudates released by some plants, e.g., *Eragrostis curvula* (weeping lovegrass) are antagonistic against plant-parasitic nematodes (Chitwood 2002). These **nematicidal** compounds include polythienyls, isothyanatyes, glucosinolates, and a range of other compounds (Sect. 3). Grass species such as *Eragrostis curvula* can be used in rotations to manage nematode problems in cropping systems (Katsvairo et al. 2006).

3. Chemical Defense Mechanisms

Many secondary plant compounds play a role in deterring herbivores; however, some herbivores have found ways “to get around the problem” or even prefer the plants that contain specific secondary compounds: **food selection**. Both topics will be discussed in this section.

3.1 Defense Against Herbivores

Chemical defense is quite obvious in poison ivy (*Toxicodendron radicans*) as well as in the stinging

nettle (*Urtica dioica*) and closely related members of the Urticaceae. Touching the nettle breaks off the tip of the hairs on leaves or stem. The walls of these hairs are thin, and contain silica, which gives the cut hair a sharp end to penetrate the skin. The contents of the hair are then released, giving local pain and swelling of the skin. This is a clear example of a **direct defense**. The exact nature of the content of the stinging hairs of *Urtica dioica* is unknown; the older literature suggests biogenic amines, including serotonin, whereas a tropical member of the Urticaceae, *Laporta moroides*, accumulates peptides, including a tricyclic octapeptide (moroidin) (Leung et al. 1986). The number of stinging hairs varies widely in *Urtica dioica*; some plants have none at all. Grazing by large herbivores is negatively correlated with the number of hairs (Pollard & Briggs 1984).

Some secondary compounds inhibit specific steps in mitochondrial respiration. For example, HCN, which blocks cytochrome oxidase, is released from **cyanogenic** compounds that are present in a wide range of species. **Fluoroacetate** (1080), after conversion to fluorocitrate, blocks aconitase, which is an enzyme in the TCA cycle. **Rotenone**, which is an isoflavonoid in roots of *Derris*, *Lonchocarpus*, and *Tephrosia* species (Fabaceae) (Yenesew et al. 2005), blocks the mitochondrial internal NADH dehydrogenase, and **platanetin**, which is a flavonoid from the bud scales of *Platanus acerifolia* (plane tree) (Ravanel et al. 1986), inhibits the mitochondrial external NADH dehydrogenase (Sect. 2.3.1 of Chapter 2B on plant respiration; Roberts et al. 1996). Seeds of a wide range of *Phaseolus* (bean) and *Cicer arietinum* (chickpea) species contain specific inhibitors of α -amylase, which is a digestive enzyme that hydrolyzes starch (Pueyo & Delgado-Salinas 1997), or of proteinases (Giri et al. 1998). Other secondary plant compounds are much less specific; for example, **tannins** precipitate proteins and thus interfere with food digestion. Toxic phenolic glycosides in *Salix* (willow) species deter herbivores. Others [e.g., glucosinolates in Brassicaceae (cabbage family)] probably evolved as secondary metabolites in plants because they are toxic to most herbivores. The stored glucosinolate **sinigrin** is converted enzymatically to highly toxic allyl isothiocyanate, which gives mustard its distinct sharpness (Fig. 4). In some herbivores mechanisms have evolved, however, that defy this chemical defense and use glucosinolates as **attractants**. In *Brassica oleracea* (cabbage) and other Brassicaceae, sinigrin attracts butterflies of *Pieris brassicae* (cabbage moth) as well as certain aphids (e.g., *Brevicoryne brassicae*) and cabbage-root flies (*Delia radicum*). Cabbage moths normally deposit their eggs only on plants

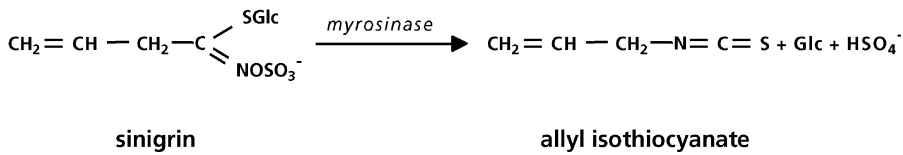

FIGURE 4. The chemical structure of sinigrin, which is a glucosinolate in *Brassica* (cabbage) species, and allyl isothiocyanate, into which it can be converted. The reaction is catalyzed by endogenous β -thioglucosidases

(myrosinases) that are localized in “myrosin” cells, scattered throughout most plant tissues. Within these cells the enzyme is stored inside myrosin grains (Rask et al. 2000).

that contain sinigrin, but accept filter paper that contains this compound as a substitute. Their larvae exclusively eat food that contains sinigrin, either naturally or experimentally added (Van Loon et al. 1992).

Cyanogenic glucosides are widespread in the plant kingdom, whereas **glucosinolates** are evolutionarily younger and found in Brassicaceae and one outgroup, the genus *Drypetes* of the Euphorbiaceae (Halkier & Gershenzon 2006). Because both groups of natural products are derived from **amino acids** and have aldoximes as intermediates, it has been hypothesized that glucosinolates developed based on a predisposition for making cyanogenic glucosides. Consistent with an evolutionary relationship between the cyanogenic glucoside and glucosinolate pathways, the aldoxime-metabolizing enzymes in both pathways belong to the same gene family. A mutation in the aldoxime-metabolizing enzyme in the cyanogenic pathway may have resulted in the production of toxic compounds, which the plant subsequently had to get rid of, instead of the original hydroxynitrile in the pathway toward cyanogenic glucosides (Halkier & Gershenzon 2006).

Many plants contain defensive phenolics [e.g., tannins in leaves of *Quercus* (oak)]. In the bark of *Picea abies* (Norway spruce) clones that are resistant to *Ceratocystis polonica* (a fungal pathogen that is transmitted through bark beetles) specialized phloem-parenchyma cells contain deposits of

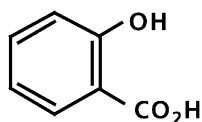

salicylic acid

FIGURE 5. The chemical structure of salicylic acid, which is produced after ingestion from some of the phenolic glycosides that regularly occur in *Populus* and *Salix* species. Salicylic acid is closely related to acetylsalicylic acid, which is the active ingredient of aspirin.

polyphenols. These parenchyma cells are enriched in phenylalanine ammonia lyase, which is a key enzyme in the synthesis of phenolics. Susceptible clones have much less of these **polyphenol-containing parenchyma cells**. The phenolics in the resistant clone are mobilized upon fungal attack which indicates that the specialized parenchyma cells are an important site of both **constitutive** and **inducible** defense (Franceschi et al. 1998).

Both *Populus* (poplar) and *Salix* (willow) plants contain a wide range of toxic phenolic glycosides, including salicin (Clausen et al. 1989). After ingestion, salicin is hydrolyzed and oxidized, producing **salicylic acid** (Fig. 5), which **uncouples oxidative phosphorylation** in mitochondrial preparations. In addition, salicylic acid is associated with stress signaling and systemic acquired resistance (Heil & Baldwin 2002). The structure of phenolic glycosides resembles that of many allelopathic compounds which suggests that the driving force in evolution for the formation of allelopathic compounds may well have been their role in deterring herbivores or pathogens (Bais et al. 2004, 2006). Both the total phenolic glycoside concentration in the leaves and the composition of these compounds vary among *Salix* species (Table 2).

The role of phenolic glycosides in the **food-selection** pattern of beetles feeding on willow leaves has been investigated extensively. Leaves of the eight willow species shown in Table 2 were used for laboratory feeding experiments with four beetle species. In all cases, the leaves of the *Salix* species that is chemically most related to the preferred species are fed on to the highest degree (Fig. 6). Both the total amount and the quality of the phenolic glycosides determine the food-selection pattern of the investigated beetles.

Mammals have been important selective influences for the patterns of defense in woody plants, which are vulnerable to mammalian herbivory throughout the winter. Mammalian herbivory is a major cause of mortality in woody plants, in part because mammals remain active and often have

TABLE 2. Phenolic glycoside concentration [mg g^{-1} (dry mass)] in the leaves of eight *Salix* (willow) species that are native to Finland or have been introduced to this area.*

	Salicortin	Salicilin	Fragilin	Triandrin	Salidroside	Picein	Total
Native willows							
<i>S. nigricans</i>	48	3	0.2				51
<i>S. phylicifolia</i>	0.5	0.1	0.1	0.3	0.1		1.8
<i>S. caprea</i>	0.3	0.2	0.1	0.1			1.2
<i>S. pendandra</i>		0.7	0.7				7.6
Introduced willows							
<i>S. cv. aquatica</i>	6.4	1.3	0.1				7.8
<i>S. dasycylados</i>	9.9	2.0	0.2				12.1
<i>S. viminalis</i>	0.1		0.1	0.1		0.2	1.5
<i>S. triandra</i>		0.3			7.4		7.8

Source: Tahvanainen (1985).

* Apart from these identified compounds, some others were present, so that the total amount differs from the sum of the identified ones.

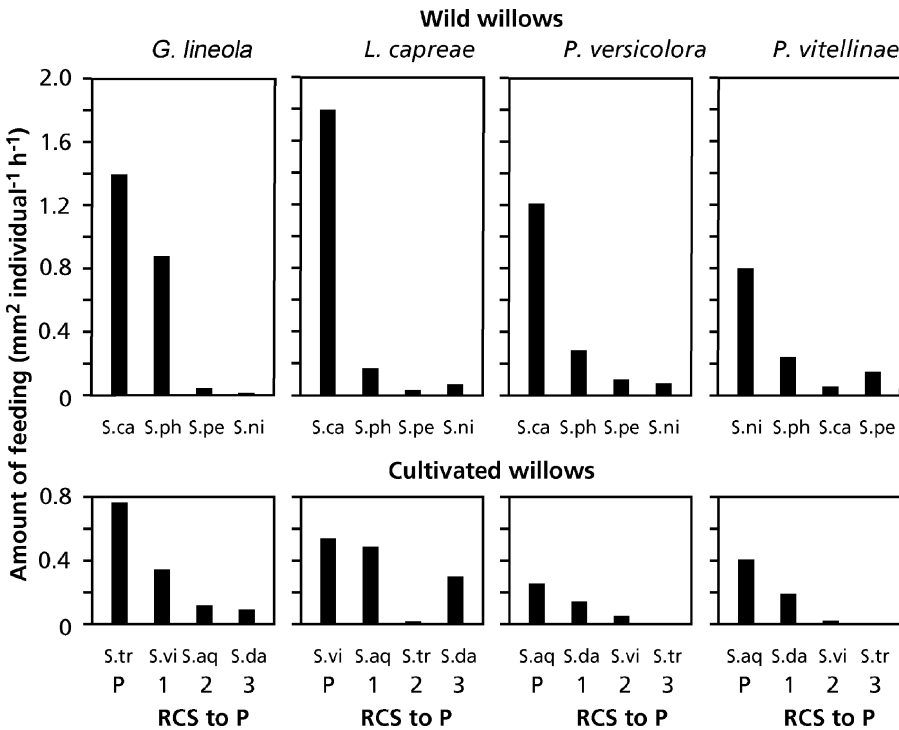

FIGURE 6. Food-selection pattern by four beetle species (*Galerucella lineola*, *Lochmaea capreae*, *Plagiodera versicolora*, and *Pratora vitellinae*) when leaves of four native and four introduced *Salix* (willow) species are offered in two separate food choice experiments. The

preferred species is placed at the left; the others are ranked according to their chemical similarity to the preferred species. The species are the same as those presented in Table 2 (Tahvanainen et al. 1985).

highest energy demand in winter, when plants cannot grow to compensate for tissues lost to herbivores. Woody plant defenses are better developed in regions with a long history of vertebrate browsing than in regions that were glaciated during the Pleistocene (Bryant et al. 1989). There is strong developmental control over defenses in woody plants, with these being most strongly expressed in juvenile woody plants that grow in a height range where they are vulnerable to mammalian herbivores. After browsing, juvenile shoots are produced that have higher levels of secondary metabolites that deter further browsing. These defenses include ether-soluble terpenes [e.g., papyriferic acid in *Betula resinifera* (paper birch) and pinosylvin in *Alnus viridis* subsp. *fruticosa* (green alder)] that deter feeding below levels required for weight maintenance, and, if consumed, result in a negative N and Na⁺ balance (Bryant et al. 1992).

There is some evidence that plants that hyperaccumulate **heavy metals** [e.g., Ni-accumulating Brassicaceae (cabbage family); Sect. 3.3 of Chapter 6 on mineral nutrition] are better protected against herbivores (Jhee et al. 2005).

3.2 Qualitative and Quantitative Defense Compounds

Secondary metabolites involved in deterring herbivores can be divided into two categories:

1. **Qualitatively** important secondary plant compounds. These are **toxins**, which are usually present in low concentrations, but may constitute up to 10% of the fresh weight of some leaves or seeds. Numerous compounds belong to this category, including **alkaloids** (Fig. 7), **cyanogenic glycosides**, **nonprotein amino acids**, **cardiac glycosides**, **glucosinolates** (Fig. 4), and proteins. Their mode of action varies widely.
2. **Quantitatively** important secondary plant compounds. These reduce the **digestibility** and/or **palatability** of the food source and invariably make up a major fraction of the biomass. They

are mostly phenolic compounds (phenolic acids, tannins, lignin; Fig. 8) or terpenoid resins (Dell & McComb 1974). Tannins and some other phenolics reduce the digestibility of plant tissues by blocking the action of digestive enzymes, binding to proteins being digested, or interfering with protein activity in the gut wall. Tannins, as well as lignin, also increase the leaf's toughness.

If one considers that relatively few resources are required to acquire protection against herbivores by toxic compounds, one may wonder why the alternative strategy of the digestibility-reducing compounds, which requires far greater investment of carbon resources, has evolved at all. The answer to this question is that there are numerous examples of herbivores in which mechanisms have evolved to cope with the toxic compounds that are effective against most herbivores. These herbivores may metabolize the toxin to an extent that it is used as a food source, they may store the toxin, sometimes after slight modification, and thus gain protection themselves, or they rapidly excrete the toxic compound. Such combinations of toxic plants and animals that cope with the toxin provide examples of **co-evolution** of plants and animals in an ever-continuing "arms race" (Ehrlich & Raven 1964).

Although the distinction between qualitative and quantitative defenses is a useful starting point, it is not a clear-cut dichotomy. Many phenolic compounds also have toxic effects on herbivores and may be more toxic against some herbivores than others (Ayres et al. 1997), and some cyanogenic glycosides or alkaloids accumulate to rather high levels in some species [e.g., prunasin in *Eucalyptus cladocalyx* (sugar gum) (Gleadow et al. 1998) and nicotine in *Nicotiana attenuata* (wild tobacco) (Baldwin 1999)].

3.3 The Arms Race of Plants and Herbivores

The expression "arms race" graphically describes the continuous evolution of ever more toxic

FIGURE 7. Alkaloid subclasses. (A) Isoquinoline alkaloids. These are synthesized (e.g., carnegine and gigantine in a species-specific manner in saguaro (*Carnegie gigantean*) and cardon (*Pachycereus pringlei*) cacti). Sentia cactus (*Lophocereus schottii*) contains as much as 30–150 mg g⁻¹ (DM) lophocerine and its trimers, pilocereine and piloceredine. (B) Bisbenzylisoquinoline alkaloids. Examples include berbaminine from barberry (*Berberis stolonifera*) and tubocurarine, an arrow poison, from

Chondrodendron tomentosum. (C) Monoterpene indole alkaloids, including quinine (from *Cinchona officinalis*) and strychnine (from *Strychnos nux-vomica*). (D) Nicotine and tropane alkaloids. These are naturally occurring insecticides and feeding deterrents in Solanaceae [e.g., nicotine in *Nicotiana tabacum* (tobacco), scopolamine in *Hyoscyamus niger* (henbane), and atropine in *Atropa belladonna* (deadly nightshade)] (Harborne 1988, Schuler 1996).

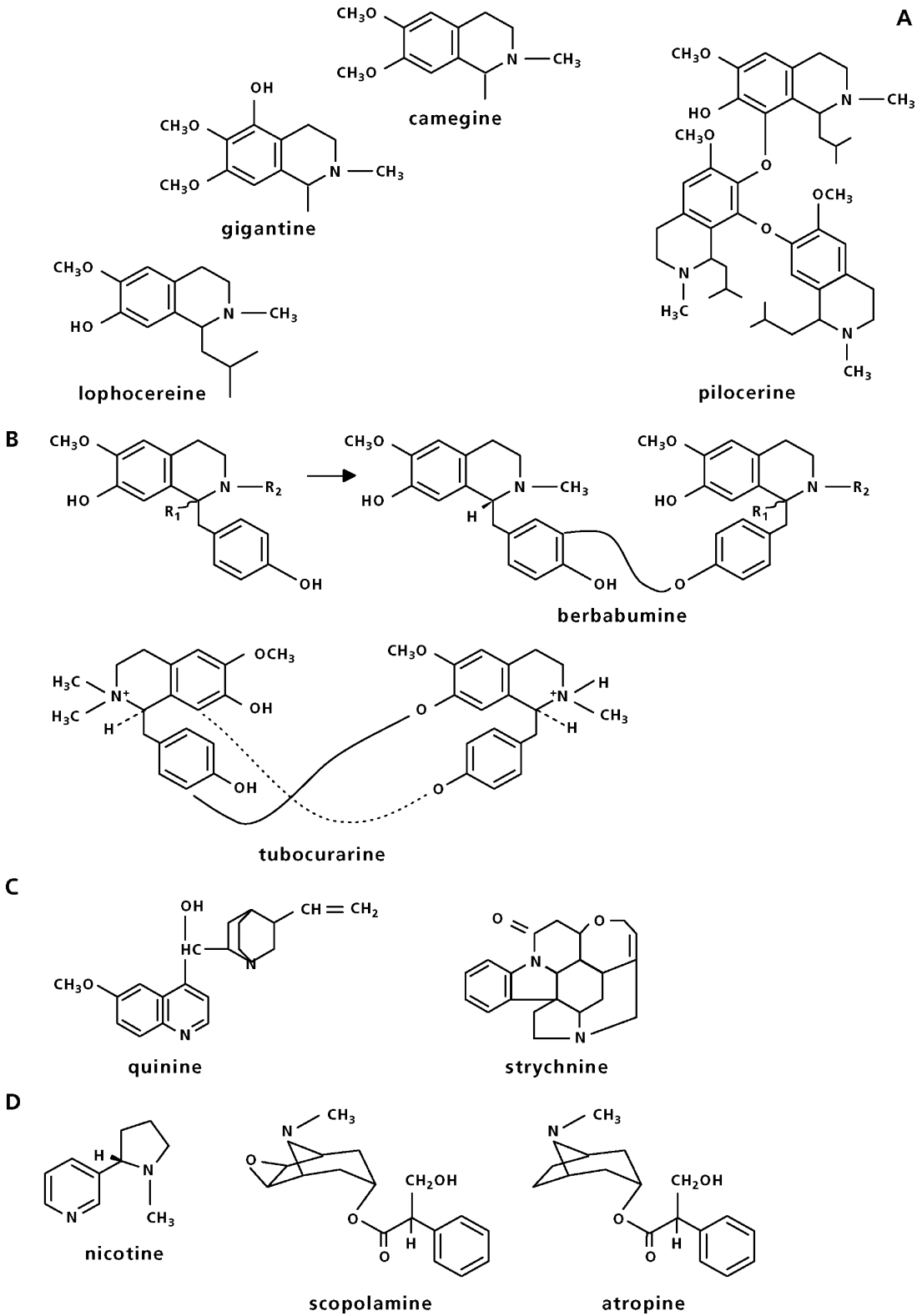

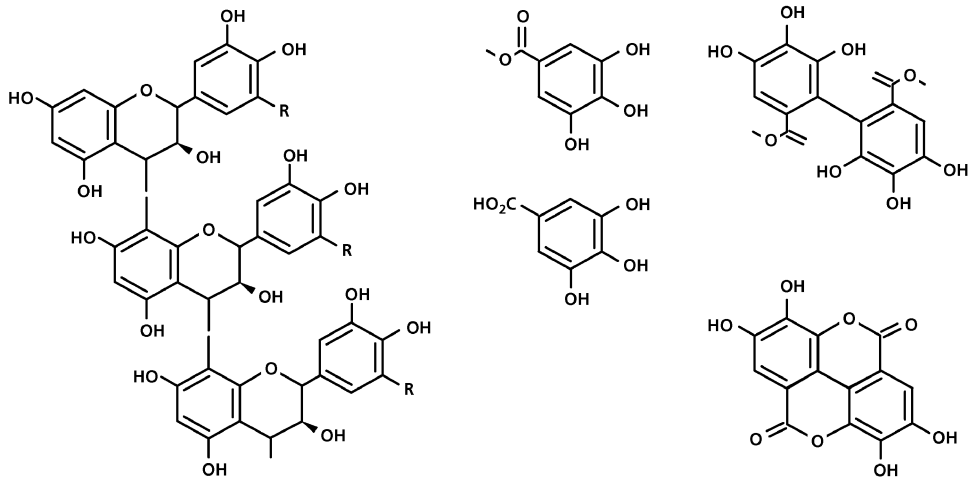

FIGURE 8. The chemical structure of proanthocyanidin (condensed tannin) (left). Gallotannin (top, middle) and ellagitannin (top, right) are hydrolyzable tannins,

releasing gallic acid (bottom, middle) and ellagic acid (bottom, right), respectively, and the esterified sugar(s), mostly glucose, upon hydrolysis.

defense compounds in plants and of more mechanisms to cope with these compounds in herbivores. Numerous examples of such a **co-evolution** exist, but they appear to be restricted to mechanisms in herbivores that store, detoxify, or excrete qualitative defense compounds, with very little evidence for evolutionary escape from quantitative defenses. We will first present a number of striking examples of co-evolution of predators coping with qualitative defenses.

Whereas the stinging hairs on members of the Urticaceae protect the plants against large herbivores, some caterpillars (e.g., those of *Inachis io*, *Vanessa atalanta*, and *Aglais urticae*) are not affected by them. Some of these caterpillars simply bite the hairs off. Snails (e.g., *Arion ater* and *Agriolimax columbianus*) are also little affected by the leaf hairs on *Urtica dioica* (stinging nettle) (Cates & Orians 1975). Plants and herbivores, particularly insects, are in a continuous battle. From a plant's perspective, success in this interaction is determined by its ability to defend itself from devastation by insect feeding. From an insect's perspective, success is measured by its ability to protect itself from a variety of toxic plants defense compounds, thereby allowing it to use specific plants as its sole food source.

One example of co-evolution that involves defensive secondary plant compounds is that of marsupials and several other native animal species in Western Australia that are resistant to the very poisonous **fluoroacetate**, which is a potent inhibitor of an enzyme of the TCA cycle (aconitase). Fluoroacetate occurs in some leguminous shrubs (mainly

Gastrolobium species) of the Western Australian flora, and is poisonous to introduced cows, sheep, and feral animals (Twigg & King 1991, Twigg et al. 1999). Consequently, fluoroacetate (1080) can be used to control feral animals, e.g., rabbits, foxes, and pigs, without harming native animals; however, there is a looming risk of resistance building up in rabbits (Twigg et al. 2002). Another well-studied example of co-evolution is the combination of *Senecio jacobaea* (tansy ragwort) and *Tyria jacobaea* (cinnabar moth) (Hartmann 1999). The *Senecio jacobaea* plants contain at least six pyrrolizidine **alkaloids** (Fig. 9). Alkaloids are characterized by a N-containing heterocyclic ring and their alkaline reaction. They represent the largest (>12000 structures) and one of the most structurally diverse groups of substances that serve as plant defense agents (Schuler 1996, De Luca & St Pierre 2000). The highly toxic alkaloids from *Senecio* may cause damage to the liver. The larvae of *Tyria jacobaea* are not harmed by these alkaloids and use *Senecio jacobaea* as a **preferred food source**; they sometimes consume the leaves of *Senecio vulgaris* (groundsel) or *Petasites hybridus* (coltsfoot) as alternative food sources. They accumulate the toxins, which even end up in the mature butterfly. Both the larvae and the butterfly are poisonous to birds. The toxic nature of these animals coincides with black and bright yellow warning coloration (visual advertisement). In addition to the larvae of *Tyria jacobaea*, there are some other animals that cope with the toxic alkaloids in *Senecio* [e.g., the tiger moth (*Arctia caja*) and the flea beetle (*Longitarsus jacobaea*)].

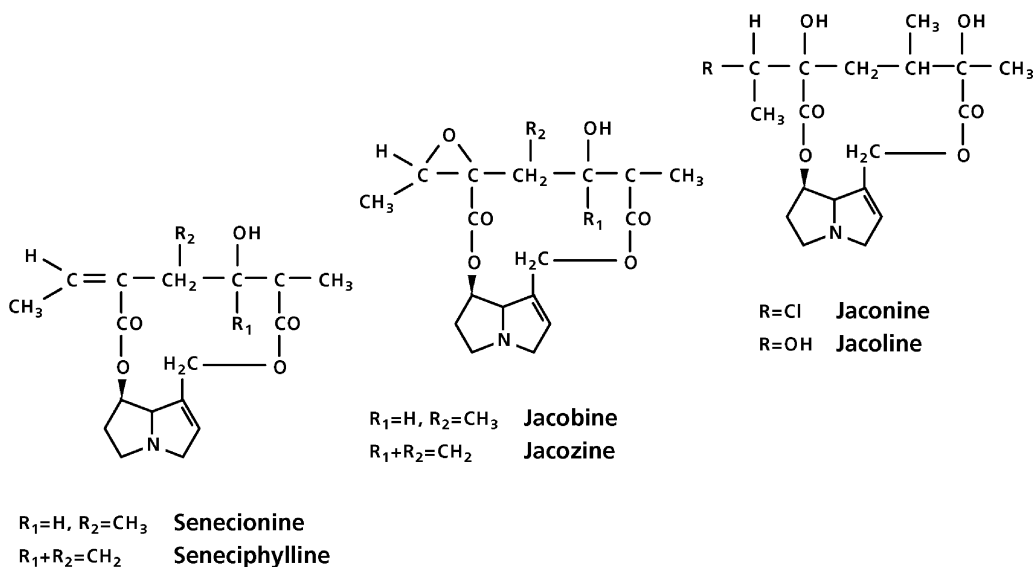

FIGURE 9. The chemical structure of some pyrrolizidine alkaloids from *Senecio jacobaea*.

The interaction of *Asclepias curassavica* (milkweed) and *Danaus plexippus* (the monarch butterfly) is similar to that of *Senecio jacobaea* and *Tyria jacobaea*; the *Asclepias curassavica*–*Danaus plexippus* interaction has an interesting additional dimension in that it is exploited by *Limenitis archippus* (the viceroy butterfly). The milk sap of *Asclepias curassavica* plants contains **cardiac glycosides** (calotropine and calactine). Cardiac glycosides (cardenolides) are bitter compounds that stimulate the heart when applied in small doses, but are lethal in slightly higher doses; the structure of some cardiac glycosides is given in Fig. 10. The presence of these toxic compounds in the larvae of *Danaus plexippus* is again advertised; moreover, caterpillars of the viceroy butterfly have similar colors, but without containing any cardiac glycosides (**mimicry**).

Being able to cope with toxic plants does not invariably lead to accumulation of the toxin. Larvae of the beetle *Caryedes brasiliensis* from Costa Rica largely feed on the seeds of *Dioclea megacarpa*. These seeds contain canavanine, a toxic **nonprotein amino acid** that resembles arginine (Fig. 11) and may constitute as much as 7–10% of the seed fresh mass. Nonprotein amino acids are toxic because they act as “antimetabolites”. That is, their structure is recognized as the same as that of the amino acid they resemble which leads to proteins without the same tertiary structure and function of the protein containing the normal amino acid. Resistance of the larvae of *Caryedes brasiliensis* is based on two

principles. First, the larvae have a slightly different tRNA synthetase, which recognizes arginine as being different from canavanine. Second, they have high levels of the enzyme urease, which breaks down canavanine. Thus, the toxin is a major N source for the larvae.

These few examples selected from a wide range show that one or more animal species have invariably co-evolved with a plant species producing a toxin. Thus, while **qualitative defense** against herbivores requires relatively little investment of resources, it is also a vulnerable strategy. Although there are some examples of animals coping with large quantities of digestibility-reducing and unpalatable compounds (**quantitative defense**), these examples are rare. Hence, the strategy that requires a major investment of carbon is most certainly the safest. A large investment of carbon in protective compounds and structures inevitably goes at the expense of the possibility of investment of carbon in growth. It is therefore most predominant in slow-growing species, especially those with evergreen leaves with a long life span (Bryant et al. 1983, Wright & Cannon 2001, Lambers & Poorter 2004). On the other hand, toxins are found in both fast-growing and slow-growing species. In the evergreen *Ilex opaca* (American holly) the toxic saponins are only found in young leaves and in the mesophyll cells of older leaves. Nonmesophyll cells of older leaves contain digestibility-reducing compounds like lignin, crystals, and tannin (Kimmerer & Potter 1987).

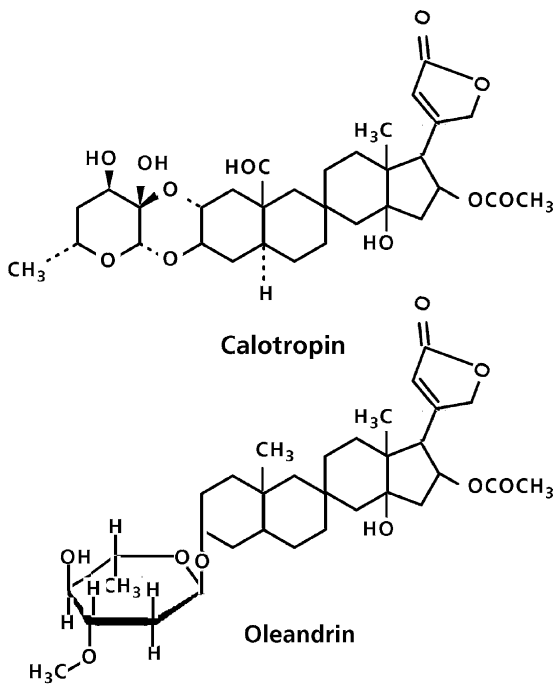

FIGURE 10. The chemical structure of some cardiac glycosides, including calotropin from *Asclepias curassavica* (milkweed).

3.4 How Do Plants Avoid Being Killed by Their Own Poisons?

Most secondary plant compounds that deter herbivores are also toxic to the plants themselves. Prussic acid (HCN) is produced upon ingestion of plant material of approximately 2000 species from some 110 families, including genotypes of *Trifolium* spp. (clover), *Linum usitatissimum* (flax), *Sorghum bicolor* (millet), *Pteridium aquilinum* (bracken fern), and *Manihot esculenta* (cassava). If HCN inhibits several enzymes in both animals and plants (e.g., cytochrome oxidase and catalase), and this also holds for plants that contain the cyanogenic compounds, how do cyanogenic plants protect themselves from this toxic HCN?

Cyanogenic plants do not actually store HCN, but contain **cyanogenic glycosides** (i.e., cyanide attached to a sugar moiety) or **cyanogenic lipids** (in Sapindaceae), and these only produce HCN upon hydrolysis. The reaction is catalyzed by specific enzymes (e.g., linamarase, which catalyzes hydrolysis of linamarin in some legumes) (Fig. 12). Synthesis of many cyanogenic compounds requires amino acids as precursors, as Fig. 12 illustrates for

the synthesis of linamarin from valine. The enzymes responsible for the breakdown of the cyanogenic compound and the cyanogenic compounds themselves occur in different cell compartments. Upon damage of the cells, such as after ingestion, the enzyme and its substrate come into contact. For example, dhurrin, which is a cyanogenic glycoside in *Sorghum* species, occurs exclusively in the vacuole of leaf epidermal cells, whereas the enzyme responsible for its hydrolysis is located in mesophyll cells. Linamarase, hydrolyzing linamarin, occurs in the walls of mesophyll cells, whereas its substrate is stored inside the cell. As long as this strict **compartmentation** between cyanogenic compounds and hydrolyzing enzymes is maintained, no problem arises for the plant itself. The linamarin (monoglucoside of acetone cyanohydrin) that is found in the roots of *Hevea brasiliensis* (rubber tree) and *Manihot esculenta* (cassava), however, is synthesized in the shoot and imported via the phloem. In the rubber tree the transport compound is linustatin, which is a nonhydrolyzable diglucoside of acetone cyanohydrin, rather than the hydrolyzable linamarin itself. Transport as the diglucoside avoids the risk of HCN production during transport from leaf cells, via the phloem, to the roots (Selmar 1993).

Although avoidance of damage by compartmentation is the best strategy, some **detoxification mechanisms** may be needed. Detoxification of HCN in plants is possible; it is catalyzed by β -cyano-alanine synthase, transforming L-cysteine + HCN into β -cyano-alanine. The N in cyanogenic compounds that are stored in seeds, can therefore be remobilized and incorporated into primary nitrogenous metabolites (Selmar et al. 1988, 1990). In addition, in vegetative plant organs, cyanogenic compounds may be subject to some turnover.

Resistance against cyanogenic glycosides in animals is based on the presence of the enzyme rhodanese (e.g., in sheep and cattle). It catalyzes the transformation of cyanide to thiocyanate. The sulfur required for this reaction comes from mercaptopyruvate. Treatment of patients suffering from HCN poisoning is based on the same principle when thiosulfate is administered to the victim.

In *Trifolium* (clover) species, as well as in others, polymorphism for cyanogenesis has been found. Genotypes are cyanogenic only when they are homozygous for both the recessive gene responsible for the production of linamarase and for the recessive gene responsible for linamarin hydrolysis. In southern Europe cyanogenic genotypes are predominant, except at higher locations. In northern and western Europe, most genotypes are acyanogenic

Nonprotein amino acid

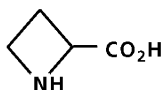
 β -cyanoalanineazetidine
2-carboxylic acid

Protein amino acid



alanine

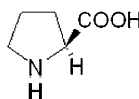

proline

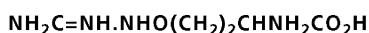

canavanine

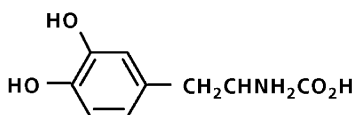
3,4-dihydroxyphenylalanine
(L-DOPA)

arginine

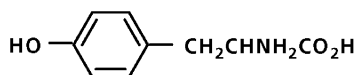

tyrosine

FIGURE 11. Some examples of nonprotein amino acids from higher plants, including canavanine from *Dioclea megacarpa*. The structure of the corresponding ordinary

amino acids is also given for comparison (Harborne 1988).

(Kakes 1990). This correlation (with temperature), however, has not yet been explained in a satisfactory manner. There may be other factors involved, such as in the case of *Hevea brasiliensis* (rubber tree), which releases HCN when it is infected by a pathogenic fungus (*Microcyclus ulei*). HCN then interferes with both the plant host and the fungal pathogen. Because of its inhibition of cytochrome oxidase, this inhibits energy-requiring defense responses, hampering the plant's ability to ward off the fungus (Lieberi et al. 1989). Being cyanogenic would then have a disadvantage. It is therefore possible that the correlation of genotype with temperature reflects the temperature dependence of a pathogenic organism.

Like cyanogenic compounds, many alkaloids are also stored in specific compartments (i.e., either

the vacuole or smaller vesicles in which they are produced). In *Papaver somnifera* (opium poppy), laticifers contain abundant vesicles that both contain morphine and the enzymes to synthesize and metabolize it. In *Berberis wilsoniae* (barberry), *Thalictrum glaucum* (rue), and many other species cells have similar "alkaloid vesicles", which contain berberin or other alkaloids and some of the enzymes of the pathway that produce them. The "alkaloid vesicles" may fuse with the central vacuole and thus deposit the alkaloids there (Hashimoto & Yamada 1994).

Ricin is a highly toxic and abundant protein in seeds of *Ricinus communis* (**castor bean**). Ricin is a ribosome-inactivating protein; similar proteins occur in taxonomically and ecologically diverse species, including crop plants (Hartley et al. 1996). Ricin

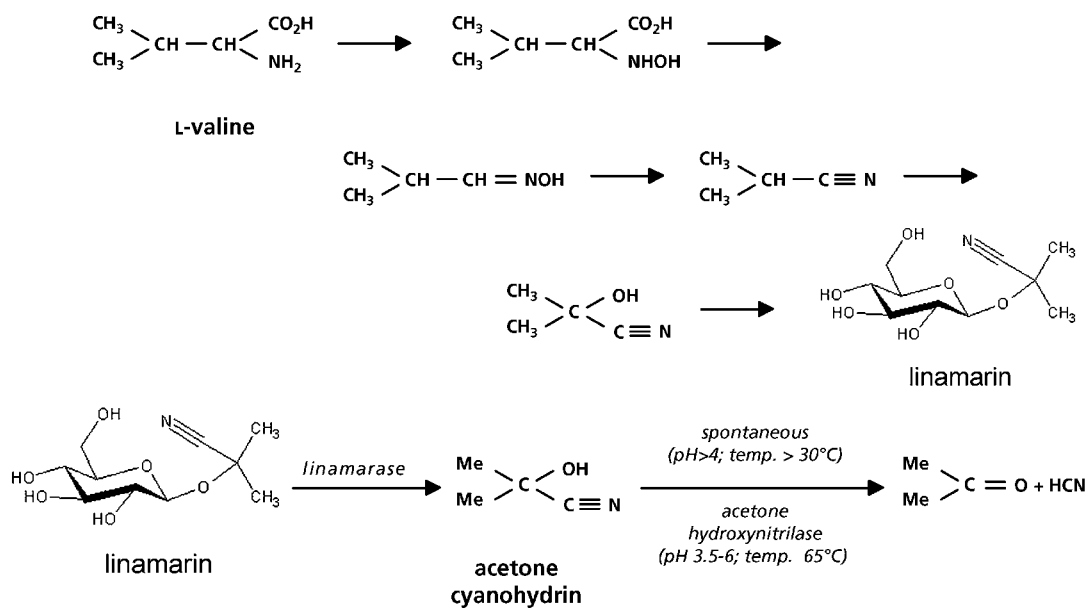

FIGURE 12. In the synthesis of linamarin (a cyanogenic glucoside) the amino acid valine is used as a precursor. The release of HCN from linamarin is catalyzed by a specific enzyme, linamarase (McMahon et al. 1995).

is a heterodimeric protein that consists of an enzymatic polypeptide that destroys ribosomal RNA; it is covalently bound to a galactose-binding lectin [lectins are proteins with noncatalytic sugar-binding domains; the first ones were discovered in *Ricinus communis* (castor bean) more than a century ago; numerous other plants were found to contain lectins since then (Etzler 1985); see also Sect. 3.3]. This bipartite structure and functional properties allow ricin to bind to galactosides on the cell surface. Upon binding, ricin enters the cell via endocytotic uptake and traverses an intracellular membrane to deliver the enzymatic component to the cytosol. Once it is there, it irreversibly inhibits protein synthesis, followed by death of the cell. Ricin is one of the most potently toxic compounds known, and entry of a single toxin molecule into the cytosol may be sufficient to kill the cell. *Ricinus* ribosomes that synthesize ricin are also susceptible to the catalytic action of this protein. How, then, does *Ricinus* avoid suicide? The subunits of which the heterodimer is composed are originally synthesized together in the form of a single precursor protein: proricin. Proricin is an active lectin, but it does not bind to ribosomal RNA. It is transported to the vacuole, where acidic endoproteases remove amino acid residues to generate the heterodimer: ricin. None of the ricin appears to escape from the vacuole (Lord & Roberts 1996).

3.5 Secondary Metabolites for Medicines and Crop Protection

Secondary metabolites that deter herbivores or inhibit pathogens have been used by humans for a very long time. The bark of willow (*Salix*) contains **salicylic acid** (Fig. 5), which is closely related to acetylsalicylic acid (**aspirin**) and has been used as medicine. Quinine, which is an alkaloid from the bark of *Cinchona officinalis* (quinine), has been used for centuries to combat **malaria**. Artemisinins are extracted from *Artemisia annua* (sweet wormwood); they are potent antimalarials, rapidly killing all asexual stages of *Plasmodium falciparum* (Eckstein-Ludwig et al. 2003). Other examples of secondary compounds used as medicine are included in Table 3; some of these are still used [e.g., atropine from *Atropa belladonna* (deadly nightshade)]. Others are used because of their antitumor activity [e.g., the diterpene taxol from *Taxus brevifolia* (western yew), and other *Taxus* species (Heinstein & Chang 1994)]. Many more compounds, as-yet-undiscovered, may well be found to have similar effects, as long as the species that contain them do not become extinct, thus offering a strong argument for plant conservation. About 25% of currently prescribed medicines originate from plant compounds that evolved as defenses against herbivores (Dirzo and Raven 2003).

TABLE 3. Examples of secondary metabolites for which man has found some use.

Chemical compound	Species	Applications
Salicylic acid	<i>Salix</i> sp., <i>Populus</i> sp.	Pain killer
Aconitine	<i>Aconitum napellus</i>	Pain killer
Atropine	<i>Atropa belladonna</i>	Ophthalmology
Cytisine	<i>Cytisus laburnum</i>	Migraine
Germerine, protoveratrine	<i>Veratrum album</i>	Muscle diseases, pain killer
Cardiac glycosides	<i>Digitalis</i> sp., <i>Asclepias</i> sp.	Heart diseases
Linarine, linine	<i>Linaria vulgaris</i>	Hemorrhoids
Quinine	<i>Cinchona officinalis</i>	Malaria
Atropine	<i>Atropa belladonna</i>	Poisoning
Taxine	<i>Taxus baccata</i>	Poisoning (arrowheads of Celts)
Cicutoxin	<i>Cicuta virosa</i>	Poisoning (of Socrates)
Hyoscyamine, scopolamine	<i>Hyoscyamus niger</i>	Poisoning (in Shakespeare's "Hamlet")
Pyrethrins	<i>Chrysanthemum cinearifolium</i>	Insecticide
Rotenone	<i>Derris</i> sp., <i>Lonchocarpus</i> sp.	Rat and fish poisoning, pesticide
Camphor	<i>Cinnamomum camphora</i>	Moth balls

Humans have also found other uses for secondary metabolites, some of these in ancient history, such as taxine [from *Taxus baccata* (yew)] to make arrowheads poisonous, and alkaloids [from *Conium maculatum* (poison hemlock)] to poison Socrates. One of the more recent applications includes the now widespread use of pyrethrins from *Chrysanthemum cinerariifolium* (Dalmatian chrysanthemum) as an "environmentally friendly" insecticide. Over 800 compounds have been reported in the Asteraceae, including nematicides [e.g., thiarubrine and terthieryl in the roots of *Calendula officinalis* (marigold)], fungicides, and bactericides (Flores et al. 1999).

The ancestors of our food plants also contain many toxic compounds, including alkaloids in *Solanum lycopersicum* (tomato) and *Solanum tuberosum* (potato) (Fig. 13). Breeding has greatly reduced the alkaloid levels in tomato and potato, so that food poisoning by potatoes, which was known until the beginning of the 20th century, no longer occurs. Whenever wild species are used to make new crosses, however, new cultivars emerge that may produce poisonous solanine. It is well known that the majority of pyrrolizidine alkaloids cause serious diseases in domestic animals and humans through liver bioactivation. Grazing animals, however, usually avoid plants with high levels of pyrrolizidine alkaloids, unless there is shortage of other herbaceous food, apparently because of their deterrent taste (Hartmann 1999).

Cyanogenic glycosides (Sect. 3.4) in *Manihot esculenta* (cassava), *Sorghum bicolor* (millet), and *Vicia faba* (broad bean) are made harmless during food preparation. This also holds for many inhibitors of digestive enzymes (proteases, amylases), if the food is properly prepared. Eating raw or insufficiently cooked beans is an unhealthy affair because they will still contain large amounts of secondary compounds. Some compounds in herbs that are commonly used to flavor our food are on the black list. These include safrole (in nutmeg, cacao, black pepper) and capsaicin (in red pepper, hot pepper), but taken in small doses they do not cause problems.

There are certainly compounds, however, that should be avoided at all costs (e.g., **aflatoxin**). This is a fungal compound produced by *Aspergillus flavus* growing on peanuts (*Arachis hypogaea*), corn (*Zea mays*), and some other crop plants. This compound may cause severe liver damage or cancer. Other secondary compounds have a distinctly positive effect on our health in that they reduce the risks for certain forms of cancer. These include the flavonoids in a so-called fiber-rich diet. These phenolics likely inhibit the production of sex hormones; hence, they appear to reduce the incidence of cancers in which these hormones play a role, including breast cancer and prostate cancer. The alkaloid camptothecin, from the roots of the Chinese medicinal herb *Camptotheca acuminata*, is a recent anticancer drug (Flores et al. 1999). Isothiocyanates, which are produced

FIGURE 13. The chemical structures of two alkaloids: solanine from *Solanum tuberosum* (cultivated potato) and demissine from *Solanum demissum* (wild potato) (Bennett & Wallsgrove 1994).

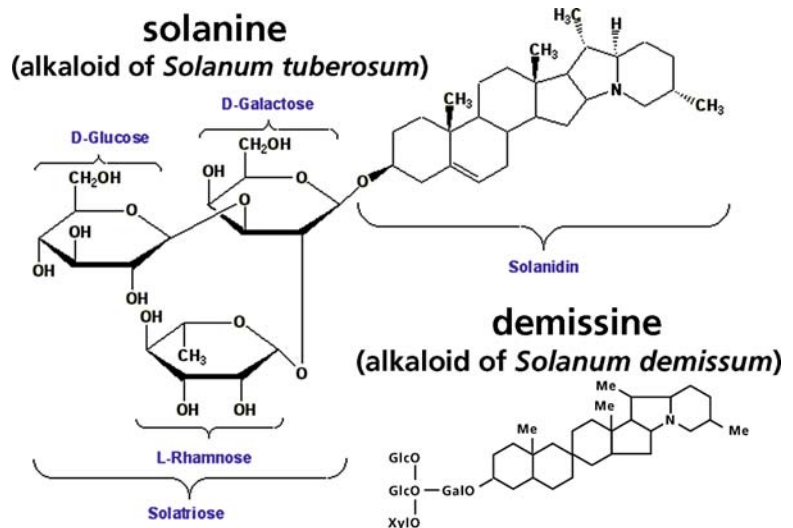

upon degradation of glucosinolates, induce anticarcinogenic enzymes which suggests that high consumption of *Brassica* (cabbage) species could reduce the risk of developing cancer. The roles of fruit, vegetables, and red wine in disease prevention have been attributed, in part, to the **antioxidant** (radical-scavenging) properties of their constituent phenol compounds (polyphenols; Sect. 3.1), some of which are more effective antioxidants in vitro than are vitamin C (ascorbic acid) and vitamin E (α -tocopherol) (Rice-Evans et al. 1997).

Breeding or genetically modifying genotypes of crop species that contain antiherbivore compounds is of increasing economic importance and may lead to more environmentally friendly methods in agriculture. The tendency to breed for oilseed varieties with low glucosinolate levels to improve the feeding quality of rape meal is an excellent example how *not* to go about it. Such a breeding approach makes the crop more vulnerable to herbivores and makes agriculture more dependent on pesticides. It would be better instead, to aim for oilseed varieties that have their leaves well protected against herbivores, while having a reduced level of glucosinolates only in their seeds (Halkier & Gershenzon 2006). This promising strategy has been taken on board in more recent breeding efforts.

There are increasingly positive developments in breeding resistant cultivars. For example, *Leptinotarsa decemlineata* (Colorado beetle) is a well-known predator of *Solanum tuberosum* (potato) and may cause severe damage to potato crops in North America and Western Europe. A closely related species of

our cultivated potato, *Solanum demissum*, is not affected by the beetle. It contains an alkaloid (demissine) that is slightly different from solanine in *Solanum tuberosum* (Fig. 13; Bennett & Wallsgrove 1994). Close relatives of crop species can be used for breeding of resistant crop cultivars. One striking example of the application of ecophysiological information on plant-herbivore interactions is the incorporation of a gene from *Phaseolus vulgaris* (common bean), encoding an amylase inhibitor, into *Pisum sativum* (garden pea). The transgenic plants suffer considerably less from attack by pea weevils (*Bruchus pisorum*) than do the wild type (Schroeder et al. 1995). Similarly, genes encoding a proteinase inhibitor or lectins have been inserted.

Herbivores may acclimate and possibly even adapt to an increased level of a specific proteinase or amylase inhibitor. They do so by producing other proteinases or amylases, whose activity is not inhibited by the plant-produced inhibitor. For example, one type of α -amylase inhibitor protects seeds of the common bean (*Phaseolus vulgaris*) against predation by the cowpea weevil (*Callosobruchus maculatus*) and the azuki bean weevil (*Callosobruchus chinensis*), but not against predation by the bean weevil (*Acanthoscelides obtectus*) or the Mexican bean weevil (*Zabrotus subfasciatus*). A serine protease in midgut extracts of the larvae of the Mexican bean weevil rapidly digests and inactivates α -amylase from *Phaseolus vulgaris* as well as from *Phaseolus coccineus* (scarlet runner bean), but not the α -amylase from wild common bean accessions or from *Phaseolus acutifolius* (teparty bean) (Ishimoto & Chrispeels 1996).

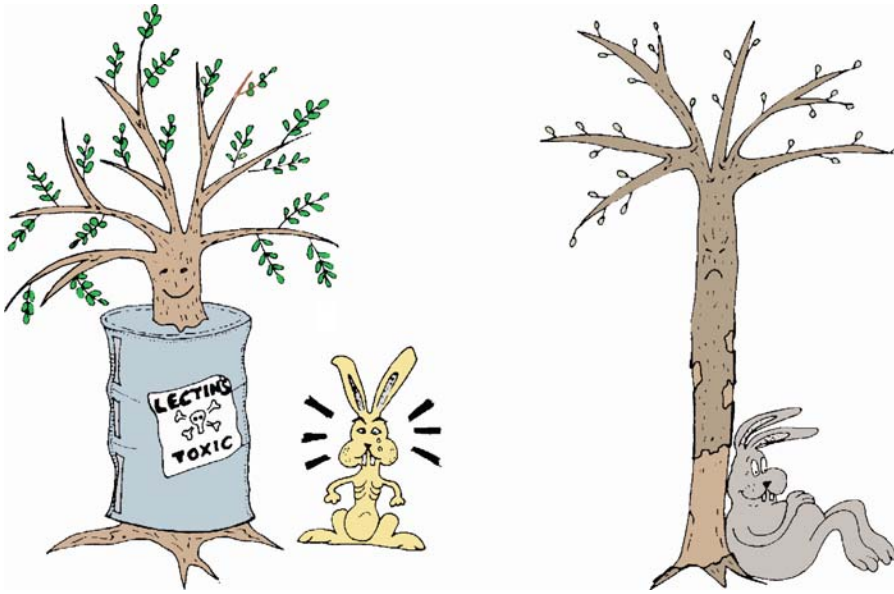

FIGURE 14. Lectins are carbohydrate-precipitating proteins. Some of these give plants protection against insects as well as vertebrates. When present in bark [e.g., in

Sambucus nigra (elderberry)] they offer good protection against rodents and deer (after Peumans & Van Damme 1995). Copyright American Society of Plant Biologists.

Lectins bind carbohydrates (by definition). As such they play a role as defense compounds (Fig. 14; Peumans & Van Damme 1995). Lectins occur in many plants, including *Sambucus nigra* (elderberry), *Hevea brasiliensis* (rubber tree), *Galanthus nivalis* (snowdrop), and *Datura stramonium* (thorn apple) (Raikhel et al. 1993). In *Sambucus nigra* lectin is located in protein bodies in the phloem parenchyma of the bark (Greenwood et al. 1986). Some lectins are highly toxic to many animals and also offer good protection against viruses and some fungi (Sect. 2 of Chapter 9C on effects of microbial pathogens). Although some insects appear to tolerate lectins, sucking insects like aphids are highly sensitive.

The gene encoding the lectin from *Galanthus nivalis* (snowdrop) has been linked to a promoter that ensures expression of the gene in the phloem (Hilder et al. 1995). It has been inserted in *Oryza sativa* (rice) in an attempt to develop a plant that contains its own insecticide to enhance its resistance to aphids and brown plant-hoppers (Sudhakar et al. 1998, Wu et al. 2002). Ever-increasing numbers of transgenic plants with a range of different resistance genes inserted are now being produced (Petersen et al. 2001, Tattersall et al. 2001, Carlini & Crossi-de-Sá 2002).

4. Environmental Effects on the Production of Secondary Plant Metabolites

Although specific secondary metabolites tend to be specific for certain species, the concentration of these compounds may vary greatly, depending on environmental conditions.

4.1 Abiotic Factors

The concentration of secondary plant compounds depends on plant age as well as on abiotic environmental factors (e.g., light intensity, water stress, waterlogging, frost, pollution, and nutrient supply). In *Leucaena retusa* (goldenball leadtree) the production of organic sulfur compounds (COS and CS₂) from crushed roots increases with increasing supply of sulfate, especially in young seedlings (Feng & Hartel 1996). The concentration of caffeine (an alkaloid) in the shoot of *Camellia sinensis* (tea) is higher when the plants are grown at high irradiance, rather than in the shade. *Pinus sylvestris* (Scots pine) trees exposed to water stress produce less resin and are affected more by herbivorous beetles. Exposure of

Toxicodendron radicans (poison ivy) to elevated atmospheric CO₂ concentrations enhances its growth as well as the production of urushiol, suggesting the rate of spread of poison ivy and its ability to recover from herbivory may be enhanced in a future environment with higher CO₂ concentrations (Ziska et al. 2007). Defoliation of *Picea abies* (Norway spruce) trees reduces the production of terpenoids which is associated with an increased attack on their bark. In other plants, stress enhances the production of secondary metabolites, e.g., in *Salix aquatica* (willow) the concentration of tannin and lignin is enhanced when plants are grown under N limitation as compared with an optimum supply (Waring et al. 1985, Northup et al. 1995). In a cross between *Festuca* and *Lolium*, the alkaloid concentration declines when plants are exposed to water stress, whereas that in *Nicotiana tabacum* (tobacco) increases. These effects may be mediated via carbohydrate-modulated gene expression (Sect. 12.1 of Chapter 2A on photosynthesis). Whereas genes that encode photosynthetic enzymes are down-regulated by carbohydrates, evidence is accumulating that a number of defense genes are positively modulated by carbohydrates (Koch 1996).

Two hypotheses have been advanced to explain patterns of environmental effects on plant secondary metabolites. The **carbon/nutrient balance** (CNB) hypothesis explains the level of investment in **carbon-based secondary metabolites** (i.e., those that contain only C, H, and O) as a balance between photosynthesis and growth, which, in turn, is sensitive to the carbon/nutrient balance of the plant (Bryant et al. 1983, Gershenzon 1984, Tuomi et al. 1984). According to the CNB hypothesis, plants allocate carbon preferentially to growth when nutrients are available. Low nutrient availability constrains growth more than it reduces photosynthesis (Sect. 5 of Chapter 7 on growth and allocation), however, leading to a build-up of carbohydrates that are funneled into production of carbon-based secondary metabolites (broadly synonymous with quantitative defenses). This hypothesis explains the high levels of plant defenses typically found in plants that grow on infertile soils, and the reductions in defense that occur in response to both nutrient addition or shading. For example, tropical trees that grow on infertile soils have higher concentrations of phenolic compounds and less herbivory than do trees that grow on more fertile sites (McKey et al. 1978). The hypothesis predicts that plants that grow more rapidly should invest less carbon in defense, as observed among seedling of the tropical tree *Cecropia peltata*

(Coley 1986). However, although the hypothesis successfully predicts outcomes in some cases, there are enough exceptions that it cannot be considered a predictive tool (Hamilton et al. 2001).

The **growth-differentiation balance** (GDB) hypothesis was advanced to explain seasonal and interannual variations in rates of production of carbon-based secondary metabolites (Loomis 1932, Lorio 1986). According to this hypothesis, growth is the primary path of carbon investment as long as conditions permit cell division and expansion; however, once water stress, photoperiod, or any other environmental factor constrains growth, cells differentiate, resin ducts form, and plants switch allocation of carbon to production of resins and other secondary metabolites. This hypothesis accounts for the greater vulnerability of *Picea mariana* (black spruce) and *Pinus banksiana* (jack pine) to attack by beetles early in the growing season, and it explains why emission of monoterpenes and resin production increase late in the year, particularly in years when water stress constrains growth (Lorio 1986, Lerdaun et al. 1997).

Herms & Mattson (1992) integrated the two hypotheses discussed above into an expanded version of the GDB hypothesis, which suggests that scarcity of any resource that restricts growth more than photosynthesis should enhance secondary metabolite production (Fig. 15). At extremely low resource availability, assimilation rate may be so low that maintenance respiration consumes most carbon, so that both growth and secondary metabolite production are limited (Waring & Pitman 1985). In the expanded GDB model, which is supported by recent evidence (Lambers & Poorter 2004), fast-growing species invest less carbon in secondary plant compounds than do slow-growing ones, when compared at a high resource availability. Herms and Mattson emphasized that further testing of their model is necessary. It may well be valid for one class of secondary compounds only (e.g., the quantitatively important defense compounds of a phenolic nature).

The CNB and GDB hypotheses provide a plausible mechanism for a pattern that should be strongly selected for: long-lived leaves of slow-growing plants should be well protected against pathogens and herbivores to minimize tissue loss (Sect. 4.1 of Chapter 9E on interactions among plants). The actual biochemical allocation to specific pathways of synthesis of individual secondary metabolites is undoubtedly regulated much more specifically than is implied by the CNB and GDB hypotheses.

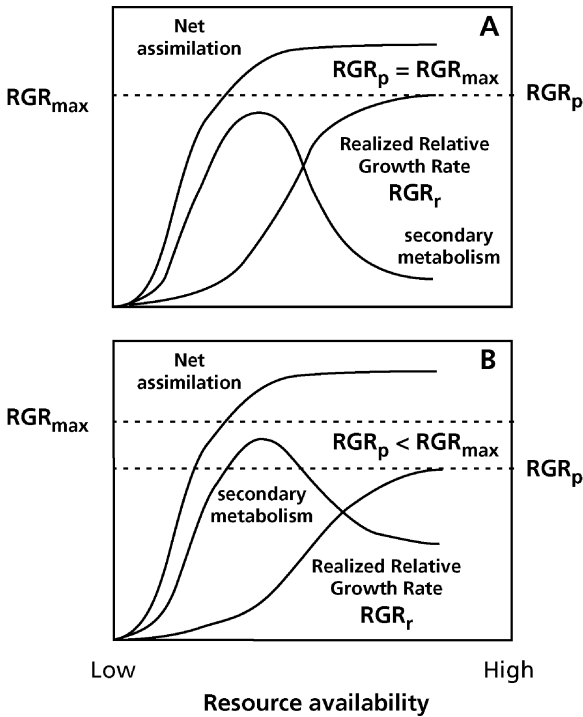

FIGURE 15. A hypothetical model that shows the realized relative growth rate (RGR_r), the net assimilation rate, and the investment of carbon in secondary plant compounds as a function of the availability of resources. Two populations (A and B) are depicted that differ with respect to the RGR that they can achieve at optimal resource availability (RGR_p). RGR_{max} in these figures denotes the maximum possible RGR of population A at the most favorable resource supply in the environment given its investment in secondary plant metabolites. Population B does not reach this RGR_{max} , due to a greater allocation to secondary metabolites (after Herms & Mattson 1992).

4.2 Induced Defense and Communication Between Neighboring Plants

The production of secondary metabolites depends on abiotic environmental factors as well as on the presence of herbivores: **induced defense**. Physical damage of leaves often enhances the transcription of genes encoding polyphenol oxidase [e.g., in *Populus* (poplar) species] (Constabel et al. 2000). It also induces the formation of tannins, and the production of proteinase inhibitors [e.g., in *Solanum tuberosum* (potato) and *Solanum lycopersicum* (tomato)], especially when it is due to insect attack (Koiwa et al. 1997, Korth & Dixon 1997). These plant responses reduce the quality of both the attacked and other leaves on the same plant as a food source. Jasmonate, ABA, salicylic acid, and ethylene play a role as signaling molecules in the systemic induction of defense (Wasternack & Partheir 1997, Gatehouse 2002). This response sometimes occurs within minutes to hours (**short-term induction**), as a result of reactions among precursors already present in the leaf. For example, chewing of *Populus tremuloides* (quaking aspen) leaves causes enzymatic hydrolysis of two phenolic glycosides (salicortin to salicin, and tremulacin to tremuloidin) with the release of 6-HCH (6-hydroxycyclohex-2-ene-1-one), which then becomes converted to phenol or catechol (potent

toxins) in the gut of the insect (Clausen et al. 1989). As a result, insects cannot feed continuously on a few leaves; rather, they must constantly move among leaves which makes them more vulnerable to predators. Short-term induced defenses are effective against those herbivores that cause the initial damage.

There are also **long-term induced defenses** produced by the next cohort of leaves after severe insect outbreaks. These serve to protect plants against catastrophic herbivory by insects with large population outbreaks. Long-term induction is typically associated with increases in phenolics or fiber, less leaf N, and often smaller leaves. Long-term induced defenses are best developed in tree populations with an evolutionary history of outbreaking insects. In some cases they are induced more strongly by insect feeding than they are by comparable amounts of physical damage which suggests a tight evolutionary linkage with insect herbivores (Haukioja 1980, Haukioja & Neuvonen 1985). Both long- and short-term induced defenses are best developed in rapidly growing woody plants, whereas slow-growing species have higher levels of background (**constitutive**) defenses that are always present to deter herbivores (Coley et al. 1985, Bryant et al. 1991).

There is increasing evidence that neighboring, unattacked plants respond by increasing the

FIGURE 16. Eavesdropping among plants in nature. (A) *Artemisia tridentata* (sagebrush) plants induce increased activity of polyphenol oxidase in neighboring *Nicotiana attenuata* (wild tobacco) plants when the sagebrush neighbors are either clipped manually or damaged by real herbivores. (B) Maximum proportion of tobacco leaves that are damaged by herbivores on tobacco plants with sagebrush neighbors that were unclipped, clipped artificially, or clipped by real herbivores (Karban et al. 2003). Copyright Blackwell Science Ltd.

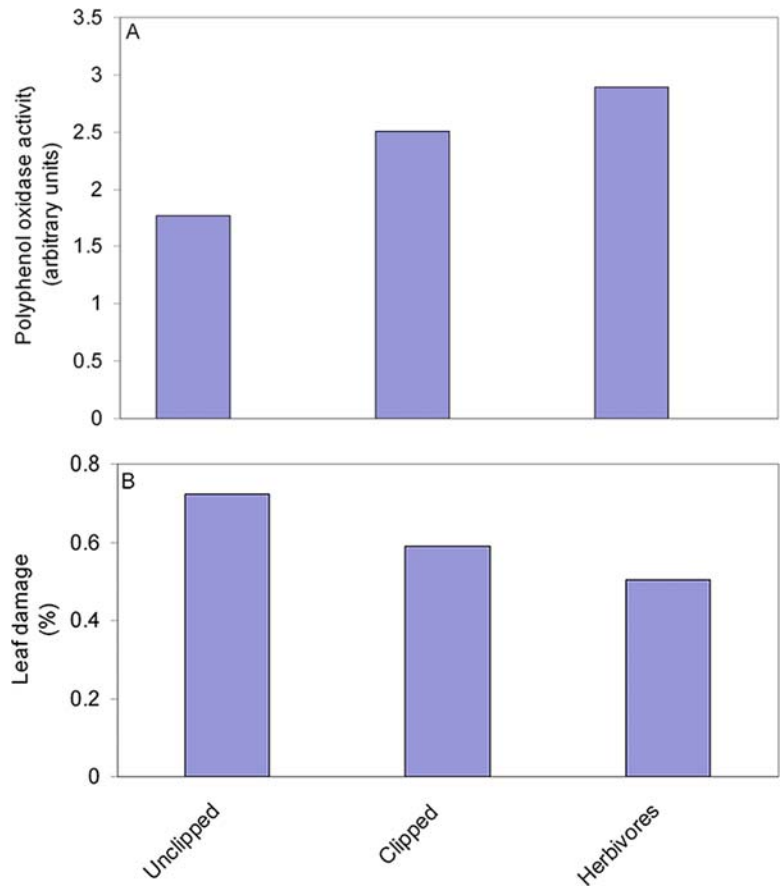

concentration of defensive compounds (Fig. 16) and become less attractive to herbivores (Dicke et al. 2003, Baldwin et al. 2006, Paschold et al. 2006). Dolch & Tschardt (2000) investigated the effects of manual defoliation, to simulate herbivory, of *Alnus glutinosa* (black alder) on subsequent herbivory by the alder leaf beetle (*Agelastica alni*) in northern Germany (Fig. 17). Subsequent damage by the leaf beetle is less when the trees are close to the manually defoliated tree. In addition, the extent of leaf consumption in laboratory feeding-preference tests and the number of eggs oviposited per leaf in another laboratory test are positively correlated with distance from the defoliated tree. **Resistance** is therefore **induced**, both in defoliated alders and in their undamaged neighbors, demonstrating that defoliation triggers interplant resistance transfer, and therefore reduces herbivory in whole alder stands. This indicates that plants **communicate** with each other after herbivore attack.

Effects of leaf damage on neighboring trees of *Acer saccharum* (sugar maple) involve volatile signal transfer between leaves, because these effects are

also found when plants are grown in separate pots. Volatile compounds play a role in this type of **communication** between plants, including octadecanoid-derived "green leaf volatiles", volatile terpenoids and phenols (Tschardt et al. 2001, Turlings & Ton 2006). **Jasmonate** is also involved; it primes defense-related genes for induction upon subsequent defense elicitation (Ton et al. 2007). Plants of different species can also respond to signals released from damaged plants. For example, *Nicotiana attenuata* (wild tobacco) plants next to damaged *Artemisia tridentata* (sagebrush) plants have higher levels of the defensive enzyme polyphenol oxidase and reduced levels of insect damage, compared with control plants next to undamaged sagebrush plants (Karban et al. 2000, 2003). In addition to signaling via volatiles released from damaged leaves, plants also communicate via signals released from roots (Dicke & Dijkman 2001, Guerrieri et al. 2002). The relative importance of airborne and soil-borne signals as well as unknown effects of intensified nutrient absorption of defoliated trees, possibly reducing foliage quality of

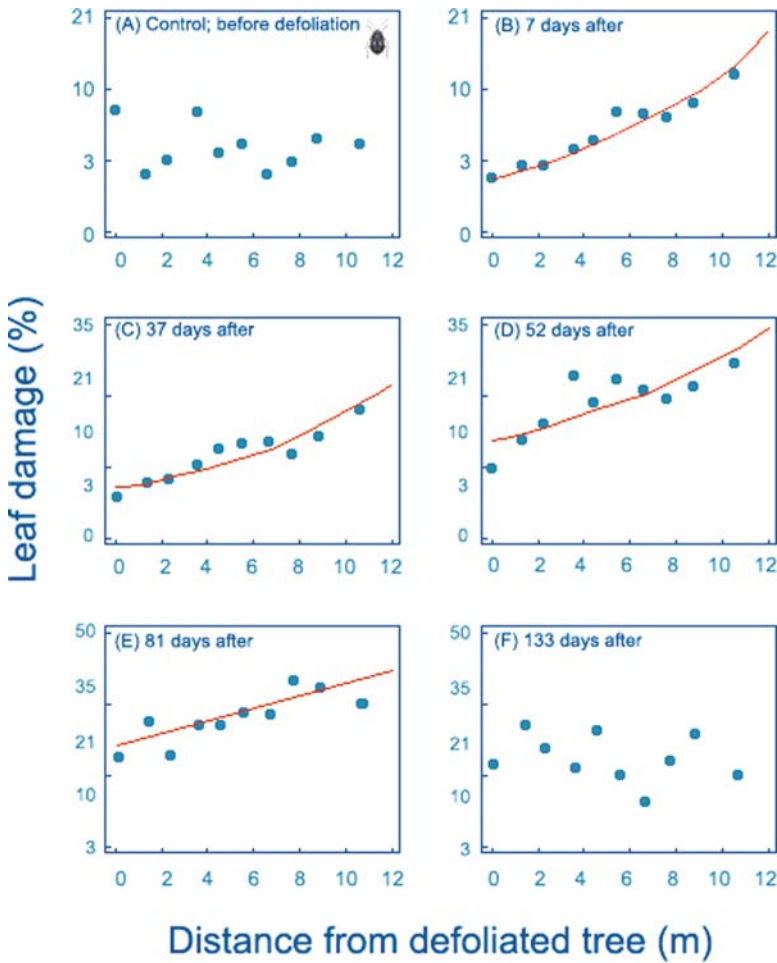

FIGURE 17. Relationship between leaf damage by *Agelastica alni* (alder leaf beetle) to *Alnus glutinosa* (black alder) and distance from the manually defoliated tree in the field. (A) Control: before defoliation, the amount of leaf damage within each plot is randomly distributed. (B–E) 7–81 days after defoliation: herbivory by *Agelastica alni* is greater at increasing distance from the manually defoliated tree. (F) 133 days after defoliation: the distribution pattern of leaf damage no longer depends on distance from the manually defoliated tree (Dolch & Tschartke 2000).

undamaged neighbors, remains to be further investigated (Fig. 18).

There is a wide variation in the extent to which plants respond to browsing with an increased concentration of phenolics. Of three South African Karoo shrubs, the deciduous species [*Osteospermum sinuatum* (African daisy)] is the most palatable. It contains very few polyphenols, does not enhance this level upon browsing, but has a high **regrowth capacity**. On the other hand, the evergreen succulent species (*Ruschia spinosa*) shows almost no regrowth after browsing, but contains the highest level of constitutive and browser-induced levels of polyphenols, condensed tannins, and protein-precipitating tannins. The evergreen sclerophyllous species [*Pteronia pallens* (scholtz bush)] shows an intermediate response in terms of regrowth capacity and browser-induced phenols. It also contains intermediate levels of phenols before browsing (Stock et al. 1993). This suggests a trade-off between

allocation to (induced) defense (**avoidance**) and regrowth capacity (**tolerance**) upon attack by herbivores.

In *Leucaena* (leadtree) species, damaging the roots or shoots greatly enhances the production of organic sulfur compounds (COS and CS₂), which are foul-smelling compounds that are toxic to bacteria, fungi, and animals like nematodes and insects (Feng & Hartel 1996). The suggestion to use some of these species as potential animal fodder should therefore be viewed with some skepticism.

4.3 Communication Between Plants and Their Bodyguards

Volatile compounds play a role in communication between neighboring plants, when attacked by herbivores (Sect. 4.2), as well as between plants and predatory mites or parasitic wasps. These

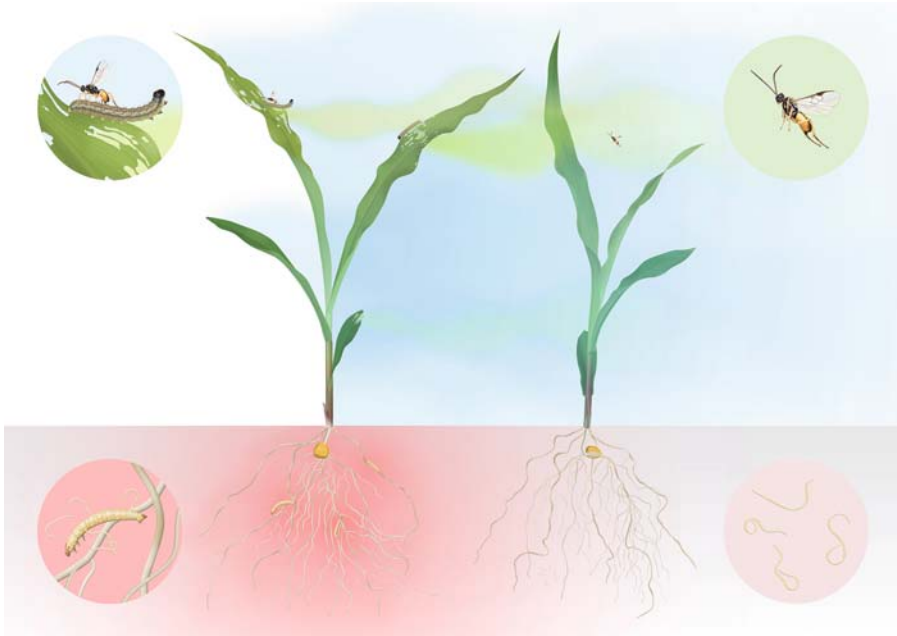

FIGURE 18. When damaged by caterpillars, young plants of *Zea mays* (corn) immediately release several typical octadecanoid-derived “green leaf volatiles” from the damaged sites (indicated in green). In addition, elicitors in the caterpillar’s oral secretions cause the induction of a systemic release of volatiles that mainly comprise terpenoids but also include some phenolics, such as indole and methyl salicylate (indicated in blue). This blend of herbivore-induced volatiles is highly attractive to various parasitic wasps that lay their eggs in the caterpillars. Below-ground beetle larvae might cause the emission of similar signals by damaged roots

(indicated in red). Corn roots release one dominating compound, (E)- β -caryophyllene, in response to root feeding. This sesquiterpene is attractive to entomopathogenic nematodes and increases the effectiveness of these nematodes in finding and killing herbivore larvae. In addition, the herbivore-induced volatiles might repel other herbivores and can induce or prime defense responses in neighboring plants. All of these effects might be exploitable for the control of agricultural pests (after Turlings & Ton 2006; copyright Elsevier Science, Ltd.).

tritrophic systems offer another fascinating example of co-evolution in the arms race between plants and herbivores, except now there is an ally involved: **indirect defense**, as opposed to the **direct defense** responses that were discussed above in this chapter. The volatiles that are released by leaves upon attack by herbivorous mites or caterpillars attract predatory mites or parasitic wasps, respectively. These predatory mites and parasitic wasps then act as **bodyguards**. The attractants produced by plants upon attack are specific in that they are not produced upon artificially damaging the leaves or are produced in much smaller quantities. Upon attack of *Brassica oleracea* (cabbage) plants by caterpillars of *Pieris brassicae* (cabbage moth) the plant responds to a specific caterpillar enzyme (β -galactosidase) with the synthesis of a mixture of volatiles, which are highly specific for a parasitic wasp, *Cotesia*

glomerata. Leaves treated with β -galactosidase from almonds respond in a similar manner, which shows that this compound acts as an “elicitor” (Mattiacci et al. 1995). *Zea mays* plants attacked by larvae of *Spodoptera frugiperda* and *Spodoptera exigua* (armyworms) respond to a specific compound [*N*-(17-hydroxylinolenoyl)-L-glutamine, or volicitin] (Alborn et al. 1997). Upon attack, they emit terpenoids and indole that attract a parasitic wasp, *Cotesia marginiventris*. Mechanical damage, without application of volicitin, does not trigger the same blend of compounds. When infested by the larvae of *Pseudaletia separata*, the corn plants emit terpenoids, indole, oximes, and nitriles that attract *Cotesia kariyai*. The production of the attractants is **systemic**. In other words, it is not restricted to the damaged parts of the plant, but also occurs in undamaged leaves; a similar systemic response occurs in *Gossypium hirsutum* (cotton) that are

attacked by larvae of the beet armyworm (*Spodoptera exigua*) (Röse et al. 1996).

Several crop species infested by the herbivorous two-spotted spider mite, *Tetranychus urticae*, or larvae of *Spodoptera exigua* (beet armyworm) become attractive to a predatory mite, *Phytoseiulus persimilis* and *Cotesia marginiventris*, respectively (Fig. 18). Many plant species respond to arthropod attack with the release of a blend of volatiles that attract predators or parasitic wasps. Each species, however, produces its own blend of chemicals that attract their **bodyguards**. Feeding of the two-spotted spider mite on the leaves of *Phaseolus lunatus* (lima bean) or *Cucumis sativus* (cucumber) strongly induces a sesquiterpene synthase, which catalyzes the formation of a volatile attractant from a precursor (Bouwmeester et al. 1999). The bodyguards can learn to distinguish between herbivore-induced volatiles emitted by different species. The attractants produced by *Phaseolus lunatus* are presented in Fig. 19. There is substantial genetic variation in the amount of attractants produced upon attack on which natural selection can act (Baldwin et al. 2006). This provides substantial scope for breeding efforts to exploit this aspect of ecological biochemistry. Tritrophic interactions are not restricted to above-ground plant organs and interacting animals. For example, *Thuja occidentalis* releases chemicals upon attack by larvae of *Otiiorhynchus sulcatus* (a weevil) and thus attracts *Heterorhabditis megidis* (a parasitic nematode), which then preys on the weevil larvae (Van Tol et al. 2001). Similar **below-ground tritrophic interactions** occur in *Zea mays* (corn). Upon attack by beetle larvae, their roots release a sesquiterpene, (*E*)- β -caryophyllene, which attracts entomopathogenic nematodes and increases the effectiveness of these nematodes in finding and killing herbivore larvae (Rasmann et al. 2005, Turlings & Ton 2006). Improved knowledge in this area should provide opportunities for applications in plant management systems, similar to those existing for above-ground tritrophic interactions (Turlings & Wäckers 2004).

A fascinating example of a tritrophic interaction is found in *Nicotiana attenuata* (wild tobacco), which contains high levels of the alkaloid nicotine (up to 12% of the dry mass of leaves). Upon attack by most herbivores, **jasmonic acid** is produced, which is transported via the phloem to the roots. Here, it induces the production of more nicotine, which is transported to the leaves, via the xylem, where it accumulates to even higher levels than in control plants. When a specialist caterpillar, *Manduca sexta* (tobacco hawkmoth) attacks *Nicotiana attenuata*, however, there is no increased synthesis and accumulation of nicotine. Rather,

bodyguards are attracted, involving specific signals, like in the examples given above. The bodyguards can kill the specialist caterpillar, without being affected by increased nicotine levels in the caterpillar. That is, in this case, suppression of the transduction pathway that leads to increased nicotine levels in the leaves is advantageous for the host plant (Kahl et al. 2000).

5. The Costs of Chemical Defense

The production of secondary plant compounds requires **investment** of carbon, as well as some other elements. Does this mean that a gram of biomass is more costly to produce if it contains large quantities of secondary plant compounds? This is not so when costs are expressed in terms of grams of glucose required for carbon skeletons and for production of energy to produce the biomass. Approximately equal amounts of glucose are needed to produce 1 g of dry mass in slow-growing herbaceous species (which contain relatively small amounts of phenolic compounds) and fast-growing ones (Fig. 20; Sect. 5 of Chapter 2B on plant respiration). Per gram of fresh mass or per unit leaf area, the situation is different, but this is due to the lower water content or thicker leaves of the slow-growing species.

5.1 Diversion of Resources from Primary Growth

There are **costs** associated with the strategy of accumulating vast quantities of secondary plant compounds. This can best be illustrated by imagining a leaf with a certain amount of protein. If half of this protein were to be replaced by lignin or tannin, then its physiological performance would probably be less. It is quite likely that its photosynthetic capacity would decline by approximately half. The higher costs of well-protected leaves, therefore, do not reflect high costs of the production of new leaves. Rather, defense is costly because it diverts resources from primary growth (an opportunity cost, i.e., the cost of resources that would otherwise be gained by an alternative allocation) (Herms & Mattson 1992) which reduces the potential growth rate of the plant.

Investment of large quantities of carbon in secondary plant compounds that reduce herbivory will lead to greater plant fitness only when the costs of repairing the damage incurred by herbivory exceed those needed for protection. This explains why quantitatively important secondary plant

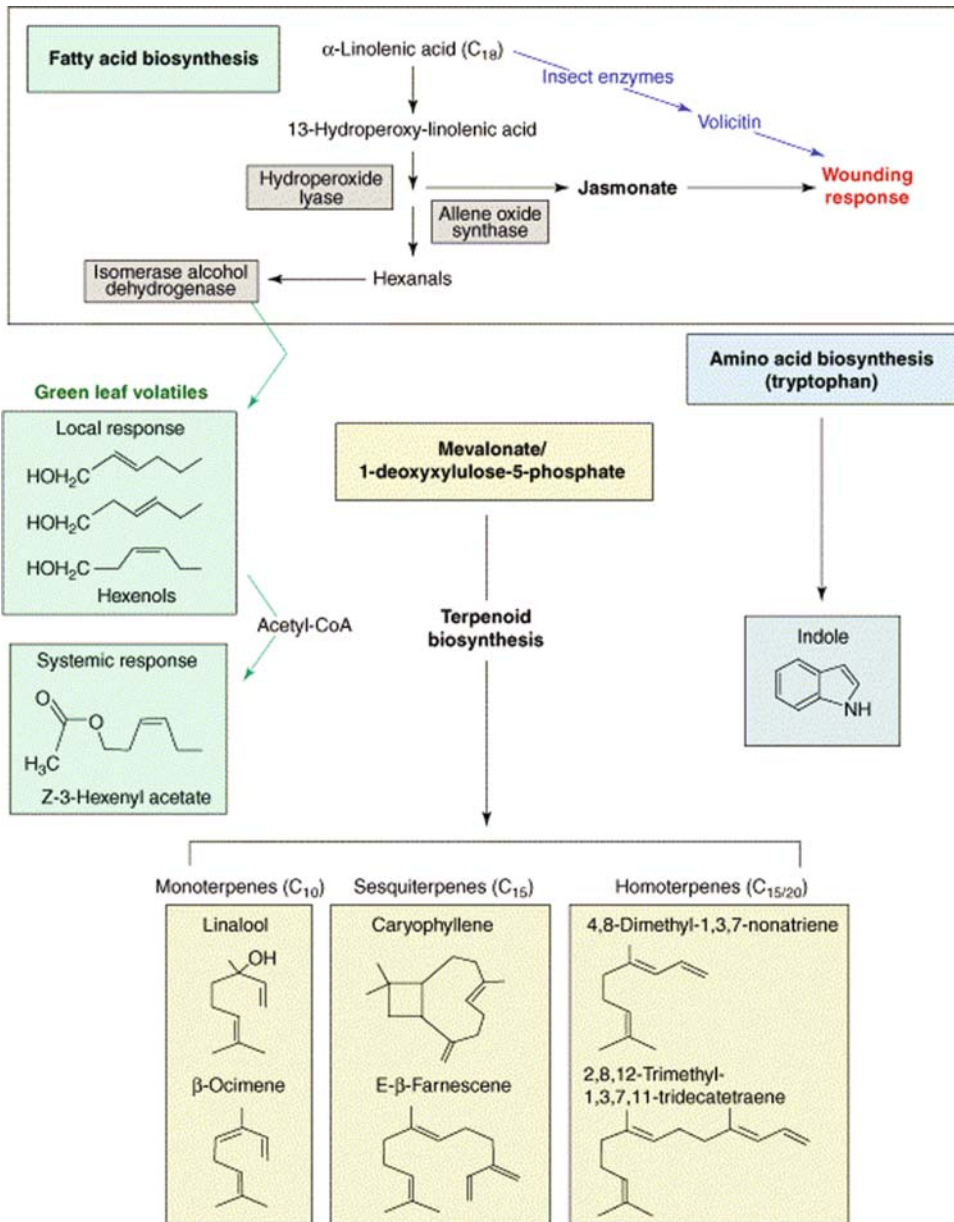

FIGURE 19. General overview of plant volatiles synthesized in response to insect attack, either both locally or systemically (after Ferry et al. 2004; copyright Elsevier Science, Ltd.).

compounds are more pronounced in inherently slow-growing species from low-productivity environments than they are in fast-growing ones from more productive habitats. On one hand, costs select against defensive adaptations, whereas on the other hand herbivore pressure leads to investment in defense. Defensive adaptations may then lead to offensive adaptations in

animals (e.g., the co-evolution of fluoroacetate-bearing legumes and Western Australian native animals) (Fig. 21). When costs of defense have been evaluated by comparing fitness of resistant and susceptible genotypes in the absence of herbivores or pathogens, the costs of resistance appear small (Vrieling & Wijk 1994, Bergelson & Purrington 1996); however, most of these tests

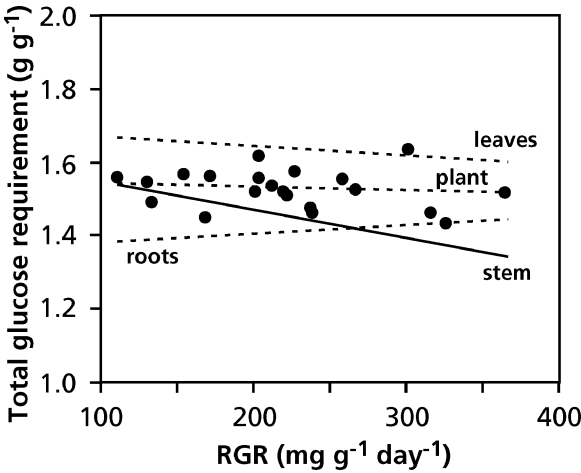

FIGURE 20. The amount of glucose required to produce biomass in slow-growing and fast-growing herbaceous species, all grown with free access to nutrients. Glucose costs include the costs for the carbon in the biomass as well as those associated with the formation of biomass, for which glucose has to be catabolized to generate ATP and NAD(P)H (Poorter & Bergkotte 1992). Copyright Blackwell Science Ltd.

have been done on rapidly growing species where we would not expect a large cost of defense.

5.2 Strategies of Predators

Two strategies may be discerned among the offensive adaptations of animals (Fig. 22). The evolutionary response to communication between plants which leads to the accumulation of protective compounds in neighboring plants may be to **suppress the communication** or to emit **countersignals**. The response to the accumulation of protective compounds in plants upon recognition of a predator

may be either to **suppress recognition** of the predator or to **consume** the plant quickly and so prevent protection (surprise). Inducible defenses may be counteracted by **suppression** of the induced defense or by decreasing the defense. Constitutive defense may be counteracted by detoxification or avoidance of the most toxic plant parts (Karban & Agrawal 2002). In addition, prior attack of *Nicotiana attenuata* (wild tobacco) by some insects, e.g., the sap-feeding *Tupiocoris notatus*, results in “**vaccination**” of the tobacco plant against subsequent attacks by chewing hornworms (*Manduca sexta*). This vaccination is mediated by a combination of direct and indirect defenses (Voelckel & Baldwin 2004, Kessler 2006).

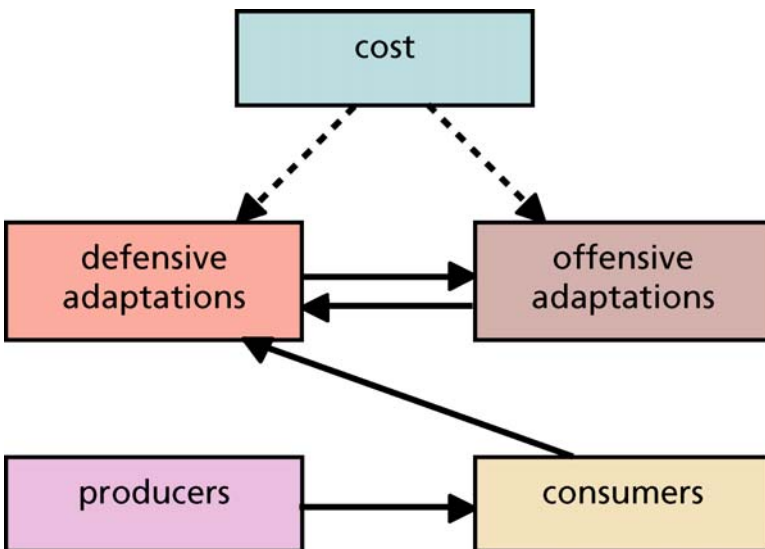

FIGURE 21. Interactions between higher plants and animals involving secondary plant compounds. Attack by herbivores leads to the evolution of protection with defense compounds (defensive adaptations in producers). At the same time, there is a selection against production of defense compounds because it incurs a cost. Defensive adaptations in plants lead to the evolution of offensive adaptations in consumers. These offensive adaptations are selected against because they incur some costs (after Rhoades 1985).

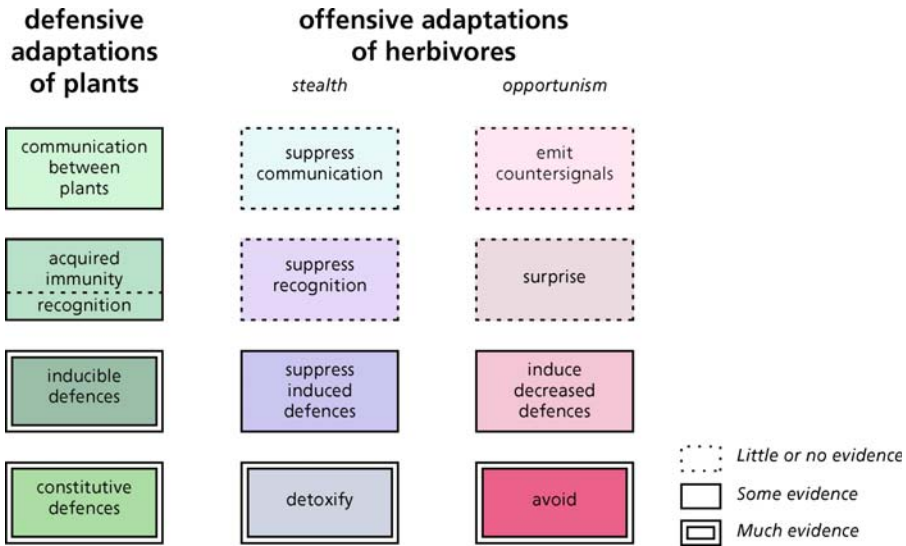

FIGURE 22. The evolutionary strategy of “stealthy” and “opportunistic” animals to cope with the defensive adaptations of plants (after Rhoades 1985).

5.3 Mutualistic Associations with Ants and Mites

Instead of investing in defense compounds, plants can also form a **mutualistic association** with animals that protect them. Several thousand seed plants have extrafloral nectaries that indicate some level of **ant defense**. Most of these mutualistic associations involve a limited co-evolved specialization between the partners. A small number of plant species that attract ants for their defense [e.g., species belonging to the genera *Acacia* (wattle), *Cecropia*, and *Macaranga*] have obligate or facultative relationships with a single ant species. *Acacia* species that form an obligate relationship provide their allies with nectar, lipids, and proteins in special structures, and shelter in special plant parts (**domatia**). The resident ants are very aggressive and defend the tree against both invertebrate and vertebrate herbivores. Some of these species have lost their major line of chemical defense against herbivores, and the tree is quickly destroyed if the ants are removed. The costs of ant defense (production of extrafloral nectaries), therefore, are partly compensated for by lower costs of chemical defense (Heil et al. 2001). However, there are additional benefits in that the ants bring in substantial resources, and most of the N that is accumulated in *Cecropia peltata* (trumpet tree) trees is derived from debris deposited by its mutualistic *Azteca* ants (Fig. 23; Sagers et al. 2000).

The defending ants form a potential risk, however, because the plants still need a suite of insect **pollinators** for cross-pollination (Pellmyr 1997). Observations on the African *Acacia zanzibarica* reveal that ants quickly abandon first-day flowers when they encounter them, and return after pollinator activity ceases. It is likely that a volatile that triggers alarm behavior in ants is produced by flowers before pollination has occurred, but this has yet to be confirmed (Willmer & Stone 1997).

In addition to ants, predatory mites may also inhabit domatia, e.g., on leaves of *Cupania vernalis* in south-east Brazil. Blocking leaf domatia shows that leaf domatia can benefit plants against herbivory in a natural system (Romero & Benson 2004).

6. Detoxification of Xenobiotics by Plants: Phytoremediation

Plants, like any other organisms in the environment, are continually exposed to potentially toxic chemicals: **xenobiotics**. These xenobiotics may be natural secondary plant chemicals, which we discussed in this chapter, industrial pollutants, or agrochemicals. Many xenobiotics are lipophilic; they are therefore readily absorbed and accumulate to toxic levels within the plant, unless effective means of detoxification are present. If plants have pathways to



FIGURE 23. An example of a mutualistic association between an ant plant and an ant. (Top left) *Cecropia peltata* growing in the cerrado in Brazil. (Bottom left) Trunk of *Cecropia peltata* showing one of the many entry points for *Azteca xanthochroa* (Aztec ant, an ant species defending the tree). The base of each petiole bears a trichilium, a pad of densely packed trichomes,

from which emerge 1–2 mm long glycogen-containing beads called Muellerian bodies. (Top right) An individual of an Aztec ant exiting the special hole in the stem, and another one descending from the stem. (Bottom right) Cross-section of the stem of *Cecropia peltata*, showing the hollow stem and perforated internodes, large enough for Aztec ants to move up and down the stem.

produce and cope with a vast array of natural secondary chemicals, can they also be put to use to clean up environmental pollutants? In Sect. 3.3.2 of Chapter 6 on mineral nutrition, we discuss the capacity of **metallophytes** to clean up inorganic pollutants. In this section we discuss the capacity of some plants to detoxify **organic pollutants** (Cunningham & Berti 1993).

The cellular detoxification systems of plants dispose of the xenobiotics by two sequential processes (Coleman et al. 1997):

1. Chemical modification
2. Compartmentmentatation

The reactions responsible for chemical modification of lipophilic xenobiotics involve hydrolysis or oxidation that makes the chemicals more hydrophilic and creates reactive sites by the addition or exposure of functional groups (e.g., hydroxyl or carboxyl groups) (step I); the modified chemicals may still be toxic. If the xenobiotic already has a functional group that is suitable for conjugation, then there is no need for step I. The next step is the conjugation of

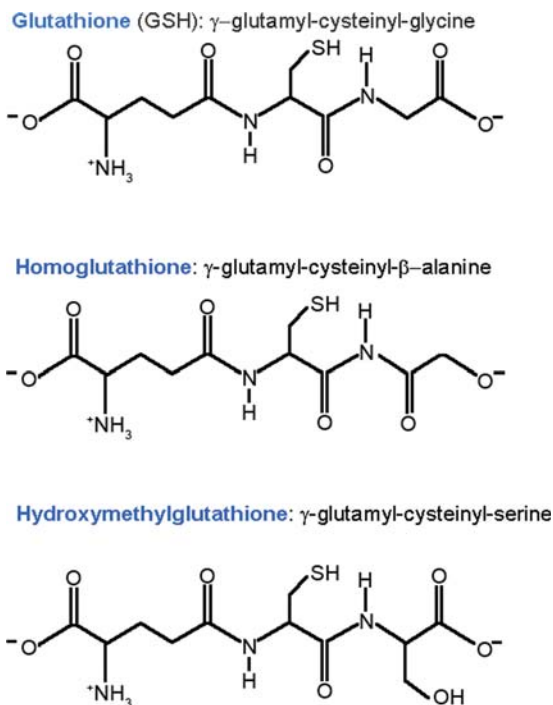

FIGURE 24. Structures of γ -glutamyl-cysteinyl tripeptides that act as protective chemicals in plants. Glutathione is the major protective tripeptide in most plants. Some leguminous species [e.g., *Vigna unguiculata* (mung bean) and *Glycine max* (soybean)] produce homoglutathione. In some grasses hydroxymethyl glutathione is a major constituent (Coleman et al. 1997).

the modified xenobiotic (phase II), followed by export from the cytosol (step III).

Hydrolysis of the xenobiotics in phase I is catalyzed by various esterases and amidases, but the major reactions are oxidations catalyzed by the **cytochrome P-450** system, which involves mono-oxygenases that insert one atom of oxygen into inert hydrophobic molecules to make them more reactive and water-soluble (Werck-Reichhardt et al. 2000). The rates of chemical transformation and the types of metabolites that are formed depend on plant genotype and accounts for variation in **herbicide resistance** and **tolerance to pollutants**. In phase II, the (modified) xenobiotic is deactivated by covalent linkage to endogenous hydrophilic molecules (e.g., glucose, malonate, or glutathione) which produces a water-soluble nontoxic conjugate. Export of the conjugates from the cytosol to the vacuole or apoplast (phase III) occurs by membrane-located transport proteins. This detoxification pathway shares many features with the pathway used by plants for the vacuolar deposition of secondary metabolites (e.g., anthocyanins).

One important detoxification mechanism is chemical modification of the xenobiotic by covalent linkage to tripeptides like **glutathione** (Fig. 24). Conjugation with xenobiotics may take place spontaneously or may require catalysis by glutathione-S-transferase. Glutathione is an important plant metabolite that acts both as a reducing agent that protects the cell against oxidative stress (Sects. 2.2.2 and 3.1 of Chapter 4B on effects of radiation and temperature) and guards against chemical toxicity via the modification reactions of phase II. Glutathione conjugates that are deposited in the vacuole can undergo further metabolism. For example, the glycine residue of the glutathione moiety may be removed enzymatically which is sometimes followed by enzymatic removal of the glutamic acid residue (Fig. 25).

The glutathione-mediated and related detoxification systems probably evolved for the metabolism and compartmentation of natural substrates. For example, a glutathione-S-transferase is required for the synthesis of **anthocyanins**; it produces a glutathione conjugate that can be transported to the vacuole. Cytochrome P-450 is, similarly, involved in anthocyanin biosynthesis. Therefore, the selective mechanisms that led to the catalytic proteins of the pathway that has an apparent specificity for industrial chemicals are probably associated with the metabolism of natural secondary plant products, including allelochemicals and pigments (Alfenito et al. 1998).

Higher plants, unlike microorganisms and animals, are unable to catabolize xenobiotics; instead, detoxification mechanisms have evolved that lead to the formation of water-soluble conjugates that are compartmented in the vacuole or deposited in the apoplast. The residues may persist in plant tissues for a considerable time, and may affect consumers of the plant tissues. A thorough understanding of the metabolic fate of xenobiotics is therefore important. Genetic engineering of crops with plant or bacterial genes has already produced transgenics that are resistant to herbicides and air pollutants. In time, similar approaches may lead to workable strategies to develop the **phytoremediation** of land polluted by industrial chemicals (Cunningham & Berti 1993, Coleman et al. 1997).

Plants can also detoxify air pollutants, for example, ozone, which is increasing in the lower atmosphere as a result of human activity. Ozone damage of sensitive plants is a common phenomenon in North America and Europe. Exposure of the needles of *Picea abies* (Norway spruce) enhances the levels of three enzymes involved in ozone detoxification:

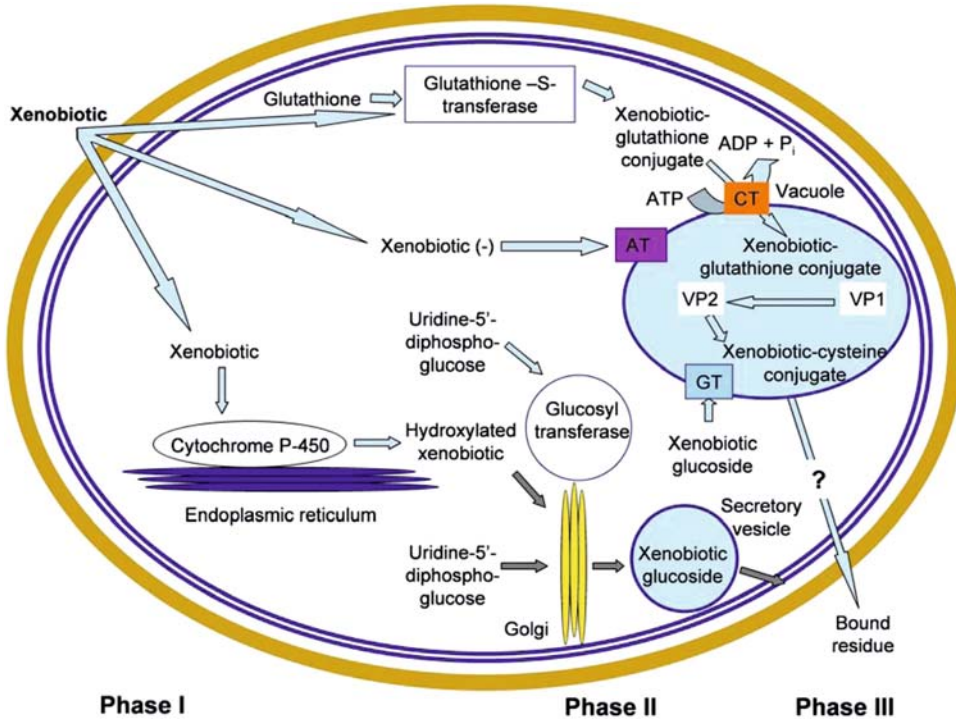

FIGURE 25. Enzyme-catalyzed reactions that are responsible for the detoxification of xenobiotics in plants are localized in or associated with several organelles and cellular compartments. The gray arrows represent a proposed pathway for the glucosylation of xenobiotics in the Golgi, followed by release of the metabolites via exocytosis. CT, glutathione-conjugate; AT, ATP-

dependent xenobiotic anion transporter; GT, ATP-dependent glucoside-conjugate transporter; VP, vacuolar peptidases that catalyze the removal of glycine (VP1) and glutamic acid (VP2) from the glutathione moiety of the conjugate. For further explanation, see text (after Coleman 1997).

superoxide dismutase, ascorbate peroxidase, and glutathione reductase (Sehmer et al. 1998).

7. Secondary Chemicals and Messages That Emerge from This Chapter

Plants produce a wealth of secondary plant compounds that play a pivotal role in defense and communication. We are only just beginning to understand how plants communicate with their neighbors, symbionts, pathogens, herbivores, and with their personal "bodyguards", both above and below ground, via chemical signals, which are often very specific. This new area is fascinating from an ecological point of view, and it has tremendous potential for major applications in agriculture, forestry, and environmental science. For example, **intercrops** can be selected that protect a crop in an

environmentally friendly manner (Sect. 6.2 in Chapter 9E on interactions among plants). For the intercrop to be of maximum benefit, however, intercrops should not compete to any great extent with the crop plant. It is up to ecophysiologicals to help define desirable traits of an intercrop, with respect to its secondary chemistry, and also in terms of root traits that minimize competitive ability of the intercrop or, even better, that are beneficial to the crop. Numerous pertinent traits can be found in this and preceding chapters to help identify a desirable intercrop. Plants can also be used for phytoremediation, to remove organic pollutants from the environment or to reduce the concentration of air pollutants, such as ozone.

Knowledge of the chemical compounds that protect plants, preferably with full identification of the genes encoding the traits, will allow us to design crop plants that are better protected against herbivores. Such plants will reduce the need for pesticides, and many examples are now available of

transgenic plants with enhanced protection. We should be aware, however, that the arms race between plants and herbivores will continue, and that for every newly designed crop genotype resistant herbivores will coevolve. A thorough understanding of the intricate chemical interactions between plants and their herbivores is required to optimize the production of new crops.

References

- Alborn, H.T., Turlings, T.C.J., Jones, T.H., Stenhagen, G., Loughrin, J.H., & Tumlinson, J.H. 1997. An elicitor of plant volatiles from beet armyworm oral secretion. *Science* **276**: 945–949.
- Alfenito, M.R., Souer, E., Goodman, C.D., Buell, R., Mol, J., Koes, R., & walbot, V. 1998. Functional complementation of anthocyanin sequestration in the vacuole by widely divergent glutathione S-transferases. *Plant Cell* **10**: 1135–1149.
- Ayres, M.P., Clausen, T.P., Redman, A.M., & Reichardt, P.B. 1997. Diversity of structure and antitherbivore activity in condensed tannins. *Ecology* **78**: 1696–1712.
- Bais, H.P., Park, S.-W., Weir, T.L., Callaway, R.M., & Vivanco, J.M. 2004. How plants communicate using the underground information superhighway. *Trends Plant Sci.* **9**: 26–32.
- Bais, H.P., Wier, T.L., Perry, L.G., Gilroy, S., & Vivanco, J.M. 2006. The role of root exudates in rhizosphere interactions with plants and other organisms. *Annu. Rev. Plant Biol.* **57**: 233–266.
- Baldwin, I.T. 1999. Inducible nicotine production in native *Nicotiana* as an example of adaptive phenotypic plasticity. *J. Chem. Ecol.* **25**: 3–30.
- Baldwin, I.T., Halitschke, R., Paschold, A., Vn Dahl, C.C., & Preston, C.A. 2006. Volatile signaling in plant-plant interactions: “talking trees” in the genomics era. *Science* **311**, 812–815.
- Bartholomew, B. 1970. Bare zone between California shrub and grassland communities: the role of animals. *Science* **170**: 1210–1212.
- Bennett, R.N. & Wallsgrove, R.M. 1994. Secondary metabolites in plant defence mechanisms. *New Phytol.* **127**: 617–633.
- Bergelson, J. & Purrington, C.B. 1996. Surveying patterns in the cost of resistance in plants. *Am. Nat.* **148**: 536–558.
- Birkett, M.A., Chamberlain, K., Hooper, A.M., & Pickett, J.A. 2001. Does allelopathy offer real promise for practical weed management and for explaining rhizosphere interactions involving higher plants? *Plant Soil* **232**: 31–39.
- Bouwmeester, H.J., Verstappen, F.W.A., Posthumus, M.A., & Dicke, M. 1999. Spider mite-induced (SS)-(E)-nerolidol synthase activity in cucumber and lima bean. The first dedicated step in acyclic C11-homoterpene biosynthesis. *Plant Physiol.* **121**: 173–180.
- Bryant, J.P., Chapin III, F.S., & Klein, D.R. 1983. Carbon/nutrient balance of boreal plants in relation to vertebrate herbivory. *Oikos* **40**: 357–368.
- Bryant, J.P., Tahvanainen, J., Sulkinoja, M., Julkunen-Titto, R., Reichardt, P., & Green, T. 1989. Biogeographic evidence for the evolution of chemical defense by boreal birch and willow against mammalian browsing. *Am. Nat.* **134**: 20–34.
- Bryant, J.P., Heitkonig, I., Kuropat, P., & Owen-Smith, N. 1991. Effects of severe defoliation on the long-term resistance to insect attack and on leaf chemistry in six woody species of the southern African savanna. *Am. Nat.* **137**: 50–63.
- Bryant, J.P., Reichardt, P.B., Clausen, T.P., Provenza, F.D., & Kuropat, P.J. 1992. Woody plant-mammal interactions. In: *Herbivores: their interactions with secondary plant metabolites*. Vol II, Ecological and evolutionary processes, 2nd edition, G.A. Rosenthal (ed). Academic Press, San Diego, pp. 343–370.
- Carlini, C.R. & Grossi-de-Sá, M.F. 2002. Plant toxic proteins with insecticidal properties. A review on their potentialities as bioinsecticides. *Toxicon* **40**: 1515–1539.
- Cates, R.G. & Orians, G.H. 1975. Successional status and the palatability of plants to generalized herbivores. *Ecology* **56**: 410–418.
- Chitwood, D.J. 2002. Phytochemical based strategies for nematode control. *Annu. Rev. Phytopathol.* **40**: 221–249.
- Chou, C.-H. & Kuo, Y.-L. 1986. Allelopathic research of subtropical vegetation in Taiwan. III. Allelopathic exclusion of understory by *Leucaena leucophylla* (Lam.) de Wit. *J. Chem. Ecology* **12**: 1431–1448.
- Clausen, T.P., Reichardt, P.B., Bryant, J.P., Werner, R.A., Post, K., & Frisby, K. 1989. A chemical model for short-term induction in quaking aspen (*Populus tremuloides*) foliage against herbivores. *J. Chem. Ecol.* **15**: 2335–2346.
- Coley, P.D. 1986. Costs and benefits of defense by tannins in a neotropical tree. *Oecologia* **70**: 238–241.
- Coley, P.D., Bryant, J.P., & Chapin III, F.S. 1985. Resource availability and plant anti-herbivore defense. *Science* **230**: 895–899.
- Coleman, J.O.D., Blake-Kalff, M.M.A., & Davies, T.G.E. 1997. Detoxification of xenobiotics by plants: Chemical modification and vacuolar compartmentation. *Trends Plant Sci.* **2**: 144–151.
- Constabel, C.P., Yip, L., Patton, J.J., & Christopher, M.E. 2000. Polyphenol oxidase from hybrid poplar. Cloning and expression in response to wounding and herbivory. *Plant Physiol.* **124**: 285–295.
- Cunningham, S.D. & Berti, W.R. 1993. Remediation of contaminated soils with green plants: an overview. *In Vitro Cell Dev. Biol.* **29P**: 207–212.
- Dell, B. & McComb, A.J. 1974. Resin production and glandular hairs in *Beyeria viscosa* (Labill.) Miq. (Euphorbiaceae). *Aust. J. Bot.* **25**: 195–210.
- De Luca, V. & St Pierre, B. 2000. The cell and developmental biology of alkaloid biosynthesis. *Trends Plant Sci.* **5**: 168–173.
- Dicke, M. & Dijkman, H. 2001. Within-plant circulation of systemic elicitor of induced defence and release from roots of elicitor that affects neighbouring plants. *Biochem. Syst. Ecol.* **29**: 1075–1087.
- Dicke, M., Agrawal, A.A. & Bruin, J. 2003. Plant talk, but are they deaf? *Trends Plant Sci.* **8**: 403–405.

- Ding, J., Sun, Y., Xiao, C.L., Shi, K., Zhou, Y.H., & Yu, J.Q. 2007. Physiological basis of different allelopathic reactions of cucumber and figleaf gourd plants to cinnamic acid. *J. Exp. Bot.* **58**: 3765–3773.
- Dirzo, R. & Raven, P.H. 2003. Global state of biodiversity and loss. *Annu. Rev. Environ. Res.* **28**: 137–167.
- Dolch, R. & Tschardt, T. 2000. Defoliation of alders (*Alnus glutinosa*) affects herbivory by leaf beetles on undamaged neighbours. *Oecologia* **125**: 504–511.
- Eckstein-Ludwig, U., Webb, R.J., Van Goethem, I.D.A., East, J.M., Lee, A.G., Kimura, M., O'Neill, P.M., Bray, P.G., Ward, S.A., & Krishna, S. 2003. Artemisinins target the SERCA of *Plasmodium falciparum*. *Nature* **424**: 957–961.
- Ehrlich, P.R. & Raven, P.H. 1964. Butterflies and plants: A study in coevolution. *Evolution* **18**: 586–608.
- Etzler, M.E. 1985. Plant lectins: Molecular and biological aspects. *Annu. Rev. Plant Physiol.* **36**: 209–234.
- Feng, Z. & Hartel, P.G. 1996. Factors affecting production of COS and CS₂ in *Leucaena* and *Mimosa* species. *Plant Soil* **178**: 215–222.
- Ferry, N., Martin, G., Edwards, M.G., Gatehouse, J.A., & Gatehouse, A.M.R. 2004. Plant-insect interactions: molecular approaches to insect resistance. *Curr. Opin. Biotechnol.* **15**: 1–7.
- Flores, H.E., Vivanco, J.M., Loyola-Vargas, V.M. 1999. "Radicle" biochemistry: the biology of root-specific metabolism. *Trends Plant Sci.* **4**: 220–226.
- Franceschi, V.R., Krekling, T., Berryman, A.A., & Christiansen, E. 1998. Specialized phloem parenchyma cells in Norway spruce (Pinaceae) bark are an important site of defense reactions. *Am. J. Bot.* **85**: 601–615.
- Gatehouse, J.A. 2002. Plant resistance towards insect herbivores: a dynamic interaction. *New Phytol.* **156**: 145–169.
- Gershenson, J. 1984. Changes in the levels of plant secondary metabolites under water and nutrient stress. In: Phytochemical adaptations to stress, B.N. Timmermann, C. Steelink, & E.A. Leowus (eds). Plenum Press, New York, pp. 273–320.
- Giri, A.P., Harsulkar, A.M., Deshpande, V.V., Sainani, M.N., Gupta, V.S., & Ranjekar, P.K. 1998. Chickpea defensive proteinase inhibitors can be inactivated by podborer gut proteinases. *Plant Physiol.* **116**: 393–401.
- Gleadow, R.M., Foley, W.J., & Woodrow, I.E. 1998. Enhanced CO₂ alters the relationship between photosynthesis and defence in cyanogenic *Eucalyptus cladocalyx* F. Muell. *Plant Cell Environ.* **21**: 12–22.
- Greenwood, J.S., Stinissen, H.M., Peumans, W.J., & Chrispeels, M.J. 1986. *Sambucus nigra* agglutinin is located in protein bodies in the phloem parenchyma of the bark. *Planta* **167**: 275–278.
- Guerrieri, E., Poppy, G.M., Powell, W., Rao, R., & Pennacchio, F. 2002. Plant-to-plant communication mediating in-flight orientation of *Aphidius ervi*. *J. Chem. Ecol.* **28**: 1703–1715.
- Halkier, B.A. & Gershenson, J. 2006. Biology and biochemistry of glucosinolates. *Annu. Rev. Plant Biol.* **57**: 303–333.
- Hamilton, J.G., Zangerl, A.R., DeLucia, E.H., & Berenbaum, M.R. 2001. The carbon-nutrient balance hypothesis: its rise and fall. *Ecol. Lett.* **4**: 86–95.
- Harborne, J.B. 1988. Introduction to ecological biochemistry. Academic Press, New York.
- Hartley, M.R., Chaddock, J.A., & Bonness, M.S. 1996. The structure and function of ribosome-inactivating proteins. *Trends Plant Sci.* **1**: 254–260.
- Hartmann, T. 1999. Chemical ecology of pyrrolizidine alkaloids. *Planta* **207**: 483–495.
- Hashimoto, T. & Yamada, Y. 1994. Alkaloid biogenesis: molecular aspects. *Annu. Rev. Plant Physiol. Plant Mol. Biol.* **45**: 257–285.
- Haukioja, E. 1980. On the role of plant defenses in the fluctuations of herbivore populations. *Oikos* **35**: 202–213.
- Haukioja, E. & Neuvonen, S. 1985. Induced long-term resistance of birch foliage against defoliators: Defensive or incidental. *Ecology* **66**: 1303–1308.
- Heil, M. & Baldwin, I.T. 2002. Fitness costs of induced resistance: emerging experimental support for a slippery concept. *Trends Plant Sci.* **7**: 61–67.
- Heil, M., Fiala, B., Maschwitz, U., & Linsenmaier, K.U. 2001. On benefits of indirect defence: short- and long-term studies of antiherbivore protection via mutualistic ants. *Oecologia* **126**: 395–403.
- Heinstein, P.F. & Chang, C.-J. 1994. Taxol. *Annu. Rev. Plant Physiol. Plant Mol. Biol.* **45**: 663–674.
- Hermes, D.A. & Mattson, W.J. 1992. The dilemma of plants: to grow or defend. *Quart. Rev. Biol.* **67**: 283–325.
- Hilder, V.A., Powell, K.S., Gatehouse, A.M.R., Gatehouse, J.A., Gatehouse, L.N., Shi, Y., Hamilton, W.D.O., Merryweather, A., Newell, C.A., Timans, J.C., Peumans, W.J., Van Damme, E., & Boulter, D. 1995. Expression of snowdrop lectin in transgenic tobacco plants results in added protection against aphids. *Transgenic Res.* **4**: 18–25.
- Ishimoto, M. & Chrispeels, M.J. 1996. Protective mechanism of the Mexican bean weevil against high levels of α -amylase inhibitor in the common bean. *Plant Physiol.* **111**: 393–401.
- Jhee, E.M., Boyd, R.S., & Eubanks, M.D. 2005. Nickel hyperaccumulation as an elemental defense of *Strepantanthus polygaloides* (Brassicaceae): influence of herbivore feeding mode. *New Phytol.* **168**: 331–344.
- Jose, S. & Gillespie, A.R. 1998a. Allelopathy in black walnut (*Juglans nigra* L.) alley cropping. I. Spatio-temporal variation in soil juglone in a black walnut-corn (*Zea mays* L.) alley cropping system in the midwestern USA. *Plant Soil* **203**: 191–197.
- Jose, S. & Gillespie, A.R. 1998b. Allelopathy in black walnut (*Juglans nigra* L.) alley cropping. II. Effects of juglone on hydroponically grown corn (*Zea mays* L.) and soybean (*Glycine max* L. Merr.) growth physiology. *Plant Soil* **203**: 199–205.
- Kahl, J., Siemens, D.H., Aerts, R.J., Gaebler, R., Kuehnemann, F., Preston, C.A. & Baldwin, I.T. 2000. Herbivore-induced ethylene suppresses a direct defense but not a putative indirect defense against an adapted herbivore. *Planta* **210**: 336–342.
- Kakes, P. 1990. Properties and functions of the cyanogenic system in higher plants. *Euphytica* **48**: 25–43.
- Karban, R. & Agrawal, A.A. 2002. Herbivore offense. *Annu. Rev. Ecol. Syst.* **33**: 641–664.
- Karban, R., Baldwin, I.T., Baxter, K.J., Laue, G., & Felton, G.W. 2000. Communication between plants: induced

- resistance in wild tobacco plants following clipping of neighboring sagebrush. *Oecologia* **125**: 66–71.
- Karban, R., Maron, J., Felton, G.W., Ervin, G., & Eichenseer, H. 2003. Herbivore damage to sagebrush induces resistance in wild tobacco: evidence for eavesdropping between plants. *Oikos* **100**: 325–332.
- Katsvairo, T.W., Rich, J.R., & Dunn, R.A. 2006. Perennial grass rotation: an effective and challenging tactic for nematode management with many other positive effects. *Pest Manage. Sci.* **62**: 793–796.
- Kessler, A. 2006. Plant–insect interactions in the era of consolidation in biological sciences. *Nicotiana attenuata* as an ecological expression system. In: Chemical ecology: from gene to ecosystem, M. Dicke & W. Takken (eds.), Springer, Dordrecht, pp. 19–37.
- Kimmerer, T.W. & Potter, D.A. 1987. Nutritional quality of specific leaf tissues and selective feeding by a specialist leafminer. *Oecologia* **71**: 548–551.
- Koch, K.E. 1996. Carbohydrate-modulated gene expression in plants. *Annu. Rev. Plant Physiol. Plant Mol. Biol.* **47**: 509–540.
- Koiwa, H., Bressan, R.A., & Hasegawa, P.M. 1997. Regulation of protease inhibitors and plant defense. *Trends Plant Sci.* **2**: 379–384.
- Korth, K.L. & Dixon, R.A. 1997. Evidence for chewing insect-specific molecular events distinct from a general wound response in leaves. *Plant Physiol.* **115**: 1299–1305.
- Lambers, H. & Poorter, H. 2004. Inherent variation in growth rate between higher plant: A search for physiological causes and ecological consequences. *Adv. Ecol. Res.* **34**: 283–362.
- Lata, J.-C., Degrange, V., Raynaud, X., Maron, P.-A., Lensi, R., & Abbadie, L. 2004. Grass populations control nitrification in savanna soils. *Funct. Ecol.* **18**: 605–611.
- Lerdau, M., Litvak, M., Palmer, P., & Monson, R. 1997. Controls over monoterpene emissions from boreal forest conifers. *Tree Physiol.* **17**: 563–569.
- Leung, T.-W. C., Williams, D.H., Barna, J.C.J., Foti, S., & Oelrichs, P.B. 1986. Structural studies on the peptide moroidin from *Laporta moroides*. *Tetrahedron* **42**: 3333–3348.
- Lieberer, R., Biehl, B., Giesemann, A., & Junqueira, N.T.V. 1989. Cyanogenesis inhibits active defense reactions in plants. *Plant Physiol.* **90**: 33–36.
- Loomis, W.E. 1932. Growth-differentiation balance vs. carbohydrate-nitrogen ratio. *Proc. Am. Soc. Hortic. Sci.* **29**: 240–245.
- Lord, J.M. & Roberts, L.M. 1996. The intracellular transport of ricin: Why mammalian cells are killed and how *Ricinus* cells survive. *Plant Physiol. Biochem.* **34**: 253–261.
- Lorio, P.L., Jr. 1986. Growth-differentiation balance: A basis for understanding southern pine beetle-tree interactions. *For. Ecol. Manage.* **14**: 259–273.
- Macías, F.A., Oliveros-Bastidas, A., Marin, D., Castellano, D., Simonet, A.M., & Molinillo, J.M.G. 2005. Degradation studies on benzoxazinoids. Soil degradation dynamics of (2R)-2-O- β -D-glucopyranosyl-4-hydroxy-(2H)-1,4-benzoxazin-3(4H)-one (DIBOA-Glc) and its degradation products, phytotoxic allelochemicals from Gramineae. *J. Agric. Food Chem.* **53**: 554–561.
- Mattiacci, L., Dicke, M., & Posthumus, M.A. 1995. β -galactosidase: An elicitor of herbivore-induced plant odor that attracts host-searching parasitic wasps. *Proc. Natl. Acad. Sci. USA* **92**: 2036–2040.
- McKey, D., Waterman, P.G., Mbi, C.N., Gartlan, J.S., & Struhsaker, T.T. 1978. Phenolic content of vegetation in two African rain forests: Ecological implications. *Science* **202**: 61–63.
- McMahon, J.M., White, W.L.B., & Sayre, R.T. 1995. Cyanogenesis in cassava (*Manihot esculenta* Crantz). *J. Exp. Bot.* **46**: 731–741.
- Muller, C.H., Muller, W.H., & Haines, B.L. 1964. Volatile growth inhibitors produced by aromatic shrubs. *Science* **143**: 471–473.
- Nimbal, C.I., Yerkes, C.N., Weston, L.A., & Weller, S.C. 1996. Herbicidal activity activity and site of action of the natural product sorgoleone. *Pesticide Biochem. Physiol.* **54**: 73–83.
- Northup, R.R., Yu, Z., Dahlgren, R.A., & Vogt, K.A. 1995. Polyphenol control of nitrogen release from pine litter. *Nature* **377**: 227–229.
- Paavolainen, L., Kitunen, V., & Smolander, A. 1998. Inhibition of nitrification in forest soil by monoterpenes. *Plant Soil* **205**: 147–154.
- Paschold, A., Halitschke, R., & Baldwin, I.T. 2006. Using “mute” plants to translate volatile signals. *Plant J.* **45**: 275–291.
- Pellmyr, O. 1997. Stability of plant-animal mutualism: Keeping the benefactors at bay. *Trends Plant Sci.* **2**: 408–409.
- Petersen, B.L., Andréasson, E., Bak, S., Agerbirk, N., & Halkier, B.A. 2001. Characterization of transgenic *Arabidopsis thaliana* with metabolically engineered high levels of p-hydroxybenzylglucosinolate. *Planta* **212**: 612–618.
- Peumans, W.J. & Van Damme, E.J.M. 1995. Lectins as plant defense proteins. *Plant Physiol.* **109**: 347–352.
- Pollard, A.J. & Briggs, D. 1984. Genecological studies of *Urtica dioica* L. III Stinging hairs and plant-herbivore interactions. *New Phytol.* **97**: 507–522.
- Poorter, H. & Bergkotte, M. 1992. Chemical composition of 24 wild species differing in relative growth rate. *Plant Cell Environ.* **15**: 221–229.
- Pueyo, J.J. & Delgado-Salinas, A. 1997. Presence of α -amylase inhibitor in some members of the subtribe Phaselinae (Phaseoleae: Fabaceae). *Am. J. Bot.* **84**: 79–84.
- Raikhel, N.V., Lee, H.-I., & Broekaert, W.G. 1993. Structure and function of chitin-binding proteins. *Annu. Rev. Plant Physiol. Plant Mol. Biol.* **44**: 591–615.
- Rask, L., Andréasson, E., Ekbohm, B., Eriksson, S., Pontoppidan, B. & Meijer, J. 2000. Myrosinase: gene family evolution and herbivore defense in Brassicaceae. *Plant Mol. Biol.* **42**: 93–114.
- Rasmann, S., Köllner, T.G., Degenhardt, J., Hiltbold, I., Toepfer, S., Kuhlmann, U., Gershenson, J., & Turlings, T.C.J. 2005. Recruitment of entomopathogenic nematodes by insect-damaged maize roots. *Nature* **434**: 732–737.
- Rasmussen, J.A., Hejl, A.M., Einhellig, F.A., & Thomas, J.A. 1992. Sorgoleone from root exudate inhibits mitochondrial functions. *J. Chem. Ecol.* **18**: 197–207.
- Ravanel, P., Tissut, M., & Douce, R. 1986. Platanetin: a potent natural uncoupler and inhibitor of the exogenous

- NADH dehydrogenase in intact plant mitochondria. *Plant Physiol.* **80**: 500–504.
- Rhoades, D.F. 1985. Offensive-defensive interactions between herbivores and plants: Their relevance in herbivore population dynamics and ecological theory. *Am. Nat.* **125**: 205–238.
- Rice-Evans, C.A., Miller, N.J., & Paganga, G. 1997. Antioxidant properties of phenolic compounds. *Trends Plant Sci.* **2**: 152–159.
- Ridenour, W.M. & Callaway, R.M. 2001. The relative importance of allelopathy in interference: the effects of an invasive weed on a native bunchgrass. *Oecologia* **126**: 444–450.
- Roberts, T.H., Rasmusson, A.G., & Møller, I.M. 1996. Plantanetin and 7-iodo-acridone-4-carboxylic acid are not specific inhibitors of respiratory NAD(P)H dehydrogenases in potato tuber mitochondria. *Physiol. Plant.* **96**: 263–267.
- Romero, G.Q. & Benson, W.W. 2004. Leaf domatia mediate mutualism between mites and a tropical tree. *Oecologia* **140**: 609–616.
- Röse, U.S.R., Manukian, A., Heath, R.R., & Tumlinson, J.H. 1996. Volatile semiochemicals released from undamaged cotton leaves. A systemic response of living plants to caterpillar damage. *Plant Physiol.* **111**: 487–495.
- Sagers, C.L., Ginger, S.M., & Evans, R.D. 2000. Carbon and nitrogen isotopes trace nutrient exchange in an ant-plant mutualism *Oecologia* **123**: 582–586.
- Schroeder, H.E., Gollasch, S., Moore, A., Tabe, L.M., Craig, S., Hardie, D.C., Chrispeels, M.J., Spences, D., & Higgins, T.J.V. 1995. Bean β -amylase inhibitor confers resistance to the pea weevil (*Bruchus pisorum*) in transgenic peas (*Pisum sativum* L.). *Plant Physiol.* **107**: 1233–1239.
- Schuler, M.A. 1996. The role of cytochrome P450 monooxygenase in plant-insect interactions. *Plant Physiol.* **112**: 1411–1419.
- Sehmer, L., Fontaine, V., Antoni, F., & Dizengremel, P. 1998. Effects of ozone and elevated atmospheric carbon dioxide on carbohydrate metabolism of spruce needles. Catabolic and detoxification pathways. *Physiol. Plant.* **102**: 605–611.
- Selmar, D. 1993. Transport of cyanogenic glucosides: linustatin uptake by *Hevea* cotyledons. *Planta* **191**: 191–199.
- Selmar, D., Liebererei, R., & Biehl, B. 1988. Mobilization and utilization of cyanogenic glycosides. *Plant Physiol.* **86**: 711–716.
- Selmar, D., Grochowski, S., & Seigler, D.S. 1990. Cyanogenic lipids. Utilization during seedling development of *Ungnadia speciosa*. *Plant Physiol.* **93**: 631–636.
- Stock, W.D., Le Roux, D., & Van der Heyden, F. 1993. Regrowth and tannin production in woody and succulent karoo shrubs in response to simulated browsing. *Oecologia* **96**: 562–568.
- Subbarao, G.V., Ishikawa, T., Ito, O., Nakahara, K., Wang, H.Y., & Berry, W.L. 2006. A bioluminescence assay to detect nitrification inhibitors released from plant roots: a case study with *Brachiaria humidicola*. *Plant Soil* **288**: 101–112.
- Subbarao, G., Rondon, M., Ito, O., Ishikawa, T., Rao, I., Nakahara, K., Lascano, C., & Berry, W. 2007a. Biological nitrification inhibition (BNI)—is it a widespread phenomenon? *Plant Soil* **294**: 5–18.
- Subbarao, G.V., Ban, T., Kishii, M., Ito, O., Samejima, H., Pearse, S.J., Hossain, A.K.M.Z., Gopalakrishnan, S., Wang, H.Y., Nakahara, K., Tsujimoto, H., & Berry, W.L. 2007b. Biological nitrification inhibition (BNI) genes from perennial *Leymus racemosus* (Triticeae) can combat nitrification in wheat farming. *Plant Soil* **229**: 55–64.
- Sudhakar, D., Fu, X., Stoger, E., Williams, S., Spence, J., Brown, D.P., Bharathi, M., Gatehouse, J.A., & Christou, P. 1998. Expression and immunolocalisation of the snowdrop lectin, GNA in transgenic rice plants. *Transgenic Res.* **7**: 371–378.
- Tahvanainen, J., Julkunen-Tiitto, R., & Kettunen, J. 1985. Phenolic glycosides govern the food selection pattern of willow feeding beetles. *Oecologia* **67**: 52–56.
- Tattersall, D.B., Bak, S., Jones, P.R., Olsen, C.E., Nielsen, J.K., Hansen, M.L., Hoj, P.B., & Møller, B.L. 2001. Resistance to an herbivore through engineered cyanogenic glucoside synthesis. *Science* **293**: 1826–1828.
- Ton, J., D'Alessandro, M., Jourdie, V., Jakab, G., Karlen, D., Held, M., Mauch-Mani, B., & Turlings, T.C.J. 2007. Priming by airborne signals boosts direct and indirect resistance in maize. *Plant J.* **49**: 16–26.
- Tscharntke, T., Thiessen, S., Dolch, R., & Boland, W. 2001. Herbivory, induced resistance, and interplant signal transfer in *Alnus glutinosa*. *Biochem. Syst. Ecol.* **29**: 1025–1047.
- Turlings, T.C.J. & Ton, J. 2006. Exploiting scents of distress: the prospect of manipulating herbivore-induced plant odours to enhance the control of agricultural pests. *Curr. Opin. Plant Biol.* **9**: 421–427.
- Turlings, T.C.J. & Wäckers, F.L. 2004. Recruitment of predators and parasitoids by herbivore-damaged plants. In: Advances in insect chemical ecology, R.T. Cardé & J. Millar (eds). Cambridge University Press, Cambridge, pp. 21–75.
- Twigg, L.E. & King, D.R. 1991. The impact of fluoroacetate-bearing vegetation on native Australian fauna: a review. *Oikos* **61**: 412–430.
- Twigg, L.E., Wright, G.R., & Potts, M.D. 1999. Fluoroacetate content of *Gastrolobium brevipes* in central Australia. *Aust. J. Bot.* **47**: 877–880.
- Twigg, L.E., Martin, G.R., & Lowe, T.J. 2002. Evidence of pesticide resistance in medium-sized mammalian pests: a case study with 1080 poison and Australian rabbits. *J. Appl. Ecol.* **39**: 549–560.
- Tuomi, J., Niemela, P., Haukioja, E. & Neuvonen, S. 1984. Nutrient stress: an explanation for plant anti-herbivore responses to defoliation. *Oecologia* **61**: 208–210.
- Understrup, A.G., Ravnskov, S., Hansen, H.C.B., & Fomsgaard, I.S. 2005. Biotransformation of 2-benzoxazolinone to 2-amino-(3H)-phenoxazin-3-one and 2-acetylamino-(3H)-phenoxazin-3-one in soil. *J. Chem. Ecol.* **31**: 1205–1222.
- Van Loon, J.J.A., Blaakmeer, A., Griepink, F.C., van Beek, T.A., Schoonhoven, L.M. & De Groot, A. 1992. Leaf surface compound from *Brassica oleracea* (Cruciferae) induces oviposition by *Pieris brassicae* (Lepidoptera: Pieridae). *Chemoecology* **3**: 39–44.
- Van Tol, R.W.H.M., Van der Sommen, A.T.C., Boff, M.I.C., Van Bezooijen, J., Sabelis, M.W., & Smits, P.H. 2001.

- Plants protect their roots by alerting the enemies of grubs. *Ecol. Lett.* **4**: 292–294.
- Voelckel, C. & Baldwin, I.T. 2004. Herbivore-induced plant vaccination. Part II. Array-studies reveal the transience of herbivore-specific transcriptional imprints and a distinct imprint from stress combinations. *Plant J.* **38**: 650–663.
- Vrieling, K. & Wijk C. A. M. 1994. Cost assessment of the production of pyrrolizidine alkaloids in ragwort (*Senecio jacobaea* L.). *Oecologia* **97**: 541–546.
- Waring, R.H. & Pitman, G.B. 1985. Modifying lodgepole pine stands to change susceptibility to mountain pine beetle attack. *Ecology* **66**: 889–897.
- Waring, R.H., McDonald, A.J.S., Larsson, S., Ericsson, T., Wiren, A., Arwidsson, E., Ericsson, A., & Lohammar, T. 1985. Differences in chemical composition of plants grown at constant relative growth rates with stable mineral nutrition. *Oecologia* **66**: 157–160.
- Wasternack, C. & Parthier, B. 1997. Jasmonate-signalled plant gene expression. *Trends Plant Sci.* **2**: 302–307.
- Weck-Reichhart, D., Hehn, A., & Didierjean, L. 2000. Cytochromes P450 for engineering herbicide tolerance. *Trends Plant Sci.* **3**: 116–123.
- Weir, T., Bais, H., Stull, V., Callaway, R., Thelen, G., Ridenour, W., Bhamidi, S., Stermitz, F., & Vivanco, J. 2006. Oxalate contributes to the resistance of *Gaillardia grandiflora* and *Lupinus sericeus* to a phytotoxin produced by *Centaurea maculosa*. *Planta* **223**: 785–795.
- Willmer, P.G. & Stone, G.N. 1997. How aggressive antguards assist seed-set in *Acacia* flowers. *Nature* **388**: 165–167.
- Wright, I.J. & Cannon, K. 2001. Relationships between leaf lifespan and structural defences in a low-nutrient, sclerophyll flora. *Funct. Ecol.* **15**: 351–359.
- Wu, H., Haig, T., Pratley, J., Lemerle, D., & An, M. 2000a. Allelochemicals in wheat (*Triticum aestivum* L.): Variation of Phenolic acids in root tissues. *J. Agric. Food Chem.* **48**: 5321–5325.
- Wu, H., Pratley, J., Lemerle, D. & Haig, T. 2000b. Evaluation of seedling allelopathy in 453 wheat (*Triticum aestivum*) accessions against annual ryegrass (*Lolium rigidum*) by the equal-compartment-agar method. *Aust. J. Agric. Res.* **51**: 937–944.
- Wu, A., Sun, X., Pang, Y., & Tang, K. 2002. Homozygous transgenic rice lines expressing GNA with enhanced resistance to the rice sap-sucking pest *Laodelphax striatellus*. *Plant Breeding* **121**: 93–95.
- Wu, H., Pratley, J., Lemerle, D., An, M., & Liu, D. 2007. Autotoxicity of wheat (*Triticum aestivum* L.) as determined by laboratory bioassays. *Plant Soil* **296**: 85–93.
- Yenesew, A., Mushibe, E.K., Induli, M., Derese, S., Midiwo, J.O., Kabaru, J.M., Heydenreich, M., Koch, A., & Peter, M.G. 2005 7a-O-methyldeguelol, a modified rotenoid with an open ring-C, from the roots of *Derris trifoliata*. *Phytochemistry* **66**: 653–657.
- Yu, J.Q., Shou, S.Y., Qian, Y.R., Zhu, Z.J., & Hu, W.H. 2000. Autotoxic potential of cucurbit crops. *Plant Soil* **223**: 147–151.
- Ziska, L.H., Sicher Jr, R.C., George, K., & Mohan, J.E. 2007. Rising carbon dioxide, plant biology public health: potential impacts on the growth and toxicity of poison ivy (*Toxicodendron radicans*). *Weed Sci.* **55**: 288–292.

9C. Effects of Microbial Pathogens

1. Introduction

Plants frequently encounter potentially pathogenic fungi, bacteria, and viruses, yet disease results from relatively few of these exposures. In many cases there is no obvious trace of its occurrence, and the microorganism fails to establish itself due to a low pathogenicity or highly effective plant defense mechanisms. Other encounters leave evidence of an intense plant-microbe interaction, which results in the arrest of pathogen development after attempted colonization. In these cases plant tissues often display activated defense functions that produce antimicrobial compounds (phytoalexins), enzymes, and structural reinforcement that may limit pathogen growth (Delaney 1997). Plant defense responses against **pathogens** have much in common with responses following **herbivore** attack (Chapter 9B on ecological biochemistry), in terms of both signaling and final outcome, as will be explored below.

Because of the marked differences between their cellular structures and modes of life, one might expect very different strategies for attack, defense, and counterattack to have evolved in plants and animals and their respective pathogens. However, current evidence suggests that plants and animals share several individual components of host-pathogen interactions, either conceptually or mechanistically (Taylor 1998).

2. Constitutive Antimicrobial Defense Compounds

Host resistance to microbial pathogens may be based on the constitutive accumulation of inorganic compounds, e.g., **silicon** in *Oryza sativa* (rice), a typical Si-accumulating species (Sect. 4.1 of Chapter 6 on mineral nutrition). Silicon may act as a **physical barrier**, when it is deposited beneath the cuticle to form a cuticle-Si double layer. This layer can mechanically impede penetration by fungi. An alternative mechanism is that soluble Si acts as a **modulator of host resistance** to pathogens. Several studies in both monocots and dicots have shown that plants supplied with Si can produce phenolics and phytoalexins (Sect. 3) in response to fungal infection, such as those causing rice blast and powdery mildew. Si may also activate some defense mechanisms. For example, in roots of *Cucumis sativus* (cucumber) that are infected and colonized by *Pythium*, Si enhances the activity of chitinases, peroxidases, and polyphenoloxidases. Unlike rice, many plants do not accumulate Si at high enough levels to be beneficial; genetically manipulating the Si uptake capacity of the root might help plants to accumulate more Si and improve their ability to overcome biotic and abiotic stresses (Ma & Yamaji 2006).

Other inorganic compounds that may confer resistance against microbial pathogens include **heavy metals**, which offer an attractive explanation

for the existence of **hyperaccumulators** (Sect. 3.3 of Chapter 6 on mineral nutrition). The hypothesis that hyperaccumulation confers resistance against biotic stress was initially formulated based on an observation that fewer insects feed on Ni hyperaccumulators. Further investigations have subsequently shown that high levels of Ni, Zn, Cd, or Se can provide effective protection against fungi, or even viruses (Poschenrieder et al. 2006). Hyperaccumulation might therefore offer **cross-resistance** against microbial pathogens and herbivores (Sect. 3.1 of Chapter 9A on ecological biochemistry). Organic compounds, rather than inorganic nutrients or heavy metals, are the most common molecules involved in plant defense. Some of these compounds have multiple defense functions, acting against both microbial pathogens and herbivores (**cross-resistance**). For example, aucubin and catalpol, two iridoid glycosides present in *Plantago lanceolata* (snake plantain), confer *in vivo* resistance to both the generalist insect herbivore *Spodoptera exigua* (beet armyworm) and the biotrophic fungal pathogen *Diaporthe adunca*. The bitter taste of iridoid glycosides probably deters feeding by *Spodoptera exigua*, whereas the hydrolysis products formed after tissue damage following fungal infection likely mediate pathogen resistance (Biere et al. 2004).

Plants produce a wide range of compounds with an **antimicrobial effect (phytoanticipins)** (VanEtten et al. 1994). Some of these have already been discussed in Sect. 2.1 of Chapter 9B on ecological biochemistry (e.g., alkaloids, flavonoids, and lignin). **Saponins** are plant glycosides that derive their name from their soap-like properties. A common species that contains saponins is *Saponaria officinalis* (soapwort), which used to be grown near wool mills; the soapy extracts from its leaves and roots were used for washing wool. Saponins consist of triterpenoid, steroid, or steroidal glyco-alkaloid molecules that bear one or more sugar chains (Fig. 1). Saponins have been implicated as preformed determinants of resistance to fungal attack. For example, wounding of *Avena strigosa* (lopsided oat) plant tissue which results from pathogen attack causes a breakdown of compartmentalization, which allows an enzyme to contact the saponin avenacoside B, yielding a fungitoxic compound that causes loss of membrane integrity (Osborn 1996).

Lipid-transfer proteins, which we discussed in Sect. 3.5 of Chapter 4B on effects of radiation and temperature, may also be active in plant defense. Lipid-transfer proteins from, e.g., *Raphanus sativus* (radish), *Hordeum vulgare* (barley), and *Spinacia oleracea* (spinach) are active against several pathogens,

with varying degrees of specificity (Kader 1996). In addition, in *Allium cepa* (onion) some of the genes encoding antimicrobial proteins with lipid-transfer activity are up-regulated in response to infection by fungal pathogens (Kader 1997). An additional onion (*Allium cepa*) seed protein with homology to lipid-transfer proteins has a strong antimicrobial activity, without being able to transfer lipids. The name lipid-transfer protein is unfortunate in that the transfer of lipids is unlikely to be the (sole) role of these proteins *in vivo* (Cammue et al. 1995). It is as yet unknown how lipid-transfer proteins inhibit the growth of pathogens.

Lectins (defense compounds against herbivores; Sects. 3.4 and 3.5 of Chapter 9B on ecological biochemistry) are also effective against pathogens. For example, the lectin in rhizomes of *Urtica dioica* (stinging nettle) hydrolyzes fungal cell walls (Raikhel et al. 1993). **Thionins**, which are cysteine-rich proteins, represent another group of antimicrobial proteins that are involved in plant defenses (Epple et al. 1997).

The constitutive defense against microorganisms obviously incurs **costs** for synthesis and storage. When a range of cultivars of *Raphanus sativus* (radish) that differ widely in their sensitivity to *Fusarium oxysporum* (fungal wilt disease) are compared, the most resistant ones have the lowest relative growth rate and vice versa (Fig. 2). The exact nature of the constitutive defense is unknown, but it is probably not based solely on the presence of glucosinolates, which tend to be present only in low amounts (Sect. 3.1 of Chapter 9B on ecological biochemistry). Slow-growing, resistant radish cultivars contain more cell-wall material in leaves, but their roots have a high biomass density due to more cytoplasmic elements (proteins) rather than large amounts of cell-wall material. It has been speculated that this higher protein concentration accounts for the rapid and adequate resistance reaction, although at the expense of greater construction and turnover costs (Hoffland et al. 1996a).

In some phytopathogenic fungi, **detoxifying enzymes** have evolved that break through the plant's constitutive or induced defense against fungal attack (VanEtten et al. 1994). A number of fungi avoid the toxicity of plant saponins. Some do so by growing only in extracellular plant compartments. Some fungi that infect *Solanum lycopersicum* (tomato) **lower the pH** at the infection sites to levels at which the saponin in tomato (α -tomatin; Fig. 1) has no effect on membrane integrity. More important mechanisms involve a change in **membrane composition** of the fungus and the production of **saponin-detoxifying enzymes** (Osborn 1996).

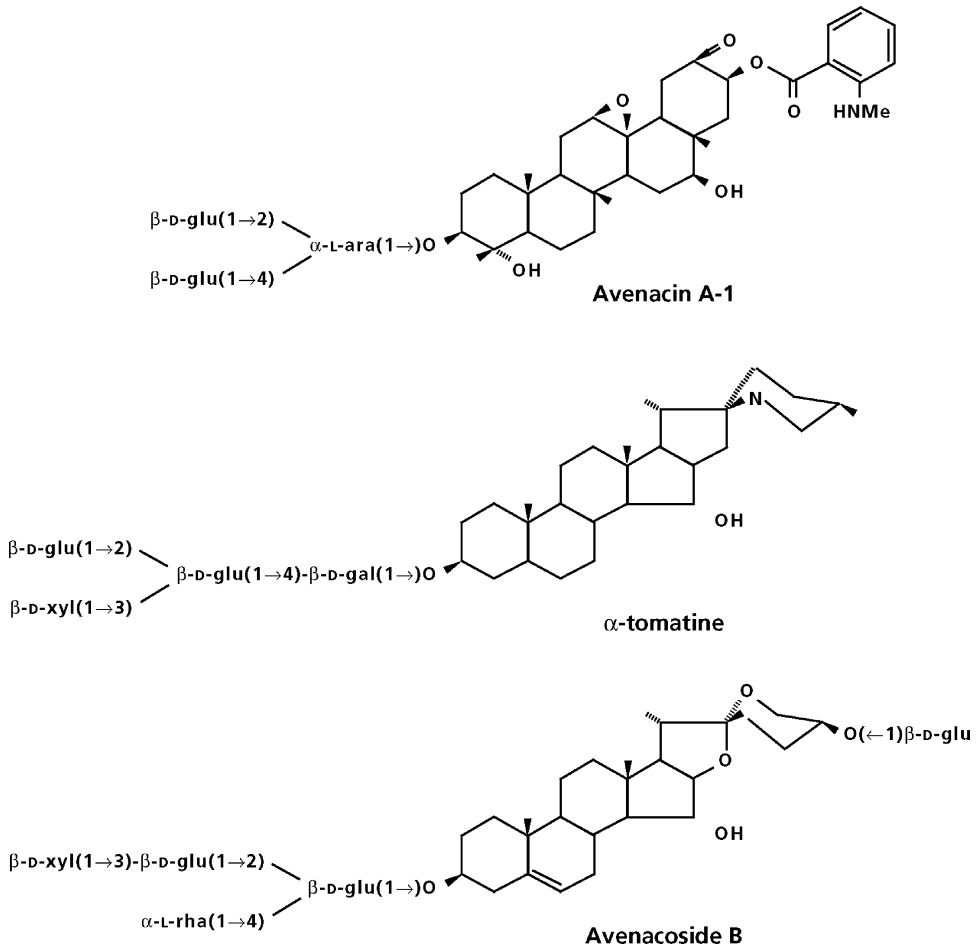

FIGURE 1. Structures of saponins from *Solanum lycopersicum* (tomato) and *Avena strigosa* (oat) (Osborn 1996).

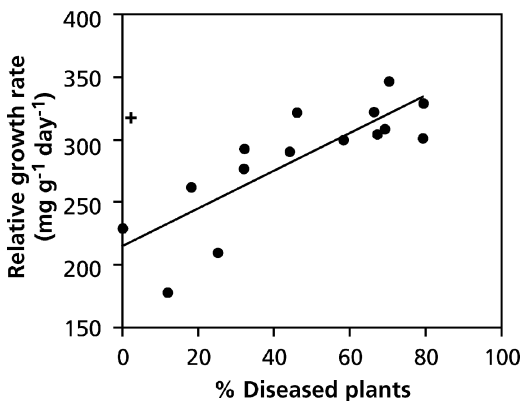

FIGURE 2. Correlation between the relative growth rate (RGR) of *Raphanus sativus* (radish) grown in the absence of pathogens and resistance level to *Fusarium oxysporum* in 15 cultivars. Each symbol refers to a different cultivar (after Hoffland et al. 1996a).

3. The Plant's Response to Attack by Microorganisms

Highly sophisticated defense strategies have evolved in plants to counteract pathogenic microorganisms. The primary immune response in plants has evolved to recognize common features of the microbial pathogens that are referred to as **pathogen-associated molecular patterns** (PAMPs) (Christholm et al. 2006). PAMP-triggered immunity is part of the first line of induced defense, and results in a basal level of resistance. During the evolutionary "arms race", pathogens acquired the ability to suppress this first line of induced defense via the delivery of effector proteins. In turn, plants acquired R proteins that are able to recognize these

attacker-specific effector proteins, resulting in a highly effective second line of defense called **effector-triggered immunity**. Effector-triggered immunity is also known as the gene-for-gene relationship, which was first identified in the 1940s in *Linum usitatissimum* (flax) and its fungal pathogen *Melampsora lini* (flax rust) (Flor 1971). Many different plant genes that encode disease resistance occur in clusters, either as single genes with multiple alleles that encode different resistance specificities or as a series of tightly linked genes forming complex loci (Pryor & Ellis 1993). Resistance to pathogens is thought to involve a specific recognition between a resistant plant and the pathogen. This interaction triggers a set of responses that act to confine the pathogen. If the specific gene is absent in the plant or in the pathogen (or in both), then there is no concerted defense response and disease generally ensues. There are many examples of gene-for-gene interactions of plants with fungi, bacteria, and nematodes (Taylor 1997); however, there are also more general defenses in plants.

Plants react to pathogen attack by activating an elaborate defense system that acts both locally and systemically which is in many ways similar to the kind of response we discussed in Sect. 3 of Chapter 9B on ecological biochemistry. In many cases, local resistance is manifested as a **hypersensitive response** (Stakman 1915): membrane damage, necrosis, and collapse of cells. This "suicidal" response is often confined to individual penetrated cells. It is considered as a sacrifice of locally infected tissue (sometimes only one or a few cells) to protect against the spread of the pathogen into healthy tissue. Mutants that spontaneously form patches of dead tissue (necrosis) occur in many plant species. Further analysis of these mutants shows that the hypersensitive response is caused by the production of toxic compounds by the plant or pathogen and

also results, partly, from genetically programmed cell death (Jones & Dangl 1996). The hypersensitive response differs from cell death that spreads beyond the point of infection which follows from the interaction of a susceptible plant and a virulent pathogen. In this interaction, cell death does not effectively prevent pathogen multiplication or spread (He 1996).

The hypersensitive response often enhances the production of **reactive oxygen species** (O_2^- , H_2O_2), which are generated by a signaling pathway similar to that employed by mammalian neutrophils during immune responses (Mehdy et al. 1996). Reactive oxygen species are involved in cross-linking of cell-wall proteins, rendering these more resistant to attack by enzymes from the pathogen. The reactive oxygen species are also thought to be toxic for pathogens. In addition they may act as "second messengers" in the induction of defense genes (Boller 1995). These reactive oxygen species might be the cause of up-regulation of the gene encoding the **alternative oxidase** (Fig. 3). Up-regulation of this gene greatly enhances the capacity for cyanide-resistant respiration of the infected plant tissue (Sect. 4.8 of Chapter 2B on plant respiration). Increased activity of the alternative path presumably allows a rapid flux through the oxidative pentose phosphate pathway and NADP-malic enzyme, thus producing carbon skeletons and NADPH that are required in the defense reaction (Fig. 4; Simons & Lambers 1998).

In the hypersensitive response of a resistant plant to an avirulent pathogen ("incompatible interaction") specific molecules from the pathogen physically interact with specific molecules from the host which causes an array of defense responses (De Wit 1997). These responses include an **oxidative burst**, which can lead to cell death; thus, the pathogen may be "trapped" in dead cells and be prevented from

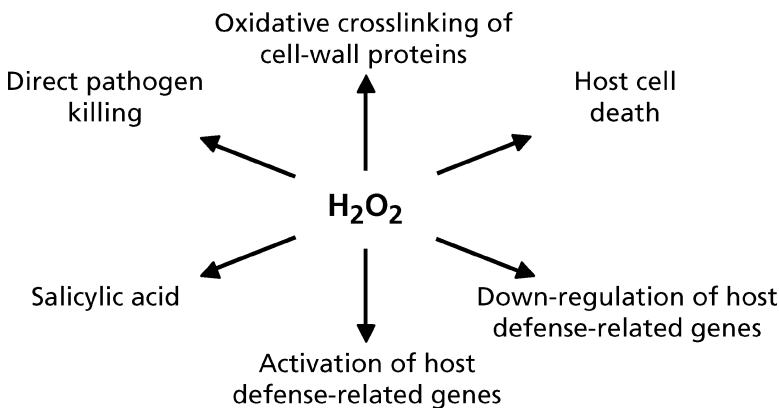

FIGURE 3. A central role for hydrogen peroxide in defense responses of plants to microbial pathogens infection. The responses shown occur in different plant species and may not occur within a given species (Mehdy et al. 1996). Copyright Physiologia Plantarum.

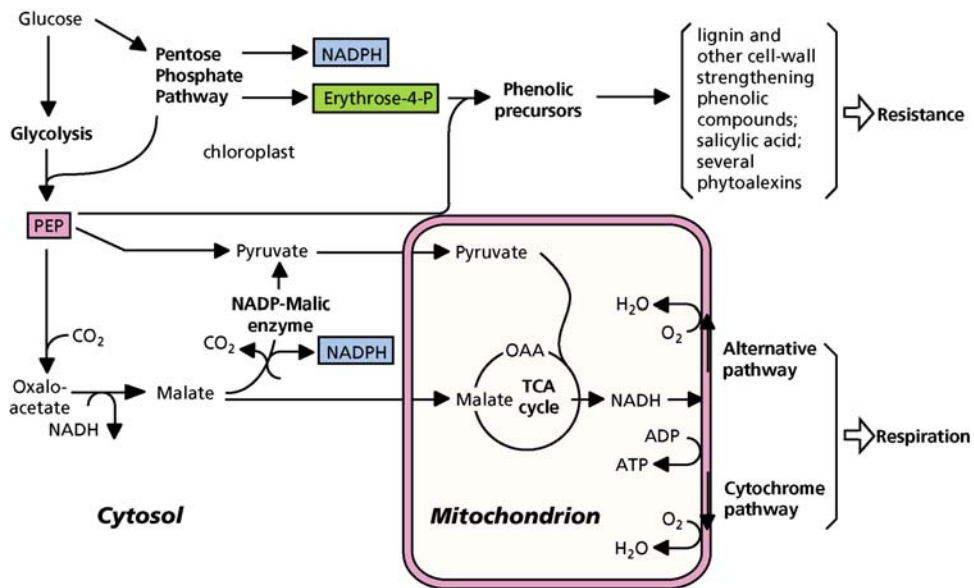

FIGURE 4. Major metabolic pathways involved in the plant's resistance response to pathogens and its association with respiration. Plant defense requires an increased production of erythrose-4-phosphate for numerous phenolic precursors. Erythrose-4-phosphate is produced in the oxidative pentose pathway, which also generates the NADPH that is required for the biosynthesis of, e.g., lignin and some phytoalexins.

Additional NADPH is produced by NADP-malic enzyme, which decarboxylates malate to pyruvate. Increased activity of these reactions enhances the production of pyruvate, which is postulated to require an increased activity of the alternative path. Up-regulation of the gene encoding the alternative oxidase may be triggered by accumulation of reactive oxygen species (after Simons & Lambers 1998).

spreading from the site of infection. The cells surrounding the site of entry modify their cell walls so that they can inhibit penetration by the pathogen (Heil & Bostock 2002). They also produce antimicrobial compounds, such as **phytoalexins** (i.e., low-molecular-mass antibiotics that are not found in uninfected plants). The chemical nature of phytoalexins is extremely variable (Fig. 5); closely related species often have phytoalexins with a similar structure. Microorganisms, or components thereof (**elicitors**), induce the formation of phytoalexins (Boller 1995). Numerous other compounds in microbial pathogens (e.g., carbohydrates and lipids) may also cause nonspecific production of phytoalexins. In addition, cell-wall components (e.g., glucans or glucomannans) may elicit rapid synthesis of phytoalexins in resistant cultivars.

Now that phytoalexins have been introduced, we stress two points. First, accumulation of a specific compound upon attack does not prove that this compound is involved in resistance. Rather, accumulation may be a side reaction that has nothing to do with the actual resistance mechanism. To prove that a compound is involved in a resistance

mechanism may require mutants that are unable to make the putative defense compound. Some 40 years ago, Chamberlain & Paxton (1968) demonstrated that the stems of a cultivar of *Glycine max* (soybean), which is susceptible for the fungus *Phytophthora megasperma*, can become resistant upon addition of a phytoalexin isolated from a resistant cultivar. Inhibition of phenylalanine **ammonia lyase**, which is a key enzyme in the synthesis of isoflavanoids, decreases the concentration of phytoalexins and increases the growth of the infecting fungus. Similar to what we discussed in Sect. 3.3 of Chapter 9B on ecological biochemistry, there is also an **arms race** between plants and microbial pathogens, which have evolved to detoxify phytoalexins. For example, isolates of the phytopathogenic fungus *Nectria haematococca* produce pisatin demethylase that detoxifies the toxic phytoalexin pisatin in *Pisum sativum* (pea) (VanEtten et al. 1995). The second point we stress is that synthesis of phytoalexins is only one of a range of mechanisms involved in combating the pathogen. Production of hydrolytic enzymes (e.g., chitinases and glucanases) is also part of the defense response (Vierheilig et al. 1993). The

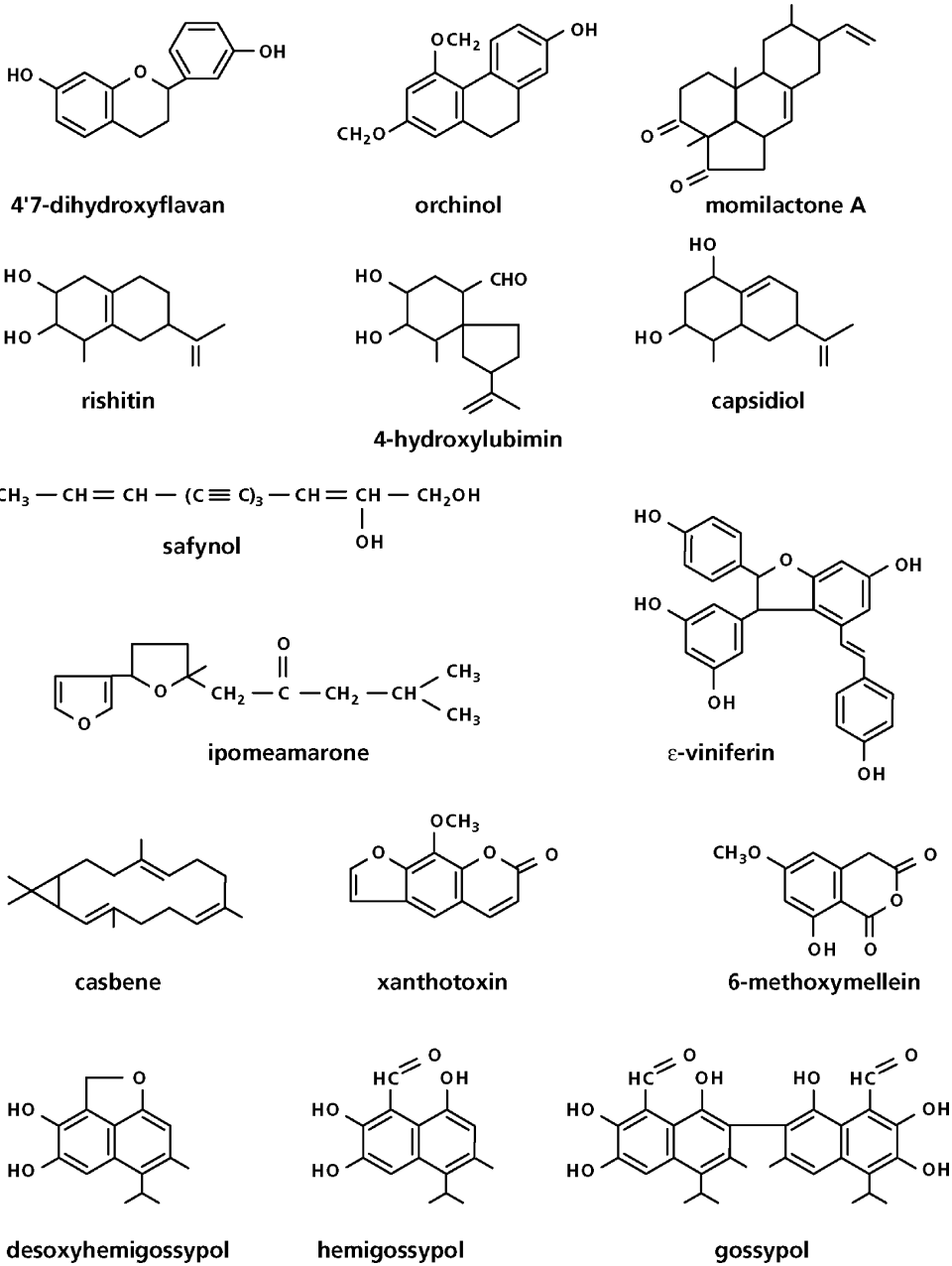

FIGURE 5. Some examples of phytoalexins in different plant species (Bell 1981). With permission, from the Annual Review of Plant Physiology, Vol. 32, copyright 1981, by Annual Reviews Inc.

proteins induced upon pathogen attack are referred to as **pathogenesis-related proteins (PRs)**; they accumulate either in intercellular spaces or intracellularly in the vacuole (Heil & Bostock 2002, Van Loon et al. 2006). Some of these PRs confer disease resistance (Brogie et al. 1991) and inhibit fungal growth *in vitro* as well as *in vivo* (Boller

1995). Whilst phytoalexins typically accumulate at the site of attack, PR proteins also accumulate **systemically** (Van Loon et al. 2006).

After attack of a resistant host by an avirulent pathogen, the enzymes required for the synthesis of phytoalexins are first produced *de novo*, and then the phytoalexins accumulate. The chemicals are

produced in living plant cells, and may well lead to the death of these cells, due to their toxicity for the host plant as well as for the pathogenic microorganism. Some phytoalexins [e.g., glyceollin from *Glycine max* (soybean)] are specific inhibitors of complex I of the mitochondrial electron-transport chain (Sect. 2.2.1 of Chapter 2B on plant respiration). Glyceollin can be found in soybean roots as soon as 2 hours after inoculation with the fungus *Phytophthora megasperma* (Hahn et al. 1985).

In several pathosystems, the hypersensitive response to an avirulent pathogen (incompatible interaction) as well as the response to a virulent pathogen (compatible interaction) is accompanied by an **induced systemic resistance** to infection by other pathogens (Ryals et al. 1994). It involves the accumulation of **salicylic acid** (Tenhaken & Rübel 1998) and activation of **PR genes** (Linthorst 1991). **Salicylic acid** is required for the expression of **systemic acquired resistance (SAR)** (Durrant and Dong 2004). Although salicylic acid can be transported in the plant, reciprocal graftings of transgenic plants, in which salicylic acid is degraded, and nontransformed plants as rootstocks or scions, show that salicylic acid is not the translocated signal in SAR (Vernooij et al. 1994). **Methyl salicylate**, which is a volatile liquid known as oil of wintergreen, is produced from salicylic acid by a number of plant species. It is a major volatile compound released by *Nicotiana tabacum* (tobacco) inoculated with tobacco mosaic virus. Methyl salicylate may act as an airborne signal that activates disease resistance and the expression of defense-related genes in neighboring plants and in the healthy tissues of the infected plants (Shulaev et al. 1997). Plants treated with salicylic acid or acetylsalicylic acid (aspirin) for 12–24 hours are primed to respond much faster to pathogen-derived signals with the production of phytoalexins and their biosynthetic enzymes, PRs, and the production of reactive oxygen species (Kauss & Jeblick 1996, Conrath et al. 2002). People are therefore not the only organisms that benefit from use of aspirin.

Resistance genes are also activated by exposure to ethylene or the vapor of methyl jasmonic acid [e.g., in *Solanum lycopersicum* (tomato), *Medicago sativa* (alfalfa), or *Nicotiana tabacum* (tobacco)]. Methyl jasmonic acid is a cyclopentanone that is synthesized from linolenic acid; it is well known as a fragrant constituent of the essential oil of *Jasminum grandiflorum* (Spanish jasmine). Jasmonic acid or methyl jasmonic acid from either a synthetic solution or from undamaged twigs of *Artemisia tridentata* (sagebrush) are equally effective. They are common secondary metabolites that often occur in higher levels

in damaged plants (Bruin et al. 1995). Plants like *Artemisia tridentata* are promising for use as an **“intercrop”** (i.e., plants used in combination with a crop plant to protect the crop against pests in an environmentally friendly way). “Intercropping” has been proposed as a method to contribute to **pest control**.

Plants can also become resistant by exposure to nonpathogenic root-colonizing bacteria [e.g., to fluorescent *Pseudomonas* sp. in *Dianthus caryophyllus* (carnation) (Van Peer et al. 1991) and *Raphanus sativus* (radish) (Hoffland et al. 1996b), and to *Serratia plymuthica* in *Cucumis sativus* (cucumber) (Wei et al. 1991)]. In this **induced systemic resistance**, however, salicylic acid does not play a role (Van Loon et al. 1998, Pieterse et al. 2001, 2002).

4. Cross-Talk Between Induced Systemic Resistance and Defense Against Herbivores

The responses to microbial pathogens (Sect. 3) have much in common with responses to herbivory (Sect. 3 of Chapter 9B on ecological biochemistry). For example, the expression of resistance to **pathogens** as well as to **insect herbivores** involves two signaling pathways, one involving **salicylic acid** and another involving **jasmonic acid**. Stimulation of induced systemic resistance in field-grown *Solanum lycopersicum* (tomato) plants with benzothiadiazole (a salicylate mimic) (1) attenuates the jasmonate-induced expression of the antiherbivore defense-related enzyme **polyphenol oxidase**, and (2) compromises host-plant resistance to larvae of the beet armyworm, *Spodoptera exigua*. On the other hand, treatment of plants with jasmonic acid at concentrations that induce resistance to insects reduces **pathogenesis-related protein** gene expression induced by benzothiadiazole; this partially reverses the protective effect of benzothiadiazole against bacterial speck disease, which is caused by *Pseudomonas syringae*. This suggests that the sharing of elements of the two defense pathways may involve trade-offs. Therefore, effective utilization of induced systemic resistance to multiple pests typically encountered in agriculture requires understanding potential signaling conflicts in plant defense responses (Thaler et al. 1999).

Considering the example of *Solanum lycopersicum* (tomato), discussed above, variable outcomes can be expected, because there can be **cross-talk** between signaling leading to induced defense as well as signaling resulting in induced resistance against herbivores. On one hand, resistance elicited by one group

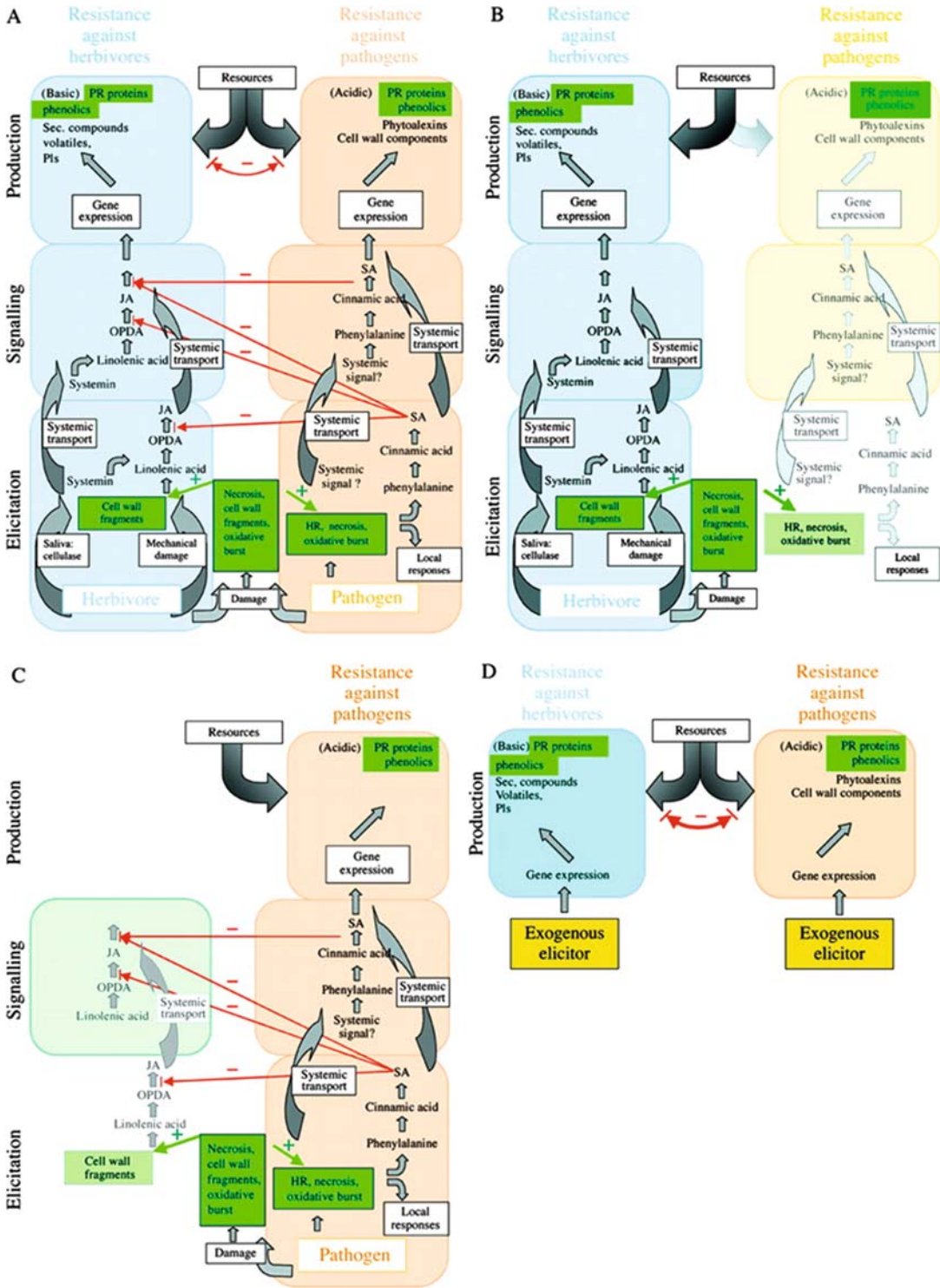

FIGURE 6. Variable outcomes of cross-talk between signaling leading to induced systemic resistance and signaling resulting in induced resistance against herbivores.

(A) Overview of interactions. At the level of elicitation and production, several “common factors” (in green boxes) appear in both signaling pathways (necrosis,

of enemies and active (also) against another is called **cross-resistance** (e.g., resistance against pathogens induced by herbivores, and vice versa). Cross-resistance has been found in different systems. For example, feeding by thrips and aphids reduces infection of *Cucurbita citrullus* (watermelon) by the fungus *Colletotrichum orbiculare*. Defoliation of *Glycine max* (soybean) by *Pseudoplusia includens* (soybean looper moth) reduces the severity of two different fungal infections. Beetle grazing can induce resistance against fungal infections in *Rumex obtusifolius* (bitter dock). *Helicoverpa zea* (corn earworm) feeding can increase resistance of *Solanum lycopersicum* (tomato) plants to an aphid species (*Macrosiphum euphorbiae*), a mite species (*Tetranychus urticae*), corn earworm (*Spodoptera exigua*), and to a bacterial phytopathogen, *Pseudomonas* (Bostock 2005). In *Arabidopsis thaliana* (thale cress), feeding by caterpillars of the cabbage white butterfly (*Pieris rapae*) results in enhanced resistance against the bacterial pathogens *Pseudomonas syringae* and *Xanthomonas campestris*, and turnip crinkle virus (De Vos et al. 2006).

Instead of cross-talk, there may be trade-offs, i.e., compromised resistance against one group of enemies when the plant is in the induced stage against the other group. For example, chemical induction of induced systemic resistance decreases the plants' ability to express wound-inducible proteinase inhibitors. Similarly, salicylic acid treatment inhibits wound- and jasmonic-acid-induced responses in the same plant, and application of jasmonic acid partially reduces the efficacy of chemically induced systemic resistance elicitors. Results available so far show that salicylic acid can inhibit the signaling cascade at different steps that are located both upstream and downstream of jasmonic acid (Heil & Bostock 2002, Spoel et al. 2003).

In summary, there are three steps in the induction pathway leading to defense: (1) **elicitation**, (2) **signaling**, and (3) **production**, i.e., gene expression

and synthesis of enzymes and other proteins involved in the establishment of the resistant phenotype. Interactions probably occur independently on all three levels (Fig. 6).

- (1) **Elicitation:** Salicylic acid is synthesized in response to mechanical damage, necrosis, and oxidative stress. Compounds resulting from the degradation of cells or cell walls might be involved in eliciting the systemic signal, and induced systemic resistance can thereby be induced by different types of enemies. Correspondingly, jasmonic acid can be induced in response to cell-wall degradation. Further elicitors in the context of both wound response and induced systemic response include the development of reactive oxygen species (Fig. 6A and B). Therefore, events at the elicitation level will mainly lead to the expression of a rather non-specific cross-resistance.
- (2) **Signaling:** Further interactions can occur at the signaling level. Different activities of the various intermediates leading to jasmonic acid may lead to a diversity of potential outcomes. Similar regulatory properties might characterize the salicylic acid-dependent signaling. An inhibition of the jasmonic acid pathway by salicylic acid has been described in different plant species. While herbivores can induce both an induced systemic response and induced resistance to herbivores (Fig. 6B), an induction by pathogens leads to synthesis of high concentrations of salicylic acid, and thus blocks later steps in signaling involving the jasmonic acid pathway. Phenotypically, pathogen attack thus induces mainly (or only) induced systemic response compounds (Fig. 6C).
- (3) **Production:** The trade-offs might, in contrast, occur mainly at the production level (i.e., signal-response coupling; Fig. 6D). Production of defensive compounds can be limited by the

FIGURE 6. (continued) cell wall fragments, and oxidative burst during elicitation; phenolics and PR proteins at the production level) and these might represent factors leading to cross-resistance phenomena. (B) Elicitation by a herbivore. While inducing mainly the pathway leading to jasmonic acid, the "common" elicitors might lead to partial induction of induced systemic resistance signaling. Resources are mainly allocated to herbivore resistance, but some resistance against pathogens is expressed, too. (C) Elicitation by a pathogen. The partial induction of the pathway leading to jasmonic acid by the "common" elicitors might lead to the

occurrence of some early metabolites in the pathway leading to jasmonic acid, but later the pathway is blocked by the inhibitory effects of salicylic acid. On the phenotypic level, only resistance against pathogens is expressed. (D) Exogenous elicitation bypasses regulatory mechanisms at the elicitation and the signaling levels. The competition between both pathways for limiting resources therefore dominates the outcome and leads to phenotypically visible trade-offs when both pathways are induced at the same time (Heil & Bostock 2002, by permission of Oxford University Press).

supply of available precursors such as amino acids, ATP, and other biosynthetic cofactors, and so does not depend only on the outcome of events at the signaling level. Induction of salicylic-acid-responsive and jasmonic-acid-responsive genes appears to occur each at the cost of the other group, presumably since plants are compromised in the total amount of defensive compounds that can be produced during a limited time span.

5. Messages from One Organism to Another

Plants continually receive messages from their environment, including chemical messages (elicitors) released by pathogenic and nonpathogenic microorganisms. Resistant plants respond to these messages by defending themselves. This involves sacrificing a small number of cells in a programmed manner, and trapping the pathogen inside dead cells; it also involves both a physical and chemical defense of the surviving cells. Upon attack by pathogens, both resistant and surviving sensitive plants acquire greater resistance to subsequent attack, be it by the same or by a different pathogen. In recent years remarkable surveillance mechanisms have been discovered that have evolved in plants to recognize microbial factors and combat pathogenic microbes (Chisholm et al. 2006). The discovery of resistance that is induced by nonpathogenic rhizobacteria which is a process of plant **immunization** to diseases is receiving increased attention. It may help us protect our crops against pathogens in an environmentally friendly manner.

Many plants may be damaged by herbivores at the same time as being attacked by microbial pathogens. The subsequent defense responses may either induce cross-resistance or involve a trade-off, depending on the plant species and the attacking organism. If nonpathogenic rhizobacteria would induce cross-resistance, this would offer potential for applications in intensive agricultural systems.

References

Bell, A.A. 1981. Biochemical mechanisms of disease resistance. *Annu. Rev. Plant Physiol.* **32**: 21–81.
 Biere, A., Marak, H.B., and Van Damme, J.M.M. 2004. Plant chemical defense against herbivores and pathogens:

generalized defense or trade-offs? *Oecologia* **140**: 430–441.
 Boller, T. 1995. Chemoperception of microbial signals in plant cells. *Annu. Rev. Plant Physiol. Plant Mol. Biol.* **46**: 189–214.
 Bostock, R.M. 2005. Signal crosstalk and induced resistance: straddling the line between cost and benefit. *Annu. Rev. Phytopathol.* **43**: 545–580.
 Broglie, K., Holliday, M., Cressman, R., Riddle, P., Knowtown, S., Mauvais, C.J., & Broglie, R. 1991. Transgenic plants with enhanced resistance to the fungal pathogen *Rhizoctonia solani*. *Science* **254**: 1195–1197.
 Bruin, J., Sabelis, M.W., & Dicke, M. 1995. Do plants tap SOS signals from their infested neighbours. *Trends Ecol. Evol.* **10**: 167–170.
 Cammue, B.P.A., Thevissen, K., Hendriks, M., Eggermont, K., Goderis, I.J., Proots, P., Van Damme, J., Osborn, R.P., Guerbet, F., Kader, J.-C., & Broekaert, W.F. 1995. A potent antimicrobial protein from onion seeds showing sequence homology to plant lipid transfer proteins. *Plant Physiol.* **109**: 445–455.
 Chamberlain, D.W. & Paxton, J.D. 1968. Protection of soybean plants by phytoalexins. *Phytopathology* **58**: 1349–1350.
 Chisholm, S.T., Coaker, G., Day, B., & Staskawicz, B.J. 2006. Host-microbe interactions: shaping the evolution of the plant immune response. *Cell* **124**: 803–814.
 Conrath, U., Pieterse, C.M.J., & Mauch-Mani, B. 2002. Priming in plant-pathogen interactions. *Trends Plant Sci.* **7**: 210–216
 Delaney, T.P. 1997. Genetic dissection of acquired resistance to disease. *Plant Physiol.* **113**: 5–12.
 De Vos, M., Van Zaanen, W., Koornneef, A., Korzelius, J.P., Dicke, M., Van Loon, L.C., & Pieterse, C.M.J. 2006. Herbivore-induced resistance against microbial pathogens in *Arabidopsis*. *Plant Physiol.* **142**: 352–363.
 De Wit, P.J.G.M. 1997. Pathogen avirulence and plant resistance: A key role for recognition. *Trends Plant Sci.* **2**: 452–458.
 Durrant, W.E. & Dong, X. 2004. Systemic acquired resistance. *Annu. Rev. Phytopathol.* **42**: 185–209.
 Epple, P., Apel, K., & Bohlmann, H. 1997. Overexpression of an endogenous thionin enhances resistance of *Arabidopsis* against *Fusarium oxysporum*. *Plant Cell* **9**: 509–520.
 Flor, H. 1971. Current status of the gene-for-gene concept. *Annu. Rev. Phytopathol.* **9**: 275–296.
 Hahn, M.G., Bonhoff, A., & Griesenbach, H. 1985. Quantitative localization of the phytoalexin glyceollin I in relation to fungal hyphae in soybean roots infected with *Phytophthora megasperma* f. sp. *glycinea*. *Plant Physiol.* **77**: 591–601.
 He, S.Y. 1996. Elicitation of plant hypersensitive response by bacteria. *Plant Physiol.* **112**: 865–869.
 Heil, M. & Bostock, R.M. 2002. Induced systemic resistance (ISR) against pathogens in the context of induced plant defences. *Ann. Bot.* **89**: 503–512.
 Hoffland, E., Niemann, G.J., Van Pelt, J.A., Pureveen, J.B.M., Eijkel, G.B., Boon, J.J., & Lambers, H. 1996a. Relative

- growth rate correlates negatively with pathogen resistance in radish. The role of plant chemistry. *Plant Cell Environ.* **19**: 1281–1290.
- Hoffland, E., Hakulinen, I., & Van Pelt, J.A. 1996b. Comparison of systemic resistance induced by avirulent and non-pathogenic *Pseudomonas* species. *Phytopathology* **86**: 757–762.
- Jones, A.M. & Dangl, J.L. 1996. Logjam at the Styx: programmed cell death in plants. *Trends Plant Sci.* **1**: 114–119.
- Kader, J.-C. 1996. Lipid-transfer proteins in plants. *Annu. Rev. Plant Physiol. Plant Mol. Biol.* **47**: 627–654.
- Kader, J.-C. 1997. Lipid-transfer proteins: A puzzling family of plant proteins. *Trends Plant Sci.* **2**: 66–70.
- Kauss, H. & Jeblick, W. 1996. Influence of salicylic acid on the induction of competence for H₂O₂ elicitation. *Plant Physiol.* **111**: 755–763.
- Linthorst, H. 1991. Pathogenesis-related proteins of plants. *Crit. Rev. Plant Sci.* **10**: 123–150.
- Ma, J.F. & Yamaji, N. 2006. Silicon uptake and accumulation in higher plants. *Trends Plant Sci.* **11**: 392–397.
- Mehdy, M.C., Sharma, Y.K., Sathasivan, K., & Bays, N.W. 1996. The role of activated oxygen species in plant disease resistance. *Physiol. Plant.* **98**: 365–374.
- Osbourn, A. 1996. Saponins and plant defence—a soap story. *Trend Plant Sci.* **1**: 4–9.
- Pieterse, C.M.J., Van Pelt, J.A., Van Wees, S.C.M., Ton, J.T., Léon-Kloosterziel, K.M., Keurentjes, J.J.B., Verhagen, B.W.M., Knoester, M., Van der Sluis, I., Bakker, P.A.H.M., & Van Loon, L.C. 2001. Rhizobacteria-mediated induced systemic resistance: triggering, signalling and expression. *Eur. J. Plant Pathol.* **107**: 51–61.
- Pieterse, C.M.J., Van Wees, S.C.M., Ton, J., Van Pelt, J.A., & Van Loon, L.C. 2002. Signalling in rhizobacteria-induced systemic resistance in *Arabidopsis thaliana*. *Plant Biol.* **4**: 535–544.
- Poschenrieder, C., Tolra, R., & Barceló, J. 2006. Can metals defend plants against biotic stress? *Trends Plant Sci.* **11**: 88–295.
- Pryor, A.J. & Ellis, J.G. 1993. The genetic complexity of fungal disease resistance genes in plants. *Adv. Plant Pathol.* **10**: 281–305.
- Raikhel, N.V., Lee, H.-I., & Broekaert, W.F. 1993. Structure and function of chitin-binding proteins. *Annu. Rev. Plant Physiol. Plant Mol. Biol.* **44**: 591–615.
- Ryals, J., Uknes, S., & Ward, E. 1994. Systemic acquired resistance. *Plant Physiol.* **104**: 1109–1112.
- Shulaev, V., Silverman, P., & Raskin, I. 1997. Airborne signalling by methyl salicylate in plant pathogen resistance. *Nature* **385**: 718–721.
- Simons, B.H. & Lambers, H. 1998. The alternative oxidase: is it a respiratory pathway allowing a plant to cope with stress? In: Plant responses to environmental stresses: from phytohormones to genome reorganization, H.R. Lerner (ed.). Marcel Dekker, New York, pp. 265–286.
- Spoel, S.H., Koornneef, A., Claessens, S.M.C., Korzelius, J.P., Van Pelt, J.A., Mueller, M.J., Buchala, A.J., Métraux, J.-P., Brown, R., Kazan, K., Van Loon, L.C., Dong, X., & Pieterse, C.M.J. 2003. NPR1 modulates cross-talk between salicylate- and jasmonate-dependent defense pathways through a novel function in the cytosol. *Plant Cell* **15**: 760–770.
- Stakman, E.C. 1915. Relation between *Puccinia graminis* f.sp. *tritici* and plants highly resistant to its attack. *J. Agric. Res.* **4**: 195–199.
- Taylor, C.B. 1997. Unraveling disease resistance specificities. *Plant Cell* **9**: 466–469.
- Taylor, C.B. 1998. Defense responses in plants and animals—more of the same. *Plant Cell* **10**: 873–876.
- Tenhaken, R. & Rübel, C. 1998. Salicylic acid is needed in hypersensitive cell death in soybean but does not act as a catalase inhibitor. *Plant Physiol.* **115**: 291–298.
- Thaler, J.S., Fidantsef, A.L., Duffey, S.S., & Bostock, R.M. 1999. Trade-offs in plant defense against pathogens and herbivores: a field demonstration of chemical elicitors of induced resistance. *J. Chem. Ecol.* **25**: 1597–1609.
- VanEtten, H.D., Sandrock, R.W., Wasman, C.C., Soby, S.D., McCluskey, K., & Wang, P. 1994. Detoxification of phytoanticipins and phytoalexins by phytopathogenic fungi. *Can. J. Bot.* **73** (Suppl. 1): S518–S525.
- Van Loon, L.C., Bakker, P.A.H.M., & Pieterse, C.M.J. 1998. Systemic resistance induced by rhizosphere bacteria. *Annu. Rev. Phytopathol.* **36**: 453–483.
- Van Loon, L.C., Rep, M., & Pieterse, C.M.J. 2006. Significance of inducible defense-related proteins in infected plants. *Annu. Rev. Phytopathol.* **44**: 135–162.
- Van Peer, R., Niemann, G.J., & Schippers, B. 1991. Induced resistance and phytoalexin accumulation in biological control of *Fusarium* wilt of carnation by *Pseudomonas* sp. strain WCS417r. *Phytopathology* **81**: 728–734.
- Vernooij, B., Friedrich, L., Morse, A., Reist, R., Kolditz-Jawhar, R., Ward, E., Uknes, S., Kessmann, H., & Ryals, J. 1994. Salicylic acid is not the translocated signal responsible for inducing systemic acquired resistance but is required in signal transduction. *Plant Cell* **6**: 959–965.
- Vierheilig, H., Alt, M., Neuhaus, J.-M., Boller, T., & Wiemken, A. 1993. Colonization of transgenic *Nicotiana sylvestris* plants, expressing different forms of *Nicotiana tabacum* chitinase, by the root pathogen *Rhizoctonia solani* and by the mycorrhizal symbiont *Glomus mosseae*. *Mol. Plant-Microbe Interact.* **6**: 261–264.
- Wei, G., Kloepper, J.W., & Tuzun, S. 1991. Induction of systemic resistance of cucumber to *Colletotrichum orbiculare* by selected strains of plant growth-promoting rhizobacteria. *Phytopathology* **81**: 1508–1512.

9D. Parasitic Associations

1. Introduction

We have so far mainly dealt with **autotrophic** plants that assimilate CO₂ from the atmosphere into complex organic molecules and acquire nutrients and water from the rhizosphere. There are also fascinating higher plant species that lack the capacity to assimilate sufficient CO₂ to sustain their growth and that cannot absorb nutrients and water from the rhizosphere in sufficient quantities to reproduce successfully. These plants comprise approximately 1% of all flowering plant species; they are parasitic and rely on a host plant to provide them with the materials they cannot acquire from their abiotic environment (Kuijt 1969). About 4000 plant species within 270 genera in over 20 families [predominantly angiosperms; we only have firm evidence for one gymnosperm parasite: *Parasitaxus ustus* (conifer coral tree) (Field & Brodrib 2005)] rely on a parasitic association with a host plant for their mineral nutrition, water uptake, and/or carbon supply (Table 1). They inhabit ecosystems ranging from the high Arctic to the tropics (Press & Phoenix 2005). Some of these species [e.g., *Striga* spp. (witchweed), *Orobanchae* spp. (broomrape), *Cuscuta* spp. (dodder), and *Arceuthobium douglasii* (Douglas-fir dwarf mistletoe)] are economically important pests that cause large yield losses of crop or forest plants, especially in Africa and Mediterranean countries (Estabrook & Yoder 1998). Other parasitic species (*Cystanthe* spp.) are grown commercially to extract traditional medicines in China, or for their fragrant wood [*Santalum*

album and *Santalum spicatum* (sandalwood)]. Ecologically, parasitic plants fill a fascinating niche in their exploitation of other plants to acquire sparingly available resources.

Parasitic angiosperms are generally divided into **holoparasites** and **hemiparasites** (Table 1). Holoparasites are **obligate** parasites. That is, they depend entirely on their host for the completion of their life cycle. They do not contain appreciable amounts of chlorophyll and lack the capacity to photosynthesize; their CO₂-compensation point may be as high as 2000 μmol mol⁻¹ (Dawson et al. 1994), much higher than that of autotrophic plants (Sect. 2.2.1 of Chapter 2A on photosynthesis). Holoparasites also lack the capacity to assimilate inorganic N. Hemiparasites may be either **facultative** or **obligate** parasites. They contain chlorophyll and have some photosynthetic capacity, but they depend on their host for the supply of water and nutrients. The distinction between holoparasites and hemiparasites is not sharp. For example, *Striga* species are considered hemiparasites, but they have very little chlorophyll and show only a limited photosynthetic capacity (Table 2).

Parasitic angiosperms are further subdivided into **stem parasites**, such as the holoparasitic *Cuscuta* and *Cassytha* (dodder) and the hemiparasitic *Viscum* and *Ameyema* (mistletoes), and **root parasites**, such as the holoparasitic *Orobanchae* (broomrape) and the hemiparasitic *Striga* (witchweed) (Stewart & Press 1990).

TABLE 1. Taxonomic survey of families of parasitic vascular plants.

Subclass-Family	Type of parasitism	Representative genus
Angiospermae:		
Magnoliidae		
– Lauraceae	Hemiparasitism	<i>Cassytha</i>
Rosidae		
– Balanophoraceae	Holoparasitism	<i>Balanophora</i>
– Eremolepidaceae	Hemiparasitism	<i>Cynomorium</i>
– Hydnoraceae	Holoparasitism	<i>Eremolepis</i>
– Krameriaceae	Hemiparasitism	<i>Hydnora</i>
– Loranthaceae	Hemiparasitism	<i>Krameria</i> <i>Loranthus</i> <i>Nuytsia</i> <i>Tapinanthus</i>
– Misodendraceae	Hemiparasitism	<i>Misodendrum</i>
– Olacaceae	Hemiparasitism	<i>Ola</i>
– Opiliaceae	Hemiparasitism	<i>Cansjera</i>
– Rafflesiaceae	Holoparasitism	<i>Rafflesia</i>
– Santalaceae	Both	<i>Dendrotrophe</i> <i>Exocarpus</i> <i>Santalum</i>
– Viscaceae	Both	<i>Amyema</i> <i>Phoradendron</i> <i>Viscum</i>
Asteridae		
– Cuscutaceae	Holoparasitism	<i>Cuscuta</i>
– Lennoaceae	Holoparasitism	<i>Lennoa</i>
– Orobanchaceae	Holoparasitism	<i>Conopholis</i> <i>Orobanche</i> <i>Alectra</i> <i>Melampyrum</i> <i>Odontites</i> <i>Rhinanthus</i> <i>Striga</i>
– Scrophulariaceae	Both	
Gymnospermae:		
– Podocarpaceae	Hemiparasitism	<i>Podocarpus</i> <i>Parasitaxis</i>

Source: After Kuijt (1969), Atsatt (1983).

Parasites may be small herbaceous species [e.g., *Rhinanthus sclerotinus* (yellow rattle) and *Melampyrum pratense* (cow-wheat)], shrubs [e.g., *Santalum acuminatum* (quandong), or large trees [e.g., *Nuytsia floribunda* (Western Australian Christmas tree) and *Exocarpus cupressiformis* (cherry ballart)]. Most parasitic plants have a broad host range. For example, *Castilleja* (paintbrush) species parasitize over a hundred different hosts from a variety of families (Press 1998), and *Rhinanthus minor* (yellow rattle) has approximately 50 different host species from 18 families within European grasslands; a single *Rhinanthus minor* plant may parasitize up to seven different host species simultaneously. Shoot parasites

TABLE 2. Some characteristics of *Striga hermonthica* (purple witchweed), which is an obligate root hemiparasite, in comparison with *Antirrhinum majus* (snapdragon), which is a related nonparasitic species.

Trait	<i>Striga hermonthica</i>	<i>Antirrhinum majus</i>
Stomatal frequency (mm^{-2})		
Adaxial leaf surface	114	36
Abaxial leaf surface	192	132
Stem	24	28
Transpiration ($\text{mmol m}^{-2} \text{s}^{-1}$)	8.5	5.7
Chlorophyll <i>a+b</i> content (g m^{-2})	2.6	7.2
Soluble protein content (g m^{-2})	12	23
Photosynthesis		
Per m^2 leaf area ($\mu\text{mol s}^{-1}$)	2.5	15.0
Per g chlorophyll ($\mu\text{mol s}^{-1}$)	1.0	2.6
Water-use efficiency [$\text{mmol CO}_2 \text{mol}^{-1} (\text{H}_2\text{O})$]	0.3	2.9

Source: Shah et al. (1987).

tend to have a smaller host range than do root parasites, but broad host ranges still occur, such as with *Cuscuta* and *Cassytha* species (dodders) with hosts that number in the hundreds. Also, the tropical rain-forest mistletoe *Dendrophthoe falcate* has nearly 400 known host species. Parasitic plants that can only utilize one or few host species are the exception; one of the most notable is the root parasite *Epifagus virginiana* (beech-drops), which only parasitizes *Fagus grandifolia* (American beech). Among shoot parasites, mistletoes provide examples of narrow host range, including the dwarf mistletoe *Arceuthobium minutissimum* (Himalayan dwarf mistletoe), which only parasitizes the pine species *Pinus griffithii* (Himalayan blue pine) and epiparasitic mistletoes, e.g., *Phoradendron scabberimum*, which only grow on other mistletoes (Estabrook & Yoder 1998, Press & Phoenix 2005).

2. Growth and Development

2.1 Seed Germination

Many parasitic angiosperms have small seeds with a hard seed coat and remain viable for many years. The seeds have very small reserves so that the seedlings run the risk of dying if they do not quickly find a host to attach to. **Germination** of the seeds of the holoparasitic stem parasite *Cuscuta* (dodder) is completely independent of its host (Dawson et al. 1994),

but many species [e.g., *Alectra* (witchweed), *Orobanch*e (broomrape), and *Striga* (witchweed)] require a **chemical signal** from their host to trigger germination which increases their chances to survive (Bouwmeester et al. 2007). The first naturally occurring stimulant, **strigol**, was identified from *Gossypium hirsutum* (cotton, a nonhost); it stimulates germination of *Striga*. Strigol has also been found in root exudates from plants that do act as a host for *Striga* (Siame et al. 1993). It is a sesquiterpene, active in concentrations as low as 10^{-12} M in the soil solution. A second compound has been isolated from the root exudate of *Vigna unguiculata* (cowpea), which is a host for both *Striga* and *Alectra*. A range of other germination-stimulating compounds have since been isolated from roots of a range of species. These stimulants have somewhat differing structures; they are collectively known as **strigolactones** (Fig. 1). When seeds of *Striga asiatica* are placed in agar at a distance of about 5 mm from the root surface of *Sorghum bicolor* (millet), germination takes place. No germination occurs at a distance of 10 mm or more. Germination only occurs after a minimum of 5 hours exposure to 1 mM hydroquinone.

The stimulant from *Sorghum bicolor* (millet) enhances the synthesis of the phytohormone **ethylene**, which is an absolute requirement for the germination of the *Striga* (witchweed) seeds. Inhibition of the action or synthesis of ethylene prevents the effect of the germination stimulant, whereas its action can be substituted by ethylene (Logan & Stewart 1991, Babiker et al. 1993).

The release of strigol by roots of cotton, which is not a host, has encouraged the use of this species as a “trap crop” for *Orobanch*e (broomrape) and *Striga* (witchweed). [A “**trap crop**” is a “**false host**” that is used to stimulate the germination of as many seeds as possible, so that the problems for the next crop, which can act as a host, are minimized.] If strigol is abundant in the soil during seed ripening, then it does not stimulate germination in the normal concentration range. A much higher concentration of strigol is then required to allow germination. This may be a mechanism avoiding germination at the end of the season, when the concentration of root exudates may be high.

Analogues of strigol and numerous other, unrelated compounds have been synthesized and tested for their capacity to stimulate germination. Such compounds are potentially useful to reduce the economic problems that parasites cause to crops.

What might be the evolutionary advantage, if any, of the release of compounds that promote the growth and development of parasitic plants, and thus endanger their own existence? Some of the

chemicals that act as triggers for germination or haustorium formation are **allelochemicals** or related to **phytoalexins**. For example, the stimulant from *Sorghum bicolor* (millet) readily oxidizes to a more stable quinone (sorgoleone) that strongly inhibits the growth of neighboring weeds (Sect. 2 of Chapter 9B on ecological biochemistry; Einhellig & Souza 1992). More importantly, plant-derived **strigolactones**, which are well known as germination stimulants for root parasitic plants, are “branching factors”, involved in a critical step in host recognition by **arbuscular mycorrhizal fungi** (Sect. 2 of Chapter 9A on symbiotic associations) (Akiyama et al. 2005, Bouwmeester et al. 2007). In *Trifolium pratense* (red clover), which is a host for arbuscular mycorrhizal fungi as well as for the root holoparasitic plant *Orobanch*e *minor* (broomrape), a reduced P_i supply promotes the release of orobanchol (a strigolactone), by clover roots. The level of orobanchol exudation is controlled by P_i availability and correlates with germination stimulation activity of the root exudates. Therefore, under **P_i deficiency**, roots not only attract symbiotic fungi, but may also promote root parasitic plants through the release of strigolactones (Yoneyama et al. 2007a). It is therefore not surprising that root exudates from **arbuscular mycorrhizal** plants of *Sorghum bicolor* (millet) induce lower germination of *Striga hermonthica* (purple witchweed) seeds than do exudates from non-mycorrhizal sorghum plants (Lendzemo et al. 2007). Field inoculation with arbuscular mycorrhizal fungi reduces the impact of *Striga hermonthica* on cereal crops and has the potential to contribute to integrated *Striga* management (Lendzemo et al. 2005).

N deficiency in *Sorghum bicolor* (millet) also promotes the production and exudation of 5-deoxystrigol, the host recognition signal for arbuscular mycorrhizal fungi (Yoneyama et al. 2007b). This would explain why germination of *Striga hermonthica* (purple witchweed) decreases with increasing root N concentrations (Ayongwa et al. 2006). Root parasitic plants have long been associated with nutrient-poor soils. This may in part be explained by their low competitive ability, but the recent findings that increased N and P availability reduce the release of strigolactones now offers an additional explanation.

2.2 Haustoria Formation

All parasitic plant species, with the exception of members of the Rafflesiaceae, have a **haustorium**, which is a specialized multifunctional organ that functions in attachment, penetration, and transfer

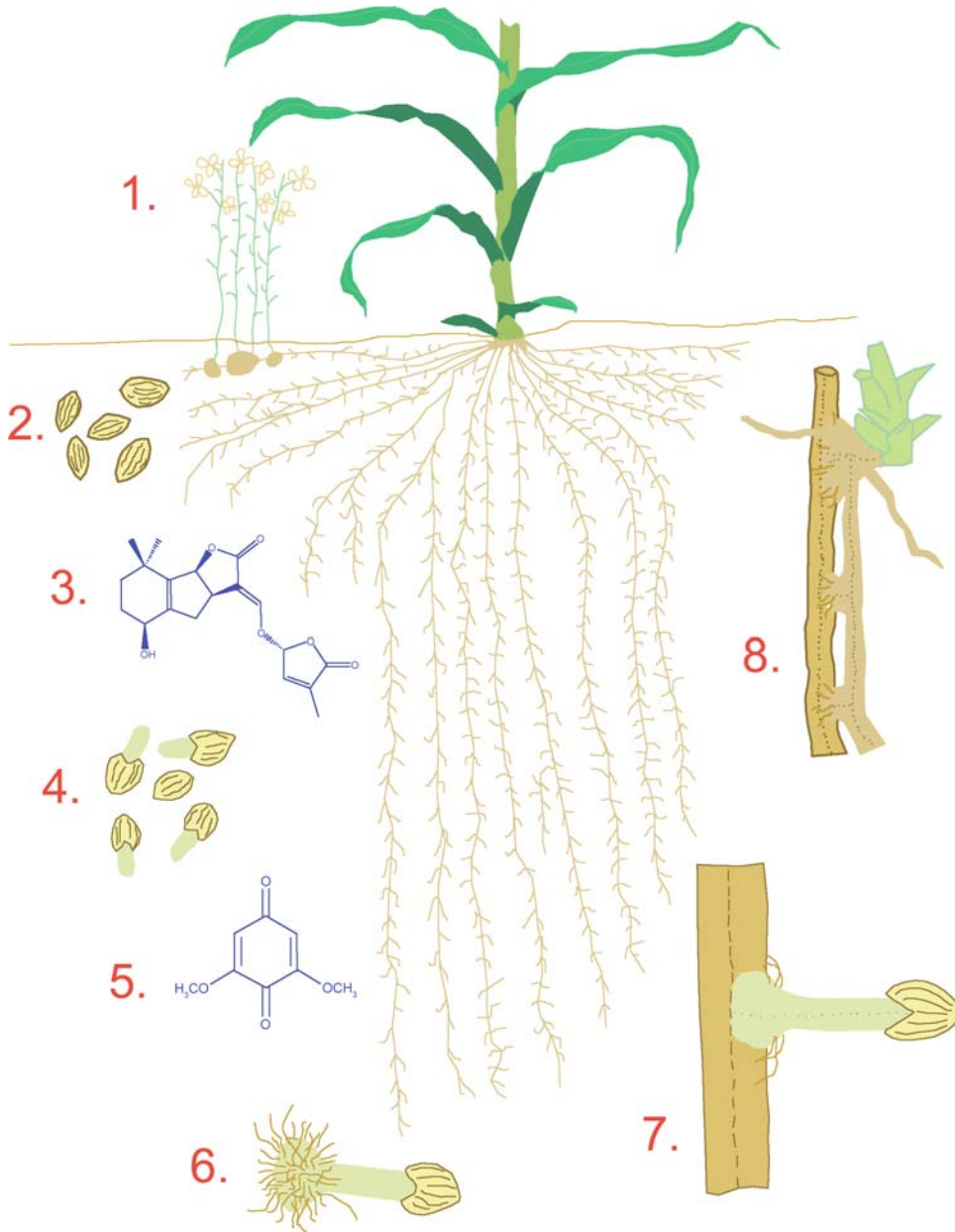

FIGURE 1. Life cycle of *Striga* (witchweed), an obligate root hemiparasite that can only complete its life cycle when attached to a host (1). Germination of the very small seeds (2) is stimulated by signal molecules (strigolactones) released from the roots of a host plant (3).

Attachment via a haustorium (4) requires an additional signal molecule (5). Upon penetration of the root via its haustorium, inorganic nutrients are imported from the host's xylem (7). Once the parasite starts growing, more haustoria are produced (8).

of water and solutes. Most parasitic plants will only develop a functional haustorium in the presence of a **chemical signal** from the host, which differs from the signal that triggers germination. For example, haustorium formation in *Striga* (witchweed) species

proceeds only when a signal molecule is released from host roots. An example of such a signal molecule is 2,6-dimethoxy-*p*-benzoquinone, which is produced by the host roots, in response to an enzyme from the parasite (Smith et al. 1990, Yoder

1999). Seeds of *Zea mays* (corn) are a rich source of a range of anthocyanins, other flavonoids, and simple phenolics that induce haustoria formation in *Triphysaria versicolor* (yellow owl's clover) (Albrecht et al. 1999). The chemical signals are often bound tightly to cell walls and are not released into the root environment. They are classified into four groups: flavonoids, *p*-hydroxy acids, quinones, and cytokinins; they are biologically active in the concentration range of 10^{-5} – 10^{-7} M (Estabrook & Yoder 1998). The holoparasitic stem parasite *Cuscuta pentagona* (dodder) uses volatile cues from *Solanum lycopersicum* (tomato), *Impatiens walerana* (patient Lucy), and *Triticum aestivum* (wheat) to direct its growth toward nearby plants. Seedlings of the parasite can distinguish volatiles from different hosts and preferentially grow toward *Solanum lycopersicum* plants. Several individual compounds from *Solanum lycopersicum* and *Triticum aestivum* elicit directed growth by *Cuscuta pentagona*, whereas one compound from *Triticum aestivum* is repellent (Runyon et al. 2006).

Signals that are involved in preventing haustoria formation and subsequent attachment of the parasite to its host may explain **resistance** of some species to parasites (Rispaill et al. 2007). Complete resistance to *Striga hermonthica* (purple witchweed) infection has not been identified in *Zea mays* (corn). A valuable source of resistance may be present in the genetic potential of wild germplasm, especially a wild relative of corn, *Tripsacum dactyloides* (gamma grass). *Striga hermonthica* development is arrested after attachment to *Tripsacum dactyloides*. Vascular continuity is established between parasite and host, but there is poor primary haustorial tissue differentiation on *Tripsacum dactyloides* compared with that on *Zea mays*. Partial resistance is inherited in a hybrid between the two species. *Tripsacum dactyloides* produces a signal that inhibits haustorial development: this signal may be mobile within the parasite haustorial root system (Gurney et al. 2003). Two distinct defense responses against *Rhinanthus minor* (yellow rattle) occur in the nonhost forbs *Leucanthemum vulgare* (field daisy) and *Plantago lanceolata* (snake plantain). *Leucanthemum vulgare* encapsulates the parasite's invading structures, thus preventing it from gaining access to the stele. In *Plantago lanceolata* host cell fragmentation occurs at the interface between the parasite and host. Grasses and a legume that are good hosts for *Rhinanthus minor* show no evidence of defense at the host/parasite interface (Cameron et al. 2006).

Elaborate work has been done on the ultrastructure of haustoria formation in a range of root parasites [e.g., in the Australian root hemiparasite *Olox phyllanthi* (Kuo et al. 1989)]. Walls of parasitic cells

that contact host xylem are thickened with polysaccharides rather than with lignin. Host xylem pits are a major pathway for water and solute transport from the host to the haustorium, whereas direct connections between xylem-conducting elements of host and parasite are extremely rare. Symplasmic connections between the two partners are absent. Cells of the parasite that are adjacent to host cells often have an appearance similar to that of **transfer cells**.

The completely encircling haustorium of the root hemiparasite *Nuytsia floribunda* (Western Australian Christmas tree) is unique in cutting the host root transversely by means of a sclerenchymatic sickle-like sclerenchymatous cutting device (Fig. 2). Electron micrographs suggest that the developing haustorium acts as "scissors", which effectively cut off the distal part of the host from the rest of the plant. Parenchymatous tissue of the parasite then develops tube-like apical extensions into the cut host xylem vessels, thereby facilitating absorption of xylem solutes from host xylem sap. Conducting xylem tissue in the haustorium terminates some distance from the interface, so absorbed substances must traverse several layers of parenchyma before gaining access to the xylem stream of the parasite. When grown in pots with a range of hosts, as well as in the field, *Nuytsia floribunda* has a more negative water potential than its host, causing water movement to the parasite (Calladine & Pate 2000).

After germination in the soil, the seedlings of the obligate stem parasite *Cuscuta* (dodder) start to grow up and circumnutate. Under favorable conditions many stems may grow from a twined seedling after attachment to the host. Enzymes from the parasite soften the surface tissue of the host, and the haustorium penetrates the host tissue. Vascular cells of the parasite contact vascular cells of the host, and the contents of the host's sieve tubes and xylem conduits are diverted into the parasite. As the dodder continues to grow, it maintains its support by continually reattaching to host plants (Fig. 3; Dawson et al. 1994).

Transfer of solutes via the haustorium may be partly passive, via the apoplast. The presence of parenchyma cells with many mitochondria, dictyosomes, ribosomes, and a well-developed ER, however, suggests that active processes play a role as well. Indeed, compounds absorbed by the haustoria may be processed before entering the shoot. As a result, the carbohydrates, amino acids, and organic acids in the xylem sap of *Striga hermonthica* (purple witchweed) and *Olox phyllanthi* differ from those in their hosts. The major compound in *Striga hermonthica* is mannitol, which does not occur in the



FIGURE 2. Haustoria of root hemiparasites on host roots. (A) *Santalum acuminatum* (quandong) and (B) *Nuytsia floribunda* (Western Australian Christmas tree) (courtesy M.W. Shane, School of Plant Biology, the University of Western Australia, Perth, Australia).



FIGURE 3. Haustoria of the stem holoparasite *Cassytha* sp. parasitizing on a leaf of *Banksia elderiana* (photo H. Lambers).

host *Sorghum bicolor* (millet). Similarly, in xylem sap of *Sorghum bicolor* asparagine predominates as a nitrogenous compound, and malate and citrate as organic acids, whereas the major nitrogenous compound of *Striga hermonthica* is citrulline, and shikimic acid is the main organic acid. The carbohydrate concentrations in the parasite xylem sap may be five times higher than those in the host (Pate 2001).

2.3 Effects of the Parasite on Host Development

Although some hemiparasitic plants can grow in the absence of a host, their productivity is greatly enhanced when they are attached to a host (Fig. 4). At the same time, the growth of the host is reduced when a parasite is attached to it. The reduction in growth and grain yield of *Sorghum bicolor* (millet)

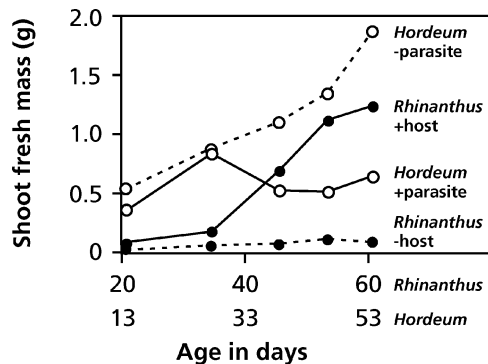

FIGURE 4. The increment of shoot fresh mass of *Hordeum vulgare* (barley), either grown alone or with a hemiparasite attached to its roots, and of *Rhinanthus serotinus* (late-flowering yellow rattle), a hemiparasite, either grown alone or attached to its host (Klaren 1975). Reproduced with the author's permission.

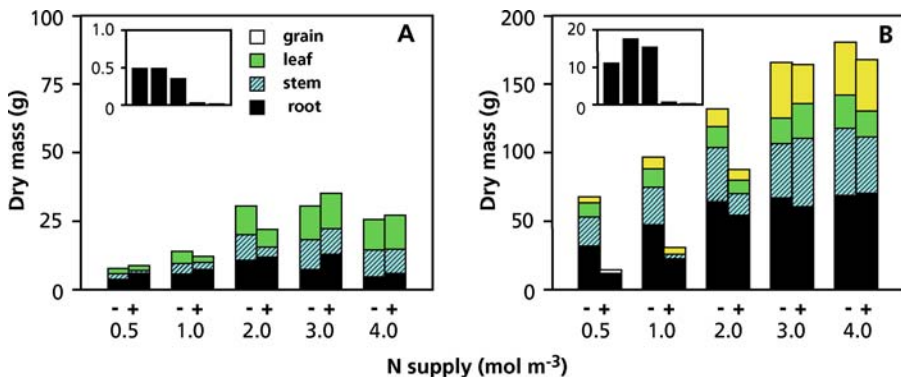

FIGURE 5. Partitioning of dry mass in *Sorghum bicolor* (millet) grown at a range of N-supply rates in the absence (–) and presence (+) of *Striga hermonthica* (purple witchweed). Dry masses of the parasite are

shown in the insets; (A) and (B) refer to 50 and 140 days after planting. Different shades in the columns, from bottom to top, refer to roots, stems, leaves, and seeds (after Cechin & Press 1993).

infected by the parasitic *Striga hermonthica* (purple witchweed) is strongest at low N supply and may disappear completely at optimum N supply. The parasite is also affected by the low N supply, with considerably reduced seed germination, reduced attachment, and poor growth of *Striga hermonthica* plants (Fig. 5).

Even though the root growth of *Ricinus communis* (castor bean) is inhibited when parasitized by *Cuscuta reflexa* (dodder), which is an obligate stem holoparasite, the rate of NO_3^- uptake per unit root mass is stimulated by 40 and 80% at high and low NO_3^- supply, respectively (Jeschke & Hilpert 1997). The rate of NO_3^- uptake in the host plant obviously increases with increasing N demand of the parasite–host association (Sect. 2.2.3 of Chapter 6 on mineral nutrition). When parasitized by holoparasites, host plants may transiently show a higher rate of **photosynthesis**, greater stomatal conductance, and higher rates of transpiration, despite their smaller root system (Watling & Press 2001). Enhanced photosynthesis may be due to a higher N concentration in the leaves (Sect. 6.1 of Chapter 2A on photosynthesis), a higher sink demand (Sect. 4.2 of Chapter 2A on photosynthesis), or delayed leaf senescence (Jeschke & Hilpert 1997, Hibberd et al. 1998, 1999). Hemiparasites tend to have a negative effect on host photosynthesis (Watling & Press 2001).

Xylem-tapping stem hemiparasites (mistletoes), such as *Phoradendron juniperinum* (juniper mistletoe) and *Amyema preissii* (wire-leaf mistletoe), have no phloem connection with their host and they tend to kill the host shoot beyond the point of infection. In this way, the mistletoe is the only green tissue to be supplied via the xylem by a particular branch.

Despite the absence of phloem connections, the growth of the mistletoe and that of xylem of the host are closely correlated. Just like the correlation between leaf area and sapwood area in trees (Sect. 5.3.5 of Chapter 3 on plant water relations), there is also a close correlation between the leaf area of the mistletoe and the sapwood area of the host branch proximal to the point of attachment (Fig. 6). This indicates that enlargement of the host stem must

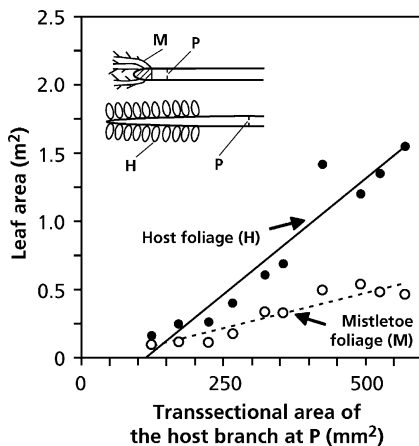

FIGURE 6. Correlations between the area of the foliage of a nonparasitized branch of *Acacia acuminata* (raspberry jam) or the foliage of the xylem-tapping stem hemiparasite *Amyema preissii* (mistletoe), parasitizing on *Acacia acuminata*, and the transectional area of the branch of the host. Note that a similar transectional branch area supports substantially more foliage of the host than of the parasite (after Tennakoon & Pate 1996a).

proceed, despite the impossibility of transport of any signals from the parasites' leaves via the phloem. For a similar area of foliage, the mistletoe appears to require a substantially greater sapwood area than does the host plant itself. This is probably related to a relatively high rate of transpiration of the hemiparasite (Sect. 4).

3. Water Relations and Mineral Nutrition

Most herbaceous root and stem hemiparasites have high **stomatal frequencies**, high rates of **transpiration**, and lower **water-use efficiency** than their host (Schulze & Ehleringer 1984, Davidson & Pate 1992). The stomata of the herbaceous hemiparasites do respond to water stress, but stomatal closure is induced at much lower relative water contents (Fig. 7). Thus, the gradient in **water potential** between leaves and roots is steeper for the parasite than it is for its host, facilitating the flux of solutes imported via the xylem (Klaren & Van de Dijk 1976, Davidson et al. 1989). This reflects a lower sensitivity of the stomata to ABA, the hormone associated with stomatal closure during water stress (Sect. 5.4.2 of Chapter 3 on plant water relations), in the parasitic species [*Striga hermonthica* (purple witchweed)]

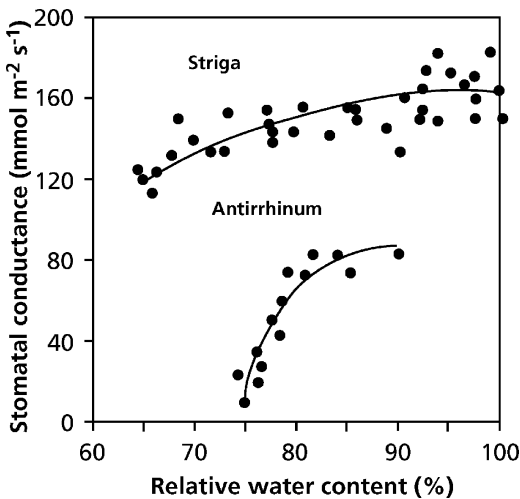

FIGURE 7. The relationship between stomatal conductance and the relative water content of the leaves for the hemiparasite *Striga hermonthica* (purple witchweed) and the closely related nonparasitic plant *Antirrhinum majus* (snapdragon) (Shah et al. 1987). Copyright Physiologia Plantarum.

than in related nonparasites (*Antirrhinum majus*) (Shah et al. 1987). Leaves of *Zea mays* (corn) plants that are parasitized by *Striga hermonthica* have higher levels of ABA than leaves of control plants, and the concentration of this phytohormone is an order of magnitude higher again in the leaves of the parasite (Taylor et al. 1996). The stomates of *Striga hermonthica* do not close, however, even when the relative water content of its leaves declines to 70% or less.

Rapid rates of transpiration are one of the reasons for a more negative **water potential** of the shoots of the hemiparasites compared with that of their hosts. This low shoot water potential of hemiparasites requires accumulation of solutes to maintain turgor. In *Santalum acuminatum* (quandong) a significant proportion of the osmotic potential is accounted for by mannitol, Na^+ , K^+ , and Cl^- . A water potential difference of 1–2 MPa is maintained between this hemiparasitic shrub and its host. Xylem sap and leaves of *Santalum acuminatum* contain considerable concentration (0.1–0.4 mol kg^{-1} tissue water) of mannitol (Loveys et al. 2001b). A favorable water-potential gradient toward the *Striga hermonthica* (purple witchweed) is maintained even when rates of transpiration are severely reduced. This is due to the haustorial resistance to water flow, which is 1.5–4.5 times greater than that offered by the parasite shoot (Ackroyd & Graves 1997). Both the high rate of transpiration and the increased resistance across the haustoria facilitate the diversion of host resources to the parasite. These host resources may also include **secondary metabolites** (naturally occurring insecticides) that increase the parasite's resistance against insects, e.g., in *Santalum acuminatum* (quandong) attached to *Melia azedarach* (cape lilac) (Loveys et al. 2001a).

The high rates of transpiration of hemiparasitic plants have major consequences for the **leaf temperature** of the parasitic plants. The leaf temperature of *Striga hermonthica* (purple witchweed) may be as much as 7°C below air temperature (Sect. 2.1 of Chapter 4A on leaf energy budgets). The use of **antitranspirants**, which reduce transpirational water loss, may enhance the leaf temperature of parasites to an extent that the leaves blacken and die. These compounds have been suggested as tools to control parasitic pests (Press et al. 1989).

The high stomatal conductance and high rate of transpiration of parasites allows rapid import of solutes via the xylem. As expected, the C_i of hemiparasites is relatively high and the **carbon-isotope fractionation** is stronger in mistletoes than it is in their host, because of the high stomatal conductance of the parasite (Sect. 6 of Chapter 3 on plant water

TABLE 3. Carbon-isotope fractionation values for mistletoe–host pairs (number of pairs in brackets) from different continents; mean values and standard errors in brackets.

Region	Carbon-isotope composition (‰)		Difference between host and mistletoe (‰)
	Host	Mistletoe	
		Nitrogen-fixing hosts	
United States (7)	–26.3 (0.5)	–26.5 (0.2)	0.2
Australia (28)	–26.9 (0.2)	–28.3 (0.3)	1.4
South Africa (4)	–24.7 (0.3)	–25.7 (1.0)	1.1
		Nonfixing hosts	
United States (8)	–23.4 (0.1)	–26.6 (0.1)	3.2
Australia (19)	–26.5 (0.3)	–28.8 (0.2)	2.3
South Africa (11)	–24.7 (0.4)	–26.9 (0.6)	2.2

Source: Ehleringer et al. (1985).

relations). It is interesting that the difference in fractionation between host and parasite is less when the host is an N₂-fixing tree than when it is a nonfixing one. It has been suggested that more nitrogenous compounds are imported when the host is fixing N₂ which then reduces the transpiration and increases the parasite's water-use efficiency (Schulze & Ehleringer 1984). The smaller difference in the case of the N₂-fixing hosts, however, also reflects a high isotopic fractionation by the rapidly transpiring hosts (Table 3). The decline in carbon-isotope fractionation with increasing N concentration is, in fact, due to **enhanced carbon import** from the host; a substantial part of the carbon in mistletoes originates from the host via the xylem as organic acids and amino acids (Sect. 4).

Holoparasites, which predominantly import compounds from the sieve tubes of the host, have distinctly lower **Ca:K ratios** than do parasites that only tap the xylem (Ziegler 1975). This is due to the fact that Ca is only present in very low concentrations in phloem sap, whereas most other minerals occur in higher concentrations in phloem sap than in xylem fluid (Sect. 2 of Chapter 2C on long-distance transport). To acquire sufficient Ca for their growth, some additional xylem connections are required. Whereas *Cuscuta reflexa* (dodder) acquires 94% of its N and 74% of its K from the phloem of the host *Lupinus albus* (white lupin), virtually none of its Ca arrives via the phloem (Jeschke et al. 1995).

Because most xylem-tapping mistletoes, with the notable exception of *Olax phyllanthi* (Tennakoon & Pate 1996b), have no mechanism to selectively import specific ions that arrive via the xylem or to export ions that have arrived in excess of their requirement, mistletoes often accumulate vast amounts of inorganic ions. Increased succulence

with increasing leaf age and sequestration of Na in older leaves appear to be mechanisms to maintain inorganic solute concentrations at a tolerable level (Popp et al. 1995). A consequence of the accumulation of vast amounts of inorganic ions is the need for compatible solutes in the cytoplasm (Sect. 4.1 of Chapter 3 on plant water relations). This may well account for the high concentrations of polyols in xylem-tapping mistletoes (Richter & Popp 1992, Popp et al. 1995). Some of the accumulated ions may be excreted via leaf glands [e.g., in *Odontites verna* (red bartsia) and *Rhinanthus serotinus* (late-flowering yellow rattle) (Govier et al. 1968, Klaren & Van de Dijk 1976)].

Rapid import of N may lead to higher concentrations of organic N in the leaves of the parasite than in those of the host. This often coincides with a similarity in leaf shape and appearance: **cryptic mimicry** (Bannister 1989). The N concentration of the parasite's leaves, however, is sometimes lower than that of the host, which may coincide with differences in leaf shape and appearance between host and parasite: **visual advertisement**. Because many herbivores prefer leaves with a high organic N concentration, it has been suggested that both "cryptic mimicry" and "visual advertisement" **reduce herbivory** (Ehleringer et al. 1986).

High leaf nutrient concentrations in combination with a low nutrient-resorption proficiency (Sect. 4.3 of Chapter 6 on mineral nutrition) in hemiparasitic plants give rise to litter with high nutrient concentrations (Quested et al. 2002, 2003). Since most hemiparasites also produce less **quantitative secondary metabolites** (Sect. 3.2 of Chapter 9B on ecological biochemistry) than their hosts, their leaf litter tends to decompose readily. As a consequence, hemiparasites can accelerate nutrient cycling in

nutrient-poor communities, as found for *Bartsia alpina* (velvetbells) in a European subarctic community (Bardgett et al. 2006, Quested et al. 2005). In the nutrient-impooverished environment of Western Australia, introduced weeds often thrive under hemiparasitic trees and shrubs, when they show very poor growth away from these plants.

4. Carbon Relations

Hemiparasites are assumed to rely on their hosts only for water and mineral nutrients, but to fix their own CO₂. Their photosynthetic capacity, however, is often very low (0.5–5.0 μmol m⁻² s⁻¹), and in many species there is substantial carbon import from the host. *Striga gesnerioides* (witchweed), which is an obligate root hemiparasite, has a very low photosynthetic capacity coupled with a very high rate of respiration. There is no net CO₂ fixation even at light saturation (Graves et al. 1992), so it imports carbohydrates from its host. In *Striga hermonthica* (purple witchweed) approximately 27% of the carbon is derived from its host [*Sorghum bicolor* (millet)] at a low N supply; this value declines to approximately 6% at a high N supply and higher rates of host photosynthesis (Cechin & Press 1993). Xylem-tapping mistletoes also import a large fraction of all their carbon from the host (Schulze et al. 1991) [e.g., 23–43% in *Viscum album* (European

mistletoe) (Richter & Popp 1992)]. Two methods have been used to assess heterotrophic carbon gain in the African xylem-tapping mistletoe, *Tapinanthus oleifolius* (lighting match). One method is based on an analysis of xylem sap and transpiration rate (Sect. 3.4 of Chapter 8 on life cycles; Pate et al. 1991); the other is based on an analysis of carbon-isotope composition and gas exchange (Sect. 5.3 of Chapter 2A on photosynthesis, Box 2A.2; Marshall & Ehleringer 1990). Both methods agree and yield values in the range of 55–80%, with the higher values pertaining to older leaves that have high transpiration rates (Table 4).

The presence of a parasite like *Cuscuta europaea* (dodder) on the stem of a host plant greatly enhances the release of amino acids and other solutes from the **phloem** of the host (Fig. 8). In *Cuscuta* parasitizing on *Genista acantholada*, *Lupinus albus* (white lupin), or *Digitalis* sp. (foxglove) alkaloids and glycosides synthesized in the host are transported to the parasite (Rothe et al. 1999). These results suggest an open symplastic connection between the phloem of host and parasite. This is confirmed by translocation experiments using fluorescent dyes, which are translocated together with the assimilates in the phloem and unloaded symplastically into the sinks. In all investigated host–parasite systems with *Cuscuta* species 3 hours after application the dyes are detectable in the parasite. In both the host and the parasite the

TABLE 4. Heterotrophic carbon gain of the xylem-tapping mistletoe *Tapinanthus oleifolius* (lighting match) on *Euphorbia virosa* (milkbush) and *Acacia nebrownii* (water acacia).*

	<i>Tapinanthus oleifolius</i> on <i>Euphorbia virosa</i>		<i>Tapinanthus oleifolius</i> on <i>Acacia nebrownii</i>
	Young leaves	Old leaves	
Carbon-budget method			
Carbon concentration of xylem sap (mmol C l ⁻¹ xylem sap)	121	121	116
Transpiration [l H ₂ O m ⁻² (10 hour) ⁻¹]	1.3	3.9	1.6
Carbon import via the xylem (C _x) [mmol C m ⁻² (10 hour) ⁻¹]	157	470	188
CO ₂ assimilation in photosynthesis [mmol CO ₂ m ⁻² (10 hour) ⁻¹]	126	108	144
Total carbon gain [mmol C m ⁻² (10 hour) ⁻¹]	283	578	332
Heterotrophic carbon gain (%)	55	81	57
δ¹³C-difference method			
δ ¹³ C xylem sap (‰)	-16.92	-16.92	-21.05
δ ¹³ C parasite leaves (‰, measured)	-23.73	-18.99	-26.81
δ ¹³ C parasite leaves (‰, predicted from measured C _i /C _a)	-29.60	-33.20	-32.88
Heterotrophic carbon gain (%)	46	87	51

Source: Richter et al. (1995).

* The host-derived part of the mistletoe's carbon was calculated from the carbon flux from the host xylem sap (i.e., carbon concentration in the xylem sap multiplied by the transpiration rate; "carbon-budget method") or from the difference between the predicted and the actual carbon isotope ratios of the parasite ("δ¹³C-difference method").

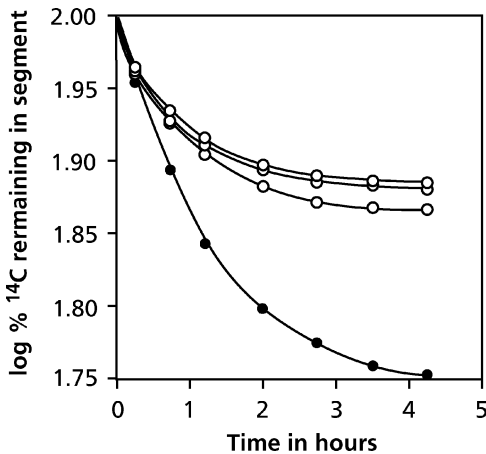

FIGURE 8. The effect of *Cuscuta europaea* (dodder), a stem parasite, on the release of ^{14}C -labeled valine from the sieve tubes in the stem of its host, *Vicia faba* (broad bean). The values represent the fraction of the labeled amino acid originally present in the stem segment that was not released from the sieve tubes to the apoplast. Open symbols refer to nonparasitized segments of the stem; filled symbols refer to the release in the apoplast of the segment where the parasite had formed a haustorium (after Wolswinkel et al. 1984). Copyright American Society of Plant Biologists.

fluorescence is restricted to the phloem (Birschwilks et al. 2006).

A parasite like *Striga gesnerioides* (witchweed) may use up to 70% of all the imported carbohydrates for its respiration; the use of carbon from the host may be even more important for the yield reduction of its host, *Vigna unguiculata* (cowpea), than the reduction in host photosynthesis (Graves et al. 1992). It is not clear why such a large fraction of imported carbon is used in respiration; in the holoparasite *Cuscuta reflexa* (dodder), when it grows on the stem of *Lupinus albus* (white lupin), only 29% of all the incorporated carbon is respired (Jeschke et al. 1994). This value is in the same range as that of heterotrophic plant parts of nonparasitic plants (Sect. 5 of Chapter 2B on plant respiration).

The reduction in photosynthesis of the host *Sorghum bicolor* (millet) by *Striga hermonthica* (purple witchweed) is strongest at a low N supply and high infection rate (approximately 40%). This may be associated with reduced N concentrations in the host leaves or reduced stomatal conductance which is due to the high demand for N and water of the parasite. At a very low infection rate and high N supply, there may be some enhancement of photosynthesis in the presence of the parasite, which is

due to the stimulation of photosynthesis by enhanced sink strength (Cechin & Press 1993).

5. What Can We Extract from This Chapter?

The 4000 or so species of parasitic angiosperms of the world flora collectively represent an extraordinarily broad assemblage of taxa from distantly related families of dicotyledonous species and an equally profuse range of woody forms, morphologies, and life strategies. **Hemiparasites** tend to have high rates of transpiration and a low shoot water potential which ensures rapid intake of **xylem solutes**. Hemiparasites also import carbon (amino acids, organic acids) via the transpiration stream which supports their carbon requirement to a varying extent: from almost none to virtually completely.

Holoparasites tap the host's phloem and depend entirely on their host for their carbon requirements. Because the phloem contains very little Ca, holoparasites have distinctly lower Ca:K ratios than do hemiparasites.

Some parasitic plants are notorious **pests**, reducing crop yield in many areas of the world. A thorough understanding of host factors that affect seed germination of some parasitic plants may help to control these pests, either by employing trap crops or by using analogues that stimulate seed germination of the parasite. The possibility of using intercrops to reduce the impact of parasitic weeds on crops is further explored in Sect. 6.3 of Chapter 9E on interactions among plants.

References

- Ackroyd, R.D. & Graves, J.D. 1997. The regulation of the water potential gradient in the host and parasite relationship between *Sorghum bicolor* and *Striga hermonthica*. *Ann. Bot.* **80**: 649–656.
- Akiyama, K., Matsuzaki, K., & Hayashi, H. 2005. Plant sesquiterpenes induce hyphal branching in arbuscular mycorrhizal fungi. *Nature* **435**: 824–827.
- Albrecht, H., Yoder, J.L., & Phillips, D.A. 1999. Flavonoids promote haustoria formation in the root parasite *Triphysaria versicolor*. *Plant Physiol.* **119**: 585–591.
- Atsatt, P.R. 1983. Host-parasite interactions in higher plants. In: *Encyclopedia of plant physiology*, N.S. Vol. 12C, O.L. Lange, P.S. Nobel, C.B. Osmond, & H. Ziegler (eds). Springer-Verlag, Berlin, pp. 519–535.
- Ayongwa, G.C., Stomph, T.J., Emechebe, A.M., & Kuyper, T.W. 2006. Root nitrogen concentration of

- sorghum above 2% produces least *Striga hermonthica* seed stimulation. *Ann. Appl. Biol.* **149**: 255–262.
- Babiker, A.G.T., Ejeta, G., Butler, L.G., & Woodson, W.R. 1993. Ethylene biosynthesis and strigol-induced germination of *Striga asiatica*. *Physiol. Plant.* **88**: 359–365.
- Bannister, P. 1989. Nitrogen concentration and mimicry in some New Zealand mistletoes. *Oecologia* **79**: 128–132.
- Bardgett, R.D., Smith, R.S., Shiel, R.S., Peacock, S., Simkin, J.M., Quirk, H., & Hobbs, P.J. 2006. Parasitic plants indirectly regulate below-ground properties in grassland ecosystems. *Nature* **439**: 969–972.
- Birschwilks, M., Haupt, S., Hofius, D., & Neumann, S. 2006. Transfer of phloem-mobile substances from the host plants to the holoparasite *Cuscuta* sp. *J. Exp. Bot.* **57**: 911–921.
- Bouwmeester, H.J., Roux, C., Lopez-Raez, J.A., & Becard, G. 2007. Rhizosphere communication of plants, parasitic plants and AM fungi. *Trends Plant Sci.* **12**: 224–230.
- Calladine, A. & Pate, J.S. 2000. Haustorial structure and functioning of the root hemiparasitic tree *Nuytsia floribunda* (Labill.) R.Br. and water relationships with its hosts. *Ann. Bot.* **85**: 723–731.
- Cameron, D.D., Coats, A.M., & Seel, W.E. 2006. Differential resistance among host and non-host species underlies the variable success of the hemi-parasitic plant *Rhinanthus minor*. *Ann. Bot.* **98**: 1289–1299.
- Cechin, I. & Press, M.C. 1993. Nitrogen relations of the sorghum-*Striga hermonthica* host-parasite association: growth and photosynthesis. *Plant Cell Environ.* **16**: 237–247.
- Davidson, N.J. & Pate, J.S. 1992. Water relations of the mistletoe *Amyema fitzgeraldii* and its host *Acacia acuminata*. *J. Exp. Bot.* **43**: 1459–1555.
- Davidson, N.J., True, K.C., & Pate, J.S. 1989. Water relations of the parasite: host relationship between the mistletoe *Amyema linophyllum* (Fenzl) Tieghem and *Casuarina obesa* Miq. *Oecologia* **80**: 321–330.
- Dawson, J.H., Musselman, L.J., Wolswinkel, P., & Dörr, I. 1994. Biology and control of *Cuscuta*. In: Reviews of weed science, Vol. 6, S.O. Duke (ed). Imperial Printing Company, Champaign, pp. 265–317.
- Ehleringer, J.R., Schulze, E.D., Ziegler, H., Lange, O.L., Farquhar, G.D., & Cowan, I.R. 1985. Xylem-tapping mistletoes: water or nutrient parasites? *Science* **227**: 1479–1481.
- Ehleringer, J.R., Ullmann, I., Lange, O.L., Farquhar, G.D., Cowan, G.D., & Schulze, E.-D. 1986. Mistletoes: a hypothesis concerning morphological and chemical avoidance of herbivory. *Oecologia* **70**: 234–237.
- Einhellig, F.A. & Souza, I.F. 1992. Phytotoxicity of sorgo-leone found in grain sorghum root exudates. *J. Chem. Ecol.* **18**: 1–11.
- Estabrook, E.M. & Yoder, J.I. 1998. Plant-plant communication: Rhizosphere signaling between parasitic angiosperms and their hosts. *Plant Physiol.* **116**: 1–7.
- Field, T.S. & Brodrib, T.J. 2005. A unique mode of parasitism in the conifer coral tree *Parasitaxus ustus* (Podocarpaceae). *Plant Cell Environ.* **28**: 1316–1325.
- Govier, R.N., Brown, J.G.S., & Pate, J.S. 1968. Hemiparasitic nutrition in angiosperms. II. Root haustoria and leaf glands of *Odontites verna* (Bell.) Dum. and their relevance to the abstraction of solutes from the host. *New Phytol.* **67**: 863–972.
- Graves, J.D., Press, M.C., Smith, S., & Stewart, G.R. 1992. The carbon canopy economy of the association between cowpea and the parasitic angiosperm *Striga gesnerioides*. *Plant Cell Environ.* **15**: 283–288.
- Gurney, A.L., Grimaneli, D., Kananpiu, F., Hoisington, D., Scholes, J.D., & Press, M.C. 2003. Novel sources of resistance to *Striga hermonthica* in *Tripsacum dactyloides*, a wild relative of maize. *New Phytol.* **160**: 557–568.
- Hibberd, J.M., Quick, W.P., Press, M.C., & Scholes, J.D. 1998. Can source-sink relations explain responses of tobacco to infection by the root holoparasitic angiosperm *Orobancha cernua*? *Plant Cell Environ.* **21**: 333–340.
- Hibberd, J.M., Quick, W.P., Press, M.C., Scholes, J.D., & Jeschke, W.D. 1999. Solute flux from tobacco to the parasitic angiosperm *Orobancha cernua* and the influence of infection on host carbon and nitrogen relations. *Plant Cell Environ.* **22**: 937–947.
- Jeschke, W.D. & Hilpert, A. 1997. Sink-stimulated photosynthesis and sink-dependent increase in nitrate uptake: nitrogen and carbon relations of the parasitic association *Cuscuta reflexa*-*Ricinus communis*. *Plant Cell Environ.* **20**: 47–56.
- Jeschke, W.D., Bäuml, P., Rätz, N., Czygan, F.-C., & Proksch, P. 1994. Modelling of the flows and partitioning of carbon and nitrogen in the holoparasite *Cuscuta reflexa* Roxb. and its host *Lupinus albus*. L. II. Flows between host and parasite and within parasitized host. *J. Exp. Bot.* **45**: 801–812.
- Jeschke, W.D., Bäuml, P., & Rätz, N. 1995. Partitioning of nutrients in the system *Cuscuta reflexa*-*Lupinus albus*. *Appl. Biol.* **42**: 71–79.
- Klaren, C.H. 1975. Physiological aspects of the hemiparasite *Rhinanthus serotinus*. PhD Thesis, University of Groningen, the Netherlands.
- Klaren, C.H. & Van de Dijk, S.J. 1976. Water relations of the hemiparasite *Rhinanthus serotinus* before and after attachment. *Physiol. Plant.* **38**: 121–125.
- Kuijt, J. 1969. The biology of parasitic flowering plants. University of California Press, Berkeley.
- Kuo, J., Pate, J.S., & Davidson, N.J. 1989. Ultrastructure of the haustorial interface and apoplasmic continuum between host and the root hemiparasite *Oxalis phyllanthi* (Labill.) R. Br. (Oxalaceae). *Protoplasma* **150**: 27–39.
- Lenzemo, V.W., Kuyper, T.W., Kropff, M.J., Van Ast, A. 2005. Field inoculation with arbuscular mycorrhizal fungi reduces *Striga hermonthica* performance on cereal crops and has the potential to contribute to integrated *Striga* management. *Field Crops Res.* **91**: 51–61.
- Lenzemo, V.W., Kuyper, T.W., Matusova, R., Bouwmeester, H.J., & Van Ast, A. 2007. Colonization by arbuscular mycorrhizal fungi of sorghum leads to reduced germination and subsequent attachment and emergence of *Striga hermonthica*. *Plant Signal. Behav.* **2**: 58–62.

- Logan, D.C. & Stewart, G.R. 1991. Role of ethylene in the germination of the hemiparasite *Striga hermonthica*. *Plant Physiol.* **97**: 1435–1438.
- Loveys, B.R., Tyerman, S.D., & Loveys, B.R. 2001a. Transfer of photosynthate and naturally occurring insecticidal compounds from host plants to the root hemiparasite *Santalum acuminatum* (Santalaceae). *Aust. J. Bot.* **49**: 9–16.
- Loveys, B.R., Loveys, B.R., & Tyerman, S.D. 2001b. Water relations and gas exchange of the root hemiparasite *Santalum acuminatum* (quandong). *Aust. J. Bot.* **49**: 479–486.
- Marshall, J.D. & Ehleringer, J.R. 1990. Are xylem-tapping mistletoes partially heterotrophic? *Oecologia* **84**: 244–248.
- Pate, J.S. 2001. Haustoria in action: case studies of nitrogen acquisition by woody xylem-tapping hemiparasites from their hosts. *Protoplasma* **215**: 204–217.
- Pate, J.S., True, K.C., & Rasins, E. 1991. Xylem transport and storage of amino acids by S.W. Australian mistletoe and their hosts. *J. Exp. Bot.* **42**: 441–451.
- Popp, M., Mensen, R., Richter, A., Buschmann, H., & Von Willert, D.J. 1995. Solutes and succulence in southern African mistletoes. *Trees* **9**: 303–310.
- Press, M.C. & Phoenix, G.K. 2005. Impacts of parasitic plants on natural communities. *New Phytol.* **166**: 737–751.
- Press, M.C., Nour, J.J., Bebawi, F.F., Stewart, G.R. 1989. Antitranspirant-induced heat stress in the parasitic plant *Striga hermonthica*—a novel method of control. *J. Exp. Bot.* **40**: 585–591.
- Quested, H.M., Press, M.C., Callaghan, T.V., & Cornelissen, H.J. 2002. The hemiparasitic angiosperm *Bartsia alpina* has the potential to accelerate decomposition in sub-arctic communities. *Oecologia* **130**: 88–95.
- Quested, H.M., Press, M.C., & Callaghan, T.V. 2003. Litter of the hemiparasite *Bartsia alpina* enhances plant growth: evidence for a functional role in nutrient cycling. *Oecologia* **135**: 606–614.
- Quested, H.M., Callaghan, T.V., Cornelissen, J.H.C., & Press, M.C. 2005. The impact of hemiparasitic plant litter on decomposition: direct, seasonal and litter mixing effects. *J. Ecol.* **93**: 87–98.
- Richter, A. & Popp, M. 1992. The physiological importance of accumulation of cyclitols in *Viscum album* L. *New Phytol.* **121**: 431–438.
- Richter, A., Popp, M., Mensen, R., Stewart, G.R., & Von Willert, D.J. 1995. Heterotrophic carbon gain of the parasitic angiosperm *Tapinanthus oleifolius*. *Aust. J. Plant Physiol.* **22**: 537–544.
- Rispail, N., Dita, M.-A., Gonzalez-Verdejo, C., Perez-de-Luque, A., Castillejo, M.-A., Prats, E., Roman, B., Jorrián, J., & Rubiales, D. 2007. Plant resistance to parasitic plants: molecular approaches to an old foe. *New Phytol.* **173**: 703–712.
- Rothe, K., Diettrich, B., Rahfeld, B., & Luckner, M. 1999. Uptake of phloem-specific cardenolides by *Cuscuta* sp. growing on *Digitalis lanata* and *Digitalis purpurea*. *Phytochemistry* **51**: 357–361.
- Runyon, J.B., Mescher, M.C., De Moraes, C.M. 2006. Volatile chemical cues guide host location and host selection by parasitic plants. *Science* **313**: 1964–1967.
- Schulze, E.-D. & Ehleringer, J.R. 1984. The effect of nitrogen supply on growth and water-use efficiency of xylem-tapping mistletoes. *Planta* **162**: 268–275.
- Schulze, E.-D., Lange, O.L., Ziegler, H., Gebauer, G. 1991. Carbon and nitrogen isotope ratios of mistletoes growing on nitrogen and non-nitrogen fixing hosts and on CAM plants in the Namib desert confirm partial heterotrophy. *Oecologia* **88**: 457–462.
- Shah, N., Smirnoff, N., & Stewart, G.R. 1987. Photosynthesis and stomatal characteristics of *Striga hermonthica* in relation to its parasitic habit. *Physiol. Plant.* **69**: 699–703.
- Siame, B.P., Weerasuriya, Y., Wood, K., Ejeta, G., & Butler, L.G. 1993. Isolation of strigol, a germination stimulant for *Striga asiatica*, from host plants. *J. Agric. Food Chem.* **41**: 1486–1491.
- Smith, C.E., Dudley, M.W., & Lynn, D.G. 1990. Vegetative/parasitic transition: Control and plasticity in *Striga* development. *Plant Physiol.* **93**: 208–215.
- Stewart, G.R. & Press, M.C. 1990. The physiology and biochemistry of parasitic angiosperms. *Annu. Rev. Plant Physiol. Plant Mol. Biol.* **41**: 127–151.
- Taylor, A., Martin, J., & Seel, W.E. 1996. Physiology of the parasitic association between maize and witchweed (*Striga hermonthica*): is ABA involved? *J. Exp. Bot.* **47**: 1057–1065.
- Tennakoon, K.U. & Pate, J.S. 1996a. Effects of parasitism by a mistletoe on the structure and functioning of branches of its host. *Plant Cell Environ.* **19**: 517–528.
- Tennakoon, K.U. & Pate, J.S. 1996b. Heterotrophic gain of carbon from hosts by the xylem-tapping root hemiparasite *Oxalis phyllanthi* (Oxalaceae). *Oecologia* **105**: 369–376.
- Watling, J.R. & Press, M.C. 2001. Impacts of infection by parasitic angiosperms on host photosynthesis. *Plant Biol.* **3**: 244–250.
- Wolswinkel, P., Ammerlaan, A., & Peters, H.F.C. 1984. Phloem unloading of amino acids at the site of *Cuscuta europaea*. *Plant Physiol.* **75**: 13–20.
- Yoder, J.I. 1999. Parasitic plant responses to host plant signals: a model for subterranean plant–plant interactions. *Curr. Opin. Plant Biol.* **2**: 65–70.
- Yoneyama K., Yoneyama K., Takeuchi Y., & Sekimoto, H. 2007a. Phosphorus deficiency in red clover promotes exudation of orobanchol, the signal for mycorrhizal symbionts and germination stimulant for root parasites. *Planta* **225**: 1031–1038.
- Yoneyama, K., Xie, X., Kusumoto, D., Sekimoto, H., Sugimoto, Y., Takeuchi, Y., Yoneyama, K. 2007b. Nitrogen deficiency as well as phosphorus deficiency in sorghum promotes the production and exudation of 5-deoxystrigol, the host recognition signal for arbuscular mycorrhizal fungi and root parasites. *Planta* **227**: 125–132.
- Ziegler, H. 1975. Nature of transported substances. In: *Encyclopedia of plant physiology*, N.S. Vol. 1, M.H. Zimmermann & J.A. Milburn (eds). Springer-Verlag, Berlin, pp. 59–100.

9E. Interactions Among Plants

1. Introduction

In previous chapters we dealt with many physical and chemical environmental factors that affect a plant's performance, and with the effects of micro-symbionts, herbivores, pathogens, and parasites. For many plants, however, the most important factor shaping their environment is other plants. One of the most active debates in both ecology and agriculture focuses on the question of the mechanisms by which plants interact with one another. Plant-plant interactions range from positive (**facilitation**) to neutral to negative (**competition**) effects on the performance of neighbors (Bazzaz 1996, Li et al. 1999). Competition occurs most commonly when plants utilize the same pool of growth-limiting resources (**resource competition**). Competition may also occur when one individual produces chemicals that negatively affect their neighbors (**interference competition** or **allelopathy**). Competition between two individuals is often highly asymmetric, with one individual having much greater negative impact than the other.

The question of which species wins in competition also depends strongly on the time scale of study. Short-term outcomes of competition often depend on rates of resource acquisition and growth, whereas equilibrium persistence of a species in a community is affected by rates of resource acquisition, tolerance of ambient resource availability, efficiency of converting acquired resources into biomass, and

retention of acquired resources (Goldberg 1990). Rare events, e.g., a severe drought, flood, fire, or frost, once in a decade, may be more important for the outcome of competition than mean conditions.

The **competitive ability** of a species depends on environment. There are no "super species" that are competitively superior in all environments; rather, there are **trade-offs** among traits that are beneficial in some environments, but which reduce competitive ability in other environments. For a plant to compete successfully in a particular environment, it must have specific ecophysiological traits that allow effective growth in that environment (the **physiological filter** discussed in Sect. 3 of Chapter 1 on assumptions and approaches). An extreme cold temperature represents an absolute boundary for survival of some *Rhododendron* species in a common garden experiment, whereas warm temperatures do not. These *Rhododendron* species may therefore survive **global warming** in situ because of high temperature tolerance, but temperature effects on reproduction are uncertain. There may also be a significant time lag between change in climate and transient species distribution which makes the effect of global warming on species distribution difficult to predict (Vetaas 2002).

We have provided many examples of physiological traits necessary for ecological success in dry, cold, hot, saline, flooded, or other harsh environments. Only those species that are adapted, or can acclimate to, such environmental conditions can survive,

compete, and reproduce successfully in these environments. As the saying goes: “when the going gets tough, the tough get going”. Other plants typically grow in more favorable conditions where abiotic stresses are moderate. Most species can survive in these conditions, but only a small proportion compete effectively (Sect. 3 of Chapter 1 on assumptions and approaches). We have already discussed many of the traits that enable plants to grow rapidly under these conditions. Although this brief introduction of “plant

strategies” provides a context for the present discussion of ecophysiological traits that are important in competitive interactions, the situation is far more complicated (Box 9E.1). Traits that are important for **competitive success** at an early stage of succession may differ greatly from those that are pertinent in later stages. Similarly, plant characteristics that determine the outcome of competition in short-term experiments often differ from those that give a species a competitive edge in the long run (Sect. 4).

Box 9E.1 Plant Ecological Strategies

Mark Westoby

Department of Biological Sciences
Macquarie University
Sydney, NSW 2109
Australia

Plant ecological strategy schemes arrange species in categories or along spectra, according to their ecological attributes. One aim is to express an understanding of the main opportunities and selective forces that shape the life histories, architectures, growth allocations, and physiologies of plants. Another is to describe vegetation in terms of a limited number of types, for practical convenience. A third

is to position particular species within a wider comparative context.

Many schemes have been proposed. Some split up species on the basis of a single attribute thought to be important. For example Raunkiaer’s life-form scheme is based on the location of the buds where regrowth arises after the unfavorable season of the year (Fig. 1). Other schemes have an overtly conceptual basis.

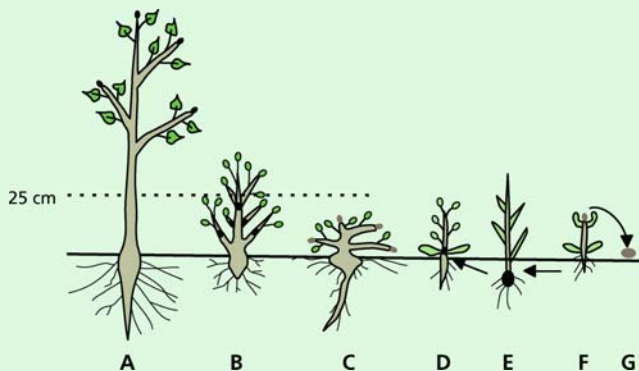

FIGURE 1. Plant life-forms of Raunkiaer (1907, English translation 1934). Perennating organs are shown in black, woody organs in pink, and deciduous organs green. (A) Phanerophyte (tree or tall shrub), with buds more than 25 cm above the ground. (B) Chamaephyte, semishrub, slightly woody at the base, with buds less than 25 cm above the ground. (C) Chamaephyte,

semishrub, with buds less than 25 cm above the ground. (D) Hemicryptophyte, perennial herb with its bud at ground surface. (E) Geophyte, perennial herb with a bulb or other perennating organ below the ground surface. (F) Therophyte, annual plant surviving unfavorable periods only as seed. (G) Therophyte, annual plant surviving unfavorable periods only as seed. Barkman (1988) reviewed the wide range of life form and growth form systems.

continued

Box 9E.1 *Continued*

FIGURE 2. The C–S–R triangle model (Grime 1979). The strategies at the three corners are C, competition-winning species; S, stress-tolerating species; R, ruderal species. Particular species can engage in any mixture of these three primary strategies, and the mixture is described by their position within the triangle.

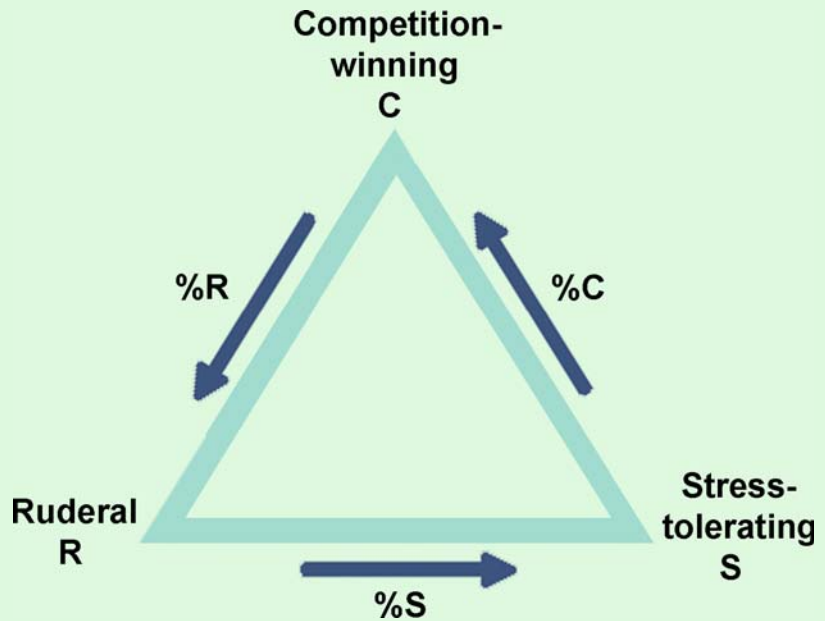

Grime's (1977) triangle (Fig. 2) (see also Sects. 6.1 and 6.3 of Chapter 7 on growth and allocation) is a two-dimensional scheme. A C–S axis (Competition-winning species to Stress-tolerating species) reflects adaptation to favorable vs. unfavorable sites for plant growth, and an R-axis (Ruderal species) reflects adaptation to disturbance.

Trait-Dimensions

A recent trend in plant strategy thinking has been trait-dimensions, that is, spectra of variation with respect to measurable traits. Compared with category schemes, such as Raunkiaer's, trait dimensions have the merit of capturing continuous variation in quantitative properties. Compared with the C–S–R scheme, trait dimensions have the advantage that the position of a species along the spectrum can be quantified straightforwardly and compared with other species worldwide. Trait-dimensions are a very active and open-ended research area (Westoby et al. 2002, McGill et al. 2006, Westoby & Wright 2006). Here I first summarize two dimensions that are quite well characterized and understood, then

comment briefly on some other dimensions that are not yet so well understood.

Leaf Economics Spectrum

Five traits that are coordinated across species are leaf mass per area (LMA), leaf life-span, leaf N concentration, and potential photosynthesis and dark respiration on a mass basis. In the five-trait space, 79% of all variation worldwide lies along a single main axis (Fig. 33 of Chapter 2A on photosynthesis; Wright et al. 2004). Species with low LMA tend to have short leaf life-spans, high leaf nutrient concentrations, and high potential rates of mass-based photosynthesis. These species occur at the "quick-return" end of the leaf economics spectrum. The fast turnover of plant parts permits a more flexible response to the spatial patchiness of light and soil resources (Grime 1994). At the "slow-return" end of the spectrum are species with long leaf life-span, expensive leaf construction (high LMA), low nutrient concentrations, and lower photosynthetic rates.

continued

Box 9E.1 *Continued***Seed-Size–Seed-Output Dimension**

Species having smaller seeds can produce more seeds within a given mass devoted to reproduction. Seed mass varies 10^4 - or 10^5 -fold, even across co-existing species. It is therefore the strongest influence on seed output per square meter of canopy cover, and therefore on the chance that an occupied site will disperse a propagule to an establishment opportunity. Seed mass is also a good indicator of a cotyledon-stage seedling's ability to survive various hazards (Leishman et al. 2000, Westoby et al. 2002).

Some Other Dimensions

Canopy height at maturity is universally recognized as expressing important differences among species; height strategies also include the pace of height gain and the capacity of a stem to persist over time having reached a given height. The best traits to express these dimensions have not yet been clarified.

Leaf size is closely correlated with the size of terminal twigs and with branch spacing. It expresses scaling of the shoot architecture, but the ecological significance of leaf size remains poorly understood.

Sapwood density is potentially influenced by the proportion of the cross-section that is vessel lumen, and by the density of tissue outside lumens. Potential outcomes from low wood density therefore include higher hydraulic conductivity and capacitance, and faster shoot elongation from a given dry mass invested in

stem. It is not yet clear whether there are one or more major dimensions of variation in wood properties.

Two species properties of high importance for plant geography and for modeling vegetation under global change are temperature preferences and the rooting depth from which water is extracted by transpiration. Up to now, however, no species traits have been found that capture these outcomes and that are readily measurable.

Plant Strategy Variation

Plant strategic traits are expected to vary consistently in relation to physical environment, e.g., mean seed mass is *ca.* 300-fold larger in the tropics than at 60° latitude (Moles et al. 2007). Nevertheless, it is striking that for the quantitative traits investigated so far, variation across species within a site is at least as important as variation across site averages worldwide. This means that plant strategy traits are as much about different styles of sustaining a population within sites, as they are about adaptation to physical environment.

The Future

Brisk progress is being made currently with plant strategy dimensions, especially because data for many traits are accumulating into worldwide datasets, giving a firm context for interpreting costs and benefits. At the same time, there remain many unresolved questions and a great deal of opportunity for future research.

In this text on physiological ecology we emphasize the physiological mechanisms rather than the community consequences of competition. An ecophysiological attempts to explain competitive interactions in terms of the performance of individual plants that make up a community. The challenge then is to scale up from the knowledge that is available at the cell, organ, and whole-plant level to the processes that occur in natural and managed communities.

An important aspect of the functioning of a plant among surrounding competitors may well be to *avoid* potentially negative effects. That is, rather than producing leaves that are acclimated to shade, or roots that can access sparingly available nutrients, a plant might grow away from its neighbors and make leaves that are acclimated to a high level of irradiance and roots that can exploit a favorable nutrient supply. This requires mechanisms, however, that allow a plant to detect the proximity of its neighbors (Sect. 3).

2. Theories of Competitive Mechanisms

Several theoretical frameworks have been developed to predict the outcome of plant competition, each of which makes different assumptions about the mechanisms by which competition occurs. Grime (1977) suggested that species with high **relative growth rates** are effective competitors because rapid growth enables them to dominate available space and to acquire the most resources (Sect. 6.1 of Chapter 7 on growth and allocation). If correct, then traits that promote rapid resource acquisition and growth should be favored. On the other hand, Tilman (1988) suggested that the species that can draw a resource down to the lowest level (R^*) is the best competitor for that resource, because this enables a species to tap that resource at levels below those required by other species. These perspectives are not incompatible (Grace 1990). We expect that, in short-term growth experiments, especially in high-resource environments, traits that contribute to rapid growth contribute to competitive success. At equilibrium, however, especially in low-resource environments, when species effects on resource availability should be greatest, the potential of a species to extract scarce resources may be more important than maximum rates of resource acquisition.

If **resource competition** occurs by **depletion of a shared limiting resource**, then there are at least two ways in which a species might be an effective competitor: drawing down resources to a low level (low R^*) and/or tolerating low levels of resources (Goldberg 1990). The physiological bases of these two facets of competition are quite different, as discussed later. Because of physiological trade-offs, however, traits that promote **resource draw-down** and **tolerance of low resource supply** may be correlated (Sect. 7).

Two major **physiological trade-offs** have been discussed as the basis of broad patterns of competitive ability in different environments. First, there is a trade-off between rapid growth to occupy space and maximize resource acquisition vs. resource conservation through reductions in tissue turnover (Grime 1977) (Sect. 4). Second, there is a trade-off between allocation to roots to acquire water and nutrients vs. allocation to shoots to capture light and CO_2 (Sect. 7; Tilman 1988). Because of these trade-offs, no species can be a superior competitor in all environments, but instead will specialize to grow and compete effectively in a certain restricted set of environments.

The effects of competition, as measured experimentally, are observed in both high-resource and low-resource environments (Goldberg & Barton 1992, Gurevitch et al. 1992). In low-resource environments, however, where growth rates are slow, competitive exclusion may take a very long time. Before there is any winner, environmental conditions (e.g., climate, fire) may change. This might account, in part, for the enormous richness of plant species on severely nutrient-impooverished sandplains in South Africa and Western Australia (Myers et al. 2000). On the other hand, the distribution of the Proteaceae along a transect on nutrient-impooverished soils supporting fynbos in South Africa appears to be determined by adaptations to local soil factors more than by competitive exclusion (Richards et al. 1997).

Competition is least likely to occur in recently disturbed sites where low plant biomass and/or high resource supply minimize resource limitation. In other cases, coexisting species may be limited by different factors, as when species have radically different phenology, height, or rooting depth. In order for plants to minimize competition, they must adjust growth to tap resources that are not utilized by neighbors.

3. How Do Plants Perceive the Presence of Neighbors?

Plants can perceive the proximity of neighbors, as described in discussing plant growth in shady conditions. First, a reduction in the level of photosynthetically active radiation reduces the concentration of soluble sugars, which can be sensed by plant cells (Sect. 6.3 of Chapter 2A on photosynthesis). Second, special pigments, **cryptochrome** and **phytochrome**, perceive both the level and the red/far-red ratio of radiation (Sect. 5.1.1 of Chapter 7 on growth and allocation). In *Populus* (poplar), for example, linear relationships exist between stem growth rate, plant spacing, and Pfr/Pt calculated from radiation that is propagated vertically within the canopy. The dynamics of developing or regenerating canopies is partly based on phytochrome-mediated perception of the proximity of neighboring plants (Gilbert et al. 1995, Ritchie 1997). Through the phytochrome system, plants clearly sense cues that indicate current or future shading. Shade-avoiding species typically respond with enhanced stem elongation, whereas no such response is found for species naturally occurring under a dense canopy (Sect. 5.1.1 of Chapter 7 on growth and allocation; Fig. 1).

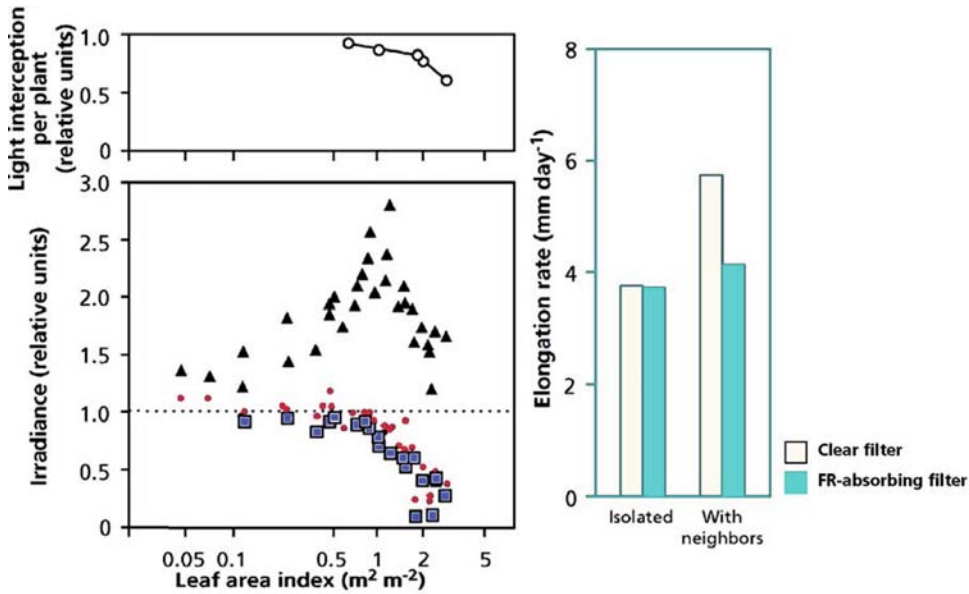

FIGURE 1. (Left) Effects of increasing the leaf area index [LAI, m² (leaf area) per m² (soil surface)] in even-height canopies of dicotyledonous seedlings on (top) light interception and (bottom) the light climate of the stem. Seedling stands of *Sinapis alba* (mustard) and *Datura ferox* (thorn apple) of differing densities and plant sizes were used to obtain a range for the leaf area index. The values are given relative to the measurements obtained for isolated plants (horizontal line). Triangles, far-red light; circles, red light; squares, blue light. (Right) Elongation

response of the first internode of *Datura ferox* (thorn apple) seedlings to the proximity of neighboring plants. The seedlings were placed at the center of an even-height canopy with a leaf area index of approximately 0.9. During the 3-day experiment the seedlings are surrounded by cuvettes containing distilled water (clear filter) or a CuSO₄ solution (far-red-absorbing filter) that maintain the red/far-red radiation near 1.0 (Ballaré et al. 1995; reproduced with the author's permission from *HortScience* 30: 1172–1182).

Plants are also capable of “smelling” the presence of neighbors that release above-ground **chemical signals**, such as jasmonate or other volatiles (Sect. 2 of Chapter 9B on ecological biochemistry, Sect. 3 of Chapter 9C on effects of microbial pathogens). Contrary to common expectation, plants have highly sensitive **chemoperception** systems that play a central role in communication with surrounding organisms (Chapters 9A–9D). Physically touching surrounding plants is an additional way in which neighbors can be perceived (Sect. 5.7 of Chapter 7 on growth and allocation).

Plants can also perceive the presence of surrounding plants because of their neighbors' effect on above-ground **microclimate**, which is caused by differential heat exchange. This can have a tremendous effect on the outcome of competition (e.g., in frost-prone areas). Tree seedlings may grow well in forest clearings for the first few years, but once a grassy groundcover establishes, the growth of the young trees becomes retarded and more susceptible to frosts. Although some of these effects might be due to competition for nutrients and water, this

cannot account for their greater frost sensitivity. When seedlings of *Eucalyptus pauciflora* (snow gum) are surrounded by grass, the minimum air temperature experienced by seedlings decreases by as much as 2°C, and they experience more frosts. These effects cause greater photoinhibition, reduced growth, and a shorter growing season for seedlings surrounded by grass compared with those in bare patches. Thus, the microclimate above grass adversely affects spring growth of juvenile trees and may account for much of the competitive inhibition of tree seedling growth by grass during spring (Fig. 2).

Plants can also sense the presence of neighbors below ground. For example, below-ground competition of *Lolium perenne* (perennial ryegrass) with *Plantago lanceolata* (snake plantain) markedly reduces root mass and root length of *Lolium perenne*, without any effect on shoot growth. Contrary to the effects of a limiting nutrient supply, competition with *Plantago lanceolata* does not affect the specific root length. This suggests the perception of the presence of *Plantago lanceolata* by the grass roots via an

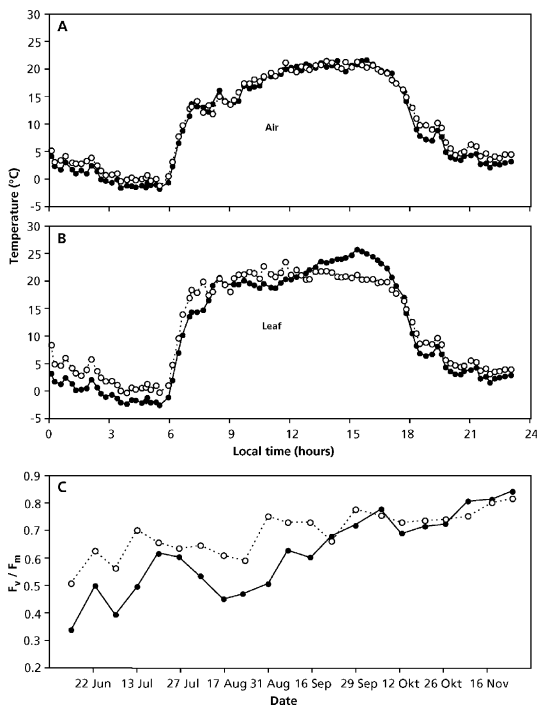

FIGURE 2. Diurnal variation in (A) air temperature and (B) the temperature of the leaves of *Eucalyptus pauciflora* (snow gum) above an open patch (open symbols) and above grass (filled symbols), measured from midnight to midnight on a day in September (early spring). Temperatures were measured 10 cm above ground level for one leaf of a seedling; seedlings were about 2 m apart. (C) Seasonal changes in average weekly midday values for the fluorescence characteristic F_v/F_m , which is an indicator of the quantum yield of photosynthesis, for seedlings of *Eucalyptus pauciflora* grown in an open habitat (open symbols) or above grass (filled symbols) (Ball et al. 1997). Copyright Blackwell Science Ltd.

allelochemical (Fitter 1976). Roots of two native California shrub species, *Haplopappus ericoides* (California goldenbush) and *Haplopappus venetus* (isocoma), similarly reduce overlap with the roots of an invasive introduced perennial succulent, *Carpobrotus edulis* (iceplant), by redistributing root growth further down in the soil profile (Fig. 3). Removal of *Carpobrotus edulis* from around the native shrubs also results in higher predawn xylem water potentials which suggest that the invasive succulent uses some water that would have been available for the native shrubs (D'Antonio & Mahall 1991). The change in rooting pattern could partly reflect differential root proliferation in zones of high availability of nutrients or water (Sect. 3.4 of Chapter 3 on plant water relations). The effect also occurs,

however, when plants are well provided with water and nutrients which indicates a specific response to avoid the roots of neighbors (Mahall & Callaway 1991).

A chemical root interaction (i.e., the accumulation of **allelochemicals**) is a likely explanation for many of the patterns observed in the field (Sect. 2 of Chapter 9B on ecological biochemistry). When the roots of *Ambrosia dumosa* (white bursage), whose growth is normally inhibited by the presence of the roots of *Larrea divaricata* (creosote bush), are treated with activated charcoal that adsorbs allelochemicals, the inhibition is reduced. This is consistent with inhibition by a slowly diffusing allelochemical that is released by the roots of *Larrea divaricata*, and may account for the dispersed distribution of *Larrea divaricata* in the Mojave Desert in California, USA.

The intraspecific inhibition of root growth of *Ambrosia dumosa* (white bursage), however, is not affected by activated charcoal, indicating that it depends on **physical contact**. The nature of deterrence by direct contact with the roots of *Ambrosia dumosa* is not clear (Mahall & Callaway 1992), but it might involve **thigmomorphogenetic processes** (Sect. 5.8 of Chapter 7 on growth and allocation). Plants clearly differ in their response to surrounding plants of the same species just as they differ in their response to plants of a different species (Huber-Sannwald et al. 1996).

Climbing plants, which depend on neighboring plants for support, somehow perceive the presence of mechanical support. The elongation of tendrils is suppressed when they contact a supporting structure (Sect. 5.8 of Chapter 7 on growth and allocation). Provided with support other than a neighboring plant, climbing plants grow taller than unsupported individuals. Unsupported plants allocate more resources to their shoot branches, possibly increasing the chance of reaching a supportive structure, and allocate less to their roots. This indicates that it is the support itself, rather than any aspect of the neighboring plant's physiology that affects the allocation pattern of climbing plants (Putz 1984, Den Dobbelden & Oosterbeek 1995).

There are clearly many ways in which plants perceive their neighbors, both above and below ground. Plants may respond in such a way as to avoid competition or in a manner that makes them superior competitors. That is, plants that are sufficiently **plastic** for certain traits may well be able to avoid their neighbors and grow in such a way as to tap resources not utilized by neighbors (Sect. 6). In the following sections we explore what ecophysiological traits determine competitive success when

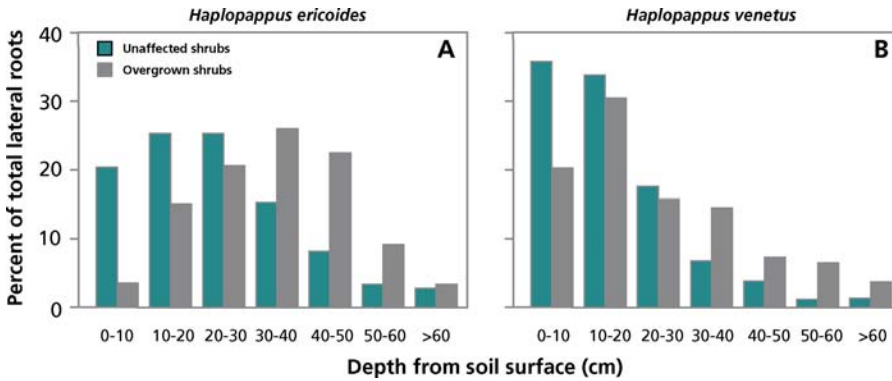

FIGURE 3. Percentage of total number of lateral roots of two shrubs, *Haplopappus ericoides* and *Haplopappus venetus* in each 10 cm depth increment below soil surface. Open bars: no competing invasive plants of *Carpobrotus*

edulis (iceplant) present; filled bars: competing plants of *Carpobrotus edulis* present (D'Antonio & Mahall 1991). Copyright Botanical Society of America, Inc.

plants are forced to compete for the same pool of limiting resources.

4. Relationship of Plant Traits to Competitive Ability

4.1 Growth Rate and Tissue Turnover

Evidence from field studies, laboratory experiments, and ecological theory have converged on the conclusion that species from high-resource environments exhibit high **relative growth rate** (RGR), whereas species from low-resource environments compete most effectively by minimizing tissue loss (greater **tissue longevity**) more than by maximizing resource gain (Sects. 3 and 6 of Chapter 7 on growth and allocation). The ecological advantage of a high potential RGR seems straightforward: fast growth results in the rapid occupation of a large space which leads to the preemption of limiting resources (Grime 1977). A high RGR may also facilitate rapid completion of the plant's life cycle which is essential for **ruderals**, whose habitat does not persist for a long time. In growth analyses and in short-term competition experiments carried out at a limiting nutrient supply, potentially fast-growing species grow faster and produce more biomass than do slow-growing ones (Lambers & Poorter 2004). Even when growing naturally in a nutrient-poor meadow, in competition with surrounding plants, the species with the highest RGR_{max} grows fastest and produces most biomass in relatively short experiments (Fig. 4). The greater competitive ability in these short-term experiments is associated

with a higher leaf area ratio (LAR), due to a lower leaf mass density (Lambers & Poorter 2004); it is also associated with a higher specific root length (SRL), due to thinner roots (Eissenstat 1992) and a lower root mass density (Ryser & Lambers 1995).

Why do plants with a small root diameter and low tissue mass density (i.e., a high specific root length) and with thin leaves and a low tissue mass density (i.e., a high specific leaf area) fail to dominate on nutrient-poor sites? For widely different species, including evergreen and deciduous ones, the low **tissue mass density** of fast-growing species is associated with a more rapid turnover of their leaves and a shorter **mean residence time of nutrients** (Sect. 4 of Chapter 6 on mineral nutrition). In a comparison of ecologically contrasting grass species, slower-growing species from nutrient-poor habitats also tend to have a higher tissue mass density and slower turnover rates than do faster-growing ones from more productive sites (Ryser 1996). Turnover of plant parts inevitably causes loss of about half of the leaf nutrients from the plant and reduces the mean residence time of the nutrients (Sect. 4 of Chapter 6 on mineral nutrition). Although rapid growth may therefore lead to a competitive advantage in the short term, even when the nutrient supply is severely limiting, there is a penalty associated with this trait in the long run (Berendse & Aerts 1987, Tilman 1988). That is, the losses associated with tissue turnover become so large that they cannot be compensated for by uptake of nutrients from the nutrient-poor environment. As a result, the fast-growing species are outcompeted by the slower-growing ones, once the time scale of the experiment is long enough that differences in

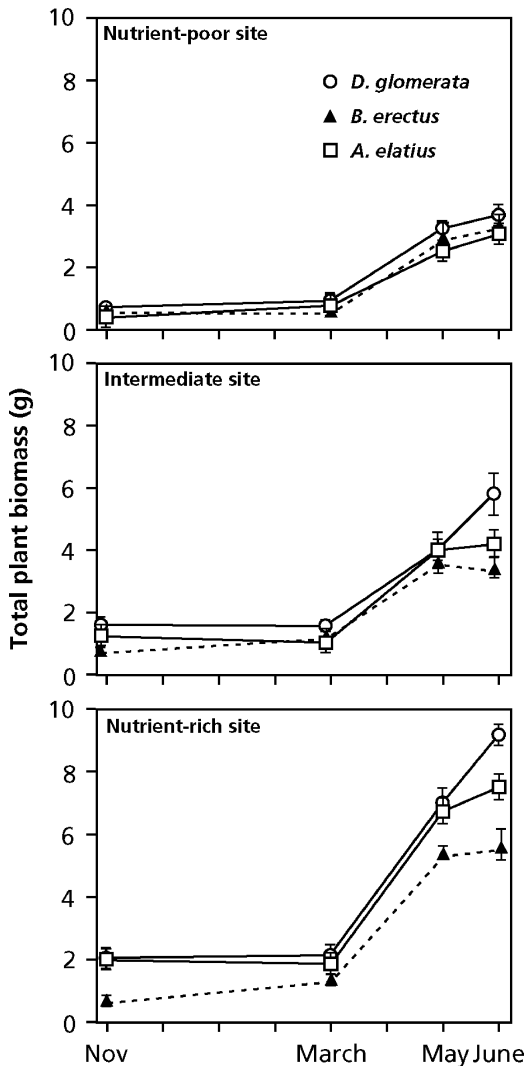

FIGURE 4. Total biomass of three tussock-forming grasses, growing in three meadows that differ in nutrient availability. The grasses differ in their RGR_{max} , with *Bromus erectus* (upright brome; filled triangles) having the lowest RGR_{max} , *Arrhenaterum elatius* (oatgrass; open squares) an intermediate RGR_{max} , and *Dactylis glomerata* (open circles) the highest (Schläpfer & Ryser 1996). Copyright Oikos.

tissue loss and mean residence time influence the outcome of competition (Aerts & Van der Peijl 1993).

Why should a low tissue mass density be associated with faster turnover and shorter residence times? Part of the answer is straightforward: a high tissue mass density reflects a large investment in cell walls, sclerenchyma, and fibers, which reduce the palatability and digestibility of the tissue and

allow the tissue to withstand abiotic stresses and deter herbivores. Or, as expressed by Eeyore (Milne 1928): "Why do all plants which an animal likes, have the wrong sort of swallow or too many spikes" (Sect. 3.3 of Chapter 7 on growth and allocation).

Senescence is a highly programmed process of tissue death that also causes tissue turnover. The rate of tissue turnover is quite separate from tissue mass density, though correlating with it for reasons that will become clear in this section. This programming is obviously prolonged for leaves with a greater longevity, even though we understand very little of the mechanisms underlying these differences. If the programming, however, is such that the leaves last a long time, the leaves must be constructed in such a way that biotic and abiotic factors do not prevent longevity. In other words, natural selection for slow turnover and a large investment in defense should go together which explains the close correlation between the two, without there being a causal link.

There is a third reason for shorter nutrient residence times in faster-growing species at a low nutrient supply (Sect. 7 of Chapter 7 on growth and allocation). Species differ in the manner in which they respond to a limitation by nutrients in the environment: the typical response of a fast-growing species upon sensing nutrient shortage is to promote leaf senescence and so withdraw nutrients from older leaves and use these for its newly developing tissues. A slow-growing species that naturally occurs on nutrient-poor sites will slow down the production of new tissues, with less dramatic effects on leaf senescence and allocation pattern. In other words, the environmentally induced senescence is much stronger in faster-growing species than in slower-growing ones. We again understand too little of a plant's physiology to account fully for our ecological observations, but the result is clear: the environmentally induced senescence of the rapidly growing species causes them to lose more nutrients.

4.2 Allocation Pattern, Growth Form, and Tissue Mass Density

In nutrient-rich conditions, *Lychnis flos-cuculi* (ragged robin) genotypes with an inherently high leaf mass ratio (LMR) achieve higher yields in competition with *Anthoxanthum odoratum* (sweet vernalgrass) and *Taraxacum hollandicum* (dandelion) than do genotypes with a lower LMR. At a low nutrient supply, this allocation pattern confers no advantage; moreover, genotypes with an inherently high specific leaf area (SLA) tend to produce smaller rosettes

(Biere 1996). This information on the ecological significance of SLA is consistent with results on an African C_4 species that has been introduced into Venezuela. The introduced species with a high SLA outcompetes a native C_4 species that has a low SLA in relatively fertile places, but not in more infertile habitats (Baruch et al. 1985). On subantarctic islands the introduced grass *Agrostis stolonifera* (creeping bentgrass), with a high SLA, is similarly able to survive in the wind-sheltered places, but it is not found outside these shelters, whereas *Agrostis magellanica*, which is characterized by a lower SLA due to more sclerenchyma, occurs in the wind-swept parts of these islands (Pammenter et al. 1986). A high LAR, due to a high SLA and/or a high LMR, which is associated with a high growth rate, is advantageous in productive environments. On the other hand, a low SLA, which is associated with a low growth rate, confers a selective advantage in relatively unfavorable environments (Sects. 3.7 and 6.3 of Chapter 7 on growth and allocation; Lambers & Poorter 2004).

Just as SLA is an important above-ground trait for a plant's competitive ability, the **specific root length** (SRL) is an important below-ground characteristic, determining a plant's ability to compete for nutrients and water. This can be illustrated using two tussock grasses, competing with *Artemisia tridentata* (sagebrush) as an indicator species (Eissenstat & Caldwell 1988). *Agropyron desertorum* (desert wheatgrass) is an introduced species, with a greater competitive ability than the native *Pseudoroegneria spicata* (formerly *Agropyron spicatum*; bluebunch wheatgrass). When *Artemisia tridentata* plants are planted among near-monospecific stands of one of the two tussock grasses, they show lower survival, less growth and reproduction, and a more negative water potential during part of the season when surrounded by *Agropyron desertorum* than they do when they compete with *Pseudoroegneria spicata*. *Agropyron desertorum* extracts water more rapidly from the soil profile, but it is remarkably similar in architecture, shoot phenology, root mass distribution in the soil profile, growth rate in various environments, and the efficiency of water and N use (Eissenstat & Caldwell 1987). Its roots are thinner, however, so that the length per unit mass (SRL) is about twice that of the less competitive *Pseudoroegneria spicata*. This higher SRL, in combination with more root growth in winter and early spring, allows the more competitive tussock grass to extract water more rapidly from the profile. These traits likely contribute to the observation that *Artemisia tridentata*, growing side by side with the two tussock grasses, acquires 86% of all its absorbed labeled P_i

from the interspace shared with *Pseudoroegneria spicata*, and only 14% from the interspace with *Agropyron desertorum* (Fig. 5). Clipping of the tussock grasses enhances P_i uptake by sagebrush substantially, confirming that the grasses competed for resources from the soil before clipping (Caldwell et al. 1987). Because P_i is highly immobile in soil, roots of the competing plants or their associated mycorrhizal fungal hyphae must have been very close to each other.

To be a successful competitor above ground as well as below ground, plants would need a high SLA as well as a high SRL, both of which can be realized through a low tissue mass density. Competitive species naturally occurring in productive meadows do, indeed, have a low leaf mass density as well as a low root mass density (Ryser & Lambers 1996).

4.3 Plasticity

Previous chapters provided numerous examples of the acclimation of photosynthesis, respiration, and biomass allocation to environmental factors such as irradiance and nutrient supply. A high capacity to acclimate reflects a genotype's **phenotypic plasticity** for a specific trait; however, a relatively small plasticity for one trait may result from a large plasticity in other traits. For example, the low morphological plasticity (stem length) of an alpine *Stellaria longipes* (Sect. 5.7 of Chapter 7 on growth and allocation) is a consequence of a high physiological plasticity (ethylene production). Both traits are directly related to the same environmental cue (wind stress) and the expressed phenotype has a direct bearing on the plant's fitness (Emery et al. 1994). In addition, a large morphological plasticity in biomass allocation between roots and leaves in response to nutrient supply or irradiance results in a low plasticity of the plant's growth rate, so that this varies relatively little between different environments (Fig. 6).

It has been suggested that a high plasticity allows a genotype to maintain dominance in spatially or temporally variable environments by enabling them to continuously explore new patches that have not been depleted, thus sustaining resource capture and maintaining fitness (Grime et al. 1986). By contrast, in habitats of predictably low resource supply, plant production would be restricted to a continuously low level and a strategy of conservation of captured resources, associated with slow growth, would be favored. Such a contention is hard to verify, in view of the fact that greater plasticity for one trait is made possible by smaller plasticity for another.

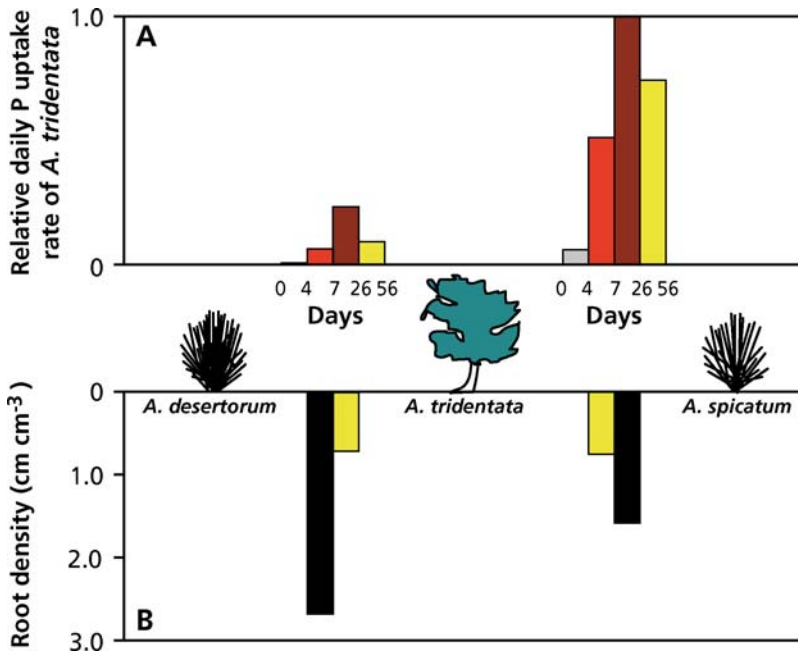

FIGURE 5. (A) The relative rate of P_i absorption. That is, the average daily uptake of P_i isotopes, ³²P and ³³P, by root tips of *Artemisia tridentata* (sagebrush) from soil interspaces shared with one of two tussock grasses, the native *Pseudoroegneria spicata* or the introduced *Agropyron desertorum* at various times after labeling. The separate labels were injected at either side of *Artemisia tridentata*, in the interspace shared with one of the two tussock grasses. This made it possible to assess from

which interspace the label had been acquired. (B) Rooting density of the tussock grasses (filled bars) and of *Artemisia tridentata* (open bars). Rooting densities were not significantly different in the two interspaces or between the tussock grass species, but they were significantly less for *Artemisia tridentata* than they were for the tussock grasses. From Caldwell et al. (1985). Reprinted with permission from AAS.

There are certainly convincing examples of greater plasticity associated with competitive ability in a particular environment. **Late-successional species** tend to have a greater potential for adjustment of their photosynthetic characteristics to **shade** than do early-successional species (Küppers 1984). A classic case is the response of stem elongation to shade light (Sect. 5.1 of Chapter 7 on growth and allocation and Sect. 2). Shade light also suppresses branching in dicotyledonous species and enhances tillering in grasses like *Lolium perenne* (perennial ryegrass) and *Lolium multiflorum* (Italian ryegrass), and this plastic response is probably important in coping with neighbors (Deregibus et al. 1983). To confirm the importance of the **phytochrome system** for the perception of neighboring plants, Ballaré (1994) used transgenic plants of *Nicotiana tabacum* (tobacco), over-expressing a phytochrome gene. These transgenics show a dramatically smaller response to the red/far-red ratio of radiation and

to neighboring plants. In a stand of such transgenics, the small plants of the population are rapidly suppressed by their neighbors. These results indicate that a high degree of plasticity in morphological parameters plays an important role in the competition with surrounding plants.

With respect to variation in nutrient supply, the present information is far from conclusive. Fast-growing species from high-resource environments often show less or a similar change in allocation parameters like root mass ratio and stem mass ratio compared with slow-growing ones from nutrient-poor environments (Poorter et al. 1995). A survey of a large number of species finds no correlation between relative growth rate and allocation (root mass ratio and stem mass ratio) (Reynolds & D'Antonio 1996).

In summary, it appears that fast-growing species from high-resource environments are more plastic for some traits, such as photosynthetic characteristics and the rate of stem elongation in response to shade, surrounding plants, and wind. When it comes to

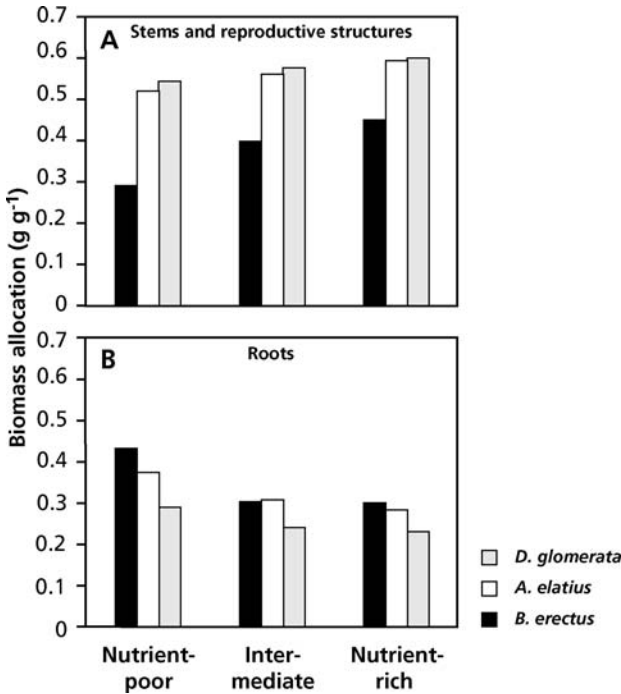

FIGURE 6. Biomass allocation to (A) stems and reproductive structures and (B) roots of three tussock grasses, growing in three meadows that differ in nutrient availability: nutrient-poor, intermediate and nutrient-rich. The grasses differ in their RGR_{max} , with *Bromus erectus* (upright brome; filled bars) having the lowest RGR_{max} , *Arrhenaterum elatius* (oatgrass; open bars) an intermediate RGR_{max} , and *Dactylis glomerata* (cocksfoot; shaded bars) the highest (after Schläpfer & Ryser 1996).

below-ground plant traits and morphological plasticity in response to the supply of nutrients, this conclusion is hard to substantiate, in part because plasticity in many traits (e.g., nutrient uptake, root growth, and nutrient storage) can influence the response of allocation to nutrient supply.

5. Traits Associated with Competition for Specific Resources

5.1 Nutrients

We have shown the physiological basis for the trade-off between rapid growth and tolerance of low nutrient supply (Sect. 4). What evidence is there that species growing on infertile soils draw down resources below levels used by potential competitors (i.e., low R^*) and what might be the processes responsible for such **resource draw-down**? The most explicit test of the R^* hypothesis is a field experiment in which several perennial prairie grasses that naturally occur on sites of different soil fertilities are planted in monoculture and in competition on several soils of differing fertility (Wedin & Tilman 1990, Tilman & Wedin 1991). Within 3 years, monocultures of the more slowly growing species reduce the concentration of

extractable soil NO_3^- and NH_4^+ to lower levels than do monocultures of high-RGR species from more fertile sites (Fig. 7). In addition, soil NO_3^- concentrations are just as low in competition treatments between fast and slow-growing species as they are in monocultures of the slow-growing species. This coincides with elimination of the more rapidly growing species. The traits most consistently associated with competitive success in these experiments are a high **allocation to root biomass** and **low RGR**. High allocation to roots is the plant trait that correlates most strongly with the N draw-down. The low RGR reduces loss rates and enhances tolerance of low supply rates.

What other nutritional traits might be involved in competition for nutrients? The **uptake kinetics** of species from infertile soils are unlikely to result in low soil solution concentrations. These species typically have a lower I_{max} of nutrient uptake and do not differ consistently in K_m from species that occur on fertile soils (Sect. 2.2.3.1 of Chapter 6 on mineral nutrition). The influence of uptake kinetics on soil solution concentration should be greatest for mobile nutrients (e.g., NO_3^-) and least pronounced for cations (e.g., NH_4^+) and P_i (Sect. 2.1.2 of Chapter 6 on mineral nutrition).

Plants and their mycorrhizal partners from specific nutritional situations often have a capacity to tap sources of nutrients unavailable to other species,

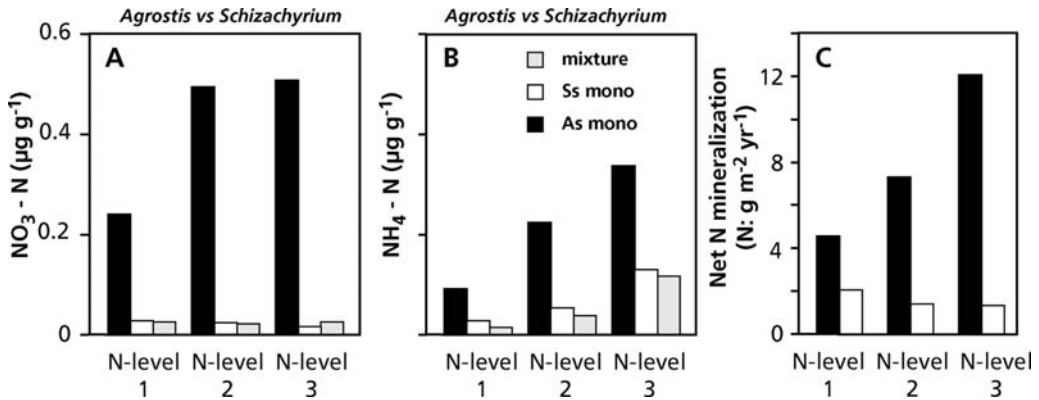

FIGURE 7. Extractable soil NO_3^- and NH_4^+ and net N mineralization in experimental monocultures of an early-successional, fast-growing prairie grass (*Agrostis scabra*) and a late-successional, slow-growing prairie grass (*Schizachyrium scoparium*) and of the two species growing together in mixture. Plants from a Minnesota

prairie (United States) were grown for 3 years in soils that contain three levels of N, after which soil samples were extracted for measurement of NO_3^- and NH_4^+ . Net N mineralization was measured monthly in the field (Tilman & Wedin 1991, Wedin & Tilman 1990). Copyright Ecological Society of America.

such as sorbed P or organic N (Sects. 2.2.4 and 2.2.5 of Chapter 6 on mineral nutrition). Traits of roots and their mycorrhizal partners that allow access to N that has been immobilized by tannins provide access to a N pool that is not available to species lacking these traits (Sect. 2.4 of Chapter 9A on symbiotic associations).

The most likely cause of **nutrient draw-down** by species in infertile soils is **immobilization** of nutrients due to the low nutrient and high tannin concentrations of the litter of species adapted to infertile soils (Sect. 4.3.2 of Chapter 6 on mineral nutrition and Sect. 3.1 of Chapter 9B on ecological biochemistry). Leaf litter from such plants decomposes very slowly, leading to slow net mineralization rates (Fig. 7). In addition, a large proportion of the litter is produced by roots, which typically have lower tissue nutrient concentrations than do leaves, and which are dispersed throughout the soil, so that the zone of immobilization coincides with the zone of uptake.

Nutrient-impooverished habitats, such as the heathlands of Western Australia and South Africa, are among the most species-rich habitats in the world. How do so many species coexist where strong competition for nutrients must be critical for survival? There are some specialized root traits (cluster roots) that enable certain species to tap sorbed P that is unavailable to other species (Sects. 2.2.4 and 2.2.5 of Chapter 6 on mineral nutrition). Although species differ in preference for forms of N, most species have the physiological capability to tap all forms of soluble N and to adjust their capacities

for uptake and assimilation, depending on supply (Sect. 2.1.2 of Chapter 6 on mineral nutrition). Allelochemicals may inhibit **nitrification** (Sect. 2 of Chapter 9B on ecological biochemistry). Since NH_4^+ is far less mobile than NO_3^- , such inhibition may enhance the availability of N for plants whose roots release nitrification inhibitors. Ectomycorrhizas and ericoid mycorrhizas may break down **protein N** that would otherwise not be directly available to plants (Lambers et al. 2008).

Except in severely nutrient-impooverished soils (Lambers et al. 2006), competitive coexistence of multiple species in a community is not a simple function of capacity to tap a unique resource or capacity to draw down a single resource; rather, it involves a wide range of traits and subtle differences in resistance to different environmental circumstances.

5.2 Water

The mechanism by which **desiccation-resistant plants** draw down soil moisture is well established. The lower the **water potential** that a species can tolerate, the lower the level to which it can reduce soil moisture. When soil water potential falls below the minimum water potential tolerated by potential competitors, they can no longer withdraw water from the soil. The traits that enable a species to maintain activity at a low water potential include osmotic or elastic adjustment and a stomatal conductance that is relatively insensitive to signals associated with a low root or leaf water potential (Sects. 4.1 and 5.4.1 of

Chapter 3 on plant water relations). This highlights a stark contrast with the mechanisms involved in competing for nutrients (Sect. 5.1). Interestingly, water has not been explored within the context of R^* , whereas it would appear to fit quite well within the concept based on nutrient acquisition.

Transpiration is the major avenue of water loss to the atmosphere and therefore of soil drying in dense vegetation. In general, the species with greatest **desiccation resistance** have a suite of morphological and biochemical traits that enable them to conserve water (e.g., CAM and C_4 photosynthesis, low stomatal conductance, low hydraulic conductance of the stem). When water is available, most plants maximize stomatal conductance and therefore water loss. In a mixed-species community, the species responsible for the greatest quantity of water loss are not those that are most resistant of water stress. The desiccation-resistant species are probably most important in the final stages of moisture draw-down, after less resistant species become dormant. The abundance of different life forms and physiological strategies in deserts indicates that there are many ways of competing effectively in dry environments, only some of which involve extreme resistance of low soil water potential. Other modes of competing effectively in deserts include phenological **avoidance** of drought and rapid growth when water is available.

Roots commonly pass through dry soil layers to deep horizons that contain more moisture. In the dry soil layers the soil matric potential may be more negative than the hydrostatic pressure in the xylem of the roots. Water may then move from the roots to the dry soil, and roots can form a bridge for water transport between soil layers (Sect. 5.2 of Chapter 3 on plant water relations). Stolon-connected plants in separate moist and dry soil compartments similarly may transport considerable quantities of water from one soil compartment to the other (Van Bavel & Baker 1985).

A low conductance between roots and soil or of the soil might preclude substantial efflux of water from roots. A nocturnal down-regulation of water-channel proteins (Sect. 5.2 of Chapter 3 on plant water relations) might reduce water loss to dry soil. Although water efflux from roots into soil might be viewed as undesirable, there is no metabolic cost to water movement, and the water released at night is available for reabsorption during the day. In addition, the moist soil may promote nutrient acquisition by roots and prolong the activity of symbiotic microorganisms such as mycorrhizal fungi in the upper soil layers. The moist soil may also prevent chemical signals that would otherwise

originate from roots in contact with dry soil (Sect. 5.4.1 of Chapter 3 on plant water relations). Some of the hydraulically lifted water will probably be available for shallow-rooted competing plants. As much as 20–50% of the water used by a shallow-rooted tussock grass [*Agropyron desertorum* (desert wheatgrass)] comes from water that is hydraulically lifted by neighboring sage brush (*Artemisia tridentata*) in the Great Basin desert of western North America (Richards & Caldwell 1987). *Acer saccharum* (sugar maple) similarly provides by hydraulic lift 46–61% of the water used by *Fragaria virginiana* (Virginia strawberry) growing beneath the tree (Dawson 1993). Individuals that are large enough to be quantitatively important in **hydraulic redistribution** will have predictable access to water and will be taller than the shallow-rooted species; therefore, they may not be severely impacted by this competition.

5.3 Light

Strong **competition for light** seldom coincides with strong competition for below-ground resources for two reasons. First, high availability of below-ground resources is an essential prerequisite for the development of a leaf canopy dense enough to cause intense light competition, which is strongest under conditions where water and nutrients are not strongly limiting to plant growth. Second, trade-offs between shoot and root competition constrain the amount of biomass that can be simultaneously allocated to acquisition of above- and below-ground resources (Tilman 1988). Those species that are effective competitors for light are trees with a high above-ground allocation.

As with water, the species that most strongly reduce light availability are not necessarily the species that are most tolerant of low light. Species that are tall and have a high **leaf area index** (LAI) have greatest impact on light availability, whereas understory plants and late-successional species are generally the most shade-tolerant. Because light is such a strongly directional resource, competition for light is generally quite asymmetric, with the taller species having greatest impact on the shorter species, with often little detectable effect of understory species on the overstory, at least with respect to light competition.

5.4 Carbon Dioxide

Carbon dioxide is relatively well mixed in the atmosphere; therefore, plant uptake creates less localized depletion of CO_2 than of nutrients, water, or light.

Nonetheless, photosynthesis is often CO₂-limited, especially in C₃ plants. Plants with contrasting photosynthetic pathways may therefore differ in their competitive ability in relation to atmospheric CO₂ concentration. For example, one might expect the growth of C₄ plants, whose rate of photosynthesis is virtually saturated at current CO₂ concentrations of 370 μmol mol⁻¹, to respond less to the global rise in atmospheric CO₂ concentration than that of C₃ plants. To test this hypothesis, Johnson et al. (1993) compared the growth of C₃ and C₄ plants, while growing in competition at CO₂ concentrations, ranging from pre-industrial levels to 350 μmol mol⁻¹, the prevalent CO₂ concentration at the time of the experiment. As expected, photosynthesis and growth were enhanced more by high levels of CO₂ in C₃ species than in C₄ species. Whereas the C₄ species outyielded the C₃ plants at low CO₂ concentrations, the C₃ plants were superior competitors at elevated [CO₂] (Fig. 8). How can we assess whether a change in competitive ability as suggested by the data in Fig. 9 has indeed occurred? To address this question, soil organic matter of known age was analyzed for ¹³C to estimate changes in the relative abundance of C₃ and C₄ species between the Late Pleistocene and the Early Holocene in northern Mexico. This showed an increase in C₃ species about 9000 years ago, a time when Antarctic ice cores showed a rapid rise in atmospheric [CO₂]. Plant macrofossils from packrat middens show that this vegetation change coincided with an increase in aridity, which should have favored C₄ species. The vegetation change, therefore, was most

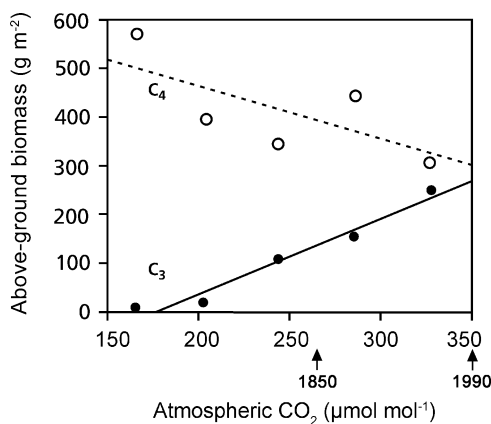

FIGURE 8. Above-ground biomass of C₃ and C₄ species that developed from the seed bank of a Texas savanna soil over a range of CO₂ concentrations from 150 to 350 μmol mol⁻¹ over a period of 13 weeks (Johnson et al. 1993).

likely caused by increased atmospheric CO₂ rather than by climatic change.

Further evidence that C₃ plants profit more from a rise in atmospheric [CO₂] than C₄ plants comes from work on a woody C₃ legume, *Prosopis glandulosa* (honey mesquite). This invasive species has increased in abundance in North American C₄-dominated grasslands over the past 150 years. When grown in monoculture, its below-ground biomass, rate of N₂ fixation, and water-use efficiency are increased at present-day levels of atmospheric CO₂, in comparison with historically lower levels. In competition with a C₄ grass, *Schizachyrium scoparium* (little bluestem), however, there is no effect on biomass. Rising levels of CO₂ may well have contributed to its success, but the shrub's strategy to avoid competition with neighboring grasses is probably more important (Polley et al. 1994).

Will C₃ species continue to conquer the world at the expense of C₄ species in years to come, while the concentration of CO₂ continues to rise? In experiments using around 340 and 620 μmol CO₂ mol⁻¹ air, the competitive ability of *Festuca elatior* (tall fescue) or *Triticum aestivum* (wheat) (both C₃) is enhanced compared with that of *Sorghum halepense* (Johnsongrass) or *Echinochloa frumentacea* (Japanese millet) (both C₄), respectively (Carter & Peterson 1983, Wong & Osmond 1991). Drake and co-workers studied the effects of elevated [CO₂] on natural salt-marsh vegetation, consisting of both C₃ [predominantly *Scirpus olneyi* (olney threesquare)] and C₄ [mainly *Spartina patens* (salt hay grass)] sedges. After 4 years of exposure to elevated [CO₂], the biomass of *Scirpus olneyi* is greatly enhanced, both on sites where this species occurs as a pure stand and also where it grows in mixtures with *Spartina patens*. There is very little effect of elevated [CO₂] on the biomass of *Spartina patens* growing in a mono-specific community, whereas it is reduced on sites where it grows in competition with the C₃ sedge (Arp et al. 1993).

The results show that C₄ plants decreased in competitive ability since the beginning of the industrial revolution. They may well continue to lose ground with a further rise in atmospheric CO₂ concentration. Elevated CO₂ concentrations interact with temperature, however, and affect plant growth in a manner that may be quite different from a plant's response to elevated [CO₂] alone. The climate change caused by elevated [CO₂] may well have an opposite effect on competition between C₃ and C₄ species. Increased temperatures and drier climates might favor C₄ grasses and lead to an expansion of the area occupied by C₄ species in Australia (Henderson et al. 1995).

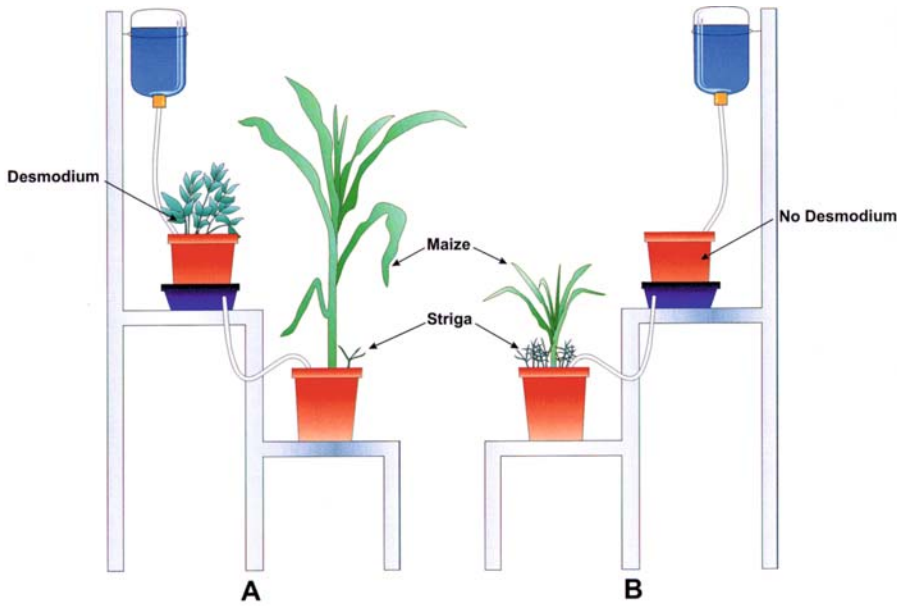

FIGURE 9. Diagram of an experiment to investigate the allelochemical mechanism of the fodder legume *Desmodium uncinatum* (silverleaf) in suppressing *Striga hermonthica* (witchweed) infestation of *Zea mays* (corn).

A comparison was made between corn plants irrigated by root eluates of *Desmodium uncinatum* (A) with those irrigated by water passing through pots containing only autoclaved soil (B) (redrawn after Khan et al. 2002).

Elevated atmospheric CO_2 concentrations can alter availability of other environmental resources that can shift competitive balance in unpredictable ways. In a dry North American prairie, elevated $[\text{CO}_2]$ causes an increase in soil moisture as a result of the reduction in stomatal conductance and transpiration. The improved soil moisture favors tall C_4 grasses over a subdominant C_3 grass which is opposite the result expected from direct photosynthetic response to CO_2 (Mo et al. 1992, Owensby et al. 1993).

Many of the published studies on competitive interactions of C_3 and C_4 species have been conducted in relatively fertile soils (Reynolds 1996), where we would expect photosynthetic performance to have the strongest connection to growth and competitive ability. Nutrient limitation reduces plant growth response to elevated CO_2 (Luo et al. 2004, Edwards et al. 2005, Reich et al. 2006), and there is no consistent competitive advantage of C_3 or C_4 species at low nutrient availability. Therefore, **nutrient limitation** could reduce any competitive advantage that C_3 species might have with future increases in atmospheric CO_2 . In summary, despite the greater photosynthetic responsiveness of C_3 plants to elevated CO_2 , compared with that of C_4 species, this may not translate into a future competitive advantage (Mooney et al. 1999).

The results on the outcome of competition between C_3 and C_4 plants as dependent on the CO_2 concentration in the atmosphere suggests photosynthesis has been a major factor in determining past competitive interactions, but is that also the case if we restrict our comparison to C_3 plants only? There is a wealth of information on the photosynthetic traits of "invasive" species as well as on early-succession woody species and the species that ultimately replace these. Succession is far more complicated than can be accounted for by competitive interactions alone. Competition in the succession following a fire or upon canopy destruction by a storm is a race without a single winner, unlike in a standard athletic contest. The entry in subsequent races may occur via vegetative regeneration, via a stored seed bank, or via dispersal to other locations, but the prerequisite for any of these is sufficient carbon and nutrient accumulation at some stage during vegetative growth. In succession, therefore, competition does play a role, and at later stages of succession the early-successional species are very poor competitors. Two exotic vines, *Pueraria lobata* (kudzu) and *Lonicera japonica* (Japanese honeysuckle), are major weed species in the south-eastern United States. In comparison with a number of native vines, *Rhus radicans* (poison ivy), *Parthenocissus quinquefolia* (Virginia creeper), *Vitis vulpina* (wild

grape), and *Clematis virginiana* (virgin's bower), they have very similar rates of photosynthesis. Thus, the highly prolific growth of the two exotic weedy vines cannot be explained by higher rates of photosynthesis (Carter et al. 1989).

6. Positive Interactions Among Plants

Not all plant–plant interactions are competitive. Plants often ameliorate the environment of neighbors and increase their growth and survivorship (**facilitation**), particularly at the seedling stage and where the physical environment or water and nutrients strongly constrain growth (Callaway 2007).

6.1 Physical Benefits

In hot dry environments, seedlings often establish preferentially in the shade of other **nurse plants**. At the seedling stage, barrel cacti (*Ferocactus acanthodes*) suffer high mortality in deserts because of their small thermal mass. Seedlings in the shade of other plants are 11°C cooler than they are in full sun and only survive in shade (Turner et al. 1966, Nobel 1984). Facilitation due to shading also occurs in oak savannas by reducing desiccation and overheating, and in salt marshes by reducing soil evaporation and therefore salt accumulation (Callaway 1995). Hydraulic lift by deep-rooted plants may increase water potential and growth of adjacent plants (Sect. 7.2). Other facilitative effects of plants include oxygenation of soils, stabilization of soils, physical protection from herbivores, and attraction of pollinators (Callaway 1995).

6.2 Nutritional Benefits

A second general category of facilitation involves enhanced **nutrient availability**. The most dramatic examples of this are establishment of N₂-fixing species in early-successional and other low-N habitats (Vitousek et al. 1987, Chapin et al. 1994). Decomposition of high-N litter of N₂-fixing plants increases N availability in these environments. In other cases, organic matter enhances the nutrient and water status of understory plants (Callaway 1995).

When P is limiting and most of it is sorbed onto soil particles, plants that access sorbed P due to the release of carboxylates from their roots can benefit their neighbors that lack this ability (Sect. 2.2.5 of

Chapter 6 on mineral nutrition; Cu et al. 2005). On calcareous soil, Fe uptake is restricted in calcifuge species, e.g., *Arachis hypogaea* (peanut). When peanut is intercropped with *Zea mays* (corn), which releases phytosiderophores, peanut does not show signs of Fe deficiency and yields much better (Sect. 2.2.6.2 of Chapter 6 on mineral nutrition; Zuo et al. 2000). These nutritional benefits can therefore be taken advantage of in **intercropping** systems in agriculture (Hauggaard-Nielsen & Jensen 2005).

In the real world, plant–plant interactions involve complex mixtures of competitive and facilitative effects, which often occur simultaneously. For example, at Glacier Bay, Alaska, *Alnus sinuata* (Sitka alder) is an early colonizer that has multiple effects on *Picea sitkensis* (Sitka spruce), which is the ultimate-successional dominant. Alder increases spruce growth by adding N and organic matter, but negatively affects spruce growth through shading and root competition. Alder increases seedling mortality as a result of seedling burial by litter and by providing habitat for seed predators (Chapin et al. 1994). Over the long term, the net effect of alder is to reduce stand density and increase the growth of individual spruce trees. Similar combinations of competitive and facilitative effects have been observed in many studies, with the net effect of one plant on another often changing with time, depending on variation in weather and successional stage (Aguilar et al. 1992, Callaway 1995).

6.3 Allelochemical Benefits

As discussed in Sect. 2 of Chapter 9B on ecological biochemistry, some plants release allelochemicals that affect herbivores. For example, *Eragrostis curvula* (weeping lovegrass) releases chemicals that have a **nematicidal** effect. Such species may be used to manage nematodes in agriculture (Katsvairo et al. 2006).

In subsistence farming in Kenya, intercropping of *Zea mays* (corn) with the fodder legumes silverleaf (*Desmodium uncinatum*) and greenleaf (*Desmodium intortum*) dramatically reduce the infestation of maize by **parasitic witchweeds** such as *Striga hermonthica*, due to allelochemicals released by the fodder legumes. Laboratory studies have shown that the allelochemical is a germination stimulant for *Striga hermonthica* as well as an inhibitor for haustorial development (Sects. 2.1 and 2.2 of Chapter 9D on parasitic association) (Fig. 9).

Certain plants release **stress signals** even when undamaged, and these can cause defense responses in intact neighbors. These discoveries provide the basis for new crop protection strategies, either

through conventional intercropping with plants that release stress signals or by genetic modification of plants (Pickett et al. 2003). Similar signaling discoveries within the **rhizosphere** offer potential to extend these approaches into new ways of controlling weeds and pests, by exploiting the potential of allelochemicals through signaling rather than by direct physiological effects (Sect. 4.3 of Chapter 9B on ecological biochemistry). “**Push-pull strategies**” involve the behavioral manipulation of pests and their natural enemies via the integration of stimuli that act to make the protected resource unattractive or unsuitable to the pests (push) while luring them toward an attractive source (pull) from where the pests are subsequently removed (Cook et al. 2007). The push and pull components are usually integrated with methods for population reduction, preferably biological control. While the use of intercrops as part of the push-pull strategy reduces the area available for the actual crop to a small extent, it greatly enhances the yield of the crop per unit area. The strategy is a valuable tool for **integrated pest management** aiming to reducing pesticide input and has been used successfully in subsistence farming in Africa (Hassanali et al. 2008).

These are just a few of numerous examples of chemical interactions between plants involving other organisms. They reveal an exciting ecophysiological complexity that we are only just beginning to appreciate. Possibilities for applications in agriculture are numerous, as alluded to above and in several other chapters.

7. Plant–Microbial Symbiosis

Many woody species that appear in early phases of succession (e.g., after a fire) are **N₂-fixing legumes**. When the level of N in the soil increases, their rates of N₂ fixation decline (Sect. 3.9 of Chapter 9A on symbiotic associations). At later stages during succession, such pioneers may succumb to phytophagous arthropods [e.g., the pioneer *Acacia baileyana* (Cootamundra wattle), in Australia]. The competitive success of *Acacia saligna* (orange wattle), which was introduced into South Africa from Australia to stabilize sand dunes, is partly ascribed to its symbiotic association with rhizobia (Stock et al. 1995).

If competing plants are **mycorrhizal**, we also need to consider the ability of their external mycelium to capture nutrients. If they share a common external mycelium, then competition exists between the plants to acquire nutrients from that external mycelium. Can mycorrhizal infection alter the

balance between different species? When seedlings of the grass *Festuca ovina* (sheep fescue) grow in nutrient-poor sand in competition with seedlings of other species, they grow less well in the presence of AM fungi than they do in their absence. Seedlings of many of their competitors, however, grow substantially better (with the exception of nonmycorrhizal species) in the presence of AM (Grime et al. 1987). The grass *Lolium perenne* (perennial ryegrass) and the dicot *Plantago lanceolata* (snake plantain) show similar values for RGR when the plants are grown separately, irrespective of their mycorrhizal status (Fig. 10). When grown in competition, however, the mycorrhizal *Plantago lanceolata* has a higher mean RGR than *Lolium perenne*, whereas the opposite occurs when the plants are nonmycorrhizal. This suggests that the coexistence of *Plantago lanceolata* in grasslands may depend on mycorrhizas (Newman et al. 1992).

Competitive interactions may become complicated when species differ in their mycorrhizal dependency (Sect. 2.1.2 of Chapter 9A on symbiotic associations; Koide & Li 1991). For example, of two tallgrass prairie grasses, *Andropogon gerardii* (big bluestem) is 98% dependent on the symbiosis, vs. only 0.02% in *Koeleria pyranidata* (junegrass). When competing in pairs, *Andropogon gerardii* dominates in the presence of mycorrhizal fungi, whereas

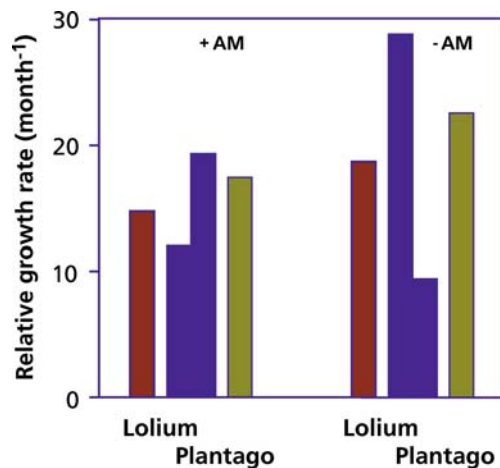

FIGURE 10. Relative growth rates of the grass *Lolium perenne* (perennial ryegrass) and the dicot *Plantago lanceolata* (snake plantain) grown in a glasshouse in heat-sterilized, nutrient-poor grassland soil that was originally free of mycorrhizal fungi. The plants were grown separately (open bars) or together (filled bars), either without AM fungi or inoculated at the time that the plants were competing, as judged from the size of the plants (Newman et al. 1992).

Koeleria pyramidata does in the absence of the fungus (Hettrick et al. 1989).

Some herbaceous pioneers are **nonmycorrhizal** (Sect. 2.2. of Chapter 9A on symbiotic associations). Some of these plants may grow well in the early phase of succession because of their special ability to release P_i from sparingly available sources (Sect. 2.2.5 of Chapter 6 on mineral nutrition) or because the P_i availability is high. At later stages, mycorrhizal species may arrive and replace nonmycorrhizal species. When growing in competition with the nonmycorrhizal *Brassica nigra* (black mustard), growth and nutrient uptake of the mycorrhizal *Panicum virgatum* (switchgrass) are reduced when plants are of equal size. The presence of collembola that graze mycorrhizal fungi enhances the competitive advantage of the nonmycorrhizal black mustard. When seedlings of the nonmycorrhizal *Brassica nigra* have to compete with the mycorrhizal plants of *Panicum virgatum* that germinated 3 weeks earlier, the situation is reversed: *Brassica nigra* is negatively affected by competition, whereas the larger and older grass plants are not (Boerner & Harris 1991). This may account, in part, for the gradual replacement of nonmycorrhizal annuals by mycorrhizal perennials.

Allelochemicals released by the mycorrhizal fungus may also be important in the replacement of nonmycorrhizal species (Sect. 2.2 of Chapter 9A on symbiotic associations). Germination and seedling growth of nonmycorrhizal species are inhibited by the presence of mycorrhizal hyphae in the rhizosphere (Fig. 11). When P fertilization suppresses the mycorrhizal microsymbiont, the deleterious effects on

root growth and functioning of nonmycorrhizal species become less pronounced. This might lead us to the erroneous conclusion that the growth of the plants whose biomass increases most strongly with P fertilization is more limited by P than is that of the mycorrhizal plants. If we go to the root of the problem, however, intricate allelochemical interactions that involve mycorrhizal fungi may well account for our field observations (Francis & Read 1994).

Mycorrhizal fungi can harm nonmycorrhizal plants, but the reverse may also occur. When *Glycine max* (soybean) is grown in the vicinity of the nonmycorrhizal species *Urtica dioica* (stinging nettle), infection of the soybean roots by the mycorrhizal fungus *Glomus mosseae* is inhibited (Fig. 12A). A fungitoxic **lectin** (Sect. 2.2 of Chapter 9A on symbiotic associations) distinctly inhibits the growth of fungal hyphae (Fig. 12B) which suggests that the lectin might be partly responsible for the effect of the presence of nonmycorrhizal species on the performance of mycorrhizal plants. Other lectins [e.g., from mycorrhizal hosts like *Triticum aestivum* (wheat), *Solanum lycopersicum* (tomato), or *Solanum tuberosum* (potato)] that have a high affinity for chitin have no antifungal properties (Schlumbaum et al. 1986). It remains to be firmly established if the lectin from roots and rhizomes of stinging nettle is the major factor that accounts for the effect of this nonmycorrhizal plant on mycorrhizal neighbors.

Herbivory has equally strong effects on competitive interactions, with the effect depending on the selectivity of herbivores. Plants that are

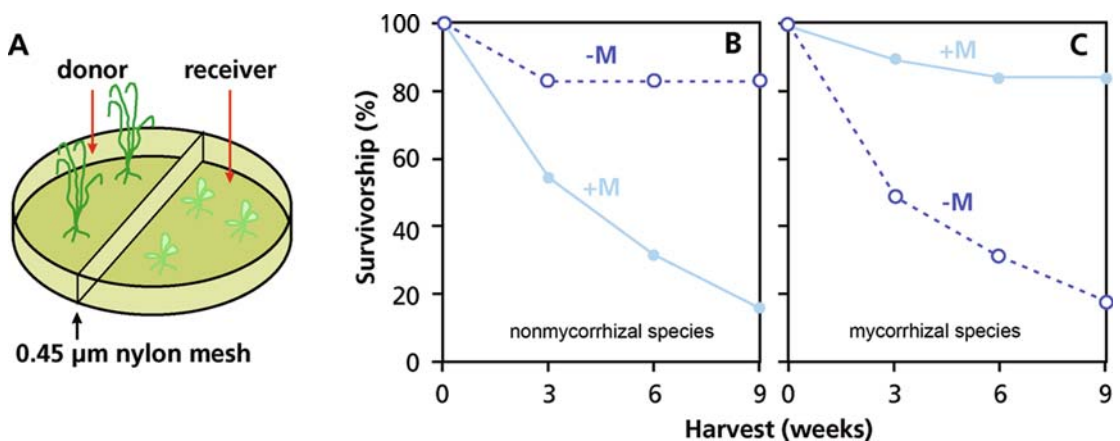

FIGURE 11. (A) Experimental design to assess the effect of the presence of mycorrhizal hyphae on the survival of seedlings of mycorrhizal and nonmycorrhizal species. (B) Effects of mycorrhizal fungi on seedling survival of

the nonmycorrhizal *Arenaria serpyllifolia* (thyme-leaved sandwort). (C) Effects of mycorrhizal fungi on seedling survival of the mycorrhizal *Centaureum erythraea* (common centaury) (Francis & Read 1994).

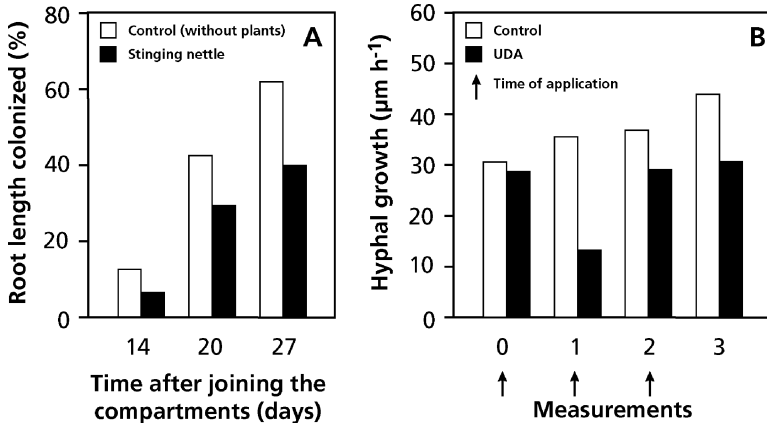

FIGURE 12. (A) Spread of the mycorrhizal fungus *Glomus mosseae* across the rhizosphere of *Urtica dioica* (stinging nettle) or control soil, without stinging nettle. Uncolonized *Glycine max* (soybean) plants were used as acceptor plants. They were separated from well-colonized soybean plants (donor plants) by a test container of soil planted with stinging nettle or a container

of soil without plants. (B) Effect of agglutinin from *Urtica dioica* on the hyphal growth of *Glomus mosseae*. The growth of hyphae of germinated spores was measured after application of small droplets of purified agglutinin. Application was repeated at 1 hour intervals (arrows) (Vierheilig et al. 1996).

selectively grazed, due to low defensive investment or other reasons, always have a reduced competitive ability compared with ungrazed neighbors. In the presence of nonselective grazing (the “lawnmower effect”), however, species that lack well-developed defensive mechanisms are typically more tolerant of grazing (Bryant & Kuropat 1980, Rosenthal & Kotanen 1994).

8. Succession

Successional changes in species composition following disturbance are the net result of different rates of **colonization**, **growth**, and **mortality** of early and late-successional species (Egler 1954, Walker & del Moral 2003). Competition and facilitation both play strong roles in successional change, and the resulting change in species composition through succession is associated with predictable changes in ecophysiology. The physiology of initial colonizers differs strikingly between primary succession, when plants colonize an area for the first time, and secondary succession, when plants recolonize previously vegetated areas after disturbances such as fire or agriculture. Soils in primary succession typically have low N and organic matter content (Fig. 6.1A of Chapter 6 on mineral nutrition).

Primary-successional soils initially lack a buried seed pool, requiring colonizers to disperse to the site, whereas secondary-successional sites are colonized from the buried seed pool, resprouting individuals, and dispersal to the site. Propagules of early colonizers of primary succession have seeds that are as small as, or smaller than, those of species that colonize secondary succession, which, in turn, are smaller than seeds of late-successional species (Fig. 13), perhaps because colonizers of many primary-successional environments have further to travel than do secondary-successional colonizers. The larger **seed size** of late-successional species (see also Sect. 3.1 of Chapter 8 on life cycles) provides reserves to support growth in fully vegetated sites, where competition is likely to be more intense.

When grown under favorable laboratory conditions, early-successional species grow more rapidly than do late-successional species. A high **RGR** (Sect. 2) is a trait selected for, as pointed out by Grime (1977). A high RGR is associated with a high specific leaf area (SLA; Sect. 3.1 of Chapter 7 on growth and allocation). Colonizers of primary-successional habitats have lower RGR than do colonizers of more fertile secondary-successional disturbed sites (Fig. 14) which suggests that among colonizing species low soil fertility has selected for species with traits that cause low RGR. A low RGR is associated with a low SLA

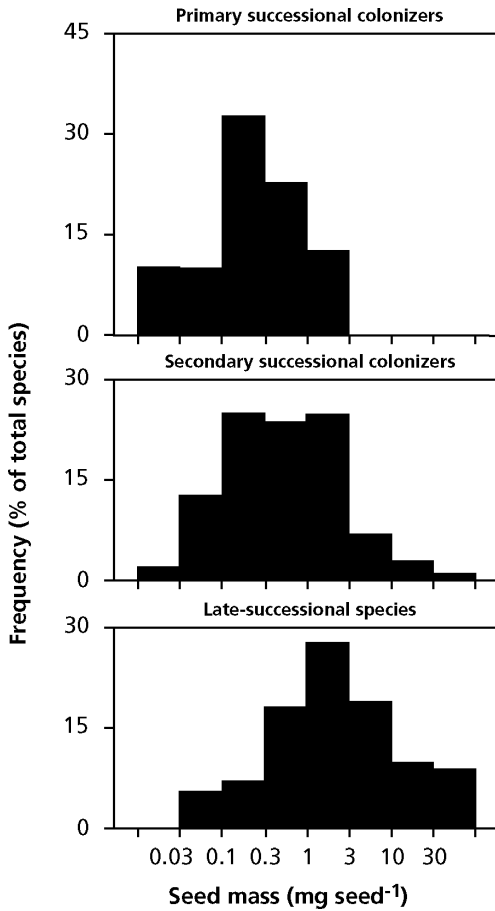

FIGURE 13. Frequency distribution of log (seed mass) for British species that are colonizers of primary-successional (skeletal, $n = 60$ species), secondary-successional (disturbed, $n = 88$ species), or late-successional (woodland, $n = 58$ species) habitats. Data calculated from Grime et al. (1981).

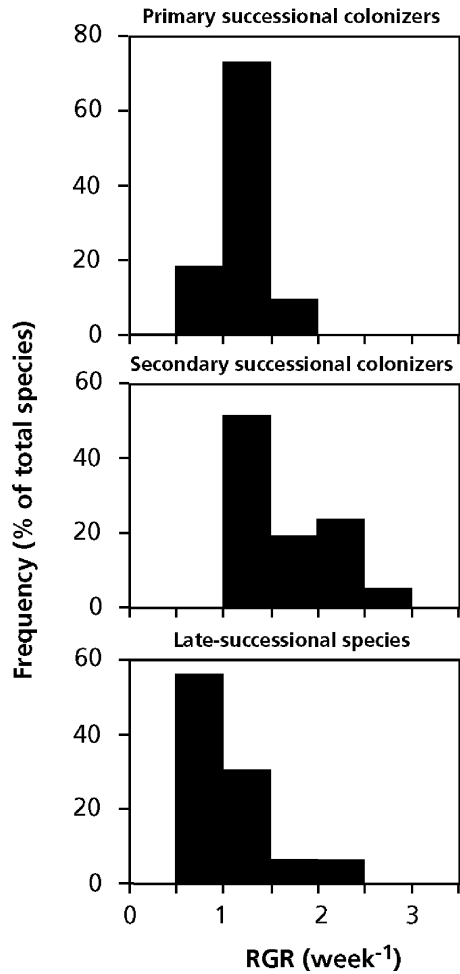

FIGURE 14. Frequency distribution of RGR for British species that are colonizers of primary-successional (skeletal), secondary-successional (disturbed), or late-successional (woodland) habitats. Calculated from Grime & Hunt (1975) after classifying species according to Grime et al. (1981).

(Sect. 3 in Chapter 7 on growth an allocation), which is accounted for by a large investment in quantitative defense (Sect. 3.2 in Chapter 9B on ecological biochemistry). Plants that occur at later-successional stages may also have nutrient-acquisition strategies that deplete the soil nutrients to a greater extent (Sect. 2), as pointed out by Tilman (1988, 1990).

Early-successional trees or shrubs invariably have higher rates of **photosynthesis** on an area basis than do those that appear later in succession (Table 1; Raaimakers et al. 1995, Owens 1996). When the light-saturated rates of photosynthesis of shrubs (Table 1) are compared with those of the final climax tree species, *Fagus sylvatica* (beech) which are only as low as $3\text{--}4 \mu\text{mol m}^{-2} \text{s}^{-1}$, it is quite obvious that

high rates of photosynthesis cannot explain the replacement of early-successional species by later ones. The late-successional and invasive species have a more positive carbon balance, due to their greater leaf area and better exposure of the leaves. The physiological mechanisms accounting for leaf expansion and leaf exposure are clearly far more important than are the photosynthetic capacity of individual leaves in explaining the outcome of competition.

As with photosynthesis, early- and mid-successional species typically have higher potential to absorb nutrients than do late-successional species

TABLE 1. Photosynthetic characteristics of a number of Central European woody species from a hedgerow.

Photosynthetic trait, units	Species, time of appearance during succession, and competitive ability				
	<i>Rubus corylifolius</i> (blackberry) early pioneer, low competitive ability	<i>Prunus spinosa</i> (blackthorn) later pioneer	<i>Crataegus macrocarpa</i> (hawthorn) late-successional	<i>Acer campestre</i> (field maple) late-successional	<i>Ribes uvacrispa</i> (gooseberry) later-successional shrubby undergrowth species
A_{\max} ($\mu\text{mol m}^{-2} \text{s}^{-1}$)	11–15	9–12	8–12	8–11	6–14
Stomatal conductance at A_{\max} ($\text{mmol m}^{-2} \text{s}^{-1}$)	150–250	350–450	350–500	150–200	150–350
Photosynthesis per unit leaf N [$\mu\text{mol g}^{-1} \text{(N) s}^{-1}$]	8.6–11.6	4.7–6.3	3.6–5.3	4.3–5.9	4.5–10.5
Photosynthesis per unit leaf [$\mu\text{mol g}^{-1} \text{(P) s}^{-1}$]	83–113	56–75	30–45	44–60	62–144

Source: Küppers et al. 1984.



FIGURE 15. Rate of P_i uptake by excised roots of tree seedlings from an Alaskan primary-successional flood-plain sequence grown in a glasshouse (after Walker & Chapin 1986).

(Fig. 15). This could reflect their high potential growth rate and, consequently, the high nutrient demands of colonizing species.

Herbivores are often a major cause of plant mortality during succession. Late-successional species, with their long-lived leaves have higher concentrations of defensive compounds and are therefore less palatable than early-successional species (Fig. 16).

In summary, the changes in ecophysiological traits through succession are identical to those described earlier in species that compete effectively in high- vs. low-resource sites, explaining the change in competitive balance that causes species replacement through succession.

9. What Do We Gain from This Chapter?

There is no single ecophysiological trait that gives a genotype competitive superiority. The outcome of competition may be due to the occurrence of an event, such as flooding, frost, fire, or drought, with which one genotype is better able to cope and therefore survive, whereas other genotypes may lose out. Superior traits in one environment (e.g., a low tissue mass density, which is associated with rapid growth when nutrients are plentiful) may be inferior traits in a different environment, when a low tissue density is associated with relatively large losses of nutrients when nutrients are scarce. These trade-offs among suites of physiological traits are critical to understanding patterns of competitive success in different environments.

Competitive advantage may depend on a plant's secondary metabolism (i.e., the exudation of allelochemicals that harm other plants, excretion of compounds that solubilize sparingly available nutrients or detoxify harmful soil components, production of chemicals that chelate Al or heavy metals, or the accumulation of defensive compounds that reduce the effects of herbivore attack and diseases). If plants did not produce such defense compounds, they might be able to grow faster in productive environments. In the longer term, however, such plants may succumb to pests or attack by a pathogenic bacterium, such as *Crataegus monogyna* (hawthorn) in Europe and many *Acacia* species in Australia. When released in a foreign environment, where such pests are absent, some species may become invasive [e.g., *Acacia saligna* (orange wattle) from

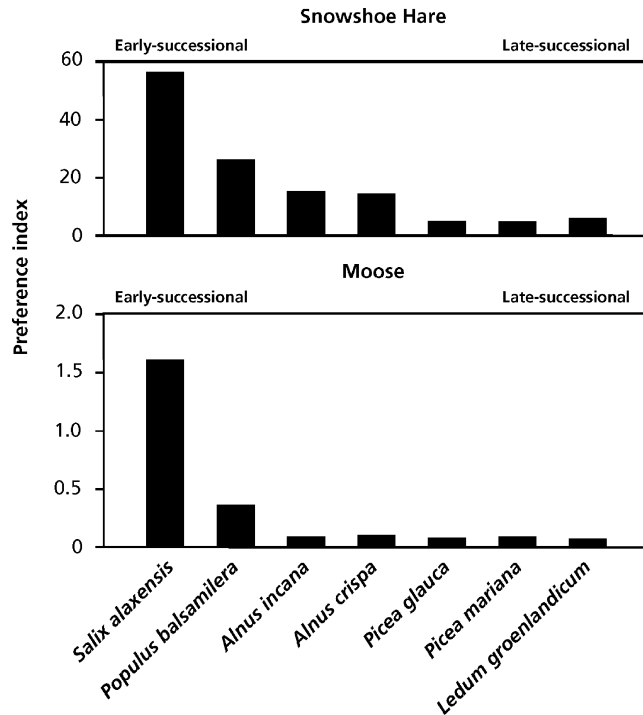

FIGURE 16. Preference by two species of herbivores for plant species from an Alaskan primary-successional floodplain sequence (after Bryant & Chapin 1986).

Australia, which was introduced in South Africa to stabilize sand dunes (New 1984)]. Other examples include *Prunus padus* (bird cherry) from North America which was introduced in Western Europe, and *Salix* species (weeping willow) from Asia and *Rubus corylifolius* (blackberry) from Europe, both of which now invade river valleys in Australia.

A large phenotypic plasticity for various plant traits (e.g., photosynthetic characteristics, nutrient acquisition, and stem elongation) may also contribute to competitive success. In addition, competitive advantage may be based on a profitable association with another organism, such as a symbiotic N₂-fixing microorganism, a mycorrhizal fungus, or a higher plant, that happens to be a suitable host to parasitize.

References

- Aerts, R. & Van der Peijl, M.J. 1993. A simple model to explain the dominance of low-productive perennials in nutrient poor habitats. *Oikos* **66**: 144–147.
- Aguiar, M.R., Soriano, A., & Sala, O.E. 1992. Competition and facilitation in the recruitment of seedlings in Patagonian steppe. *Funct. Ecol.* **6**: 66–70.
- Arp, W.J., Drake, B.G., Pockman, W.T., Curtis, P.S., & Whigham, D.F. 1993. Interactions between C₃ and C₄ salt marsh plant species during four years of exposure to elevated atmospheric CO₂. *Vegetatio* **104/105**: 133–143.
- Ball, M.C., Egerton, J.J.G., Leuning, R., Cunningham, R.B., & Dunne, P. 1997. Microclimate above grass adversely affects growth of seedling snow gum (*Eucalyptus pauciflora*). *Plant Cell Environ.* **20**: 155–166.
- Ballaré, C.L. 1994. Light gaps: sensing the light opportunities in highly dynamic canopy environments. In: Exploitation of environmental heterogeneity by plants, M.M. Caldwell & R.W. Pearcy (eds). Academic Press, San Diego, pp. 73–110.
- Ballaré, C.L., Scopel, A.L., Jordan, E.T., & Vierstra, R.D. 1994. Signaling among neighboring plants and the development of size inequalities in plant populations. *Proc. Natl. Acad. Sci. USA* **91**: 10094–10098.
- Ballaré, C.L., Scopel, A.L., & Sanchez, R.A. 1995. Plant photomorphogenesis in canopies, crop growth, and yield. *HortSci.* **30**: 1172–1182.
- Barkman, J.J. 1988. New systems of plant growth forms and phenological plant types. Plant form and vegetation structure. Adaptation, plasticity and relation to herbivory, M. J. A. Werger, P. J. M. Van der Aart, H. J. During, & J. T. A. Verhoeven (eds). SPB Academic Publishing, The Hague, pp. 9–44.

- Baruch, Z., Ludlow, M.M., & Davis, R. 1985. Photosynthetic responses of native and introduced C₄ grasses from Venezuelan savannas. *Oecologia* **67**: 388–393.
- Bazzaz, F.A. 1996. Plants in changing environments. Cambridge University Press, Cambridge.
- Berendse, F. & Aerts, R. 1987. Nitrogen-use efficiency: A biologically meaningful definition? *Funct. Ecol.* **1**: 293–296.
- Biere, A. 1996. Intra-specific variation in relative growth rate: impact on competitive ability and performance of *Lychmis flos-cuculi* in habitats differing in soil fertility. *Plant Soil* **182**: 313–327.
- Boerner, R.E.J. & Harris, K.K. 1991. Effects of collembola (Arthropoda) and relative germination date on competition between mycorrhizal *Panicum virgatum* (Poaceae) and non-mycorrhizal *Brassica nigra* (Brassicaceae). *Plant Soil* **136**: 121–129.
- Bryant, J.P. & Chapin III, F.S. 1986. Browsing-woody plant interactions during boreal forest plant succession. In: Forest ecosystems in the Alaskan taiga. A synthesis of structure and function, K. Van Cleve, F.S. Chapin III, P.W. Flanagan, L.A. Viereck, & C.T. Dyrness (eds). Springer-Verlag, New York, pp. 213–225.
- Bryant, J.P. & Kuropat, P.J. 1980. Selection of winter forage by subarctic browsing vertebrates: The role of plant chemistry. *Annu. Rev. Ecol. Syst.* **11**: 261–285.
- Caldwell, M.M., Eissenstat, D.M., Richards, J.H., & Allen, M.F. 1985. Competition for phosphorus: Differential uptake from dual-isotope-labeled soil interspaces between shrub and grass. *Science* **229**: 384–386.
- Caldwell, M.M., Richards, J.H., Manwaring, J.H., & Eissenstat, D.M. 1987. Rapid shifts in phosphate acquisition show direct competition between neighbouring plants. *Nature* **327**: 6123–6124.
- Callaway, R.M. 1995. Positive interactions among plants. *Bot. Rev.* **61**: 306–349.
- Callaway, R.M. 2007. Positive interactions and interdependence in plant communities. Springer, Dordrecht.
- Carter, D.R. & Peterson, K.M. 1983. Effects of a CO₂-enriched atmosphere on the growth and competition interaction of a C₃ and a C₄ grass. *Oecologia* **58**: 188–193.
- Carter, G.A., Teramura, A.H., & Forseth, I.N. 1989. Photosynthesis in an open field for exotic versus native vines of the south-eastern United States. *Can. J. Bot.* **67**: 443–446.
- Chapin III, F.S., Walker, L.R., Fastie, C.L., & Sharman, L.C. 1994. Mechanisms of primary succession following deglaciation at Glacier Bay, Alaska. *Ecol. Monogr.* **64**: 149–175.
- Cook, S.M., Khan, Z.R., & Pickett J.A. 2007. The use of push-pull strategies in integrated pest management. *Annu. Rev. Entomol.* **52**: 375–400.
- Cu, S.T.T., Hutson, J., & Schuller, K.A. 2005. Mixed culture of wheat (*Triticum aestivum* L.) with white lupin (*Lupinus albus* L.) improves the growth and phosphorus nutrition of the wheat. *Plant Soil* **272**: 143–151.
- D'Antonio, C.M. & Mahall, B.E. 1991. Root profiles and competition between the invasive, exotic perennial, *Carpobrotus edulis* and two native shrub species in California coastal shrub. *Am. J. Bot.* **78**: 885–894.
- Dawson, T.E. 1993. Water sources of plants as determined from xylem-water isotopic composition: perspectives on plant competition, distribution, and water relations. In: Stable isotopes and plant carbon-water relations, J.R. Ehleringer, A.E. Hall, & G.D. Farquhar (eds). Academic Press, San Diego, pp. 465–496.
- Den Dobbelen, K.C. & Oosterbeek, B. 1995. The availability of external support affects allocation patterns and morphology of herbaceous climbing plants. *Funct. Ecol.* **9**: 628–634.
- Deregibus, V.A., Sanchez, R.A., & Casal, J.J. 1983. Effects of light quality on tiller production in *Lolium* spp. *Plant Physiol.* **72**: 900–902.
- Edwards, E.J., McCaffery, S., & Evans. J.R. 2005. Phosphorus status determines biomass response to elevated CO₂ in a legume: C₄ grass community. *Global Change Biol.* **11**: 1968–1981.
- Egler, F.E. 1954. Vegetation science concepts. I. Initial floristic composition, a factor in old-field vegetation development. *Vegetatio* **4**: 414–417.
- Eissenstat, D.M. 1992. Costs and benefits of constructing roots of small diameter. *J. Plant Nutr.* **15**: 763–782.
- Eissenstat, D.M. & Caldwell, M.M. 1987. Characteristics of successful competitors: an evaluation of potential growth rate in two cold desert tussock grasses. *Oecologia* **71**: 167–173.
- Eissenstat, D.M. & Caldwell, M.M. 1988. Competitive ability is linked to rates of water extraction. A field study of two aridland tussock grasses. *Oecologia* **75**: 1–7.
- Emery, R.J.N., Chinnappa, C.C., & Chmielewski, J.G. 1994. Specialization, plant strategies, and phenotypic plasticity in populations of *Stellaria longipes* along an elevational gradient. *Int. J. Plant Sci.* **155**: 203–219.
- Fitter, A.H. 1976. Effects of nutrient supply and competition from other species on root growth of *Lolium perenne* in soil. *Plant Soil* **45**: 177–189.
- Francis, R. & Read, D.J. 1994. The contribution of mycorrhizal fungi to the determination of plant community structure. *Plant Soil* **159**: 11–25.
- Gilbert, I.R., Seavers, G.P., Jarvis, P.G., & Smith, H. 1995. Photomorphogenesis and canopy dynamics. Phytochrome-mediated proximity perception accounts for the growth dynamics of canopies of *Populus trichocarpa* × *deltoides* “Beaupré”. *Plant Cell Environ.* **18**: 475–497.
- Goldberg, D.E. 1990. Components of resource competition in plant communities. In: Perspectives on plant competition, J.B. Grace & D. Tilman (eds). Academic Press, San Diego, pp. 27–49.
- Goldberg, D.E. & Barton, A.M. 1992. Patterns and consequences of interspecific competition in natural communities: a review of field experiments with plants. *Am. Nat.* **139**: 771–801.
- Grace, J.B. 1990. On the relationship between plant traits and competitive ability. In: Perspectives on Plant Competition, J.B. Grace & D. Tilman (eds). Academic Press, San Diego, pp. 51–65.

- Grime, J.P. 1977. Evidence for the existence of three primary strategies in plants and its relevance to ecological and evolutionary theory. *Am. Nat.* **111**: 1169–1194.
- Grime, J.P. 1979. Plant strategies and vegetation processes. Wiley, Chichester.
- Grime, J.P. 1994. The role of plasticity in exploiting environmental heterogeneity. Exploitation of environmental heterogeneity by plants: ecophysiological processes above- and below-ground, M.M. Caldwell & R.W. Pearcy (eds). Academic Press, New York. pp. 1–19.
- Grime, J.P., Mason, G., Curtis, A.V., Rodman, J., Band, S.R., Mowforth, M.A.G., Neal, A.M., & Shaw, S. 1981. A comparative study of germination characteristics in a local flora. *J. Ecol.* **69**: 1017–1059.
- Grime, J.P., Crick, J.C., & Rincon, E. 1986. The ecological significance of plasticity. In: Plasticity in Plants, D.H. Jennings (ed). Company of Biologists, Cambridge, pp. 5–29.
- Grime, J.P., Mackey, J.M.L., Hillier, S.H., & Read, D.J. 1987. Floristic diversity in a model system using experimental microcosms. *Nature* **328**: 420–422.
- Gurevitch, J., Morrow, L.L., Wallace, A., & Walsh, J.S. 1992. A meta-analysis of competition in field experiments. *Am. Nat.* **140**: 539–572.
- Hassanali, A., Herren, H., Khan, Z.R., & Pickett, J.A. 2008. Integrated pest management. *Phil. Trans. R. Soc. London B* **363**: 611–621.
- Hauggaard-Nielsen, H., & Jensen, E.S. 2005. Facilitative root interactions in intercrops. *Plant Soil* **274**: 237–250.
- Henderson, S., Hattersley, P., Von Caemmerer, S., & Osmond C.B. 1995. Are C₄ pathway plants threatened by global climatic change? In: Ecophysiology of photosynthesis, E.-D. Schulze & M.M. Caldwell (eds), Springer-Verlag, Berlin, pp. 529–549.
- Hetrick, B.A.D., Wilson, G.W., & Hartnett, D.C. 1989. Relationship between mycorrhizal dependence and competitive ability of two tallgrass prairie species. *Can J. Bot.* **67**: 2608–2615.
- Huber-Sannwald, E., Pyke, D.A., & Caldwell, M.M. 1996. Morphological plasticity following species-specific competition in two perennial grasses. *Am. J. Bot.* **83**: 919–931.
- Johnson, H.B., Polley, H.W., & Mayeux, H.S. 1993. Increasing CO₂ and plant–plant interactions: effects on natural vegetation. *Vegetatio* **104/105**: 157–170.
- Khan, Z.R., Hassanali, A., Overholt, W., Khamis, T.M., Hooper, A.M., Pickett, J.A., Wadhams, L.J., & Woodcock, C.M. 2002. Control of witchweed *Striga hermonthica* by intercropping with *Desmodium* spp., and the mechanism defined as allelopathic. *J. Chem. Ecol.* **28**: 1871–1885.
- Katsvairo, T.W., Rich, J.R., & Dunn, R.A. 2006. Perennial grass rotation: an effective and challenging tactic for nematode management with many other positive effects. *Pest Manage. Sci.* **62**: 793–796.
- Koide, R.T. & Li, M. 1991. Mycorrhizal fungi and the nutrient ecology of three oldfield annual plant species. *Oecologia* **85**: 403–412.
- Küppers, M. 1984. Carbon relations and competition between woody species in a central European hedgerow. I. Photosynthetic characteristics. *Oecologia* **64**: 332–343.
- Lambers, H. & Poorter, H. 2004. Inherent variation in growth rate between higher plant: A search for physiological causes and ecological consequences. *Adv. Ecol. Res.* **34**: 283–362.
- Lambers, H., Shane, M.W., Cramer, M.D., Pearse, S.J., & Veneklaas, E.J. 2006. Root structure and functioning for efficient acquisition of phosphorus: matching morphological and physiological traits. *Ann. Bot.* **98**: 693–713.
- Lambers, H., Shaver, G., Raven, J.A., & Smith, S.E. 2008. N- and P-acquisition change as soils age. *Trends Ecol. Evol.* **23**: 95–103.
- Leishman, M.R., Wright, I.J., Moles, A.T., & Westoby, M. 2000. The evolutionary ecology of seed size. Seeds—the ecology of regeneration in plant communities, M. Fenner (ed). CAB International, Wallingford, pp. 31–57.
- Li, L., Yang, S., Li, X., Zhang, F., & Christie, P. 1999. Interspecific complementary and competitive interactions between intercropped maize and faba bean. *Plant Soil* **212**: 105–114.
- Luo, Y., Currie, W.W., Dukes, J.S., Finzi, A., Hartwig, U., Hungate, B., McMurtrie, R.E., Oren, R., Parton, W., J. Pataki, D.W., Shaw, M.R., Zak, D.R., & Field, C.B. 2004. Progressive nitrogen limitation of ecosystem responses to rising atmospheric carbon dioxide. *BioSci.* **54**: 731–739.
- Mahall, B.E. & Callaway, R.M. 1991. Root communication among desert shrubs. *Proc. Nat. Acad. Sci.* **88**: 874–876.
- Mahall, B.E. & Callaway, R.M. 1992. Root communication mechanisms and intracommunity distribution of two Mojave Desert shrubs. *Ecology* **73**: 2145–2151.
- McGill, B.J., Enquist, B.J., Weiher, E., & Westoby, M. 2006. Rebuilding community ecology from functional traits. *Trends Ecol. Evol.* **21**: 178–185.
- Myers, N., Mittermeier, R.A., Mittermeier, C.G., Dafonseca, G.A.B., & Kent, J. 2000. Biodiversity hotspots for conservation priorities. *Nature* **403**: 853–858.
- Milne, A.A. 1928. The house at Pooh Corner. Dutton, New York.
- Mo, H., Kirkham, M.B., He, H., Ballou, L.K., Caldwell, F.W., & Kanemasu, E.T. 1992. Root and shoot weight in a tallgrass prairie under elevated carbon dioxide. *Env. Exp. Bot.* **32**: 193–201.
- Moles, A.T., Ackerly, D.D., Tweddle, J.C., Dickie, J.B., Smith, R., Leishman, M.R., Mayfield, M.M., Pitman, A., Wood, J.T., & Westoby, M. 2007. Global patterns in seed size. *Global Ecol. Biogeog.* **16**: 109–116.
- Mooney, H.A., Canadell, J., Chapin III, F.S., Ehleringer, J.R., Körner, C., McMurtrie, R.E., Parton, W.J., Pitelka, L.F., & Schulze E.-D. 1999. Ecosystem physiology responses to global change. In: The terrestrial biosphere and global change: implications for natural and managed ecosystems, B. Walker, W. Steffen, J. Canadell, & J. Ingram (eds). Cambridge University Press, Cambridge, pp. 141–189.
- New, T.R. 1984. A biology of acacias. Oxford University Press, Melbourne.

- Newman, E.L., Eason, W.R., Eissenstat, D.M., & Ramos, M.I.F.R. 1992. Interactions between plants: the role of mycorrhizae. *Mycorrhiza* **1**: 47–53.
- Nobel, P.S. 1984. Extreme temperatures and thermal tolerances for seedlings of desert succulents. *Oecologia* **62**: 310–317.
- Owens, M.K. 1996. The role of leaf and canopy-level gas exchange in the replacement of *Quercus virginiana* (Fagaceae) by *Juniperus ashei* (Cupressaceae) in semiarid savannas. *Am. J. Bot.* **83**: 617–623.
- Owensby, C.E., Coyne, P.I., Ham, J.M., Auen, L.M., & Knapp, A.K. 1993. Biomass production in a tallgrass prairie ecosystem exposed to ambient and elevated CO₂. *Ecol. Appl.* **3**: 644–653.
- Pammenter, N.W., Drennan, P.M., & Smith, V.R. 1986. Physiological and anatomical aspects of photosynthesis of two *Agrostis* species at a sub-antarctic island. *New Phytol.* **102**: 143–160.
- Pickett, J.A., Rasmussen, H.B., Woodcock, C.M., Matthes, M., & Napier J.A. 2003. Plant stress signalling: understanding and exploiting plant–plant interactions. *Biochem. Soc. Trans.* **31**: 123–127.
- Polley, H.W., Johnson, H.B., & Mayeux, H.S. 1994. Increasing CO₂: Comparative responses of the C₄ grass *Schizachyrium* and grassland invader *Prosopis*. *Ecology* **75**: 976–988.
- Poorter, H., Van de Vijver, C.A.D.M., Boot, R.G.A., & Lambers, H. 1995. Growth and carbon economy of a fast-growing and a slow-growing grass species as dependent on nitrate supply. *Plant Soil* **171**: 217–227.
- Putz, F.E. 1984. The natural history of lianas on Barro Colorado Island, Panama. *Ecology* **65**: 1713–1724.
- Raaimakers, D., Boot, R.G.A., Dijkstra, P., Pot, S., & Pons T.L. 1995. Photosynthetic rates in relation to leaf phosphorus content in pioneer versus climax tropical rainforest species. *Oecologia* **102**: 120–125.
- Raunkiaer, C. 1934. The life forms of plants and statistical plant geography. Clarendon Press, Oxford.
- Reich, P.B., Hobbie, S.E., Lee, T., Ellsworth, D.W., West, J.B., Tilman, D., Knops, J.M.H., Naeem, S., & Trost, J. 2006. Nitrogen limitation constrains sustainability of ecosystem response to CO₂. *Nature* **440**: 922–925.
- Reynolds, H.L. 1996. Effects of elevated CO₂ on plants grown in competition. In: Carbon dioxide, populations, and communities, C. Körner & F.A. Bazzaz (eds). Academic Press, San Diego, pp. 273–286.
- Reynolds, H.L. & D'Antonio, C. 1996. The ecological significance of plasticity in root weight ratio in response to nitrogen. *Plant Soil* **185**: 75–97.
- Richards, J.H. & Caldwell, M.M. 1987. Hydraulic lift: substantial nocturnal water transport between soil layers by *Artemisia tridentata* roots. *Oecologia* **73**: 486–489.
- Richards, M.B., Cowling, R.M., & Stock, W.D. 1997. Soil factors and competition as determinants of the distribution of six fynbos Proteaceae species. *Oikos* **79**: 394–406.
- Ritchie, G.A. 1997. Evidence for red:far red signaling and photomorphogenic growth response in Douglas-fir *Pseudotsuga menziesii* seedlings. *Tree Physiol.* **17**: 161–168.
- Rosenthal, J.P. & Kotanen, P.M. 1994. Terrestrial plant tolerance to herbivory. *Trends Ecol. Evol.* **9**: 145–148.
- Ryser, P. 1996. The importance of tissue density for growth and life span of leaves and roots: a comparison of five ecologically contrasting grasses. *Funct. Ecol.* **10**: 717–723.
- Ryser P. & Lambers H. 1995. Root and leaf attributes accounting for the performance of fast- and slow-growing grasses at different nutrient supply. *Plant Soil* **170**: 251–265.
- Schläpfer, B. & Ryser, P. 1996. Leaf and root turnover of three ecologically contrasting grass species in relation to their performance along a productivity gradient. *Oikos* **75**: 398–406.
- Schlumbaum, A., Mauch, F., Vögeli, U., & Boller, T. 1986. Plant chitinases are potent inhibitors of fungal growth. *Nature* **324**: 365–367.
- Stock, W.D., Wienand, K.T., & Baker A.C. 1995. Impacts of invading N₂-fixing *Acacia* species on patterns of nutrient cycling in two Cape ecosystems: evidence from soil incubation studies and ¹⁵N natural abundance values. *Oecologia* **101**: 375–382.
- Tilman, D. 1988. Plant strategies and the dynamics and function of plant communities. Princeton University Press, Princeton.
- Tilman, D. 1990. Mechanisms of plant competition for nutrients: the elements of a predictive theory of competition. In: Perspective on plant competition, J.B. Grace & D. Tilman (eds). Academic Press, San Diego, pp. 117–141.
- Tilman, D. & Wedin, D. 1991. Dynamics of nitrogen competition between successional grasses. *Ecology* **72**: 1038–1049.
- Turner, R.M., Alcorn, S.M., Olin, G., & Booth, J.A. 1966. The influence of shade, soil, and water on saguaro seedling establishment. *Bot. Gaz.* **127**: 95–102.
- Van Bavel, C.H.M. & Baker, J.M. 1985. Water transfer by plant roots from wet to dry soil. *Naturwissensch.* **72**: 606–607.
- Vetaas, O.R. 2002. Realized and potential climate niches: a comparison of four *Rhododendron* tree species. *J. Biogeog.* **29**: 545–554.
- Vierheilig, H., Iseli, B., Alt, M., Raikhel, N., Wiemken, A., & Boller, T. 1996. Resistance of *Urtica dioica* to mycorrhizal colonization: a possible involvement of *Urtica dioica* agglutinin. *Plant Soil* **183**: 131–136.
- Walker, L.R. & Chapin III, F.S. 1986. Physiological controls over seedling growth in primary succession on an Alaskan floodplain. *Ecology* **67**: 1508–1523.
- Walker, L.R. & del Moral, R. 2003. Primary succession and ecosystem rehabilitation. Cambridge University Press, Cambridge.
- Wedin, D.A. & Tilman, D. 1990. Species effects on nitrogen cycling: a test with perennial grasses. *Oecologia* **84**: 433–441.
- Westoby, M. & Wright, I.J. 2006. Land-plant ecology on the basis of functional traits. *Trends Ecol. Evol.* **21**: 261–268.
- Westoby, M., Falster, D.S., Moles, A.T., Vesk, P.A., & Wright, I.J. 2002. Plant ecological strategies: some

- leading dimensions of variation between species. *Annu. Rev. Ecol. Syst.* **33**: 125–159.
- Wong, S.C. & Osmond, C.B. 1991. Elevated atmospheric partial pressure of CO₂ and plant growth. III. Interactions between *Triticum aestivum* (C₃) and *Echinochloa frumentacea* (C₄) during growth in mixed culture under different CO₂, N nutrition and irradiance treatments, with emphasis on below-ground responses estimated using ¹³C value of root biomass. *Aust. J. Plant Physiol.* **18**: 137–152.
- Wright, I.J., Reich, P.B., Westoby, M., Ackerly, D.D., Baruch, Z., Bongers, F., Cavender-Bares, J., Chapin, T., Cornelissen, J. H.C., Diemer, M., Flexas, J., Garnier, E., Groom, P.K., Gulias, J., Hikosaka, K., Lamont, B.B., Lee, T., Lee, W., Lusk, C., Midgley, J.J., Navas, M.L., Niinemets, U., Oleksyn, J., Osada, N., Poorter, H., Poot, P., Prior, L., Pyankov, V. I., Roumet, C., Thomas, S.C., Tjoelker, M.G., Veneklaas, E.J. & Villar, R. 2004. The worldwide leaf economics spectrum. *Nature* **428**: 821–827.
- Zuo, Y., Zhang, F., Li, X., & Cao, Y. 2000. Studies on the improvement in iron nutrition of peanut by intercropping with maize on a calcareous soil. *Plant Soil* **220**: 13–25.

9F. Carnivory

1. Introduction

Since the classic work of Charles and Francis Darwin (1875, 1878) well over a century ago on the carnivorous habit of *Drosera*, considerable information has accumulated on the significance of captured animal prey in the nutrition of carnivorous plants. **Carnivory** includes the catching and subsequent digestion of the freshly trapped prey. This is a common form of nutrition in the animal kingdom, but is rare in plants, with only about 800 species from 10 families (Table 1). Carnivorous plants are distributed worldwide, but they are generally restricted to sunny, wet, nutrient-poor environments. This distribution pattern suggests that, under these conditions, carnivory has a major **benefit** for plant survival. The major benefits will be **nutritional** (Ellison 2006). The restricted distribution of carnivorous plants, however, also suggests that the **costs** of the carnivorous habit exclude carnivores from most habitats. These costs include a reduced **photosynthetic capacity** of carnivorous tissues (Mendez & Karlsson 1999, Ellison & Farnsworth 2005).

2. Structures Associated with the Catching of the Prey and Subsequent Withdrawal of Nutrients from the Prey

Carnivorous plants invariably have highly specialized structures, such as **adhesive hairs** or **emergences** [e.g., in *Pinguicula* (butterwort), *Drosera*

(sundew) and *Byblis* (rainbow plant)], bladder-like **suction traps** [in *Utricularia* (bladderwort), **“lobster-pot”** or **eel traps** [in *Genlisea* (corkscrew plant)], **snap-ping traps** [in *Dionaea* (Venus’ fly trap) and *Aldrovanda* (waterwheel plant)], or **pitfalls** [e.g., in *Nepenthes* (pitcher plant), *Sarracenia* (pitcher plant), and *Cephalotus* (Albany pitcher plant)] (Fig. 1, Table 1). The pitfall traps mostly contain water and are an ecological niche for protozoa, algae, and numerous small animals, of which some (e.g., the larvae of many Diptera) are exclusively associated with this habitat.

Although it is strictly speaking not a carnivorous species, *Capsella bursa-pastoris* (shepherd’s purse) has a mucous layer that surrounds the germinating seeds, which has the capacity to catch and digest nematodes, protozoa, and bacteria (Barber 1978). Other **protocarnivorous** species include *Geranium viscosissimum* (sticky purple geranium), *Potentilla arguta* (glandular cinquefoil), which are common in the Pacific Northwest of the United States, and *Stylidium* species (trigger plants) in Australia (Darnowski et al. 2006). Many “sticky” plants show proteinase activity on their glandular surfaces. They digest proteins that are trapped on these surfaces and subsequently absorb and translocate the breakdown products (Spomer 1999). Sticky plants have glands on their shoot surfaces that exude mucilage. This may have evolved as a defense against small arthropod herbivores. The mucilage hinders their movement, trapping them on the surface, where they die. Carnivorous species with adhesive surfaces [e.g., *Drosera* (sundew), *Byblis* (rainbow

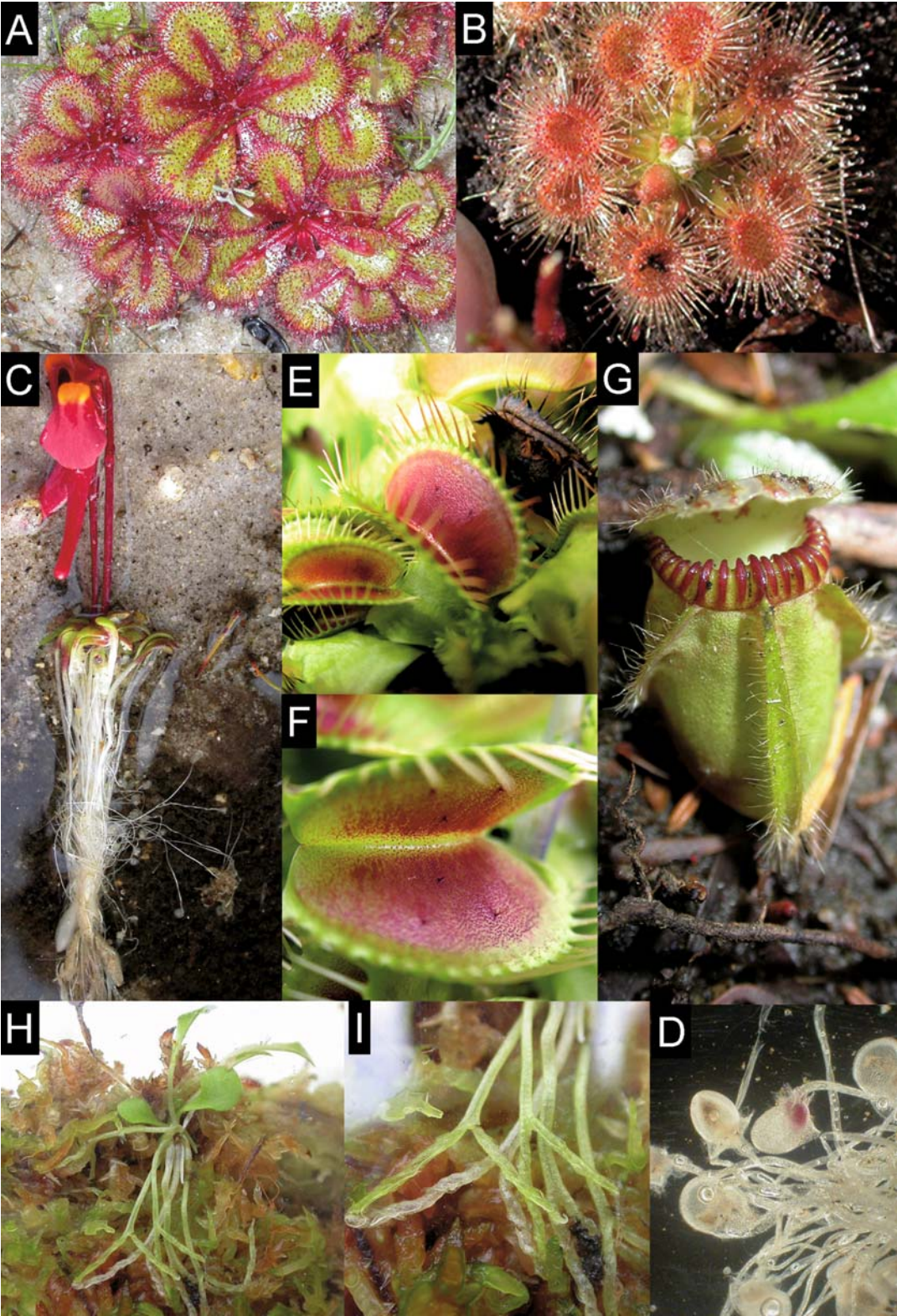

TABLE 1. Carnivorous plant families and genera with their geographical distribution and trapping mechanisms.

Family	Genus	N	Geographical distribution	Trapping mechanism					
				Eel trap	Suction trap	Snapping trap	Pitfall pitcher	Adhesive trap	Movement involved
Nepenthaceae	<i>Nepenthes</i>	70	Madagascar, Seychelles, Sri Lanka, Assam, S. China, Indochina, Malaysia, N.E. Australia, New Caledonia				x		
Sarraceniaceae	<i>Sarracenia</i>	8	Atlantic N. America				x		
	<i>Heliamphora</i>	5	Guyana Highlands				x		
	<i>Darlingtonia</i>	1	California, Oregon				x		
Dioncophyllaceae	<i>Triphyophyllum</i>	1	W. Africa					x	
Droseraceae	<i>Drosera</i>	90	Worldwide					x	x
	<i>Dionaea</i>	1	N. and S. Carolina			x			
	<i>Aldrovanda</i>	1	Central Europe, Asia, N.E. Australia, Africa			x			x
Drosophyllaceae	<i>Drosophyllum</i>	1	W. Mediterranean					x	x
Byblidaceae	<i>Byblis</i>	5	Australia, New Guinea					x	
Roridulaceae	<i>Roridula</i>	2	S. Africa					x	
Cephalotaceae	<i>Cephalotus</i>	1	S.W. Australia				x		
Lentibulariaceae	<i>Pinguicula</i>	46	Northern hemisphere					x	x
	<i>Genlisea</i>	21	Central America, tropical and S. Africa, Madagascar	x					
Stylidiaceae	<i>Utricularia</i>	c. 200	Worldwide		x				x
	<i>Stylidium</i>		W. Australia						

Sources: Lüttge (1983), Mabberley (2000), Anderson & Midgley (2002), Darnowski et al. (2006).

Note: N is the number of species in each genus.

plant), *Roridula* (fly bush), and *Pinguicula* (butterwort)] probably evolved from glandular or "sticky" protocarnivores (Juniper et al. 1989). Examples of protocarnivores include tropical bromeliads and *Dipsacus* (teasel), which have primitive "pitfalls" (Christy 1923).

Some carnivorous plants attract their prey by the production of nectar at the edge of the trap. This nectar is actively secreted and the carbon costs of this process may amount to 4–6% of the plant's total carbon budget (Pate 1986, as cited in Karlsson et al. 1991). The extrafloral nectar also contains a range of

amino acids, so there are also N costs (Dress et al. 1997). In addition, the carnivorous plants secrete adhesive substances by special glands [e.g., *Drosera* (sundew) and *Pinguicula* (butterwort)]. All carnivorous plants are green and capable of C₃ photosynthesis. Hence, carbon is unlikely to be a major element to be withdrawn from their prey, although it is certainly incorporated. Carnivorous species naturally occur on nutrient-poor, wet, acidic soils, with the exception of *Pinguicula* (butterwort), which grows on a chalky substrate. Most species have a poorly developed root system, and many are considered

FIGURE 1. (continued) Examples of carnivorous plants with different trapping structures. (A, B) *Drosera tubaestylus* and *Drosera pulchella* with adhesive hairs. (C, D) intact plant of *Utricularia menziesii* and detail of the trap of *Utricularia multifida* (bladderwort), with bladder-like suction traps. (E, F) *Dionaea muscipula* (Venus' fly trap), with snapping trap and trigger hairs. (G) *Cephalotus follicularis* (Albany pitcher plant), with pitfall. (H) *Genlisea violacea* (corkscrew plant) with

lobster-pot or eel traps. (A, B, C, and G: photo H. Lambers; D: courtesy M.W. Shane, School of Plant Biology, the University of Western Australia, Perth, Australia; E and F, courtesy M.C. Brundrett, School of Plant Biology, the University of Western Australia, Perth, Australia; H and I, reproduced with permission from <http://www.exoticplants.com/database/cps/genlisea/page/violacea.htm>).

TABLE 2. Response to feeding in the natural habitat of a mineral nutrient supplement or insects (16 *Drosophila* flies per plant) to members of a natural population of the annual *Drosera glanduligera* (pygmy sundew).

	No <i>Drosophila</i> applied		<i>Drosophila</i> applied	
	No mineral nutrients applied	Mineral nutrients applied	No mineral nutrients applied	Mineral nutrients applied
Biomass (mg DM)	4.4	7.1	13.3	11.0
N concentration (mmol g ⁻¹ DM)	1.1	0.8	1.5	1.3
Total N (μmol plant ⁻¹)	4.9	5.7	19.9	14.2
P concentration (μmol g ⁻¹ DM)	26	17	22	33
Total P (nmol plant ⁻¹)	114	124	299	368

Source: Karlsson & Pate (1992).

nonmycorrhizal (Sect. 2.2. of Chapter 9A on symbiotic associations; Adlassnig et al. 2005). It is generally assumed that carnivory is an adaptation to nutrient-poor soils and that inorganic nutrients are largely derived from the prey. There is a positive effect of supplementary feeding with prey on growth, even when this is done in the plant's natural habitat (Thum 1988, Zamora et al. 1997). However, this growth response to prey addition also occurs at high soil nutrient levels, which suggests that nutrients may not be the only mechanism by which carnivory enhances growth (Karlsson et al. 1991).

N is a major element withdrawn from the prey (Ellison & Gotelli 2001, Millett et al. 2003). Relatively tall, erect, or climbing *Drosera* (sundew) species may derive approximately 50% of all their N from insect feeding, whereas species with a rosette habit derive less N from insects (12–32%,

depending on site) (Schulze & Schulze 1990). Carnivorous plants are likely to derive other elements from their prey as well, in particular P (Pate & Dixon 1978, Karlsson & Carlsson 1984, Ellison 2006) (Tables 2 and 3). For *Nepenthes mirabilis* (pitcher plant), *Cephalotus follicularis* (Albany pitcher plant), and *Darlingtonia californica* (pitcher plant) the maximum fraction of N that is derived from insects is 62, 26, and 76%, respectively (Schulze et al. 1997). When insects are scarce (e.g., in the extremely nutrient-poor habitat of the tuberous sundew *Drosera erythrorhiza* (red ink sundew) in Western Australia), the input of N from the catch of arthropods by the glandular leaves may be very small. Isotopic tracer studies (¹⁵N; Sects. 2.4 and 3.6 of Chapter 9A on symbiotic associations) show that 76% of all N in the prey is transferred to the plant in *Drosera erythrorhiza* (red ink sundew), but this constitutes only 11–17% of its total N requirement in its natural environment (Dixon et al. 1980). In this habitat, specialized small beetles that do not stick to the glandular emergences compete with the plant for food by consuming the prey stuck to the leaf hairs. The glandular emergences might therefore function primarily to deter herbivores. The efficiency of insect capture in *Sarracenia purpurea* (northern pitcher plant) (i.e., the number of captures per number of visits by potential preys) is also very low: less than 1% (Newell & Nastase 1998). These examples illustrate the importance of quantitative assessments in determining the actual significance of the carnivorous habit in acquiring nutrients from a prey in a natural habitat.

TABLE 3. The effect of feeding *Utricularia gibba* (bladderwort) with *Paramecium* on Mg and K deficiency.

Media	Internodes		Number of bladders formed
	Number (% of control)	Length	
Complete medium (= control)	100	100	
Complete plus feeding	96	104	
Complete minus Mg ²⁺	38	33	85
Complete minus Mg ²⁺ plus feeding	53	42	151
Complete medium (= control)	100	100	66
Complete plus feeding	136	139	86
Complete minus K ⁺	72	52	66
Complete minus K ⁺ plus feeding	100	83	104

Source: Sorenson & Jackson (1968).

3. Some Case Studies

This section presents some more detailed ecophysiological studies of carnivorous plants.

3.1 *Dionaea Muscipula*

One of the most fascinating traps is that of *Dionaea muscipula* (Venus' fly trap), which is a species endemic on sandy soils in the central south-eastern coastal plain of North America (Fig. 1F). The trap consists of two lobes that are attached to a petiole. There are three "trigger hairs" on each lobe (Fig. 1F). Mechanical stimulation of these hairs leads to rapid closure of the trap. This is one of the fastest movements known in plants and is sufficiently rapid to catch even the most alert insects (Hodick & Sievers 1988, 1989). One of the six hairs inside the trap must be stimulated twice within 20s; stimulation of two different hairs within the same time frame has the same effect (Fig. 2). Touching of one of the hairs leads to an **action**

potential, which is propagated over the surface of one of the lobes (Fig. 3). At least two action potentials are required to close the trap. **Ca** in the cell wall is a prerequisite for any action potential to develop. In the absence of available Ca [e.g., when it is experimentally bound by a strong chelator (EGTA)], no action potential is produced. Inhibitors of the cytochrome path, uncouplers (Sect. 2.3.3 of Chapter 2B on plant respiration), and compounds that block Ca channels (e.g., LaCl_3) also inhibit the trap's excitability. We do not yet know what role, either direct or indirect, Ca plays in the signal transduction that leads to the closure of the trap.

Trap closure involves an increased **wall extensibility** of the lower epidermal cells (Table 4). Increased extensibility of the lower epidermis, in combination with the **tissue tension** (Sect. 4 of

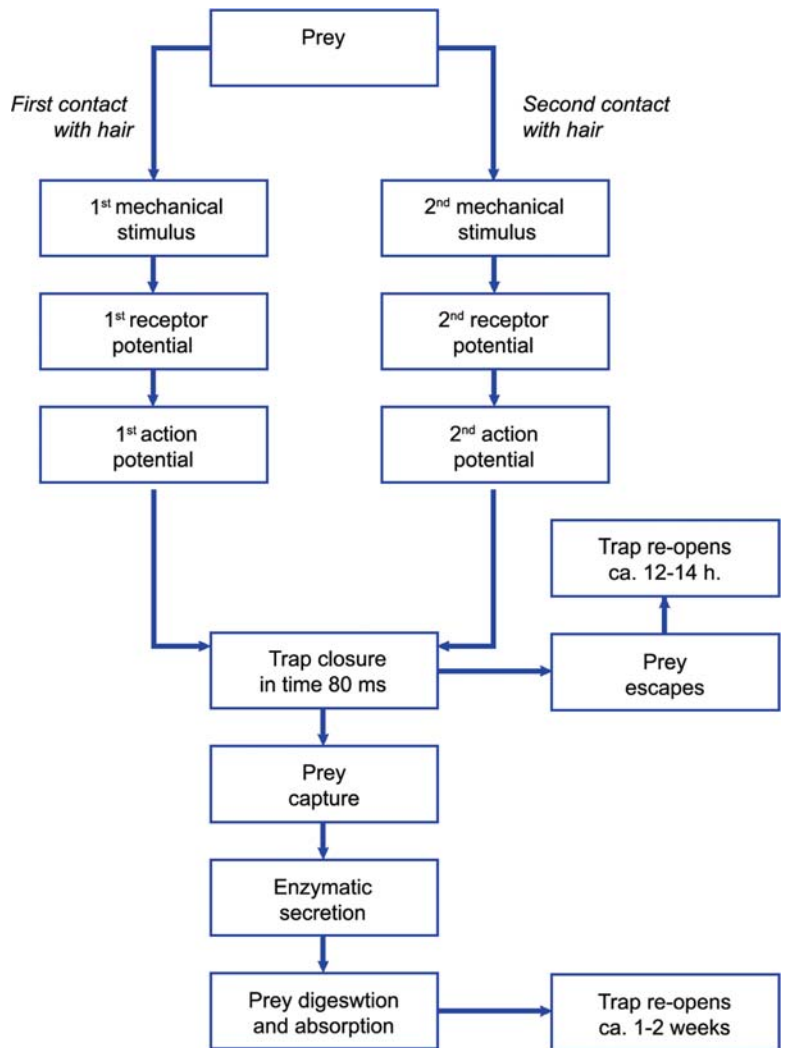

FIGURE 2. A scheme of the events after stimulation of the hairs of *Dionaea muscipula* (Venus' fly trap). The time elapsed between the first and second stimulus cannot exceed 20 s (after Jacobson 1965).

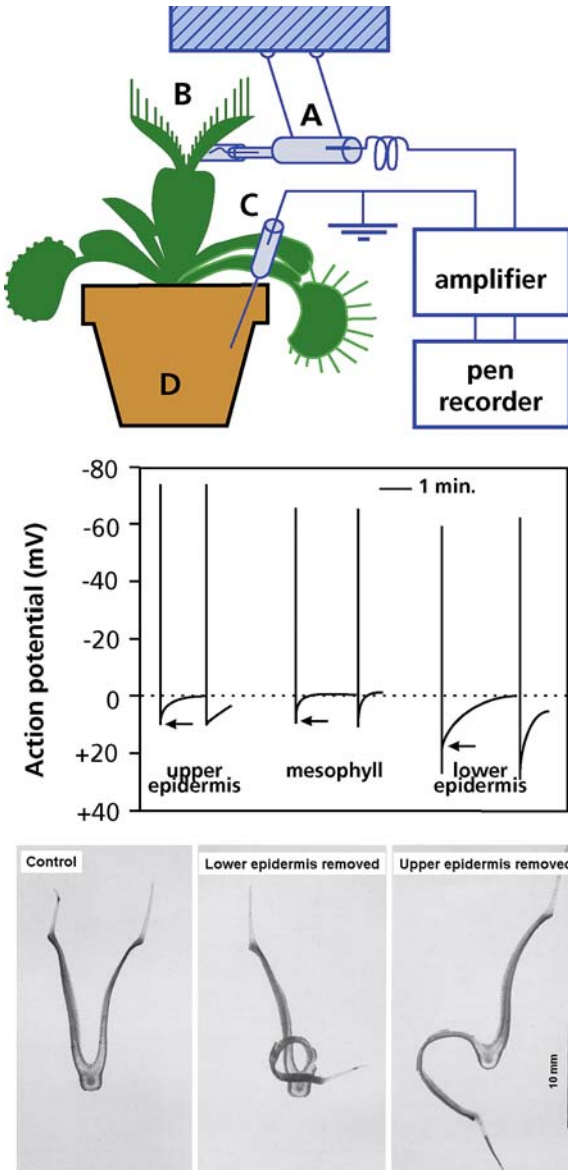

FIGURE 3. (Top) A scheme of the experimental design to determine action potentials from the surface of *Dionaea muscipula* (Venus' fly trap). One electrode (A), suspended by a thread pendulum to maintain electrical contact with the leaf (B) during movement. The reference electrode (C) is inserted into the substratum and earthed. (Middle) Extracellular recordings of action potentials during trap closure (arrows). Trigger hairs (not shown), the upper and lower epidermis, as well as the mesophyll produce action potentials. (Bottom, a) Cross-section of the Venus' flytrap, left intact. (Bottom, b) Similar cross-section, but with the lower epidermis of the right-hand lobe removed, forcing the lobe to curl inward, illustrating what happens when the cells of the lower epidermis suddenly expand upon triggering of the sensitive hairs, as during trap closure. (Bottom, c) Similar cross-section, but with the upper epidermis of the left-hand lobe removed, forcing the lobe to curl outward, illustrating what happens when the cells of the lower epidermis slowly expand during growth, as during trap re-opening (Hodick & Sievers 1988, 1989).

Chapter 3 on plant water relations), leads to trap closure. The tissue tension is due to the relatively elastic walls of the mesophyll cells ("swelling tissue"), compared with that of the epidermal cells. The presence of the relatively rigid upper and lower epidermal cells prevents the cells in the swelling tissue from reaching full turgor while the trap is open. The changes in extensibility that allow closure of the trap are not due to cell-wall acidification, as is the case when auxin induces similar changes in cell-wall properties (Sect. 2.2.2 of Chapter 7 on growth and allocation).

Closure of the trap occurs in two steps. The first step is a movement triggered by **mechanical** stimulation. If this is not followed by **chemical** stimulation, the trap gradually opens, due to the growth of the upper epidermis. If a chemical stimulus (in the form of chemical compounds from the hemolymph of the trapped insect) does occur, then the trap closes tightly and special glands begin to secrete **hydrolases** (e.g., proteases, phosphatases, DNAase) and fluid (Table 5). Trap opening is a much slower process, requiring extension (growth) of the upper epidermis (Fagerberg & Howe 1996). The opening

TABLE 4. The relative extensibilities of the upper and lower sides of the trap of *Dionaea muscipula*, measured as reversible (elastic) and irreversible (plastic) extension, induced by the application of a constant load for 10 minutes.

	Upper side	Lower side
Trap closed		
Elastic extensibility	3.5	6.9
Plastic extensibility	1.6	11.4
Trap closed and then paralyzed		
Elastic extensibility	nd	8.1
Plastic extensibility	nd	12.6
Trap open and then paralyzed		
Elastic extensibility	3.5	2.7
Plastic extensibility	1.8	1.8

Source: Hodick & Sievers (1989).

Note: Tissue strips were extended perpendicularly to the midrib (nd = not determined). In some of the experiments, the trap was paralyzed with LaCl_3 , which blocks Ca^{2+} channels and prevents excitability in whole leaves.

and closing of the trap can occur only a few times, until both the upper and the lower epidermis have achieved their maximum length.

Snapping traps such as in *Dionaea muscipula* occur in only one other genus: the aquatic *Aldrovanda* (waterwheel plant). Molecular studies have shown that *Aldrovanda* is sister to *Dionaea*, and that the pair is sister to *Drosera*. Snap-traps are derived from adhesive traps and have a common ancestry among flowering plants (Cameron et al. 2002).

TABLE 5. The effect of chemical compounds normally present in the hemolymph of the prey, on the secretion of digestive fluids by *Dionaea muscipula*.

N-compound	Protein secretion % of control	Volume secretion % of control
Whole fly (<i>Calliphora</i>)	100	100
Uric acid	63	107
Ammonia	44	121
Glutamine	20	94
Urea	9	27
Phenylalanine	–	16

Source: Robins (1976).

Note: Data are expressed as a percentage of the values found for whole flies.

3.2 The Suction Traps of *Utricularia*

The genus *Utricularia* (bladderwort), with over 200 species, is the most widespread of all carnivorous plants (Juniper et al. 1989). Many species from this rootless genus are aquatic or hygrophytic plants, occurring in nutrient-poor shallow water or flooded soil. Small bladders are produced on the shoots, either in water or in wet soil (Fig. 1C,D). A single trap is an ovoid bladder, up to 10 mm in length, with an entrance and a stalk (Fig. 4). The ventral part of the trap wall in the entrance forms the **threshold**. The inner surface of the trap is covered by four-armed hairs (quadrifids), which secrete **enzymes** that digest the captured prey. The inner surface of the threshold is covered by two-armed hairs (bifids), which mainly play a role in the movement of water out of the bladder lumen. Both types of hairs consist of a basal cell, a middle cell (which is a **transfer cell**), and terminal secretory cells. In the posterior part of the pavement epithelium there are hairs with terminal cells, whose cuticles (“velum”) seal up the trap door. Commonly, there are glandular hairs near the trap entrance; these hairs produce mucilage for prey attraction. Thus the trap contains several types of hairs that are specialized to perform quite different functions (Fineran 1985, Płachno & Jankun 2004).

Small animals (e.g., *Daphnia* species) touch one of the hairs of a trap door, causing the “door” to snap open inward. The inside of the trap has a lower **hydrostatic pressure** than the outside, so water flows in when the trap opens, carrying the prey with it (Fig. 4). Then the trap door closes again. The entire process takes 10–15 ms. The role of the hairs might be that of a “lever”, but action potentials may also play a role. The low hydrostatic pressure inside the bladder is the result of active transport of Cl^- from the lumen of the bladder to the cells that surround it (across membrane A in Fig. 5). Na^+ follows down an electrochemical potential gradient. Active transport is probably via “two-armed glands” (Fig. 5). Transport of NaCl to the cells that surround the lumen of the bladder causes a gradient in water potential between the lumen and these cells. As a result, water flows from the lumen to these cells causing an increase in turgor which in turn promotes the transport of Na^+ , Cl^- , and water out of the cells in the direction of the medium that surrounds the bladder. Suction traps only occur in *Utricularia* species.

Digestion of the prey in the bladders of *Utricularia* species requires the secretion of **enzymes**, as in other carnivorous plants (Sirová et al. 2003). Apart

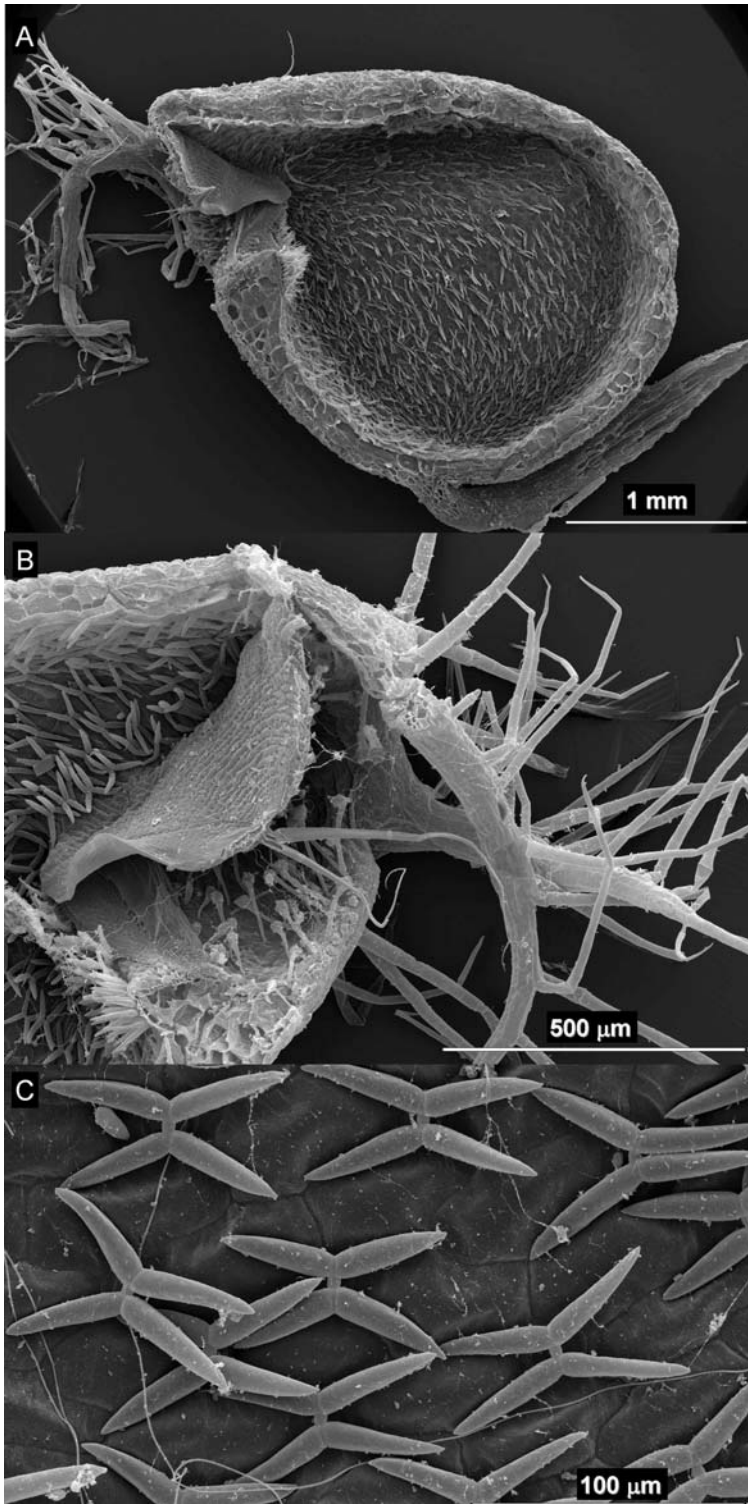

FIGURE 4. (Top) Median section through a trap of *Utricularia intermedia*, showing antennae above the trap door at the left and numerous quadrifid (four-armed) and bifid (two-armed) hairs inside the lumen of the trap. A stalk attaches the trap to the rest of the plant (Piachno & Jankun 2004). Copyright Polish Academy of Science. (Bottom, left) Detail of the trap door showing two sensitive hairs attached to the door, pointing toward the outside solution. Note the bifid hairs attached to the threshold of the door, and the quadrifid hairs at all other locations surrounding the lumen. (Bottom middle) Higher magnification view of quadrifid hairs. (Bottom right) Higher magnification view of quadrifid hairs (courtesy B.J. Piachno, Department of Plant Cytology and Embryology, The Jagiellonian University, Cracow, Poland).

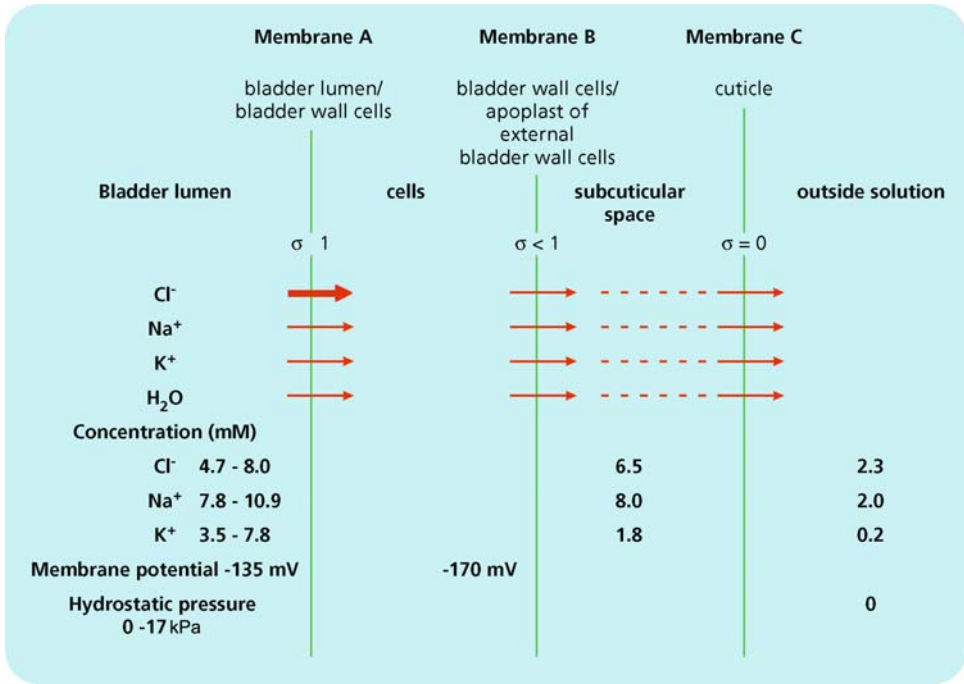

FIGURE 5. A model of solute and water flow in the resetting of the bladder of *Utricularia* species. Heavy arrow: active transport; thin arrows: passive transport; dotted lines connecting the arrows: bulk flow of solution through the subcuticular space to the outside. The

values of ionic concentrations and pressure in the bladder lumen show the range between triggered and reset bladder. The potential difference in the lumen, apart from a very rapid change at the time of triggering, is constant during resetting (Sydenham & Finlay 1975).

from captured prey, bladders also harbor communities of living algae, zooplankton, and associated debris. Bladders of *Utricularia purpurea* in the Everglades of South Florida, where plants invest an average of 26% of their biomass in bladders, capture only a few aquatic microinvertebrates. It has therefore been suggested that the major benefit of bladders to the plant may be a mutualism with the community inside the bladder, rather than a predator-prey interaction (Richards 2001).

Molecular studies have shown that *Genlisea* is sister to *Utricularia*, and that the pair is sister to *Pinguicula* (Jobson et al. 2003). *Genlisea* attracts protozoa chemotactically, trapping them in its subterranean leaves (Barthlott et al. 1998); it also traps a range of other small organisms (Płachno et al. 2005).

3.3 The Tentacles of *Drosera*

The organs of adhesive traps such as those of *Drosera* (sundew, (Fig. 1A,B) and *Pinguicula* (butterwort) can also move after mechanical and/or chemical

triggering. The tentacles (emergences) on the leaves function in catching and digestion of the prey, so that the tentacles, or even the entire leaf, may surround the prey as a result of their movement. Some of these (faster) movements are triggered by **action potentials** (Williams & Spanswick 1976). Two action potentials within 1 minute are required to trigger bending of a tentacle. The slower movements require a chemical stimulus (Williams 1976).

Digestion of the prey by carnivorous plants requires specific digestive enzymes, including **chitinases**, which hydrolyze the chitin in arthropod skeletons (Matusikova et al. 2005). Some of these enzymes are produced by the plant, in response to chemical stimuli from the prey, but it is likely that some hydrolytic enzymes are also produced by microorganisms, and that the carnivorous plant takes advantage of the presence of such microorganisms (Chandler & Andersson 1976).

Species with adhesive or flypaper traps belong to different families (Table 1), and some of them are closely related to species with different trapping mechanism, offering clear examples of **divergent evolution** (Albert et al. 1992).

3.4 Pitchers of *Sarracenia*

Sarracenia purpurea (northern pitcher plant), which is common to North America, has modified leaves that form open, fluid-containing pitchers. Secretions produced at the lip of the pitcher attract insects, some of which fall into the pitcher, drown, and are subsequently digested. During the early development of the plant, the pitcher produces traps with large, flat phyllodes that initially do not function well as traps and are primarily photosynthetic organs. At a later developmental stage of the plant, large, fully developed traps are produced. These traps can live for over a year, but most of the prey is caught within the first 50 days after the trap opens. Like other carnivorous plants, *Sarracenia purpurea* produces **hydrolytic enzymes**. Expression of protease, RNAase, DNAase, and phosphatase is partly developmentally controlled; it is also induced by the addition of nucleic acids, protein, or reduced N to the fluid in the trap (Gallie & Chang 1997). This suggests that hydrolase expression is induced upon perception of the appropriate chemical signals, which could improve the cost: benefit ratio of the carnivorous habit.

Though morphologically and functionally similar, pitcher plant genera belong to three distinctly separate families (Table 1). In particular, *Cephalotus follicularis* (Albany pitcher plant, Fig. 1G) is phylogenetically very distant, belonging to its own genus and family. This offers another fascinating example of **convergent evolution** (Adams & Smith 1977, Albert et al. 1992).

3.5 Passive Traps of *Genlisea*

A passive type of trap that is only found in the genus *Genlisea* (corkscrew plant) is the “**lobster-pot**” or “**eel trap**” (Barthlott et al. 1998). *Genlisea violacea* forms a rosette of small photosynthetic, green leaves that are attached to subterranean white traps, which are highly modified carnivorous leaves (Fig. 6). The Y-shaped traps are 2–15 cm long and about 1 mm thick. The hollow arms of the trap open into a hollow tubular neck, with an inner diameter of 200–500 μm . The tube ends in a slightly dilated vesicular cavity. The entire central cavity of the arms and neck is filled with water and lined with hairs pointing toward the vesicle. As such, *Genlisea* traps function as “eel traps”. Microscopically small preys are attracted to enter the traps, and, due to the inward-pointing hairs, are led toward the vesicle. Here, **enzymes** are secreted, and the prey is digested. The traps of *Genlisea* attract and catch protozoa (Barthlott et al. 1998; Płachno et al. 2005, 2007), but the kind of prey it traps depends on the food that is available, and *Genlisea* is fairly opportunistic in its feeding behavior (Płachno et al. 2005).

Based on a similarity to traps of *Utricularia*, it has been suggested that there might also be active water flow in *Genlisea* traps. However, *Genlisea* traps lack bifid glands that would be responsible for water pumping as in *Utricularia* traps. There is virtually no water in the traps of *Genlisea* species, showing that the traps are passive (Adamec 2003).

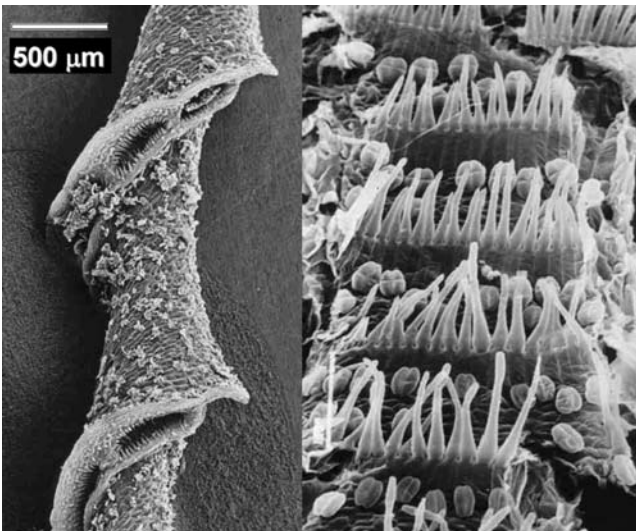

FIGURE 6. Passive trap of *Genlisea margaretae*. (Left) Scanning electron micrograph showing detail of a single trap; note the inward-pointing hairs. (Right) Higher magnification scanning electron micrograph of the inside of the tube. Courtesy W. Barthlott, University of Bonn, Germany.

4. The Message to Catch

Carnivory is a rare trait in the plant world, predominantly associated with nutrient-poor habitats which is why carnivorous species are relatively common in ancient, severely nutrient-impoverished landscapes of Western Australia, South Africa, and the Pantepui Highlands. Another center of diversity is the south-east of the United States, especially on nutrient-poor lateritic or sandy soils. There are **benefits** of the carnivorous habit, in that the prey provides an extra source of nutrients (“fertilizing effect”). There are also **costs** associated with secreting nectar, slime, and enzymes, but these would seem relatively small. The larger costs of the carnivorous habit are probably a reduced photosynthetic capacity, which would exclude carnivorous species from nutrient-rich sites where competition for light is important.

Carnivorous plants with adhesive surfaces probably evolved from protocarnivorous “sticky” glandular plants. Protocarnivory is much more widespread than carnivory. If glandular crops with protocarnivorous capabilities were engineered, these could reduce the need for pesticides and even require a somewhat lower fertilizer input. The various trapping mechanisms of carnivorous plants offer great examples of both **convergent** and **divergent evolution**.

References

- Adamec, L. 2003. Zero water flows in the carnivorous genus *Genlisea*. *Carniv. Plant Newslett.* **32**: 46–48.
- Adams, R.M. & Smith, G.W. 1977. An S.E.M. survey of the five carnivorous pitcher plant genera. *Am. J. Bot.* **64**: 265–272.
- Adlassnig, W., Peroutka, M., Lambers, H. & Lichtscheidl, I.L. 2005. The roots of carnivorous plants. *Plant Soil* **274**: 127–140.
- Albert, V.A., Williams, S.E., & Chase, M.W. 1992. Carnivorous plants: phylogeny and structural evolution. *Science* **257**: 1491–1495.
- Anderson, B. & Midgley, J. 2002. It takes two to tango but three is a tangle: mutualists and cheaters on the carnivorous plant *Roridula*. *Oecologia* **132**: 369–373.
- Barber, J.T. 1978. *Capsella bursa-pastoris* seeds. Are they “carnivorous”? *Carniv. Plant Newslett.* **7**: 39–42.
- Barthlott, W., Porembski, S., Fischer, E., & Gemmel, B. 1998. First protozoa-trapping plant found. *Nature* **392**: 447.
- Cameron, K.M., Wurdack, K.J., & Jobson, R.J. 2002. Molecular evidence for the common origin of snap-traps among carnivorous plants. *Am. J. Bot.* **89**: 1503–1509.
- Chandler, G.E. & Andersson, J.W. 1976. Studies on the nutrition and growth of *Drosera* species with reference to the carnivorous habit. *New Phytol.* **76**: 129–141.
- Christy, M. 1923. The common teasel as a carnivorous plant. *J. Bot.* **61**: 33–45.
- Darnowski, D.W., Carroll, D.M., Plachno, B.J., Kabanoff, E., & Cinnamon, E. 2006. Evidence of protocarnivory in triggerplants (*Stylidium* spp.; Stylidiaceae). *Plant Biol.* **8**: 805–812.
- Darwin, C. 1875. Insectivorous plants. Murray, London.
- Darwin, F. 1878. Experiments on the nutrition and growth of *Drosera rotundifolia*. *J. Linn. Soc. Bot.* **17**: 17–23.
- Dixon, K.W., Pate, J.S., & Bailey, W.J. 1980. Nitrogen nutrition of the tuberous sundew *Drosera erythrorhiza* Lindl. with special reference to catch of arthropod fauna by glandular leaves. *Aust. J. Bot.* **28**: 283–297.
- Dress, W.J., Newell, S.J., Nastase, A.J., & Ford, J.C. 1997. Analysis of amino acids in nectar from pitchers of *Sarracenia purpurea* (Sarraceniaceae). *Am. J. Bot.* **84**: 1701–1706.
- Ellison, A.M. 2006. Nutrient limitation and stoichiometry of carnivorous plants. *Plant Biol.* **8**: 740–747.
- Ellison, A.M. & Farnsworth, E.J. 2005. The cost of carnivory for *Darlingtonia californica* (Sarraceniaceae): evidence from relationships among leaf traits. *Am. J. Bot.* **92**: 1085–1093.
- Ellison, A.M. & Gotelli, N.J. 2001. Evolutionary ecology of carnivorous plants *Trends Ecol. Evol.* **16**: 623–629.
- Fagerberg, W.R. & Howe, D.G. (1996) A quantitative study of tissue dynamics in Venus’ fly trap *Dionaea muscipula* (Droseraceae). II. Trap reopening. *Am. J. Bot.* **83**: 836–842.
- Fineran BA. 1985. Glandular Trichomes in *Utricularia* : a review of their structure and function. *Isr. J. Bot.* **34**: 295–330.
- Gallie, D.R. & Chang, S.-C. 1997. Signal transduction in the carnivorous plant *Sarracenia purpurea*. Regulation of secretory hydrolase expression during development and in response to resources. *Plant Physiol.* **115**: 1461–1471.
- Hodick, D. & Sievers, A. 1988. The action potential of *Dionaea muscipula* Ellis. *Planta* **174**: 8–18.
- Hodick, D. & Sievers, A. 1989. On the mechanism of trap closure of Venus flytrap (*Dionaea muscipula* Ellis). *Planta* **179**: 32–42.
- Jacobson, R.L. 1965. Receptor response in Venus’s fly-trap. *J. Gen. Physiol.* **49**: 117–129.
- Jobson, R.W., Playford, J., Cameron, K.M., & Albert, V.A. 2003. Molecular phylogenetics of Lentibulariaceae inferred from plastid *rps* 16 intron and *trn* L-F DNA sequences: implications for character evolution and biogeography. *Syst. Bot.* **28**: 157–171.
- Juniper, B.E., Robins, R.J., & Joel, D.M. (1989.) The carnivorous plants. Academic Press, London.
- Karlsson, P.S. & Karlsson, B. 1984. Why does *Pinguicula vulgaris* L. trap insects? *New Phytol.* **97**: 25–30
- Karlsson, P.S. & Pate, J.S. 1992. Contrasting effects of supplementary feeding of insects or mineral nutrients on the growth and nitrogen and phosphorus economy of the pygmy species of *Drosera*. *Oecologia* **92**: 8–13.

- Karlsson, P.S., Nordell, K.O., Carlsson, B.A., & Svensson, B.M. 1991. The effect of soil nutrient status on prey utilization in four carnivorous plants. *Oecologia* **86**: 1–7.
- Lüttge, U. (1983) Ecophysiology of carnivorous plants. In: Encyclopedia of plant physiology, N.S. Vol. 12C, O.L. Lange, P.S. Nobel, C.B. Osmond, & H. Ziegler (eds). Springer-Verlag, Berlin, pp. 489–517.
- Mabberley, D.J. 2000. The Plant-book. A portable dictionary of the higher plants. Cambridge University Press, New York.
- Matušíková, I., Salaj, J., Moravčíková, J., Mlynárová, L., Nap, J.-P., & Libantová, J. 2005. Tentacles of in vitro-grown round-leaf sundew (*Drosera rotundifolia* L.) show induction of chitinase activity upon mimicking the presence of prey. *Planta* **222**: 1020–1027.
- Mendez, M. & Karlsson, P.S. 1999. Costs and benefits of carnivory in plants: insights from the photosynthetic performance of four carnivorous plants in a subarctic environment. *Oikos* **86**: 105–112.
- Millett, J. Jones, R.I., & Waldron, S. 2003. The contribution of insect prey to the total nitrogen content of sundews (*Drosera* spp.) determined in situ by stable isotope analysis. *New Phytol.* **158**: 527–534.
- Newell, S.J. & Nastase, A.J. 1998. Efficiency of insect capture by *Sarracenia purpurea* (Sarraceniaceae), the northern pitcher plant. *Amer. J. Bot.* **85**: 88–91.
- Pate, J.S. & Dixon, K.W. 1978. Mineral nutrition of *Drosera erythrorhiza* Lindl. with special reference to its tuberous habit. *Aust. J. Bot.* **26**: 455–464.
- Płachno, B.J. & Jankun, A. 2004. Transfer cell wall architecture in secretory hairs of *Utricularia intermedia*. *Acta Biol. Crocov. Ser. Bot.* **46**: 193–200.
- Płachno, B.J., Adamus, K., Faber, J., and Kozłowski, J. 2005. Feeding behaviour of carnivorous *Genlisea* plants in the laboratory. *Acta Bot. Gall.* **152**: 159–164.
- Płachno, B.J., Kozieradzka-Kiszkurno, M. & Swiatek, P. 2007. Functional ultrastructure of *Genlisea* (Lentibulariaceae) digestive hairs. *Ann. Bot.* **100**: 195–203.
- Richards, J.H. 2001. Bladder function in *Utricularia purpurea* (Lentibulariaceae): is carnivory important? *Am. J. Bot.* **88**: 170–176.
- Robins, R. J. 1976. The nature of the stimuli causing digestive juice secretion in *Dionaea muscipula* Ellis (Venus's flytrap). *Planta* **128**: 263–265.
- Schulze, W. & Schulze, E.-D. 1990. Insect capture and growth of the insectivorous *Drosera rotundifolia* L. *Oecologia* **82**: 427–429.
- Schulze, W., Schulze, E.-D., Pate, J.S., & Gillison, A.N. (1997) The nitrogen supply from soils and insects during growth of the pitcher plants *Nepenthes mirabilis*, *Cephalotus follicularis* and *Darlingtonia californica*. *Oecologia* **112**: 464–471.
- Sirová, D., Adamec, L., & Vrba, J. 2003. Enzymatic activities in traps of four aquatic species of the carnivorous genus *Utricularia*. *New Phytol.* **159**: 669–675.
- Sorenson, D.R. & Jackson, W.T. 1968. The utilization of paramecia by the carnivorous plant *Utricularia gibba*. *Planta* **83**: 166–170.
- Spomer, G.G. 1999. Evidence of protocarnivorous capabilities in *Geranium viscosissimum* and *Potentilla arguta* and other sticky plants. *Int. J. Plant Sci.* **160**: 98–101.
- Sydenham, P.H. & Findlay, G.P. 1975. Transport of solutes and water by resetting bladders of *Utricularia Aust.* *J. Plant Physiol.* **2**: 335–351.
- Thum, M. 1988. The significance of carnivory for the fitness of *Drosera* in its natural habitat. 1. The reactions of *Drosera intermedia* and *D. rotundifolia* to supplementary insect feeding. *Oecologia* **75**: 472–480.
- Williams, S.E. 1976. Comparative sensory physiology of the Droseraceae—the evolution of a plant sensory system. *Proc. Am. Phil. Soc.* **120**: 187–204.
- Williams, S.E. & Spanswick, R.M. 1976. Propagation of the neuroid action potential of the carnivorous plant *Drosera*. *J. Comp. Physiol. A: Neuroethol. Sens. Neur. Behav. Physiol.* **108**: 211–223.
- Zamora, R., Gomez, J.M. & Hodar, J.A. 1997. Responses of a carnivorous plant to prey and inorganic nutrients in a Mediterranean environment. *Oecologia* **111**: 443–451.

10

Role in Ecosystem and Global Processes

10A. Decomposition

1. Introduction

Decomposition of plant litter involves the physical and chemical processes that reduce litter to CO₂, water, and mineral nutrients. It is a key process in the **nutrient cycle** of most terrestrial ecosystems, and the amount of carbon returned to the atmosphere by decomposition of dead organic matter is an important component of the global carbon budget (Sect. 2.6 of Chapter 10B on ecosystem and global processes; Chapin et al. 2002).

Sooner or later, plant material that has not been consumed by herbivores or pathogens, or lost through a fire, is decomposed. Only a small proportion of recalcitrant organic matter and products of microbial decomposition become stabilized for thousands of years as **humus**. Most root-released material (exudates and other root-derived organic matter) is incorporated in the soil microbial biomass or lost as CO₂ within weeks, at least at a high nutrient supply. When nutrients limit growth, soil microorganisms utilize the root-derived material more slowly because microbial growth is limited by nutrients, rather than by carbon (Schimel & Bennett 2004). In wet, anoxic environments, some of it may end up as peat, or even coal. In that case, carbon is temporarily removed from the global carbon cycle. The rate of **carbon sequestration** in peatlands is

mainly determined by low rates of decomposition of dead organic matter, rather than high rates of primary production. Due to the relatively large peat cover on Earth, changes in the extent to which peatlands act as a CO₂-sink will affect the global carbon budget (Gorham 1991).

N and P are released enzymatically during decomposition. Proteins and other N-containing polymers are broken down to monomers (amino acids, nucleotides) that can be absorbed by plants or soil microorganisms (Chapin et al. 2002). Under low-N conditions, plants and microorganisms (including mycorrhizal fungi) compete for this organic N. As N availability increases, this competition becomes less intense, and soil microorganisms become more energy limited. Under these circumstances, they break down amino acids to meet their energy demands and convert N to inorganic forms (NH₄⁺ and NO₃⁻), which are excreted and can be absorbed by other microbes or plants (**N mineralization**) (Schimel and Bennett 2004). **P mineralization** differs from that of N in that P_i is cleaved from P-containing polymers by plant or microbial phosphatases without breakdown of the associated carbon skeleton (Sect. 2.1.2 of Chapter 6 on mineral nutrition). P and C mineralization and the formation of N-containing monomers occur external to microbial cells, whereas N mineralization occurs within microbial cells.

2. Litter Quality and Decomposition Rate

2.1 Species Effects on Litter Quality: Links with Ecological Strategy

In a comparison of 125 British vascular plant species, which cover a wide range of life forms, leaf habits, and taxa, the rate of leaf litter decomposition can be predicted from a limited number of whole-plant traits, reflecting the plants' physiological and structural adaptation to environment (Fig. 1; Cornelissen 1996, Cornelissen et al. 1999, Pérez-Harguindeguy et al. 2000). These traits include life-form, deciduous vs. evergreen habit, leaf toughness, autumn coloration of the leaf litter, family and a species' success in disturbed and productive habitats. In this wide comparison of species from the British Isles, as in other comparisons (Aerts 1997), there is a negative relationship between decomposition rate and **leaf life span**. For example, leaves of woody climbers and ramblers, which tend to have short-lived leaves with little investment in quantitatively important defense compounds, decompose more readily than those of subshrubs, which often inhabit infertile habitats and invest more in chemicals that reduce leaf digestibility and palatability, such as lignin and tannins (Sect. 3.2 of Chapter 9B on ecological biochemistry).

Across species and plant functional types, the **specific leaf area** (SLA) tends to be positively correlated with the rate of decomposition of the leaf litter

(Cornelissen et al. 1999, Garnier et al. 2004). Long-lived leaves, with relatively large investments in quantitatively important chemical defense, tend to have a lower SLA (Wright et al. 2005). This accounts for the positive correlation between rate of litter decomposition and SLA. Deviations from this relationship may be due to variation in other leaf traits that do not influence SLA much, but do have afterlife effects on litter decomposition. Such traits include, for instance, cuticle structure, mobile secondary (defense) chemistry, and tissue pH (Swift et al. 1979, Cornelissen et al. 2006). The association between autumn colors and decomposition is also a reflection of the leaf's secondary chemistry (Fig. 1). Brown colors are associated with phenolics, which slow down the rate of decomposition, in a manner similar to their effects on protein digestion (Sect. 3.2 of Chapter 9B on ecological biochemistry).

Litter turnover is also closely associated with mycorrhizal type. Species with **ericoid mycorrhizas** typically have poor litter decomposability, compared with **ectomycorrhizal species**, whereas **arbuscular mycorrhizal** plant shows comparatively fast litter decomposition. These results indicate that within a representative subset of a flora, ericoid and ectomycorrhizal strategies are linked with low ecosystem turnover and arbuscular mycorrhizal species with high ecosystem turnover (Cornelissen et al. 2001).

To explain the biochemical basis of variation in leaf litter decomposition, more information is required about **leaf chemistry**: rates of litter decomposition are negatively correlated with both the

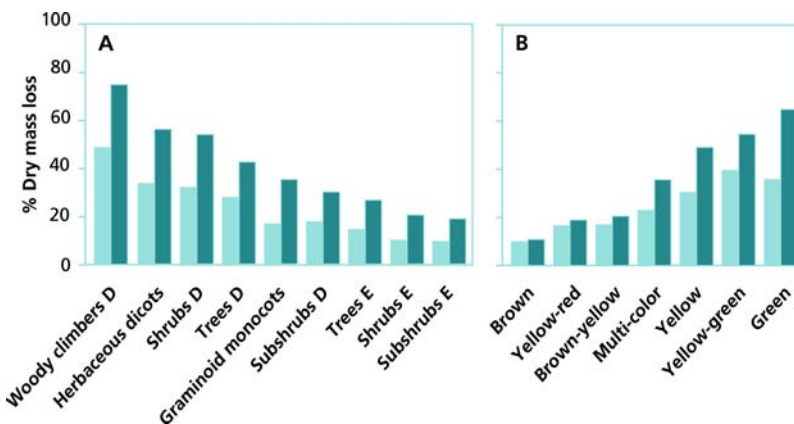

FIGURE 1. Mass loss (% of original mass) of litter of 125 British species as related to (A) growth form and duration of decomposition period (8 weeks, closed bars; 20 weeks, open bars) or (B) initial litter color (for deciduous woody species only) and mesh size of the bag that

contained the litter (0.3 mm mesh, closed bars; 5 mm mesh, open bars). D = deciduous; E = evergreen. Litter was buried in leaf mould near Sheffield, England. Means were calculated from mean values of individual species (based on information in Cornelissen 1996).

lignin:nutrient ratio (N or P) and the **lignin concentration** (Berg & Staaf 1981, Berendse et al. 1989, Fox et al. 1990). **Polyphenols** also affect litter quality, and may in some cases have a larger effect than N or lignin (Hättenschwiler & Vitousek 2000). For example, *Sphagnum* (peat moss) species produce **phenolic compounds**, the most important one being sphagnum acid. Decomposition of *Sphagnum* litter is remarkably slow because of the anoxic, acidic conditions in the bog environment (Sect. 2.2) and also because of the chemical composition of the acidic litter (Johnson & Damman 1993, Cornelissen et al. 2006). Leachates from *Sphagnum* species reduce the decomposition rate of litter from other plants as well (Verhoeven & Toth 1995). Decomposition rate often correlates inversely with C:N ratio, especially among herbaceous species, which vary in N and P concentrations, but typically have low concentrations of quantitative defensive compounds in leaves. Thus both carbon and nutrient chemistry influence decomposition rate, although their relative importance may vary across species.

Species differences in allocation strongly influence decomposition because of the strikingly different chemistry of leaves, wood, and roots. Stems and roots, with their high lignin and low N concentration, decompose more slowly than do leaves. Species differences in litter quality due to differences in allocating wood vs. leaves often exceed

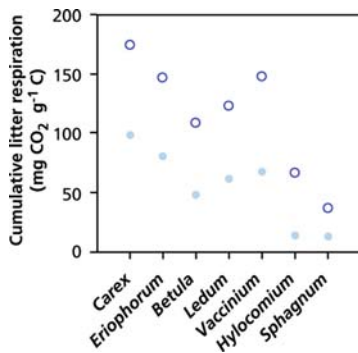

FIGURE 2. Cumulative respiration of litter of seven Alaskan tundra species incubated in the laboratory with tundra soil over 149 days at either 4°C (filled circles) or 8°C (open circles). Each litter bag has the same initial mass but includes leaves, stems, and roots in proportion to their production in the field. Litter respiration is estimated by subtracting the average respiration in the controls (soil only) from the total respiration in those incubations amended with litter (Hobbie 1996). Copyright by the Ecological Society of America. Species include from left to right: two sedges, three dwarf shrubs, and two mosses.

differences due to the variation in leaf quality (Hobbie 1995). For example, dwarf birch (*Betula nana*), a tundra deciduous shrub, has a low overall decomposition rate, when all plant parts are included, despite relatively rapid rates of leaf decomposition (Fig. 2). Woody stems of slow-growing, late-successional species, with their higher concentrations of quantitative defenses, tend to decompose more slowly than do less dense woody stems of rapidly growing species (Chambers et al. 2000, Eaton & Lawrence 2006).

We know relatively little about species differences in **root decomposition**, despite the large proportion of litter production that occurs below ground. Fine roots generally decompose in weeks to months, whereas coarse roots are much slower to decompose (Ruess et al. 1996). Variation in root decomposition among species or functional types is associated more with variation in root litter quality, and less so with climate-linked variables (Silver & Miya 2001).

2.2 Environmental Effects on Decomposition

Environment affects decomposition both because of its effect on the quality of litter produced and because of its direct effects on microbial activity (Swift et al. 1979). The direct effects of environment on microbial activity are similar to effects on plant production, resulting in highest rates of decomposition in warm, moist environments (Sect. 2.5 of Chapter 10B on ecosystem and global processes). In anaerobic soils (e.g., in peatlands), decomposition is more restricted than is plant production, which results in substantial **carbon sequestration** (Sect. 1). Plant species strongly influence decomposition through their effect on environment. For example, arctic mosses are effective thermal insulators, resulting in cold soils that retard decomposition even more than might be expected from their low litter quality (Hobbie 1995).

Microbial respiration associated with the decomposition of surface litter is often enhanced at night because dew provides moisture for microbial activity and decreases during the day as the litter dries out (Edwards & Sollins 1973). In dry environments, the moister conditions beneath vegetation may favor decomposition. In particularly sunny and dry environments, **photodegradation** can be an important process for litter breakdown, even dominating over microbial decay (Austin & Vivanco 2006).

Environment also affects tissue chemistry, and therefore litter quality. The higher tissue N and P concentrations in plants on fertile soils result in high litter nutrient concentrations (Table 21 in Chapter 6 on mineral nutrition) and therefore high rates of decomposition. Among woody plants, growth in infertile soils also increases **quantitative defenses**, further contributing to the slow decomposition of litter produced on these soils (Sect. 4.1 of Chapter 9B on ecological biochemistry). Reciprocal transplants of litter among forests, which differ strongly in litter quality and environment, often show that litter quality exerts a stronger effect on decomposition than do differences in temperature or moisture (Flanagan & Van Cleve 1983).

3. The Link Between Decomposition Rate and Nutrient Supply

3.1 The Process of Nutrient Release

A major reason for interest in decomposition is its close link to **nutrient supply**. In most ecosystems, the nutrients released during decomposition provide >90% of the N and P supply to plants (Table 21 in Chapter 6 on mineral nutrition). Our understanding of the processes by which nutrients are released from plant litter and become available to plants has improved considerably in recent years. In a comparison of herbaceous species in Britain, the best predictor of the rate of leaf litter decomposition is total concentration of Ca, Mg, and K in green leaves (Cornelissen & Thompson 1997). The relatively high litter pH associated with a high Ca concentration may favor microbial decomposition (Cornelissen et al. 2006).

Interspecific variation in pH and base content of leaf litter may partly explain why the correlations of litter decomposition with C:N are often much poorer than predicted by theory.

P is ester bonded to carbon skeletons in plant litter. However, its release is only indirectly linked to decomposition because the ester bond is readily cleaved by **phosphatases** without breakdown of the associated carbon skeleton. Phosphatases are produced by plant roots, ectomycorrhizal and ericoid **mycorrhizal fungi**, and **saprophytic microorganisms** (i.e., those microorganisms whose energy supply is derived from dead organic matter). Decomposition is indirectly linked to P release because decomposition rate determines microbial demand for P and therefore the rate of production of microbial phosphatases. In addition, decomposition of cell walls by fungi increases access of microbial phosphatases to P-containing compounds in plant litter.

N is the nutrient whose release from plant litter is most tightly linked to decomposition because, like decomposition, it requires the breakdown of organic compounds in plant litter. In many biomes, the first steps in decomposition are consumption by invertebrate fauna that reduce the size of litter particles. This step is important for **cuticle** damage, allowing access of microbes to the tissues and leaching of mobile phenols once membranes are ruptured (Swift et al. 1979). Subsequent N release involves the breakdown of **particulate organic N (PON)**; polymers such as proteins and nucleic acids) to **dissolved organic N (DON)**, i.e., compounds that are small enough (e.g., amino acids and nucleotides) to be absorbed by microbial cells (Fig. 3). DON production is catalyzed by microbial **exoenzymes** (enzymes that are secreted by microbial cells into

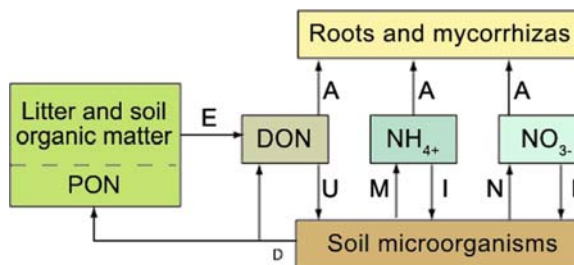

FIGURE 3. Simplified diagram of microbially mediated N transformations in soils. Particulate organic nitrogen (PON) in plant litter and soil organic matter is broken down to dissolved organic N (DON) by exoenzymes (E); this is the rate-determining process in supplying plant-available N. Soil microorganisms take up (U) DON and use it to support their growth if they are N-limited; they

also immobilize (I) NH₄⁺ and NO₃⁻, if present. If microorganisms are energy limited, they break down DON for energy, and excrete NH₄⁺, the process of N mineralization (M), or NO₃⁻, the process of nitrification (N). Plants and their mycorrhizas absorb (A) some combination of DON, NH₄⁺, and NO₃⁻, depending on relative availability.

the soil matrix) and is typically the rate-limiting step in N release from plant litter (Chapin et al. 2002). Both mycorrhizas (especially ectomycorrhizas) and saprophytes produce coenzymes that convert PON to DON. DON can then be absorbed by saprophytes, plant roots, and their mycorrhizal partners. Under strongly N-limiting conditions (e.g., tundra and peatlands), microbial growth is extremely N-limited, so all DON absorbed by microorganisms supports microbial growth, and negligible N mineralization occurs; under these circumstances, DON is the predominant form of N absorbed by all soil organisms, including plants (Schimel and Bennett 2004). In less N-limited environments (e.g., conifer forests), some N mineralization occurs in N-rich microsites, where microbes are energy limited and use DON as an energy source, excreting NH_4^+ as a waste product (**N mineralization**), which diffuses into the bulk soil from these N-rich microsites. In these environments, plants and other microorganisms absorb both DON and NH_4^+ to meet their N demands. In extremely fertile soils, most soil microsites are N-rich, so breakdown of DON to NH_4^+ occurs abundantly and meets microbial energy demands. Some of this NH_4^+ is absorbed by nitrifying bacteria that use NH_4^+ as an energy source and excrete NO_3^- as a waste product (**nitrification**). In summary, across a soil fertility gradient (which often correlates with a gradient in soil pH), the relative availability of N utilized by plants ranges from predominantly DON in infertile, often acidic soils to NH_4^+ in soils of intermediate fertility, to predominantly NO_3^- in fertile soils.

Sulfur (S) is intermediate between N and P in terms of its linkage to decomposition because some S is ester bonded (like P) and can be released by **sulfatases** without decomposition, but other S atoms are covalently linked and require decomposition to dissolved organic forms before they can be absorbed and metabolized by soil microorganisms (Mitchell & Fuller 1988).

3.2 Effects of Litter Quality on Mineralization

When litter or soil organic matter contains nutrients in excess of microbial demands, N and P are excreted by soil microorganisms (net **mineralization**) during the decomposition process and become available for plant uptake (Sect. 3.1, Fig. 6.2 in Chapter 6 on mineral nutrition). On the other hand, if the organic matter is low in nutrients, microorganisms meet their nutrient demand by absorbing nutrients from the soil solution (net

immobilization), resulting in competition for nutrients between soil microorganisms and plants. After nutrient resorption (Sect. 4.3.2 of Chapter 6 on mineral nutrition), plant litter often has a higher C:N ratio than microbial biomass. Empirical observations suggest that above a critical C:N ratio of about 20:1, microorganisms absorb nutrients from the soil solution, causing net N immobilization (Paul & Clark 1989). As microorganisms decompose the organic matter and respire carbon to meet respiratory demands for growth and maintenance, the C:N ratio of litter declines. Net N mineralization occurs when the C:N ratio falls below the critical 20:1 ratio. The result is that fresh litter often initially increases in N concentration due to microbial immobilization, before net mineralization occurs. In many P-limited forest ecosystems, P is immobilized to a significantly greater extent than is N in the first stages of decomposition (Attwell & Adams 1993).

Net immobilization occurs to a greater extent and for a longer time where plants produce litter with low tissue N and P concentrations. In those ecosystems where plant growth is N-limited, litter C:N ratios strongly govern decomposition and N immobilization, with P being mineralized more quickly, whereas in areas of heavy **N deposition**, as in the Netherlands, C:P ratios exert stronger control over decomposition, and N is mineralized more quickly (Aerts & De Caluwe 1997). The high litter N and P concentrations of plants on fertile soils, with their high growth rate and SLA, thus promote nutrient mineralization, whereas there is slower mineralization in ecosystems dominated by slow-growing plants with low SLA (Hobbie 1992, Van Breemen 1993).

If nutrient concentration affects mineralization so strongly, then will the low tissue nutrient concentrations caused by **elevated atmospheric CO_2 concentrations** reduce litter nutrient concentrations and therefore decomposition rate? In most cases studied to date, differences in leaf chemistry caused by elevated $[\text{CO}_2]$ diminish during senescence, perhaps due to respiration of accumulated starch, so that litter quality and therefore decomposition and mineralization rates are similar for litter produced under elevated and ambient $[\text{CO}_2]$ (Norby et al. 2001). Elevated atmospheric CO_2 concentrations only cause accumulation of soil carbon when N is added at rates well above typical atmospheric N inputs. Soil carbon sequestration under elevated CO_2 is constrained both directly by N availability and indirectly by nutrients needed to support N_2 fixation (Sect. 3.8 in Chapter 9A on symbiotic associations; Van Groenigen et al. 2006).

Species differences in the types of carbon compounds they contain magnify differences in mineralization rate due to litter nutrient concentration. The high concentrations of quantitative secondary metabolites in species with long-lived leaves (Sect. 2.1) retard decomposition because of both the toxic effects on microorganisms and the difficulty of breakdown of secondary metabolites. **Phenolic** compounds that are decomposed slowly include lignin and tannin (Sect. 3.2 of Chapter 9B on ecological biochemistry). High tannin concentrations reduce the rate of **mineralization** of the litter, so that, for instance, most of the N in the boreal forest soil occurs as complexes of organic N and tannin, rather than as NO_3^- , NH_4^+ , or amino acids (Northup et al. 1995). Tannins and other protein-binding phenolics also inhibit **nitrification**, the microbial conversion of ammonia, via NO_2^- to NO_3^- (Baldwin et al. 1983). In many species, including *Pinus* (pine), the concentration of tannin and lignin is enhanced when plants are grown under N limitation as compared with an optimum N supply (Bryant et al. 1983, Gershenzon 1984). As a result, the availability of N is even further reduced, at least for plants lacking mechanisms to release N from the tannin–organic N complexes (Sect. of Chapter 9A on symbiotic associations; Northup et al. 1995, Aerts & De Caluwe 1997).

There is clear evidence that some **mycorrhizal fungi** produce enzymes that allow them to derive mineral nutrients and carbon from organic sources (Sect. 2.4 of Chapter 9A on symbiotic associations). Especially, **ectomycorrhizas** and **ericoid mycorrhizas** are capable of using relatively complex organic N sources (Sect. 2.4 of Chapter 9A on symbiotic associations), possibly including the complexes produced under pine stands growing under nutrient-poor conditions. A direct release of N from organic compounds by ectomycorrhizal fungi seems to be confined to the older litter layers (Colpaert & Tichelen 1996).

For nonmycorrhizal species in nutrient-poor environments, associations with mycorrhizal fungi cannot provide access to complexes of organic N with tannins. In nonmycorrhizal *Rhizophora mangle* (red mangrove), defenses are largely carbon-based (**quantitative**; Sect. 3.3 of Chapter 9B on ecological biochemistry). These plants have long been used for their high proanthocyanidin (condensed tannin) content of their wood, bark, and leaves. **Polyphenolics** account for approximately 23% of the total leaf dry mass. Interestingly, during leaf senescence, prior to leaf abscission, polyphenols largely disappear, leaving only the largest tannin polymers. The ecological significance of these changes may be that

litter decomposition in the mangrove swamps would be greatly inhibited by the phenolic compounds that are broken down before leaf abscission. This breakdown would favor litter decomposition, rather than render the litter poorly available as is the case for pine needles. Since mycorrhizal associations are not a strategy available mangrove swamps, breakdown of phenolic compounds before leaf abscission may be an alternative strategy to the one discussed above for mycorrhizal pines (Kandil et al. 2004). Indeed, leaf litter of *Rhizophora mangle* decomposes within 5 months (Middleton & McKee 2001).

In situations where the N availability is low because of plants that produce phenolics, invasion of grasses [*Molinia caerulea* (cotton grass) and *Deschampsia flexuosa* (tufted hair-grass)] into nutrient-poor habitats dominated by ericaceous dwarf shrubs [*Calluna vulgaris* (Scottish heather) and *Erica tetralix* (crossleaf heath)] may enhance rates of **mineralization**. Such invasions are made possible by N deposition, due to **acid rain**. They may enhance the rate of N cycling in the system because organic N contained in the litter of the grasses is mineralized faster than that in residues of the dwarf shrubs (Van Vuuren et al. 1992). Similarly, increased fire frequency in nutrient-poor Mediterranean woodlands may enhance P availability and weed invasion, which then further enhances the rate of nutrient cycling (Fisher et al. 2006).

3.3 Root Exudation and Rhizosphere Effects

The presence of living roots can greatly enhance litter decomposition and mineralization, either by directly using organic matter in the litter through associations with ectomycorrhizal fungi (Sect. 4.2 of Chapter 9A on symbiotic associations) or by providing a carbon source that either stimulates or retards the growth and activity of soil microorganisms and nematodes (Cheng & Coleman 1990, Griffiths et al. 1992, Zhu & Ehrenfeld 1996). There may be either positive or negative effects of roots on mineralization, depending on environmental conditions.

Root exudates are released in response to a limiting supply of P or micronutrients or to toxic levels of some metals (Sects. 2.25, 2.2.6, 3.1.3, and 3.3.4 of Chapter 6 on mineral nutrition; Farrar et al. 2003, Nguyen 2003). They stimulate mineralization only if microorganisms consume the exuded carbohydrates and, in addition, decompose soil organic matter in the rhizosphere or are grazed by soil animals. Gram-negative bacteria with high growth rates, but a low capability to degrade complex substrates, are

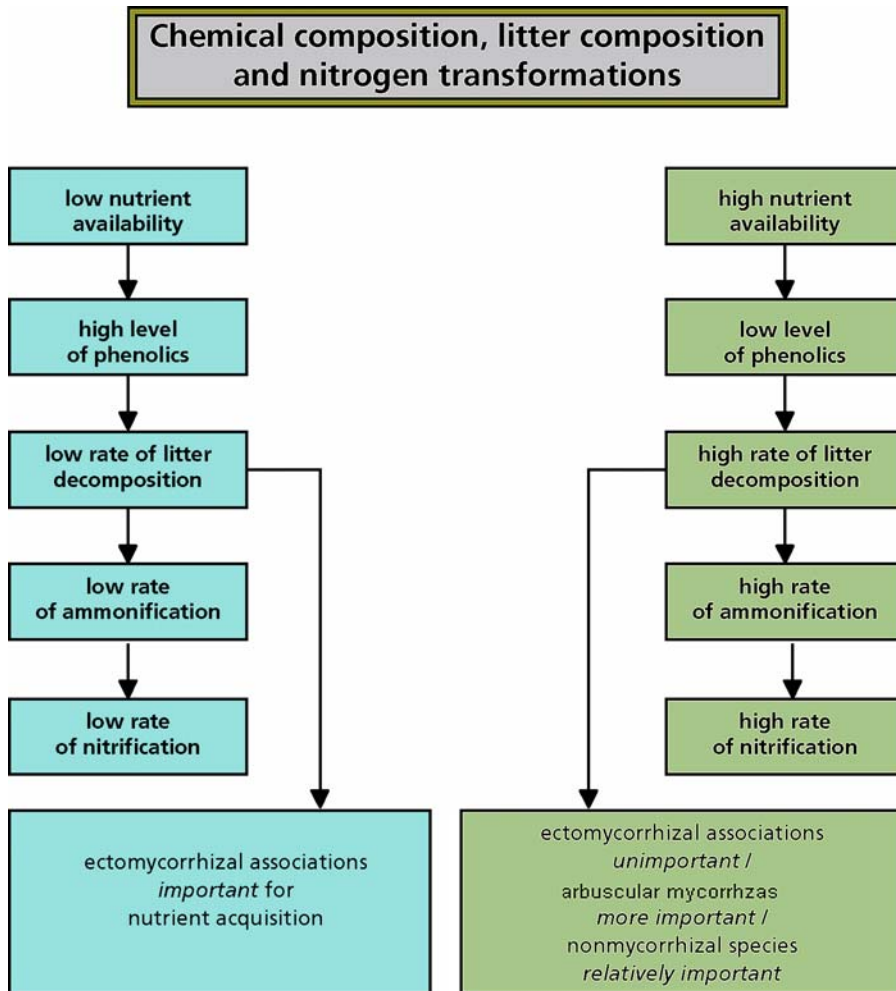

FIGURE 4. Generalized scheme to account for effects of chemical composition of biomass and litter on rates of decomposition and nitrification (see also Read & Perez-Moreno 1993). Only two extreme situations are shown, with many intermediate habitats or stages of succession occurring between these extremes. Rates of litter decomposition as dependent on nutrient supply in the habitat. In slow-growing species growing in low-nutrient soils (*left*), the concentrations of N and P tend to be low and phenolics accumulate. These phenolics act as digestibility-reducing defense compounds in the living plant. They also reduce the rate of litter decomposition, thus reducing the rate at which nutrients become available for plant growth. Some mycorrhizal associations, but not AM, may access complexes of organic N and phenolics, and thus make N available for plant growth. Such mycorrhizal associations are absent in nearly all herbaceous species and some woody species, but are common in, e.g., ericaceous and coniferous species. Ectomycorrhizal associations predominate among the woody species. Nonmycorrhizal species (e.g., Proteaceae) dominate when P is poorly available because the

total amounts of P are low and predominantly sorbed to soil particles. In plants growing in high-nutrient soils (*right*), the concentration of nutrients is high and that of phenolics is low. The litter of these plants also has low concentrations of phenolics and relatively higher nutrient levels. Consequently, it is readily decomposed, releasing NH_4^+ that is either absorbed by plant roots or used by soil microorganisms. Some of these microorganisms (*Nitrosomonas*) use NH_4^+ as an energy source, oxidizing it to NO_2^- , which is then further oxidized to NO_3^- by other soil microorganisms (*Nitrobacter*). The entire process, from NH_4^+ to NO_3^- , is called nitrification. It occurs more rapidly in the high-nutrient environment of faster-growing plants. Arbuscular mycorrhizas are more common in high-nutrient environment of the faster growing species. Nonmycorrhizal, ruderal species may dominate during the earliest stages of succession, when soil P levels are relatively high and P_i is readily available; nonmycorrhizal species with root clusters dominate at very late stages of succession, when there is little soil P and most P_i is sorbed.

generally the major microorganisms that are stimulated by exudation. For example, when wheat (*Triticum aestivum*) or rye (*Secale cereale*) plants are grown in soil with ^{14}C -labeled straw, only 6% of the microbial biomass is labeled with ^{14}C . This microbial biomass, however, is highly active in releasing $^{14}\text{CO}_2$, indicating a “**priming**” of decomposition by the exudates (Cheng & Coleman 1990, Carney et al. 2007). Under conditions of low nutrient availability, this priming effect is often less pronounced, perhaps because bacteria have insufficient nutrients to grow and attack soil organic matter (Van Veen et al. 1989) and because plants may intensely compete with soil microorganisms for nutrients under these conditions (Norton & Firestone 1996). This may explain why agricultural and other mineral soils often show a **positive effect** of roots on N mineralization (Van Veen et al. 1989, Bottner et al. 1991), whereas these effects are less pronounced or **negative** in infertile or highly organic soils (Harris & Riha 1991, Tate et al. 1991, Parmelee et al. 1993). Similarly, roots of tree seedlings stimulate N mineralization in fertile mull soils, but decrease mineralization in infertile highly organic mor soils (Bradley & Fyles 1996). **Root exudates** may be effective in **priming** mineralization of fertile mull soil organic matter because of its relatively labile carbon. By contrast, lignolytic activity may control soil N turnover in infertile mor soils, where bacteria stimulated by root exudates lack the enzymatic capacity to degrade lignin. Thus, soil fertility may determine the nutritional consequences of root exudation both through its effect on the C/N balance of bacteria and through its effects on the recalcitrance of soil organic matter.

Roots may also promote mineralization as a result of more intense grazing of bacteria by protozoa. The increased growth of bacteria in response to exudates in the rhizosphere attracts protozoa, which use the bacterial carbon to support their growth and maintenance; the protozoa excrete the mineralized nutrients, which are then available for uptake by the plant (Clarholm 1985). We expect this nutrient release by bacterial grazers to be most pronounced in fertile soils, where bacterial growth rates would be highest. The rapid bacterial growth in response to root exudates can also positively affect the plant by outcompeting microorganisms that have detrimental effects on plants.

There are obviously major technical difficulties in studying the complex biotic interactions that may occur in the rhizosphere. However, recent molecular advances now enable the discovery of novel microorganisms with unforeseen metabolic capabilities, revealing new insight into the underlying processes regulating nutrient cycles at local to global scales.

With the ability to sequence functional genes from the environment, molecular approaches now enable us to identify microorganisms and metabolic processes and develop an understanding of many globally important biogeochemical processes (Zak et al. 2006).

Elevated $[\text{CO}_2]$ can influence mineralization through its effects on rhizosphere processes, but CO_2 effects on microbial processes vary, depending on the plant species present and soil fertility (Van Groenigen et al. 2006). Plant species composition influences how soil N cycling will respond to further increases in $[\text{CO}_2]$ (Hungate et al. 1996, Carney et al. 2007). The nature of the rhizosphere community affects the quantity and quality of root exudates, with much higher exudation rates occurring in nutrient-poor soils than in common solution culture. Different populations of soil bacteria and fungi can have distinct effects on the quantity and quality of root exudates (Leyval & Berthelin 1993, Rygielwicz & Andersen 1994) and therefore on patterns of mineralization in the rhizosphere.

4. The End Product of Decomposition

Decomposition of plant litter is a key process of the nutrient cycles of most terrestrial ecosystems. Rates of decomposition strongly depend on chemical composition, with slower rates being associated with acidic litter with a low base content, low concentrations of N or P, and high concentrations of phenolics (tannin, lignin). Since plants in nutrient-poor habitats tend to accumulate more quantitative secondary plant compounds and have low base and N and P concentrations, their litter is decomposed rather slowly, thus aggravating the low-nutrient status in these habitats. Some mycorrhizal associations appear pivotal in accessing N in litter containing high concentrations of phenolics (Fig. 4).

References

- Aerts, R. 1997. Climate, leaf litter chemistry and leaf litter decomposition in terrestrial ecosystems: A triangular relationship. *Oikos* **79**: 439–449.
- Aerts, R. & De Caluwe, H. 1997. Nutritional and plant-mediated controls on leaf litter decomposition of *Carex* species. *Ecology* **78**: 244–260.
- Attwell, P.M. & Adams, M.A. 1993. Nutrient cycling in forests. *New Phytol.* **124**: 561–582.

- Austin, A.T. & Vivanco, L. 2006. Plant litter decomposition in a semi-arid ecosystem controlled by photodegradation. *Nature* **442**: 555–558.
- Baldwin, I.T., Olson, R.K., & Reiners, W.A. 1983. Protein-binding phenolics and the inhibition of nitrification in subalpine balsam fir soils. *Soil Biol. Biochem.* **15**: 419–423.
- Berendse, F., Bobbink, R., & Rouwenhorst, G. 1989. A comparative study on nutrient cycling in wet heathland ecosystems. II. Litter decomposition and nutrient mineralization. *Oecologia* **78**: 338–348.
- Berg, B. & Staaf, H. 1981. Leaching, accumulation and release of nitrogen in decomposing forest litter. *Ecol. Bull.* **33**: 163–178.
- Bottner, P., Cortez, J., & Sallih, Z. 1991. Effect of living roots on carbon and nitrogen of the soil microbial biomass. In: Plant root growth, D. Atkinson (ed.). Blackwell Scientific, London, pp. 201–210.
- Bradley, R.L. & Fyles, J.W. 1996. Interactions between tree seedling roots and humus forms in the control of soil C and N cycling. *Biol. Fertil. Soils* **23**: 70–79.
- Bryant, J.P., Chapin III, F.S., & Klein, D.R. 1983. Carbon/nutrient balance of boreal plants in relation to herbivory. *Oikos* **40**: 357–368.
- Carney, K.M., Hungate, B.A., Drake, B.G., & Megonigal, J.P. 2007. Altered soil microbial community at elevated CO₂ leads to loss of soil carbon. *Proc. Natl. Acad. Sci. USA* **104**: 4990–4995.
- Chambers, J.Q., Higuchi, N., Schimel, J.P., Ferreira, L.V., & Melack, J.M. 2000. Decomposition and carbon cycling of dead trees in tropical forests of the central Amazon. *Oecologia* **122**: 380–388.
- Chapin III, F.S., Matson, P.A., & Mooney, H.A. 2002. Principles of terrestrial ecosystem ecology. Springer-Verlag, New York.
- Cheng, W. & Coleman, D.C. 1990. Effect of living roots on soil organic matter decomposition. *Soil Biol. Biochem.* **22**: 781–787.
- Clarholm, M. 1985. Interactions of bacteria, protozoa and plants leading to mineralization of soil nitrogen. *Soil Biol. Biochem.* **17**: 181–187.
- Colpaert, J.V. & Van Tichelen, K.K. 1996. Decomposition, nitrogen and phosphorus mineralization from beech leaf litter colonized by ectomycorrhizal or litter-decomposing basidiomycetes. *New Phytol.* **134**: 123–132.
- Cornelissen, J.H.C. 1996. An experimental comparison of leaf decomposition rates in a wide range of temperate plant species and types. *J. Ecol.* **84**: 573–582.
- Cornelissen, J.H.C. & Thompson, K. 1997. Functional leaf attributes predict litter decomposition rate in herbaceous plants. *New Phytol.* **135**: 109–114.
- Cornelissen, J.H.C., Perez-Harguindeguy, N., Diaz, S., Grime, J.P., Marzana, B., Cabido, M., Vendramini, F., Cerabolini, B. 1999. Leaf structure and defence control litter decomposition rate across species and life forms in regional floras on two continents. *New Phytol.* **143**: 191–200.
- Cornelissen, J.H.C., Aerts, R., Cerabolini, B., Wergler, M.J.A., & Van der Heijden, M.G.A. 2001. Carbon cycling traits of plant species are linked with mycorrhizal strategy. *Oecologia*. **129**: 611–619.
- Cornelissen, J.H.C., Queded, H.M., van Logtestijn, R.S.P., Pérez-Harguindeguy, N., Gwynn-Jones, D., Díaz, S., Callaghan, T.V., Press M.C., & Aerts, R. 2006. Foliar pH as a new plant trait: Can it explain variation in foliar chemistry and carbon cycling processes among subarctic plant species and types? *Oecologia* **147**: 315–326.
- Edwards, N.T. & Sollins, P. 1973. Continuous measurement of carbon dioxide evolution from partitioned forest floor components. *Ecology* **54**: 406–412.
- Eaton, J.M. & Lawrence, D. 2006. Woody debris stocks and fluxes during succession in a dry tropical forest. *For. Ecol. Manage.* **232**: 46–55.
- Farrar, J., Hawes, M., Jones, D. & Lindow, S. 2003. How roots control the flux of carbon to the rhizosphere. *Ecology* **84**: 827–833.
- Fisher, J.L., Veneklaas, E.J., Lambers, H., & Loneragan, W.A. 2006. Enhanced soil and leaf nutrient status of a Western Australian *Banksia* woodland community invaded by *Ehrharta calycina* and *Pelargonium capitatum*. *Plant Soil* **284**: 253–264.
- Flanagan, P.W. & Van Cleve, K. 1983. Nutrient cycling in relation to decomposition and organic matter quality in taiga ecosystems. *Can. J. For. Res.* **13**: 795–817.
- Fox, R.H., Myers, R.J.K., & Vallis, I. 1990. The nitrogen mineralization rate of legume residues in soil as influenced by their polyphenol, lignin, and nitrogen contents. *Plant Soil* **129**: 251–259.
- Garnier, E., Cortez, J., Billes, G., Navas, M.L., Roumet, C., Debussche, M., Laurent, G., Blanchard, A., Aubry, D., Bellmann, A., Neill, C., & Toussaint, J.P. 2004. Plant functional markers capture ecosystem properties during secondary succession. *Ecology* **85**: 2630–2637.
- Gershenzon, J. 1984. Changes in the levels of plant secondary metabolites under water and nutrient stress. In: Phytochemical adaptations to stress, B.N. Timmermann, C. Steelink, & F.A. Loewus (eds.). Plenum Press, New York, pp. 273–321.
- Gorham, E. 1991. Northern peatlands: Role in the carbon cycle and probable responses to climate warming. *Ecol. Appl.* **1**: 182–195.
- Griffiths, B.S., Welschen, R., Van Arendonk, J.J.C.M., & Lambers, H. 1992. The effects of nitrogen supply on bacteria and bacterial-feeding fauna in the rhizosphere of different grass species. *Oecologia* **91**: 253–259.
- Harris, M.M. & Riha, S.J. 1991. Carbon and nitrogen dynamics in forest floor during short-term laboratory incubations. *Soil Biol. Biochem.* **23**: 1035–1041.
- Hättenschwiler, S. & Vitousek, P.M. 2000. The role of polyphenols in terrestrial ecosystem nutrient cycling. *Trends Ecol. Evol.* **15**: 238–243.
- Hobbie, S.E. 1992. Effects of plant species on nutrient cycling. *Trends Ecol. Evol.* **7**: 336–339.
- Hobbie, S.E. 1995. Direct and indirect effects of plant species on biogeochemical processes in arctic ecosystems. In: Arctic and alpine biodiversity: Patterns, causes and ecosystem consequences, F.S. Chapin III & C. Körner (eds.). Springer-Verlag, Berlin, pp. 213–224.
- Hobbie, S.E. 1996. Temperature and plant species control over litter decomposition in Alaskan tundra. *Ecol. Monogr.* **66**: 503–522.

- Hungate, B.A., Canadell, J.C., & Chapin III, F.S. 1996. Plant species mediate changes in microbial N in response to elevated CO₂. *Ecology* **77**: 2505–2515.
- Johnson, L.C. & Damman, A.W.H. 1993. Decay and its regulation in *Sphagnum* peatlands. *Adv. Bryol.* **5**: 249–296.
- Kandil, F.E., Grace, M.H., Seigler, D.S., & Cheeseman, J.M. 2004. Polyphenolics in *Rhizophora mangle* L. leaves and their changes during leaf development and senescence. *Trees* **18**: 518–528.
- Leyval, C. & Berthelin, J. 1993. Rhizodeposition and net release of soluble organic compounds by pine and beech seedlings inoculated with rhizobacteria and ectomycorrhizal fungi. *Biol. Fertil. Soils* **15**: 259–267.
- Middleton, B.A. & McKee, K.L. 2001. Degradation of mangrove tissues and implications for peat formation in Belizean island forests. *J. Ecol.* **89**: 818–828.
- Mitchell, M. & Fuller, R. 1988. Models of sulfur dynamics in forest and grassland ecosystems with emphasis on soil processes. *Biogeochemistry* **5**: 133–163.
- Nguyen, C. 2003. Rhizodeposition of organic C by plants: Mechanisms and controls. *Agronomie* **23**: 375–396.
- Norby, R.J., Cotrufo, M.F., Ineson, P., O'Neill, E.G., & Canadell, J.G. 2001. Elevated CO₂, litter chemistry, and decomposition: A synthesis. *Oecologia* **127**: 153–165.
- Northup, R.R., Yu, Z., Dahlgren, R.A., & Vogt, K.A. 1995. Polyphenol control of nitrogen release from pine litter. *Nature* **377**: 227–229.
- Norton, J.M. & Firestone, M.K. 1996. N dynamics in the rhizosphere of *Pinus ponderosa* seedlings. *Soil Biol. Biochem.* **28**: 351–362.
- Parmelee, R.W., Ehrenfeld, J.G., & Tate, R.L., III 1993. Effects of pine roots on microorganisms, fauna, and nitrogen availability in two soil horizons of a coniferous forest spodosol. *Biol. Fert. Soils* **15**: 113–119.
- Paul, E.A. & Clark, F.E. 1989. Soil microbiology and biochemistry. Academic Press, San Diego.
- Pérez-Harguindeguy, N., Diaz, S., Cornelissen, J.H.C., Vendramini, F., Cabido, M., & Castellanos, A. 2000. Chemistry and toughness predict leaf litter decomposition rates over a wide spectrum of functional types and taxa in central Argentina. *Plant Soil* **218**: 21–30.
- Read, D.J. & Perez-Moreno, J. 2003. Mycorrhizas and nutrient cycling in ecosystems – A journey towards relevance? *New Phytol.* **157**: 475–492.
- Ruess, R.W., Van Cleve, K., Yarie, J., & Viereck, L.A. 1996. Contributions of fine root production and turnover to the carbon and nitrogen cycling in taiga forests of the Alaskan interior taiga forests on the Alaskan interior. *Can. J. For. Res.* **26**: 1326–1336.
- Rygielwicz, P.T. & Andersen, C.P. 1994. Mycorrhizae alter quality and quantity of carbon allocated below ground. *Nature* **369**: 58–60.
- Schimel, J.P. & Bennett, J. 2004. Nitrogen mineralization: Challenges of a changing paradigm. *Ecology* **85**: 591–602.
- Silver, W.L. & Miya, R.K. 2001. Global patterns in root decomposition: Comparisons of climate and litter quality effects. *Oecologia* **129**: 407–419.
- Swift, M.J., Heal, O.W., & Anderson, J.M. 1979. Decomposition in terrestrial ecosystems. Blackwell Scientific Publications, Oxford.
- Tate III, R.L. O'Reilly, L., Parmelee, R.W. & Ehrenfeld, J.G. 1991. Nitrogen mineralization: root and microbial interactions in pitch pine microcosms. *Soil Sci. Soc. Am. J.* **55**: 1004–1008.
- Van Breemen, N. 1993. Soils as biotic constructs favouring net primary productivity. *Geoderma* **57**: 183–211.
- Van Groenigen, K.-J., Six, J., Hungate, B.A., De Graaff, M.-A., Van Breemen, N., & Van Kessel, C. 2006. Element interactions limit soil carbon storage. *Proc. Natl. Acad. Sci. USA* **103**: 6571–6574.
- Van Veen, J.A., Merckx, R., & Van de Geijn, S.C. 1989. Plant- and soil related controls of the flow of carbon from roots through the soil microbial biomass. *Plant Soil* **115**: 179–188.
- Van Vuuren, Aerts, R., Berendse, F., & De Visser, W. 1992. Nitrogen mineralization in heathland ecosystems dominated by different plant species. *Biogeochemistry* **16**: 151–166.
- Verhoeven, J.T.A. & Toth, E. 1995. Decomposition of *Carex* and *Sphagnum* litter in fens: Effect of litter quality and inhibition by living tissue homogenates. *Soil Biol. Biochem.* **27**: 271–275.
- Wright, I.J., Reich, P.B., Cornelissen, J.H.C., Falster, D.S., Groom, P.K., Hikosaka, K., Lee, W., Lusk, C.H., Niinemets, U., Oleksyn, J., Osada, N., Poorter, H., Warton, D.I., & Westoby, M. 2005. Modulation of leaf economic traits and trait relationships by climate. *Global Ecol. Biogeog.* **14**: 411–421.
- Zak, D.R., Blackwood, C.B., & Waldrop, M.P. 2006. A molecular dawn for biogeochemistry. *Trends Ecol. Evol.* **21**: 288–295.
- Zhu, W. & Ehrenfeld, J.G. 1996. The effects of mycorrhizal roots on litter decomposition, soil biota, and nutrients in a spodosolic soil. *Plant Soil* **179**: 109–118.

10B. Ecosystem and Global Processes: Ecophysiological Controls

1. Introduction

In previous chapters, we emphasized the integration among processes from molecular to whole-plant levels and considered the physiological consequences of interactions between plants and other organisms. In this chapter, we move up in scale to consider relationships between **plant ecophysiological processes** and those occurring at **ecosystem to global scales**. Plant species differ substantially in their responses to environment and to other organisms. It is not surprising that these physiological differences among plants contribute strongly to functional differences among ecosystems.

2. Ecosystem Biomass and Production

2.1 Scaling from Plants to Ecosystems

The supply rates of light, water, and nutrients that govern ecosystem processes are functions of ground area and soil volume. Therefore, a critical initial step in relating the processes in individual plants to those in ecosystems is to determine how **plant size and density** relate to **stand biomass**. In sparse stands of plants, there is no necessary relationship between size and density, so plants increase in mass without changes in density (Fig. 1). As plants begin to compete, however,

mortality reduces plant density in a predictable fashion. Mid- and late-successional communities in approximate equilibrium with their environment, where plant density is determined more by mortality than recruitment, show an inverse relationship between $\ln(\text{biomass})$ and $\ln(\text{density})$, with a slope of about $-3/2$. This **self-thinning line** was initially derived empirically for pure stands under cultivated and natural conditions (Yoda et al. 1963). It has subsequently been observed in a wide array of studies, including mixed communities, both experimental and in the field, in ecosystems ranging from meadows to forests (Weller 1987). The slope and intercept of the self-thinning line vary among species and experimental conditions (Weller 1987, Vandermeer and Goldberg 2003), but the relationship provides an empirical basis to extrapolate from individuals to stands of vegetation. Given that

$$\ln(b) = -3/2 \ln(d) \quad (1)$$

it follows that

$$b = (d)^{-3/2} \text{ or } d = (b)^{-2/3} \quad (2)$$

$$B = b \cdot d = d^{-1/2} = b^{1/3} \quad (3)$$

where b is individual biomass (g plant^{-1}), d is density (plants m^{-2}), and B is stand biomass (g m^{-2}) for a single species growing in competition under specific conditions. These relationships indicate that for a given plant species and environment, increases in stand biomass are typically associated with increased plant size and reduced density. Biomass

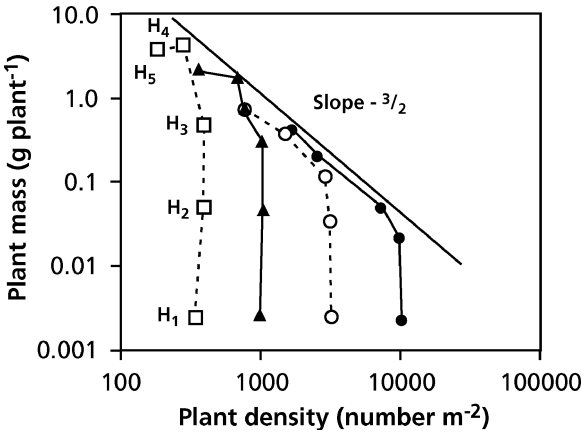

FIGURE 1. Self-thinning in four populations of *Lolium perenne* (perennial ryegrass) planted in glasshouse beds at four densities. H₁–H₅ are replicates harvested at five successive intervals. Following germination, plant biomass increases without change in density due to increased size of individual plants. As plants begin to compete, smaller individuals die, causing a decrease in density and a slower rate of increase in average plant biomass. From this point onward, the biomass–density relationship follows a self-thinning line in which $\ln(\text{biomass})$ and $\ln(\text{density})$ have a slope of $-3/2$ (modified after Kays & Harper 1974). Copyright Blackwell Science Ltd.

per individual can, in turn, be used as a basis for scaling metabolism to the ecosystem scale (Niklas & Enquist 2001).

2.2 Physiological Basis of Productivity

Net primary production (NPP) is the net biomass gain by vegetation per unit time. The main plant traits that govern NPP ($\text{g m}^{-2} \text{ yr}^{-1}$) are **biomass** (g m^{-2}) and **RGR** ($\text{g g}^{-1} \text{ yr}^{-1}$):

$$\text{NPP} = \text{Biomass} \cdot \text{RGR} \quad (4)$$

Most of the woody biomass of trees and shrubs consists of dead cells, so scaling from individuals to stands in woody vegetation (or in vegetation comparisons that include woody species) generally uses leaf biomass rather than total biomass (Niklas & Enquist 2001). Woody biomass is important

primarily as a way for plants to raise their leaves above those of neighbors.

At the **global scale**, **climate** and associated patterns of disturbance (e.g., fire) are the major determinant of NPP (Fig. 2; Schimper 1898) because of constraints on both the growth of individual plants and the types of species that can compete effectively. Highest productivity occurs in rainforests, where warm moist conditions favor plant growth and development of a large plant size; lowest values are in desert and tundra, where low precipitation or temperature, respectively, constrains growth (Table 1). In the tropics, where temperature is not a constraint, rainforests have greater productivity than dry deciduous forests, which are more productive than savannas, i.e., productivity declines with reduced water availability and/or increases in disturbance by fire. Similarly, where moisture is less limiting to growth, productivity is governed by

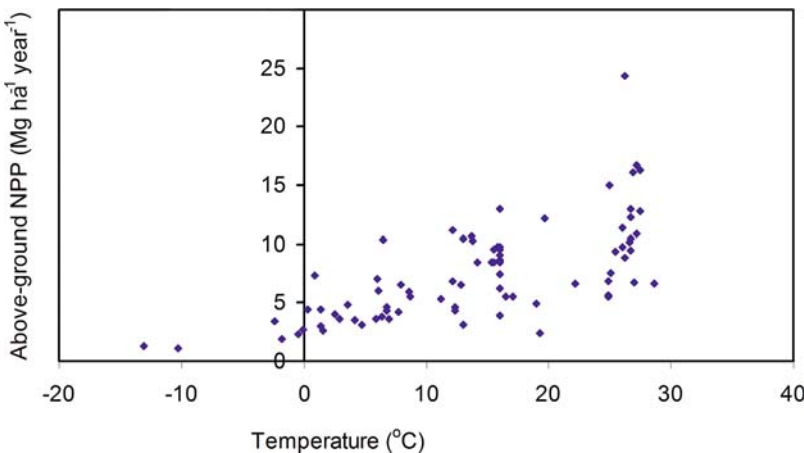

FIGURE 2. The relationships between net primary production and mean annual precipitation (Schoor 2003). Copyright Ecological Society of America.

TABLE 1. Primary production and biomass estimates for the world.

Ecosystem type	Area (10 ⁶ km ²)	Mean biomass (kg C m ⁻²)	Total biomass (10 ⁹ ton C)	Mean NPP (g C m ⁻² yr ⁻¹)	Total NPP (Gt C yr ⁻¹) ^a	RGR (yr ⁻¹)
Tropical rainforest	17.0	20	340	900	15.3	0.045
Tropical seasonal forest	7.5	16	120	675	5.1	0.042
Temperate evergreen forest	5.0	16	80	585	2.9	0.037
Temperate deciduous forest	7.0	13.5	95	540	3.8	0.040
Boreal forest	12.0	9.0	108	360	4.3	0.040
Woodland and shrubland	8.0	2.7	22	270	2.2	0.100
Savanna	15.0	1.8	27	315	4.7	0.175
Temperate grassland	9.0	0.7	6.3	225	2.0	0.321
Tundra and alpine meadow	8.0	0.3	2.4	65	0.5	0.217
Desert scrub	18.0	0.3	5.4	32	0.6	0.107
Rock, ice, and sand	24.0	0.01	0.2	1.5	0.04	–
Cultivated land	14.0	0.5	7.0	290	4.1	0.580
Swamp and marsh	2.0	6.8	13.6	1125	2.2	0.165
Lake and stream	2.5	0.01	0.02	225	0.6	22.5
Total continental	149	5.5	827	324	48.3	0.058
Total marine	361	0.005	1.8	69	24.9	14.1
Total global	510	1.63	829	144	73.2	0.088

Source: Schlesinger (1991).

Note: ^aGigatons (Gt) are 10¹⁵ g.

temperature, decreasing from tropical to temperate to boreal forests and finally to tundra.

At local to regional scales, climate continues to be important, with strong differences in productivity associated with altitudinal gradients in temperature and precipitation and with temperature differences between north- and south-facing slopes. At regional scales, however, differences in soil moisture and nutrients due to topographic variation in drainage and erosional transport of soils and due to differences in parent material (the rocks that give rise to soils) exert increasingly strong controls over productivity. For example, marshes are among the most productive habitats in most climate zones, due to high moisture and nutrient availability. Low-moisture and low-nutrient environments are typically dominated by slowly growing species with low specific leaf area, high leaf mass density, low rates of photosynthesis per unit leaf mass, and low leaf area ratios (Sect. 3 of Chapter 7 on growth and allocation). These plant traits, sometimes combined with low plant density, result in low biomass and productivity.

At the local scale, there can still be important differences in biomass and productivity, due to differences in species traits, even with the same climate

and parent material. Species introductions can result in strikingly different species dominating adjacent sites. For example, in California, *Eucalyptus globulus* (Tasmanian bluegum) forests have been planted on sites that would otherwise be grasslands. The *Eucalyptus globulus* forest has a biomass and productivity much greater than that of the grassland, despite the same climate and parent material. *Eucalyptus globulus* has deeper roots that tap water unavailable to the grasses, thus supporting the larger biomass and productivity (Robles & Chapin 1995). Once the grassland or forest is established, it is difficult for species of contrasting life forms to colonize. Consequently, there can be **alternative stable community types** with strikingly different biomass and productivity in the same environment. Greater water use by the trees compared with grasslands may have significant consequences for the availability of water elsewhere in the landscape. In deserts, deep-rooted **phreatophytes** can tap the water table and support a larger biomass and productivity than do shallow-rooted species. Thus, although climate and resource supply govern large-scale patterns of productivity (Schimper 1898), the actual productivity on a site depends strongly on historical factors that govern the

disturbance regime and species present at a site (Sect. 3 of Chapter 1 on assumptions and approaches).

2.3 Disturbance and Succession

Stand age modifies environmental controls over biomass and productivity. After **disturbance**, the most common initial colonizers are herbaceous weedy species that have high reproductive allocation, effective dispersal and are commonly well represented in the buried seed pool (Sect. 3.1 of Chapter 8 on life cycles). There is initially an exponential increase in plant biomass, due to the exponential nature of plant growth (Sect. 2.1 of Chapter 7 on growth and allocation). Relative growth rate (RGR) declines as plants get larger and begin to compete with one another. In addition, as succession proceeds, there is often a replacement of rapidly growing herbaceous species by woody species that grow more slowly, which are taller and shade out the initial colonizers. This causes a further decline in RGR (Table 2), despite the increase in biomass and productivity through time. In some ecosystems, productivity declines in late succession due to declines in soil nutrient availability and, in some forests, to declines in leaf area and photosynthetic capacity associated with reduced hydraulic conductance of old trees (Sect. 5.2.2 of Chapter 2B on plant respiration, Sect. 5.1 of Chapter 3 on plant water relations). Thus, changes in productivity through succession are governed initially by rates of colonization and RGR, followed by a gradual transition to a woody community that has lower RGR, but whose larger plant size results in further increases in productivity. Finally, over centuries to millennia, soils decline in P availability, causing further decline in the

productivity that can be supported (Sect. 2.1.1 of Chapter 6 on mineral nutrition; Wardle et al. 2004).

Disturbance regime determines the relative proportion of early and late successional stands in a region. For example, **fire** is a natural agent of disturbance that is particularly common at intermediate moisture regimes. In deserts, there is often insufficient fuel to carry a fire, although grass invasions in moist deserts can increase fire probability. By contrast, in temperate and tropical ecosystems with high precipitation or in arctic ecosystems with low evapotranspiration, naturally occurring vegetation is too wet to carry a fire in most years. In grasslands, fire occurs so frequently that woody plants rarely establish, so the region is dominated by herbaceous vegetation with high RGR and modest productivity. These vegetation characteristics are favorable to mammalian grazers, which act as an additional disturbance to prevent colonization by woody plants. Most grasslands have sufficient water and nutrients to support growth of woody plants. It is primarily the disturbance regime that maintains the high-RGR, non-woody nature of grasslands.

Plant traits strongly influence the disturbance regime of ecosystems. In grasslands, grasses produce an abundant fine-structured fuel that burns readily when dry because of the high specific leaf area (SLA), high leaf production rate, and low leaf longevity. Abundant below-ground reserve storage and meristem pools allow grasses to recover after grazing or fire. Thus, there is a common suite of **adaptations** that enable plants to tolerate fire and/or grazing in grasslands. Introduction of grasses into forests, shrublands, or deserts can increase fire frequency and cause a replacement of forest by savanna (D'Antonio & Vitousek 1992). Once the grasses create this disturbance regime with high

TABLE 2. Above-ground biomass, production, and nitrogen flux in major temperate ecosystem types, maximum height, and relative growth rate of species typical of these ecosystem types^a.

Parameter	Grassland	Shrubland	Deciduous forest	Evergreen forest
Above-ground biomass ^a (kg m ⁻²)	0.3 ± 0.02	3.7 ± 0.05	15 ± 2	31 ± 8
Above-ground NPP ^a (kg m ⁻² yr ⁻¹)	0.3 ± 0.02	0.4 ± 0.07	1.0 ± 0.08	0.8 ± 0.08
N flux ^a (g m ⁻² yr ⁻¹)	2.6 ± 0.2	3.9 ± 1.6	7.5 ± 0.5	4.7 ± 0.5
Canopy height ^b (m)	1	4	22	22
Field RGR (yr ⁻¹) ^c	1.0	0.1	0.07	0.03
Laboratory RGR ^b (wk ⁻¹)	1.3	0.8	0.7	0.4

Source: Chapin (1993).

^aNote: Data are means ± SE.

^aBokhari & Singh (1975), Cole & Rapp (1981), Gray & Schlesinger (1981), and Sala et al. (1988).

^bGrime & Hunt (1975), Tilman (1988).

^cAbove-ground production/above-ground biomass.

fire frequency, tree and shrub seedlings can no longer establish. Boreal conifers also create a fire regime that favors their own persistence. They are more flammable than deciduous trees because of their large leaf and twig surface area, low moisture content, and high resin content, an anti-herbivore/pathogen defense (Sect. 3.2 of Chapter 9B on ecological biochemistry; Van Cleve et al. 1991). Thus, there is an increase in fire probability when succession is accompanied by changes in plant functional types. When species shifts do not occur, there is little or no change in flammability with increasing stand age (Schoennagel et al. 2004). The invasion of the North American boreal forest by black spruce (*Picea mariana*) in the mid-Holocene caused an increase in fire frequency (Lynch et al. 2002), clearly showing the role of plant traits in determining community composition through their effects on fire regime.

2.4 Photosynthesis and Absorbed Radiation

One scaling approach is to extrapolate directly from leaf carbon exchange to the ecosystem level based on the relationship between photosynthesis and absorbed radiation. This approach was pioneered in agriculture (Monteith 1977) and has been extended to estimate patterns of carbon exchange in natural ecosystems (Field 1991). The fraction of incident photosynthetically active radiation that is absorbed by plants (**APAR**) is either converted to new biomass (NPP) or is respired. APAR depends on total leaf area, its vertical distribution and its photosynthetic capacity. Both light and leaf N decline in a predictable fashion through the canopy, with N preferentially allocated to the tops of canopies to maximize light utilization (Sect. 3.1 of Chapter 2A on photosynthesis, Box 5.1). Thus, as an initial simplification, the plant canopy can be treated as a **big leaf**, whose photosynthetic capacity depends on total canopy N (Sect. 2 of Chapter 5 on scaling-up; Farquhar 1989, Field 1991). In unstressed crops, dry matter accumulation is roughly proportional to integrated radiation interception over the growing season with a conversion efficiency of about 1.4 g MJ^{-1} (Monteith 1977). Natural ecosystems vary 10–100-fold in NPP (Table 1). Most of this variation is due to variation in APAR rather than in conversion efficiency, which varies about two-fold among studies. There are no striking ecological patterns in reported values of conversion efficiency, with much of the variation among studies likely due to differences in methodology, rather than inherent differences among ecosystems (Field

1991). Most of the variation in APAR is due to variation in **leaf area index** (LAI) (>50-fold variation among ecosystems), although leaf N concentration can vary nine-fold among ecosystems (Sect. 6.3 of Chapter 2A on photosynthesis; Reich & Oleksyn 2004). Thus, carbon gain and NPP are reduced in unfavorable environments due to the small amount of leaf biomass that can be supported and leaf N concentration that can be attained (Sect. 5 of Chapter 7 on growth and allocation).

The relatively consistent conversion of APAR into plant production among ecosystems provides a tool for estimating global patterns of NPP. APAR can be estimated from satellite-borne sensors, using the **normalized difference vegetation index** (NDVI):

$$\text{NDVI} = (\text{NIR} - \text{VIS}) / (\text{NIR} + \text{VIS}) \quad (5)$$

where NIR (W m^{-2}) is reflectance in the near infrared, and VIS (W m^{-2}) is reflectance in the visible. NDVI uses the unique absorption spectrum of **chlorophyll** which differs from that of clouds, water, and bare soil to estimate absorbed radiation. Stands with high rates of photosynthesis have a high NDVI because they have low values of reflected VIS and high values of reflected NIR. NDVI is an excellent predictor of APAR and daily net photosynthesis in short-term plot-level studies (Fig. 3). It also provides good estimates of NPP using satellites (Fig. 4). The consistency of this relationship supports the argument that there may be a relatively constant efficiency of converting absorbed radiation into plant biomass. One reason for the modest variation in conversion efficiency between APAR and NPP may be the similarity of growth respiration across plant tissues and species (Sect. 5.2 of Chapter 2B on plant respiration). From a pragmatic perspective, the strong relationship between NDVI and NPP is important because it allows us to estimate NPP directly from satellite images (Fig. 4). In this way, we can estimate **regional and global patterns of NPP** in ways that avoid the errors and biases that are associated with the extrapolation of harvest data to the global scale.

Any factor that alters the leaf area of an ecosystem or the availability of water or N changes the capacity of that ecosystem for carbon gain by moving vegetation along the generalized APAR–NPP relationship. **Climate** has obvious effects on LAI and leaf N (Reich & Oleksyn 2004). The physiological differences among plant species that we have discussed throughout the book also have pronounced effects on the leaf area and leaf N that can be supported in any environment, as mediated by

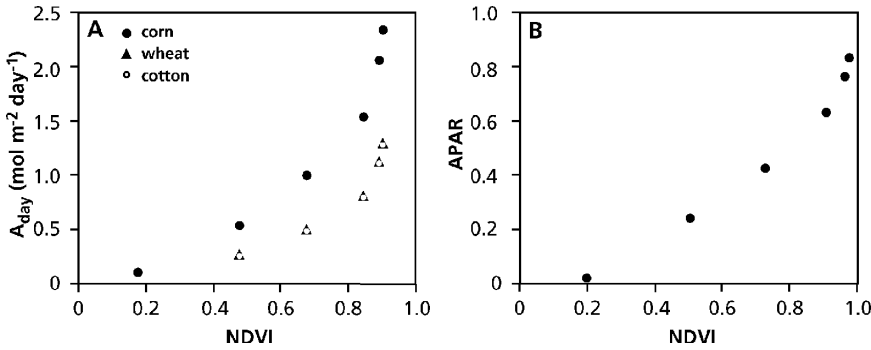

FIGURE 3. Relationship of normalized difference vegetation index (NDVI) to daily net rate of CO₂ assimilation (A_{day}) and to the fraction of absorbed photosynthetically active radiation (APAR). These

relationships were simulated based on data collected from wheat (*Triticum aestivum*), corn (*Zea mays*), and cotton (*Gossypium*) (After Field 1991, as redrawn from Choudhury 1987).

competitive interactions, herbivores, and pathogens. In general, the sorting of species among habitats by competition over the long term probably maximizes APAR and NPP, whereas pathogens and herbivores tend to reduce APAR and NPP. Disturbance regime also influences regional APAR and NPP, as does human land conversion of natural ecosystems to pastures and agriculture.

Satellite-based measurements of NDVI provide evidence for several large-scale changes in NPP. In the tropics and in the southern margin of the boreal forest, there have been decreases in NDVI associated with forest clearing and conversion to agriculture. The West African Sahel and Northern Mexico also show reductions in NDVI associated with land degradation due to overgrazing (Milich & Weiss 2000, Archer et al. 2001). At high latitudes, however, NDVI increased until about 1990, after which it continued increasing in tundra but

declined in boreal forest (Goetz et al. 2005). These high-latitude changes in NDVI are particularly intriguing because they are remote from areas of large-scale anthropogenic land-use change and could reflect broad biospheric responses to changes in climate. High-latitude warming may have increased NPP through increased length of growing season or direct temperature effects on growth (Callaghan et al. 2005). The declining NDVI in boreal forest may reflect warming-induced drought stress or reductions in biomass by insect outbreaks and wild-fire (Goetz et al. 2005), which are increasing in areal extent (Kurz & Apps 1995, Kasischke & Turetsky 2006). There are also potential artifacts associated with lack of calibration of satellite sensors among years that complicate the interpretation. The striking trends in changes in NDVI nevertheless strongly suggest that global NPP can be substantially altered over broad regions of the globe.

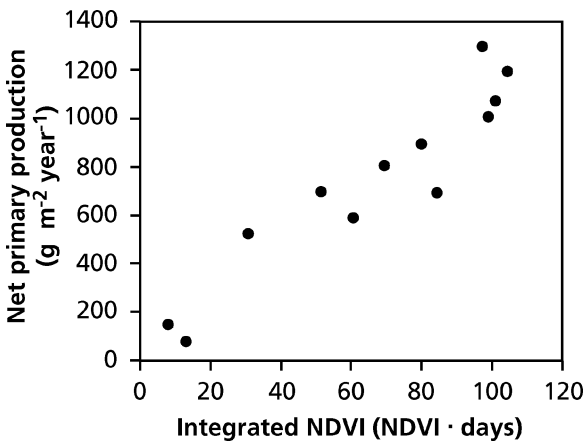

FIGURE 4. Relationship between mean net primary production (NPP) for several biomes and the seasonally integrated normalized difference vegetation index (NDVI) measured from satellites. Each point represents a different biome (after Field 1991, as redrawn from Goward et al. 1985).

2.5 Net Carbon Balance of Ecosystems

Net ecosystem production (NEP, $\text{g C m}^{-2} \text{yr}^{-1}$) of carbon by an ecosystem depends on the balance between **net primary production** (NPP, $\text{g C m}^{-2} \text{yr}^{-1}$) and **heterotrophic respiration** (R_h , $\text{g C m}^{-2} \text{yr}^{-1}$) or between **gross photosynthesis** (P_g , $\text{g C m}^{-2} \text{yr}^{-1}$) and **total ecosystem respiration** (R_e , $\text{g C m}^{-2} \text{yr}^{-1}$), which is the sum of R_h and plant respiration (R_p , $\text{g C m}^{-2} \text{yr}^{-1}$).

$$\text{NEP} = \text{NPP} = R_h = P_g - R_e \quad (6)$$

NEP is important because it is usually the major determinant of **Net Ecosystem Carbon Balance (NECB)**, the increment in carbon stored by an ecosystem. Under some circumstances, however, additional carbon fluxes (e.g., fire, harvest, leaching, lateral transfers of organic or inorganic C, and volatile emission of carbon in forms other than CO_2) are large enough to influence NECB, especially over long time periods (Chapin et al. 2006). We have discussed the plant physiological and environmental constraints on NPP (Sects. 2.2 and 2.4). **Decomposers** account for most of the heterotrophic respiration. Their respiration depends on by moisture and temperature and on the quantity, quality, and location (above or below ground) of organic matter produced by plants (Sect. 3 of Chapter 10A on decomposition). In general, conditions that favor high NPP also favor high R_h . For example, both NPP and decomposition are higher in the tropics than in the arctic and higher in rainforests than in deserts, due to similar environmental sensitivities of NPP and R_h . Similarly, species that are highly productive produce more litter or higher quality litter than do species of low potential productivity. Thus, habitats dominated by productive species are characterized by high decomposition rates (Sect. 3.2 of Chapter 10A on decomposition). There is also a necessary functional linkage between NPP and R_h . NPP provides the organic material that fuels R_h , and R_h releases the minerals that support NPP (Harte & Kinzig 1993). For all these reasons, NPP and R_h tend to be closely matched in ecosystems at steady state (Odum 1969, Wofsy et al. 1993). Therefore, at steady state, by definition, NEP and changes in carbon storage are small and show no correlation with NPP or R_h . In fact **peat bogs**, which are among the least productive ecosystems, are ecosystems with the greatest long-term carbon storage.

NEP is a small difference between two very large fluxes, **gross photosynthesis** (P_g) and **ecosystem respiration** (R_e) (Fig. 5). Although NEP, on average, is close to zero in ecosystems at steady state, it

shows large-enough seasonal variation to cause seasonal fluctuations in atmospheric CO_2 at the global scale (Fig. 2A.55 in Chapter 2A on photosynthesis) with decreases in atmospheric CO_2 concentrations in the northern hemisphere during the summer, when terrestrial photosynthesis is greatest, and increases in winter, when terrestrial photosynthesis declines below the rate of ecosystem respiration. Over long timescale, factors other than NEP also influence NECB. The most clear-cut causes of ecosystem variation in NECB are successional cycles of disturbance and recovery. Most disturbances initially cause a negative NECB. Fire releases carbon directly by combustion (not part of NEP) and indirectly by producing conditions that are favorable for R_h (part of NEP) (Kasischke et al. 1995). For example, removal of vegetation typically reduces transpiration, causing an increase in soil moisture, and increases soil temperature due to greater radiation absorption (lower albedo and greater penetration of solar radiation to the soil surface) (Table 3). The warmer, moister soils enhance R_h , and the reduction in plant biomass reduces NPP, resulting in negative NEP for years after a forest wildfire (Kasischke et al. 1995). Eventually, however, photosynthesis exceeds R_h , leading to carbon accumulation in the ecosystem (a positive NECB). Agricultural tillage breaks up soil aggregates and increases access of soil microbes to soil organic matter, resulting in a similar increase in R_h and negative NEP following conversion of natural ecosystems to agriculture. Prairie soils often lose half their soil carbon within a few decades after conversion to agriculture (Davidson & Ackerman 1993).

NEP can also vary substantially among years, due to different environmental responses of photosynthesis and respiration. For example, northern ecosystems are a net carbon source in warm years and a carbon sink in cool years (Oechel et al. 1993, Zimov et al. 1996) because heterotrophic respiration responds to temperature more strongly than does photosynthesis in cold climates.

2.6 The Global Carbon Cycle

Recent large-scale changes in the global environment (e.g., regional warming, N deposition, and elevated atmospheric CO_2 concentrations) can alter NEP, if they have differential effects on photosynthesis and respiration. For example, photosynthesis responds more strongly to atmospheric CO_2 concentration than does heterotrophic respiration, so the terrestrial biosphere might increase net CO_2 uptake in response to the increases in atmospheric $[\text{CO}_2]$

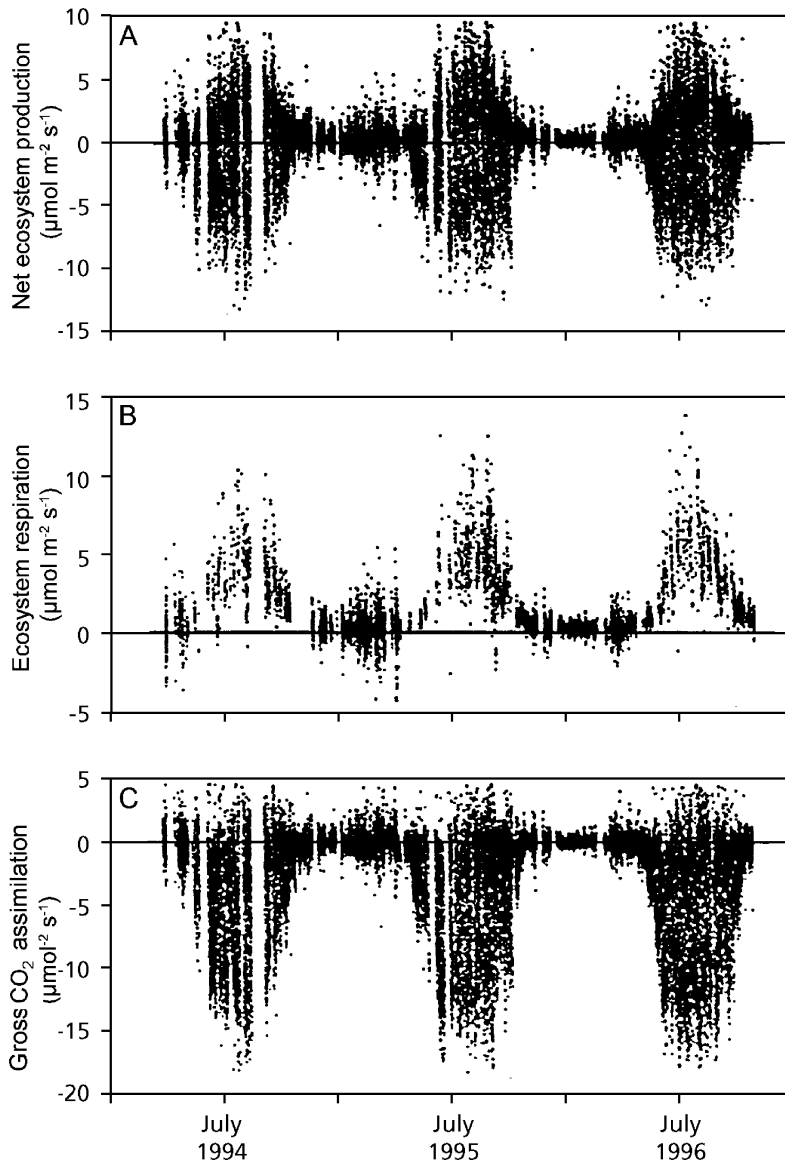

FIGURE 5. Annual course of (A) net ecosystem production (NEP), (B) ecosystem respiration (Resp), and (C) gross CO_2 assimilation (P_g) in an old-growth black spruce (*Picea marina*) forest in northern Canada. Positive values are fluxes from the ecosystem to the atmosphere. Note that fluxes vary considerably from day to day, with largest fluxes of both photosynthesis and respiration in summer (after Goulden et al. 1997).

TABLE 3. Short-wave (150–4000 nm) albedos for various surface types.

Surface type	Measured albedo
Clouds: cumulus	0.85
Clouds: cirrus	0.35
Snow: ice	0.7–0.90
Sands: dry	0.40–0.50
Sands: wet	0.20–0.25
Grasslands	0.15–0.35
Forests	0.10–0.20
Ocean	0.02–0.07

Source: Graetz (1991).

caused by fossil fuel combustion and land-use change. NPP in most terrestrial ecosystems is nutrient-limited, however, strongly constraining the capacity of vegetation to respond to elevated $[\text{CO}_2]$. In relatively young landscapes, N is the key limiting nutrient (Sect. 2.1.1 of Chapter 6 on mineral nutrition). Therefore, the clearest evidence for increases in NPP in response to elevated $[\text{CO}_2]$ is in these landscapes with N deposition, where there are widespread increases in tree growth (Kauppi et al. 1992). NPP is only half the story, however: NPP must change more strongly than R_h and disturbance rate, if there is to be an increase in NECB.

Only 45% of the annual anthropogenic input of CO₂ remains in the atmosphere, with the rest being removed by the oceans or the terrestrial biosphere (Sect. 12 of Chapter 2A on photosynthesis). The location of this **missing sink** of atmospheric CO₂ is difficult to identify by direct measurement because its global magnitude (5.0 Gt C yr⁻¹) (Canadell et al. 2007) is only about 5% of global NPP, much smaller than measurement errors and typical interannual variability. Isotopic fractionation in photosynthesis (Box 2A.2) has provided an important key to identifying the magnitude and location of the missing sink. Atmospheric transport models can be run in “inverse mode” (i.e., opposite to the direction of cause to effect) to estimate the global distribution of CO₂ sources and sinks that are required to match the observed geographic and seasonal patterns of concentrations of CO₂ and ¹³CO₂ in the atmosphere (Fig. 2A.55 in Chapter 2A on photosynthesis; Tans et al. 1990, Ciais et al. 1995, Denning et al. 1995). CO₂ uptake by the terrestrial biosphere can be distinguished from the CO₂ that dissolves in the ocean because of the strong **isotopic fractionation** during photosynthesis. Similarly, atmospheric stoichiometry between CO₂ and O₂ separate biological from physical causes of changing atmospheric [CO₂]. Although there are still many uncertainties, these models suggest that terrestrial ecosystems account for about 56% (2.8 Gt C yr⁻¹) of the missing sink, and that these terrestrial sinks are concentrated at mid to high northern latitudes (Canadell et al. 2007). Tropical forests also respond strongly to increased atmospheric [CO₂], but this is offset by high rates of deforestation, which release CO₂ to the atmosphere (Bala et al. 2007, Field et al. 2007).

Human activities have caused the CO₂ concentration to increase 35% since 1750 (half of this increase since 1970), after about 10000 years of relatively stable concentration. Atmospheric [CO₂] is now higher than any time in at least 650000 years (IPCC 2007). The capacity of ecosystems to sequester this anthropogenic CO₂ appears to be saturating for several reasons (Canadell et al. 2007). In part, this is a logical consequence of the *A-C_c* curve (Fig. 2A.6 in Chapter 2A on photosynthesis), which begins to saturate in most C₃ plants at the current CO₂ concentration (380 mol mol⁻¹) of the atmosphere. This effect is amplified by declines in the photosynthetic capacity of ecosystems due to complex interactions among changes in nutrient and water availability, land-cover change, and pollution; the oceans exhibit an even greater decline in the capacity to sequester CO₂ (Canadell et al. 2007). This sobering observation suggests that we cannot depend on the terrestrial ecosystems to “solve” the problem of rising

concentrations of atmospheric CO₂ and that society must take serious measures to reduce CO₂ emissions, to prevent dangerous rates of climate warming (Stern 2006).

3. Nutrient Cycling

3.1 Vegetation Controls over Nutrient Uptake and Loss

The controls over nutrient uptake and loss by stands of vegetation are basically the same as those described for individual plants (Sect. 2.2 of Chapter 6 on mineral nutrition) (Chapin 2003). Nutrient supply ultimately determines nutrient uptake at the stand level. However, individual plants influence their **acquisition of nutrients** directly by root biomass and the kinetics of ion uptake and indirectly by influencing nutrient supply rate. **Root biomass**, including **mycorrhizas** is the major plant parameter governing stand-level nutrient uptake because a large root biomass is the major mechanism by which plants minimize diffusional limitations of nutrient delivery to the root surface (Sect. 2.2.1 of Chapter 6 on mineral nutrition). The absolute magnitude of root biomass is probably greatest in high-resource environments, where there is a large total plant biomass (e.g., forests; Table 2). Root biomass varies less across ecosystems (Table 5 in Chapter 3), however, than does total biomass because proportional allocation to roots increases in low-resource environments (Sect. 5.4.4 of Chapter 7 on growth and allocation). *I*_{max} of ion uptake is generally greatest in plants that grow rapidly (a high plant demand for nutrients) and would therefore contribute to the high nutrient uptake in high-resource environments. In low-nutrient environments, vegetation maximizes nutrient acquisition through high root biomass (an acclimation response rather than adaptation), symbiotic associations (with mycorrhizal fungi and N₂-fixing microorganisms), and by solubilizing scarcely available P or organic N (Sect. 2.2 of Chapter 6 on mineral nutrition and Sects. 2.3, 2.4, 2.5, and 3.7 of Chapter 9A on symbiotic associations). Despite adaptations and acclimations of plants to maximize nutrient acquisition on infertile soils, there is a strong correlation between NPP and nutrient uptake by vegetation, because of the widespread occurrence of nutrient limitation in most ecosystems (Chapin 2003).

Annual **nutrient return** from vegetation to soils is greatest in high-nutrient environments. Where NPP and biomass are high, there is a low mean

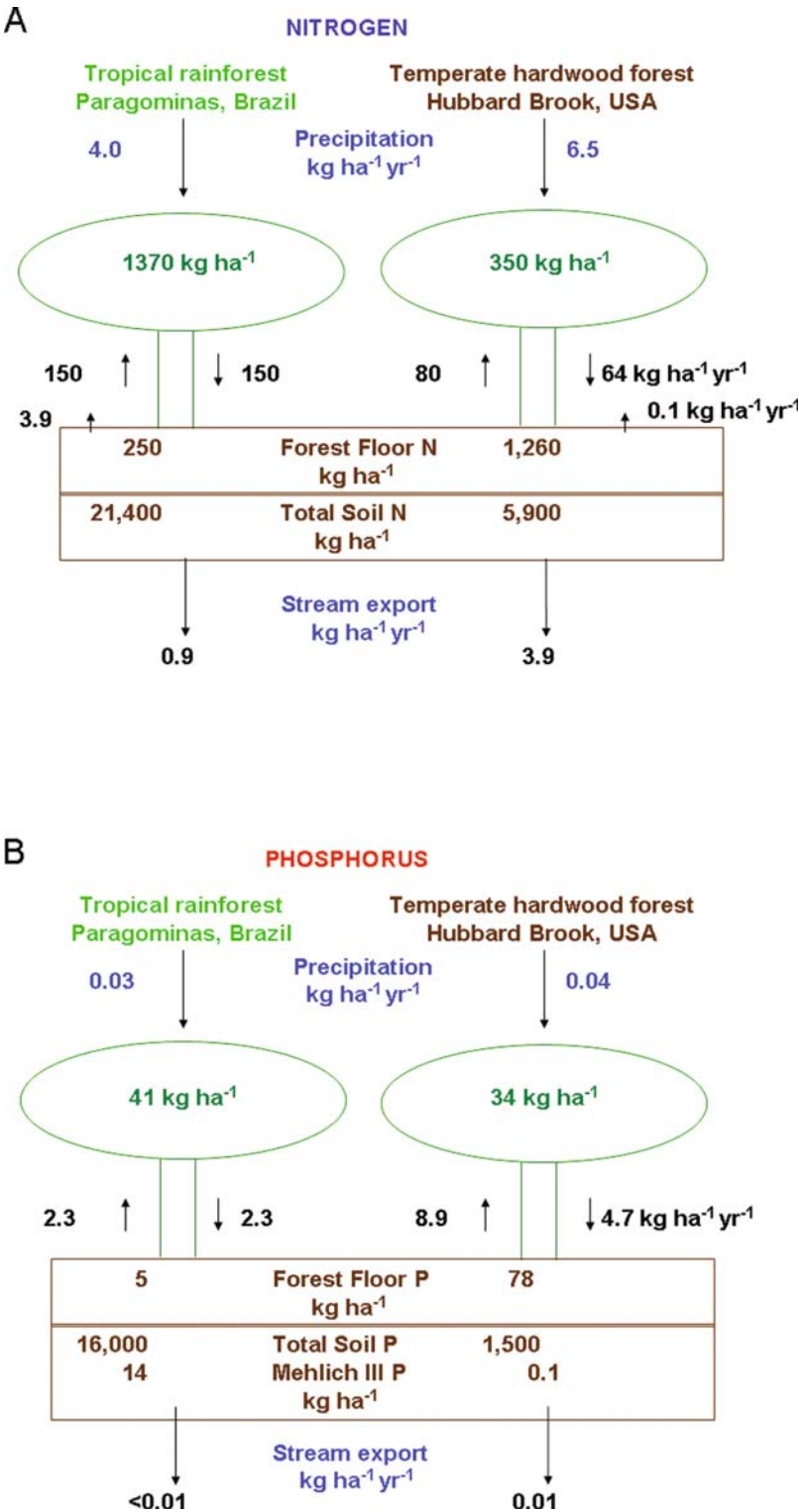

FIGURE 6. Comparison of nutrient cycles at a mature moist tropical evergreen forest at Fazenda Vitória, Paragominas, Pará, Brazil and at a 55-year-old temperate mixed deciduous forest at Hubbard Brook, New Hampshire, United States. (A) N cycle. (B) P cycles. Arrows indicate bulk precipitation inputs, plant uptake, litter and throughfall return to the soil, soil surface emissions of $\text{NO}+\text{N}_2\text{O}$, and stream export of total dissolved N. Soil stocks are to 8 m depth at Paragominas, whereas the soil depth averages about 0.5 m to the underlying glacial till at Hubbard Brook (after Davidson et al. 2004).

residence time of nutrients in plants (rapid leaf and perhaps root turnover) and high nutrient concentrations in litter (Sect. 4.3.2 of Chapter 6 on mineral nutrition). P is very conservatively cycled, relative to N, in systems where P is a major limiting nutrient, e.g., in Amazon rainforests and Western Australian sandplains, and N is more conservatively cycled where N is limiting, e.g., in a temperate deciduous forest in New Hampshire (Fig. 6; Davidson et al. 2004). Thus, for both plant nutrient uptake and loss, the differences observed among ecosystems are the same as would be predicted by the patterns of acclimation and adaptation of individual plants, but are more pronounced because of the larger size of plants in favorable environments.

3.2 Vegetation Controls over Mineralization

The effects of climate and resource availability on nutrient supply are similar to those described for decomposition (Sect. 2.5, Sect. 2.1.1 of Chapter 6 on mineral nutrition), with high rates of nutrient supply under favorable environmental conditions. Within these environmental constraints, however, **plant traits** strongly influence nutrient supply through their effects on root exudation, microenvironment, and litter quality. Litter quality differs among ecosystems and strongly influences mineralization rates (Sect. 3.1 of Chapter 10A on decomposition). **Root exudates** provide a labile carbon source of sugars, organic acids, and amino acids that can either enhance or reduce mineralization, depending on soil fertility (Sect. 3.3 of Chapter 10A on decomposition). Root exudates may also inhibit **nitrification** (Sect. 2 of Chapter 9B on ecological biochemistry; Lata et al. 2004). Over longer timescales, successional development of vegetation modifies soil temperature (shading), soil moisture (transpiration), and the quantity and quality of organic matter inputs (litter and root exudates) (Sect. 2.2 of Chapter 10A on decomposition).

Over long timescales (decades to centuries), patterns of **nutrient input and loss** exert additional influences over nutrient supply. There is only fragmentary understanding of these long-term controls, although we know that abundance of N₂-fixing plants strongly influences N inputs (Vitousek & Howarth 1991). For example, introduction of the N₂-fixing tree *Myrica faya* (candleberry myrtle) into the Hawaiian Islands greatly increased N inputs, N supply, and annual rates of N cycling (Vitousek 2004). Replacement of perennial grasses by annual grasses, with their shorter period of physiological

activity, may account for autumn N losses from California grasslands. Anthropogenic inputs of N from industrial fixation and planting of legume crops now exceed inputs by natural fixation at the global scale (Vitousek et al. 1997), suggesting that there may be substantial changes in the regulation of inputs and outputs of N in natural ecosystems.

4. Ecosystem Energy Exchange and the Hydrologic Cycle

4.1 Vegetation Effects on Energy Exchange

4.1.1 Albedo

Energy exchange at the ecosystem scale is influenced by the properties of individual leaves and stems (e.g., albedo and the partitioning of dissipated energy between sensible and latent heat) (Sect. 2.1 of Chapter 4A on the plant's energy balance) as well as by any contrasts between plant properties and those of the underlying surface. In addition, canopy complexity reduces albedo because any incoming radiation that is initially reflected by a leaf or stem is more likely to encounter another surface before being reflected back to space. This contributes to the lower albedo of conifers than of trees with round flat canopies. The atmosphere is nearly transparent to the short-wave radiation emitted by the sun, so **air temperature** at local to global scales is primarily determined by the amount of energy absorbed and dissipated by the Earth's surface. Therefore, the influence of vegetation on surface reflectance (**albedo**) can have substantial effects on climate. For example, snow and sand have higher albedos than vegetation, and therefore reduce absorption of radiation at the surface (Table 3). In tundra, any increase in plant height relative to snow depth or increased density of tall shrubs or trees will mask the snow and reduce the albedo (i.e., increase absorbed energy and the energy dissipated to the atmosphere), thus raising the temperature of the overlying air (McGuire et al. 2006). Model simulations suggest that when temperature warmed at the last thermal maximum, 6000 yr ago, the **treeline** moved northward, reducing the regional albedo and increasing energy absorption (Foley et al. 2003b). Approximately half of the **climatic warming** that occurred at that time is estimated to be due to the northward movement of treeline, with the remaining climate warming due to increased solar input (Fig. 7). The warmer regional climate, in turn, favors tree reproduction and establishment at

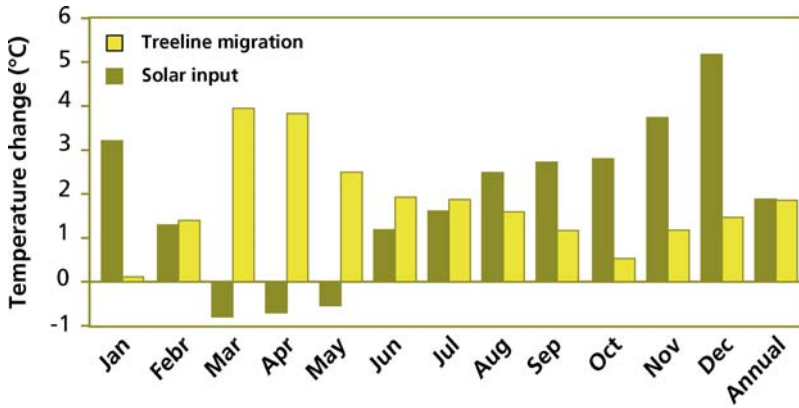

FIGURE 7. The change in arctic air temperature at the last thermal maximum caused directly by changes in solar inputs and caused by the change in albedo associated with northward movement of treeline, as simulated by a general circulation model (redrawn from Foley et al. 1994).

treeline (Payette & Filion 1985, Lloyd et al. 2003), providing a positive feedback to regional warming. Thus, changes in vegetation height, relative to snow depth, could exert a large effect on regional climate. The warming-induced advance in date of snowmelt is already contributing substantially to high-latitude warming (Chapin et al. 2005, Euskirchen et al. 2007).

Vegetation effects on albedo also influence regional climate in arid areas. For example, a 30-year drought in the Sahel at the end of the 20th century reduced plant density, exposed more light-colored soil, and thus reduced absorbed radiation. This reduced heating and convective uplift of the overlying air, resulting in less advection of moisture from the Atlantic and reduced precipitation (Foley et al. 2003a). The resulting increase in drought, compounded by degradation of the land by **overgrazing**, acts as a positive feedback to further reduce plant production and biomass, stabilizing this pattern of regional drought.

Differences in albedo among vegetated surfaces are more subtle than those between vegetation and snow or soil. Vegetation albedo depends primarily on **phenology**. Leaf appearance in deciduous ecosystems increases albedo if the soil surface is dark and reduces albedo over light-colored surfaces. Evergreen communities show minimal seasonal change in albedo. Even the small differences in albedo among plant species could be climatically important. For example, grasslands typically have higher albedo than forests because of their more rapid leaf turnover and retention of dead reflective leaves in the canopy. Similarly, the higher albedo of deciduous than of conifer forests results in less energy absorption and transfer to the atmosphere (Liu et al. 2005). For this reason, forest fires that cause a replacement of late-successional conifers by early successional herbs, shrubs, and deciduous trees act as a negative feedback to climate warming

(Randerson et al. 2006). Policies that seek to promote ecosystem feedbacks to mitigate climate change have focused almost entirely on carbon sequestration associated with expanded forest extent and have ignored the large (and often contrasting) climate feedbacks caused by changes in **energy budget** (Betts 2000, Field et al. 2007). A valuable contribution of climate-change science to the policy arena would be a more comprehensive assessment of **ecosystem feedbacks** to the climate system. For example, the carbon sequestration effect (climate cooling) might prove to be strongest in the tropics, where warm moist conditions speed the carbon cycle, and changing cloudiness ameliorate the albedo effect. In contrast, the albedo effect (climate warming) of increased forest cover is most likely strongest at high latitudes, where there is a large albedo contrast between forests and snow-covered treeless lands. These observations suggest that efforts to reduce deforestation might have most favorable climate consequences in the tropics, where they provide a simultaneous benefit of reducing biodiversity loss.

4.1.2 Surface Roughness and Energy Partitioning

The **roughness of the canopy** surface determines the degree of **coupling** between plants and the atmosphere and the extent to which stomatal conductance influences the partitioning between latent and sensible heat (Sect. 2 of Chapter 5 on scaling-up). Roughness is determined primarily by topography and vegetation structure. Tall uneven canopies have a high surface roughness that creates mechanical turbulence. The resulting eddies of air transport bulk air into the canopy and canopy air back to the free atmosphere. This increases the efficiency of

water, gas, and energy exchange, relative to short-statured canopies such as those of most grasses or annual crops. The lower roughness of short-statured vegetation creates a thicker boundary layer and reduces the influence of stomatal regulation by individual leaves on overall conductance of the canopy to water loss, especially under moist conditions.

On average, the energy absorbed by an ecosystem must be balanced by energy returned to the atmosphere as sensible or latent heat flux. The ratio of sensible to latent heat flux (**Bowen ratio**) varies 100-fold among ecosystems, from less than 0.1 in tropical oceans to 10 in deserts, and depends primarily on climate and soil moisture. Ecosystems with abundant moisture have high rates of evapotranspiration (latent heat flux) and therefore a low Bowen ratio. Strong winds and rough canopies reduce temperature build-up at the surface which drives sensible heat flux, also leading to low Bowen ratios and high evapotranspiration. The Bowen ratio is important because it determines the strength of the linkage between energy exchange and the hydrologic cycle. This linkage is strongest in moist ecosystems with low Bowen ratio, where most of the energy absorbed by the ecosystem is dissipated by water transfer to the atmosphere.

4.2 Vegetation Effects on the Hydrologic Cycle

4.2.1 Evapotranspiration and Runoff

Climate clearly has a critical direct effect on the supply of water to ecosystems as a result of precipitation inputs. In addition, climate determines the rate at which water returns to the atmosphere due to climatic effects on soil moisture availability and the vapor pressure gradient that drives evapotranspiration. However, plant size and leaf area index (LAI) also exert strong controls over **evapotranspiration**. In wet canopies, LAI determines the amount of water that can be intercepted and stored by the canopy, and plant size and canopy roughness determine the rate at which this water evaporates. Similarly, during winter, plant size and canopy roughness determine the amount of snow intercepted by the canopy and returned to the atmosphere by sublimation.

When canopies are dry, soil moisture, climate, and LAI interact in complex ways to control evapotranspiration. Under moist-soil conditions, climate determines the driving forces for evapotranspiration (the net radiation that must be dissipated and the vapor pressure deficit of the bulk air), and plant

size and canopy roughness determine the surface turbulence and boundary layer conductance that control how efficiently this water is transferred to the atmosphere. In general, the moisture content of the air (and the corresponding effect on stomatal conductance) is the most important climatic control over evapotranspiration in well-coupled rough canopies, but net radiation (and the amount of energy to be dissipated) is the most important control in smooth canopies where atmosphere–canopy exchange is less tightly coupled to atmospheric conditions. LAI has surprisingly little influence on evapotranspiration under these moist-soil conditions; it simply determines the extent to which water evaporates from leaves vs. the moist soil surface (Kelliher et al. 1995). As soil moisture and soil surface evaporation decline, however, LAI and stomatal conductance exert increasing importance over evapotranspiration.

Plant biomass indirectly influences evapotranspiration because of its correlation with the quantity of litter on the soil surface which influences the partitioning of water between surface **runoff** and **infiltration** into the soil. Surface **runoff** is negligible in forests and other communities with a well-developed litter layer but can be substantial in dry ecosystems with minimal litter accumulation (Running & Coughlan 1988).

In dry environments, stomatal conductance and rooting depth exert additional influence over evapotranspiration. Desiccation-tolerant species keep their stomata open at times of lower water availability and thus support greater evapotranspiration during dry periods than do species typical of more mesic environments (Schulze & Hall 1982). Tall plants such as trees generally transpire more water than herbs because of their more extensive root systems and greater leaf area and canopy roughness. Consequently, forest harvest reduces evapotranspiration and increases runoff (Bormann & Likens 1979), especially during seasons of rapid plant growth. In summary, plant size, which is a function of resource availability in the environment, is the major determinant of canopy water loss, although the response of stomatal conductance to plant water status becomes important under dry conditions. At the global scale, river runoff has increased during the 20th century, primarily as a result of CO₂-induced reductions in stomatal conductance (Gedney et al. 2006).

The same plant traits that influence evapotranspiration (Sect. 4.1.3) influence **soil moisture**. In northern regions, species characteristic of steppe vegetation have higher rates of evapotranspiration than do mosses and other vegetation characteristic

TABLE 4. Average evapotranspiration rate of tundra and steppe plants from weighing lysimeters under field conditions in northeast Siberia during July.

Surface type	Evapotranspiration rate (mm day ⁻¹)	
	Field capacity	Natural precipitation
Tundra plants		
Lichen	1.6	0.9
Moss	2.8	1.0
Steppe plants		
<i>Agropyron</i>	6.7	2.5
<i>Eriophorum</i>	5.3	3.0
<i>Equisetum</i>	4.0	1.6
<i>Artemisia</i>	6.1	2.3
Probability of tundra-steppe difference	0.03	0.02

Source: Zimov et al. (1995).

Note: Lysimeters were either maintained at field capacity by twice-daily watering or given access only to natural precipitation.

of tundra (Table 4). Either of these vegetation types can persist under the climate typical of tundra, with the higher transpiration rate of steppe plants maintaining the low soil moisture that favors these species and the lower transpiration rate of tundra species causing higher soil moisture that favors tundra species. Zimov et al. (1995) hypothesized that extirpation of mega-herbivores by humans at the end of the Pleistocene shifted the competitive balance from steppe species that tolerate grazing to tundra species. The resulting reduction in evapotranspiration would have increased soil moisture, contributing to the shift from dry steppe to mossy tundra that occurred at the end of the Pleistocene.

4.2.2 Feedbacks to Climate

Species differences in evapotranspiration can have climatic consequences. Simulations suggest that conversion of the Amazon basin from forest to pasture would cause a permanent warming and drying of South America because the shallower roots of grasses would reduce evapotranspiration and cause greater energy dissipation as sensible heat (Foley et al. 2003a). These drier conditions would favor persistence of grasses. In Mexico, the reduction in transpiration that resulted from overgrazing increased sensible heat flux, causing regional warming (Balling 1988). Summer air masses that move from the Arctic Ocean into arctic Canada carry only enough moisture to account for 25% of the

precipitation that occurs on land (Walsh et al. 1994). Thus, the remaining 75% of precipitation must originate from evapotranspiration over land. In other words, recycling of moisture between the land surface and the atmosphere accounts for most of the precipitation in this part of the Arctic (Chapin et al. 1997).

Environmental conditions could influence **vegetation feedbacks** to precipitation. For example, global warming caused by a doubling of atmospheric [CO₂] is predicted to increase precipitation by 8%. The reduction in stomatal conductance caused by this rise in CO₂ concentration (Sect. 10.1 of Chapter 2A on photosynthesis), however, should reduce the magnitude of the expected precipitation increase to only 5% (Henderson-Sellers et al. 1995). On the other hand, increased plant growth and stomatal conductance caused by N deposition might increase evapotranspiration and therefore precipitation. Thus, the interaction among environmental factors that influence plant growth and physiology modulate many of the terrestrial feedbacks to climate (Gedney et al. 2006).

In most ecosystems, there is a close correlation of evapotranspiration with gross photosynthesis because a high leaf area and high stomatal conductance promote both processes. In low-resource communities, however, canopies are sparse, and the soil or surface mosses contribute substantially to evapotranspiration (Chapin et al. 1997). Below an LAI of 4, evapotranspiration becomes increasingly uncoupled from photosynthesis, due to proportional increase in surface evaporation (Schulze et al. 1994).

5. Moving to a Higher Level: Scaling from Physiology to the Globe

Physiological differences among species have important predictable consequences for ecosystem and global processes. Environments with favorable climate and high resource availability support growth forms that are highly productive due to either large size or high RGR, depending on time since disturbance. By contrast, unfavorable environments support slow-growing plants, whose well-developed chemical defenses minimize rates of herbivory and decomposition. Fast-growing plants have high rates of photosynthesis and transpiration (on a mass basis), rapid tissue turnover, herbivory, and decomposition. Plant size is one of the major determinants of exchanges of carbon, nutrients, energy, and water. Vegetation differences in size

and growth rate feed back to reinforce natural environmental differences, largely because large plants reduce soil moisture, and rapidly growing plants produce litter that enhances nutrient availability.

At regional scales, large size and high stomatal conductance promote evapotranspiration and therefore precipitation, whereas small size or sparse vegetative cover dissipates more energy as sensible heat, leading to higher air temperatures. At high latitudes, large size reduces albedo by covering the snow with a dark surface, thereby promoting regional warming during winter and spring. The increasing recognition of the importance of plant traits in influencing ecosystem processes and climate provide a central role for physiological ecology in studies of ecosystem and global processes. These physiological processes are now being incorporated into **Dynamic Global Vegetation Models (DGVMs)** to simulate the changes in competitive balance and species shifts expected to occur in response to climatic change (Cramer et al. 2001, Woodward & Lomas 2004).

References

- Archer, S., Boutton, T.W., & Hibbard, K.A. 2001. Trees in grasslands: Biogeochemical consequences of woody plant expansion. In: Global biogeochemical cycles in the climate system, E.-D. Schulze, S.P. Harrison, M. Heimann, E.A. Holland, J. Lloyd, I.C. Prentice, & D. Schimel (eds.). Academic Press, San Diego, pp. 115–138.
- Bala, G., Caldeira, K., Wickett, M., Phillips, T.J., Lobell, D.B. Delire, C., & Mirin, A. 2007. Combined climate and carbon-cycle effects of large-scale deforestation. *Proc. Natl. Acad. Sci. USA* **104**: 6550–6555.
- Balling, R.C. 1988. The climatic impact of a Sonoran vegetation discontinuity. *Clim. Change* **13**: 99–109.
- Betts, R.A. 2000. Offset of the potential carbon sink from boreal forestation by decreases in surface albedo. *Nature* **408**: 187–190.
- Bokhari, U.G. & Singh, J.S. 1975. Standing state and cycling of nitrogen in soil-vegetation components of prairie ecosystems. *Ann. Bot.* **39**: 273–285.
- Bormann, F.H. & Likens, G.E. 1979. Pattern and process in a forested ecosystem. Springer-Verlag, New York.
- Callaghan, T.V., Björn, L.O., Chernov, Y., Chapin, F.S. III, Christensen, T., Huntley, B., Ims, R., Jolly, D., Matveyeva, N., Panikov, N., Oechel, W.C., & Shaver, G.R., 2005. Arctic tundra and polar desert ecosystems. In: Arctic climate impact assessment. Cambridge University Press, Cambridge, pp. 243–352.
- Canadell, J.G., Pataki, D.E., Gifford, R., Houghton, R.A., Luo, Y., Raupach, M.R., Smith, P., & Steffen, W. 2007. Saturation of the terrestrial carbon sink. In: Terrestrial ecosystems in a changing world, J.G. Canadell, D. Pataki, & L. Pitelka (eds.). Springer, Berlin, pp. 59–78.
- Chapin III, F.S., 2003. Effects of plant traits on ecosystem and regional processes: A conceptual framework for predicting the consequences of global change. *Ann. Bot.* **91**: 455–463.
- Chapin F.S. III, McFadden, J.P., & Hobbie, S.E. 1997. The role of arctic vegetation in ecosystem and global processes. In: Ecology of arctic environments, S.J. Woodin & M. Marquiss (eds.). Blackwell Scientific, Oxford, pp. 121–135.
- Chapin, F.S. III, Sturm, M., Serreze, M.C., McFadden, J.P., Key, J.R., Lloyd, A.H., McGuire, A.D., Rupp, T.S., Lynch, A.H., Schimel, J.P., Beringer, J., Chapman, W.L., Epstein, H.E., Euskirchen, E.S., Hinzman, L.D., Jia, G., Ping, C.-L., Tape, K.D., Thompson, C.D.C., Walker, D.A., & Welker, J.M. 2005. Role of land-surface changes in arctic summer warming. *Science* **310**: 657–660.
- Chapin, F.S. III, Woodwell, G.M., Randerson, J.T., Lovett, G.M., Rastetter, E.B., Baldocchi, D.D., Clark, D.A., Harmon, M.E., Schimel, D.S., Valentini, R., Wirth, C., Aber, J.D., Cole, J.J., Goulden, M.L., Harden, J.W., Heimann, M., Howarth, R.W., Matson, P.A., McGuire, A.D., Melillo, J.M., Mooney, H. A., Neff, J.C., Houghton, R.A., Pace, M.L., Ryan, M.G., Running, S.W., Sala, O.E., Schlesinger, W.H., & Schulze, E.-D. 2006. Reconciling carbon-cycle concepts, terminology, and methods. *Ecosystems* **9**: 1041–1050.
- Choudhury, B.J. 1987. Relationships between vegetation indices, radiation absorption, and net photosynthesis evaluated by a sensitivity analysis. *Rem. Sens. Env.* **22**: 209–233.
- Ciais, P., Tans, P.P., Trolier, M., White, J.W.C., & Francey, R.J. 1995. A large northern hemisphere terrestrial CO₂ sink indicated by the ¹³C/¹²C ratio of atmospheric CO₂. *Nature* **269**: 1098–1102.
- Cole, D.W. & Rapp, M. 1981. Elemental cycling in forest ecosystems. In: Dynamic properties of forest ecosystems, D.E. Reichle (ed.). Cambridge University Press, Cambridge, pp. 341–409.
- Cramer, W., Bondeau, A., Woodward, F.I., Prentice, I.C., Betts, R.A., Brovkin, V., Cox, P.M., Fisher, V., Foley, J.A., Friend, A.D., Kucharik, C., Lomas, M.R., Ramankutty, N., Sitch, S., Smith, B., White, A., & Young-Molling, C. 2001. Global response of terrestrial ecosystem structure and function to CO₂ and climate change: Results from six dynamic global vegetation models. *Global Change Biol.* **7**: 357–373.
- D'Antonio, C.M. & Vitousek, P.M. 1992. Biological invasions by exotic grasses, the grass-fire cycle, and global change. *Annu. Rev. Ecol. Syst.* **23**: 63–87.
- Davidson, E.A. & Ackerman, I.L. 1993. Changes in soil carbon inventories following cultivation of previously untilled soils. *Biogeochemistry* **20**: 161–164.
- Davidson, E.A. Neill, C., Krusche, A.V., Ballester, V.V.R., Markewitz, D., & Figueiredo, R. de O. 2004. Loss of nutrients from terrestrial ecosystems to streams and the atmosphere following land use change in Amazonia. In: Ecosystems and land use change geophysical monograph series 153, R. DeFries, G. Asner, & R.H. Houghton

- (eds.). American Geophysical Union, Washington, pp. 147–158.
- Denning, A.S., Fung, I.Y., & Randall, D. 1995. Latitudinal gradient of atmospheric CO₂ due to seasonal exchange with land biota. *Nature* **376**: 240–243.
- Euskirchen, S.E., McGuire, A.D., & Chapin III, F.S. 2007. Energy feedbacks to the climate system due to reduced high latitude snow cover during 20th century warming. *Global Change Biol.* **13**: 2425–2438.
- Farquhar, G.D. 1989. Models of integrated photosynthesis of cells and leaves. *Phil. Trans. R. Soc. Lond. Series B* **323**: 357–367.
- Field, C.B. 1991. Ecological scaling of carbon gain to stress and resource availability. In: Integrated responses of plants to stress, H.A. Mooney, W.E. Winner, & E.J. Pell (eds.). Academic Press, San Diego, pp. 35–65.
- Field, C.B., Lobell, D.B. Peters, H.A. & Chiariello, N.R. 2007. Feedbacks of terrestrial ecosystems to climate change. *Annu. Rev. Environ. Res.* **32**: 1–29.
- Foley, J.A., Kutzbach, J.E., Coe, M.T., & Levis, S. 1994. Feedbacks between climate and boreal forests during the Holocene epoch. *Nature* **371**: 52–54.
- Foley, J.A., Coe, M.T., Scheffer, M., & Wang, G. 2003a. Regime shifts in the Sahara and Sahel: Interactions between ecological and climatic systems in Northern Africa. *Ecosystems* **6**: 524–539.
- Foley, J.A., Costa, M.H., Delire, C., Ramankutty, N., & Snyder, P. 2003b. Green surprise? How terrestrial ecosystems could affect Earth's climate. *Front. Ecol. Environ.* **1**: 38–44.
- Gedney, N., Cox, P.M., Betts, R.A., Boucher, O., Huntingford, C., & Stott, P.A. 2006. Detection of a direct carbon dioxide effect in continental river runoff. *Nature* **439**: 835–838.
- Goetz, S.J., Bunn, A.G., Fiske, G.A., & Houghton, R.A. 2005. Satellite-observed photosynthetic trends across boreal North America associated with climate and fire disturbance. *Proc. Natl. Acad. Sci. USA* **102**: 13521–13525.
- Goulden, M.L., Daube, B.C., Fan, S.-M., Sutton, D.J., Bazzaz, A., Munger, J.W., & Wofsy, S.C. 1997. Physiological responses of a black spruce forest to weather. *J. Geophys. Res.* **102D**: 28987–28996.
- Goward, S.N., Tucker, C.J., & Dye, D.G. 1985. North American vegetation patterns observed with the NOAA-7 advanced very high resolution radiometer. *Vegetatio* **64**: 3–14.
- Graetz, R.D. 1991. The nature and significance of the feedback of change in terrestrial vegetation on global atmospheric and climatic change. *Climatic Change* **18**: 147–173.
- Gray, J.T. & Schlesinger, W.H. 1981. Nutrient cycling in Mediterranean type ecosystems. In: Resource use by chaparral and matorral, P.C. Miller (ed.). Springer-Verlag, New York, pp. 259–285.
- Grime, J.P. & Hunt, R. 1975. Relative growth rate: Its range and adaptive significance in a local flora. *J. Ecol.* **63**: 393–422.
- Harte, J. & Kinzig, A.P. 1993. Mutualism and competition between plants and decomposers: Implications for nutrient allocation in ecosystems. *Am. Nat.* **141**: 829–846.
- Henderson-Sellers, A., McGuffie, K., & Gross, C. 1995. Sensitivity of global climate model simulations to increased stomatal resistance and CO₂ increase. *J. Climat.* **8**: 1738–1756.
- IPCC. 2007. Climate Change 2007: The Physical Science Basis. In: Contribution of working group I to the fourth assessment report of the intergovernmental panel on climate change, S. Solomon, D. Qin, M. Manning, Z. Chen, M. Marquis, K. B. Averyt, M. Tignor, & H.L. Miller (eds.). Cambridge University Press, Cambridge.
- Kasischke, E.S., Christensen, N.L., & Stocks, B.J. 1995. Fire, global warming, and the carbon balance of boreal forests. *Ecol. Appl.* **5**: 437–451.
- Kasischke, E.S., & Turetsky, M.R. 2006. Recent changes in the fire regime across the North American boreal regional and temporal patterns of burning across Canada and Alaska. *Geophys. Res. Lett.* **33**: doi:10.1029/2006GL025677.
- Kauppi, P.E., Mielikäinen, K., & Kuusela, K. 1992. Biomass and carbon budget of European forests, 1971 to 1990. *Science* **256**: 70–74.
- Kays, S. & Harper, J.L. 1974. The regulation of plant and tiller density in a grass sward. *J. Ecol.* **62**: 97–105.
- Kelliher, F.M., Leuning, R., Raupach, M.R., & Schulze, E.-D. 1995. Maximum conductances for evaporation from global vegetation types. *Agric. For. Meteorol.* **73**: 1–16.
- Kurz, W.A. & Apps, M.J. 1995. An analysis of future carbon budgets of Canadian boreal forests. *Water Air Soil Poll.* **82**: 321–331.
- Lata, J.-C., Degrange, V., Raynaud, X., Maron, P.-A., Lensi, R., & Abbadie, L. 2004. Grass populations control nitrification in savanna soils. *Funct. Ecol.* **18**: 605–611.
- Liu, H.P., Randerson, J.T., Lindfors, J., & Chapin, F.S. III. 2005. Changes in the surface energy budget after fire in boreal ecosystems of interior Alaska: An annual perspective. *J. Geophys. Res.* **110**: D13101, doi:10.1029/2004JD005158.
- Lloyd, A.H., Rupp, T.S., Fastie, C.L., & Starfield, A.M. 2003. Patterns and dynamics of treeline advance on the Seward Peninsula, Alaska. *J. Geophys. Res.* **107**: NO. D2, 8161, doi:10.1029/2001JD000852.
- Lynch, J.A., Clark, J.S., Bigelow, N.H., Edwards, M.E., & Finney, B.P. 2002. Geographical and temporal variations in fire history in boreal ecosystems of Alaska. *J. Geophys. Res.* **108**: 8152, doi:10.1029/2001JD000332.
- McGuire, A.D., Chapin III, F.S., Walsh, J.E., & Wirth, C. 2006. Integrated regional changes in arctic climate feedbacks: Implications for the global climate system. *Annu. Rev. Environ. Res.* **31**: 61–91.
- Milich, L. & Weiss, E. 2000. GAC NDVI interannual coefficient of variation (CoV) images: Ground truth sampling of the Sahel along north-south transects. *Int. J. Rem. Sens.* **21**: 235–260.
- Monteith, J.L. 1977. Climate and the efficiency of crop production in Britain. *Phil. Trans. R. Soc. Lond. B* **281**: 277–294.
- Niklas, K.J. & Enquist, E.J. 2001. Invariant scaling relationships for interspecific plant biomass production rates and body size. *Proc. Natl. Acad. Sci. USA* **98**: 2922–2927.
- Odum, E.P. 1969. The strategy of ecosystem development. *Science* **164**: 262–270.

- Oechel, W.C., Hastings, S.J., Vourlitis, G., Jenkins, M., Riechers, G., & Grulke, N. 1993. Recent change of Arctic tundra ecosystems from a net carbon dioxide sink to a source. *Nature* **361**: 520–523.
- Payette, S. & Fillion, L. 1985. White spruce expansion at the tree line and recent climatic change. *Can. J. For. Res.* **15**: 241–251.
- Randerson, J.T., Liu, H., Flanner, M., Chambers, S.D., Jin, Y., Hess, P.G., Pfister, G., Mack, M.C., Treseder, K.K., Welp, L., Chapin, F.S. III, Harden, J.W., Goulden, M.L., Lyons, E., Neff, J.C., Schuur, E.A.G., & Zender, C. 2006. The impact of boreal forest fire on climate warming. *Science* **314**: 1130–1132.
- Reich, P.B. & Oleksyn, J. 2004. Global patterns of plant leaf N and P in relation to temperature and latitude. *Proc. Natl. Acad. Sci. USA* **101**: 11001–11006.
- Robles, M. & Chapin III, F.S. 1995. Comparison of the influence of two exotic species on ecosystem processes in the Berkeley Hills. *Madroño* **42**: 349–357.
- Running, S.W. & Coughlan, J.C. 1988. A general model of forest ecosystem processes for regional applications. I. Hydrologic balance, canopy gas exchange and primary production processes. *Ecol. Modelling* **42**: 125–154.
- Sala, O.E., Parton, W.J., Joyce, L.A., & Lauenroth, W.K. 1988. Primary production of the central grassland region of the United States. *Ecology* **69**: 40–45.
- Schimper, A.F.W. 1898. Pflanzengeographie auf physiologischer Grundlage. Fisher, Jena.
- Schlesinger, W.H. 1991. Biogeochemistry: An analysis of global change. Academic Press, San Diego.
- Schoennagel, T., Veblen, T.T., & Romme, W.H. 2004. The interaction of fire, fuels, and climate across Rocky Mountain forests. *BioSci.* **54**: 661–676.
- Schulze, E.-D. & Hall, A.E. 1982. Stomatal responses, water loss and CO₂ assimilation rates of plants in contrasting environments. In: Encyclopedia of plant physiology, Vol. 12B, O.L. Lange, P.S. Nobel, C.B. Osmond, & H. Ziegler (eds.). Springer-Verlag, Berlin, pp. 181–230.
- Schulze, E.-D., Kelliher, F.M., Körner, C., Lloyd, J., & Leuning, R. 1994. Relationship among maximum stomatal conductance, ecosystem surface conductance, carbon assimilation rate, and plant nitrogen nutrition: A global ecology scaling exercise. *Annu. Rev. Ecol. Syst.* **25**: 629–660.
- Schuur, E.A.G. 2003. Productivity and global climate revisited: The sensitivity of tropical forest growth to precipitation. *Ecology* **84**: 1165–1170.
- Stern, N. 2006. The Stern review: The economics of climate change. Cambridge University Press, Cambridge.
- Tans, P.P., Fung, I.Y., & Takahashi, T. 1990. Observational constraints on the global CO₂ budget. *Science* **247**: 1431–1438.
- Tilman, D. 1988. Plant strategies and the dynamics and function of plant communities. Princeton University Press, Princeton.
- Van Cleve, K., Chapin III, F.S., Dryness, C.T., & Viereck, L.A. 1991. Element cycling in taiga forest: State-factor control. *BioSci.* **41**: 78–88.
- Vandermeer, J.H. & Goldberg, D.E. 2003. Population ecology. Princeton University Press, Princeton.
- Vitousek, P.M. 2004. Nutrient cycling and limitation: Hawaii as a model system. Princeton University Press, Princeton.
- Vitousek, P.M. & Howarth, R.W. 1991. Nitrogen limitation on land and in the sea: How can it occur? *Biogeochemistry* **13**: 87–115.
- Vitousek, P.M., Aber, J.D., Howarth, R.W., Likens, G.E., Matson, P.A., Schindler, D.W., Schlesinger, W.H., & Tilman, G.D. 1997. Human alteration of the global nitrogen cycle: Sources and consequences. *Ecol. Appl.* **7**: 737–750.
- Walsh, J.E., Zhou, X., Portis, D., & Serreze, M. 1994. Atmospheric contribution to hydrologic variations in the arctic. *Atmosphere-Ocean* **32**: 733–755.
- Wardle, D.A., Walker, L.R., & Bardgett, R.D. 2004. Ecosystem properties and forest decline in contrasting long-term chronosequences. *Science* **305**: 509–513.
- Weller, D.E. 1987. A reevaluation of the $-3/2$ power rule of plant self-thinning. *Ecol. Monogr.* **57**: 23–43.
- Wofsy, S.C., Goulden, M.L., Munger, J.W., Fan, S.-M., Bakwin, P.S., Daube, B.C., Bassow, S.L., & Bazzaz, F.A. 1993. Net exchange of CO₂ in a mid-latitude forest. *Science* **260**: 1314–1317.
- Woodward, F.I. & Lomas, M.R. 2004. Vegetation dynamics: Simulating responses to climatic change. *Biol. Rev.* **79**: 643–670.
- Yoda, K., Kira, T., Ogawa, H., & Hozumi, K. 1963. Self-thinning in overcrowded pure stands under cultivated and natural conditions. *J. Biol. Osaka City Univ.* **14**: 107–129.
- Zimov, S.A., Chuprynin, V.I., Oreshko, A.P., Chapin III, F.S., Reynolds, J.F., & Chapin, M.C. 1995. Steppe-tundra transition: An herbivore-driven biome shift at the end of the Pleistocene. *Am. Nat.* **146**: 765–794.
- Zimov, S.A., Davidov, S.P., Voropaev, Y.V., Prosiannikov, S.F., Semiletov, I.P., Chapin, M.C., & Chapin, F.S. III. 1996. Siberian CO₂ efflux in winter as a CO₂ source and cause of seasonality in atmospheric CO₂. *Clim. Change* **33**: 111–120.

Glossary

- Abaxial** located on the side furthest from the axis, e.g., the lower side of a leaf
- Abiotic** not directly caused or induced by organisms
- Absorbance** fraction of radiation incident on a surface that is absorbed
- Abscisic acid, ABA** *phytohormone* (15-carbon compound that resembles the terminal portion of some *carotenoid* molecules) involved in *stress* responses; its name is derived from its involvement in leaf abscission; it reduces cell expansion and causes *stomatal* closure
- Acclimation** Increased tolerance to *stress* and/or improved plant performance as a result of structural and physiological adjustment by individual plants to specific environmental conditions (see also *plasticity*)
- Accumulation** build-up of storage products resulting from an excess of supply over *demand*; also termed interim deposition
- Acidifuge** avoiding acid soils; with a preference for a substrate that does not have a low pH
- Active (or reactive) oxygen species (ROS)** hydrogen peroxide (H_2O_2), superoxide radicals ($\text{O}_2^{\cdot-}$), and hydroxyl radicals ($\text{OH}\cdot$), the compounds can cause cell damage, but are also involved in *signal transduction*
- Active transport** transport of molecules across a *membrane* against an electrochemical gradient through expenditure of metabolic energy
- Acyanogenic** not releasing cyanide
- Adaptation** evolutionary adjustment of the genetic basis of a trait that enhances the performance in a specific environment
- Adaxial** located on the side nearest to the axis, e.g., the upper side of a leaf
- Adsorption** binding of ions or molecules to a surface (e.g., of a soil particle or a root)
- Advection** net horizontal transfer of gases
- Aerenchyma** tissue with large air spaces that facilitate transport of gases in plants
- Agglutinin** synonym for *lectin*
- Albedo** fraction of the incident short-wave radiation reflected by a surface (typically plant cover or bare soil or rock)
- Alkaloid** *secondary plant compound* (often toxic), characterized by its alkaline reaction and a heterocyclic ring (e.g., nicotine, caffeine, and colchicine)
- Allelochemical** *secondary metabolite*, released by living plants or decomposing plant *litter* that (either negatively or positively) affects other organisms
- Allelopathy** suppression of growth of one plant by another of a different species due to the release of toxic substances
- Allocation** proportional distribution of products or newly acquired resources among different organs or functions in a plant
- Alternative oxidase** *mitochondrial enzyme* catalyzing the transfer of electrons from ubiquinol (the reduced form of ubiquinone) to O_2

- Alternative pathway (of respiration)** nonphosphorylating electron-transport pathway in the inner *membrane* of plant *mitochondria*, transporting electrons from ubiquinol (the reduced form of ubiquinone) to O₂, catalyzed by the *alternative oxidase*
- Amphistomatous** with *stomata* at both the *adaxial* (upper) and *abaxial* (lower) sides of a leaf
- Amylase** *starch*-hydrolyzing enzyme
- Anion** negatively charged ion
- Anisotropic** not equal in all directions; for example, the longitudinal walls of anisotropic cells have different chemical and biophysical properties from those of the radial walls
- Anoxia** absence of oxygen in (part of) a plant's environment
- Annual** species with a life cycle of less than a year; the short life cycle can be environmentally or developmentally determined
- Antiport** Co-transport of one compound in one direction coupled to transport of another compound (mostly H⁺) in the opposite direction
- Apatite** Ca₅(PO₄)₃(OH,F); it accounts for 95% of the total P in igneous rock, and it constitutes a major substrate for weathering, which releases inorganic phosphate for plants and microorganisms
- Apoenzyme** Enzymatic protein that requires a *coenzyme* to function
- Apoplast (=apoplasm)** space in a plant's tissue outside the space enclosed by plasma *membranes* (*symplast*); it includes the *cell walls* and the dead tissues of the xylem
- Apoplastic (=apoplasmic) phloem loading** transport of assimilates from *mesophyll* to the sieve tubes of the *phloem* occurring partly through the *apoplast*
- Aquaporin** water-channel protein in a *membrane*
- Arbuscular mycorrhiza** a type of *mycorrhiza* that forms arbuscules (highly branched exchange structures) within cortical cells of the root
- Assimilation** incorporation of an inorganic resource (e.g., CO₂ or NH₄⁺) into organic compounds (in the case of CO₂ assimilation also used as a synonym for *photosynthesis*)
- ATPase** enzyme catalyzing the *hydrolysis* of ATP, producing ADP and P_i; the energy from this hydrolysis is used to pump protons across a membrane (e.g., *plasma membrane*, *tonoplast*), thus generating an electrochemical gradient
- ATPase/ATP synthase** enzyme complex in the inner *membrane* of *mitochondria* and the *thylakoid membrane* of *chloroplasts* catalyzing the formation of ATP, driven by the *proton-motive force* (pmf)
- Autotoxicity** deleterious effect of a chemical compound released by plants of the same species
- Autotrophic growth** increment in mass, volume, length, or area of plants or parts thereof which depend on carbon fixed in *photosynthesis* by the growing organism itself (see also *heterotrophic growth*)
- Autotrophic respiration** *respiration* by autotrophic plants and their associated *mycorrhizas* and *symbiotic N₂-fixing* structures (see also *heterotrophic respiration*)
- Auxin** *phytohormone* (indole-3-acetic acid) involved in growth promotion and meristem *differentiation*; the name literally means enhancing and is derived from its growth-promoting action; there are also synthetic auxins
- Avoidance** plant *strategy* of resisting adverse conditions by preventing deleterious effects of these conditions, e.g., winter seed *dormancy*
- Bacteroid** state of *rhizobia* after they have penetrated the root and the *symbiosis* has been established
- Bark** Tissue with both a protective (outer bark) and transport (inner bark) function; inner bark consists of secondary *phloem* that carries sugars, amino acids, and minerals from a *source* to a *sink*
- Biennial** species whose individuals typically live for two growing seasons, vegetative growth in the first year and continued growth and seed production in the second year; several species known as biennials can, however, have an extended vegetative period (*monocarpic perennial*), others are strictly biennial
- Biomass** Mass of plants (and other living organisms)
- Biomass density** dry mass of plant tissue per unit of fresh mass or volume (in the first case, the presence of intercellular air spaces is not taken into account)
- Biotic** caused or induced by organisms
- Biotic filter** *biotic* interactions, which eliminate species that would otherwise have survived the *abiotic* environment of a site
- Blue-light receptors** two classes of *photoreceptors*, cryptochromes and phototropins, that absorb in the blue region of the spectrum; the receptors are involved, e.g., in the perception of irradiance and the directional component of light and thus affect *photomorphogenesis*
- Bolting** rapid extension of the flowering stalk
- Boundary layer** thin layer of air, water, or soil around the leaf or root with reduced mass

- transport and increased reliance on *diffusion* for transport processes, conditions differ from those further away
- Boundary layer conductance/resistance** *conductance/resistance* for transport of CO₂, water vapor, or heat between the leaf surface and the atmosphere measured across the *boundary layer*
- Bowen ratio** the ratio between sensible heat loss and heat loss due to *transpiration*
- Bulk density** mass of dry soil per unit volume
- Bulk soil** soil beyond the immediate influence of plant roots (see *boundary layer*)
- Bundle sheath cells** cells surrounding the vascular bundle of a leaf
- C₃ photosynthesis** photosynthetic pathway in which the first step of CO₂ *assimilation* is the *carboxylation* of ribulose 1,5-bisphosphate (RuBP) by *Rubisco*; the first product is phosphoglyceric acid (PGA), a three-carbon intermediate
- C₄ photosynthesis** photosynthetic pathway in which the first step of CO₂ *assimilation* is the *carboxylation* of phosphoenolpyruvate (PEP) by PEP carboxylase during the day; the first product is oxaloacetic acid (OAA) a four-carbon intermediate
- Calcicole** species with a preference for calcareous or high-pH soils
- Calcifuge** species that typically occupies acidic soils and is absent from calcareous or high-pH soils
- Callose** b-(1-3)-polymer of glucose, synthesized in sieve tube elements of the *phloem* in response to damage, sealing of the sieve tubes; callose is also produced in other cells upon microbial attack, thus providing a physical barrier
- Calmodulin** ubiquitous Ca²⁺-binding protein whose binding to other proteins depends on the intracellular Ca²⁺ concentration; component of *signal-transduction pathways*
- Calvin cycle (Calvin—Benson cycle, carbon reduction cycle)** pathway of photosynthetic CO₂ *assimilation* beginning with *carboxylation* of RuBP by *Rubisco*
- Canopy conductance/resistance** *conductance/resistance* for transport of CO₂, water vapor, or heat between the plant canopy and the atmosphere measured across the *boundary layer* of the canopy
- Carbamylation** reaction between CO₂ and an amino group; in many species, *Rubisco* is activated by carbamylation, catalyzed by *Rubisco activase*
- Carbonic anhydrase** enzyme catalyzing the interconversion of HCO₃⁻ and CO₂
- Carboxylate** organic acid minus its protons
- Carboxylation** binding of a CO₂ molecule to a CO₂-acceptor molecule
- Carboxylation efficiency** initial slope of the CO₂-response curve of *photosynthesis*
- Carotenoid** accessory photosynthetic pigment; carotenoids of the *xanthophyll cycle* play a role in dissipation of excess energy
- Carrier** protein involved in ion transport across a *membrane*
- Caruncle** (= *strophiole*) an outgrowth of a seed coat, near the *hilum*; preformed weak site in the seed coat
- Casparian band/strip** waxy suberin impregnation on the radial and transverse wall of *endodermis* and *exodermis* cells that renders the wall impermeable to water
- Cation** positively charged ion
- Cavitation** breakage of a water column in a xylem conduit due to air seeding
- Cellulose** structural polymer of glucose; major component of plant *cell walls* giving tensile strength
- Cell wall** structural matrix surrounding plant cells; part of the *apoplast*
- Cell-wall elasticity** reversible change in *cell-wall* dimensions
- Cell-wall extensibility** irreversible extension of *cell walls*, due to structural changes
- Chaperones** group of *stress proteins* that are encoded by a multigene family in the nucleus; chaperones bind to and stabilize an otherwise unstable conformation and, thus, mediate the correct assembly of other proteins
- Chelate** compound that combines reversibly, usually with high affinity, with a metal ion (e.g., iron, copper, or calcium)
- Chelator** *cation-binding* organic molecule, such as citric acid, malic acid, and *phytosiderophores*
- Chemiosmotic model** theory accounting for the synthesis of ATP driven by a *proton-motive force*
- Chilling injury/tolerance** injury caused by exposure of plants or tissues to low temperatures (> 0°C); *tolerance* of such temperatures
- Chitin** polymer of *N-acetylglucosamine*; component of the exoskeleton of arthropods and the *cell wall* of fungi, but **not** of plants
- Chitinase** chitin-hydrolyzing enzyme that breaks down fungal *cell walls*
- Chlorenchyma** tissue containing *chloroplasts*
- Chlorophyll** green pigment in the photosynthetic *membrane (thylakoid)* involved in light capture as the first step in *photosynthesis*

- Chloroplast** organelle (plastid) in which *photosynthesis* occurs
- Chromophore** light-absorbing constituent of a macromolecule (*photoreceptor*) that is responsible for light absorption
- Citric acid cycle** *Tricarboxylic acid cycle*
- Climax species** species that are confined to later stages of succession in a plant community; as opposite to *pioneer*
- Clonal growth** asexual production of physiologically complete plants; a form of vegetative reproduction
- Cluster roots** bottle-brush-like or Christmas-tree-like structures in roots with a dense packing of root hairs, releasing *carboxylates* into the *rhizosphere*, thus solubilizing poorly available nutrients (e.g., phosphate) in the soil
- CO₂-compensation point** CO₂ concentration at which the rate of CO₂ *assimilation* by *photosynthesis* is balanced by the rate of CO₂ production by *respiration*
- Coenzyme** a nonproteinaceous organic substance that combines with a specific protein, the *apoenzyme*
- Coevolution** evolution of two (or more) species of which at least one depends on the other as a result of selection by mutual interactions
- Cofactor** inorganic ion or *coenzyme* required for an enzyme's activity
- Cohesion theory** accounts for the ascent of sap in the xylem due to the cohesive forces between ascending water molecules under high tension and the adhesive forces between water and capillaries in the wall of xylem conduits
- Companion cell** cell type in the *phloem*, adjacent to sieve element, involved in phloem loading
- Compartmentation** restriction of compounds or processes to specific cells, or parts of a cell, such as storage of *secondary metabolites* in vacuoles
- Compatible interaction** response of a susceptible host to a virulent pathogen; positive interaction between pollen and pistil allowing guidance of the sperm cells toward the ovule
- Compatible solute** solute that has no deleterious effect on metabolism at high concentrations
- Compensation point** conditions (temperature, [CO₂], light) where net CO₂ exchange by a leaf or plant is zero (i.e., *photosynthesis* equals *respiration*)
- Competition** interaction among organisms (of the same or different species), which utilize common resources that are in short supply (resource competition), or which harm one another in the process of seeking a resource, even if the resource is not in short supply (interference competition)
- Competitive ability** probability of winning in *competition* with another species in a particular environment
- Conductance** flux per unit driving force (e.g., concentration gradient); inverse of resistance
- Constitutive** produced in constant amount (as opposed to regulated) (e.g., genes can be expressed constitutively)
- Constitutive defense** background level of plant defense in the absence of induction by herbivores or pathogens
- Construction cost** carbon and nutrients required to produce new tissue, including the *respiration* associated with the biosynthetic pathways
- Contractile roots** mature roots that decrease in length, while increasing in diameter, thus pulling the plant deeper in the soil, as in geophytes
- Convective heat transfer** direct transfer of heat (e.g., from leaf to air) and further transport by turbulent movement
- Convergent evolution** process whereby, in organisms that are not closely related, similar traits evolve independently as a result of *adaptation* to similar environments or ecological niches
- Coupling factor** *ATP synthetase* in thylakoid membrane of *chloroplasts* and inner membrane of *mitochondria*
- Crassulacean acid metabolism** photosynthetic pathway in which the first step of CO₂ *assimilation* is the *carboxylation* of phosphoenolpyruvate (PEP) by PEP carboxylase; the first product is oxaloacetic acid (OAA)—a four-carbon intermediate; in contrast to C₄ *photosynthesis*, in CAM *photosynthesis*, the CO₂ assimilation occurs predominantly during the night with open *stomata*
- Crista** fold of the inner *mitochondrial membrane*
- Critical daylength** length of the night triggering flowering
- Cross-resistance** The phenomenon in which an organism that has acquired *resistance* to one pathogen or herbivore through direct exposure simultaneously has acquired resistance to other pathogens or herbivores to which it has not been exposed. Cross-resistance arises because the biological mechanism of resistance is the same and arises through identical genetic mutations
- Cross-talk** Communication between different *signal transduction pathways*
- Cryptochrome** *blue-light-absorbing photoreceptor*, involved in *photomorphogenesis*
- Cuticle** waxy coating of external plant surfaces

- Cuticular conductance/resistance** *conductance/resistance* for transport of CO₂ or water vapor movement through the *cuticle*
- Cutin** waxy substances that are part of the *cuticle*; polymer consisting of many long-chain hydroxy fatty acids that are attached to each other by ester linkages, forming a rigid three-dimensional network
- Cyanogenic** releasing cyanide
- Cytochrome** colored, heme-containing protein that transfers electrons in the respiratory and photosynthetic electron transport chain
- Cytochrome oxidase** *mitochondrial* enzyme catalyzing the final step in the transfer of electrons from organic molecules to O₂
- Cytochrome P450** element in the synthesis of anthocyanins and in the detoxification of *xenobiotics*
- Cytochrome pathway** phosphorylating electron-transport pathway in the inner *membrane* of plant *mitochondria*, transporting electrons from NAD(P)H or FADH₂ to O₂, with *cytochrome oxidase* being the terminal oxidase
- Cytokinin(s)** a class of *phytohormones*, involved, e.g., in the delay of leaf *senescence*, cell division, cell extension, release of *dormancy* of buds, and *chloroplast differentiation*
- Cytoplasm** contents of a cell that are contained within its plasma *membrane*, but outside the vacuole and the nucleus
- Cytosol** cellular matrix in which *cytoplasmic* organelles are suspended
- Dark reaction** carbon fixation during *photosynthesis*; does not directly require light but uses the products of the light reaction (see also *Calvin cycle*)
- Dark respiration** processes in the *cytosol*, *plastids*, and *mitochondria* that break down carbon-containing compounds and generate ATP; it produces CO₂ and consumes O₂ when aerobic; when referring to gas exchange, all decarboxylation and O₂-consuming processes are included, apart from *photorespiration*
- Deciduous** Having leaves that fall off or are shed seasonally in response to specific environmental cues, such as that occurs during or preceding unfavorable seasons (see also *evergreen*)
- Decomposition** breakdown of organic matter through fragmentation, microbial and chemical alteration, and leaching
- Defense compound** *secondary metabolite* conferring some degree of protection from pathogens or herbivores
- Dehydrins** immunologically distinct family of proteins (*Lea* D11 family) that typically accumulate in plants during the late stages of embryogenesis or in response to any environmental influence that has a dehydrating effect
- Delayed greening** pattern of leaf development typical of shade-tolerant rain-forest species; leaves are initially white, red, blue, or light-green during the stage of leaf expansion, reflecting their low concentration of *chlorophyll* and associated photosynthetic proteins
- Demand** requirement; the term is used in the context of the control of the rate of a process (e.g., nutrient uptake, CO₂ *assimilation*) by the amount needed
- Demand function** dependence of net CO₂ *assimilation* rate on the intercellular or *chloroplast* CO₂ concentration, irrespective of the supply of CO₂ at ambient atmospheric CO₂ concentration
- Denitrification** microbial conversion of nitrate to gaseous nitrogen (N₂ and N₂O); nitrate is used as an electron acceptor
- Desiccation tolerance** tolerance of extreme water *stress*, with recovery of normal rates of metabolism shortly following rehydration
- Desorption** the reverse of *adsorption*
- Diaheliotropism** solar tracking in which the leaf or flower remains perpendicular to incident radiation
- Differentiation** cellular specialization
- Diffuse porous** wood in which wide and narrow xylem *vessels* are randomly distributed throughout each annual growth ring
- Diffusion** net movement of a substance along a concentration gradient due to random kinetic activity of molecules
- Diffusion shell** zone of nutrient depletion around individual roots caused by active nutrient uptake at the root surface and *diffusion* to the root from the surrounding soil (see also *boundary layer*)
- Disulfide bond** covalent linkage between two sulfhydryl groups on cysteines
- Divergent evolution** naturally selected changes in related species that once shared a common characteristic, but have come to be different during the course of their evolution
- Dormancy** state of seeds or buds that fail to grow when exposed to an environment that would otherwise have favored *germination* or growth
- Dorsiventral** having structurally different upper and lower surfaces (see also *isobilateral*)
- Down-regulation** decrease of the normal rate of a process, sometimes involving suppression of

- genes encoding enzymes involved in that process
- Ecophysiology** study of the physiological mechanisms by which organisms cope with their environment
- Ecosystem** ecological system that consists of all the organisms in an area and the physical environment with which they interact
- Ecosystem respiration** sum of plant and *heterotrophic respiration*
- Ecotone** environmental gradient
- Ecotype** genetically differentiated population that is restricted to a specific habitat
- Ectomycorrhiza** *mycorrhizal* association in some trees in which a large part of the fungal tissue is found outside the root
- Efficiency** rate of a process per unit plant resource
- Elastic modulus** force needed to achieve a certain reversible change in cell volume
- Embolism** see *cavitation*
- Emissivity** coefficient that describes the thermal radiation emitted by a body at a particular temperature relative to the radiation emitted by an ideal black body
- Endocytosis** uptake of material into a cell by an invagination of the plasma *membrane* and its internalization in a *membrane-bound vesicle*
- Endodermis** innermost layer of root cortical cells that surrounds the vascular tissue; these cells are surrounded by a suberized Casparian strip that blocks *apoplastic* transport
- Ephemeral** short lived
- Epidermis** outermost cell layer of an organ, typically covered by a *cuticle*
- Epinasty** downward bending of a plant organ; see also *hyponasty*
- Epiphyte** plant living on another plant as a support, without a *symbiotic* or parasitic association
- Ethylene** ethene (C₂H₄); a gaseous *phytohormone*; ethylene is, e.g., a signaling compound when roots are exposed to *hypoxia*, inducing *aerenchyma* formation and petiole extension
- Evapotranspiration** water loss from an *ecosystem* by *transpiration* and surface evaporation
- Evergreen** Bearing foliage that persists and remains throughout the year, as opposed to *deciduous*
- Exclusion** prevention of net entry of a molecule; it may be due to low permeability for a molecule or to its *extrusion*
- Excretion** active secretion of compounds (e.g., salt from leaves)
- Exodermis** outer cortical cell layer in roots, immediately below the *epidermis*; these cells are surrounded by a suberized Casparian strip that blocks *apoplastic* transport
- Expansin** cell-wall enzyme involved in cell expansion
- Extensin** rigid cell-wall glycoprotein, rich in hydroxyproline, that represents 5–10% of the dry weight of most primary *cell walls*; significant component of the secondary walls of sclerenchyma cells
- Extinction coefficient** coefficient describing the exponential decrease in irradiance through a compartment that absorbs radiation (e.g., a leaf, a canopy, or a pigment in solution)
- Extrusion** ion transport from root cells to the external medium, dependent on respiratory metabolism
- Exudate** compounds released by plants (mostly by roots); also xylem or *phloem* fluid that appears when the stem is severed from the roots or a cut is made in the stem
- Exudation** release of *exudates*, or the appearance of fluid from cut roots or stems
- Facilitation** positive effect of one plant on another
- Facultative CAM plants** plants that photosynthesize by *Crassulacean Acid Metabolism* (CAM) during dry periods and by C₃ or C₄ *photosynthesis* at other times
- Feedback** influence of a product of a later step in a chain on an earlier step; fluctuations in rate of the process or concentration of metabolites are minimized with negative feedbacks or amplified with positive feedbacks
- Feedforward** response in which the rate of a process is affected before any deleterious effect of that process has occurred; for example, the decline in *stomatal conductance* before the *water potential* in leaf cells has been affected
- Fermentation** anaerobic conversion of glucose to organic acids or alcohol
- Field capacity** water content that a soil can hold against the force of gravity
- Flavanols, flavines, flavones** families of *flavonoids*
- Flavonoid** one of the largest classes of plant *phenolics*, in which two aromatic rings are connected by a carbon link to a third phenyl ring; representatives of this class play a role in the *symbiosis* between *rhizobia* and legumes, as *phytoalexins*, as *antioxidants*, in the colors of flowers and as *defense compounds*

- Fluence response** response to a dosage of light
- Fluorescence** *photons* emitted when excited electrons return to the ground state
- Frost hardening** *acclimation* of a plant as a result of exposure to low temperatures that make it *frost tolerant* (e.g., hardening in autumn)
- Frost hardiness/tolerance** physiological condition that allows exposure to subzero temperatures without cellular damage
- Geotropism** growth response of plant organs with respect to gravity
- Germination (of a seed)** emergence of a part of the embryo through the seed coat, normally the radicle
- Gibberellin** class of *phytohormones*; the first gibberellin was found in the fungus *Gibberella fujikora*, from which these phytohormones derive their name; gibberellins are involved, e.g., in the promotion of seed *germination*, stem extension, and *bolting*
- Giga-** prefix denoting 10^9
- Glass** Solidlike liquid with an extremely high viscosity; examples of a glass are macaroni and “glass” as we know it from everyday life (which is **not** a solid, but a fluid, as apparent from the gradually changing properties of glass when it gets old); glass formation, rather than the formation of ice crystals, is essential to prevent damage incurred by the formation of ice crystals
- Glaucousness** shiny appearance (of leaves), due to the presence of specific wax compounds
- Glucoside** (or glycoside) compound in which a side chain is attached to glucose by an acetal bond
- Glucosinolate** secondary sulfur-containing metabolite in Brassicaceae (cabbage family) which gives these plants a distinct sharp smell and taste
- Glutathione** tripeptide (γ -glutamyl-cysteinylglycine) that acts as a reducing agent, protecting the cell against oxidative *stress*, and guards against chemical toxicity, via modification of (modified) *xenobiotics*
- Glycolipid** *membrane* lipid molecule with a short carbohydrate chain attached to a hydrophobic tail
- Glycolysis** ubiquitous metabolic pathway in the *cytosol* in which sugars are metabolized to pyruvate and/or malate with production of ATP and NADH (when pyruvate is the end product)
- Glycophyte** species restricted to nonsaline soils
- Glycoprotein** any protein with one or more covalently linked oligosaccharide chains
- Glycoside** (or glucoside) compound in which a side chain is attached to a sugar by an acetal bond
- G protein** intracellular *membrane-associated* proteins activated by several receptors
- Grana** stacked region of photosynthetic *membranes* (*thylakoids*) in *chloroplasts* that contains *photosystem II* with its *light-harvesting complex*
- Gross photosynthesis** amount of carbon dioxide assimilated in *chloroplasts*; it is measured as net *photosynthesis* plus dark *respiration*
- Growth** increment in mass, volume, length, or area of plants or parts thereof
- Growth respiration** amount of *respiration* required per unit increment in *biomass*; it is **not** a rate
- Guard cells** specialized *epidermal* cells that surround the *stomata* and regulate the size of the *stomatal pore*
- Guttation** water *exuded* by leaves due to *root pressure*
- Halophyte** species that typically grows on saline soils
- Hartig net** hyphal network of *ectomycorrhizal* fungi that have penetrated intercellularly into the cortex of a higher plant
- Haustrorium** organ that functions in attachment, penetration, and transfer of water and solutes from a host to a parasitic plant
- Heartwood** central mass of xylem in tree trunks not functioning in water transport; it often contains substances that prevent decay and has a darker color than the surrounding *sapwood*
- Heat-shock protein** protein produced upon heat or other *stresses*
- Heavy metal** metal with a mass density exceeding 5 g mL^{-1}
- Heliotropism** solar tracking; movement of a leaf or flower that follows the angle of incident radiation
- Heme** cyclic organic molecule that contains an iron atom in the center which binds O_2 in leghemoglobin and carries an electron in *cytochromes*
- Hemicellulose** heterogeneous mixture of neutral and acidic polysaccharides, which consist predominantly of galacturonic acid and some rhamnose; these *cell-wall* polymers coat the surface of *cellulose* microfibrils and run parallel to them
- Heterodimer** protein complex composed of two different polypeptide chains

- Heterotrophic growth** *growth* of plants or parts thereof which depend on carbon supplied by another organism or organ of the plant (see also *autotrophic growth*)
- Heterotrophic respiration** *respiration* by nonautotrophic organisms (see also *autotrophic respiration*)
- Hexokinase** enzyme catalyzing the *phosphorylation* of hexose sugars while hydrolyzing ATP; a specific hexokinase is involved in *sugar sensing*
- Hilum** Seed scar where the funiculus (the stalk of the ovule) was once attached
- Historical filter** historical factors that prevent a species from arriving at a site
- Homeostasis** tendency to maintain constant internal conditions in the face of a varying external environment
- Homodimer** protein complex composed of two identical polypeptide chains
- Hormone** organic compound produced in one part of a plant and transported to another, where it acts in low concentrations to control processes (*phytohormone*)
- Humic substances** high-molecular-weight polymers with abundant *phenolic* rings and variable side chains found in *humus*
- Humus** amorphous soil organic matter
- Hydraulic lift** upward movement of water from deep moist soils to dry surface soils through roots along a *water potential* gradient
- Hydrenchyma** water-storing tissue; during dehydration of a plant, water is predominantly lost from the cells in the hydrenchyma, while other cells lose relatively less water
- Hydrolysis** cleavage of a covalent bond with accompanying addition of water, —H being added to one product and —OH to the other
- Hydrophyte** plant that grows partly or wholly in water, whether rooted in the mud, as a lotus, or floating without anchorage, as the water hyacinth
- Hygrophyte** species typically occurring on permanently moist sites; see also *mesophyte* and *xerophyte*
- Hydrotropism** morphogenetic response (of roots) to a moisture gradient
- Hyponasty** Upward bending of a plant organ (see also *epinasty*)
- Hypostomatous** with *stomates* at the *abaxial* (lower) side of the leaf only
- Hypoxia** low oxygen concentration in (part of) a plant's environment
- Immobilization** nutrient absorption from the soil solution and sequestering by soil microorganisms
- Incompatible interaction** response of a resistant host to a virulent pathogen; interaction between pollen and pistil preventing sperm cells from reaching the ovule
- Induced defense** increased levels of plant *secondary metabolites* in response to herbivory or pathogen attack
- Infiltration** movement of water into the soil
- Infrared radiation** radiation with wavelengths between approximately 740 nm and 1 mm; *short-wave infrared* is emitted by the sun (<3 μm), *long-wave infrared* is emitted at Earth temperatures (>3 μm)
- Interception** acquisition of nutrients by roots as a result of growing through soil; the nutrients contained in the soil volume displaced by the growing root; precipitation water remaining in a plant canopy that does not reach the soil
- Intercrop** one crop plant grown in combination with at least one other crop on the same plot at the same time (e.g., an annual crop grown between trees)
- Interference competition** *competition* mediated by production of *allelochemicals* by a plant
- Intermediary cell** *phloem* cell in plants with a *symplastic* pathway of *phloem* loading; sucrose moves from the *mesophyll* into these cells, where it is processed to form oligosaccharides that move to the sieve tube
- Internal conductance/resistance** *conductance/resistance* for transport of CO₂ between the substomatal spaces and its *carboxylation* at the site of *Rubisco* in the *chloroplast*
- Ion channel/ion-selective channel** pore in a *membrane* made by a protein, through which ions enter single file; channels are specific and either open or closed, depending on *membrane* potential or the presence of regulatory molecules
- Isobilateral** having structurally similar upper and lower surfaces (see also *dorsiventral*)
- Isohydric** maintaining a constant water status
- Isoprene** small unsaturated hydrocarbon, containing five carbon atoms (2-methyl-1,3-butadiene); volatile compound, synthesized from mevalonic acid and precursor of other isoprenoids; can be produced in large amounts by photosynthesizing tissue at high temperatures
- Isotope discrimination** alteration of the isotopic composition of an element via processes of *diffusion*, evaporation, and chemical transformation,

due to small differences in physical and chemical properties of isotopes; typically discrimination against the rare (heavy) isotope

Isotope effect end result of various processes that have different rate constants for different isotopes of the same element

Isotope fractionation process that occurs when different isotopes of the same element have different rate constants for the same reaction or process, or chain of reactions or processes

Isotropic similar in all directions

Jasmonic acid *secondary plant compound* [3-oxo-2-(2'-*cis*-pentenyl)-cyclopropane-1-acetic acid], named after its scent from jasmine; *stress* signaling molecule in plants as well as **between** plants

Juvenile phase stage in the life cycle of a plant between the *seedling* and *reproductive* phases; the vegetative phase in herbaceous plants; typically a period of rapid *biomass* accumulation

k_{cat} catalytic constant of an enzyme: rate of the catalyzed reaction expressed in moles per mole catalytic sites of an enzyme (rather than per unit protein, as in V_{max})

K_i concentration of an inhibitor that reduces the activity of an enzyme to half the rate of that in the absence of that inhibitor

K_m substrate concentration at which a reaction proceeds at half the maximum rate

K strategy suite of traits that enable a plant to persist in a climax community

Kranz anatomy specialized leaf anatomy of C_4 species with photosynthetic *bundle sheath cells* surrounding vascular bundles

Krebs cycle *tricarboxylic acid cycle*; metabolic pathway in the *matrix* of the *mitochondrion* oxidizing acetyl groups derived from imported substrates to CO_2 and H_2O

Latent heat energy consumed or released by evaporation or condensation, respectively, of water (enthalpy of transformation); it results in respectively loss and gain of heat

Law of the minimum obsolete concept that plant growth is always limited at any point in time by one single resource; it is not valid in this strict sense

Leaf area index total leaf area per unit area of ground

Leaf area ratio (LAR) ratio between total leaf area and total plant *biomass*

Leaf conductance/resistance *conductance/resistance* for transport of CO_2 or H_2O (vapor) of a leaf (it includes the conductance/resistance for the *stomatal* and the *boundary layer* pathways in the case of H_2O , and additionally for the *internal mesophyll* pathway in the case of CO_2)

Leaf-mass density leaf dry mass per unit of fresh mass or volume (in the first case, the presence of intercellular air spaces is not taken into account)

Leaf mass per unit leaf area (LMA) leaf mass expressed per unit leaf area

Leaf mass ratio (LMR), or leaf mass fraction (LMF) ratio of leaf and whole plant *biomass*

Leaf turnover replacement of *senescing* leaves by new ones, not accounting for a change in leaf area

Lectin protein with noncatalytic sugar-binding domains; lectins are involved in defense and cellular interactions

Leghemoglobin Hemoglobin-like protein in nodules that associates with O_2 by means of a bound *heme* group

Light-compensation point irradiance level at which the rate of CO_2 *assimilation* in *photosynthesis* is balanced by the rate of CO_2 production in *respiration*

Light-harvesting complex complex of molecules of *chlorophyll*, accessory pigments, and proteins in the *thylakoid membrane* that absorbs quanta and transfers the excitation energy to the reaction center of one of the *photosystems*

Light reaction transfer of energy from absorbed light to ATP and NADP(H) in the photosynthetic *membrane* (*thylakoid*)

Light saturation (of photosynthesis) range of irradiances over which the rate of CO_2 *assimilation* is maximal and insensitive to level of irradiance

Lignan *phenolic* compound with antifungal, anti-feeding, and antitumor activity; minor component in most plants and tissues, but quantitatively more important in the wood of some tree species (e.g., redwood)

Lignin large amorphous *polyphenolic* polymer that confers woodiness to stems

Litter dead plant material that is sufficiently intact to be recognizable

Litter quality chemical properties of *litter* that determine its susceptibility to *decomposition*, largely determined by concentrations of *secondary metabolites* and nutrients

- Lockhart equation** equation that describes cell expansion in terms of *turgor* pressure and *cell-wall* properties
- Long-day plant** plant whose flowering is induced by exposure to short nights
- Long-wave infrared** radiation with wavelengths larger than approximately 3 μm emitted at Earth temperatures
- Lumen** cavity, such as the space surrounded by the *thylakoid membrane* or the trap of *Utricularia* surrounded by cells
- Luxury consumption** uptake of nutrients above the rate that enhances plant growth rate
- Lysigenous aerenchyma** Gas-transport tissue in plants that is formed from spatially selective death of expanded cells (see also *schizogenous aerenchyma*)
- Macronutrients** inorganic nutrients that a plant requires in relatively large quantities: K, Ca, Mg, N, S, P
- Macrosymbiont** larger partner (i.e., higher plant) in a *symbiosis* with a microorganism
- Maintenance respiration** *respiration* required to maintain the status quo of plant tissues
- Mass flow** movement of substances at equal rates as the fluid or gas in which they occur (e.g., transport of solutes in flowing water and CO_2 in flowing air)
- Matric potential** component of the *water potential* that is due to the interaction of water with capillaries in large molecules (e.g., clay particles in soil)
- Matrix** a substance in which other structures or organelles are embedded; used for the compartment inside *chloroplasts* or *mitochondria*, not including the *membrane* system; also used for the substance in which cell-wall macromolecules are embedded
- Mean residence time (of a nutrient in a plant)** - time a nutrient remains in the plant, between uptake by the roots and loss (e.g., due to leaf shedding, consumption by a herbivore)
- Mega-** prefix (M) denoting 10^6
- Membrane** (*phospholipid*) bilayer that surrounds cells (*plasmalemma*), cell organelles, and other cell compartments
- Membrane channel** transmembrane protein complex that allows inorganic ions, small molecules, or water to move passively cross the lipid bilayer of a *membrane*
- Membrane fluidity** loose term to describe the extent of disorder and the molecular motion within a lipid bilayer; fluidity is the inverse of viscosity
- Mesophyll** photosynthetic cells in a leaf; in a *dorsiventral* leaf often differentiated in *palisade* and *spongy parenchyma* cells
- Mesophyte** plant that typically grows without severe moisture *stresses* (see also *hygrophyte* and *xerophyte*)
- Metallophyte** species that typically grows in areas with high concentrations of certain heavy metals in the soil
- Micro-** prefix (μ) denoting 10^{-6}
- Microclimate** local atmospheric zone where the climate differs from the surrounding atmosphere. (e.g., near a leaf, within a forest and near a body of water)
- Microfibril** structural component in *cell walls*, consisting of bundles of around 50 *cellulose* molecules, that provides the tensile strength of the wall
- Metallothionein** low-molecular-mass metal-binding protein
- Micronutrients** inorganic nutrients that a plant requires in relatively small quantities: Mo, Cu, Zn, Fe, Mn, B, Cl (see *macronutrients*)
- Microsymbiont** smaller partner (i.e., microorganism) in a *symbiosis* with a higher plant
- Mimicry** resemblance of an organism to another organism or object in the environment, evolved to deceive predators, prey, pollinators, etc.
- Mineralization** breakdown of organic matter releasing inorganic nutrients in the process
- Mistletoe** xylem-tapping stem parasite
- Mitochondrion** organelle in which part of the respiratory process (*tricarboxylic acid cycle*, respiratory electron transport) occurs
- Monocarpic** life cycle that ends after a single seed production event; the plant flowers only once during its lifetime, which can be after several years or even decades of vegetative growth
- Mycorrhiza** (plural is mycorrhizae or mycorrhizas) structure arising from a symbiotic association between a mycorrhizal fungus and the root of a higher plant (from the Greek words for fungus and root, respectively)
- Mycorrhizal dependency (of plant growth)** the ratio of dry mass of mycorrhizal plants to that of plants of the same genotype grown without mycorrhizal fungus under the same environmental conditions
- Nano-** prefix (n) denoting 10^{-9}
- Net assimilation rate (NAR)** rate of plant *biomass* increment per unit leaf area; synonym is *unit leaf rate* (ULR)

- Net ecosystem carbon balance (NECB)** net change in *ecosystem* carbon content due to all processes, including *photosynthesis*, *respiration*, loss of *biomass*, leaching, and lateral movements and transfers
- Net ecosystem production (NEP)** organic carbon accumulation that equals gross *photosynthesis* minus *ecosystem respiration* or *net primary production* minus *heterotrophic respiration*
- Net primary production (NPP)** quantity of new plant material produced annually per unit ground area including lost plant parts; equals *gross photosynthesis* minus *autotrophic respiration*
- Nitrification** microbial process that transforms ammonia, via nitrite, into nitrate
- Nitrogen assimilation** incorporation of inorganic nitrogen (nitrate, ammonium) into organic compounds
- Nitrogen fixation** reduction of dinitrogen gas to ammonium by specialized microorganisms
- Nod factor** product of *nod* genes required for successful *nodulation* in the legume—*rhizobium symbiosis*
- Nod gene** *rhizobial* gene involved in the process of *nodulation*
- Nodulation** formation of nodules in symbiotic N₂-fixing plants
- Nodulins** class of plant proteins that are synthesized in legumes upon infection by *rhizobia*
- Normalized difference vegetation index (NDVI)** greenness index used to estimate above-ground net primary production from satellites, based on *reflectance* in the visible and near *infrared*
- Nuclear magnetic resonance (NMR) spectroscopy** technique used to make a spectrum of molecules with a permanent magnetic moment, due to nuclear spin; the spectra are made in a strong magnetic field that lines up the nuclear spin in all the molecules; it can, for instance, be used to measure the pH in different cellular compartments *in vivo* because the site of the peak in a spectrum depends on the pH around the molecule
- Nutrient productivity** rate of plant *biomass* increment per unit nutrient in the plant
- Nutrient resorption** withdrawal of nutrients from a plant part during *senescence* before shedding
- Nutrient-use efficiency** growth per unit of absorbed plant nutrient which equals nutrient productivity times mean residence time of the nutrient; *ecosystem* nutrient-use efficiency is the ratio of *litterfall* mass to *litterfall* nutrient content (i.e., the amount of *litter* produced per unit of nutrient lost in *senescence*)
- Opportunity costs** diminished growth resulting from diversion of resources from alternative functions that might have yielded greater growth
- Osmoregulation** adjustment of the concentration of osmotic solutes in plant cells in response to changes in soil *water potential*
- Osmosensor** system involved in sensing a change in the concentration of solutes in cells; osmosensors were first extensively studied in yeasts and subsequently also identified in plants
- Osmotic potential** component of the *water potential* that is due to the presence of osmotic solutes; its magnitude depends on solute concentration
- Oxidative pentose phosphate pathway** metabolic pathway that oxidizes glucose and generates NADPH for biosynthesis
- Oxidative phosphorylation** formation of ATP (from ADP and P_i) coupled to a respiratory electron-transport chain in *mitochondria* and driven by a proton-motive force
- Oxygenation** the binding of O₂ to a substrate, without changing the redox state of O (e.g., ribulose-1,5-bisphosphate by *Rubisco*); it also refers to the addition of O₂ to a medium (e.g., water)
- Palisade mesophyll** transversally oriented elongated photosynthetic cells at the *adaxial* side of a *dorsiventral* leaf
- PAR** *photosynthetically active radiation* (400—700 nm)
- Paraheliotropism** leaf movement that positions the leaf more or less parallel to the incident radiation throughout the day
- Parent material** rock and other substrates that generate soils through weathering
- Pectin** *cell-wall* polymer rich in galacturonic acid
- Perennial** species whose individuals typically live more than 2 years; the length of the life cycle can be indeterminate or end after a single seed production event (*monocarpic*)
- Peribacteroid membrane** plant-derived *membrane* that surrounds one or more bacteroids in root nodules
- Pericarp** matured ovulatory wall in a seed
- Pericycle** layer of outermost stelar cells, adjacent to the *endodermis*

- Permanent wilting point** soil *water potential* at which a plant can no longer absorb water from the soil; it is species specific but is generally taken to be -1.5 MPa
- Peta-** prefix (P) denoting 10^{15}
- Phenol** compound that contains a hydroxyl group on an aromatic ring
- Phenolics** aromatic hydrocarbons, many of which have antimicrobial and anti-herbivore properties
- Phenology** time course of periodic developmental events in an organism that are typically seasonal (e.g., budbreak or flowering)
- Phenotypic plasticity** range of variation of a trait in a genotype as a result of growth in contrasting environmental conditions
- Phenylalanine ammonia lyase** enzyme that catalyzes the first step in the conversion of the amino acid phenylalanine into *phenolics*
- Phloem** long-distance transport system in plants for *mass flow* of carbohydrates and other solutes
- Phosphatase** enzyme hydrolyzing organic phosphate-containing molecules
- Phospholipid** major category of *membrane* lipids, generally composed of two fatty acids linked through glycerol phosphate to one of a variety of polar groups
- Phosphorylation** process involving the covalent binding of a phosphate molecule; many enzymes change their catalytic properties when phosphorylated
- Photodamage/photodestruction** damage to/destruction of components of the photosynthetic apparatus as a result of exposure to high irradiance, frequently in combination with other *stress* factors; the result is *photoinhibition*
- Photoinhibition** decline in *photosynthetic efficiency* upon exposure to high irradiance; the decline can be transient (less than 24 hours), which is related to protection of the photosynthetic apparatus, or it can be longer lasting, which implies *photodamage*
- Photomorphogenesis** Plant development affected by light; generally under control of *photoreceptors*
- Photon** discrete unit of light that describes its particle-like properties (quantum); light also has wavelike properties
- Photon flux density (PFD)** A measure of the level of irradiance in the (near) visible spectral region; it is expressed as *photons* incident on a (horizontal) plane per unit of time; photosynthetic *photon flux density* (PPFD) refers to the *photosynthetically active* part of the spectrum; see also *quantum flux density*
- Photoperiod** length of the daylight period each day
- Photoperiodic** responding to the length of the night
- Photoreceptor** A protein with chromophore that absorbs light in a specific spectral region; it is typically the start of a *signal-transduction pathway* leading to *photomorphogenetic* events
- Photorespiration** production of CO_2 in the metabolic pathway that metabolizes the products of the *oxygenation* reaction catalyzed by *Rubisco*; see also *respiration*
- Photosynthesis** process in which light energy is used to reduce CO_2 to organic compounds; occurs in *chloroplasts* in higher plants and algae
- Photosynthetic efficiency** *efficiency* of the use of light for *photosynthesis* (*quantum yield*); mostly used in conjunction with *chlorophyll fluorescence*
- Photosynthetic nitrogen-use efficiency** rate of *photosynthesis* expressed per unit (organic) nitrogen in the photosynthesizing tissue
- Photosynthetic quotient** ratio between CO_2 uptake and O_2 release in *photosynthesis*
- Photosynthetic water-use efficiency** ratio between photosynthetic carbon gain and *transpirational* water loss
- Photosynthetically active radiation (PAR)** radiation used to drive *photosynthesis* (400–700 nm); the spectral region is similar to that of visible light, but the spectral sensitivity is different from that of the human eye
- Photosystem** unit comprising pigments and proteins where the excitation energy derived from absorbed *photons* is transferred to an electron; there are two types of photosystems (I and II) that are embedded in the photosynthetic *membrane* (*thylakoid*)
- Phototropism** growth of plant organs in response to the directional component of light perceived by the *blue-light photoreceptor* phototropin
- Phreatophyte** plant species that accesses deep layers of water
- Phyllosphere** immediate surroundings of a leaf
- Phylogenetic constraint** genetic constitution of a population or taxon that restricts evolutionary change; it can prevent the development of particular traits
- Physiological filter** physiological limitations due to intolerance of the physical environment, which prevent survivorship of plant species that arrive at a site
- Phytate** calcium salt of *myo-inositol hexakisphosphate*; organic P-storage compound in seeds and *endodermis* of some plant species and major fraction of organic P in soils

- Phytoalexin** plant defense compound against microorganism, whose synthesis is triggered by components of microbial origin
- Phytoanticipin** *constitutively* produced plant defense compound against microorganism
- Phytochelatin** sulfur-rich peptide which binds (heavy) metals
- Phytochrome** *photoreceptor* absorbing red or far-red radiation (depending on its configuration); this pigment is involved in the perception of the presence of light, light quality, and daylength
- Phytohormone** plant compound produced in one part of the plant and having its effect in another part at minute concentrations (nanomolar and picomolar range)
- Phytomining** Extracting naturally occurring metals from soils, by utilizing the uptake capacity of plants that accumulate these metals
- Phytoremediation** use of green plants to remove, contain, or render harmless environmental contaminants
- Phytosiderophore** iron-chelating organic molecule in grasses
- Pico-** prefix (p) denoting 10^{-12}
- Pioneer** species that is a major component of a vegetation at early stages of *succession*; used in contrast to *climax species*
- Pit** narrow channel through the thick secondary walls of *vessel* elements in xylem
- Pit membrane** relatively thin structure in each *pit* which is formed from the primary *cell wall* and consists of a dense network of hydrophilic *cellulose* polymers
- Plasmalemma** *plasma membrane*; external membrane surrounding the *cytoplasm*
- Plasmodesma(ta)** minute *membrane*-lined channels that traverse the plant *cell wall* to provide a *cytoplasmic* pathway for transport of substances between adjacent cells
- Plasmolysis** separation of the *cytoplasm* from the *cell wall* due to water loss; only happens in water, not in air
- Plasticity** the ability of an organism to adjust depending on the external environment
- Pneumatophore** specialized portion of the root that emerges from water-logged soils, believed to be used for gas exchange
- Poikilohydric** plants or plant parts (seeds, pollen) that can dry out without losing their capacity to function upon rehydration
- Post-illumination CO₂ fixation** CO₂ fixation that occurs briefly after a light pulse
- ppb** part per billion; 1 nmol mol^{-1} ; 1 ng g^{-1} ; nl l^{-1} (not an acceptable SI unit)
- ppm** part per million; $1 \text{ } \mu\text{mol mol}^{-1}$; $1 \text{ } \mu\text{g g}^{-1}$; $\mu\text{l l}^{-1}$ (not an acceptable SI unit)
- Pressure chamber** chamber in which a plant or part thereof can be pressurized; it is, among others, a part of the equipment used to determine the *water potential* in the xylem of plant stems
- Pressure potential** pressure component of the *water potential*; it is positive in nonplasmolyzed living plant cells (*turgor*) and negative in the xylem of transpiring plants (suction)
- Pressure probe** microcapillary that is injected in a living cell to measure cell *turgor*
- Protease/proteinase** protein-hydrolyzing enzyme
- Protein turnover** breakdown and synthesis of proteins that does not account for a change in protein concentration
- Proteoid root (=cluster root)** cluster root; a short-lived dense package of root hairs that exudes nutrient solubilizing compounds; the name stems from the family of the Proteaceae
- Protocarnivory** capability of plants to digest arthropods or other organic items that are trapped on sticky surfaces or in "tank" traps and absorb the breakdown products of the trapped material
- Proton co-transport** transport mechanism that allows movement of a compound against the electrochemical gradient for that molecule, using the *proton-motive force*
- Proton-motive force** driving force across cell *membranes* due to a membrane potential and/or proton gradient
- Protoplasmic streaming** flow of the *cytoplasm*, mediated by the cytoskeleton
- Protoplast** cell *membrane* with *cytoplasm* and cell organelles inside; it is isolated after enzymatic removal of the *cell wall*
- Pulvinus** "joint" in a petiole that allows the movement of a leaf, due to transport of ions between cells in the pulvinus, followed by changes in *turgor* (e.g., in many legumes)
- Q₁₀** change in rate of a reaction in response to a 10°C change in temperature
- Qualitative defense compound** highly toxic secondary plant metabolite that protects against attack by herbivores at low concentration
- Qualitative long-day plant** plant that will not flower unless the length of the night gets below a critical value
- Qualitative short-day plant** plant that will not flower unless the length of the night gets above a critical value

- Quantitative defense compound** secondary plant metabolite that gives some protection against attack against a broad range of herbivores when present in large amounts
- Quantitative long-day plant** plant whose flower induction is promoted by exposure to short nights
- Quantitative short-day plant** plant whose flower induction is promoted by exposure to long nights
- Quantum flux density** a measure of the level of irradiance; it is expressed as quanta incident on a (horizontal) plane per unit of time; see also *photon flux density*
- Quantum yield** moles of CO₂ fixed or O₂ evolved in *photosynthesis*, or electrons transported in the photosynthetic *membrane*, per mole of quanta absorbed; in the context of gas exchange often restricted to the linear, light-limited part of the *photosynthesis*—irradiance curve; when measuring chlorophyll fluorescence, it refers to the full range of photosynthetic irradiance
- Recalcitrant organic matter** soil organic matter that takes a long time to be decomposed
- Recalcitrant seeds** seeds that do not tolerate desiccation and are consequently difficult to store for longer periods; they typically germinate shortly after dispersal without first going through a phase of *dormancy*
- Receptor** protein with a high affinity and specificity for a signaling molecule (e.g., a *phytohormone*), which is the start of a *signal-transduction pathway*
- Reductive pentose phosphate pathway** metabolic pathway that utilizes NADPH produced in the light reaction of *photosynthesis* and produces triose-phosphate
- Reflectance** fraction of radiation incident on a surface that is reflected (e.g., a leaf, or the Earth surface)
- Relative humidity** water vapor concentration of air relative to the maximum water vapor concentration at that temperature
- Relative water content** water content of a plant tissue relative to the water content at full hydration
- Reserve formation** build-up of storage products that result from diversion of plant resources to storage from alternative *allocations*, such as growth
- Resistance (against stress)** plant capacity to minimize the impact of *stress* factors in the environment, either by the presence of tolerance mechanisms or by *avoidance* of the stress
- Resorption** translocation of nutrients and soluble organic compounds from senescing tissues prior to abscission
- Resource competition** use of the same pool of growth-limiting resources by two or more plants
- Respiratory quotient** ratio between CO₂ release and O₂ consumption in *dark respiration*
- Resurrection plant** plant that withstands complete dehydration and resumes functioning upon rehydration
- Rhizobia** collective term for bacteria that fix N₂ in *symbiosis* with legumes or *Parasponia* of the genera *Rhizobium*, *Bradyrhizobium*, *Sinorhizobium*, *Mesorhizobium*, and *Azorhizobium*
- Rhizosphere** zone of soil influenced by the presence of a root
- Ring porous** wood in which xylem *vessels* produced early in the growing season are longer and wider than those produced in late wood, adding to the distinction of annual growth rings
- Rock phosphate** Inorganic phosphate compound with very low solubility
- Root density** total root length per unit soil volume
- Root-mass density** see *biomass density*
- Root-mass ratio (RMR)** ratio between root *biomass* and total plant biomass, synonym is root mass fraction (RMF)
- Root pressure** positive *water potential* in the xylem due to ion transport into the xylem of roots and subsequent osmotic uptake of water
- Root shoot ratio** ratio between root and shoot *biomass*
- Root turnover** replacement of (old) roots by new ones, not accounting for a change in the total amount of roots
- Roughness** unevenness of a surface that creates turbulence and enhances convective exchange between the surface and the atmosphere
- Rubisco** ribulose-1,5-bisphosphate carboxylase/oxygenase; enzyme catalyzing the primary step in the Calvin-cycle, the attachment of CO₂ to the CO₂-acceptor molecule ribulose 1,5-bisphosphate (RuBP); also catalyzes the *oxygenation* of RuBP
- Rubisco activase** protein catalyzing the carbamylation of *Rubisco* that regulates its activity; chaperone protein protecting the catalytic sites of *Rubisco* at extreme temperatures and in darkness

- Ruderal species** species that flourish on disturbed sites and complete their life cycle relatively rapidly
- Runoff** gravitational water loss from an *ecosystem*; the difference between precipitation and evapotranspiration (surface and groundwater runoff)
- Saline soils** soils with high salt concentration
- Salt gland** group of cells involved in salt *excretion*
- Saponin** secondary plant compound with soap-like properties
- Sapwood** most recent wood in the xylem of a tree trunk, with open xylem conduits that still function in water transport; it has often a lighter color than the innermost *heartwood*
- Scarification** breaking, scratching, or softening the seed coat to allow moisture penetration
- Schizogenous aerenchyma** Gas-transport tissue in plants that is the outcome of highly regulated and species-specific patterns of cell separation and differential cell expansion that creates spaces between cells (see also *lysigenous aerenchyma*)
- Sclerenchyma** tissue that can consist of two types of cells: sclereids and fibers, which both have thick secondary walls and are frequently dead at maturity
- Scleromorph** containing a relatively large amount of *sclerenchyma*
- Sclerophyllous** leaves that are *scleromorph*; they are thick, tough and have a thick *cuticle*
- Secondary metabolites** compounds produced by plants that are not essential for normal growth and development; they are frequently involved in the interaction with a plant's *biotic* and *abiotic* environment
- Seedling phase** recently germinated plants that still have their cotyledons attached
- Self-thinning** reduction in plant density due to increased mortality as a result of *competition*
- Senescence** programmed series of metabolic events that involve metabolic breakdown of cellular constituents and transport of the breakdown products out of the senescing organ that ultimately dies
- Serotinous** state of cones on a tree that remain closed with release of seeds delayed or occurring gradually
- Serpentine soil** soils that naturally contain high levels of various heavy metals and magnesium, but low concentrations of calcium, nitrogen, and phosphate
- Short-day plant** plants whose flowering is induced by exposure to long nights
- Signal-transduction pathway** chain of events by which a chemical messenger (e.g., a *phytohormone* or other signaling molecule) or physical (e.g., radiation) signal is sensed and relayed into a chain of molecular events that lead to a response; it can operate at the cellular or whole-plant level, involving long-distance transport of the signal
- Sink** part of the plant that shows a net import of a compound (e.g., a root is a sink for carbohydrates and a leaf is a sink for inorganic nutrients); see also *source*
- Soil texture** particle size distribution in a soil, e.g., the relative proportions of sand, silt, and clay
- Solar tracking** movement of a leaf or flower that positions this organ at a more or less constant angle relative to the incident radiation throughout the entire day
- Source** part of a plant that shows a net export of a compound (e.g., a leaf is a source for carbohydrates and a root is a source for inorganic nutrients); see also *sink*
- Specific leaf area (SLA)** leaf area per unit leaf dry mass
- Specific leaf mass** leaf dry mass per unit leaf area (LMA)
- Specific root length (SRL)** root length per unit root dry mass
- Spongy mesophyll** loosely packed photosynthetic cells at the *abaxial* side of a *dorsiventral* leaf
- Stomata** structures in the leaf *epidermis* formed by specialized epidermal cells; mostly the term refers to the pores, as well as to the stomatal apparatus
- Stomatal pore** opening in the leaf *epidermis* between two guard cells of *stomata*
- Starch** polymer of glucose; storage compound in plastids
- Stomatal conductance/resistance** *conductance/resistance* for transport of CO₂ or water vapor through the stomata
- Storage** build-up of a metabolically inactive pool of compounds that can subsequently serve to support growth or other physiological functions; see *reserve formation*
- Strategy** complex suite of traits allowing *adaptation* to a particular environment
- Stratification** breaking of seed *dormancy* by exposure of moist seeds to low temperatures
- Stress** environmental factor that reduces plant performance

- Stress protein** protein that is produced only or in greater quantities upon exposure to *stress*
- Stress response** the immediate detrimental effect of *stress* on a plant process causing reduced plant performance
- Stroma** *matrix* within the *chloroplast* containing Calvin-cycle enzymes and in which the *thylakoid membrane* system is suspended
- Strophiole (=caruncle)** an outgrowth of a seed coat, near the *hilum*; preformed weak site in the seed coat that allows entry of water when sufficiently weathered
- Suberin** polymer containing long-chain acids, hydroxy acids, alcohols, dicarboxylic acid, and *phenols*; the exact structure is not fully understood; cell-wall component in many locations (e.g., *Casparian strip*, corky periderm)
- Subsidiary cell** epidermal cell type around many stomata, located distally and laterally to a guard cell
- Succession** directional change in plant species composition resulting from biotically driven changes in resource supply
- Succulence** thick fleshy state of herbaceous tissues due to high water content; it is quantified as the volume of water in the leaf at a *relative water content* of 100% divided by the leaf area
- Succulent** plant with tissue of high degree of *succulence*
- Sugar sensing** the perception of internal sugar concentrations that is at the start of a *signal-transduction pathway*
- Summer annual** species whose seeds germinate after winter and completes its life cycle before the start of the next winter
- Sunfleck** short period of high irradiance that interrupts the background of low diffuse radiation in and under leaf canopies caused by direct sunlight that penetrates small holes in the canopy
- Supercooling** refers to the noncrystalline state of water at sub-zero temperatures
- Supply function** equation describing CO₂ *diffusion* from the atmosphere into the leaf, supplying substrate for *photosynthesis*
- Symbiosis** intimate association between two organisms of different species (in this text, the term is used when both symbionts derive a long-term selective advantage)
- Symbiosome** *membrane*-surrounded space containing one or more *rhizobia* in an infected cell of a root nodule in a legume
- Symplast** space comprising all the cells of a plant's tissues connected by *plasmodesmata* and surrounded by a *plasma membrane*
- Symplastic phloem loading** occurs in plants in which photosynthates moves from the *cytoplasm* of the *mesophyll* cells of the leaves, via *plasmodesmata*, to intermediary cells; after chemical transformation into oligosaccharides, these move, again via *plasmodesmata*, to the sieve tubes
- Symport** Co-transport of one compound in one direction coupled to transport of another compound (mostly H⁺) in the same (uniport) or opposite (*antiport*) direction
- Systemic resistance** *resistance* that is induced by a herbivore or a microorganism at a location that differs from the plant part that has been primarily affected; the organisms that induce the resistance may be parasitic or have a growth-promoting effect
- Tannin** class of protein-precipitating polymeric *phenolic* secondary plant compound; typically a *quantitative defense compound*
- TCA cycle** *Tricarboxylic acid cycle*
- Terpenoid** class of *secondary plant compounds* containing C and H, produced from the precursor mevalonic acid
- Testa** seed coat
- Thermogenic respiration** *respiration* that increases the temperature of an organ, such as the flowers of *Arum* lilies
- Thigmomorphogenesis** altered growth of plant organs in response to a physical force (touch, wind, vibrations, rain, turbulent water flow)
- Thylakoid** photosynthetic *membrane* suspended in the *stroma* in *chloroplasts*; it encloses a lumen and contains the photosynthetic pigments, electron-transport chain components and *ATP-synthase*
- Tissue-mass density** dry mass per unit volume of a tissue
- Tissue tension** result of differences in *turgor* and/or *cell-wall* elasticity between different cells in a tissue or organ; the tension is relaxed when the organ is cut, resulting in deformation; tissue tension plays an important role in the closing mechanism of the carnivorous Venus fly trap (*Dionaea*)
- Tolerance** endurance of unfavorable environmental conditions
- Tracheid** cell type in the xylem

- Trade-off** balancing of investment in mutually exclusive traits (e.g., protective structures vs. photosynthetic machinery in leaves)
- Transfer cell** cell involved in transport that has a proliferation of the plasma *membrane* causing surface enlargement (e.g., in the *phloem* of plants using the *apoplastic phloem*-loading pathway, in the *epidermis* of aquatic plants using bicarbonate)
- Translocation** transport of solutes through the *phloem*
- Transmittance** fraction of radiation incident on a body that passes through the body; mostly used with reference to leaves
- Transpiration** water loss from leaves or whole plants due to evaporation from within a leaf or other plant parts
- Tricarboxylic acid cycle (TCA cycle)** conversion of malate or pyruvate to CO₂ within the *mitochondria*
- Trichome** epidermal hair on a leaf or stem
- Trypsin** protein-hydrolyzing enzyme (in animals)
- Turgor** positive hydrostatic pressure in live plant cells
- Uncoupler** chemical compound that enhances the *membrane conductance* for protons and so uncouples electron transport from *phosphorylation*
- Unit leaf rate (ULR)** synonym for *net assimilation rate (NAR)*
- Up-regulation** increase in the normal rate of a process, sometimes involving increased transcription of genes encoding enzymes involved in that process
- V_{max}** substrate-saturated rate of a chemical conversion catalyzed by an enzyme (expressed per unit protein, rather than per mole catalytic sites as in *k_{cat}*)
- Vacuole** *membrane*-bound cell compartment filled with water and solutes; among others used for storage of sugars, nutrients, and *secondary metabolites*
- Vapor pressure deficit (VPD)** difference in actual vapor pressure and the vapor pressure in air of the same temperature and pressure that is saturated with water vapor
- Vapor pressure difference (Δw)** difference in vapor pressure between the intercellular spaces and the atmosphere
- Vegetative reproduction** asexual reproduction of plants through detachment of a part that develops into a complete plant; clonal growth
- Vegetative storage protein** proteins accumulating in vegetative plant parts (leaves and hypocotyls) at a high supply of nitrogen (e.g., in *Glycine max*)
- Vernalization** induction of flowering by exposure to low temperatures (from the Latin word *ver* = spring)
- Vessel** water-conducting element of the xylem
- Viscoelastic creep** mixture of viscous and elastic processes during *cell-wall* expansion; also unsavory character met in dark alleys
- Viviparous seeds** seeds that germinate prior to abscission from the maternal plant (e.g., mangrove species)
- Wall loosening** refers to the process during which covalent or noncovalent bonds between *cellulose* microfibrils and other macromolecules are broken, so that the cell under *turgor* can expand
- Water channel** pore for water transport in *membranes* consisting of a specialized protein (*aquaporin*); water moves single file
- Water potential** chemical potential of water divided by the molar volume of water, relative to that of pure water at standard temperature and pressure
- Water status** loose term referring to aspects of the plant's *relative water content*, *turgor*, *water potential*, etc.
- Water stress** *stress* due to shortage of water
- Water-use efficiency** ratio between the gain of (above-ground) *biomass* in growth or CO₂ in *photosynthesis* and *transpirational* water loss
- Wilting point** *water potential* at which *turgor* pressure is zero
- Winter annual** species whose seeds germinate before or in winter and completes its life cycle before the start of the next summer; typically found in Mediterranean-type climates
- Xanthophyll cycle** chemical transformations of a number of carotenoid molecules in the *chloroplast* that avoid serious damage by excess radiation
- Xenobiotic** potentially toxic chemical that is found in an organism where it is normally not occurring; can be restricted to synthetic compounds, but is also used in a wider sense

Xerophyte plant that typically grows in dry environments, see also *mesophyte* and *hygrophyte*

Yield coefficient a proportionality constant in the Lockhart equation that refers to the plasticity of *cell walls*

Yield threshold minimum *turgor* pressure for cell expansion

Zeatin a *phytohormone* belonging to the *cytokinins*, the name stems from *Zea mays* (corn), from which it was first isolated

Index

- A**
- Absciscic acid (ABA), 54, 197, 238, 325, 326–327, 340, 348, 384
- Absorbance/Absorptance, 13, 27, 29–30, 32, 33, 41–42, 228, 229
- Absorbed photosynthetically active radiation (APAR), 560
- Acclimation
elevated [CO₂], 89–90, 361–362
irradiance, 26–29, 31–36, 41–47, 55, 62–63, 124, 127, 132, 209, 237, 240, 251, 268–270, 341–347, 367, 514
shade, 26–35, 41–43, 47, 51, 63, 90, 124–125, 127, 190, 237, 251, 341–342, 345, 367, 508, 514–515
See also Temperature
- Accumulation, 6, 36, 45, 47, 49, 63, 76, 108, 118–123, 127, 133, 175, 177, 178, 180, 244, 251, 262, 273, 275, 287, 289–290, 292, 294, 298, 299, 301, 303, 329, 336–338, 340, 356, 362, 386, 390, 396, 432, 435, 454, 466, 468, 479, 483, 485, 498, 499, 511, 520, 521, 526, 549, 559, 561, 567
- Acetaldehyde, 119
- Acetic acid, 238, 326, 434
- Acetylene, 431, 434
- Acid growth, 76–79
- Acidic soils, 535, 549
- Acidification
cell wall, 324–327, 333, 348, 367, 538
soil, 415
- Acid rain, 257, 284, 307, 550
- Action potential, 537–539, 541
- Activation energy, 20, 60, 61, 225, 346
- Acyanogenic, 455–456
- Adaptation
irradiance, 28, 209, 237, 265–266, 268, 340–342, 363, 367, 381–382, 387, 389–390, 397, 398, 433, 508
shade, 28, 51, 164, 237, 340–343, 364, 386–391, 508, 509, 558
temperature, 6, 11, 51, 60–61, 84, 127–129, 165, 180, 182, 209, 211, 237, 239, 241–243, 255, 265–268, 303, 306, 309, 340–342, 375–378, 380, 382–385, 390, 391, 393–398, 433, 558, 565
See also Temperature
- Adult
Foliage, 388, 390, 398
- Adventitious roots
as affected by flooding, 358–360
- Aerenchyma
Lysigenous, 356, 357
Schizogenous, 587
- Aflatoxin, 458
- Agglutinin
nonmycorrhizal plants, 523–524
- Albedo, 561, 562, 565–566, 569
- Alcohol dehydrogenase, 119
- Alkaline soils, 271, 289, 310
- Alkaloid
UV tolerance, 239
- Allelochemical, 106, 378, 445–447, 471, 493, 511, 517, 520, 521–522, 523, 526
- Allelopathic compound, 445–447, 449
- Allelopathy, 8, 445–448, 505
- Allocation, 2, 8, 26, 59, 89, 122, 127, 130, 132–134, 139, 143, 171, 174, 180, 182, 198, 210–211, 227, 235, 248, 251, 262, 268, 270, 280–281, 296, 302–304, 321–367, 375, 386, 388–389, 391, 396–398, 418, 461–462, 464, 466, 506–507, 509–516, 518, 524, 525, 538, 547, 557–559, 563
See also Biomass; Carbon; Nitrogen; Nutrient
- Allomone, 395

- Alpine
 Environment, 2, 6, 11, 81, 127, 231, 232, 240–241, 268–269, 290, 295, 328, 347, 395, 514, 557
 plant/species, 6, 63, 226, 232, 240, 268, 332, 336, 360
- Alternative oxidase, expression
 in cluster roots, 117
 regulation, 110–112
 oxidation/reduction, 103–105, 107, 111, 114–117, 124, 126, 131
 α -keto acids, 108, 110–111
- Alternative (respiratory) path(way)
 activity in leaves, 122–123
 activity in roots, 102–103
 competition with cytochrome path, 109–110
 ecophysiological significance, 112–113
 energy overflow hypothesis, 114–117
 photosynthesis under high-light conditions, 126
 thermogenesis, 112
 when cytochrome path is restricted, 118
- Aluminum
 Resistance, 129
 specification as dependent on pH, 129–130
 toxicity, 275
- Amide, 337, 339, 350, 425, 429, 431
- Amine
 pollination, 112
- Amino acid
 uptake by roots, 159, 163, 165
- Aminocyclopropan-carboxylic acid (ACC), 326–327
- Ammonium (NH_4^+), 257, 266, 269, 275–276, 284, 291, 416, 432
- Amylase
 inhibitor of, 459
- Anaerobic soil, 121
- An- C_3 curve, 43, 68
- Absorptance, 27, 29, 41, 42, 228
- Annual plant, 506
- Anoxia, 120
- Antheraxanthin, *see* xanthophyll cycle
- Anthocyanin, 63, 213, 390–391, 471, 495
- Antifreeze proteins, 214
- Antifungal, 391, 523
- Antimetabolite, 454
- Antioxidant, 240, 459
- Antiport, 159
- Ant plant, 470
- Aphid
 cross resistance, 487–488
 phloem feeding, 160
- Apical dominance, 326, 343
- Apoplast, 85, 140, 154–157, 159, 171, 175, 179, 180, 197, 199, 214, 243, 244, 287, 294, 299, 337, 415, 418, 422, 426, 434, 437, 471, 495, 501
- Apoplastic phloem loading, 156
- Apparent quantum yield, 27
- Appressorium, 408
- Aquaporin
 effects of cytosolic acidosis, 120–121
 expression in seed coat, 157, 159
 mesophyll conductance, 25
 role in water uptake, 180
- Aquatic plant/species, 41, 80, 82–83, 85, 118, 121
- Arbuscular mycorrhiza (AM)
 litter decomposition, 546
- Arbuscule, 404, 408–409, 416
- Arctic
 Environment, 558
 plant/species, 63, 127, 261, 270, 395
- Arginine
 transport in AM hyphae, 416–417
- Arms race, 451, 465, 481, 483
- Ascomycota, 408, 410, 436
- Ascorbic acid/ascorbate (vitamin C), 41, 42, 239, 240, 459, 472
- Ash content, 138
- Asparagine, 337, 429, 431, 496
- Aspirin, 449, 457, 485
- Atmospheric deposition
 of N, 257
 of P, 257
- ATPase/ATP synthase, 14, 33, 34, 76, 106, 107, 129, 159, 199, 200, 263–265, 276, 277, 298, 409, 430
- Atropine, 451, 457, 458
- Attractant, 425, 448, 465–466
- Autoregulation
 mycorrhiza formation, 416
 nodulation, 435
- Autotoxicity, 447
- Auxin (IAA), 326
- Avoidance, 4, 52, 211, 216, 244, 288, 291, 329, 330, 359, 385, 436, 455, 464, 468, 518
- Azorhizobium, 423, 424
- Azospirillum, 422, 433
- B**
- Bacteroid, 425, 427, 429–430
- Basidiomycota, 408, 409, 410
- Benefits, 6, 7, 121, 253, 275, 403, 418, 419, 421, 469, 508, 521, 533, 543
- Benzoxazinoid, 446
- Benzyladenine, 350, 351
- Betaine, 424
- Bicarbonate, 75, 83, 130, 411
- Biennial, 63, 336, 338–339, 383, 385, 387, 393, 394
- Big-leaf model, 249, 251, 253
- Biodiversity, 421, 443, 566
- Biomass density, 480, 556
- Biotic filter, 2, 3, 6
- Blue-light receptor, 199, 203, 325
- Bodyguards, 464–466, 472
- Boron
 tolerance to deficiency, 157, 286–287
- Boundary layer
 conductance/resistance, 21, 22, 52, 53, 172, 203–204, 207, 230, 232, 234, 235, 247, 249, 251, 253, 567
- Bradyrhizobium, 423–424, 430
- Branching factor, 408, 493
- Bulliform cell, 207
- Bundle sheath cells, 65, 67, 70, 72, 152, 154, 155–156
- C**
- C_3 - C_4 intermediate, 70–73
- C_3 -CAM intermediates, 81–82, 85, 86, 90
- C_3 -plant/species, 11, 16, 17, 19, 22–23, 39–40, 56–58, 60, 64, 65, 67–71, 73, 75–76, 78, 80, 82–83, 89–90, 104, 207, 361, 519, 520, 563
- C_4 -plant/species, 22–24, 39, 58, 64, 65, 67–76, 79–81, 83, 85, 89–90, 182, 205, 207, 304, 354, 362, 514, 519–520
- Cadmium (Cd), 275, 289, 290, 292
- Caffeine, 460

- Calcareous soils, 276, 278, 288–289, 413
- Calcirole, 288–289, 310
- Calcifuge, 152, 284, 288–289, 310, 521
- Calcium (Ca)
 Deficiency, 324–327
 effect on Na⁺ influx, 264–265, 297
 phloem, 153–154, 159
 second messenger, 199, 289, 361
- Calcium-pectate complexes, 325
- Callose
 Phloem, 153–154
- Calmodulin, 287, 361
- Calvin (Benson) cycle, 12, 14, 15, 16, 18, 32–33, 36, 43–48, 51, 62, 65, 67, 73, 76, 78, 94, 140, 291
- CAM, 81–82, 85, 86, 90
- CAM cycling, 80
- CAM idling, 80
- CAM plant, 24, 75–82, 117, 182, 207, 210, 366, 367
- CAM plant/species, 11, 24, 73, 75–82, 90, 117, 182, 207, 210, 366, 367
- Canopy
 conductance/resistance, 249
 rough, 252
 smooth, 251, 252
- Canopy height, 508, 558
- Canopy roughness, 567
- Capillaroid roots, 273
- Capillary forces, 185, 186, 213
- Carbamylation, 43
- Carbohydrate status, 51, 123, 125, 251
- Carbon
 allocation, 16, 47, 51, 122, 205, 235, 279
 balance, 7, 8, 47, 87, 101, 127, 132–143, 160, 210, 228, 346, 525, 561
 budget, 127, 132, 134, 322, 333, 391, 500, 535, 545
 global, 545
 concentration, 83, 322, 323, 334, 362, 500
 isotope (¹³C), 87
 loss, 27, 120, 390, 391
 reduction (photosynthetic), 12, 14–16, 33
 sequestration, 545, 547, 549, 566
 use, 7, 122, 131–133, 139, 321–323, 333, 366, 418
- Carbon dioxide
 concentration in atmosphere, 8
 effect on respiration, 118
 greenhouse gas, 122
- Carbonic anhydrase, 23, 24, 65, 82, 83, 172
- Carbon-isotope
 Composition, 22, 56, 74, 75, 81–82, 85, 87, 206, 499, 500
 Fractionation, 22, 24, 56–57, 81, 82, 85, 388, 498, 499
- Carboxylase efficiency, 65, 68, 75–80, 203
- Carboxylate, 17, 65, 67–68, 72, 76–77, 102, 117, 129, 140, 259, 271, 273–274, 279, 285, 288–290, 292, 385, 403, 404, 412–413, 445, 483, 521
- Carboxylates
 Exudation, 140, 288
- Carboxylation, 79, 82, 89, 117, 164
- Carboxylation efficiency, 18
- Cardiac glycoside, 451, 454–455, 458
- Carnivorous plant, carnivory, 8, 175, 255, 533–543
- Carotenoid, *see* xanthophyll cycle
- Carrier, 263–265, 268, 286, 297, 310, 326, 429
- Casparian strip, 179–181
- Catalase, 210, 241, 455
- Caterpillar, 453–454, 465–466, 487
- Cation leaching, 140, 159, 260, 263, 264, 275, 284, 287, 291, 303, 310, 324, 430
- Cavitation, embolism, 188–192
- A-C_c curve, 53, 54–55, 56
- Cell
 Division, 238, 286, 287, 321, 323–324, 327, 341, 351, 352, 357, 424, 425, 427, 447, 461
 Elongation, 174, 210, 321, 325, 327, 328, 347, 355, 357, 385
 Expansion, 139, 159, 163, 323–324, 327, 328, 344, 351, 355, 390
 Number, 323, 349
 Size, 238
- Cellulose, 136, 172–173, 324–325, 352
- Cell-wall
 acidification, 324–325, 327, 333, 348, 367, 538
 elasticity, 177–178, 286, 344
 extensibility, 174, 327–328, 346, 358, 360
 plasticity, *see* yield coefficient
 thickness, 328, 365, 390
 yield coefficient, 324, 328, 344, 346, 355
- Channel
 ion, 123, 133, 134, 140–141, 259, 264–265
- Chaperone, 241, 294
- Chelator, 277, 288, 294, 537
- Chemiosmotic model, 107
- Chemoperception, 510
- Chilling
 Injury, 62, 242–243
 Sensitivity, 71
 Tolerance, 242–243
- Chitin, 413, 523, 541
- Chitinase, 427, 479, 483, 541
- Chlorenchyma, 196, 209
- Chlorophyll
 a/b ratio, 35
 concentration, 27, 31, 34–35, 90, 226, 248, 276, 341, 343, 390
- Chlorophyll fluorescence and photosynthesis, 14, 22, 31–32, 36–40, 52, 54, 63, 237, 244, 359
- Chloroplast, 11–20, 22, 24–25, 32–35, 39, 41–43, 47–48, 52, 57, 61, 65, 67, 68, 117, 132, 213, 242, 263, 327, 390, 397
- Chronosequence, 256
- Circadian clock, 393
- Citrate, Citric acid, 103, 104, 107, 108, 117, 214, 271, 273, 287–288, 290, 292, 295, 413, 448, 496
- Citrate synthase, 214
- Citric acid cycle (TCA cycle, Krebs cycle), 101, 103–104, 120, 121, 128, 132, 448, 453
- Climate, 3, 7, 8, 26, 35, 53, 73, 74, 127, 129, 177, 178, 181, 182, 183, 212, 257, 261, 329, 336, 338, 342, 354, 363, 380, 383, 386, 505, 509, 510, 519, 547, 556–557, 559–560, 563, 565–569

- Climax species, 333
 Climbing plant/species, 160
 Clonal growth, 389
 Cluster roots, proteoid roots, 117, 257, 271, 273, 335, 412, 413, 415, 517
 C/N ratio, 338
 CO₂-compensation point, 16, 18, 20, 68, 70, 72, 83, 265, 491
 CO₂ response
 Growth, 52–53
 photosynthesis, 16–21
 Coevolution, 408
 Cohesion theory, 185, 186
 Coils, 406, 409
 Cold
 Dehardening, 63, 243
 Hardening, 63, 243, 345
 hydrophilic proteins, 243
 short days, 243, 345
 stress, 242–243
 Colonization, 363, 408–410, 412, 413, 415–416, 418, 421, 479, 524, 558
 Communication, 409, 462–466, 468, 472, 510
 Companion cell, 151–152, 154–156, 158, 160
 Compartmentation, 71, 77, 242, 291, 292, 301, 455, 470, 471
 Compatible response, 485
 Compatible solute, 71, 75, 114, 122, 123, 175, 210, 216, 301, 303, 499
 Competition, 4, 47, 109, 111, 284, 286, 297, 305, 336, 340, 363, 364, 367, 385–386, 396, 415, 436, 437, 445–447, 487, 505–513, 515–526
 Competitive ability, 306, 363, 365, 472, 493, 505, 509, 512–516, 519–520, 524, 526
 Competitive strategy, 183, 367, 385, 508, 509
 Complex I, 103–104, 107, 119, 485
 bypass of, 118
 Complex II, 104
 Complex III, 104
 Complex IV, 104–105
 Conductance, 7, 18, 20–25, 32, 43, 44, 52–56, 58–60, 63, 70, 76, 80, 89, 136, 160, 172, 178–180, 182–183, 187–188, 191–199, 201–207, 210–212, 216, 230, 232, 234–235, 247, 249, 251–253, 261, 289, 347–349, 354, 357, 388, 413, 417, 436, 447, 497–498, 501, 517–518, 520, 526, 558, 566–569
 Constitutive defense, 462, 468, 480
 Construction cost
 biochemical composition, 136, 138
 carbon and ash content, 138
 elemental composition, 138
 heat of combustion, 138
 Contractile roots, 182
 Convection, convective heat transfer, 184, 225, 226, 230–232
 Convergent evolution, 6, 73, 332, 542
 Copper, 260, 275, 276, 289, 295
 Coralloid roots, 260, 275, 276, 289, 295
 Costs, 6, 7, 54, 67, 120, 123, 129, 133–144, 235, 263, 265, 270, 296, 299, 337, 340, 349, 396, 418–419, 434–435, 458, 466–469, 480, 508, 533, 535, 543
 Coupling factor, 14, 33, 34, 104, 112, 425, 487
 Coupling (between plants and atmosphere), 566–567
 Crassulacean acid metabolism, *see* CAM
 Critical daylength, 391
 Crop plant/species, 121, 186, 192, 267, 271, 273, 288, 297, 310, 342, 393, 397, 419, 456, 458, 459, 466, 472, 485
 Cross-resistance, 480, 487–488
 Cross-talk, 241, 485–487
 Cryoprotectin, 241, 485–487
 Cryoprotection, 243, 244
 Cryptochrome, 35, 329, 344, 509
 Crystal, 214, 228, 243, 289, 454
 Cuticle, 299, 307, 359, 479, 546
 Decomposition, 548
 Cuticular conductance/
 resistance, 203–204, 230
 Cuticular wax, 365
 UV tolerance, 239
 Cutin, 203
 Cyanide (HCN), 101, 103, 105, 114, 115, 395, 431, 455
 Cyanide-resistant respiration, 112, 118, 129, 482
 Cyanobacteria, 69, 83, 403, 422–423, 425
 Cyanogenic glucoside, 449, 457
 Cyanogenic lipid, 118, 455
 Cycling, 7, 80, 280, 349–350, 382, 397, 413, 421, 447, 499, 550, 563, 565
 Cyclobutane-pyrimidine dimer, 238
 Cysteine, 292, 455, 480
 Cytochrome, 14–15, 33, 101, 103–105, 107–111, 113–119, 122–124, 129–132, 135, 138, 142, 301, 448, 455, 456, 471, 537
 Cytochrome oxidase, 110, 114–115, 116, 124, 129–130, 301, 448, 455–456
 Cytochrome P-450, 471
 Cytochrome path(way), 101, 104–105, 107–118, 124, 129, 131–132, 138, 142, 537
 Cytokinin, 91, 198, 281, 325–327, 340–341, 350–353, 397, 495
 Cytosolic acidosis, 119–120
D
 Dark reaction (of photosynthesis), 11, 12, 55, 244
 Dark respiration
 Photosynthesis, 19, 27, 34, 132, 251
 Dauciform roots, 273
 Daylength, 329, 341, 345, 391–393, 398
 Day-neutral plants, 391
 Day respiration, 19
 Deciduous, 6, 25, 181, 188, 191, 196, 198, 211–212, 239, 305–309, 330, 332, 464, 506, 512, 546, 556–559, 564–566
 Decomposition, 8, 75, 257, 259, 279, 284, 306, 308, 352, 416, 433, 447, 545–552
 De-etiolation, 329, 330, 385
 Defense
 constitutive, 462, 468, 480

- direct, 448, 465, 468
 against herbivores, 8, 364, 445–460
 indirect, 465, 468
 induced, 462–464, 468, 480–481, 485
 response (in AM hosts), 408
 Defense compound, 8, 131, 136, 451, 453, 460, 461, 468, 469, 479–481, 483, 526, 546, 551
 Defoliation, 51, 339, 461, 463–464, 487
 Dehydration, 202, 209, 210, 213–215, 243, 244
 Dehydrin, 214, 244
 Delayed flowering, 387
 Delayed greening, 390
 Demand function, 18, 21, 25, 53–55
 Denitrification, 257–259, 432, 448
 Desiccation
 Avoidance, 211–212
 Resistance, 175, 178, 518
 Tolerance, 212, 384
 Desorption, 275, 296
 Detoxification, 210, 279, 285, 288, 292, 295, 302, 455, 468–472
 Development, 387–393, 394–395, 436, 492–498
 Dew point, 182, 234, 547
 Diaheliotropism, 226
 Differentiation, 192, 321, 326, 361, 461, 495
 Diffuse porous, 188, 191
 Diffusion
 Coefficient, 21, 259–261, 270, 283–284
 Rate, 261
 Shell, 260
 Digestibility-reducing
 compound, 451, 454
 Dissipation (thermal), 62–63
 Dissolved organic matter (DON), 548–549
 Disturbance, 8, 35, 362–363, 375, 380–381, 385–386, 507, 524, 556, 558, 561–562, 568
 Disulfide bond, 110
 Domatia, 469
 Dormancy, 211, 243, 303, 327, 329–330, 358, 375–378, 380–385
 Down-regulation, 51, 55, 89–91, 266, 268, 280, 291, 327, 351, 352, 412, 416, 518
 Drosophila, 241, 536
 Drought deciduous, 196, 211
 Drought effects, 211–214
 Dual-affinity transport system, 265
 Dulcitol, 152
 Dutch elm disease, 191
 Dwarf, 25, 30, 32, 137, 327, 360, 422, 491, 492, 547, 550
 E
 Early-successional species, 385, 515, 520, 524–526
 Ecological amplitude, 2, 4, 255, 284, 310
 Ecosystem, 181, 260, 308–309, 545–552, 555–569
 Ecosystem respiration, 561–562
 Ecotone, 578
 Ecotype, 26, 291, 295–296, 341, 345, 360, 392
 Ectomycorrhiza, 291, 404, 406, 408, 410, 413–414, 416, 418, 421, 517
 litter decomposition, 546, 548–551
 Eddy covariance, 251
 Efficiency, 45, 46, 53, 56, 58, 68–71, 79, 206–209, 252–253, 302–307, 308–309, 388, 492
 EGTA, 215, 537
 Elastic modulus, 176–178, 212
 Electron transport
 in chloroplasts, 18, 21, 32–33, 39, 68–69, 117–118, 242, 359
 in mitochondria, 107, 115, 485
 Elevated [CO₂]
 effects on N₂ fixation, 435
 effects on photosynthesis, 561–562
 effects on root exudation, 279–280
 Elicitation, 428, 463, 486–487
 Elicitor, 131, 428, 465, 483, 487, 488
 Embolism, cavitation, 188–192
 Embryo, 155, 157, 159, 213–214, 243–244, 375–376, 378, 384, 540
 Emission
 isoprene, 241–242
 long-wave radiation, 230
 Emissivity, 229
 Endemic species, 290
 Endocytosis
 phloem transport, 154–155
 root nodules, 428–429
 Endodermis, 179–181, 267, 346, 409
 Endophyte, 434, 436–437
 Endosymbiont, 423, 436–437
 Energy budget, 225–235
 Energy demand, 101, 124, 131, 134, 232, 451, 545, 549
 effect on glycolysis, 107–108
 Ephemeral, 578
 Epicuticular wax, 365
 UV tolerance, 239
 Epidermis, 12, 82, 159, 179, 181, 183, 209, 239–240, 267, 280, 301, 338, 359, 424, 427, 537–539
 Epiphyte, 80, 177
 Ericoid mycorrhiza, 406, 413, 416, 517, 548, 550
 litter decomposition, 546
 Essential element, 2, 304
 Ethanol, 49, 101, 119–120
 Ethylene
 aerenchyma formation, 356–357
 as affected by ABA, 353
 as affected by flooding, 358–359
 as affected by soil compaction, 355–356
 leaf senescence, 357–358
 Etiolation, 329
 Evapotranspiration, 183, 250, 297, 558, 567–569
 Evergreen, 6, 25, 62–63, 139, 171, 177, 181, 188, 191, 198, 211–212, 239, 305–309, 330, 332, 454, 464, 512, 546, 557, 558, 564, 566
 Evolution, 73–75, 157, 178, 435
 Exclusion, 123, 285, 288, 291, 294, 297, 298–299, 301, 509
 Excretion, 129, 140, 271, 273, 276, 288, 298–299, 301, 310, 403, 404, 433, 526
 Exodermis, 121, 179–181, 346
 Expansin, 324–325, 347, 348, 356–357, 360
 Extensin, 327
 Extinction coefficient, 26, 31, 248
 Extrafloral nectaries, 469
 Extrusion, 14, 83, 104–105, 109, 112, 115, 263, 275, 325, 395

- Exudate, 169, 259, 274–275, 279, 290–292, 294, 355, 408–409, 413, 435, 446, 448, 493, 545, 550, 552, 565
- Exudation, 102, 140, 192, 279–280, 287–289, 322, 335, 355, 396, 413, 416, 433, 447, 493, 526, 550, 552, 565
- F**
- Facilitation, 505, 521, 524
- Facultative CAM plants, 76, 79–80, 367
- False host, 493
- Fast- and slow-growing species (comparison), 362–363
- Feedback, 48–49, 51, 55, 58, 61, 62, 436
inhibition of photosynthesis, 47
- Feedforward, 196, 198, 203, 340–341, 344, 351, 355, 367
- Fermentation, 101, 118–120
- Fertilization, 268, 303, 310, 419, 523
- Fiber, 7, 31, 159, 160, 188, 240, 334, 344, 365, 458, 462, 513
- Fick's first law, 21
- Field capacity, 169–170, 568
- Filter
Biotic, 2–3, 6
Historical, 6
Physiological, 6, 505
- Fire, 6, 73, 336, 337, 362–363, 377–379, 385, 398, 505, 509, 520, 522, 524, 526, 550, 556, 558–559, 561
- Flavonoid, 394, 410, 425–427, 458, 480, 495
inhibition of respiration, 408, 448–449
role in legume-rhizobium recognition, 408, 424
secondary plant compound, 448–449
UV absorption, 239
- Flooding
O₂ barrier, 121–122
soil CO₂ concentration, 130
soil O₂ concentration, 355–356
- Flower induction, 393–394
- Fluence response, 329–330, 381
- Fluorescence, 14, 22, 31–32, 36–40, 52, 54, 63, 65, 80, 181, 210, 228, 237, 244, 291, 359, 501, 511
- Fluoroacetate, 453, 467
effect on aconitase (TCA cycle), 448
secondary compound, 448
- Food selection, 448–450
- Forest, 181, 196, 257, 390, 557, 558, 562, 564
- Forisomes, 154
- Formate, formic acid
exudation by mycorrhizal fungi, 413
- Frankia, 421–424, 429
- Freezing
Injury, 214–215
Resistance, 243
tolerance, 214–215, 243
short days, 243
- Frost
Damage, 62, 129, 214, 242, 243
Hardening, 243
Hardiness, 129
Protection, 243
Tolerance, 129, 243–244
role of soluble carbohydrates, 243
- Fructan, 136, 152, 175, 178, 337, 339
- Fructose
absence in phloem sap, 152
- Fruit(ing), 47, 51, 90, 131, 134, 139, 152, 157, 242, 278, 308, 377–378, 395–398, 459
- Functional equilibrium, 350, 352
- Functional type, 546, 547, 559
- Fungitoxic, 480, 523
- Fungus, 131, 133, 263, 270, 327, 404, 406, 408–410, 412, 413, 415–419, 421, 456, 480, 483, 485, 487, 523, 524, 527
- G**
- Galactose, 152, 327, 457
- Gap, 35, 167, 169, 378, 382, 385, 386, 390
- Gap detection, 385
- Gas exchange, 52–53, 79, 84, 247–253, 359, 388
- Geophyte, 182, 506
- Geotropism, 579
- Germination, 375–387, 492–494, 556
- Gibberellic acid (GA), 327, 384
- Gland
Salt, 228, 298–299, 301
- Glass, 168, 177, 214
- Glaucous(ness), 579
- Global change, 19, 130, 244, 253, 508
- Global warming, 90, 122, 505, 568
- Glomeromycota, 408, 415
- Glucose
absence in phloem sap, 151–152
reducing, 152
- Glucosinolate, 413, 448–449, 451, 459, 480
nonmycorrhizal plants, 413
qualitative defense, 453, 454
- Glutamine, 337, 429, 431, 465, 539
- Glutathione, 239, 240, 292, 471–472
- Glycine
role in photorespiration, 15
- Glycinebetain, 175, 424
- Glycolate pathway, 17
- Glycolipid, 579
- Glycolysis, 76, 101, 103, 105, 107–109, 119–120, 128, 131–132
- Glycophyte, 298, 301
- Glycoprotein, 244
- Glycoside, 449, 450, 455
- Gold (Au)
Accumulation, 291
- Grana, 12, 14, 30, 32–33, 65
- Gravitropism, 357
- Grazing, 269, 339, 448, 458, 487, 524, 552, 558, 568
- Greenhouse effect, 87
- Greenhouse gas, 122, 421
- Gross photosynthesis, 248, 561, 568
- Growth
Analysis, 322–323, 334, 341, 345, 360
Potential, 102, 132, 141, 216, 365, 466, 526
respiration, 135, 136, 140, 559
- Guard cells, 177, 199–200, 203
- Guttation, 182, 234, 579
- H**
- Halophyte
Respiration, 123
- Hartig net, 406, 410
- Harvest index, 396
- Haustorium, 493–495
- Heat
Production, 112–114, 234, 395

- shock protein
 Storage, 241, 243, 292, 294
 Heathland, 305, 306, 517
 Heavy metal
 Resistance, 291–296
 Tolerance, 290
 Toxicity, 284
 Heliotropism, 207
 Hemicellulose, 136, 324–325
 Hemiepiphyte, 177, 196, 209
 Hemiparasite, 58, 491, 492,
 494–501
 Herbicide
 Resistance, 471
 Herbivore, 445, 459, 463, 465–467,
 479–480, 487, 526, 559
 Herbivory, 54, 305, 309, 363, 365,
 385, 390, 391, 437, 449,
 461–464, 466, 469, 485, 499,
 523, 568
 Heterodimer, 457
 Heterotrophic respiration, 561
 Hexokinase, 51, 89, 349
 High-affinity transport system
 (HATS), 265, 267
 High-irradiance response (HIR),
 329, 330, 381
 Histidine, 292, 295, 296
 Historical filter, 6
 Höfler diagram, 176
 Holoparasite, 496, 497, 501
 Homeostasis, 127–129, 268
 Honeydew, 160
 Host recognition, 408, 493
 mycorrhizal fungi, 409
 parasitic plants, 408
 rhizobium, 408
 Humic substances, 287
 Humus, 279, 287, 545
 Hydathode, 183
 Hydraulic
 Conductivity, 188, 190–192,
 250, 350, 508
 Lift, 182–183, 518, 521
 Signals, 54, 197
 Hydrenchyma, 196, 209
 Hydrophyte, 356
 Hydrostatic pressure
 Cells, 155
 phloem, 151
 soil, 165
 Utricularia bladder, 539
 Xylem, 151
 Hydrotropism, 174
 Hygrophyte, 580
 Hyperaccumulation, 289, 290,
 294, 295, 480
 Hypersensitive response, 482,
 485, 488
 Hypocotyl, 325, 328–330, 338
 Hyponastic growth, 358–359
 Hypostomatous, 580
 Hypoxia
I
 IAA, auxin, 238, 326
 Ice formation, 215
 Imbibition, 118, 375, 376, 383
 Immobilization, 258, 259, 276,
 279, 294, 447, 517, 549
 Immunization, 488
 Incompatible response, 390, 482,
 485, 509
 Induced defense, 462, 464, 468,
 480, 481, 485
 Induced resistance
 Systemic, 153, 485–487
 Phloem, 153
 Infection, 131, 404, 408–410, 412,
 413, 416, 417, 419, 423, 424,
 435–436, 479–480, 482–483,
 485, 487, 495, 497, 501,
 522–523
 Infection thread, 425, 427–428
 Infiltration, 29, 297, 567
 Infrared radiation, 26, 122,
 225–229
 Inorganic phosphate (P_i), 14, 48,
 109, 120, 257, 337, 415
 Inositol phosphate, 271, 337
 Integrated pest management, 522
 Intercellular
 Space, 18, 23–24, 29, 52–53, 57,
 65, 67, 72, 121, 179, 186,
 202
 CO_2 concentration (C_i), 21
 Interception, 1, 260, 330, 510,
 559
 Intercrop(ping), 271, 273–274,
 278, 310, 472, 485, 501,
 521–522
 Interference competition,
 445–448, 505
 Intermediary cell, 154–157, 161
 Internal conductance/resistance,
 see mesophyll
 conductance/resistance
 Invertase, 178
 Ion-specific channel, 263
 Iron (Fe)
- deficiency, 121, 275
 phloem, 152
Irradiance
 Acclimation, 26–29, 31–36,
 41–47, 55, 62–63, 124,
 127, 132, 209, 237, 240,
 251, 268–270, 341–347,
 367, 514
 Adaptation, 28, 209, 237,
 265–266, 268, 340–342, 363,
 367, 381–382, 387, 389–390,
 397, 398, 433, 508
 Excess, 26, 36, 237
 Level, 33, 35, 36, 42–43, 44,
 135, 237, 329, 342, 343,
 390, 397
 spectral composition, 329,
 344–345
 Isohydric, 196–198, 216
 Isoprene, 242, 244
 Isoprene emission, 241–242
 Isotope discrimination, 117,
 206–207
 Isotope effect, 22–23, 115
 Isotope fractionation, 22, 23–24,
 56–57, 75, 81, 82, 85, 113,
 115–116, 118, 123, 124, 388,
 498–499
 Isotropic, 581
J
 Jarowization, vernalization, 387,
 393–394
 Jasmonate/jasmonic acid, 327,
 378, 462, 463, 510
 Juglone, 447
 Juvenile
 Foliage, 388
 Phase, 375, 385, 386–387
K
 Kinetin, *see* cytokinin
 Kranz anatomy, 64, 72, 85
 Krebs cycle, Tricarboxylic acid
 cycle(TCA cycle), 101,
 103, 104, 120–121, 128,
 132, 448, 453
 Kstrategy, 581
L
 Lactate/lactic acid, 101, 119–120
 Lambert-Beer, 34, 248
 Latent heat, 183, 232, 565, 567
 Late-successional species, 385,
 515, 518, 524–526, 547

- Laticifer, 456
- Law of the minimum, 581
- Leaching, 164, 257–259, 284, 306–307, 309, 447–448, 548, 561
- Lead (Pb)
Accumulation, 290–293
- Leaf
Anatomy, 27–32
as dependent on growth irradiance, 34–35
as dependent on nitrogen supply, 352
area index (LAI), 26, 247, 248, 250, 380, 510, 518, 559, 567
area ratio (LAR), 211, 253, 270, 322, 323, 342, 366, 388, 512, 557
conductance/resistance, 18, 21, 196–199, 201, 204–206, 232, 249, 251, 252, 261
dimension, 82, 232, 234, 247
elongation, 238, 328, 333–334, 348, 356, 357, 360
growth, 133–134, 211, 303, 308, 325, 327, 333, 338, 346, 348, 350, 352–354, 357, 390
hair, 228, 232, 235, 239, 365, 453, 536
hopper, 460
initiation, 198
longevity, 216, 306, 307, 342, 365, 366, 558
mass density, 59, 332–333, 334, 341, 342, 365, 366, 512, 514, 557
mass per unit leaf area (LMA), 322, 323, 332
mass ratio (LMR), 322, 323, 342, 344, 361, 366, 513
orientation, 206, 208, 226, 227
respiration, 122–123, 125, 127–135, 323, 360, 362
rolling, 175, 207, 228
senescence, 302, 308, 336, 337–338, 351, 367, 397, 398, 497, 513, 550
size, 178, 216, 508
temperature, 15, 20, 49, 52, 53, 60–63, 202, 206, 207, 209, 226–232, 234–235, 241–242, 253, 260, 360, 390, 498
thickness, 34, 59, 62, 79, 332, 343
turnover, 365–366, 566
- Leaf-cutter ants, 390–391
- Lea genes, 214
- Lectin, 457, 460, 480, 523
- Leghemoglobin, 429, 436
- Legume, 152, 159, 304, 397, 408, 422–436
- Lichen, 62, 568
- Life
Cycle, 211, 284, 329, 377, 385, 388, 398, 409, 436, 491, 494, 512
Form, 84, 331, 332, 506
Span, 59, 362, 363, 364, 365, 454, 507, 546
- Light
Extinction, 26–27
profile
in canopies, 26–27
in leaves, 31
quality, 329–330
reaction, 12, 14, 18, 45, 78, 132, 140, 237, 244
requirement (of seed germination), 380, 381, 383
saturation, 18–20, 31, 44, 70, 500
- Light-compensation point (of photosynthesis), 27, 135, 390
- Light-harvesting complex (LHC), 13, 15, 34, 237
- Lignin, 136–139, 179, 333, 334–335, 352, 446, 451, 454, 461, 466, 480, 483, 495, 546, 547, 550, 552
- Lignin:nutrient ratio
Decomposition, 546–547
- Lime chlorosis, 289
- Liming, 435
- Lipid
Composition, 346
- Lipid transfer protein, 244, 480
- Litter
Decomposition, 352, 546, 548, 550, 551
Production, 547
Quality, 546–549, 565
- Lockhart equation, 323–327, 328, 354
- Long day, 124, 339, 345–346, 387, 391–393, 433
- Long-day plant/species, 391–393
- Long-wave radiation, 226, 229–232, 234, 235
- Low-affinity transport system (LATS), 267
- Low fluence response (LFR), 329–330, 381
- Luxury consumption, 262, 268, 336, 421
- M**
- Macronutrient, 260, 310
- Macrosymbiont, 403, 413, 429, 436
- Magnesium, 257, 260, 287, 290
- Maintenance respiration
measurement, 461
protein turnover, 134–135
solute gradients, 134–135
- Malate dehydrogenase, 65, 76, 103, 175, 214
- Malate, malic acid, 65, 67, 76–78, 79, 80, 85, 86, 103–104, 107, 114, 117, 130–132, 175, 199, 203, 214, 271, 275, 287–288, 290, 292, 413, 430–431, 483, 496
- Malic enzyme, 65, 67, 76, 103, 130–131, 482, 483
- Malonate, 471
- Manganese (Mn)
Phloem, 152
Toxicity, 275
- Mangrove, 121, 299, 301, 375, 378, 550
- Mannitol
osmotic solute, 175
parasite, 495–496
phloem, 152
radical scavenger, 175
xylem, 495–496
- Mass flow, 121, 151, 153, 184, 259, 260–261, 299, 307, 310, 416
- Matric potential, 165, 168, 169, 170
- Mean residence time, 304–306, 308, 309, 512–513
- Mechanical resistance, 354
- Mediterranean, 4, 6, 81, 176, 177, 188, 201, 212, 250, 253, 261, 336, 354, 383, 390, 491, 535, 550
- Membrane
Channel, 140
Fluidity, 62, 241, 242, 346
- Meristem size, 328, 331, 333, 349
- Mesophyll
conductance/resistance (g_m), 18, 22–25, 32–33, 55, 56, 57, 60, 204

- Mesophyte, 356
 Metallophyte, 255, 290, 302, 310, 470
 Metallothionein, 292, 294
 Methane
 Flooding, 121–122
 greenhouse gas, 122
 Methyl salicylate, 465, 485
 Microbial respiration, 251, 547
 Microclimate, 225, 247, 250, 253, 510, 527
 Microfibril, 199, 203, 324–325
 Micronutrient, 539
 MicroRNA (miRNA), 153
 Microsymbiont, 403, 418–419, 420, 434–435, 437, 505, 523
 Midday depression, 180
 Midrib, 154
 Mimicry, 454, 499
 Mimosine, 447
 Mineralization, 183, 257–259, 275, 279, 280, 347, 378, 416, 517, 545, 548–550, 552, 565
 Minor vein anatomy, 154–155
 Missing sink, 563
 Mistletoe, 56, 195, 397, 491–492, 497–500
 Mitochondrial respiration, 105, 132, 447, 448
 Mitochondrion, mitochondria, 12, 15, 17, 65, 67, 70, 72–73, 78, 83, 101, 103–107, 109, 111, 112, 114, 117, 118, 126, 128–129, 132, 213, 242, 243, 263, 408, 429, 431, 495
 Mitosis, 287, 331, 336
 Monocarpic perennial, 388
 Monoterpene emission, 241–242
 Morphogenesis, 26
 Mor soils, 552
 Moss(es), 80, 137, 212, 255, 342, 547, 567–568
 Mucilage, 288, 533, 539
 Mull soils, 552
 Multilayer model, 250, 251
 Mycoheterotrophic, 409, 421
 Mycorrhiza
 arbuscular, 417–418
 ecto406, 408, 410, 413–416, 418, 421
 effects on photosynthesis, 418–419
 effects on water acquisition, 417–418
 ericoid mycorrhiza, 406, 408, 410, 413
 interactions with
 nonmycorrhizal species, 412–413
 orchid mycorrhiza, 406, 408, 409
 release of carboxylates, 404, 412, 413
 release of phosphatases, 413–416
 role in nitrogen acquisition, 421–422
 role in phosphorus acquisition, 413–416
 role in water acquisition, 417–418
 Mycorrhizal dependency
 Growth, 404–408
 phosphorus, 403
 Mycorrhizal network, 419–421
 Mycorrhizal responsiveness, 410–412
 Mycorrhizal species
 interactions with
 nonmycorrhizal species, 412–413
 Mycorrhizal symbiosis
 carbon costs, 418–419
 N
 NAD(P)H dehydrogenase
 bypass of complex I, 119
 dependence on N supply, 451
 Natural abundance of, ¹⁵N, 432, 433
 N deposition, 89, 549–550, 561–562, 568
 Necrosis, 63, 482, 486, 487
 Nematicidal, 448, 521
 Nematode
 phloem unloading, 160
 triphagic systems, 465
 Nernst equation, 263, 264, 267
 Net assimilation rate (NAR), 322, 323, 333–335, 340, 341–343, 345, 462
 Net Ecosystem Carbon Balance (NECB), 561
 Net ecosystem production (NEP), 561, 562
 Net photosynthesis, 19, 27, 55, 60, 63, 68, 74, 89, 122, 248, 559, 569
 Net primary production (NPP), 164, 396, 556, 560
 Niche, 2, 3, 491, 533
 Nickel, 289, 290
 Nicotine, 451, 466
 Nitrate (NO₃⁻), 39, 102, 103, 120, 125, 138, 257, 266–270, 276, 280, 281, 350, 378, 380, 385, 436
 Nitrate reductase, 267–270, 280, 281, 350, 378, 436
 Nitrification
 inhibition by allelochemicals, 447–448
 Nitrite (NO₂⁻), 257, 261, 270, 436, 550, 551
 Nitrogen
 Assimilation, 49
 Concentration, 499, 501
 Content, 338
 Fixation, 432
 isotope (¹⁵N), 432–433
 mineralization, 257, 259, 280, 517, 545, 549, 552
 remobilization, 338
 Nitrogenase, 429, 431–432, 436
 Nitrogen productivity (NP), 306
 Nitrogen-use efficiency (NUE), 54, 249, 302, 306, 388
 Nod factor, 425–428, 435
 Nod gene, 425–426
 Nodulation, 410, 420, 421, 424–428, 435
 Nodule, 419, 423–425, 427–430, 435–436
 Nodulin429
 Nondestructive growth analysis, 360
 Nonmycorrhizal species
 interactions with mycorrhizal species, 412–413
 Nonprotein amino acid, 447, 451, 454, 456
 Normalized difference
 vegetation index (NDVI), 559–560
 Nuclear magnetic resonance (NMR) spectroscopy
 ATP production in vivo, 107–109
 pH in intact cells, 107–109
 Nurse plant, 521
 Nutrient
 Absorption, 303, 338, 346, 415, 463
 Acquisition, 3, 58, 140, 143, 257, 262, 265, 284–301, 309, 336, 387, 410, 412, 414, 518, 527, 563

- Nutrient (cont.)
 Availability, 8, 27, 90, 102, 123, 133, 136, 143, 255, 257, 280, 282, 306, 308, 310, 347, 365, 385, 398, 461, 513, 516, 520, 521, 552, 557, 558, 569
 Budget, 306, 308
 Cycle, 545, 552, 564
 Deficiency, 280, 310
 Loss, 164, 306–307, 309, 365, 421
 Productivity, 304, 322, 323
 resorption
 leaves, 307–308
 roots, 308
 supply
 decomposition, 257
 toxicity, 549–550
 transfer (mycorrhiza), 415
 uptake, 122, 141, 211, 261, 262, 265–266, 268–269, 303, 306, 309, 334, 336, 338, 346, 347, 364, 396, 415, 516, 523, 563, 565
 Nutrient-use efficiency (NUE), 268, 302–304, 307, 308–310
- O**
 Oil of wintergreen, 485
 Oligofructan, 152
 Oligosaccharides
 Phloem, 151–152
 Opportunity costs, 340
 Orchid
 mycorrhizal association, 406
 Osmoprotection, 214
 Osmoregulation, 151
 Osmotic adjustment, 55, 114, 175, 177
 Osmotic potential, 165, 167, 169, 170, 171, 175–178, 180, 182, 186, 198, 337, 344, 350, 498
 Osmotic solute, 122, 166, 168, 175, 178, 198, 337, 348
 Overflow hypothesis, 114
 Overgrazing, 560, 566, 568
 Oxalate, oxalic acid, 287–288, 292, 295, 413, 446
 Oxidative pentose phosphate pathway, 101, 103, 131, 482
 Oxidative phosphorylation, 103, 106, 107, 108, 114, 449
- Oxygen
 isotope (¹⁸O), 79
 sensitivity of nitrogenase (N₂ fixation), 429–431
 sensitivity of photosynthesis, 434–435
 Oxygenation reaction of Rubisco, 18, 73
 Ozone, 63, 238, 244, 471, 472
- P**
 Palatability-reducing compound, 365
 Palisade mesophyll/parenchyma, 29, 30, 31, 34, 341
 Palmitic acid
 ectomycorrhiza, 408, 410, 416
 Paraheliotropism, 227
 Parasitic
 Fungus, 409
 Plant, 408
 Wasp, 464, 465, 466
 Parent material, 257, 557
 Particulate organic matter (PON), 548
 Passage cell, 179, 180, 181
 Pathogen, 131, 160, 191, 425, 427, 437, 445, 449, 456, 479, 480, 481, 482, 483, 484, 485, 487, 488, 559
 Pathogenesis-related protein (PR protein), 244, 484, 487
 Peat bog, 561
 Pectin, 215, 286, 303, 325, 357
 Pedogenesis, 279
 Penetrometer, 355
 Pentose phosphate pathway, 101, 103, 131, 482
 PEP carboxykinase, 65, 67, 76
 PEP carboxylase, 23, 24, 65, 68, 75, 76, 77, 78, 79, 80, 203
 Perennial, 25, 338–339
 Periarbuscular membrane, 408
 Peribacteroid membrane, 425, 427, 428, 429, 430
 Pericarp, 377
 Pericycle, 180, 280, 427, 429
 Permanent wilting point, 169, 170
 Pest, 485, 522
 PH, 40, 41, 42, 62, 63, 78, 82, 83, 84, 86, 107, 108, 109, 119, 120, 121, 129, 130, 152, 155, 180, 197, 199, 200, 256, 257, 261, 274, 275, 276, 284, 286, 288, 289, 307, 325, 328, 348, 357, 434, 435, 546, 548, 549
- Phenology, 375, 509, 514, 566
 Phenol, phenolic
 arbuscular mycorrhiza, 273
 defense, 446–473
 UV-B, 239
 Phenotypic plasticity, 514, 527
 Phenylalanine ammonia lyase, 449, 483
 Phloem, 151–153, 155, 156, 157, 159, 160, 161
 Phloem sap
 Composition, 151, 152, 160, 298, 397
 Phosphatase, 270, 271, 542
 Phosphate
 diffusion in soil, 413
 effect on cluster-root formation, 257
 effect on mycorrhiza formation, 413
 sorption, 259, 274
 toxicity, 262, 266, 268
 Phosphoglyceric acid (PGA), 14, 15, 16, 67
 Phospholipid, 271, 287, 346
 Phosphorus, 164, 255, 257, 260, 263, 270, 287, 307, 310, mineralization, 259
See also Phosphate
 Phosphorylation, 45, 78, 103, 106, 107, 108, 114, 120, 180, 265, 266, 269, 449
 Photodamage/photodestruction, 27, 33, 36, 237
 Photodegradation, 547
 Photoinhibition, 26, 27, 36, 39, 40, 42, 55, 62, 63, 226, 227, 339, 510
 Photon flux density (=irradiance), 117
 Photooxidation
 at low temperature, 239
 Photoperiod, 26, 132, 215, 228, 341, 345–346, 391, 392, 397, 461
 Photoperiodic, 345
 Photophosphorylation, 45
 Photorespiration, 15, 16, 17, 19, 27, 52, 60, 67, 68, 69, 70, 71, 72, 73, 74, 77, 82, 84, 96, 104, 105, 132
 Photosynthetic
 active radiation (PAR), 26, 37, 226, 227, 228, 509, 559, 560

- capacity, 7, 24, 31, 33, 34, 35, 51, 53, 55, 58, 59, 62, 63, 71, 89, 136, 238, 242, 248, 251, 291, 334, 351, 397, 491, 500, 533
- induction, 43, 44, 45
- nitrogen-use efficiency (PNUE), 53, 54, 58, 71, 249, 302, 304, 305, 306, 309
- quotient (PQ), 14, 77, 78
- water-use efficiency, 56, 203, 206, 207, 252
- Photosystem (PSI, PSII), 12, 15, 37, 39, 40, 42, 291, 447
- Phototropism, 227, 325
- Phreatophyte, 211, 212, 557
- Phyllosphere, 118
- Phylogenetic constraint, 331
- Physiological amplitude, 3, 4, 284, 310
- Physiological filter, 6, 505
- Phytase, 271
- Phytate, 271
- Phytoalexin, 117, 131, 424, 470, 483, 484, 485
- Phytoanticipin, 480
- Phytochelatin, 292, 294, 295
- Phytochrome, 26, 238, 325, 329, 330, 343, 344, 345, 351, 367
- Phytohormone, 54, 90, 163, 165, 197, 211, 213, 241, 280, 326, 327, 349, 352, 358, 384, 392, 493, 498
- Phytometallophore, 277
- Phytomining, 290
- Phytoremediation
heavy metals, 290
xenobiotics, 469–471
- Phytosiderophore, 277, 278, 287, 403, 521
- Pioneer, 35, 333, 522, 523, 526, 559
- Pitcher plant, 533, 535, 536, 542
- Pit-membrane pore, 189, 193
- Plant ecology strategy scheme, 506
- Plasma membrane, 83, 129, 154, 155, 156, 159, 179, 180, 199, 200, 243, 244, 262, 263, 264, 265, 267, 268, 275, 276, 277, 285, 286, 291, 294, 297, 298, 299
- Plasmodesmata
connectivity, 155
frequency, 155, 156
phloem loading, 157
root nodules, 429
water transport, 180
- Plasmolysis, 585
- Plastic(ity), 411, 511, 514–516, 539
- Platanetin, 448
- Pneumatophore, 121
- Poikilohydric, 212
- Pollination, 149, 394, 395, 396, 469
- Pollinator, 112, 226, 394, 396, 398, 445, 469, 521
- Polyamines, 239
- Polygalacturonic acid, 324
- Polymer trapping, 156
- Polyphenol
litter decomposition, 352, 546, 548, 550, 551
- Polyphenol, 449, 462, 463, 464, 479, 483, 547, 550
- Polyphosphate/poly-P, 337, 415
- Post-illumination CO₂ fixation, 45, 46, 76, 78, 85
- Potassium (K), 164, 257, 260
- Prairie, 89, 163, 360, 386, 421, 516, 517, 520, 522, 561
- Precipitation, 74, 81, 83, 164, 170, 171, 172, 174, 183, 192, 212, 257, 259, 286, 297, 302, 377, 413
- Predator mite, 464, 465, 466, 469
- Predawn water potential, 192
- Pressure
Chamber, 185, 186, 189, 198, 348
potential, 585
pressure-volume curve(only in ref)
probe, 177, 200, 327, 328
vessel, 348
- Pressurized flow
aerenchyma, 121
- Priming, 552
- Programmed cell death, 356, 397, 398, 482
- Proline, 175
- Protease, 210, 457, 458, 459, 538, 542
- Protease/proteinase, 210, 328, 448, 457, 458, 459, 462, 487, 533, 538, 542
- Protease/proteinase inhibitor, 459, 462, 487
- Protein
Bodies, 339, 460
Synthesis, 118, 137, 210, 213, 264, 265, 304, 337, 347, 351, 352, 378, 457
- Turnover, 127, 134, 135, 210
- Proteoid root, cluster root, 117, 271, 272, 273, 366, 412, 413, 415, 517
- Protocarnivory, 543
- Proton
Cotransport, 140, 263, 268, 415
efflux, 415
extrusion, 14, 83, 104, 105, 109, 112, 115, 275, 395
- Proton-motive force (pmf), 14, 104, 107, 237, 264, 430
- Protoplasmic streaming, 585
- Protoplast, 324
- Protozoa, 533, 541, 542, 552
- Prussic acid, 455
- Pyruvate, 207, 208, 209, 360
- Push-pull strategy, 522
- Pyrimidine dimer, *see*
Cyclobutane-pyrimidine dimer
- Pyruvate, pyruvic acid, 65, 67, 75, 76, 103, 108, 111, 119, 130, 131, 132, 483
- Q**
Q₁₀, 127–128, 135
- Qualitative defense (compound), 453, 454
- Qualitative long-day plant, 585
- Qualitative short-day plant, 585
- Quantitative defense (compound), 365, 451, 453–454, 461, 525, 547, 548
- Quantitative long-day plant, 586
- Quantitative short-day plant, 586
- Quantum yield, 27, 31, 34, 36–40, 54, 61, 63, 68–69, 73–75, 117, 210, 248, 390, 511
- Quenching (fluorescence), 38
- Quinine, 451, 457, 458
- S**
Salicylic acid, 131, 327, 449, 457, 458, 462, 485, 487, 488
- Saline soils, 123, 169, 171, 198, 296–297
- Salinity
respiration, 122
- Salt (NaCl)
accumulation, 521
crystals, 228
effect on leaf energy balance, 206, 249
exclusion, 123, 297–298, 301

- Salt (NaCl) (cont.)
 excretion, 299
 gland, 228, 298, 299, 301
 resistance, 301
 resistant species, 194, 243, 244, 288, 290, 291, 302, 348, 518
 sensitive species, 194, 216, 243, 348, 358
 tolerance, 216
 toxicity, 297
- Saponin, 454, 480, 481
- Sapwood, 184, 187, 188, 194, 195, 196, 497, 498, 508
- Savanna, 91, 171, 519, 521, 556, 557, 558
- Scaling, 91, 144, 207, 247–253, 508, 555, 556, 559, 566, 568
- Sclerenchyma, 333, 352, 365, 495, 513, 514
- Sclerenchymatic cell, 333, 352, 365
- Scleromorph(ic), 24, 25, 204, 212, 307
- Sclerophyllous, 177, 464
- Secondary metabolite, 75, 138, 352, 445, 448, 451, 457, 458, 460, 461, 462, 471, 485, 498, 499, 500, 550
- Seed
 bank, 376, 383, 385, 386, 519, 520
 coat, 157, 159, 375, 376, 377, 384, 397, 492
 dormancy, 375–376, 382, 383, 385
 filling, 337, 338
 germination, 329, 375, 377, 378, 379, 381, 385, 398, 408, 445, 447, 492–493, 497, 501
 mass, 368, 386, 395, 508, 525
 number, 386
 phloem unloading, 157, 159
 reserves, 385, 386
 ripening, 493
 size, 363, 386, 387, 396, 508, 524
 yield, 338
- Seeder species, 337
- Seedling
 bank, 376, 383, 385, 386, 519, 520
 emergence, 376
 establishment, 386, 388, 389
 phase/stage, 385, 386, 521
- Selenium (Se), 480
- Self-thinning, 555, 556
- Senescence, Senescent, 27, 273, 302, 303, 306, 307, 308, 309, 327, 329, 336, 337, 351, 367, 397, 398, 497, 513, 549, 550
- Sensible heat, 230, 232, 566, 567, 568, 569
- Sensitivity analysis, 234, 282–284
- Serotinus, 496, 499
- Serpentine soils, 257, 290, 295
- Shade
 acclimation, 32, 342
 adaptation, 342–343
 adapted species, 33, 35, 134, 342, 390
 avoiding plants/species, 26, 35, 341, 342, 343, 344, 367, 509
 leaf, 26, 30
 plant, 1, 26, 29, 41, 42, 43, 90, 127, 342, 343
 species, 123, 125, 127, 343
 tolerant, 41, 329, 341, 342, 343, 344, 367, 388, 390, 518
- Shoot
 shoot mass ratio, 361, 515
 temperature, 346, 347
- Short-day plant/species, 345, 391–393
- Short days, 124, 243, 339, 345, 391, 392, 393
- Short-wave radiation (SR), 225, 226, 229, 230, 234, 235, 565
- Sieve element, 151, 152, 153, 154, 155, 156, 157, 160
- Sieve plate, 153
- Sieve tube
 diameter, 153, 160, 161
- Signal-transduction (pathway), 90, 241, 286, 287, 341, 348, 349, 426
- Silicon (Si), 200, 262, 264, 479
- Simulation model, 7, 282, 284, 306, 341
- Sinigrin, 448, 449
- Sink
 axial, 157, 159
 terminal, 157
- Smoke signal, 377, 378
- Soil
 compaction, 168, 327, 353, 354, 355, 356
 moisture, 54, 59, 169, 171–173, 182, 196, 197, 227, 261, 262, 417, 517, 520, 557, 561, 565, 567, 568, 569
 temperature, 336, 561, 565
 texture, 169
- Solar tracking, 226, 395
- Sorbitol
 compatible solute, 122, 123
 phloem, 152
- Sorgoleone, 447, 493
- Source, 51, 257
- Source-sink interaction, 51, 308
- Spadix, 112, 131, 234
- Species distribution, 4, 284, 366, 505
- Specific leaf area (SLA), 59, 216, 322, 323, 330, 331, 332, 333, 334, 341, 342, 343, 345, 352, 361, 364, 365, 366, 512, 513, 514, 524, 546, 557, 558
- Specific root length (SRL), 286, 323, 342, 510, 512, 514
- Spider mite, 466
- Spittlebug nymphs, 191
- Spongy mesophyll, 29, 30, 31, 240
- Stable isotope, 79, 114, 172
- Stachyose, 152, 156
- Starch, 12, 15, 47, 49, 51, 65, 76, 77, 103, 105, 120, 136, 321, 336, 337, 448, 549
- Stem
 elongation, 325, 326, 343, 344, 367, 369, 509, 515, 527
 growth, 327, 332, 360, 396, 509
 respiration, 322, 323
 stem mass ratio, 322, 323, 361, 515
- Steppe, 163, 567, 568
- Stomatal
 action, 205
 aperture, 199, 200, 203
 conductance, 54, 196, 357, 388, 526
 patchiness, 43, 54
 pore, 196, 199, 200
 resistance, 21
- Stoma(ta)/stomates, 164, 182, 198, 200, 203, 204, 211, 498
- Storage
 amides, 337, 338, 339
 amino acids, 337
 carbohydrates, 102, 103, 337, 338, 416
 carbon, 337–338
 nitrate, 337
 nitrogen, 338
 nutrients, 338
 phosphate, 337
 protein, 338
 water, 339

- Strategy, 54, 156, 160, 177, 197, 211, 276, 277, 278, 279, 287, 297, 304, 321, 338, 363, 364, 366, 390, 451, 454, 455, 459, 466, 469, 506, 507, 508, 514, 519, 522, 546–547, 550
- Stratification, 383
- Stress, 53, 54, 55, 59, 122, 132, 163, 175, 177, 188, 190, 191, 199, 207, 210, 212, 216, 241, 242, 261, 266, 297, 308, 325, 327, 348, 349, 350, 354, 437, 460, 461, 498, 518
- Stress protein, 2, 40, 89, 90, 112, 127, 163, 180, 210, 213
- Stress response, 4, 5, 6, 127, 210, 243, 268, 327
- Stress-tolerant plant/species, 303, 363, 388
- Strigol, 408, 493
- Strigolactone
 - arbuscular mycorrhiza, 416, 493
 - parasitic plants, 408, 493, 494
- Stroma, 12, 14, 32, 33, 34, 35, 65, 117, 132
- Strophiole, 377
- Strychnine, 451
- Suberin
 - flooding, 179
- Submergence, 356, 358, 359, 360
- Subsidiary cell, 199, 200
- Subtropical species, 270, 346
- Succession, 135, 367, 506, 520, 522, 523, 524–525, 526, 551, 558–559
- Succinate, Succinic acid, 104, 107, 110, 114, 117, 273, 290, 413, 430, 431
- Succulence, 76, 499, 503
- Succulent, 75, 76, 79, 80, 130, 173, 196, 209, 210, 211, 212, 226, 464, 511
- Sucrose
 - nonreducing, 151
 - phloem, 14, 47, 49, 51, 61, 105, 151, 152, 154, 155, 156, 157, 159, 337, 429
- Sugar
 - cryoprotection, 243, 244
 - sensing, 90, 345, 348, 351
- Sugar alcohol, 105, 122, 152, 153, 157
- Suite of traits, 321, 322, 359, 366
- Sulfatase, 549
- Sulfate (SO_4^{2-}), 118, 257, 266, 284, 455, 460
- Sulfide (S^{2-}), 108, 110, 118, 275
- Sulfur (S), 260, 266, 455, 460, 464, 549
- Summer annual, 383, 384
- Sunfleck, 43, 45, 46, 47
- Sun plant, 26, 342
- Sun species, 46, 124, 127
- Supercooling, 215
- Superoxide, 116, 118, 210, 239, 241, 472
- Superoxide dismutase (SOD), 210, 239, 241, 436, 472
- Supply function of
 - photosynthesis, 18, 21, 25, 53
- Symbiosis, 403, 409, 410, 418, 420, 421, 422, 423, 424, 425, 427, 428, 434–435, 436, 522–524
- Symbiosome, 425, 427, 428, 430
- Symplast, 140, 154, 179, 180, 286, 294, 310, 346
- Symplastic phloem loading, 161
- Symport, 140, 159
- Systemic, 35, 36, 153, 267, 273, 280, 281, 416, 417, 435, 449, 462, 465, 482, 484, 485–488
- T**
- Take-all disease, 416, 437
- Tannin, 136, 138, 352, 447, 448, 449, 451, 453, 461, 462, 464, 466, 517, 546, 550, 552
- Taproot, 212, 336, 337, 338, 339
- Taxine, 458
- Taxol, 457
- TCA cycle (Krebs cycle, tricarboxylic acid cycle), 101, 103–104, 120, 121, 128, 132, 448, 453
- Temperature
 - acclimation of photosynthesis, 61, 89–90, 514
 - acclimation of respiration, 124, 127, 128
 - adaptation of photosynthesis, 60
 - adaptation of respiration, 60–63
- Temperature coefficient (Q_{10}), 127
- Terpenoid, 395, 445, 447, 451, 461, 463, 465, 480
- Thermogenic respiration, 395
- Thigmotropism
 - (thigmomorphogenesis), 360, 511
- Thionin, 480
- Thylakoid, 11, 12, 13, 14, 15, 31, 33, 34, 36, 42, 46, 61, 65, 90, 213, 237, 244, 263
- Tiller(ing), 361, 389, 515
- Tissue-mass density, 365, 512, 513–514, 526
- Tissue tension, 175, 397, 398, 537, 538
- α -Tocopherol (vitamin E), 240, 459
- Tolerance, 211, 212, 214–216, 242–243, 359
- Touch-specific genes, 361
- Toxin, 119, 437, 447, 451, 453, 454, 457, 458, 462
- Trace element, 289
- Tracheid, 154, 180, 187, 190, 191, 214
- Trade-off, 7, 54, 135, 139, 160, 192–194, 334, 341, 386, 389, 396, 464, 485, 487, 505, 509, 526
- Transfer cell
 - phloem, 73
- Transgenic, 89, 118, 175, 243, 280, 353, 354, 459, 460, 473, 485, 515
- Translocation, 104, 268, 340, 351, 389, 500
- Transmittance, 26, 41
- Transpiration
 - cooling effects, 225, 234, 235
 - cuticular, 203–204
 - physiological control, 558
 - stomatal, 198, 203, 249, 252, 253
- Transport
 - active, 154, 155, 156, 159, 263, 264, 409, 415, 539, 541
 - mitochondrial electron transport, 106, 107, 112, 115, 120, 128, 485
 - passive, 541
 - photosynthetic electron transport, 14, 32, 38, 46, 62, 117, 359
- Trap crop, 493, 501
- Trehalose, 36
- Tricarboxylic acid cycle
 - Krebs cycle, 101
 - TCA cycle, 103, 104, 120, 121, 128, 132, 448, 453

- Tricarboxylic acid cycle, TCA101, 103–104, 120, 121, 128, 132, 448, 453
- Trichome, 204, 289, 291, 294, 299, 301, 470
- Triose phosphate, 12, 14, 16, 46, 47, 49, 67, 213, 214
- Tritrophic interaction, 466
- Tropical species, 346, 375, 393
- Tuber, 321, 337, 345, 391, 393
- >Tundra, 26, 122, 137, 257, 259, 260, 261, 271, 303, 338, 416, 547, 549, 556, 557, 560, 565, 568
- Turgor
pressure, 163, 165, 176, 177, 178, 196, 198, 323, 324, 344, 355
threshold, 324
turgor-loss point, 175, 176, 201
- Turnover
cyanogenic compounds, 448, 455, 456
leaf, 365, 366, 566
protein, 107, 127, 134, 135, 210, 264
root, 365, 366, 565
- U**
- Ubiquinone, 103–105, 108, 110, 111, 118, 124, 447
- Ultraviolet (UV)
absorption, 238
epidermis, 181, 239, 240
phenolic compounds, 239, 394
damage, 237, 238–239, 244, 390
prevention, 238–239
repair, 268, 269, 274
exposure, 239
leaf angle, 227–228
protection, 238–239
reflection, 226, 228
- Uncoupler, 105, 106, 114, 123, 125, 537
- Uncoupling protein (UCP), 103, 106, 107, 112, 119, 129
- Up-regulation, 61, 127, 266, 267, 327, 361, 393, 482, 483
- Urease, 304, 454
- Ureide, 304, 425, 429, 431
- UV-B, 238, 239, 240
- V**
- Vacuole, 72, 76, 78, 109, 120, 175, 199, 240, 285, 292, 294, 295, 299, 301, 394, 415, 455, 456, 457, 471, 484
- Vapor pressure deficit (water), 54, 202, 209, 247, 253, 567
- Vapor pressure difference (water), 23, 56, 79, 172, 201, 234, 235, 252, 352
- Vegetative reproduction, 388, 389
- Vegetative storage protein, 303, 337, 338
- Verbascose, 152
- Vernalization, 387, 393
- Very low fluence response, 329, 330, 381
- Vesicle, 301, 404, 409, 410, 416, 456, 542
- Vesicular-arbuscular mycorrhiza, *see* arbuscular mycorrhiza
- Vessel, 183, 187, 188, 189, 191, 192, 193, 194, 348
- Vine
phloem, 151, 160, 195
xylem, 151, 160, 182, 188, 192, 193, 195
- Violaxanthin, *see* Xanthophyll cycle
- Virus
phloem, 153, 460
- Visual advertisement, 153, 453, 499
- Viviparous seeds, 375
- W**
- Wall loosening, 325, 348, 349, 356, 361
- Water
channel, 180, 210, 263, 291, 346, 350
channel protein, 180, 210, 263, 291, 346, 350, 518
deficit, 196, 203, 210, 227, 228, 338
potential, 54, 114, 121, 125, 151, 155, 165, 166, 167, 169, 170, 171, 174, 175, 176, 177, 178, 179, 182, 185, 191, 198, 202, 216, 297, 346
shortage, 51, 85, 176, 196, 358, 367
status, 165, 196, 197, 198, 324, 348, 398, 418, 521, 567
stress, 4, 54–55, 266, 286, 349, 507
effect on respiration, 127
transport in the xylem, 165
- Water-storing capacity, 196
- Water-use efficiency (WUE)
intrinsic, 23, 54, 56, 63, 89, 204, 206, 207
- Wax
- UV tolerance, 239
- Weathering
role of ectomycorrhizal fungi, 291, 410, 421, 550
- Source of nutrients, 257, 259, 543
- Weed, 2, 63, 164, 379, 380, 382, 445, 446, 447, 520, 550
- Whole plant approach, 2, 5, 7, 26, 103, 128, 201, 212, 291, 302, 303, 304, 321–322, 328, 330, 333, 346, 347, 362, 508, 555
- Wilting point, 169, 170
- Wind
effects on growth, 360–361
- Winter annual, 383, 384, 393
- Wounding, 338, 480
- X**
- Xanthophyll cycle, 31, 36–41, 237, 239, 242, 244
- Xenobiotic, 469–472
- Xerophyte, 213
- Xylem
exudation, 170
pressure, 185, 189, 191
sap, 119, 152, 182, 184, 185, 186, 190, 191, 197, 270, 289, 348, 353, 354, 397, 431, 495, 496, 498, 500
vessel, 160, 165, 182, 183, 186, 187, 188, 189, 212, 264, 346, 495
diameter, 187, 188, 194
- Xyloglucan endotransglycosylase (XET)325, 356, 361
- Y**
- Yield
coefficient (cell wall), 324, 328, 374, 376, 385
quantum (gas exchange, fluorescence), 64, 67
threshold (cell wall), 328, 354, 374, 385
of the root, 355
of the soil, 355
- Z**
- Zeatin, 356, 381
- Zeaxanthin, *see* Xanthophyll cycle
- Zinc (Zn), 290, 306, 307, 319, 320, 321, 325, 326, 340, 395, 510