



Third Edition

SCIENCE AND PRACTICE OF STRENGTH TRAINING

Vladimir M. Zatsiorsky
William J. Kraemer
Andrew C. Fry

Third Edition

Science and Practice of Strength Training

Vladimir M. Zatsiorsky, PhD

The Pennsylvania State University

William J. Kraemer, PhD

The Ohio State University

Andrew C. Fry, PhD

University of Kansas



HUMAN KINETICS

Library of Congress Cataloging-in-Publication Data

Names: Zatsiorsky, Vladimir M., 1932- author. | Kraemer, William J., 1953- author. | Fry, Andrew C., 1956- author.

Title: Science and practice of strength training / Vladimir M. Zatsiorsky, PhD, Pennsylvania State University, William J. Kraemer, PhD, CSCS,*D, FNCSA, FACSM, FISSN, FACN, Ohio State University, Andrew C. Fry, PhD, CSCS,*D, FNCSA, University of Kansas.

Description: Third edition. | Champaign, IL : Human Kinetics, [2021] | Includes bibliographical references and index.

Identifiers: LCCN 2019045468 (print) | LCCN 2019045469 (ebook) | ISBN 9781492592006 (hardcover) | ISBN 9781492592013 (epub) | ISBN 9781492592020 (pdf)

Subjects: LCSH: Physical education and training. | Muscle strength. | Biomechanics.

Classification: LCC GV711.5 .Z38 2021 (print) | LCC GV711.5 (ebook) | DDC 613.7/13--dc23

LC record available at <https://lccn.loc.gov/2019045468>

LC ebook record available at <https://lccn.loc.gov/2019045469>

ISBN: 978-1-4925-9200-6 (print)

Copyright © 2021 by Vladimir M. Zatsiorsky, William J. Kraemer, and Andrew C. Fry

Copyright © 2006 by Vladimir M. Zatsiorsky and William J. Kraemer

Copyright © 1995 by Vladimir M. Zatsiorsky

Human Kinetics supports copyright. Copyright fuels scientific and artistic endeavor, encourages authors to create new works, and promotes free speech. Thank you for buying an authorized edition of this work and for complying with copyright laws by not reproducing, scanning, or distributing any part of it in any form without written permission from the publisher. You are supporting authors and allowing Human Kinetics to continue to publish works that increase the knowledge, enhance the performance, and improve the lives of people all over the world.

The web addresses cited in this text were current as of October 2019, unless otherwise noted.

Senior Acquisitions Editor: Roger W. Earle; **Developmental Editor:** Anne Hall; **Managing Editor:** Hannah Werner; **Copyeditor:** Lisa Himes; **Indexer:** Rebecca L. McCorkle; **Permissions Manager:** Martha Gullo; **Graphic Designer:** Denise Lowry; **Cover Designer:** Keri Evans; **Cover Design Specialist:** Susan Rothermel Allen; **Photograph (cover):** Visual China Group/Getty Images; **Photographs (interior):** Photo on page 3 © skynesher. Photo on page 15 © Visionhaus/Corbis Sport/Getty Images. Photo on page 41 © Matthias Hangst/Getty Images. Micrographs on page 54 courtesy of Dr. Robert S. Staron's laboratory. Photo on page 61 © Laurence Griffiths/Getty Images. Photo on page 79 courtesy of Vladimir Zatsiorsky. Photo on page 99 © MoMo Productions/Stone Sub/Getty Images. Photos on pages 119, 125, 171, 213, 257, and 291 © Human Kinetics. Photo on page 159 © Andy Astfalck/Getty Images. Photo on page 177 © Skynesher/E+/Getty Images. Photos on pages 195 and 241 courtesy of Dr. Kraemer's laboratory. Photo on page 235 © Hirung/E+/Getty Images. Photo on page 245 © RyanJLane/E+/Getty Images. Photo on page 258 © Westend61/Getty Images. Photos on pages 264, 265, and 266 courtesy of Life Fitness Academy, Photographer: Carlos Ortiz. Photos on page 275 © Gerard Martin. Photo on page 281 © Al Bello/Getty Images. Photo on page 282 © Monkey Business/fotolia.com. Photos on page 285 courtesy of Dr. Kraemer's, Dr. Volek's, and Dr. Simonetti's laboratories at The Ohio State University, Columbus, OH; **Photo Asset Manager:** Laura Fitch; **Photo Production Manager:** Jason Allen; **Senior Art Manager:** Kelly Hendren; **Illustrations:** © Human Kinetics, unless otherwise noted; **Printer:** Sheridan Books

Printed in the United States of America 10 9 8 7 6 5 4 3 2 1

The paper in this book is certified under a sustainable forestry program.

Human Kinetics

1607 N. Market Street
Champaign, IL 61820
USA

United States and International

Website: **US.HumanKinetics.com**

Email: info@hkusa.com

Phone: 1-800-747-4457

Canada

Website: **Canada.HumanKinetics.com**

Email: info@hkcanada.com

E7847



Tell us what you think!

Human Kinetics would love to hear what we can do to improve the customer experience.

Use this QR code to take our brief survey.

To my grandchildren—Anastasiya, James, Yana,
Ellen, Irene, and Jaclyn—with love.

V.M.Z.

To my wife, Joan; my son, Daniel, and his wife, Amie; my daughters,
Anna and Maria; and my granddaughters, Olivia and Catherine:
Thank you for your love and support.

W.J.K.

I dedicate this text to the loves of my life—my wife, Mary,
and my children, Jared and Lindsey. Their undying and unconditional
love, and their appreciation of my passions and my career,
are a precious part of my life. Thank you!

A.C.F.

This page intentionally left blank

Contents



Foreword	ix
Preface	xi
Acknowledgments	xiii
Symbols and Abbreviations	xv

PART I BASIS OF STRENGTH TRAINING

1	Basic Concepts of Training Theory	3
	Adaptation as a Main Law of Training	3
	Generalized Theories of Training	9
	Training Effects	13
	Summary	14
2	Task-Specific Strength	15
	Elements of Strength	15
	Determining Factors: Comparison Across Tasks	19
	Summary	40
3	Athlete-Specific Strength	41
	Muscle Force Potential (Peripheral) Factors	41
	Neural (Central) Factors	52
	Taxonomy of Strength	57
	Summary	57

PART II CONCEPTS OF STRENGTH TRAINING

4	Training Intensity	61
	Measurement Techniques	61
	Exercising With Different Resistance	64
	Training Intensity of Elite Athletes	68
	Optimal Training Intensities From Comparative Research	70
	Methods of Strength Training	71
	Summary	76

	5	Timing in Strength Training	79
		Structural Units of Training	79
		Short-Term Planning	81
		Medium-Term Planning (Periodization)	86
		Periodized Programming Models	89
		Summary	94
	6	Exercises Used for Strength Training	99
		Classification	99
		Exercise Selection for Beginning Athletes	100
		Exercise Selection for Qualified Athletes	101
		Additional Types of Exercises Used for Strength Training	113
		Experimental Methods of Strength Training	121
		Breathing During Strength Training	123
		Summary	124
	7	Velocity in the Weight Room	125
		How to Measure Velocity	126
		Considerations When Testing	130
		Measuring High-Velocity Lifts in the Weight Room	134
		Slow-Velocity Concentric Resistance Exercise	138
		Slow-Velocity Eccentric Resistance Exercise	143
		Velocity-Related Assessments in the Weight Room	144
		Training Method Variations and Weight Room Velocity	151
		Using Lifting Velocity to Determine Training Load and Volume	156
		Summary	157
	8	Injury Prevention	159
		Factors Contributing to Increased Injury Risks in the Weight Room	159
		Training Rules to Avoid Injury	160
		Lower Back Pain and Injury	160
		Biomechanical Properties of Intervertebral Discs	161
		Mechanical Load Affecting the Intervertebral Discs	162
		Injury Prevention to the Lumbar Region	166
		Summary	175
	9	Overreaching, Overtraining, and Recovery	177
		Training Monotony and Variation	181
		Types of Resistance Exercise	182
		Psychology of Resistance Exercise Overtraining	182
		Speed Is Very Sensitive	183
		Lifting Power Decrements	184

- Vertical Jump 185
- Rate of Force Development 186
- Strength Decrements 186
- So Which Performance Tests? 187
- Physiology of Resistance Exercise Overtraining 189
- Sequence of Performance Impairments 192
- Summary 192

10 **Monitoring Athletes in the Weight Room** **195**

- Purpose of Testing 195
- Who Is the Tester? 196
- What Is Monitored? 197
- Practical Considerations Related to Assessment 198
- Monitoring Tests 200
- Analyzing and Reporting Results 209
- Summary 212

11 **Goal-Specific Strength Training** **213**

- Developing a Profile of Target Goals 214
- Evidence-Based Practice 215
- Testing and Monitoring Progress 216
- Strength Performance 217
- Power Performance 218
- Muscle Mass 222
- Endurance Performance 224
- Injury Prevention 229
- Summary 231

PART III STRENGTH TRAINING FOR SPECIFIC POPULATIONS

12 **Strength Training for Women** **235**

- Coaching Style Is Important 237
- The Need for Strength Training for Women in Sports 238
- Benefits and Myths of Strength Training for Women 239
- Trainable Characteristics of Muscle 241
- Development of Lean Tissue Mass 241
- Physiological Contrasts Between Women and Men 247
- Strength Training Guidelines for Women Athletes 250
- Incidence of Injury 251
- Menstrual Cycle and Strength Training 251
- The Female Athlete Triad 253
- Summary 255

13 Strength Training for Young Athletes 257

- Safety and Strength Training for Young Athletes 258
- Types of Musculoskeletal Injuries 260
- Primary Factors in Avoiding Injury 261
- When to Start 263
- Benefits of Strength Training for Young Athletes 269
- Myths of Strength Training for Children 271
- Strength Training Guidelines for Young Athletes 272
- Long-Term Athletic Development 275
- Summary 280

14 Strength Training for Senior Athletes 281

- Age and Its Effects on Strength and Power 282
- Training for Strength Gains 287
- Training for Muscular Power 290
- Nutrition, Aging, and Exercise Challenges 291
- Recovery From Resistance Exercise 292
- Strength Training and Bone Health 294
- Strength Training Guidelines for Senior Athletes 294
- Summary 296

Glossary 297

Bibliography 304

Index 315

About the Authors 327

Earn Continuing Education Credits/Units 328

Foreword

The third edition of *Science and Practice of Strength Training* was written by three authors who are internationally recognized as scientists and experts in the field of strength training. All are high-level scientific investigators and have a long history of practice in the field of strength training. Dr. Zatsiorsky has enormous experience in strength training from the former Soviet Union and Eastern Bloc countries. Professors Kraemer and Fry have vast experience and offer the American perspective on strength training. The text in this book is written in a unique and understandable manner, presenting the current knowledge of strength training and conditioning. Each of the authors has vast experience in teaching at universities, giving presentations at several international congresses, and leading seminars on the theory and practice of strength training. Such backgrounds have also enabled them to exchange information and new ideas in the field of strength training. The authors have an extensive collection of publications in the field as researchers in strength training. In addition, they also have vast experience as coaches and practitioners. Therefore, the text in the book represents a unique way to use science in designing successful strength training programs for various purposes. Consequently, it provides the reader with beneficial tools for developing strength training programs.

This book is for serious strength coaches, athletes, and fitness enthusiasts who desire to create individualized strength training programs to lead to successful gains in strength, power, fitness, and selective performance characteristics. This book is not for those individuals who look for a shortcut approach to strength training (such as one with an exact number of reps per set or one that says this exercise is better than that exercise). This book *does* cover all the aspects needed in the field of strength training: basic concepts of training theory; task- and athlete-specific strength; velocity and exercises in strength training; monitoring strength training; goal-specific strength training; program design; periodization; overtraining and recovery; specificity of exercises; and strength training for men and women, youth, and older athletes. You may have limited experience or more experience in the field of strength training. Either way, you will find provocative concepts that will affect your ideas on how to create and plan more challenging and specific strength training programs. I can highly recommend this book to all people who are seriously interested in strength conditioning, to get new ideas and to improve their knowledge as well as to work successfully in practice.

Professor Keijo Häkkinen, PhD
University of Jyväskylä, Finland

This page intentionally left blank

Preface

The field of strength training has continued to advance, yet the fundamental principles that govern the development of strength remain constant. With the past, present, and future considered, we are excited to present this third edition of *Science and Practice of Strength Training*. Dr. Zatsiorsky and Dr. Kraemer were colleagues for almost 10 years at The Pennsylvania State University. Our collaboration as authors continues into this third edition due to an ongoing mutual interest in and passion for the topic of strength training. To address the continued dimensionality of strength training, we are honored to bring on Dr. Andrew Fry as a coauthor for this edition. Dr. Fry was a doctoral student of Dr. Kraemer's at Penn State and has continued his impressive scientific career in the study of strength training research over the past 27 years.

Just as the second edition built on the first edition, we have continued this approach by expanding on the concepts and complexities of how to develop strength and power to optimize the development of athletes and fitness enthusiasts of all ages. In addition to updated information, this revised text includes new chapters on training velocity in the weight room, overreaching and overtraining, and monitoring athletes in the weight room to better assess progress and effectiveness of the programs used.

The textbook has been developed from our vast experience in the field and contains documented experiences of more than 1,000 elite athletes, including Olympic, world, continental, and national champions and record holders. Dr. Kraemer also brings coaching experience from junior high school through college levels. His work on training studies with collegiate and professional athletes brings an additional dimension to the textbook that expands its conceptual relevance. Dr. Fry has studied strength training for decades with a particular interest in overtraining; his work with high school, college, and national and international athletes in the weight room parallels his molecular and cellular work on muscle, allowing him to make valuable connections between the lab and weight room programming.

Science and Practice of Strength Training is for readers who are interested in muscular strength and ways to enhance their development. Thus, it is for coaches, students who plan to become coaches, and athletes who want to be self-coaches. It is designed for serious readers who are willing not only to remember and repeat the information but also to understand it and put it to use. Over the years, coaches and athletes have asked each of us for the best exercise, method, or training program to develop strength. Answers to such questions are complicated, because no single program works for all athletes at all times or under all conditions. The individual needs of each athlete vary, and what works at one point in time may not work at another time. The best programs are those that are based on solid principles and concepts with the understanding that change is inevitable.

This textbook is written for the practitioner, and thus we provide a straightforward examination of the concepts and principles needed to make decisions on appropriate program design for athletes. While many try to oversimplify the topic of strength training, it is, by nature, complex yet understandable. Many aspects of the book address this complexity while providing straightforward approaches for specific circumstances. We offer program examples to demonstrate some of the principles and concepts discussed in the book; however, it is not meant to be a recipe book, because such an approach is fraught with pitfalls.

Strength training research has been growing dramatically each year and gives further credibility to concepts that were for many years only anecdotal. Despite that, the design and practice of strength training programs will never solely be the result of following the step-by-step processes found in scientific studies. Instead, it is the combination of solid principles, practical insights, coaching experiences, and directions based on scientific findings that results in the optimal knowledge for creating a program for a specific athlete.

This book is no doubt filled with biases, as it is heavily influenced by our experiences. Dr. Zatsiorsky's experience is predominantly in the former

Soviet Union, former East Germany (German Democratic Republic), and Bulgaria. Dr. Kraemer and Dr. Fry bring an American perspective. The integration of our separate perspectives has yielded much success and has allowed many hybrids of training theory to be put forth.

This book is intended to be comprehensive. Concepts that are outdated or have been shown to be ineffective through research have been modified or eliminated to provide an up-to-date overview of training concepts and theories that are on the cutting edge of both practice and science.

The book consists of three parts. Part I describes the basis of strength training and includes three chapters. Chapter 1, *Basic Concepts of Training Theory*, emphasizes the concepts that are, for the most part, the bedrock of strength development. In Chapter 2, *Task-Specific Strength*, the principles related to task specificity are developed. Chapter 3, *Athlete-Specific Strength*, is designed to enhance one's knowledge on how programs can vary by sport and individual athlete needs. Part II examines some of the important concepts in strength training. Chapter 4, *Training Intensity*, shows how important and varied the concept of intensity is in a strength training program. Chapter 5, *Timing in Strength Training*, examines different phases and progressions in program concepts. Chapter 6, *Exercises Used for Strength Training*, provides an overview of the choices of program exercises and their differences and applications. Chapter 7, *Velocity in the Weight Room*, presents new concepts in how strength is expressed at different velocities of movement and how it impacts performance. Chapter 8, *Injury Prevention*, addresses how one can prevent common injuries and how strength training is vital in injury prevention in sports. In Chapter 9, *Overreaching, Overtraining, and Recovery*, vital research from the past 30 years shows the

importance of proper progression and recovery to eliminate injury and loss of progress in a strength training program. Chapter 10, *Monitoring Athletes in the Weight Room*, presents concepts and ideas for athlete monitoring to determine the effectiveness of strength training programs being used and athlete progress toward training goals. This leads into Chapter 11, *Goal-Specific Strength Training*, which is vital for progress in each training cycle. Finally, in Part III, we take a closer look at different populations with Chapter 12, *Strength Training for Women*; Chapter 13, *Strength Training for Young Athletes*; and Chapter 14, *Strength Training for Senior Athletes*.

We do not address drug use in sports, which continues to receive worldwide attention. We maintain that the practice is harmful to health, unethical in sport, and illegal. We believe that the much wider array of anabolic drugs now being used by athletes has diminished the desire to optimize training methods using the body's own natural anabolic mechanisms (e.g., the endocrine system). This book is written to allow the reader to train without drugs and to maximize the body's ability to make natural gains by optimizing the strength training programs used.

This book uses limited references to underscore the practical approach we took in writing it. With the knowledge base of the field of strength training expanding each year, we provide select references to books, reviews, and position stands to allow you to access more background reading material to enhance your understanding of various concepts and principles. If we were to provide all such references, the sheer magnitude of the book would overwhelm its practical nature. The integration of coaching theory and scientific underpinnings in this text continues to promote a more sophisticated practice of strength training.

Acknowledgments

The third edition of this book represents a historical evolutionary timeline for both the authors and the content presented. Strength training has seen the development of myriad approaches that enhance the fundamental ability of the body to produce more force. However, many of the principles remain intact and are the bedrock of program design.

For the first edition, Dr. Zatsiorsky was aided by numerous people, including Dr. Richard C. Nelson, who founded the biomechanics laboratory at Penn State in 1967, and Dr. Robert J. Gregor (now professor emeritus at Georgia Tech University) and Dr. Benno M. Nigg (now professor emeritus at the University of Calgary), who invited him to be a visiting researcher at their laboratories. The first edition of the book was partly written during this time.

For the genesis of the second edition, Dr. Zatsiorsky and Dr. Kraemer both thank the many professionals at Human Kinetics, most notably Dr. Mike Bahrke, for bringing two former colleagues together again in a new collaboration on this topic of mutual interest and synergistic perspectives.

The third edition was stimulated by the support and persistence of Mr. Roger Earle, senior acquisitions editor in the Trade and Professional Division at Human Kinetics, a former weightlifter himself. He pushed to continue this iconic book by Dr. Zatsiorsky, whose fundamental principles and approaches to strength training have stood the test of time. While the second edition showed the expanse and evolution of concepts and theories with the addition of Dr. Kraemer's authorship, this third edition will benefit the readership of this book by cutting through the myriad misinformation now pervasive on this topic with the addition of Dr. Fry's expertise.

We would also like to acknowledge Ms. Hannah Werner, our managing editor at Human Kinetics, for her patience and help in the process of producing this work. We would also like to say a special thank you to the many team members at Human Kinetics who worked so hard to make this book the best it could be from all of the different perspectives needed in book publishing, including Anne

Hall, developmental editor, Denise Lowry, graphic designer, Kelly Hendren, senior art manager, Joe Buck, senior graphic designer, Heidi Richter, illustrator, and Joanne Brummett, production director.

Dr. Kraemer is indebted to many people, and it would be impossible to do justice to their many contributions. I must thank Dr. Steve Fleck, with whom I have worked for decades in this area, and my late friend Coach Jerry Martin, who worked with me day by day at the University of Connecticut for over a decade to develop a model for bridging the gap between the laboratory and the weight room.

Dr. Fry would like to thank William J. Kraemer and Robert S. Staron; these mentors showed great patience, helped me develop an appreciation of the topics covered in this text, and allowed me to pursue related lines of research while a student and postdoctoral fellow. Also, a thank you to all my colleagues, both coaches and academics, who have helped me better understand the principles and concepts applied in these chapters. To my numerous and valued students, who have been part of innumerable discussions, planning sessions, and data collections over the years: These interactions have kept me inspired and up to date on developing training concepts. Don't ever underestimate the value of these opportunities to learn. Finally, a thank you to the athletes and fellow coaches who have willingly permitted me to apply many of these training principles to their programs.

Each of us would like to acknowledge the multitude of athletes, students, graduate students, and faculty colleagues who have worked with us in the weight room, in classes, and in research projects, thereby providing us with the intellectual challenges and exciting discussions that have enriched our experiences, insights, and views on strength training. Finally, we thank the many strength and conditioning professionals and fitness enthusiasts in the field who have encouraged our work and motivated us to continue to develop our scientific theories and concepts in resistance training, many of which are found in the pages of this book.

This page intentionally left blank

Symbols and Abbreviations

ACWR	Acute:chronic workload ratio	MHC	Myosin heavy chain protein
BW	Body weight	MSD	Muscle strength deficit
CF_{mm}	Maximum competition weight	MU	Motor unit
CK	Creatine kinase	N	Newton; the unit of force
CV	Coefficient of variation	P_m	Maximal muscular performance attained when the magnitude of a motor task parameter is fixed
ΔF_m	Gain in maximal force	P_{mm}	Maximum maximum power attained when the magnitude of a motor task parameter is altered
EMG	Electromyography	POMS	Profile of Mood States
EMS	Electrical stimulation of muscles	RC	Reactivity coefficient
ESD	Explosive strength deficit	RESTQ	Recovery-stress questionnaire for athletes
F	Force	RFD	Rate of force development
F_m	Maximal force attained when the magnitude of a motor task parameter is fixed	RM	Repetition maximum
F_{mm}	Maximum maximum force attained when the magnitude of a motor task parameter is altered	SD	Standard deviation
FT	Fast-twitch muscle fibers	ST	Slow-twitch muscle fibers
g	Acceleration due to gravity	T_m	Time to peak performance
GH	Growth hormone	TF_{mm}	Maximum training weight
HR	Heart rate	V_m	Maximal velocity attained when the magnitude of a motor task parameter is fixed
HRV	Heart rate variability	V_{mm}	Maximum maximum velocity attained when the magnitude of a motor task parameter is altered
Hz	Hertz	VJ	Vertical jump
IAP	Intra-abdominal pressure		
IES	Index of explosive strength		
IGF	Insulin-like growth factor		
IMTP	Isometric midthigh pull		
LBPS	Low back pain syndrome		

This page intentionally left blank

PART I



BASIS OF STRENGTH TRAINING

The primary goal of this book is to provide readers with practical recommendations, or a prescription, for training athletes. Practical advice, however, cannot be given without first providing descriptions of what should be trained and why some methods are better than others. Part I of the book describes theory, while part II covers a host of different topics on the methods of strength training, injury prevention, and monitoring to ensure the success of the program. Part III deals with training for specific populations.

The first part, which is entirely descriptive, develops several concepts in a natural, sequential order. Chapter 1 is introductory and provides an overview of the principles of training theory: It describes the peculiarities of adaptation to a physical load; discusses two prevailing theories of training—the supercompensation theory and the fitness-fatigue theory—both of which are widely and enthusiastically embraced as effective methods; and spells out the nomenclature of training effects. Although the concepts and terminology introduced in this chapter are used throughout the book, the chapter is self-contained and presumes that the reader has no prior scientific knowledge.

Chapters 2 and 3 address the factors that determine muscular strength. It is assumed that readers

have some knowledge of exercise physiology and sport biomechanics, or at least are acquainted with the basic physiology of the muscles. Readers who are not familiar with this material, however, should not be discouraged from reading the book; the main concepts are explained in a format intelligible for a reader with a minimal background in exercise and sport science. Readers who do have trouble understanding chapters 2 and 3 need not read them in one sitting but can return to them later while reading the balance of the book.

Chapter 2 lays the foundation for the notion of muscular strength, classifying and explaining the evidence collected by measuring muscular force. It introduces the concept of maximal muscular performance, as well as two primary relationships (parametric and nonparametric), and defines the notion of muscular strength. It then follows with a detailed discussion of various factors involved in motor tasks, such as resistance, time available for force development, movement velocity, movement direction, and body posture. The integrating idea for these diverse topics is rather simple and straightforward: exercise specificity. For training to be effective, exercises should be similar to the main sport activity, and the exercise similarity should be established according to the criteria discussed in this chapter.

Chapter 3 addresses muscular strength from another standpoint: that of the performer rather than the motor task. Some people have greater strength than others. Why? What properties do elite athletes have that allow them to be exceptional? The internal factors determining muscular strength are latent. Hence, they can be identified only by using a physiological approach. If we are able to identify them, we open the road to goal-directed training of these primary factors, so the exercises and methods addressed here will center on specific targets rather than on strength in general. This chapter is based

on facts and theories originated by exercise physiologists. Two main groups of internal factors are discussed: muscular and neural.

Among the muscular factors, primary attention is given to the muscle dimension and its counterpart, body weight. Other factors, including nutrition and hormonal status, are briefly highlighted as well. The neural mechanisms, such as intra- and intermuscular coordination, are reviewed in the later sections. Chapter 3 is essential for understanding training methods.

BASIC CONCEPTS OF TRAINING THEORY

Strength conditioning theory is part of a broader field of knowledge, the science of training athletes, also termed *training science* or *theory of sport training*. Training science courses cover the components of athlete preparation, including conditioning (not only for strength but also for speed, endurance, flexibility, and other motor abilities); learning of sport technique; and periodization, that is, variation of training programs in a season. Throughout this book, the concepts and approaches developed within the framework of training science are used extensively. In today's world of strength and conditioning, it is crucial to have programs designed with careful consideration of basic scientific principles for each individual and sport. Optimizing program development and safety for each athlete must be a priority. This chapter introduces you to the issues of training in general. The ideas and terminology you encounter here will be used in the remainder of the book.

Adaptation as a Main Law of Training

If a training routine is planned and executed correctly, the result of systematic exercise is improvement of the athlete's physical fitness, particularly strength, as the body adapts to physical **load**. In a broad sense, **adaptation** means the adjustment of an organism to its environment. If the environment changes, the organism changes to better survive in the new conditions. In biology, adaptation is considered one of the main features of living species.



Immediate and Delayed Effects of Training

Immediately after a training session, performance usually degrades due to **fatigue**. Nobody expects to become stronger after 1 set of drills or a single training session. So, why do multiple training sessions over time end in performance improvement? Improvement occurs because the body adapts to the progression and repeated exposure to the training load.

However, one must also consider **maladaptation**, the inability of an individual to positively respond when programs are not progressively applied and when the loading and metabolic demands exceed the adaptive potential of the organism. In short, maladaptation implies too much, too soon.

Exercise or regular **physical activity** is a very powerful stimulus for adaptation. The major objective in training is to induce specific adaptations in order to improve sport performance. This requires adherence to a carefully planned and executed training program. From a practical point of view, the following four features of the adaptation process assume primary importance for sport training:

1. Stimulus magnitude (overload)
2. Accommodation
3. Specificity
4. Individualization

Overload

To bring about positive changes in an athlete's state, an exercise **overload** must be applied. A training adaptation takes place only if the magnitude of the **training load** is above the habitual level. During the training process, there are two ways to induce an adaptation. One is to increase the training load (intensity, volume) while continuing to employ the same drill—for example, endurance running. The other is to change the drill, provided that the exercise is new and the athlete is not accustomed to it.

If an athlete uses a standard exercise with the same training load over a very long time, there will be no additional adaptations and the level of physical fitness will not substantially change (figure 1.1). If the training load is too low, detraining occurs. In elite athletes, many training improvements are lost within several weeks, even days, if an athlete stops exercising. During the competition period,

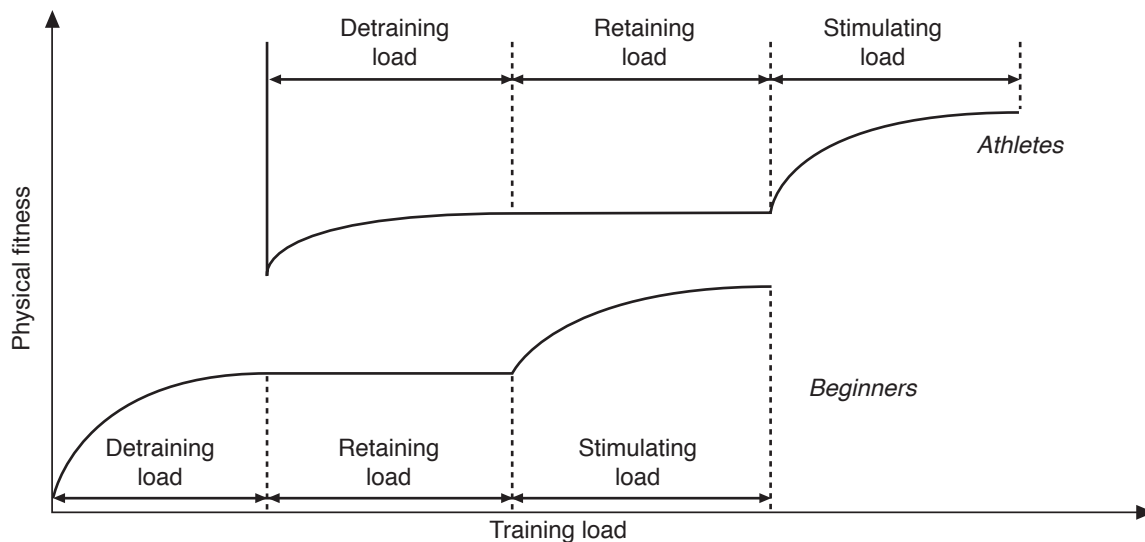

FIGURE 1.1 Relationship between training load (detraining, retaining, stimulating) and level of physical fitness. Rectangles indicate the neutral zones (retaining loads) corresponding to small fluctuations in the training load at which the level of fitness is basically not changed. Note the stepladder effect showing a change in the adaptation curve with a change in the training stimulus. A training load that leads to the detraining of high-level athletes may be extremely high for beginners.

Overload Example

Identical triplets possessed equal levels of strength; each was able to lift a 57.5-kg barbell one time. They began to exercise with a 50-kg barbell, lifting the barbell in 1 set until failure five times. After a period of time, the athletes adapted to the training routine, their preparedness improved, and they were able to lift a 60-kg barbell one time. However, despite continued training, they did not make further gains in performance because they accommodated to the training program.

At this stage, the three athletes made different decisions. Athlete A decided to increase the training load (weight lifted, number of **repetitions** in a set, number of sets) or change the exercise. The new load was a stimulating one for this athlete and performance improved. Athlete B continued to employ the previous routine and performance results were unchanged (retaining load). Athlete C decreased the training load and strength performance declined (detraining load).

elite athletes cannot afford complete passive rest for more than 3 days in a row (typically only 1 or 2 days).

Training loads can be roughly classified according to their magnitude as

- **stimulating**, in which the magnitude of the training load is above the neutral level and positive adaptation may take place;
- **retaining**, in which the magnitude is in the neutral zone where the level of fitness is maintained; and
- **detraining**, in which the magnitude of the load leads to a decrease in performance results, in the functional capabilities of the athlete, or both.

The need for a constant increase in training loads, considered necessary for positive adaptation, leads to **progressive resistance training**: When strength levels improve, larger training loads are used. Because the preparation of elite athletes usually lasts 8 to 12 years, their progressive resistance training leads to extremely demanding training programs. The training load of elite athletes is roughly 10 times greater than that of

beginners having 6 months of training experience. Elite weightlifters lift approximately 5,000 tons/year, while the load for novices is only 1/10 or 1/12 this level. The same is true for other sports. For instance, the year-round training mileage of elite cross-country skiers is between 8,000 and 12,000 km. For beginners, it is about 1,000 km.

Accommodation

If athletes employ the same exercise with the same training load over a long period of time, performance improvement (gain) decreases (see figure 1.2). This is a manifestation of **accommodation**, often considered a general law of biology. According to this law, the response of a biological object to a constant stimulus decreases over time. By definition, accommodation is the decrease in response of a biological object to a continued stimulus.

In training, the stimulus is physical exercise and the response is performance gain as a result of adaptation, a process known as **transformation**. With an increase in training volume or duration, the magnitude of adaptations diminishes—the **principle of diminishing returns**. In beginning athletes,

A Bizarre Bank Metaphor

Banks usually pay higher interest rates to the customers who deposit money for longer periods of time or make large contributions. Imagine a bank—the bizarre bank—that adopts the opposite policy: The longer you keep the money in the bank and the larger the deposit, the smaller the interest. Most likely a bank with this policy would soon be out of business. However, this is exactly how our body works. Over long periods of training or when athletes increase the training load, they will see a decrease in the performance improvement per unit of training load, or the interest on their capital.

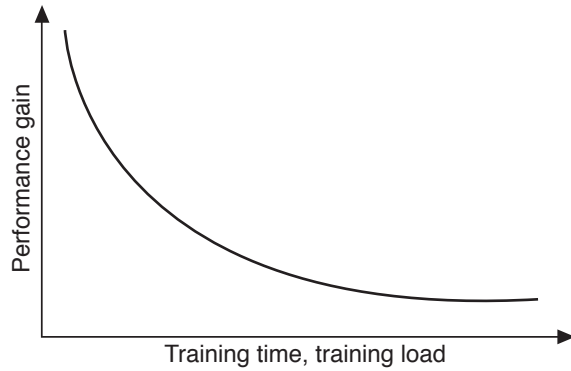

FIGURE 1.2 Dependence of performance improvement (gain) on time of training or training load. As a result of accommodation, the gain decreases.

relatively small training loads may lead to large performance improvements, while in athletes with multiyear experience, even heavy training routines may result in no performance changes. This is due to the lack of an adaptive window for change, which is typically dictated by the individual's genetic ceiling for a given characteristic being trained.

Because of accommodation, it is inefficient to use standard exercises or a standard training load over a long period of time. Training programs must vary. At the same time, because of the specificity of training adaptations, the training exercises should be as close as possible to the main sport exercise in muscular coordination and physiological demand. The highest transfer of training result occurs with the use of **sport-specific exercises**. These two requirements lead to one of the main conflicts in training elite athletes: Training programs should be both variable, to avoid accommodation, and stable, to satisfy the demand for specificity.

To avoid or decrease the negative influence of accommodation, training programs are periodically modified. In principle, there are two ways to modify training programs:

- Quantitative—changing training loads (for instance, the total amount of weight lifted)

- Qualitative—replacing the exercises

Qualitative changes are broadly used in the training of elite athletes, at least by those who are creative.

Specificity

Training adaptations are highly specific. It is well known that strength training increases both muscle mass and strength, while endurance training induces other changes such as increases in aerobic capacity. Because of adaptation **specificity**, the exercises and training in various sports are different.

Specificity may be described in another way, as an issue of **transfer of training results**. Imagine, for example, a group of young athletes who have trained over a certain period of time with one exercise: exercise A, barbell squats. Ultimately, their performances improve. Let's suppose that the gain is the same for all the athletes, say 20 kg. What will happen with the performances of these athletes in other exercises, such as the standing vertical jump, sprint dash, or freestyle swimming (exercises B, C, and D)? We may predict that the results in these exercises will improve to different degrees. The gain may be substantial in the standing jump, relatively small in sprint running, and next to nothing in swimming. In other words, the transfer of training results from exercise A to exercises B, C, and D is variable.

The transfer of training gains can differ greatly even in very similar exercises. In an experiment, two groups of athletes performed an isometric knee extension at different joint angles, 70° and 130° (a complete leg extension corresponds to 180°). The maximal force values, F_m , as well as the force gains, ΔF_m , observed at different joint angles were varied (figure 1.3).

The strength gains at various joint positions were different for the two groups. For the subjects in the first group, who exercised at the 70° knee-joint angle (see figure 1.3a), the strength gains in all joint

Avoiding Accommodation in Olympic Cycles

Several elite track and field athletes, who were successful at three Olympic Games in a row, avoided accommodation. How? None of them used the same training program every year; instead, they varied the training routines. Some of the athletes used the drills that they believed were most efficient (for instance, overhead throwing of a 3-kg shot by a javelin thrower) only during an Olympic season, or one time in a 4-year period. This was done to avoid accommodation.

Transfer of Training Results: Why Is It Important?

The first books about athlete preparation, published in the 19th century, make interesting reading. The preparation for competition consisted of the main sport exercise and nothing else. If one competed in the 1-mi run, workouts consisted of only 1-mi runs.

However, coaches and athletes soon understood that such preparation was not sufficient. To run a mile successfully, an athlete must not only have stamina but must also possess appropriate sprinting abilities, good running technique, and strong and flexible muscles and joints. It is impossible to develop these abilities by running the same fixed distance repeatedly. As a consequence of this realization, training strategies were changed. Instead of multiple repetitions of a single exercise, many auxiliary exercises were adopted into training programs to improve the abilities specific to a given sport. The general concept of training changed.

The question then arises: How do you choose more efficient exercises that result in a greater transfer of training effect from the auxiliary to the main sport movement? Consider the following problems:

1. Is long-distance running a useful exercise for endurance swimmers? For cross-country skiers? For race walkers? For bicyclists? For wrestlers?
2. To improve the velocity of fast pitches, a coach recommends that pitchers drill with baseballs of varying weight, including heavy ones. What is the optimal weight of the ball for training?
3. A conditioning coach planning a preseason training routine for wide receivers must recommend a set of exercises for leg strength development. The coach may choose one of several groups of exercises or combine exercises from different groups. The exercise groups are
 - one-joint isokinetic movements, such as knee extension and flexion, on exercise apparatuses,
 - similar one-joint drills with free weights,
 - barbell squats,
 - isometric leg extensions,
 - vertical jumps with additional weights (heavy waist belts),
 - uphill running, and
 - running with parachutes.

Which exercise is most effective? In other words, when is the transfer of training results greater?

positions were almost equal. The transfer of training results from the trained body posture (70°) to untrained positions (other joint angles) was high. In the athletes of the second group, who trained at the 130° knee-joint angle (see figure 1.3*b*), transfer of training gains was limited to the neighboring joint angles: The strength gain was low for small joint angles (compare strength gains in angles 130° and 90°). The same held true for barbell squats. In the first group, the strength gain in the trained body posture was 410 ± 170 N and in squatting it was 11.5 ± 5.4 kg. In the second group, the strength in the trained posture increased by 560 ± 230 N; however, in spite of such a high gain, the barbell squat performance improved by only 7.5 ± 4.7 kg. The strength gain in the trained posture in the

second group was higher (560 ± 230 N versus 410 ± 170 N), but the improvement in the barbell squats was lower (7.5 ± 4.7 kg versus 11.5 ± 5.4 kg) due to minimal transfer of training results.

As performances in different exercises have different modalities (force, time, distance) and are not directly comparable, a dimensionless unit should be employed to estimate the transfer of training result. Such a unit is a result gain expressed in standard deviations:

$$\text{Result gain} = \frac{\text{Gain of performance}}{\text{Standard deviation of performance}}.$$

For instance, if the average performance of a group is 60 ± 10 kg (average \pm standard deviation) and the performance of an athlete improves by 15

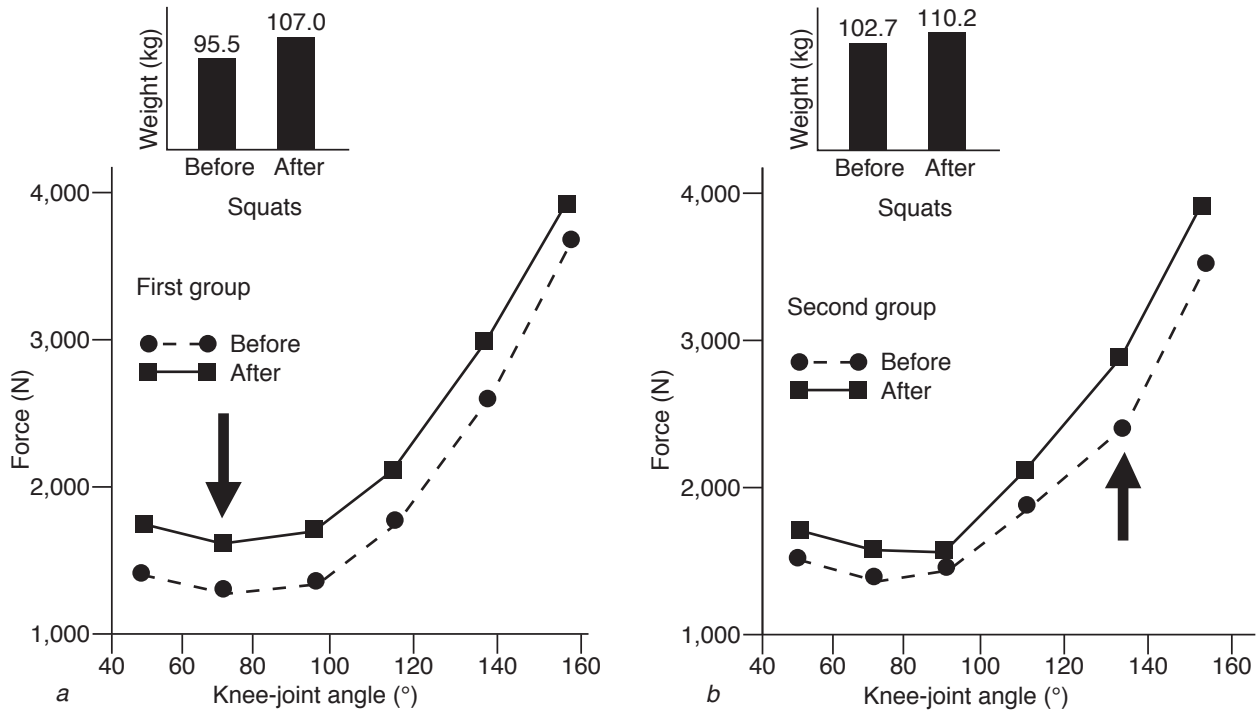

FIGURE 1.3 Performance improvements (strength gains) in two experimental groups. The vertical arrows show the angles at which isometric training took place. Strength was measured in leg extensions as well as in barbell squats.

Data from W.M. Zatsiorsky and L.M. Raitsin, "Transfer of Cumulative Training Effects in Strength Exercises," *Theory and Practice of Physical Culture* 6 (1974): 7-14.

kg as a result of training, the athlete's personal gain equals 15/10 or 1.5 standard deviation. In scientific literature, the result gain for a group computed as [(Posttraining mean - Pretraining mean) / Pretraining standard deviation] is known as the **effect size**. For the estimation of transfer, a ratio of the gains in nontrained exercises (exercises B, C, and D) and the trained exercise (exercise A) is employed. The coefficient of the transfer of training is, by definition, the following ratio:

$$\text{Transfer} = \frac{\text{Result gain in nontrained exercise}}{\text{Result gain in trained exercise}}$$

Both gains are measured in standard deviations (SD). The higher the ratio, the greater the transfer of training results. If the transfer is low, the effect of training is specific. In the example from figure 1.3, the training effects were more specific for the group that performed exercise at the 130° knee-joint angle. Specificity of adaptation increases with the level of sport mastership. The higher an athlete's level of fitness, the more specific the adaptation. The transfer of training gain is lower in good athletes; for beginners, almost all exercises are useful. It is possible to improve

the strength, speed, **endurance**, and flexibility of people with extremely low physical fitness through simple calisthenics. The performance of beginning bicyclists can be improved with barbell squats. Elite athletes should use more specific exercises and training methods to increase competitive preparedness.

Individualization

All people are different. The same exercises or training methods elicit a greater or smaller effect in various athletes. Innumerable attempts to mimic the training routines of famous athletes have proven unsuccessful. The general ideas underlying noteworthy training programs, not the entire training protocol, should be understood and creatively employed. The same holds true for average values derived from training practices and scientific research. Coaches and athletes need to use an average training routine cautiously. Only average athletes, those who are far from excellent, prepare with average methods. Champions are not average; they are exceptional. **Individualization** of training will optimize results and enhance the desired adaptation to the training protocol.

Calculating the Transfer of Training Results

In the experiment discussed in the text, the following data were recorded (see figure 1.3):

Test	Before	After	Gain of performance	Result gain	Transfer
GROUP 1 (ISOMETRIC TRAINING AT AN ANGLE OF 70°)					
Force at an angle 70°, N	1,310 ± 340	1,720 ± 270	410 ± 170	410 / 340 = 1.2	
Squatting, kg	95.5 ± 23	107 ± 21	11.5 ± 5.4	11.5 / 23 = 0.5	0.5 / 1.2 = 0.42
GROUP 2 (ISOMETRIC TRAINING AT AN ANGLE OF 130°)					
Force at an angle 130°, N	2,710 ± 618	3,270 ± 642	560 ± 230	560 / 618 = 0.91	
Squatting, kg	102.7 ± 28	110.2 ± 23	7.5 ± 4.7	7.5 / 28 = 0.27	0.27 / 0.91 = 0.30

Note the results:

Characteristics	Superior group	Comparison
Gain of performance in trained exercise	Group 2	560 vs. 410 N
Result gain in trained exercise	Group 1	1.2 vs. 0.91 SD
Transfer of training results	Group 1	0.42 vs. 0.30
Gain of performance in nontrained exercise	Group 1	11.5 ± 5.4 vs. 7.5 ± 4.7 kg

Because of the higher transfer of training results, the method used to train the first group better improved the squatting performance.

Generalized Theories of Training

Generalized training theories are very simple models that coaches and experts use broadly to solve practical problems. These models include only the most essential features of sport training and omit numerous others. Generalized theories (models) serve as the most general concepts for coaching. Coaches and athletes use them especially for conditioning and also for planning training programs.

One-Factor Theory (Theory of Supercompensation)

In the **one-factor theory**, the immediate training effect of a workout is considered as a depletion of certain biochemical substances. The athlete's dispo-

sition toward a competition or training, called **preparedness**, is assumed to vary in strict accordance with the amount of this biochemical substance available for immediate use. There is evidence in exercise and sport science literature that certain substances are exhausted as a result of strenuous training workouts. An example is muscle glycogen depletion after high-volume **anaerobic exercise** or long-term aerobic exercise.

After the restoration period, the level of the given biochemical substance is believed to increase above the initial level. This is called supercompensation, and the time period when there is an enhanced level of the substance is the **supercompensation phase** (figure 1.4).

If the **rest intervals** between workouts are too short, the level of an athlete's preparedness

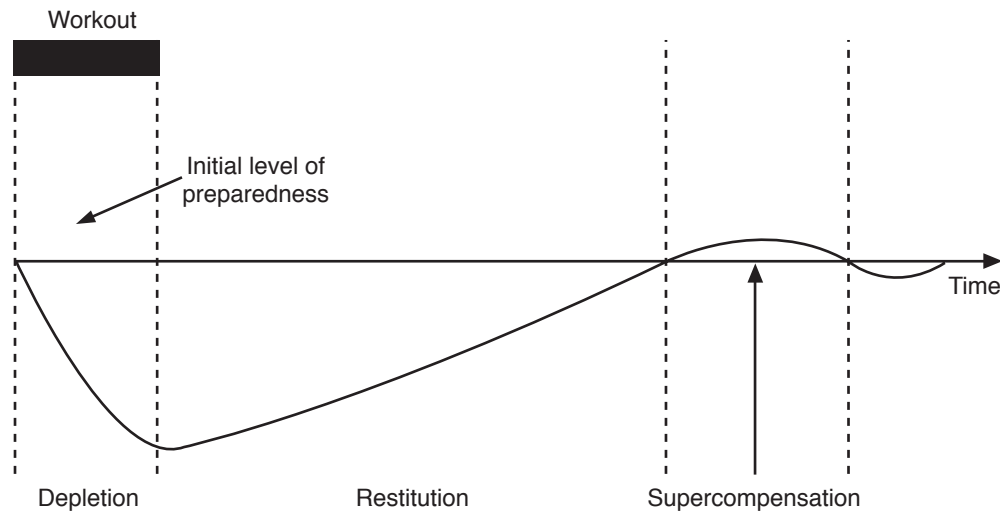

FIGURE 1.4 Time course of the restoration process and athlete's preparedness after a workout according to the supercompensation theory. The vertical axis is both for the amount of substance and for the level of preparedness. According to the model, the two curves coincide.

decreases (see figure 1.5*a*). If the rest intervals between consecutive workouts are the right length, and if the next training session coincides in time with the supercompensation phase, the athlete's preparedness advances (figure 1.5*b*). Finally, in the case of very long intervals between sessions, an athlete's physical abilities do not change (figure 1.5*c*). Coaches and athletes should avoid time intervals between serial training sessions that are either too short or too long. Instead, they should seek the following:

- Optimal rest intervals between successive training sessions
- An optimal training load in each workout

The aim in selecting these intervals and loads is to ensure that a subsequent training session coincides with the supercompensation phase.

Within the framework of this theory, more sophisticated variations of the training schedule are also acceptable. One variation that is popular among coaches, the overloading microcycle (or impact microcycle), is shown in figure 1.6. In this case, after several training sessions with high training loads and short time intervals between sessions, a relatively long period of rest is included. The common belief is that such a training routine produces a final supercompensation that is greater than normal (compare figures 1.5*b* and 1.6).

For several decades, the supercompensation model has been the most popular training theory. It

has been described in many textbooks and is widely accepted by coaches. In spite of its popularity, however, it deserves critical scrutiny.

The very existence of the supercompensation phase for a majority of metabolic substances has never been experimentally proven. For some metabolites, like muscle glycogen, after-exercise depletion has been definitely demonstrated. It is possible to induce glycogen supercompensation by combining a proper training routine with carbohydrate loading. This procedure is used only before important competitions, not training, and it is specific to sports where glycogen levels are impacted from the bioenergetic demands of the activity. The concentrations of other biochemical substrata whose role in muscular activity has been proven to be very important—for example, **adenosine triphosphate (ATP)**—do not change substantially even after very hard exercise. The restoration of initial levels of different metabolic substances requires unequal amounts of time. It is absolutely unclear which criteria one should use for selecting proper time intervals between consecutive workouts. In general, the theory of supercompensation is too simple to be correct. This concept over time has lost much of its popularity.

Two-Factor Theory (Fitness-Fatigue Theory)

The **two-factor theory (fitness-fatigue theory)** of training is more sophisticated than the **supercompensation theory**. It is based on the idea

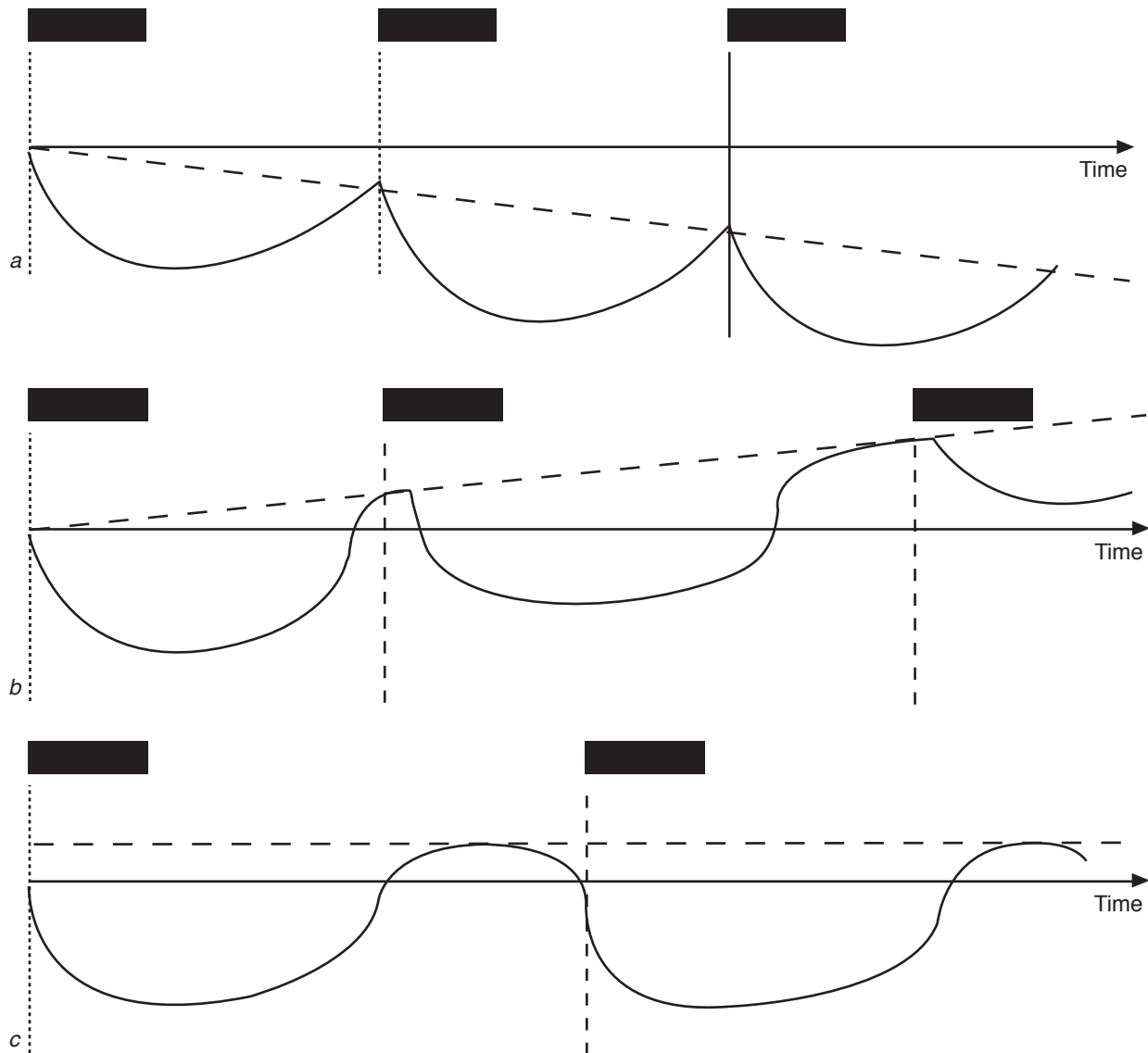

FIGURE 1.5 Supercompensation theory. The vertical axis is both for the amount of substance and for the level of preparedness. There are three situations with rest intervals between sequential training workouts (represented by the black rectangles): (a) The intervals are too short and the level of athlete preparedness decreases due to accumulated fatigue; (b) the intervals are optimal and the subsequent workouts match with the supercompensation phase; and (c) the intervals are too long and there is no stable training effect.

that preparedness, characterized by the athlete's potential sport performance, is not stable but rather varies with time. There are two components of the athlete's preparedness: those that are slow changing and those that are fast changing. The term **physical fitness** is used for slow-changing motor components of the athlete's preparedness. Physical fitness does not vary substantially over several minutes, hours, or even days. However, fatigue, psychological overstress, or a

sudden illness such as flu may quickly change an athlete's disposition toward competition. An athlete's preparedness is sometimes thought of as a set of latent characteristics that exist at any time but can be measured only from time to time. According to the two-factor model, the immediate training effect after a workout is a combination of two processes:

1. Gain in fitness prompted by the workout
2. Fatigue

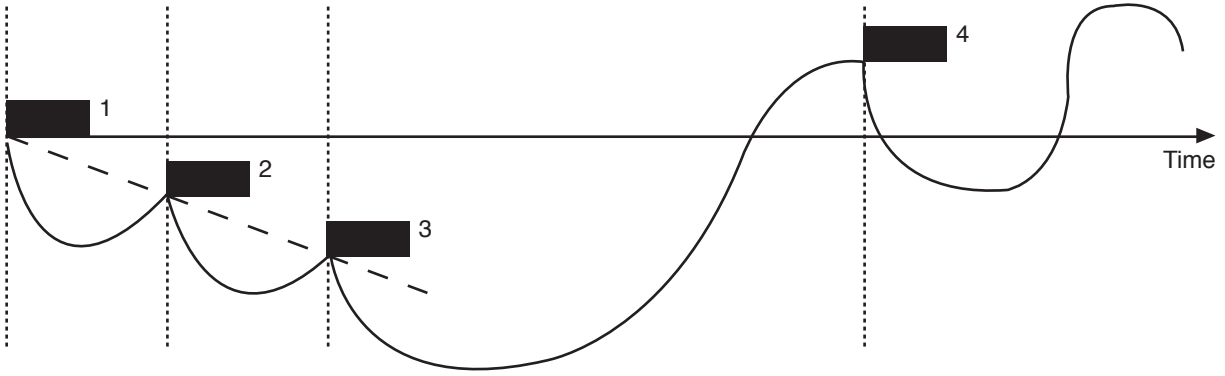

FIGURE 1.6 Using black rectangles to represent four sequential training sessions, the rest intervals between the first three sessions are too short to allow full restoration, so fatigue is accumulated. The interval between the third and fourth sessions is longer than usual but optimal for the situation. The fourth training session coincides with the supercompensation phase after the first three sessions.

After one workout, an athlete's preparedness

- ameliorates due to fitness gain, but
- deteriorates because of fatigue.

The final outcome is determined by the summation of the positive and negative changes (figure 1.7).

The fitness gain resulting from one training session is supposed to be moderate in magnitude but long lasting. The fatigue effect is greater in magnitude but relatively short in duration. For most crude estimations, it is assumed that for one workout with an average training load, the durations of the

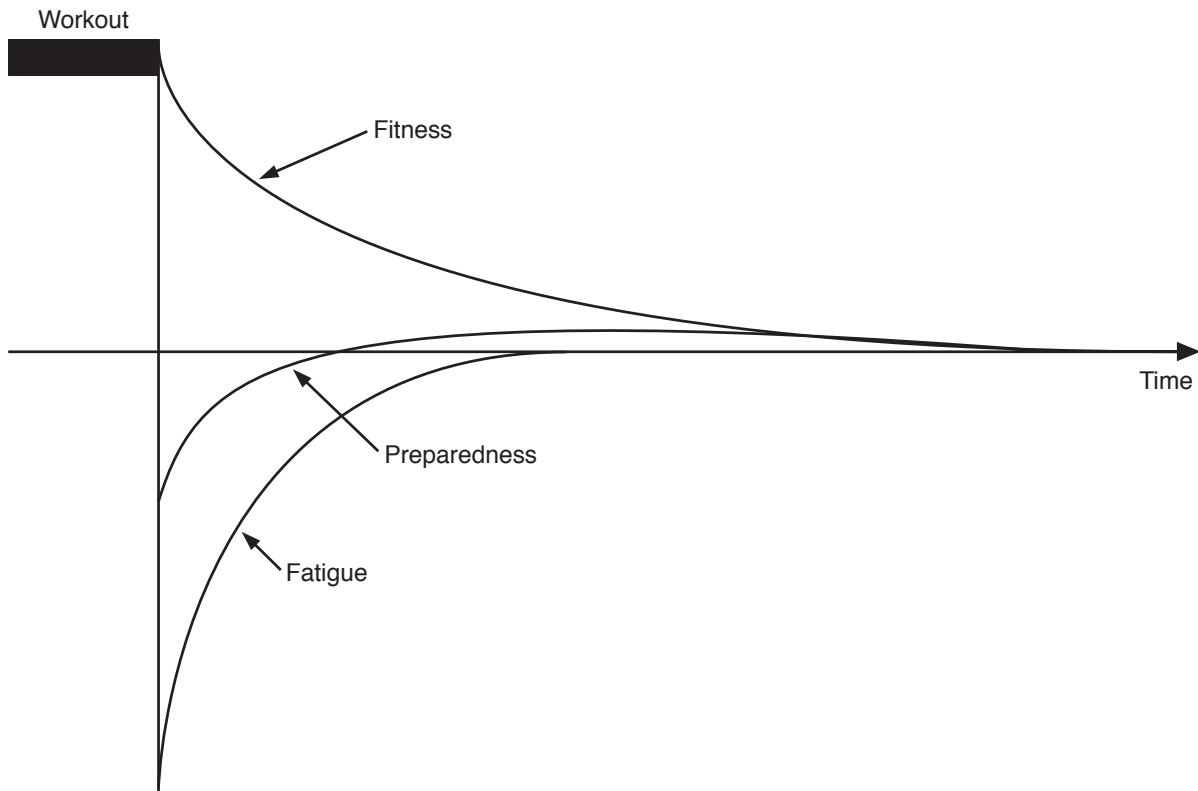

FIGURE 1.7 Two-factor theory (model) of training. The immediate effect of a training session is characterized by the joint action of two processes: fitness gain and fatigue. Athlete preparedness improves because of fitness gain and worsens because of fatigue.

One- and Two-Factor Models of Training

These models help coaches to grasp and visualize the timing of workout–rest intervals during preparation of athletes and to view training as an organized process rather than a chaotic sequence of drill sessions and rest periods.

Imagine two coaches with different coaching philosophies. Coach A strictly adheres to the one-factor theory of training and is trying to schedule a training session for when (in his estimation) the supercompensation phase takes place. Coach B prefers the two-factor theory of training and is looking for rest intervals that are long enough for proper restoration and, at the same time, short enough to maintain the acquired physical fitness level. At times the training plans of the two coaches may look similar, but the underlying philosophies are not the same. You would see the greatest differences in plans for **tapering**, or **peaking**, periods that take place immediately before important competitions. Coach A would probably recommend that his athletes decrease the number of training sessions (but not the load during the sessions) in order to compete at the climax of the supercompensation phase. For instance, in accordance with the one-factor theory, he has the athletes train only two or three times during the final week before the main competition, with each workout containing a relatively large load. Coach B, on the other hand, prefers that her athletes maintain acquired preparedness, avoid fatigue, and participate in several warm-up-type training sessions. The idea here is to decrease the training load during each session rather than the number of workouts.

fitness gain and the fatigue effect differ by a factor of three: The fatigue effect is three times shorter in duration. This implies that if the negative impact of fatigue lasts, for instance, 24 h, the positive traces from this workout will remain through 72 h.

The time course of the immediate training effect after a single workout can be described by the equation

$$\text{Preparedness} = P_0 + P_1 e^{-k_1 t} - P_2 e^{-k_2 t},$$

where

P_0 is the initial level of preparedness before the training workout;

P_1 is the fitness gain;

P_2 is the fatigue effect estimated immediately after the workout;

t is time;

k_1 and k_2 are time constraints; and

e is the base of the system of natural logarithms, approximately 2.718.

According to the two-factor theory of training, the time intervals between consecutive training sessions should be selected so that all the negative traces of the preceding workout pass out of existence but the positive fitness gain persists. This model has become rather popular among

coaches and is used predominantly to plan training, especially during the final training days before a competition.

Training Effects

Training effects—that is, changes that occur within the body as a result of training—can be further classified as follows:

- **Acute effects** are the changes that occur during exercise.
- **Immediate effects** are those that occur as a result of a single training session and that are manifested soon after the workout.
- **Cumulative effects** occur as a result of continued training sessions or even seasons of training.
- **Delayed effects** (also called chronic effects) are those manifested over a given time interval after a performed training routine.
- **Partial effects** are changes produced by single training means (e.g., bench press exercise).
- **Residual effects** are defined as the retention of changes after the cessation of training beyond time periods during which adaptation can take place.

Summary

The major objective in training is to induce specific adaptations toward the improvement of athletic performance. In strength training, adaptation means the adjustment of an organism to exercise (physical load). If a training program is properly planned and executed, an athlete's strength improves as a result of adaptation.

Training adaptation takes place when the training load is above usual or the athlete is not accustomed to an exercise. Training loads are roughly classified as stimulating, retaining, and detraining loads. In order to induce the adaptation, the following are required:

1. An exercise overload must be applied.
2. The exercises and training protocol must be specific (corresponding to the main sport exercise).
3. Both exercises and training load (intensity, volume) should vary over time periods. When the same exercise with the same training load is employed over a long period of time, performance gains decrease (accommodation).

4. Training programs must be adjusted individually to each athlete. Remember that all people are different.

To plan training programs, coaches use simple models that are based on only the most essential features. These models are known as generalized theories of training.

The theory of supercompensation, or one-factor theory, is based on the idea that certain biochemical substances are depleted as a result of training workouts. After the restoration period, the level of the substance increases above the initial level (supercompensation). If the next workout takes place during the supercompensation phase, the athlete's preparedness increases. In the fitness-fatigue theory (two-factor theory), the immediate effect after a workout is considered a combination of (1) fitness gain prompted by the workout and (2) fatigue. The summation of positive and negative changes determines the final outcome.

The effects of training can be classified as acute, immediate, cumulative, delayed, partial, or residual.

TASK-SPECIFIC STRENGTH

If the goal is knowing *how* an athlete must train to achieve the best results, the steps along the way are to first know *what* it is that should be trained and to understand *why* the training must be performed in a prescribed way. To understand strength training, one must first clearly understand muscular strength in general.

In this chapter you will examine the definition of muscular strength and learn the main factors that determine its manifestation. When an athlete sincerely attempts a maximal effort, the resulting force depends on both the motor task and the athlete's abilities. Therefore, we will look at the determining factors as they compare across tasks and then, in chapter 3, examine the determining factors as they compare across athletes. The carryover from the exercises used in the weight room to the sport skills is relevant to the concept of task-specific strength.

Elements of Strength

If an athlete were asked to produce a high force against a penny, the effort would fail. In spite of the best effort, the magnitude of force would be rather small. We may conclude that the magnitude of muscular force depends on the external resistance provided. Resistance is one of the factors that act to determine the force generated by an athlete, but only one. Other factors are also important, which we will explore in detail.

Maximal Muscular Performance

Imagine an athlete who is asked to put a shot several times, making different efforts in various attempts.



According to the laws of mechanics, the throwing distance is determined by the position of the projectile at release and its **velocity**, or speed (both magnitude and direction), at that moment. Let's suppose that the release position and release angle

of the shot are not changed in different attempts. In this case, the throwing distance (performance) is determined only by the initial velocity of the projectile. As the subject throws the shot with different efforts in different attempts, the throwing distance is maximal in only one case. This is the individual's **maximal muscular performance** (maximal distance, maximal velocity). The symbol P_m (or V_m for maximal velocity, F_m for maximal force) will be used throughout this book to specify maximal muscular performance.

Parametric Relations

At the next stage of the experiment, the athlete puts the shots with maximal effort, trying to achieve the best possible result. However, instead of putting the men's shot (7,257 g), the athlete puts the women's shot (4,000 g). The shot velocity is obviously greater using the lower weight. Two different values of V_m , one for the men's shot and one for the women's shot, are registered as a result of this experiment.

In science, a variable that determines the outcome of the experiment (such as mass or distance) or the specific form of a mathematical expression is a **parameter**. In other words, the parameter is an independent variable that is manipulated during the experiment. We may say that in the last exam-

ple, the experimental parameter (shot mass) was changed. If the shot mass (parameter) is changed in a systematic way, for instance in the range from 0.5 kg to 20 kg, the maximal muscular performance (P_m , V_m , F_m) for each used shot will be different.

The dependent variables, in particular F_m and V_m , are interrelated. The relation between V_m and F_m is called the maximal parametric relation, or simply the **parametric relationship**. The term *parametric* is used here to stress that V_m and F_m were changed because the values of the motor task parameter were altered. The parametric relation between V_m and F_m is typically negative. In the throw of a heavy shot, the force applied to the object is greater and the velocity is less than in the throw of a light shot. The greater the force F_m , the lower the velocity V_m . The same holds true for other motor tasks (figure 2.1; see also figure 2.10 on page 26).

Nonparametric Relations

Each point on a parametric curve (V_m - F_m) corresponds to the maximal performance at the given value of the motor task parameter (i.e., object weight, external resistance, gear ratio, distance). Among these performances are peak values such as the highest F_m or V_m . These achievements, the highest among the maximal, are termed **maximum**

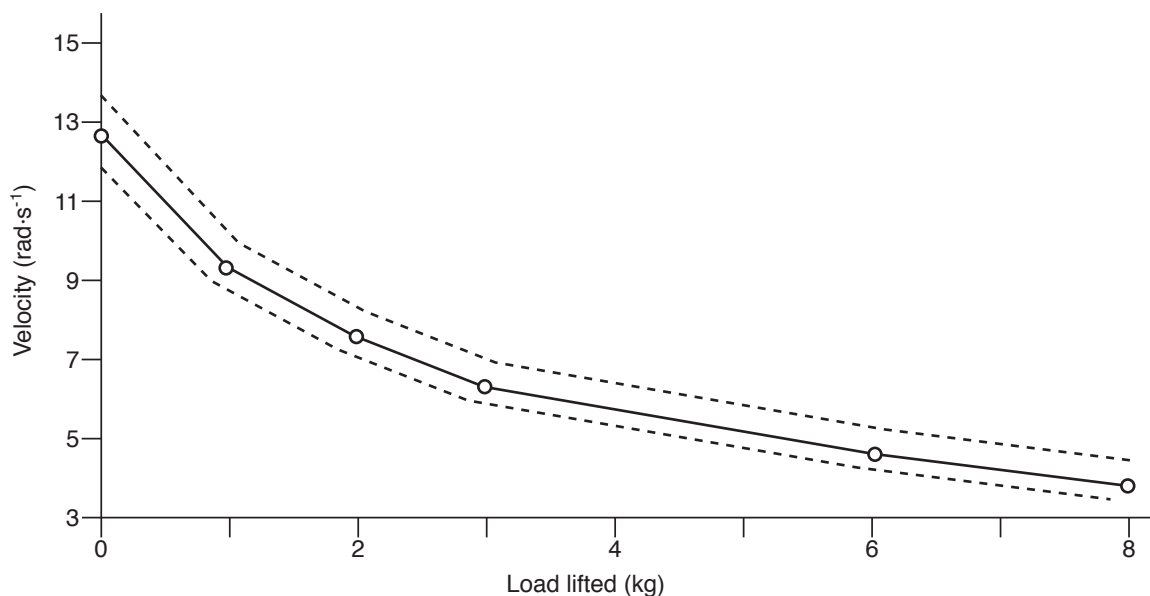

FIGURE 2.1 Parametric relations between force and velocity. In the experiment, 100 young males performed fast shoulder flexions with the arm extended while holding a barbell. The load lifted in different trials varied from 0 (unloaded arm) to 8.0 kg. The maximal lifting velocity V_m was recorded in each trial. The data are group average and standard deviations.

Reprinted by permission from V.M. Zatsiorsky, Yu. I. Smirnov, and N.G. Kulik, "Relations Between the Motor Abilities, Part 1," *Theory and Practice of Physical Culture* 31, no. 12 (1969): 35-48.

Examples of Parametric Relations

A coach suggested that athlete–cyclists change the gear ratios of their bikes during training. The higher the ratio, the greater the force applied to the pedals and the lower the pedaling frequency. The (inverse) relation between the force and the frequency (the velocity of foot motion) is an example of a parametric relation.

Here are examples of parametric force–velocity relations from different activities:

Activity	Variable parameter	Force	Velocity	Relation
Cycling	Gear ratio	Force applied to the pedal	Pedaling (frequency rate)	Inverse (negative)
Rowing, kayaking, canoeing	Blade area of an oar or a paddle	Applied to the oar or the paddle	The blade with respect to the water	Same
Uphill/downhill ambulation	Slope	At takeoff	Ambulation	Same
Throwing	Weight/mass of the implement	Exerted upon the implement	Implement at the release	Same
Standing vertical jump	Modified body weight; weight added (waist belt) or reduced (suspension system)	At takeoff	Body at the end of takeoff	Same

Note that all relations are negative (inverse)—the higher the force, the lower the velocity.

maximorum performance. The symbols P_{mm} , V_m , and F_{mm} are used to represent them. These levels can be achieved only under the most favorable conditions. For instance, V_m can be attained only if the external mechanical resistance is minimal and the movement time is short (e.g., in the throwing of light objects or in the sprint dash), and F_{mm} can be attained only if the external resistance is sufficiently high.

The relation between P_{mm} (V_m , F_{mm}) on the one hand and P_m (V_m , F_m , T_m) on the other is called the **maximal nonparametric relationship**, or simply the **nonparametric relationship**. The following performance pairs are examples of nonparametric relationships:

- The maximal result in a bench press (F_{mm}) and the throwing distance of putting 7- or 4-kg shots (P_m or V_m)
- The maximum maximorum force in a leg extension and the height of a standing jump

Nonparametric relations, unlike parametric ones, are typically positive. For instance, the greater the value of F_{mm} , the greater the value of the V_m , meaning the stronger the athlete, the faster the athlete can perform a given movement. This conclusion is only valid if the resistance overcome by the athlete, such as the weight of the implement, is sufficiently large (figure 2.2). For instance, in activities where athletes propel their own bodies, such as in standing vertical jumps, a positive correlation between the F_{mm} and V_m is commonly observed: Stronger athletes jump higher. This is especially true for beginning athletes. If the resistance (the parameter value of the task) is low, the correlation between F_{mm} and V_m is small. In such tasks, for example in table tennis strokes, stronger athletes do not have an advantage. The correlation between maximum maximorum values of F_{mm} and V_m is 0: Stronger athletes are not necessarily the fastest ones.

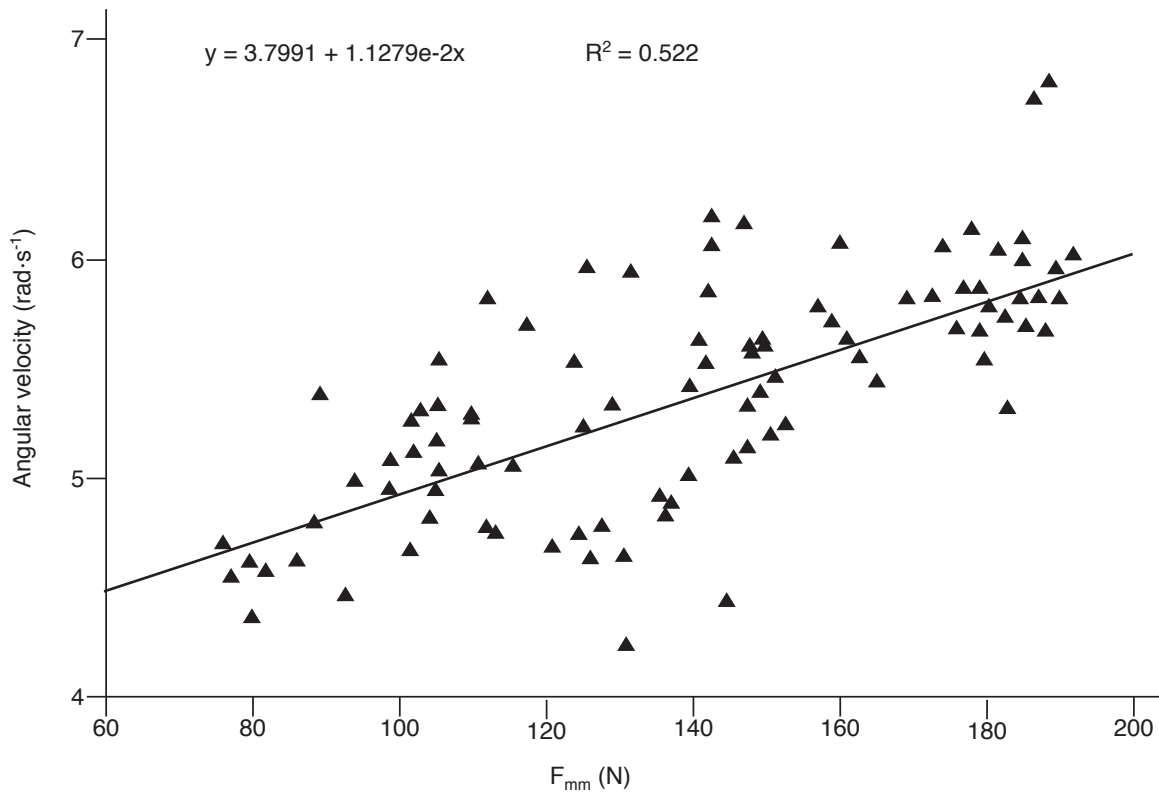

FIGURE 2.2 Nonparametric relation between the maximum maximum force (F_{mm}) and the velocity of shoulder flexion (V_m) with arm extended. Load (a dumbbell) of 6 kg in the hand; 100 subjects. Compare with figure 2.12 on page 28. Data from V.M. Zatsiorsky, "Motor Abilities of Athletes," unpublished doctoral dissertation (Moscow: Central Institute of Physical Culture, 1960), 46.

When considering the training of maximal muscular strength, one should distinguish between F_{mm} and F_m .

Defining Muscular Strength

Strength, or **muscular strength**, is the ability to generate maximum external force, F_{mm} . Recall

that in mechanics and physics, **force** is defined as an instantaneous measure of the interaction between two bodies. Force manifests itself in two ways: Either the movement of a body is changed or the body is deformed (or both). Force is a vector quantity. It is characterized by (1) magnitude, (2) direction, and (3) point of application. Since force

Example of Nonparametric Relations

A swim coach wants to determine the importance of dryland strength training for her athletes. In order to solve this problem, she measures (1) the maximal force (F_{mm}) produced by the athletes in a specific stroke movement against high resistance and (2) swimming velocity.

She assumes that if the correlation between the two variables is high, then the F_{mm} values are important and it is worthwhile spending the effort and time to enhance maximal force production. If the correlation is low (i.e., the strongest athletes are not the fastest ones), there is no reason to train for maximal strength. Other abilities such as **muscular endurance** and flexibility are more important.

The coach finds that the correlation between F_{mm} and swimming velocity is significant. The better swimmers generate larger forces in specific movements. This is an example of a nonparametric relation.

Why Is Strength Training Vital for Sprinters and Jumpers?

Body weight (during the upward takeoff motion) and body mass (during both the horizontal and vertical push-offs) provide high resistance. If you practice a leg extension without any external resistance, the strength training will be of small value, since there is no positive relation between the maximum maximum force (F_{mm}) and the maximum maximum velocity (V_{mm}) in this case.

is an instantaneous measure and all human movements are performed over a certain span of time, the entire force–time continuum, not just the force at a given instant of time, is typically what interests coaches and athletes.

Many different forces exist in athletic movements. In biomechanics, they are divided into two groups: internal forces and external forces. A force exerted by one constituent part of the human body on another part is an **internal force**. Internal forces include bone-on-bone forces and tendon-to-bone forces, among others. The forces acting between an athlete's body and the environment are called **external forces**. Thus, according to this definition of strength, only external forces are regarded as a measure of an athlete's strength.

It is well known that an active muscle exerts force on the bone while

- shortening (**concentric** or **miometric action**),
- lengthening (**eccentric** or **plyometric** [plio-metric] **action**), or
- remaining the same length (**static** or **isometric action**).

Note that *metric* means “length,” *mio* means “less,” *pleio* (*plio-*) means “more,” and *iso* means “same” or “constant.” In the United States, *plyometrics* has become a common spelling, with *pliometrics* an alternative. Disregarding the differences between muscular force (force developed by a muscle) and

muscular strength (maximal force exerted on an external body), this simple classification can be used to discern variations of muscular strength.

In another sense, strength can be defined as the ability to overcome or counteract external resistance by muscular effort. In the case of concentric muscular action, resistance forces act in the direction opposite to the **motion**, whereas in eccentric action, the external forces act in the same direction as the motion.

Determining Factors: Comparison Across Tasks

If, in different attempts, all body parts move along the same trajectory or very similar trajectories, we say that the motion itself is the same regardless of differences in such elements as time and velocity. So, by definition, a motion is determined only by the geometry of movement, not by its kinematics or kinetics. For instance, a **snatch** (one of the lifts in **Olympic-style weightlifting**, in which the barbell is lifted from the floor to over the head in one continuous motion) with a barbell of different weights is one motion, and the takeoff in a vertical jump with or without an additional load is also one motion.

Maximal forces exerted by an athlete in the same motion, for instance in the leg extension, are different if conditions are changed. The two types of factors that determine these differences are extrinsic (external) and intrinsic (internal).

What Is Muscular Strength?

A subject was asked to flex an elbow joint with maximal effort to generate the highest possible force and velocity against different objects. The objects included a dime, a baseball, a 7-kg shot, and dumbbells of different weights, including one that was too heavy to lift. The maximal forces (F_m) applied to the objects were measured and found to be unequal.

The question: Which of the F_m values represents muscular strength?

The answer: According to the definition given, the highest one. The F_{mm} , not F_m , is the measure of muscular strength.

Extrinsic Factors and the Role of Resistance

Force is the measure of the action of one body against another, and its magnitude depends on the features and movements of both bodies in action. The force exerted by an athlete on an external body (e.g., a free weight, a throwing implement, the handle of an exercise machine, water in swimming and rowing) depends not only on the athlete but also on external factors.

To judge the role of external resistance, imagine an athlete who exerts maximal force (F_m) in a leg extension such as squatting. Two experimental paradigms are employed to measure the external resistance. In the first case, the maximal isometric force (F_m) corresponding to different degrees of leg extension is measured. Many researchers have found that the correlation between the force F_m and leg length (the distance from the pelvis to the foot) is positive: If the leg extends, the force increases (figure 2.3, curve A; see also figure 1.3). Maximum force (F_{mm}) is achieved when the position of the leg is close to full extension. This is in agreement with everyday observations—the heaviest weight can be lifted in semisquatting, not deep squatting, movements.

However, if the leg extension force is registered in a dynamic movement such as a takeoff in jumping, the dependence is exactly the opposite (figure 2.3, curve B). In this case, maximal force is generated in the deepest squatting position. The correlation of F_m to leg length, then, is negative. Here the mechanical behavior of a support leg resembles the behavior of a spring; the greater the deformation (i.e., knee bending), the greater the force. Remember that in both experimental conditions (isometric and jumping takeoff), the athlete is making maximal effort. Thus, both the magnitude of F_m and the correlation of F_m to leg length (positive or negative) are changed because the type of resistance changes. In the first case the resistance is the immovable obstacle and in the second it is the weight and inertia of the athlete’s body.

Mechanical Feedback

All strength exercises, depending on the type of resistance, can be separated into those with and

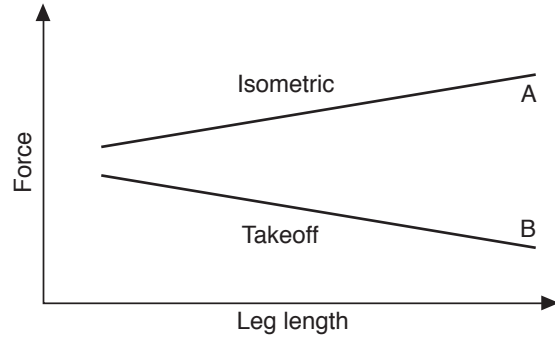

FIGURE 2.3 Relations between maximal force in leg extension and body position (leg length). Curve A is isometric testing. Curve B is force generated as the leg extends during a takeoff.

those without **mechanical feedback**. Consider, for instance, a paddling movement in water. In hydrodynamics, the force applied to water is proportional to the velocity squared ($F = kV^2$). However, the oar’s velocity is the result of an athlete’s efforts, an external muscular force. The chain of events is represented in figure 2.4. Here, active muscular force leads to higher oar velocity, which in turn increases water resistance. Then, to overcome the increased water resistance, the muscular force is elevated. Thus, increased water resistance can be regarded as an effect of the high muscular force (mechanical feedback).

Imagine a different example, that of an individual pushing a heavy truck that is already moving. Regardless of all the force applied by the person, the truck moves with the same velocity. The human’s muscular efforts result in no change in the truck’s movement (no mechanical feedback).

Sport movements usually involve mechanical feedback: The movement, as well as resistance, is changed as a result of an athlete’s force application. Mechanical feedback is absent only in the performance of isometric exercises and in work with isokinetic devices.

With isokinetic devices, the velocity of limb movements around a joint is kept constant. The resistance of the device is equal to the muscular force applied throughout the range of movement. The maximal force F_m is measured in dynamic conditions, provided that the preset velocity has been attained by the moving limb.

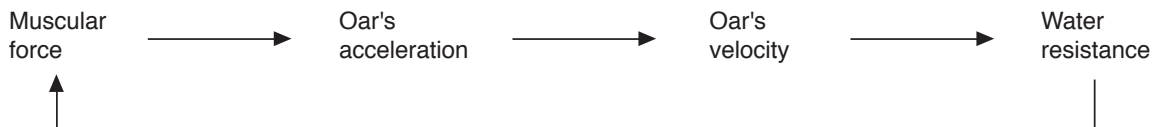

FIGURE 2.4 Mechanical feedback loop.

Types of Resistance

Because of the specific requirements of strength exercises, selecting the proper class of mechanical resistance equipment is important in training. The equipment typically used in resistance training programs can be categorized according to the type of resistance involved.

In resistance based on **elasticity**, the magnitude of force is determined by the range of displacement. The length of an object with ideal elasticity increases in proportion to the force applied. The formula is $F = k_l D$, where F is force, k_l is a coefficient (stiffness), and D is displacement (deformation). In other words, the greater the range of motion (e.g., the deformation of a spring, stretch cord, or rubber band), the higher the exerted muscular force. In such exercises, the resistance and the force exerted by an athlete increase during the motion and attain the maximal value at the end of the movement (the tension in the bands is greatest when the band is maximally extended).

Another type of resistance is based on **inertia**. A movement follows Newton's second law of motion: $F = ma$, where m is mass and a is **acceleration**, or rate of speed. The force is proportional to the mass (inertia) of the accelerated body and its acceleration. As the body mass is typically selected as a parameter of a motor task, the force determines the acceleration. Because of gravity and friction, however, it is difficult to observe movement in which the resistance is formed only by inertia. The motion of a billiard ball on a horizontal surface is one example.

In science, movement against inertial resistance is studied by using an **inertia wheel**, or pulley, that rotates freely around an axis perpendicular to its

surface plane. A rope is wound repeatedly around the pulley and a subject then pulls the rope; the force exerted by the subject in turn rotates the pulley and does mechanical work. With this device, the potential **energy** of the system is constant and all mechanical work, except small frictional losses, is converted into kinetic energy. By varying the mass (or moment of inertia) of the wheel, we can study the dependence of exerted muscular force, particularly F_m , on the mass of the object. The results are shown in figure 2.5.

If the mass of an accelerated object is relatively small, the maximal force exerted by an athlete depends on the size of the mass (see zone A in figure 2.5b). It is impossible to exert a large F_m against a body of small mass. For instance, it is unrealistic to apply a great force to a coin. If the mass of an object is large, however, the F_m depends not on the body mass but only on the athlete's strength (figure 2.5b, zone B).

An example from sport training shows the relation between mass and force. When objects of different masses are thrown (e.g., shots 1.0-20.0 kg are used in training), the force applied to the light shots is relatively small and heavily influenced by the shot mass (zone A). The force exerted on the heavy shots, however, is determined only by the athlete's strength (zone B).

Resistance can also be based on **weight**. The formula is $F = W + ma$, where W is the weight of the object and a is the vertical acceleration. If a is 0 (the object is at rest or in uniform motion), the force equals the object weight. When exercising with free weights, an athlete needs to fix the barbell in a static position. Typically, it is not feasible to relax

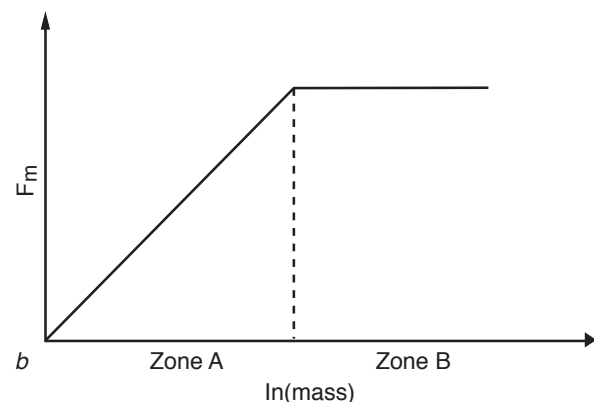
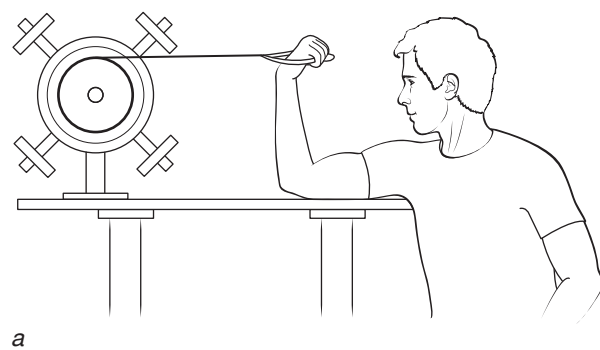

FIGURE 2.5 The inertia wheel (a) and the dependence of maximal exerted force F_m on the mass of the moving object (b). Scale on the abscissas is logarithmic.

Reprinted by permission from V.M. Zatsiorsky, *Motor Abilities of Athletes* (Moscow: Fizkultura i Sport, 1966).

before and immediately after the effort as is possible for a motion against other types of resistance (for instance, in a swimmer's stroke). All exercises in which athletes move their own bodies (gymnastics strength exercises) are classified as having this type of resistance.

If a body is accelerated by muscular force, the direction of the acceleration does not coincide with the direction of this force except when the movement is vertical. Rather, it coincides with the direction of the resultant force, which is a vector sum of the muscular force and the force of gravity. Since gravity is always acting downward, the athlete should compensate for this action by directing the effort higher than the desired movement direction. For instance, in shot putting, the direction of the shot acceleration does not coincide with the direction of the athlete's force applied to the shot (figure 2.6). The same is true for jump takeoffs.

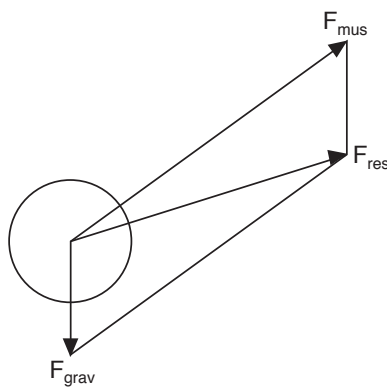

FIGURE 2.6 Muscular (F_{mus}) and gravity (F_{grav}) forces applied to a shot. Shot acceleration coincides in direction with the resultant force (F_{res}) but not with F_{mus} .

Hydrodynamic resistance predominates in water sports such as swimming, rowing, and kayaking. Force in this case depends on the velocity squared: $F = k_2 V^2$, where V is the velocity relative to water and k_2 is a coefficient of hydrodynamic resistance. It is difficult to model this type of resistance on land. Thus the selection of proper strength or dryland training in water sports is a special problem. The use of weights or elastic resistance is not a satisfactory solution. While performing a stroke in the water, the athlete relaxes immediately before and after the stroke and also exerts maximal force against the water resistance at a time when the maximal velocity is achieved. These two features are both unattainable with springs and free weights.

With some training devices the resistance is provided by **viscosity**. Here the exerted muscular force is proportional to the movement velocity, $F = k_3 V$. These exercise machines are mainly used as a substitute for natural water conditions and for dryland training in water sports.

Compound resistance is also used in training. For instance, one end of a rubber band can be fixed to the floor and the second attached to a barbell. In this case, when the barbell is being lifted, the athlete overcomes the resistance of the barbell weight (which is constant), the barbell inertia (which is proportional to the acceleration of the barbell), and the elastic force (which grows larger the higher the barbell is lifted).

Intrinsic Factors

The strength that an athlete can exert in the same motion depends on several variables: time available for force development, velocity, direction of move-

Selection of Dryland Exercises for Swimmers

A swim coach explored several types of training devices for dryland training. Lying in a prone position on a couch, the athletes initiated a stroke pattern against provided resistance. First they used extensible rubberlike bands. However, during this exercise the pulling force inevitably increased from the beginning to the end of the pull. This movement pattern is not similar to the customary stroke. Then the swimmers used a weightlifting exercise machine with a pulley to pull a rope attached to a load. The resistance was almost constant over the range of the pull, but they couldn't relax their muscles at the end of the motion. Their arms were forcibly jerked in the reverse direction. Finally the athletes used training devices with friction resistance (or hydrodynamic resistance). These provided either constant resistance (friction devices) or resistance proportional to the pull velocity (hydrodynamic exercise machines), which mimicked water resistance. The resemblance, however, was far from ideal; during the natural stroke, the resistance force is proportional to the squared values of the hand velocity with respect to the water.

ment, and body position. The cause of muscular strength is, obviously, the activity of individual muscles. The variables just mentioned also determine the force output of single muscles. However, the relation between the activity of specific muscles and muscular strength (e.g., in lifting a barbell) is not straightforward. Muscular strength is determined by the concerted activity of many muscles. Active muscles produce a pulling effect on the bones in a straight line. But the translatory action of muscular forces also induces a rotatory movement in the joints. As various muscles are inserted at different distances from the joint axes of rotations, their rotatory actions (moments of force) are not in direct proportion to the force developed by muscles. The rotatory movements in several joints are coordinated so as to produce the maximal external force in a desired direction, such as the vertical direction required to lift a barbell. Thus, complicated relations exist between muscular force (force exerted by a given muscle) and muscular strength (maximal external force). Regardless of these differences, many facets of muscular biomechanics and the physiology of isolated muscles are manifested in the complex movements involving numerous muscles.

Time Available for Force Development

It takes time to develop maximal force for a given motion (figure 2.7). The time to peak force (T_m) varies with each person and with different motions; on average, if measured isometrically, it is approximately 0.3 to 0.4 s. Typically, the time to

peak force is even longer than 0.4 s. However, the final increase in force is very small, < 2 to 3% of F_m , and force output begins to fluctuate, preventing a precise determination of the time to peak force. In practice, the final portion of the force–time curve is usually disregarded.

The time for maximal force development can be compared with the time typically required by elite athletes to perform several motions:

Motion	Time (s)
TAKEOFF	
Sprint running	0.08-0.10
Long jump	0.11-0.12
High jump	0.17-0.18
DELIVERY	
Javelin	0.16-0.18
Shot put	0.15-0.18
Hand takeoff (horse vaulting)	0.18-0.21

It is easy to see that the time of motion is less than T_m in all examples given. Because of their short durations, the maximal possible force F_{mm} cannot be attained during the performance of these motions.

As the resistance decreases and the motion time becomes shorter, the difference between F_m (the maximal force reached in a given condition) and F_{mm} (the highest among the maximal forces attained in the most beneficial condition) increases. The difference

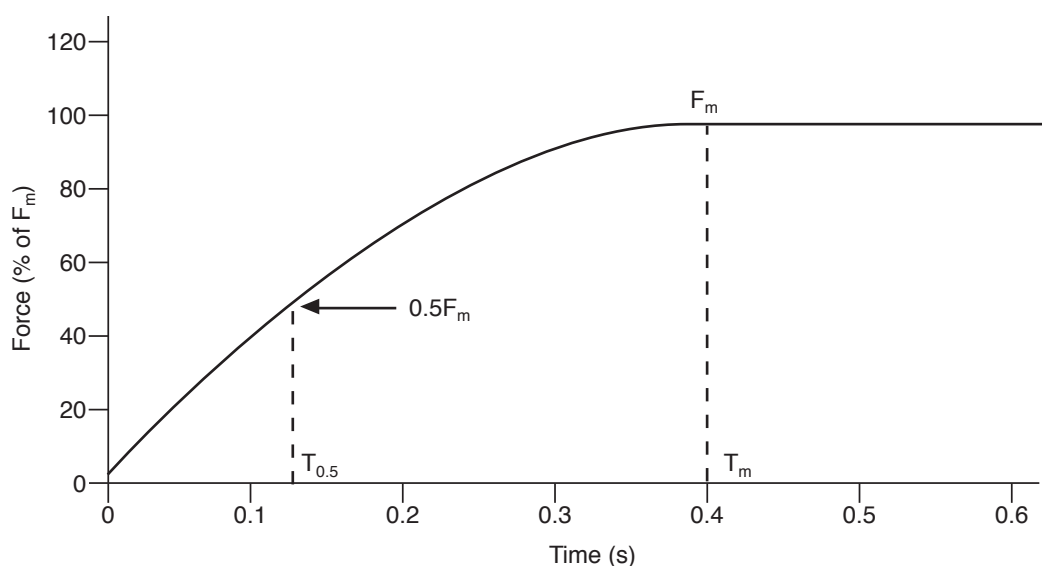

FIGURE 2.7 Development of maximal muscular force over time. T_m is the time to peak force F_m ; $T_{0.5}$ is the time to 1/2 of F_m .

between F_{mm} and F_m is termed the **explosive strength deficit (ESD)** (figure 2.8). By definition:

$$\text{ESD (\%)} = 100(F_{mm} - F_m) / F_{mm}$$

ESD shows the percentage of an athlete's strength potential that was not used in a given attempt. In movements such as takeoffs and delivery phases in throwing, ESD is about 50%. For instance, among the best shot-putters during throws of 21.0 m, the peak force F_m applied to the shot is in the range of 50 to 60 kg. The best results for these athletes in an arm extension exercise (F_{mm} , bench press) are typically about 220 to 240 kg, or 110 to 120 kg for each arm. Thus, in throwing, the athletes can only use about 50% of F_{mm} .

In principle, there are two ways to increase the force output in explosive motions—to increase F_{mm} or

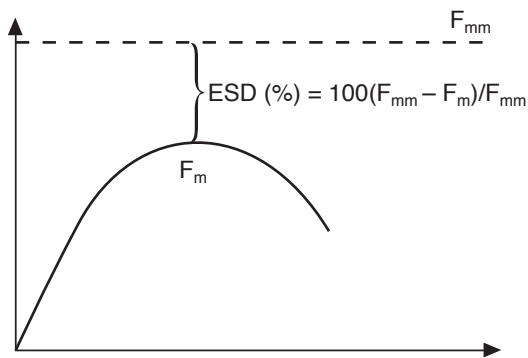

FIGURE 2.8 Determining explosive strength deficit.

decrease ESD. The first method brings good results at the beginning of sport preparation. If a young shot-putter improves achievement in, say, the bench press from 50 to 150 kg and also pays proper attention to the development of other muscle groups, this athlete has a very strong basis for better sport performance in shot putting. This is not necessarily valid, however, for a bench press gain from 200 to 300 kg. In spite of efforts devoted to making such a tremendous increase, the shot-putting result may not improve. The reason for this is the very short duration of the delivery phase. The athlete simply has no time to develop maximal force (F_{mm}). In such a situation, the second factor, explosive strength, not the athlete's maximal strength (F_{mm}), is the critical factor. By definition, **explosive strength** is the ability to exert maximal forces in minimal time.

Let's compare two athletes, A and B, with different force-time histories (figure 2.9). If the time of motion is short (i.e., in the time-deficit zone), then A is stronger than B. The situation is exactly opposite if the time of the movement is long enough to develop maximal muscular force. Training of maximal strength cannot help athlete B improve performance if the motion is in the time-deficit zone.

When sport performance improves, the time of motion turns out to be shorter. The better an athlete's qualifications, the greater the role of the **rate of force development** in the achievement of high-level performance. This has become an impor-

Why Is a Finger Snap Faster and Stronger Than Unobstructed Finger Extension?

Recall your elementary school years: Place the tip of your index finger against the tip of your thumb as shown and exert a maximal extension force. Keep the finger under tension for some time and then let it go. Snap the palm of your other hand. In the second trial, simply extend the index finger. You will find that the snapping is much faster and stronger. Why?

Here is the explanation: The time of finger extension is approximately 0.1 s. This time is too short to exert the maximal force. In contrast, during the first part of the snapping maneuver the time available for force development is not limited and the maximal tension is accumulated. Then the trigger is released and the accumulated tension is manifested during the movement. While this experiment looks like a kid's joke, a similar technique is used by scientists to get rid of the effects of the rate of force development on force manifestation. It is called the quick-release technique (see page 27).



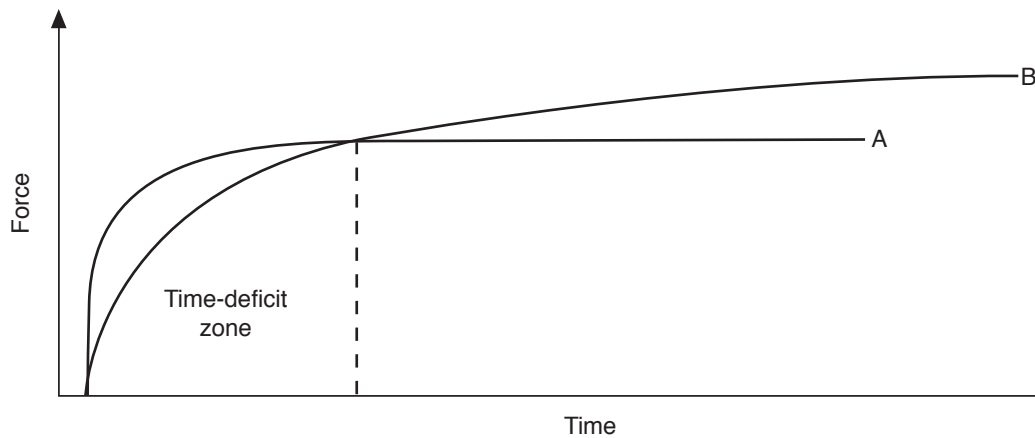

FIGURE 2.9 Force–time histories of two athletes, A and B. If the time available for force development is short (in the time-deficit zone), A is stronger than B. If the time is not limited, B is stronger.

tant biomarker in sport science for both evaluating training programs and athlete potentials in sports.

Several indices are used to estimate explosive strength and the rate of force development (see figure 2.7 for the key to the symbols).

(1) **Index of explosive strength (IES):**

$$\text{IES} = F_m / T_m,$$

where F_m is the peak force and T_m is the time to peak force.

(2) **Reactivity coefficient (RC):**

$$\text{RC} = F_m / (T_m W),$$

where W is an athlete's weight. RC is typically highly correlated with jumping performances, especially with body velocity after a takeoff.

(3) **Force gradient**, also called the **S-gradient** (S for start):

$$\text{S-gradient} = F_{0.5} / T_{0.5},$$

where $F_{0.5}$ is one half of the maximal force F_m and $T_{0.5}$ is the time to attain it. S-gradient characterizes the rate of force development at the beginning phase of a muscular effort.

(4) **A-gradient** (A for acceleration):

$$\text{A-gradient} = F_{0.5} / (T_{max} - T_{0.5}).$$

A-gradient is used to quantify the rate of force development in the late stages of explosive muscular efforts.

F_m and the rate of force development, particularly the S-gradient, are not correlated. Strong people do not necessarily possess a high rate of force development.

Velocity

The force–velocity relation is a typical example of the parametric relations described earlier in the discussion of maximal muscular performance. Motion velocity decreases as external resistance

Defining a Training Target: Strength or Rate of Force Development?

A young athlete began to exercise with free weights, performing squats with a heavy barbell. At first he was able to squat a barbell equal to his body weight (BW). His performance in a standing vertical jump was 40 cm. After 2 years, his achievement in the barbell squats was 2 BW, and the vertical jump increased to 60 cm. He continued to train in the same manner and after 2 more years was able to squat with a 3-BW barbell. However, his jump performance was not improved because the short takeoff time (the rate of force development) rather than maximal absolute force became the limiting factor.

Many coaches and athletes make a similar mistake. They continue to train maximal muscular strength when the real need is to develop rate of force.

(load) increases. For instance, if an athlete throws shots of different weights, the throwing distance (and initial velocity of the implement) increases as shot weight decreases. Maximum force (F_{mm}) is attained when velocity is small; inversely, maximum velocity (V_{mm}) is attained when external resistance is close to 0 (figure 2.10; see also figure 2.1 on page 16).

Experiments carried out on single muscles in laboratory conditions yield the force-velocity curve (figure 2.11), which can be described by the hyperbolic equation known as Hill's equation (after A.V. Hill, 1938).

$$(F + a)(V + b) = (F_{mm} + a)b = C,$$

where

- F is the force;
- V , velocity of muscle shortening;
- F_{mm} , maximal isometric tension of that muscle;
- a , a constant with dimensions of force;

b , a constant with dimensions of velocity; and C , a constant with dimensions of power.

The force-velocity curve can be considered part of a hyperbolic curve with the axis (external) shown in figure 2.11. The curvature of the force-velocity graph is determined by the ratio $a:F_{mm}$. The lower the ratio, the greater the curvature. Line curvature decreases if $a:F_{mm}$ increases. The ratio $a:F_{mm}$ varies from 0.10 to 0.60. Athletes in power sports usually have a ratio higher than 0.30, while endurance athletes and beginners have a ratio that is lower. Force-velocity (as well as torque-angular velocity) relations in human movements are not identical to analogous curves of single muscles because they are a result of the superposition of the force outcome of several muscles possessing different features. Nevertheless, force-velocity curves registered in natural human movements can be considered hyperbolic. This approximation is not absolutely accurate, but the accuracy is acceptable for the

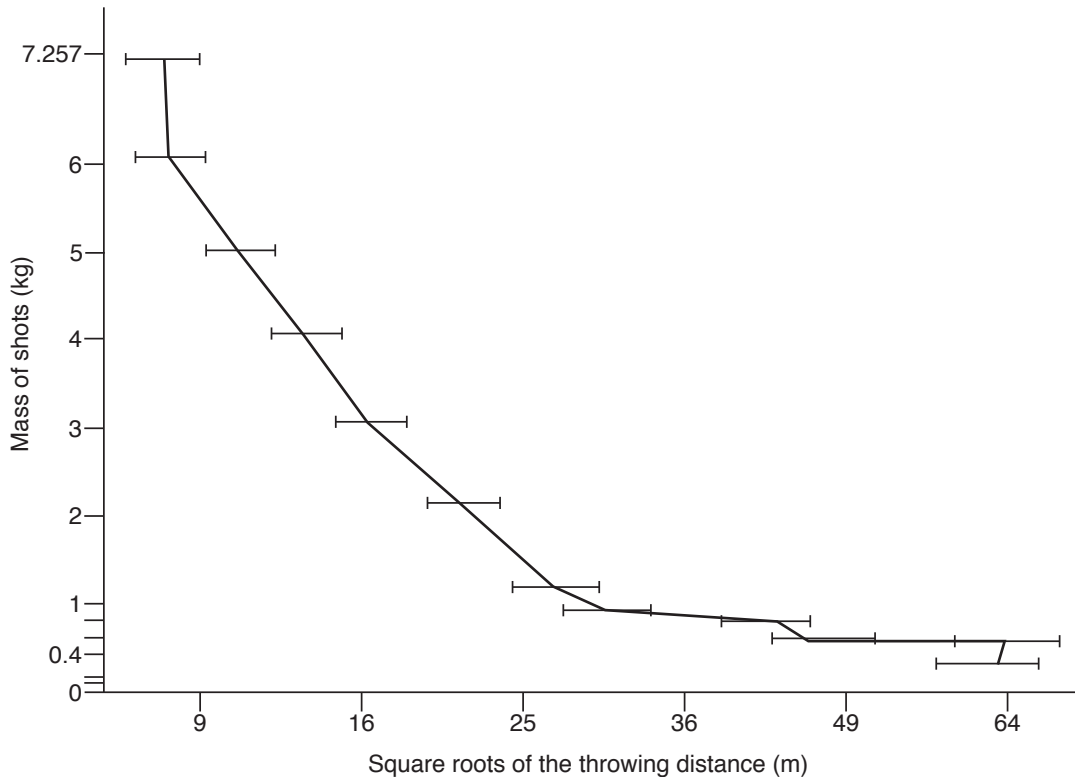

FIGURE 2.10 Relation between the mass of an implement and throwing distance. Athletes ($n = 24$) performed overhead throwing of shots of different weights from a standing position. The throwing distance, provided that the point of release and the release angle do not vary, is the function of the release velocity. Thus the relation between the shot weight and the throwing distance represents (approximately) the parametric force-velocity relation.

Reprinted by permission from V.M. Zatsiorsky and E.N. Matveev, "Force-Velocity Relationships in Throwing (As Related to the Selection of the Training Exercises)," *Theory and Practice of Physical Culture* 27, no. 8 (1964): 24-28.

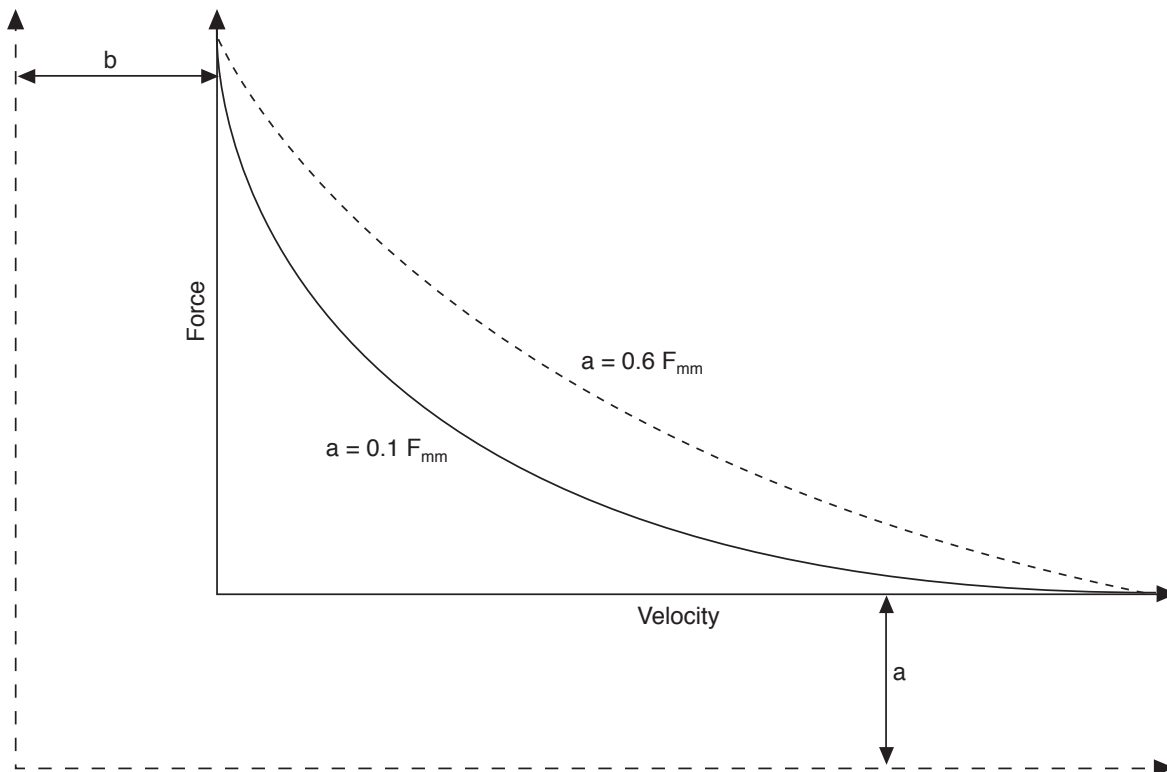

FIGURE 2.11 Force–velocity relation. Note the constants a and b .

Data from V.M. Zatsiorsky, “Motor Abilities of Athletes,” unpublished doctoral dissertation (Moscow: Central Institute of Physical Culture, 1960).

practical problems of sport training. Various main sport movements encompass different parts of the force–velocity curves.

In some athletic motions the force–velocity curve can look different from that shown in figure 2.11. This occurs in fast movements when the time available for force development is too short to develop maximal force, thus distorting the “real” force–velocity curve. To exclude the influence of the time available for force development, experimenters use the **quick-release technique**. In this method a subject develops force under isometric conditions with a body segment mechanically locked into position. The lock is then trigger released, permitting the subject to perform a movement against the given resistance. In this case, the initial conditions for muscle shortening are determined by the magnitude of force, not the rate or time of force development.

Force–velocity relations can also be studied with isokinetic devices that keep velocity constant during a movement. However, the velocity range of modern isokinetic equipment is relatively small, preventing the study of very fast movements.

Several consequences of the force–velocity equation are important for sport practice:

1. It is impossible to exert a high force in very fast movements. If an athlete performs the first phase of a movement too fast, the ability to apply great force in the second phase may be somewhat diminished. For instance, too fast a start in lifting a barbell from the floor may prevent an athlete from exerting maximal force in the most advantageous position—when the barbell is near the knees.

2. The magnitudes of force and velocity developed in the intermediate range of the force–velocity curve depend on the maximal isometric force F_{mm} . In other words, an athlete’s maximal strength F_{mm} determines the force values that can be exerted in dynamic conditions. The dependence of force and velocity developed in dynamic conditions on the maximal force F_{mm} is greater in movements with relatively high resistance and slow speed (figure 2.12). At the same time, there is no correlation between maximal force (F_{mm}) and maximal velocity (V_{mm}). The ability to produce maximal force (i.e., muscular strength) and the ability to achieve great velocity in

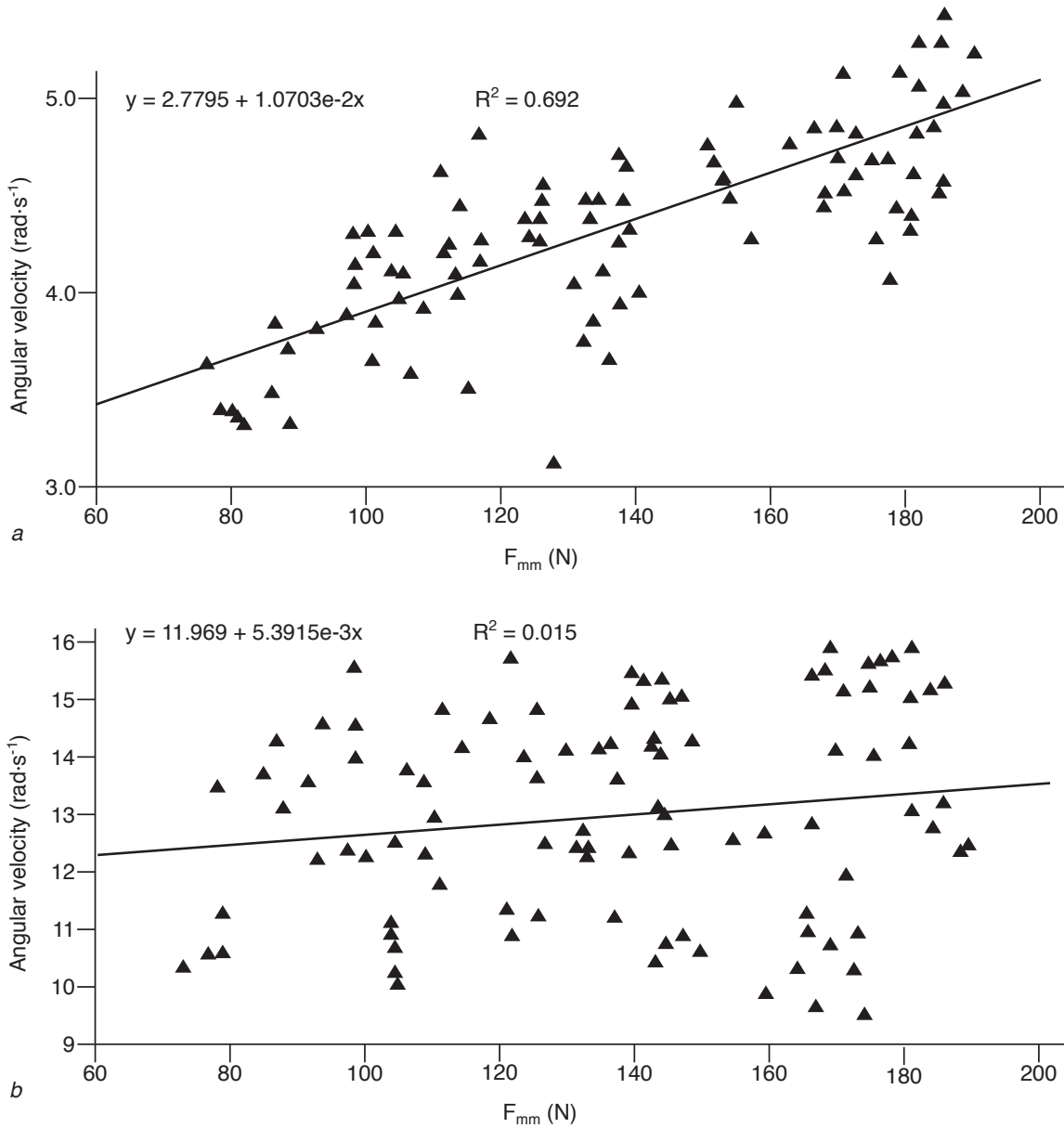

FIGURE 2.12 Nonparametric relation between the maximum moment force (F_{mm}) and the velocity of shoulder flexion with arm extended. Scattergrams of F_{mm} versus (a) the V_m and (b) V_{mm} are shown (the black triangles are the subjects). Compare with figure 2.2. (a) Load (dumbbell) of 8 kg in the hand; there is a high correlation between F_{mm} and angular velocity (V_m). (b) No load; there is no significant correlation between F_{mm} and V_{mm} .

Reprinted by permission from V.M. Zatsiorsky, *Motor Abilities of Athletes* (Moscow: Russian State Academy of Physical Education and Sport, 1969), 48.

the same motion are different motor abilities. This is true for extreme areas of the force–velocity curve, while intermediate values depend on the F_{mm} .

3. Maximal mechanical power (P_{mm}) is achieved in the intermediate range of force and velocity. As the velocity of the movement increases, the exerted force decreases and the released energy (work + heat) increases. Efficiency (i.e., ratio of work to energy)

achieves its greatest value when the velocity is about 20% of V_{mm} with mechanical power greatest at speeds of about one third of maximum (figure 2.13).

It may seem surprising that the greatest power value is at a velocity one third the value of maximal velocity (V_{mm}). One should not forget, however, that in the simplest case, power equals force multiplied by velocity:

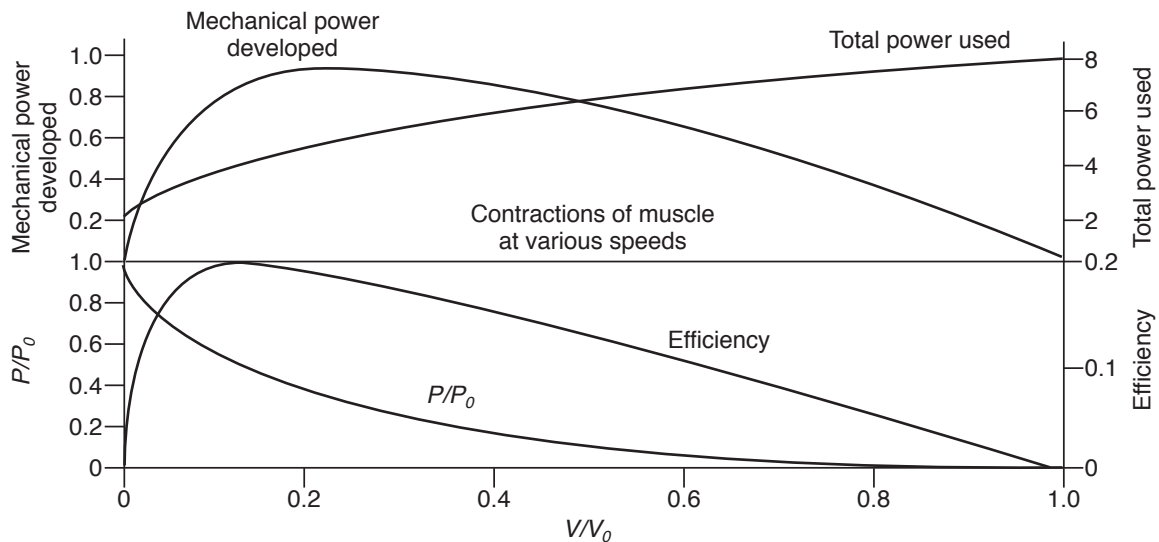

FIGURE 2.13 Dependence of various movement variables on motion velocity. Abscissa: speed V as a fraction of maximal speed V_0 under zero load (the symbol V_{mm} is used for this quantity throughout this book). Ordinate: Force exerted = P as a fraction of maximal force F_0 at zero speed; Efficiency = Mechanical work done / (Total energy used); Mechanical power = PV ; Total power used = PV / (Efficiency). From experiments performed on isolated muscles and on men.

Reprinted by permission from A.V. Hill, "The Dimensions of Animals and Their Muscular Dynamics," *Science Progress* 38, no. 150 (1950): 209-230.

$$P = w / t = F(D / t) = F(V),$$

where P is power, w is work, F is force, D is distance, t is time, and V is velocity. Since F_m and V_m are inversely related, the power is maximal when the magnitudes of force and velocity are optimal—about one third of maximal levels of maximal velocity (V_{mm}) and about one half of maximal force (F_{mm}). As a consequence, the maximal power (P_{mm}) equals approximately one

sixth of the value that could be achieved if one were able to exert both highest force (F_{mm}) and highest velocity (V_{mm}) simultaneously: $P_{mm} = 1/3V_{mm}(1/2F_{mm}) = 1/6(V_{mm}F_{mm})$.

This is why the power level is greater when a relatively light shot is put than when a heavy barbell is lifted. For example, the power level is 5,075 W (6.9 horsepower [HP]) in putting a 7.25-kg shot 18.19

Why Do Shot-Putters and Javelin Throwers Pay Different Attention to Heavy Resistance Training?

In sports such as shot putting and javelin throwing, as well as in throwing in baseball or softball, the motor task is similar—to impart maximal velocity to an implement. Why then do athletes in these sports train differently (and why are their physiques so dissimilar)? Elite shot-putters spend about 50% of their total training time on heavy resistance training, while world-class javelin throwers spend only 15 to 25% of their total training time in the weight room. The reason? The implement weights are so different. The shot weight is 7.257 kg for men and 4 kg for women; the javelins weigh 0.8 and 0.6 kg. For top athletes, the velocity of a shot release is nearly $14 \text{ m} \cdot \text{s}^{-1}$, while javelin release velocity is above $30 \text{ m} \cdot \text{s}^{-1}$. These values correspond to different parts of a (parametric) force–velocity curve. The shot-putters need a high F_{mm} because of a high (nonparametric) correlation between maximal strength and the velocity of movement at delivery phase (and similarly, the shot velocity). This correlation is low in javelin throwing. In turn it would be much smaller for a table tennis stroke, since the paddle is very light. The correlation is 0 when the maximal strength (F_{mm}) is compared to the maximal velocity (V_{mm}) of an unloaded arm.

m, but only 3,163 W (4.3 HP) during the snatch of a 150-kg barbell. At the same time, the maximal applied force F_m is equal to 513 N for the shot and 2,000 N for the snatch. Though the exerted force is less in shot putting, the exerted power is greater in this case because of the much higher speed of movement.

In some sport movements, it is possible to change the magnitude of external resistance (e.g., cycling gear, area of the blade of an oar). If the final aim in this case is to develop maximal power P_{mm} , it can be achieved with a certain optimal combination of resistance (external force) and cadence (velocity).

Direction of Movement (Plyometrics, Stretch–Shortening Cycle)

Force in the yielding phases of a motion, under conditions of imposed muscle lengthening (eccentric or plyometric muscle action), can easily exceed the maximal isometric strength of an athlete by 50 to 100%. The same holds true for isolated muscles. The eccentric force for a single muscle may reach a level of up to twice the zero velocity (isometric) force.

Eccentric Muscular Action A typical example of eccentric muscular activity can be seen in landing. The force exerted during the yielding phase of landing from a great height can substantially exceed either the takeoff or maximal isometric force. The ground reaction force is typically higher in the first half of the support period (during the yielding phase when the hip, knee, and ankle joints are flexing) than in the second half when the joints extend.

For another example, consider the grip force exerted during the lifting of a heavy barbell. The maximal isometric grip force of male weightlifters, measured with a grip dynamometer, is typically less than 1,000 N and is much lower than the force applied to the barbell. For instance, an athlete lifting a 250-kg barbell applies a maximal instantaneous force of well over 4,000 N to the weight. The force, 2,000 N per arm, is needed to accelerate the barbell. Although the maximal grip strength is only half as high as the force applied to the barbell, the athlete can sustain this great force without extending the grip.

Eccentric forces substantially increase with initial increases in joint movement velocity (and correspondingly the velocity of muscle lengthening) and then remain essentially constant with additional increases in velocity (figure 2.14). This is mainly true for qualified athletes and in multijoint motions such as the leg extension. (According to published

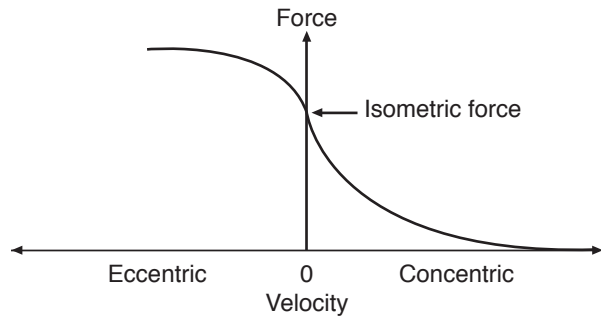

FIGURE 2.14 Force–velocity curve for concentric and eccentric muscular actions.

data, in untrained persons, maximal voluntary torque output during eccentric knee extension or flexion is independent of movement velocity and remains at an isometric level.) If the same external force is exerted concentrically and eccentrically, fewer **muscle fibers** are activated while the muscle lengthens. Because of this, if the same force is developed, the level of electric activity of muscles (EMG) is lower in exercises with eccentric muscular action.

Because exercises with eccentric muscular action typically involve high force development, the risk of injury is high—a risk coaches should understand. Even if the eccentric force is not maximal, such exercises (e.g., downhill running) may easily induce **delayed muscle soreness**, especially in unprepared athletes. The cause of the muscle soreness is damaged muscle fibers. A small magnitude of the damage is considered by some experts a normal precursor to the adaptation of muscle to increased use. Conditioning muscle reduces the amount of injury.

Reversible Muscular Action Eccentric muscular actions are as natural in human movements as are concentric actions. Many movements consist of eccentric (stretch) and concentric (shortening) phases. This **stretch–shortening cycle** is a common element of many sport skills and is referred to as the reversible action of muscles. Examples are the windup movement in throwing and the counter-movement before the takeoff in standing jumps.

If a muscle shortens immediately after a stretch

- force and power output increases, and
- energy expenditure decreases.

Thus, muscles can produce greater mechanical force and power while using less metabolic energy.

Reversible muscular action is an innate part of some movements, such as the landing and takeoff in running (“a spring in the leg”; figure 2.15); in

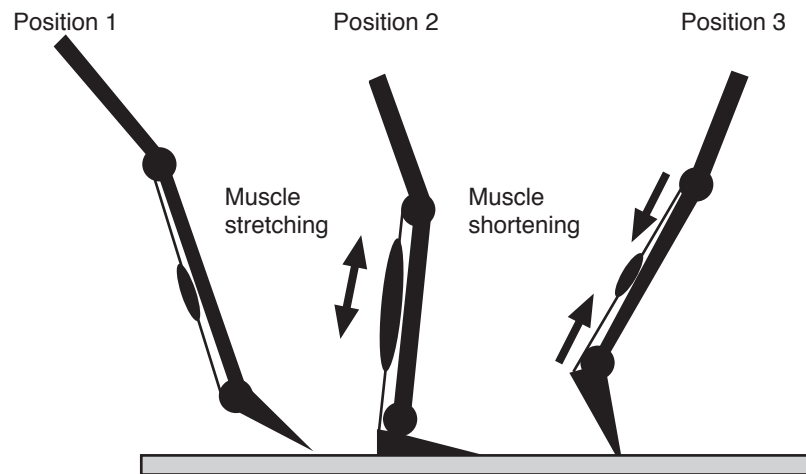

FIGURE 2.15 Stretch–shortening cycle during the support period in running. The plantar flexors of the foot are stretched during the first part of the support period (from position 1 to position 2) and shorten afterward, from position 2 to position 3.

other movements, such as throwing, these actions must be learned. Since many sport movements are highly complex and executed in a very brief time, even some elite athletes fail to perform this reversible muscular action correctly.

Increased force is exerted in the shortening phase of a stretch–shortening cycle for four main reasons. First, at the peak of the cycle, that is, at the moment of transition from lengthening to shortening, the force is developed in isometric conditions; thus the influence of high velocity is avoided, and F_{mm} rather than F_m is exerted. Second, since the force begins to rise in the eccentric phase, the time available for force development is greater. Countermovement jumps (not drop jumps) are evidence of such an occurrence.

Apart from these two mechanisms, two other factors influence the outcome of movements with reversible muscular action: peripheral, or muscle and tendon elasticity, and central (neural), or reflex action.

Muscle and tendon elasticity plays a substantial role in enhancing the motor output in sport movements. If a tendon or active muscle is stretched, the elastic energy is stored within these biological structures. This deformation energy is recoiled and used to enhance motor output in the concentric phase of the stretch–shortening cycle. According to physical principles, the magnitude of the stored energy is proportional to the applied force and the induced deformation. Since muscle and tendon are arranged in series, they are subjected to the same force, and the distribution of the stored energy between them

is in this case only a function of their deformation. The deformation, in turn, is a function of muscle or tendon stiffness or its inverse value, **compliance**. See figure 2.16.

The stiffness of a tendon is constant, while the stiffness of a muscle is variable and depends on the forces exerted. The passive muscle is compliant; that is, it can be easily stretched. The active muscle is stiff: One must apply great force to stretch it. The greater the muscle tension, the greater the stiffness of the muscle—the stronger the muscle resists its stretch. Superior athletes can develop high forces. The stiffness of their muscles, while active, exceeds the stiffness of their tendons (figure 2.17). That is why elastic energy in elite athletes (for instance, during takeoffs) is stored primarily in tendons rather than in muscles. Tendon elasticity and a specific skill in using this elasticity in sport movement (takeoff, delivery) are important for elite athletes. It is interesting that animals that are fast runners, such as horses, have short, strong muscles and lengthy, compliant tendons. Such tendons work as springs; they allow for storing and recoiling a large amount of mechanical energy at each step.

Consider the **neural mechanisms** governing reversible muscular action during a drop jump landing. After the foot strike, there is a rapid change in both the muscle length and the forces developed. The muscles are forcibly stretched, and at the same time, muscle tension rises sharply. These changes are controlled and partially counterbalanced by the concerted action of two motor reflexes: the **myotatic**, or **stretch, reflex** and the **Golgi tendon reflex**.

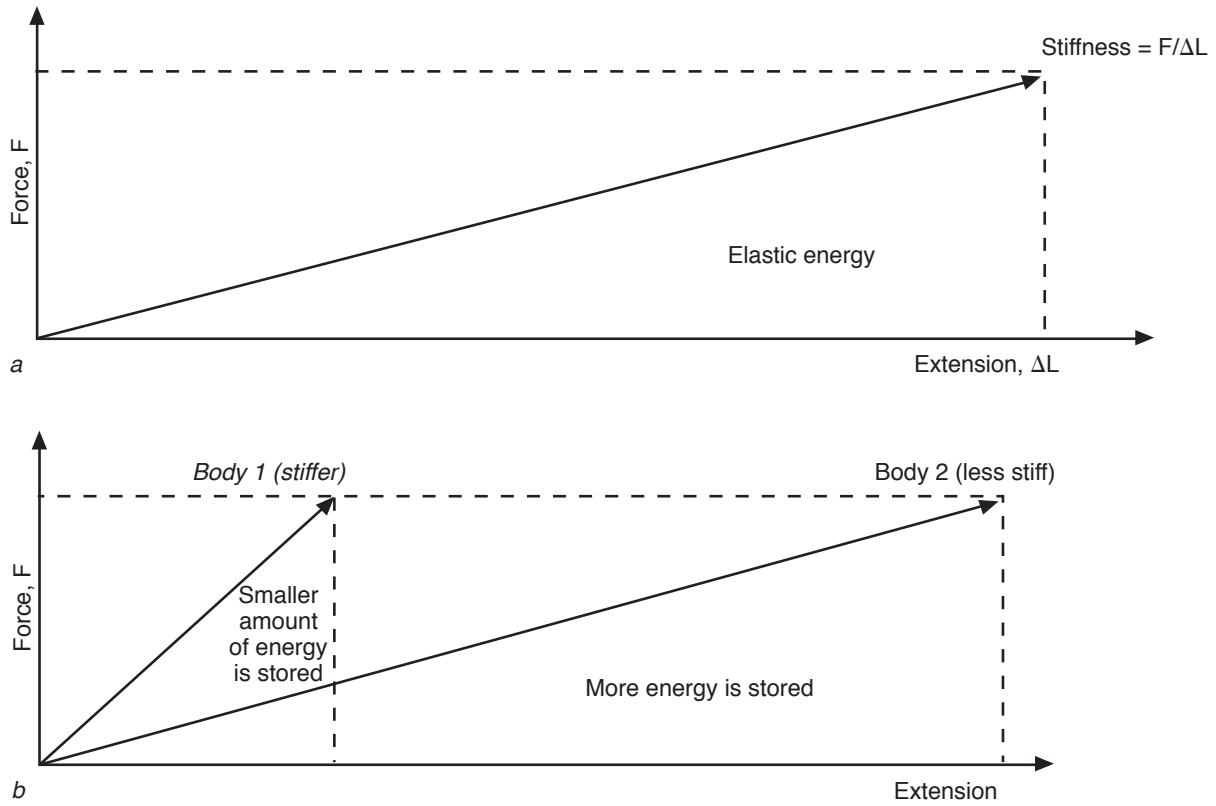

FIGURE 2.16 Accumulation of potential energy during deformation (extension) of elastic bodies. (a) The amount of the stored elastic energy equals an area of the triangle with the deformation (ΔL) and force (F) as the sides. The stiffness equals the ratio $F/\Delta L$. (b) Effect of equal forces on the elastic energy accumulation in two bodies of different stiffness. Body 1 is stiffer and its deformation is smaller. Body 2 is less stiff (more compliant) and it deforms more, so it stores a larger amount of elastic potential energy.

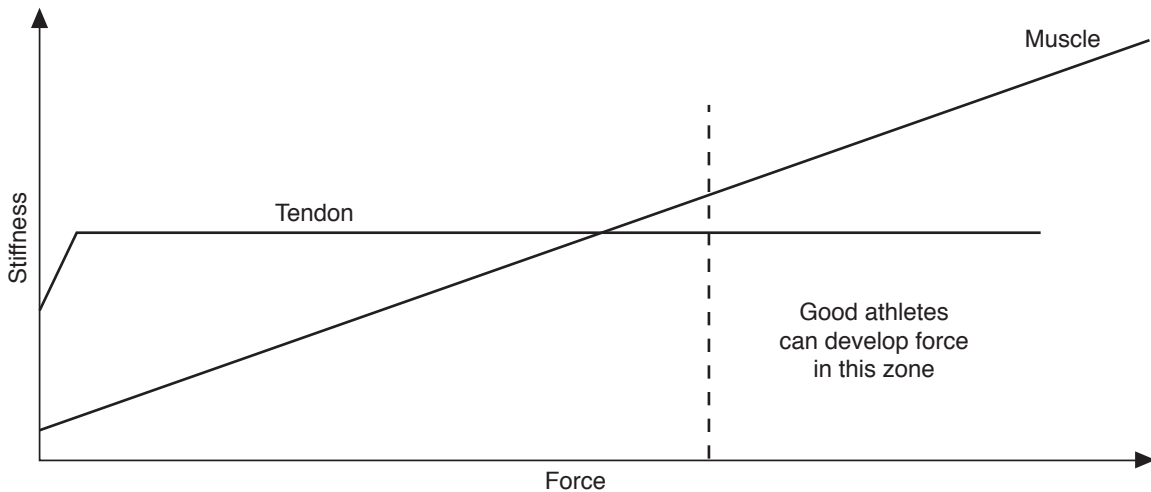

FIGURE 2.17 Stiffness of a muscle and a tendon at different levels of muscular force. Since elite athletes develop high forces, the stiffness of the muscle, while active, may exceed tendon stiffness. In such cases, the tendons are deformed to a greater extent than the muscles and thus store more potential energy.

These reflexes constitute two feedback systems that operate

- to keep the muscle close to a preset length (stretch reflex; length feedback) and
- to prevent unusually high and potentially damaging muscular tension (Golgi tendon reflex; force feedback).

The myotatic reflex receptors, or **muscle spindles**, are arranged parallel to the muscle fibers that constitute the bulk of the muscle. When the muscle is stretched by an external force, the muscle spindles are also subjected to stretching. The stretching induces an increase in muscle spindle discharge. The latter causes an increased discharge of **alpha-motoneurons** and in turn a reflex contraction of the stretched muscle. This reflex contraction causes the muscle to return to its initial length in spite of the load applied to the muscle (**length feedback**).

Golgi tendon organs are arranged in series with the muscle fibers. These receptors are sensitive to forces developed in the muscle rather than to length

changes as is the case with muscle spindles. If muscle tension increases sharply, the Golgi tendon reflex evokes the inhibition of muscle action. The ensuing drop in muscle tension prevents the muscle and tendon from incurring damage (**force feedback**).

The **effluent** discharge to the muscle during the stretching phase of a stretch-shortening cycle is modified by the combined effects of the two reflexes mentioned earlier: the positive (excitatory) effect from the myotatic reflex and the negative (inhibitory) effect from the Golgi tendon reflex. During landing, a stretch applied to a leg **extensor** produces (via myotatic reflex) a contraction in that muscle; simultaneously, a high muscle tension sets up a Golgi tendon reflex in the same muscle, thus inhibiting its activity (figure 2.18). If athletes, even strong ones, are not accustomed to such exercises, the activity of the extensor muscles during takeoff is inhibited by the Golgi tendon reflex. Because of this, even world-class weightlifters cannot compete with triple jumpers in drop jumping. As a result of specific training, the Golgi tendon reflex is inhibited

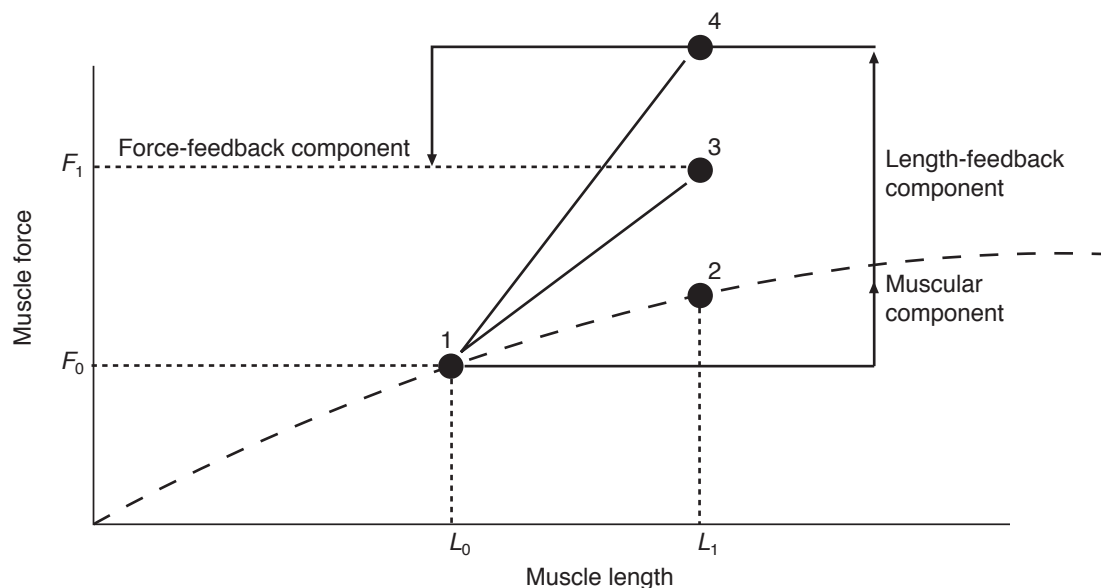

FIGURE 2.18 Neural mechanisms of enhanced force output in the stretch-shortening cycle. As a result of stretch from L_0 to L_1 , the muscular force increases from F_0 to F_1 . Three functional components responsible for the strength enhancement are shown. First, the muscular component—the force during lengthening increases due to muscle and tendon elasticity (stiffness). Second, the force output increases due to the length-feedback component—the component arises from the facilitatory spindle discharge (myotatic reflex). Third, the force-feedback component originating from the Golgi tendon organs. The length-feedback component increases muscle stiffness (resistance to the lengthening) whereas the force-feedback component decreases it. The final outcome is the line from 1 to 3. The slope of this line defines the stiffness. The theory was originally developed by J.C. Houk and published in “Feedback Control of Muscle: A Synthesis of the Peripheral Mechanisms” 1974, in V.B. Mountcastle (ed.) *Medical Physiology*, 13th ed. (pp. 668-677), St. Louis: Mosby.

Adapted by permission from P.V. Komi, “Training of Muscle Strength and Power: Interaction of Neuromotoric, Hypertrophic and Mechanical Factors,” *International Journal of Sport Medicine* 7, suppl. 1 (1986): 10-15. By permission of the author.

and the athlete sustains very high landing forces without a decrease in exerted muscular force. The dropping height may then be increased.

Since reversible muscular action is an element of many sport movements, it must be specifically learned or trained. Before 1960 such training was accidental, and improvement in this skill was a by-product of other exercises. Only since that time have exercises with reversible muscular action, such as drop jumps, been incorporated into training. Note that this training method has been erroneously called plyometrics by some. The term is not appropriate in this case, since reversible, not eccentric, muscular action is the training objective.

In beginners, performance in exercises with reversible muscular action can be improved through other exercises such as heavy weightlifting. In qualified athletes, this skill is very specific. Performances in drop jumps, for example, are not improved as a result of the usual strength exercising, even with heavy weights (figure 2.19). Maximal muscular strength (F_{mm}) and forces produced in fast reversible muscular action (F_m) are not correlated in good athletes and should be treated, and trained, as separate motor abilities.

Posture, Strength Curves

The strength that an athlete can generate in a given motion depends on body posture (joint angles). For

instance, the maximal force that one can exert on a barbell depends on the height of the bar (figure 2.20). The maximal force F_{mm} is exerted when the bar is slightly above the knee height. The plot of the external force exerted by an athlete (or the moment of force) versus an appropriate measure of the body position (i.e., joint angle) is a **strength curve**.

In single joints, the joint strength curves assume three general forms: ascending, descending, and concave (figure 2.21). Examples are provided in figure 2.22. Note the large difference in force produced at different joint positions.

For each movement, there are angular positions at which the maximal values of the F_m (F_{mm}) can be reached. During elbow flexion, the F_{mm} is generated at an angle of 90° (figure 2.22a); for elbow extension the F_{mm} values are obtained at an angle of 120°, the F_{mm} in shoulder flexion is exerted when the arm is slightly behind the trunk (figure 2.22b), and so on. Strength values at the weakest positions, or the so-called **sticking points**, are also very important. The heaviest weight that is lifted through a full range of joint motion cannot be greater than the strength at the weakest point.

Biomechanically, the F_{mm} is a function of muscular forces, or tensions, that undergo two transformations. The muscular forces transform into joint moments and the joint moments transform into external force: Muscle-tendon forces → Joint

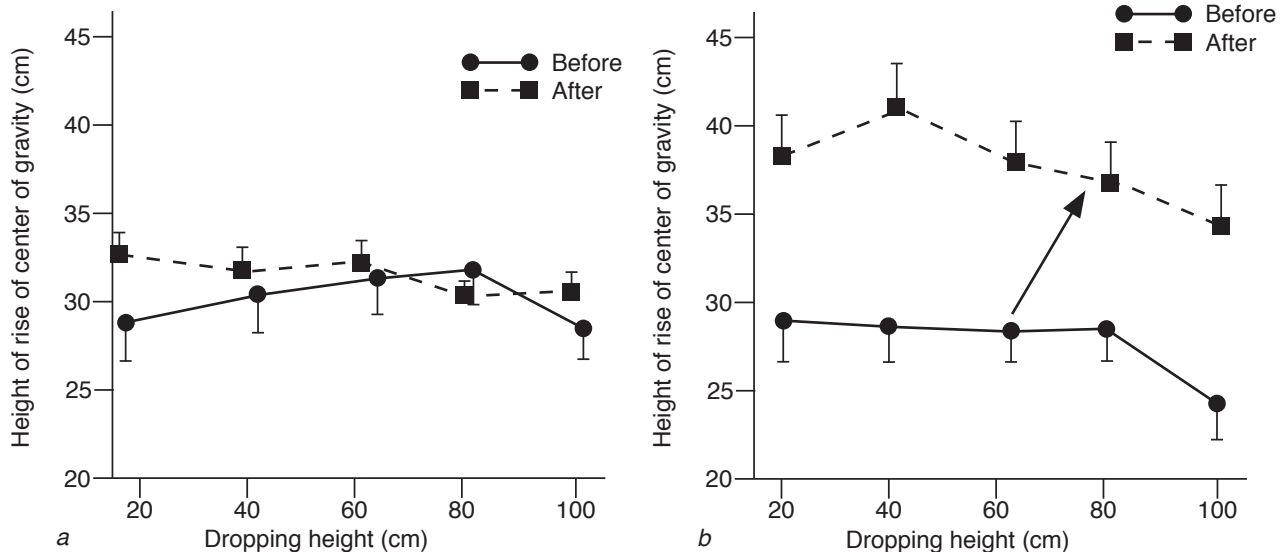

FIGURE 2.19 Changes in drop-jump performances by experienced athletes after 24 weeks of training with (a) heavy weights and (b) specific jumping training. (a) Heavy resistance (70%-100% of F_{mm}) training ($n = 11$). (b) Explosive (power) strength training ($n = 10$).

Adapted from K. Häkkinen and P.V. Komi, "Changes in Electrical and Mechanical Behavior of Leg Extensor Muscles During Heavy Resistance Strength Training," *Scandinavian Journal of Sports Sciences* 7 (1985): 55-64; and K. Häkkinen and P.V. Komi, "Effect of Explosive Type Strength Training on Electromyographic and Force Production Characteristics of Leg Extensor Muscles During Concentric and Various Stretch-Shortening Cycle Exercises," *Scandinavian Journal of Sports Sciences* 7 (1985): 65-76. Used with permission of P.V. Komi.

Muscles and Tendons as Springs in Series

To visualize a stretch–shortening cycle, imagine two springs connected in series. The first spring (tendon) possesses given characteristics (stiffness, compliance) that do not change during motion. The characteristics of the second spring (muscle) vary and depend on the level of muscle activation.

When the muscle is relaxed, it is very compliant. If an external force is applied to such a muscle–tendon complex, the muscle can easily be stretched. The resistance to deformation is small, and only the muscle, not the tendon, is extended. However, if the muscle is activated, its resistance to the external pulling force increases. In this instance, the tendon rather than the muscle is deformed when a tensile force is applied.

The level of muscle activation is not constant, however, even when an athlete is trying to generate a maximal muscular effort. In addition to voluntary control, the muscles are under subconscious reflex control that is presumably realized on the spinal level. At least two reflexes are acting concurrently. One (stretch) reflex takes charge of maintaining the set muscle length—if the muscle is extended, it is additionally activated to resist the deformation force and to restore the original length. The second (Golgi organ) reflex prevents the muscle from injury due to excessive force—when the muscle tension or its rate is too high, the neural impulsion to the muscle from the spinal cord is inhibited.

The real intensity of muscle activation is a tradeoff between the two reflexes (plus volitional muscle activation). The intensity of each reflex, which is not constant, determines the final outcome. When athletes are accustomed to sharp, forcible muscle–tendon stretching, for instance in drop jumps, the Golgi organ reflex is inhibited and high forces can be generated. The objective of drop-jumping drills is, in this case, to accommodate the athletes to fast muscle stretching rather than to immediately generate large forces.

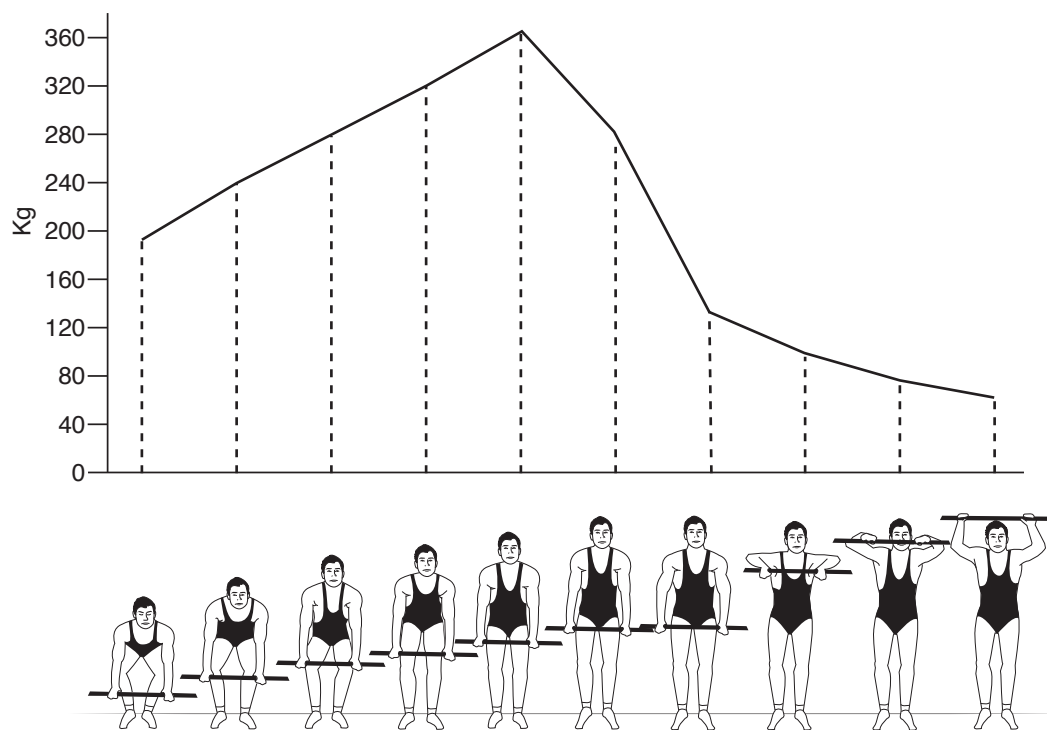

FIGURE 2.20 The maximal isometric force F_m applied to a bar at different body positions (at different heights of the bar). This is an example of the strength curve in a multijoint movement.

Adapted by permission from D.D. Donskoy and V.M. Zatsiorsky, *Biomechanics* (Moscow: Fizkultura i Sport, 1979), 203.

Why Do Elite Weightlifters Start a Barbell Lift From the Floor Slowly?

A good weightlifter imparts the greatest effort to a barbell, trying to accelerate it maximally, when the bar is approximately at knee-joint height. There are two reasons for this. First, at this position the highest forces can be generated (figure 2.20). Second (see discussion on velocity, page 24), the force decreases when the movement velocity increases (parametric force–velocity relation). The barbell must approach the most favored body position for force generation at a relatively low velocity to impart maximal force to the bar. This two-phase technique is used by all elite weightlifters except in the lightweight categories. These athletes are short (below 150 cm), and the bar is located at knee-joint level in the starting position before the lift.

This is an example of how two extrinsic factors of force generation (force posture and force velocity) are combined to develop maximal force values.

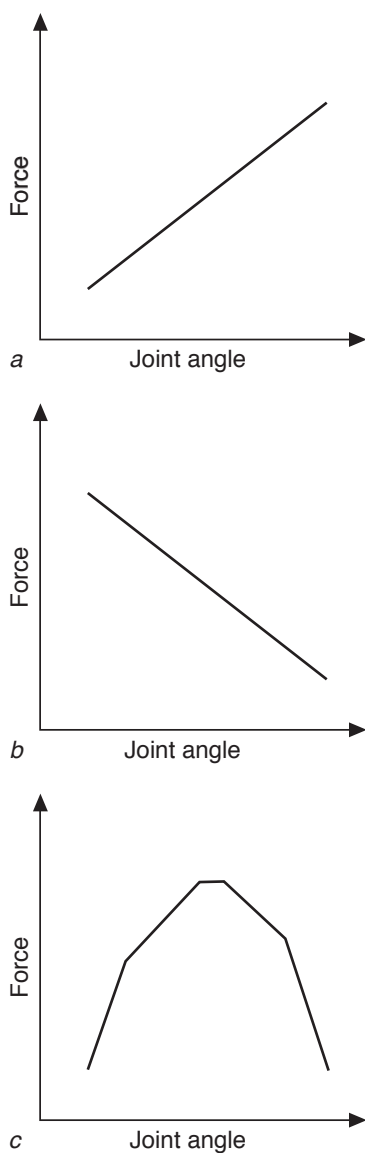

FIGURE 2.21 Three main forms of joint strength curves: (a) ascending, (b) descending, and (c) concave.

Adapted from J.G. Hay, "Mechanical Basis of Strength Expression," in *Strength and Power in Sport*, edited by P.V. Komi (Oxford: Blackwell Scientific, 1992), 200.

moments \rightarrow Strength (F_{mm} , end-point force). We consider these transformations in sequence.

Muscular Force at Different Body Positions Muscle tension depends on muscle length. When a joint angle changes, the muscle length, or the distance from muscle origin to insertion, also changes. In turn, the change of the muscle length results in the change of muscle tension. This happens for two reasons. First, the area of overlapping actin and myosin filaments is changed, thus modifying the number of cross-bridge attachments that can be established (see chapter 3). Second, the contribution of elastic forces, especially from parallel elastic components, is changed. Because of the interplay of these two factors, the relation between the instantaneous muscle length and force production is complex. We can, however, disregard such complexity and accept as a general rule that with a few exceptions (for example, the rectus femoris muscle in some bicyclists), muscles exert smaller tension at smaller lengths. In contrast, higher forces are exerted by stretched muscles.

When a joint approaches the limits of its **range of motion**, the passive elastic forces increase. For instance, during the arm cocking in pitching, the external rotation of the shoulder approaches 180° (figure 2.23). At this angular position, the muscles and other soft anatomical tissues of the shoulder are deformed. Resisting the deformation, the tissues contribute to the joint torques that reach maximal values.

The length of a two-joint muscle depends on the angular positions at both joints that the muscle crosses. In such joints, the F_{mm} values depend not only on the angular position at the joint being tested but also on the angular position of the second joint. For instance, the contribution of the gastrocnemius, which is a two-joint muscle, to plantar-flexion

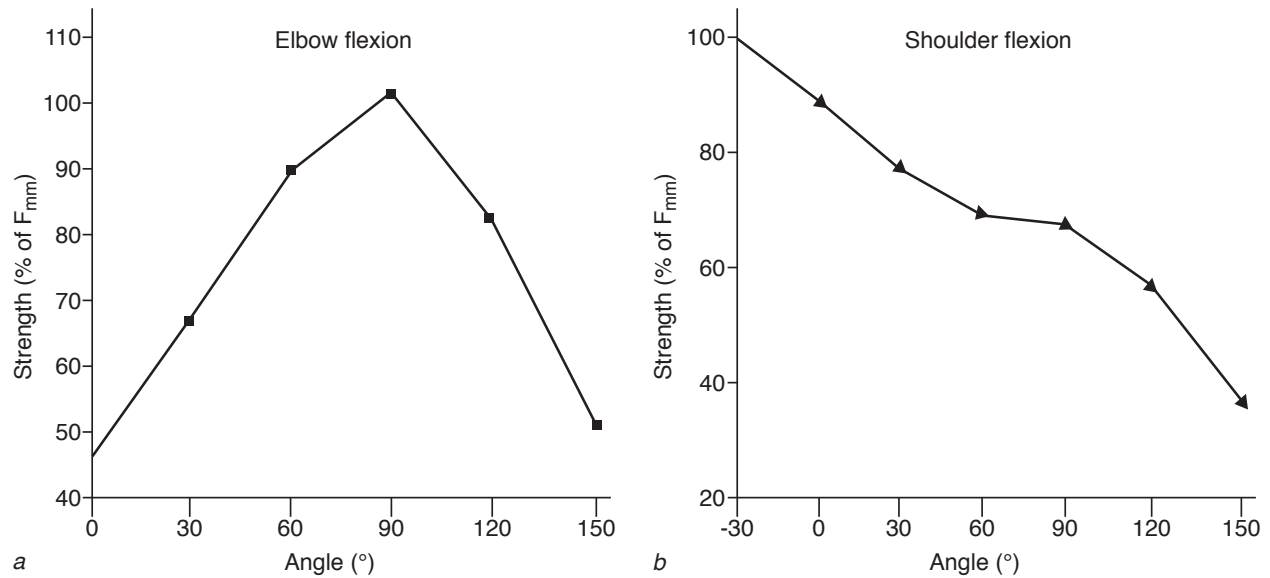

FIGURE 2.22 Relations between joint angles and isometric force in elbow flexion (a) and shoulder flexion (b). The angles were defined from the anatomical position. Based on average data of 24 athletes. The elbow flexion force was measured with the forearm in a supinated position. The shoulder flexion measurements were made with subjects in a supine posture. The forearm was in a midrange position (between supinated and pronated). At -30° , the arm was positioned behind the trunk.

From V.M. Zatsiorsky and L.M. Raitsin, *Force-Posture Relations in Athletic Movements* (Moscow: Russian State Academy of Physical Education and Sport, 1973). Technical report. By permission of the Russian State Academy of Physical Education and Sport.

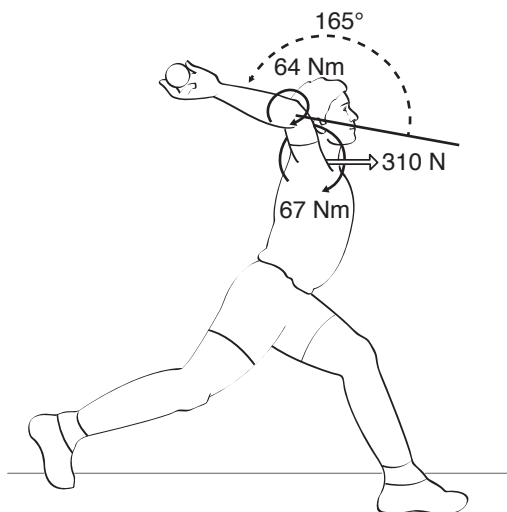

FIGURE 2.23 Forces in pitching. In this instance, the highest forces are observed.

Reprinted by permission from G.S. Fleisig, J.R. Andrews, C.J. Dillman, and R.F. Escamilla, "Kinetics of Baseball Pitching with Implications About Injury Mechanisms," *The American Journal of Sports Medicine* 23, no. 2 (1995): 233-239.

torque at the ankle joint is reduced as the knee is flexed and, consequently, the gastrocnemius is shortened. When the knee is maximally flexed and the ankle is plantarflexed, the gastrocnemius muscle is unable to produce active force. This leg

position can be used for selective training of the soleus muscle.

The length-tension curves are usually recorded for isometric contraction at discrete joint positions or at discrete muscle lengths. The curves do not represent precisely the force exerted during muscle stretching or shortening. During a stretch, the tension is larger. During shortening, the tension is smaller than the tension exerted in static conditions.

Transformation of Muscular Forces Into Joint Moments

Any force tends to rotate the body about any axis that does not intersect the line of force action. The turning effect of the force is called the **moment of force**, or **torque**. The moment (M) of a force F equals the product of the magnitude of F and the shortest distance, d , from the center of rotation to the line of force action, $M = Fd$. The distance d is called a **moment arm**. When a muscle exerts tension, the muscle tension generates a rotational effect at the joint. A joint moment produced by a muscle equals the following product:

$$\text{Joint moment} = \text{Muscle tension} \times \text{Muscle moment arm.}$$

When a joint angle varies, the moment arm of a muscle spanning the joint changes. For instance, fourfold difference has been measured in the moment arm of the biceps brachii (long head) in

assorted elbow angle positions; the **force arm** was 11.5 mm at the 180° angle (full extension) and 45.5 mm at the 90° angle of elbow flexion. Thus, if muscle tension were identical in each case, the moment of force developed by the muscle in elbow flexion would change fourfold. The external force (strength) would also be four times higher.

In summary, when a joint angle varies, the externally registered force (strength) changes due to two reasons: (1) The muscles produce different tension and (2) the muscular forces act through different moment arms (figure 2.24).

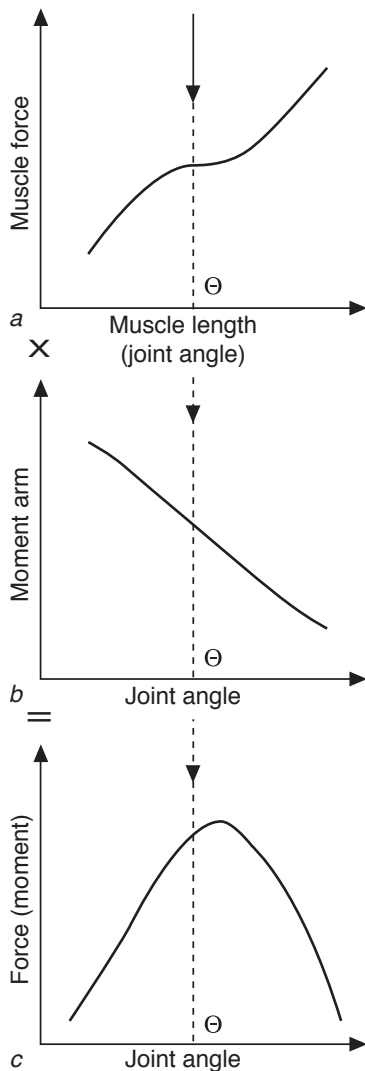

FIGURE 2.24 External muscular torque (strength) registered at any joint angle is the product of muscle tension and moment arm at this joint configuration. The downward arrows and the dotted lines indicate a certain joint angle. (c) The entire joint strength curve is a result of multiplication of (a) the muscle tension–angle curve and (b) the moment arm–angle curve.

Many muscles produce moments about more than one joint axis. These muscles have several functions. For instance, the biceps both flexes and supinates the forearm at the elbow joint. Let's briefly discuss two effects of such an anatomical arrangement that are important for practitioners.

First, muscles produce moments of force not only in the desired direction (primary moments) but also in other directions (secondary moments). To counterbalance the secondary moments, which are not necessary for the intended purpose, additional muscles are activated. The number of active muscles increases but the strength may decrease. Consider, for example, a forceful arm supination with the elbow flexed at a right angle, as in driving a screw with a screwdriver. During the supination effort, the triceps, even though it is not a supinator, is also active. A simple demonstration proves this: Perform a forceful supination against a resistance while placing the second hand on the biceps and triceps of the working arm. Both the biceps and the triceps spring into action simultaneously. The explanation is simple. When the biceps acts as a supinator, it also produces a flexion moment (secondary moment). The flexion moment is counterbalanced by the extension moment exerted by the triceps.

Second, athletes tend to perform forceful movements in a way that minimizes secondary moments. For instance, during pull-ups performed on gymnastics rings, the performers always supinate the arms while flexing the elbow joints. Nobody teaches them to do so; the movement pattern is simply more convenient for the performers.

Performing Chin-Ups: Overhand Grip Versus Underhand Grip

With the arm pronated, the biceps cannot generate its maximal tension because of the possible supination effect. Therefore, when performing elbow flexion, pronation of the forearm decreases the strength of the elbow curl. Because of this anatomical fact, it is simpler to perform chin-ups on a high bar using an underhand grasp than an overhand grasp.

From Joint Moments to Muscular Strength (End-Point Force) In a single-joint task, the strength (the force exerted at the end effector) equals the ratio of the joint moment to the moment arm of the external force. Therefore, the closer the external force to the joint, or, in other words, the smaller the moment arm of the force, the larger the external force that the same joint moment would generate.

In multilink chains the transformation of joint moments into the end-point force is much more complex. Fortunately, one important case is simple: The highest forces in leg or arm extension can be exerted when the extremity is almost completely extended (figures 2.25 and 2.26). At this leg or arm position the line of force action is close to the knee or elbow joint and hence the moment arm of the force is small. When the leg or arm is completely extended, the force acts along the extremity, and moment arm of the force is close to 0. As a result, at this joint configuration people can sustain extremely large forces.

In a nutshell, selection of proper body position affects the maximal values of the external force that athletes can produce.

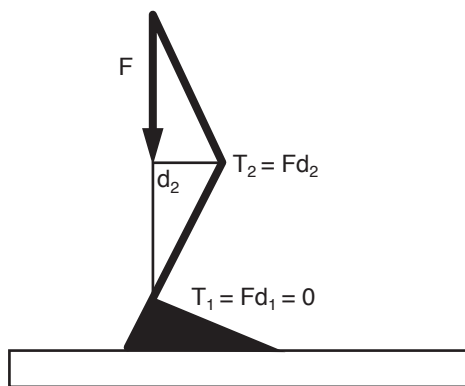

FIGURE 2.25 The closer the leg is to full extension, the smaller the moment arm (d_2) of the load force is with respect to the knee joint and, hence, the smaller the knee-joint moment (T_2) required to bear the force F ($T_2 = Fd_2$). This explains why the heaviest loads can be borne when the legs are almost completely extended. When the line of force action passes through the joint center, the joint moment is 0. In the figure shown, this happens at the ankle joint (i.e., there is no movement [T_1] and no movement arm [d_1]). In contrast, when the leg or arm is nearly outstretched, large external forces can be exerted with low joint moments.

Reprinted by permission from V.M. Zatsiorsky, *Kinetics of Human Motion* (Champaign, IL: Human Kinetics, 2002), 140.

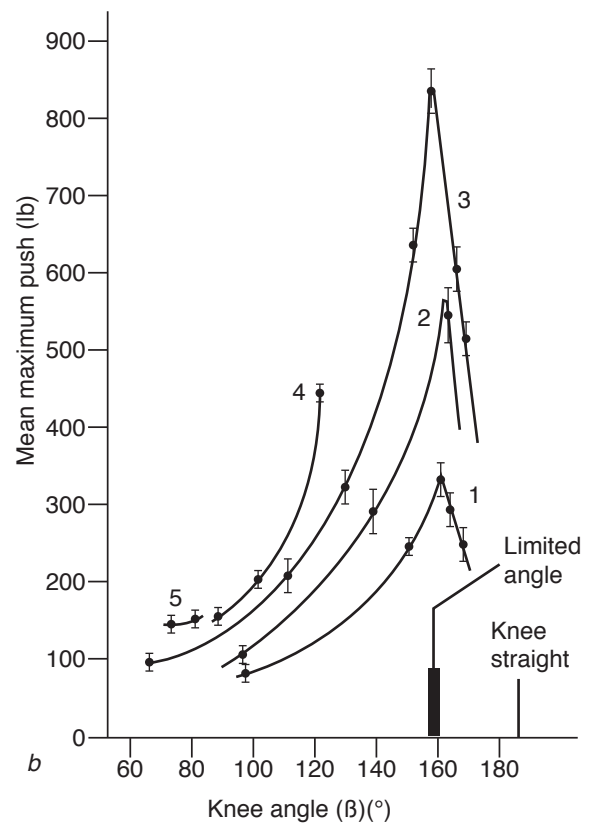
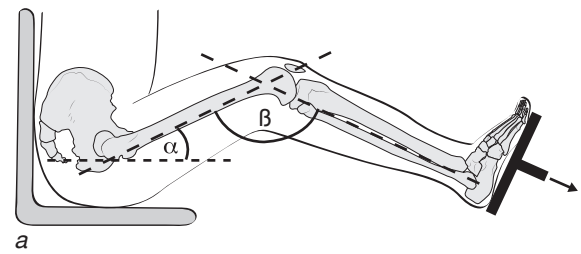

FIGURE 2.26 Dependence of the pushing force on limb position in seated subjects. (a) Experimental setup. (b) The mean maximum push (± 2 standard deviations) exerted isometrically by six subjects on a pedal placed in different positions. For each of the five different angles of thigh to the horizontal (α), the knee angle (β) varied. Curve 1 represents the data for angle α between -15° and -6° ; curve 2 for α between $+5^\circ$ and $+10^\circ$; curve 3, 15° to 19° ; curve 4, 33° to 36° ; and curve 5 corresponds to the thigh angle $\alpha = 48^\circ$ to 49° . Curves 4 and 5 necessarily stop as shown, well before the limiting angle is reached. At these thigh positions, the knee cannot be extended further due to the limitation provided by the hamstring. Note the ninefold difference between the force magnitudes at different body postures.

Reprinted by permission from P. Hugh-Jones, "The Effect of Limb Position in Seated Subjects on Their Ability to Utilize the Maximum Contractile Force of the Limb Muscles," *Journal of Physiology* 105, no. 4 (1947): 332-344.

Summary

An athlete can perform a given motor task, such as throwing, lifting, or jumping, with different levels of effort. When effort is maximal, the athlete attains a maximal muscular performance for the given task. Each motor task is characterized by certain variables called parameters—such as resistance, angle of slope in uphill running, or weight of an implement—and the magnitudes of these parameters.

If the parameters of a motor task are changed systematically, the parametric relation between the dependent variables of maximal muscular performance can be established. The parametric relation between the maximal force (F_m) and maximal velocity (V_m) is negative: The higher the force, the lower the velocity. The highest maximal force (F_{mm}) is called the maximum force. The dependence between F_{mm} values and the maximal velocity (V_m) at a given parameter proportion is the nonparametric relation, a correlation that is typically positive (i.e., the higher the force, the greater the velocity). The magnitude of the correlation depends on the parameter values: The greater the resistance, the higher the coefficient of the correlation.

Muscular strength is the ability to produce maximum external force F_{mm} . It can be generated and measured only at certain parameter values of a motor task, such as muscular force exerted on a heavy implement. When athletes attempt to produce maximal force, the generated force values depend on the motor task. Even when the “geometry” of a motion (e.g., involved body limbs, movement trajectory) is fixed, the resulting force varies.

Several factors determine the force values across motor tasks. These factors are classified as extrinsic (external) and intrinsic (internal). The force exerted by an athlete on an external body depends not only on the athlete but also on external factors, in particular the type of resistance (such as elasticity, inertia, gravity force, and hydrodynamic force).

The type of resistance influences the pattern of the force produced. Imagine that the same arm motion (e.g., in a lateral–medial direction) is performed against different resistance: first, springs, and then, viscosity (the arm moves in tough dough). In the first instance, the resistance increases in proportion to the movement amplitude; in the second, resistance is proportional to the movement velocity. Often the resistance provided by a strength exercise apparatus does not resemble the type of resistance found in natural sport movements. This is detrimental to the efficiency of strength training.

Several intrinsic characteristics of motor tasks are important for producing maximal force. Time available for force development is a crucial factor in many sport events. The time required to produce maximal force is typically longer than the time available for the manifestation of strength in real sport movements. Thus the rate of force development, rather than the force itself, is the crucial factor in a successful athletic performance. The relative contributions of the maximal force and the rate of force development depend on the level of athletic performance. The higher the performance, the shorter the time available for force production and thus the greater the importance of the rate of force development. The ability to produce maximal forces in minimal time is called explosive strength. Strong people do not necessarily possess explosive strength.

Movement velocity influences the magnitude of the force that can be produced; the higher the velocity, the smaller the force (parametric relation). Thus the lower the movement velocity and, consequently, the greater the force values produced during the natural athletic movement, the greater the contribution of F_{mm} (and also of heavy resistance training) toward athletic performance.

Direction of movement (i.e., whether the muscle is shortening or lengthening during a motion) is a matter of primary importance. The highest forces are generated during eccentric muscular action as well as during reversible muscular action, when the muscle is forcibly stretched and then permitted to shorten. Such a stretch–shortening cycle is an innate part of many athletic movements. The magnitude of the force produced during the stretch–shortening muscular action, as well as the magnitude of the stored and recoiled potential energy of deformation, depends on both the elastic properties of muscles and tendons and the neural control of muscle activity. The interplay of two spinal reflexes (stretch reflex and Golgi organ reflex) is considered to be a major factor toward determining neural inflow to the muscle during the stretch–shortening cycle.

Furthermore, the magnitude of the manifested muscular force depends largely on body posture. For one-joint motions, joint strength curves (i.e., the force–angle relations) are affected by changes in muscle–tendon forces and changes in the moment arms of these forces. In multijoint body movements, the strongest as well as the weakest (sticking) points exist throughout the whole range of motion at which maximal (minimal) force values are manifested.

ATHLETE-SPECIFIC STRENGTH

In the previous chapter we looked at how strength depends on various factors specific to the tasks within a given sport or activity. We turn now to the factors that affect maximal forces produced by individual athletes, and how they may vary from person to person, that is, the determining factors in a comparison across athletes. We conclude the chapter and examination of the determinants of strength with a taxonomy to help you consolidate and sort what you have learned in chapters 2 and 3.

Individual athletes generate different maximal forces when they perform similar motions. These variations stem mainly from two factors:

- The maximal force capabilities of individual muscles, or **peripheral factors**.
- The coordination of muscle activity by the central nervous system, or **central factors**. Two aspects of neural coordination are discernible: intramuscular coordination and intermuscular coordination.

Although this is not a book on physiology, some attention must be given to those factors vital in our understanding of strength training and its adaptive potential.

Muscle Force Potential (Peripheral) Factors

Among the peripheral factors affecting muscle force potential, muscle dimensions seem to be the most important. Muscle mass, or the number of muscle



fibers in a muscle, and muscle dimensions are affected by training and by other factors, including nutrition and hormonal status.

Muscle Dimensions

It is well known that muscles with a large physiological **cross-sectional area** produce higher forces than similar muscles with a smaller cross section. This is true regardless of muscle length. With heavy resistance training in which the muscle cross section is increased, there is typically an accompanying increase in maximal strength. The cross-sectional area of a muscle is directly related to the number of muscle fibers and their summated fiber cross-sectional areas.

Skeletal muscle consists of numerous fibers, or long, cylindrical muscle cells. Each fiber is made up of many parallel **myofibrils**, which consist of longitudinally repeated units called **sarcomeres**. Sarcomeres in turn include thin **filaments** consisting largely of the protein **actin** and thick filaments of the protein **myosin**. The actin and myosin filaments partially overlap. Myosin filaments have small outward helical projections called cross bridges. These cross bridges end with myosin heads that make contact, known as **cross-bridge attachments** or links, with the thin filaments during contraction. According to the sliding-filament theory, shortening of the sarcomere, and hence the muscle fiber, occurs as a result of the active relative sliding of the actin filaments between the myosin filaments.

The force produced by a muscle is the outcome of activity of muscle subunits (sarcomeres, myofibrils, muscle fibers). The maximal force produced by a sarcomere depends to some extent on the total number of myosin heads available for the cross-bridge links with actin filaments. The total number of cross-bridge links in a given sarcomere is the product of

- the number of actin and myosin filaments, or the cross-sectional area of all the filaments and
- the number of myosin heads that can interact with actin filaments, or the sarcomere length.

Muscles with long sarcomeres (longer actin and myosin filaments) exert greater force per unit of cross-sectional area because of the greater extent of possible overlap.

All the sarcomeres of one myofibril work in series. The force exerted by, or on, any element of a

linear series (i.e., by any sarcomere in the myofibril) is equal to the force developed in each of the other elements in the series. Therefore, all sarcomeres of the myofibril exert the same force, and the force registered at the ends of the myofibril does not depend on its length.

The force produced by a muscle fiber is limited by the number of actin and myosin filaments and consequently by the number of myofibrils working in parallel. The differences in parallel and serial action of sarcomeres are listed in figure 3.1 using the example of two fibers consisting of two sarcomeres each. To estimate the muscle potential in force production, instead of calculating the number of filaments, researchers determine their total cross-sectional area. The ratio of the filament area to the muscle fiber area is called **filament area density**.

Strength training can increase the number of filaments per myofibril, myofibrils per muscle fiber, and filament area density; thus there is a rise in both muscle cell size and strength. We know little about the influence of strength training on sarcomere length.

The capacity of a muscle to produce force depends on its physiological cross-sectional area, and particularly on the number of muscle fibers in the muscle and the cross-sectional areas of the fibers.

It is commonly known that the size of a muscle increases when it is subjected to a strength training regimen. This increase is called **hypertrophy** and is typically displayed most notably by bodybuilders, as it is one of the targeted goals of that sport. Whole-muscle hypertrophy is caused by

- a small increase in the number of muscle fibers (fiber **hyperplasia**) or
- primarily an enlargement of cross-sectional areas of individual fibers (fiber hypertrophy).

Investigations have found that both hyperplasia and hypertrophy contribute to muscle size increase. However, the contribution of fiber hyperplasia is rather small (<5%) and may be disregarded for practical purposes of strength training. Muscle size increases are caused mainly by individual fiber size increases, not by the gain in fibers (through fiber splitting). People with large numbers of fibers have a greater potential for hypertrophy, such as highly competitive powerlifters, weightlifters, or bodybuilders, than do people with smaller numbers of fibers in their muscles, such as marathon runners. The size of individual fibers, and consequently the

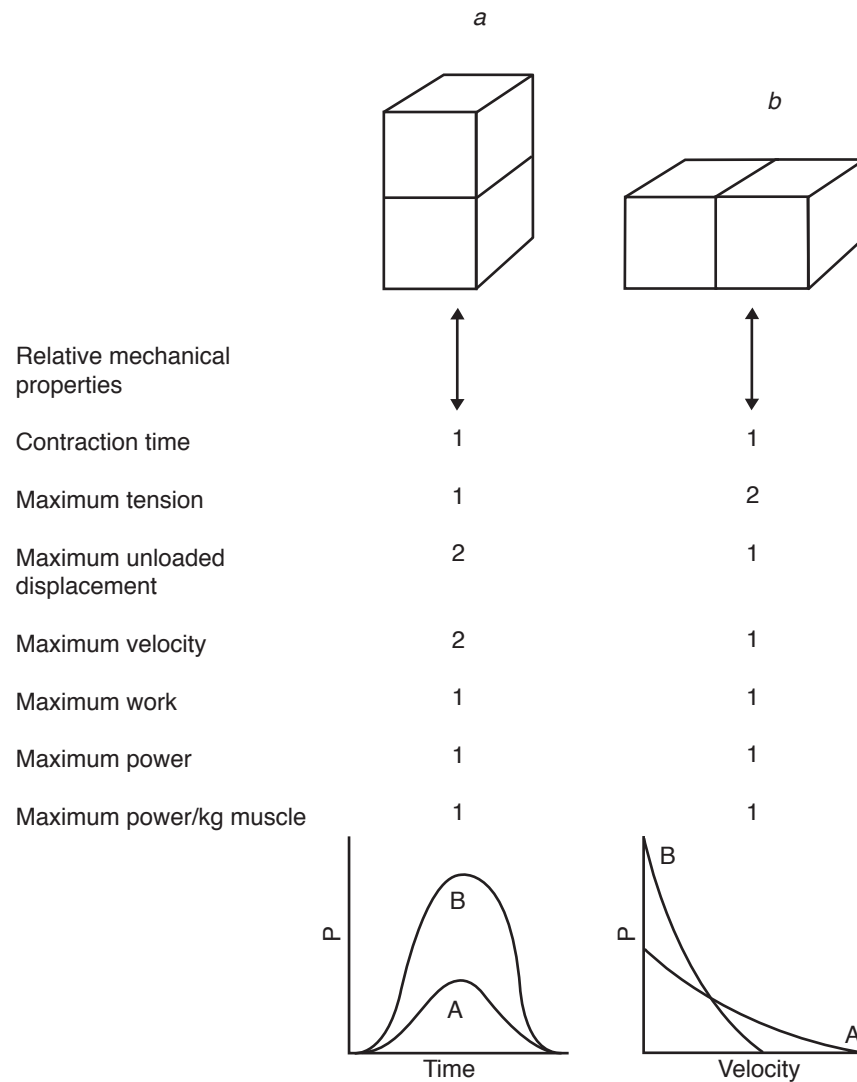

FIGURE 3.1 The relative effects of different arrangements of sarcomeres, (a) in series and (b) in parallel, on the mechanical properties of a muscle fiber. In addition, the relative isometric and isotonic properties are illustrated at the bottom of the figure.

Reprinted by permission from W.R. Edgerton, R.R. Roy, R.G. Gregor, et al., "Morphological Basis of Skeletal Muscle Power Output," in *Human Muscle Power*, edited by N.L. Jones, N. McCartney, and A.J. McComas (Champaign, IL: Human Kinetics, 1986), 44.

size of the muscles, increases as a result of proper training. The number of fibers is not changed substantially.

Two extreme types of muscle fiber hypertrophy can be schematically depicted: sarcoplasmic and myofibrillar hypertrophy (figure 3.2).

Sarcoplasmic hypertrophy of muscle fibers is characterized by the growth of sarcoplasm (semi-fluid interfibrillar substance, water), also called "cell swelling," which contributes to cell growth and to some sizing effects due to the maintenance of osmotic gradients. Additionally, increases in the density of non-contractile proteins (e.g., Z bands,

titin, nebulin) with the non-contractile protein titin most prominently contributing to eccentric force production.

Myofibrillar hypertrophy is an enlargement of the muscle fiber as part of an activated **motor unit** (or **MU**, the alpha motor neuron and its associated muscle fibers that comprise a motor system output); the muscle fiber gains more myofibril proteins and, correspondingly, more actin and myosin filaments. Correspondingly, non-contractile proteins increase as they provide the lattice work for the contractile protein organization and special arrangements. The synthesis of actin and myosin proteins in

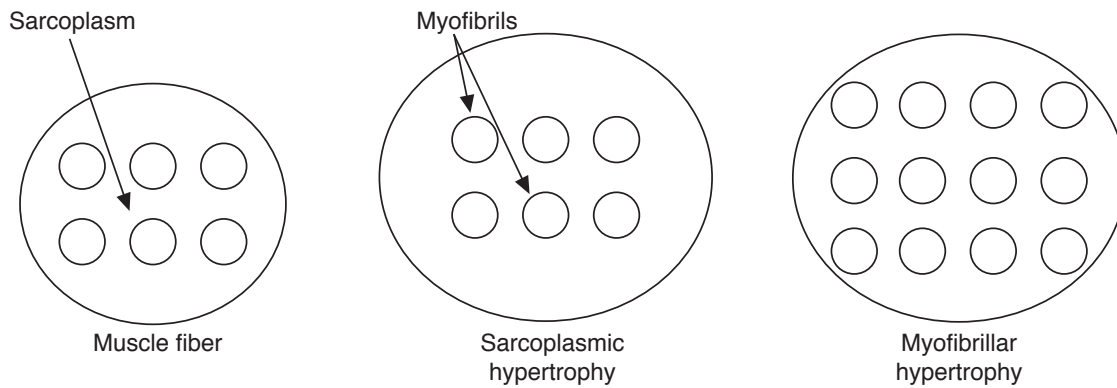

FIGURE 3.2 Sarcoplasmic and myofibrillar hypertrophy.

a muscle cell is controlled by the genes in the cell nucleus. Strength exercises can prompt the molecular signaling of genes located on the DNA in the nucleus, stimulating them to build actin and myosin proteins (contractile proteins) as well as the non-contractile proteins. Contractile proteins are synthesized, the proteins form new filaments, and filament density increases. This type of fiber hypertrophy leads to increased muscle force production. Heavy resistance exercises lead to a mix of sarcoplasmic and myofibrillar hypertrophy of muscle fibers. Depending on the training routine, the types of fiber hypertrophy are manifested in varying degrees based on the amount of activation they receive. Activation of the motor units, made up of the alpha motor neuron and its associated fibers, will hypertrophy when stimulated repeatedly in a training program. If heavy enough resistance is used (see size principle) and enough motor units are activated in the muscle, the absolute size of the intact muscle will increase as well. Heavy resistance training will result in increased muscle size and force capability if properly applied over time. Training must be organized to stimulate the synthesis of contractile proteins and to increase filament muscle density.

The repair and remodeling of muscle is partially associated with a certain degree of breakdown, which in turn leads to repair and remodeling of the activated muscle fibers. Thus, a certain amount of **catabolism** (breakdown of muscle fibers) occurs, which in part, can signal anabolic processes. For many years this was thought to be incorrect, but scientists now feel it can play a role in the process even if the damage is minor because hypertrophy can occur when damage markers are low; in many ways catabolism is part of the process of muscle tissue remodeling despite the level of damage involved.

However, if muscle damage or breakdown is too severe (e.g., eccentric loads or work volume limits were exceeded) the repair process can be delayed. If inflammation levels become too high and sustained, then normal repair and remodeling processes are hampered. Typically workout recovery, with minimal soreness, should occur in 24 to 48 h, and if muscles are extremely sore, “too much too soon” was done in the workout. At its worst end point, the risk of rhabdomyolysis exists (i.e., a breakdown of muscle that compromises kidney functions and can lead to permanent disability or even death) if workouts are not carefully designed and individualized for toleration of the loading progressions. Fiber hypertrophy is a supercompensation of muscle proteins over a recovery period. With training, stronger muscle fibers resist the extent of damage and can repair and remodel more quickly, which is due, in part, to the eccentric loading even when using the typical “concentric-eccentric” repetition, and supports heavier loading regiments within a training cycle.

The mechanisms involved in muscle protein synthesis are becoming clearer each year with new technologies and molecular tools to test and examine the hypertrophy process. Yet with a multitude of different signaling processes and interactions, the complexity remains in explaining the numerous pathways and effects on the various biocompartments in muscle in the hypertrophic adaptive mechanisms. It comes down to the inherent interplay between protein synthesis and degradation. As we have noted before, some breakdown and damage of muscle fibers occur when the motor unit is recruited. This damage can be greater when using heavier resistances (called mechanical damage) due to the high force per cross-sectional area. Some fibers in that motor unit may also have greater damage and

may require regeneration or may be lost. However, in typical training these minor tears or damage of the sarcolemmal walls of the fibers can be easily repaired. Thus the damage phenomenon is on a continuum for each recruited motor unit based on the force demands of the exercise. Type I muscle fibers found in the low-threshold, slower motor units are many times more resistant to damage due to thicker non-contractile proteins. However, workouts with short rest periods can also cause muscle damage when inflammation is extreme and immune cells produce high levels of free radicals and other toxic substances (called chemical damage), which attack the muscle fiber's sarcolemmal walls as well cause damage over longer time periods of 48 to 72 h. This is why a recovery day is vital after such workouts in a training progression.

A number of factors are involved in the hypertrophic processes of muscle fibers. Muscle fibers associated with a motor unit must be activated by the resistance load to initiate the hypertrophic process. Hypertrophy, beyond homeostatic maintenance of normal resting levels, will not occur in inactivated muscle fibers. Once motor units and their associated muscle fibers are activated, a variety of signals from the body systems (e.g., **hormones**, cytokines, metabolic substances) interact with the muscle fibers' receptors to transmit signal messages to the DNA machinery. In addition, these substances can bind to "satellite cells," which lie dormant under the sarcolemmal walls and are also signaled from the contraction forces. These signals that activate the satellite cells can then differentiate and help repair muscle tears with the production of myoblasts that act like a paste or bandage to fix the fiber's membrane. If the muscle fiber experiences an increase in the amount of contractile and non-contractile proteins resulting in increased size or what we call hypertrophy, satellite cells further differentiate to contribute nuclei that allow this increased size to be managed when size increases are greater than 25%-35%. Skeletal muscle is a multinucleated cell with each nucleus responsible for a given area of protein, called a nuclear domain. Signals from anabolic hormones—most notably by testosterone in men, cytokines, myokines—stimulate the process of protein synthesis in which proteins are produced, organized, and placed in the proper geometric position in the fibers, thus increasing muscle fiber size. If enough motor units in the muscle are properly activated, this effect becomes more widespread and the intact muscle increases in size and mass. This multifaceted hypertrophy process needs to be

supported by appropriate nutrition, sleep, lifestyle behaviors, and optimal training progressions to limit the catabolic signal that can inhibit or offset this anabolic hypertrophic response and adaptation.

A few hypotheses that were popular among coaches many years ago are now completely disregarded, including the following:

- The blood overcirculation hypothesis suggests that increased blood circulation in working muscles is the triggering stimulus for muscle growth. One of the most popular methods of bodybuilding training, called *flushing*, is based on this assumption. It has been shown, however, that active muscle hyperemization (i.e., the increase in the quantity of blood flowing through a muscle) caused by physical therapeutical processes does not, in itself, lead to the activation of protein synthesis. Blood flow to the exercising muscle is important for delivery of essential nutrients and hormones; however, its effects are related to the activation of maximal number of the motor units in the muscle.

- The muscle hypoxia hypothesis, in contrast to the blood overcirculation theory, stipulates that a deficiency, not an abundance, of blood and oxygen in muscle tissue during strength exercise triggers protein synthesis. Muscle arterioles and capillaries are compressed during resistance exercise and the blood supply to an active muscle is restricted. Blood is not conveyed to muscle tissue if the tension exceeds approximately 60% of maximal muscle force.

However, by inducing a hypoxic state in muscles in different ways, researchers have shown that oxygen shortage does not stimulate an increase in muscle size. Professional pearl divers, synchronized swimmers, and others who regularly perform low-intensity movements in oxygen-deficient conditions do not have hypertrophied muscles. Tissue hypoxia directly increases the amount of free radical formation and local tissue damage and studies have shown that resistance training can reduce this effect. Thus, hypoxia for the most part is detrimental to optimal recovery and repair patterns in muscle.

- The adenosine triphosphate (ATP) debt theory is based on the assumption that ATP concentration is decreased after heavy resistance exercise (about 15 repetitions in 20 s per set were recommended for training). However, findings indicate that, even in a completely exhausted muscle, the ATP level is not changed.

A fourth theory, although it has not been validated in detail, appears more realistic and appropriate for practical training—the **energetic theory of muscle hypertrophy**. According to this hypothesis, the crucial factor for increasing protein catabolism is a shortage of energy available for protein synthesis in the muscle cell during heavy strength exercise. The synthesis of muscle proteins requires a substantial amount of energy. The synthesis of one peptide bond, for instance, requires energy liberated during the hydrolysis of two ATP molecules. For each instant in time, only a given amount of energy is available in a muscle cell. This energy is spent for the **anabolism** of muscle proteins and for muscular work. Normally, the amount of energy available in a muscle cell satisfies these two requirements. During heavy resistance exercise, however, almost all available energy is conveyed to the contractile muscle elements and spent on muscular work (figure 3.3).

Since the energy supply for the synthesis of proteins decreases, protein degradation increases. The uptake of amino acids from the blood into muscles is depressed during exercise. The mass of proteins catabolized during heavy resistance exercise exceeds the mass of protein that is newly synthesized. As a result, the amount of muscle proteins decreases somewhat after a strength workout, while the amount of protein catabolites (e.g., the concentration of nonprotein nitrogen in the blood) rises above its resting value. Then, between training sessions, protein synthesis is increased. The uptake of amino acids from the blood into muscles is above resting values. This repeated process of enhanced degradation and synthesis of contractile proteins may result in the supercompensation of protein (figure 3.4). This principle is similar to the overcompensa-

tion of muscle glycogen that occurs in response to endurance training.

Type I, or **slow-twitch fibers**, and **type II**, or **fast-twitch fibers**, do not hypertrophy in exactly the same manner. Type I muscle fibers rely more on reducing the amount of myofibrillar protein degradation, while type II muscle fibers rely more on increasing synthesis. While both functions are operational in a muscle fiber, these differences do support certain training considerations. Type I muscle fibers will be more responsive to detraining and may require a higher maintenance frequency than type II muscle fibers. Conversely, because type I muscle fibers are used continuously in the progression of the recruitment process of motor units that go from low to high threshold (size principle), when damaged they can take a longer time to repair due to the higher content of non-contractile proteins; low threshold motor units with type I fibers are more sensitive to chemical damage insults.

Whatever the mechanisms for stimulating muscle hypertrophy, the vital parameters of a training routine that induce such results are exercise intensity (the exerted muscular force) and exercise volume (the total number of repetitions, performed mechanical work). The practical aspects of this theory will be described in chapter 4.

Body Weight

Muscle mass constitutes a substantial part of the human body mass or body weight. (In elite weightlifters, muscle mass is about 50% of body weight.) That is why, among equally trained individuals, those with greater body weight demonstrate greater strength.

The dependence of strength on weight is seen more clearly when tested subjects have equally

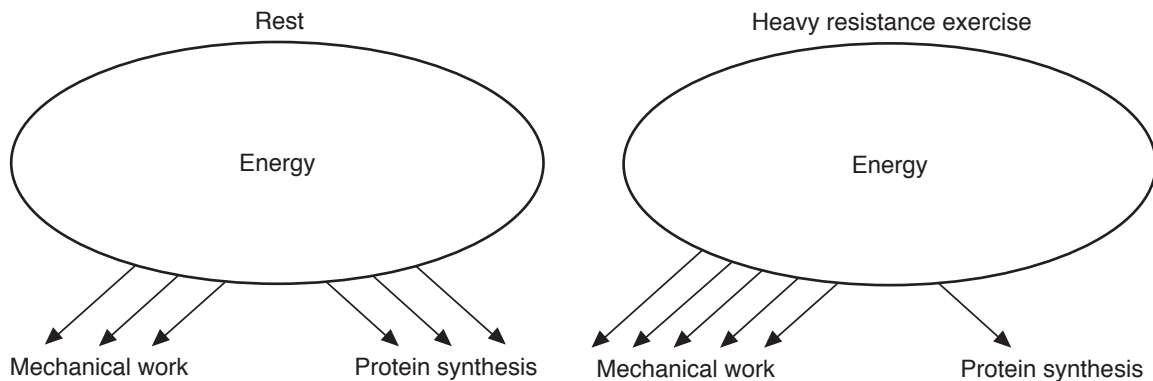

FIGURE 3.3 Energy supply at rest and during heavy resistance exercise. During heavy resistance exercise, the amount of energy immediately available for the synthesis of muscle proteins decreases.

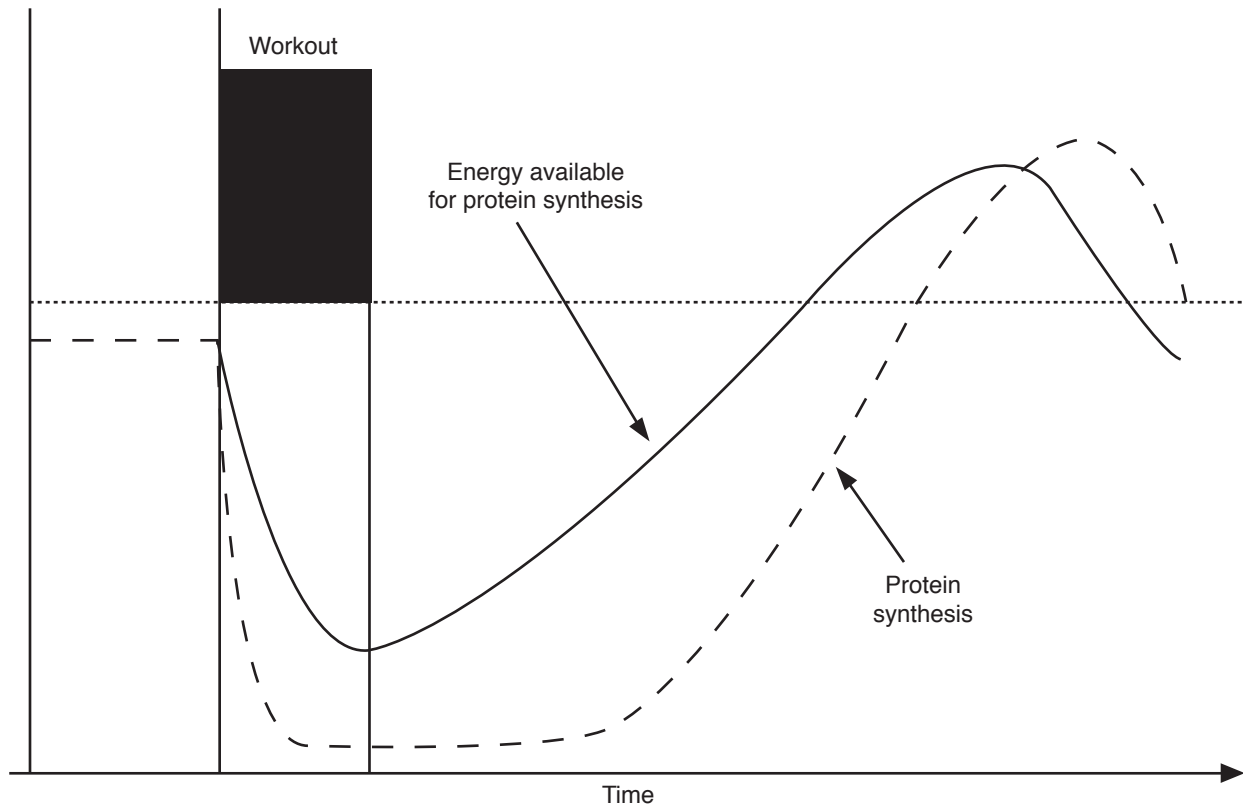

FIGURE 3.4 Energetic potential of a muscle cell and the rate of protein anabolism.

Adapted by permission from A.A. Viru, "Influence of Exercise on Protein Metabolism," in *Lectures in Exercise Physiology*, edited by A.A. Viru (Tartu, Estonia: The Tartu University Press, 1990), 123-146. By permission of the author.

superb athletic qualifications. World-record holders in weightlifting have shown a very strong correlation between performance level and body weight, 0.93. The correlation for participants at the world championships has been 0.80, and among those not involved in sport activities, the correlation has been low and may even equal 0.

To compare the strength of different people, the strength per kilogram of body weight, or **relative strength**, is usually calculated. On the other hand, muscular strength, when not related to body weight, is called **absolute strength**. Thus, the following equation is valid:

$$\text{Relative strength} = \text{Absolute strength} / \text{Body weight}$$

With an increase in body weight, among equally trained athletes of various weight classes, absolute strength increases and relative strength decreases (figure 3.5). For instance, a previous world record in the **clean and jerk** lift in the 56-kg weight category equaled 168.0 kg. Hence, the relative strength is 3.0 (168.0 kg of force / 56 kg of body weight = 3.0). The

body weight of an athlete in the super-heavyweight division, on the other hand, must be above 105 kg and is typically 130 to 140 kg. If the best athletes of this weight class had a relative strength of 3.0 kg of force per kilogram of body weight, they would lift approximately 400 kg in the clean and jerk. In reality, the world record in this weight class is 263.5 kg.

Because of their great relative strength, athletes of small body dimensions have an advantage in lifting their own bodies. Elite wrestlers of lightweight classes can usually perform more than 30 pull-ups on a horizontal bar; for athletes in the super-heavyweight category, 10 pull-ups is an excellent achievement.

To see what causes such discrepancies, imagine two athletes, A and B, with equal fitness levels but different body dimensions. One of them is 1.5 times as tall as the other (figure 3.6). Their heights are 140 and 210 cm, and all anteroposterior and frontal diameters are also in the proportion of 1:1.5.

Compare the linear measures (length of segments, diameters), surface measures (physiological

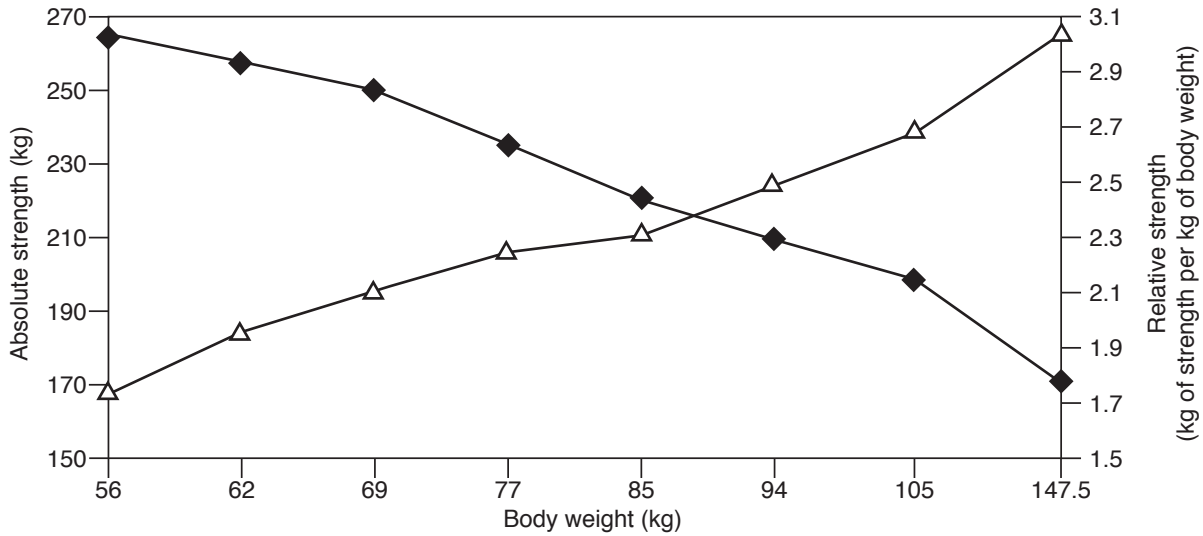

FIGURE 3.5 Absolute (triangle line) and relative (diamond line) strengths of elite weightlifters at different weight classes. Historical world records in the clean and jerk (as of January 01, 2005) serve as indices of absolute strength. For the super-heavyweight category (>105 kg), the actual weight of the athlete is shown (H. Rezazadeh, Iran, body weight 147.5 kg; his record is 263.5 kg; the relative strength is 263.5/147.5 = 1.786 kg of strength/kg of body weight).

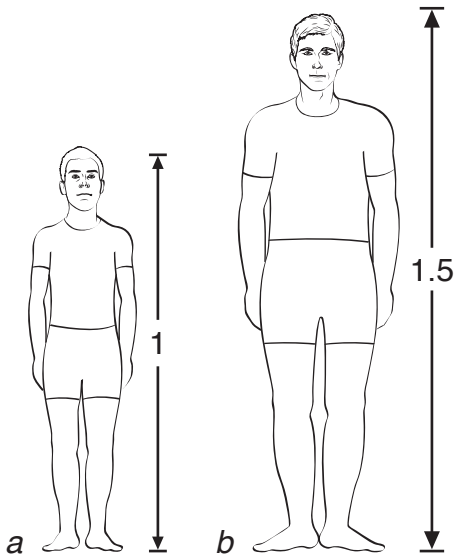

FIGURE 3.6 Two athletes of different body dimensions.

cross-sectional area, body surface), and volume measures (volume, body mass):

Measure	A	B
Linear	1	1.5
Area (and strength)	1	1.5 ² = 2.25
Volume (and body weight)	1	1.5 ³ = 3.375

Thus, the proportion for body height is 1:1.5; the proportion for area (including muscle physiological

cross-sectional area) is 1:2.25; and the proportion for volume and weight is 1:3.375. Athlete B is 2.25 times stronger than athlete A, but also 3.375 times heavier. Athlete B has the advantage in absolute strength, and athlete A the advantage in relative strength.

The relationship between body weight and strength can then be analyzed using simple mathematics. Taking into account that

$$W = aL^3,$$

where W is the body weight, L is the linear measure, and a is a constant (coefficient), we can write

$$L = aW^{1/3}.$$

Since strength (F) is proportional to muscle physiological cross-sectional area, it is also proportional to L^2 :

$$F = aL^2 = a(W^{1/3})^2 = aW^{2/3} = aW^{0.666}.$$

Or, in logarithmic form,

$$\log_{10} F = \log_{10} a + 0.666(\log_{10} W).$$

We can validate the last equation by using, for instance, the world records in weightlifting. With this objective the logarithm of body weight is plotted in figure 3.7 against the logarithm of weight lifted by an athlete. The regression coefficient is 0.63 (close to the predicted 0.666), proving that the equation is valid. Such an equation (or corresponding tables such as table 3.1) can be used to compare the strength of people with different body weights. The table shows that a 100-kg force in the

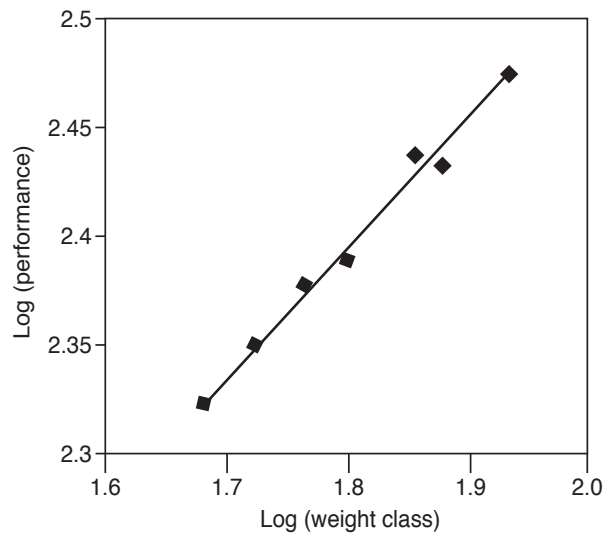

FIGURE 3.7 The relation between athlete strength and body weight. The world records in weightlifting (snatch plus clean and jerk lifts) for female athletes of different weight categories are used as indices of maximal strength. The records are for January 1, 2005. Because the body weight of athletes of the weight category above 75 kg is not precisely controlled by the rules, these data are not included in the analysis (during the 2004 Olympics the record holder—G. Tang, China—had a body weight of approximately 120 kg). Note the logarithmic scale. The empirical regression equation is $\log_{10} F = 1.27 + 0.63(\log_{10} W)$.

67.5-kg weight class corresponds to 147 kg in super-heavyweight lifters.

For linemen in football, super-heavyweight lifters, and throwers, among others, absolute strength is of great value. For sports in which the athlete's body

rather than an implement is moved, relative strength is most important. Thus, the cross, a ring exercise performed in men's gymnastics, is performed only by those athletes whose relative strength in this motion is near 1 kg per kilogram of body weight (table 3.2). Because the gymnast does not suspend the entire body (there is no need to apply force to maintain handholds), the cross can be performed when relative strength is slightly less than 1.0.

In sports in which absolute strength is the main requirement, athletes should train in a manner that stimulates gains in lean muscle mass. As weight increases, the percentage of body fat must remain constant, or even decrease, to ensure that the weight gain is primarily in lean body mass.

An increase in relative strength may be accompanied by different changes in body weight. Sometimes it is accompanied by stabilization or even weight loss. Table 3.3 illustrates this phenomenon for an athlete who lost weight and increased her performance. Proper eating habits and regular weight control are necessary for all athletes. Weekly weigh-ins and regular determinations of body composition (skinfold measurements, underwater weighing) are an excellent idea.

A common athletic practice is to reduce body weight before competition. Athletes "make weight" in order to increase their relative strength and improve performance. In sports with weight categories, such as wrestling and judo, athletes succumb to this practice to be eligible for a division lower than their usual weight division. Food restriction, fluid deprivation, and dehydration induced by thermal procedures such as the sauna are used toward this end.

TABLE 3.1 Equivalent Strength Levels for Athletes of Different Body Weight

BODY WEIGHT (KG)							
56	60	67.5	75	82.5	90	110	120
44	46	50	54	57	61	69	73
53	55	60	64	69	73	83	88
62	65	70	75	80	85	96	103
71	76	80	86	91	97	111	117
79	83	90	97	103	109	125	132
88	92	100	107	114	121	139	147
132	139	150	161	171	182	208	220
177	185	200	215	229	242	277	293
221	231	250	290	285	303	346	367
265	277	300	322	343	363	415	425

Data from V.M. Zatsiorsky and I.F. Petrov, "Applied Aspects of the Analysis of the Relations Between the Strength and Body Weight of the Athletes," *Theory and Practice of Physical Culture* 27, no. 7 (1964): 71-73.

TABLE 3.2 Maximal Force of Arm Adduction in Cross Position of Two World Champions in Gymnastics

Name	Arm adduction force (kg)	Body weight (kg)	Force excess over the weight (kg)	Relative force (kg of force per kg of body weight)	Number of crosses in a composition
Azarian, A.	89	74	15	1.20	5-6
Shachlin, B.	69.2	70	-0.8	0.98	1-2

Adapted from A.A. Korobova and A.B. Plotkin, *Strength Testing of Elite Athletes: Technical Report #61-105* (Moscow: All-Union Research Institute of Physical Culture, 1961), 48.

TABLE 3.3 Body Weight Changes and Some Indirect Indices of Relative Strength in 1960 Olympic Champion (Long Jump) V. Krepkina

Age	Weight (kg)	Height (m)	Weight / height	Standing jump (cm)	Long jump (cm)	Sprint 100 m (s)
16	64	1.58	40.5	214	490	13.6
24	55	1.58	34.8	284	617	11.3

Data from V.M. Zatsiorsky, *Motor Abilities of Athletes* (Moscow: Fizkultura i Sport, 1966), 26.

This strategy is acceptable when properly employed (weight loss should not exceed 1 kg per week in average athletes and 2.5 kg in elite ones). However, extreme weight reduction is detrimental to athletic performance and is unsafe. Rapid loss of body weight over short periods of time leads to lean tissue and water loss rather than the loss of fat. In addition, there is a depletion of glycogen stores, the most important energy source for high-intensity performance. The athlete's capacity decreases as a consequence of reduced carbohydrate availability or as a result of disturbed fluid balance. Thus, it is important that athletes follow only long-term, planned weight reduction programs with food restriction in the range of 2 to 4 kJ/day (500-1,000 kcal/day) below normal energy intake.

Abuses associated with extreme and rapid weight loss, such as the use of rubber suits, laxatives, enemas, induced vomiting, and diuretics, cannot

be justified. **Diuretics**, for instance, are considered doping; their use is prohibited by the Medical Commission of the International Olympic Committee (IOC). Unfortunately, in spite of all efforts to discourage the malpractice of rapid weight reduction, many athletes continue to lose weight through unacceptable and unsafe methods. These methods should be vigorously opposed especially for children and teenagers.

The alternative to weight loss is an increase in relative strength through gains in muscle mass. This is completely justified, and athletes should not be wary of growth in muscles carrying the main load in their sport movements.

Other Factors (Nutrition, Hormonal Status)

Strength training activates the synthesis of contractile muscle proteins and causes fiber hypertrophy

Why Do Athletes From Various Sports Have Different Body Dimensions?

Why are gymnasts short? (The height of the best male gymnasts is usually in the range of 155 to 162 cm; female gymnasts are typically 135 to 150 cm tall and often even shorter.) They have to lift their own body and nothing else, so relative, not absolute, strength is important in gymnastics. Short athletes have an advantage in this sport.

Why are the best shot-putters tall and heavy (but not obese)? Absolute strength is important in this case. Athletes with large body dimensions have a distinct advantage in this sport.

Female Gymnasts at Risk

Christy Henrich, one of the best American gymnasts of the 1980s, is a well-known example of the tragic consequences of eating problems. When she weighed 95 lb (43 kg), she was told by her coaches that she was too fat to make the Olympic team. She began a life of anorexia and bulimia, still missing the Olympics by a fraction of a point. Less than a decade later she died at age 22, weighing only 52 lb (23.5 kg). Coaches should comment about weight issues thoughtfully and carefully.

only when there are sufficient substances for protein repair and growth. The building blocks of such proteins are amino acids, which must be available for resynthesis in the rest period after workouts.

Amino acids are the end products of protein digestion (or hydrolysis). Some amino acids, termed **essential** or indispensable, cannot be produced by the body and must be provided by food. Amino acids supplied by food pass unchanged through the intestinal wall into the general blood circulation. From there they are absorbed by the muscles according to the specific amino acid needed by that muscle to build up its own protein. In practical terms, then,

- the full assortment of amino acids required for protein anabolism must be present in the blood during the restitution period; and
- proteins, especially essential ones, must be provided by the proper kinds of foods in sufficient amounts.

Athletes in sports such as weightlifting and shot putting, in which muscular strength is the dominant motor ability, need at least 2 g of protein per kilogram of body weight. In superior athletes during periods of stress training, when the training load is extremely high, the protein need may be higher but consuming more than 2.45 g of protein per kilogram of body weight per day causes the excess protein to be oxidized and more energy is expended. This is a diet strategy some athletes, such as bodybuilders, use to expend more energy in the “cut phase” of their context preparation, but it places excessive demands on the liver and kidneys and is not conducive to health. This amount of protein must be provided by foods with a proper assortment of essential amino acids. The essential amino acids and branch chain amino acids are important, and whey protein has been a popular supplement in strength training.

In addition to the amino acid supply, the hormonal status of an athlete plays a very important

role. Several hormones secreted by different glands in the body affect skeletal muscle tissue. These effects are classified as either catabolic, leading to the breakdown of muscle proteins, or anabolic, leading to the synthesis of muscle proteins from amino acids. Among the anabolic hormones are **testosterone**, **growth hormone (GH)**, also called somatotropin), and insulin-like growth factors (also known as somatomedins). The predominant catabolic hormone is cortisol, which is secreted by the adrenal gland. While each hormone plays a role in anabolism or catabolism, all the hormones have multiple roles in regulating the homeostatic balance in the body and cannot be exclusively defined by their role in one physiological equation. However, the net effect of a hormone for the athlete may be either positive or negative as it relates to gains in muscle and the catabolic and anabolic balance. This balance between the anabolic and catabolic indicators to skeletal muscles and other tissues is important in the equilibrium of positive and negative protein levels with the understanding that after a workout one may see a negative protein balance due to activity. Recovery allows this negative protein balance to rebound to a positive value.

The concentrations of these hormones in the blood largely determine the metabolic state of muscle fibers. The serum level of testosterone is lower in females than in males, and therefore strength training does not elicit the same degree of muscle hypertrophy in females as in males. Strength training elicits changes in the level of anabolic hormones circulating in the blood. These changes may be acute (as a reaction to one workout) or cumulative (long-term changes in resting levels). For instance, strength training elicits small increases in resting serum testosterone concentrations and induces an acute elevation in the level of circulating testosterone. A relatively high positive correlation ($r = 0.68$) has been found between the ratio of serum testosterone to sex hormone-binding globulin (SHBG) and concomitant gains in competitive weightlifting

Growth and Strength

As children and teenagers become taller and heavier, their relative strength should decrease. This often happens during pubertal growth spurts. It is not uncommon for 8-year-old boys and girls to show comparatively high values of relative strength; for instance, they might perform 10 or 12 chin-ups. But if they do not exercise regularly, they will not be able to repeat these achievements when they are 16.

Typically, however, the relative strength of children does not decrease during childhood and puberty, because during the maturation process the muscles of mature individuals produce a greater force per unit of body mass. Thus, two concurrent processes with opposite effects take place during childhood and puberty: growth (i.e., an increase in body dimensions) and maturation. Due to growth, relative strength decreases; at the same time, due to maturation, it increases. The superposition of these two processes determines the manifested strength advancement (or decline). The interplay of the two concurrent processes of child development is important in the preparation of young athletes.

Consider training methods of the best male gymnasts from countries that were once part of the USSR. They learn all the main technical stunts, including the most difficult ones, before the age of 12 or 13 when the puberty growth spurt begins. During the **puberty** period (13-16 years of age) they learn very few, if any, new technical elements. In training during this period they concentrate on conditioning, especially strength training and specific endurance training, and stability of performance. All compulsory and optional routines are trained (to achieve high stability of performance and gain specific endurance) rather than new elements and single stunts. Great attention is paid to strength development. As a result, at 17 to 18 years of age the gymnasts are prepared to compete at the international level. Dmitri Bilozherchev, for instance, won an all-around world championship when he was 16.

As the complexity of the optional routines increases, the most difficult stunts are performed (during training sessions) not by contemporary Olympic and world champions, but by their young counterparts (i.e., 12- and 13-year-old boys who are preparing at this time to compete at future Olympic Games).

results for the clean and jerk lift (figure 3.8). In such cases as in elite weightlifters where there is a very small window for potential increases in muscle fiber area, testosterone may be more interactive with receptors from the nervous system.

Serum growth hormone (GH) levels (i.e., the 22-kD form) are significantly elevated during exercise with heavy weight (70%-85% of maximal force). No change in serum GH has been observed when the resistance is reduced to allow the completion of 21 repetitions. The resting level of GH is not changed as a result of strength training. This may be due to the fact that basic GH molecules can be bound together in clusters, creating higher molecular variants, or aggregates, while the different variants, as well as binding proteins, respond differently to strength training. We are just starting to learn about the complexity of what is now called the growth hormone super family. The magnitudes of acute hormonal responses to a specific workout are related to the following:

- Amount of muscle mass activated
- Amount of work
- Amount of rest between sets and exercises

Neural (Central) Factors

The central nervous system (CNS) is of paramount importance in the exertion and development of muscular strength. Muscular strength is determined not only by the quantity of involved muscle mass but also by the extent to which individual fibers in a muscle are activated (by intramuscular coordination). Maximal force exertion is a skilled act in which many muscles must be appropriately activated. This coordinated activation of many muscle groups is called intermuscular coordination. As a result of neural adaptation, superior athletes can better coordinate the activation of fibers in single muscles and in muscle groups. In other words, they have better intramuscular and intermuscular coordination.

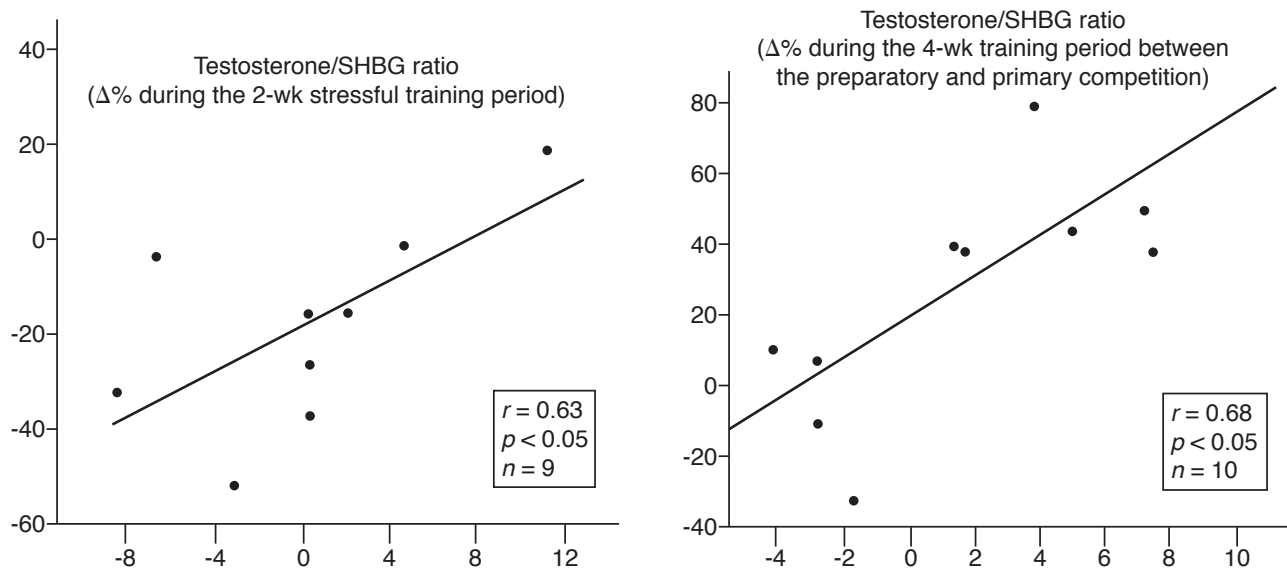

FIGURE 3.8 Relations between relative change in serum testosterone/SHBG ratio and results of the clean and jerk lift. Testosterone is not freely soluble in plasma and must bind with plasma proteins or globulins in order to circulate in blood. During resting conditions, more than 90% of testosterone is bound to either SHBG or to albumin. The remaining testosterone is in a metabolically active “free” form. This study demonstrates a significant correlation between increases in strength and the ratio of free to bound testosterone. The subjects were all Finnish champions or national record holders (or both) in weightlifting.

Adapted by permission from K. Häkkinen, A. Pakarinen, A. Alén, H. Kauhanen, and P.V. Komi, “Relationships Between Training Volume, Physical Performance Capacity, and Serum Hormone Concentration During Prolonged Training in Elite Weight Lifters,” *International Journal of Sports Medicine* 8, suppl. 1 (1987): 61-65.

Protein and Carbohydrate Intake

Intake of protein and carbohydrate before and after a workout affects the amount of testosterone that will bind to the **androgen receptors**. The increased binding of testosterone to the androgen receptors in the muscle results in what is called an *up regulation*, meaning there is an increased number of receptors that are responsive to the circulating testosterone. Testosterone is one of the major hormonal signals of increased protein synthesis in the muscle, but it must be bound to the receptor. This receptor for testosterone and all steroids is in the nuclei. When transported into the cell it will then bind and signal to the cell’s DNA machinery. Findings show that with nutrient intake, circulating testosterone decreases. This is thought to be due to the greater use and uptake of testosterone from the blood with increased binding to the androgen receptor. Thus, the intake of small amounts of essential amino acids (6-10 g), which are most important before and after a workout, can aid the protein synthesis process during and immediately after the workout by providing available amino acids for building blocks. The intake of 20-25 g of whey protein, which contains the essential amino acids, within 10 min after the workout can also help. A small amount carbohydrate (10 to 25 g) can also be consumed in the postworkout drink but is not essential, and too much can cause an insulin response that can shut down fat-burning enzymes. Growth hormone from the anterior pituitary gland and insulin-like growth factor-1 from the liver also increase with such nutrient intakes surrounding a workout. Thus macronutrient intake timing may be crucial for optimizing the anabolic environment surrounding a workout. The increased protein synthesis appears to be mediated by a host of different anabolic hormones and molecular signaling molecules (e.g., mTOR system).

Intramuscular Coordination

The nervous system uses three options for varying muscle force production. These include

- recruitment, the gradation of total muscle force by the activation and deactivation of individual motor units;
- rate coding, a change in the firing rate of motor units; and
- synchronization, the activation of motor units in a more or less synchronized way.

All three options are based on the existence of motor units (MUs). MUs are the basic elements (quantums) of motor system output. Each MU consists of a motoneuron in the spinal cord and the muscle fibers it innervates. An MU also includes a long **axon** going from the motoneuron down to the muscle, where it branches out and innervates individual muscle fibers. When a motoneuron is active, **impulses** (forces acting on a muscle to produce a change) are distributed to all the fibers in the MU. In small muscles that afford a fine level of control, MUs consist of several dozen muscle fibers. For instance, MUs in the extraocular muscles that position the eyes include on average only 23 muscle fibers. In large muscles such as the rectus femoris, on the other hand, one MU may include up to 2,000 muscle fibers.

MUs can be classified as fast or slow on the basis of contractile properties. Slow MUs, or slow-twitch (ST; also called type I) motor units, are specialized for prolonged use at relatively slow velocities. They consist of (1) small, low-threshold motor units with low discharge frequencies; (2) axons with relatively low conduction velocities; and (3) motor fibers highly adapted to lengthy **aerobic exercise**. They also have higher densities of non-contractile muscle proteins, which provide the lattice structure for the contractile proteins of actin and myosin. Fast MUs, or fast-twitch (FT; also called type II) motor units, are specialized for relatively brief periods of activity characterized by large power outputs, high velocities, and high rates of force development. They consist of (1) large, high-threshold motor units with high discharge frequencies; (2) axons with high conduction velocities; and (3) motor fibers adapted to explosive or anaerobic activities. A more detailed classification includes three types of muscle fibers: type I (slow), type IIA (fast but fatigue resistant), and IIX (fast with low resistance to fatigue) (see table 3.4 and figure 3.9). In contrast to previous reports, transition from type I to type II muscle fibers as a

TABLE 3.4 Main Types of Muscle Fibers

Type	I	IIA	IIX
Twitch rate	Slow	Fast	Fast
Resistance to fatigue	High	Average	Low
Respiration type	Aerobic	Aerobic–anaerobic	Anaerobic
Capillaries	Many	Many	Few

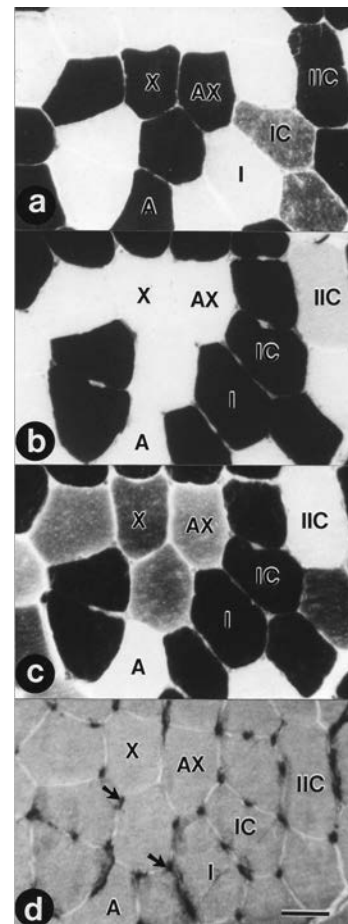

FIGURE 3.9 Micrographs of a muscle fiber cross section. Typing is achieved by using different colors from ATPase histochemical staining. The main muscle fiber types are (slow twitch) type I ("I" in the figure) and (fast twitch) type IIA ("A") and IIX ("X"), along with a representative fast-twitch hybrid IIAIX ("AX") that occurs when muscle fibers are making a transition from one type of type II fiber to another in their protein characteristics. Comprehensive classifications categorize fibers according to other criteria. The main fibers in humans from the most oxidative to the least oxidative are types I, IC, IIC, IIAC, IIA, IIAX, and IIX. Note that type C fibers are only used in histochemistry analysis to understand fiber type hybrid transitions; unlike the other types, humans do not have a C gene in the genome as a type.

result of training is not considered possible; early reports to this effect did not completely type the full array of fiber types and their hybrids.

MUs are activated according to the **all-or-none law**. At any point in time, an MU is either active or inactive; there is no gradation in the level of motoneuron excitation. The gradation of force for one MU is accomplished through changes in its firing rate (rate coding).

In humans, contraction times vary from 90 to 110 ms for ST motor units and from 40 to 84 ms for FT motor units. The maximal shortening velocity of fast motor fibers is almost four times greater than the V_m of ST motor fibers. The force per unit of fast and slow motor fibers is similar, but the FT motor units typically possess larger cross sections and produce greater force per single motor unit. Differences in the force-producing capacity among the MUs can be 100-fold.

All human muscles contain both ST and FT motor units. The proportion of fast and slow motor fibers in mixed muscles varies among athletes. Endurance athletes have a high percentage of ST motor units, while FT motor units are predominant among strength and power athletes.

Recruitment

During voluntary contractions, the orderly pattern of recruitment is controlled by the size of the motor unit. The size of the motor unit is dictated by various sizing factors, such as the number of muscle fibers, type of muscle fibers, cross-sectional area of the muscle fiber, and the threshold of activation. All these factors combined create what is called the **size principle**. Smaller motor units are found with lower neural activation thresholds and are always

activated first as force/power demands are placed on a movement. Thus, those with the lowest firing threshold are recruited first, and as the demands for larger forces are required. A progressively higher threshold and larger and more forceful MUs are also recruited to meet the force/power demands (see figure 3.10). Motor units contain only slow-twitch or fast-twitch muscle fibers and area; therefore, they are homogenous in nature as ST and FT motor units. The involvement of ST motor units is constant, regardless of the magnitude of muscle tension and velocity being developed, as they are always recruited in the process of going from low- to high-threshold motor units. In contrast, full FT motor unit activation can be difficult to achieve without extensive training. Untrained people cannot recruit all their FT motor units. Athletes engaged in strength and power training show increased MU activation with the reduction of both central and peripheral inhibition.

The recruitment order of MUs is relatively fixed for a muscle involved in a specific motion, even if the movement velocity or rate of force development alters. However, the recruitment order can be changed if the multifunction muscle operates in different motions. Different sets of MUs within one muscle might have a low threshold for one motion and a high threshold for another.

The variation in recruitment order is partially responsible for the specificity of training effect in heavy resistance exercise. If the objective in training is the full development of a muscle (not high athletic performance), one must exercise this muscle in all possible ranges of motion. This situation is typical for bodybuilders and beginning athletes, but not elite athletes. Concerns for the detraining

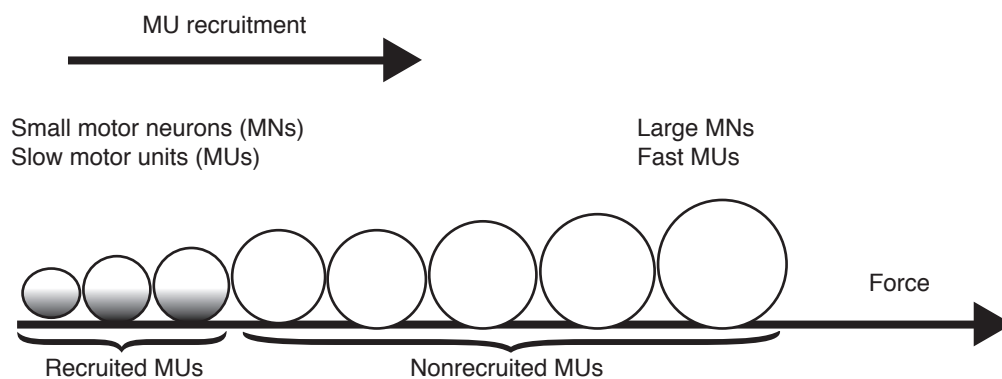

FIGURE 3.10 Size principle of alpha motor neuron recruitment. The alpha motor neurons are arranged according to their size. The small alpha motor neurons innervate slow-twitch fibers, while large alpha motor neurons innervate fast-twitch fibers. When the muscle force increases, the alpha motor neurons are activated (recruited) according to size, from small to large. In this figure, the required force is low and only small alpha motor neurons are recruited. When the force builds up, the number of active MUs increases and the fast MUs are recruited.

of muscles used at novel angles or ranges of motion must be heeded as many muscles act in synergistic or assistive support for prime movers. This may be significant for injury prevention and it supports the need to carefully examine the workouts and training programs to see that important movements and exercises other than what might be considered “core” exercises (e.g., squats, cleans, pulls, benches, rows) are also included at different times in the training cycle.

Rate Coding

The other primary mechanism for the gradation of muscle force is rate coding. The discharge frequency of motor units can vary over a considerable range. In general, the firing rate rises with increased force and power production.

The relative contributions of recruitment versus rate coding in grading the force of voluntary contractions are different in small and large muscles. In small muscles, most MUs are recruited at a level of force less than 50% of F_{mm} ; thereafter, rate coding plays the major role in the further development of force up to F_{mm} . In large proximal muscles, such as the deltoid and biceps, the recruitment of additional MUs appears to be the main mechanism for increasing force development up to 80% of F_{mm} and even higher. In the force range between 80% and 100% of F_{mm} , force is increased almost exclusively by intensification of the MU firing rate.

Synchronization

Normally, MUs work asynchronously to produce a smooth, accurate movement. However, there is some evidence that, in elite power and strength athletes, MUs are activated synchronously during maximal voluntary efforts.

In conclusion, maximal muscular force is achieved when

1. a maximal number of both ST and FT motor units are recruited;
2. rate coding is optimal to produce a fused tetanus in each motor fiber; and
3. the MUs work synchronously over the short period of maximal voluntary effort.

Psychological factors are also of primary importance. Under extreme circumstances (i.e., life-or-death situations), people can develop extraordinary strength. When untrained subjects (but not superior athletes) receive hypnotic suggestions of increased

strength, they exhibit strength increases, whereas both athletes and untrained people show strength decrements after receiving the hypnotic suggestion of decreased strength. Such strength enhancement is interpreted to mean that in extraordinary situations, the central nervous system (CNS) either increases the flow of excitatory stimuli, decreases the inhibitory influence on the motor units, or both.

It may be that the activity of alpha motor neurons in the spinal cord is normally inhibited by the CNS and that it is not possible to activate all MUs within a specific muscle group. Under the influence of strength training and in exceptional circumstances (important sport competitions included), a reduction in neural inhibition occurs with a concomitant expansion of the recruitable alpha motor neuron pool and an increase in strength.

Intermuscular Coordination

Every exercise, even the simplest one, is a skilled act requiring the complex coordination of numerous muscle groups. The entire movement pattern, rather than the strength of single muscles or the movement of single joints, must be the primary training objective. Thus, an athlete should use isolated strength exercises, in which the movement is performed in a single joint, only as a supplement to the main training program.

Here are some examples of the primary importance of the entire coordination pattern (rather than the force of single muscles) for muscular strength.

- It is possible to induce hypertrophy and increase the maximal force of a single muscle, for instance the rectus femoris, or even a muscle group (e.g., knee extensors), through electrostimulation (EMS). However, if only EMS is used, it takes a great deal of time and effort to transmute this increased potential into a measurable strength gain in a multijoint movement such as a leg extension. Some athletes who try EMS decide that it is not worth the effort (see also chapter 6 on EMS). Strength gains attained through conventional voluntary training rely on changes in the nervous system that do not occur when muscles are stimulated electrically.

- The best weightlifters are the strongest people in the world, but they cannot perform some slow gymnastics exercises, which require only strength (e.g., the cross exercise on the rings). On the other hand, elite gymnasts do not exercise with free weights to increase the force of the shoulder girdle muscles. They do this with gymnastics exercises

using body weight as resistance (heavy ankle cuffs or waist belts are added from time to time).

- If an athlete simultaneously exerts maximal force with two extremities, the force for each extremity is lower than it is in unilateral force development. Training with bilateral contractions reduces the bilateral deficit. Athletes in sports such as rowing or weightlifting that require the simultaneous bilateral contraction of the same muscle groups should use similar exercises to eliminate bilateral deficits. (However, elite super-heavyweight lifters employ exercises such as stepping up on a bench with barbells 180 kg and heavier; they do this to avoid the extremely high loading that occurs during squatting exercises, in which the barbell weight can exceed 350 kg.)

In the case of the bottleneck effect, when low strength in one joint of a kinematic chain limits performance (e.g., knee extensor strength is the limiting factor in squatting), the coach should first try to change the exercise to redistribute the load among different muscle groups. Only after that is an isolated knee extension against resistance advisable.

The important limitation of many strength training machines is that they are designed to train muscles, not movement. Because of this, they are not the most important training tool for athletes.

Taxonomy of Strength

Let us review some facts from chapters 2 and 3:

1. Magnitudes of the maximal force F_m in slow movements do not differ greatly from those in isometric actions.
2. The greatest muscular forces are developed in eccentric actions; such forces are sometimes twice those developed in isometric conditions.
3. In concentric actions, the force F_m is reduced when the time to peak force T_m decreases or the velocity increases.
4. There are no substantial correlations between maximum maximum force (F_{mm}) and the force F_m in movements with minimal external resistance (note that body weight is not minimal resistance). The correlation is greater when the resistance is increased.
5. The rate of force development (especially the S-gradient) does not correlate with the maximal force F_{mm} .

6. The force in exercises with reversible muscle action does not change after heavy resistance training, regardless of the F_{mm} increase (this is true at least for experienced athletes).

In summary, the following general scheme can be proposed as a taxonomy of muscular strength:

Type of Strength	Manifestation
Static strength (or, simply, strength)	Isometric and slow concentric actions
Dynamic strength	Fast concentric actions
Yielding strength	Eccentric actions

Additionally, the explosive strength (or rate of force development) and the force exerted in stretch-shortening (reversible) muscle actions are considered independent components of motor function.

The summary classification scheme is certainly not completely satisfactory from a scientific point of view in that it uses different bases for categorization (direction of movement, velocity, time). Furthermore, in real life a smooth transition exists rather than a sharp demarcation between different types of strength. Despite these valid criticisms, this classification system has served as a useful tool in practical work for many years, and a better system does not exist at this time.

Summary

To understand what determines differences among athletes, we scrutinize two factors: peripheral factors (that is, capabilities of individual muscles) and central factors (the coordination of muscle activity by the CNS). Among peripheral factors, muscle dimensions seem to be the most important: Muscles with a large physiological cross-sectional area produce higher forces. The size of a muscle increases when (1) a properly planned strength training program is executed and (2) the required amount and selection of amino acids are provided via nutrition. The enlargement of the cross-sectional area of individual fibers (fiber hypertrophy) rather than an increase in the number of fibers (hyperplasia) is responsible for muscle size growth. Heavy resistance exercise activates the breakdown of muscle proteins, creating conditions for the enhanced synthesis of contractile proteins during rest periods. The mass of proteins catabolized during exercise exceeds the mass of newly synthesized protein. The crucial factor for increasing the protein breakdown is a

shortage in the muscle cell of energy available for protein buildup during heavy resistance exercise.

Since muscle mass constitutes a substantial part of the human body, athletes with larger body weight demonstrate greater strength than equally trained athletes of smaller body dimensions. The strength per kilogram of body weight is called *relative strength*; muscular strength, when not related to body weight, is *absolute strength*. Among equally trained athletes of various weight classes, absolute strength increases and relative strength decreases with a gain in body weight. Body weight loss, if properly managed, is helpful toward increasing relative force. However, athletes must be warned against the malpractice of rapid weight reduction.

Neural (central) factors include intramuscular and intermuscular coordination. On the level of intramuscular coordination, three main options are used by the CNS for varying muscle force production: recruitment of MUs, rate coding, and synchronization of MUs. These can be observed in well-trained athletes during maximal efforts. The

orderly recruitment of MUs is controlled by the size of alpha motor neurons (size principle): Small alpha motor neurons are recruited first and requirements for higher forces are met by the activation of the large alpha motor neurons that innervate fast MUs. It seems that the involvement of slow-twitch MUs is forced, regardless of the magnitude of muscle force and velocity being developed. The firing rate of the MUs rises with increased force production (rate coding). The maximal force is achieved when (1) a maximal number of MUs is recruited, (2) rate coding is optimal, and (3) MUs are activated synchronously over the short period of maximal effort.

The primary importance of intermuscular coordination for generating maximal muscular force is substantiated by many investigations. Thus, entire movement patterns rather than the strength of individual muscles or single-joint movements should be the primary training objective. Explosive strength (or rate of force development) and the force exerted in stretch-shortening (reversible) muscle actions are independent components of motor function.

PART II



CONCEPTS OF STRENGTH TRAINING

Part II summarizes the requisite knowledge for coaching successfully, concentrating on information derived both from scientific evidence and the documented practical experience of elite athletes. Chapter 4, which covers intensity and methods of strength training, begins with the description of measurement techniques. It also reviews current scientific material about exercising with different resistance, analyzing metabolic reactions, intramuscular coordination, and biomechanical variables. The chapter then scrutinizes the training intensity of elite athletes and presents data from some 35 years' worth of training logs of dozens of the best athletes in the world, including Olympic champions and world-record holders from Eastern Europe. Chapter 4 also outlines three main methods of strength training and discusses in detail the parallels between practical training and scientific lore.

Chapter 5 turns to timing during training, including short-term and medium-term timing. It covers the main problems of short-term planning; how to use strength exercises in workouts and training days as well as in micro- and mesocycles; and the four main aspects of periodization: delayed transformation, delayed transmutation, training residuals, and the superposition of training effects.

Chapter 6 pertains to the issue that coaches face first and foremost when they devise strength training programs: exercise selection. The chapter examines various strength exercises, and it also classifies exercises and presents a rationale for exercise selection. For experienced athletes, decisions are fairly complex, and among the exercise features they must consider are the following: working muscles, type of resistance, time and rate of force development, movement velocity, movement direction, and the force–posture relationship. Chapter 6 also describes the peak-contraction principle, accommodating resistance, and accentuation—the three basic techniques used in modern strength training to handle the force–posture paradigm.

A later section of chapter 6 concentrates on strength exercises that are regarded by many as supplementary, including isometric exercises, self-resistance exercises, and yielding exercises. We note that exercises with reversible muscular action, such as drop jumps, are becoming more popular. Meanwhile, the sport exercises that call for added resistance, which are often referred to as speed resisted, can now hardly be called auxiliary. In fact, some experts see the shift in the popularity of this group of exercises as the most visible trend in

training since the 1980s. Chapter 6 explains how to choose and use all these training techniques. It then reviews electrostimulation and vibration training as training techniques and ends by offering some practical advice on how to breathe while exercising.

Chapter 7 addresses how lifting velocity, both high and low, contributes to the training stimulus. Many often overlooked, underappreciated, or misunderstood aspects of the training stimulus are presented in this chapter along with the implications for the desired training effects. Understanding how a strength training program can use velocity training to impact the various capabilities across the force-velocity curve and the force-time curve is essential because many sport-related skills and actions related to performance take place across a wide spectrum of movement velocities, with some in less than a second.

Chapter 8 describes measures that may prevent injuries during strength training, especially to the lumbar region, and explains the underlying theory while presenting practical techniques. Several applied aspects are discussed, including muscle strengthening, sport technique requirements, use of protective implements, posture correction and flexibility development, and rehabilitation measures.

Chapter 9 dives into the complex topic of the effects of excessively stressful strength training programs that have too little recovery time. Although this is very difficult to study, this chapter examines training errors that contribute to this problem and the performance, physiological, and psychological maladaptations that can result. The concepts of

overreaching and overtraining are also examined. Given the many misconceptions about overtraining and its causes, it is vital to understand the current concepts of its progression. Understanding the different types of overtraining and overreaching conditions and how to prevent them is crucial in helping optimize the training environment at a time when many coaches and athletes often think more is better.

Of paramount importance to any strength training program is the ability to determine its effectiveness. Chapter 10 presents information on the rapidly evolving field of measuring performances in the weight room and includes suggestions on how to effectively put this information to use. This chapter also takes on one of the more critical aspects of strength training today: monitoring athletes. Through use of monitoring technologies, wearables, data acquisition software, and evaluations in real time, coaches and athletes can better assess the quality of workouts and understand workout demands and recovery. Such data are vital to coaches and athletes to enhance their performance through optimizing and individualizing workouts and avoiding overreaching and overtraining syndromes.

Chapter 11 explores goal-specific strength training and addresses how athletes and laypeople exercise for strength not only to improve performance but also for many other reasons, such as power performance, muscle mass gain, endurance performance, or injury prevention. The chapter also summarizes specific features of strength training.

TRAINING INTENSITY

In this chapter we turn to the topic of training intensity and focus on four major issues. First we consider several methods of measuring training intensity. Then we look at the physiological characteristics of exercises with varying intensities, particularly the influence of different strength exercises on metabolism and intra- and intermuscular coordination. The third issue is the training intensities of elite, world-class athletes—information that suggests which training patterns are the most efficient. The fourth section deals with the optimal training intensities determined from the comparative research. The final section outlines the theory underlying a described training pattern and presents the primary methods of strength training.

Measurement Techniques

Training intensity can be estimated in four different ways:

- Magnitude of resistance (e.g., weight lifted) expressed as a percentage of the best achievement (F_m or F_{mm}) in a relevant movement (if the weight lifted is expressed in kilograms, it is difficult to compare the training loads of athletes who vary in mastership and weight class)
- Number of repetitions (lifts) per set (a set is a group of repetitions performed consecutively)
- Number (or percentage) of repetitions with maximal resistance (weight)
- Workout density (i.e., number of sets per hour in a workout)

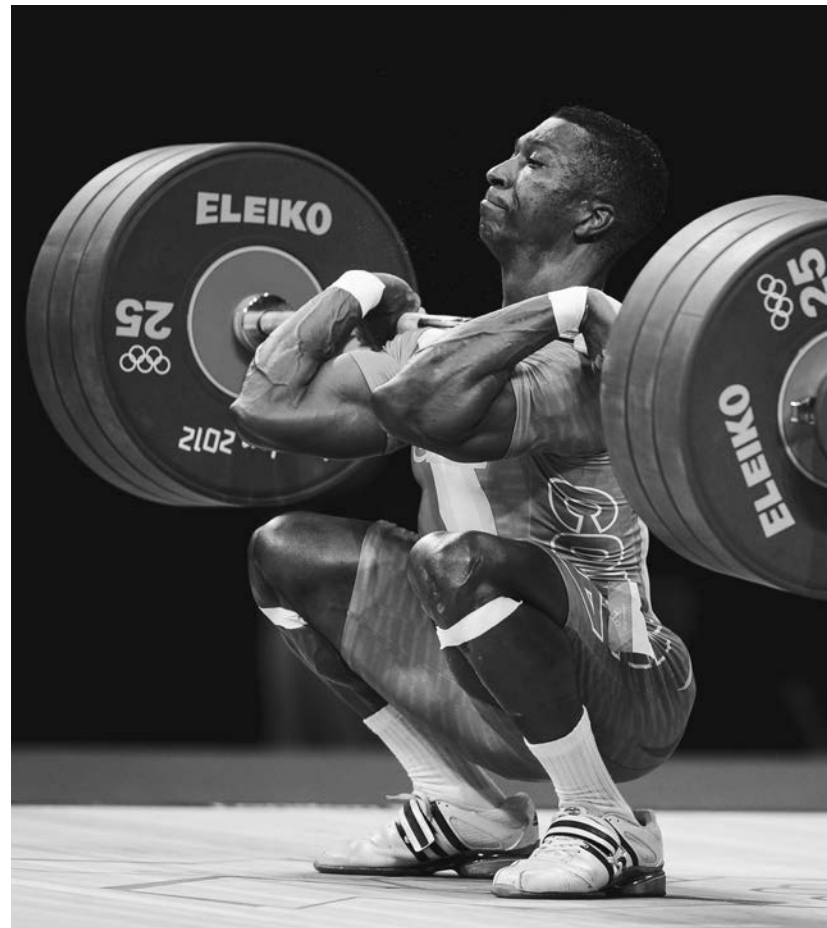

To characterize the magnitude of resistance (load), we use the percentage of weight lifted relative to the athlete's best performance. Depending on how the best achievement is determined, two main variants of such a measure may be used. One

option is to use the athletic performance attained during an official sport competition (competition $F_{mm} = CF_{mm}$), or the **maximum competition weight (CF_{mm})**. The second option is to use a **maximum training weight (TF_{mm})** for comparison.

By definition, maximum training weight is the heaviest weight (1-repetition maximum, or 1RM) an athlete can lift without substantial *emotional* stress. In practice, experienced athletes determine TF_{mm} by registering heart rate. If the heart rate increases before the lift, this is a sign of emotional anxiety. The weight exceeds TF_{mm} in this case. (Note, however, that heart rate elevation before lifting the maximal competition load CF_{mm} varies substantially among athletes. During important competitions, the range is between 120 and 180 beats per minute. To determine TF_{mm} , athletes must know their individual reactions.) The difference between the TF_{mm} and the CF_{mm} is approximately $12.5 \pm 2.5\%$ for superior weightlifters. The difference is greater for athletes in heavyweight classes. For athletes who lift 200 kg during competition, a 180-kg weight is typically above their TF_{mm} .

For an athlete, the difference between CF_{mm} and TF_{mm} is great. After an important competition, weightlifters are extremely tired even though they may have performed only 6 lifts, in comparison to nearly 100 lifts during a regular training session. Such athletes have a feeling of emptiness and cannot lift large weights. Thus they need about 1 wk of rest, during which they lift smaller weights, and cannot compete in an important competition until after 1 month (compare with the situation in other sports in which contests are held two to three times per week). The reason is not the physical load itself but the great emotional stress an athlete experiences while lifting CF_{mm} . TF_{mm} can be lifted at each training session.

It is more practical to use CF_{mm} than to use TF_{mm} for the calculation of training intensity. Since the 1960s, the average training intensity for elite athletes has been $75 \pm 2\%$.

In a sport such as weightlifting, the training intensity is characterized also by an **intensity coefficient (IC)**. This ratio is calculated as follows:

$$100(\text{Average weight lifted} / \text{Athletic performance}),$$

where Average weight lifted and Athletic performance are in kilograms, and Athletic performance is measured using the snatch plus the clean and jerk.

On average, the intensity coefficient for superior athletes has been $38 \pm 2\%$.

An appropriate CF_{mm} value to use is the average of two performances attained during official contests immediately before and after the period of training you are studying. For instance, if the performance was 100 kg during a competition in December and it was 110 kg in May, the average CF_{mm} for the period January through April was 105 kg. There are many misconceptions in sport science literature regarding the training loads used in heavy resistance training because the difference between CF_{mm} and TF_{mm} is not always completely described. It is important to pay attention to this difference.

The number of repetitions per set is the most popular measure of exercise intensity in situations in which maximal force F_{mm} is difficult or even impossible to evaluate, for instance in sit-ups.

The magnitude of resistance (weight, load) can be characterized by the ultimate number of repetitions possible in 1 set (to failure). The maximal load that can be lifted a given number of repetitions before fatigue is called **repetition maximum (RM)**. For instance, 3RM is the weight that can be lifted in a single set only three times. Determining RM entails the use of trial and error to find the greatest amount of weight a trainee can lift a designated number of times. RM is a very convenient measure of training intensity in heavy resistance training. However, there is no fixed relationship between the magnitude of the weight lifted (expressed as a percentage of the F_{mm} in relevant movement) and the number of repetitions to failure (RM). This relationship varies with different athletes and motions (figure 4.1). As the figure shows, 10RM corresponds to approximately 75% of F_{mm} . This is valid for athletes in sports where strength and explosive strength predominate (such as weightlifting, sprinting, jumping, and throwing). However, note that a given percentage of 1RM will not always correspond to the same number of repetitions to failure in the performance of different lifts.

During training, superior athletes use varying numbers of repetitions in different lifts. In the snatch and the clean and jerk, the typical number of repetitions ranges from 1 to 3, and the most common number is 2 (almost 60% of all sets are performed with 2 repetitions). In barbell squats, the range is from 2 to 7 lifts per set (more than 93% of all sets are performed in this range; see figure 4.2). You will find further examples and an explanation of these findings later on in this chapter. As a rule of thumb, no more than 10RM to 12RM should be used for muscular strength development; the exceptions to this are rare (e.g., sit-ups).

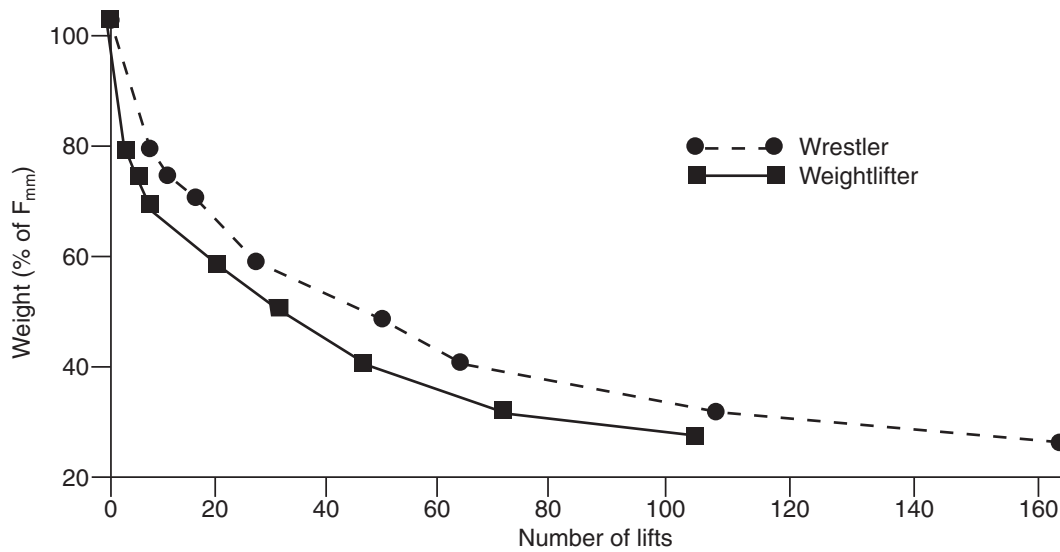

FIGURE 4.1 Dependence of the maximal number of repetitions to failure (RM, abscissa) on weight lifted (% of F_{mm} , ordinate). The results for two qualified athletes, a weightlifter and a wrestler, are shown for the bench press. The pace of lifts was 1 lift in 2.5 s. Both athletes were highly motivated.

Reprinted by permission from V.M. Zatsiorsky, N.G. Kulik, and Yu. I. Smirnov, "Relations Between the Motor Abilities," *Theory and Practice of Physical Culture*, Part 1, 31, no. 12 (1968): 35-48; Part 2, 32, no. 1 (1969): 2-8; Part 3, 32, no. 2 (1969): 28-33.

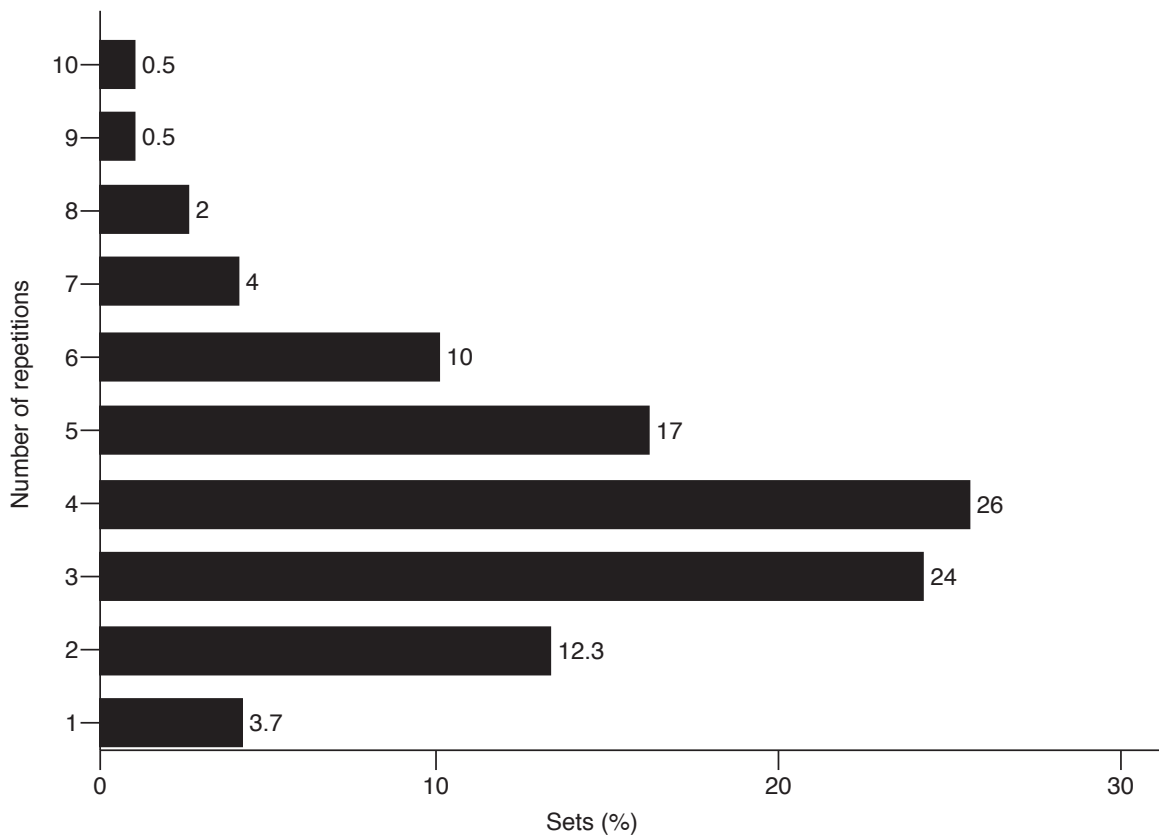

FIGURE 4.2 Number of repetitions per set in squatting with a barbell. (One year of observations in the training of eight world and Olympic champions in the clean and jerk.)

From *Preparation of the National Olympic Team in Weight Lifting to the 1988 Olympic Games in Seoul* (Moscow: Russian State Academy of Physical Education and Sport, 1989), 79. Technical report #1988-67. By permission of the Russian State Academy of Physical Education and Sport.

Determination of Training Intensity

A conditioning coach wants to prescribe a training intensity in barbell squats for two athletes, A and B. Athlete A is a competitive weightlifter from a lightweight class; athlete B is a football player. During a recent modeled competition, athlete A managed to lift a 150-kg barbell (his CF_{mm}). To prepare for the competition, athlete A excluded barbell squats from his training program for 10 days before the contest and had a complete 2-day rest. He considered the competition very important and psychologically prepared himself to set his best personal achievement in squatting. During the competition, athlete A performed squats in a fresh condition, immediately after a warm-up. Because of high emotional stress, his heart rate before the lifts was approximately 180 beats/min.

For this athlete, the maximal training weight must be around 135 kg—his TF_{mm} . To define this weight more precisely, the coach monitored the athlete's heart rate during rest intervals and found that before he lifted a 135-kg barbell his heart rate was not elevated. Therefore this weight did not elicit high emotional stress. The coach recommended that the athlete use the 135-kg weight as maximal load in the majority of training sessions during the next training cycle. This was exactly 90% of his maximal achievement attained during the competition.

Without experiencing emotional stress and using a special competition-like warm-up, athlete A was able to lift a 135-kg barbell one to two times in a set. Since the advice was to perform three to four squats in a set, athlete A exercised mainly with the 125- to 130-kg barbell. Periodically, he also used higher loads, including some greater than 135 kg. These lifts were counted and their numbers were used as an additional measure of training intensity.

Athlete B also squatted with a 150-kg barbell. But unlike athlete A, he did this during a regular session within his usual training routine. Additional rest before the test was not provided and no special measures were taken. For this athlete, the 150-kg achievement can be regarded as a maximum training weight (TF_{mm}). He can exercise with such a load regularly.

The number of repetitions with maximal resistance is an additional, very useful measure of the intensity of strength training. By definition, all lifts with a barbell above 90% of CF_{mm} are included in this category. These loads are above TF_{mm} for almost all athletes.

Exercising With Different Resistance

Different levels of resistance have different physiological effects. Varied resistance levels cause different metabolic reactions involving the breakdown and synthesis of proteins. The resistance level or intensity of exercise also influences intramuscular and intermuscular coordination.

Metabolic Reactions

According to the energetic hypothesis of muscle cell hypertrophy described in chapter 3, the crucial factor determining the balance between protein catabolism and anabolism is the amount of energy available for protein synthesis during exercise. If the

resistance is relatively small, the energy available in the muscle cell is conveyed for muscle action and, at the same time, for anabolism of muscle proteins. Thus, the energy supply satisfies both requirements. During heavy weightlifting, a larger amount of energy is provided to the contractile muscle elements and spent on muscular work. Energy transfer for the synthesis of proteins decreases, while the rate of protein breakdown (the amount of degraded protein per lift) increases. The rate of protein degradation is a function of the weight lifted: The heavier the weight, the higher the rate of protein degradation.

The total amount of degraded protein, however, is a function of both the rate of protein catabolism and the mechanical work performed (or the total weight lifted). Mechanical work is greater when resistance is moderate and several consecutive lifts are performed in 1 set. For instance, if an athlete presses a 100-kg barbell 1 time (this athlete's RM), the total weight lifted is also 100 kg. However, the same athlete should be able to lift a 75-kg barbell (to failure) about 10 times; here the total weight lifted equals 750 kg.

The mass of proteins catabolized during heavy resistance exercise can be presented as a product of the rate of protein breakdown and the number of lifts. If the resistance is very large (e.g., 1RM), the rate of protein breakdown is high but the number of repetitions is small. At the other extreme, if the resistance is small (50RM), the number of lifts and amount of mechanical work are great, but the rate of protein degradation is low. So the total amount of the degraded protein is small in both cases, but for different reasons (table 4.1).

An additional feature of such training, and an important one from a practical standpoint, is the very high training volume or total amount of weight lifted during a workout. This amount is up to five or six times greater than the amount lifted

during a conventional training routine. Athletes who train over a certain period of time in this manner (to gain body weight and induce muscle cell hypertrophy in order to compete in a heavier weight class) amass a training volume in one workout of over 20 to 30 tons and, in some cases, above 50 tons a day. Such volume hinders an athlete's capacity to perform other exercises during this period of training.

Intramuscular Coordination

Lifting maximal weight has a number of effects on motor units (MUs): A maximum number of MUs are activated, the fastest MUs are recruited, the discharge frequency of motoneurons is at its highest, and the activity of MUs is synchronous.

TABLE 4.1 Amount of Degraded Protein During Strength Training With Different Levels of Resistance

Resistance (RM)	Rate of protein degradation	Mechanical work (number of repetitions)	Total amount of degraded protein
1	High	Small	Small
5-10	Average	Average	Large
>25	Low	Large	Small

Exercising With Various Weights: Mechanical Work and Metabolic Response

An athlete whose best achievement in barbell squatting is 150 kg performs squats with 150-, 120-, and 90-kg barbells. His body weight is 77.5 kg and the weight of body parts above the knee joints is 70 kg (only this part of the body is lifted during squatting; the feet and shanks are almost motionless). Thus, the weights lifted (the barbell plus the body) are 220, 190, and 160 kg. The distance that the center of gravity is raised (the difference between the lowest and the highest position of the center of gravity) is 1 m. The athlete lifts the 150-kg barbell 1 repetition, the 120-kg barbell 10 repetitions, and the 90-kg barbell 25 repetitions. The mechanical work produced equals 220 kg·m for the heaviest barbell (220 kg multiplied by 1 rep and 1 m), 1,900 kg·m for the 120-kg barbell, and 4,000 kg·m for the lightest one (160 kg multiplied by 25 reps and 1 m). Exercising with a light barbell, the athlete produces mechanical work 18 times greater than with the heaviest.

The metabolic energy expenditures are many times larger during exercise with the light barbell. However, protein degradation is maximized when squats are performed with the 120-kg (average) barbell. During squatting with the 150-kg barbell, the intensity of protein catabolism (the amount of degraded proteins per repetition) is very high. This barbell, however, is lifted one time only. When the athlete executes the squats with the light (90-kg) barbell, the intensity of protein degradation is low. So the amount of degraded protein is low in spite of the huge value of mechanical work produced. Thus, the 120-kg load provides this particular athlete with the best combination of training intensity and volume (total load lifted).

This example illustrates what happens in a single set of lifts. Total metabolic stress from an exercise session also depends on the rest allowed between the sets (see chapter 6).

However, many athletes cannot recruit or activate some MUs to the optimal firing rate in spite of sincere efforts to develop maximal force. It is well known that high-threshold (fast) units possess a higher maximal discharge frequency. However, investigators have shown that, in untrained people during maximal voluntary contraction, many high-threshold MUs may exhibit a lower firing frequency than low-threshold MUs because the fast MUs are not fully activated even though the individual is attempting to attain maximal forces.

The “hidden potential” of a human muscle to develop higher forces can also be demonstrated by electrostimulation. During maximum voluntary contraction, the muscle is stimulated with electrical current. The stimulus induces an increase in force production above the maximal voluntary level. The ratio

$$100(\text{Force during electrostimulation} - \text{Maximal voluntary force}) / \text{Maximal voluntary force}$$

is called the **muscle strength deficit (MSD)**. The MSD typically falls in the range of 5% to 35%. The MSD is smaller for elite athletes; it is also smaller when a person is anxious or when only small muscles are activated. The very existence of the MSD indicates that human muscles typically have hidden reserves for maximal force production that are not used during voluntary efforts.

One objective of heavy resistance training is to teach an athlete to recruit all the necessary MUs at a firing rate that is optimal for producing a fused tetanus in each motor fiber. When submaximal weights are lifted, an intermediate number of MUs are activated; the fastest MUs are not recruited; the discharge frequency of the motoneurons is submaximal; and MU activity is asynchronous (see figure 3.10 on page 55). It is easy to see differences in intramuscular coordination between exercises

with maximal versus submaximal weightlifting. Accordingly, exercises with moderate resistance are not an effective means of training for strength development, particularly when improved intramuscular coordination is desired.

Many experts believe that, in the preparation of elite weightlifters, optimal intramuscular coordination is realized when weights equal to or above TF_{mm} are used in workouts. It is not mandatory from this standpoint to lift CF_{mm} during training sessions. Differences in the best performances attained during training sessions (i.e., TF_{mm}) and during important competition (i.e., CF_{mm}) are explained by psychological factors such as the level of arousal and by increased rest before a contest (recall the two-factor theory of training in chapter 1). Differences in coordination (intra- and intermuscular), however, are small and do not affect performance. Weights above TF_{mm} are used only sporadically in training (for approximately 3.5%-7.0% of all the lifts).

Biomechanical Variables and Intermuscular Coordination

When an athlete lifts maximal weights, movement velocity reaches its ultimate value and then remains nearly constant. Acceleration of the barbell varies near the zero level and the force is more or less equal to the weight of the object lifted.

In the lifting of moderate weights, there can be two variations. In figure 4.3a, efforts are maximally applied. Acceleration increases in the initial phase of the lift, then falls to zero and becomes negative in the second phase of the motion. At the beginning the force applied to the barbell is greater than the weight lifted and then decreases. The second part of the motion is partially fulfilled via the barbell's kinetic energy. In this type of lifting, muscular coordination differs from that used in the lifting of maximal or near-maximal weights. That is, mus-

What Happens When a Nonmaximal Load Is Lifted?

A person curls a 30-kg dumbbell, causing the following to occur: (1) the maximal number of MUs are recruited; (2) the fast MUs, which are also the strongest, are activated; (3) the discharge frequency of motoneurons is optimal; and (4) motoneuron activity is (maybe) synchronous.

However, when a 15-kg dumbbell is lifted, (1) only a portion of the total MUs are recruited, (2) the fastest (and strongest) MUs are not activated, (3) the frequency of neural stimulation is not optimal, and (4) MU activity is (surely) asynchronous.

Intramuscular coordination in the two activities is substantially different. Thus, lifting a 15-kg load cannot improve the intramuscular coordination required to overcome a 30-kg resistance.

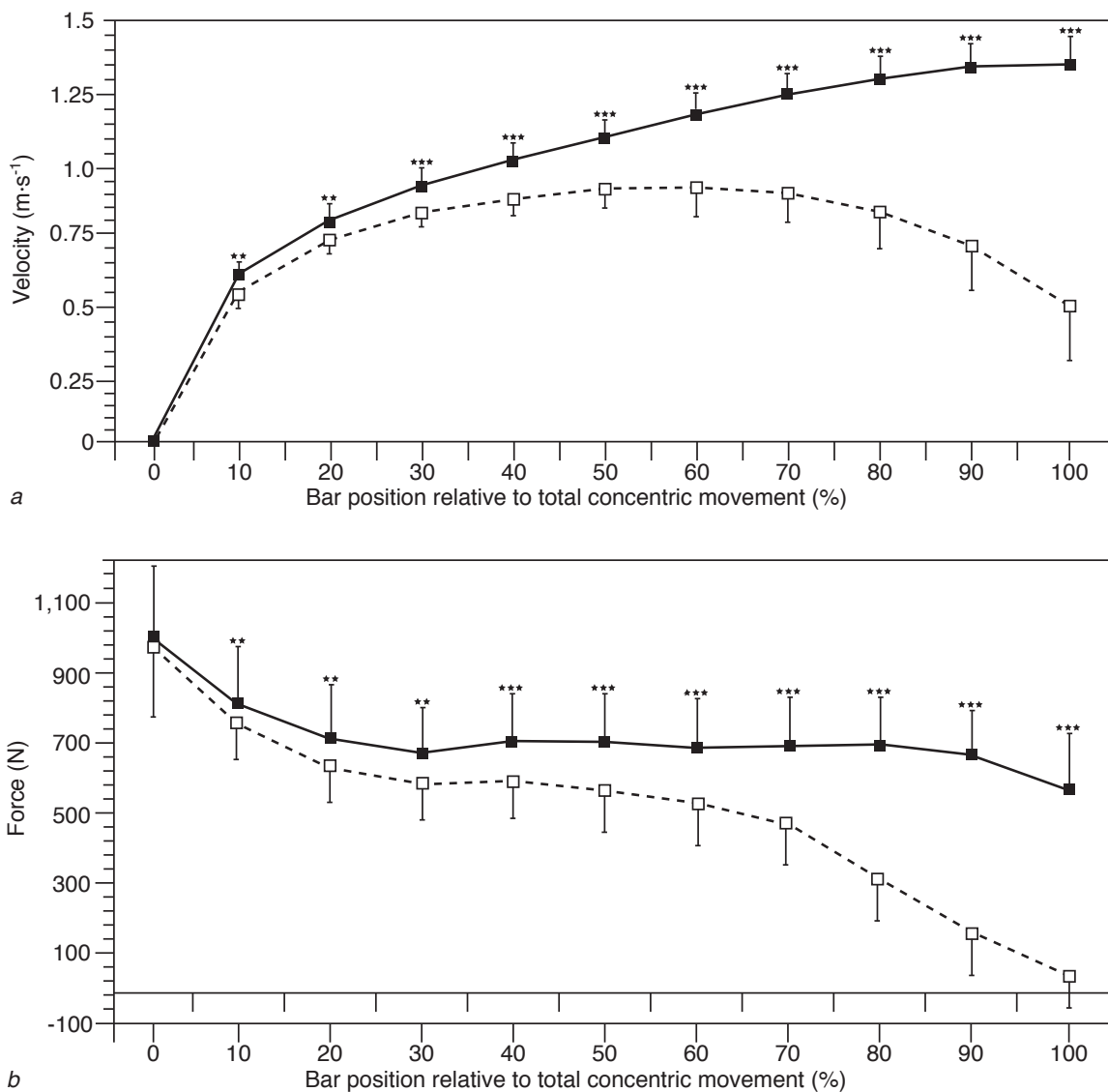

FIGURE 4.3 Bar velocity (a) and force exerted on the bar (b) during explosive bench press (dotted lines) and explosive bench throw (solid lines). Mean values and standard deviations (17 subjects); a bar weight is 45% of the individual 1RM. Stars indicate statistically significant differences between the press and throw values, ** $p < .01$; *** $p < .001$. In the final stages of the movement, the values of velocity and force during rapid press movements are smaller than during the throws. The same is valid for the level of muscle activity (not shown in the figure). The authors concluded that because during weightlifting the load must stop at the end of the lift, attempting to perform the lifts in an explosive manner while holding on to the bar with a light load will result in reduced velocity, force output, and muscle activation compared to the throw movements. The throws are also more specific to the explosive movements typically used in sport performance.

Reprinted by permission from R.U. Newton, W.J. Kraemer, K. Häkkinen, B.J. Humphries, and A.J. Murphy, "Kinematics, Kinetics, and Muscle Activation During Explosive Upper Body Movements," *Journal of Applied Biomechanics* 12, no. 1 (1996): 31-43.

cular efforts are concentrated (accentuated) only in the first half of the movement.

In the second instance (figure 4.3b), kinematic variables of the movement (velocity, acceleration) are similar to those observed when a person does a maximal lift. Acceleration, and the correspond-

ing external force applied to the barbell, is almost constant. However, this motion pattern—the intentionally slow lift—involves the coactivation of **antagonist muscle groups**. Such intermuscular coordination hampers the manifestation of maximum strength values.

Differences in underlying physiological mechanisms, experienced when exercising with various loads, explain why muscular strength increases only when exercises requiring high forces are used in training. In principle, workloads must be above those normally encountered. The resistance against which the muscle groups work must continually be increased as strength gains are made (this is called the principle of progressive resistance exercises).

In untrained individuals, the measured strength levels fall when resistance is below 20% of their F_{mm} . In athletes accustomed to great muscular efforts, this drop in strength can begin even with loads that are relatively heavy, but below their usual level. For instance, if qualified weightlifters train with weights of 60% to 85% TF_{mm} and do not lift these loads in 1 set to failure (to fatigue), the strength level is kept constant over the first month of such training and drops 5% to 7% during the second month. Athletes in seasonal sports, such as rowing, lose strength levels previously attained in the preseason training if they do not use high-resistance training during a season period, regardless of intense specific workouts.

Qualified athletes retain only muscle size, not muscular strength, when they use exclusively moderate (nonmaximal) resistances and moderate (nonmaximal) repetitions over a period of several months.

Training Intensity of Elite Athletes

The training experience of elite athletes is a useful source of information in sport science. This experience, although it does not provide sound scientific proof of the optimality of the training routines employed, reflects the most efficient training pattern known at the present time. In the future, gains in knowledge will certainly influence training protocols. Currently, however, we do not precisely know the best approaches.

The distribution of training weights in the conditioning of elite weightlifters is shown in figure 4.4. Notice that elite athletes use a broad spectrum of loads. They use loads below 60% of CF_{mm} mainly for warming up and restitution (these loads account for 8% of all the lifts). The highest proportion of weights lifted (35%) consist of those 70% to 80% of the CF_{mm} . In agreement with these data and as observed over many years, the average weight lifted by superior athletes is equal to $\pm 2.0\%$ of CF_{mm} . Loads above 90% of CF_{mm} account for only 7% of all lifts.

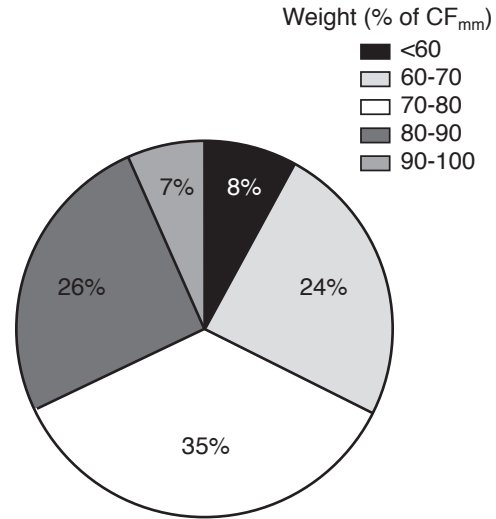

FIGURE 4.4 The distribution of weights lifted by members of the USSR Olympic team during preparation for the 1988 Olympic Games. The exercises were divided into two groups: snatch-related and clean-related. The weight lifted is expressed as a percentage of CF_{mm} in main sport exercises (either in snatch or clean and jerk). Squatting with the barbell is not included in this analysis. One year of direct observations.

Adapted from V.M. Zatsiorsky, *Training Load in Strength Training of Elite Athletes*, presented at Second IOC World Congress on Sport Sciences, October 1991, Barcelona.

The number of repetitions per set varies by exercise. In both the snatch and the clean and jerk lifts (figure 4.5), the majority of all sets are performed with 1 to 3 repetitions. In the snatch, only 1.8% of the sets are done with 4 or 5 repetitions; in the clean and jerk, the percentage of sets with 4 to 6 lifts is no more than 5.4%. The majority of sets, roughly 55% to 60%, consist of 2 repetitions.

In auxiliary strength exercises such as squatting with a barbell, where motor coordination only partially resembles the coordination in the snatch and the clean and jerk, the number of repetitions in 1 set increases. In barbell squats, for instance, the number of lifts varies from 1 to 10, with the average range being 3 to 6 (recall figure 4.2).

Generally speaking, as the intermuscular coordination in an exercise becomes simpler and as the technique of the exercise deviates from the technique of the main sport event (in this example, from the technique of both the snatch and the clean and jerk), the number of repetitions increases. In the clean and jerk, the number of repetitions is 1

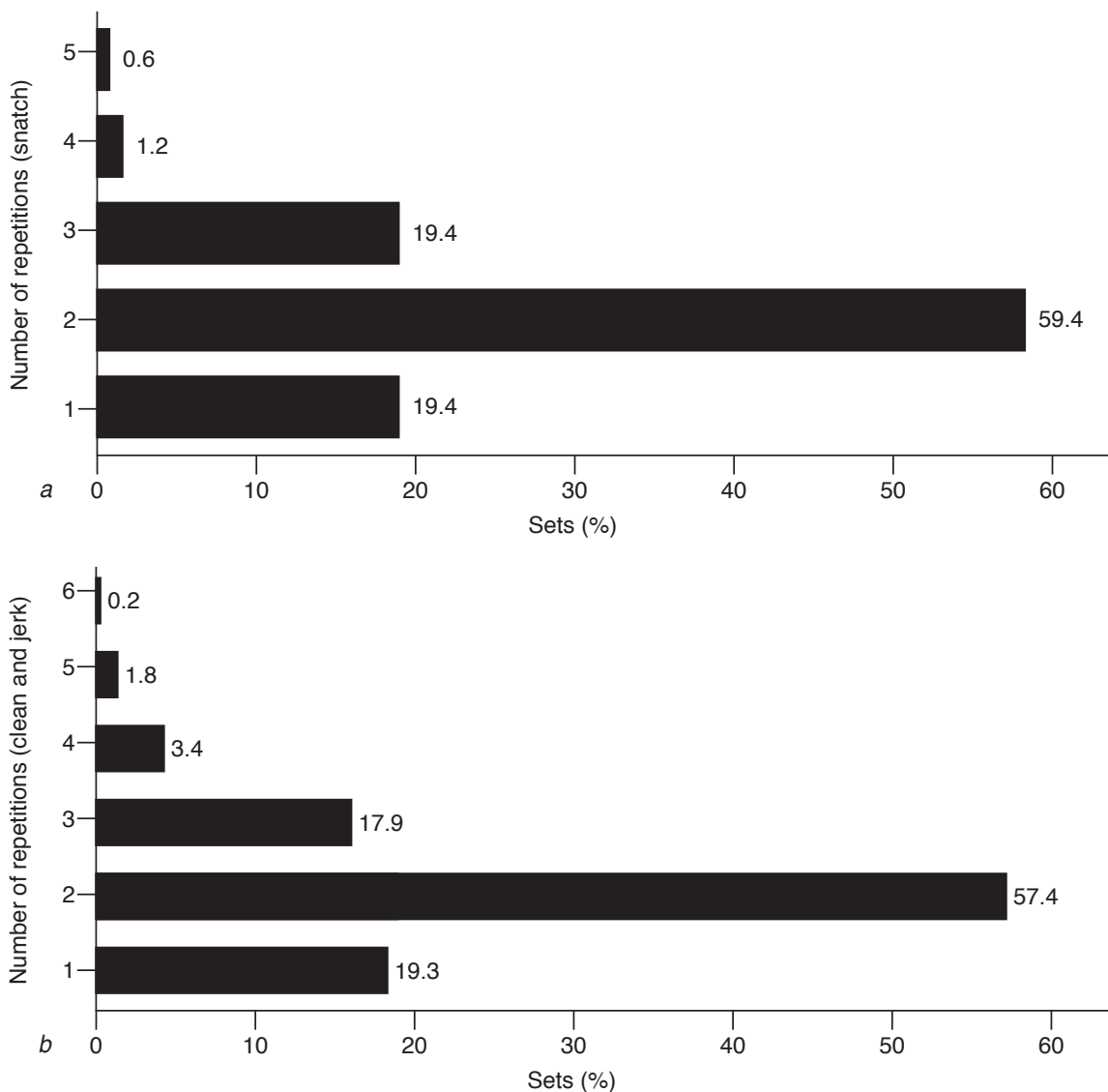

FIGURE 4.5 The percentage of sets with various numbers of lifts in (a) the snatch and (b) the clean and jerk in the training of superior athletes.

Adapted from V.M. Zatsiorsky, *Training Load in Strength Training of Elite Athletes*, presented at Second IOC World Congress on Sport Sciences, October 1991, Barcelona.

to 3 (57.4% of sets contain 2 lifts only); the typical number of repetitions in squatting is 3 to 5, and in the inverse curl the average number of lifts is around 5 to 7 per set (figure 4.6).

The number of repetitions with maximal resistance (near CF_{mm}) is relatively low. During the 1984 to 1988 Olympic training cycle, elite Soviet athletes lifted a barbell of such weight in main sport exercises (snatch, clean and jerk) 300 to 600 times per year. This amount comprised 1.5% to 3.0% of all performed lifts. The weights were further distributed as follows:

Weight of Barbell, % of CF_{mm}	Number of Lifts, %
90-92.5	65
92.6-97.5	20
97.6-100	15

In the 1-mo period before important competitions, weights above 90% of CF_{mm} are lifted in the snatch or clean and jerk, or a combination of the two, 40 to 60 times.

During the 1970s and 1980s, the Soviet and Bulgarian weightlifting teams won almost all gold

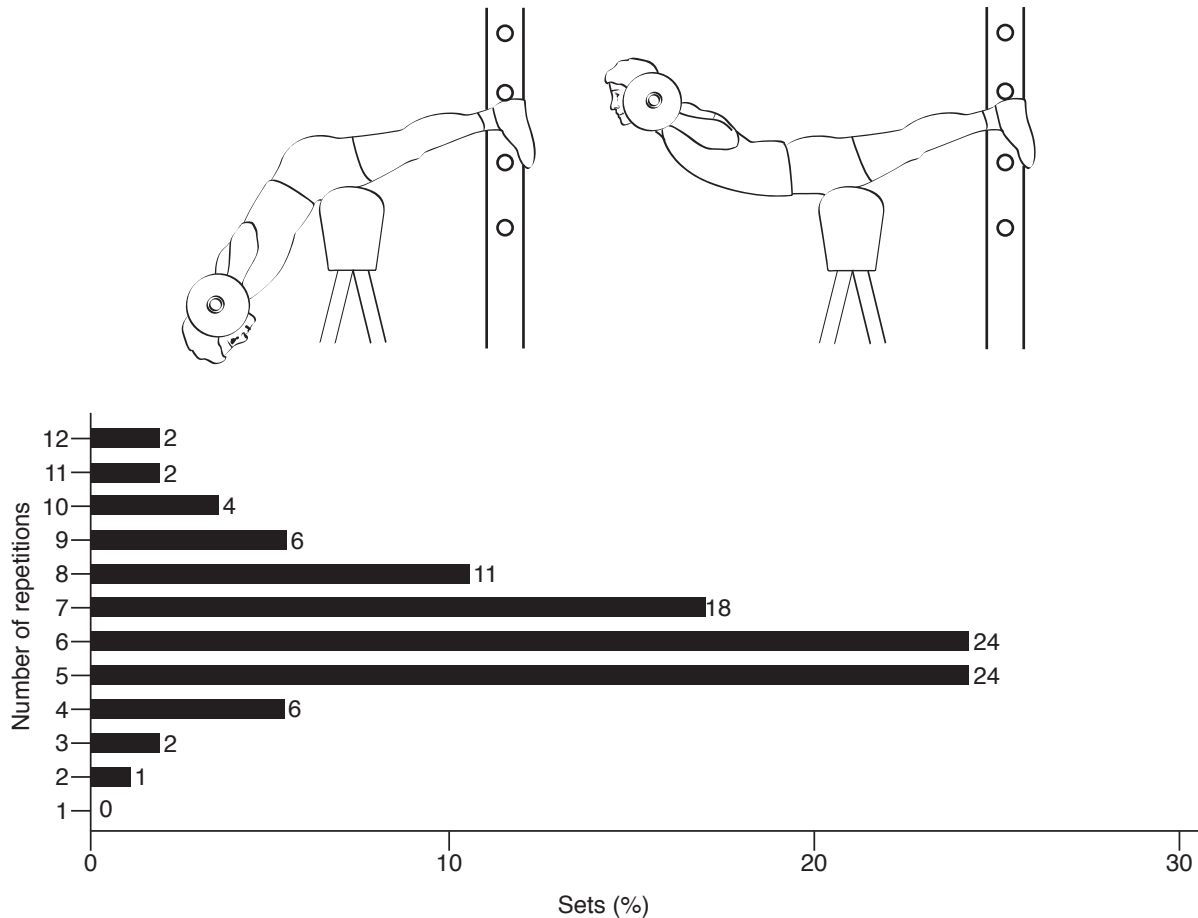

FIGURE 4.6 Inverse curl and the percentages of sets with different numbers of lifts in this exercise. Results of direct observations in the training of V. Alexeev, 1972 and 1976 Olympic champion in weightlifting (super-heavyweight category) in a total of 130 sets.

From *Preparation of the National Olympic Team in Weight Lifting to the 1980 Olympic Games in Moscow* (Moscow: Russian State Academy of Physical Education and Sport, 1981). Technical report #1981-34. By permission of the Russian State Academy of Physical Education and Sport.

medals at the world and Olympic competitions. It has often been reported that Bulgarian weightlifters lift barbells of maximal weight more than 4,000 times per year. The training intensity of Bulgarian athletes was actually higher than that for athletes of the former Soviet Union. However, the real source of such a huge discrepancy (600 versus 4,000 lifts per year) is not the training itself, but the method of determining maximal weight. In their plans and logs, athletes of the former Soviet Union used CF_{mm} , while Bulgarians stuck to the TF_{mm} designation (1RM in a given training session).

Optimal Training Intensities From Comparative Research

Elite athletes do not perform all drills at the same intensity. For instance, the exercise intensity in

main Olympic weightlifting exercises—the snatch and the clean and jerk—is much larger than in the inverse curl (see figures 4.5 and 4.6). Such a training pattern is difficult to model in experiments.

To determine optimal exercise intensity for strength training, researchers have conducted many experiments. The idea was to train athletes differently and at different RMs, and then determine the intensity that yielded on average the best performance improvement (the optimal intensity). Unfortunately, the results from different studies are difficult to compare, mainly because of the abundance of confounding factors such as differences among the subjects (gender, age, training experience) as well as among the training routines employed in various studies (number of sets, training frequency, trained muscle groups, exercises). Nevertheless, when the results of many studies are

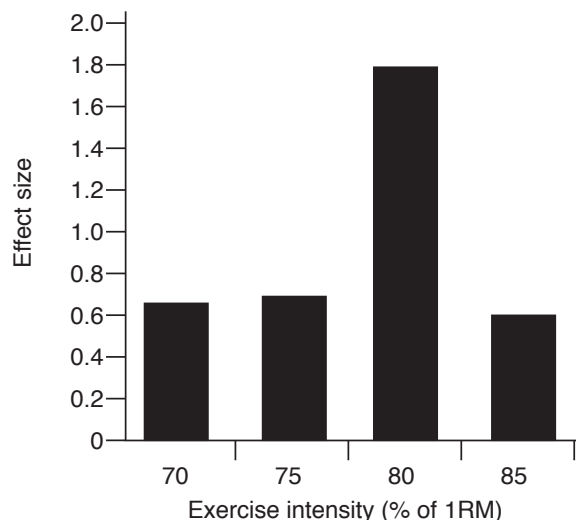

FIGURE 4.7 Performance improvement as a function of training intensity, average data. The effect size = (Post-training mean – Pretraining mean) / Pretraining standard deviation. The figure is based on the meta-analysis of 140 studies with a total of 1,433 effect sizes. Note that in each experimental group the subjects trained at the same intensity in all exercises while elite athletes use different intensities in different exercises.

Data from M.R. Rhea, B.A. Alvar, L.E. Burkett, and S.D. Ball, “A Meta-Analysis to Determine the Dose Response for Strength Development,” *Medicine & Science in Sports & Exercise* 35, no. 3 (2003): 456-464.

compared—such a quantitative analysis of the published data is called **meta-analysis**—it seems that for the athletes with more than 1 year of training experience the intensity of 80% of 1RM is close to optimal (see figure 4.7). Untrained individuals experienced maximal gains by training with an intensity of 60% of 1RM, 3 days per week, employing 4 sets per muscle group.

Returning to the training routines of elite athletes described previously, it should be noted that these repetition levels should not be mechanically copied. Rather, coaches and athletes need to understand the ideas underlying such training (the training conception) and, if they accept this conception, thoughtfully implement it. The training conception described in the ensuing text includes understanding specific features of different training methods, proper exercise selection, and timing of training.

Methods of Strength Training

It is useful to classify strength training according to methods of attaining maximal muscular tension. In the literature, methods of strength training are

sometimes classified according to the exercises used (i.e., isometric, isotonic, eccentric). We prefer to use this classification as a taxonomy of strength exercises rather than training methods. There are three ways to achieve maximal muscular tension:

1. Lifting a maximum load (exercising against maximal resistance)—that is, the **maximal effort method**
2. Lifting a nonmaximal load to failure; during the final repetitions the muscles develop the maximum force possible in a fatigued state—that is, the **repeated effort method**
3. Lifting (throwing) a nonmaximal load with the highest attainable speed—that is, the **dynamic effort method**

In addition, the lifting of nonmaximal loads an intermediate number of times (not to failure) is used as a supplementary training method (the **submaximal effort method**).

Maximal Effort Method

The method of maximal effort is considered superior for improving both intramuscular and intermuscular coordination; the muscles and central nervous system (CNS) adapt only to the load placed on them. This method should be used to bring forth the greatest strength increments. CNS inhibition, if it exists, is reduced with this approach; thus, the maximal number of MUs is activated with optimal discharge frequency and the biomechanical parameters of movement and intermuscular coordination are similar to the analogous values in a main sport exercise. A trainee then learns to enhance and memorize these changes in motor coordination (on a subconscious level).

We saw earlier that with this method the magnitude of resistance should be close to TF_{mm} . To avoid high emotional stress, CF_{mm} must be included only intermittently in the training routine. If the aim of a training drill is to train movement (i.e., both intramuscular and intermuscular coordination are the object of training), the recommended number of repetitions per set is 1 to 3. Exercises such as the snatch or the clean and jerk are examples (see figure 4.5 on page 69). When the training of muscles rather than movement training is the objective of the drill (i.e., the biomechanical parameters of the exercise and intermuscular coordination are not of primary importance since the drill is not specific and is different in technique from the main exercise),

the number of repetitions increases. One example is the inverse curl (figure 4.6 on page 70), where the typical number of repetitions is 4 to 8. The number of repetitions in squatting, on the other hand, usually falls in the range of 2 to 6 (figure 4.2 on page 63).

Although the method of maximum efforts is popular among superior athletes, it has several limitations and cannot be recommended for beginners. The primary limitation is the high risk of injury. Only after the proper technique for the exercise (e.g., barbell squat) is acquired and the relevant muscles (spinal erectors and abdomen) are adequately developed is it permissible to lift maximal weights. In some exercises, such as sit-ups, this method is rarely used. Another limitation is that maximum effort, when employed with a small number of repetitions (1 or 2), has relatively little ability to induce muscle hypertrophy. This is the case because only a minor amount of mechanical work is performed and the amount of degraded contractile proteins is in turn limited.

Finally, because of the high motivational level needed to lift maximal weights, athletes using this method can easily become burned out. The staleness syndrome is characterized by

- decreased vigor,
- elevated anxiety and depression,
- sensation of fatigue in the morning hours,
- increased perception of effort while lifting a fixed weight, and
- high blood pressure at rest.

This response is typical if CF_{mm} rather than TF_{mm} is used too frequently in workouts. Staleness depends not only on the weight lifted but also on the type of exercise used. It is easier to lift maximal

weights in the bench press (where the barbell can be simply fixed and where the leg and trunk muscles are not activated) than in the clean and jerk, where demands for the activation of leg and trunk muscles, and for balance and arousal, are much higher.

Submaximal Effort Method and Repeated Effort Method

Methods using submaximal versus repeated efforts differ only in the number of repetitions per set—intermediate in the first case and maximal (to failure) in the second. The stimulation of muscle hypertrophy is similar for the two methods. According to the energetic theory of muscle hypertrophy described in chapter 3, two factors are of primary importance for inducing a discrepancy in the amount of degraded and newly synthesized proteins. These are the rate of protein degradation and the total value of performed mechanical work. If the number of lifts is not maximal, mechanical work diminishes somewhat. However, if the amount of work is relatively close to maximal values (e.g., if 10 lifts are performed instead of the 12 maximum possible), then the difference is not really crucial. It may be compensated for in various ways, for instance by shortening time intervals between sequential sets. It is a common belief that the maximal number of repetitions in a set is desirable, but not necessary, to induce muscle hypertrophy.

The situation is different, though, if the main objective of a heavy resistance drill is to learn a proper muscle coordination pattern. The explanation is based on the size principle of MU recruitment and can be called the size principle theory of strength training. The theory has three main postulates:

1. Recruitment order of the MUs is determined by the size principle.

Strength Training Methods

An athlete's best performance in a front barbell squat is 100 kg. He is able to lift this weight one time only in a given set (1RM).

The athlete has the following variants from which to choose for strength training:

- Lift 100 kg (maximal effort method).
- Lift a load smaller than 100 kg, perhaps 75 kg, either a submaximal number of times (submaximal effort method) or to failure (repeated effort method).
- Lift (move) a submaximal load at maximal velocity, for example, jump for height with a heavy waist belt (dynamic effort method).

2. Only recruited MUs are trained.
3. The recruited MUs should experience fatigue (or at least, they should be highly activated, meaning the discharge frequency of their motoneurons should be sufficiently large).

We will explain the theory with an example. Suppose an athlete is lifting a 12RM barbell at a given rate of 1 lift per second. The muscle subjected to training consists of MUs having different endurance times from 1 to perhaps 100 s (in reality, some slow MUs have a much greater endurance time; they may be active for dozens of minutes without any sign of fatigue). The maximal number of lifts to fatigue among MUs varies, naturally, from 1 to 100. If the athlete lifts the barbell only 1 time, one division of the MUs is recruited and the second is not (see again figure 3.10 on page 55). According to the size principle, the slow, fatigue-resistant MUs are recruited first. After several lifts, some of the recruited MUs become fatigued. Obviously, MUs possessing the shortest endurance time become exhausted. After 10 repetitions, for instance, only MUs with an endurance time under 10 s are exhausted. Since the exhausted MUs cannot now develop the same tension as at the beginning, new MUs are recruited. These newly recruited high-threshold MUs are fast and nonresistant to fatigue; thus they become exhausted very quickly. If only 10 lifts of the 12 maximum possible are performed, the entire population of MUs is distributed into three divisions (figure 4.8).

1. *MUs that are recruited but not fatigued.* If they are not fatigued, they are not trained. All MUs having an endurance time above 10 s are in this category. It

is evident that this subpopulation consists of slow MUs. The slow MUs are recruited at a low level of the required force and thus are activated regularly during everyday activities. Nevertheless, without special training their force does not increase. The conclusion that seems warranted from this finding is that it is very difficult to increase the maximal force of slow, fatigue-resistant MUs. Thus, a positive correlation exists between strength enhancement and the percentage of fast-twitch muscle fibers. Individuals with a high percentage of fast MUs not only tend to be stronger but also gain strength faster as a result of strength training (figure 4.9).

2. *MUs that are recruited and fatigued.* These are the only MUs subjected to a training stimulus in this set. These MUs possess intermediate features. In this subpopulation, there are no slowest MUs (that are recruited but not fatigued) or fastest MUs (not recruited). The **corridor** of MUs subjected to a training stimulus may be relatively narrow or broad depending on the weight lifted and the number of repetitions in a set. One objective of a strength program can be to increase the subpopulation of MUs influenced by training, or to broaden the corridor.

3. *MUs that are not recruited.* Since they are not recruited they are not trained. Note that this subpopulation includes the fastest and strongest high-threshold MUs.

If the exercise is performed to failure or close to it (repeated effort method), the picture is changed in the final lifts. A maximal number of available MUs are now recruited. All recruited MUs are divided now into two subpopulations: exhausted (fatigued) and nonexhausted (nonfatigued). The training

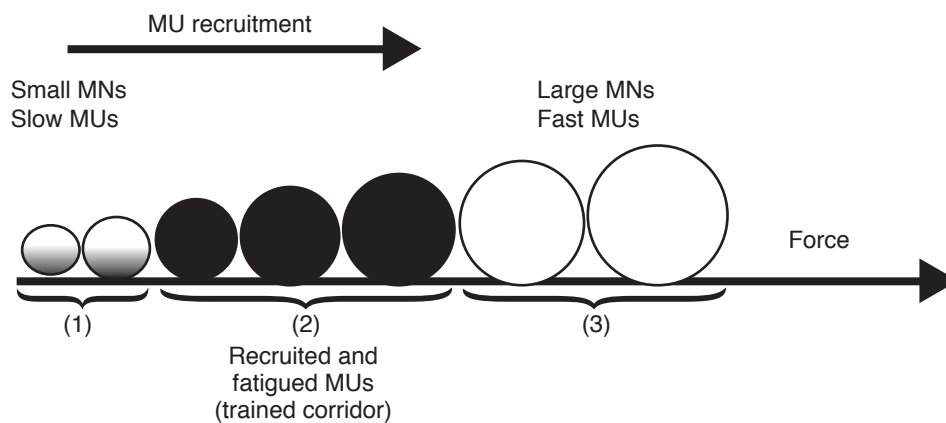

FIGURE 4.8 Subpopulations of motor units (MUs) utilized during strength exercises when nonmaximal weights are lifted. (1) MUs that are recruited but not fatigued. (2) MUs that are recruited and fatigued. (3) MUs that are not recruited.

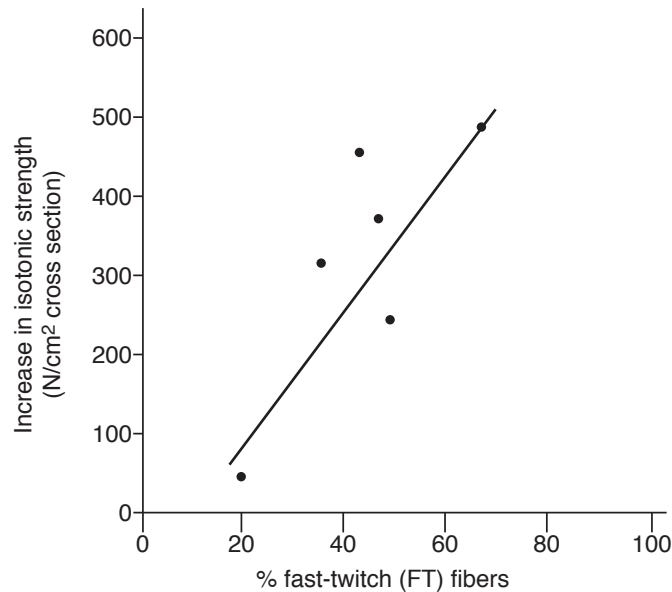

FIGURE 4.9 The increase in strength per unit of muscle cross-sectional area versus the percentage of fast-twitch muscle fiber distribution.

Reprinted by permission from B. Dons, K. Bollerup, F. Bonde-Petersen, and S. Hancke, "The Effect of Weight-Lifting Exercise Related to Muscle Fiber Composition and Muscle Cross-Sectional Area in Humans," *European Journal of Applied Physiology and Occupational Physiology* 40, no. 2 (1979): 95-106.

effect is substantial on the first group only. If the total number of repetitions is below 12, all MUs with endurance times above 12 s fall into the second group. In spite of their early recruitment, these MUs are not exhausted (because of their high endurance).

When maximal weights are lifted (maximal effort method), the MU corridor includes a smaller number of recruited and fatigued MUs (the all-black circles in figure 4.10) than when a submaximal weight is lifted a maximum number of repetitions.

Avoid Overexertion

Be competent and responsible for athlete health. Design effective, safe, and tolerable workouts and training progressions as you are legally responsible for the athletes under your care. As discussed previously in this book, using a muscle too much, too soon, or too often may induce **rhabdomyolysis**, a medical emergency that consists of the breakdown of muscle fibers resulting in the release of muscle fiber contents into circulation. Some of these contents are toxic and may result in kidney damage. The symptoms of rhabdomyolysis are abnormal urine color (dark, red, or cola colored), muscle pain, and weakness. People at risk include inexperienced exercisers, such as military recruits in basic training; dehydrated or heat-stressed performers; and individuals under severe exertion such as marathon or triathlon participants. In the medical literature, several cases of exertional rhabdomyolysis in experienced athletes have been reported. In some cases the overexertion was encouraged by personal trainers or strength coaches using it for punishment, or by head sport coaches issuing uninformed directives for increased work (e.g., 100 repetitions for sets of squats, high numbers of reps of hill running, or high volume short rest workouts). Such extreme overexertion is dangerous and should be avoided. It is also not indicative of a prudent, science-based program design, and is malpractice in the field. If rhabdomyolysis is suspected (e.g., if the urine is dark), medical diagnosis and treatment should be sought immediately. However, such a situation should not even arise if loading and progression plans are designed carefully, with special attention paid to transition periods in the yearly training cycle when athletes are not ready to jump into high-volume or high-intensity training sessions.

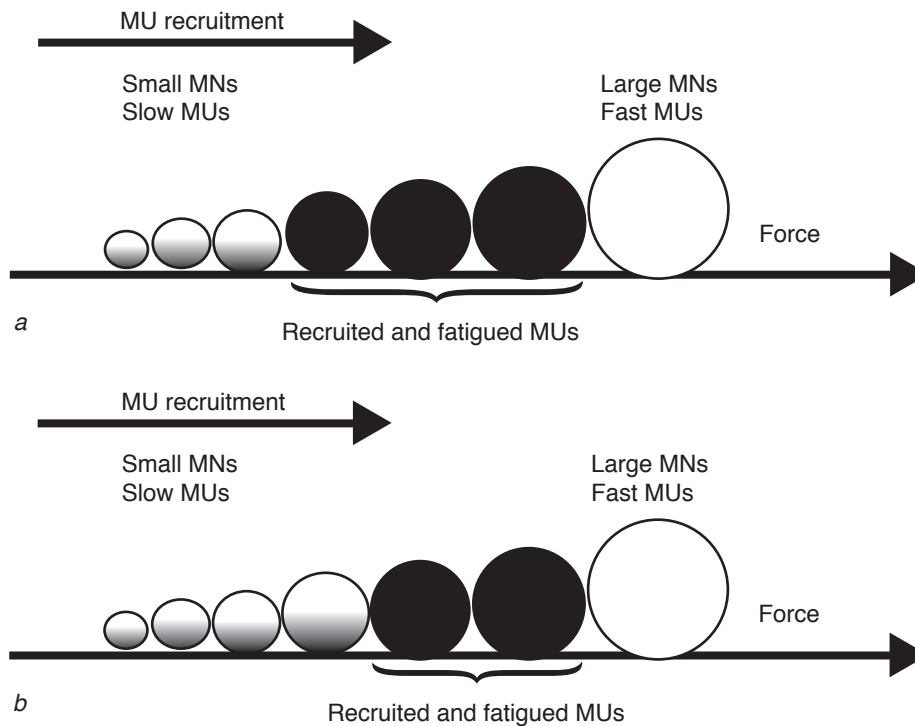

FIGURE 4.10 Subpopulations of motor units during the (a) repeated and (b) maximal effort methods. In both methods, almost all MUs are recruited (although, if you are not an elite strength athlete, it is likely that some fast MUs are still not activated), and fast MUs are primarily trained. On the contrary, some slow MUs are not trained or trained not much.

This is certainly a disadvantage for the method of maximal efforts. Only fast MUs are subjected to the training effect in this case. However, the advantages of the method outweigh any drawbacks.

When the repeated effort method or repetition maximum approach is used with a specific aim to train the MUs that are highest in recruitment order (i.e., those MUs that are innervated by the largest motoneurons; the strongest and fastest high-threshold MUs), the athlete should lift the weight with sincere exertions to failure (maximum number of times). This requirement is important. Quality is more important than quantity, or in other words, do not just “go through the motions.” If an athlete cannot perform a lift directed toward power of at least 90% of the previously demonstrated power capability, then the impact on power adaptations will be minimal and training time is wasted. The same approach exists for a high force or strength load. If an athlete can do 5 reps of squats with 220 kg on Monday, and then a week later can only do 2 reps, something is not right and training is being compromised for any strength gains. Using testing data and workout log data will indicate if quality sets are being accomplished with prescribed progression in loadings. Physiologically, the key is to

activate the targeted MUs with a training intensity or resistance to improve strength or power adaptations neuromuscularly. When training goals cannot be met, then the program must be carefully evaluated; overreaching syndrome or behavioral lifestyle problems must also be considered. Workout and program goal modifications may be needed if training problems persist, and a few recovery days should be included if pervasive issues continue throughout a number of workouts.

Compared to the maximal effort method, the repeated effort method, or repetition maximum approach, has its pros and cons. There are three important advantages to the repeated effort approach. It has a greater influence on muscle metabolism and consequently on the inducement of muscle hypertrophy. In addition, it involves a greater subpopulation of trained MUs (see figure 4.10) and poses a relatively low injury risk. This method also has limitations. The final lifts in a set are executed when the muscles are tired; thus, this training is less effective than lifting with maximal weights. Moreover, the very large training volume (the total amount of weight lifted) restricts the application of this method in the training of qualified athletes. Note, however, that the large amount of mechanical

work performed can be considered an advantage if the objective of the exercise is general health and fitness rather than specific strength enhancement.

All the methods described are, and should be, used together in the strength training of qualified athletes. Different training periodization approaches have been proposed to utilize this multi-loading or resistance programming over time. Many have attempted to answer the question: What kind of training is more effective—lifting of maximal or intermediate weights? This is similar to the question of whether 800-m runners should run in training distances shorter or longer than 800 m. They should run both. The same holds true for athletes training strength: They should employ exercises with different RMs. Training the full spectrum of the motor units in a muscle is achieved by using a wide array of resistance loads (size principle).

Dynamic Effort Method

Because of the existence of the explosive strength deficit (see chapter 2), it is impossible to attain F_{mm} in fast movements against intermediate resistance. Therefore the method of dynamic effort is used not for increasing maximal strength but only to improve the rate of force development and explosive strength.

In conclusion, a combination of these methods can increase the maximum strength F_{mm} :

Method	Immediate purpose
Maximal efforts (use repeated efforts as a second choice)	Improve neuromuscular coordination <ul style="list-style-type: none"> • MU recruitment • Rate coding • MU synchronization • Coordination pattern
Repeated efforts (and submaximal efforts or both)	Stimulate muscle hypertrophy
Repeated efforts	Increase the corridor of recruited and trained MUs

Summary

Training intensity can be estimated by the

- magnitude of resistance (i.e., weight lifted) expressed as a percentage of the best achievement attained during a competition (CF_{mm}) or in training (TF_{mm});

- the number of repetitions (lifts) per set; and
- the number (or percentage) of repetitions with maximal resistance (weight).

Exercising at varying levels of resistance causes differences in (1) metabolic reactions, (2) intramuscular coordination, and (3) biomechanical variables and intermuscular coordination. The produced mechanical work as well as the metabolic energy expenditures increase as the weight lifted decreases.

According to the energetic theory of muscle hypertrophy, the rate of protein degradation is a function of the weight lifted: The heavier the weight, the higher the rate of protein degradation. The total amount of degraded protein, however, is the function of both the mechanical work performed (or the total weight lifted) and the rate of protein catabolism. The mass of proteins catabolized during heavy resistance exercise is a product of the rate of protein breakdown and the number of lifts. The mass is maximized when training intensity is between 5RM to 6RM and 10RM to 12RM.

The physiological size principle of MU recruitment serves as a background of the size principle theory of strength training. The theory is based on three main postulates: (1) The size principle is valid, (2) only recruited MUs are trained, and (3) to be trained, the recruited MUs should experience fatigue (or at least, they should be highly activated, meaning the discharge frequency of their motoneurons should be sufficiently large). When an athlete lifts maximal weight, a maximum number of MUs are activated; the fastest MUs are recruited; the discharge frequency of motoneurons is at its highest; and MU activity is synchronous. One objective of heavy resistance training is to teach an athlete to recruit all the necessary MUs at a firing rate that is optimal for producing a fused tetanus in each motor fiber.

Elite weightlifters use a broad spectrum of loads, but the largest proportion of weights lifted is composed of those 70% to 80% of the CF_{mm} . The average weight these athletes lift is $75.0 \pm 2.0\%$ of CF_{mm} . These repetition levels should not be mechanically copied, but rather, thoughtfully implemented.

Strength training can be accomplished in three ways: (1) lifting a maximum load (exercising against maximal resistance)—the maximal effort method; (2) lifting a nonmaximal (but sufficiently large) load to fatigue, with the muscles developing the maximum force possible in a fatigued state during the final repetitions—the repeated effort method;

and (3) lifting (or throwing) a nonmaximal load with the highest attainable speed—the dynamic effort method. In addition, the lifting of nonmaximal loads an intermediate number of times (not to failure) is used as a supplementary training method (the submaximal effort method).

The maximal effort approach is considered superior for improving both intramuscular and intermuscular coordination: The maximal number of MUs is activated with optimal discharge frequency. When you use this training method, the magnitude of resistance should be close to TF_{mm} . If the aim of a training drill is to train movement, the recommended number of repetitions per set is 1 to 3. When the aim is to train muscles, on the other hand, the number of repetitions increases. The maximal effort method, while popular among superior athletes, has several limitations (i.e., high risk of injury, staleness). It also has a relatively small potential to stimulate muscle hypertrophy.

The submaximal effort and the repeated effort methods are similar in their ability to induce muscle hypertrophy. They are, however, rather different with respect to training muscular strength, especially improving the neuromuscular coordination required for maximal force production. The submaximal effort method (the lifting of nonmaximal loads, but not to failure) does not seem to be effective for training MUs that are highest in the recruitment order and improving specific intramuscular coordination. When the repeated effort method is used to train high-threshold MUs (i.e., those MUs that are innervated by the largest motoneurons; the strongest and fastest MUs), the athlete should lift the weight with sincere exertions to failure (maximum number of times). Only final lifts, in which a maximal number of MUs are recruited, are actually useful in this case.

This page intentionally left blank

TIMING IN STRENGTH TRAINING

The distribution of exercises and a training load over certain time periods, or the **timing of training**, is a matter of primary importance for the outcome of an athlete's preparation. Two main challenges in this area are how to space work and rest intervals and how to sequence exercises.

Structural Units of Training

Training can be divided into structural units. It is customary to identify these structural units as training session (workout), training day, microcycle, mesocycle, macrocycle, Olympic cycle (quadrennial cycle), and long-lasting, or multiyear, training.

The **training session (workout)** is generally viewed as a lesson comprising rest periods not longer than 30 min. The reason for such a definition, which initially appears too formal, is the need to describe training in sports in which a daily portion of exercises is distributed among several workouts. An example of such a training routine is given in table 5.1. According to the definition, these athletes have only two workouts per day because training drills separated by 30-min rest intervals are considered part of one training session. This all-day schedule is a good example of the training day of world-class athletes. One renowned athlete once joked, "My life is very rich and diversified. It consists of five parts—training, competitions, flights, sleep, and meals." This is very close to reality.

To appraise the training load of different workouts, the time needed to recover from one training session is used, according to the following classification:

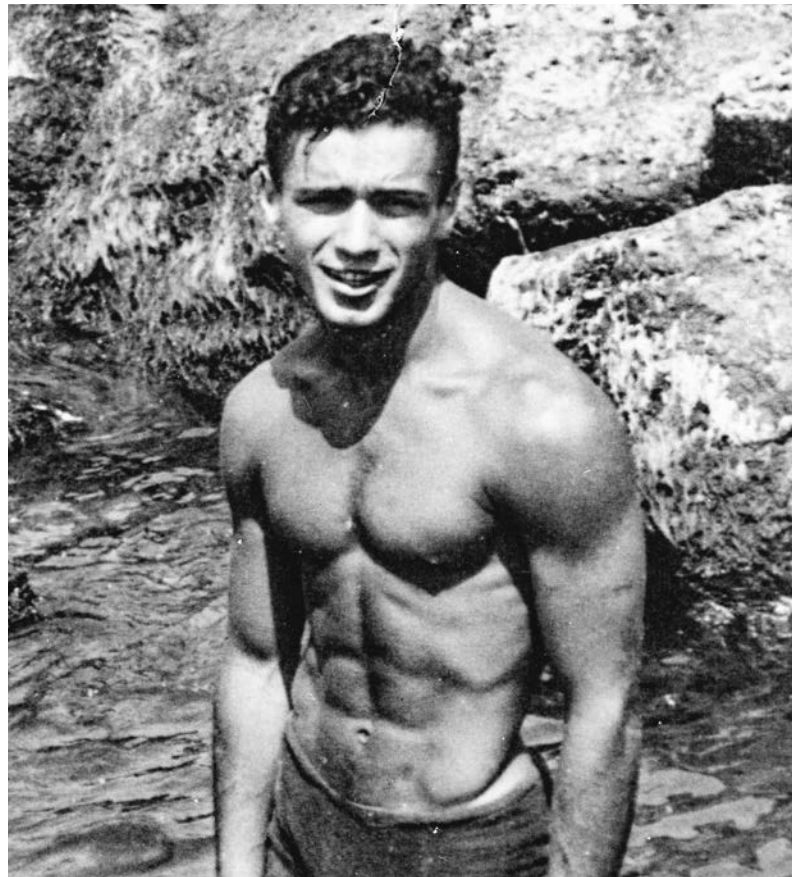

Training Load of One Workout

Training Load of One Workout	Restoration Time (h)
Extreme	72
Large	48-72
Substantial	24-48
Medium	12-24
Small	<12

TABLE 5.1 Everyday Training Schedule of the Bulgarian Olympic Weightlifting Team

Time	Mon, Wed, Fri	Tues, Thurs, Sat
9:00-10:00	Snatch	Snatch
10:00-10:30	Rest	Rest
10:30-11:30	Clean and jerk	Clean and jerk
11:30-12:30	Exercise	Exercise
12:30-1:00	Rest	Exercise
1:00-5:00	Rest	Rest
5:00-5:30	Exercise	Exercise
5:30-6:00	Exercise	Rest
6:00-6:30	Rest	Exercise
6:30-8:30	Exercise	Rest
Total exercise time	6 h	4.5 h

A **microcycle**, the third category, is the grouping of several training days. The run of a microcycle in the preparation period is usually 1 wk. In the competition period, the length of a microcycle is typically adjusted to the duration of the main competition. For instance, if a competition in wrestling lasts 3 days, it is advisable to employ microcycles of the same duration. Usually, a general framework of microcycles is routinely reproduced over a relatively long period of time (that is why it is called a cycle).

A **mesocycle** is a system of several microcycles. Typically, the duration is 4 wk with a possible range of 2 to 6 wk. The duration and even the existence of mesocycles in the training of Eastern European athletes were influenced by the practice of centralized preparation. The best athletes were once prepared in training camps throughout the year, mainly for logistical reasons; shortages in food and other important goods at home made it impossible to create normal training conditions. Such training management has its pros and cons, however. The enhanced competitiveness and increased possibilities for obtaining and sharing information are positive features. On the other hand, the standard environment, life without one's family, and the necessity of living and communicating with a single group of people, who are often rivals in the same sport, impose additional psychological burdens on the athlete. To reduce this psychological stress

and to diversify the environment, training camp locations were regularly changed. Interviews of the athletes showed that they preferred 4-wk training camps interspersed with 1- or 2-wk visits home.

There is no reason to reproduce this pattern in the West in full; however, some elements of the described training timing, mesocycles included, are undoubtedly useful. Mesocycles may be classified according to the objective of training as accumulative, transmutative, and realizational. The aim of **accumulative mesocycles** is to enhance the athlete's potential, that is, to improve basic motor abilities (conditioning) as well as sport technique (motor learning). The outcome of an accumulative mesocycle is evaluated on the basis of tests (e.g., measures of strength or aerobic capacity), the athlete's performance in auxiliary exercises, and the quality of technical skill. In these mesocycles, various exercises, including nonspecific ones, may be used for conditioning.

The **transmutative mesocycles** are employed to transform the increased nonspecific fitness into specific athlete preparedness, a process known as **transmutation**. Throughout this period, specific exercises are mainly used for conditioning and polishing sport technique. The performance during unofficial or nonimportant contests is used primarily to estimate training progress. The **realizational mesocycles**, also known as **precompetitive mesocycles**, are planned to put on the best sport performance attainable within a given range of fitness. Performance during an important competition is the only measure of success or failure during this period.

At the next structural level, **macrocycle** refers to one entire competition season and includes preseason, in-season, and postseason periods. In Europe these periods are commonly called the **preparation, competition, and transition periods**. Each **period of training** consists of several mesocycles. The typical duration of a macrocycle is a year (for winter sports) or half a year (for track and field events in which both indoor and outdoor competitions are held). In wrestling and swimming, there are three macrocycles in a year. The organization of training programs into macrocycles and periods of training is called **periodization**. Additional long-range views are helpful as well.

The **Olympic cycle** is quadrennial, 4 years in length, from one Olympic Games to another. And **long-standing, or multiyear, training** embraces the career of the athlete, from beginning to end.

Planning workouts, training days, microcycles, and mesocycles comprises **short-term planning**.

Planning macrocycles is **medium-term planning**. **Long-term planning** deals with training intervals of many years.

Short-Term Planning

In short-term planning, the effects of fatigue are the primary influencing factor. For instance, a training session should be designed so that exercises (such as strength, speed, or technique exercises) directed toward improving fine motor coordination (central factors), rather than peripheral factors, are performed in a fresh, nonfatigued state, preferably immediately after warm-up. In endurance sports, however, when the aim is to improve velocity at the completion of a distance rather than the maximal speed attainable in a fresh state, speed exercises may be performed after endurance work.

Paradigm of Timing Short-Term Training

A general principle of short-term training design is that fatigue effects from different types of muscular work are specific. This means that an athlete who is too tired to repeat the same exercise in an acceptable manner may still be able to perform another exercise to satisfaction. Changing or sequencing a drill appropriately makes it possible to assign more labor and to suitably increase the training load. For instance, if a trainee performs a leg exercise, such as squatting, and an arm exercise, such as the bench press, the total number of lifts will be greater when the exercise sequence is bench press, squatting, bench press, squatting, and so on than when the

sequence is squatting, squatting, bench press, bench press. The same principle is valid for exercises of different directions, for instance, strength and sprint exercises. The fatigue effect from a heavy resistance exercise routine primarily affects the possibility of performing or repeating an exercise of this type. Thus, one's ability to execute drills of another type is restored more quickly than one's ability to repeat the same routine (figure 5.1).

You will find that if two similar training workouts are executed in a row, the traces of fatigue from the two sessions are **superposed** (figure 5.2). If the training load is large (i.e., the restoration time takes from 48-72 h), several training sessions of this type performed sequentially may lead to severe exhaustion of the athlete.

If exercises with different targets could be trained all the time, it would be easy to distribute these exercises among training sessions to avoid the superimposition of fatigue traces. However, fitness gain decreases if several motor abilities are trained simultaneously during one workout, microcycle, or mesocycle. Therefore, it is not a good idea to have more than two or three main targets in one micro- or mesocycle. For instance, there is no reason to train, in one microcycle, maximal strength, explosive strength, aerobic capacity, anaerobic lactic acid and alactic acid capacities, maximal speed, flexibility, and sport technique. The organism cannot adapt to so many different requirements at the same time. The gains in all these motor abilities would be insignificant compared with the gain from development of only one physical quality. When the training

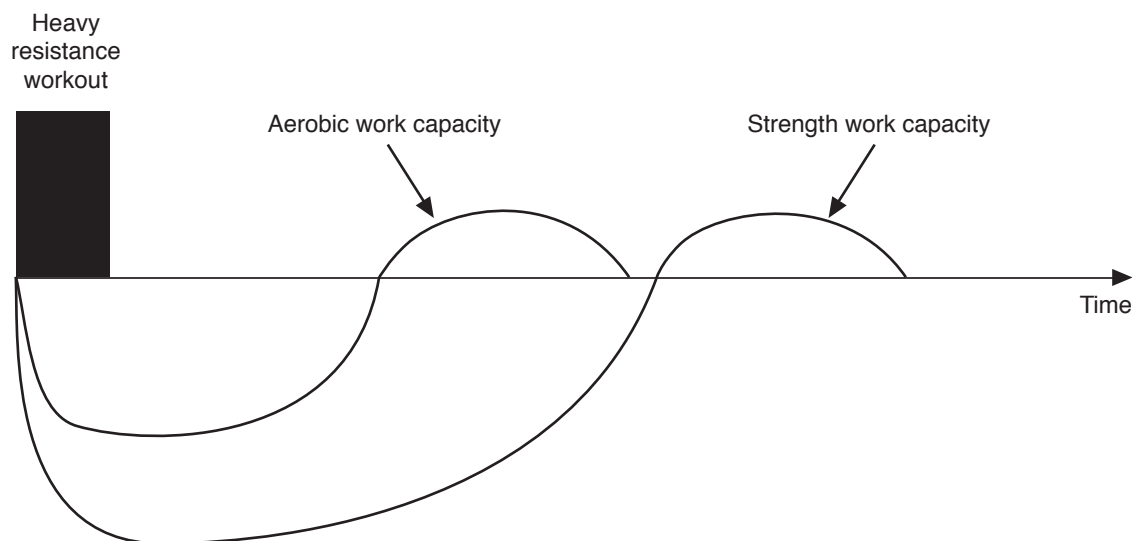

FIGURE 5.1 The time course of athlete restoration after a heavy resistance training session.

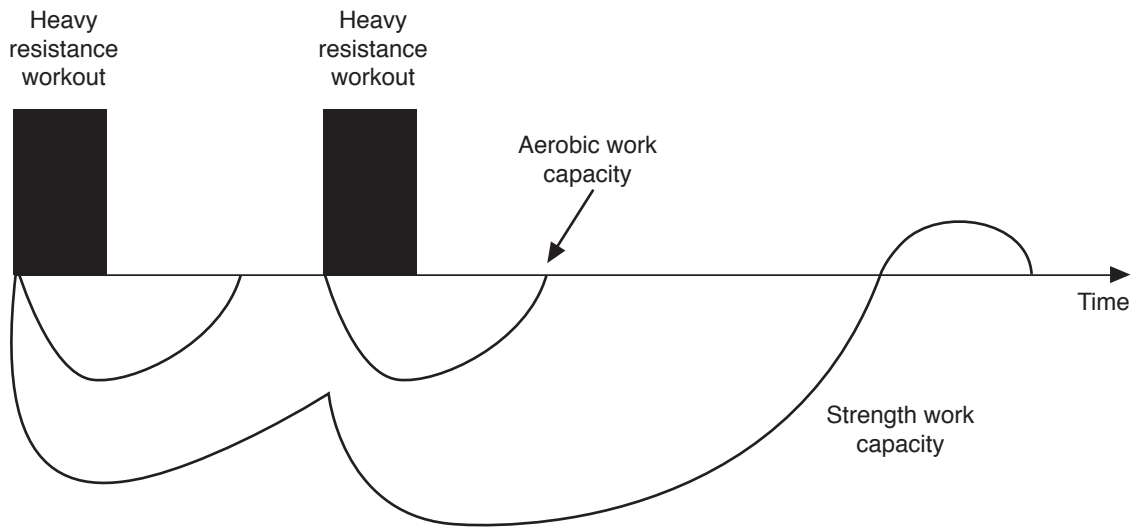

FIGURE 5.2 The superposition of two resistance workouts and their effects.

targets are distributed over several mesocycles in sequence, the fitness gain increases. Clearly, a conflict exists between the tendency to decrease the number of training targets and the tendency to increase the range of targets in a training program.

To enhance performance growth, coaches or athletes decrease the number of targets in micro- and mesocycles—in other words, they use specialty programs. In contrast, they increase this number, using combined programs, in order to have more freedom in planning the training schedule to avoid the superimposition of fatigue traces from individual workouts and the hazard of staleness.

Similar contradictions are, in general, typical for the planning of various training programs. The problem is to find a proper balance between the conflicting demands. Some world-class athletes have found that two is the optimal number of motor abilities or targets that can be improved in one mesocycle. In addition, only one essential feature of sport technique (such as tolerance to fatigue, stability) can be trained within this interval. Up to 70% to 80% of total work within the mesocycle should be addressed to the development of the targeted motor abilities (about 35%-40% per target).

Workouts and Training Days

The general idea in planning strength training sessions is to have the athlete do as much work as possible while being as fresh as possible. Unlike the situation for endurance training, it is not necessary for the athlete to become exhausted in a heavy resistance workout (do not confuse this with

exercise set). Strength gains are greater if trainees exercise when they are not tired. This is especially true when the target of the resistance exercise is neural coordination, both intra- and intermuscular. Broadly speaking, a trainee should “learn” to either decrease inhibitory output or enhance excitatory output from the central nervous system (CNS) while exercising and thereby gain strength. This learning is more successful if the trainee is fully recovered from previous activity, not fatigued. To have athletes exercise while they are as fresh as possible, the training workouts should be carefully planned.

The timing of workouts has three facets: rest-exercise alternation, exercise sequence, and intensity variation.

Rest-Exercise Alternation

In general, large interbout rest intervals are usually employed in heavy resistance training aimed at increasing muscular strength.

The total number of sets per day has not changed in the preparation of elite weightlifters over the last 50 years (most average 32-45 sets, but some athletes manage 50-52). However, the duration of a workout has changed; in 1955 to 1956 it was only 2 to 2.5 h, and in 1963 to 1964 it was 3 to 3.5 h (one training workout per day was used). Since 1970, two or more training sessions a day have been the rule, with the same number of sets distributed among them.

Both sport practice and scientific investigations have demonstrated that distribution of the training volume into smaller units produces effective adap-

tation stimuli, especially for the nervous system, provided that the time intervals between workouts are sufficient for restitution.

To prevent early fatigue, rest intervals between sets by elite athletes, especially when working with large weights, are approximately 4 to 5 min. Since the duration of a strength exercise bout is short, the exercise–rest ratio (i.e., the duration of the bout relative to rest) is very small for this type of physical activity. However, even long rest periods of 4 to 5 min are not sufficient for complete recovery, which after the lifting of a maximum training weight (TF_{mm}) requires 10 to 15 min. If the duration of a strength training workout is limited, one possible solution is to combine sets into series and schedule long (10–12 min) rest intervals between them. Since working periods are short and rest periods are long during sessions, workout density (the number of sets per hour of a workout) is not considered an informative measure of strength training intensity.

Exercise Sequence

The idea in sequencing exercises is to perform the most valuable exercises requiring fine motor coordination and maximal neuronal output in a rested state. To avoid premature fatigue, which is detrimental to a subsequent exercise, the following advice is usually given:

- Include main sport exercises before assistance exercises.
- Use dynamic, power-type drills before slow exercises, such as squats.
- Exercise larger muscle groups before smaller ones.

If the target of a workout is to increase muscular strength (not induce muscle hypertrophy; see chapter 11), successive exercises should minimally involve the same muscle groups. A sequence such as (1) arm abduction with dumbbells (only deltoid muscles are active), (2) bench press (same muscles are involved), (3) front squat (assistance exercise, performed with relatively slow speed), and (4) snatch (competition lift; requires maximal power production and complex technique) would prove incorrect. The proper series would look like this:

1. Snatch
2. Bench press
3. Squat
4. Arm abduction

Intensity Variation

Because lifting a maximum training weight (maximal effort method) is recognized as the most efficient way to train, this should be practiced at the beginning of a training workout, following the warm-up. Then athletes perform a few (2 or 3) single lifts toward the training weight expected for the competition date and several (up to 6) sets with this weight. Bulgarian athletes use a trial-and-error approach to achieve TF_{mm} every day. Russian coaches typically plan the exercise intensity in advance, considering a load 90% of CF_{mm} as TF_{mm} . A complex of combined exercise sets, for instance in snatch lifts, lasts a maximum of 30 min (6 sets \times 5 min for rest intervals).

Pyramid training, popular many years ago, involves gradually changing the load in a series of sets in an ascending and then a descending manner.

Training With Several Workouts Per Day: An Example

Bulgarian athletes have several workouts per day with a total duration of up to 6 h (see table 5.1). To the best of our knowledge, the weightlifters from Greece and Turkey who were very successful at the 2000 and 2004 Olympic Games train similarly. The exercise sessions are limited to 60 min, or even 45 min, periods. Two sessions in the morning and two in the afternoon are separated by 30-min rest intervals. The underlying assumption is that the elevated blood testosterone level can be maintained for 45 to 60 min only and that a 30-min rest is needed to restore the testosterone level. (This assumption has not been proven; the precise nature of the elevated testosterone level during a strength exercise workout is not well understood. In general, the elevation may be induced either by increased testosterone production or by a decreased amount of testosterone acceptors in muscles and other tissues.) During the 30-min rest intervals the athletes may choose to lie down and listen to music. To avoid cooldown, they are warmly dressed; their relaxed legs are slightly raised, supported by a small bench.

This has been virtually abandoned by Olympic-caliber athletes. The ascending part of such a routine induces premature fatigue, while the descending portion is not efficient because it is performed in a fatigued state. For contemporary training, fast progression to the main training load is typical.

A couple of other points about intensity variation are useful in specific circumstances. Athletes who are feeling fatigue may take single lifts at 10 to 15 kg below TF_{mm} between maximum lifts. This is also helpful for the purpose of recalling a proper technique pattern. Finally, if both the maximal effort and the repeated effort methods are used in the same workout, maximal lifts should be included first.

Advice about exercise sequence and intensity variation may be extended to the planning of a training day. Thus, exercises requiring maximal neural output (e.g., competitive lifts, power drills, lifting TF_{mm} or CF_{mm}) should be performed in a fresh state when the athlete has recovered from previous activity (i.e., during morning training workouts).

Contrasting Exercises

It is advisable to schedule flexibility and relaxation exercises between heavy resistance drills to speed up recovery and prevent loss of flexibility. The preferred area for flexibility exercises is the shoulder joints.

Mixed Training Sessions

Sessions that include the strength routine as one part of the workout are less effective than special heavy resistance workouts. In sports in which muscular strength is the ability of primary importance (e.g., field events in track and field, American

football), it is especially advisable to set apart heavy resistance drills in a separate workout. If there is not enough time to do this, strength exercises may be included in mixed workouts. To prevent negative effects, they are usually performed at the end of workouts (this practice is accepted in gymnastics and other sports). However, a coach should be aware that the same strength training complex is more effective when used at the beginning of the training session when the athletes are not fatigued.

Circuit Training

The idea of circuit training is to train several motor abilities (especially strength and endurance) at the same time. Such programs consist of several (up to 10 or 12) stations with a given exercise to be performed at each one.

The basic philosophy of circuit training (to stimulate strength and endurance simultaneously) appears dubious. It is well known that the mechanisms of biological adaptation to strength and endurance types of physical activity are dissimilar (this issue will be discussed in chapter 11). The muscles are not able to optimally adapt to both types of exercise at the same time. Combining strength and endurance exercises interferes with the ability to gain strength. Vigorous endurance activity inhibits strength development (figure 5.3).

Because of the low strength gains (in comparison with those obtained from regular strength training routines), circuit training is not recommended and is hardly ever used in strength and power sports. It may, however, be employed in sports having a high demand for both strength and endurance (rowing, kayaking) and also for conditioning in sports in

Times Past

From the training log of the Olympic (1960) champion Victor Bushuev. Drills in military (standing) press.

- Year 1958. TF_{mm} was 90 kg. The conventional pyramid protocol was executed. The following weights were lifted: 60, 65, 70, 75, 80, 85, 90, 90, 85, 80, 75, 70 kg. Each weight, except the beginning sets using 60- and 65-kg barbells, was lifted until failure. The initial part of this protocol (60-85 kg), which was not very useful, induced substantial fatigue and decreased the effect of lifting the highest loads.

- Year 1960. TF_{mm} was 110 kg. The barbell weight varied in the following sequence: 70, 90, 100 (all three weights were lifted only one time in a set), and then 110 kg. The maximal weight was lifted in 5 sets, 1 to 2 times in each set.

Since 1964, pyramids have been virtually excluded from the training of elite strength athletes.

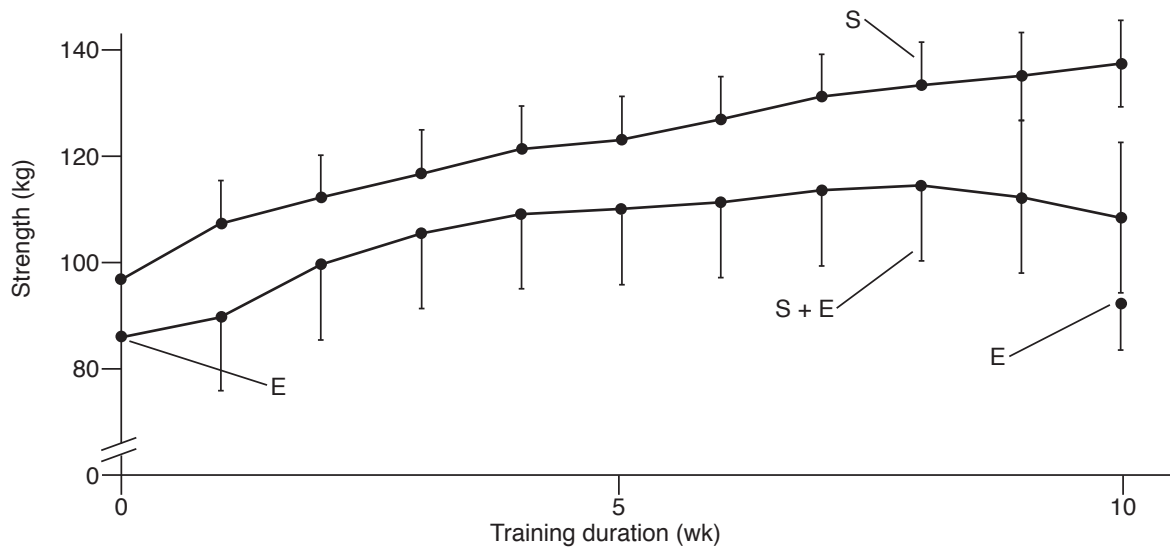

FIGURE 5.3 Simultaneous training for endurance (E) and strength (S) inhibits strength gain.

Adapted by permission from R.C. Hickson, "Interference of Strength Development by Simultaneously Training for Strength and Endurance," *European Journal of Applied Physiology and Occupational Physiology* 45, no. 2-3 (1980): 255-263.

which strength is not the dominating motor ability (volleyball, tennis). Circuit training is mainly used by athletes primarily concerned with enhancing or maintaining general fitness rather than specific muscular strength.

Microcycles and Mesocycles

The timing of heavy resistance protocols in micro- and mesocycles is dominated by two main ideas. One is to allow adequate recovery between exercise periods, and the other is to find a proper balance between the steadiness of a training stimulus (to call forth an adaptation) and its variability (to avoid premature accommodation and staleness).

Adequate Recovery

During a microcycle, rest-exercise alternation and proper exercise sequencing alleviate fatigue. The greatest training adaptation to a standard stimulus occurs when muscles are recovered from previous training periods and best prepared to tolerate the greatest overload. Keeping in mind that qualified athletes have 5 to 6 training days per week, one may conclude that the restoration time after a workout should be about 24 h—that athletes should train with small (restoration time less than 12 h) and medium (12-24 h) training loads. In this case, however, the total training load is not great enough to stimulate strength development. The solution is the

Are Special Strength Training Sessions Necessary?

Muscular strength is only one of several abilities athletes should build up; they have many other things to develop besides strength. It is up to the coach to decide whether or not to spend time on special strength training sessions. In many sports, such as tennis and even men's gymnastics, it is possible to attain the required level of strength fitness by performing strength exercises immediately after main workout drills. However, if low strength levels actually limit athletic performance, special strength workouts are useful. For example, in countries that were once part of the USSR, the junior team for men's gymnastics employs separate strength workouts; the men's team does not. In many sports, such as track and field, rowing, and kayaking, heavy resistance workouts are part of the routine. In others, such as swimming and wrestling, workouts also include specific strength exercises and loads rather than only standard heavy resistance training (dryland training in swimming, imitation of takedowns with simulated or added resistance in wrestling moves with weighted body dummies).

proper exercise alternation in consecutive workouts. Since fatigue effects from different resistance exercises are specific, it is possible to increase training loads up to an optimal level by properly rotating the exercises in sequential sessions. Exercises in consecutive training sessions should minimally involve the same muscle groups and thus repeat the same pattern of muscle coordination. It would not make sense, for instance, to plan two consecutive workouts with the snatch lift.

Recovery time from heavy resistance exercises varies with muscle size. For small muscle groups, like the calf muscles, the restitution time is typically less than 12 h. (Remember that we are concerned here with the training of experienced athletes only.) Small muscle groups (such as ankle plantar **flexors** and muscles of the forearm) may be trained several times a day. Intermediate muscle groups require more time for restitution; these can be exercised every day. Finally, it is advisable to exercise the large muscle groups with rest periods of at least 48 h. For instance, barbell squats are performed usually only two times per week with 72 or 96 h between training sessions (Olympic-caliber weightlifters perform front and back squats up to two times per week). The squats are excluded from training programs for 1 wk (in weightlifting) or 10 to 12 days (track and field) before an important competition begins.

To increase muscular strength, the schedule should include at least three heavy resistance workouts per week. It is better to distribute the same training volume into several workouts than to concentrate it into a small number of sessions. Athletes who increase the number of training sessions per week, while keeping the training volume (number of repetitions, total weight lifted) constant, usually experience visible strength gains. For instance, when the volume is distributed into two daily training sessions, the strength development is greater than it is with one session per day.

To retain strength gains, at least two training sessions per week should be scheduled.

Variability

The variability of training programs during micro- and mesocycles is realized through changes in training load (not exercise complexes). One stable complex of exercises should be performed through a mesocycle (to elicit an adaptation). This complex, consisting of perhaps 10 exercises, is distributed among the training days and workouts of one microcycle provided that each exercise is performed

at least twice a week. The time order of exercises is kept constant from one microcycle to another. For example, the snatch and front squat are routinely performed during the morning workout of the first day of each microcycle.

To avoid premature accommodation, training loads should vary from day to day and from microcycle to microcycle. The empirical **rule of 60%** has stood the test of time: The training volume of a day (microcycle) with minimal loading should be around 60% of the volume of a maximal day (microcycle) load.

Stress (Impact) Microcycles

Some experienced athletes use **stress microcycles** (figure 1.6 on page 12), in which fatigue is accumulated from day to day (due to high training loads and short rest intervals that are insufficient for restitution), if a routine training program does not bring about strength gains. The microcycle after a stress microcycle should involve small training loads. Elite athletes may tolerate up to two stress microcycles in a row (**doubled stress microcycle**); however, coaches and athletes should exercise extreme caution with this approach. Stress microcycles should not be used more than three to four times per year. Doubled stress microcycles are used only once per year.

The training volume per 4-wk mesocycle is approximately 1,700 lifts for elite weightlifters from the former Soviet Union; $1,306 \pm 99$ repetitions for qualified athletes having a Master of Sport title; and 986 ± 99 lifts for athletes with 1 year of experience in weightlifting training.

Medium-Term Planning (Periodization)

The term *periodization* refers to a division of the training season, typically 1 year long, into smaller and more manageable intervals (periods of training, mesocycles, and microcycles) with the ultimate goal of reaching the best performance results during the primary competitions of the season. To do this the athlete changes exercises, loads, and methods during preseason and in-season training. When the same training routine is applied over the entire season from the early preparatory phase (preseason) to the in-season training, improvement occurs only in the early phase and there is a subsequent leveling off. Early staleness is almost unavoidable with such a protocol.

The Issue of Periodization

Periodization is regarded as one of the most complex problems in athlete training. The proper balance between opposing demands is difficult to achieve in medium-term planning because so many factors are involved.

The efficacy of planning in macrocycles is determined for groups of athletes, not for individuals. The **efficacy coefficient** is calculated as follows:

Efficacy coefficient, % = $100(\text{Number of athletes who achieved their best performances during a most important competition of the season} / \text{Total number of athletes})$.

For national Olympic teams, such competitions as the Olympic Games and world championships are regarded as the most important. An efficacy coefficient of about 75% is considered excellent, 60% is considered good, and 50% is considered acceptable.

In medium-term planning, four issues have primary importance:

1. **Delayed transformation** of training loads (into fitness development)
2. **Delayed transmutation** of nonspecific fitness acquired in assistance exercises (relative to a main sport skill) to specific fitness
3. **Training residuals**
4. The superposition of training effects

Delayed Transformation

To conceptualize delayed transformation, imagine a group of athletes trained in the following manner. They perform the same exercise (e.g., deadlift) with a constant intensity (2RM-5RM) and volume (5 sets) during each workout (3 times per week). At the beginning, maximal strength increases relatively fast; however, after 2 to 3 months of this standard training, the rate of strength enhancement decreases as a result of accommodation. To overcome the accommodation, the coach decides to increase the training load (the number of training sessions per week, sets in workouts). But after several weeks, the performance fails to improve again. This time the coach decides to decrease the training load. After a certain period, the athletic performance again begins to improve.

In general, during periods of strenuous training, athletes cannot achieve the best performance results for two main reasons. First, it takes time to adapt to the training stimulus. Second, hard training work induces fatigue that accumulates over time. So a

period of relatively easy exercise is needed to realize the effect of the previous hard training sessions—to reveal the delayed training effect. This is called the **period of delayed transformation** (of the training work into performance growth). Adaptation occurs mainly when a retaining or detraining load is used after a stimulating load.

The time of delayed transformation lengthens as the total training load and accumulated fatigue increase. Typically, the delayed transformation lasts from 2 to 6 wk with the average time of 4 wk—exactly 1 mesocycle. This mesocycle, we recall, is known as the realizational, or precompetitive, mesocycle. Its objective is to prepare the athlete for immediate competition. The training load is low at this time. The main training work has been performed in preceding mesocycles (accumulative and transmutative). Because the effects are delayed, the adaptation occurs (or is manifested) during unloading rather than loading periods.

Delayed Transmutation

To continue the above example, when the athletes' exertions stop improving, the coach modifies the strategy and decides to change the exercises rather than the training load. Now, instead of performing the deadlift (which was the final training activity), the athletes begin to perform several assistance exercises such as leg and spine extensions and arm curls. After a couple of months of this training, the athletes' performances improve in all the drills except perhaps the only one—the deadlift—that was not trained. The athletes' potentials are now better than before; however, performance results in the deadlift are the same.

Now a special training routine must be advanced to transmute the acquired motor potential into athletic performance. Both special efforts and time are needed to attain this goal, which is realized during the transmutative mesocycles. Training in such mesocycles is highly specific. The number and total duration of transmutative mesocycles in one season depend on the total duration of preceding accumulative mesocycles. Transmutative and realizational mesocycles, when considered together as one unit, are often called the tapering (or peaking) period.

Analysis of our example shows that both the training content (exercises used) and the training load should vary over an entire training season. The accumulative, transmutative, and realizational (tapering) mesocycles follow one another in a certain order. To effectively plan these mesocycles (their

duration, content, and training load), the coach or athlete must take into account training residuals and the superposition of training effects.

Training Residuals

The reduction or cessation of training brings about substantial losses in adaptation effects. However, athletes to a certain extent can sustain the acquired training benefits over time without extensively training them continually. De-adaptation, as well as adaptation, takes time. If athletes exclude a given group of exercises (e.g., maximal strength load) from training protocols, they gradually lose the adaptations. A positive correlation exists between the time spent to elicit adaptational effects, on the one hand, and the time of detraining, on the other (figure 5.4).

Four factors mainly determine the time course of detraining: (1) duration of the immediately preceding period of training (the period of accumulation), (2) training experience of the athletes, (3) targeted motor abilities, and (4) amount of specific training loads during detraining (or retaining) mesocycles.

1. The general rule is that the longer the period of training, the longer the period of detraining, in other words, “Soon ripe, soon rotten.” When a preparatory period (preseason) is long, for instance several months, and a competition period is short (several weeks), as in many Olympic sports, it is permissible to eliminate certain exercises (like heavy resistance training) during the in-season period.

Strength adaptation is not lost in this case, mainly because the detraining period is short. However, in sports with a brief preseason period and many competitions in a row (as with games in ice hockey or tournaments in tennis), strength gains elicited during the short preseason period (weeks) are lost almost completely during the period of competition (months) if maximal strength loads are not used.

2. Mature athletes with continuous and extensive training backgrounds find that the residual effects of training are relatively stable. These athletes have slow rates of detraining and are able to achieve good results after relatively short periods of retraining. This is a result of what they have done in the past and what they are presently accomplishing. Elite athletes with training backgrounds that span many years regain motor abilities much more quickly than less experienced athletes.

3. Once special training ceases, different training benefits are lost at various rates. Anaerobic capacities are lost very quickly whereas adaptations to aerobic or maximal strength loads are relatively long lasting. The most stable benefits are training residuals based on morphological changes in skeletal muscles. Muscle size, for instance, changes slowly during both training and detraining, thus it is possible to use specialty mesocycles in which motor abilities are developed in sequence. The attained level of the motor ability (e.g., maximal strength) that was the primary target in one meso-

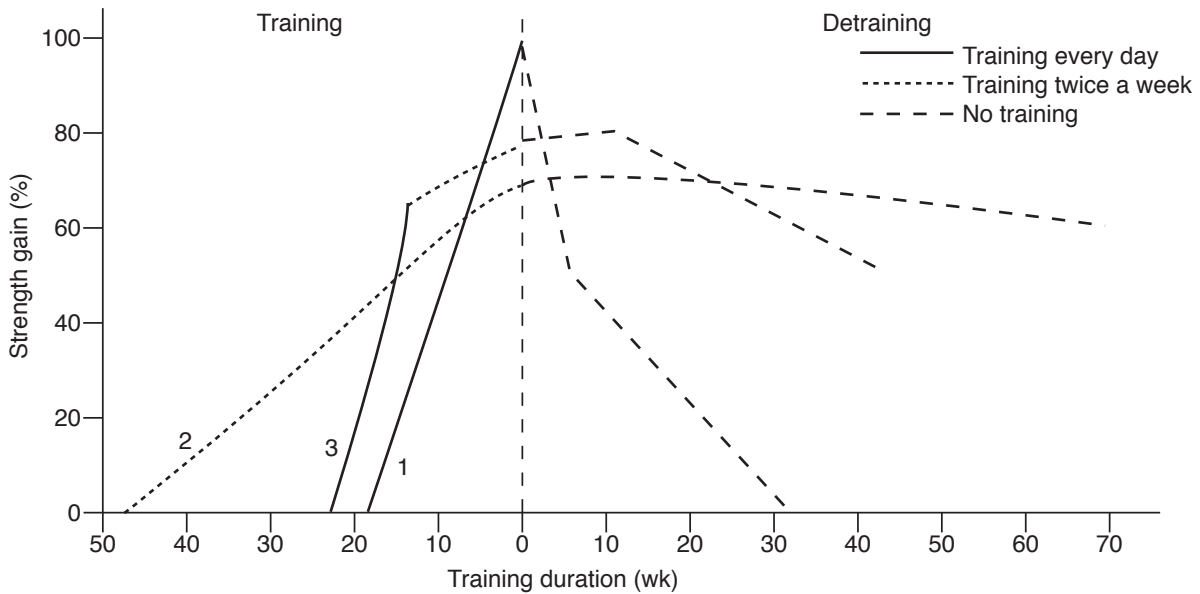

FIGURE 5.4 Time of training and detraining in three groups of subjects. Group 1 trained daily; group 2 trained twice a week; group 3 trained daily at the beginning and then twice a week.

Reprinted by permission from T. Hettinger, 1966, *Isometrisches Muskeltraining* (Stuttgart: Fischer Verlag).

cycle is maintained in subsequent mesocycles with small loads.

4. If special training loads (e.g., heavy resistance exercises) are preserved at a certain level, it is possible to either retain the acquired level of the specific motor ability or lose it at a relatively low rate. A coach may prescribe specific retaining or detraining loads for a given period during which training residuals are conserved at appropriate levels (but not improved).

Superposition of Training Effects

Various training methods do not bring the same gross beneficial effect to all physiological systems. Training effects are specialized and they affect separate systems in different ways. Methods that induce beneficial adaptation in one motor ability or physiological system may produce negative effects on another ability or system. For example, excessive strength gains associated with muscle hypertrophy may have negative effects on aerobic endurance as a result of reduced capillary density in the working muscles.

The transfer of either positive or negative effects between two types of training is not necessarily symmetrical. In other words, the effect of training activity X on ability Y is often different from the effect of training activity Y on ability X. Usually, hard strength training affects aerobic endurance negatively. The counterproductive effect of aerobic endurance training on maximal strength, if it exists, is smaller. Because of this, the strength-aerobic endurance sequence in two consecutive mesocycles provides a definite advantage; strength gains achieved during the first mesocycle are not minimized by aerobic training during the second. The opposite sequence, aerobic endurance-strength, is less efficient. In this sequence, aerobic capacity is initially enhanced but then deteriorates during the ensuing mesocycle.

Periodized Programming Models

Though most people understand the necessity of varying both training loads and training content over an entire season, being able to prescribe the optimal training plan for a given athlete and predict its effect on sport performance is not easy. This area of planning is contentious. In reality, a good periodization plan is a subtle trade-off between conflicting demands.

On the one hand, an athlete cannot develop maximum strength, anaerobic endurance, and

aerobic endurance all at the same time. The greatest gains in any one direction (for instance, strength training or aerobic training) can be achieved only if an athlete concentrates on this type of training for a reasonably long time—at least one or two mesocycles. In this case, the improvement in strength or aerobic capacity will be more substantial than that achieved with a more varied program.

Linear Models

The trade-off between conflicting demands leads to the recommendation that one should train sequentially—one target after the other. Such pattern of training is called **linear periodization** (figure 5.5a). Elite athletes have favored this widely used approach for many years.

In the 1960s, for instance, middle-distance runners used a preparation period of 7 mo consisting of the following sequence: (1) aerobic training, at that time called *marathon training* or *road training*—2.5 to 3 mo; (2) hill training or uphill running, mostly anaerobic with an increased resistance component—2.5 mo; and (3) short-track training in a stadium—about 1.5 mo. This training plan corresponds to the saying that athletes should begin a workout from the short end and a season from the long one. Similarly, throwers began the preparation period with strength exercises and, only after 2.5 to 3 mo of such training, began more specific routines.

But with this approach, because of the great amount of time and effort spent in a specific direction, an athlete has little opportunity to perform other drills or exercises. As a result of the long periods of detraining, the level of nontargeted motor abilities decreases substantially. In addition, great physical potential (e.g., strength, aerobic capacity) acquired in periods of accentuated training does not directly involve the sport movement. That is, the strength level is improved (e.g., dryland training in swimmers), but athletic results are not. Much time and effort are needed to fuse all the partial improvements into an athlete's preparedness for high-level competition.

Nonlinear Models

Another training strategy (nonlinear periodization) was developed as an alternative to linear periodization programming. The strategy is based on two ideas:

- Sequential, or even simultaneous, development of specific motor factors with frequent, intermittent changes in training targets (figure 5.5b)

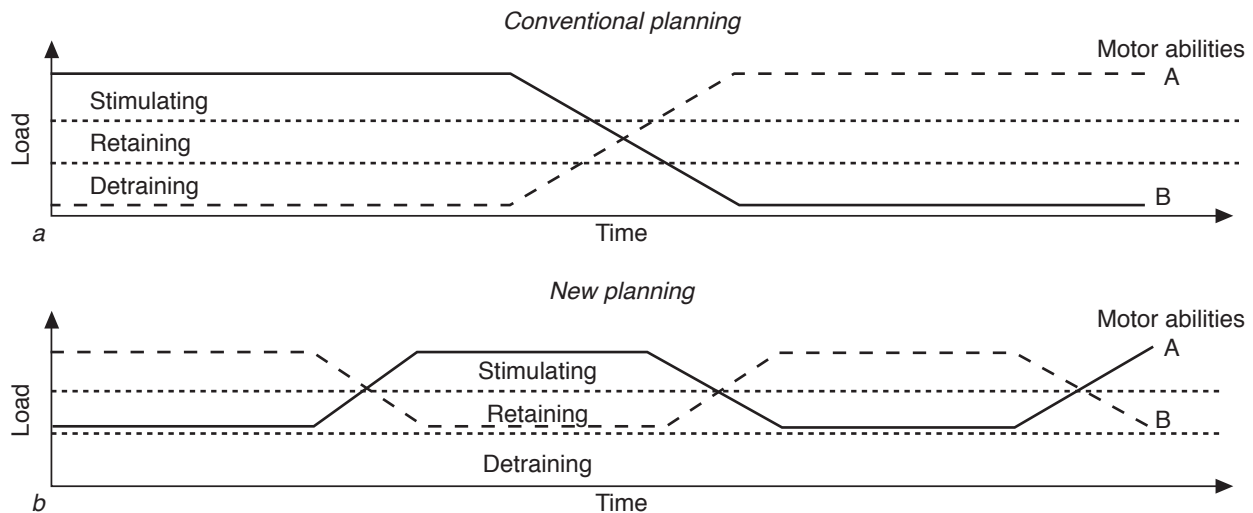

FIGURE 5.5 Two variations of timing training loads during a preseason period. Two motor abilities, A and B, are the training targets. (a) Long intervals of accentuated (targeted) training with stimulating and detraining loads, the linear periodization. (b) Short intervals of the targeted training with stimulating and retaining loads.

- Maintenance of the nontargeted motor abilities with retaining loads

This approach (training various motor abilities sequentially with frequent intermittent changes of targets) is used typically with 2-wk intervals, or half-mesocycles. Training targets are changed intermittently every 2 wk. This strategy is used, for instance, by athletes participating in Nordic-combined competitions (cross-country skiing 15 km plus ski jumping). The skiers train in 2-wk phases. During the first 2-wk period, cross-country skiing is the main objective of training with ski jumping loads only at the retaining level; this is followed by 2 wk of training ski jumping (at a stimulating load) with low retaining loads in cross-country skiing, and so on.

The term **simultaneous training** means, in this case, as close in time as possible: either on the same training day, in the same microcycle, or in intermittent microcycles (but not in the same training workout). The saying is, “All as close together as possible.” This strategy has been successfully used in several power sports, for instance with hammer throwers from the former Soviet Union. The contributing motor abilities (maximal strength, rate of force development, power) are trained during the same microcycle with this approach.

The ideas for periodization that we have been looking at are realized in training programs in a multitude of ways.

Flexible Nonlinear Models and Planned Nonlinear Models

The earlier versions of nonlinear periodization were pioneered in the early 1990s by Dr. Kraemer at Pennsylvania State University, and tested by many teams, most notably, the women’s tennis team. Athlete demands were ongoing throughout most of the year, and strength and conditioning workouts had to respond to the highly variable environment of practice, injury, sickness, play, and travel as well as the academic schedules of the student-athlete. In 2001, the model evolved as Dr. Kraemer worked with Coach Jerry Martin, Coach Andrea Hudy, and the strength and conditioning staff to study and implement a new model for periodization at the University of Connecticut (UConn). Further modifications took place over the years led by Coach Martin and Dr. Kraemer at UConn with all teams. In 2004, Coach Hudy moved to the University of Kansas and in 2019 to the University of Texas where she continued to expand and explore flexible nonlinear periodization as a training model, demonstrating its potential for student-athletes, especially basketball players. Now this model has evolved into many versions and has progressed to other sports as part of the yearly macrocycle approach. The basic tenets were to ensure that the quality of the training session became the vital factor in achieving the adaptations and performance results. Thus was born nonlinear periodization and later flexible nonlinear periodization to better respond to day-to-

day changes in life patterns of the student-athlete. Using preworkout tests and training logs became essential to nonlinear periodization plans. Training logs are carefully examined as the workout progresses to determine if target loads for exercises and sets are being met.

This nonlinear program attempts to train both the hypertrophy and neural aspects of strength within the same week. A microcycle is a day and mesocycles can be between 8 to 16 weeks based on the calendar needs and the athlete's schedule. Most academic schedules are more conducive to using 8- to 10-week mesocycles; thus athletes are working at two different physiological adaptations together within the same 7- to 10-day period of the 8- to 10-week mesocycle with the microcycle being 1 day. This appears possible and may be more conducive to many individual's schedules, especially when competitions, travel, or other schedule conflicts can make the traditional linear method difficult to follow. The intensity and volume of training varies within the week over the course of the entire training period (e.g., 10 weeks). This protocol uses a 4-day rotation (any number of days rotation can be used) with a 1- or 2-day rest period between workouts. The planned nonlinear periodization program model uses a manipulation of the different loadings or workout plans over the mesocycle. In the power training, loads that are 40% to 70% of 1RM are used; the exercises allow release of the mass (i.e., cleans, pulls, throwing, jumping); fast lifts with substantial deceleration of the implement during the last part of the movement are not used (see figure 5.3 on page 85). The primary large muscle group exercises are typically periodized, but a two-cycle program can be used to vary the small muscle group exercises. For example, loads for the triceps push-down could vary between moderate (8RM-10RM) and heavy (4RM-6RM) cycle intensities. Care is needed for small muscle groups such as the rotator cuff and hamstrings when used in isolation assistance exercises. This would provide the hypertrophy needed for such isolated muscles of a joint but also provide the strength needed to support heavier workouts of the large muscle groups. Ranges of motion in any exercise is important to gain the full training effects and adaptations needed in both the contractile and noncontractile tissues.

The flexible nonlinear periodization model starts out with a planned rotation of a nonlinear periodization model. Planned nonlinear periodization workouts use the associated rest periods

discussed in other chapters for each resistance load range used. A planned nonlinear rotation for loadings might be as follows.

- Monday: 4 sets of 12RM-15RM
- Tuesday: 4 sets of 4RM-6RM
- Wednesday: Rest
- Thursday: 4 sets of 8RM-10RM
- Friday: 5 sets of 3 for power exercises at 40%-70% of 1RM
- Saturday: Rest
- Sunday: Rest
- Monday: 4-5 sets of 1RM-3RM

In the planned program presented, the intensity spans over a 14RM range (possible 1RM sets versus 15RM sets in the week cycle). The planned nonlinear periodization workout model rotates between the different loadings for each training session. If a missed workout indicates some type of overreaching, sickness, sports injury, or fatigue then rest can be assigned. Typically, if you miss the Monday workout, the rotation order is simply pushed forward, meaning you perform the rotated workout scheduled. For example, if the light 12RM to 15RM workout was scheduled for Monday and you miss it, you simply perform it on Tuesday and continue with the planned rotation sequence. In this way no workout stimulus is missed in the training program. The first version of the flexible nonlinear programming was to test and default to another workout protocol or take a rest day in order to recover. This was a key element of success; then even more models started to develop as is typical for any periodization training model.

In more advanced planned nonlinear periodization models, an overall goal of a mesocycle is determined, and the loadings reflect that primary goal. Thus, there may be higher numbers of one loading type than in a standard planned nonlinear periodization model that uses an equal distribution of training loads over a 7- to 10-day period of time. This evolution over the past 15 years to more flexible use and more load sequencing has led to an increasingly robust concept of flexible nonlinear periodization, which not only addresses the athlete's need to do a high-quality workout that hits target resistances and volumes, but also varies the loading sequences to mimic other models at certain times of the year. In this approach one could say the nonlinear model can

“morph” different sequences of loading intensity and volume of exercises as needed. Thus, the model could include two heavy days in a row or it could reflect other periodization models for short periods of time (e.g., a week or two). Again, the key to this approach is that workouts are used that reflect the athlete’s ability to hit the target training load and then recover the next day or prior to the next workout. Changes could be made based on the athlete’s schedule as well. For example, imagine that a basketball coach changes the schedule and the athlete has to strength train after practice. A power day was scheduled, but this is now a problem because prior fatigue will impact the quality of the power training workout. In this case the athlete could default to a light workout or a rest day. Flexibility is key, and individualization is also a vitally important tenet to the program because not all individuals respond similarly to a training program in its day-to-day implementation. In one National Football League team, it was not unusual to have several different program sequences implemented due to a multitude of external factors affecting each athlete’s loading quality. The flexible nonlinear periodization program model uses the same approach with a target plan for an 8- to 12-wk mesocycle. Each mesocycle needs to have an overall target goal (e.g., general preparation, maximal strength, maximal power) with the needed training adaptations caused by various loadings and workouts to achieve within-cycle goals (e.g.,

general preparation, maximal strength, strength power, or recovery). A target goal for the flexible nonlinear program starts with a plan (just as in a typical planned nonlinear model) and creates a loading sequence for a given mesocycle of 8 to 10 wk and then modifies day-to-day workouts based on “readiness” to train or ability to perform the workout (see table 5.2).

The sequence of loading then progresses, but if an athlete cannot hit the target reps with the load, a red flag goes up and the workout is designated a light workout day or a rest day with further diagnosis of the underlying reasons assessed and addressed. In concert with the sports medicine team, the athlete is checked for illness, sleep issues, other psychosocial issues, and nutritional support, which is then addressed. Many times, it is fatigue that has accumulated due to sport coaches pushing too hard for “work hardening,” and assigning excessive exercise to punish or discipline athletes, which is inappropriate and dangerous. The strength and conditioning and sports medicine staffs must resist this type of coaching or serious problems can result. Flexible nonlinear programs respond immediately to the athlete’s need for workout modifications when exercise capacity is diminished.

Strength Training in Macrocycles

Although proper timing is vital for effective strength training, the timing of strength training in macrocycles, that is, in periods that are relatively

TABLE 5.2 Sample 8-Week Mesocycle Loading Sequences for Primary Exercises

Mesocycle goal	WEEK 1			WEEK 2			WEEK 3			WEEK 4			WEEK 5			WEEK 6			WEEK 7			WEEK 8				
	1	2	3	1	2	3	1	2	3	1	2	3	1	2	3	1	2	3	1	2	3	1	2	3		
General prep	VL	L	M	L	M	M	VL	M	L	M	H	L	H	L	H	VL	M	H	M	L	L	H	M	M	H	M
Strength	M	H	M	L	VH	M	M	H	VH	H	M	VH	H	M	H	L	VH	H	M	VH	M	M	L	VH	VH	
Strength/power	H	L	P	H	L	P	P	H	P	VH	L	P	H	P	H	P	H	P	L	P	H	P	L	P	L	P

The volumes for each primary exercise have been adjusted according to its place within the macrocycle using a nonlinear periodized plan with specific goals for each mesocycle. Flexible changes can be made for a day’s training load if target loads cannot be managed or if a training day is missed due to illness. A missed day due to schedule conflicts will be considered a rest day or a light day, and the workout plan will simply continue the next day with the previous day’s scheduled workout.

- VL = Very light day: 20RM-22RM, 1-1.5 min rest
- L = Light day: 12RM-15RM, 1-2 min rest
- M = Moderate day: 8RM-10RM, 2-3 min rest
- H = Heavy day: 4RM-6RM, 3-5 min rest
- VH = Very heavy day: 1RM-3RM, 5-7 min rest
- P = Power day: 40%-70% of 1RM in power exercises, 2-3 reps, 3-6 sets, 3-5 min rest

long (several months), is only indirectly influenced by the exercise–rest paradigm and by the desire to avoid premature fatigue. Other facets of training become more important. In macrocycles, these typically are the following:

- Demand for variability of training stimuli
- Delayed transformation of a training load (into fitness development)
- Delayed transmutation of nonspecific fitness into specific fitness
- Training residuals

Variability of Training Stimuli

Demands for variability in macrocycles are met by changing exercise programs and training methods. Exercises themselves, not just the quantitative parameters of training routines (training load, volume, intensity), must be periodically changed to avoid accommodation. The general idea is simple. As a result of accommodation, a standard training program (same exercises, similar training load) leads very quickly to slow, or no, strength gains. To activate new steps in an adaptation, the program must be changed in one or both of two ways: increasing the training load or changing the exercise complex. There are limits to increasing the training load (because of staleness and time constraints), so changing exercises is preferable. This strategy has proven its effectiveness in the preparation of many international-caliber athletes.

The training of the best hammer throwers from the countries of the former Soviet Union, who have dominated world, Olympic, and European competitions over the last 30 years, is a good example of this strategy. Nearly 120 specific exercises were selected or invented for training and were distributed into 12 complexes with 10 exercises per complex. Each complex was used, depending on the individual peculiarities of an athlete, for 2 to 4 months and was then replaced by another complex. The same complex was performed only once in the 2- to 4-year period. The most efficient exercises (for a given athlete) were used in the year of the most important competition (e.g., Olympic Games). The athletes performed hammer throws with maximal effort almost every training day. When a strength complex was changed, performance results in hammer throwing slightly deteriorated. They began to improve, however, after a period of initial adaptation to the new load (figure 5.6).

Strength training methods (submaximal effort, repeated effort, maximal effort) are used in different proportions within a macrocycle. Conventionally, a preseason period begins with a mesocycle centered mainly on the submaximal effort method (the lifting of nonmaximal loads an intermediate number of times; not to failure) and the repeated effort method (maximal number of repetitions in a set). Then the athlete shifts to the maximal effort method, increasing the lifted weight and decreasing the number of repetitions per set. The strategy is to initially prepare and develop the musculoskeletal

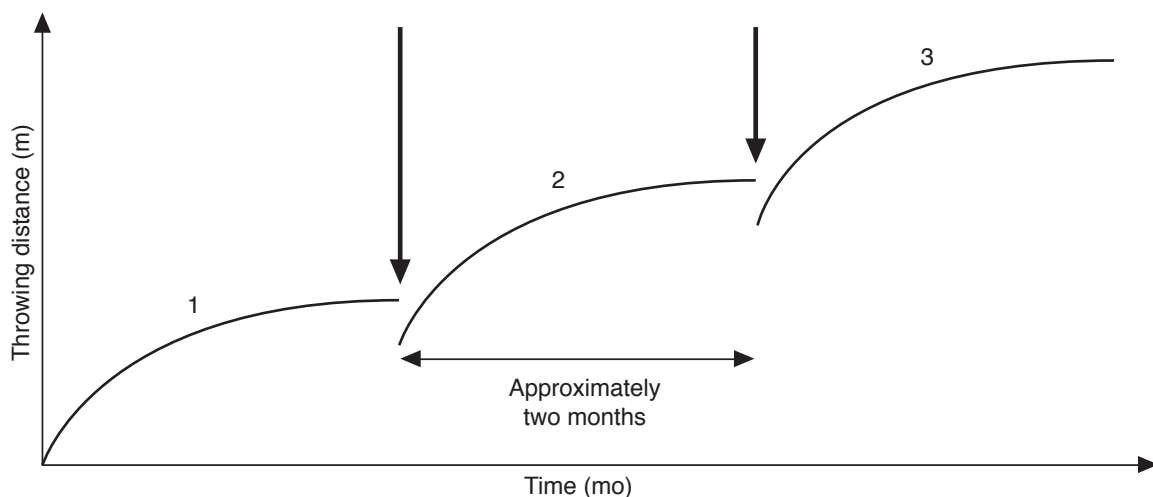

FIGURE 5.6 The effects of periodic changes in exercise complexes (vertical arrows) on the performance of hammer throwers.

Based on concept developed by the USSR National Olympic team head coach, A.P. Bondarchuk, 1980.

system (peripheral factors) and then improve neural coordination. This conventional paradigm has been substantially changed since 1980. A new tendency is to alternate or vary the training methods several times during the macrocycle. Mesocycles (4 wk) or half-mesocycles (2 wk), during which the methods of repeated or maximal efforts are emphasized, follow each other in sequence.

Delayed Transformation

Because of the time delay between an increase in training load and improvement in performance, the training load should be decreased before an important competition (the period of delayed transformation). In essence, this is the time the body needs for rest and adaptation.

The length of the transformation period is positively correlated with the amount of the training load, especially with the increment of the previously employed training load. The higher the training load increment, the greater the time needed to adapt and the longer the period of transformation. The duration of the precompetition phase, when loads are relatively low, is typically one mesocycle or approximately 4 wk. However, if the training load is sharply increased with the use of several stress microcycles, the precompetition phase may last up to 6 and even 7 wk. Conversely, when the training load is mildly enhanced, the duration of the precompetition phase is around 2 wk.

In comparison with the preparatory phase, a precompetition phase for elite weightlifters contains fewer training sessions per week (5-10 instead of 8-15), fewer exercises per workout (1-4 instead of 3-6), and fewer sets per exercise (3-5 instead of 4-8). A primary objective during this period is good rest and full restoration between workouts.

Delayed Transmutation

As the time leading up to an important competition decreases, the strength exercises should become more specific. This refers to the delayed transmutation of nonspecific fitness acquired in assistance exercises (relative to a main sport skill) into specific fitness.

Training Residuals and Retaining Loads

The level of strength an athlete has achieved can be maintained during the season (the competition period of a macrocycle) by retaining loads. Two short (30-40 min) heavy resistance workouts per

week usually provide a load of sufficient magnitude. Exercising twice a week makes it possible to preserve, but not improve, the athlete's strength during the whole season.

The total training load per macrocycle is high for elite athletes and has shown a general trend toward growth (figure 5.7 shows training loads of the Bulgarian national team). The best weightlifters of the 1960s lifted a barbell fewer than 10,000 times during a 1-year period:

- Yury Vlasov, 1960 Olympic champion in the super-heavyweight category—5,715 repetitions
- Leonid Zhabotinsky, 1964 Olympic champion in the super-heavyweight category—5,757 repetitions
- Yan Talts, 1972 Olympic champion—8,452 repetitions

In the 1973 to 1976 Olympic cycle, the average number of repetitions per year for a member of the USSR national Olympic weightlifting team was 10,600. During the 1985 to 1988 quadrennial cycle, it was 20,500.

For elite athletes, the training load, expressed in tons, varies substantially during year-round preparation (figure 5.8). However, contrary to common belief, the average weight lifted (the total weight divided by the number of lifts) is rather constant. Why? Because changes in the exercises correlate with changes in the methods of strength training. Recall that loads of 1RM to 2RM are lifted primarily in main sport exercises while a greater number of repetitions is typical for assistance exercises (see chapter 4). If an athlete decreases the weight lifted in the clean and jerk and performs many barbell squats during an accumulated mesocycle, the average weight may not change; the decrease of load in one exercise (the clean and jerk) is outweighed by the high load lifted in squats.

The rule of 60% is recommended for use in planning a macrocycle. The load in a mesocycle with minimal load is approximately 60% of a maximal mesocycle load, provided that the mesocycles are equal in duration.

Summary

The timing of training includes the spacing of work and rest intervals as well as the sequencing of exercises. Training can be divided into structural

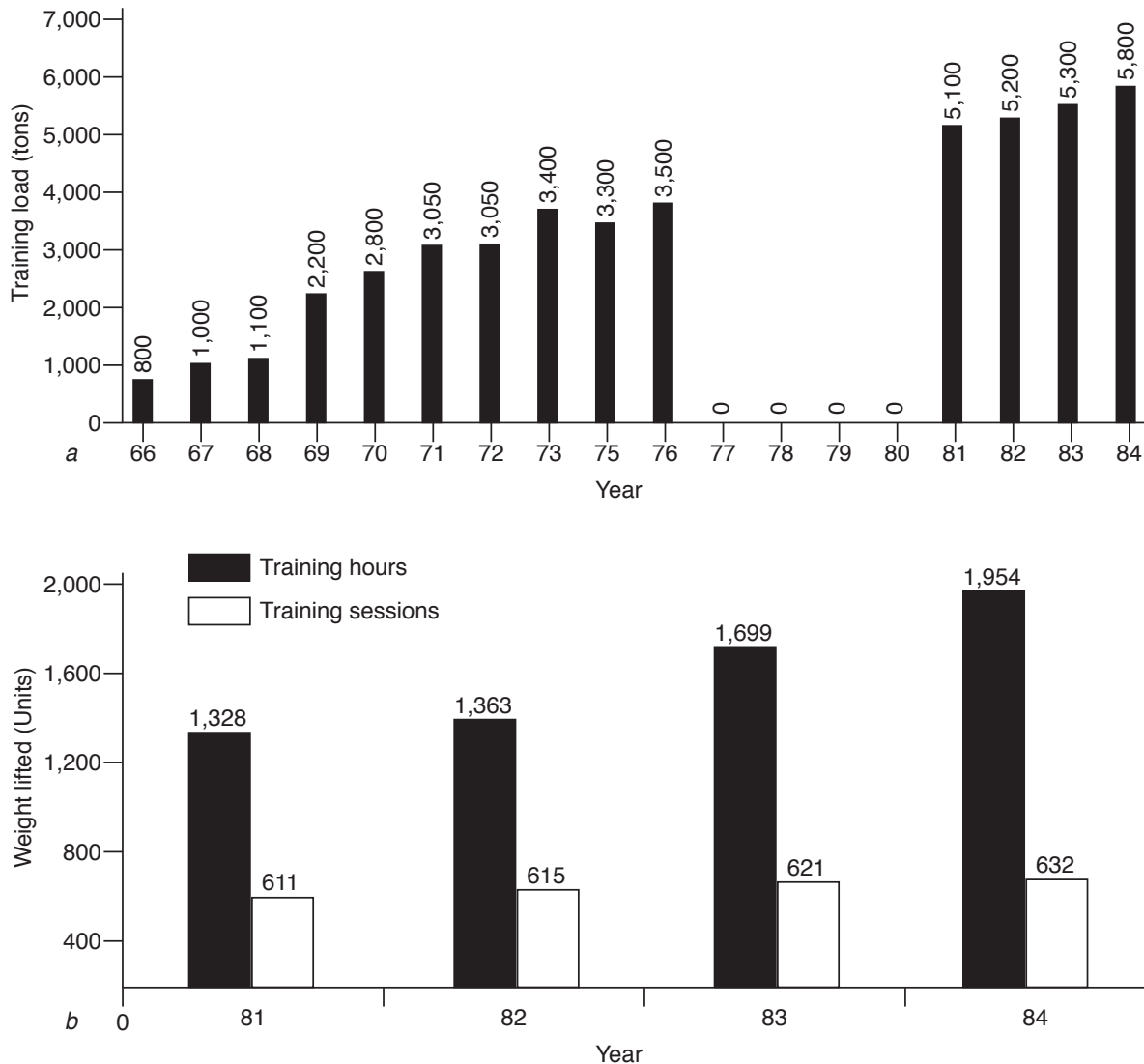

FIGURE 5.7 Training loads of the members of the Bulgarian national weightlifting team. (a) Total weight lifted. (b) Number of training hours and sessions.

Data from I. Abadjiev and B. Faradjiev, *Training of Weight Lifters* (Sofia: Medicina i Fizkultura, 1986).

units of various durations, in particular in the (1) training session (workout), (2) training day, (3) microcycle, (4) mesocycle, (5) macrocycle, (6) Olympic cycle (quadrennial cycle), and (7) long-lasting, or multiyear, training.

Short-term planning refers to the planning of workouts, training days, microcycles, and mesocycles (typically 2-6 wk). A general principle of short-term training design is that the effects of fatigue from different types of muscular work are specific. Thus an athlete who is too tired to repeat one exercise in an acceptable manner may still be able to perform another exercise to satisfaction.

Training too many motor abilities during the same workout, microcycle, or mesocycle lessens effectiveness. Two or three main targets are plenty. Try to balance the number of training targets in these cycles to enhance performance growth while also avoiding the superposition of fatigue traces from individual workouts and the hazard of staleness.

The general idea in planning workouts and training days is to have athletes do as much work as possible while they are as fresh as possible. Unlike the situation with endurance training, it isn't necessary that the athletes become exhausted in a heavy resistance workout. To prevent early fatigue, rest

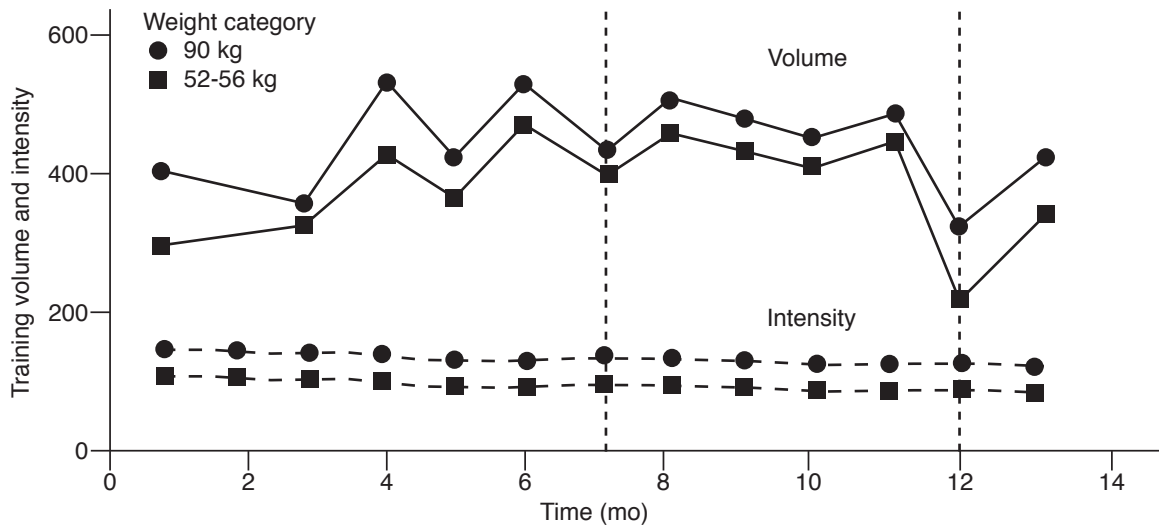

FIGURE 5.8 The distribution of training volume (tons, two top curves) and average weight lifted (kg, two bottom curves) by the USSR national Olympic team during year-round training. Average data of athletes in weight categories 52 to 56 kg ($n = 4$) and 90 kg ($n = 3$). Vertical dotted lines show the times of important competitions.

Data from *Preparation of the National Olympic Team Weight Lifting*, Annual Report #85-012 (Moscow: All-Union Research Institute of Physical Culture, 1984).

intervals between sets, especially when trainees are working with heavy weights, should be long (about 4-5 min). During training days, distributing the training volume into smaller units has a definite advantage, provided that the time intervals between workouts is sufficient for restoration.

In properly sequenced exercise, the athlete performs the most valuable exercises—those requiring fine motor coordination and maximal neuronal output—in a rested state. To prevent premature fatigue, include main sport exercises before assistance exercises; use dynamic, power-type drills before slow exercises (such as squats); and exercise larger muscle groups before smaller ones.

The method of maximal effort is recognized as the most efficient training method and should be practiced at the beginning of a training workout, following warm-up. Pyramid training is ineffective and even detrimental. Mixed training sessions that include a strength routine section are less effective for strength development than special heavy resistance workouts. The same holds true for circuit training.

In planning heavy resistance protocols in micro- and mesocycles it is important to assign adequate rest between exercise periods and to balance the stability of a training stimulus (to call forth an adaptation) and its variation (to avoid premature accommodation and staleness).

Adequate recovery during a microcycle is achieved by rest-exercise alternation and proper

exercise sequencing. To retain the attained strength gains, schedule at least two training sessions per week. The variability of training programs during micro- and mesocycles is realized through changes in training load (not exercise complexes). One stable complex of exercises should be performed through a mesocycle (to elicit an adaptation). The empirical rule of 60% has stood the test of time: The training volume of a day (microcycle) with minimal loading should be about 60% of the volume of a maximal day (microcycle) load.

Medium-term planning (periodization) deals with macrocycles. When you periodize, you divide the training season, typically 1 year, into smaller and more manageable intervals (periods of training, mesocycles, and microcycles), with the goal of getting the best performance results during the primary competitions of the season.

In periodizing, allow for delayed transformation. During periods of strenuous training, athletes cannot achieve the best performance results. They need an interval of relatively easy exercise to realize the effect of previous difficult training sessions. The adaptation occurs (or is manifested) during unloading, rather than loading, periods. Another phenomenon that you need to consider is delayed transmutation. A special training routine is needed to transmute the acquired motor potential into athletic performance. This goal is realized during highly specific training in transformation

Continuous Training Is a Must

Long breaks are customary in education. Vacations don't harm students' acquisition of knowledge or impair their intellectual abilities. After a break, they are able to study hard and learn at a faster pace.

A human body, however, behaves differently. Long breaks in training ruin physical fitness and athletic performance. De-adaptation inevitably takes place. Detraining occurs. After a prolonged period of inactivity, an athlete has to start from a decreased level of physical fitness. Time and effort are unnecessarily spent on recovering the prebreak level of fitness. If not for the break, the same efforts would be spent on increasing, not restoring, fitness. As in mountaineering, if you want to scale the summit of a high mountain, why get halfway up the mountain, go back down, and then climb the whole mountain?

Prolonged interruptions in training are not good for an athlete's health. It takes time to become accustomed to regular physical exercise and also to become unaccustomed to habitual activity. Sharp decreases in an athlete's activity level offer no benefit. In fact, there is an added risk of injury, for two reasons. Various motor abilities are retained differently. Some are lost quickly and some are more stable. The new imbalance of motor abilities, for instance between high strength and decreased flexibility and relaxation, may provoke trauma. In addition, athletes are often not psychologically attuned to their new condition. They are likely to overestimate their current potential. If they try to perform as before, they may get injured.

The National Collegiate Athletic Association (NCAA) rules do not take full account of these natural requirements. The rules limit organized practice activities to 22 to 24 weeks per year (or 144 days) and encourage intermittent rather than continuous year-round training. Voluntary and unsupervised individual workouts initiated by the student-athletes are important to maintain the previously attained fitness level. A coach is only permitted to design a general individual workout program for a student-athlete (not a specific workout program for specific days).

A better plan to educate student-athletes would be to emphasize the harm of sudden changes in activity level to their athletic preparedness and health. The athletes should be familiar with the main principles of training and should understand the personal training philosophies of their coaches.

In addition, the coach needs to design the individual workout program for each student who requires such guidance, ensure that the program is understood, and advise students about safety measures during voluntary individual workouts.

If the objective of the individual training program is limited to retaining a general fitness level, student-athletes should take several steps. They need to monitor body weight, maintaining a proper balance between overall energy expenditure and the number of **calories** supplied with food. Body weight must be kept constant; only a 2- to 3-kg gain is permitted. These athletes should also do calisthenics (strengthening and stretching exercises) and perform an aerobic activity to provide the minimal combined load required to retain fitness. Muscular strength, flexibility, aerobic capacities, and stable body weight must be maintained.

The laws of physical training must be obeyed if one wants to be successful in sport. The need for continuous training is one such law. If student-athletes who seek to become elite athletes possess the proper experience and knowledge, have access to practice facilities, and take safety precautions against trauma, their individual workout programs may be designed to enhance preparedness rather than only maintain it. In this case, the training should continue to follow the standard schedule with adjustments made to accommodate the athlete's responsibilities, such as exam schedules.

mesocycles. Finally, it is important to take training residuals into account when you plan for the medium term. De-adaptation, as well as adaptation, takes time. The time course of training should be based on the duration of the immediately preceding period of training, the training experience of

the athletes, the motor abilities being targeted, and the training volumes during training mesocycles.

A good periodization plan is a subtle tradeoff among conflicting demands. The conventional approach has been to solve the problem sequentially, for instance to begin off-season preparation with

nonspecific strength training and to then change to a highly specific technique routine. A more recent strategy is to sequentially develop specific motor abilities with frequent intermittent changes in training targets and to maintain the nontargeted motor abilities with retaining loads.

The timing of strength training in macrocycles is only indirectly influenced by the exercise–rest

paradigm and by the desire to avoid premature fatigue. Other training facets also influence timing, including the demand for variability of training stimuli, delayed transformation of training load (into fitness development), delayed transmutation of a nonspecific fitness acquired in assistance exercises (relative to a main sport skill) to specific fitness, and training residuals.

EXERCISES USED FOR STRENGTH TRAINING

The first problem a coach encounters in planning a training program is exercise selection. The alternatives seem innumerable: free weights, exercise machines, isometrics, uphill ambulation with an additional load, drop jumps, self-resistance exercises, and so on. In this chapter you will read about various classes of exercises used for strength enhancement.

Classification

Exercises used for strength training are typically classified according to the change in muscle length. They may be static, or **isometric**, which literally means “constant length,” or **dynamic**, a category further divided into exercises with concentric, eccentric, or **reversible** muscle action. Dynamic exercises are also sometimes labeled **isotonic** (from *iso*, meaning “constant,” and *tonic*, meaning “tension”). The underlying assumption is that the muscle produces an unvarying amount of tension while shortening as it overcomes a constant resistance. This is not the case for intact muscles. If external resistance (weight lifted) is constant, the tension exerted by a muscle varies during shortening because of factors such as the change in muscle moment arm.

Among dynamic exercises, one special class is termed isokinetic (*kinetic* means “speed”). During **isokinetic action**, the speed of movement is constant, regardless of muscle tension. (The term *isokinetic*, unfortunately, is not strictly defined. Speed of movement may refer to rate of change in



muscle length, velocity of the load being lifted, or angular velocity of the joint.) Special equipment, usually expensive, is necessary for proper isokinetic training.

Because dynamic exercises with concentric muscle action are much more popular in athletic training than other types of exercise, these will be our focal point.

Exercises used for strength training can also be grouped according to the muscles involved in the action (e.g., abdominal exercises, leg exercises). The strength of different muscle groups often varies greatly in one person. An athlete can have high strength in one movement, for instance in the leg extension, but be relatively weak in another, such as pull-ups. The comparative strength of different muscle groups is called **strength topography**.

In addition, exercises used for strength training are often classified according to their specificity as (1) nonspecific (e.g., barbell squats for javelin throwers or baseball pitchers); (2) specific (e.g., exercises for muscles specifically involved in a throwing task, as in figure 6.1); and (3) sport exercise with added resistance (e.g., overhand throwing of heavy objects).

Exercise Selection for Beginning Athletes

With beginning athletes, especially young people, strength topography is the main focus in the proper selection of exercises used for strength training. The most important muscle groups should be chosen and trained. The following recommendations are offered as a rule of thumb:

1. Strengthen the muscle group that, if weak, can increase the risk of trauma (e.g., neck muscles in wrestling and tackle football).
2. Train large, proximally located muscles, especially in the trunk area, with the abdominal wall muscles and spine erectors as a primary choice.
3. Increase strength in sport-related movements to a level that permits sport technique acquisition without technical mistakes.

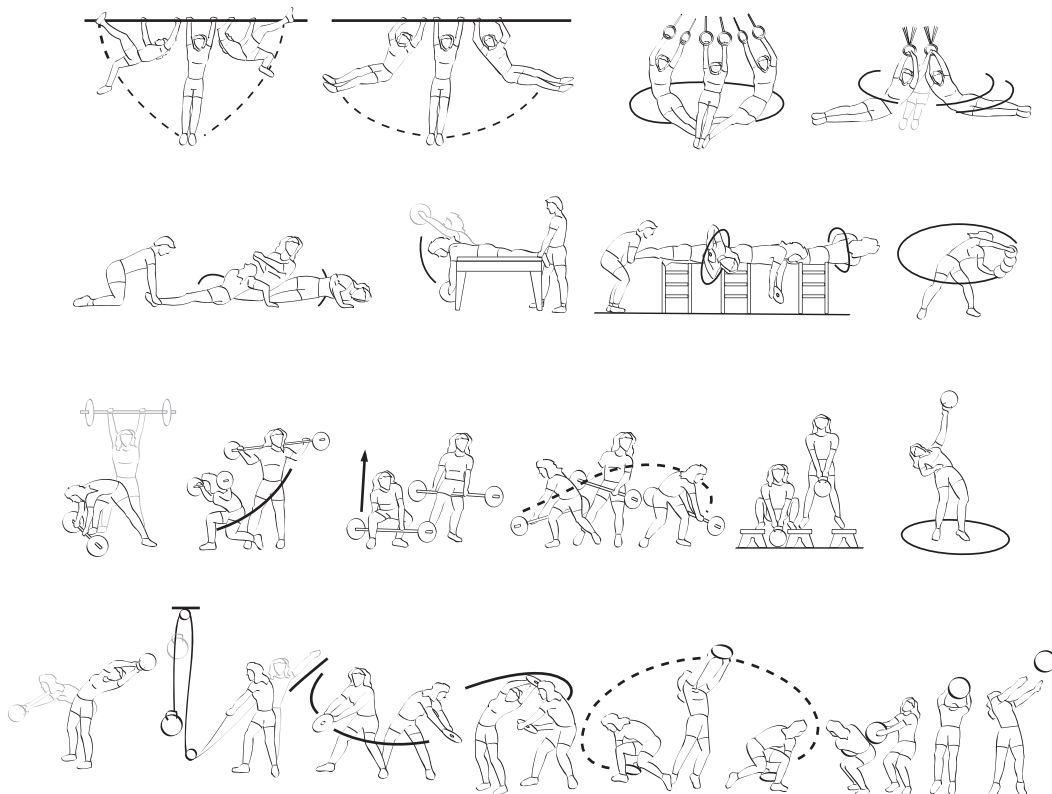

FIGURE 6.1 An exercise set of specific strength drills for strength training of female hammer throwers. In hammer throwing, the main efforts are exerted not in a vertical but in an oblique direction. The exercises included in the set are designed to respond to these requirements. Note in particular the techniques of the barbell lifts. They are quite different from the classic techniques of weight training, which are usually symmetric barbell lifts with equal loading of the right and left extremities.

Which Muscle Groups Are Most Important? How Do We Evaluate General Strength Development?

For more than a century, hand grip strength has been commonly used to estimate the strength development level of various subjects and populations. Recently, it has been used as a predictor of many health attributes or pathologies for various population types. Other studies have shown it to be very conservative and not sensitive enough for showing declines due to factors such as fatigue or jet lag, thus making it somewhat ineffective as a test for monitoring training. However, strength training does increase grip strength due to its integral part of all exercises. But, is grip strength a valid test for whole-body strength? In the grip test, the thumb produces force against the force generated by the other four fingers. Since the four fingers together can generate greater force values than the thumb alone, in reality, the strength of only the thumb is measured in the test. Is the strength of the thumb so important in athletics and everyday life that it should be considered a valid, or even a unique measure of strength development? Certainly not. Which muscle groups are, then, the most important?

This question has been addressed in several investigations. Ideally, a small number of muscle groups or exercises could represent, with maximal precision, the achievements in a large test battery. To find such a set of muscles, groups of subjects were given many (up to 100) strength tests. Statistical analyses were employed to find the most representative (important, valid) muscle groups and tests. Interestingly, the results led to the recommendations for choosing the following most important muscle groups that should be specifically targeted when working with beginning athletes: the abdominal muscles, spine erectors, leg extensors, arm extensors, and pectoralis major. When you are limited to two tests, use measures of strength on a high bar with overturn and forcible leg extension (e.g., squatting on one leg). While fascinating, for proper strength diagnosis it is still important to monitor training logs and test for the major muscle groups being used in the program (e.g., squat, bench press, rows, pulls) in order to determine if the exercise program being prescribed is effective and if changes are needed for the next cycle of training.

4. Have athletes perform movements through the entire range of angular joint motion. The submaximal effort and repeated effort methods only, not singular maximal efforts, should be employed.
5. Exercises that help in the control of the whole-body kinetic chain (e.g., squats, squat variations, pulls, power cleans, deadlifts, whole-body plyometrics) are vital for the athlete, ensuring multijoint neural communication and interactions in whole-body movements so vital in sport performances. Teaching exercise technique is a vital part of a program for the beginning athlete of any age.
6. Make sure that athletes have been carefully taught proper technique for each exercise. When increases in loading occur, make sure this proper technique is maintained and is intact. Proper technique is also needed when

using machines, and it is very important that there is a proper fit for body size and proper range of movement for the exercises being performed.

Exercise Selection for Qualified Athletes

Selecting exercises used for strength training for qualified athletes is substantially more complex than for beginners. The general idea is simple: Exercises used for strength training must be *specific*. This means that training drills must be relevant to the demands of the event an athlete is training for. Strength training drills must mimic the movement pattern that the pertinent sport skill actually entails. Here again, the term *specific* is oftentimes misinterpreted and major whole-body exercises are not used in favor of smaller or isolated exercises; this is a mistake. The importance of whole-body exercises cannot be emphasized enough for any

athlete because the kinetic chain and its control allows for optimal performances in most sports. Furthermore, such exercises can be effectively and safely loaded to benefit athletes by preventing injury and strengthening tissue that takes the pounding of sport training and practice (e.g., distance runners and gymnasts). From these whole-body major muscle group exercises, other exercises are then used to create the training program with the specificity needed for each sport and individual athlete.

However, the practical realization of this general idea is not easy. Coaches and athletes have made many efforts to find the most effective strength training drills for various sports. The main requirements of this task are described in the following section. Yielding strength and strength in reversible muscle action are considered separate motor abilities and will be discussed later in the chapter.

Working Muscles

The requirement regarding working muscles is most evident and simple. The same muscle groups must be involved in both the main sport event and in the training drill. For instance, heavy resistance exercises for the improvement of paddling in canoeing should focus on the muscles utilized in the motion patterns associated with the paddle stroke.

Unfortunately, this obvious requirement is not satisfied very often in athletic practice. Coaches and athletes often employ exercises and training equipment that are not specific—that do not involve the muscle groups active in the main sport movement. Thus, after training the major muscle groups, angle specific-type exercises are needed to address these sport-specific movements in the sport. For instance, in swimming, the athlete's

Exercise Machines Versus Free Weights

Strength exercise machines are presently in broad use. When exercising on the machines, there is no need to balance or control the weight: The movement trajectory is prescribed (scientists would say that the system has only one degree of freedom). This is different from many real-life situations in which objects must be stabilized. For instance, when lifting a barbell above the head the athlete must control the barbell position. If the barbell is displaced forward or backward the equilibrium is lost, which may result in an unsuccessful attempt and injury. In contrast, exercise machines constrain movement in certain directions. Other examples of mechanically constrained movements include opening a door, pushing a bobsled, and pedaling on a bicycle. When performers must stabilize an object in addition to exerting force on it in space, the force production drops. The force loss is a price we pay to stabilize the object.

When the movement is constrained, the performer may exert force in a direction different from the direction of motion and still perform the task. The actual constraints—the tangible physical obstacles to movement—may completely change joint torques. Consequently, different muscle groups may act when body motion is free or is actually (physically) constrained. In particular, when working on strength exercise machines, the direction of the end-point force and the joint torques may be quite distinct from what is observed in lifting or holding free weights. This may be not very important for recreational athletes, but it may be detrimental for experienced athletes whose immediate goal is the performance improvement.

Training with exercise machines as compared with free weights has certain pros and cons. The advantages include the following:

- The initial weight can be applied at low level and increased in small increments (1 kg or less);
- the risk of injury is smaller (provided that overexertion is avoided) and proper technique and fit are present;
- once learned, the technique is simpler because the machine controls the movement path. It is simple, and less time is consumed.

However, free weights are more specific for athletes. The general conclusion is that exercise machines are recommended for recreational and beginning athletes (free weights can also be used), while training with free weights—even though it requires studying lifting techniques—is advantageous for experienced athletes striving for performance improvement.

hand moves along a complex curvilinear trajectory that includes inward and outward motions (see figure 6.2). The resistance vector occurs in a three-dimensional space (figure 6.2a). During dryland training, however, swimmers typically use exercise devices with linear, straight-back pulls (figure 6.2b). Muscle activity patterns during such training are distinctly different from those experienced while swimming. It is preferable to mimic the three-dimensional hand resistance that occurs in swimming by using two- and three-dimensional exercise devices (figure 6.2c).

Muscle activity in the same exercise can vary if the performance technique, such as the body posture, is changed. This is illustrated in figure 6.3. An athlete performs shoulder squats with a barbell using different lifting techniques. Not only does the level of muscle activity change, but also the involvement of specific muscle groups; the knee extensors are used in some instances and the knee flexors in others. This underscores the need for teaching and monitoring exercise techniques, and paying attention to the positions of the exercises used in the different planes of movement when choosing exercises for a training program.

Four techniques are employed to identify the working muscle groups:

1. Muscle palpation. Muscles that become tense are the involved muscles and these should be trained with heavy resistance.
2. With new cell phone applications, the basic biomechanics and heat production can be observed and can indicate muscles that are active due to thermal heat production.
3. Biomechanical analysis of the joint torques similar to that presented in figure 6.2. The method is good but in many cases too complex for practical use.
4. Registering muscle electric activity, or **electromyography (EMG)**. This method is superior, but special equipment and technical personnel are needed for this type of analysis.

Other requirements for exercise selection, described later in this chapter, are less obvious. These are based mostly on factors determining the amount of muscular strength available in various motor tasks (see chapter 2).

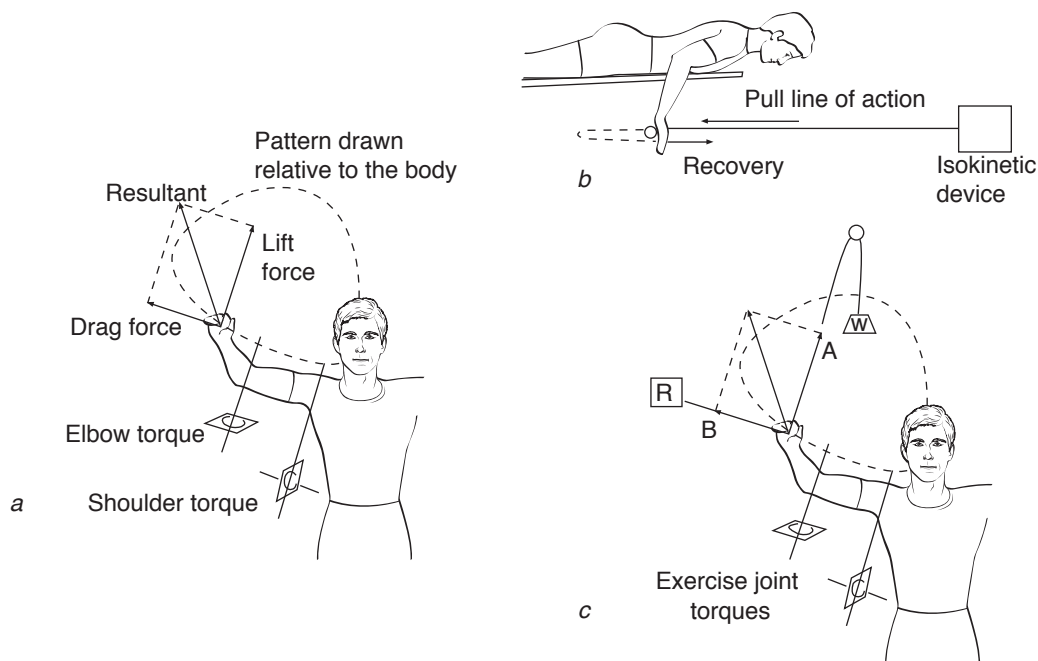

FIGURE 6.2 Swimming stroke patterns and exercise devices for dryland training. (a) Arm trajectory and propulsive forces in the breaststroke. (b) An exercise device with a straight-line pull. The device provides only single-line, one-dimensional resistance. (c) Two-dimensional resistance force. Two resistances, A and B, are provided that duplicate the lift and **drag** components of propulsive swimming force.

Reprinted by permission from R.E. Schleihauf, "Specificity of Strength Training in Swimming: A Biomechanical Viewpoint," in *Biomechanics and Medicine in Swimming*, edited by A.P. Hollander, P.A. Huijting, and G. de Groot (Champaign, IL: Human Kinetics, 1983), 188, 189, 190.

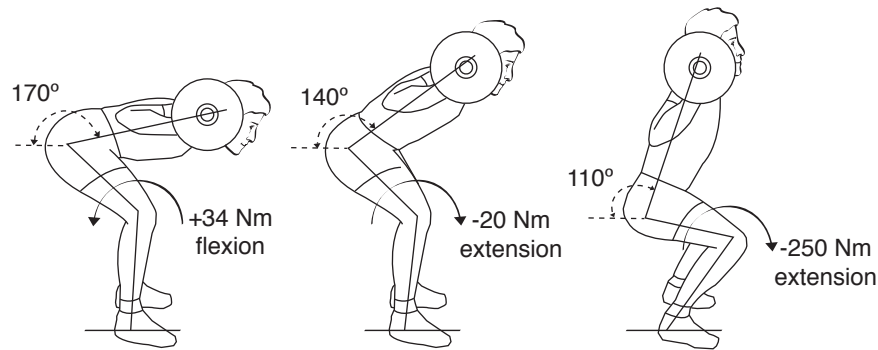

FIGURE 6.3 Net muscle moments in the knee joints (Nm) during squatting with an 80-kg barbell. Both the magnitude and direction (flexion or extension) of the moment are altered when the athlete's posture is changed.

From V.M. Zatsiorsky and L.M. Raitsin, *Force-Posture Relations in Athletic Movements* (Moscow: Russian State Academy of Physical Education and Sport, 1973). Technical report. By permission of the Russian State Academy of Physical Education and Sport.

Type of Resistance

In terrestrial movements, the weight or mass of an object (an implement, a barbell, one's own body)—or a combination of weight and mass—usually serves as resistance. In aquatic sports, such as swimming, rowing, kayaking, and canoeing, the resistance is determined by principles of hydrodynamics. If the training drill resistance is different from the resistance in the sport event the athlete is training for, both the force production (recall figure 2.3) and the pattern of muscle activity are also different.

In terrestrial movements, when an object of given mass (a throwing implement or an athlete's extremity) is accelerated, the burst of muscle action is concentrated both in time and in space. Thus, the muscle action is of short duration and the maximal force is developed in a specific body position. If other types of external resistance are used in training (e.g., devices with hydraulic resistance, rubber cords, and isokinetic machines), the maximal force is developed either throughout the whole range of the angular motion or in a body position different from the position used in the sport event. The muscle action is not concentrated

in time but instead tends toward protracted activation. Such exercises are not specific for on-land athletic events. The first choice for these sports is exercises that use free weights, the body mass, or both as resistance.

In aquatic sports, water resistance (while pulling through the water) increases with velocity (an example of mechanical feedback; see chapter 2). The relationship is quadratic, meaning that external force applied by the athlete is proportional to the squared velocity of the arm or paddle relative to the water. Athletes contract their muscles in a protracted way. This type of activity must be simulated during dryland training. The best choice here is training equipment in which the resistance is proportional to the velocity squared; however, this equipment is rather expensive and impractical.

There are also machines in which the resistance (F) is either proportional to the velocity of movement or constant through the whole range of the motion. In the first type of device, oil viscosity is used as a resistant force. In an apparatus based on hydraulics, the oil is squeezed from one chamber

Are Chin-Ups and Dips Equally Effective for Various Sports?

A conditioning coach is working with several varsity teams: football players (running backs and wide receivers), volleyball players, swimmers, and rowers. She has been asked by the head coaches to pay special attention to the enhancement of arm strength. Her general philosophy is to use exercises used for strength training that are specific to relevant sports. In addition, the time available for strength training is limited. Thus, she must recommend only the most efficient exercises. The following five variants of chinning (on a horizontal bar) versus dipping (on a parallel bar) distribution are considered: 100%/0%, 70%/30%, 50%/50%, 30%/70%, and 0%/100%.

What is your choice? Please substantiate it.

to another through an adjustable orifice. The greater the velocity of the forced oil displacement, the greater the resistance offered by the training device. Such devices usually provide resistance only in the concentric phase of the movement. In **pneumatic** devices where resistance is due to air pressure, resistance can be provided on both eccentric (positive) and concentric (negative) movements. Again, however, equipment can be expensive and multiple stations are needed to exercise all of the different muscle groups in the body. In devices of the other type, dry (Coulomb's) friction serves as resistance. The force (F) is constant if the velocity (V) is not equal to 0 ($F = \text{constant}$, if $V > 0$). The

force may be changed from 0 to F at zero velocity. These types of devices should be used as a second choice.

Time (and Rate) of Force Development

Because of the explosive strength deficit (ESD; see chapter 2), maximal force F_{mm} cannot be attained in the **time-deficit zone**. If the training objective is to increase maximal force production (F_{mm}), there is no reason to use exercises in the time-deficit zone, where F_{mm} cannot be developed. Furthermore, heavy resistance exercises are not very useful for enhancing the rate of force development in qualified athletes (figure 6.4).

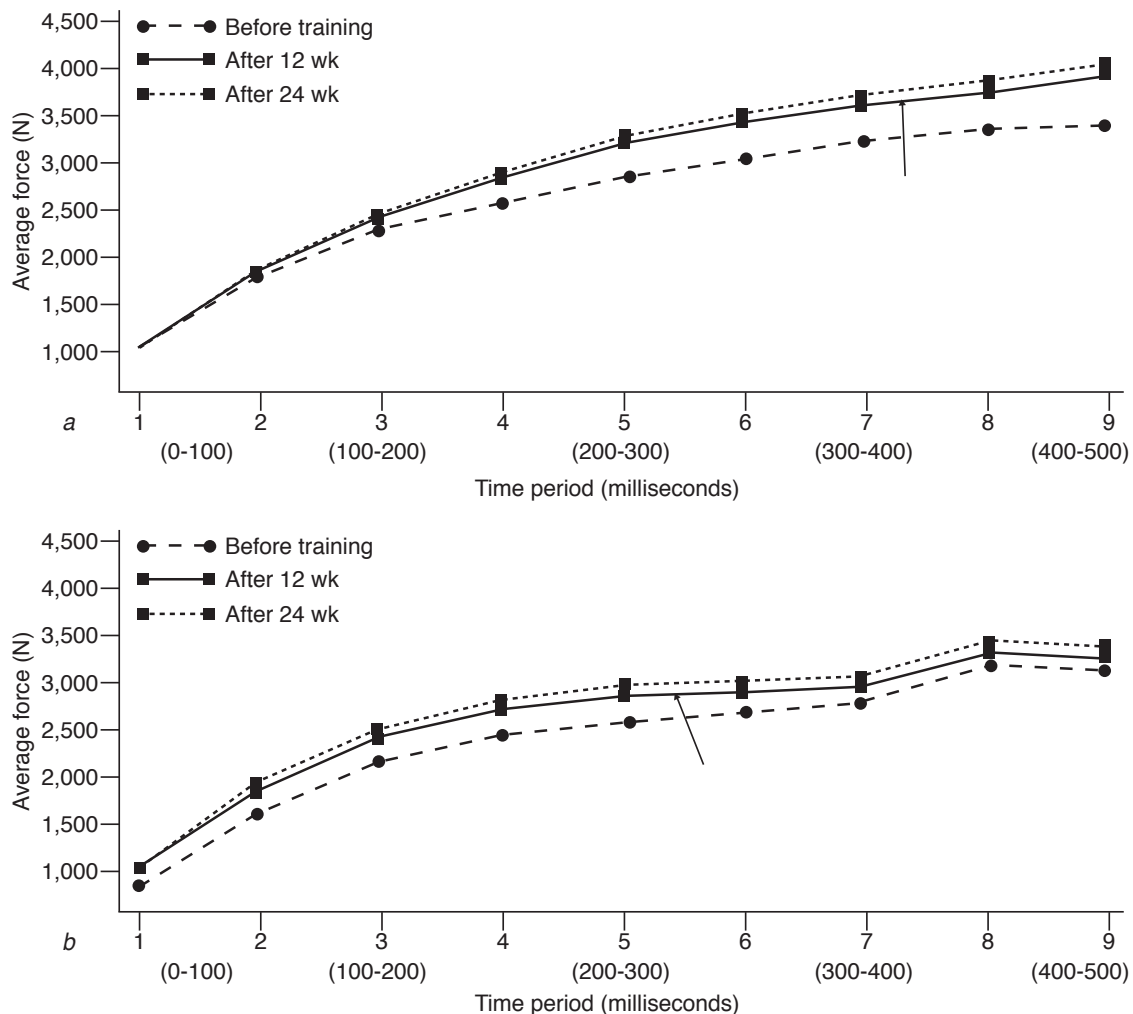

FIGURE 6.4 The influence of heavy resistance training (a) and dynamic (explosive, power) resistance training (b) on maximum strength and the rate of force development during an explosive maximal bilateral leg extension. As a result of heavy resistance training, only F_{mm} , not the initial part of the force–time curve, is enhanced. The rate of force development, especially the S-gradient, is unchanged.

(a and b) Adapted from K. Häkkinen and P.V. Komi, "Changes in Electrical and Mechanical Behavior of Leg Extensor Muscles During Heavy Resistance Strength Training," *Scandinavian Journal of Sports Sciences* 7 (1985): 55-64. (a only) Also adapted from K. Häkkinen and P.V. Komi, "Effect of Explosive Type Strength Training on Electromyographic and Force Production Characteristics of Leg Extensor Muscles During Concentric and Various Stretch-Shortening Cycle Exercises," *Scandinavian Journal of Sports Sciences* 7 (1985): 65-76. Used with permission of P.V. Komi.

If the general objective of training is to increase force production in explosive types of movement, in principle this can be done in one of two ways. One option is to increase maximal force F_{mm} . This strategy, however, brings good results only when the ESD is substantially less than 50%. As an example, imagine two athletes who put a shot with a force of 500 N. The first athlete can bench press a 120-kg barbell (roughly 600 N per arm). The ESD for this athlete is $[(600 - 500) / 600] \times 100 = 16.67\%$. This is an extremely low value for a shot-putter. The athlete has a great potential to improve performance by increasing F_{mm} . Lifting a 200-kg barbell in the bench press will surely lead to improvement in this individual's performance. For the other athlete, 1RM in the bench press is 250 kg. The ESD is $[(1250 - 500) / 1250] \times 100 = 60\%$. Further improvement of this athlete's maximal bench press, say to 300 kg, will not result in improvement in shot-putting performance.

The second option for training to enhance force production is to increase the rate of force development. It has now been shown that to enhance power training in elite athletes, maximal strength is vital (i.e., squat $2 \times$ body mass). Thus, heavy resistance exercises alone are not the best choice in this instance, especially for elite athletes as they must train the entire force-velocity curve. Special exercises and training methods are a better alternative.

Velocity of Movement

The effects of an exercise used for strength training depend on movement velocity. If exercises are performed in the high-force, low-velocity range of the **force-velocity curve** (figure 6.5a), the maximal force F_m increases mainly in the trained range. On the other hand, if exercise is done in the low-force, high-velocity range, performance improves primarily in this area (figure 6.5b).

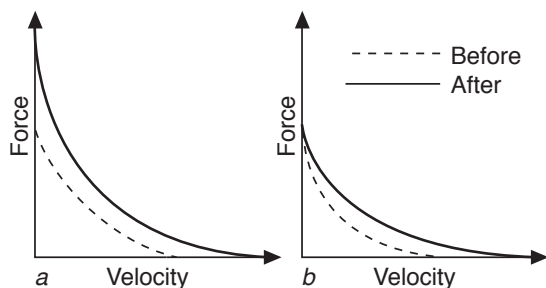

FIGURE 6.5 Force-velocity relations before and after muscle power training with different loads. (a) High resistance (around 100% of F_{mm}); (b) low resistance (around 0% of F_{mm}).

These findings serve as a basis for the recommendation to develop dynamic force at speeds that approximate the athletic motion. It is recommended to choose the resistance magnitude that will produce a movement in the same velocity range as the relevant sport event. However, if an exercise is performed in the low-force, high-velocity range, the time available for movement may be too short to develop the maximal force during the movement. The situation we looked at earlier, with training either F_{mm} or rate of force development, occurs. Hence, dynamic strength training should be complemented by training of the rate of force development and F_{mm} (see the preceding section on time and rate of force development).

Do not misinterpret the suggestion to perform exercises used for strength training with maximum velocity as advice to execute these exercises with high frequency (high number of repetitions per minute). Too high a frequency has been shown in several experiments to impede strength gain. If movement frequency is in the medium range, its precise value is of no importance. In one experiment, for instance, strength gain in the bench press was similar when a barbell was lifted 5, 10, or 15 times per minute but was much smaller for athletes who performed the lifts with the maximum possible frequency.

Are Exercises Used for Strength Training Equally Useful for All Athletes?

Two athletes of similar body dimensions possess equal achievements in the standing vertical jump. Their performances in barbell squats, however, are different. Athlete P squats a barbell equaling his body weight (BW). Athlete Q can squat a $1.5 \times$ BW barbell. For which of these athletes will barbell squatting be more beneficial? Why?

Force-Posture Relations

By selecting a proper body position in exercises used for strength training, an athlete can (1) vary the amount of resistance, (2) load particular muscle groups to different degrees, and (3) fine-tune the resistance to the joint strength curves. For instance,

What Is the Optimal Weight of Medicine Balls?

Medicine balls are popular implements for training throwing tasks. In one study, the optimal weight of medicine balls for dryland training of water polo players was determined. The ball velocity in natural conditions (in the water) served as a criterion. The results showed that the optimal medicine ball weight for dryland training is approximately 2.0 kg. Both the correlation with throwing velocity in water conditions and the gain in velocity due to training were highest with medicine balls of this weight.

in push-ups the amount of resistance can be changed by placing the hands or legs at various elevations (figure 6.6). In bench presses, the different loading of the shoulder and elbow extensor muscles can be achieved by varying the grip width: The wider the grip, the larger the load on the muscles serving the shoulder joints.

In the ensuing paragraphs, we will discuss fine-tuning resistance to the joint strength curves. The idea behind these adjustments is to train the muscular strength at different muscle lengths. Effects

of strength training are posture specific and hence muscle-length specific (figure 6.7). In strength training of experienced athletes, this fact should be taken into account.

The magnitude of weight that an athlete can lift in a given motion is limited by the strength attainable at the *weakest point* of the full range of joint motion. In other words, the weakest point of a muscle group determines the heaviest constant weight that can be lifted. If the constant external resistance (such as a barbell of a given weight) is

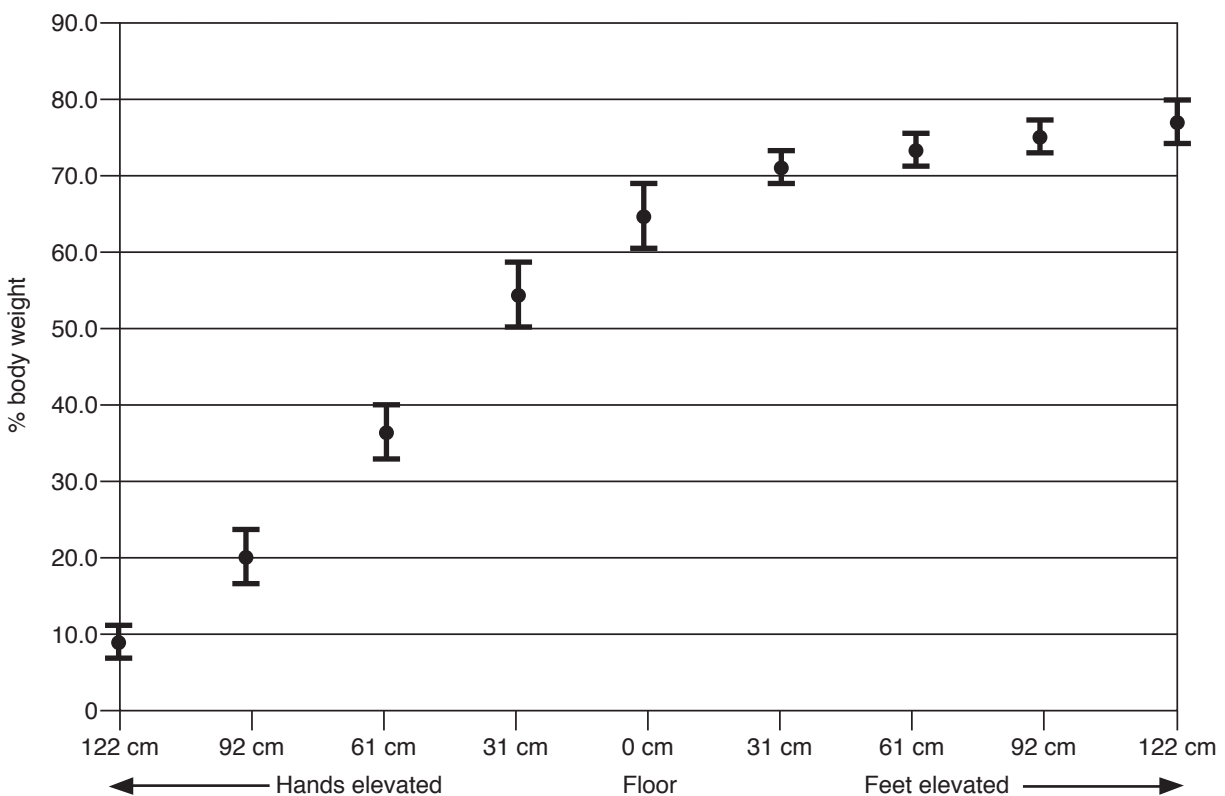

FIGURE 6.6 Percent body weight supported by the hands during push-ups at various body postures. Depending on the elevation levels of the hands and arms, the resistance changes from approximately 10% to 75% of the body weight. With the hands and the legs on the floor, the hands support approximately 65% of the body weight.

Data from research by M. Duffey and V.M. Zatsiorsky (2002).

used in heavy resistance training, the muscles are maximally activated at only the weakest point of the motion. For instance, there is a threefold difference in the maximal force that can be developed at different angles of hip flexion (figure 6.8). If someone lifts the maximal weight that is equal to 100% of F_m at the weakest point of movement (at a 70° hip-joint angle), the hip flexor muscles are taxed to only 33% of maximal strength at the strongest point (at a 150° angle). The muscles are not required to exert maximal force in this region.

Three approaches are used in contemporary strength training to manage the force-angle paradigm (the fourth “solution” is to not pay attention to this issue at all). They are the peak-contraction

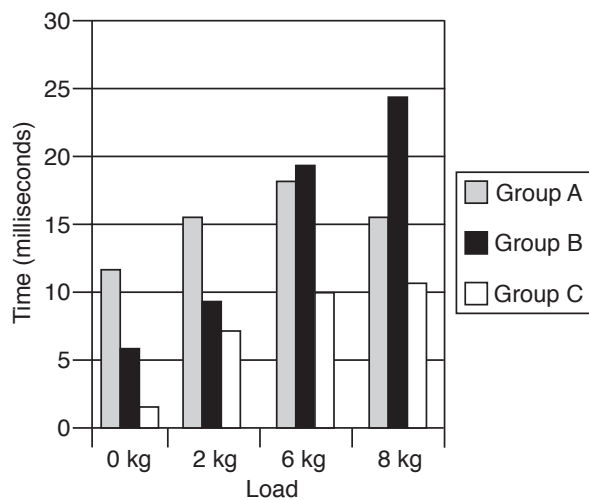

FIGURE 6.7 Effects of isometric training at the different joint positions on the time of the maximally fast arm movement (the difference between the movement time before and after the training). Starting from the dependent posture, the subjects ($n = 32$) performed a maximally fast shoulder flexion with a barbell in the hand. The mass of the barbells was 2, 6, and 8 kg. The subjects were beginning weightlifters (age 17 ± 1.2 years). In addition to the main training routine that was the same for all the subjects, group A (11 subjects) performed isometric training of the shoulder flexors at an angle of 0° to 5°. Group B trained at a shoulder angle of 90°. Group C (10 subjects) served as a control. The isometric training consisted of 3 sets of 3 maximal efforts in a session, 3 times per week, for 24 wk. The rest intervals equaled 10 s between the trials and 60 s between the sets. Training at an angle of 90° was beneficial for lifting a heavy 8-kg barbell, while training at the starting position was advantageous for lifting a 2-kg barbell and moving the unloaded arm.

Reprinted by permission from V.M. Zatsiorsky, 2003, “Biomechanics of Strength and Strength Training,” in *Strength and Power in Sport*, 2nd ed., edited by P.V. Komi (Oxford: Blackwell Science, 2003), 467, by permission of John Wiley & Sons.

principle, accommodating resistance, and accentuation.

The Peak-Contraction Principle

The idea behind the **peak-contraction principle** is to focus efforts on increasing muscular strength primarily at the *weakest points* of the **human strength curve**. Thus the entire performance, for instance 1RM, is enhanced. In practice, the peak-contraction principle is realized in one of three ways.

Selection of a Proper Body Position The resistance offered by the lifted load is not, in reality, constant over a full range of joint motion. The resistance is determined by the moment of gravitational force (i.e., by the product of weight and horizontal distance to the axis of rotation) rather than by the weight of the implement or the body part itself. The moment of gravitational force is maximal when the center of gravity of the lifted load is on the same horizontal line as the axis of rotation. In this case, the lever arm of the gravitational force is greatest. By varying body posture, it is possible, to an extent, to superimpose the human strength curve on the resistance curve in a desirable manner.

The peak-contraction principle is realized, if worse comes to worst, when the external resistance (moment of gravity force) is maximal at the point

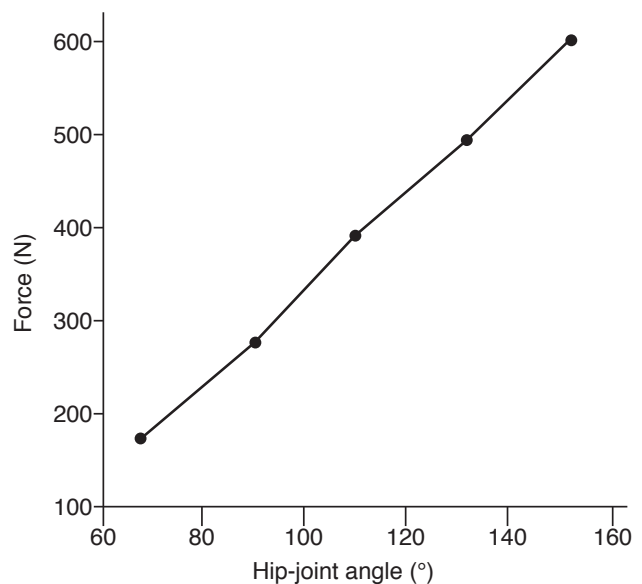

FIGURE 6.8 Strength curve in hip flexion. Isometric force, men. Angle of 180° is in anatomical position.

Adapted by permission from M. Williams and L. Stutzmann, “Strength Variation Through the Range of Joint Motion,” *Physical Therapy* 39, no. 3 (1959): 145-152, by permission of the American Physical Therapy Association.

where muscular strength is minimal. The corresponding body position is called the minimax position. The term *minimax* literally means “minimum among maximums.” At each of the joint angles, the strength that is maximal for this position, F_m , is developed. The minimum F_m from this set is the minimax value.

To visualize this concept, compare an exercise such as leg raising from two starting body positions: lying supine and hanging on a horizontal bar (figure 6.9). The second exercise imposes a much greater demand than the first.

The resistance (moment of gravity force) is nearly equal in the two exercises and reaches its maximum when the legs are placed horizontally. However, when the legs are raised in the recumbent position, the maximal resistance coincides with the strongest points of the force–angle curve (the hip flexor muscles are not shortened). When the same leg raising is performed on the horizontal bar, the hip flexor muscles are shortened at the instant the legs cross the horizontal line. Thus, the position of maximal resistance coincides with the minimal (weakest) point on the force–angle curve (“worse comes to worst”).

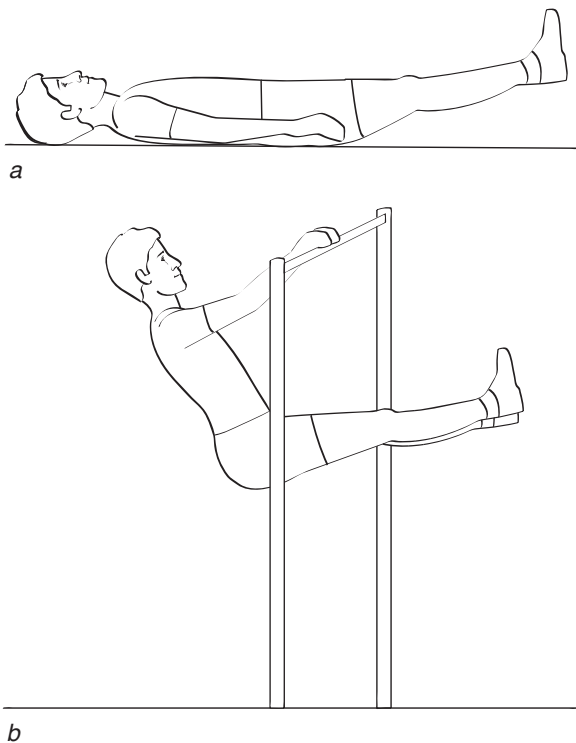

FIGURE 6.9 Leg raising from two starting positions: (a) a supine position and (b) on a horizontal bar. The exercise is more difficult to perform when it is performed on a horizontal bar.

Use of Special Training Devices An example of a special device is shown in figure 6.10. If a barbell were used in the arm curl, the maximal resistance would be at the horizontal position of the forearms. In contrast to the situation with the peak-contraction principle, the strength of forearm flexion at the elbow joint is maximal, not minimal, at this position. With the device shown in figure 6.10, maximal resistance coincides with the weakest point on the human strength curve.

The Slow Beginning Motion A slow start can be used in strength drills such as the inverse curl shown earlier (figure 4.6). The maximal resistance in this exercise is offered while the trunk is in the horizontal position. If the movement begins too fast, the lift in the intermediate range of motion is performed at the expense of the kinetic energy acquired in the first part of the movement. The erector spinae muscles, then, are not fully activated. Experienced athletes and coaches advocate a slow start for this drill.

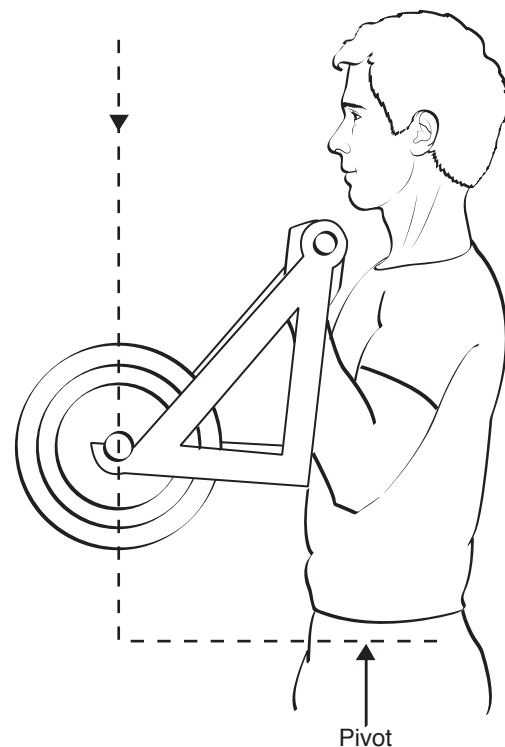

FIGURE 6.10 A device used to implement the peak-contraction principle. The device is employed to perform the arm curl. With this device, the highest resistance is provided at the end of the movement. When the elbow is maximally flexed, the athlete’s strength (i.e., the force magnitude) is minimal (see figure 2.22) and the resistance is the greatest (“worse comes to worst”).

Studies of maximal external resistance (moment of force) exerted against different points along the human strength curve (strong points or weak points) have shown that when the peak-contraction principle is employed, strength gains are higher. Thus, this training protocol has a definite advantage. Another benefit is the relatively small amount of mechanical work performed (the total weight lifted). A disadvantage, however, is that the transfer of training to other body positions is relatively low (see figure 1.3 on page 8). A coach should consider the pros and cons of this principle before implementing it.

Accommodating Resistance

The main idea of **accommodating resistance** is to develop maximal tension throughout the *complete range of motion* rather than at a particular (e.g., weakest) point. The idea was first suggested in 1879 by Zander, who developed many strength exercise machines based on this principle. The accommodating resistance was the cornerstone of the **medico-mechanical gymnastics** popular before World War I. Today, some of the Zander equipment can be seen at the Smithsonian Institution in Washington, D.C. Accommodating resistance can be achieved in two ways. One type of system offers *high resistance without mechanical feedback*. In this case, the speed of motion is constant no matter how much force is developed. This principle is realized in isokinetic equipment. The movement speed on such devices can be preset and maintained (kept constant) during a motion regardless of the amount of force applied against the machine. The working muscles are maximally loaded throughout the complete range of motion. (Isometric exercises at different joint angles, in which velocity is zero, can be considered an extreme example of this approach.) Because the velocity of muscle shortening is predetermined, the training of different types of muscle fibers (fast or slow) can potentially be stressed within the framework of the isokinetic protocol.

Isokinetic training, while very popular in physical therapy, is rarely used by elite athletes. It has shortcomings besides the high cost of the equipment, which may be prohibitive. The angular velocity of movement is typically relatively low—below $360^\circ/\text{s}$ (it may be above $5,000^\circ/\text{s}$ in athletic movements). Most training devices are designed to exclusively perform one-joint movements that are only used sporadically in athletic training.

Another type of system provides *variable resistance* that is accommodated to either the human strength

curve or movement speed. In some machines, resistance is applied in concert with the human strength curve (Nautilus-type equipment). Because of the special odd-shaped cams on these machines, the lever arm of the resistance force or applied force is variable so that the load varies accordingly (figure 6.11). The resistance (moment of force) varies in accordance with an athlete's capabilities. This variation provides greater resistance at the joint configurations where the athlete is stronger and lower resistance at weaker positions. The user must exert maximum effort throughout the range of movement.

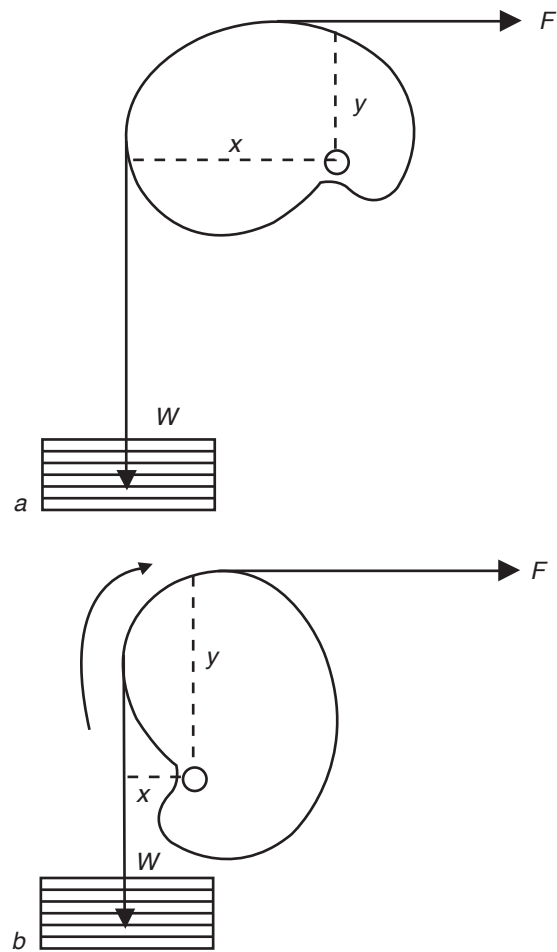

FIGURE 6.11 A cam with variable lever arms. In this arrangement, the moment arms of both applied force (F) and weight force (W) are variable. (a) The moment arm of the applied force (y) is smaller than the lever arm of the weight force (x), $y < x$; this ratio is used at points of the strength curve where a larger F can be exerted; (b) $y > x$; this ratio is used at the weakest points of the strength curve.

Adapted from M.H. Stone and H.S. O'Bryant, *Weight Training: A Scientific Approach* (Minneapolis, MN: Bellwether Press, 1987), 84, by permission of M.H. Stone.

Unfortunately, the cams of many machines are incorrectly designed and the offered resistance, contrary to claims, does not match average strength curves. A simple way to vary (increase) resistance while lifting a barbell is to use lifting chains: One end of a heavy chain is fixed to the barbell while the second end remains on the floor during the entire lift. While the bar is being lifted some links of the chain are lifted from the floor and, hence, the lifted weight increases. In such movements as barbell squats, bench presses, and military presses, lifting chains help adjust the resistance to the strength curve (see figure 2.26 on page 39). However, in some lifts that involve many body parts, the shapes of the strength curves are rather complex (see figure 2.21 on page 36), and using chains in such exercises would not be useful.

Another type of exercise apparatus accommodates resistance to movement velocity. The higher the velocity, the greater the resistance offered by the system. These devices are typically based on hydraulic principles. The velocity of movements with hydraulic machines, in contrast to isokinetic devices, may vary depending on the strength of the trainee.

Scientific experts have often questioned the validity of claims for high exercise efficiency with accommodating resistance. Exercises performed with strength training machines are biomechanically different from natural movements and traditional exercises. Most notably, the number of degrees of freedom (permissible movement directions) is limited from six in natural movements to only one with exercise machines; the typical acceleration-deceleration pattern is also different. Though isokinetic training may have certain advantages in clinical rehabilitation settings, studies have repeatedly failed to demonstrate that accommodating resistance exercises (e.g., isotonic, variable cams) hold an advantage over free-weight exercises for increasing muscular strength and inducing muscle hypertrophy.

Accentuation

In **accentuation** the main idea is to train strength only in the range of the main sport movement where the demand for high force production is maximal. In natural movements, at least on land, muscles are active over a relatively narrow range of motion. Usually, maximal muscle activity occurs near the extreme points of angular motion. The movement of body parts is first decelerated and then accelerated by virtue of muscular forces. For

instance, during the swing movement of a leg (e.g., in jumping and running), the previously stopped thigh is accelerated prior to the vertical position and decelerated afterward (figure 6.12a).

If the training objective is to increase the dynamic strength of the hip flexor muscles to improve velocity of the swing movement, there is no reason to increase the strength of these muscles beyond the range this activity requires. An exercise that satisfies the requirement for specificity of the range of force application is shown in figure 6.12b.

Accentuation is the most popular exercise strategy among many superior athletes because this approach best satisfies the requirements for exercise specificity. For instance, there is no reason to develop the strength of hip flexor muscles in their weakest position, as recommended by the peak-contraction principle, because in this range of motion it is the hip extensors, not flexors, that are active (recall figure 6.12). The same is true for exercises with accommodating resistance. There is no need for athletes to train maximal strength

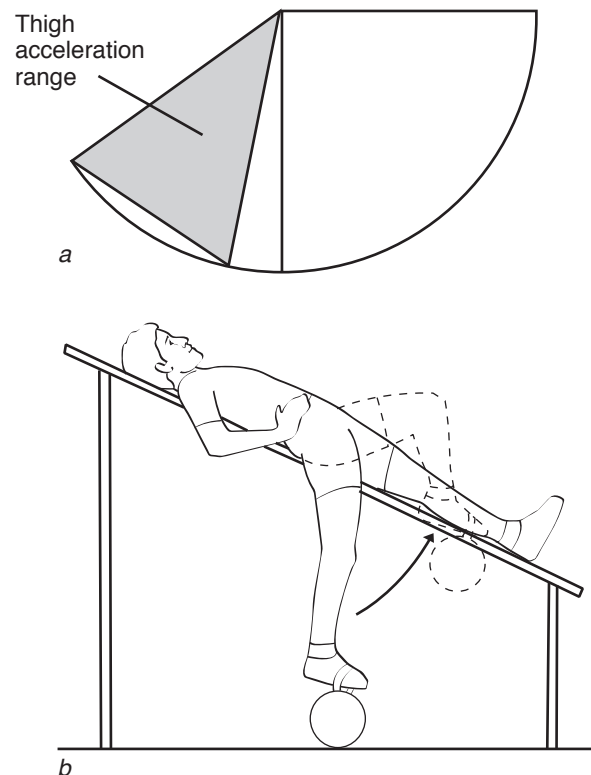

FIGURE 6.12 (a) Accentuated range of motion in swing movement of the leg. (b) An exercise designed to satisfy the requirement for accentuated muscular efforts.

Reprinted by permission from D.D. Donskoy and V.M. Zatsiorsky, 1979, *Biomechanics* (Moscow: Fizkultura i Sport, 1979), 100.

over the full range of motion if the maximal force is required in only a small part of the range.

Dynamic exercises that satisfy the requirements for exercise specificity constitute the greater portion of training protocols for qualified and

superior athletes. In the strength conditioning of elite Soviet athletes in track and field and other dryland summer sports in 1987 and 1988, more than 95% of all sets used free weights or body weight as resistance. In aquatic sports (swimming,

Squatting or Semisquatting?

A conditioning coach recommended exercises for the enhancement of leg extensor strength for six groups of athletes—elite, intermediate, and beginning volleyball players and ski jumpers. The elite and intermediate athletes had proper weight training experience, including squatting. The beginning athletes were only slightly accustomed to these exercises. The exercises the coach considered were squatting with a barbell, semisquatting, leg press against a weight, and leg press against isokinetic resistance. She then analyzed the following pros and cons:

- *Exercise specificity.* Ski jumpers perform takeoffs from a deep squat position; volleyball players almost never jump for height from deep squats.
- *Force–posture relationships.* Athletes are able to lift a greater load using a semisquat versus a squat technique. For instance, an athlete may be able to lift a barbell that is 1 body weight (BW) using the squat, and a load of 1.2 BW in a semisquat. When full squats are performed, the top effort is required only when knees are deeply bent. However, at the range of joint motion specific to a volleyball takeoff, the leg extension force generated during full squats is far from maximal (the athlete lifts only a 1-BW load but is able to lift a 1.2-BW barbell).

Thus, if the coach favored the peak-contraction principle, she would most probably recommend the deep squats (since the highest requirements are for force production in the deepest knee-bent posture where the potential for force generation is minimal). If she selected the accommodation-resistance approach, the proper exercise would be a leg press against isokinetically adjusted resistance. Finally, if exercise specificity was a matter of primary importance and she favored the accentuation principle, the selected exercises would vary between the two sports. The semisquats would be more specific for volleyball players, while the squats would be specific for ski jumpers.

- *Load imposed on lumbar spine and injury risk.* These are highest in semisquatting (because of the extremely high load), average in squats, and minimal in leg presses.

After consideration, the coach recommended the following (percentage of sets):

Skill level	Volleyball players	Ski jumpers
Elite	60% semisquats 25% squats 15% leg presses (against a weight)	20% semisquats 50% squats 30% leg presses (against a weight)
Intermediate	30% semisquats 40% squats 30% leg presses (against a weight)	10% semisquats 50% squats 40% leg presses (against a weight)
Beginning	0% semisquats 25% squats 75% leg presses (40% against a weight and 35% against isokinetic resistance)	0% semisquats 25% squats 75% leg presses (40% against a weight and 35% against isokinetic resistance)

In the beginners' group, the weight lifted in deep squats was relatively low (6RM-10RM) and primary attention was given to proper lifting technique.

rowing) the proportion of sets with free weights was below 40%.

Additional Types of Exercises Used for Strength Training

Superior athletes mainly use dynamic training exercises of concentric muscle action. Other types of exercises are used in training routines, however, either as supplementary training or for developing specific strength abilities other than F_{mm} .

Isometric Exercises

Isometric training requires no expensive equipment, can be performed anywhere, and, if the number of trained postures is few, takes little time. In spite of these advantages, isometric exercises are used in athletic training mainly as a supplemental training tool, for several reasons. First, they lack the specificity necessary for strength gains (especially for dynamic sport movements). Second, there is little transfer of training effects from the angular position selected for training to other joint angle positions. If a muscle group is overloaded (for instance at 100°), the strength gain will occur at that angle with little improvement at other angles (see again figure 1.3 on page 8 and figure 6.7 on page 108). In addition, these exercises are sometimes painful for superior athletes. The forces isometrically developed by elite athletes are extremely high. In the isometric imitation of lifting a barbell from the floor, for example, the maximal force F_{mm} in the most favorable body position may be well above 8,000 N in elite weightlifters. The mechanical load acting on different body structures, such as the lumbar spine, may exceed safe levels.

A coach who is planning isometric training should keep in mind that accommodation to isometric exercises occurs very quickly. In qualified athletes, strength gains peak in about 6 to 8 wk. Thus, the isometric training routine should be planned, maximally, for 1 to 2 mesocycles.

The following guidelines govern isometric training protocol:

- *Intensity*—maximal effort
- *Effort duration*—5 to 6 s
- *Rest intervals*—approximately 1 min if only small muscle groups, such as calf muscles, are activated; up to 3 min for large, proximally located muscles
- *Number of repetitions*—usually 3 to 5 for each body position

- *Training frequency*—4 to 6 times per week with the objective to increase F_{mm} ; 2 times per week for maintenance of the strength gain
- *Body position*—(1) in the weakest point of the strength curve, or (2) throughout the complete range of motion with intervals of 20° to 30°, or (3) in an accentuated range of angular motion

The second variant on body position is time consuming because many angles within the range must be strengthened. Qualified athletes typically recognize the third variant as the most efficient.

Isometric efforts of large, proximally located muscles may produce a high rise in blood pressure. Individuals at risk of cardiac disease, atherosclerosis, or high blood pressure should avoid these exercises. Athletes should check arterial pressure at least once a week during periods of isometric training.

Because of rapid accommodation, the strength gain from isometric exercises is generally less than from dynamic exercises. This should be taken into account when isometric strength gain is the training objective. A typical example is the cross, a ring exercise performed in men's gymnastics. As a routine sequence in this case, the gymnast should use dynamic exercises at the beginning (to speed up strength enhancement) and then intermittently add isometrics to improve the specific coordination pattern.

Isometrics are also used in sport to enhance static muscular endurance, for example in long-distance speed skating, where the demand for maintaining a bent trunk posture is extremely high. In 10,000-m skating, the load of the inclined body position has to be sustained for about 15 min. Isometrics may be used also to improve posture stability, such as that required in shooting a handgun. Holding a 3- to 5-kg weight (instead of a pistol) up to 1 min in the shooting position is a useful training exercise for shooters at the intermediate, not the superior, level. This exercise helps reduce the amplitude of arm microvibration (supposedly by increasing strength in the slow tonic muscle fibers).

Self-Resistance Exercises

Exercises based on self-resistance, not included in the classifications considered earlier, are rarely used in training and are not recommended. In such exercises, the tension of antagonist muscles resists tension of the primary **agonistic muscle group**. If the muscles are near maximal activation, the training load is extremely high. Healthy

people may do these exercises, though cautiously, for general muscle development. Immediately after self-resistance exercising, the muscles become tough and nonelastic (their resistance to palpation or indentation increases) and the circumference of the extremity enlarges. This creates the visual impression of muscular hypertrophy; for this reason, some bodybuilders do self-resistance exercises just before a contest to improve their outward appearance.

The intentional, forced activation of antagonistic muscles, however, harms the proper coordination pattern desired in almost all sport skills. Therefore, self-resistance exercises are not recommended for athletes.

Yielding Exercises

Heavy resistance exercises with eccentric muscle action (yielding exercises) are seldom used in strength training. (The term *plyometrics* for these exercises is problematic because of its misuse. Strictly speaking, plyometrics refers to movements with eccentric muscle action. However, many authors have used this term for exercises with reversible muscle action, such as depth jumping, in

which both eccentric and concentric types of muscle action are involved.)

Eccentric exercises easily provoke delayed muscle soreness. All athletes, at one time or another, experience delayed muscle pain, soreness, and a concomitant decrease in strength after exercise sessions. The soreness occurs typically 24 to 48 h after the workout. Greater soreness is reported with yielding exercises (figure 6.13).

Several theories of delayed muscle soreness have been suggested. They can be divided into two main groups. The damage theory suggests that muscular soreness is induced by damage done to the muscle or **connective tissues** during exercise. According to the spasm theory, on the other hand, a cyclical three-stage process causes delayed muscle soreness. First, exercise induces ischemia within the muscles. As a consequence of the ischemia, an unknown “pain substance” is accumulated. In turn, the pain elicits a reflectoric muscle spasm. Due to the spasm, ischemia increases, and so forth, and the whole process is repeated in this cyclical manner.

Delayed muscle soreness can be prevented by gradually increasing training intensity and volume.

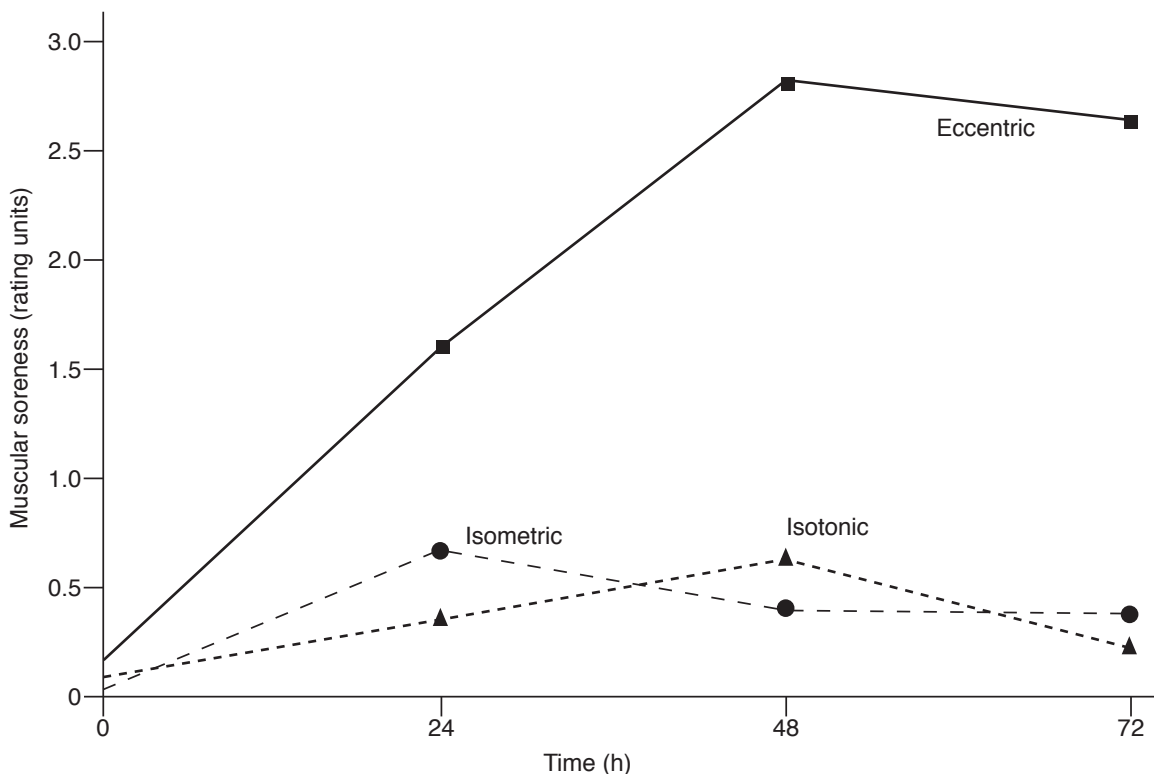

FIGURE 6.13 Delayed muscle soreness following different training routines. Soreness is most pronounced after yielding exercises.

Reprinted with permission from *Research Quarterly for Exercise and Sport*, Vol. 44, No. 4, pages 458-469. Copyright 1973 by the American Alliance for Health, Physical Education, Recreation and Dance [now SHAPE America], 1900 Association Drive, Reston, VA 20191.

It is especially important that training progressions are tolerable for the athletes and that sport coaches do not use the strength and conditioning activities for punishment or work hardening of athletes, which results in injury, damage, or even sudden death as pointed out in prior chapters. Mild to moderate soreness can accompany strength training protocols, but when it occurs at noticeable levels, recovery strategies are needed. Rest, compression, and ice are some of the standard methods used to fight muscle soreness. Additionally, athletes need to know that they should not use alcohol or aspirin to cure muscle soreness because such substances limit clotting activities and promote bleeding and swelling. Inflammation and swelling of a muscle or joint is a “red flag” for acute overuse and requires immediate attention. Stretching exercises, especially static ones, before and after training are helpful yet do not prevent soreness if significant tissue damage occurs.

Solid nutrition with adequate calories and needed protein can help tissue repair and remodeling. Unfortunately, most treatments not involving drugs (ice, nutritional supplements, stretching, and electrical stimulation) have been somewhat ineffective in treating high levels of delayed muscle soreness when inflammation and swelling is beyond normal recoverable ranges. Thus, manageable soreness should be recoverable within 24 to 48 h. If training continues in the face of high levels of soreness, muscle damage worsens requiring more recovery time and loss of quality training time. Thus, the proper progression of program loading on all fronts from resistance to rest periods is vital to the athlete’s adaptive success. Monitoring the loading is also important to curb the highly motivated athlete or ignorant sport coach who does not understand training technology and the harm it can do to the athlete.

Additionally, warm-up sets also allow the athlete and coach to determine if any organic injury exists in the range of motion of the exercise to be performed and are often forgotten due to the rush to begin the primary program sets. Many times sport injuries are discovered in the weight room as loading is applied, and are not due to the strength training but the sport. The source of soreness and injury needs to be understood, and strength training workouts need to be sensitive to these external challenges resulting in injury outside the weight room.

Suggestions about the use of yielding exercises depend on the training objective (i.e., whether the

target is concentric, eccentric, or reversible muscle action). When the goal is concentric or isometric muscle action, exercising with eccentric actions offers no particular advantage. However, an athlete may use these exercises to prepare, for the most part psychologically, for loads above 1RM. A barbell of very high weight (about 110% of the 1RM in the relevant movement, e.g., front squat) is actively lowered in these exercises. To prevent accidents, the athlete should be assisted. When these exercises were performed by members of the Soviet national weightlifting team in the 1984 to 1988 Olympic cycle, the training volume (the total number of repetitions multiplied by the average weight) did not exceed 1% of the total weight lifted.

Yielding exercises are broadly used in gymnastics for training such stunts as the cross on the rings or a horizontal handstand on the parallel bars. Concentric exercises are more efficient for this purpose. However, if used by athletes who are not strong enough to perform these stunts properly, special technical devices or individual assistance is usually required.

Theoretically, eccentric exercises should be used to train the yielding strength manifested during landing in parachuting, ski jumping, figure skating, or gymnastics. In these exercises (landing from a large drop distance), however, high impact forces are almost unavoidable, and special precautions must be taken to prevent injury and muscular soreness (exercises should be brought into training gradually; soft surfaces such as gymnastics mats should be used to absorb the impact). It is especially important to perform landings softly, preventing the heels from hitting the ground. In spite of these precautions, the risk of injury and degenerative changes in articular cartilages and subchondral bones is still too high, so the number of landings should be minimal. Both coaches and athletes need to recognize that overuse, as well as inappropriate use of yielding exercises, are unsafe.

Yielding exercises should *not* be used for training reversible (stretch–shortening) muscle action. The very essence of the stretch–shortening cycle is the *immediate* use of enhanced force production, induced by the prestretch, in the push-off phase. The pause between eccentric and concentric phases of a movement eliminates any advantage that could be gained from the stretch–shortening cycle. This cycle is one uninterrupted movement, not two combined movements. Athletes trained in the landing, rather than the immediate takeoff phase, stop themselves in the lower body position and perform

Bouncing, Not Sticking—Don't Repeat This Mistake!

A coach, trying to improve explosive strength of athletes, advised them to perform, as he said, “plyometrics drills”: drop jumps from height in a standing landing posture. The height was from 150 to 250 cm. The landing was performed on gymnastics mats. Although the athletes experienced substantial muscle soreness after the first training session, the coach insisted on continuing the exercise, assuring the athletes that “gain without pain” is not possible. However, in spite of many efforts, the athletic performances in takeoff-related activities did not improve. Moreover, the coordination pattern of the support phase (in jumping or even running) deteriorated. The athletes began to break one uninterrupted eccentric–concentric movement (landing–takeoff, stretch–shortening cycle) into two slightly connected motions: landing and then takeoff.

During natural movements, the primary requirement for a proper motion pattern is not to resist the external force and decrease the body's kinetic energy but to increase the potential for the ensuing takeoff. This goal is realized if both the potential energy of muscle–tendon elastic deformation and the enhanced muscle activation (induced by the interplay of the stretch reflex and Golgi tendon reflex) are used during the second phase of the support period. If an athlete stops after landing, the potential elastic energy dissipates into heat, and the potentiated muscle activity vanishes. The splitting of one continuous landing–takeoff motion into two motor patterns is a typical “bad habit.” The bad habit can take hold quickly and firmly, and much time and effort are needed to correct this mistake. “Bouncing” rather than “sticking” should be accentuated in landing drills.

the stretch–shortening action as two sequential movements instead of one continuous movement. Because of the negative transfer of training effect, the use of yielding exercises does not improve performance in the reversible muscle action.

Exercises With Reversible Muscle Action

In reversible muscle action exercises, a muscle group is stretched immediately before shortening. One example is drop jumping, that is, dropping to the floor from an elevation and then immediately jumping for height. In exercises with reversible muscle action, resistance is determined by the kinetic energy of the falling body rather than its weight (mass) or velocity alone. The kinetic energy (E) is defined by the formula $E = mV^2 / 2$, where m is mass and V is velocity. In reversible movements (exercises), the same magnitude of kinetic energy can be achieved with different combinations of velocity (dropping distance) and mass. An increase in mass always leads to a decrease in rebound velocity. The moderate increase of velocity at approach initially leads to an increase of rebound velocity, but if the approaching velocity is too high, the rebound velocity decreases (figure 6.14). The optimal magnitude in approaching velocity (and kinetic energy) depends on the mass of the moving body.

The most popular exercises involving reversible muscle action are single-leg, double-leg, and

alternate-step hopping. Among experienced athletes, drop or depth jumping is popular. Many coaches assume that drop jumps are directed toward improving the storage and reuse of elastic energy during takeoff. However, more energy is stored and reutilized only if the muscle tension is greater (see chapter 2). So the actual source of enhanced motor output is the increased muscle force production during this type of activity. The enhanced force is a result of

- inhibition of the reflex from Golgi organs (because this reflex is inhibitory, an “inhibition of the inhibition” takes place),
- potentiation of the stretch reflex, and
- proper timing.

There are two main variations on the drop jump. It is done with small amplitude of leg flexion during landing and takeoff (bouncing) or large-amplitude flexion (squatting or countermovement jumping).

Bouncing should be performed with minimal contact time. Athletes are advised to do the takeoff as though the surface is like a hot frying pan. The dropping distance should be adjusted to keep the athlete's heels from hitting the ground. The horizontal velocity at landing should be high enough to avoid plantar hyperflexion. Squatting technique is recommended to improve jumping ability in vertical jumps (e.g., for basketball, volleyball); starting

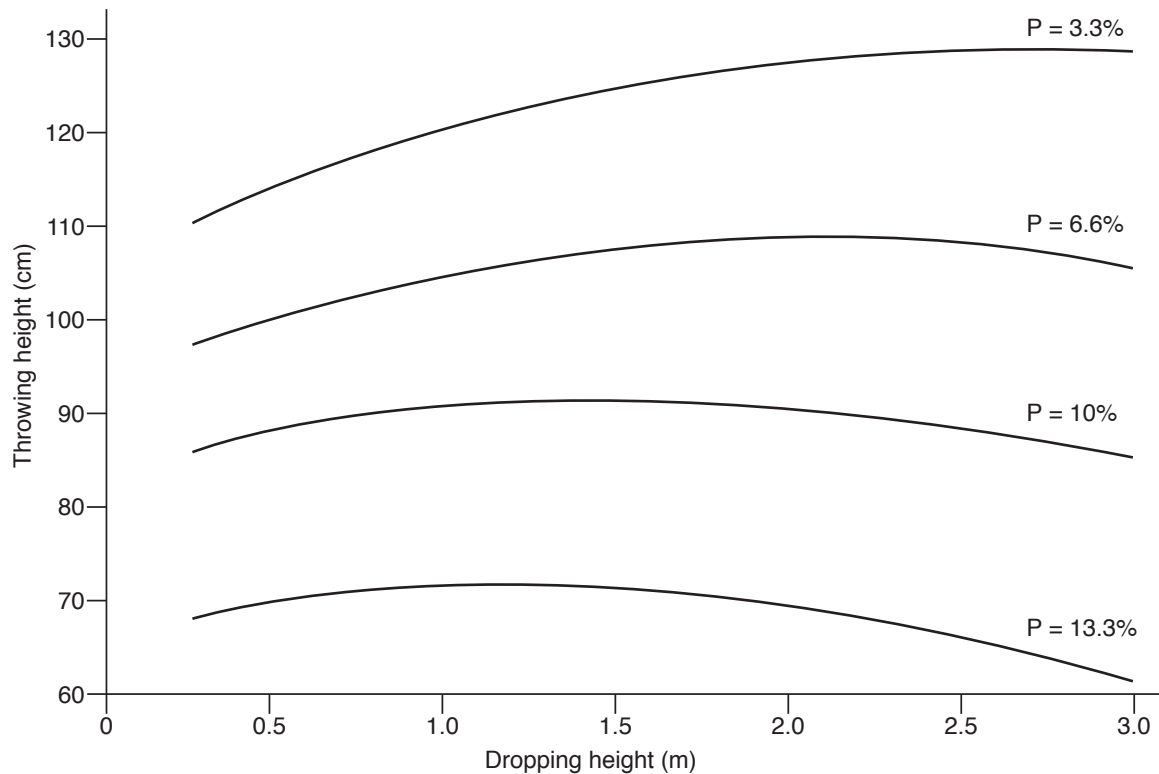

FIGURE 6.14 Changes in the height of an implement thrown as a function of its weight and dropping height. With a special installation in laboratory conditions, shots of different weights (3.3%, 6.6%, 10.0%, 13.3% of F_{mm}) were dropped from various heights (from 0.5 to 3.0 m). An elite shot-putter put shots vertically (in supine position). The height of each throw was measured. According to basic mechanics, dropping height is proportional to the dropping velocity squared and the throwing height is proportional to the square rebound velocity.

Reprinted by permission from Y.V. Verkhoshansky, *Special Strength Training in Sport* (Moscow: Fizkultura i Sport, 1977), 145. By permission of the author.

velocity in football, ice hockey, and sprinting; and explosive strength of football linemen, throwers, and weightlifters. Squats, though, should not be too deep. The range of knee flexion should be only slightly greater than in the primary sport movement.

Typically, a jumper makes initial ground contact with extended legs. However, if the aim is to improve the rate of force development, especially in the knee extensors, exercises requiring landing on a bent leg may be used. This is the case also when the athlete wants to improve landing on a flexed leg (for instance, figure skaters, while performing jumps with several twists, land on a flexed support leg).

Practical experience shows that drop jumps are a very effective drill. However, the injury risk is high and accommodation to these exercises occurs very quickly. Therefore, these guidelines are recommended:

1. Follow the prescribed sequence of exercises during multiyear training—regular jumping exercises, weight training exercises, and then

drop jumping. Drop jumps should not be performed by young athletes with training experience of less than 3 to 4 years.

2. Do not use drop jumps continuously for more than 1 or 2 mesocycles. Vary exercises by performing with and without additional weight vests (belts). After initial adaptation (usually two to three training workouts), use weight vests for 2 to 3 wk; then exercise without weights and increase the dropping distance gradually.
3. Maintain the proper level of explosive strength during the competition period by doing drop jumps once every 7 to 10 days. Exclude these jumps from the training program at least 10 days before an important competition.
4. Determine the exercise intensity (kinetic energy, weight, dropping distance) on an individual basis. The main requirement is proper technique (i.e., smooth transition

from the yielding phase to the push off, heels not hitting the ground).

Drills for training the stretch-shortening cycle should not be limited to drop jumps, though often they are. The possibility of increasing the mass of the falling body is rather limited in drop jumps—people wear weight vests or belts, but these cannot be as heavy, for example, as 100 kg. In view of the complex relationship between kinetic energy, velocity, and body mass, on the one hand, and the motor output of reversible muscle action, on the other, training with stretch-shortening cycle devices, where both the mass and velocity may be changed, is recommended. An example of such a machine is shown in figure 6.15.

Sport Exercises With Added Resistance: Speed-Resisted Training

You can best meet requirements for exercise specificity when you use the main sport movement, with increased resistance, for training. This is called **speed-resisted training**. Examples are uphill cycling and cycling with a changed gear ratio.

Each sport event is performed against a given resistance and at a given velocity. The resistance is predetermined by the mass of the implement or the athlete's body (inertia forces) and by body dimensions (aerodynamic or hydrodynamic forces). If an athlete performs the movement as fast as possible, movement velocity is a function of the resistance (an additional example of a parametric relation-

ship; see chapter 2). If the resistance increases, the velocity decreases. There are two general rules in speed-resisted training:

1. Extra resistance should be provided in the direction of propulsion (e.g., in locomotions in the anterior direction).
2. The resistance should not be too large; it should not substantially change the sport technique. For instance, when swimmers tow bulky objects their bodies tend to assume a vertical orientation. If this happens the resistance is too large and should be decreased.

Resistance in terrestrial athletic events can be increased by adding weight, by adding uphill movement, by retarding the athlete's progression, and by increasing aerodynamic resistance with parachutes.

Implements of heavier weight such as weight vests, belts, wrist cuffs, or ankle cuffs may be worn. Although adding this weight is simple, note that it is principally the demand for vertical force (acting against gravity) that is increased with supplementary loads. However, the typical requirement in athletics is to increase the horizontal component of the exerted force. Exercising with additional weight requires that force be exerted in an inappropriate (vertical) direction. In running, for instance, this leads to excessive body lift in the flight phase. Furthermore, locomotion using additional weights, especially ankle weights, increases impact stresses on lower extremities. Such training aids have lost

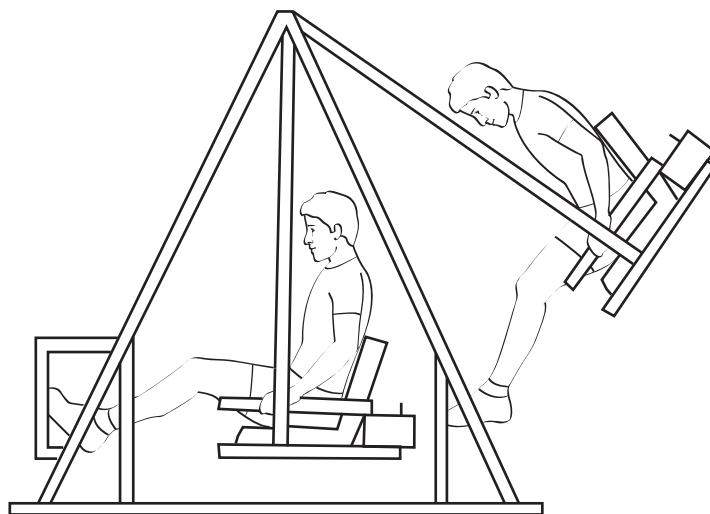

FIGURE 6.15 A swing exercise machine for training reversible muscle action in landings and takeoffs. Both the range of motion and mass of the system are varied in training. The mass of the swinging assembly may be increased up to 200 to 300 kg and even more; this is important when training qualified athletes.

favor over the past 20 years due to their effects on movements and injury.

Including some form of uphill ambulation, such as running, walking, or skiing, is limited by the possible changes in sport technique. Some coaches have tried retarding the athlete's progression. For example, athletes run with a harness, tow a sled, or use a pulley machine with a weight stack. These methods are cumbersome in that the equipment is bulky and heavy. Typically they are used only in short movement ranges (e.g., for the sprint start, but not for sprint running).

Increased aerodynamic resistance, on the other hand, is a popular method among elite athletes in sports such as speed skating and running. Small parachutes are used for this purpose (figure 6.16). When the athlete runs, the parachute inflates, creating a drag force. The higher the running velocity, the greater the resistance force. Parachutes of several different sizes are used in training. The impeding drag force, depending on parachute size, may vary from about 5 to 200 N (within the speed range 6 to 10 m · s⁻¹). To prevent parachute oscillation during

ambulation, the parachutes should have a small opening in the center (the stabilizer).

Parachutes offer several advantages over other methods of resistance training:

- The resistance (drag) force acts strictly in the direction of the athlete's movement.
- Sport technique is not negatively altered.
- Parachutes are not limited to use in straight ambulation, but can also be used when the athlete is running curves, running over hurdles, or changing direction (as in football or soccer).
- Parachutes weigh only a few ounces.
- A parachute can be released while the person is running, which provides an impetus to increase movement velocity (this is called an assisted drill).

The only drawback of parachutes is that they offer the same amount of resistance in both the support and the nonsupport phases of running. Thus they hamper movement speed during flight



FIGURE 6.16 Use of a parachute in running drills.

while slightly changing the position of body joints during foot landing, as in hurdle running.

For maximum effect, one should vary the parachute size in micro- and mesocycles as well as in workouts. Resistant and customary training are executed during preparatory microcycles, while the assisted drills are mainly utilized near the competition season. In a workout as well as in a sequence of training blocks, the resistance, determined by the parachute size, is decreased by degrees. During a training workout, the first drills (after warm-up) are performed under the heaviest resistance of that training session, and the final attempts are executed under the lightest resistance. Before and immediately after parachute drills, the same drills are performed under normal conditions. Parachutes are typically used two to three times per week. Sessions with parachutes are interspersed with the usual workouts. During a competition period, parachutes are used to induce a feeling of enhanced speed and explosiveness. For contrast, they are used three to five times within sport-specific drills at the beginning of a session, followed by the usual drills without a parachute.

In aquatic sports such as swimming or rowing, hydrodynamic resistance can be increased. With this objective, the streamlining of the body or its frontal area is altered. This can be accomplished by increasing the resistance offered by the boat or the swimmer's body or by expanding the hydrodynamic resistance of the propeller (the blade of the oar in rowing, the paddle in kayaking and canoeing, the swimmer's arm); for instance, using hand paddles is common in swimming.

In both cases, the force exerted by the athlete increases. However, the mechanisms of the force output augmentation are biomechanically different, so the training effects are also dissimilar. In aquatic locomotion, the external force developed by an athlete is determined by both athlete strength, in particular the individual's force-velocity curve (parametric $F_m - V_m$ relationship), and the water resistance offered (figure 6.17). As in all parametric relationships, force decreases as movement velocity increases. An athlete cannot develop high force at a high velocity of muscle shortening. Conversely, water resistance increases with a gain in velocity. Note that, in the first case, velocity is relative to the athlete's body (in essence, it is the velocity of muscle shortening); in the second case, the velocity of the propeller, relative to the water, is the point of interest.

The exerted force is indicated in figure 6.17c by the bold arrow. To the left of this point, where velocity is small, the athlete's strength is higher than the hydrodynamic resistance. Picture an athlete slowly moving her arm or paddle in the water. No matter how strong the person is, the exerted force is limited by water resistance, which is low in this case due to low velocity. However, if the movement velocity and the corresponding water resistance are high enough, the demand for a large force can exceed the athlete's capacity. In this case, the athlete's ability to produce sufficient force is the limiting factor.

It is known that, biomechanically, a propeller's velocity relative to the water in the direction of the boat's (body's) motion (V_w^p) equals the difference between the velocity of the propeller with respect

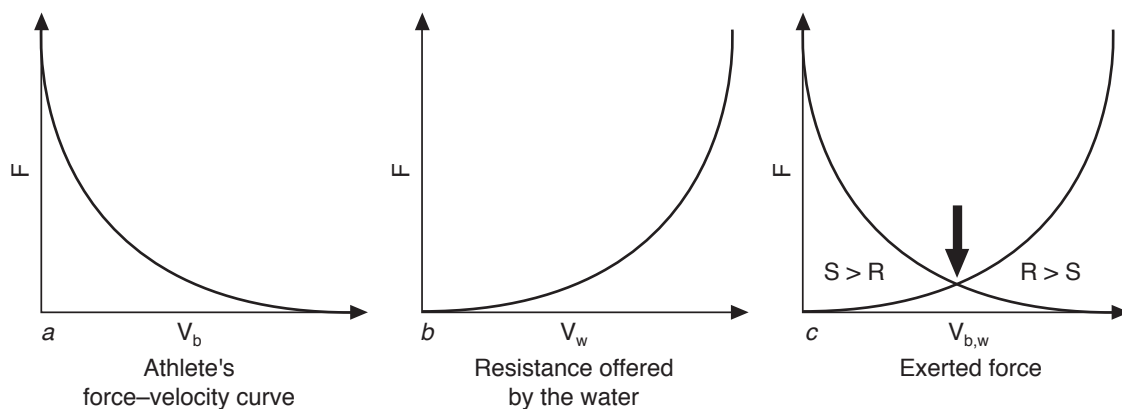

FIGURE 6.17 The force exerted by an athlete is determined by the interplay of (a) the force-velocity curve (the maximal force developed by an athlete at a given velocity when high resistance is met) and (b) water resistance. The interception of these curves corresponds to (c) the force exerted by the athlete against water resistance. To the left of this point the strength potential of the athletes exceeds the amount of resistance ($S > R$); to the right, $R > S$ (S , strength; R , resistance). V_b is relative velocity of body segments; V_w is velocity of the body relative to the water.

to the boat (V_b^p) and the amount of boat (body) velocity (V_w^b):

$$V_w^p = V_b^p - V_w^b.$$

When hydrodynamic resistance of the boat or the swimmer's body increases, the boat's (body's) velocity relative to the water (V_w^b) decreases. Furthermore, if propeller velocity relative to the boat (body) is kept the same, then its velocity relative to the water (V_w^p) increases. So, when stroking at the same velocity with respect to the boat or body (V_b^p is a constant), the athlete meets greater water resistance by virtue of the increased propeller velocity relative to the water (V_w^p).

When the hydrodynamic resistance of the propeller is increased (e.g., with hand paddles), the same stroking speed (V_b^p) produces greater body (boat) velocity (V_w^b). The propeller's velocity relative to the water (V_w^p) then decreases instead of increases as in the previous case. The exerted force, however, increases as a result of poor streamlining of the propeller (table 6.1).

It is recommended that these additional resistances be raised alternately. Note also that the amount of added resistance is limited by change in sport technique. If the technique is altered substantially, the additional resistance must be decreased.

Experimental Methods of Strength Training

During the last two decades, many attempts have been made to use transcutaneous muscle electrostimulation (EMS) and mechanical vibration as training methods for athletes.

Electrostimulation

In theory, one advantage of EMS is the activation of predominantly fast motor fibers that are difficult to recruit voluntarily. During EMS, the size principle of motor unit recruitment is no longer valid; fast-twitch motor fibers are activated first in this case. These have a lower threshold to externally applied

electric current and, in addition, many fast-twitch motor fibers are located superficially, close to the external edge of muscles.

Potentially, EMS can be a useful supplement to conventional strength training methods. It can enhance not only maximal stimulated force but also voluntary force, speed of motion, and muscular endurance. The time to accommodation is usually about 20 to 25 training days in conditioning for maximal strength and 10 to 12 days for maximal velocity. During EMS training for muscular endurance, the leveling off is not attained even after 35 sessions. Positive results, including improvement in sport performance, have been demonstrated in weightlifting, gymnastics, and track and field events, as well as in the jumping ability of volleyball and basketball players.

The method was originally developed in the former Soviet Union in the late 1960s. However, contrary to popular opinion, athletes of the former Soviet Union have not regularly used EMS as a substitute for traditional strength training. Athletes' attitudes toward this method vary substantially. Many elite athletes have been very positive regarding EMS use. For instance, some Olympic champions in kayaking and canoeing have sought to stimulate several muscles, including the biceps brachii and deltoid, over a 1-mo period before important competitions, including the Olympic Games.

At the same time, in spite of evidence that maximal strength may be enhanced as a result of EMS, this method has not been accepted by numerous qualified athletes. In addition to a customary conservatism, there are two main reasons. First, athletes cannot use enhanced isometric (specially stimulated) values in real sport events. The time and effort needed to transmute acquired changes into force output of the real movement are too great. Second, some athletes using EMS have an unpleasant feeling of lack of muscular control and a loss of coordination and simply refuse to continue. These findings confirm the idea that, loosely expressed, only muscles (not neural factors) are trained with EMS. The ability

TABLE 6.1 Boat (Body) Versus Propeller (Paddle, Hand) Resistance Changes

Resistance increased	Velocity of the propeller relative to the body, V_b^p	Velocity of the body relative to the water, V_w^b	Velocity of the propeller relative to the water, V_w^p	Cause of greater exerted force
Boat (body)	=	<	>	Greater velocity, V_w^p
Propeller	=	>	<	Greater resistance offered

to activate trained skeletal muscles does not seem to be augmented as a result of this kind of protocol.

There may be several reasons for such different athlete attitudes toward EMS. First, EMS can be used in improper proportion to conventional strength training. If the proportion of EMS training is too great (for a given athlete), the transmutation may become difficult. And second, inappropriate muscle groups can be selected for the EMS training (again for a certain athlete). If the strongest muscle from the muscle group is stimulated and the weakest one is not, there is no performance improvement.

To date, EMS has been routinely used by qualified athletes in only isolated cases. One example is correction of functional flatfoot, an acute arch flatness of the foot occurring as a result of high training loads in runners and jumpers. Regular EMS (twice a day) of the small arch muscles helps prevent and treat this malady. Another example is stimulation of the spine erectors in athletes, in particular rowers and kayakers, who are susceptible to low back pain. EMS was also used in training of the shoulder adductor muscles used to perform the cross in men's gymnastics.

The following EMS routine, known as the Russian protocol, is typically used:

- Carrier signal—sinusoidal or triangle
- Frequency—above 2,500 Hz
- Modulation—50 Hz
- Duty cycle—50% (the signal is applied for 10 ms with a 10-ms interval between trials)
- Stimulus amplitude (SA)—adjusted individually to induce a force above 100% of maximal voluntary isometric force F_{mm} or to the limit of subject tolerance; SA depends on the output impedance of the stimulator and typically exceeds 90 V
- Contraction time—10 s
- Rest between contractions—50 s
- Number of contractions—10 per day
- Number of training days—5 per week

The most important feature of the described stimulation protocol is the frequency of the carrier signal, which should be located in the sound frequency band, above 1,500 Hz. EMS, when performed properly, is almost painless. The electrode surface must be wetted with a special paste to achieve homogeneous electrical resistance at the skin–electrode interface.

Present knowledge about EMS is not satisfactory as a basis for a final recommendation. The prospects for using EMS in athletic training should be further investigated.

Vibration Training

Mechanical vibration—periodic oscillations applied to an athlete's body—can be used as a training tool as well as a massage tool. While vibratory massage has been well known for more than a century, vibration training, specifically in strength training, is a relatively new idea.

The effect of vibration depends mainly on (1) place of application of the vibration; (2) direction of vibration, either perpendicular to the muscle surface or along the muscle; (3) duration of vibration; and (4) vibration intensity. The intensity is a function of the vibration frequency w and vibration amplitude x and is measured as either vibration acceleration a , $a_{max} = w^2x$, or as vibration energy, which is proportional to the product of the squared values of the vibration frequency and amplitude. In the vibration massage, vibratory stimuli are commonly applied to the targeted muscle or tendon and induce oscillations perpendicular to the longitudinal direction of muscle fibers. The muscles are voluntarily relaxed and the energy of vibration is relatively low.

In vibration training, the stimuli are applied to the end point of a kinematic chain (e.g., to the hand) and induce oscillations that propagate along the muscles. There are two varieties of vibration training: exercises used for strength training with superimposed vibratory stimulation and motor tasks performed under whole-body vibration. In the second case, an exercise is performed on a vibrating plate; a vibratory wave is transmitted from the feet to the entire body while the muscles are either contracted or stretched. In general, an idea of the vibration training is to combine voluntary muscle activation or stretching with the vibration stimuli.

According to recent research, vibration training resulted in significant changes of several motor abilities, with the stretch–shortening cycle (such as countermovement jumps, serial high jumps, and so on) being the most sensitive to the treatment. A hypothesis has been suggested that the effects of vibration training are similar to the effects induced by such means as drop jumps: They both depress inhibitory reflex from Golgi tendon organs on muscle activation. Because the parameters of the vibration (frequency, amplitude, duration) sharply

differed in the performed studies, it is impossible to presently recommend an optimal procedure. As noted in one study, accommodation to the vibration pattern and style can make any changes limited and ineffective; thus how to use it over time is unclear. Vibration training is still a topic of research.

Breathing During Strength Training

If maximal force is exerted while inhaling, exhaling, or making an expiratory effort with the glottis (the opening between the vocal cords) closed—called the **Valsalva maneuver**—the amount of force increases from inspiration to expiration to Valsalva maneuver. The underlying mechanism for this phenomenon is a pneumomuscular reflex in which increased intralung pressure serves as a stimulus for the potentiation of muscle excitability. The true mechanisms of enhanced muscle excitability have yet to be studied.

Although the Valsalva maneuver might be considered a useful breathing technique for ultimate force production, it also provokes a cardiovascular response that many physicians consider harmful, particularly in individuals with heart problems. Because air cannot escape, the intrathoracic pressure sharply increases (up to 40-100 mmHg and even higher, whereas normally it is 2-15 mmHg lower than atmospheric pressure). Because of the high intrathoracic pressure and associated compression of the venae cavae, which return blood to the heart, venous return to the heart decreases. In turn, both stroke volume and cardiac output decrease. As a result of the small venous return and high intrathoracic pressure, the heart dimensions, particularly the chamber dimensions, are lessened (this is called the Valsalva effect). The decreased stroke volume is compensated for by increased heart rate, sometimes above 170 beats per minute. In addition, blood pressure increases substantially. (Values up to 320/250 mmHg have been measured during barbell squats.) The elevation is explained mainly by the high intramuscular pressure, which results in increased total peripheral resistance and increased blood pressure.

The decreased cardiac output may further result in brain anemia and a loss of consciousness. (This has happened many times during weightlifting competitions involving the military press; this lift has been excluded from the Olympic weightlifting program since 1972.) Immediately after the lift,

intrathoracic pressure abruptly falls and a large amount of blood overfills the heart. Then, both stroke volume and cardiac output rise, blood pressure decreases, and after some time, all values return to normal.

Athletes adapt to such changes, and properly planned and executed strength training does not cause hypertension. Contrary to common misconceptions, heavy resistance training (again, if properly planned and executed) results in positive adaptations of the cardiovascular system. At the same time, athletes and coaches should exercise these cautions during physically strenuous activities:

1. Permit the Valsalva maneuver, or expiration efforts with a closed glottis, only during short-time ultimate efforts. Beginners often stop breathing during repetitive lifts of low intensity. A coach should discourage this practice. In principle, high intrathoracic pressure is undesirable; on the other hand, high intra-abdominal pressure is considered useful. The torque generated by intra-abdominal pressure reduces the compressive force acting on the intervertebral discs and may lessen the probability of spinal disc injury and, ultimately, increase lifting ability (see chapter 8).
2. Beginners should not be given many exercises with ultimate and near-ultimate efforts.
3. An athlete should not inspire maximally before a lift. The maximal inhalation unnecessarily increases intrathoracic pressure.
4. Forced expirations, rather than the Valsalva maneuver, should be used whenever possible.
5. Beginners should inhale and exhale during performances, especially when the weight is held on the chest.
6. Finally, there are two ways to match breathing phases (the inspiration and expiration) with the performed movement—the anatomical and the biomechanical match.

This last point requires some elaboration. In movements with small efforts (similar to those in calisthenic exercises such as a trunk inclination) the inhalation should coincide with the trunk extension and the exhalation with the trunk bending. This is called an **anatomical match** (of breathing phases and movement). In contrast, when high

forces are generated the expiration should match the forced phase of movement regardless of its direction or anatomical position. For instance, rowers exhale or use the Valsalva maneuver during the stroke phase when the greatest forces are developed; nevertheless, the legs and trunk are extended at this time rather than flexed (as compared with trunk and leg flexion without an additional external load in calisthenic exercises). This breathing is termed a **biomechanical match**. During exercises used for strength training, the breathing phases and movement should be matched biomechanically rather than anatomically.

Summary

Exercises used for strength training are classified in various ways. For example, they may be static (isometric) or dynamic (concentric, eccentric, reversible, isokinetic). They may concentrate on particular muscle groups, whose comparative strengths are called strength topography. Strengthening with whole-body exercises using the body's kinetic chain for control of movement is vital for athletic success and important for power development and performances. Or the exercises may be classified according to how specific they are to the sport task.

With beginners, especially young people, strength topography is the main concern in selecting strength training exercises. For example, you should choose the most important muscle groups, strengthening those that might be at risk for injury if they are weak, training proximally located muscles, and strengthening muscles that are needed to perform sport movements. For more advanced or mature athletes, however, the goal is to select strength training exercises that are specific and mimic the movement pattern used in the actual sport skill. This is a complex demand that requires careful analysis of movement including resistance, timing and rate of force development, movement direction, and variations of muscular strength over the range of joint motion.

Muscular strength varies over the full range of joint motion, depending on changes in both muscle lever arms and muscle force. To manage this force–posture relation, trainees may use the peak-contraction principle, which focuses on increasing muscular strength primarily at the weakest points of the human strength curve through the selection of proper body positioning, special training devices, and a slow starting motion. Or they may develop maximal tension throughout the complete range of motion (accommodating resistance, used with some physical therapy isokinetic equipment and in some training machines). A third method is training in the range of the main sport movement where the demand for high force production is maximal (this accentuation method has been popular with Russian and Eastern European athletes).

Isometric exercises are seldom used, and self-resistance and yielding exercises carry risks, so they are not recommended. Exercises with reversible muscle action are effective but accommodation occurs quickly with these exercises. Sometimes additional resistance is added to main sport exercises that best meet the requirements for sport specificity.

Recently, two nontraditional methods, electrostimulation of muscles and vibration training, have attracted great interest as methods to enhance muscular strength. Although the methods show promise for strength training, they need further investigation.

Breathing patterns affect force production, with maximal force production occurring during the Valsalva maneuver. With small efforts, the inhalation should coincide with the trunk's extension and the exhalation with the trunk's bending (an anatomical match of breathing phases and movement). With high force, however, expiration must match with the forced phase of movement, regardless of the movement direction or anatomical position (a biomechanical match). During exercises used for strength training the breathing phases and movement should match biomechanically rather than anatomically.

VELOCITY IN THE WEIGHT ROOM

When entering the weight room to train, many people focus on muscular strength and muscle hypertrophy. It is easy to believe that speed, agility, and related movement patterns are developed in other portions of the training program. However, as we will see in this chapter, velocity is a critical component of all activities in the weight room. What is not always appreciated is that muscular strength is fundamental to speed and agility, which is why a proper strength training program is so important. We will take another look at several key factors first presented in chapter 2, in particular, the parametric relationships between velocity and other descriptors of lifting performance. Furthermore, we will examine several examples of nonparametric relationships because muscle performances developed in the weight room are transferred to sports and other types of activities. Additionally, throughout this chapter you will find sidebars with examples of how velocity, and its related kinetic variables, are critical components of sport and training performance. But before we discuss this in more detail, we need to define several important terms, where s = displacement, t = time, v = velocity, and d = change.

- Velocity (v) = ds/dt
- Acceleration (a) = dv/dt
- Force (F) = mass \times a (N; newton)
- Power (P) = $F \times v$ (W; watt)

Several additional variables can also provide valuable information in the training room.



- Work = $F \times ds$ (J; joule)
- Impulse = $\Sigma F \times dt$
- **Momentum** = $\text{mass} \times dv$ (P)

These equations confirm that every biomechanical variable of interest in the weight room is influenced by velocity. This can include velocity of the barbell, or any implement being lifted or moved, as well as velocity of the body itself. As such, it is critical to understand the role of velocity when performing exercises and to recognize the interdependence of these variables. Figure 7.1 provides one example of how velocity contributes to power at all loads, which is an important goal for many weight training programs. Although the relative load at which power is greatest depends on many factors that will be discussed later, power at all relative loads is highly dependent on lifting velocity. The seminal work by A.V. Hill in 1950 shows that power measured in stimulated, isolated animal muscles generated the greatest power at approximately 30% of maximum forces and velocities, and this finding has been further supported by power measures on single muscle fibers. However, as we will see later in this chapter, many factors in the training hall change these relationships when measured during strength training exercises. Hill also states that velocity and force were the “only important variables” for power. This finding means that maximal strength is paramount to performance, but so is training at numerous points along the velocity continuum.

An in-depth study of the physiology of velocity in the weight room can readily identify a number of possible contributing factors to the contractile velocity of skeletal muscle, including the following:

- Neural regulation (motor unit recruitment patterns, EMG characteristics, excitation and inhibition)
- Endocrine variables
- Neuroendocrine and autonomic nervous system variables
- Anatomical structure
- Metabolic factors related to contractile velocity
- Others

Indeed, the relationship of velocity and force in skeletal muscle has been closely examined in the laboratory for many decades (Hahn, 2018; Alcazar et al., 2018; Alcazar et al., 2019). This chapter, however, will focus on velocity performance variables as observed in the weight room. In this manner, the practical applications and understanding of the role of velocity will be readily apparent.

How to Measure Velocity

Coaches and athletes have been interested in measuring velocity of barbell movement for at least half a century. Initial attempts were simple cloth measuring tapes attached to a moving bar to determine distances moved in measured time periods.

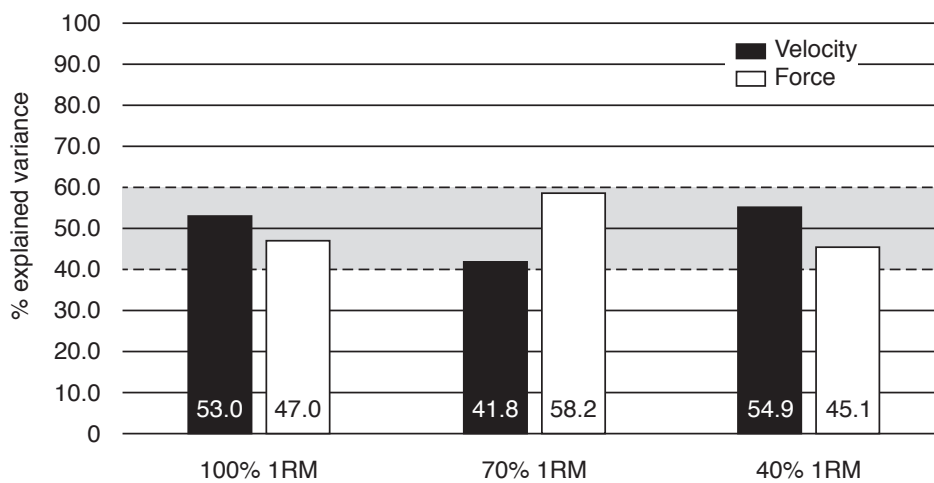
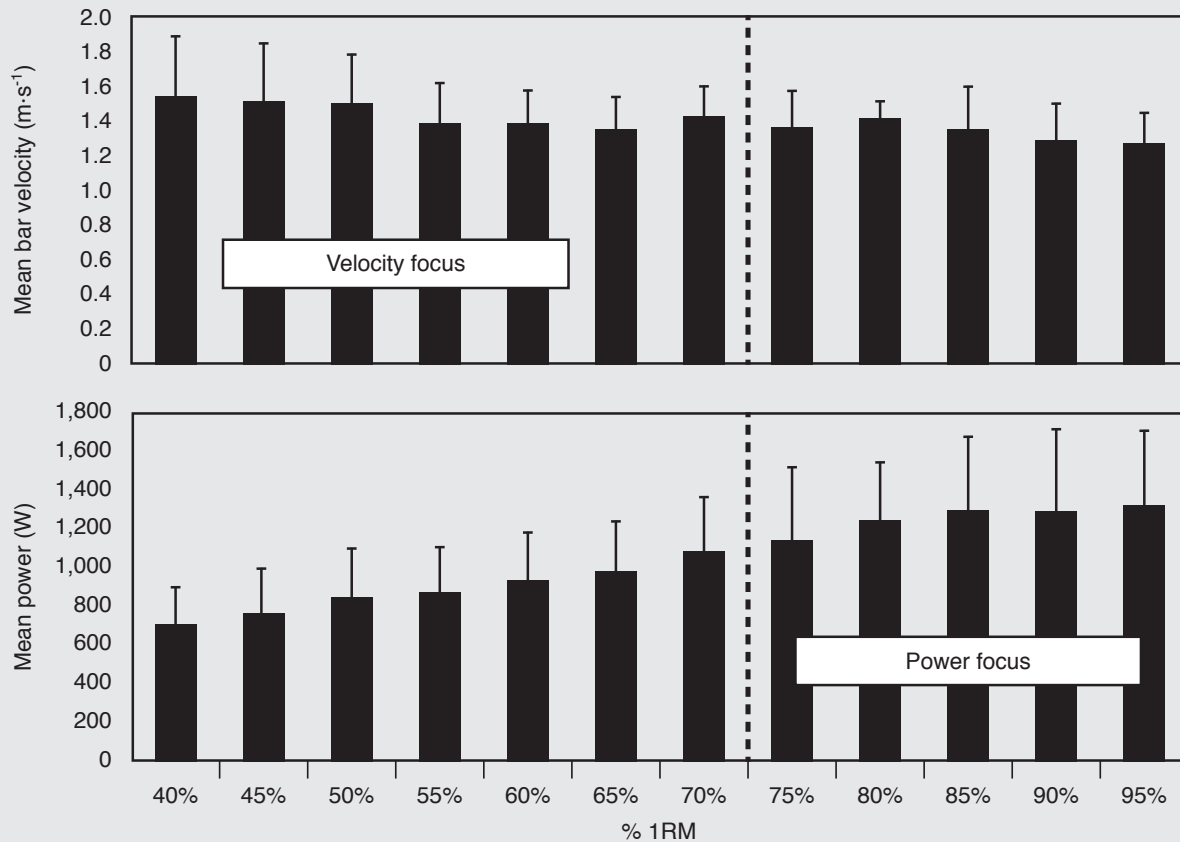

FIGURE 7.1 Although power is often a focus of training in the weight room, velocity is a major contributor to power. Regardless of the relative load or the power produced, multiple regression analyses indicate that velocity explains approximately half of the resulting power.

Reprinted by permission from A.C. Fry, C.E. Bailey, and D. Cabarkapa, “Relative Contributions of Force and Velocity to Peak Power Across a Load Spectrum,” *Malaysian Journal of Movement, Health & Exercise* 8, no. 2 (2019): 11-16.

Different Loads Emphasize Velocity or Power

These graphs show the mean velocity and power for box power cleans across a load spectrum. Velocities were statistically similar for all loads below 75% 1RM, whereas power for all loads above 70% 1RM were similar. It appears that training in these respective relative intensity ranges for this exercise focuses on either velocity or power.



Data from Moore, Fry, Melton, et al. (2003).

Since these first crude efforts, a number of effective technologies for measuring lifting velocity have emerged, not only in the laboratory, but also in the training room or in competition.

Videography

As early as the late 1800s, Muybridge used early photographic technology to document various animal movement patterns. A decade later, Marey created time-series photographic records called chronophotography to analyze human movements. This also led to his development of the dynamograph (or load cell) and the dynamographic platform (or force plate). Eventually, as weight training became popular, some of the first attempts to quantify lifting velocity used 16 mm filming and the subsequent tedious digitizing process to analyze the results.

Typically, frame rates were 24 frames per second (fps), which was satisfactory for some analyses, but could be a limiting factor with higher lifting velocities. More recently, video technology and the accompanying software has permitted a digital record of lifting to be used for biomechanical analysis. Typical sampling rates for video were approximately 30 fps, although manipulation of the digital record could double that to 60 fps via deinterlacing. Still, these sampling rates were occasionally too slow for accurate evaluation of high-velocity activities. Recent advances in digital camera technology have made ready access to high video sampling rates (e.g., 60 fps, 120 fps, 240 fps, or even 1,000 fps), but not all analysis software can accommodate these rates. Although not always required, reflective, infrared, or signal-emitting markers can be attached to a

barbell, thus permitting easier digitizing of the barbell (and occasionally, body) movement. Without these markers, individuals manually identified and recorded important locations frame by frame; as can be imagined, this was a very time-consuming process. Recent advances have also allowed cameras to visually recognize a barbell without markers attached, thus resulting in easy-to-collect, and reasonably accurate barbell velocity data. Once actual video is recorded, appropriate software is needed to convert the video record to digital data that can then be analyzed for the variables of interest. The software options range from free, online, downloadable programs, to expensive, but powerful, analytical programs. The preferred program depends considerably on the purpose of the analysis, the resources available, and the turnaround time requirements.

Tether-Based Devices

Some of the first velocity-measuring devices for the training room used tether-based technology to monitor movement of the barbell. In some instances vertical bar position is directly measured (i.e., linear position transducer or linear encoder), while linear velocity transducers can also be used. Regardless of which is used, the mass of the resistance is manually entered into the device. Data are then derived in the following sequence: position → velocity → acceleration → force (when the known mass is entered) → power (force × velocity). It is important to note the numerous derivations, each of which can add to measurement error. Regardless, many devices on the market are capable of providing reasonably accurate results, but some report only a few of the variables listed previously. It is important to note that some systems only include acceleration due to gravity in their calculations for force (i.e., $9.8 \text{ m} \cdot \text{s}^{-1} \cdot \text{s}^{-1}$), and fail to add the accelerations resulting from moving the barbell. This omission will result in an erroneously low calculation of force, specifically for peak values. Figure 7.2 shows how a tether-based laboratory position transducer can provide ground reaction force data very similar to data collected with a force plate. However, although tether-based systems are capable of providing accurate data, not all commercially available systems do. Numerous factors can contribute to measurement error, such as sampling rate, nonvertical movement, or algorithms used. Some tether-based systems are available that compensate for nonvertical movements, which may enhance accuracy for some exercises. These devices

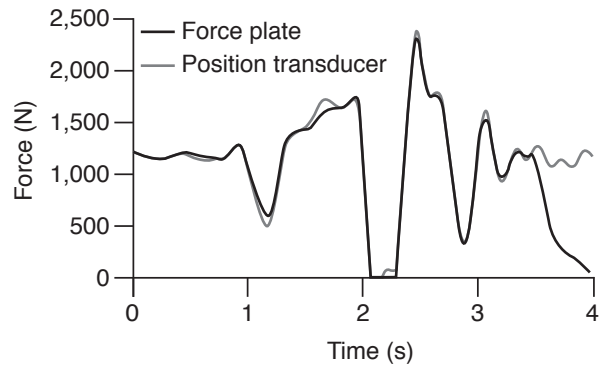

FIGURE 7.2 Actual ground reaction forces during a squat as measured by a force plate, as well as the forces derived from a tether-based position transducer.

Reprinted by permission from L.Z.F. Chiu, B.K. Schilling, A.C. Fry, and L.W. Weiss, "Measurement of Resistance Exercise Force Expression," *Journal of Applied Biomechanics* 20, no. 2 (2004): 204-212.

can also provide barbell trajectory information by triangulation methods when multiple tethers are used or when mathematically calculated. Besides measuring barbell movement, tether-based devices have also been attached to the body to measure velocity and related variables during exercises such as jumps. When done correctly, this technology can provide data somewhat similar to what a force plate might provide. It should be noted that the sensitivity of some tether-based devices can be adjusted, which means that it is possible to adjust the distance moved before the lift is measured. This adjustment can help avoid "false" lifts where the barbell moves a little bit, such as when being initially lifted out of a rack prior to the first repetition. This slight lift can erroneously be recorded as the first repetition, unless the sensitivity has been set to a larger range of motion before recording. Adjusting such sensitivity can help avoid movements being recorded that are not the actual repetitions being prescribed. However, many tether-based systems do not record data until the bar has moved a greater distance than the sensitivity level, which means some of the data from the repetition will not be recorded. Decreasing the sensitivity can partially rectify this problem.

Accelerometers

Advancements from tether-based systems have resulted in accelerometer-based technology. These devices can be quite small and easy to attach to a barbell or weight stack on a machine, as well as to a moving part of the body (e.g., the wrist, which always follows the movement of the barbell). The sensitivity of these devices can be quite remarkable, and they are

more than capable of sensing the accelerations relevant in the training room. When three-dimensional accelerometers are used, the position of the accelerometer is irrelevant because the resulting velocity vectors are simply calculated from all three axes (i.e., x, y, z). These devices also avoid the often-problematic issue of a tether impeding movement, or becoming tangled or broken. However, as with tether-based technology, these devices are only as good as the sampling rate, the algorithms used, the inclusion or exclusion of nonvertical movements, and the quality of the accelerometer. Regardless, accelerometry can be a very precise measuring tool in the weight room,

and many commercially available devices appear to be appropriate for the coach or athlete. Whether these devices are suitable for laboratory use must be verified by the scientist (see figures 7.2 and 7.3).

Motion Capture Systems and Three-Dimensional Cameras

New technology is now available to detect and record barbell movement without using manually placed markers or tethers. This includes systems that track barbell movements using what are commonly called three-dimensional cameras. Using calculations similar to those previously described

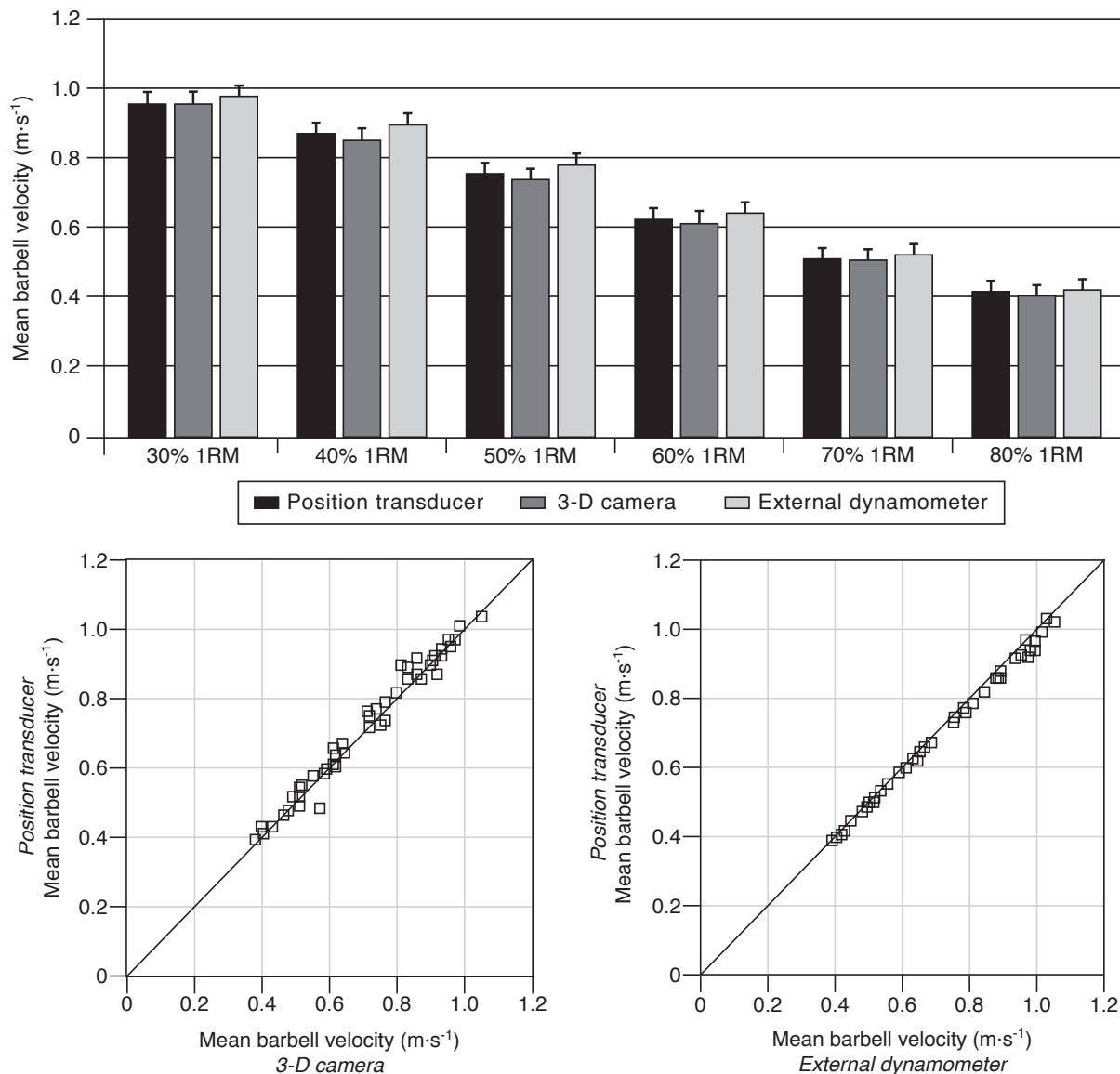

FIGURE 7.3 Both tether-based (external dynamometer) and three-dimensional camera motion capture systems have been shown to be valid and reliable devices for monitoring barbell velocity and power.

Reprinted from A.C. Fry, L. Bradford, T.J. Herda, et al., "Validation of a 3-Dimensional Motion Capture System for Determining Barbell Power and Velocity During the Bench Press," presented at Central States ACSM Conference, Warrensburg, MO (2013).

for deriving barbell velocity and power, these devices can immediately upload the collected data to a server for ease of data management. With the addition of small touch pads mounted on each lifting station, immediate feedback can be provided to the lifter. As with any other type of technology, the validity and reliability of these devices must be verified to ensure collected data are accurate (see figure 7.3).

Force Plates

Total system (body plus barbell) ground reaction forces can be directly measured when resistance exercise is performed on a force plate. High-quality force plates are capable of measuring force in all three axes (i.e., x , y , and z), while industrial scales can be modified to record ground reaction forces in just the vertical axis. For most purposes in the weight room, a one-dimensional force plate is adequate since almost all the forces of interest are typically vertical in nature. Starting with the directly measured forces, velocity can be derived in the following manner: force \rightarrow acceleration \rightarrow velocity \rightarrow position. With these data, power can be calculated, and the concentric and eccentric phases of the lift can be determined. It is important to note, however, that

since the force plate is measuring system forces, the data derived are not for the barbell alone, but also for the center of mass of the total system. Because of this important distinction, the results can be considerably different. For some exercises, the difference can be minimal (e.g., barbell squats), while for others the difference is significant (e.g., bench press, cleans). These differences will be shown in detail later.

Considerations When Testing

When measuring velocity in the weight room, there are a number of factors to consider when interpreting the results. Several are listed here.

Movement/Exercise Tested

Exercises will have different velocity characteristics. As we will see in the following pages, different exercises can have unique kinetic and kinematic properties.

Instructions Used

It is paramount that the person administering the velocity test correctly informs the lifter of specific

Lifting Velocities of Children

The ability to develop force is age dependent during childhood. Even when lifting similar relative loads (70% 1RM), the ability to develop velocity increases with age for both boys and girls.

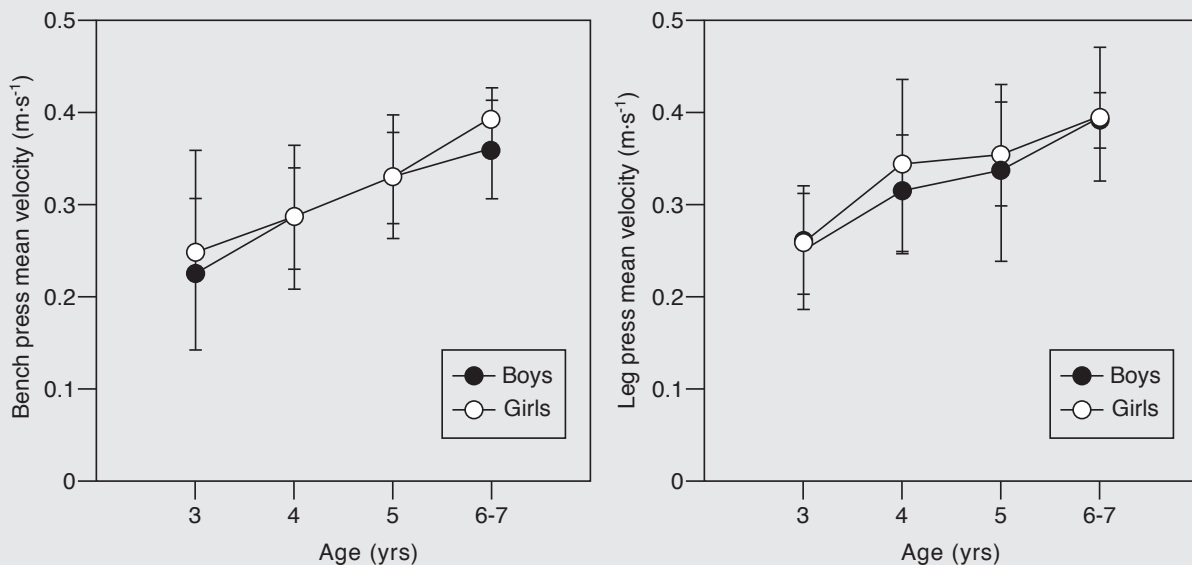

Reprinted by permission from A.C. Fry, C.C. Irwin, J.X. Nicoll, and D.E. Ferebee, "Muscular Strength and Power in 3- to 7-Year-Old Children," *Pediatric Exercise Science* 27, no. 3 (2015): 345-354.

expectations. Incorrectly performed tests provide useless data. This includes consistent encouragement to ensure maximal velocities are attained.

Familiarization

As with many types of testing, it is advantageous for the lifter to have some practice trials to ensure the lift is correctly performed and maximum velocities are attained. Caution must be used, however, to avoid fatiguing the lifter, which will result in erroneously low velocity values.

Peak or Mean Values—Which One?

Many devices report both peak and mean values. For most lifts, these values are highly related with correlation coefficients of $r > 0.90$, but the values will typically be quite different. Figure 7.4 shows two force–time curves, both of which are affected by barbell velocities. The force tracing in figure 7.4a is for a purposely slow-velocity deadlift with a moderate load. Note the spike in force at the start of the lift, which is often seen when force is increased to overcome the inertia of the resting bar. The remainder of the lift signifies a consistently lower force. The result is that the peak value is quite different from the mean value for the entire lift. Figure 7.4b shows the force–time curve for a maximal velocity barbell pause squat with a moderate load. Again, the force is large at the beginning of the lift to overcome the inertia of the motionless bar and body. The decrease in force occurs as the lifter passes through what is often called the “sticking point,” when force capacity is at a biomechanical disadvantage. Finally, the force increases at the end of the range of motion as the barbell accelerates and the lifter approaches full extension. The velocities will vary considerably at different points in the range of motion, so the tester must decide which velocity characteristic is most relevant for the purpose of the testing.

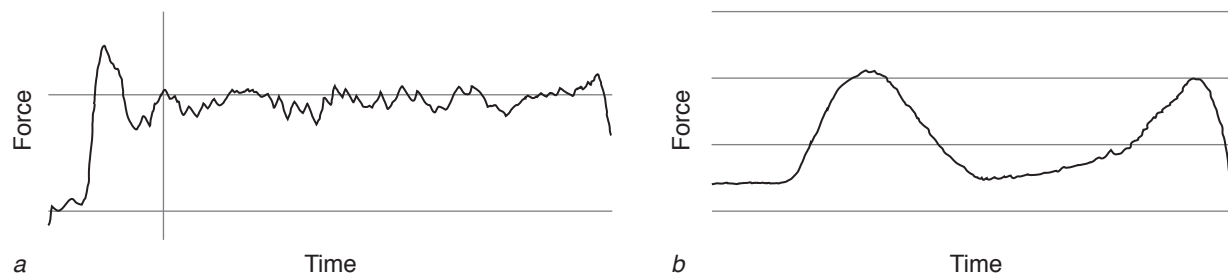

FIGURE 7.4 Force–time curves for (a) a slow-velocity deadlift and (b) a high-velocity pause speed squat.

Sampling Rate

The number of data samples collected every second is the sampling rate, and is reported in hertz (Hz). With high-velocity activities, if the sampling rate is too low, valuable information is likely to be missed. In the laboratory, sampling rates of 500 to 1,000 Hz are common; however, no commercially available velocity-measuring device samples at those rates. At the other end of the spectrum, video-based methods will sample at approximately 30 Hz, which is fine for many applications. But in general, higher sampling rates are desirable, and sometimes absolutely necessary, for certain activities.

Problems With Weightlifting and Its Derivatives

Another critical consideration occurs when the clean, snatch, or jerk lifts are being performed. As shown in figure 7.5, the peak values for lifts like the clean typically occur toward the top of the lift as the bar passes through the second pull. This value is typically very repeatable. However, problems sometimes occur when measuring mean velocity. In these cases, the measuring device may not recognize the completion of the second pull at the top of the barbell trajectory. Instead, the portion of the lift in which the lifter stands erect after catching the barbell is included in the calculations. Since this portion of the lift is much slower, the mean velocity values are erroneously slower. The sensitivity setting of some measuring devices can be set to ignore this portion of the lift, which is an easy remedy. However, many coaches have simply relied on peak values, rather than mean values, for these lifts.

Propulsive Forces

When lifting at high velocities, most of the range of motion is needed to develop force to move the resistance as fast as possible. However, at light loads,

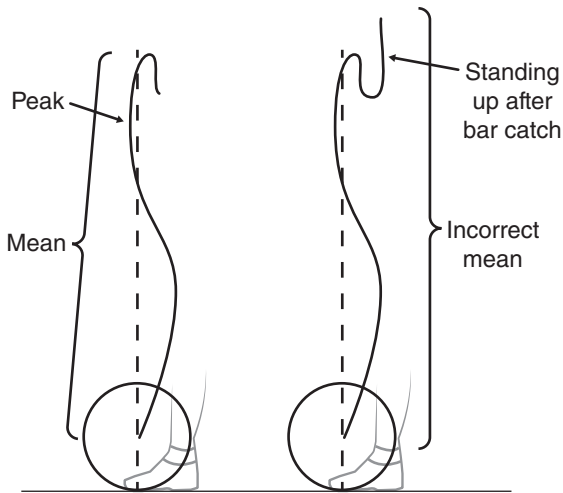

FIGURE 7.5 Barbell trajectories for a power clean exercise showing where mean and peak velocity values are obtained. The trajectory on the right illustrates the small portion of the power clean exercise after the bar is racked at the shoulders and the lifter stands erect. This portion of the lift is not of interest when measuring barbell velocity, but many measuring devices incorrectly include velocity from this part of the lift.

the final portion of the lift is used to decelerate the barbell. The part of the force–time curve needed to accelerate the barbell is sometimes called the **propulsive** phase. It is believed by some that the velocities and forces during this phase are most related to lifting performance and the training effect. A few devices will recognize this phase and report propulsive phase data. For example, the propulsive phase for light bench press loads (<40% 1RM) constitute 70% to 80% of the range of motion, while for moderate bench press or barbell squat

loads (50%-70% 1RM) the propulsive phase is 85% to 95% of the lift, and for heavy loads (≥80% 1RM) the entire range of motion is typically the propulsive phase. The propulsive phase of a bench press is shown in figure 7.6. The propulsive phase is also extended to the entire range of motion when the barbell is released (e.g., bench press throw) or when the lifter jumps off the ground (e.g., squat jump or weighted jump).

Last Repetition Effect

Typically, the lifter being tested believes they are giving their best effort when performing velocity testing in the weight room. It is not unusual, however, that a little “extra effort” is given on the final lift, especially for a maximal or difficult load. The result may look like figure 7.7 where the lifter was performing a perceived maximum lift on the last two lifts at the right of the graph. This is another reason that proper instructions must be given, and that test familiarization be included.

Device or Technology Used

Although lifting velocity can be correctly measured using a variety of devices, as previously discussed, the results may not be identical. This is because different velocities are being measured. If only the barbell (or weight stack or other implement) is being monitored, then the velocity of the barbell’s center of mass is recorded. On the other hand, if a force plate is being used, the center of mass of the system mass (body plus barbell) is measured. It must be noted that the body does not move to the same extent as the barbell for many lifts. For example, barbell squats require the lifter’s center of mass to

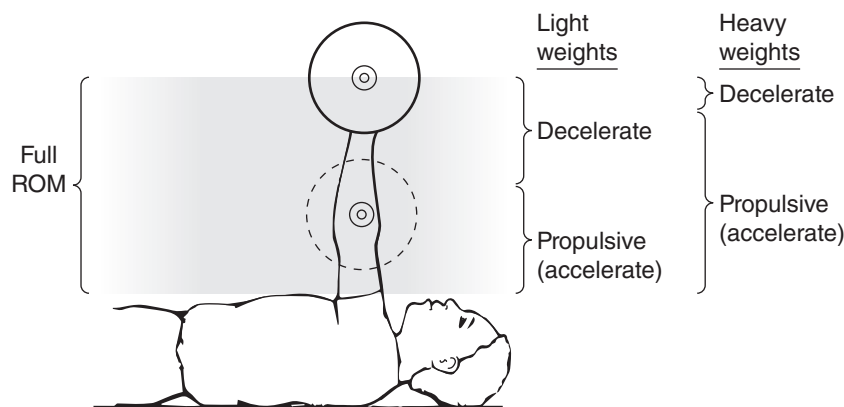

FIGURE 7.6 During high-velocity lifts, early portions of the range of motion of the lift are dedicated to the propulsive phase to create the desired velocity, while the end of the range of motion is used to decelerate the barbell. The distance of the propulsive phase increases as the load gets heavier.

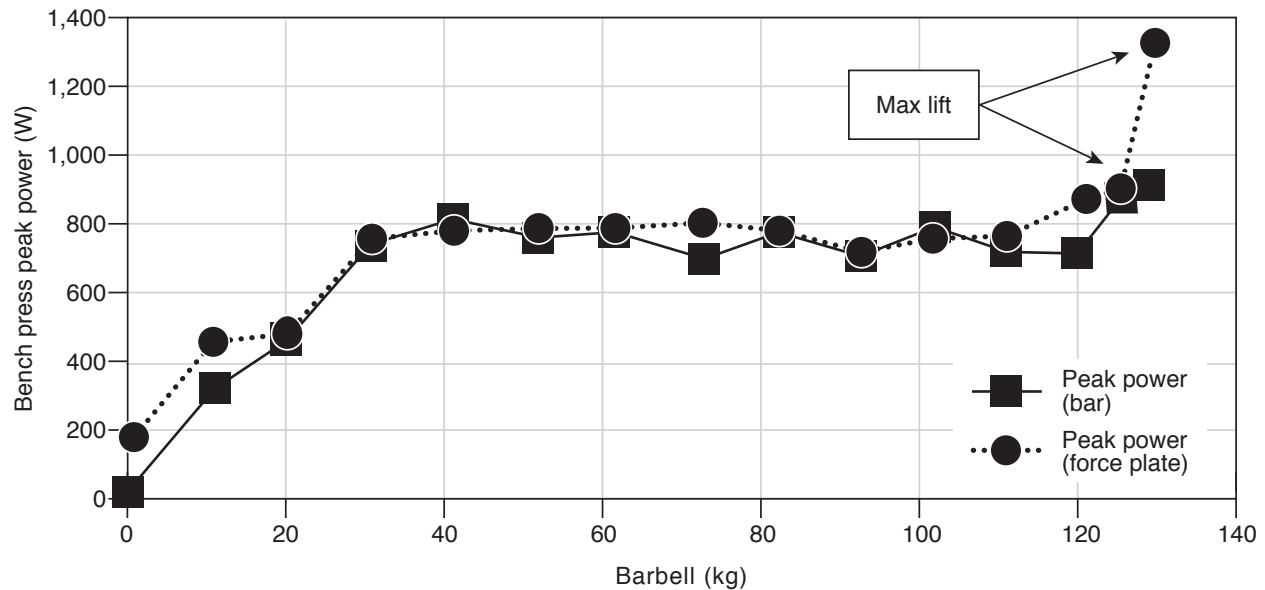

FIGURE 7.7 Sometimes unusually high velocity or power results when the lifter gives a little “extra effort” on a difficult lift; this is known as the last repetition effect. The last lifts at the right of this power–load curve were considered new bench press 1RM lifts. This can make lifting velocity tests difficult to interpret.

move a distance very similar to the barbell’s center of mass. For other lifts like the bench press (see figure 7.8), very little of the body is moving, so the velocities measured by a force plate will be much lower. Lifts such as the clean are somewhere in between. When comparing lifting velocities, be sure you know how the velocities were measured in order to correctly interpret the results.

Location of Attached Device

If a tether, accelerometer, or sensor is attached to the end of a barbell, velocity measurement error can easily occur when exercise technique is compromised. For example, if one end of the barbell is held higher than the other, or the barbell moves out of the frontal plane (called helicoptering) the mea-

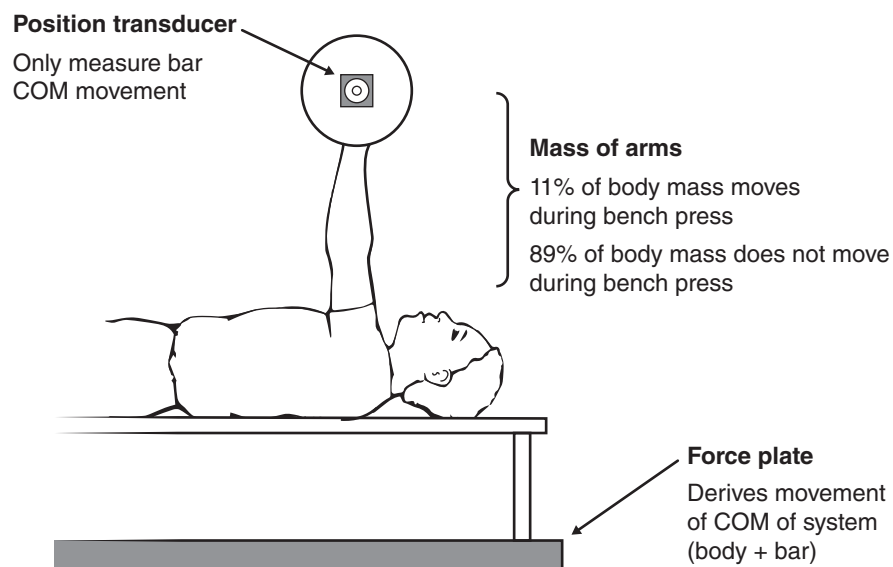
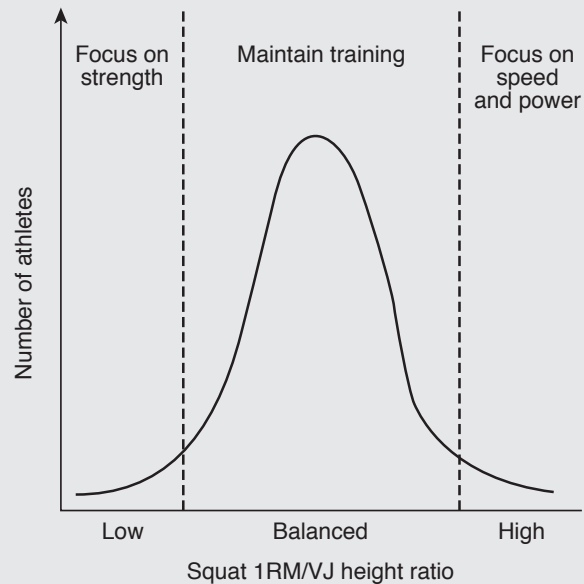

FIGURE 7.8 Different velocity values will result if the body is included in the measurement, such as when using a force plate. In the case of the bench press shown here, most of the body is not moving. The result is force-plate derived data with lower velocity values than if using a device that measures only the barbell. COM = center of mass.

Balance Between Strength and Power

American football strength and conditioning coaches routinely measure barbell squat strength and vertical jump heights for their athletes. The simple ratio of an athlete's squat 1RM strength divided by the vertical jump height provides helpful information on whether the athlete has balanced capabilities between strength and speed or power. Athletes with very high or low ratios will then have their training modified to address their weaknesses.



sured distance the barbell moves will be incorrect. To ensure accurate results, the tester must monitor proper exercise technique, or can attach tethered devices at both ends of the bar, or the center of the bar, to account for uneven bar movements.

Measuring High-Velocity Lifts in the Weight Room

Now that we have discussed the importance of measuring velocity in the weight room, and some of the challenges and considerations, let's examine the velocities commonly found. This is a return to topics introduced in chapters 2 and 6, given in more detail. This discussion will primarily focus on five items:

- Comparisons of data collected with a position transducer, which monitors only the barbell, or with a force plate that includes the system mass (lifter's body plus barbell)
- Comparisons of mean values with peak values
- Velocity characteristics' influence on force and power
- Shapes and slopes of the resulting curves and lines
- Velocity, and related characteristics, of different exercises and their variations

Also note that many of the figures in this chapter are not from published data but are examples taken from well-trained individuals in the training room and athletic performance laboratory. However, they are representative of what would be expected in many settings.

Barbell Squats

We will first examine the velocity characteristics of one of the most commonly measured weight room exercises, the barbell squat and its variations. In particular, the speed squat is performed at maximal concentric velocity without leaving the ground, and to a depth of the top of the thigh parallel with the ground (i.e., inguinal fold below the top of the knee). Squat jumps are similar except that the athlete leaves the ground at the end of the lift. A weighted jump uses a squat depth similar to that used for an unweighted vertical jump test. Figure 7.9 shows example velocity, force, and power curves expressed across light to heavy loads. The vertical dotted line in each graph indicates the 1RM load for the individual tested. First, note the difference in the velocity curves that measure just the barbell (using a position transducer of some type) with those that measure the system mass (body plus barbell) using a force plate; one device is tracking the barbell center of mass while the other is tracking the center of mass of the system, which are not identical.

However, for the barbell squat exercise, the vertical displacement of both centers of mass are very similar and will result in small to no differences. This is why one can enter the system mass for a squat exercise when using a position transducer and get results similar to a force plate. But if you look closely at panels *a* and *b*, you will see that the two testing devices do not produce identical results. If precision is needed, these data are not interchangeable. In panel *c*, the range of motion of the weighted jump is limited enough that the difference in centers of mass do not make a difference.

A common question when testing velocity is whether to use mean velocity or peak velocity.

Figure 7.9 illustrates how these values can be quite different for all variables. Although these variables are almost always highly correlated ($r > 0.90$), they are not identical and should not be used interchangeably. Also, the available sampling rate will impact the accuracy of the peak values in particular. Since peak values are from a single sampling point, too few samples means it is easier to miss the actual peak value.

Since velocity is a contributing variable to force and power, panels *d-i* illustrate how the different loads and velocities produce the uniquely different curves for each of these variables. Whereas this chapter focuses on velocity in the weight room, we must

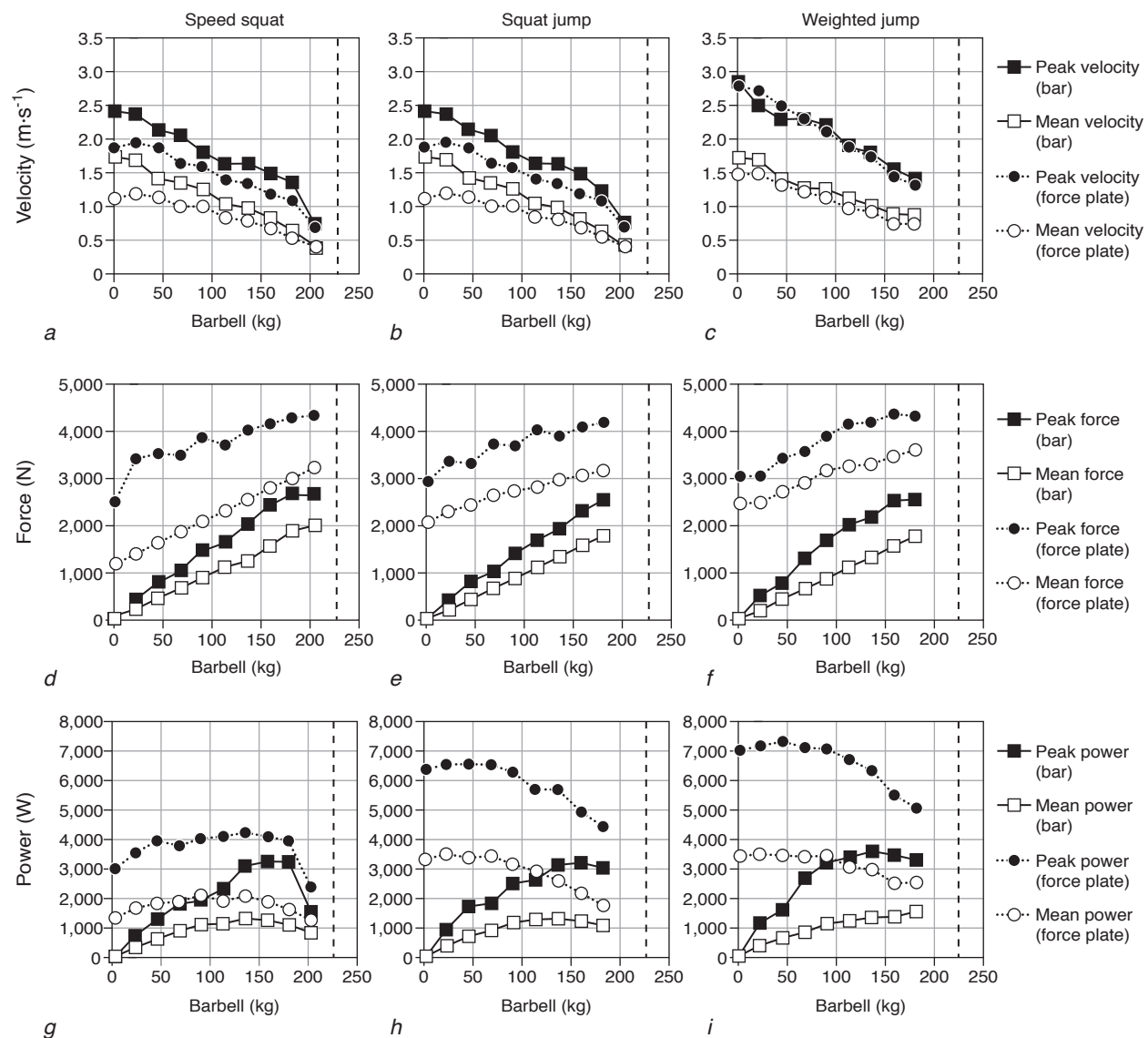

FIGURE 7.9 Velocity (panels *a, b, c*), force (panels *d, e, f*) and power (panels *g, h, i*) for speed squats (panels *a, d, g*), jump squats (panels *b, e, h*), and weighted jumps (panels *c, f, i*) for a well-trained individual. The vertical dashed lines indicate 1RM loads.

also consider these equally important variables to fully understand why velocity is so important. Comparing the velocity (panels *a, b, c*) and force curves (panels *d, e, f*) clearly demonstrates how lower velocities are associated with greater forces. This is accomplished even when the lifter is attempting to lift at maximal velocity; only the loads being lifted influence the velocity attained. It is also important to notice that the inverted U-shape characteristic of power curves (panels *g, h, i*) are considerably different due to two factors. First, when only the barbell is monitored, the greatest powers are consistently at heavier loads than when a force plate is used and the greatest powers are at lighter loads. Inclusion of the body mass in these calculations is a critical difference in the results. Secondly, when the lifter leaves the ground and completely avoids the deceleration phase of the lift (panels *b* and *i*), the greatest power occurs at lighter loads. These differences may explain in part why some scientific literature identifies lower relative intensities (i.e., $\leq 30\%$ 1RM) for generating the greatest power, and other sources identify higher intensities (i.e., 60%-80% 1RM). Both calculations are correct, it just depends on how the data are collected. Additionally, the coach and athlete must decide on which measure is most important for their needs. For example, some athletes may need to focus on what the system mass is doing (e.g., American football lineman), while others are more concerned with what the athlete can do with an external device or load (e.g., baseball pitcher, javelin thrower, or weightlifter).

Power Cleans

Now let's examine the velocity and related characteristics of one of the faster movements in the weight room, the clean lift. First, we'll define what each of the lifts entail. The term *power* simply means that the lifter does not go into a full squat to catch the barbell at the end of the pulling phase. The barbell is caught with the knees only slightly bent. For many athletes, this is the most common position for catching the barbell. This also means the barbell is pulled a greater distance. The clean lift (or full clean) requires the lifter to squat under the bar after full extension. This is the preferred technique for competitive weightlifters since the barbell needs to be pulled to a lower height and greater loads can be lifted. The box clean simply starts the lift with the barbell off the ground. In other words, this is a partial lift where only the top of the pull is performed. This is a common assistance lift for the clean exercise. It also avoids the stretch-shortening cycle that occurs with the typical hang clean. Note that the loads used for figure 7.10 are selected based on the lifter's power clean 1RM for comparison purposes.

We will now examine the same aspects of velocity characteristics for the clean, but will see how different the clean is from the squat exercises just discussed. First, notice in figure 7.10 that once again the velocities from force plate-derived data are quite different from those measured directly from the barbell (panels *a, b, c*). The main distinction is that the differences are much greater than for the squat exercise. This is due to the body's center of mass moving much less than the bar's center of mass for

Contributions of Strength and Power to Explosive Performance

Monitoring weight room performances over time for high-level collegiate basketball players indicates that increasing strength is critical for increasing power, which in turn is necessary for high-velocity jumping performances. This supports strength, power, and velocity training for sport performance.

Speed squat power (per kg of BW) 1RM squat strength (per kg of BW)

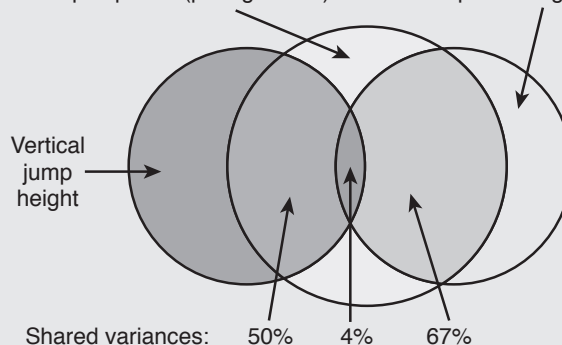

Squat strength (1RM) → squat power → VJ height

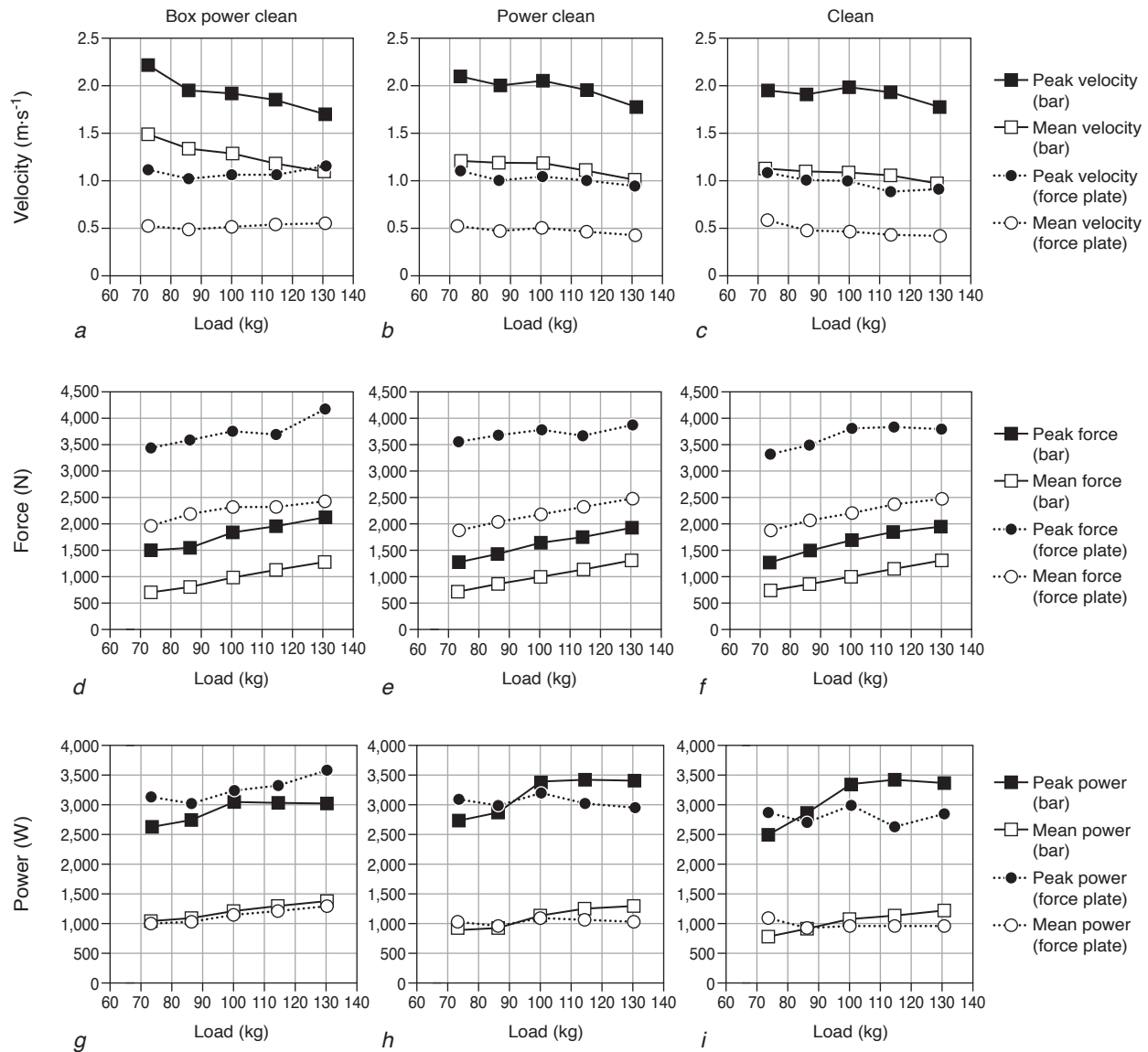

FIGURE 7.10 Velocity (panels a, b, c), force (panels d, e, f), and power (panels g, h, i) for box power cleans (panels a, d, g), power cleans (panels b, e, h), and cleans (panels c, f, i) for a well-trained individual. 1RM for a box power clean = 145 kg.

the clean. This results in much lower recorded lifting velocities when using the system mass. However, the opposite is observed for force, in which the addition of body mass, when recording with a force plate, produced higher forces than when only monitoring the barbell (panels d, e, f), which is more similar to the squat exercise.

The combination of velocity and force for the clean exercises results in very similar barbell or system powers (panels g, h, i) whether you are using a force plate or monitoring only the barbell. When comparing the velocity, force, and power curves for each exercise variation, all of the curves look very similar. This is most likely due to each lift includ-

ing the second pull of the clean exercise, where peak kinetic and kinematic values occur. However, do not interpret this to mean that full cleans (i.e., including a squat to catch the barbell) do not serve a valuable training effect. Depending on the needs of the athlete, this lift may incorporate important movement patterns helpful to the individual.

As expected, peak and mean values are considerably different. In each graph in figure 7.10, the sensitivity of the barbell position transducer is set to ignore any movement after completion of the concentric portion of the pull, thus avoiding some of the problems previously described. One unique characteristic of all of these curves is the narrow

range of velocities. The clean and its derivatives are all time-limited lifts. It is not possible to perform these exercises slowly, even with maximal loads. The result is that all lifts, from heaviest to lightest, produce very high velocities. This is evident from the relatively low slopes for all the curves shown.

When comparing the clean curves (figure 7.10) with the squat curves (figure 7.9), there are two additional important factors. First, unlike squats, the cleans are not preceded by an eccentric action. This will greatly influence the resulting velocities, forces, and powers. Also, the lightest lifts for the clean curves were at approximately 50% power clean 1RM loads, while the squats were performed with as little as 1-kg loads. If the clean curves were extended to <50% 1RM loads, the values for velocity would likely be greater.

Bench Press

Figure 7.11 illustrates velocity (figure 7.11a), force (figure 7.11b), and power (figure 7.11c) for the barbell bench press exercise. The lifts represented on these curves were performed without a pause on the chest, sometimes called “touch and go,” meaning there was an eccentric phase immediately preceding the concentric portion of the lift that is shown. As previously discussed, only the upper limbs of the body move for this exercise, so even though the force plate measures include the system mass (body plus barbell), very little of the body is moving (approximately 11% body mass) and contributing to the system center of mass velocity. Thus, velocities derived from the force plate are considerably less than those derived from the barbell.

Peak values for velocity and force are greater than mean values as has been seen for all exercises examined. System forces are consistently much higher than the corresponding barbell forces. Even though most of the body is stationary during this exercise, it still contributes to the system ground reaction forces, resulting in much higher values seen in the middle panel. The combination of velocity and force results in the strikingly similar powers for both measuring methods as seen in the right panel. It is likely that the bench press will produce smoother results if a pause is performed at the bottom of the lift, thus minimizing the effect of the stretch-shortening cycle, and possibly the effect of a “bounce” off the chest. The changing contributions of the propulsive and deceleration phases may also contribute to the variable results seen for peak power. Certainly bench press throws are likely to change the shapes of these curves, but this form of the exercise can be problematic due to safety considerations.

In summary, measuring velocity in the weight room is highly affected by the test methods and devices used, the use of either mean or peak values, and the types of exercises performed. A knowledgeable coach or trainer needs to account for these factors when interpreting results.

Slow-Velocity Concentric Resistance Exercise

Let’s revisit a topic first introduced in chapters 2 and 3, lifting weights slowly. For at least the past half century, some resistance exercise enthusiasts

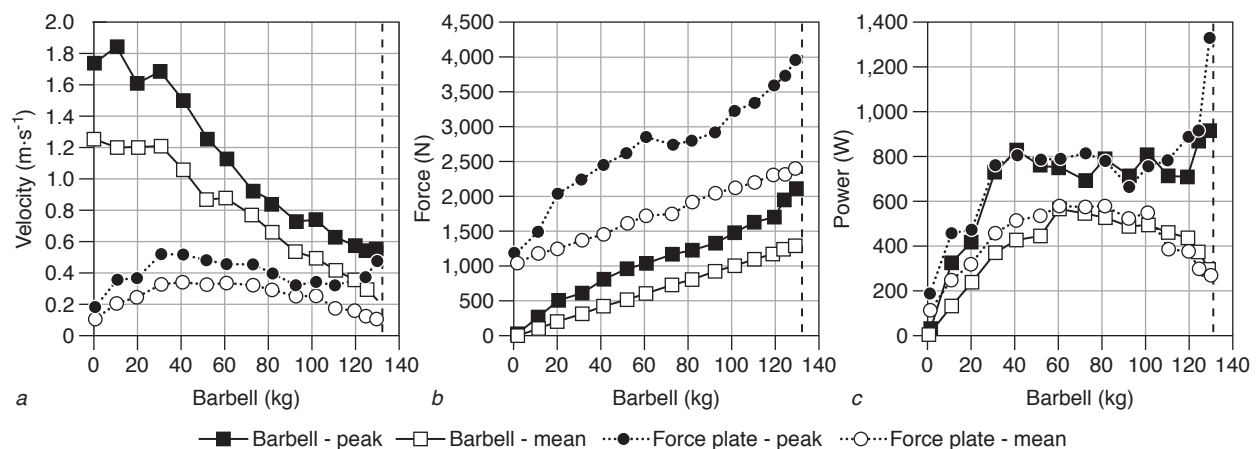
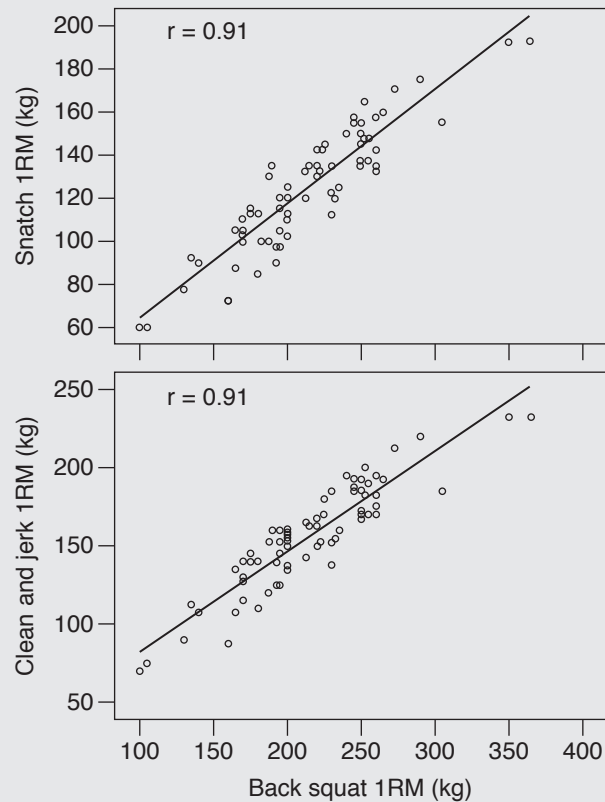

FIGURE 7.11 (a) Velocity, (b) force, and (c) power for the barbell bench press exercise for a well-trained individual. The vertical dashed lines indicate 1RM loads. The increase in peak power sometimes seen at maximal loads (see figure 7.7) is also evident for peak velocity and force.

Weightlifting Performance Is Related to Strength

Weightlifting movements (i.e., snatch and clean and jerk) require high bar velocities and technical proficiency. However, high levels of muscular strength are essential for successful weightlifting performance. These figures show the strong association between barbell squat strength and weightlifting. These data represent competitors at all levels, from recreational to international level.

Reprinted by permission from R.A.J. Lucero, A.C. Fry, C.D. LeRoux, and M.J. Hermes, "Relationships Between Barbell Squat Strength and Weightlifting Performance," *International Journal of Sports Science & Coaching* 14, no. 4 (2019): 562-568.



have advocated performing lifting exercises with a purposefully slow velocity. This type of resistance training has been given numerous labels, including high-intensity training, super-slow, or tempo training, among others. Proponents of slow-velocity resistance exercise have made numerous claims for the effectiveness of slow-velocity training methods, such as greater force, power, muscle hypertrophy, and motor unit recruitment to name a few. While the scientific literature has not supported these claims, this type of training remains popular for some. In many cases, the isokinetic force-velocity curve is used to support use of slow-velocity motions for producing high muscular forces. As we will see, this interpretation of the isokinetic force-velocity curve can be problematic since the dynamometer allows only one velocity, while free weight exercise velocity is influenced by numerous factors. Undoubtedly, slow-velocity resistance exercise can produce muscle growth and enhanced strength for some. Clinicians will often effectively prescribe slow-velocity movements as part of a rehabilitative

or therapeutic training program. However, the question must be asked, "Is this an optimal training method?" This section will examine the kinetic and kinematic characteristics of purposefully slow resistance exercise.

Perhaps the easiest place to begin is by performing a barbell squat while on a force plate. Figure 7.12 illustrates the ground reaction forces when performing a parallel squat with a modest load of 25 kg. As expected, when the lifter maximally accelerated during the concentric phase of the lift, the forces are considerably greater. On the other hand, when the barbell is lifted very slowly, the ground reaction forces are almost identical to the forces produced by simply holding the barbell while standing on the force plate, that is, an *isometric muscle action*. The physics equations given at the beginning of this chapter highlight these differences in the forces produced. As we will see in many additional examples, slowing down the lifting velocity will always have this effect when using constant external resistances.

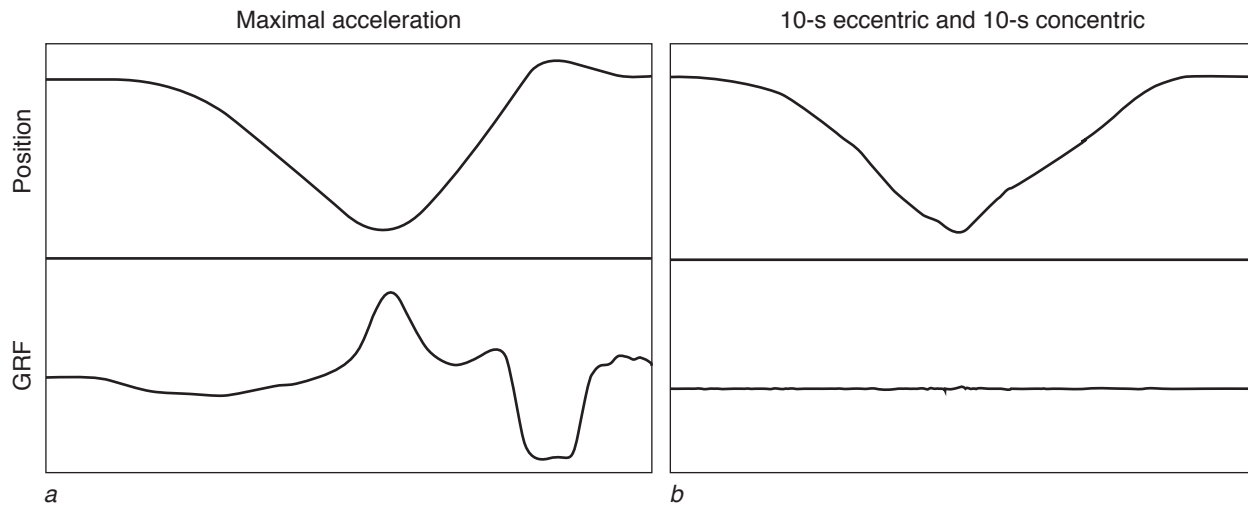

FIGURE 7.12 Two position–time and force–time curves for an individual who is barbell squatting with a load of 25 kg. (a) shows the resulting forces when maximal acceleration is used for the concentric phase, while (b) shows the forces when 10-s eccentric and 10-s concentric phases are used for the lift. GRF = ground reaction forces.

Now let's examine the effect of slow lifting when performed at different velocities. Does the large decrease in force or power occur at lifting velocities that are not as slow as shown in figure 7.12? Figure 7.13 illustrates how a seemingly small change in lifting velocity can greatly diminish barbell power during a bench press. The left side of figure 7.14 shows mean barbell force and power as measured by a force plate when the load remains constant but the barbell vertical velocity is altered by changing the concentric phase time from 10 s to less than 1 s. As might be surmised from the previous discussion of high-velocity lifting, mean barbell forces are not altered when using this relative load (50% 1RM). However, mean barbell power increases linearly as velocity increases, due entirely to the greater velocity. It should be noted that the force–velocity curve in the top left panel in figure 7.14 is considerably different from the curves generated from isokinetic testing. Clearly isokinetic force–velocity curves cannot be used to infer the kinetic characteristics of free weight (or weight stack machine) lifting when the velocity is purposefully slowed down. But what if the load is changed and the lifter maximally accelerates the barbell during the concentric phase at each load? The right two panels in figure 7.14 show the mean barbell forces and powers under these conditions. For these lifts, the barbell velocity decreases as the load increases. This is not due to the lifter purposely slowing down the lift but is rather the effect of having to move a greater mass. Anyone who routinely lifts high relative intensity loads should have experienced this phenomenon.

Contrary to what one might read, the barbell is not slowed down at heavier loads by the lifter in order to develop more force, but rather the barbell is slowed down due to the greater barbell mass. This is similar to the mass–distance curve presented in chapter 2 (see figure 2.10). It is also somewhat similar to the isokinetic force–velocity curve often cited, only now the changes in velocity are due to the different barbell masses, and not due to the isokinetic device controlling the velocity.

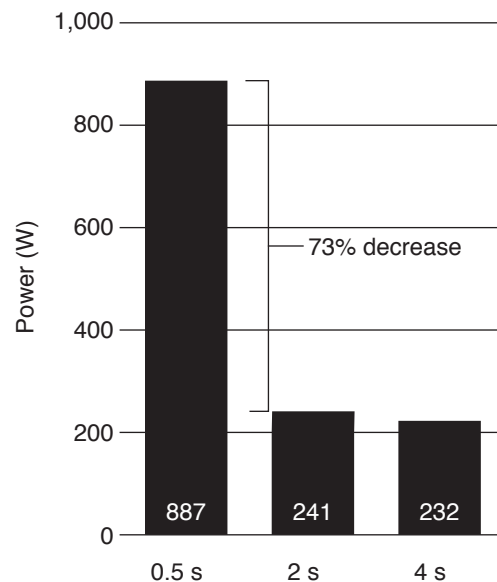

FIGURE 7.13 Barbell peak power while performing the bench press exercise with 100 kg at three commonly used lifting velocities, with concentric durations of 0.5, 2, and 4 s.

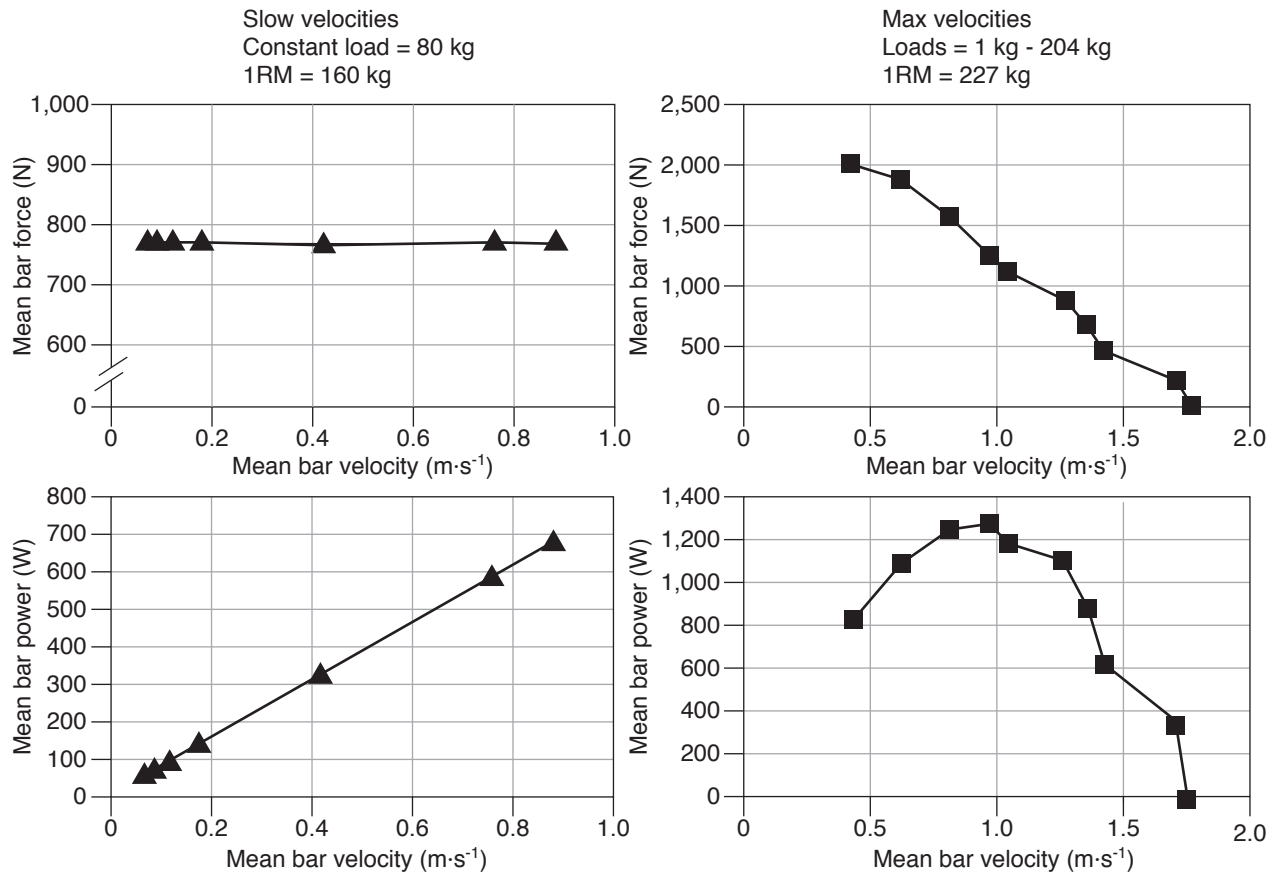

FIGURE 7.14 Barbell force and power for the squat exercise over a range of lifting velocities. On the left, barbell velocity is volitionally controlled from a 10-s concentric lift (far left triangles) to a maximum acceleration lift (far right triangles) while using a constant load. On the right, all lifts were performed with maximal acceleration, but with increasing loads (far right squares = 1 kg, far left squares = 204 kg).

What if a different exercise was performed, such as the deadlift? Figure 7.15 is similar to figure 7.14, with several important distinctions due to the different lifts. First, the concentric phase of the squat is preceded by an eccentric phase, meaning the primary mover muscles are already contracted and will contribute to a stretch-shortening cycle for all loads lifted. This is not the case for the deadlift, in which there is an initial small spike in the force to overcome the inertia of the stationary bar at light loads. This increased force is less evident at higher loads. The result is that the mean forces for the deadlift are slightly higher as bar velocity increases at lighter loads. Thus, the resistance exercise used can alter the shape of the force-velocity curve. However, both the squat and deadlift exercises produce the characteristic “inverted U” power-velocity curve that was discussed in the previous section.

Since many athletes and coaches like to monitor lifting velocity, it is helpful to know exact bar velocities when the lift is purposefully slowed down.

Although the same load (80 kg) is used for all lifts, the left panel of figure 7.16 shows how barbell velocity can range from $<0.1 \text{ m} \cdot \text{s}^{-1}$ to nearly $0.9 \text{ m} \cdot \text{s}^{-1}$ depending on how long the concentric phase lasts. The middle panel illustrates both mean and peak forces when only measuring the barbell or when using a force plate and including the lifter’s body mass (i.e., system mass). As discussed in the previous section, distinct results occur depending on whether only the barbell is monitored, or whether the entire system mass is monitored with a force plate. When system forces are measured using a force plate, the gray arrow in the middle panel of figure 7.16 indicates the ground reaction force generated by simply standing motionless on the force plate. It appears that purposefully slow lifting velocity has little to no effect on mean concentric forces. Also notice how an increase in the lifting velocity causes a greater difference between mean and peak values for both force and power. And as previously seen, the force-velocity curve with this

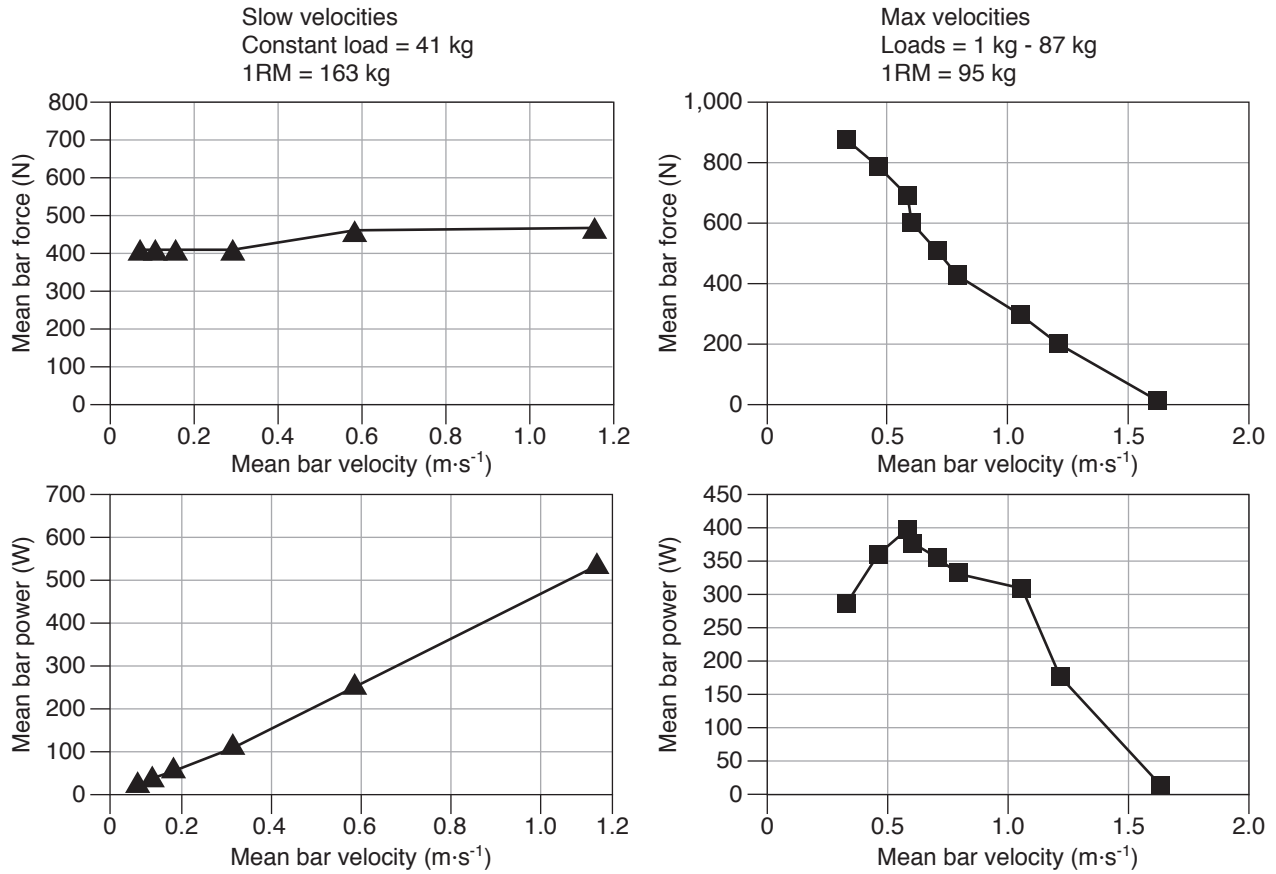

FIGURE 7.15 Barbell force and power for the deadlift over a range of lifting velocities. On the left, barbell velocity is volitionally controlled from a 10-s concentric lift (far left triangles) to a 1-s lift (far right triangles) while using a constant load (25% 1RM). On the right, all lifts were performed with maximal acceleration, but with increasing loads (far right squares = 1 kg, far left squares = 87 kg).

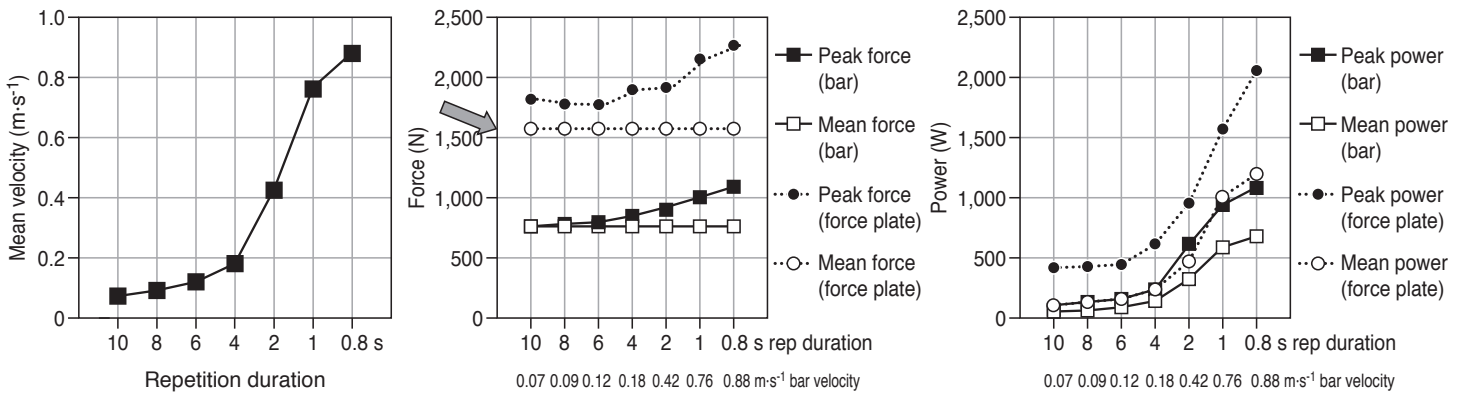

FIGURE 7.16 Comparison of squat variables at different slow velocities. Barbell mean velocity and mean and peak force and power when 50% 1RM barbell squats are performed at different barbell velocities. Data for both the barbell only and the system (bar plus body) masses are shown on the force and power curves. Additionally, both peak and mean force and power are illustrated. The arrow in the middle panel indicates just the gravitational force from the system mass (bar + body) prior to moving.

type of slow-velocity resistance exercise using a constant load for free weights is considerably different from the classical isokinetic force-velocity curves. When power-velocity curves for constant loads for free weights are graphed as in the right panel of figure 7.16, the “inverted-U” profile is no longer evident. As would be expected from the formula for power (i.e., force \times velocity), even though force is unaffected (mean values) or modestly increased, the increasing lifting velocities will generate greater power.

Slow-Velocity Eccentric Resistance Exercise

A popular method of training is performing slow, controlled velocity eccentric exercise, commonly called negatives. Some advocates of this type of training suggest that this training is effective since you resist gravity to a greater extent when lowering the load slowly compared to normal lowering velocities. However, we will see this is not necessarily true. In figure 7.17 we see the force-velocity curve for both eccentric and concentric deadlifts. Notice how the right side of the graph is very similar to other graphs we have discussed (see figures 7.14, 7.15, 7.16), with peak force increasing as velocity increases, and mean force occasionally affected at the highest velocities. However, the eccentric velocities did not particularly affect

the mean barbell forces. Why would this be? Especially since these lifts can be very difficult to perform.

To answer this question, one must remember that the acceleration of gravity is always present. So let's examine the resulting accelerations for one of the controlled eccentric lifts and two of the concentric deadlifts indicated by the arrows in figure 7.17 (i.e., 8-s eccentric, 2-s and 1-s concentric). When measured on a force plate, the acceleration of the system mass is derived from the ground reaction forces by dividing newtons of force by kilogram mass of the system. When the acceleration of the system mass for these deadlifts are adjusted for acceleration due to gravity, as shown in table 7.1, it becomes readily apparent that slow, controlled eccentric resistance exercise has minimal effect on force production. This explains the shape of the eccentric force curves in figures 7.17 and 7.18. So rather than increasing force production, slow eccentric lifts have a negligible effect on force production. On the other side of the force-velocity curves in figures 7.17 and 7.18, a small change in lifting velocity from a 2-s lift to a 1-s lift will increase force considerably (an increase of 12% in this case). The net result is that trying to increase force production during constant external resistance exercise by moving slowly is a futile endeavor. Instead, effective strategies for increasing force are rather simple; either increase the mass lifted, or increase the lifting velocity.

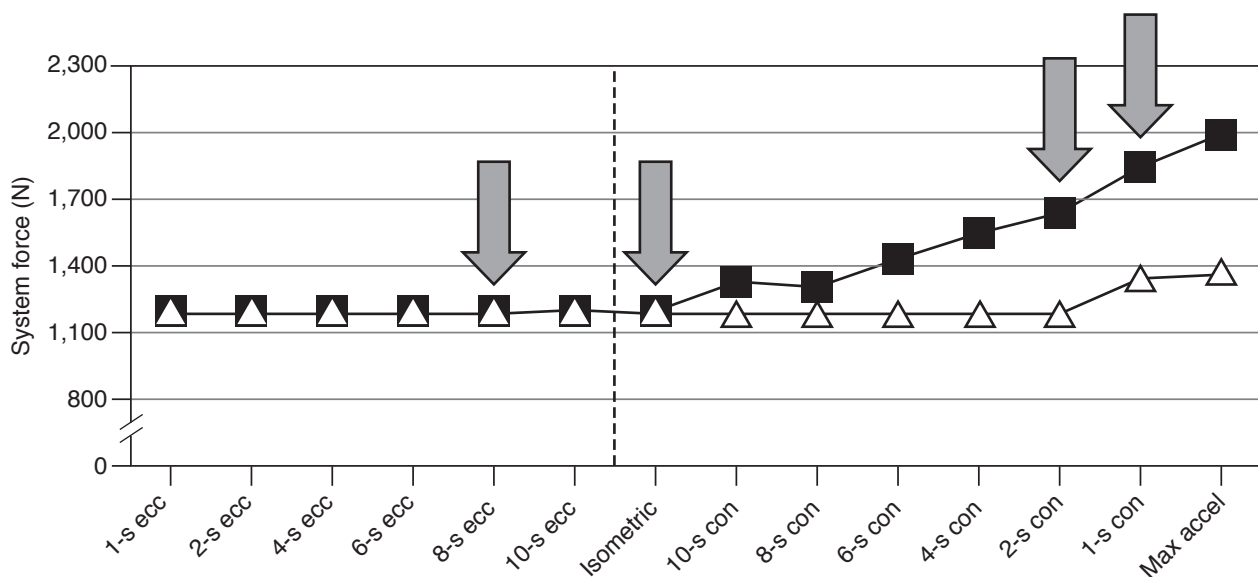

FIGURE 7.17 System forces for the controlled velocity deadlift exercise with a constant load of 41 kg when plotted from fastest eccentric actions on the left, to fastest concentric actions on the right. Data for the lifts indicated by the four arrows are listed in table 7.1. Black squares = peak force, white triangles = mean force.

TABLE 7.1 Accelerations and Forces of Eccentric and Concentric Deadlifts, Including Acceleration due to Gravity

Type	Duration (s)	System mass (kg)	Mean velocity ($m \cdot s^{-1}$)	Peak force (N)	Peak acceleration: force/mass ($m \cdot s^{-1} \cdot s^{-1}$)	Peak acceleration-gravity ($m \cdot s^{-1} \cdot s^{-1}$)	Difference from isometric
Eccentric	8	121.1	-0.09	1,181	9.75	-0.06	0.6%
Isometric	0	121.1	0.0	1,188	9.81	0.00	—
Concentric	2	121.1	0.42	1,637	13.52	3.71	37.8%
Concentric	1	121.1	0.76	1,835	15.15	5.34	54.4%

These values are for the four lifts indicated by the arrows in figure 7.17.

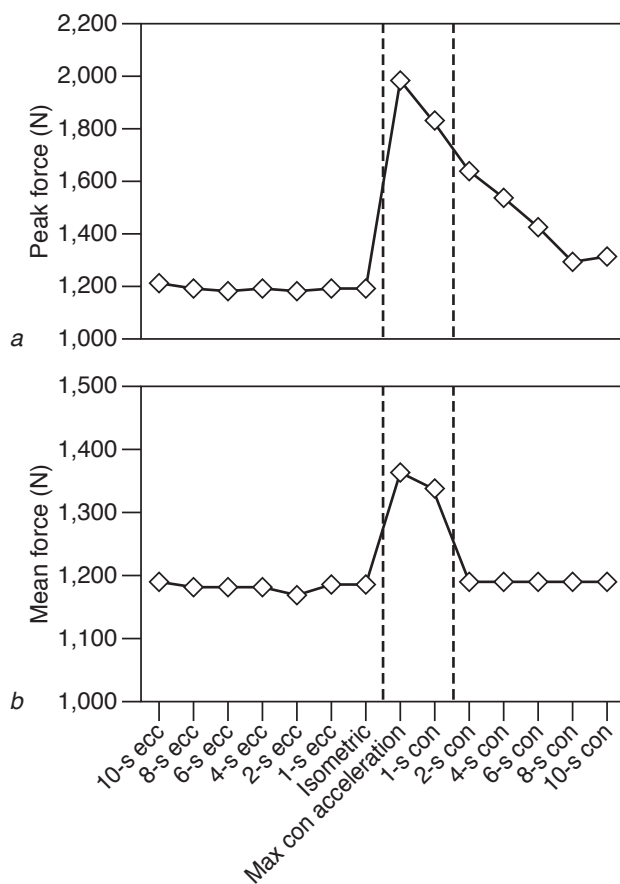

FIGURE 7.18 Another diagram of the (a) peak and (b) mean system forces for the deadlift performed at different velocities. In this diagram, the velocities performed in typical resistance exercise training programs are located between the dotted lines.

Let’s take another perspective on purposefully slow-velocity resistance exercise. One of the primary arguments for this type of training is that the time the muscles are under a load is a primary factor for muscle growth and strength. This is also

called **time under tension**. It is sometimes argued that even if a single repetition of a purposefully slow-velocity resistance exercise produces less force and power, the real value of slow-velocity lifting is when an entire training session is performed. When multiple repetitions of multiple exercises are put together, the collective time under tension is quite large, thus producing the desired results. In order to examine this more closely, training sessions that are typically used for either slow-velocity or maximal acceleration resistance exercise need to be examined to compare commonly used training principles. Table 7.2 describes the results when two different training sessions for the barbell bench press and barbell squat were performed using different movement velocities. Although both training sessions were performed to near volitional failure, the differences in the forces, power, work, and impulse are remarkably greater when the barbell is moved at maximal concentric velocity. And although time under tension has been suggested by some to be an important training variable, these data suggest that it is the total work (joules; $N \times ds$) and the combination of force and time (impulse; $N \times s$) in a training session that are likely more important.

Velocity-Related Assessments in the Weight Room

Measurement of lifting velocity can be very helpful in the weight room. There are a number of ways this information can be used. The following section will discuss a number of benefits from velocity assessment during strength training, as well as different types of tests. Additionally, there are some important considerations that can affect the results of the tests’ validity. While assessing velocity and

TABLE 7.2 Comparison of Concentric Performance During Resistance Exercise Training Sessions Typical of Either Very Slow Velocity or Maximal Acceleration Training

Variable	3 × 10 – 70% 1RM max acceleration	1 × 10 – 28% 1RM very slow velocity
Concentric duration	Approx. 1 s	10 s
BARBELL SQUAT		
Mean force (N)	* 44% greater	—
Mean power (W)	* 1,176% greater	—
BARBELL BENCH PRESS		
Mean force (N)	* 130% greater	—
Mean power (W)	* 2,022% greater	—
TOTAL TRAINING SESSION		
Time under tension	—	* 156% greater
Work (J)	* 344% greater	—
Impulse (N·s)	* 41% greater	—

* Denotes workout with greater value.

Adapted from P.R. Dietz, A.C. Fry, T.J. Herda, et al., "Attenuated Kinetic and Kinematic Properties During Very Slow Tempo Versus Traditional Velocity Resistance Exercise," *International Journal of Sport Science and Coaching* (in review).

A "Mass–Distance" Curve Example

In the laboratory, testing for force–velocity curves often requires expensive equipment. However, as described in figure 2.10 on page 26, a simple field test can be performed by throwing different weighted objects and measuring the distances thrown. The mass of the object replaces measures of force, and since distance thrown is dependent on release velocity, this replaces direct measures of velocity. Curves like the one shown using different weighted medicine balls and sport balls can provide helpful training guidance.

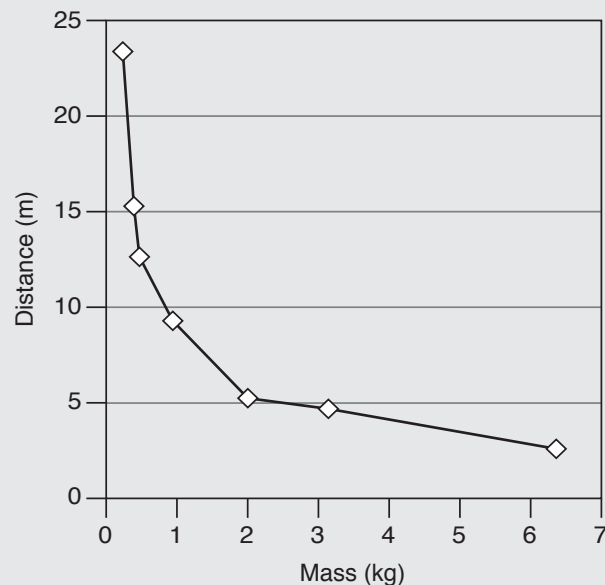

velocity-related variables in the weight room is not necessarily difficult, the nature of the tests must be completely understood to be able to properly interpret the results. These assessments must also be performed correctly to ensure the results are repeatable and valid.

Velocity–Load Curves

The creation of a load–velocity curve is often one of the first applications of velocity measures in the weight room. Recording the mean or peak velocity for lifts across a spectrum of loads permits the calculation of the **line of best fit** for this relationship.

The line of best fit is the statistically derived line on a graph that describes the values, such as shown by straight or curved lines. Typically, this produces a linear relationship, as shown in figure 7.19a from an actual athlete. Note that this figure is very similar to panel a in figure 7.9. The relationships between relative intensity (percentage of 1RM) and velocity is a very stable variable, which permits using lifting velocity for exercise prescription purposes, which we will discuss later. Additionally, the ability to move rapidly while under a heavy load is a desirable trait for many sport events.

Power–Load Curves

In addition to velocity, many measuring devices also report mean and peak lifting power. Since power pro-

duction is a product of force \times velocity, and is a major training goal for many programs, determining the power–load curve for an athlete, such as that shown in figure 7.19b, can provide helpful training information. For example, some coaches use this information to determine training loads for maximizing power when squatting. This curve also illustrates what relative load (percentage of 1RM) is associated with maximum power. Note that this curve is similar to the curve shown in panel g of figure 7.9.

Assessing Progress

An important component of an effective training program is assessing progress. Both velocity–load and power–load curves are one method of monitoring training progress. Figure 7.20 shows a highly

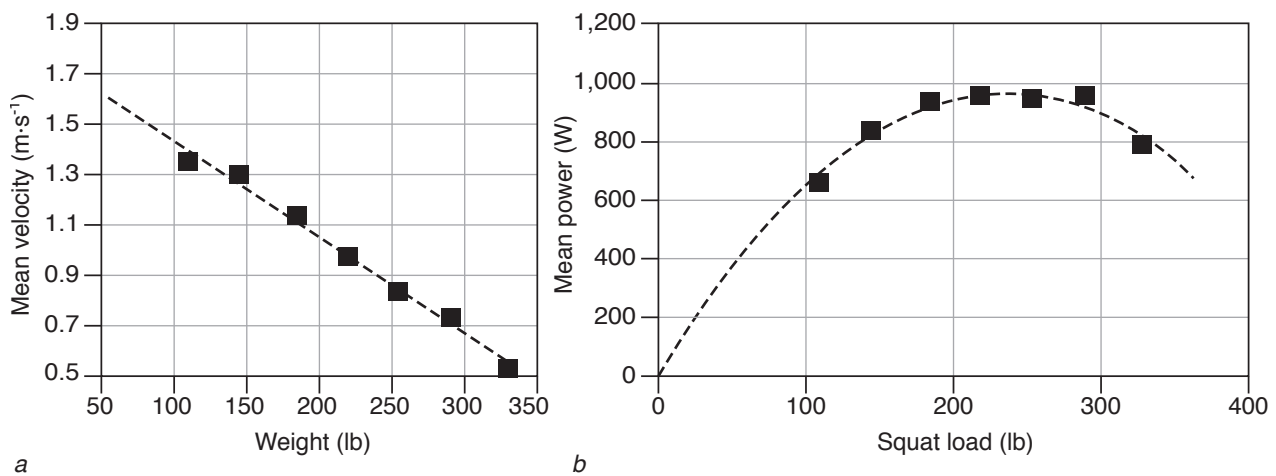

FIGURE 7.19 Velocity–load (panel a) and power–load curves (panel b) for an individual taken from weight room data. Mean velocity indicates a linear relationship with barbell load for the back squat exercise, while mean power illustrates the characteristic inverted U shape.

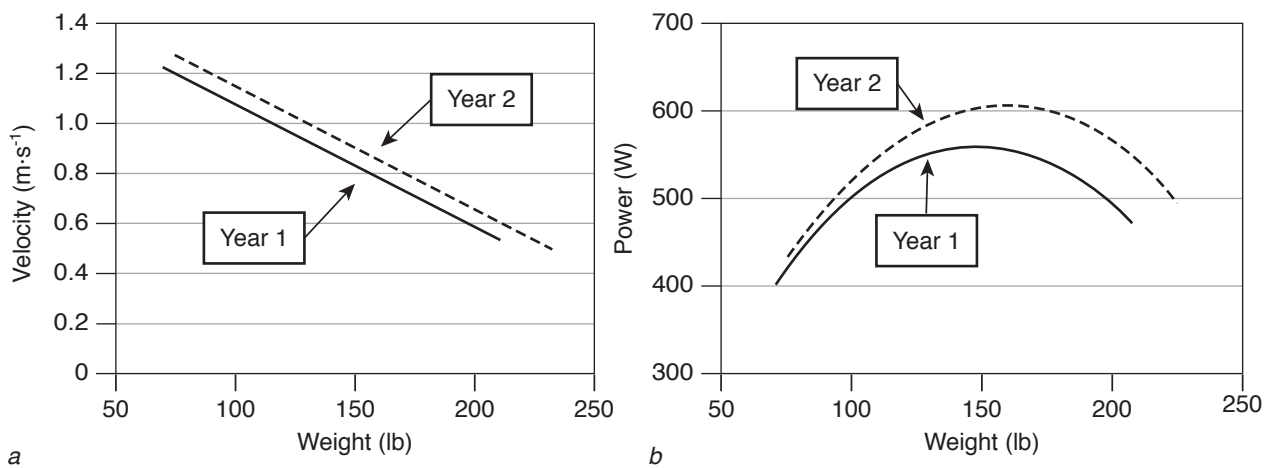

FIGURE 7.20 Testing data from two successive years for an athlete showing progress for the mean velocity–load (panel a) and mean power–load curves (panel b) for the barbell speed squat exercise. Both curves shifted up (indicative of increased velocity and power) and to the right (indicative of increased force via 1RM strength).

trained athlete's progression in velocity and power for the speed squat over a year of training for his sport. Since the velocity-load relationship is so stable (figure 7.20a), the increase shown indicates a very successful training year. The right end of both curves shifted to the right due to the increased squat 1RM strength, while the relative load (percentage of 1RM) for maximum power remained stable (figure 7.20b).

How Muscle Fiber Types Affect the Curves

There are many factors that contribute to the shapes and positions of the velocity-load and power-load curves. One variable that is often overlooked is the contribution of the different fiber types in the contracting muscles. The relative percentages of the different myosin heavy chain (MHC) protein isoforms (i.e., I, IIa, and IIx) is highly correlated ($r > 0.90$) with the cross-sectional areas of the different fiber types. Recent data indicate that individuals with a greater percentage of MHC IIa have greater contractile velocities across all relative intensities (see figure 7.21), meaning the slope of the velocity curve is more negative, and the y -intercept is greater.

With a greater percentage of MHC IIa, power increases and peaks at a lower percentage of 1RM, indicative of enhanced contractile velocity. Both of these curves suggest that athletes needing enhanced velocity and power should train for preferential hypertrophy of the type IIa fibers.

Predicting 1RM Strength With Velocity-Based Training

The process of testing for maximal strength can be a tedious and demanding process. This is especially the case when very large loads can be lifted, as in barbell squats, deadlifts, bench presses, and cleans. One alternative method for estimating 1RM strength is to use velocity-based testing. This involves assessing the lifting velocity at a number of submaximal loads, from which a regression line can be created to determine the loads corresponding to 100% 1RM loads (see figure 7.22). This point is the estimated 1RM strength for the exercise, although this value may be affected by the individual's training status. While this method of strength testing may be useful in some practical settings, close examination of these testing methods shows there is occasionally considerable variability in the results. Large day-to-day variability in velocity at submaximal loads can produce large differences in the slopes of these lines, and the estimated 1RM strength. Indeed, repeated testing using this method produces greater variability than does actual testing at 1RM loads. This, however, does not mean that velocity-based 1RM testing does not serve a role. Since actual 1RM strength is resistant to short-term fluctuations in the weight room training load (see chapter 9 on overtraining), changes in velocity at submaximal

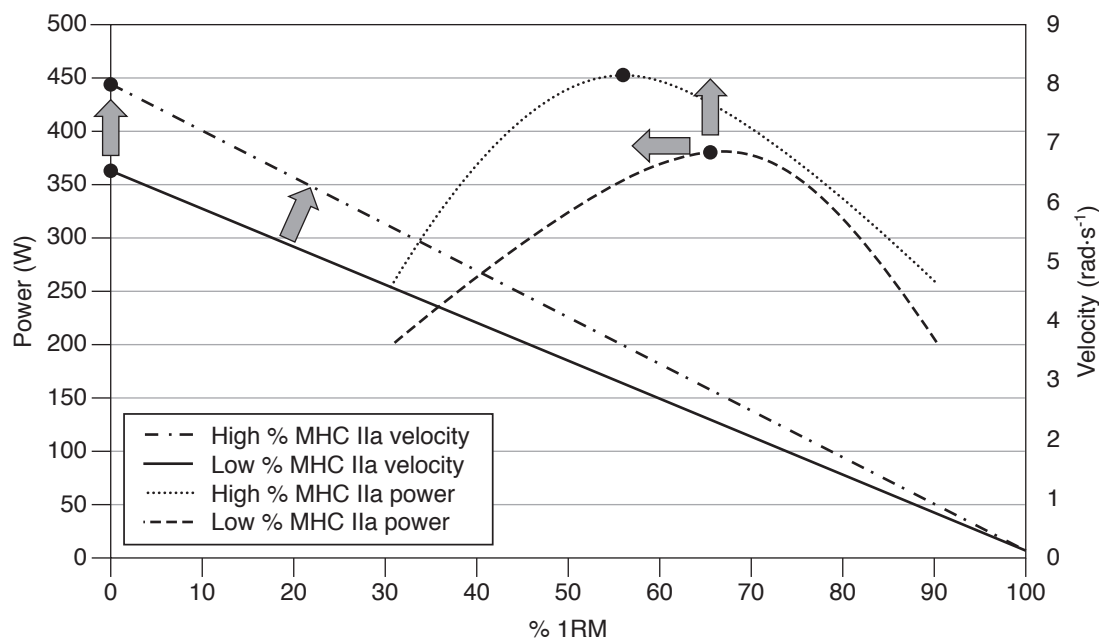

FIGURE 7.21 The effect of relative content of myosin heavy chain (percentage of MHC) on the velocity-load and power-load curves for 42 individuals performing knee extensions. Greater percentages of MHC IIa shifts both curves in the directions indicated by the arrows.

Reprinted from M.T. Lane and A.C. Fry, "Myosin Heavy Chain Expression Relationships to Power-Load and Velocity-Load Curves," *Journal of Sports Medicine and Physical Fitness* (in review).

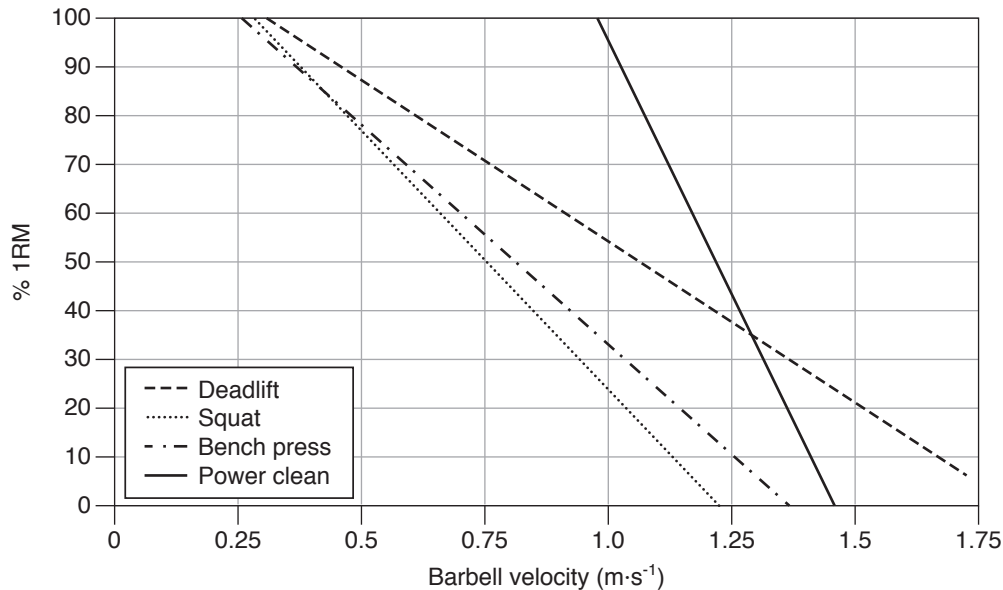

FIGURE 7.22 Examples of load–velocity curves for four exercises showing how extension of the regression line to 100% 1RM values can provide an estimate of 1RM strength. Note also how some exercises have a different load–velocity relationship (e.g., power clean).

Adapted by permission from B. Mann, *Developing Explosive Athletes: Use of Velocity Based Training in Training Athletes*, 3rd ed. (Muskegon, MI: Ultimate Athlete Concepts, 2016), 48.

loads may serve as a more sensitive indicator of training stress.

Using lifting velocity to determine training session loads and exercise prescription may be a helpful tool for several reasons. First, prescribing loads based on the measured lifting velocity ensures the athlete is training in the desired training zone. Figure 7.23 shows the load and velocity ranges corresponding to popular categories of strength characteristics. Second, since there is so much interindividual variation in the lifting capacities at a prescribed percentage of 1RM, using velocity to prescribe training loads—or **velocity-based training**—may result in greater accuracy when determining appropriate loads. This is not to say that velocity-based training is better than prescribing by relative or absolute loads (e.g., a percentage of 1RM or 10RM), but rather it is an alternative approach that some coaches find helpful. This may be especially true when training large groups of athletes who have a wide range of training experience and lifting capabilities.

How Height Affects Velocity-Based Training

One often overlooked aspect of using velocity-based training prescription is the height of the athlete. A careful look at figure 7.23 shows that there is

a considerable range of velocities appropriate for each of the strength characteristics and relative intensities. Some resistance exercise programming theorists have categorized the qualities of strength based on velocity and force characteristics: absolute strength, acceleration strength, strength-speed (greater emphasis on strength), speed-strength (greater emphasis on speed), and starting strength. Since it is common to prescribe one particular target velocity for training a lift, error can be introduced when ignoring the stature of the athlete. Figure 7.24 shows how taller athletes will move a barbell faster than a shorter athlete. Adjustments in prescribed velocities should be made when height is a factor to ensure the individual is training with loads for the desired strength characteristics, and the appropriate repetition ranges.

Rate of Force Development Measures

Since chapter 2 introduced the concept of rates of force development, its definition, and types, this section will address some other related aspects. Although the assessment of rate of force development is not a direct measure of lifting velocity, it is definitely related. In other words, it is a measure of how rapidly force can be generated, in either a dynamic or a static state. It is defined as the dF/dt where F = force, t = time, and d = change.

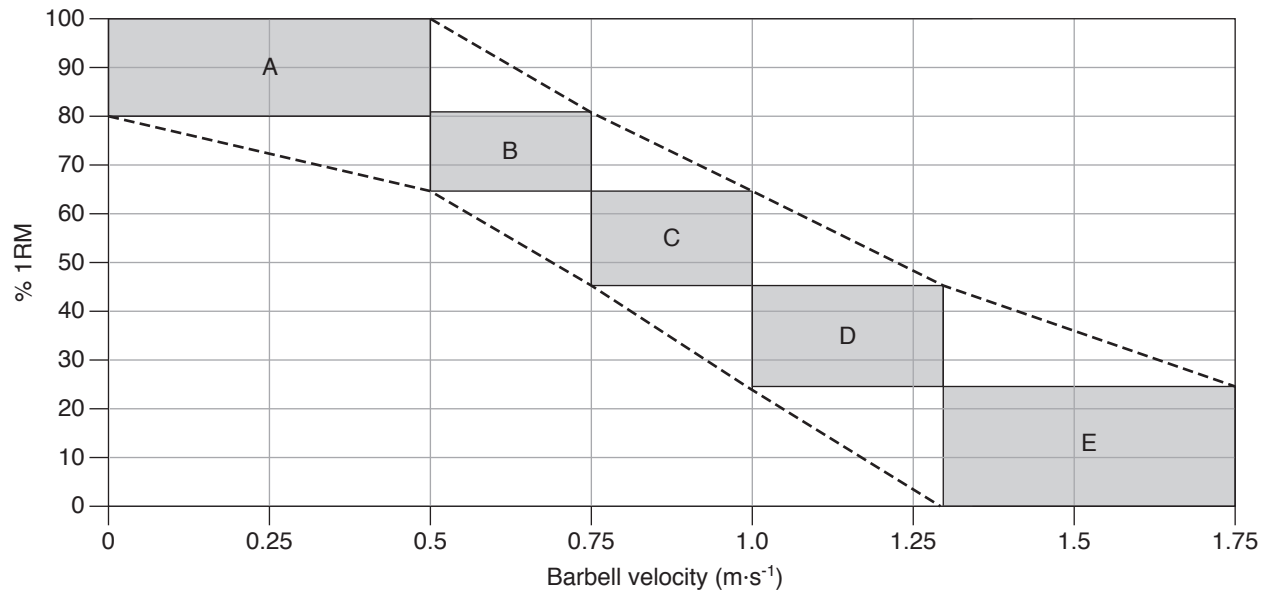

FIGURE 7.23 Suggested ranges of velocities for many weight room exercises, and the strength characteristics associated with these velocities for high-level collegiate athletes. The zones may need to be adjusted for different populations. A = absolute strength, B = acceleration strength, C = strength-speed, D = speed-strength, and E = starting strength. Note that the weightlifting exercises (snatch, clean, jerk) are primarily at the right side of this figure, and the relative loads (percentage of 1RM) will be different as seen in figure 7.22.

Adapted by permission from B. Mann, *Developing Explosive Athletes: Use of Velocity Based Training in Training Athletes*, 3rd ed. (Muskegon, MI: Ultimate Athlete Concepts, 2016), 20.

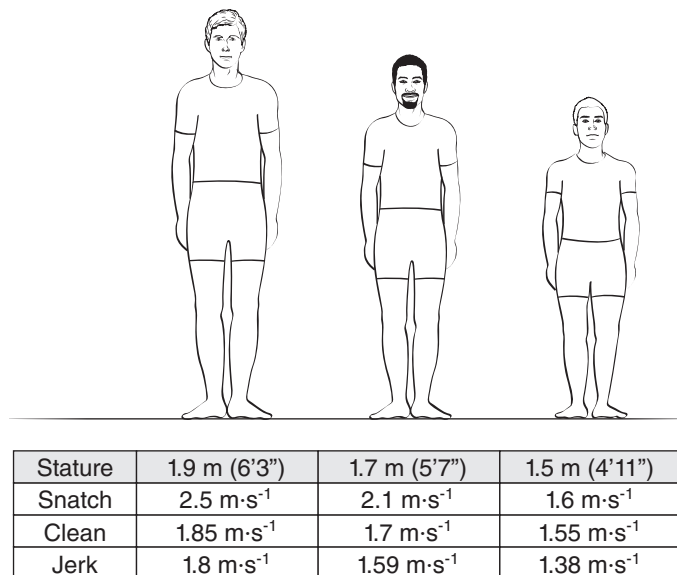

FIGURE 7.24 The stature of a lifter will affect the lifting velocities. This table illustrates example maximal velocities for weightlifting exercises for individuals of different heights.

Adapted by permission from B. Mann, *Developing Explosive Athletes: Use of Velocity Based Training in Training Athletes*, 3rd ed. (Muskegon, MI: Ultimate Athlete Concepts, 2016), 60.

Dynamic rates of force development are determined when the body (or a portion of the body) or an external load are moved (or lifted). A good example of this is shown in figure 7.25 taken from a vertical jump test. The rate of force development for a dynamic activity such as this is highly dependent on factors such as the type of muscle action (concentric or eccentric), the contributions of a stretch-shortening cycle, and the precise identification of the starting and ending points of the measure. Dynamic measures of rate of force development are sometimes difficult to interpret due to these confounding factors. These measures are sometimes not very stable, and often exhibit low test-retest reliability. This is because small changes in the force or time components can have large effects on the resulting slope. On the other hand, the measures appear to be sensitive to the training stresses, and are sometimes used to monitor training status.

Static, or isometric, rates of force development are often easier to interpret since the contractile conditions are more controlled than for dynamic measures. Rates of

Force Is Important for Batting

While baseball batting is considered a high-velocity, high-skill event, there is considerable force contribution. These graphs illustrate how important weight room strength and force development during batting is to successful high-velocity sport performance.

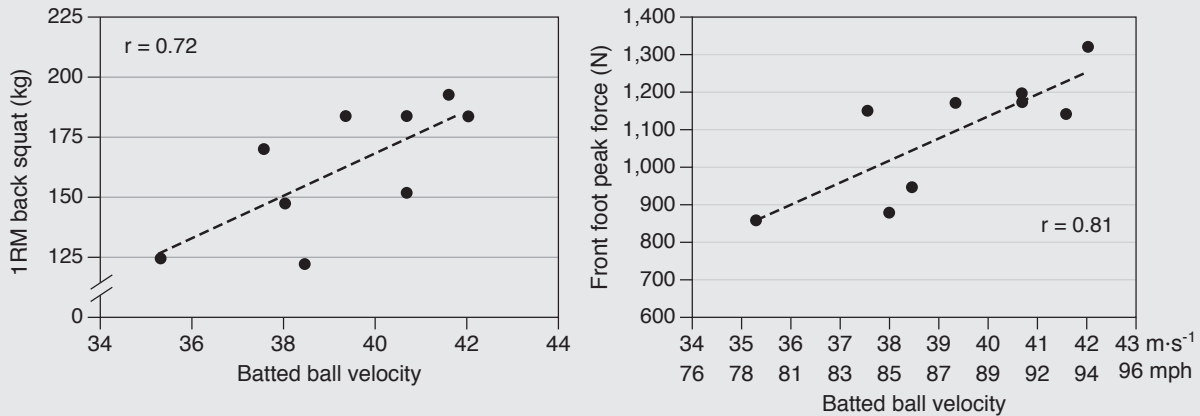

Left panel reprinted from A.C. Fry, D. Honnold, A. Hudy, et al., "Relationships Between Muscular Strength and Batting Performances in Collegiate Baseball Athletes," presented at NSCA National Conference, Orlando, FL (2010). Right panel reprinted from C.M. Forsythe, A.C. Fry, M.C. Haggerty, and M.J. Andre, "Relationship of Ground Reaction Forces and Other Performance Measures With Batted-Ball Velocity in Collegiate Baseball Players," presented at NSCA National Conference, Kansas City, MO (2011).

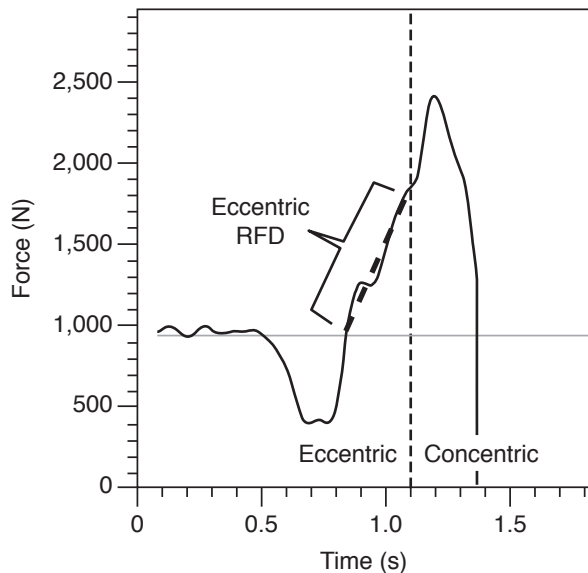

FIGURE 7.25 Force–time curve for a standing countermovement vertical jump test. Rates of force (RFD) development can be measured in numerous ways. This figure shows the eccentric rate of force development starting when force returns to baseline (i.e., gravitational force for the body mass) and ending at the completion of the eccentric phase.

force development at various joints and for numerous muscle groups have been measured for years; however, recently the isometric midhigh pull test has become very popular. This test is performed

using a stationary barbell set at the beginning height of the second pull of a clean. Proper positioning of the individual is absolutely critical for valid and repeatable results. The bar is pulled as rapidly and forcefully as possible for approximately 5 s. Figure 7.26 shows an example force–time curve from an isometric midhigh pull test. Because the total body contributes to this activity, very high forces result. However, compared to single-joint tests of this type, the isometric midhigh pull takes longer to reach maximum force. This test has been successfully used to monitor training and recovery status.

Seated Shot Put (Medicine Ball) Test

Thus far, none of the velocity measures discussed have focused on the upper body, and many require expensive or elaborate equipment to measure. The seated shot put test was originally developed to examine upper-body power for the sport of American football. Using an indoor 16-lb shot put or medicine ball, the athlete uses a chest pass-like motion to throw the shot put as far as possible while in a seated position. The torso can lean forward during the throwing motion, but the hips must remain stationary. The distance thrown is the measure of interest. This relatively simple and inexpensive test has shown strong correlations with bench press 1RM strength for both men

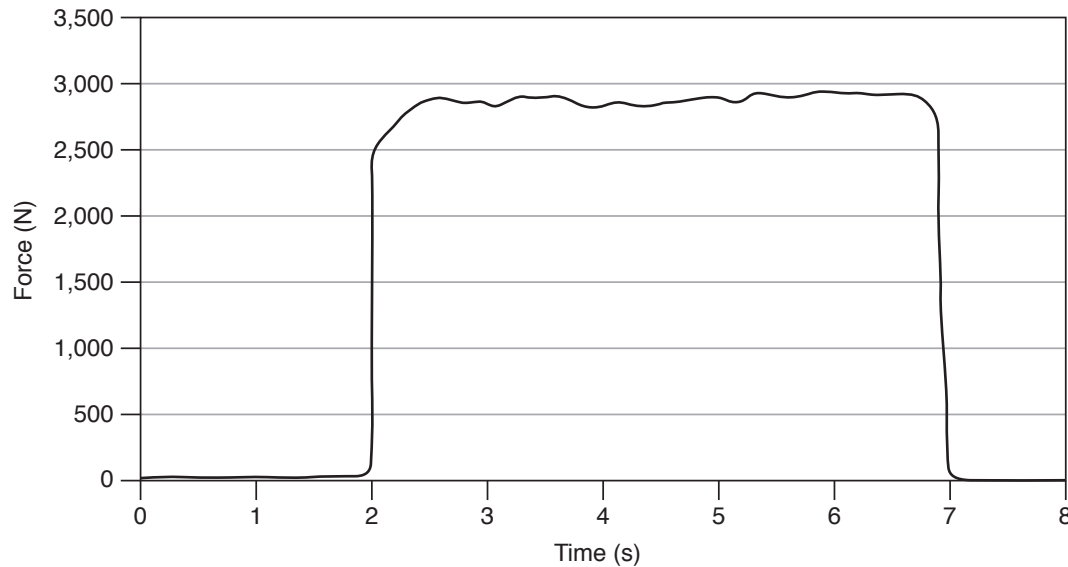

FIGURE 7.26 Example of a force–time curve from an isometric midhigh pull test. There are numerous ways to measure rates of force development from this test.

Reprinted by permission from G.G. Haff and C. Dumke, *Laboratory Manual for Exercise Physiology*, 2nd ed. (Champaign, IL: Human Kinetics, 2019), 262.

($r = 0.76$) and women ($r = 0.82$), and isometric bench press F_m for men ($r = 0.64$) and women ($r = 0.52$). These correlations help illustrate the relationships between velocity, strength, and power.

Speed Squat Fatigue Testing

The Wingate Anaerobic Test is a highly validated assessment for short-term anaerobic power and fatigue performed on a computer-interfaced cycle ergometer. Speed squat testing in the weight room with free weights can also produce results that are related to the Wingate test. The Kansas Squat Test monitors speed squat performance across a set of 15 repetitions at 70% of 1RM system mass (includes body mass) where each repetition is started every 6 s.

Mean barbell velocities of close to $1.0 \text{ m} \cdot \text{s}^{-1}$ for the entire 15 repetitions have been observed for trained athletes. Peak and mean squat power were highly correlated with peak and mean Wingate power (see figure 7.27), although power fatigue was considerably different. This is an example of a lifting velocity test providing valuable power capacity information for the coach and athlete.

Training Method Variations and Weight Room Velocity

One of the benefits of resistance exercise is that there are so many variations to the exercises and the training programs possible. Let's take a look at

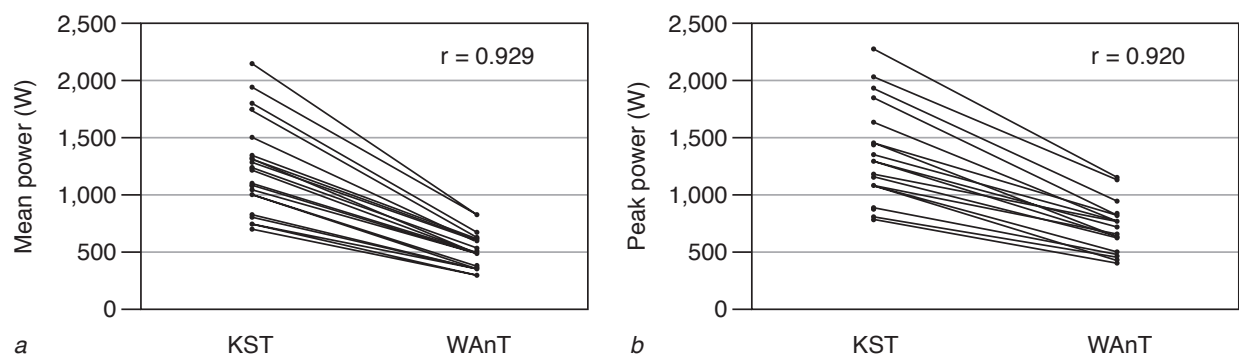
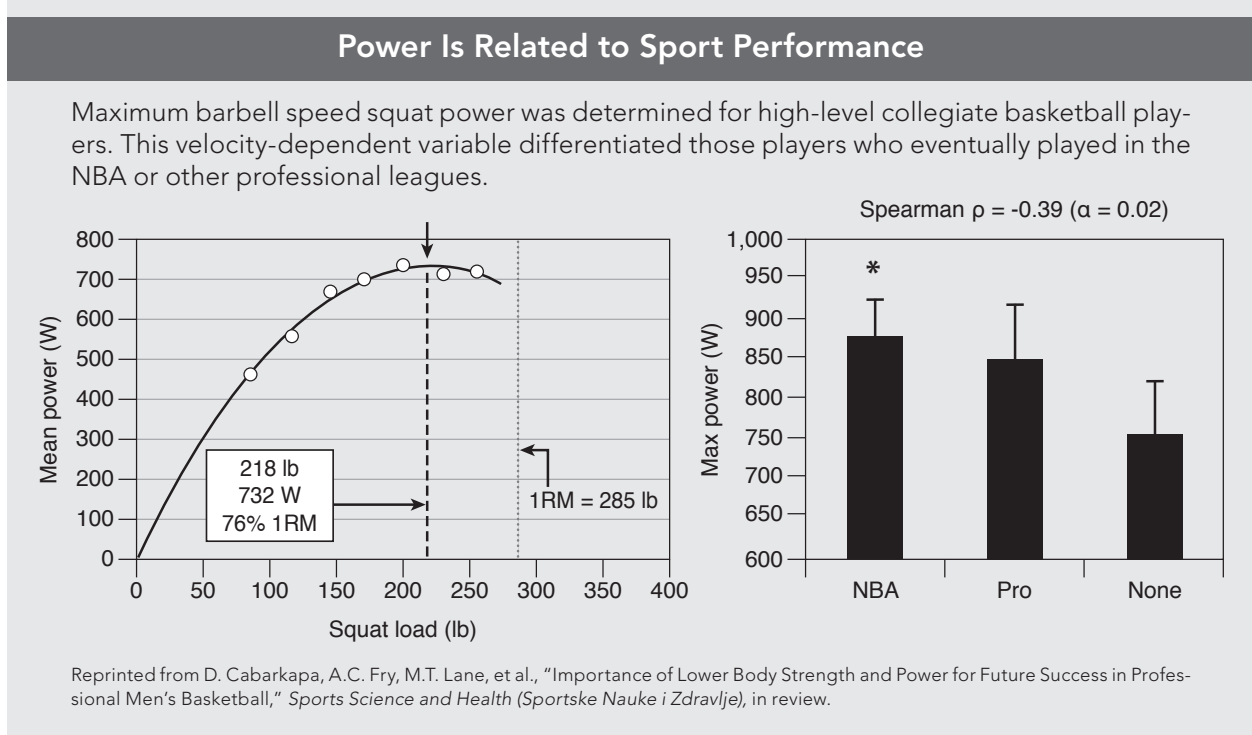

FIGURE 7.27 These graphs illustrate the correlations for (a) mean and (b) peak power between the Kansas Squat Test (KST), a test of barbell velocity and power, and the popular Wingate Anaerobic Test (WAnT) using a cycle ergometer.

Reprinted by permission from P.E. Luebbers and A.C. Fry, "The Kansas Squat Test: A Valid and Practical Measure of Anaerobic Power for Track and Field Power Athletes," *Journal of Strength and Conditioning Research* 29, no. 10 (2015): 2716-2722.



a few of these methods that influence velocity in the weight room.

Augmented Eccentric Loading

In augmented, or accentuated, eccentric loading, the resistance is greater for the eccentric portion of the lift compared to the concentric portion. Typically, the use of weight releasers permits the additional eccentric load to drop off the bar at the completion of the eccentric phase. Some evidence suggests that performance of the subsequent concentric lift is enhanced; however, much of the

research to date indicates this is difficult to create. Figure 7.28 illustrates how 30% 1RM squat jumps did not have significantly greater bar velocity when using additional eccentric loads of 30%, 50%, or 80% 1RM, but smaller eccentric loads enhanced 1RM. It is likely that the choice of exercise is important, with different exercises having different durations of the eccentric phase.

Postactivation Potentiation

An intriguing method to enhance weight training velocity used by some coaches and athletes is called

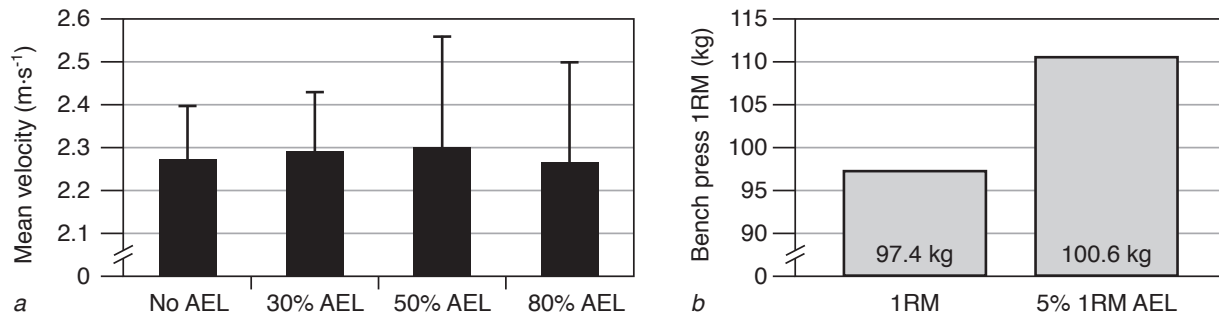

FIGURE 7.28 (a) Results of different augmented eccentric loads (AEL) for 30% 1RM squat jumps showed no differential effects on jump velocity. (b) However, small increases in eccentric loads (5% 1RM) produced significant increases in 1RM strength.

Left panel: Adapted by permission from C.A. Moore, L.W. Weiss, B.K. Schilling, A.C. Fry, and Y. Li, "Acute Effects of Augmented Eccentric Loading on Jump Squat Performance," *Journal of Strength and Conditioning Research* 21, no. 2 (2007): 372-377. Right panel: Adapted from B.K. Doan, R.U. Newton, J.L. Marsit, et al., "Effects of Increased Eccentric Loading on Bench Press 1RM," *Journal of Strength and Conditioning Research* 16, no. 1 (2002): 9-13.

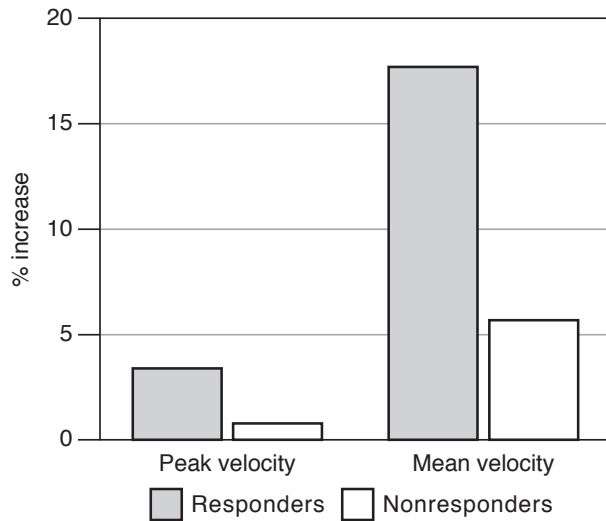

FIGURE 7.29 Highly trained individuals appear to respond best to a potentiating stimulus in the weight room. This figure shows the percentage increase in knee extension performance at 70% 1RM loads.

Adapted from J.C. Smith and A.C. Fry, "Effects of a Ten-Second Maximum Voluntary Contraction on Regulatory Myosin Light-Chain Phosphorylation and Dynamic Performance Measures," *Journal of Strength and Conditioning Research* 21, no. 1 (2007): 73-76.

postactivation potentiation. Lifting a relatively heavy but not fatiguing load, followed by a short rest period, results in enhanced lifting performance. For example, 5 min after a single 10-s isometric knee extension effort, dynamic knee extension velocity at 70% 1RM loads was increased for some subjects (see figure 7.29). Sprint cycling power has also been shown to increase after a potentiating effort in the weight room. It appears that postactivation potentiation is most effective for highly trained individuals, and that performance is enhanced 5-10 min postactivation.

Static Stretching

Figure 7.30 illustrates how static stretching immediately prior to a high-power event can be detrimental. Three minutes of static stretching of the shoulder girdle muscles resulted in lower barbell velocity when performing an 80% 1RM free weight bench press immediately after the stretch. Bar power was also decreased due to the stretching. It is not clear how long this effect lasts. Regardless, the use of dynamic stretching protocols instead of static stretching prior to lifting or other high-velocity or high-power events will avoid these decrements.

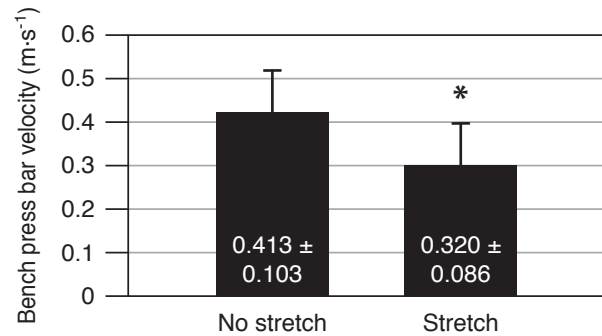

FIGURE 7.30 Static stretching immediately prior to a high-velocity lifting activity can decrease lifting velocity, as well as power.

Reprinted by permission from M.J. Andre, A.C. Fry, E. McLellan, L.W. Weiss, and C.M. Moore, "Acute Effects of Static Stretching on Bench Press Power and Velocity in Adolescent Male Athletes," *International Journal of Sports Science & Coaching* 9, no. 5 (2014): 1145-1152.

Chains and Elastic Bands Resistance

Barbell velocity is altered when using chains for resistance. This is a form of **variable resistance**, with the greatest loads at the top of the range of motion. The load is decreased as the bar is lowered and the chains lay on the ground. The net result is that bar velocity is greatly increased, while force and power are also affected, as shown in figure 7.31. It should be noted that these figures are for chain resistance only. In many cases, barbell plates and chains are used in combination, and the differences in velocity, force, and power will be less. Similar results will be observed when using elastic bands for resistance.

Rotational Resistance

Rotational resistance exercise devices use rotational inertial resistance to create training forces. Typically, a tether is attached to and wound around a disc at a given distance from the axis of rotation. By pulling the tether, a torque is applied to the disc, setting it into rotation. Because the disc has mass, it also has rotational inertia, which is the property of an object to resist changes in angular motion. The rotational inertia of the disc is positively correlated with the difficulty of accelerating the system. While the system may be set into motion using minimal force, applying a maximal force throughout the range of motion will result in maximal acceleration and velocity. Since the rotational inertia of the disc counters the efforts of the individual, greater muscular effort will result in greater resistance experienced by the individual.

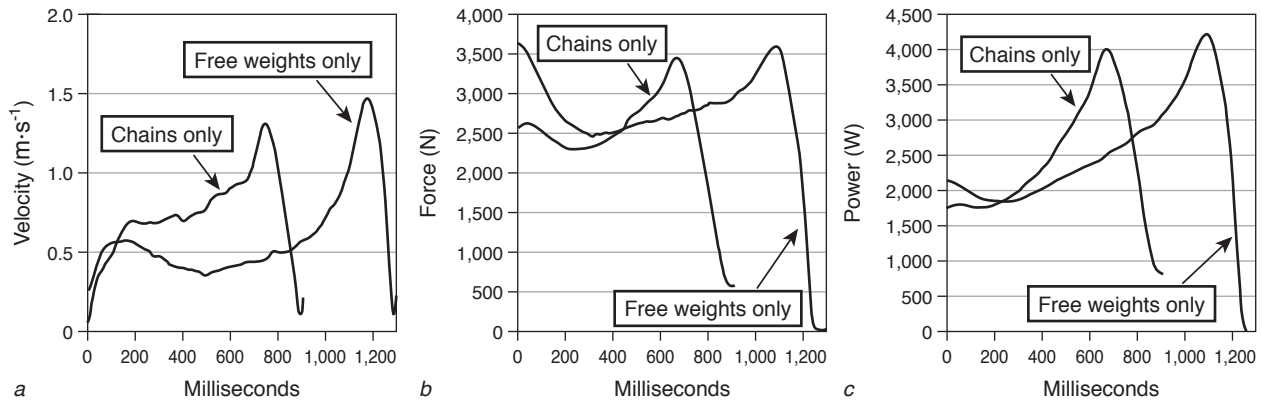

FIGURE 7.31 Using chains for resistance on a barbell are a form of variable resistance, and can greatly affect concentric barbell (a) velocity, (b) force, and (c) power. The example shown in this figure is for a chain load equivalent to 90% 1RM with barbell plates at the top of the squat range of motion.

As the tether unwinds from the disc during the concentric portion of the exercise, kinetic energy is built up. Once the individual reaches the end of the concentric range of motion, the tether is completely unwound. At this point, the disc will continue to spin due to kinetic energy, rewinding the tether around the disc. This becomes the eccentric portion of the exercise, and it is during this period that the individual resists the pull of the tether to slow the disc.

Some devices can use different counterweight masses, tether-pulley arrangements, and a variable

radius axis to create different training velocities. These adjustments affect the resulting forces, but as shown in figure 7.32, power can remain relatively constant when a variable radius axis is used.

Isokinetic Resistance

Isokinetic resistance involves the movement velocity being controlled by the training device while the resulting force is measured. Originally touted by many as the optimal method for maximizing force throughout the resistance exercise range of motion, we now know this is not necessarily the

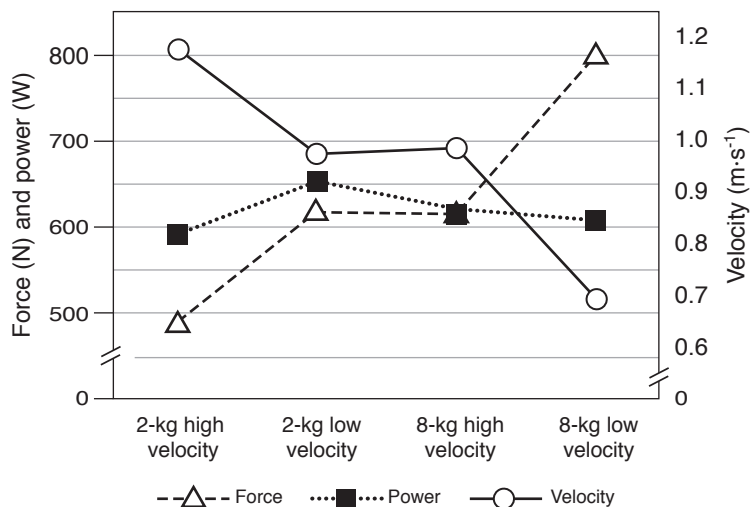
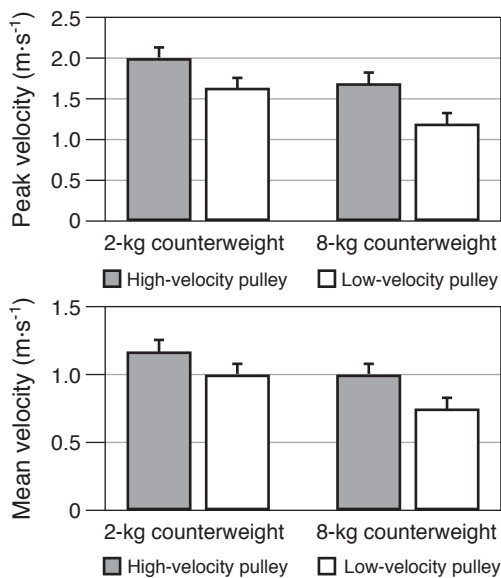

FIGURE 7.32 Kinetics of a rotational inertia resistance exercise device. Changing the rotating mass (i.e., counterweight), the alignment of the tether pulleys, and use of a variable radius axis alters the velocities attained. The right side of the figure also shows how these unique combinations can result in a relatively constant power across the conditions, even though velocity and force vary considerably.

case. Figure 7.33 shows a comparison between an isokinetic bench press at a very slow velocity, which is favorable for high force production, and a free weight bench press with a commonly used, moderate training load (80% 1RM). It is clear that even with a moderate load, when the athlete attempts to maximally accelerate the barbell, forces greater than isokinetic forces are attained. Larger free weight loads or velocities will likely exhibit greater forces at various places along the range of motion continuum.

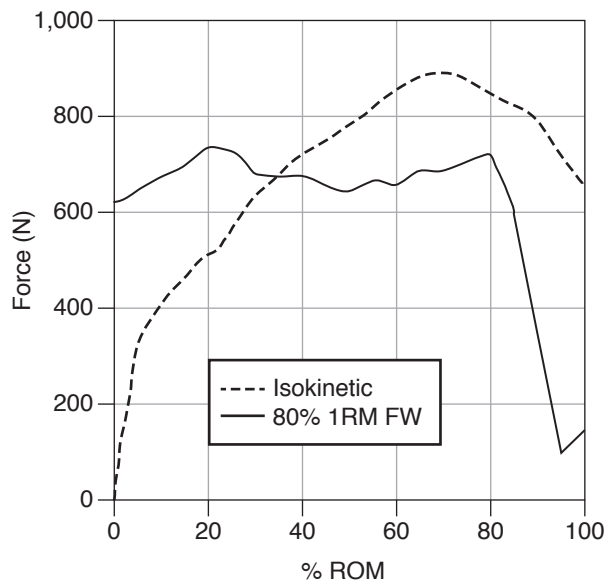
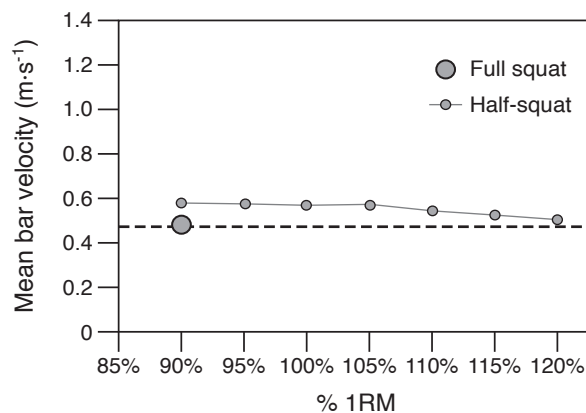

FIGURE 7.33 Isokinetic and free weight force expressed over the range of motion (ROM) for a bench press. Even a moderate load of 80% 1RM for free weights (FW) produces force comparable to a maximal isokinetic effort at a very slow velocity ($0.061 \text{ m} \cdot \text{s}^{-1}$).



Partial Range of Motion Exercises

Partial range of motion exercises will alter the typical lifting velocities. When half-squats were performed, heavier loads could be lifted and bar velocities increased 10%-20% (see figure 7.34). These increases result in greater forces and power, but the decreased range of motion decreases mechanical work. Even though parallel or lower barbell squats are typically prescribed for free weights, some coaches occasionally prescribe partial range of motion exercises to change the orthopedic stresses or to alter muscle-tendon stiffness characteristics.

Immediate Feedback

Anecdotal evidence exists that when athletes receive immediate lifting velocity feedback (i.e., while performing the set of an exercise), performance is enhanced. Few data exist as to whether this occurs in the weight room. However, data for one sport team that incorporated velocity-based training using repetition-by-repetition feedback, lifting performance was visually greater than for the previous training year when this feedback was not available. Figure 7.35 shows velocity-load and power-load curves for one athlete who did not train with immediate feedback prior to testing in year 1, followed by two years where velocity feedback was immediately available during each training session.

Monitoring Acute Training Fatigue

Many weight training sessions are designed to focus on high-quality repetitions rather than high-volume work. This means that the velocity and power of each repetition is of primary importance. One

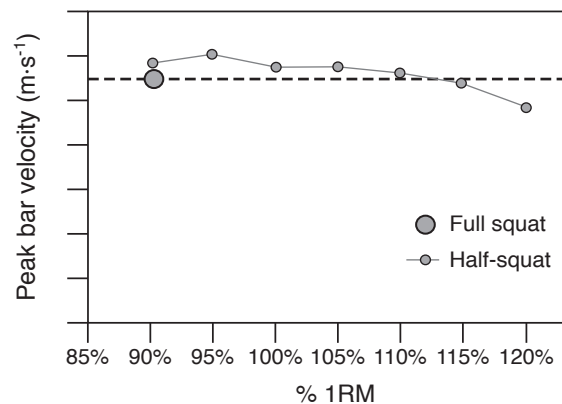

FIGURE 7.34 Decreasing the range of motion for a lift such as the barbell squat will increase barbell velocity, even though the loads are equal to or greater than full range of motion lifts.

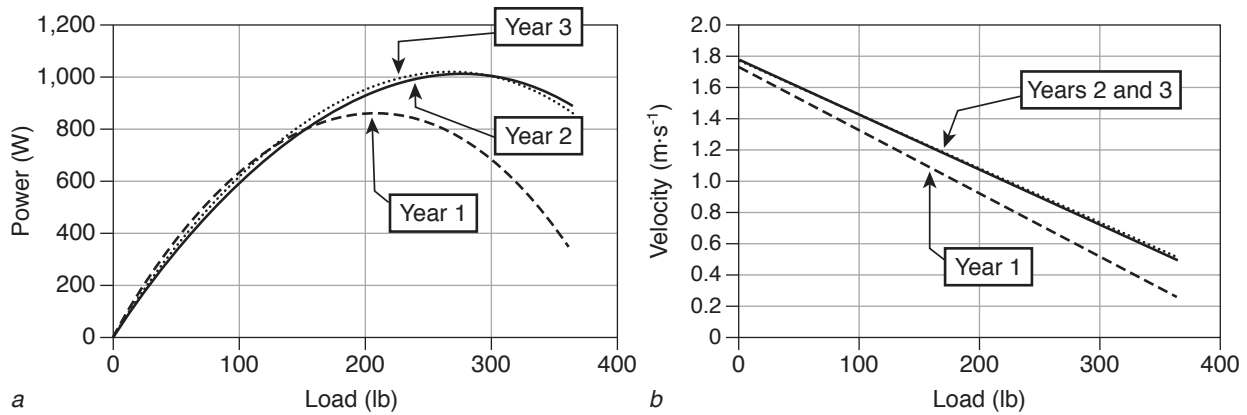

FIGURE 7.35 Example of one athlete’s (a) power–load and (b) velocity–load curves before (year 1) and after (years 2 and 3) immediate lifting velocity feedback was available for all training sessions.

method to ensure each repetition is of maximal quality is to monitor the velocity (or power) of each repetition of each set. When velocity deteriorates beyond a critical point, the training set is terminated. In this manner, all repetitions generate the desired barbell velocity for the training purposes. For example, it might be determined that decreases in lifting velocity must remain within 10% or 20% of the initial repetition, or velocities must decrease $<0.3 \text{ m} \cdot \text{s}^{-1}$. Once decrements greater than that occur, the set is terminated. Using velocity in this manner produces training sessions that correspond with the desired motor unit recruitment strategies and metabolic conditions.

Using Lifting Velocity to Determine Training Load and Volume

Lifting velocity as measured in the weight room can be used several different ways to determine resistance exercise training loads and volumes. As previously described, the velocities attained during a training session can help determine whether a lifter is using an appropriate load (see figure 7.23). This is sometimes called velocity-based training. Additionally, if prescribing loads based on 1RM strength, lifting velocities for submaximal loads can be used to estimate current 1RM strength (see figure 7.22).

Force Is Related to Softball Pitching Performance

The skill of fast-pitch softball pitching is highly dependent on force development. This graph illustrates how critical the ground reaction forces (GRF) of the lead foot translates to pitch velocity in miles per hour (mph). Thus, force is a critical component of velocity as applied to this sport.

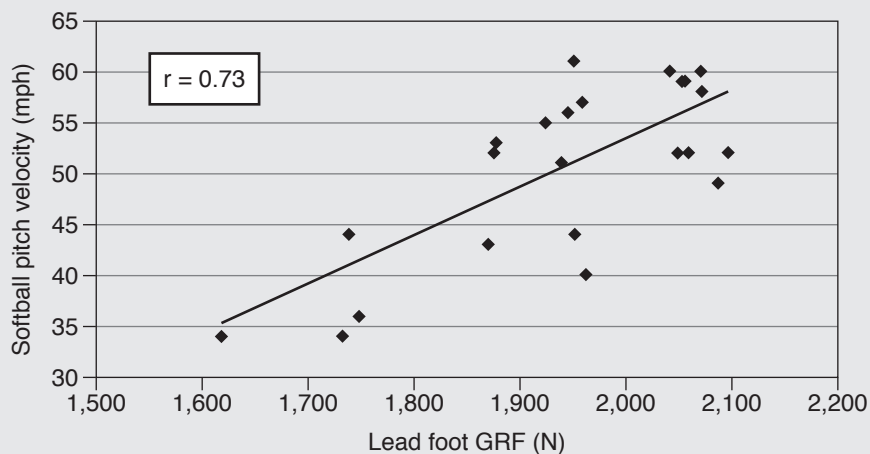

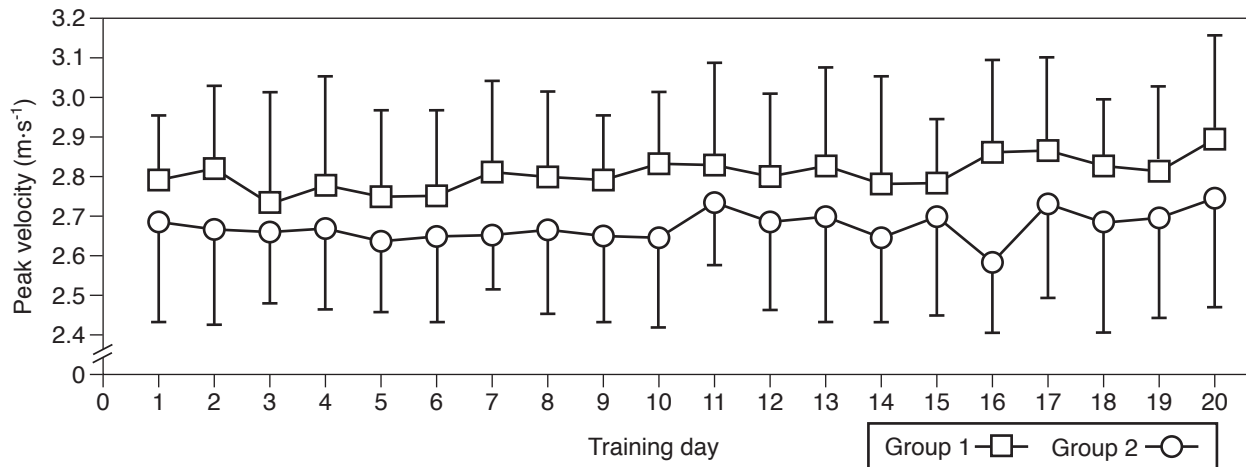

FIGURE 7.36 Example of daily pretraining squat jump barbell velocities with 20% 1RM loads for two training groups over a three-week mesocycle. Changes of $\pm 3\%$ from the three previous days indicated loads needed to be adjusted up or down.

Reprinted from A.R. Bryce, M.J. Hermes, A.C. Fry, J.X. Nicoll, and A.J. Sterczala, "A Comparative Study of Strength Improvements With Two Types of Autoregulatory Training," *Journal of Strength and Conditioning Research* (in review), by permission of A.R. Bryce.

Another approach involves the concept of **autoregulated progressive resistance exercise (APRE)**. This is a system of training programming that adjusts for an individual athlete's physiological and mental state. In other words, it attempts to match training stress to training readiness, thus adapting to an individual's acute needs and capabilities. While there are a number of methods to determine training readiness (e.g., training questionnaires, heart rate variability, salivary biomarkers, rates of force development), not all are practical for daily use in the training room. One method involves monitoring lifting velocity at a submaximal load that can be part of the athlete's warm-up. Figure 7.36 illustrates the variability in these velocity measures over the course of a three-week resistance exercise mesocycle. Studies on the efficacy of autoregulation for resistance exercise indicate this type of training can be effective. It remains to be seen whether this type of training is better than a well-designed periodized program

administered by a well-informed coach who is capable of making necessary adjustments when needed. However, velocity testing for determining appropriate training loads is an attempt to optimally stress the athlete based on their training readiness. It has also been suggested as an appropriate method to maximize performance gains when sport athletes have training mesocycles of limited duration based on training and competition schedules.

Summary

It is easy to underestimate the important contributions of velocity to all types of lifting in the weight room. This chapter provides a cursory overview of many of the ways velocity can be measured, and how it contributes to lifting performance and thus muscular strength. Despite maximal strength being a principle component of muscular performance, it still is affected by other factors, with velocity being one of the most important.

This page intentionally left blank

INJURY PREVENTION

Any sport or conditioning activity has an inherent risk of injury. Many different factors contribute or interact to increase risk. Interestingly, risk of injury in resistance training is low. Athletes often discover an injury from a sport practice while doing controlled exercise movements in the weight room, but they are misinterpreted as being related to the resistance exercise. Historically, there are lower incidences of injury in the weight room from performing progressive heavy resistance exercise programs than other training activities, sport training, or sports. Furthermore, unique to strength training is its assistance in injury prevention by strengthening tissues challenged by sports, allowing for faster recovery due to the body's knowledge of muscle breakdown and repair. Finally, it is the primary anaerobic activity in any sport or fitness program.

Historically, the general risk of injury for a well-coached strength training program has been estimated to be about 1 per 10,000 athlete-exposures. (An athlete-exposure is one athlete taking part in one training workout or competition.) Injury risks have been estimated in resistance training sports as ranging from 0.24 to 5.50 injuries per 1,000 h of exposure with the lower end representative of bodybuilding and the upper end representative of strongman programs; other resistance training sports would be contained within this relatively small range of injury incidence. Compared to other sports such as tackle football, alpine skiing, baseball pitching, ice hockey, and soccer, strength training has a very low risk of injury, especially when properly designed programs are implemented and supervised by qualified coaches.



Factors Contributing to Increased Injury Risks in the Weight Room

It has been said that “The only way you can get injured in strength training is by accident or improper exercise technique and spotting.” While this partially addresses the basic issues related to

injury, many other factors can contribute to increasing the probability of injury. Injuries of all sorts, from musculoskeletal to dermatological to pathological, are due to some of the following weight room issues, and should be carefully examined to reduce injury potential:

- Improperly managed and maintained equipment
- Improperly taught exercises
- Inadequate qualified supervision
- Crowded exercise stations with inadequate movement patterns
- Improper storage and handling of equipment and weights
- Prior existing injuries from a sport or other conditioning activities
- Inexperienced spotters or no spotters
- Ill-fitting weight machines that do not match the body dimensions of the athlete
- Improperly paced programs—too much too soon
- Limited lead-in times after vacations or holidays when performing high-volume and high-intensity workouts
- Incomplete recovery from prior workouts or sport practice sessions
- Mismatch of program for age-appropriate toleration and progression
- Lack of weight room cleanliness including equipment, biohazard cleanup, sanitation, and poor environmental control
- Inappropriately slippery flooring and inappropriate footwear
- Distracting environment for athletes performing exercises
- Sick athletes who are allowed to train
- Improperly cleared or uncleared athletes who are allowed to participate in conditioning activities

It is important that the weight room and training facility has an emergency plan, first aid, and individuals certified in CPR and in the use of AED units on-site for acute care. For guidance on safety and weight room management, see the NSCA Strength and Conditioning Professional Standards and Guidelines (2017).

Athletes exercising with heavy weights who neglect certain training rules are susceptible to

trauma. However, when properly performed, heavy resistance training is a relatively safe activity, as the incidence of injuries is low.

Training Rules to Avoid Injury

Common sense and professional knowledge dictate how to avoid injury related to the contributory factors previously noted. As an athlete you can make sure that you follow some very simple rules.

- Learn how to correctly perform the exercises included in your program.
- Ensure that you properly fit the machine or equipment being used and can execute the full range of the exercise movement.
- Perform a warm-up set and ensure that you do not experience any pain during the exercise.
- Do not overdose. Avoid rhabdomyolysis (see chapter 4).
- Work up to heavier loads with proper progression if you are a beginner.
- Ensure that technique training is applied before increasing load.
- Check technique of the lift when increasing the intensity of the exercise.
- Enlist experienced spotters when you are doing free weight exercises.
- Emphasize harmonic strength topography to avoid imbalance in muscle development. Make sure your program addresses both upper and lower body and the muscle groups around each joint (e.g., biceps-triceps; quadriceps-hamstrings).
- Be aware of your surroundings including other lifters and weight room movement patterns; allow for space to “dump” loads when doing certain lifts that require a platform.
- Ensure that you have the appropriate equipment to do certain lifts (e.g., lifting platform, bumper plates, power racks, or proper kettlebells).

Lower Back Pain and Injury

There is an issue in the strength training paradigm that warrants special attention—the lumbar spine region. The discussion that follows examines this concern in detail.

According to epidemiological data, up to 80% of the adult population suffer temporary or chronic

pain in the low back region (the so-called low back pain syndrome, or LBPS). LBPS as a cause of inability to work is either first or second among all illnesses, yielding only to flu and catarrhal diseases. In strength training athletes, damage to the lower back constitutes 44% to 50% of all the injuries sustained.

In addition to such factors as metabolic abnormalities, infections, and genetic predisposition, biomechanical factors (especially spine overloading) are regarded as the primary causes of LBPS. However, in spite of the great mechanical load imposed on the lumbar region in sports like weightlifting and rowing, many elite athletes in these sports have no spinal problems during their lives. Proper sport techniques and fundamentally sound training patterns provide reliable protection against LBPS.

Although the precise cause of LBPS is not known in many cases, volumes of data have shown that changes in **intervertebral discs** are often the initial cause of pain. Back injuries can also be due to inefficiency in motor control, when the muscles that stabilize the trunk are activated later than necessary.

Biomechanical Properties of Intervertebral Discs

Intervertebral discs consist of a fibrous ring, the **annulus fibrosus**, and a jellylike nucleus, the **nucleus pulposus**. In young persons, the jellylike

nucleus contains up to 85% water, and the laws of hydrostatic pressure apply—namely, **Pascal's law**, stating that pressure is distributed equally on all sides. Intradisc pressure can be determined by inserting a needle with a pressure gauge into the jellylike disc nucleus. With age, the water content of intervertebral discs is gradually reduced, and the laws of hydrostatic pressure cease to manifest themselves in the nucleus pulposus.

When discs are loaded in different directions, their mechanical properties are different. When two vertebrae are compressed with the disc connecting them along the axis of the spine (the ordinate axis), the hydrostatic pressure in the nucleus is approximately 1.5 times greater than the average pressure acting on the disc surface (we'll designate this F). Here the vertical pressure on the fibrous ring amounts to just $0.5 F$. On the other hand, when horizontal pressure occurs, the disc stretches from within and the force reaches 4 to 5 F on the surface of the fibrous ring (figure 8.1).

The fibrous ring consists of several cylindrical layers, each of which has fibers proceeding at an angle of approximately 30° to the horizontal; but the directions of the fibers' paths change in adjoining layers. In the discs of young and elderly persons, with an identical external mechanical load, both the amount of pressure acting on particular layers of the fibrous ring and its direction are different (figure 8.2).

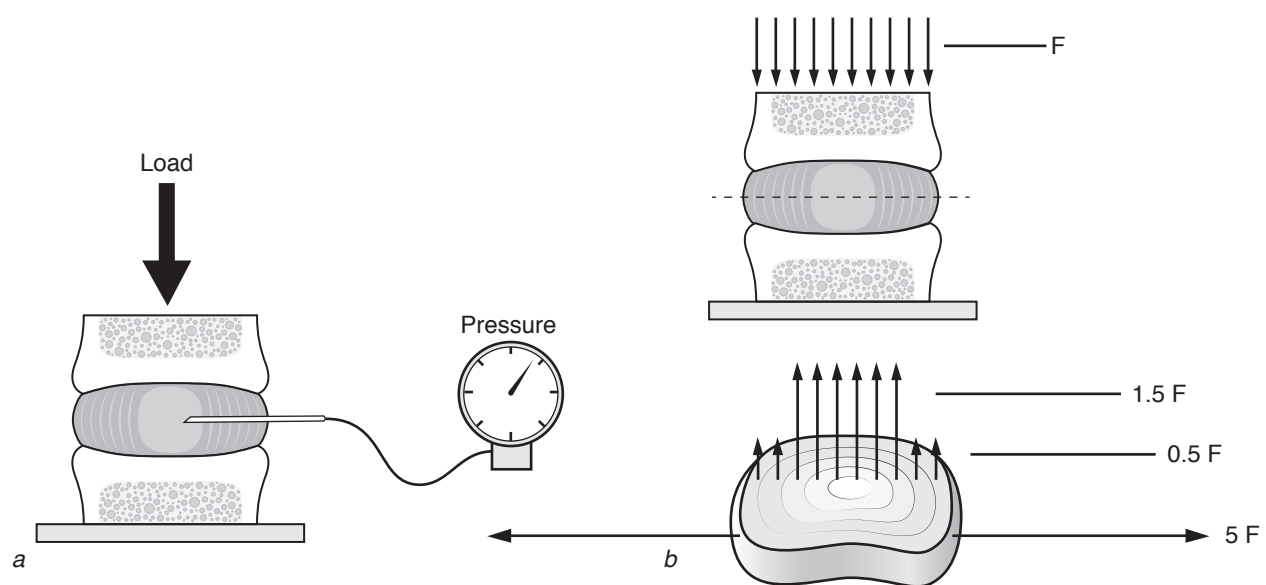

FIGURE 8.1 Pressure in the intervertebral discs under a vertically imposed load. (a) A scheme of measurement. (b) Pressure distribution. The compressive stress in the nucleus pulposus is 1.5 times higher than the externally applied load (F) per unit area.

Adapted by permission from A. Nachemson, "Towards a Better Understanding of Low-Back Pain: A Review of the Mechanics of the Lumbar Disc," *Rheumatology and Rehabilitation* 14, no. 3 (1975): 129-143.

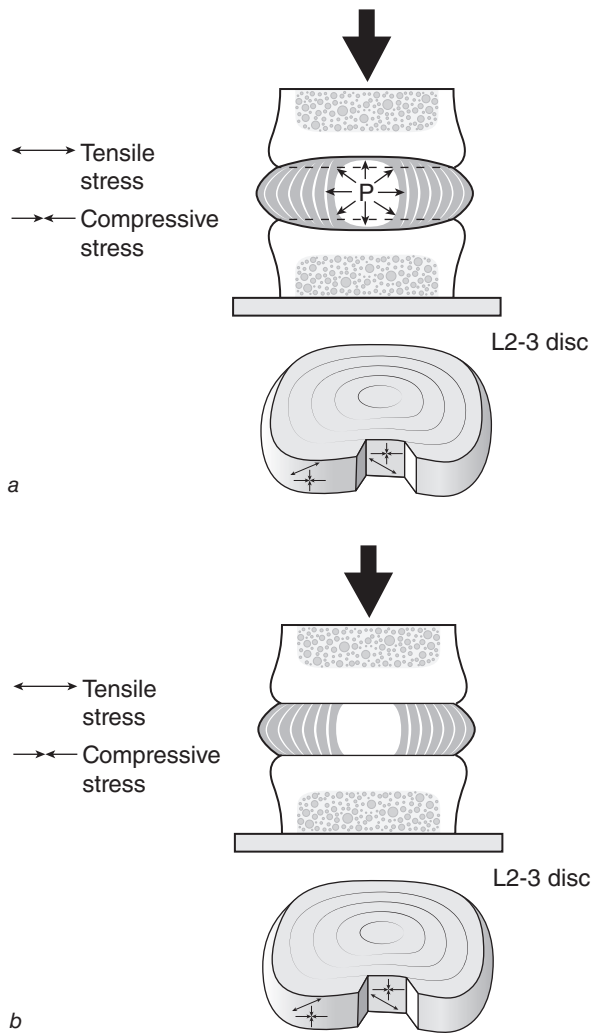

FIGURE 8.2 Pressure (P) affecting individual layers of the fibrous ring in (a) normal discs (for young persons) and (b) degenerated discs (for elderly persons). Notice the change in the amount and direction of the pressure.

(a) © Human Kinetics. Adapted from W. Liemohn, *Exercise Prescription and the Back* (New York: McGraw-Hill, 2001).

The mechanical strength of discs during a vertical load is adequate; it is not inferior to the strength of adjoining vertebrae. However, a strictly vertical load on the spinal column is not typical for actual everyday situations. Even during regular standing posture, the load does not operate precisely along the axis of the vertebrae (the ordinate axis) because of the curvature of the spinal column. Biomechanical analysis indicates that people are the most susceptible to trauma in situations in which a considerable mechanical load affects the intervertebral discs during trunk bending or rotation.

During a lean of the spinal column, the nucleus pulposus is shifted to the side opposite the lean and

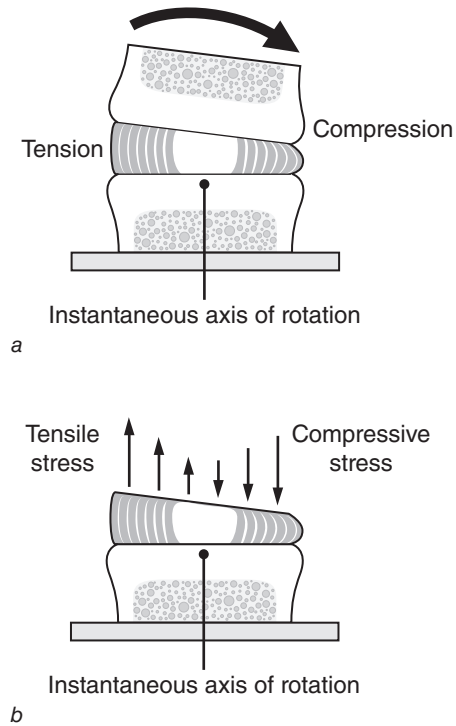

FIGURE 8.3 (a) Disc deformation; (b) mechanical stresses.

(a) © Human Kinetics. Adapted from W. Liemohn, *Exercise Prescription and the Back* (New York: McGraw-Hill, 2001).

the fibrous ring is somewhat protruded (figure 8.3). This may induce compression of the spinal cord rootlets and cause a painful sensation.

Mechanical Load Affecting the Intervertebral Discs

Intervertebral discs are affected by impact loads and static loads. The latter include loads encountered not only during the maintenance of a given posture but also during the execution of relatively slow movements, when it is possible to ignore waves of impact deformation.

Impact Loads

Landings from gymnastics dismounts, jumping, and running cause the body to undergo an impact load, spreading shock waves to the spine. We can estimate the impact load by the magnitude of acceleration registered on different parts of the body.

In ordinary walking the difference between accelerations of the pelvic region and those of the head amounts to 0.5 to 1.0 g (*g* is the acceleration due to gravity). The spine must absorb a shock of

similar magnitude with each step. Research on 50-m ski jumping has shown that accelerations of the pelvic region at the moment of landing exceed 10 g; at the same time, the intra-abdominal pressure (to be discussed later in this chapter) reaches 90 mmHg. Loads on the spine were reduced when jumpers performed deep (about 40 cm) squats and were increased when they landed with straighter legs. Loads increased in proportion to the sine of the angle between the direction of the speed vector and the slope of the mountain. These examples evidence the exceptionally large loads that the spinal column is subjected to during landings in different sport exercises.

The softening (shock absorption) of an impact load during landing is provided by the combined influence of

- the properties of the supporting surface;
- footwear quality;
- the dampening properties of the motor system, primarily the foot and the knee joints (in persons suffering from LBPS these properties are often reduced); and
- landing techniques.

With soft landing techniques, in which ankle plantar flexion and knee flexion are coordinated, the magnitude of impact forces is sharply reduced. During soft landing by experienced athletes, only 0.5% of the body's kinetic energy is spent to deform body tissues (bone, cartilage, spine). During a stiff landing, the deformation energy amounts to 75% of the body's mechanical energy. The difference is 150-fold ($75 / 0.5 = 150$).

Static Load Acting on Intervertebral Discs

Forces that affect intervertebral discs can significantly exceed the body's weight and the weight being lifted. They are produced chiefly by muscle tension. Let's look at the mechanism that causes these loads by examining an example of upright standing posture (figure 8.4).

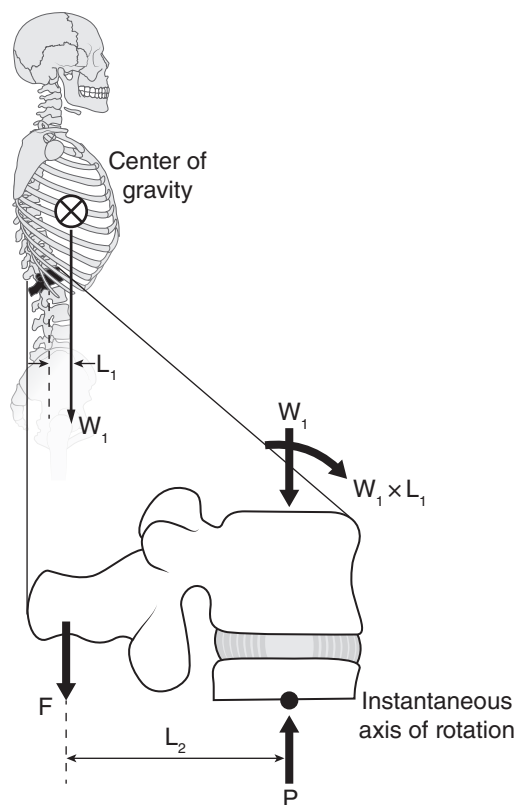

FIGURE 8.4 Mechanism for creating a mechanical load on the intervertebral discs. W_1 , weight of the above-lying parts of the body; L_1 , the moment arm; $W_1(L_1)$, the flexion bending moment due to gravity; F , force of the extensor muscles of the spinal column; L_2 , their moment arm. Since the system is at equilibrium $W_1(L_1) = F(L_2)$. Therefore $F = (W_1 \times L_1) / L_2$. The force acting on the intervertebral disc (P) is equal to the sum of the weight of the above-lying parts of the body and the muscle-pulling force, $P = W_1 + F$ or $P = W_1(1 + L_1 / L_2)$.

© Human Kinetics. Adapted from W. Liemohn, *Exercise Prescription and the Back* (New York: McGraw-Hill, 2001).

Mechanism of Origin

In this case, the weight of the upper body acts on L4 (the fourth lumbar vertebra). The center of gravity of the upper body is not situated directly over the intervertebral disc, but somewhat in front of it. Therefore, a rotational moment of the force of

Land Properly

In order to prevent spinal injuries during landings, use mats and shoes with good shock-absorbing capacities and employ proper landing motor patterns. Touch the ground with legs extended and feet plantarflexed, and, immediately after ground contact, avoid a stiff landing by flexing the knees. Practice soft landings, without impact. Good ballet dancers land in such a way that virtually no sound is made, which is a good example to emulate.

gravity, causing the upper half of the body to lean forward ($W_1 \times L_1$, see figure 8.4) must be opposed by a counterbalanced moment. This moment is provided by the action of the spine erectors. These muscles are situated near the axis of rotation (which is located near the region of the nucleus pulposus of the intervertebral disc), and therefore the moment arm of the pull L_2 is small. To produce the necessary moment of force, these muscles in turn generate considerable force F (in accordance with the lever principle—the smaller the distance, the greater the force). Since the line of action of the muscle force F runs almost parallel to the spinal column, this force, added to the force of gravity, sharply increases the pressure on the intervertebral discs.

As a result, a force acting on L4 in the usual upright position amounts not to half the body weight, but to the body weight. During leans, lifts, and other specific movements, external forces create a considerable moment relative to the axis of rotation that passes through the lumbar intervertebral discs. The muscles and especially the ligaments of the spinal column are close to the axis of rotation, so the force they produce sometimes exceeds the weight of the load being lifted and that of the upper parts of the body. This force contributes significantly to the mechanical load that falls on the intervertebral discs (table 8.1).

TABLE 8.1 Force (Body Weight) Acting on L3 in Different Situations

Posture or movement	Force
Lying, supine position, traction 30 kg applied	0.14
Lying, supine position, legs straight	0.43
Upright standing posture	1.00
Walking	1.21
Lateral trunk lean to one side	1.35
Sitting unsupported	1.43
Isometric exercises for muscles of abdominal wall	1.57
Laughter	1.71
Incline forward 20°	1.71
Sit-up from supine position, legs straight	2.50
Lifting a 20-kg load, back straight, knees bent	3.00
Lifting a 20-kg load from forward lean, legs straight	4.85

Role of Intra-Abdominal Pressure

The mechanism and the very role of the **intra-abdominal pressure (IAP)** load have been questioned by some researchers. What is presented here reflects the most commonly accepted explanation.

The formula calculations cited in the caption of figure 8.4 indicate that even during a lean with an 80-kg weight, the load on the lumbar vertebrae can be greater than 1,000 kg, which exceeds the limit of their mechanical strength. At the same time we know that athletes can lift significantly greater weights without apparent harm. Of course, this is true in part because of the considerable strength of individual anatomical structures of the spinal column in trained persons. But the main reason is one that these calculations do not take into account—the role of the internal support that emerges as a result of elevated IAP during the execution of many strength exercises (figure 8.5).

IAP increases during muscular efforts, especially during a Valsalva maneuver. As a result of internal support, the pressure on intervertebral discs can be reduced by up to 20% on average and up to 40% in extreme cases.

The most accessible method of measuring IAP is to introduce a pressure gauge into the stomach cavity. Here the intrastomachic pressure, which is almost the same as the IAP, is measured. Figures 8.6 and 8.7 show data on IAP measured during the execution of various physical exercises. Based on the results of several investigations, a couple of conclusions can be drawn.

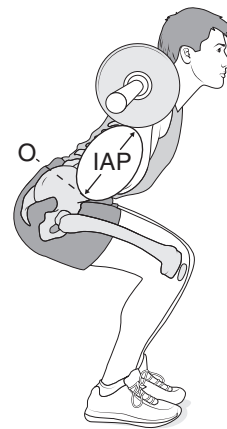

FIGURE 8.5 Internal support of the spinal column can be compared to the mechanical action of a ball located in the abdominal cavity. Intra-abdominal pressure (IAP) produces the spinal extension moment relative to the axis of rotation O.

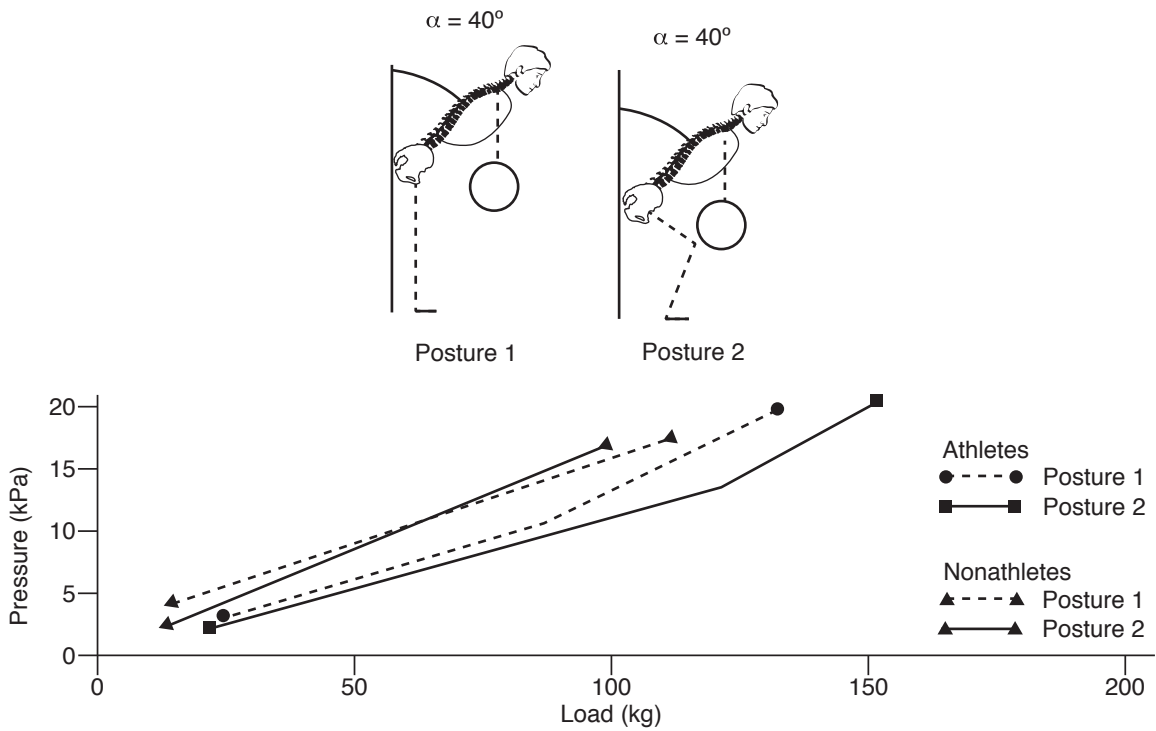

FIGURE 8.6 Intra-abdominal pressure during weightlifting.

Reprinted by permission from V.M. Zatsiorsky and V.P. Sazonov, "Biomechanical Foundations in the Prevention of Injuries to the Spinal Lumbar Region During Physical Exercise Training," *Theory and Practice of Physical Culture* 7 (1985): 33-40.

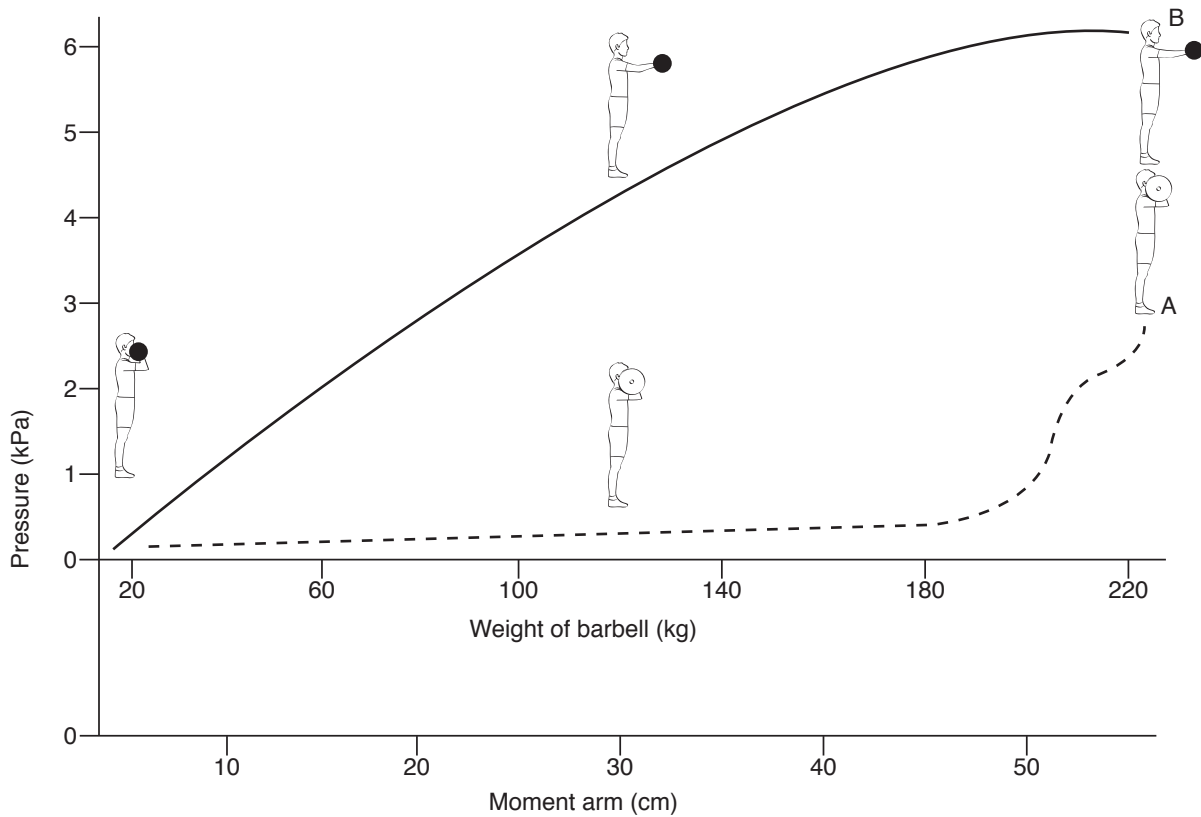

FIGURE 8.7 Intra-abdominal pressure when there is an increase (A) in the weight borne on the shoulders, and (B) in the moment arm of force (distance from the load to the shoulders) during slow arm extension, constant weight 20 kg.

From V.P. Sazonov, *Biomechanical Studies in the Prevention of Injuries to the Spinal Lumbar Region During Physical Exercise Training* (Moscow: Russian State Academy of Physical Education and Sport, 1985). By permission of the Russian State Academy of Physical Education and Sport.

We find that the IAP is proportional to the moment of force relative to the axis of rotation passing through the intervertebral discs (but not to the force produced or to the weight lifted). Because different techniques can be employed to perform identical exercises with the same weight, the externally generated force corresponds to different moments of force. Depending on the moment arm, some technique variations are more dangerous than others. We can also conclude that with an increase in the ability to lift maximal weights, IAP increases, promoting a decrease in mechanical loads affecting the spinal column.

High IAP is generated by the activity of muscles in the abdominal wall, the intercostal muscles, and the **diaphragm**. If the magnitudes of IAP and other variables (weight lifted, body posture) are measured, the amount of mechanical pressure acting on the intervertebral discs can be estimated with acceptable accuracy by specially developed biomechanical models.

Injury Prevention to the Lumbar Region

To prevent injuries to the lumbar region of the spine or reduce the consequences of these injuries, it is necessary to maximally reduce the load falling on the lumbar section of the spine and to strengthen the muscles of the lumbar region, or to create a **muscular corset**. People differ markedly both in the extent of muscle development in the lumbar region and in the size of the maximal loads that they can bear. Therefore, in practice, preventive advice should be strictly individualized.

From a practical standpoint, there are several important guidelines for the prophylaxis of low back problems for athletes. It is helpful for prevention to strengthen certain muscle groups and to use proper sport technique. Some athletes may benefit from

- the use of special implements designed to decrease spinal load,
- posture correction and improvement of flexibility, and
- the use of rehabilitation procedures.

Muscle Strengthening

LBPS occurs more frequently in persons with weak or nonproportionally developed muscles such as a

weak abdominal wall. Proper muscle development is required for the prevention of LBPS. In addition to strengthening erector spine muscles, athletes should exercise the muscles of the abdominal wall (not only the rectus abdominis but also the oblique muscles of the abdomen) and the short, deep muscles of the back. This issue becomes complicated because it is precisely the exercises aimed at forming a muscular corset that are often associated with large loads on the lumbar spine. To prevent spinal overloading during strengthening of the spine erector muscles, extreme caution is necessary. This is especially true for teenagers and women. The **3-year rule** is useful here, meaning an athlete needs a 3-year introduction to strength training before any maximal loading should occur.

Squat technique, teaching, and movement cues are vital for all athletes and especially tall athletes, which has been a point of controversy in the world of strength training due to lower back issues. With proper instruction, practice, and monitoring of technique and loading, the squat can be effectively used (Chiu and Burkhardt, 2011; Myer et al., 2014). Additionally, other exercises can be used to augment the squat exercise (e.g., front squat, box squat, and belt squat) (Sands et al., 2012). For the barbell squat, the high bar placement is a good starting point for the exercise, with shoulder-width placement of the hands to keep a tight upper back and stable shelf for the bar and feet pointed out at about 45°. Foot placement is in the strength position—wider than shoulder width. For tall athletes this might require a bit wider foot placement. Interestingly it is identical to the catch phase foot placement in the power clean in which one jumps up from the shoulder-width narrow power position of the feet and then moves the feet out and catches the bar in the strength position. The back is straight and one moves as to sit down on a chair with the back maintaining straight position as the hips move back and the thighs move to the parallel level. Coach Roger Marandino, a former college and professional NFL strength coach, stated that the movement down to the parallel position and back up has to be fluent and confident; this is a result of proper positioning, practice, and confidence in the movement pattern with the load being used. Interestingly, in **powerlifting** the eccentric velocity is slower in better lifters, yet fluent in motion.

It was concluded in a study by Oshikawa et al. (2018):

During parallel back squats, the average lumbar lordosis angle was significantly larger in hip external rotation than in the hip neutral position. During full back squats, lumbar erector spinae and multifidus activities were significantly lower in hip external rotation than in the hip neutral position, whereas gluteus maximus activity was significantly higher in hip external rotation than in the hip neutral position. The back squat in hip external rotation induced improvement of lumbar kyphosis, an increasing of the gluteus maximus activity and a decrease of both lumbar erector spinae and multifidus activities.

Exercises for Muscles of the Abdominal Wall

Let's first analyze the load imposed on intervertebral discs in a lying position. For a person lying supine with legs outstretched, the load falling on the intervertebral discs is rather significant and is equal to approximately 35% to 40% of body weight. This is related primarily to activity of the **iliopsoas** (the compound iliacus and psoas magnus muscles;

figure 8.8), which apparently is manifested externally in the preservation of lumbar **lordosis**.

When the legs bend at the knees, the hip flexors shorten and the force of their pull drops to 0. As a result, the pressure in the intervertebral discs decreases. Pain usually disappears in patients in this position. A coach can judge the cessation of lumbar muscle activity by the disappearance of lumbar lordosis; in other words, the back becomes flat.

Exercises for the Rectus Abdominis Muscle

Muscles of the abdominal wall deserve special attention during heavy resistance training, especially with beginning athletes and teenagers, for three main reasons. First, these muscles stabilize the trunk and participate in locomotion as well as in many other movements. Second, well-developed muscles of the abdominal wall help maintain proper function of the internal organs in the abdominal region. Finally, adequate strength of this muscle group is the best prevention for an **abdominal hernia** (i.e., the protrusion of an internal organ or its part through the abdominal wall). A hernia may be provoked by increased IAP resulting from

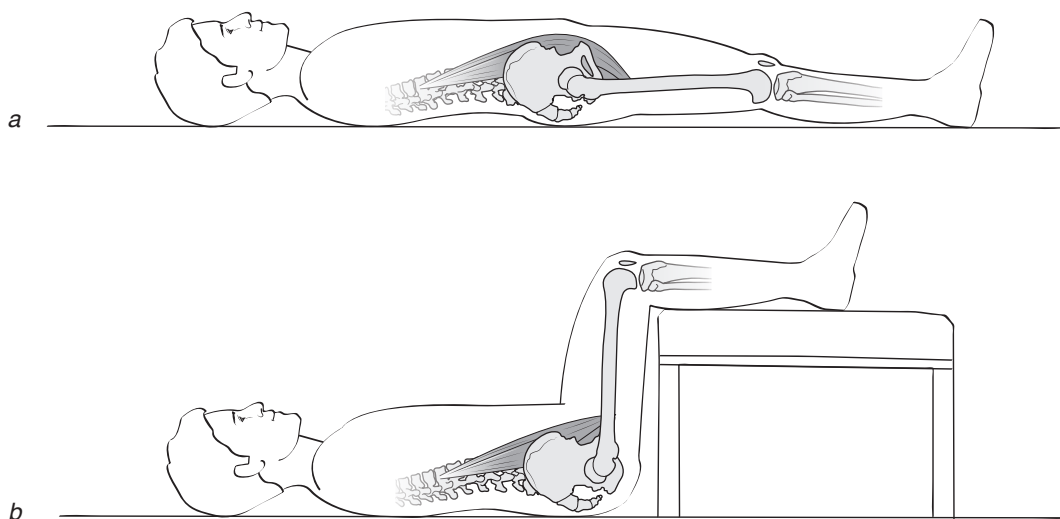

FIGURE 8.8 Influence of the iliolumbar muscles on the creation of pressure in the intervertebral discs. (a) The iliopsoas muscles are stretched; the force of their pull is applied to the spine. There is definite pressure on the discs, and lumbar lordosis is retained, thus there is some protrusion of the discs posteriorly (see figure 8.3 on page 162). In LBPS patients in an exacerbation period, this position can be painful. (b) The iliopsoas muscles are shortened and do not show the force of the pull. As a result, the pressure in the discs is lower, the spine straightens out in the lumbar region, and the discs do not stick out past the edge of the vertebrae. Pain usually disappears.

Reprinted by permission from V.M. Zatsiorsky and V.P. Sazonov, "Biomechanical Foundations in the Prevention of Injuries to the Spinal Lumbar Region During Physical Exercise Training," *Theory and Practice of Physical Culture* 7 (1985): 33-40.

lifting heavy loads. That is, if an athlete's spine extensors are strong and the abdominal muscles are relatively weak, high IAP may lead to a hernia. Hernias in young athletes should be regarded as a coach's blunder. They occur when the training of abdominal muscles has been neglected.

Exercises for abdominal wall muscles fall into two groups: (1) leg raising with the torso securely anchored and (2) sit-ups, that is, raising the torso with the legs securely anchored. Leg raising in the supine position is accomplished by the activity of the flexor muscles in the hip joints (the iliopsoas muscles, the rectus femoris muscles, and others). The rectus abdominis muscle, fastened at its lower end to the symphysis pubis, is relatively inactive; it secures the pelvis and increases IAP. It begins to shorten only when the legs are raised high enough. At this point, however, the moment of force of gravity, pulling the legs down, is relatively slight. Since the initial pressure on the discs is rather high and the activity of the abdominal wall muscles is not significant (though it is precisely for their development that this exercise is done), this exercise is not especially valuable. Certainly it should not be the only exercise used to train the abdominal muscles.

Leg raising in a hanging position is much more effective (here the rectus abdominis muscle contracts when the moment of gravity of the legs reaches its maximum), but it is feasible only for trained persons. The so-called basket hang is an example of an exercise from this group. Here the performer is suspended from a horizontal bar with legs extended. The knees are drawn up to the chest until the pelvis tilts up and back, and then the trainee uncurls to the extended position.

Sit-ups are considered a major exercise for the rectus abdominis muscles. Persons at high risk of LBPS should perform sit-ups with the legs bent, because in this position the load on the spine is lighter and the effect on the abdominal wall muscles is greater; the iliopsoas muscles are in a shortened state and do not take part in generating a rotational moment of force. In sit-ups done from a straight-leg starting position, the main portion of the torque is produced by the iliopsoas muscles (which is not appropriate to the training goals here), and pressure on the intervertebral discs is very great (pressure corresponding approximately to a forward lean in the upright position with a 20-kg weight in the hands). This type of exercise is hardly ever recommended for persons who have recently recovered from an attack of low back pain.

Sit-ups should be performed with the torso in a bent position. The first step is to move the head and shoulders (thrusting the chest and abdomen forward reduces activity of the abdominal wall muscles). Note that sit-ups do have drawbacks. The abdominals are prime movers for only the first 30° to 45° of flexion movement while the hip flexors are responsible for the last 45°. Because the hip flexors are exercised through a short arc, this can induce their adaptive shortening and, in turn, hyperlordosis. Persons with LBPS can limit themselves to the first part of this exercise until the shoulder girdle becomes slightly elevated. In partial sit-ups such as this (also called partial curls or crunches), the knees are flexed to a much more oblique angle (140°-150°) and the trainee raises the trunk off the floor about 30°.

One of the exercises most frequently recommended for persons at high risk of LBPS is raising the pelvis and legs from the supine position. This exercise resembles the first part of an elbow (shoulder) stand—the birch tree (figure 8.9, exercise 5). Here pressure on the intervertebral discs is small, and involvement of the abdominal wall muscles is significant.

For people with LBPS and possessing a low level of muscular strength, isometric exercises are recommended. These individuals are advised to begin training of the muscular corset after an aggravation of LBPS. The value of these exercises is that they put a certain load on the muscles of the abdominal wall with almost no increase in pressure on the intervertebral discs. To do the exercises, after a normal inhalation, the person contracts the musculature of the abdominal wall and back with the glottis closed and the rectal sphincter contracted, trying to produce a strong exhalation. Since this kind of straining is created through the action of the musculature of the trunk and diaphragm, multiple repetitions elicit a training effect. The exercise should be repeated 10 to 15 times with the muscle contraction lasting 3 to 5 s. This series should be repeated three to four times a day. In experiments conducted with a double-blind control, isometric exercises have been shown to produce a decidedly better effect than other types of exercises.

Exercises for the Oblique and Internal Abdominis Muscles

In many movements, such as symmetrical weight lifts, high IAP is created primarily as a result of activity of the oblique and internal abdominis muscles

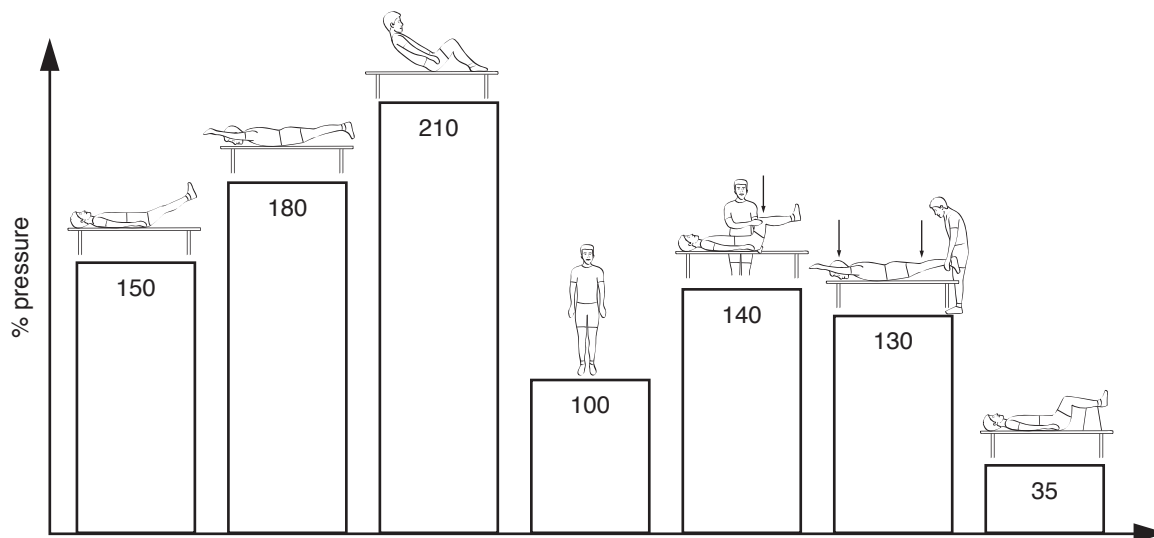

FIGURE 8.9 Intradisc pressure (in percentage of pressure relative to the upright posture) in several exercises for strengthening the muscular corset.

Reprinted by permission from A.L. Nachemson, "The Lumbar Spine: An Orthopaedic Challenge," *Spine* 1, no. 1 (1976): 59-71.

rather than the rectus abdominis. The reason is that the rectus abdominis, while active, generates a trunk-bending moment that should be counterbalanced by an additional moment produced by the antagonistic muscles—the spine extensors. The higher the activity of the rectus abdominis muscles, the greater the IAP (which is good). At the same time, however, the higher the activity of these muscles, the greater is the bending moment that must be overcome by the spine extensors in order to produce the required extensor moment of the spine. As a result, the trunk flexors are modestly activated during weightlifting tasks. The IAP is generated chiefly by activity of the oblique abdominis muscles (and diaphragm). In addition, strong oblique muscles reinforce the erector spinae **fasciae**. The fasciae support the spine and reduce strain on the back extensor muscles. So exercises for the oblique and internal abdominis muscles, such as trunk rotations against resistance and lateral sit-ups (trunk lifts), should be included in training protocols.

Exercise for the Short, Deep Muscles of the Back

Muscles of the lumbar region (specifically, the epaxial muscles, such as the interspinales connecting adjacent spinous processes or the intertransversalis connecting adjacent transverse processes of the vertebrae) are difficult to activate in ordinary physical exercises.

The following exercise is recommended for training these muscles. The athlete stands with the back

against a wall so that heels, buttocks, shoulders, and the back of the head touch the wall. The next step is to address the lumbar lordosis by completely straightening the spine so that the lumbar region rests against the wall and even exerts pressure on it. Here, contact between the wall and the other parts of the body should continue (figure 8.10). This exercise often proves difficult for even highly skilled athletes. When this is the case, it can be tried in a supine position. After mastery, it can be done without the aid of a wall. The usual pattern is 5 to 6 attempts of 4 to 5 s each.

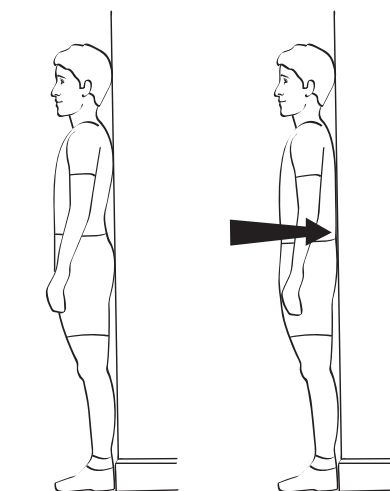

FIGURE 8.10 An exercise for the short, deep muscles of the back (so-called pelvic tilt).

Requirements for Proper Sport Technique

When the body is inclined forward, the activity of muscles that extend the spinal column increases at first; then, with a deeper lean, this activity almost completely disappears (see figure 8.11). The ligaments and fasciae of the back assume the load here. Since they are close to the axis of rotation, they should produce considerable force to counteract the force of gravity moment. Here, pressure on the intervertebral discs is very high.

A rounded back is dangerous in lifting weights because, as a result of lumbar spine flexion, the compression load acts on the anterior part of the intervertebral discs while the extension load acts on the posterior part. Specifically, a pressure concentration takes place. This pressure, that is, the amount of force falling on a unit of the disc surface, is very considerable (figure 8.12).

Some practical advice is to avoid rounding the back when lifting weights (figure 8.13). In addition, if possible, lift weights while squatting rather than stooping. This is a principle that should be learned from childhood so that proper methods of lifting weights become habit. Physical education should stress developing the extensor muscles of the legs so

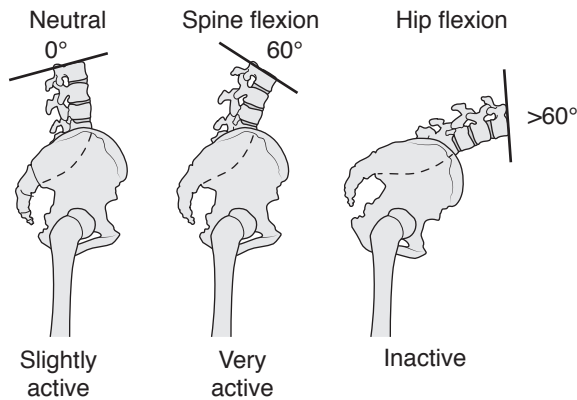

FIGURE 8.11 The activity of the muscles that support the spinal column during the execution of a forward lean. Lumbar flexion accounts for approximately 45° to 60° of motion until the posterior ligaments become taut. The second part of the movement is performed due to the pelvic rotation until the pelvis is passively restricted by the gluteus and hamstrings. In this position, no muscular activity is seen. The trunk weight is counterbalanced by passive forces of the erector spinae fasciae, posterior ligaments, and muscles.

Reprinted by permission from V.M. Zatsiorsky and V.P. Sazonov, "Biomechanical Foundations in the Prevention of Injuries to the Spinal Lumbar Region During Physical Exercise Training," *Theory and Practice of Physical Culture* 7 (1985): 33-40.

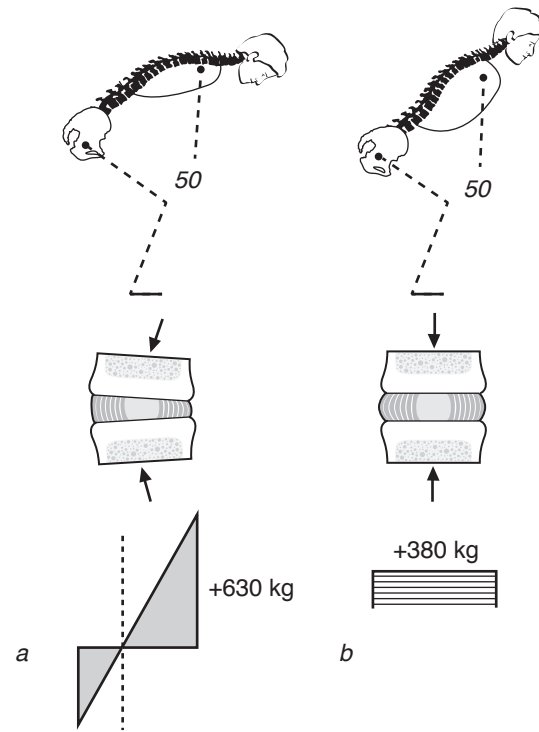

FIGURE 8.12 Load on the intervertebral discs when 50 kg is lifted by different methods. (a) Incorrect (rounded back) technique; and (b) correct. Compression loads on a lumbar intervertebral disc amount to 630 kg and 380 kg, respectively.

Reprinted by permission from V.M. Zatsiorsky, *Motor Abilities of Athletes* (Moscow: Fizkultura i Sport, 1966), 60.

that, subjectively, it is as easy for a person to squat as to stoop.

Teenage athletes (in sports such as tennis, basketball, and volleyball) often neglect conditioning training, including strength development, during the initial stages of multiyear preparation. At the age of 20, they find that their athletic performance is limited by poor physical fitness. Then they try to develop strength as fast as possible by copying the training patterns of athletes from other sports such as track and field, especially with free weights. But 20-year-old track and field athletes have had several years of experience in conditioning. It is impossible for novices to replicate their training routine. It is simply dangerous.

An unfortunate example concerns a conditioning coach who was invited to work with the USSR women's tennis team in the early 1980s. He had never worked with comparable athletes before and had no conception of their inexperience with strength training. The training routine he recommended

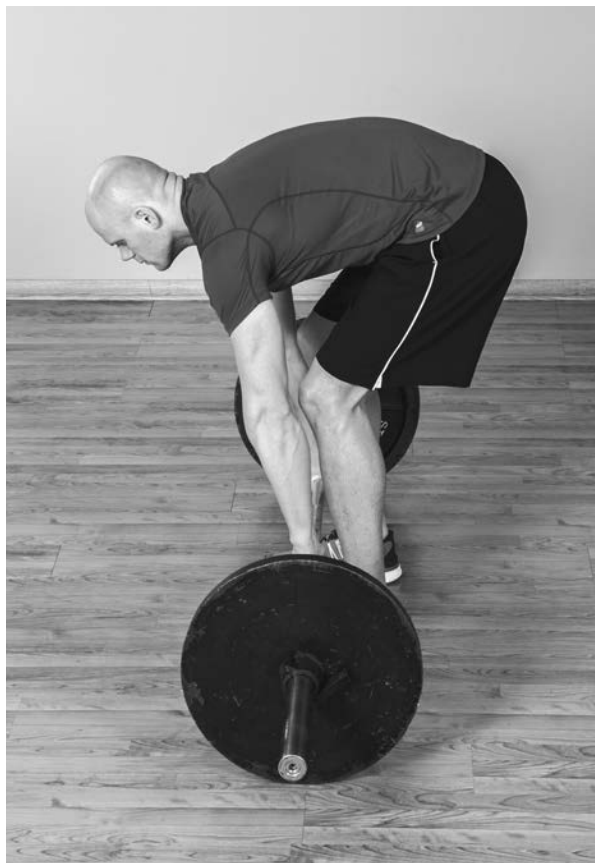

FIGURE 8.13 Avoid rounding the back when lifting weights; instead, maintain lumbar lordosis.

duplicated heavy resistance programs from other sports. The result? In 6 months, 9 of 10 athletes had low back problems. Eight of them never rehabilitated completely and dropped out of international sport.

Implements

Several types of implements can be used to enhance IAP and fix the lumbar spine. One of these is a special bolster used during exercises for the muscles that extend up the spinal column (figure 8.14). Weightlifting belts are also recommended to increase the IAP and reduce the load on the spine. By tradition, weightlifting belts are constructed to provide support against spinal deformation. This is important in an

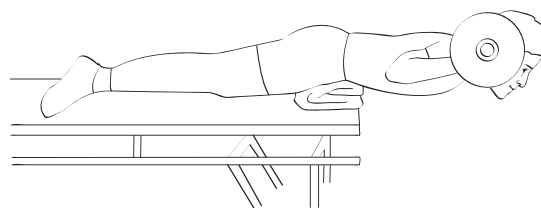

FIGURE 8.14 Use of a pad placed under the abdomen increases the IAP and lessens the load on the intervertebral discs.

Reprinted by permission from V.M. Zatsiorsky and V.P. Sazonov, "Biomechanical Foundations in the Prevention of Injuries to the Spinal Lumbar Region During Physical Exercise Training," *Theory and Practice of Physical Culture* 7 (1985): 33-40.

Be Aware Checklist

Extreme caution is in order when weightlifting is executed by women (because of the more compliant intervertebral discs), very tall men, and teenagers. Check the following:

- Do these athletes have an immediate need for weight training? Why free weights? Strength exercises without free weights are innumerable. Be creative.
- Do your trainees have proper prior experience in strength training (without a barbell)? Recall the 3-year rule. Is this principle satisfied?
- Strengthen trunk muscles—spine erectors and abdominal muscles.
- Use exercise machines first, and then free weights.
- Teach correct lifting technique. Monitor the lifting pattern.
- Begin with small loads. Inappropriate weight, rather than the barbell itself, is the source of risk. For a majority of inexperienced athletes, a bar without added plates provides adequate resistance.
- Use weightlifting belts and bolsters.
- Teach proper breathing patterns.
- Readers who are interested in strength training of women, young athletes, and seniors are advised to read chapters 12, 13, and 14, respectively.

exercise such as a standing barbell press. Although this exercise has been excluded from the Olympic weightlifting program, the construction of waist belts for weightlifting remains the same. According to some research, belts that support the abdomen, rather than the spine, increase the IAP and consequently decrease spinal load to a greater extent (figure 8.15).

Posture Correction and Flexibility Development

Increased lumbar lordosis gives rise to a higher risk of LBPS. Lordosis compensates the obliquity of the sacrum (and, hence, pelvis), which is tilted with respect to the vertical. The position of the sacrum is characterized by a sacrovertebral angle formed by the upper surface of the first sacral vertebra and the horizontal. Normally, the smaller this angle, the better. A more horizontal position of the pelvis favors stability at the lumbosacral junction.

The slant of the pelvis can be corrected by the proper strength development of corresponding muscles. (Note that in heavier people the pelvis is usually directed more obliquely because of the weight of the body bearing on it, and in this case the first recommendation is to lose weight.) The following are the corresponding muscles:

- Trunk flexors (rectus abdominis) and hip extensors (hamstrings). These muscles, when activated, tend to decrease the sacral angle, rotating the sacrum in a more vertical position (and correspondingly the pelvis into a more horizontal attitude). The abdominals are said to control excessive anterior pelvic tilt.
- Trunk extensors and hip flexors (rectus femoris). These rotate the pelvis into a more oblique position.

In athletes who perform many barbell squats and sit-and-reach exercises but neglect to strengthen the abdomen and stretch the hip flexors, the hamstrings are often flexible while the abdominal muscles are weak and the hip flexors are tight. In this case the anterior pelvic tilt becomes exaggerated. In turn, hyperlordosis appears, causing the discs to bulge posteriorly and putting compressive stress on the vertebral facets. The nerve roots that exit from the vertebrae can be compressed and this can lead to pain. To correct pelvic tilt and hyperlordosis, the advice is to strengthen the abdominal muscles and perform stretching exercises to decrease tightness of the hip flexors.

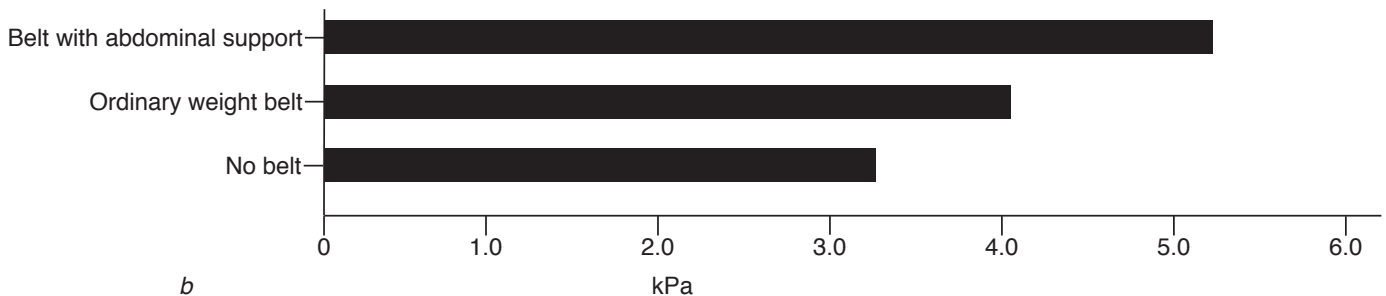
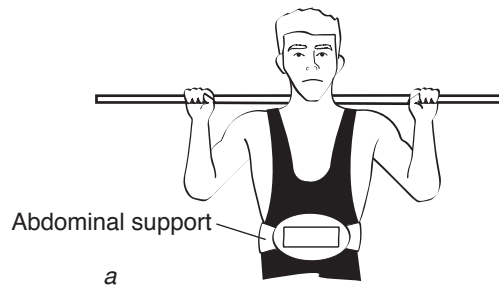

FIGURE 8.15 IAP during resistance exercise. (a) A belt with firm abdominal support (Russian patent #1378834 to V.M. Zatsiorsky and V.P. Sazonov, November 8, 1987). (b) IAP while lifting two 10-kg dumbbells (shoulder flexion with the arms stretched, not the exercise seen in a) under three conditions: belt with abdominal support, ordinary weight belt, and no belt.

Reprinted by permission from V.M. Zatsiorsky and V.P. Sazonov, "Belt-Corsets Reducing Risk of the Spine Lumbar Trauma at Weight Lifting and Strength Exercises," *Theory and Practice of Physical Culture* 3 (1987): 15-18.

Have Lower Back Problems?

First, consult a physician. Ask for a diagnosis. Usually an X-ray, nuclear magnetic resonance imaging (NMRI), or both are required. Keep the results for future reference. If nothing serious is discovered and training is permitted, then take these steps:

Step 1—For an acute pain period

Perform relaxation exercises for at least 1 to 2 weeks and do the isometric exercises described in the section on exercises for the rectus abdominis muscle. The goal of relaxation exercises is first to decrease and then to completely eliminate muscle spasm. Here are examples from a relaxation routine:

- Lie down. Relax facial muscles. Relax eyelids. The eyes should be semiclosed during the entire routine.
- Relax neck muscles. Permit your head to fall down freely to the right without any muscular resistance. Only gravity is acting. Wait 3 s; rotate your head faceup. Relax again. Permit the head to fall down to the left. Repeat 3 or 4 times on each side.
- Bend the right knee with foot on the floor. Relax. Permit the leg to extend, the foot gliding along the floor. Again, only gravity force is involved. Repeat with each leg 3 to 5 times.
- Bend an arm. Relax. Permit the arm to fall down. Repeat with the second arm. Relax. Repeat several times.
- Perform isometric exercises for the abdominal muscles.
- Repeat the relaxation routine in reverse order. Relax, relax, relax.

Step 2—When the pain disappears

Temporarily decrease the load on the lumbar spine (e.g., use leg lifts instead of squats). Then analyze these factors:

- Your training routine—Did you overload the spinal region? Did you squat too much the last time? Did you perform too many deadlifts?
- Your fitness level—(1) Are your spine erectors, rectus abdominis, oblique abdominis, and epaxial muscles strong enough? Did you neglect to strengthen them? (2) How is your flexibility? Can you touch the floor? With your palms? Are your hip flexors tight? (3) Is your pelvis inclined much in your customary posture? Do you have large lumbar lordosis?
- Your lifting technique—Is your spine rounded during lifting? Ask somebody to check it.
- Your abdominal support—Do you wear a waist belt when lifting? Does this belt have an abdominal support? Do you use bolsters?
- Your restoration measures—What kind of restoration measures do you usually use between training workouts? None? This is not advisable.

Depending on the answers, prescribe corrective and preventive measures for yourself. Reread this chapter carefully and decide what suits you best. Follow the new routine. When these measures are taken, 9 of 10 athletes completely restore their abilities and experience no difficulty or have only minor problems with their spines.

Rehabilitation Procedures

To restore the dimensions and properties of compressed intervertebral discs created by exposure to large systematic loads (weightlifting, rowing), restorative measures are usually recommended.

These include massage and swimming in warm ($-30\text{ }^{\circ}\text{C}$) water after a training session with heavy lifts for 5 to 15 min. The swimming can be replaced by a whirlpool bath. When the load falling on the intervertebral discs is reduced, the degree of disc hydration increases (figure 8.16).

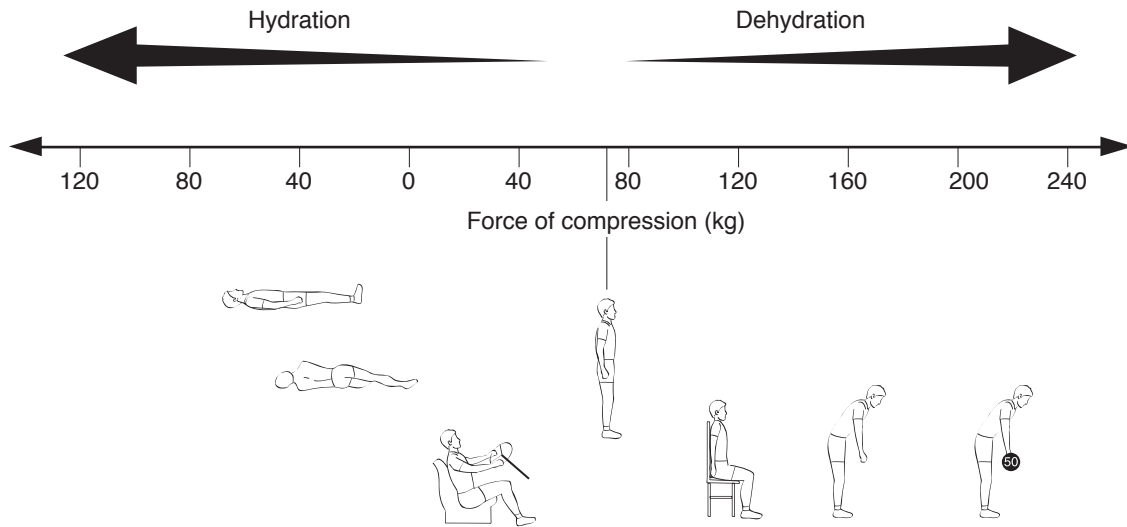

FIGURE 8.16 Intradisc pressure and water saturation of nucleus pulposus (for L3 disc).
 Reprinted by permission from A. Nachemson, "Towards a Better Understanding of Low-Back Pain: A Review of the Mechanics of the Lumbar Disc," *Rheumatology and Rehabilitation* 14, no. 3 (1975): 129-143.

Many coaches recommend alternating weightlifting with hangs during a training session. However, spine length in the majority of athletes decreases during such hangs. Usually a reflex activation of the trunk muscles takes place and these contracted muscles prevent the spine from lengthening. Consequently, the dimensions of the intervertebral discs are not restored. Not all athletes can relax in the hanging position. In addition, full disc hydration occurs only during prolonged removal of the compressive load acting on the spine, and this does not happen with hangs alone.

Spinal traction has proven to be a much more effective procedure. Figure 8.17 shows the recommended posture and unit (a **split table**) for this stretching. Spinal traction, performed twice a

week with individually adjusted traction force (up to 100 kg for elite weightlifters from the super-heavyweight class), is a very useful restorative measure.

Spinal traction is recommended only to athletes with no history of LBPS. Preliminary medical investigation and permission from a physician are required. When an athlete is already suffering from LBPS, traction can be a negative influence. Figure 8.18 shows a reason for this. During traction, the lumbar lordosis diminishes, the spinal column takes on a straighter position, and there is a relative shift of the spinal cord rootlets in a caudal direction. Therefore, if disc protrusion has occurred under a nerve rootlet, traction increases the pain (figure 8.18a); but if it is above the rootlet, the pain

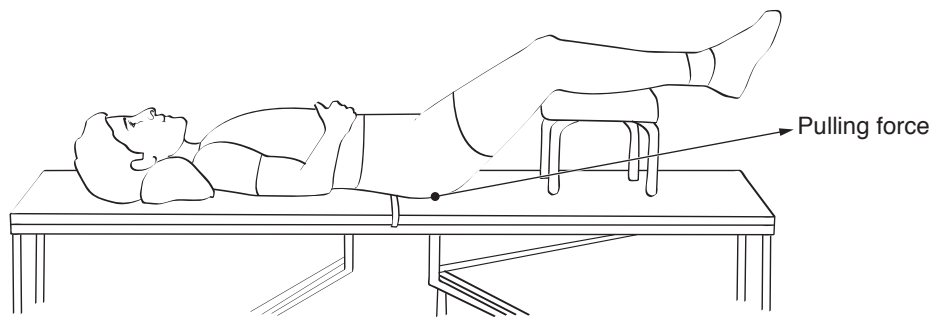

FIGURE 8.17 An apparatus—a split table—used for spinal traction. The athlete’s legs are bent, and the force of the pull is oriented at an angle to the horizontal (in order to keep the back flat).
 From V.M. Zatsiorsky and S.S. Arutiunjan, *Spinal Traction as a Rehabilitation Tool* (Moscow: Central Institute of Physical Culture, 1987).

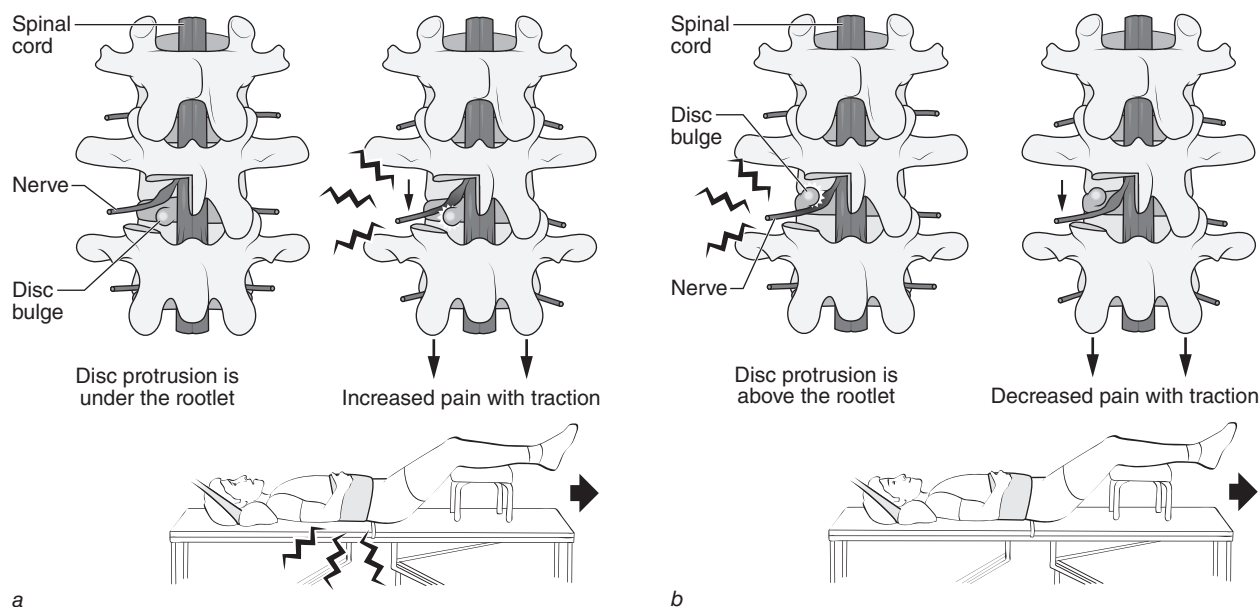

FIGURE 8.18 The influence of spinal traction on pain. (a) Increased pain with traction when the disc protrusion is under a nerve rootlet. (b) Decreased pain with traction when the disc protrusion is above a nerve rootlet.

is alleviated (figure 8.18*b*). A physician needs to determine whether spinal traction is advisable for a given athlete.

Patients experiencing pain due to disc protrusion usually try to alleviate the pain by moving the neural rootlet farther from the protrusion place: When they are standing or walking they incline the trunk to one side. This is a symptom of the relative location of the compressed rootlet: If the patient inclines away from the painful side, the rootlet is above the protrusion. For this patient, traction is not recommended; it will exacerbate the pain. However, if the patient inclines toward the painful side, this is a sign that the rootlet is below the protrusion. For this patient, traction can be useful. In any case, the decision should be made by a medical doctor.

Summary

Coaches and athletes should give special attention to prevention of injury to the lumbar spine region in heavy resistance training. This can be especially true for taller athletes (e.g., basketball players, volleyball players, American football linemen).

Biomechanically, intervertebral discs are characterized in large part by water saturation and intradisc pressure. During a vertical load the mechanical strength of discs is adequate, not inferior, to the strength of adjoining vertebrae. But during a lean of

the spinal column, the nucleus pulposus is shifted to the side opposite the lean and the fibrous ring is somewhat protruded. This can induce compression of the spinal cord rootlets and give rise to a painful sensation.

Mechanical loads affecting the intervertebral discs are classified as impact and static. Impact loads are typically experienced during landing. An impact load during landing is softened by the combined influence of the supporting surface, the quality of the footwear, the dampening properties of the motor system, and the landing technique. Soft landing techniques, in which ankle plantar flexion and knee flexion are coordinated, reduce the magnitude of impact forces.

Static loads acting on intervertebral discs are mainly generated by muscle tension and tendon forces rather than by the external load itself. During weightlifting, an extremely high load on the lumbar vertebrae can be reduced somewhat by elevated IAP, which acts as an internal support. As a result, the pressure on intervertebral discs can be reduced nearly 20% on average and up to 40% in extreme cases. When the ability to lift maximal weights increases, IAP increases, promoting a decrease in mechanical loads affecting the spinal column.

To prevent injuries to the lumbar region of the spine, it is necessary to maximally reduce the load falling on the lumbar region and strengthen the muscles of the region (create a muscular corset).

Among the prophylactic measures are muscle strengthening and proper sport technique.

Muscle groups that need to be strengthened, in addition to erector spinae muscles, are the abdominal wall muscles and the short, deep muscles of the back. Proper sport technique also prevents injury. Lumbar lordosis should be preserved when weights are lifted. If possible, weights should be lifted while squatting rather than stooping.

Implements can enhance IAP and fix the lumbar spine. Two of these are waist belts, especially those with a firm abdominal support, and bolsters.

Posture correction and flexibility development are also recommended, especially for people with increased lumbar lordosis. To correct pelvic tilt and hyperlordosis, the abdominal muscles must be strengthened and tightness of the hip flexors must be decreased.

To restore the dimensions and properties of intervertebral discs compressed by exposure to large, systematic loads, some rehabilitation measures are useful. These include massage, swimming in warm water, and, especially, spinal traction.

OVERREACHING, OVERTRAINING, AND RECOVERY

Overtraining is a commonly used term, but in many cases is used incorrectly. In the past, many individuals have reported being overtrained at some point in their training histories, including over 70% of those surveyed in one report. But what exactly is overtraining? How is it defined? One important concept to keep in mind is that overtraining is the process, while overtraining syndrome is the result. In other words, the process of **overtraining** involves the volumes and intensities of the training being performed that contribute to the inability of the human body to adequately recover. The net result is the **overtraining syndrome**, a myriad of symptoms and conditions that collectively contribute to impaired performances. Many of these signs and symptoms will be discussed in more detail later in this chapter, but the central concept in the overtraining paradigm is that performance is impaired.

Over the years, many terms have been used synonymously with overtraining, including those listed in table 9.1. Although not an exhaustive list, it becomes readily apparent that this topic can be confusing. To help address this issue, several prominent international sport and exercise science organizations created a joint task force to help define overtraining, to establish what we know and don't know about it, and to determine what needs to be done to better understand this phenomenon. The original document was published in 2006 and helped to define and clarify the problem. A subsequent version was published in 2013 and presented the current



TABLE 9.1 Terms Commonly Associated With Overtraining

Overreaching <ul style="list-style-type: none"> • Functional overreaching • Nonfunctional overreaching 	Underrecovered
	Failure to adapt
	Stressful training syndrome
Overworked	Unexplained underperformance
Overstressed	Underperformance
Burnout	Staleness
Overfatigued	Stagnation
Excessive fatigue	Maladaptation
Imbalance of work and recovery	Chronic fatigue

base of knowledge as applied to numerous sport and exercise settings, as well as to specific physiological systems and the psychology of overtraining. These documents made clear that overtraining is accompanied by impaired performances, and recovery requires weeks, months, or longer.

If recovery can be attained in a matter of one or two weeks, this is called **overreaching**. When subsequent performance is enhanced after overreaching, it is called **functional**, and is often a desired training strategy to optimize later performance. When recovery from overreaching takes longer, and produces no supercompensation or enhanced performance, it is called **nonfunctional**. The goal of this chapter is to present these concepts as they per-

tain specifically to resistance exercise and strength training, and to present some practical applications based on the science as it is currently understood.

The problem of overtraining in sport has received much attention in recent decades, but the concept of overtraining dates back over 150 years. Although not focusing on sport performance, but rather physical effort, it was stated in 1866 that “the exertion shall not exceed the powers of recruitment; and . . . the recruitment shall be facilitated by adequate diet and rest” (Nilsson, 1987). More recently, the consensus statement on overtraining defines the problem as excessive overload combined with inadequate recovery. Needless to say, there are many and varied combinations of training stress and

What Is Overtraining and Overreaching?

Overtraining and overreaching is the process, and overtraining syndrome is the result. An international task force charged with identifying the current knowledge on this topic clarified differences in these conditions. This table summarizes their definitions.

Process	Training (overload)	Intensified training →		
		Functional overreaching (short-term OR)	Nonfunctional overreaching (extreme OR)	Overtraining syndrome (OTS)
Outcome	Acute fatigue	Functional overreaching (short-term OR)	Nonfunctional overreaching (extreme OR)	Overtraining syndrome (OTS)
Recovery	Day(s)	Days – weeks	Weeks – months	Months +
Performance	Increase	Temporary performance decrement (e.g., training camp)	Stagnation or decrease	Decrease

Reprinted from R. Meeusen, M. Duclos, C. Foster, et al., “Prevention, Diagnosis, and Treatment of the Overtraining Syndrome: Joint Consensus Statement of the European College of Sport Science and the American College of Sports Medicine,” *European Journal of Sport Science* 13, no. 1 (2012): 1-24. Copyright © European College of Sport Science, reprinted by permission of Informa UK Limited, trading as Taylor & Francis Group, www.tandfonline.com on behalf of European College of Sport Science.

recovery that can result in impaired performance. The study of this topic can be very challenging for several reasons. First, it is very difficult to identify an overtrained individual or team at the right time to have a meaningful examination of what exactly is going on. If overtrained athletes are identified, the process has already occurred, and how the condition developed cannot be closely examined.

Secondly, it is difficult to replicate an overtraining scenario in a laboratory setting. Numerous attempts to study the physiology, psychology, and training conditions that lead to overtraining syndrome have come up short. In other words, impaired performances have not resulted. As a result, much of the study of overtraining depends on data from a wide range of training conditions. These training conditions can include excellent and beneficial training programs, to very stressful training programs or phases (e.g., microcycles or mesocycles), to full-blown overtraining conditions where impaired performances can require months of recovery.

Finally, most of the research on overtraining is not focused on resistance exercise. Figure 9.1 illustrates a continuum of training stresses that can be found in the training room with resistance exercise. While this figure may still be an oversimplification of a complex problem, it helps to understand that the chronic resistance exercise stimulus can range from very easy to extremely difficult and challenging. To fully understand the entire process, it is critical to understand training at various locations along this continuum. It should be also noted that although figure 9.1 makes it look like there are three distinct types of resistance exercise that contribute to overtraining,

it is not that simple to differentiate. It is the author's opinion that most of the overtraining scenarios in the weight room involve excessive training volume; however, it is possible the center of the continuum is most prevalent in the real world. In this context, high-volume overtraining in the weight room is based on extremely large amounts of work (i.e., total repetitions, mechanical work [joules], volume-load [repetitions \times weight lifted]), while high-intensity overtraining is based on excessively high percent 1RM loads, and many overtraining scenarios used both. Indeed, there are many additional factors that contribute as well, which will be discussed in this chapter. This continuum also illustrates that highly stressful training in the weight room is not necessarily overtraining or overreaching but is rather a necessary part of many training programs. The last thing to consider in figure 9.1 is that many training scenarios are not limited to what goes on in the weight room. It is essential to recognize that stressors are additive, and other components of the total training program and outside life contribute to the total stress profile.

In 1936, to explain how biological systems respond to stress, Hans Selye first presented what later became known as **general adaptation syndrome (GAS)**. Although Selye was not a sport or exercise scientist, he showed an understanding of the potential application of GAS in the training room when he stated GAS was the "response of the organism to stimuli such as ... muscular exercise." In recent years, critics of using GAS for sport and exercise training have suggested that this model doesn't truly represent responses and adaptation to stress. However, it must be remembered that this is a paradigm

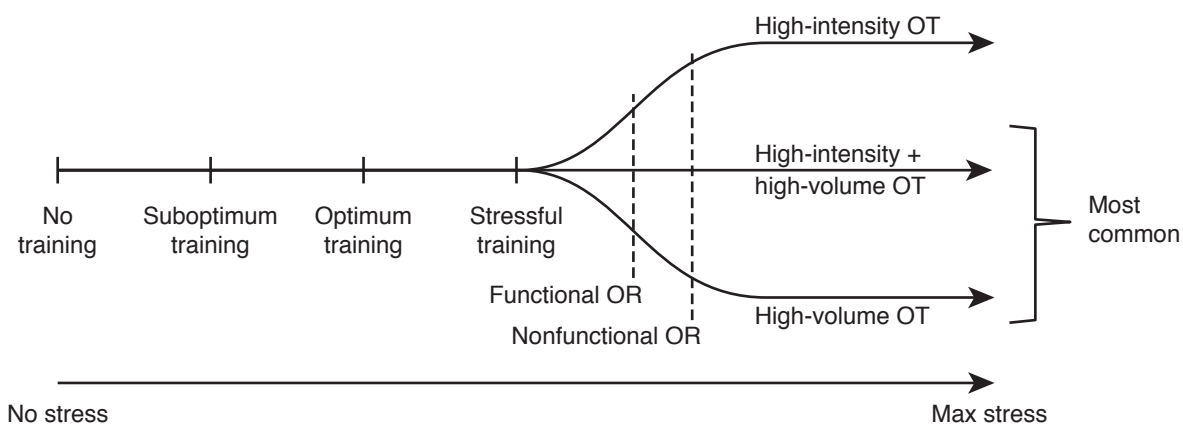

FIGURE 9.1 Resistance exercise training stress continuum leading to an overtraining syndrome. An understanding of responses and adaptations to the entire continuum of training is necessary to understand the causes and the development of overtraining in the weight room.

representing the general response to a stressor, and the actual characteristics of the response pattern can vary considerably depending on the stressor. In figure 9.2 we see the GAS modified to diagram different levels of training stresses and responses. In addition to illustrating how excessive overload and inadequate recovery can lead to an overtraining

syndrome, it also shows how a carefully designed training program can lead to optimum performance. Additionally, this figure demonstrates how poor performances are not necessarily due to overtraining. Poor coordination of the training program with the competition schedule can be the culprit as shown in the subpeak performances in figure 9.2. Mistiming

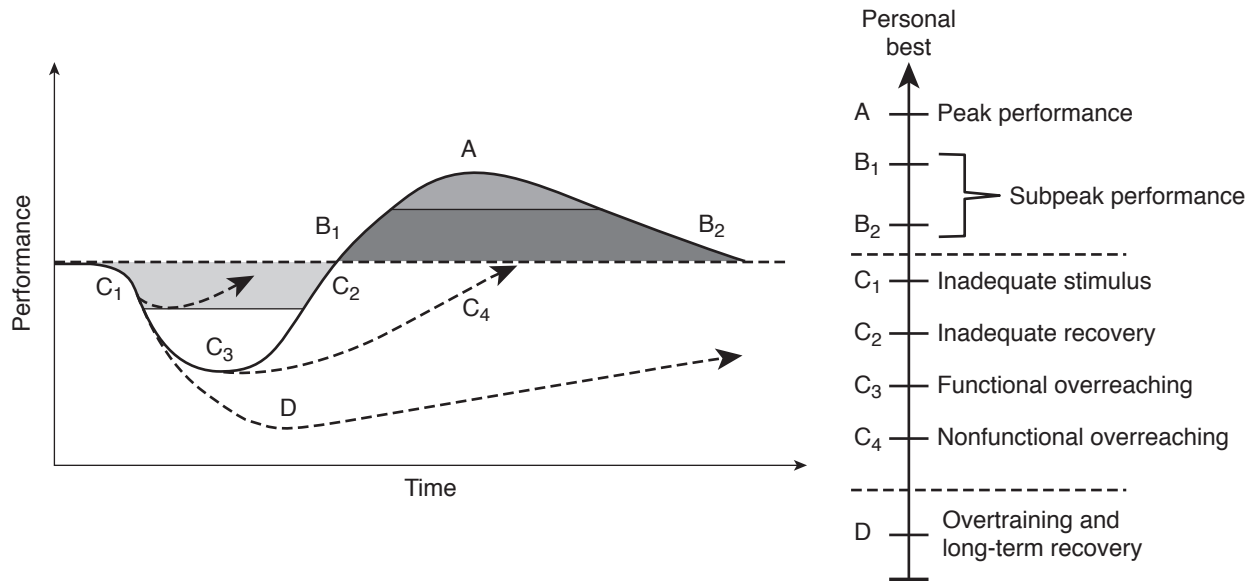
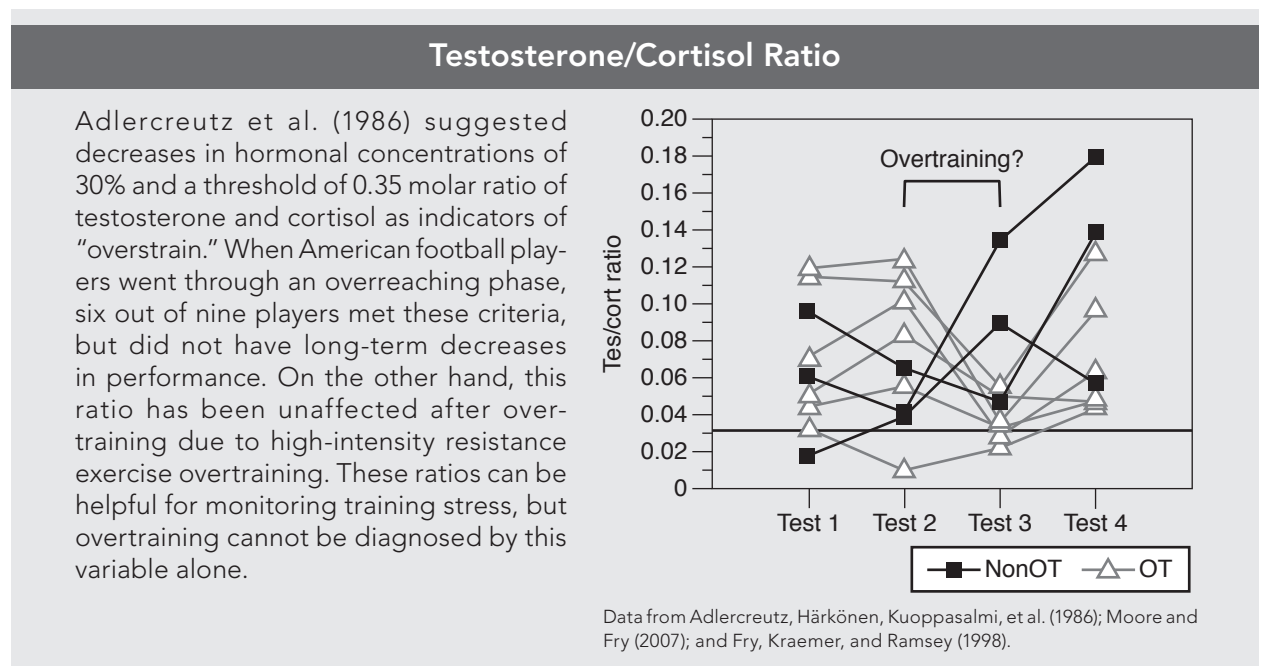

FIGURE 9.2 The general adaptation syndrome in response to different levels of training stress. The continuum on the right is the resistance exercise overtraining paradigm, which indicates the various conditions present in response to stressful training. A – optimum recovery and performance, B – mistiming of subsequent training or competition, C₁ and C₂ – inadequate training or recovery, C₃ – training stress permits optimum recovery and performance, C₄ – training stress does not permit adequate recovery and performance, and D – excessive overload and inadequate recovery leading to overtraining.



of the training program are indicated by B_1 , B_2 , and C_2 in the figure, while inappropriate training stresses are indicated by C_1 , C_4 , and D .

Training Monotony and Variation

Many training programs are monotonous or lack variation. This is likely due to the absence of a training plan or lack of a properly designed plan, and can present itself when the same training program is performed every day, or there is not enough variety in the training stimulus. In an attempt to avoid this problem, a common error for some coaches and trainers is to change the training program just for the sake of changing it. In other words, no strategy or thought has been put into the change, other than to randomly switch out a component of the training. While the term *training monotony* is easy to use, the problem lies in how to measure it. In the world of endurance training, it is suggested to monitor mean heart rates and distances run. The product

of heart rate (intensity) and distance (volume) for each training session is recorded. The coefficient of variation (% CV; $[SD/mean] \times 100$) for a period of training (i.e., macrocycle or mesocycle) is determined to provide an indication of the variability of the training stimulus. For the weight room, the same concept of volume and intensity can be applied by using volume-loads for each training session (i.e., total repetitions \times weight lifted). Figure 9.3 shows an example of the lack of adequate training variety in an actual sport training setting. In this example from American football, this off-season program and the following 7 wk of sport practice resulted in nonfunctional overreaching. The athletes simply returned to their original levels of performance by the end of the 4-mo mesocycle. The original resistance exercise program appeared to incorporate variety (as indicated by the solid arrows). Although it is difficult to identify specific target values for percent of coefficient of variation (CV) for volume-load, the percent of CV for volume-load was fairly

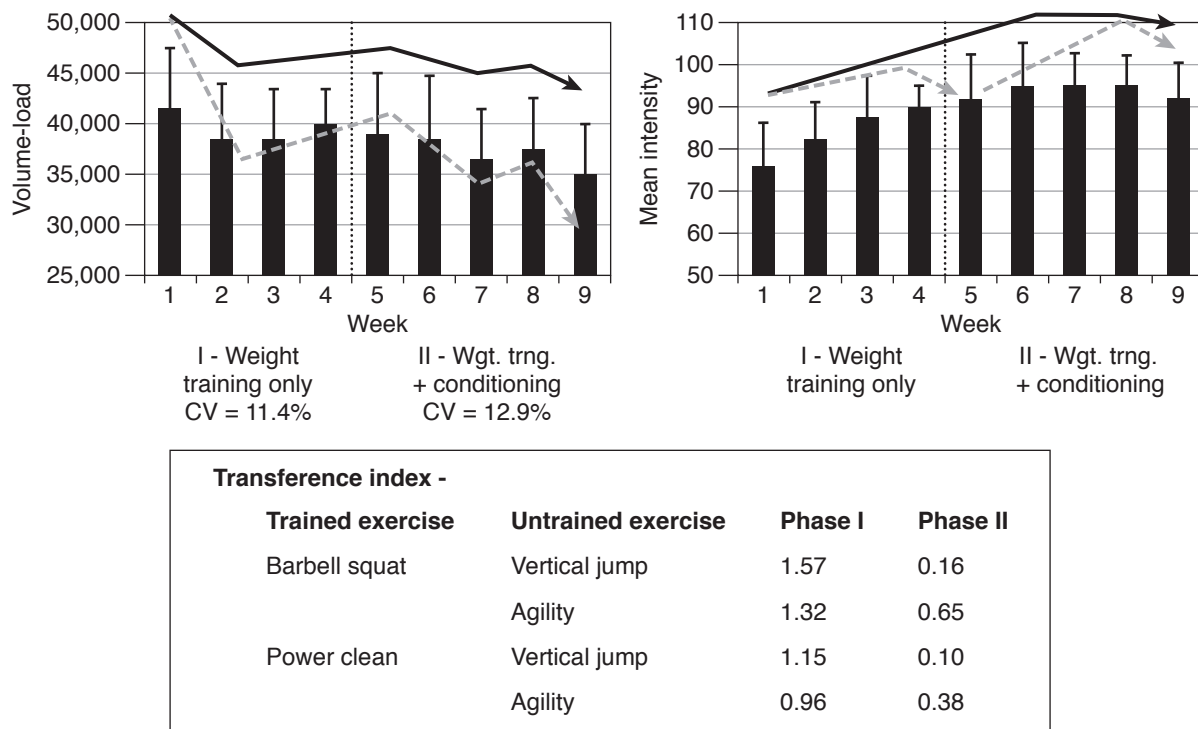

FIGURE 9.3 Training monotony and transference of training effects for an off-season American football strength and conditioning program that led to nonfunctional overreaching.

Phase I (weeks 1-4) – only weight training, Phase II (weeks 5-10) – weight training and morning conditioning sessions (i.e., sprinting, agility, plyometrics, flexibility, metabolic conditioning). Solid arrows – patterns of volume-load and relative intensity (pretraining % 1RM). Gray dashed arrows – suggested improvement for greater training variability. Transference index values show high values of transference to the practice field during phase I, but loss of transference when additional training was added to the program.

Reprinted by permission from C.A. Moore and A.C. Fry, "Nonfunctional Overreaching During Off-Season Training for Skill Position Players in Collegiate American Football," *Journal of Strength and Conditioning Research* 21, no. 3 (2007): 793-800.

low (<13% for both phases of training). It was determined that greater variation in the training could easily be prescribed as shown by the gray dashed lines. A closer look at the values for volume-load show that there was actually very little difference between the highest and lowest points of this variable. This is one indication of the value of recovery and training variation.

Another variable of interest in figure 9.3 is the transference index. The transference index is a helpful indicator as to whether the exercises used in the weight room are carrying over to on-the-field performances, in this case vertical jumps and the American football 5-10-5 agility test. As with the percent of CV for training monotony assessment, there are no specific values that indicate success. Rather, this measure can be used when examining various tasks and phases of training to determine if transference is occurring, and to what extent it is occurring. The values in figure 9.3 are not surprising since the athletes were relatively novice in the weight room at the beginning of the training. Both the high strength (barbell squat) and high power (power clean) exercises showed strong transference to the important tests for this sport (i.e., 5-10-5 agility test and vertical jump height). The fact that the strength exercise exhibited slightly greater transference during phase I is not unexpected since enhanced strength may be most beneficial for athletes who are novice in the weight room. It is expected that additional years of this testing may have shown the power exercise becoming more important. Note, however, that transference decreased dramatically during phase II for both exercises. It was determined that the training performed outside the weight room interfered with the progress previously seen. This is an excellent example of how training stressors are additive.

Types of Resistance Exercise

While it may be obvious to the readers of this text, it is critical to remember that not all resistance exercise is the same. For example, one might use a standard training session of 3 sets \times 10 repetitions of leg extension exercise and assume the results apply to all forms of strength training. This, however, is far from the case. A thorough understanding of the complexities of the resistance program and training-related variables must be appreciated to adequately interpret the results of the training. A list of variables to consider is found in table 9.2.

Psychology of Resistance Exercise Overtraining

Although considerable study of the psychology of endurance overtraining has been performed, less is known about resistance exercise overtraining. Attempts to examine this have been made using the **Profile of Mood States (POMS)** with national caliber weightlifters, but the length of the survey and the time required to complete it are problematic. An abridged version of the POMS was also developed but did not exhibit appropriate validity. It is likely that use of the full POMS would result in an “iceberg” profile (i.e., lower values for all states except fatigue) as is shown with endurance exercise, but this has not been adequately demonstrated for resistance exercise overtraining.

The Recovery-Stress Questionnaire for Athletes (RESTQ) has great potential for monitoring overtraining stress, but to date, the only attempt to use this in the weight room was inconclusive since an overtraining syndrome did not result. A short (15 items, Likert scale) survey developed specifically for resistance exercise overtraining was shown to be reliable and is easily included in daily training logs. Topics include perceptions of eagerness to train, recovery, strength, muscle soreness, and knee and low back pain. In every instance this instrument has been used, the first and most marked responses to stressful resistance training are a dramatic decreased desire to train, and a lack of recovery. These responses precede any documented physiological changes or decreases in performance. This may be even more apparent to coaches who know their athletes and their desire to train. Additionally, during overtraining in the weight room, the lifter’s confidence when performing maximal lifts (100% 1RM) decreases after 8 days of an inappropriately intense training program (figure 9.4). Known as **self-efficacy**, this decrease in confidence can be extremely detrimental to an athlete attempting to perform at high levels. Such changes in the lifter’s psychological profile is likely influenced by the motivational and **caring climates** that the coach or trainer creates. Based on studies of the **achievement goal theory** and caring climates, this area of sport psychology study reports that the desire to train and to give a best effort is enhanced when coaches and trainers adopt task-oriented motivation strategies, and create an empathetic environment toward their athletes. It is important to note that these approaches have little

TABLE 9.2 Resistance-Exercise-Related Variables to Consider When Evaluating Expected Responses and Adaptations to Overtraining

<p>Muscle action</p> <ul style="list-style-type: none"> • Concentric • Eccentric • Isometric • Isokinetic • Stretch–shortening cycle • Amortization time 	<p>Purpose of the program</p> <ul style="list-style-type: none"> • Sport-specific • Lifting sports • Occupational • Rehabilitation/therapy • Recreational
<p>Free weights or machines</p> <ul style="list-style-type: none"> • Large or small muscle mass • Multiple or single joints • Complex or simple movement pattern • Fast or slow velocity • Order of performing exercises • Body weight or external loads • Relative intensity (e.g., % 1RM) • Absolute intensity (e.g., resistance in lb or kg) • Total number of repetitions • Total work (joules; force \times distance) <ul style="list-style-type: none"> • Concentric work • Eccentric work • Total impulse (newtons; force \times time) • Interset rest intervals 	<p>Training history of the population</p> <ul style="list-style-type: none"> • Novice or experienced • Type of training preceding overtraining • Injuries (current or past) • Illnesses • Age • Sex
	<p>Chronic resistance exercise program</p> <ul style="list-style-type: none"> • Periodized or not periodized • Type of periodization
	<p>Other training</p> <ul style="list-style-type: none"> • Sport training • Conditioning programs
	<p>Other factors</p> <ul style="list-style-type: none"> • Sleep • Diet • Work • Family/personal

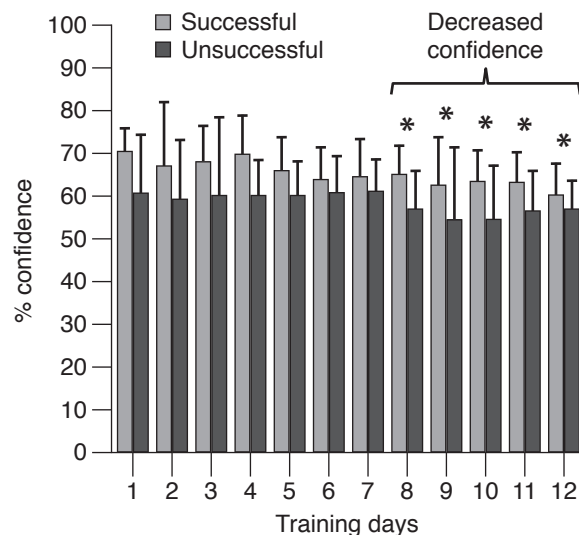
**FIGURE 9.4** Despite adjusting loads for current strength levels, subjects attempting to lift 100% 1RM loads daily for 2 wk exhibited decreased confidence (self-efficacy) after 7 training days.

Data from M.D. Fry, A.C. Fry, and W.J. Kraemer, "Self-Efficacy Responses to Short-Term High-Intensity Resistance Exercise Overtraining," International Conference on Overtraining and Overreaching in Sport: Physiological, Psychological and Biomedical Considerations (Memphis, TN, 1996).

to do with the design of the resistance training program, and still permit the coach or trainer to provide an appropriately challenging training program. To date, sport scientists have not adequately studied the psychology of resistance exercise overtraining.

Speed Is Very Sensitive

Speed is an absolutely critical contributor to athletic performance; however, it can be expressed in several ways. Whenever sprinting performance has been tested in response to resistance exercise overtraining or overreaching, extremely large decrements in sprint velocities result within 1 wk. Even though muscle soreness was not a factor, sprint times for a 9.1-m (10-yd) sprint were 0.11 s slower, and 36.6-m (40-yd) sprints were 0.20 s slower. As expected, control subjects who did not overtrain were able to maintain their sprint performances. While at first glance these slower sprint times may not seem like much, figure 9.5 shows how big a difference this can be for a competing athlete. Compared to any other



FIGURE 9.5 Slower sprint times resulting from high-intensity resistance exercise overtraining. The slower times at both distances suggest the largest decrements occur at the start of the sprint, and result in an athlete unable to keep up with a competitor.

Data from Fry, Kraemer, Lynch, et al. (1994) and Fry, Webber, Weiss, et al. (2000).

performance measure, it appears that sprint speed may be the first performance measure adversely affected. Care should be taken when sprint testing since muscle strains to the sartorius or rectus femoris muscles have occurred during this high-velocity activity when accompanied by overtraining.

Lifting Power Decrements

Both coaches and athletes understand the importance of muscular power for optimal performance in many sports. Excessive use of high-power training using barbell speed squats has produced decreases of more than 20% for barbell velocity and approximately 14% for barbell power. When similar training was used in a later study, power stagnated while control subjects made continued progress. In both proj-

ects, bar power and velocity were adversely affected, but maximal strength as measured by 1RM squats was unaffected. In addition, a nonspecific measure of strength, the knee extension exercise, was also unaffected. Interestingly, when resistance exercise overtraining was induced using excessive volumes of maximal loads (i.e., 100% 1RM), lifting power at the velocity closest to training velocities was decreased by over 30%. When high volumes of resistance exercise have been used to induce overreaching over a 1-wk period (>1,000 reps/wk), upper-body power decreased by over 30%, whereas lower-body lifting power was maintained. It appears that perhaps the upper body may be more sensitive to impaired power performances during lifting when exposed to this type of training. Overall, either excessive use of maximal loads, high power, or high volumes of

How Does Sport Psychology Fit In?

Considerable research exists on the psychological states affected by overtraining with endurance athletes, but few data exist for overtraining in the weight room. An underappreciated area of overtraining psychology is the motivational climate created by the coach or trainer. The study of achievement goal theory indicates that athletes who perceive a task-oriented and caring climate

- try harder,
- are more committed to the team and sport,
- have better relationships with coaches and teammates,
- deal with perceived stress better,
- possess enhanced mental skills,
- have a decreased physiological stress response,
- experience enhanced performance, and
- have more fun.

Adapted from M.D. Fry and E.W. Moore, "Motivation in Sport: Theory and Application," in *APA Handbook of Sport and Exercise Psychology: Vol. 1, Sport Psychology*, edited by M.H. Anshel, T.A. Petrie, and J.A. Steinfeldt (Washington, DC: American Psychological Association, 2019): 273-299.

resistance exercise impair power performance. Considering that half of power (force \times velocity) is due to speed of bar movement, it is not surprising that the impaired sprinting performances described previously are also evident when lifting is misprescribed, resulting in power decrements or **stagnation**. It would be interesting to see how excessive use of the lifts with the greatest power (i.e., snatches, cleans, jerks) would affect power, as well as other aspects of performance. It has not been definitively determined as to whether decreases in power actually occur later than decreases in sprinting speed. However, since velocity is so sensitive to training stress, and force is less so, it makes sense that decreases in the combination of force and velocity (power) would take slightly longer to develop.

Vertical Jump

The simplest measure of lower-body power outside the laboratory is most likely the vertical jump (VJ) test. Originally developed by Dr. Dudley A. Sargent as a “fair physical test of man,” this test can assess training effectiveness and sporting capabilities. Currently, the VJ test is used as both an assessment of jump height, as well as a tool to examine the ground reaction forces developed during this explosive activity. When maximal or near-maximal loads are used excessively, VJ height has not been

impaired. Barbell squat jump peak power with 30% 1RM loads is also unaffected when high volumes of training have produced an overreaching scenario. However, increasing weight training volume three-fold for a week can decrease vertical jump power by >5%. With the advances in force plate technology and accompanying software, it is now easier to measure and evaluate the ground reaction forces during a vertical jump test. Although not evaluated in a scientific setting, empirical reports from coaches using force plate technology suggest that the eccentric rates of force development (ECC RFD) during a countermovement VJ will decrease during stressful phases of training (figure 9.6). Since rates for force development are often sensitive measures, this variable should be closely examined when an athlete is experiencing highly stressful training that may lead to overtraining or overreaching.

An interesting variation of the vertical jump test is the Bosco repeated VJ test. This test has shown considerable promise for monitoring competition readiness in elite gymnasts. Enhanced Bosco test performance was highly indicative of selection for international competition. Variations of this test have also elicited dramatic alterations in the jump heights and kinetics after acute fatigue from a single jump training session. Not only VJ height decreased, but also flight times and impulse. Future study of resistance exercise overtraining may want to include

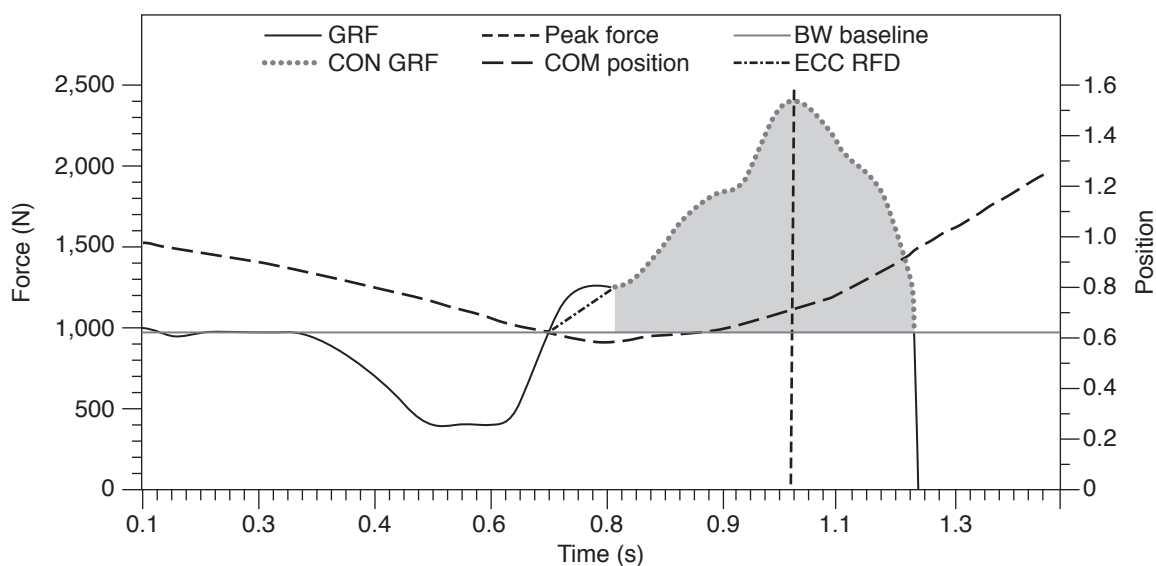

FIGURE 9.6 Ground reaction force (GRF) for a subject during the countermovement vertical jump (black solid line), the center of mass (COM position) (black dashed line), and GRF peak force before takeoff (black short dashed line). Body weight (BW) baseline (gray solid line), eccentric rate of force development (ECC RFD) (black dash-dotted line), concentric (CON) GRF (gray dotted line), and the CON positive impulse (shaded area) in the area under GRF above the BW baseline.

Reprinted by permission from E.M. Mosier, “The Effects of Vertical Jump Fatigue and Sprint Fatigue on Total-Body Biomechanics,” doctoral dissertation at University of Kansas, 2018.

not only single VJ kinetics, but also repeated VJ tests to monitor the ability to repeat VJ performances.

Rate of Force Development

Since speed and power appear to be very sensitive to resistance exercise overtraining, it makes sense that decreases in the rate of force development (RFD) would also be part of a resistance exercise overtraining syndrome. However, the results depend on how RFD is measured. Initial attempts to examine RFD used an isometric knee extension test, but no changes were observed, even when squat strength decreased by >10%. This included not only total RFD, but also various components of the force–time curve (i.e., S-gradient, A-gradient). To date, no attempts have been made to evaluate dynamic knee extension RFD in response to an overtraining stimulus.

Recent years have seen the advent of the isometric midhigh pull (IMTP) test. This assessment is performed while on a force plate, and there are numerous examples of the effectiveness of this test for monitoring athlete training progression. For example, weightlifters performing an 11-wk periodized training program routinely used the IMTP test, which was sensitive to changes in the training volume. It is also clear that there are many ways to measure the resulting force–time curve, and it is

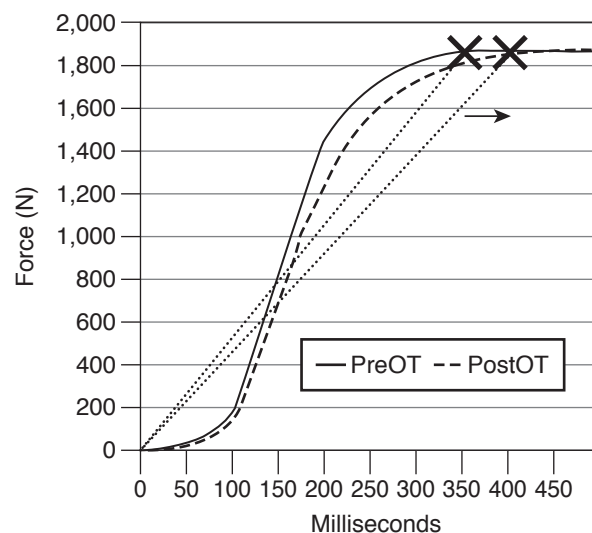

FIGURE 9.7 Theoretical force–time curves from an isometric midhigh pull test before and after an overtraining stimulus. In this example, maximal force is not affected, but the time to maximum force results in a lower RFD. Various portions of the curves may also respond differently.

Adapted by permission from G.G. Haff, "Strength-Isometric and Dynamic Testing," in *Performance Assessment in Strength and Conditioning*, edited by P. Comfort, P.A. Jones, and J.J. McMahon (London: Routledge, 2019), 166-192.

likely that different training programs may affect various portions of the curve differently. Although the IMTP test has not been used in an overtraining study, figure 9.7 shows a theoretical IMTP force–time curve that might result from the early stages of overtraining in the weight room. In some ways, this may be similar to the suggested changes in the eccentric RFD during the VJ test. But why would IMTP and VJ RFD reflect overtraining, while isometric knee extension RFD does not? Two possible factors come to mind; a dynamic movement may be preferred, and multiple-joint activities may be more sensitive than single-joint activities. Regardless, performance tests to evaluate RFD could be an easily implemented testing tool for overtraining and overreaching.

Strength Decrements

When using resistance exercise to enhance strength, it is only logical that overtraining interferes with strength improvements. When only high volumes of resistance exercise are used to induce overtraining or overreaching, maximal strength (i.e., 1RM) for the exercises trained will decrease. In some cases, these decreases are accompanied by elevations in circulating creatine kinase (CK), an indirect indicator of delayed-onset muscle soreness or muscle damage. Even though the subjects in these studies were well trained to begin with, they had difficulty tolerating the very large increases in lifting volumes (up to threefold increases). It should be noted here, however, that the elevations in CK observed in these studies were considerably lower than in studies on muscle damage. As such, it is important to realize that muscle damage studies are not necessarily the same as overtraining studies, even though they may share some common traits. Ironically, when maximal loads (i.e., 100% 1RM) are used to induce high-intensity resistance exercise overtraining, it is very difficult to produce decreases in maximal strength. Indeed, 1RM strength is perhaps the last performance variable to decrease in this setting. The human body appears to preserve maximal strength capacities, perhaps as a survival mechanism. So even though maximal loads are used repeatedly across a 2-wk overtraining phase, the subjects were able to retain slow-velocity strength longer than other measured variables. An interesting aspect of high-intensity overtraining of this type is that small decreases (e.g., 5%-10% 1RM) in the relative intensity used for training can avoid strength decrements entirely. This illustrates the importance

of periodizing the training loads to enhance training tolerance of these heavy loads. Furthermore, training capacity with heavy loads was less when using free weights versus weight machine squats. Therefore, the resistance training modality can have a profound impact on the ability to tolerate stressful phases of weight training. High volumes of resistance exercise have also resulted in altered lifting technique. Bar trajectories moved further away from the weightlifter's body during the second pull for snatches after a stressful phase of training (figure 9.8). Even though snatch 1RM strength had not changed at the time, it is likely that kinematic changes in lifting technique would lead to future problems.

Ironically, when excessive use of high-power resistance exercise is used to induce an overtraining syndrome (i.e., high volumes of speed squats), maximal strength is unaffected. Even though power- and velocity-specific performances were impaired, maximal strength was preserved, indicating that the lifts used for training may be most affected. Therefore, performances specific to the training appear to be most sensitive to an overtraining stimulus.

So Which Performance Tests?

The previous paragraphs lead us nicely to the following question: Which performance tests are most appropriate for monitoring overtraining? While

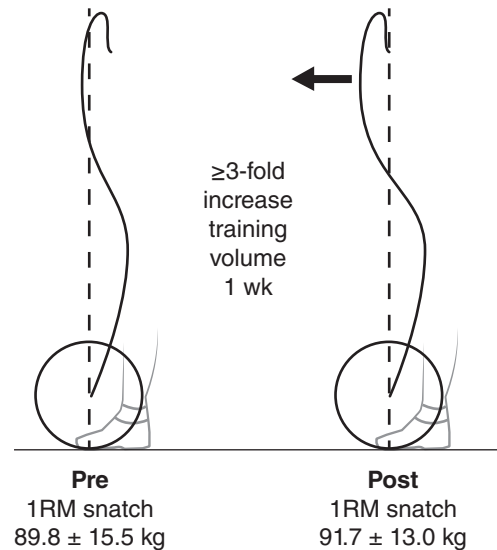

FIGURE 9.8 One week of high-volume weightlifting overreaching resulted in no decreases in 1RM snatch, but barbell trajectories began to deteriorate. This was evident from video analyses showing the bar swinging away from the body during the second pull.

Adapted from M.H. Stone and A.C. Fry, "Increased Training Volume in Strength/Power Athletes," in *Overtraining in Sport*, edited by R.B. Kreider, A.C. Fry, and M.L. O'Toole (Champaign, IL: Human Kinetics, 1998), 87-106.

there are many performance tests available to the coach and researcher alike, it seems that only certain tests are sensitive enough to the often-subtle performance decrements observed with overtraining.

Orthopedic Injuries Can Be a Factor

Orthopedic injuries must be ruled out when experiencing decreases in performance. Subject A was medically diagnosed with an overuse injury of the knee and experienced a 36% decrease in 1RM squat strength. All other overtrained lifters (controls) maintained voluntary isometric quadriceps strength, and decreased stimulated strength, while subject A actually increased in both. It was believed that orthopedic inhibition may have affected dynamic movements while not affecting static tests.

Reprinted by permission from A.C. Fry, W.J. Kraemer, J.M. Lynch, and J.M. Barnes, "Overload Injury of the Knees With Resistance-Exercise Overtraining: A Case Study," *Journal of Sport Rehabilitation* 10, no. 1 (2001): 57-66.

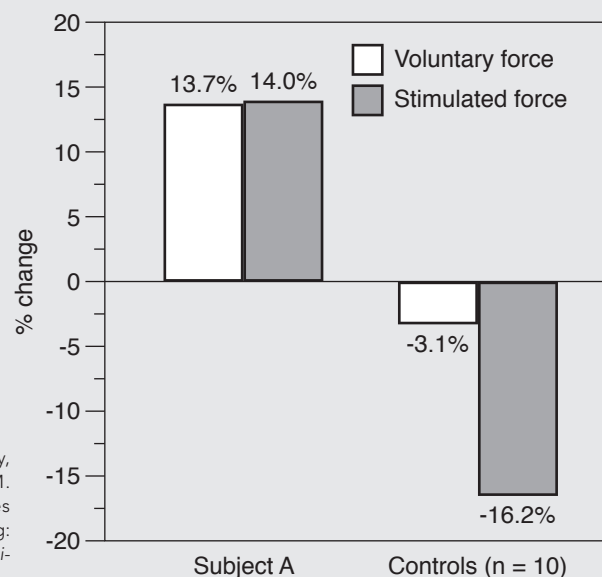

Even though a performance test is effective for other purposes (e.g., monitoring normal training progress, rehabilitation, and therapy), it may not be suitable when it comes to overtraining in the weight room. A cursory overview of the types of tests available for muscle performance after overtraining suggests several key considerations; are they single joint or multijoint and are they static (isometric) or dynamic. Figure 9.9 summarizes the effectiveness of these factors for four categories of tests: rate of force development (RFD), maximal voluntary contraction (MVC), power, and velocity.

Single-joint assessments of rate of force development have not been sensitive to resistance overtraining, although this has been limited to overtraining with maximal loads. Although not previously used for overtraining research, isometric midhigh pulls, which are multijoint, can detect important changes in the resistance exercise training program. It is likely that this test would be able to detect performance decrements from overtraining. With the advent of readily available data from force plates, empirical reports of vertical jump ground reaction forces indicate that the eccentric rate of force devel-

opment may decrease during stressful weight room training phases. As such, vertical jump testing of this type may be an effective assessment tool when trying to monitor impending overtraining.

Muscular strength can be assessed using maximal voluntary contraction. As with RFD, there are differences in the results based on how these tests are administered. Single-joint isometric (static) knee extension tests have not shown to be affected by overtraining in the weight room when using maximal loads, whereas the results of dynamic (i.e., isokinetic) knee extensions tests readily decrease. It is possible that static maximal force decreases with high-volume overtraining, but this has yet to be demonstrated. Despite static volitional force of the quadriceps not being decreased, stimulated quadriceps force is rapidly decreased, suggesting peripheral maladaptation. Multijoint isometric force tests such as the isometric midhigh pull can detect changes in the training program during normal periodized training, but to date this test has not been used to monitor resistance exercise overtraining. It is speculated that this test would likely be affected by overtraining in the weight room, either with high-intensity



		RFD		MVC	
		Single joint	Multijoint	Single joint	Multijoint
Static (isometric)		Knee extension 	Isometric midhigh pulls Likely	Knee extension  (unless stimulated)	Isometric midhigh pulls Likely (due to vol-load)
	Dynamic	Unknown ?	Vertical jump Likely	Yes ↓ isokinetic	Yes ↓ 1RM (but last to ↓)
		Power		Velocity	
		Single joint	Multijoint	Single joint	Multijoint
Static (isometric)		Not applicable	Not applicable	Not applicable	Not applicable
	Dynamic	Yes ↓ isokinetic	Yes ↓ on machines or free weights	Yes ↓ isoinertial	Yes ↓ on machines or free weights

FIGURE 9.9 Suitability of types of muscle performance tests for monitoring responses to resistance exercise overtraining. RFD = rate of force development, MVC = maximal voluntary contraction, \triangle = no change.

Is Peripheral Maladaptation Part of the Problem?

When overtrained lifters suffered 11% decreases in 1RM strength, it was accompanied after 1 and 2 weeks by large decreases in quadriceps-stimulated strength as well. This indicates maladaptation peripheral to the site of femoral nerve stimulation at the inguinal fold.

Reprinted by permission from A.C. Fry, W.J. Kraemer, F. Van Borselen, et al., "Performance Decrements With High-Intensity Resistance Exercise Overtraining," *Medicine & Science in Sports & Exercise* 26, no. 9 (1994): 1165-1173.

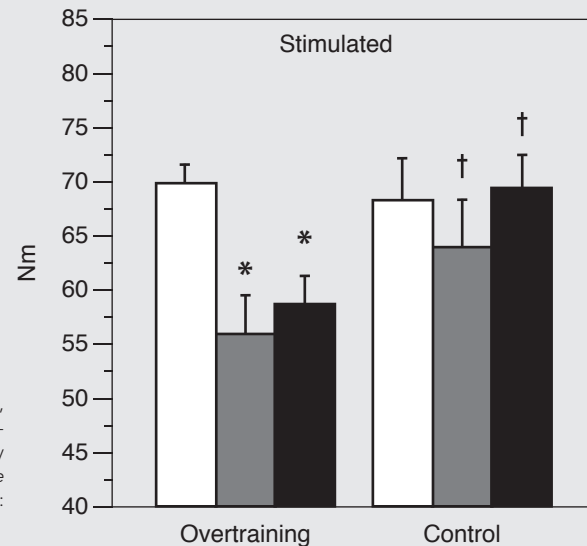

or high-volume overtraining. When maximal loads are used to induce overtraining, 1RM barbell squats (multijoint dynamic) strength decreased. This test, however, seems to be the last muscle performance test to decrease, indicating that it is not very sensitive to the overtraining stress. Contrary to this, when excessive volumes of resistance exercise are prescribed, both upper- and lower-body 1RM strength decreases.

Measures of muscular power and velocity are obviously not static. However, both single-joint and multijoint measures of lifting power decrease with stressful weight training, suggesting that power measures (both mean and peak power) are desirable for monitoring the effects of overtraining in the weight room. Likewise, measures of barbell or machine weight stack velocity also decrease due to this type of stressful training. It is likely that the external dynamometers and accelerometers now readily available for the weight room are valuable tools for documenting or avoiding overtraining when lifting.

Regardless of which tests are performed, there are several factors to consider. With endurance overtraining, repeated graded exercise tests have been successful for identifying impaired performance and physiology. This repeated-testing approach to resistance exercise overtraining has not yet been used. It has also been reported that athletes who have previously experienced phases of overtraining or overreaching appear to have developed a greater tolerance of these stressful phases. Carefully prescribing this type of stressful training

may be an effective long-term training strategy for these athletes. It is also apparent that many of the characteristics of high-volume resistance exercise overtraining are somewhat similar to overtraining with endurance athletes who routinely perform extremely large volumes of training. High-intensity resistance exercise overtraining, however, exhibits many unique characteristics.

Physiology of Resistance Exercise Overtraining

So what exactly is going on to cause all these decreases in muscle performance? The physiology of overtraining is very complex and highly dependent on many factors. However, there are several physiological systems that appear to contribute to some extent, and others that are likely candidates. While the focus of this chapter is on muscular performance, it is worth noting how several systems can play a role (figure 9.10).

Here is a summary of some of the variables described in figure 9.10.

Decreases in Muscular Force

First, the decreases in muscular force indicate a compromised ability of the muscle itself to function properly. This presence of peripheral maladaptation is supported by decreased stimulated force. This impaired force-producing capability is likely a contributing factor to decreases in rates of force

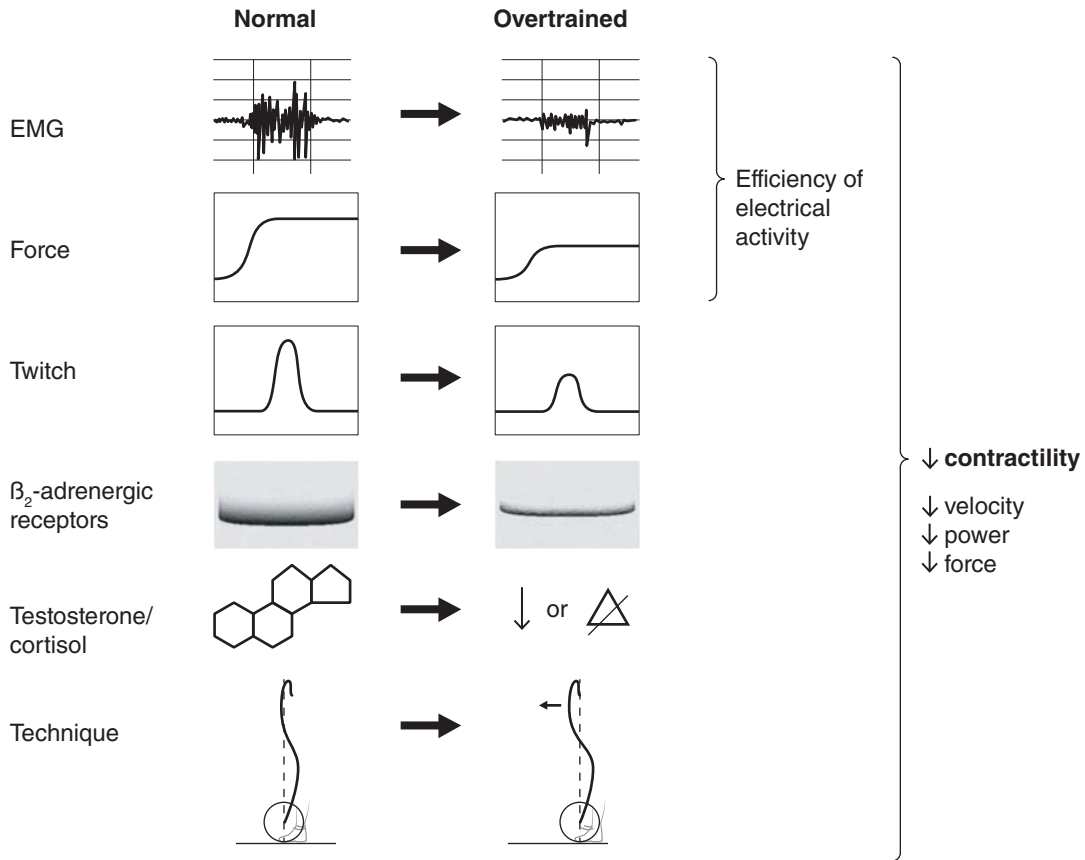

FIGURE 9.10 Key factors contributing to resistance exercise overtraining.

development. Changes in fiber types or myosin heavy chain expression are not contributing factors, but it is clear that stress-signaling proteins (i.e., mitogen-activated protein kinases [MAPKs]) are activated via phosphorylation in response to resistance exercise overtraining.

Electromyographic Activity

Electromyographic (EMG) activity is altered due to resistance exercise overtraining. Although few data are available, it is known that overtraining with maximal loads results in decreased peak EMG amplitude and decreased rates of EMG development,

Central Contributions to Decreased Performance

Although central factors such as neural recruitment reduction may contribute to overtraining, few data on this are available. After high-intensity resistance exercise overtraining, changes in EMG amplitude were positively correlated with changes in muscle force ($r = 0.80$). These data suggest an inability to recruit high-threshold motor units. Emerging technology will soon make it more practical to study this more effectively.

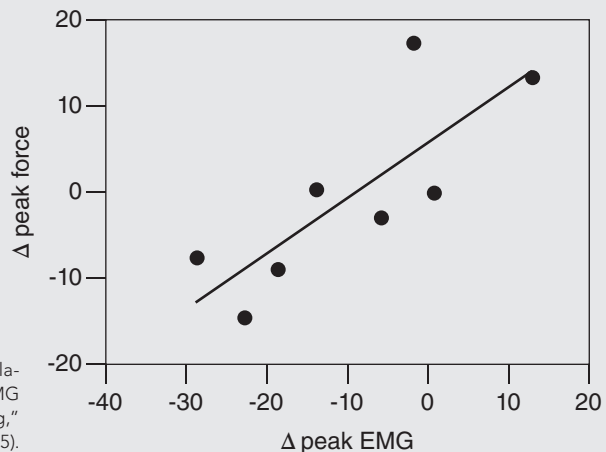

Data from A.J. Sterczala, J.X. Nicoll, and A.C. Fry, "The Relationship Between Performance Decrements and Peak EMG Amplitude Following Resistance Exercise Overreaching," Central States ACSM Conference, Warrensburg, MO (2015).

suggesting a decreased ability to recruit high threshold motor units and an impaired ability to rapidly activate the muscle. The combination of decreased EMG activity and impaired force-producing capabilities could result in lower EMG/force ratios. This was originally called “efficiency of electrical activity” by deVries and has been shown to be sensitive to changes in the stresses of weight training.

Hormone Levels

While many hormones have been implicated in overtraining syndrome, most focus has been on the testosterone/cortisol ratio (T/C). Usually measured in the blood, recent advances have made salivary measures more practical and valid for the coach and athlete. Originally suggested by Adlercreutz as a possible biomarker of overtraining, changes to this ratio do not always accompany resistance exercise overtraining. Overtraining with high volumes almost always decreases resting T/C ratios, while overtraining with maximal loads has little effect on T/C. Additionally, this ratio often changes with different phases of a properly designed weight training program, so it cannot be used by itself as a definitive indicator of overtraining. So what function do these hormones play in this type of stressful training? It has been speculated that the T/C ratio indicates the anabolic/catabolic status of the body, but these hormones can affect many other systems, and are likely part of the body’s attempt to counter the effects of overtraining. Emerging work on muscle steroid receptor responses to stressful training may help clarify the role of these hormones during resistance exercise.

Autonomic Nervous System

The autonomic nervous system has been implicated in the overtraining syndrome. It appears that in response to resistance exercise overtraining, the sympathetic nervous system (SNS) predominates in an attempt to maintain homeostasis, while in endurance athletes with overtraining due to very high training volumes, the parasympathetic system predominates. With high-intensity resistance exercise overtraining, large increases in basal and exercise-induced epinephrine are related to changes in muscle performance. At the same time, the primary receptors for epinephrine in skeletal muscle (β_2 -**adrenergic receptors**) are rapidly down-regulated. The net result is that many functions and activities of the muscle cell are affected, such as metabolism and contractility, among others.

Heart Rate Variability

Heart rate variability (HRV) has become a popular tool to monitor the presence of impending overtraining. Used clinically to assess autonomic nervous system activity, its value in the sport training world is not always clear. Attempts in the lab with stressful resistance exercise have reported no changes to HRV, but it was not clear that overtraining actually occurred. But much evidence exists for the value of HRV monitoring with endurance athletes, so further work is needed to determine the value of HRV with weight training. Related to this is resting heart rate (HR) assessments. Again, resting HR is very popular for endurance athletes, but anecdotal evidence with resistance exercise suggests that overtraining may have already occurred by the time resting HR increases.

Cellular Responses to Overreaching

The western blots shown here indicate a decrease in skeletal-muscle androgen (testosterone) receptor content after an overreaching training phase and increases in phosphorylation at two sites. While it is often helpful to monitor circulating hormonal concentrations in response to stressful resistance exercise, the physiological response is also influenced by receptor activity.

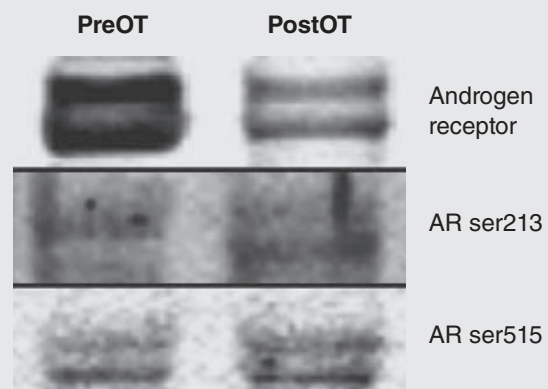

Adapted by permission from J.X. Nicoll, A.C. Fry, E.M. Mosier, L.A. Olsen, and S.A. Sontag, “MAPK, Androgen, and Glucocorticoid Receptor Phosphorylation Following High-Frequency Resistance Exercise Non-Functional Overreaching,” *European Journal of Applied Physiology* 119, no. 10 (2019): 2237-2253.

Overtraining and Decreased Sympathetic Sensitivity in Muscle

Some types of resistance exercise overtraining (OT) result in elevations in epinephrine concentrations at rest and in response to exercise. This can result in downregulation of β_2 -adrenergic receptors, the target of epinephrine in skeletal muscle. The large decrease shown in this figure can affect many aspects of muscle function, such as contractility.

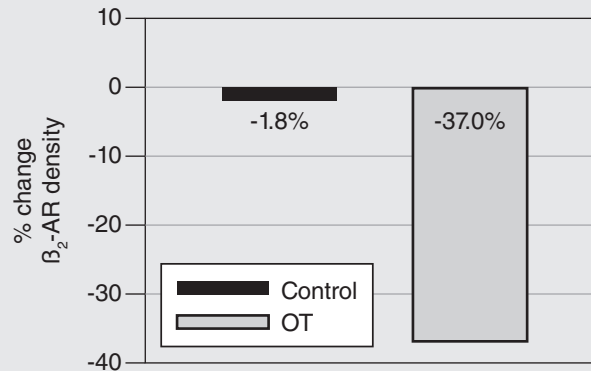

Reprinted by permission from A.C. Fry, B.K. Schilling, L.W. Weiss, and L.Z. Chiu, " β_2 -Adrenergic Receptor Downregulation and Performance Decrements During High-Intensity Resistance Exercise Overtraining," *Journal of Applied Physiology* 101, no. 6 (2006): 1664-1672.

Muscle Damage

Muscle damage is always a possible contributor to any type of overtraining. However, for most individuals who are able to train with the high volume and intensity needed to overtrain, it is likely that they have developed a training tolerance that minimizes muscle damage. Indeed, the levels of circulating creatine kinase (CK), indicative of muscle damage, are usually much lower than reported in the classical studies of delayed-onset muscle soreness. When excessive CK levels are present, such as from rhabdomyolysis, it is often due to a single inappropriately prescribed training session or to a hyperthermia condition.

Glycogen Stores

Depleted muscle glycogen stores can occur after strenuous exercise but are readily restored with proper dietary habits. High-volume resistance exercise overtraining may be due in part to glycogen depletion, but this can be readily avoided with dietary monitoring. Glycogen depletion due to high-intensity resistance exercise overtraining has not been observed, but it is possible that impaired muscle cell metabolism could contribute to this condition.

Lactate Response

Lactate response can be blunted after resistance exercise overtraining. Again, this could be due to impaired muscle cell metabolism. Using ratings of perceived exertion scales (RPE), this can be monitored by recording the lactate/RPE ratio.

Sequence of Performance Impairments

When confronted with the possibility of an overtraining syndrome and its accompanying performance decrements, it is imperative to recognize the signs and symptoms. One major problem is that many of the traits of overtraining in the weight room are not identical to overtraining from endurance activities. Another is that some symptoms that are being monitored may not occur as rapidly as others. Figure 9.11 illustrates what appears to be the sequence of symptoms and performance decrements that occur in response to resistance exercise overtraining. The knowledgeable and effective coach is wise to look for early signs of impending problems, rather than waiting for the advanced signs to be present.

Summary

Overtraining in the weight room is a very complex issue, but one that a successful coach or athlete must be aware of. This chapter has presented a great deal of information as it is currently known on how the body responds to this type of stressful training. When carefully prescribed, overreaching can be a very useful training tool, resulting in strong supercompensation effects and success on the playing field. When misapplied, the athlete and coach miss out on potential opportunities. It should also be remembered that many resistance exercise programs are accompanied by sport-specific training, which complicates the training environment and the physiological and performance responses. Based on

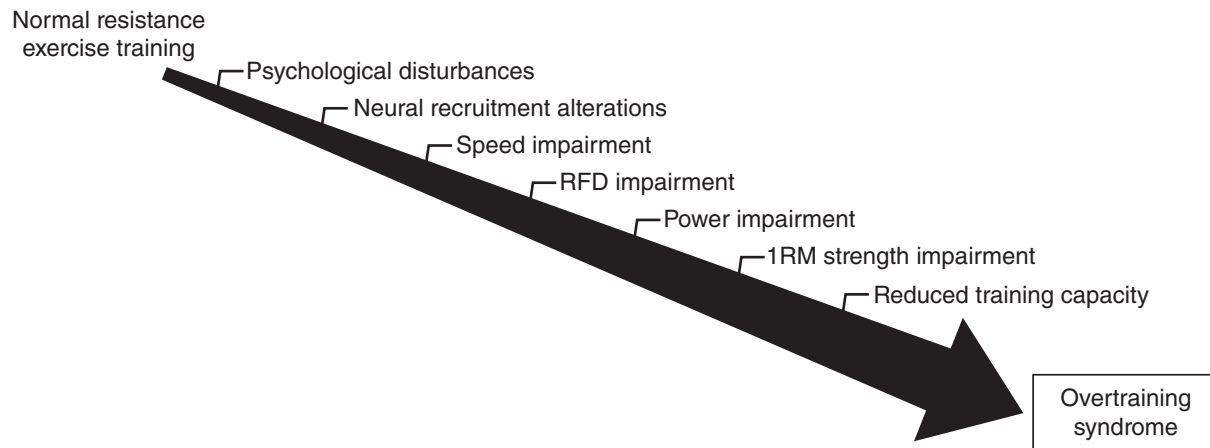

FIGURE 9.11 Suggested sequence of appearance of overtraining signs in the weight room.

the data presented, and on logical interpretations of the information, inferences can be made to help recognize and avoid overtraining in the weight room. Table 9.3 lists a number of these suggestions and conclusions, while table 9.4 identifies some of the

known or theorized changes in performance with different types of resistance exercise overtraining. Additional work needs to be done to more fully understand the problem of overtraining, but this list contains practical information from what is known.

TABLE 9.3 Summary of Overtraining With Resistance Exercise

Avoiding overtraining
One or more days of training abstinence enhances recovery; rest days are critical
Limit excessively long training sessions and too many sessions in a day
Use caution with excessive training volumes and large increases in training volume (>30%)
Prior exposure to stressful training enhances training stress tolerance
Variation in the training stimulus is critical; use of periodized training is important
Avoid excessive training to failure
Coordinate resistance exercise with other stressors (e.g., sport training or other conditioning)
Incorporate recovery strategies (e.g., sleep, diet, mental skills)
Training capacity is sometimes greater than expected
Effects on performance
Speed (e.g., sprinting) is first performance variable to deteriorate
Power (e.g., VJ, high-velocity lifts) is second to deteriorate
Strength (e.g., 1RM) is last to deteriorate
Free weight training is more susceptible to overtraining than machine weight training
Proper training program design is critical to avoid overtraining
Technique breakdown may present with more complex lifts (e.g., cleans, snatches, jerks)
Single-joint assessments not as effective as multijoint tests for detecting performance decrements
Many static (isometric) assessments (especially single joint) are not as effective as dynamic tests for detecting performance decrements

(continued)

TABLE 9.3 (continued)

Effects on performance (continued)
Vertical jump kinetics (i.e., ground reaction forces) are more sensitive to overtraining than vertical jump height; weighted jumps may be more sensitive than body weight jumps
Tests that are most sensitive are likely training-specific
Isokinetic tests are more sensitive than isometric tests, but less than dynamic constant external resistance (DCER; also called isoinertial)
Physiology and psychology of resistance exercise overtraining
Endocrine responses reflect training stress for high-volume overtraining
Psychological variables may be most sensitive indicators (e.g., desire to train, self-efficacy)
Orthopedic factors due to overtraining can present different overtraining symptoms
Delayed-onset muscle soreness is not likely a major factor with highly trained individuals
Muscle glycogen depletion may be a factor with high-volume overtraining
Peripheral maladaptation of skeletal muscle may contribute to decreased performance
Neural recruitment of motor units may be altered with overtraining
Autonomic nervous system via increased sympathetic activity can contribute to an overtraining syndrome
Lactate response to training may be decreased
Decreased blood glucose and increased free fatty acids may result from high-volume overtraining

TABLE 9.4 Known and Theorized Effects of Different Types of Resistance Exercise Overtraining/Overreaching on Common Performance Measures

Quality	High intensity	High power	High volume	Resistance exercise and conditioning
Speed	↓ 1st	Unknown	Unknown	↓
Power	↓ 2nd	↓	↓	↓
Strength (force)	↓ last or no change	No change	↓ or no change	↓
Rate of force production	No change in single joint	No change in single joint; IMTP?	↓ IMTP	↓
Agility	↓	Unknown	Unknown	↓
Exercise technique	Unknown	Unknown	↓	Unknown

↓ = decrease; IMTP = isometric midhigh pull

MONITORING ATHLETES IN THE WEIGHT ROOM

Athlete monitoring and performance assessment are widely used terms in the sport and exercise communities, but let's examine what this means, and how monitoring and assessment can be done effectively. Although assessment programs can include many different settings, let's focus on assessments in the weight room. Indeed, assessment programs can carry over to other settings, such as sport training, occupational performance, tactical performance (i.e., military, law enforcement, firefighting, first responders), rehabilitation, health, and general fitness. However, to include assessment programs for all those areas would be too extensive for this chapter. Suffice it to say, a proper monitoring program for the weight room and related training will help progress in all of these other areas. Thus far, the reader has gained considerable insight as to methods of training, and measures that can be used to monitor performance capabilities and training progress. Now let's focus on what needs to be measured and how this can be effectively carried out.

Purpose of Testing

Before any assessment program is properly developed, a thorough understanding of the purpose of the training program is needed. People train in the weight room for many reasons, and each reason should have specific desired outcomes or goals. Indeed, this is part of a needs analysis that should always be performed before designing a training program. The desired outcomes will determine the assessments that must be included to establish the effectiveness of the training.



Why Is the Testing Being Performed?

Before developing a testing protocol, ask the question, “Why is this testing being performed?” Is it being performed to understand how training in the weight room affects the underlying physiology, biomechanics, or psychology of the individual? Or is it to determine how one’s physiology, biomechanics, or psychology affects lifting or sport performance? While these two scenarios are certainly related, they are not identical, and they can have a large impact on the assessment program. Both are important, but one focuses on exercise science, and the other focuses on performance/sport science.

An important consideration is to determine the end goal of the testing. Is the purpose of the testing program to help monitor training progression and contributions to performance? Or is it to better understand the underlying physiology and mechanics of the human body? Both are good and noble directions of study, but both can have distinctly different approaches to testing. For example, a sport scientist studies athletes in order to provide useful information to the coach and athlete in order to enhance athletic performance. On the other hand, a laboratory researcher may study highly trained and uniquely gifted athletes to better understand the physiology of how the human body responds and adapts at the extremes of human training and performance. While both are worthwhile endeavors, this chapter will focus on assessments designed to focus on high-level performances such as those encountered by athletes and related professions.

To begin, consider the six steps of evidence-based practice as described by Amonette, English, and Kraemer (2016). Before any assessment system is designed and implemented, they suggest the following process:

1. Determine the question that needs to be answered.
2. Collect the data and do the testing.
3. Evaluate the results.
4. Apply the results, or put the evidence into practice.

5. Confirm whether the results were as expected.
6. Reevaluate the process.

By following a carefully planned and implemented testing program in the weight room, the results should provide valuable data that the coach and athlete can effectively use.

A cursory look at figure 10.1 shows how many variables may be important to monitor. An obvious area of focus is sport performance, either actual competition data, or variables related to the sport (e.g., size, strength, power, speed). A related area involves the health of the athlete. An unhealthy athlete is unable to optimally perform and is at an increased risk of injury. Health is also important for those training for other purposes, such as general fitness or occupational purposes. An often-overlooked aspect of training is enjoyment, which is a component of sport and exercise psychology. Even though there may be other outcomes that appear to be a greater priority, it has been clearly shown that when training participants enjoy the training and the process of physical preparation, they work harder, they better comply with the training, and they give greater and more consistent effort.

Who Is the Tester?

At one time, it was thought that only a sport scientist in the laboratory performed the types of assessments discussed in this chapter. With the advancements in technology and statistical capabilities,

Who Is On Board?

The simple answer to this question is that the coach and athlete **MUST** be on board. This is more likely when the coach (and possibly the athlete) is part of the planning process in creating a testing program. If either the coach or athlete are not convinced of the importance of the testing, it is highly unlikely that the results will be valid.

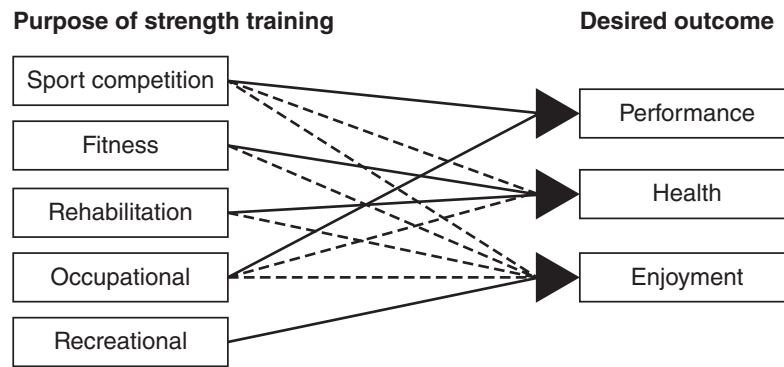

FIGURE 10.1 Summary of the various purposes for strength training and the desired outcomes. Solid lines indicate suggested primary outcomes, and dotted lines indicate secondary outcomes. Both are important because different training scenarios may emphasize different outcomes.

and increased knowledge in the general field of kinesiology, advanced methods of testing can now be realistically performed by many. The following is a nonexhaustive list of professions often involved with training and sport assessment:

- Sport or exercise scientist
- Strength and conditioning professional
- Sport coach
- Medical personnel (athletic trainer, physiotherapist, medical doctor)
- Personal trainer
- Sport data analyst
- Sport testing technician

Not all professions fill the same roles. There are various individuals who administer tests and collect data, closely examine and analyze existing data, perform testing as part of the training and conditioning program, or monitor the health and fitness status of the individual. In addition, trained professionals are needed to correctly interpret the results, and to relay this information to the coach, strength and condi-

tioning professional, and athlete who need to know how the results will impact the training program.

What Is Monitored?

It is important to remember that the results of any testing must be relevant to the purpose of the training. One must avoid a “shotgun” approach, in which many tests are performed just for the sake of testing. This can result in a lot of wasted time and effort. The testing protocol should be efficient and completely relevant to the training purposes and goals. A term sometimes used is **fear of missing out**, in which tests are included just in case the results might be helpful. But the quality of testing is more important than the quantity of testing. The tests should also include measures that provide actionable, or useful, results. Assessment programs for investigative purposes are perfect for the laboratory, but care must be taken to avoid what some call “fishing expeditions” in which a large amount of data are collected in case something shows up. Figure 10.2 illustrates several important areas of assessment this chapter will address.

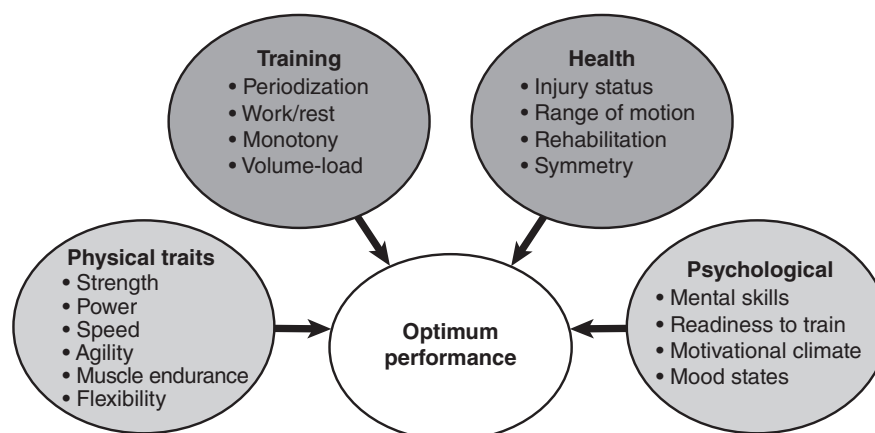

FIGURE 10.2 Common areas of assessment.

This chapter will focus on assessing physical traits and the accompanying training programs critical to success in the weight room. Additionally, measures of health and psychological variables can also greatly contribute to success, but for detailed information on these assessment areas, please see the bibliography.

Practical Considerations Related to Assessment

Many factors contribute to successful assessment programs for the weight room. The following are a few to consider.

Logistics

A well-planned testing protocol is essential for valid results. Factors such as time availability, environmental conditions, number of tests to be performed, equipment needs and availability, and time of day are just a few of the considerations.

Technology

New testing technology is being developed at a rapid pace in recent years. In many cases, this technology improves the speed and accuracy of testing and the ability to manage large amounts of data. Some technology may be cost prohibitive, and so simpler testing protocols may be necessary. It is also important to ask, “Do the needs of the athlete determine the testing, or does the available technology determine the testing?” In other words, make sure the tests include the variables that are most important to the purposes of the training.

Test Familiarization

All individuals being tested should have the ability to practice the tests to ensure results are valid. In other words, a poor performance should not occur

because the athlete isn’t familiar with the test. This also applies to those administering the tests; they must know correct testing techniques to ensure validity.

Short- and Long-Term Monitoring

The purpose of the testing will help to determine the types of tests to be included. For example, short-term monitoring might include tests that help to determine that day’s training program, such as with autoregulated progressive resistance exercise. These tests must be sensitive to the small daily fluctuations that can occur. Other tests may involve monitoring training responses that occur over longer periods of time, such as periodized mesocycles, or macrocycles such as shown in figure 10.3. These tests need to be capable of detecting adaptations that occur over longer periods.

Order of Testing

When multiple tests are performed during the same session, care must be taken to ensure fatigue from one test doesn’t interfere with subsequent tests. Tests that may be fatiguing must be performed toward the end of the session. For example, nonfatiguing tests, such as body weight, height, body composition tests, and psychological or training surveys, should be performed early in the testing order. Tests of speed and short-term power such as sprint and vertical jump tests might be performed next. Tests of maximal strength, such as 1RM tests, would follow since the earlier tests will not interfere with this type of strength testing. Within 1RM tests, measures of lifts that generate high power, such as weightlifting movements, must be performed before slower lifts with slower velocities, such as squats or presses. Finally, tests that are very fatiguing must be performed last. This might include muscular endurance tests, or similar anaerobic endurance tests. Regardless of

Problems Studying Current Athletes

Many times, athletes are studied because of their athletic accomplishments and high levels of training status. Several factors must be carefully considered before testing these populations:

- These individuals may have very strict time constraints that interfere with extensive testing.
- The testing itself may interfere with the training process and competition schedules.
- Certain tests may require undesirable recovery needs.
- There may be concern over who has access to the collected data.

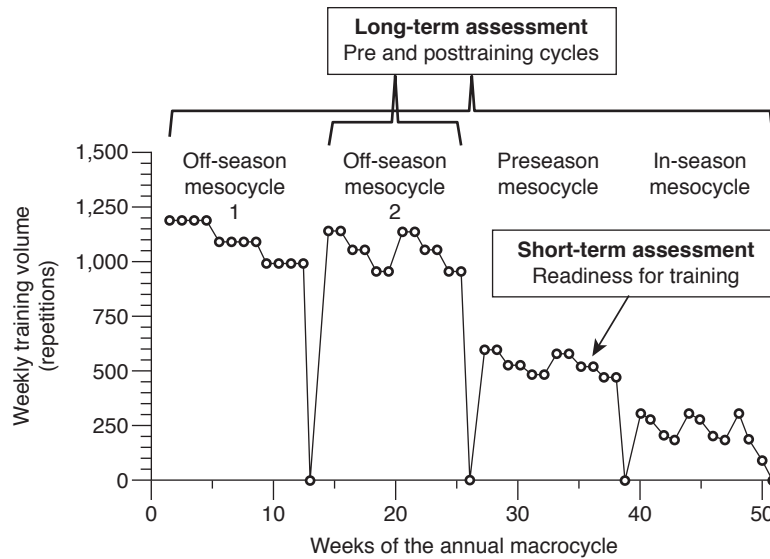

FIGURE 10.3 Assessments often focus on only certain areas of the training macrocycle. This figure illustrates how both long-term and short-term training goals can be addressed with a well-designed assessment program.

Adapted by permission from H. Hasegawa, J. Dziados, R.U. Newton, et al., "Periodized Training Programmes for Athletes," in *Handbook of Sports Medicine and Science: Strength Training for Sport*, edited by W.J. Kraemer and K. Häkkinen (London: Blackwell Scientific, 2001), 111. © 2002 by Blackwell Science Ltd.

which specific tests are performed, none of the tests should fatigue the athlete to the extent that subsequent tests produce submaximal results. If test order does not follow these guidelines, poor performances are not due to the athlete's capabilities, but are due to poor planning by the coach or trainer. Needless to say, testing sessions must be carefully planned. Tests can be spread out over several days or sessions to avoid test fatigue, and the number of tests can be reduced to make the process feasible and valid.

Communication

Poor communication may be one of the biggest problems when a sport scientist works with coaches and athletes. Testing results must be made available to those who need the data, and this must be done in a timely manner. Too often the data are collected but not effectively transmitted to those who need the results.

What Is an Important Result?

The coach and strength and conditioning professional must be able to recognize a meaningful testing result for the population studied and the test being performed. Is a 1-kg increase in 1RM strength important? For some individuals, this is the result of a disappointing training program. For others, it means a new world record has been set. Recognizing meaningful data are related to effective goal setting, which should be part of every training program.

Collaboration

Those who work in the world of strength training know that the most effective programs often require input from numerous contributors. Certainly, the strength and conditioning professional and athlete are involved, but so is the sport-specific coach, athletic trainer or physiotherapist, psychologist, dietician,

Problems When Using Nonathletes as Research Subjects

It is not unusual that access to competing athletes for scientific study is limited, and sometimes related research is performed with nonathletes. While the results may be of interest and help understand training methods and performance capabilities, they are not necessarily applicable to high-level athletes. Characteristics of the population studied, such as training status and performance capabilities, must be carefully examined to determine the relevance of the results.

and the medical doctor. When collaboration, cooperation, and respect occur between all these individuals, the opportunities for optimal performance are enhanced. It is equally important that these individuals also understand their role based on their area of expertise.

Who Is Being Tested?

Tests must be used that are appropriate for the age, sex, and training experience of those being evaluated. Just because new technology and tests are available does not mean they are the most appropriate or are necessary for some populations. For example, assessing the progress of a beginner in the weight room may simply involve one or two 1RM strength tests, and perhaps body weight. At the other extreme, someone training to compete at the Olympic Games will certainly want to have the most precise and appropriate tests to permit them to perform with the best in the world. An individual's training history and current training status can certainly influence the types of tests performed, but they can also greatly impact the expected results (see figures 1.1 and 1.2). It is well known that an untrained person just beginning a structured strength training program can achieve large improvements in the initial stages of training. At the other end of the spectrum, a world-class athlete is pleased with very small improvements, since the potential for adaptations decreases as the athlete gets closer to his or her full potential. Figure 10.4 is one example of how the expected gains can differ depending on the prior training experiences.

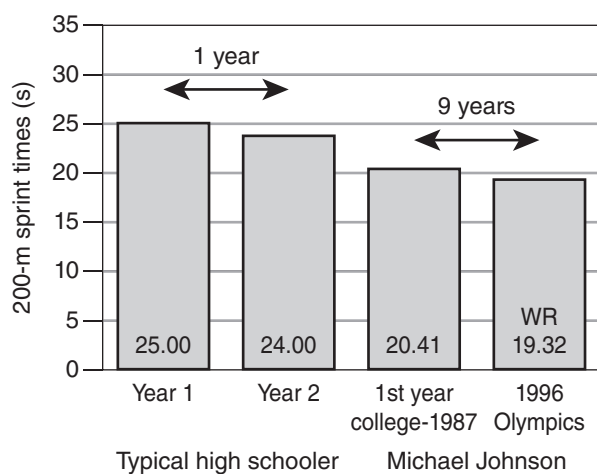

FIGURE 10.4 The training status and performance level of those being tested can greatly influence the expected results. It took Michael Johnson, world champion sprinter, 9 years of intensive training to improve his 200-m time by a little over 1 s. A novice sprinter might reasonably make this much improvement in just 1 year.

Monitoring Tests

Among the challenges when trying to monitor progress in the weight room is deciding what types of tests to perform, and which specific tests provide the most useful information. The following section presents some possible tests that have been shown to be useful or have been suggested for monitoring programs. This list is not all-inclusive, but instead gives readers a helpful starting point for developing their own assessment programs. Note that there is considerable overlap between several of these categories due to the nature of the tests and the characteristics being analyzed.

Muscular Strength Data

This category of tests includes many that have been used for a long time, as well as newer variations.

One Repetition Maximum (1RM)

Maximal strength is commonly determined by measuring the most weight that can be lifted on training-specific exercises. Proper lifting technique is essential, because when exercise technique is altered, the results are also likely to be different. An example of this is the barbell squat that can be performed to different depths. This simple difference will provide different results.

Isometric Tests

Force production can be measured when movement of the resistance is not allowed, meaning the primary muscles are neither shortening nor lengthening. Single-joint or multijoint exercises can be measured in this manner. Load cells or force plates are required to determine the actual muscular force developed. Proper and consistent positioning of the body is critical to obtain reliable data.

Isometric Midhigh Pull (IMTP)

Perhaps the most popular isometric test currently in the weight room is the IMTP test. Although proper positioning of the lifter is absolutely critical, this test can be very reliable. Maximum force, as well as several types of rates of force development can be assessed.

Isokinetic Tests

Isokinetic dynamometers that can control the velocity of movement must be used to assess velocity-specific strength. Although most isokinetic testing is performed using single-joint exercises, isokinetic devices are also available for multijoint activities

(e.g., squats). Although it has been argued that isokinetic tests have little external validity due to the artificial conditions of the test, they can still provide valuable information concerning muscle strength capabilities. It should be appreciated that these devices are not able to assess force at high velocities such as encountered in many sporting activities.

Testing Devices

Strength can be assessed with either free weights or machines, but these different modalities will produce different results.

Multijoints Versus Single Joints

The choice of exercise will depend on the purpose of the test. Total-body exercises provide valuable information concerning all the body's muscles and joints working in synergy. Single-joint tests can provide helpful information on a single muscle or muscle group.

Type of Muscle Actions

Force can be determined when muscles are static (isometric), dynamic (moving), or ballistic (very high rates of movement). Additionally, muscles can be lengthening (eccentric) or shortening (concentric) while producing force. Each of these conditions will produce different levels of force.

Mean or Peak Force?

New technologies permit the measure of mean force or peak force over the entire exercise or movement. Both can be valuable measures depending on what is being tested. In many cases, these values will be highly related to each other, but the peak values are often considerably higher and cannot be directly compared with mean values.

Strength at Relative Loads

Strength performance at different relative intensities (% 1RM or % of body weight) can be determined. Tests of these types permit measures of mean and

peak forces across a **loading spectrum** (i.e., loads from 0%-100% 1RM).

Explosive Strength Deficit

This measure was described in detail in chapter 2. This type of test determines the time-deficit zone, and the force attained in this time-limited period is compared to absolute maximum force.

Reactive Strength Index

Although numerous variations of this test have been devised, the original test examines the ratio of ground contact time to vertical jump height for a depth jump. Drop heights are increased until the maximal jump height is determined, from which the **reactive strength index** is determined. High levels of eccentric force capacity are required for high values on this test.

Impulse

This biomechanical variable is the product of force \times time. Some advocate the use of time under tension as a critical variable to monitor for resistance exercise, but focusing only on time ignores the critical factor of load. Impulse includes force in this assessment.

Mechanical Work

Another way to quantify training in the weight room is to determine the total work performed. **Work** is defined as the mean force during the exercise multiplied by the distance the mass is moved (i.e., force \times distance) and is reported in joules. Again, this is somewhat similar to volume-load, except more precise. Contributing factors include the range of motion of the exercise, the acceleration of the exercise, and the mass of the resistance. Since distance is a factor, isometric exercise produces no mechanical work. Although the calories required for weight training is often overlooked, it should be noted that the work performed during strength training is associated with the caloric cost during

Realities of "Field Testing"

In many ways, assessments performed in the laboratory are useful due to the ability to control so many confounding variables. However, much of the external validity can be lost when testing away from the actual training site. So, if testing is to be performed in the training room or the competition site, the inability to control all facets of the surrounding environment or the test conditions must be willingly accepted. The results of the testing must also be interpreted within the context of the conditions of the "field" site.

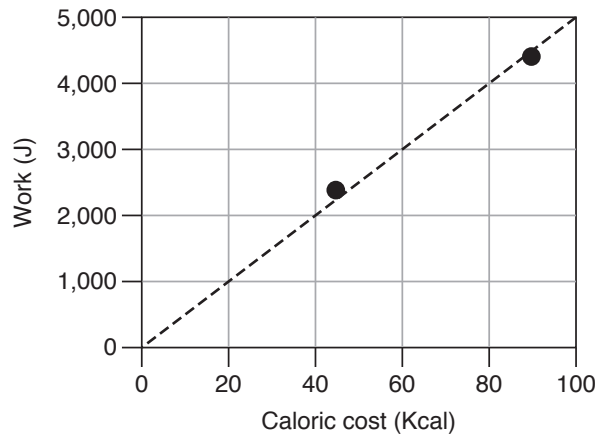

FIGURE 10.5 The metabolic cost of resistance exercise is related to the mechanical work performed.

Data from A.C. Fry, E. Landes, and C.A. Moore, "The Metabolic Cost of Resistance Exercise: A Case Study of a Competitive Powerlifter," *KAHPERD Journal* 91, no. 1 (2019), <https://www.smores.com/s7yuc-kahperd-journal-2019>.

the training session and the subsequent recovery period (figure 10.5).

Lifting Velocity Data

Assessing lifting velocity helps analyze the characteristics of different types of resistance exercise, and permits velocity-based resistance training.

Peak or Mean Velocity

As with force measures, velocity can be determined for either the average value over the entire exercise or movement, or the highest velocity. While both values are often highly correlated, each may provide useful information. The sampling rate (Hz) of the testing devices must be high enough to ensure valid peak measures.

Velocity–Load Spectrum

Mean or peak velocity can be determined for exercises across the loading spectrum. The resulting velocity–load relationship is negative, with increasing loads resulting in decreasing velocities. While this is well known to anyone who resistance trains

regularly, what is not always appreciated is that the slope of the velocity–load line, and the intercepts with the velocity and the load axes, can change in response to resistance training. Additionally, different individuals and different exercises can have unique relationships. Velocity–load curves are discussed in detail in chapter 7.

Velocity-Based Training

An alternative method for prescribing resistance training loads is based on the lifting velocity associated with the relative load (% 1RM). This relationship is discussed in chapter 7. Routine measures of lifting velocity provide a valid measure to determine if absolute loads are appropriate for the purpose of the training and the sets and repetitions prescribed.

Lifting Power Data

Once force and velocity are measured, power can easily be derived. Since enhanced muscular power is often a training goal, the ability to validly test and monitor training power is a valuable tool in the weight room.

Power–Load Spectrum

Mean or peak power can be determined for lifts across the loading spectrum. The resulting power–load curve is an inverted “U” as described in chapter 7. As previously discussed, numerous factors contribute to the shape and magnitude of this curve (e.g., range of motion, barbell or system, center of mass, dynamic or ballistic actions). The resulting curve can be used to identify resistance training loads associated with maximal power for the tested exercise.

Power Fatigue

The Wingate Anaerobic Test is a highly validated test for anaerobic endurance and power. A resistance training version for anaerobic power and power endurance is the Kansas Squat Test that involves 15 repetitions of the barbell back squat with a load based on body mass and squat strength levels.

Time Constraints

One of the most critical considerations when developing an assessment program is time availability. In many cases, limited time is available, so only the highest prioritized and meaningful assessments can be included. Too often, an excessive amount of time is spent testing, which means less time for training.

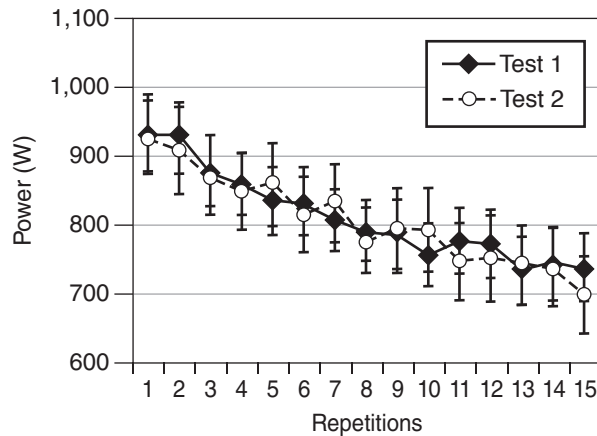

FIGURE 10.6 The repeatability of lifting power for the Kansas Squat Test. Peak and mean power as well as percent fatigue can be determined from this test.

Data from P.E. Luebbers and A.C. Fry, "The Kansas Squat Test: A Valid and Practical Measure of Anaerobic Power for Track and Field Power Athletes," *Journal of Strength and Conditioning Research* 29, no. 10 (2015): 2716-2722.

This test is highly reliable (see figure 10.6) and was designed to be easily performed in the weight room using one of the popular barbell accelerometers or position transducers that are readily available. Peak power, mean power, and percent fatigue can be determined for an activity specific to the weight room.

Force or Velocity, Which Is It?

It is often asked whether force or velocity is more important to power. Some may feel that velocity is less trainable, so perhaps force (strength) should be the focus in the weight room. Others have suggested that strength only accounts for 25% of sprinting speed, and have extrapolated this to mean that enhancing strength is less important for high-velocity events such as sprinting. What we know is that when power is determined across a wide range of loads, force and velocity *both* significantly contribute to the resulting power at all loads (see figure 7.1 on page 126). Thus, muscular strength (force) is always important.

Power Density

With the advent of technology in the weight room that can monitor lifting power, coaches are now interested in power qualities during a training session. Average power for all repetitions of all exercises during a single session can be used to determine power density when the duration of the

session is included. In some ways, this is analogous to the commonly used **volume-load** measure (i.e., repetitions \times load), but it also factors in the power produced.

Rate of Force Development Data

Increased muscular strength is certainly a goal for many weight training programs. But as clearly discussed in chapters 2 and 7, how rapidly force can be produced may be just as important, if not more. The rate of force development (RFD) can be determined for both static and dynamic exercises. Accurate assessments require high sampling rates (e.g., 500-1,000 Hz) to ensure validity. Even with adequate sampling rates, repeatability of these measures can be problematic. Slight differences in time (e.g., 10-20 ms) and force produced (e.g., 50-100 N) can result in large differences in the RFD. Regardless, when correctly performed, RFD measures can be very reliable and valid measures of how rapidly force can be produced. RFD is often determined for single-joint exercises, but recent years have witnessed the increased popularity of a relatively simple multijoint, total body RFD measure: the isometric midhigh pull test.

Isometric Midhigh Pull (IMTP)

This test was designed to mimic the point of greatest force production during the second pull of a barbell clean. The lifter is secured by lifting straps to a static barbell at the midhigh position while standing on a force plate. In this position, the torso is near vertical while the hips and knees are slightly flexed. The testing position must be constant for all subsequent tests for reliable results. Slight deviations from this position can produce reliable results but are not likely to produce maximal force. On a signal, the lifter pulls rapidly and maximally on the bar for 3 to 5 s. The ground reaction force is then analyzed for maximal force as well as various RFDs.

The RFD of Interest

The RFD of interest can range from the total force-time curve from start to maximum, the instantaneous peak RFD between two successive sampling points, or various windows of time (e.g., 0-20 ms, 0-50 ms, 50-100 ms, 100-200 ms). Some believe that increases in the early portions of the curve represent improved ability to recruit high-threshold motor units, while changes in the later portions of the curve represent the ability to recruit more motor units. Indeed, untrained individuals appear to have more difficulty attaining high RFD at the end of

the pull. The test can also use the S-gradient and A-gradient described in chapter 2, as well as the explosive strength deficit.

RFD With Concentric and Eccentric Actions

RFD can be determined for both concentric and eccentric actions. Whereas concentric RFD is related to the ability to move quickly and accelerate, eccentric RFD is associated with braking forces, or the ability to change directions. High eccentric RFDs contribute to short amortization phases. For example, strong performances on the reactive strength index described previously is dependent on high rates of eccentric RFD.

Are These Tests Related to Sport Performance?

It is generally accepted that progress in the weight room can contribute to enhanced sport performance. Needless to say, this relationship is not perfect, but there is a considerable amount of data supporting the performance benefits for athletes. The ability to transfer training results from the weight room to the athletic field was presented in chapter 1 and can be quantified with the coefficient of the transfer of training. On a regular basis, coaches and strength and conditioning professionals should use this tool to evaluate the effectiveness of their training programs. It is interesting to note that some individuals believe the role of a strength program is solely to decrease the risk of injury to athletes, or that gains in weight room performance have little to do with athletic performance. However, this has already been refuted in chapter 9, where there are many examples of the transference of training effects for sports such as American football (see figure 10.7), weightlifting, baseball, basketball, and softball, to name a few.

Training Data

Besides physical performance in the weight room, the actual training program needs to be routinely evaluated. The following are several aspects to assess.

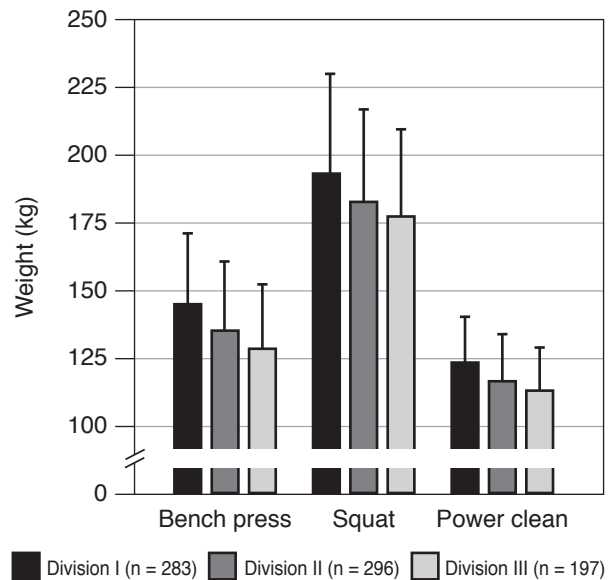

FIGURE 10.7 Greater performance in the weight room is associated with sport skill and levels of competition. Although there is considerable overlap for these American football players from NCAA Divisions I, II, and III, there are significant differences for these basic strength assessments.

Adapted by permission from A.C. Fry and W.J. Kraemer, "Physical Performance Characteristics of American Collegiate Football Players," *Journal of Applied Sport Science Research* 5, no. 3 (1991): 126-138.

Periodization

The effectiveness of the various phases of training, regardless of the training model prescribed, should be routinely evaluated to determine subsequent training prescriptions. To do this, the training plan is divided into logical phases, typically mesocycles, although longer or shorter periods can also be assessed. Since not all periodization phases necessarily produce gains for all variables of interest, the testing results must be put in the context of the training phase being monitored. For example, perhaps a high training-volume mesocycle is being performed where maximal strength is not expected to be optimized. However, maximal strength may

Are Practical Applications Readily Apparent?

One classification used in the research world categorizes scientific studies into basic or applied research. While there is an absolute need for basic research, this chapter is focused on applied research that can be readily interpreted for use by the coach, strength and conditioning professional, or athlete. When the assessment program is designed, does it permit data collection that can have a direct influence on how training is actually performed?

still be tested to determine how well this performance variable responded despite not being a primary focus of that mesocycle. It may also be helpful to test more frequently during certain times of the macrocycle, such as during a competition phase, as long as it does not interfere with training and performance. Consistent and planned testing is required to better understand the effectiveness of the training program.

Acute:Chronic Workload Ratio (ACWR)

This ratio uses a measure of the training load (e.g., volume-load in the weight room), and how much the recent workload (e.g., past week) compares to previous periods of training. Much attention has been paid to this ratio in an attempt to determine whether the strength training program is excessive during certain phases. Considering there can be a lot of training that occurs outside the weight room, this can also be an attempt to quantify the total training stress. While there are no exact values that are necessarily problematic, concern arises when this ratio shows large increases. In other words, the volume or intensity (or both) of training has increased to an unaccustomed level. While stressful phases of training are a characteristic of many effective programs, at times, the accumulated stress can be more than the individual or group can tolerate. The ACWR can be a potentially valuable tool that the coach uses to routinely monitor the total training program. It should be noted, however, that there is not a large amount of data to support the effectiveness of this ratio. If valid, this monitoring tool is likely most effective when the ratio is measured within the context of the training scenario and when it is performed over extended periods of time.

Recovery

An occasionally overlooked concern is whether the athlete has adequately recovered from prior training or competitions, or past injury or illness. If training recovery is the issue, weight room performance tests may be most appropriate, whereas if injury or illness is the concern, health-related variables may be of most concern. It is not wise to resume normal training loads if recovery is not complete. If recovery time is a result of planned cycles of high-volume or high-intensity training, then the rate of recovery will determine how rapidly the next phase of training can be implemented. Or perhaps the training program can be adjusted to include a recovery phase as part of the planned training program.

Training Monotony

Boredom in training can often result when the same training program is used repeatedly without thought to planned variation. Training monotony has been suggested as a contributing factor to overtraining and is likely a contributor to low training compliance and retention. This can be readily resolved with a periodized strength training program designed specifically for the purpose of the training and the population being trained. But can training monotony be quantified? One method, adopted from endurance athletes, quantifies the athletes' training sessions by multiplying average heart rate during a training session by the duration of the session. For the weight room, volume and intensity can be estimated from the daily volume-load, or perhaps work (force \times distance) performed. This value is recorded daily, and the mean and standard deviation (SD) of these values for a phase of training are calculated. The SD is then divided by the mean, and expressed as a percentage called the coefficient of variation. The greater this value, the greater the variation in the training. As with the ACWR, there are not specific values for this measure of monotony that are necessarily good or bad. Rather, the coach should track the pattern over time to see if training variation changes or should be improved. This measure also emphasizes the importance of recovery days and cycles.

Autoregulation

A popular method to train in the weight room is called *autoregulated progressive resistance exercise (APRE)*. This training is sometimes used when training activities outside the weight room and outside the control of the weight room coach can interfere with the strength training program. At the beginning of each weight training session, a simple and nonfatiguing, but sensitive and reliable task of some type is performed to determine the individual's readiness to train. This assessment should not interfere with the subsequent training and can be incorporated into the warm-up for the training. Tests can be as simple as a finger-tap test on a keyboard, a vertical jump test (preferably on a force plate or with an accelerometer), or barbell velocity or power at submaximal loads. When performance on this pretraining test is greater or lower than previous recent sessions, the training load and intensity are adjusted accordingly. The goal with this type of training is to prescribe weight room training as close as possible to the training capacity and tolerance of the individual on any specific day.

The challenge is to identify the appropriate test. When properly implemented, APRE training can accommodate for stresses outside the weight room.

Subjective Training Load Assessments

An alternative method to the APRE performance tests is measures of the subjective perceptions of the person being trained. This typically involves completing a short questionnaire or survey prior to the training session. Honest answers are certainly critical to the validity of these tests, but when the questionnaires are well-constructed, administered, and interpreted, these subjective self-assessments can be very helpful.

Physiological Parameters

Although the measures in this section are not exhaustive or specific to the weight room, the variables included may provide valuable information about the underlying contributing factors to optimum performance or unexplained underperformance. Although not all of the variables listed below have been clearly validated for athlete monitoring, they are still worthy of consideration.

Endocrine Markers

Hormonal responses to a single training session or in response to a long-term strength training

phase have been studied for decades. Many hormones will respond acutely to a training session, and basal concentrations can also be affected by the training (see figure 10.8). Although many different hormones have been studied in response to strength training, hormones commonly used for monitoring training and performance in the weight room include testosterone (and free or unbound testosterone), cortisol, and the 22-kD isoform of growth hormone. Table 10.1 describes hormones, neurohormones, immune, inflammatory and metabolic markers, and other biomarkers that have been suggested for monitoring training status. It should be noted that many of these variables have not been shown to be valid or consistent indicators of training stress or recovery.

Blood, Saliva, or Urine Hormone samples are typically measured in the blood, but saliva or urine can also be used, although there is a time delay for these biocompartments, and the sensitivity of saliva and urine measures is less.

Time of Day The timing of sample collection is extremely critical since some hormone concentrations follow diurnal rhythms based on the time of day. For example, resting levels of testosterone and cortisol are elevated early in the day, which can interfere with proper interpretation of the results.

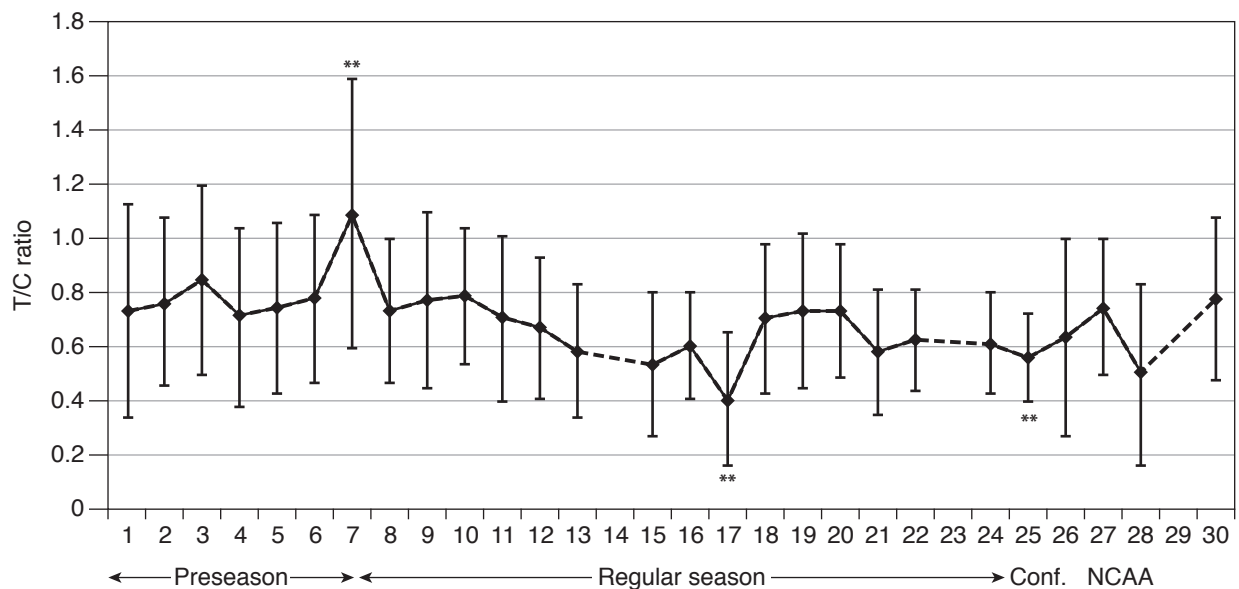

FIGURE 10.8 Weekly assessment of salivary biomarkers (testosterone/cortisol ratio) for a high-level collegiate basketball team. Corresponding patterns were evident when compared with the training and competition schedules.

Reprinted from M.J. Andre, A.C. Fry, P.E. Luebbbers, et al., "Weekly Salivary Biomarkers Across a Season for Elite Men Collegiate Basketball Players," *International Journal of Exercise Science* 11, no. 6 (2018): 439-451, <https://digitalcommons.wku.edu/ijes/vol11/iss6/8>, by permission of the authors, licensed by <https://creativecommons.org/licenses/by-nd/4.0/legalcode>.

TABLE 10.1 Common Hormones and Related Biomarkers That Have Been Suggested for Strength Training and Performance Monitoring

Hormone or biomarker	Comment
HORMONES	
Testosterone	↓ with ↑ training stress
Cortisol	↑ with ↑ training stress
Testosterone/cortisol ratio	Inversely related to training volume
Growth hormone	May ↓ with ↑ training stress
Dehydroepiandrosterone (DHEA)	May ↓ with ↑ training stress
Insulin-like growth factor-1 (IGF-1)	May ↓ with ↑ training stress
Sex hormone-binding globulin (SHBG)	Related to % free (unbound) testosterone
Luteinizing hormone (LH)	Pulsatile hormone; single time points not relevant
NEUROHORMONES	
Epinephrine	↑ resting and postexercise with ↑ training stress
Norepinephrine	↑ postexercise with ↑ training stress
IMMUNE AND INFLAMMATORY	
Interleukins - IL-1 β , IL-1 α , IL-6, IL-8, IL-10, IL-15	↑ have been associated with training stress
TNF- α	Proinflammatory
sTNF- α RII	Soluble receptor for TNF- α , counters actions of TNF- α
METABOLIC MARKERS	
Lactate/work	Indicates altered exercise-induced metabolism
Macronutrient markers	Numerous variables
Micronutrient markers	Numerous variables
OTHER BIOMARKERS	
Creatine kinase	Excessive ↑ indicates muscle damage
Urea nitrogen	May ↑ with ↑ training stress
Tryptophan	May ↑ with ↑ training stress
Glutamine	May ↓ with ↑ training stress
Glutamine/glutamate	May ↓ with ↑ training stress
Myoglobin	May ↑ with ↑ training stress
Blood urea nitrogen (BUN)	May ↑ with ↑ training stress

Many of these variables have not been validated for monitoring purposes.

Sex For some hormones, men and women have different concentrations. Additionally, the female menstrual cycle can affect some hormones, making interpretation of results difficult.

Immune and Inflammatory Markers

Numerous indicators of inflammatory responses have been examined. In some cases, these variables indicate the presence or absence of illness

or disease, and in other situations they indicate the physiological responses to training and tissue remodeling.

Other Biomarkers

Levels of muscle disruption or damage are indicated by several of these markers, while amino acid imbalances or metabolism related to training stresses are indicated by others.

Neuromuscular Markers

The ability of the nervous system to recruit motor units in an orderly and optimal manner can be altered by the strength training program. For example, electromyographic (EMG) magnitude may increase or decrease based on the ability to recruit high-threshold motor units. Some have measured changes in the rate of EMG development at the beginning of a muscle action to observe the ability of the nervous system to initiate motor unit recruitment. For years, the ratio of EMG activity to force production (EMG/force ratio) has been used as an indicator of efficiency of electrical activity and has been shown to fluctuate in response to the strength training program. Recently, EMG decomposition techniques have been developed to noninvasively measure recruitment of multiple individual motor units, which holds much promise for further understanding of neuromuscular responses to strength training.

Heart Rate Variability

The catecholamines listed in table 10.1 (epinephrine and norepinephrine) provide insight on sympathetic activity, both at rest and in response to strength training. Several other indicators related to the sympathetic nervous system have also been used to understand and monitor strength training. The receptors for epinephrine in skeletal muscle (β_2 -adrenergic receptors) are downregulated with stressful strength training but are not practical to assess outside the laboratory. However, **heart rate variability (HRV)** is a noninvasive method to determine the relative contributions of the sympathetic and parasympathetic nervous systems. Used for decades by cardiologists to determine autonomic nervous system activity, HRV is an effective tool to monitor training responses and recovery. Simply, HRV can be determined by the variability of the R-R interval of the heart rhythm, in other words, the interval between heartbeats. A simpler measure

is resting heart rate, but this measure appears to be more responsive to high strength training volumes rather than intensities.

Metabolic Markers

Many different metabolic markers have been suggested for athlete-monitoring test panels. In general, these variables will provide general insight as to the health and functioning of the athlete, which in turn can help the coach or strength and conditioning professional make informed decisions. Of particular interest is the acute lactate response to an exercise stimulus. Changes in this ratio indicate changes in metabolic efficiency during strength training.

Health and Injury Parameters

If athletes are not healthy, they are not able to train appropriately or perform optimally. Considerable effort must be made to decrease the risk of future injuries and illnesses, and to monitor recovery from either of these.

- *Injury status and rehabilitation.* If baseline testing has been performed, a recovering athlete can be tested to see if they are ready to return to normal training.
- *Range of motion.* Flexibility is often overlooked but can contribute to improper movement patterns or inefficient exercise technique.
- *Symmetry.* Muscular strength imbalances between agonist–antagonist muscles and muscle groups, or bilateral asymmetries, can result from prior injuries, chronic overuse patterns, inappropriate training or usage patterns, and postural abnormalities.
- *Motor control.* Healthy movement patterns and the ability to control the body through fundamental motions is an important component of physical fitness. Numerous motor capacity tests are available to monitor these skills.

Turnaround Time for Feedback

Too often, when testing is performed in the weight room, the results are not available for weeks or months. It is critical to get the testing results to the coach in a timely manner so that appropriate program or training adjustments can be made while the data are relevant. Ideally, data are available immediately, or within a few days, for the results to have maximum impact. On the other hand, long-term retrospective analyses (e.g., results of the past year of training) may be less dependent on rapid turnaround times.

- *Balance and stability.* Similar to motor control measures, the ability to control balance is also a contributing factor to general physical fitness.
- *Risk of injury.* All of the previously listed types of tests provide supporting evidence of the risk of injury. Even though it is difficult to establish direct associations between many of these tests and injury occurrence, these assessments, combined with many of the other tests described in this chapter, can create a profile used by the coach or strength and conditioning professional to adjust the strength training when appropriate.

Psychological Parameters

A comprehensive assessment program needs to account for psychological factors. The following is a brief introduction to this type of testing, and the interested reader is referred to the bibliography for more detailed information.

Mental Skills

Any coach or athlete understands the importance of physical training for optimum performance. Also important is the development of mental skills that contribute to enhanced performance. Just like physical training, mental skills also require consistent and organized training. And just as an assessment program for physical traits is helpful, so too are routine assessments for mental skill development.

Readiness to Train

Many weight training programs are autoregulated, meaning the daily training is based on the individual's physical and emotional readiness to train that day. Besides physical performance tests, subjective measures of self-perceptions of training readiness, when validly collected, can provide simple and valuable information for the strength training program.

Perceptions of Motivational Climate

It has been clearly shown that when the coach or strength and conditioning professional creates a climate that focuses on effort and improvement (i.e., task-involving) as opposed to focusing purely on who is best or top performer (i.e., ego-involving), athletes enjoy the training more, try harder, and comply more with the training. These findings are based on achievement goal theory and the concept of creating a caring climate. The Perceived Motivational Climate in Sport Questionnaire (PMCSQ)

and the Caring Climate Scale (CCS) are available to determine the type of climate coaches are creating in the training room, and how the athletes perceive the climate.

Profile of Mood States (POMS)

There is a large amount of research on mood states and how they relate to the training program. Although not originally developed to monitor athletes and training, the POMS has successfully tracked changes in mood states that are due to fluctuations in the training program. However, this survey is fairly long and is difficult to administer on a regular basis.

Recovery-Stress Questionnaire for Athletes (RESTQ)

The RESTQ is a valid survey instrument designed specifically to track an athlete's ability to recover from stressful training. Like the POMS, this test is fairly long and is difficult to administer on a daily or frequent basis.

Analyzing and Reporting Results

Collecting relevant and important data in the weight room is only part of the challenge. What comes next is making sense of the data. This often means applying some basic statistical concepts to the results you collect. There are many excellent texts that go into great detail on statistical methods, and you can check some of the options in the bibliography for this chapter. However, let's briefly examine some of these tools.

Group or Individual Data

When collecting performance-related data in the weight room, it is important to consider whether group (or team) data are most important, or whether individual results are of most interest. Perhaps both are important. For example, many times it is desirable to analyze how an entire group of individuals, such as a team, responds to a training method. This can provide the coach or strength and conditioning professional valuable information as to the effectiveness of the training methods and the status of the group as a whole. On the other hand, not all individuals respond in a similar manner. Thus, individual data must also be closely evaluated (see figure 10.9). The first of the following statistical tools focus primarily on group data, while individual data are discussed at the end.

Should the Testing Be “Preregistered”?

In an attempt to minimize questionable research study designs and statistical analyses, some have advocated “preregistering” research studies. This means that once the study design and statistical analysis is determined, the study design and statistical approach are available for all to peruse and should not deviate from the plan. Only the original research question and test variables should be examined. Unfortunately, many potentially relevant findings might not be apparent because some have been discovered by accident; thus many sport scientists could miss valuable information. This, however, is not an excuse for sloppy testing and research. The purpose of the testing should always be considered.

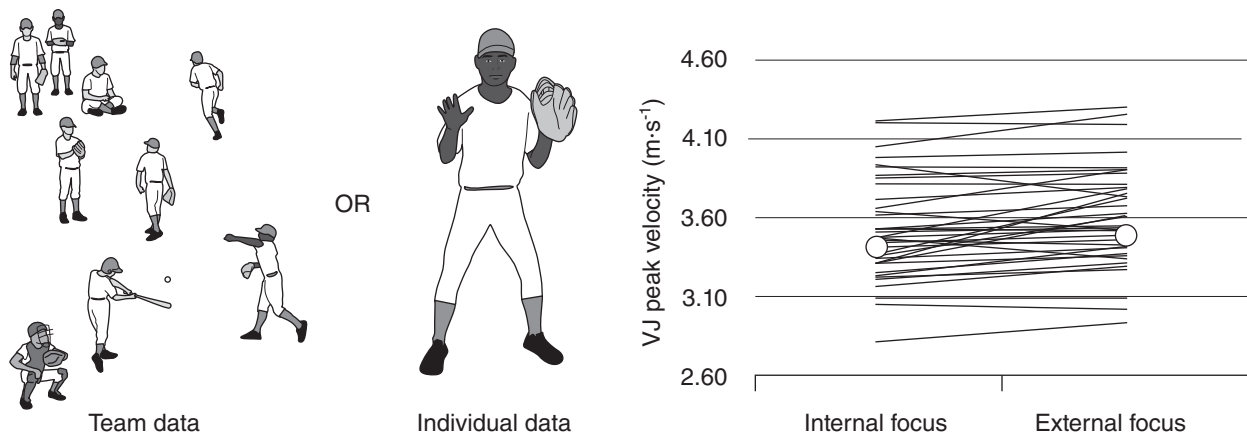

FIGURE 10.9 Data for an entire group or team can provide helpful information for general patterns, but individualized data allows the training program to be more specific. The data on the right show that the mean vertical jump velocity for a team increased (open circles) when coaching cues with an external focus were used. However, the individual responses (lines) indicate not all athletes responded in this manner.

Reprinted by permission from A.L. Kershner, A.C. Fry, and D. Cabarkapa, “The Effect of Internal vs. External Focus of Attention Instructions on Countermovement Jump Variables in NCAA Division I Student-Athletes,” *Journal of Strength and Conditioning Research* 33, no. 6 (2019):1467-1473.

Parametric Statistics

This category of statistical analysis includes methods that are typically taught and used for data sets that are normally distributed. This means the data are distributed in a manner similar to a bell-shaped curve as identified by **skewness** (symmetry of the distribution) and **kurtosis** (shape of the distribution) scores. These methods include *t*-tests, analyses of variance, some types of correlations and regressions, among numerous others. A basic understanding of these methods is essential for those analyzing data related to weight room activity, as well as activities outside the weight room (e.g., sport-specific training, occupational activities, rehabilitation, and other types of exercise for general fitness). An important thing to remember about parametric statistics is that the results provide information as to the likelihood of the results (indicated by the α

level), not necessarily on the size of the effect. That is, how likely are the results to be repeatable? The level of significance indicates this likelihood. For example, significance at $\alpha = 0.05$ indicates there is a 95% likelihood that the results are repeatable, or a 5% chance that they are not repeatable. Although an α of 0.05 is often the default value, it may be important to carefully examine if this cutoff value is too stringent for the purposes of the testing. The coach or athlete may be satisfied with a 90% level of confidence, or even lower. Another consideration is that the level of statistical significance depends greatly on the size of the data set.

Nonparametric Statistics

It is not unusual that data collected in the weight room are not normally distributed. When this is the case, parametric statistics can contribute to

error when analyzing and interpreting the data. In these cases, nonparametric statistics are often used. Examples of data that are not normally distributed include the following:

- Use of ordinal scales (e.g., scores are listed in order of magnitude)
- Use of interval categories (e.g., scores are grouped)
- One or more assumptions of parametric statistics is violated (e.g., nonnormality of the data)
- Small sample sizes
- Values other than the mean value are of interest (e.g., median scores)

One problem with nonparametric statistics is that the results are not as statistically powerful as with parametric statistics. Even so, it is not unusual that data collected in the weight room and related venues may not be normally distributed, and nonparametric tests are appropriate. Examples of these types of tests include the chi-squared test (for examining data distributions or categories), the Wilcoxon signed-rank test (for comparisons to a reference or target value), the Mann-Whitney test (for comparing two independent groups), the Kruskal-Wallis or the Friedman tests (for comparing groups), and Spearman's rank correlation coefficient (for examining categorical relationships), among others.

Bayesian Statistics

An emerging statistical approach is based on Bayes' theorem. This has led to use of Bayesian statistics, which provides a different statistical interpretation, that of probability, or a degree of belief in a result, based in part on prior knowledge. Rather than purely using the "frequentist" approach that is part of parametric statistics and is simply based on numerical data, Bayesian statistics provides several levels or classifications of belief that a result or event

occurred. For example, the likelihood that a result or event occurred may be classified as very likely, somewhat likely, undetermined, somewhat unlikely, or very unlikely. It is believed by some that these types of categories provide more useful information for the practitioner to effectively interpret. With the advent of advanced computer technologies, this complex statistical tool is becoming more popular.

Magnitude-Based Inferences

This interesting, and controversial, statistical method was developed specifically for sport and exercise analysis purposes, although it can certainly be applied to other settings. A concern often arises when analyzing sport-related data that standard statistical tools are too conservative. It is possible that results and measures have considerable importance in the world of sports, but are not significant from a statistical perspective. When this happens, potentially important training methods or tools may be incorrectly dismissed. For example, it is well known that increases in a competitive lift of 2.5 kg can be the difference between winning a competition or being a runner-up. Or on the track, differences in 100-m sprint times of 0.1 s may be the difference between winning or not even medaling. However, these performance differences may be far from statistically significant when using more conventional statistical methods. To help remedy this conundrum, some suggest using statistical tools that are based on a predetermined magnitude of performance change that is meaningful. From a practical perspective, this makes perfect sense. One of the essential challenges is how to determine what is a meaningful difference. Some scientists are leery of this statistical method since it is not always clear how this meaningful difference is determined. On the other hand, practitioners in the training rooms and fields may find this type of analysis very helpful. Careful examination of this method, and all statistical methods, is warranted to ensure the collected data are interpreted appropriately.

Do These Data Need to Be Published?

Academic researchers are often concerned with the ability to publish the results of any testing they perform. However, there may be times when a coach or athlete may not want data disseminated in this manner. Or sometimes the conditions and limitations of the testing preclude publishing the results. While publishing test and research results is extremely helpful to the sport science profession, it may not always occur. These types of analyses may simply be for internal use by the coach, strength and conditioning professional, and athlete.

Effect Size

As previously mentioned, most of the statistical tools discussed thus far are concerned with the probability or likelihood of a result. At times, the size of the result is of greater importance. Calculation of an effect size is one simple method to quantify this. Originally developed by Cohen, this statistical tool is based solely on how large an effect is and is aptly called the effect size. In its simplest form, it is the mean change in performance divided by the standard deviation of the original scores. However, there are many variations of how this is specifically calculated. It must be remembered that a large effect size can be present without statistical significance, and vice versa. As such, these types of results must be carefully interpreted.

Case Studies

Many times, when working with athletes or other individuals, results for a single person must be evaluated. An analysis with only one subject (i.e., $n = 1$) is called a **case study** and it can be a very useful tool for the coach or strength and conditioning professional. Indeed, case studies are an important component of medical research. To analyze these types of data, nonparametric tests are often employed. Although the statistical power of these analyses is limited, this is often the only way the results for a specific individual can be interpreted. When data are plotted across time, it is possible to determine trends or patterns in the data using the nonparametric Mann–Kendall trend test, or its variations.

Nonstatistical Examination

This is not actually a statistical method; however, it is an approach sometimes used in the coaching world. Data are simply visually examined for patterns and changes. Sometimes this is jokingly called

the “TLAR” method, which stands for “that looks about right.” The knowledgeable coach or strength and conditioning professional, however, can recognize patterns that may be of importance. The effectiveness of this approach is not to be underestimated. However, caution is also advised. Coaches and strength and conditioning professionals, like everyone else, bring their own biases and perspectives to this approach, which can contaminate and interfere with the appropriate interpretation of the results.

Reporting Results to Your Audience

This aspect of the process is often overlooked. When working directly with coaches, strength and conditioning professionals, and athletes, testing results must be made available as rapidly as possible. Test reports that take a long time to get to the intended user may be too late. For example, assessments of the effectiveness of a particular training mesocycle must be made available before the next training phase begins, otherwise, the data may no longer be useful. Additionally, the information should be provided in an easy-to-understand format. In many cases, figures and tables can provide the bulk of the report with a brief description of methods and analysis. Extensive reviews of literature and in-depth discussions are typically not necessary for internal reports. The end result is providing the test results to the person who needs it as rapidly as possible.

Summary

An effective and efficient assessment system for the weight room is a valuable tool to ensure the most appropriate training program is being prescribed. Careful consideration of the factors discussed in this chapter can help ensure the coach and athlete optimizes their training.

Too Long of a Report; KISS

Providing a report of the testing results for all parties involved is paramount to completing the testing process. If testing results are not provided, the results cannot be put to full use. However, the coach and athlete need the data presented in a simple and straightforward manner. The report can be considered an “executive summary” where the raw and analyzed data, the key points, and interpretations are presented in an accurate and concise manner. The acronym KISS stands for “keep it simple, stupid.” More detail can be provided later if needed.

GOAL-SPECIFIC STRENGTH TRAINING

Resistance training in its many forms is a modality that can be used to help develop the human body to meet a wide variety of training goals from increased strength to improved brain cognition with aging. Each year research shows the importance of this modality to be a fundamental and necessary part of any aspect of a sport training program or for general improvement of health and wellness. Over the past half century, the use of this modality for athletes has gained almost complete acceptance in every sport.

Many times, however, this enthusiasm has led to a mind-set of “more is better” and subsequent abuse by some strength and conditioning coaches not schooled in the exercise science and medical aspects related to workout and program design. A current crisis exists with sport coaches wanting “work hardening” or to “beat up” the athlete in the weight room and with conditioning activities, with little worry about the dangers of not using scientifically developed programs to build athletes’ bodies. Such practices have led to unprecedented numbers of injuries and deaths in high school and collegiate athletes related to heat stroke, sickle cell, and rhabdomyolysis effects, and, at best, they have led to undue physical abuse and unnecessary muscular damage with such workouts (Casa et al., 2012, 2013). This has also resulted in a greater prevalence of nonfunctional overreaching or overtraining syndromes being developed by athletes. It is important to pay close attention to rest and recovery during and after a workout because it is



an essential part of optimal training (see chapter 9). Setting realistic training goals for different cycles or phases of a program is vital to provide the focus needed for the step-by-step development of the human body. In this chapter we examine the concept of setting goals and how such goals can be accomplished with different strength training concepts in program design.

Developing a Profile of Target Goals

Developing a set of target goals for each individual or athlete is a starting point in designing a particular phase of training. Programs may be designed for improvements of various factors or for maintenance of others. Thus, program design can be multifaceted depending upon the goals for that individual in that training phase. Most individuals and athletes have multiple target goals that must be addressed for eventual success. However, when developing a program it is unrealistic to try to meet all of the goals at once. Thus, each training phase must have priorities. Each particular phase must be directed to impact a specific targeted goal of a program. Therefore, from the start, it is important to have an idea of what these target end point goals are for each training phase.

Some target goals will take longer to achieve than others, and once achieved, may simply be maintained with attention now refocused on other target training goals in the next phase of the program. The status of each training target goal is determined by its importance in achieving performance and health outcomes in the sport performance or fitness program. Thus, an individual must determine target goals to achieve desired success. One way to do this is to develop a set of targeted analytics to accomplish in the training program. This can take the form of target profile goals for a training phase, with the ultimate targeted goals as end points for maintenance. In some sports, athletes are always trying to increase the end point goal and essentially become limited by their genetic ceiling for change.

Focus of Target Goals

Strength training programs are typically part of a larger conditioning program that includes many different aspects of development (e.g., endurance, agility, balance, flexibility). While many of these elements can be addressed in a strength training program, some have their own specific conditioning programs (e.g., agility). Thus the target goals for a strength training program need to be specific to what a modality can accomplish, and knowledge of each element of a program is vital for successful program design and development, with compatibility of programs carefully noted (e.g., endurance training needs being in concert with strength and power).

To begin, one goes back to a basic program design approach and does a needs analysis of the sport or

health pathology for preventive medicine being targeted. While strength and power are almost always a part of every strength training program, one needs to see the full array of what is needed and the absolute level to achieve in order to be successful in a sport or health outcome. An example of targeted goals for a sport can be seen in table 11.1.

As one can see in table 11.1 a host of different targets have been established for an elite male wrestler, and a strength and conditioning program must monitor this information as well, to optimize the wrestler's skill sets in the sport. Some characteristics are trainable and others are not (e.g., arm span to height). If one is unable to meet a physical target goal, deficiencies will exist. In our example, this may impact the wrestler's success in certain matchups with an opponent. The more deficiencies, the less chance of success against a wider array of wrestling opponents if one relies only on wrestling skill sets. Thus, in wrestling, for example, there can be technique style clashes with an opponent that puts one wrestler at a disadvantage to beat the opponent. Another example could be mismatch in physical attributes (e.g., strength, power) that gives one wrestler the advantage over the other. Thus, wrestling styles and physical attributes are all groups of strategies that allow a wrestler to win. However, as competition is elevated to higher and higher levels, the champion must bring to the matches a host of strategies that cannot be beaten; thus, only a small number of elite wrestlers have these strategies available to beat the rest of the contenders. This leads to the obvious idea that not all athletes can be a champion in a particular sport unless they can bring a set of "strategies" to deal with the various demands of the competition. Thus, it is always a matchup of the metrics one sees in sport competitions. This goes for any sport or any set of health outcomes in preventive medicine. At the right side of table 11.1 are the profile variables, some of which are not trainable and thus some aspects for every sport have to be there inherently. Many other variables (e.g., blood buffering capacity, cognitive processing) can also be added because many things contribute to a wrestler's success. Therefore, the biomarkers for any sport can be extensive as we learn more about each sport or pathology we are trying to address. The next step is to determine the starting point, what to develop in a strength training program, and the athlete's phase of training (e.g., beginner, youth, advanced, experienced with strength training, master's level).

TABLE 11.1 Example Physical Profile of an Elite Wrestler in Men's Collegiate and World Competition

Variable	Level of demand	Trainable variable
Squat	1.9-2 × body mass	Yes
SINGLE-HAND GRIP STRENGTH		
Strength range:	35-45+ kg	Yes
Difference between hands:	<5%-7%	Yes
Bench press	1.5-1.6 × body mass	Yes
Isometric midhigh pull (peak force)	6,000-7,500 newtons	Yes
Treadmill $\dot{V}O_{2,max}$	50-60 ml · kg ⁻¹ · min ⁻¹	Yes
Cycle $\dot{V}O_{2,peak}$	42-50 ml · kg ⁻¹ · min ⁻¹	Yes
WINGATE LEG CYCLE TEST		
Peak power (30 s):	900-1,000 W	Yes
W per kg of body mass:	14-16 W	Yes
Mean leg power:	475-615 W	Yes
Mean W per kg of body mass:	6-8 W/kg	Yes
WINGATE ARM CYCLE TEST		
W per kg of body mass	Light weights: 7.75-8.6 W/kg Middle weights: 8-9.5 W/kg Heavier weights: 8-9.5 W/kg	Yes Yes Yes
Peak power (30 s)	Light weights: 630-730 W Middle weights: 780-935 W Heavier weights: 900-1,015 W	Yes Yes Yes
RESPONSE TO VISUAL LIGHT SIGNAL IN A WRESTLING STAND-UP DRILL		
Reaction time:	<0.1 s	Yes
Movement time:	<0.4 s	Yes
RESPONSE TO WHISTLE SOUND SIGNAL IN A WRESTLING STAND-UP DRILL		
Reaction time:	<0.08 s	Yes
Movement time:	<0.4 s	Yes
PHYSICAL		
Arm span to height	12+ in. (31+ cm) greater than height	No
Body mesomorphy score	Higher mesomorphic	Partially

Therefore, the profile's information on the targets that define end points for sport, or information on an athlete's physical traits are partially related to creating the target goals for a strength training program. Here again, one needs to carefully determine the targets to be addressed in the program and the athlete's phase of training from beginner to advanced levels. Inherent to this process is the need for athlete testing that reflects the source data used in creating the profile. One needs to use evidence-based practices to search for the different biomarkers that define an athlete and a sport. Or if examining patient populations, targets need to

be defined and addressed to enhance health and reduce risks.

Evidence-Based Practice

To address any questions that may arise in the development of a strength training program, the use of a six-step evidence-based process can be helpful. It can act as a type of compass by using the best possible method to find and evaluate existing knowledge on a topic. It is best practiced by a team of professionals to gain perspectives on multiple levels. This process is explained in detail by Amonette and colleagues (2016). The following is a brief summary of the

six-step process that allows for a better “decision-making process,” which is ongoing and dynamic in nature.

1. Developing the Question

One type of question may be general in nature, such as “What do we know about sleep and performance?” This type of question sets the stage for more specific ones that might arise later after getting a general feel for sleep biology. Such a question has a multitude of knowledge sources from government recommendations to books on the topic. A more specific type of question might then be asked, such as “If we do our strength and conditioning workouts at 6 a.m. with the track team, how will our amount of sleep affect the workout quality?” A basic general understanding is needed before moving on to a specific question. Conversely, simply gaining a general understanding of a topic to become aware of potential issues or problems that may exist may be desired.

2. Searching for Evidence

Based on what you have already read in this chapter, this can be a daunting task on multiple levels. You can gain insight from colleagues and experts in the field, look at relevant textbooks to gain general information and review some of the published references they cite, or use search engines (e.g., PubMed, Sport Discus, Google Scholar) to find published peer-reviewed studies. Using a general key word such as “sleep” can result in thousands of papers on the topic indicating the need to use more specific key terms.

3. Evaluating the Evidence

Once you have done the searches and gained insight from textbooks and experts, you must start to evaluate it. A team of professionals working together is optimal for this process as context and limitations may be seen differently by different professionals. You can rank the evidence based on its relevance to the question you are trying to address. This evidence is then used to create a best practices choice to answer the question and act on it at this point in time.

4. Incorporating the Evidence

As one famous strength coach, Jerry Martin at the University of Connecticut, said, “We now know the science but how do we implement it?” As the next step in the process, how do you incorporate the evidence into practice with your client, patient, or athlete who have widely ranging abilities? For example, how do

you use heavy days in your workout plan to emphasize strength development? Or how do you reduce precompetition anxiety and fear in wrestlers?

5. Confirming the Evidence

The evidence must now be evaluated for veracity before you can incorporate it into your work. Certain medical fields have used ranking procedures to address how closely the evidence is related to the question or topic (e.g., I, II, III or A, B, C). Does the evidence have the proper context for age, sex, and training level? Are the tests valid? Are the insights from an expert coach, for example, relevant to your level of athletes? You now must evaluate the information you will be basing your decisions on.

6. Reevaluating the Evidence

Finally, things change or new evidence emerges, and the results on a particular topic from 10 years ago or even 6 months ago may now be in question with new findings or new understanding on a topic. Therefore, you have to be vigilant about the process and the methods you are using based on best practices and technological and scientific progress. Does the idea of being “a student for life” come to mind?

Testing and Monitoring Progress

As previously noted, testing determines if progress is being made toward the target goal of the strength training program. Over the past 10 years, testing and evaluation of players has become part of the training process, player development, and player selection in pro drafts. While vital to the process it must be manageable, valid, and reliable or it is of little value. The tests must reflect, in our example, how the data were generated to profile the elite wrestler (e.g., use of a Vertec to determine counter-movement power potential versus a force plate). If the profile target goal was found in your evidence-based study of wrestlers’ power in the literature, and if they used a Vertec, you cannot use a force plate or jump pad for testing because it is not the source method. For those who say “I do not want my athletes to train for the test,” this is a bygone-era statement that belies the world of sport analytics we live in. Furthermore, the tests should be directly related to the sport or health profile and be part of the metrics for success. The key is to carefully choose the right test battery for the training cycle (partial metric) and in total for the sport analytics (total metric), be able to administer it, and then manage it by targeting it in the strength training program if

it is trainable. In part, with the proliferation of computerized training set ups in power racks containing data for a host of different variables (e.g., velocity, reps, resistance, sets, power, form) there is more information than ever that can be obtained, but at the very least, accurate training logs are needed to chart progress and make decisions.

To evaluate progress, one can use a type of spider or radar plot to show the athlete's progress in relation to the short-term cycle and long-term sport analytic targeted training goals. Figure 11.1 demonstrates this concept and allows for one to quickly see progress in the pretraining and post-training phases. The main target goals should be related to the training phase's desired adaptations, despite the fact that some goals may exist over many training phases (e.g., 1RM strength) until maintenance becomes the primary goal. Keep in mind that each individual will have a genetic ceiling, in which

changes in training response will be small or will not change at all. This is especially true for an elite athlete continually working to improve (e.g., Olympic weightlifter trying to increase a competitive lift) or an individual with little training potential for the desired target (e.g., an ectomorphic somatotype trying to gain large hypertrophy in a limb with low number of muscle fibers). The “art of the profession” is needed for decisions such as how much time and effort to put forth in a program to gain a specific target goal, and determining whether or not that target goal can ever be realized.

Strength Performance

From fitness enthusiasts to elite athletes, training for strength is often related not only to strength development in a lift, but also to the other physiological benefits that accompany improvement in

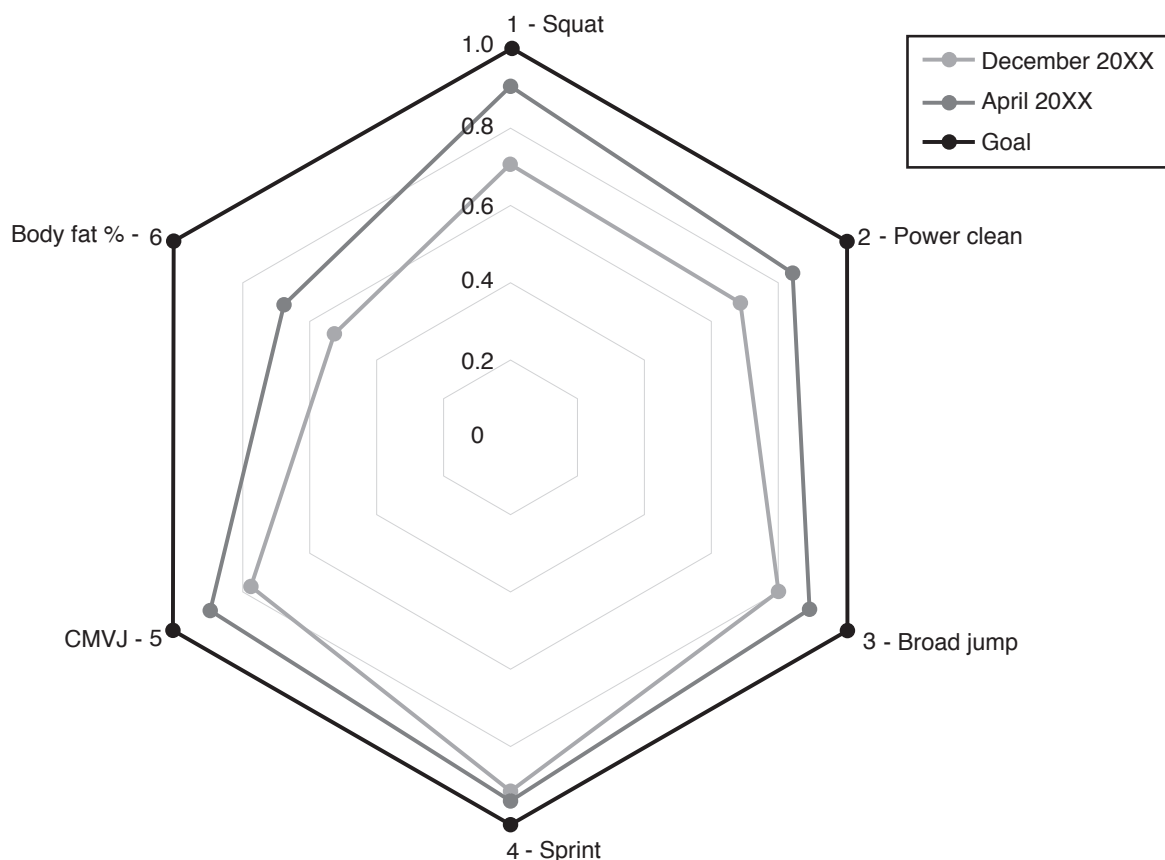

FIGURE 11.1 Example of using spider/radar graphs to show an athlete's status on different metrics related to the goals for a training cycle at different times. Other graphs can show an athlete's proximity to the metrics needed for different levels of competition. Long-term goals for the different metrics were: squat $2 \times$ body mass, countermovement vertical jump (CMVJ) 82 cm, power clean $1.9 \times$ body mass, broad jump 3.05 m, 36.57-m sprint 4.8 s, percent body fat 15%. In our example you can see that with testing in December (light gray line) the starting point indicated that body fat was the major component not optimized for the athlete, which may have affected a currently decent sprint time. After 4 months of training, all metrics except for speed made gains suggesting again that body fat may still inhibit the optimal speed of the athlete. Thus, nutritional aspects along with continued work on core squat strength need to be addressed.

strength, which include improvements in connective tissue density and higher-functioning endocrine glands that can tolerate stress and better aid in the recovery process. Experienced strength and power athletes also train the underlying muscular and neural factors to improve neuromuscular coordination (motor unit recruitment, rate coding, synchronization, the entire coordination pattern), even if maximal force improvement is their primary objective. This loading becomes an important variable in program design, and as with any program variation, training across the resistance load continuum is vital for gaining specific benefits and providing adequate rest and recovery from workouts. By varying the type of exercise (i.e., intensity and training load), one can induce positive adaptation in the desired direction. Conversely, standard exercises and a constant load elicit only premature accommodation and can result in suboptimal end points in training or what many call **staleness**.

All three facets of heavy resistance training—exercise type, training method (maximal versus submaximal efforts), and training volume—should be changed in a systematic way to make desired progress in a particular training phase. Because the superposition of training effects among different heavy resistance methods is not negative, in principle, these methods may be combined in a single microcycle or even in a single training day and session. For instance, it is possible to lift a 1RM barbell and then use the method of submaximal effort in the same workout. However, the proper timing of exercises, methods, and loads over time brings better results. In the typical timing pattern, an exercise complex is changed once every two mesocycles. For instance, only two or three snatch-related exercises of nine total are used during two consecutive mesocycles. The snatch-related exercises are classified according to the type of motion and the initial barbell position. The types of motion are (1) competition snatch (barbell is lifted and fixed in a deep squat position), (2) power snatch (barbell is caught overhead with only slight leg flexion), and (3) snatch pull (barbell is only pulled to the height

and not fixed). There are three initial barbell positions: (1) from the floor, (2) from blocks positioned above the floor, and (3) from the hang. Thus, there are nine total combinations.

In this typical pattern of timing, the dominant methods are changed every mesocycle, with the routine during the first mesocycle directed primarily at inducing muscle hypertrophy (mainly by the methods of submaximal and repeated efforts). The training load is varied, usually according to the empirical 60% rule.

Power Performance

In many sports, strength exercises are performed with the main objective to improve power, or the velocity of movement, against a given resistance (body weight, implement mass) rather than maximal strength itself. In such situations, maximal strength is regarded as a prerequisite for high movement speed. However, the transmutation of acquired strength gains into velocity gains is not easy. It has also become evident in training athletes that maximal strength in the squat is an important prerequisite for optimal power training (e.g., $2 \times$ body mass for men and $1.75 \times$ body mass for women). For elite athletes especially, this appears to add to the rapidity and magnitude of power gains. Two other issues of primary importance are the proper selection of strength exercises and training timing.

The requirements for exercise specificity should be thoroughly satisfied. The exercise of first choice should be the main sport exercise with additional resistance, or speed-resisted training (note that we are discussing the training of qualified athletes, not novices)—see chapter 6. This resistance should be applied in the proper direction (in locomotion, horizontally) and not exceed a level at which the motion pattern (the sport technique) is substantially altered.

Before a training period, it is advisable to test athletes in the main sport exercises with additional resistance (as well as with decreased resistance, if possible) to determine at least part of the resistance (force)–velocity curve for each trainee (figure 11.2).

Training Goal: Maximal Strength

Combine high-intensity training (to improve neuromuscular coordination) with the repeated effort method or submaximal effort method, or combine all three, to stimulate muscle hypertrophy. Utilize heavy-enough loads within different training cycles to stimulate maximal force development adaptations. Change the exercise batteries regularly. Vary the training load.

For instance, shot-putters can be tested with both a standard implement (7,257 g) and with shots of 8- and 9-kg weights. Using the data on outstanding athletes as norms and comparing these data with individual testing results, a coach can recommend the appropriate training protocol for the given period—whether the athlete should pay primary attention to training with heavy or light implements.

When selecting strength exercises for power training, the coach and athlete should be attentive to all the facets of exercise specificity described in chapter 6 (working muscles, type of resistance, time and rate of force development, velocity of movement, direction of movement, and the force–posture relationship). Working muscles should be the same as those in the main sport exercise, and the type of resistance should mimic the main sport exercise as much as possible. This is especially true during the peaking cycle; after previous fundamental training cycles addressed the basic strength phases of development, technique practice in the sport becomes the focus. Still, fundamental movements that address the whole-body structural integrity and kinetic chain stability at the core of any program should not be abandoned (e.g., squats, power cleans, deadlifts, bench press, seated rows) for more specialized lifting movements related to the sport actions.

If the time available for force development in a sport exercise is short (less than 0.3 s), the rate of force development, rather than maximal strength itself, is a deciding factor. Comparing maximum force production with the maximum attainable

force in the fast movement has proven to be a useful tool for planning training programs. If the explosive strength deficit (i.e., the difference between maximum strength and the force values generated during a sport movement at takeoff, delivery phase, and so on) is too high (more than about 50% of F_{max}), heavy resistance training directed toward the enhancement of maximum strength is not efficient in trying to impact power. The time of force development is too long to impact that part of the force–time curve making maximum strength gain of little value toward increasing the velocity (power) of the motion. Because of the short duration of effort, a training cycle must be created to focus on the rate of force development (RFD) rather than maximum strength as the primary training objective.

Maximal concentric efforts, such as the lifting of maximal loads, can enhance the RFD in some athletes if fundamental strength is not present from prior training. However, because such motor tasks require maximal force rather than maximal RFD, this method may not bring positive results in power for highly trained athletes.

To enhance RFD, exercises with maximally fast bursts of muscle action against high loads are used. Since the load is high, movement velocity may be relatively low, but the RFD must be extreme: The bursts of muscle action should be performed as fast as possible with maximum voluntary effort. These exercises are done in a rested state, usually immediately after a warm-up. The typical routine consists of 3 sets with 3 repetitions against a load of

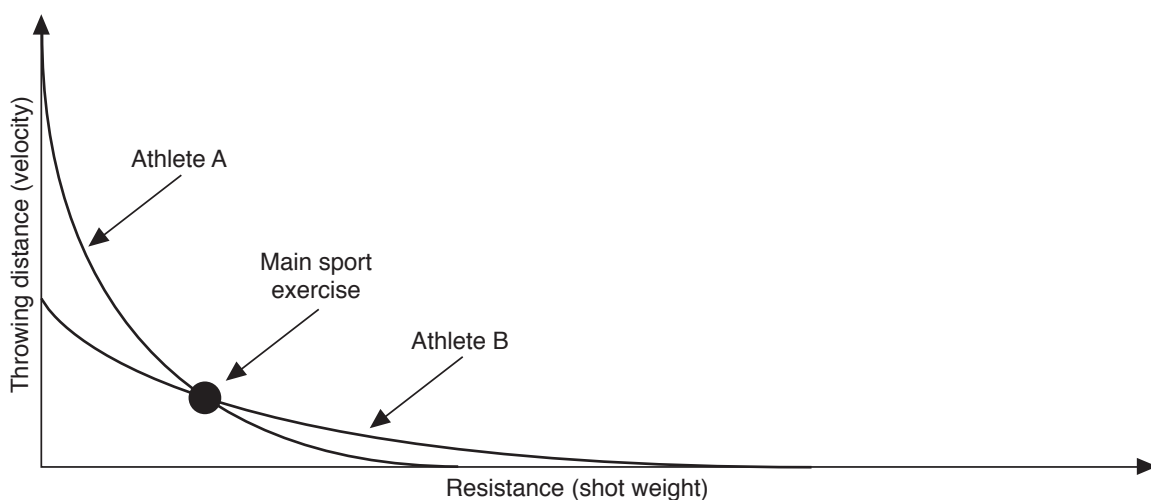

FIGURE 11.2 Testing results for two athletes having the same sport performance in puts of the standard shots. The athletes' achievements in throwing heavy implements are different. Since athlete A has lower results with heavy implements than athlete B, it is possible to conclude that his strength potential may be greatly improved by exercising with heavy implements. Athlete B must pay more attention to other training directions (e.g., polishing sport technique or putting light implements).

about 90% of maximum. Rest intervals between sets should be long (about 5 min). Other muscle groups that do not contribute to fatigue and limit maximal efforts in the lifts can be exercised during the rest intervals. When the training objective is to improve RFD, these exercises are commonly performed four times per week, and to retain the RFD, twice a week. Because of accommodation, after 6 to 8 wk of such training the exercises should be changed.

The rate of force development can also be improved during the training of reversible muscle action (see discussion of the stretch–shortening cycle later in this chapter).

Movement velocity is the next important feature of strength exercises used to enhance power. The typical objective in this case is to increase the velocity of a performed movement against a given resistance. In a force–velocity diagram, this appears as a shift of the corresponding force–velocity value from point $F-V_1$ to point $F-V_2$ (figure 11.3*a*). However, it is impossible to change the position of any one point on the force–velocity curve (i.e., the movement velocity with the given resistance) without altering the position of the entire curve (i.e., the velocity with different resistances). Four variations on changing the force–velocity values are possible.

In the first variation (figure 11.3*b*), the positive velocity gain appears over the entire range of the force–velocity curve. If this were a force–velocity curve for a throwing task (in which the mass of the implement was changed and the throwing distance was measured), the force–velocity curve change indicates that after training, the athlete could throw farther using both heavy and light implements. This variation is typical for young athletes and is rarely seen with experienced ones. Training with exercises executed in a high-resistance, low-velocity range favors a gain in movement velocity with high resistance (figure 11.3*c*), and performance results with heavy implements are mainly improved. This is the most typical way to improve athletic performance. The third variation, training with a low-resistance, high-velocity demand, brings forth improvement in the low-resistance zone (figure 11.3*d*). This is a useful but auxiliary training strategy to be alternated with high-resistance training (during or immediately before a tapering period).

Finally, training in the intermediate range of resistance (e.g., with a main implement only) leads to a straightening of the force–velocity curve (figure 11.3*e*). Here performance results improve in the median span of the curve. This is an outcome of

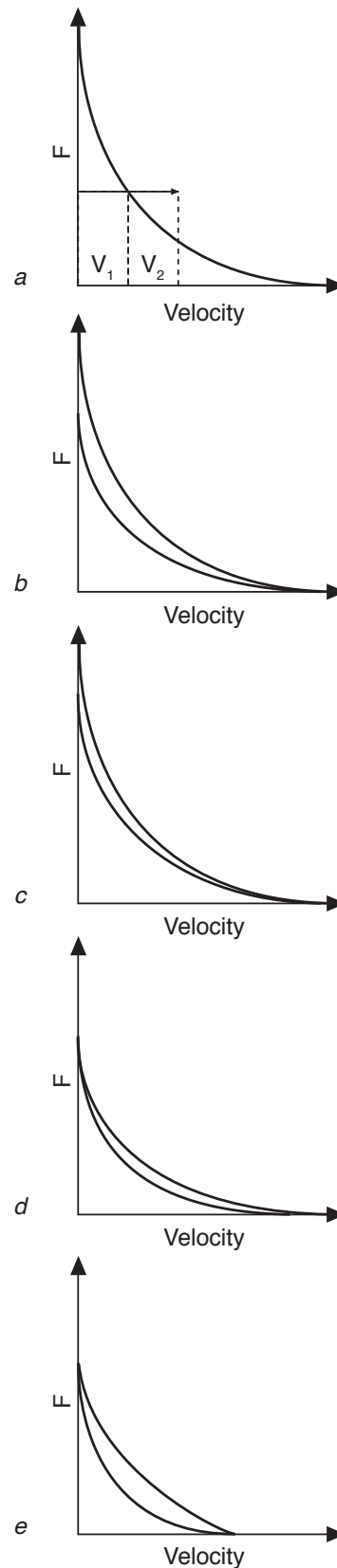

FIGURE 11.3 Changes of force–velocity curves resulting from training.

specific training with constant implements. With this pattern of force-velocity gain, the performance is only briefly improved (usually for no more than one season), and the magnitude of gain is relatively small. The force-velocity curve can become straight but it cannot become convex. To substantially improve performance at a given resistance, achievements in the high-resistance or low-resistance zones must also be enhanced. This situation is rather controversial. On the one hand, training results depend on exercise velocity, and in order to improve the

velocity with standard resistance, an athlete must exercise in the same force-velocity range as in the main sport exercise. This specific training elicits the force-velocity curve change shown in figure 11.3e, but this change represents only a short-term effect. On the other hand, a substantial performance improvement requires less-specific exercises in the high-resistance, low-velocity domain as well as in the low-resistance, high-velocity domain. These considerations are confirmed by the training practice of elite athletes (figure 11.4).

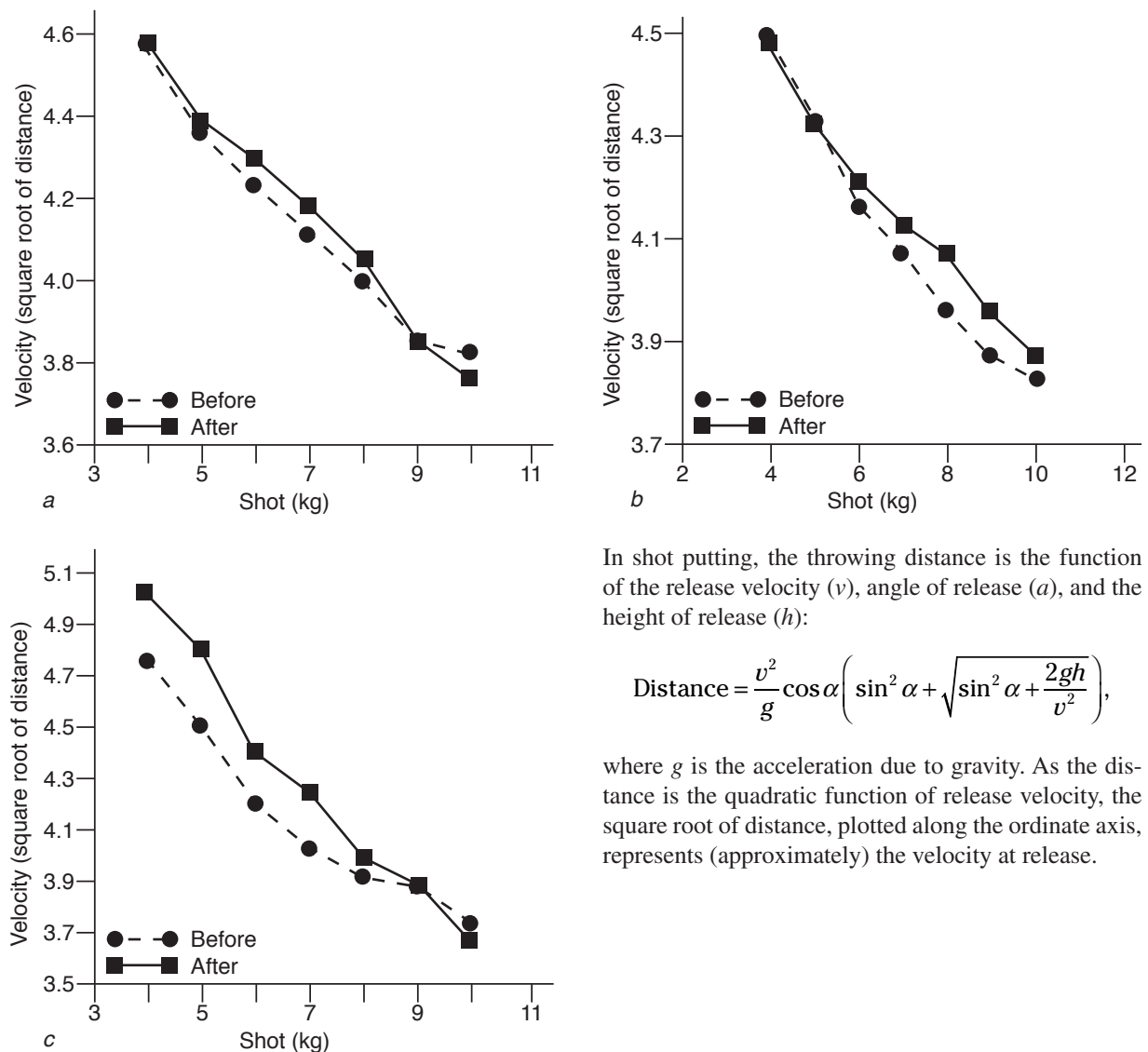

FIGURE 11.4 Performance results in standing shot putting before and after 7-wk training with different shots; 4- to 10-kg shots were used for testing. (a) Standard shots; only 7,257-g shots were used ($n = 4$). (b) Heavy shots (8-10 kg); a throwing routine consisting of heavy shots (70% of all the puts) and standard shots (7,257 g, 30%) ($n = 4$). (c) Light shots (4.5-6.0 kg); the puts of light shots constituted 70% of all efforts ($n = 3$).

(b) and (c) from V.M. Zatsiorsky and N.A. Karasirov, *The Use of Shots of Various Weights in the Training of Elite Shot Putters* (Moscow: Russian State Academy of Physical Education and Sport, 1978). By permission of the Russian State Academy of Physical Education and Sport.

In shot putting, the throwing distance is the function of the release velocity (v), angle of release (α), and the height of release (h):

$$\text{Distance} = \frac{v^2}{g} \cos \alpha \left(\sin^2 \alpha + \sqrt{\sin^2 \alpha + \frac{2gh}{v^2}} \right),$$

where g is the acceleration due to gravity. As the distance is the quadratic function of release velocity, the square root of distance, plotted along the ordinate axis, represents (approximately) the velocity at release.

The direction of applied movement is a key determinant of exercise effect. In many movements, muscles are forcibly stretched before shortening (stretch–shortening cycle, reversible muscle action). As described in chapter 2, the underlying mechanisms of the reversible muscle action are complex. For this reason reversible muscle action is specific (especially in highly trained athletes) and should be trained as a separate motor ability (similarly, in this respect, to anaerobic endurance and rate of force development). The exercises used for this purpose are described in chapter 6.

In conclusion, strength training for power production is composed of main sport exercises with added resistance and assistance exercises. The latter are directed toward the development of (1) maximal strength, (2) rate of force development, (3) dynamic strength (the muscular force generated at a high velocity of movement), and (4) force produced in stretch–shortening (reversible) muscle action. The proportion of exercises from these groups should be determined individually for each athlete and should change when the athlete's status changes.

Muscle Mass

While muscle hypertrophy is a primary goal of bodybuilders, athletes do not typically aim at increasing muscle mass. However, muscle hypertrophy is an important way to increase muscular strength. Furthermore, some athletes (linemen in football, throwers) are able to use heavy body mass

to their advantage and thus want to increase muscle mass. Accordingly, methods that are essentially bodybuilder techniques are used by competitive athletes, too.

The main objective of such a training routine is the maximal activation of the majority of muscle tissue, which in turn stimulates a breakdown and repair process that results in increased size and density of contractile proteins in the muscle fibers. Thus, rest and recovery are needed to optimize this breakdown and repair process, and are cornerstones of periodization models that have been developed over many decades. The volume and intensity of training interact to create enough activation of motor units in muscle so as to stimulate breakdown along with the stimulation of anabolic signals from hormones and growth factors to augment the hypertrophy process. However it has been determined that muscle fibers in a motor unit that are not stimulated do not experience cellular hypertrophy. Thus, loadings of 5RM to 7RM and 10RM to 12RM have been used with adequate set numbers to create both the recruitment demands to activate a significant amount of muscle tissue, in addition to stimulating the optimal anabolic environment for optimizing hypertrophy. Training protocols are therefore designed with this same primary objective, to activate the muscle tissue, resulting in a breakdown of proteins in the chosen muscle groups and then allowing for the repair and remodeling process to occur during rest and recovery after the workout.

Training Goal: Muscle Power

Perform the main sport exercise with added resistance. This is often the quickest way to make gains in athletic performance. It is also insufficient. The performance results initially advance but soon stop improving due to accommodation. Make sure fundamental strength capabilities are present to help augment power development. Other training means are then necessary.

Enhance maximal strength. It is impossible for athletes to generate a large force in a fast movement if they cannot develop similar or even greater force values in a slow motion. But don't overemphasize the role of maximal strength in power production. Being a strong athlete does not mean being a power athlete. It is true that all elite power athletes are very strong people. On the other hand, not all strong individuals can execute movement powerfully when combining large force and high velocity. Thus, training the entire force–velocity curve is important for optimal outcomes in performance.

Train RFD. If the time available for force development is short, RFD is more important than maximal strength. Enhance not only maximal (F_{max}) but also dynamic strength—the force developed at a high velocity of movement. Use drills requiring the utmost muscular effort against moderate resistance (the method of dynamic effort). Employ specific drills and methods to improve reversible (stretch–shortening) muscle action. This is a specific motor ability.

- Rest intervals between sets are short—1 to 2 min to stimulate metabolic and hormonal signals compared to 3 to 5 min in weightlifting training when the aim is to emphasize neuronal output.

- In one workout or even in 1 day, no more than two to three muscle groups or body parts are exercised. Then, on the following day, exercises for other muscle groups are included. This is called **split training**. For example, arms, shoulders, and abdominal muscles are exercised on day 1; legs on day 2; chest and back on day 3; and day 4 is a rest day. With the split system, a muscle group is fully exhausted during a workout and then given time to recover (in this example, about 72 h). The muscle group is exercised twice a week. The split system is never used for perfecting the neural mechanisms of strength enhancement.

- Several exercises (usually from two to five) for the same muscle group are employed during

a single training unit. Exercises may vary within the sequence; for instance, a curl with a dumbbell can be performed with the hand alternately in the supinated and pronated positions. However, this is not done to alternate the muscle groups; that is, initially all exercises of one muscle group should be executed. For instance, all back exercises are performed first, and then chest exercises are performed. The idea is the same, to activate and exhaust the muscle group as much as possible. Exercise angles for the same muscle group, slightly changed from each other, are performed consecutively. This method, called flushing, was initially based on the assumption that increased blood circulation stimulates muscle growth. Up to 20 to 25 sets per muscle group may be executed in one workout. Table 11.2 summarizes the comparison between training to emphasize muscle mass and training to emphasize strength.

Training Goal: Muscle Mass

Activate muscle tissue to stimulate the breakdown of proteins in the chosen muscle groups during training workouts to allow for protein supercompensation during rest and recovery periods. Use weights with RM between 5 to 7 and 10 to 12 (the repeated effort and submaximal effort methods) to activate enough tissue and create the anabolic environment needed for repair and remodeling of tissues.

Follow the recommendations given in table 11.2.

TABLE 11.2 Training Protocols to Induce Muscle Hypertrophy or Muscle Strength (Neural Factors)

Training variable	Muscle hypertrophy	Strength (neural factors)
Intent	To activate and exhaust working muscles	To recruit the maximal number of motor units with optimal discharge frequency
Intensity (RM)	From 5-7 to 10-12	1-5
Rest intervals between sets	Short (1-2 min)	Long (3-5 min)
Rest intervals between workouts emphasizing same muscle groups	Long (48-72 h)	Short (24-48 h)
Exercises in a workout	Three or fewer muscle groups (split system)	Many muscle groups
Exercise alternation in a workout	Flushing: exercises for the same muscle group may alternate; exercises for various groups do not alternate	Recommended
Training volume (load, repetitions, sets)	Larger (4-5 times)	Smaller (4-5 times)

Endurance Performance

Endurance is defined as the ability to bear fatigue. Or in other words, the ability to resist the reduction of force and power with repetitive muscle actions. Human activity is varied, and the character and mechanism of fatigue are different in every instance. Fatigue caused by repetitive movement of a finger using a finger ergograph, for instance, has little in common with the fatigue of a marathon runner or a boxer. Thus, the corresponding types of endurance will differ.

Muscular Endurance

Endurance of muscles can be manifested in exercises with heavy resistance, such as the repetitive bench press, that do not require great activation of the cardiovascular and respiratory systems. Fatigue is caused by the functioning of elements in the neuromuscular system that are directly involved in the performance of the movement.

Muscular endurance is typically characterized either by the number of exercise repetitions one can carry out until failure (the maximum number of pull-ups, one-legged squats), or by the time one can maintain a prescribed pace of lifts or a posture. In either case, the load can be set in terms of absolute

values such as kilograms or newtons (e.g., a 50-kg barbell) or in relation to the maximal force (e.g., a barbell 50% of F_{mm}). Accordingly, the **absolute and relative indices of endurance** are determined. In estimating the absolute endurance, individual differences in muscular strength are ignored. Everyone is asked to press the same weight, for instance. When relative endurance is measured, on the other hand, all are asked to press a weight that equals the same percentage of their maximum strength.

The absolute indices of endurance show considerable correlation with muscular strength; individuals of great strength can repeat a vigorous exercise more times than those of lesser strength (figure 11.5). However, this correlation is observed only with resistance that is at least 25% of maximum strength. When the load is smaller, the number of possible repetitions quickly rises and is, in practical terms, independent of maximal strength (figure 11.6) and does not correlate positively with maximal strength, often showing a negative correlation.

Let's consider an example of what we have seen about the correlation between strength and endurance. Suppose two athletes can bench press weights of 100 and 60 kg, respectively. It is obvious that the first athlete can press a 50-kg weight more times than the second athlete and that the absolute indi-

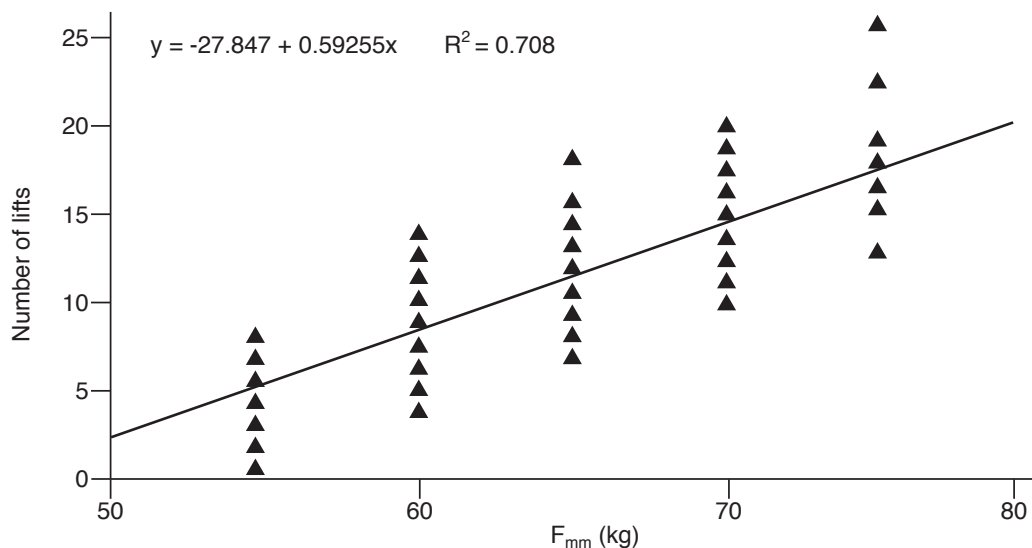

FIGURE 11.5 Maximal weight lifted in the bench press (F_{mm} , kg) versus the number of lifts of a 50-kg barbell in the same movement. The pace of the lifts was 1 lift every 2 s. The subjects were wrestlers 16 to 18 years old ($n = 60$). The average value of the maximal strength was 67.5 kg. So the weight lifted (50 kg) was equal to approximately 75% of the average F_{mm} of the sample. The number of experimental points in the graph (41) is less than the number of subjects (60), since performance of some athletes was identical. When F_{mm} and the number of lifts were the same, two or several points coincided.

Reprinted by permission from V.M. Zatsiorsky, N. Volkov, and N. Kulik, "Two Types of Endurance Indices," *Theory and Practice of Physical Culture* 27, no. 2 (1965): 35-41.

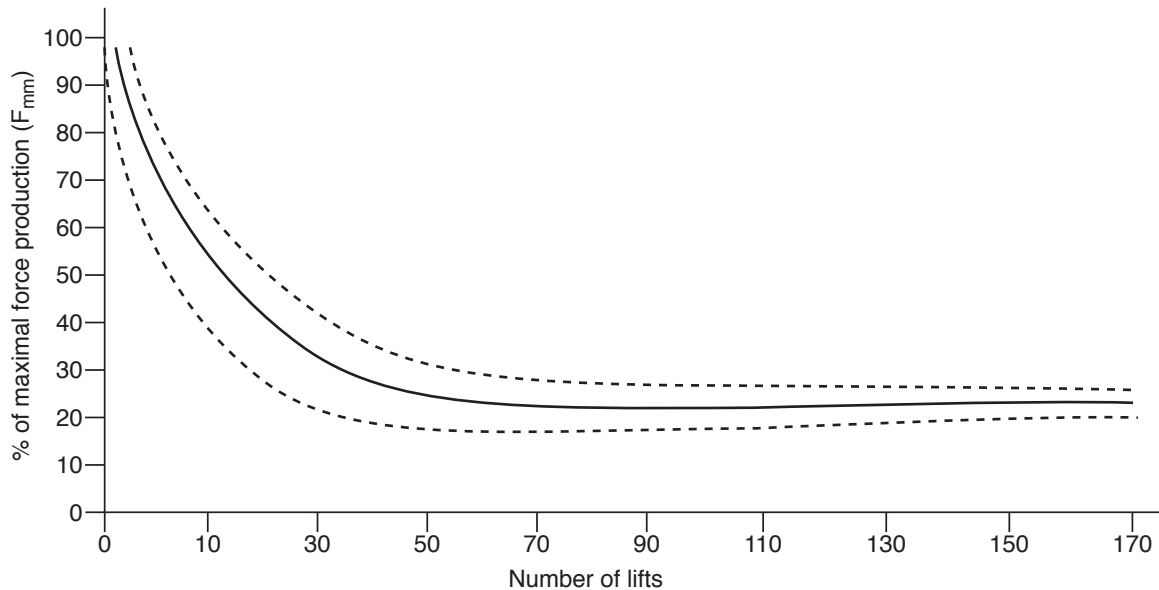

FIGURE 11.6 The dependence of the number of bench press lifts on the relative weight of a barbell. Average data of 16 weightlifters; the solid line represents rounded average figures; the broken line is for the standard deviation.

Reprinted by permission from V.M. Zatsiorsky, N. Volkov, and N. Kulik, "Two Types of Endurance Indices," *Theory and Practice of Physical Culture* 27, no. 2 (1965): 35-41.

ces of endurance for the first athlete will be better. If both athletes are told to press a weight of 10 kg (less than 25% of maximal strength for each), it is impossible to predict who will exhibit more endurance. In this case, endurance (measured by the number of repetitions) does not depend on strength level. If both athletes press a weight equal to 50% of their maximal force production (50 and 30 kg, respectively), it is again impossible to predict who will show greater endurance. Here, too, endurance does not correlate with strength.

Since athletes are not matched during a competition according to strength, practice should focus on absolute endurance. As we have noted, these indices are essentially dependent on the strength level; as the resistance an athlete must overcome increases, so does the dependence. Thus, when it is necessary to repeatedly overcome considerable resistance (more than 75%-80% of the maximum

muscular strength), there is no need for special endurance training. When resistance is smaller, though, one must concentrate on the development of both strength and endurance. In gymnastics, for instance, an athlete who cannot hold a cross for 3 s during a ring exercise (as the rule requires) must still train strength, not endurance. But a gymnast who performs four crosses in one combination and cannot hold a fifth must train endurance (together with strength). Repeatedly performing strength exercises with resistance constituting 40% to 80% of maximum strength is the recommendation in this case. The repetitions are performed as many times as possible. If the magnitude of resistance is less than 20% to 25% of the athlete's strength, strength training (i.e., a training routine directed at increasing maximum strength) does not immediately improve athletic performance. In the past, athletes from sports such as marathon running

225-lb Bench Press Test

The National Football League's (NFL) 225-lb bench press test for maximal number of repetitions has been a popular test used by American football teams to estimate 1RM strength. While it has been shown to correlate with a player's 1RM it has been less sensitive to tracking the short-term changes in 1RM to small gains in strength with training.

rarely used heavy resistance training. However, over the past couple decades, heavy resistance training has become a part of endurance runners' conditioning programs to help strengthen connective tissues and prevent injury.

To estimate the potential merit of strength training in a given sport, we should compare the force developed by an athlete during the main sport exercise to the individual's maximum strength during a similar motion. For instance, in a single scull, elite rowers apply an instantaneous force of up to 1,000 N to the oar handle. In dryland conditions, they generate forces of 2,200 to 2,500 N in the same posture. This means that during rowing, the athletes must overcome a resistance equaling 40% to 50% of their F_{mm} . Since the proportion of the force generated during the main sport movement is high, there is no doubt that strength training directed toward enhancement of maximum strength is useful for

the rowers. However, it should be combined with muscular endurance conditioning.

Circuit training is an effective and convenient way to build muscular endurance. Here a group of trainees is divided into several (7-12) subgroups according to the number of stations available. Each trainee performs one exercise at each apparatus (station) as though completing a circle (figure 11.7). Body weight exercises, free weights, and exercise machines as well as stretching exercises may be used at different stations. Consecutive stations should not consist of exercises involving the same muscle groups. Trainees move quickly from one station to the next with a short rest interval in between each. The circuit is finished once the exercises at all stations are completed. The time for a single circuit is prescribed.

All the characteristics of training programs (specificity, direction, complexity, and training

Training Goal: Muscular Endurance

Compare the magnitude of force (F) generated in the movement of interest (for instance, during each stroke in rowing) with the maximal force values (F_{mm}) attained in the same motion during a single maximal effort in the most favored body position.

If $F > 80\%$ of F_{mm} , don't train endurance. Train maximal strength. If $F < 20\%$ of F_{mm} , don't train maximal strength. Train endurance. If $20\% < F < 80\%$ of F_{mm} , train both maximal strength and muscular endurance. Use the method of submaximal effort. Vary the magnitude of resistance. Exercises in a set must be performed until failure. Employ circuit training.

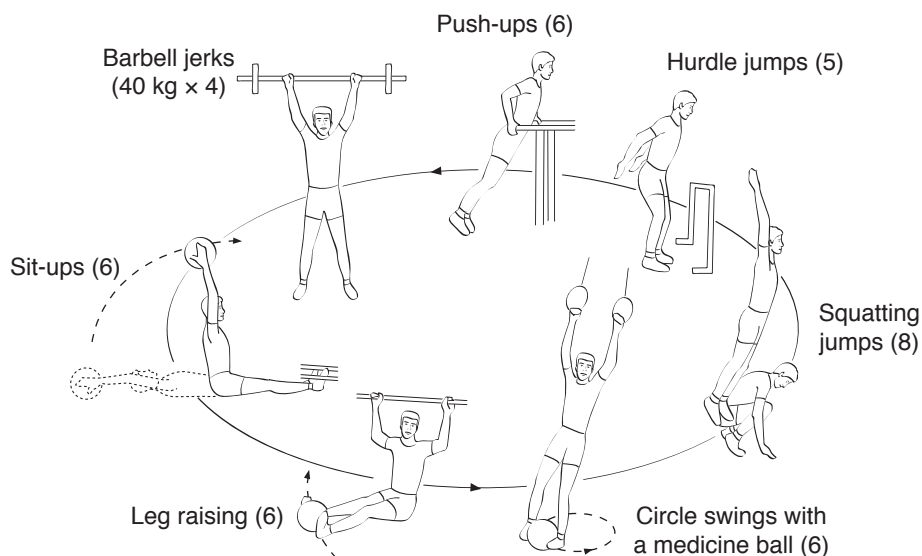

FIGURE 11.7 An example of circuit training.

Reprinted by permission from V.M. Zatsiorsky, *Motor Abilities of Athletes* (Moscow: Fizkultura i Sport, 1966), 156.

load) can be easily specified and modified within a general framework of circuit training. However, in practice, only a limited variety of circuit programs are in use. Typically, circuit training routines use resistance of 50% to 70% of 1RM; 5 to 15 repetitions per station; interstation rest intervals of 15 to 30 s; 1 to 3 circuits; and a total duration of 15 to 30 min.

Endurance Sports

In endurance sports, high energy demands are met by increased oxygen consumption as well as augmented anaerobic metabolism. The cardiovascular and respiratory systems become highly active. Athletic performance is limited by the central systems of circulation, respiration, and heat dissipation rather than peripheral muscle function alone. The correlation between local and general endurance has been shown to be small. Attempts to limit the off-season training of endurance athletes (speed skaters and skiers) to local endurance exercises (one-leg squatting) proved unsuccessful. Trainees improved their performance in one-leg squatting from 30 to 50 times to several hundred times (and even to more than 1,000 times) without any substantial improvement in the main sport. Because of these findings, strength training was not popular among endurance athletes for many years. It was considered a waste of time and effort.

As noted before, this is not the case, however, in contemporary sport. Since improvements in both endurance and strength are desirable for optimum performance in many sports, strength exercises are now extensively used by endurance athletes. However, the intent is not to enhance maximal strength per se, but (and this is the most important part of the concept) to enhance the force generated by the slow motor fibers. Recall that human muscles are composed of different fiber types, roughly classi-

fied as slow and fast. Slow motor fibers are highly adapted to lengthy aerobic muscular work. Fast motor fibers, adapted to short bursts of muscle activity, are characterized by large force and power output and high rates of force development. In the main sport, strength training is directed at increasing maximal muscular force production and thus primarily addresses maximal involvement of the fast motor units (MUs) and their strength gain.

In endurance sports, the objective is exactly the opposite. Here the athlete wants to work as long as possible at a given intensity involving the slow motor fibers. In this case only, the metabolic response to exercise is aerobic and the athlete's work is sustained. The recruitment of fast motor fibers during prolonged work is apparently not desirable and in endurance events elite athletes stay under the lactate threshold, limiting the recruitment of fast-twitch motor units. Thus, during an endurance event, the lower the proportion of the activated fast motor fibers that are not fatigue resistant the better. So the force repeatedly exerted by an athlete during an endurance exercise should not be compared with maximum strength but with the maximum sustainable force by the slow (fatigue-resistant, oxidative) motor fibers alone. In resistance training this would mean that higher numbers of repetitions would be completed in a set.

Relatively low resistance and long exercise bouts are used to enhance the strength potential of endurance athletes. The corridor of MUs subjected to a training stimulus should presumably include slow MUs. Among coaches, it is a common belief that muscles must work at the highest levels of their aerobic capacity. Exercise sets that comprise, for instance, 5 min of repetitive lifts are common. While training in the 1980s, world-record holder and several-time Olympic champion in 1,500-m swimming, Vladimir

Effect of Loading

Over the last two decades, studies in untrained men and women by Robert Staron's group at Ohio University indicated that higher repetitions of 20RM-28RM do not impact muscle fiber hypertrophy over short-term training periods, while heavier loads 3RM-5RM and 9RM-11RM increased the muscle fiber size of all muscle fiber types. The strength increased to a significantly greater extent in the heavier loads (3RM-5RM > 9RM-11RM > 20RM-28RM) while conversely the higher-resistance group made greater improvements in relative (number of repetitions at 60% of 1RM) muscular endurance (20RM-28RM > 9RM-11RM > 3RM-5RM) showing the specificity of loading on neuromuscular characteristics.

Salnikov, performed up to 10 exercise bouts on a special exerciser during dryland training. Each set was 10 min long. This routine, classified by swimming experts as strength training, only slightly resembles the training protocols used by weightlifters.

A study of the compatibility of high-intensity run training and strength training in active duty U.S. military participants provided insight into the role of different training modalities on muscle fiber hypertrophy and physical performances (see figure 11.8). In brief, the use of a 4-days-a-week, high-intensity strength training and endurance training program impacts muscle fiber size in the combined group where hypertrophy is inhibited in the type I

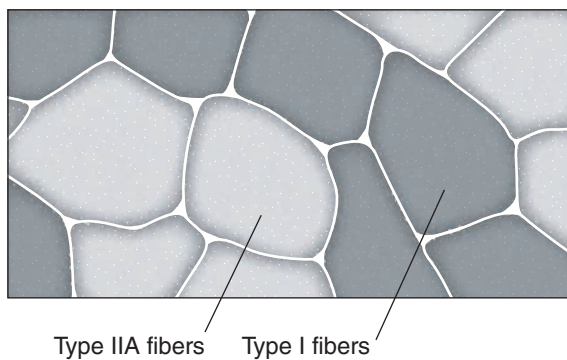

Training modality	Type I	Type IIA
High-intensity endurance running workouts	↓	↔
High-intensity strength training workouts	↑	↑
Upper body-only high-intensity strength and endurance training (concurrent)	↔	↔
High-intensity strength and endurance training (concurrent)	↔	↑

FIGURE 11.8 Effects of concurrent high-intensity strength and endurance training on thigh (vastus lateralis) muscle fiber hypertrophy. Changes in muscle fiber cross-sectional area size of the slow-twitch type I muscle fiber and the fast-twitch type IIA muscle fiber types are shown. Arrows show increase, decrease, or no change.

Data from W.J. Kraemer, J.F. Patton, S.E. Gordon, et al., "Compatibility of High-Intensity Strength and Endurance Training on Hormonal and Skeletal Muscle Adaptations," *Journal of Applied Physiology* 78, no. 3 (1995): 976-989.

(slow-twitch) fibers but not in the type II (fast-twitch) fibers. Interestingly, without any strength training, type I fibers in the endurance group decreased in size, theoretically in the attempt to gain advantage in capillary transport distance for oxygen to the mitochondria. Upper-body training alone presented no observable changes in any of the muscle fiber types. This lack of a decrease or increase in muscle fiber size in the type I fibers resulted in their recruitment as part of motor units needed from the lower-body musculature to provide for the isometric stabilization of the upper body performing the exercises. This provided enough force to the lower-body muscles to limit any decreases in the size changes in the type I muscle fibers, but was not enough of a stimulus to cause increases in any muscle fiber size. Loss of type I fiber proteins also leads to the loss of important noncontractile proteins as connective tissue for injury prevention. Strength and power performances only increased in those lifts that were trained. And strength training did not affect maximum oxygen consumption or run performances.

Such strength training is even more difficult to combine with endurance types of activity. The concept of exercise compatibility becomes an issue, for strength development more than endurance development, as seen in the 1990s when compatibility issues took center stage in many investigations. The demands of the two types of activities are different. It has been shown that when heavy strength training is combined with high-intensity endurance training, strength gains are diminished; thus, care must be taken when combining endurance training with strength training. When strength and endurance training are done concurrently, it is difficult for an organism to adapt simultaneously to the conflicting demands. Consequently, the combination of endurance and strength training impairs strength gains in comparison to strength training alone. This is also true with respect to endurance training. As the time between the two types of exercises lessens, the impediment becomes greater. Same-day training, for instance, impedes development to a greater extent than does training on alternate days. Another factor that influences the interference is the magnitude of the training load; the greater the load, the more incompatible strength training is with endurance training.

The solution is to conduct sequential strength and endurance programs, first focusing on strength training and then on endurance (figure 11.9). It is less efficient to proceed in the other order.

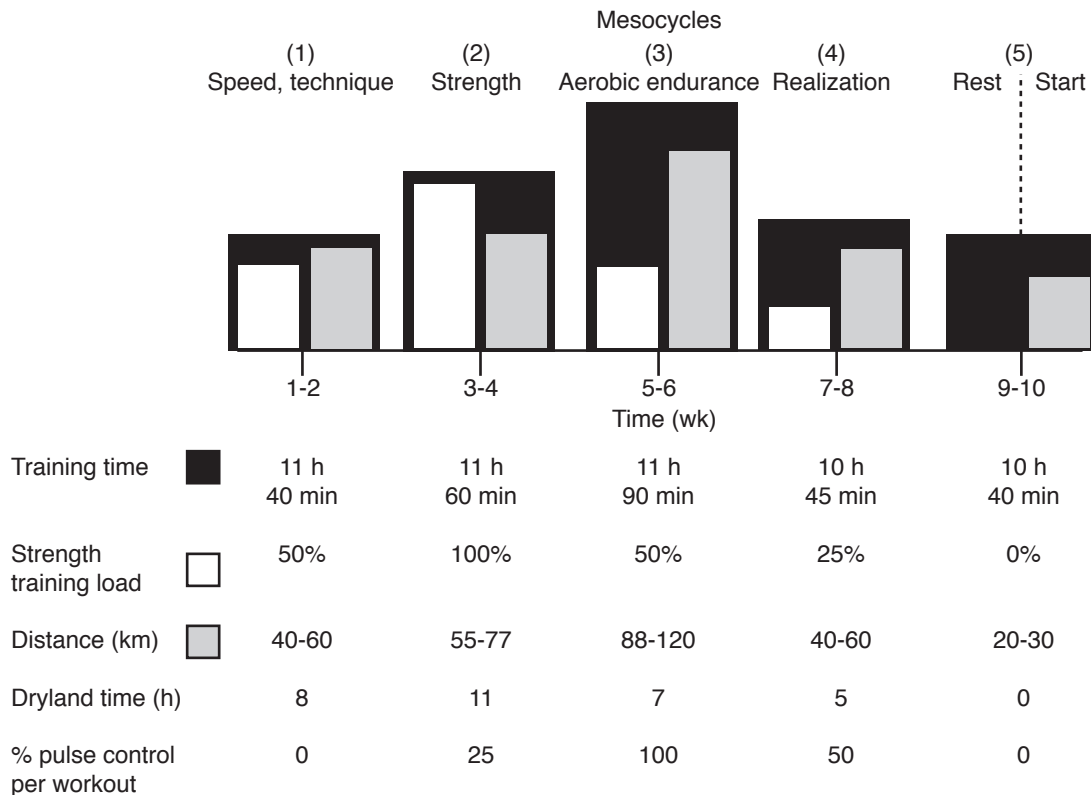

FIGURE 11.9 Training plan of Vladimir Salnikov (1980 and 1988 Olympic champion in 1,500-m swimming) developed by his coach, Igor Koshkin. Note that the strength training mesocycle (2) precedes the endurance-oriented training. Also note that nontargeted motor ability is maintained with a retaining training load. The retaining load is roughly two to three times less than the stimulating one. For instance, dryland training time per week was 11 h during the strength-oriented mesocycle and only 5 h during the realization mesocycle; swimming distance per week was maximally 60 km and minimally 40 km. Finally, note that nontraditional 2-wk mesocycles are used; usually 4-wk mesocycles are used.

From *Preparation of the National Swimming Teams to the 1980 Moscow Olympic Games*, Technical Report #81-5 (Moscow: All-Union Research Institute of Physical Culture, 1981), 242.

The motor ability that is not the prime target of training during a given mesocycle should be maintained with a retaining training load (except during the tapering period, when a detraining load is appropriate).

Injury Prevention

Heavy resistance training results in both increased muscular strength and the increased mechanical strength of connective tissue structures around a joint (tendons, ligaments, ligament-bone junction

strength). Strength training increases bone mineral content. A stronger muscle absorbs more energy than a weak muscle before reaching the point of muscle injury. This may be important for injury prevention.

To plan training routines that reduce the risk of injury, it is necessary to consider (1) muscle groups and joint motion, (2) muscle balance, and (3) coordination pattern.

Muscle groups that need to be strengthened can be classified as nonspecific and specific (actively

Training Goal: General (Cardiorespiratory, Especially Aerobic) Endurance

Try to enhance the strength of slow motor units (fibers) that are oxidative and fatigue resistant. Don't use maximal weight loads. Utilize submaximal weight loads in combination with a large number of repetitions. Apply strength and endurance programs sequentially.

involved in a given sport). The most important nonspecific muscle groups, which should be intentionally trained by young athletes regardless of their sport, are the abdominal muscles and trunk extensors that stabilize the pelvis and trunk; such stabilization is necessary for all movements of the extremities. This **core stability**—which depends also on the hip abductor and hip external rotation strength—is important for injury prevention. Improving the strength of these muscle groups is desirable to develop a base for intensive training. Each sport uses specific muscle groups, which may vary from the neck muscles (football, wrestling) to the small foot muscles (jumping, sprinting).

Muscles and joint structures need to be strengthened not only for joint movements that take place in the main sport exercise but also for other angular joint movements. It is especially important to strengthen joint structures in lateral movements (**abduction–adduction**) and in rotation relative to the longitudinal axis of a body segment (foot eversion–inversion, for example). For instance, football players usually perform many exercises to increase the strength of knee extensors. However, knee injuries are often caused by lateral forces acting during sideways movements or collisions. If the muscles and joint structures that resist lateral knee movement are not strengthened, the injury risk is very high. The same holds true for ankle motion. If only plantar flexion is trained, the athlete cannot resist high lateral forces acting on the foot; strength may be too low to prevent hyperinversion (or hypereversion) and consequently trauma occurs. Unfortunately, strength exercise machines, which are so popular now, provide resistance in only one direction—they have only one degree of freedom. Thus, users do not have to stabilize the working parts of the apparatus as they do in exercising with free weights. Athletes accustomed to exercise machines lose a very important facet of motor coordination—joint stabilization. Even when the aim of strength training is to increase joint stability (for instance, in the case of knee laxity after a trauma), many athletic trainers and physical therapy specialists recommend exercising with isokinetic apparatuses that permit knee flexion and extension only. Lateral movements, however, are not trained, when it is exactly these muscles and structures that should be the training target.

Muscle balance is also important to prevent injury. First, a large imbalance in strength between the two legs should be corrected. If one leg is sub-

stantially stronger than the other, the running athlete will perform a more powerful takeoff with the stronger leg and then land on the weak leg, which is then systematically overloaded and at greater risk of injury. A difference of 10% or more in the strength of the two legs, or a difference of more than 3 cm in thigh circumference, necessitates focusing on the weak leg. A second type of imbalance that should be avoided is between muscles and their antagonists (for instance, quadriceps and hamstrings). The force for knee extension is generated by the quadriceps, while deceleration of the tibia is the function of the hamstrings, which absorb the energy provided by the quadriceps. When the muscles are imbalanced such that the quadriceps are relatively stronger, hamstring overloading can result. Some sports medicine investigators have suggested that, to minimize the risk of injury, hamstring strength must be not less than 60% of quadriceps strength. This recommendation is valid for strength values measured at the joint angular velocity of 30° per s.

Finally, pay attention to the coordination pattern of strength exercises. The majority of movements include the stretch–shortening cycle, and injuries often occur during stretching phases of these cycles or during the transition from stretching to shortening, when muscle force is maximal (see chapter 2). Thus, exercises designed to decrease susceptibility to trauma should include reversible muscle action. Properly scheduled exercises employing reversible muscle action are useful for preventing injury. In these exercises, muscles are trained in natural conditions. Proper coordination patterns, muscular strength, and flexibility are all improved at the same time. As an example, repeated jumps on a specially designed curved (triangle) surface (figure 11.10), when performed regularly and correctly, strengthen the anatomical structures of the ankle joint and reduce risk of ankle sprains and dislocations.

Ultimately, injury prevention has to be based on appropriate exercise stress individually directed for each athlete in a progressive manner. This is especially important for transition periods such as returning from vacations, holiday breaks, injury and sickness, or from one sport season to the next. This is when toleration and ability to recover and adapt from a workout is compromised. Careful progression during these times is vital to prevent injury or even death. Workouts must be carefully and individually measured for suitability and target goals need to take the prudent delays of getting back into the program into consideration.

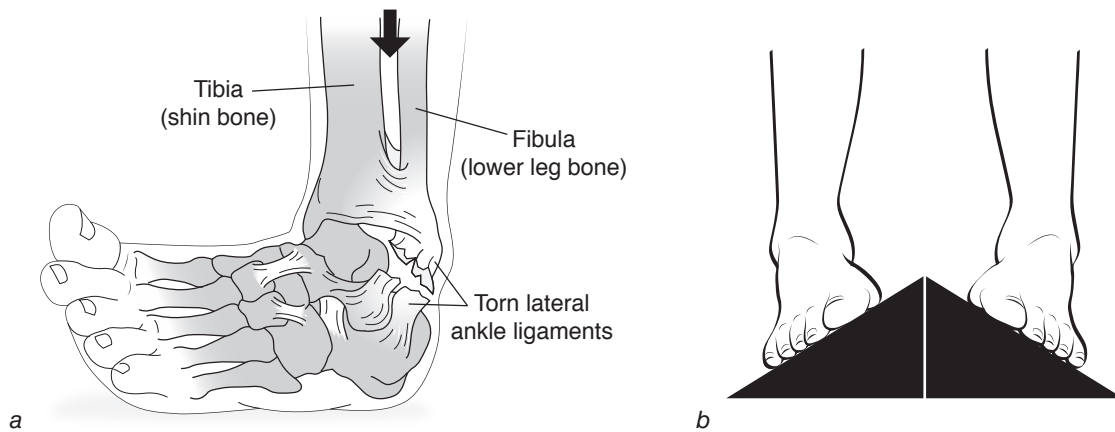

FIGURE 11.10 (a) Excessive foot inversion resulting from incorrect landing. Such a landing causes the ankle sprain. The flawed landing occurred because the ankle joint muscles did not properly resist the foot inversion. To increase the strength of these muscles and to teach the athlete to activate these muscles during landing, repetitive low-height jumps on the triangle can be used. These jumps should be performed in a very gentle manner. (b) Foot position during the contact phase in repetitive jumping used to improve the athlete's ability of resisting inversion of the feet. The supporting surfaces of the device meet at the top of the triangle. To improve the ability of resisting foot eversion, a device with the supporting surfaces meeting at the bottom should be used.

Summary

The general idea in strength training for strength performance is not to train strength itself as a unified whole; rather, it is to train the underlying muscular and neural factors. To improve neuromuscular coordination (MU recruitment, rate coding, MU synchronization, entire coordination pattern), the best method is maximal effort. On the other hand, to stimulate muscle hypertrophy, repeated effort and submaximal effort methods are more appropriate.

Although maximal strength is a prerequisite for high movement speed, its transmutation into velocity, or power, requires training not only maximal strength but also RFD, dynamic strength, and force produced in stretch-shortening (reversible) muscular action. In sport exercises where the time available for force production is too brief to

reach maximal force values, the RFD rather than maximum strength must be the primary training objective.

The aim of exercises designed to increase muscle mass is to break down proteins in particular muscle groups; this in turn stimulates the synthesis of contractile proteins during rest periods. The most effective loads for this type of training range between 5RM to 7RM and 10RM to 12RM.

Endurance is defined as the ability to bear and resist fatigue (i.e., the decrease in force and power output). Human activity is varied, and as the character and mechanism of fatigue are different in every instance, so is endurance. Muscular endurance is typically characterized by either the number of possible exercise repetitions until failure, or by the time one can maintain a prescribed pace of lifts or a posture. In either case, the load can be set with absolute values (e.g., lifting a 50-kg barbell) or relative

Training Goal: Injury Prevention

Strengthen the abdominal muscles, trunk extensors, and the hip joint muscles. Strengthen muscle groups specific to your sport. Muscles must be strengthened for the joint movements that take place in the main sport exercise and for other angular joint movements. Train the muscles that resist lateral displacement of the knee and ankle joints. Correct imbalance of antagonists as well as disparities in muscular strength between the extremities. Employ drills encompassing reversible muscular action.

to the maximal force (lifting a barbell 50% of F_{mm}). With resistance greater than 25% of maximum strength, the absolute indices of endurance correlate positively with muscular strength. Relative indices of muscular endurance often correlate negatively with maximal strength.

Since athletes are not matched during a competition according to strength, practice should focus on absolute endurance. Athletes for whom resistance typically is less than 75% to 80% of maximal muscular strength should concentrate on the development of both strength and endurance. To estimate the potential value of strength training in a given sport, compare the force developed by an athlete during the main sport exercise to the individual's maximum strength during a similar motion. Note that circuit training is an effective and practical way to build muscular endurance.

Whereas strength training for the most part aims at maximal involvement and strength development of the fast MUs, the objective in endurance sports is exactly the opposite—to work as long as possible at a given intensity while involving the slow motor fibers. Relatively low resistance and long exercise bouts are used to increase the strength potential of endurance athletes. However, higher loads can be used to help strengthen connective tissue and prevent injury.

Strength training is difficult to combine with endurance types of activity (e.g., running, cycling,

skiing). When strength and endurance training are done concurrently, it is difficult for an organism to adapt simultaneously to the conflicting demands. The solution is to conduct sequential strength and endurance programs and carefully monitor the frequency and intensities of both training modalities. Focus first on strength training and then on endurance.

Training routines designed to decrease injury risk will address muscle groups and joint motion, muscle balance, and coordination patterns. Plan training to strengthen both nonspecific and specific muscle groups (those actively involved in a given sport). The most important nonspecific muscle groups, which should be intentionally trained by young athletes regardless of the sport, are the abdominal muscles, trunk extensors, and hip joint muscles. Muscles and joint structures also need to be strengthened not only for the joint movements of the main sport exercise but also for other angular joint movements. It is especially important to strengthen joint structures in lateral movements and in rotation relative to the longitudinal axis of a body segment. Another aspect of injury prevention is avoiding or correcting imbalance of muscles and antagonists as well as imbalance in strength between the extremities. Finally, exercises designed to decrease the susceptibility to trauma should include reversible muscular action.

PART III



STRENGTH TRAINING FOR SPECIFIC POPULATIONS

In order to gain some insights into the subtle differences in training special populations, part III examines the training of women, children, and older athletes. With new position stands and information on the different populations, it is vital to understand the similarities and differences in strength training approaches.

Chapter 12 examines the unique issues of training women. Over the last decade or so, it has been established that the training programs for women are no different from those for men. However, understanding some of the challenges faced by female athletes is important. Are there true sex/gender differences? How do these differences affect the design of a training program? These are just two of the questions that are addressed in chapter 12. Sociopsychological issues related to body image also influence the success of strength training programs when proper loads and optimal training methods are not used due to the fear of “getting big.” This chapter seeks to provide further insights into optimal program design by explaining differences in strength of women when compared to the strength of men, muscle fiber size relationships when com-

pared to those of men, menstrual cycle influences, and differences in the underlying mechanisms of adaptations to strength training in women.

In chapter 13, we examine the strength training of young athletes. Not long ago, medical professionals discouraged young athletes from lifting weights due to fears that it would stunt growth and was ineffective. However, in order to meet the increasing demands of competitions and practice and minimize the threat of sports injury, the concept of preparing the young athlete’s body is more important than ever. Are strength training programs safe for young athletes? If so, what are the differences when compared to adult programs? Many professional organizations have gained consensus on these issues, and we overview guidelines to be used when designing a strength training program for children of different ages. In this chapter we discuss the basic needs for training children safely and the importance of experienced adult supervision. Safety is important in any strength training program, but for young athletes it is paramount in order to eliminate injury to growth plates and to optimize growth and development in addition to

sport performance. With the many myths associated with the strength training of children, accurate understanding is important to give the practitioner the insights needed to develop safe and effective strength training programs for young athletes.

In chapter 14, we take a closer look at the aging process and how to address training for the older athlete. With the dramatic increase in the population of individuals over the age of 65 years, resistance training has become one of the most important modalities to fight aging and help performances in masters' competitions. An extensive new position stand on resistance training and aging by the National Strength and Conditioning Association underscores the importance of proper exercise

prescription of this modality for health, fitness, and performance. Understanding the aging process provides insights into the adaptive mechanisms that affect the response to training. Aging affects the absolute gains that can be made. What type of program should be used for training older athletes? How much improvement might one expect? Can exercise offset the aging process? Such questions influence program design and expectations when training the older athlete. In addition, they are important for developing specific goals and training objectives. Offsetting age-related losses should be the objective of most strength training programs. Improving performance is vital for successful aging and especially for the older athlete.

STRENGTH TRAINING FOR WOMEN

Have we come to a point in history in which it is no longer a major issue if women athletes can—or should—lift weights to enhance their performance and prevent injury? In many high schools, clubs, and universities both men and women use this modality to gain the physical development important to performances in all sports. Many top athletes of all ages have led the way, recognizing the importance of strength training in meeting the challenges related to athletic competition.

The importance resides in understanding the basics of resistance training program design and monitoring progress. Knowing how to teach and implement fundamental exercises in a resistance training program design is essential. Many times, individualized progression within a team concept plays a vital role in implementation. At its core is using basic principles that are important to the process and to sport science, from biomechanics to physiology to nutrition.

For women who are not athletes this may be different. In one study of 421 college-aged women only 66% of the sample population met the standard strength training recommendations, indicating that there may still be a ways to go in the general population of women (Patterson et al., 2015). This could be due to the tedious work of strength training as any athlete who participates in resistance training programs knows. However, increased interest in research on resistance exercise and strength training has produced an exponential increase in scientific studies



in all of the areas of health, fitness, and performance (see figure 12.1). This has led to an overwhelming amount of evidence in favor of using strength training as a crucial tool for health and fitness promotion in women. Therefore, ideally, women of all ages can progress through their athletic development process with properly designed, age-related strength training programs just like their male counterparts.

It is important that programs be individualized because every person brings a different anatomical and physiological profile to a training program. Individual assessments and ultimately exercise prescriptions for each woman are essential to optimize the specific type of physical development needed for success in a particular sport. Individualization arises from paying attention to the following factors for both men and women:

1. Progress in testing results toward cycle training goals
2. Recovery metrics for sleep, soreness, fatigue, anxiety, stress, sickness, or other issues
3. Toleration of the workout volume and load with attention to the training log
4. Comparison of training log to the workouts to determine if prescribed resistances, sets, and reps are being met
5. Ensuring that variation used in a periodized method is effective; repetitive use of the same periodization model has been shown to go stale if sequencing is always the same.

6. Body mass and body composition MUST be carefully used in evaluations, and an approach must be developed by the sports medicine physician and team because inappropriate use of this metric has influenced eating disorders. Errant comments from coaches pertaining to body mass can potentially cause an athlete to use dangerous methods of weight control. These practices can also cause serious emotional damage to the athlete. Coaches must know the signs and symptoms of potential eating disorders and understand that issues such as anorexia nervosa are medical pathologies and must be dealt with by physicians. (See <https://www.mirror-mirror.org/athlete.htm>, <https://www.nationaleatingdisorders.org/learn/help/coaches-trainers>.)

Many factors impact training quality and performance in the weight room as well as in the sport. The factors that impact performance for both men and women are shown in figure 12.2. Understanding the demands of sport practice is vital for knowing an athlete’s training potential when they begin to work out in the weight room. The strength training program must take into consideration the factors that can impact performance or the training plan can become ineffective. For example, factors such as sleep and nutrition impact recovery and quality of training in the weight room. The demands of a sport and its required physical development can range from the production of instantaneous power in an

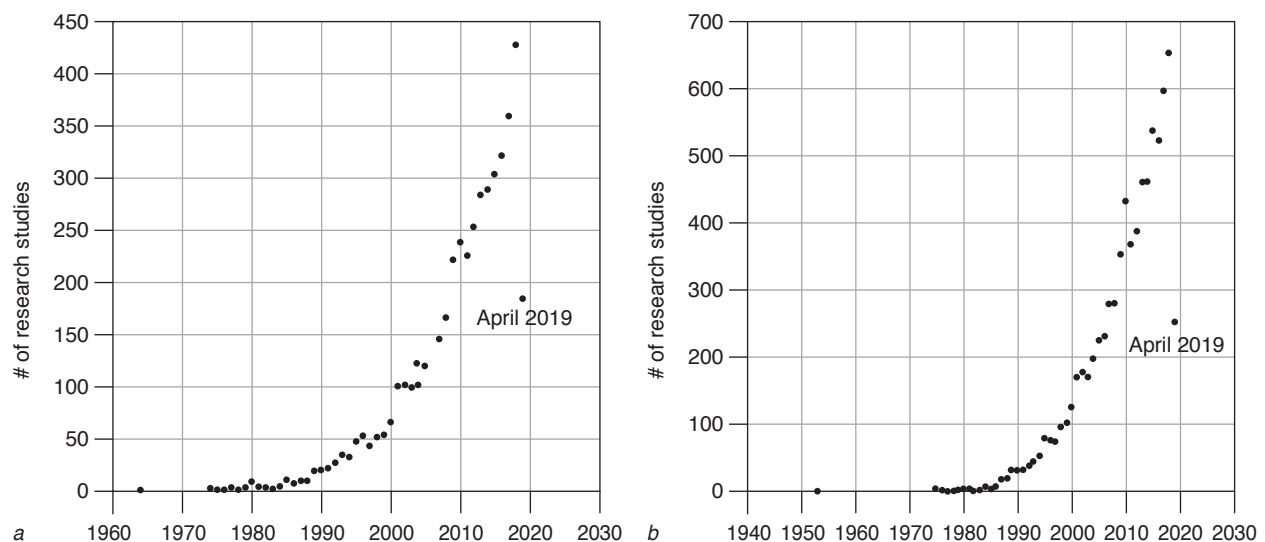

FIGURE 12.1 Research studies on (a) women and strength/resistance training and (b) women and acute exercise have exponentially increased over time.

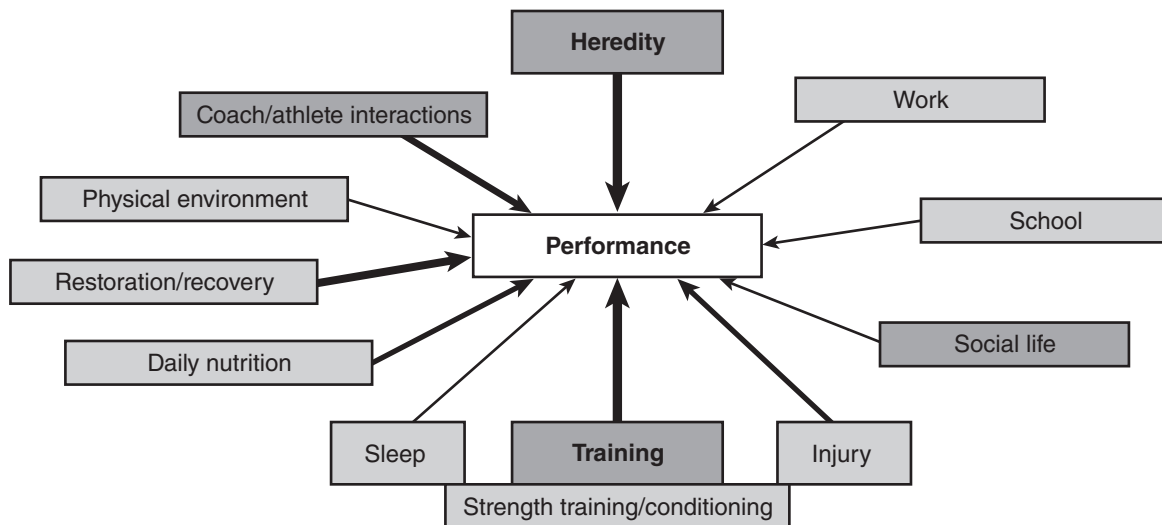

FIGURE 12.2 Many factors contribute to sport performance but also impact the quality of training, recovery, and performance in a strength and conditioning program.

event such as the shot put, to the protection of connective tissue due to the pounding of the lower body in an ultraendurance event such as the marathon. While a sport-specific training program is used to focus on different aspects of each sport, many basic lifts and loading needs are similar across all sports (e.g., squats and heavy [3RM-5RM or 85%-95% of 1RM] loading days). The modern-day program for women athletes reflects the same types of program design used for men.

The fundamental concept for anyone who participates in a sport at any age is that one needs to *train* in order to safely *compete*. This requires proper allocation of time during the week for properly supervised strength and conditioning workouts. With the risk of injury present in each sport, tissue strength and structural integrity of the body is important to withstand the stressors. In addition, strength-trained tissues better recover from the continual breakdown and repair process involved with day-to-day training demands outside the weight room.

Thus, with traditional gender roles having now long changed, the issues have become related to opportunity, facilities available to implement properly designed strength training programs for both men and women, and adherence to fundamental principles beyond program fads popularized by social media. Thus, the goal for women becomes identical to men in that each individual desires to

optimize their physical development to enhance performance, prevent injury, and cope with the demands of recovery in their sport.

Coaching Style Is Important

Coaching in the weight room involves more than following misguided coaching trends that intend to use the weight room for work hardening by yelling and screaming. Physiologically, this produces the opposite effect and increases the sympathetic drive, including adrenal exhaustion, and extending recovery time due to fear, anxiety, and sickness. Thus, coaching behaviors in the weight room are important for both men and women and need to be positive (e.g., Positive Coaching Alliance; Gilbert, 2016).

Additionally, Dr. Wade Gilbert, of the Human Kinetics Coaching Education Center, makes some interesting points in the article “Coaching Males/Coaching Females.” Biologically, there are fundamental differences in the male and female brain structures and the functions related to both neural, endocrine, and behavioral responses. Some of Dr. Gilbert’s points are as follows:

There can be no denying that there are some real and important gender differences for coaches to consider. For example, male and female brains have important structural and functional differences. Certain parts of the female brain

are larger than the male brain, and vice versa. Also, the male brain is designed to process serotonin—a key factor in regulating mood and emotion—over 50% faster than the female brain. And gender is typically the single greatest predictor of many mental health conditions. Males are much more likely to succumb to drug and alcohol addiction whereas females experience much more depression and anxiety.

Some additional gender differences that can have direct implications for coaching relate to memory, communication, and relationships.

- *Memory.* Females recall experiences with more detail and emotion, males typically remember the gist of an experience (big picture); the female brain is designed to see events in emotional high definition.
- *Communication.* When stressed due to conflict, females focus on nurturing (“tend and befriend”) whereas males tend to withdraw; female brains are wired to have stronger and more elaborate verbal communication skills (cables connecting the right and left hemispheres of the brain are thicker in the female brain).
- *Relationships.* Physical activity and competition are the preferred method for building relationships among males; females prefer to bond through talking and sharing stories.

The Need for Strength Training for Women in Sports

It is interesting to look at the physical changes in sports that have occurred over the past 40 years. It is obvious that size, strength, and power are crucial factors for women’s success in sports from tennis to basketball. Much of this can be related to the proper use of strength training in each sport. It is no longer a question in high schools, colleges, or club sports around the world whether women should, or can, have a weight training program to help them prepare for their sport. As competitive levels of each sport increase from high school on up to international competitions, the demands for optimizing physical development increase for women as it does for men. With the greater demands for power, speed, and intensity in women’s sports on all levels there is a significant need for increased upper-body strength along with increased total-body power.

One of the major differences between men and women is a dramatic difference in upper-body size and strength, and it is the physical capabilities of the upper body that limit performance outcomes in many sports (e.g., spike velocity in volleyball, shooting range in basketball). In addition, the integration of power into whole-body movements (e.g., sprint speed, jumping, and change of direction) is also needed for successful performance.

Upper-Body Size and Strength Demands

The primary challenge faced by the majority of women is the need for development of the upper-body musculature. This is highly individualized and is based on each woman’s genetic inheritance. While men and women have the same number of genes, they are differentially expressed, leading to what we know as dimorphic genetic expression, or sexual dimorphisms, between men and women. This effect presumably occurs in women during crucial phases of the embryonic development when the G-cycle of production for the number of skeletal muscle fibers occurs. Men will produce higher numbers of muscle fibers and fundamental differences between men and women are observed including anatomic placement between upper- and lower-body musculature. Differences in the number and location of muscle fibers that make up the motor units also exist among women. For women this means that if significantly increasing the number of skeletal muscle fibers (*hyperplasia*) is not possible, one is left with optimizing the size of muscle fibers (*hypertrophy*) in each motor unit. In order to do this, loading and exercise angles must “get at,” or **recruit**, motor units in the upper body in order to increase muscle fiber size (related to the size principle).

The upper body’s importance and function in each sport exists on a continuum, from the development of postural local muscular endurance in an elite distance runner to the strength and power needed in the upper body for shot putting. Training programs for women must be aware of the need for upper-body muscular development and its importance for all women in each sport. Upper-body training should never be left out in a strength training program, even for endurance runners, as it is part of the structural kinetic integrity of the body, and with aging, becomes an important survival need. Thus, the extent of the program for upper-body strength training must be individualized and related to each sport and its demands.

For women participating in sports that are dependent upon upper-body musculature, more exercises may need to be added to optimize the full development of all available muscle fibers in the motor units. In order to develop the upper-body musculature under these conditions, all available muscle fibers need to be activated, which requires heavier loading and the use of more exercise angles to stimulate overall physical development of the available musculature. This may require the use of bodybuilding techniques to develop the hypertrophy needed for certain upper-body muscle groups. These techniques can then be integrated into a program of total-body strength and power exercises.

Power Demands

Total-body power development and exercises such as power cleans and other Olympic-style weightlifting exercises are vital for sport performance gains. Total-body power is becoming an increasingly important training component for almost all women's sports and must be seriously addressed in a strength training program. The need for basic strength also influences the speed of improvement, meaning an optimal basic strength development target would be that the woman can squat $1.75 \times$ body mass. The strength development in concert with power development are linked. Additionally, squat and then squat variations including front squat to split squats to lunge will address different aspects of power in the vertical and horizontal directions, respectively.

The need for this improved physical capability can be seen in the changes that have taken place in many sports, from the big power serves in tennis to the greater physical demands of rebounding in women's basketball. Increased power demands in sports are now considered status quo and must be met with better strength training programs and better athletes (see figure 12.3). Power development is a vital component of any strength training program for women.

Women have greater potential than men for upper-body strength and muscular development primarily due to a lack of aggressive training programs for the upper body. In general this means the following:

1. Each upper-body muscle must be exercised at more angles.

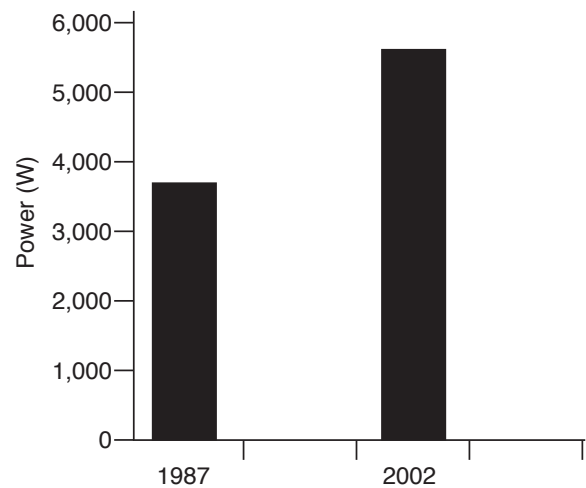

FIGURE 12.3 Peak power in a countermovement vertical jump by University of Connecticut volleyball players. Unpublished data from Dr. Kraemer's laboratory.

2. Exercises should be integrated with closed kinetic-chain power exercises.
3. Heavier resistances must be used and integrated into a periodized strength training program.
4. Multiple set training should be used.
5. A periodized training format should be developed.

Benefits and Myths of Strength Training for Women

At this point in history it may not be relevant to exhort the benefits of strength training for women, especially for athletes, as this modality is now more accepted; however, a fear of heavy loading still exists in younger female athletes. The benefits of strength training for women involved in sports at all ages have been recognized and noted for over 25 years (Fleck and Kraemer, 2014; Ebben and Jensen, 1998). Nevertheless, let's point out some of these benefits from an appropriate strength training program:

- Enhanced bone modeling to increase bone strength and reduce the risk of **osteoporosis**
- Stronger connective tissues to increase joint stability and help prevent injury
- Increased functional strength for sports and daily activity
- Increased lean body mass and decreased nonfunctional body fat

- Higher **metabolic rate** because of an increase in muscle and a decrease in fat
- Improved self-esteem and confidence
- Improved physical performance in sport-specific skills

A number of factors may reduce or eliminate these benefits, including the exclusive use of weight training machines, training with loads that are too light, and not progressing in resistance or intensity. However, because strength training can affect almost every system in the body, its appropriate use in conditioning programs for women athletes can be vital to success.

Historically, women at certain ages have not gained the benefits of a strength training program because certain misconceptions prevent coaches, or women themselves, from optimally training; while these phenomena are slowly becoming outdated they can still exist, especially at younger ages. Thus, program design can be compromised. Women and men use the same training approaches, but as noted among bodybuilders, some women will use the same approach using more exercises in the attempt to fully develop upper-body muscular size. These myths were captured over 20 years ago in a classic review by Ebben and Jensen entitled “Debunking Myths That Block Opportunity” in 1998. Each

Debunking Myths That Block Opportunity

- **Myth 1:** Strength training causes women to become larger and heavier. The truth is, strength training helps reduce body fat and increase lean weight. These changes may result in a slight increase in overall weight, since lean body mass weighs more than fat. However, strength training results in significant increases in strength, no change or a decrease in lower-body girths, and a very small increase in upper-extremity girth. Only women with a genetic predisposition for hypertrophy who participate in high-volume, high-intensity training will see substantial increases in limb circumference.

- **Myth 2:** Women should use different training methods than men. Women are often encouraged to use weight machines and slow, controlled movements out of a fear that using free weights, manual resistance, explosiveness (high velocity, low force), or exercises that use body weight as resistance will cause injury.

In fact, no evidence suggests that women are more likely to be injured during strength training than men. Proper exercise instruction and technique are necessary to reduce the risk of injuries for both men and women. All strength training participants should follow a program that gradually increases the intensity and load.

Furthermore, sport-specific exercise should closely mimic the biomechanics and velocity of the sport for which an athlete is training. The best way to achieve this is to use closed-kinetic-chain exercise that involves multiple joints and muscle groups and the ranges of motion specific to the sport. For example, the push press—rather than triceps kickbacks—offers a superior arm extension training stimulus for improving the ability to throw the shot put in track and field.

- **Myth 3:** Women should avoid high-intensity or high-load training. Women are typically encouraged to use limited resistance, such as light dumbbells, in their strength exercises. Often such light training loads are substantially below those necessary for physiologic adaptations and certainly less than those commonly used by men.

Most women are able to train at higher volumes and intensities than previously believed. In fact, women need to train at intensities high enough to cause adaptation in bone, muscle, cartilage, ligaments, and tendons. When exercise intensity provides insufficient stimulus, physiologic benefits may be minimal. To gain maximum benefit from strength training, women should occasionally perform their exercises at or near the repetition maximum for each exercise.

Reprinted by permission from W.P. Ebben and D.R. Jensen, “Strength Training for Women: Debunking Myths that Block Opportunity,” *The Physician and Sportsmedicine* 26, no. 5 (1998): 86-97.

athlete and coach should do a gut check to make sure these myths do not exist in the culture of your training program or training facility. Such misconceptions are primarily related to the issues outlined in the inset presentation.

Trainable Characteristics of Muscle

It is important to remember that each sport requires a different emphasis on various trainable characteristics of the neuromuscular system. In general these trainable characteristics might be defined as follows:

- Lean tissue mass development
- Maximal strength development
- Maximal power development
- Local muscular endurance

The balance of these training components will depend on the demands of the specific sport and individual athlete.

Development of Lean Tissue Mass

While this concern is diminishing it still exists, even among athletes. The fear of “getting big” or developing too much muscle can be related to many factors including media, social media, and self-image. Athletes who are highly motivated to perform and win may not see this as an issue like it was twenty or thirty years ago, but for younger women, such concerns may

still exist. This is thought to be highly related to the culture of the weight room and its management, and has been historically more prominent in sports that have not been considered classic strength or power sports. The fear of getting too big or looking like a male is fundamentally unfounded, and development of lean tissue mass in women is extremely important, especially in the upper body. In order for muscle tissue to be developed, it must be stimulated by the workout protocol; in other words, the muscle tissue must be activated. However, perceptions on what “getting big” means to women is also highly individual and must be viewed and respected because it may encompass meanings that are not related to the actual training effects from a program. These may include thoughts such as “I don’t want to look like a female bodybuilder,” or “I don’t want bulky muscles,” or “I won’t have long muscles,” or “I’ll be able to see my muscles bulge,” among many other feelings. In the authors’ experiences working with thousands of women in sports, training, and research we have found very few, if any, that were dissatisfied with a fully trained state after a strength training program; in fact it always seems to be the opposite.

With strength training there is an increase in muscle size and a decrease in subcutaneous fat stores (see figure 12.4 and figure 12.5). Changes in body composition are also influenced by nutritional intake that must be appropriate for caloric needs and the prevention of menstrual problems, influencing decreased fat depositions with whole-body training (Volek et al., 2006; Fleck and Kraemer, 2014). Increased muscle size and decreased subcutaneous

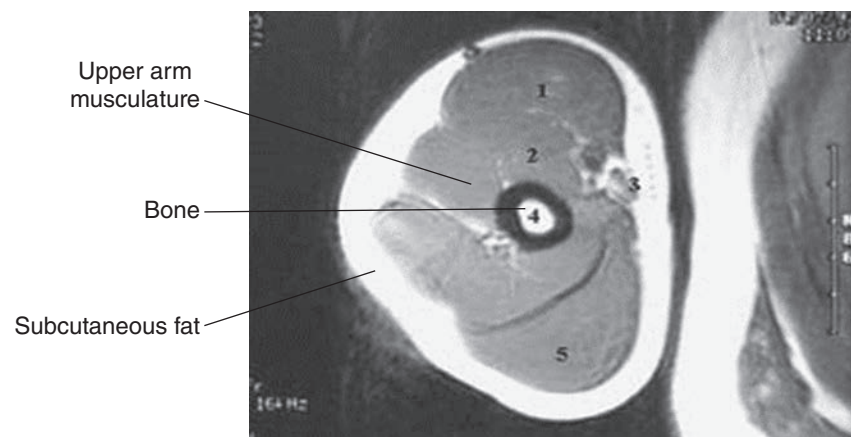

FIGURE 12.4 A cross section of the upper arm musculature (gray areas) of a trained young woman using magnetic resonance imaging (MRI). The subcutaneous fat (outer white area) decreases with strength training and proper nutritional programming allowing more definition of the upper arm musculature.

fat is observed with training and proper diet, which results in higher muscular definition, an ultimate goal of bodybuilders at the extreme end of the continuum. But with typical training the actual size of the limb can be smaller, yet the muscle is larger underneath allowing for more force and power to be produced. This is many times more prominent in the arms of women where greater gains are made due to more training potential; therefore, muscle definition becomes more obvious. With women in the movies and in music now showcasing arms and abs more than ever, some of the social stigma on hypertrophy, size, and definition is becoming less fearful. However, it is important to note that training effects are highly related to the program design and an individual's response, which is due to genetic differences in fat deposition and muscular fiber profiles. Yet, strength training will enhance

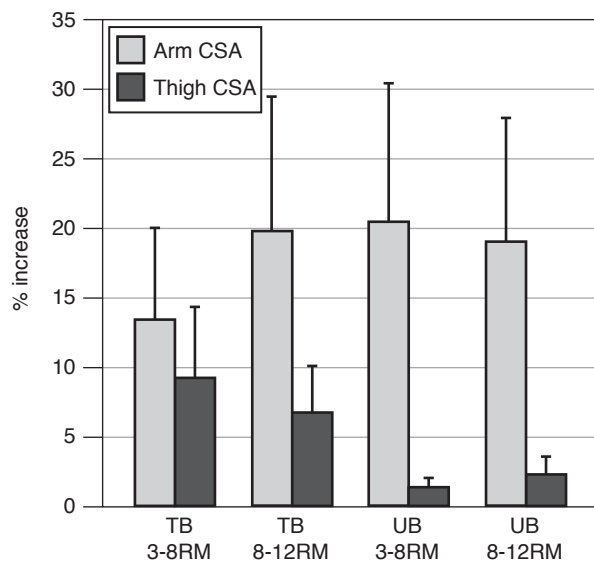

FIGURE 12.5 TB = Total-body program; UB = Upper-body program; CSA = Cross-sectional area. The response of upper- and lower-body training programs demonstrate that the largest gains in muscle size measured by magnetic resonance imaging (MRI) over a 6-mo training program are observed in the arms of women. Total-body programs produced significant ($p < 0.05$) increases in both arm and thigh hypertrophy while upper-body programs produced significant increases in the arm musculature only. Arm hypertrophy was greater than the percent gain in thigh hypertrophy in all groups except the total-body 3RM-8RM loading program. Linear periodization progressed in all groups over the 6 mo of training from the higher RM to the lower RM loading.

Data from W.J. Kraemer, B.C. Nindl, N.A. Ratamess, et al., "Changes in Muscle Hypertrophy in Women With Periodized Resistance Training," *Medicine & Science in Sports & Exercise* 36, no. 4 (2004): 697-708.

muscle size in women if an appropriate program is designed.

Stimulation of muscle is a function of **motor unit activation** (size principle). This means that motor units (an alpha motor neuron and its associated muscle fibers) involved in the exercise must be stimulated to contract. Motor unit activation and how it relates to a strength training workout can be best understood by examining the basic concept of the size principle in prescribing exercise routines (see chapter 3). Interestingly, we lose motor units, typically the type II motor units and their associated fast-twitch fibers as we age, and thus strength training is vital for reducing this age-related decline, especially in women. Scientists have looked at the factors related to the size of the motor unit in many ways, including

1. the number of muscle fibers found in a motor unit,
2. the size of the cross-sectional area of the muscle fibers, and
3. the amount of electrical stimulus (quanta of neurotransmitter release) needed to cause a **neuron** to fire.

Understanding the basics of the size principle is vital to gaining insight into the stimulation of muscle with strength training, but it is especially relevant when training women. As noted previously, if a woman is reluctant to lift heavy weights, many benefits of strength training are never realized despite the myths and claims of light resistance training being as effective as heavy resistance training. Proper training periodization uses loads across the loading continuum. Nevertheless, it is only with the use of heavy resistance that motor units containing the larger muscle fibers are stimulated or trained.

The *size principle*, studied for over 25 years by Dr. Elwood Henneman at Harvard University, dictates that motor units are activated from smallest to largest in a sequential pattern to meet the external demands of the exercise (i.e., to lift the amount of weight on the barbell). The number of motor units activated is matched to the demands of the resistance used for specific force and power production to perform the exercise movement. This principle applies for both concentric and eccentric muscle actions or in other words, lifting movements. Again, many factors influence the size of motor units, which range from small to large with variations

across muscles in the array of motor units that exist. It is important to understand that differences also exist among individuals, as not all women (or men) will have the same array of motor units available in a given muscle (e.g., in the quadriceps of an elite distance runner, fewer fast-twitch motor units exist versus in the same muscle of an elite 100-m sprinter). Such variation also underscores the inherent differences among numerous types of athletes, from strength and power athletes to endurance athletes. Thus, the complement of motor units that an athlete possesses dictates, in part, the performance potential for various activities. Figure 12.6 illustrates the change in motor unit activation and fiber recruitment as force production increases.

Within the construct of the training program, a number of program design factors need to be considered when trying to maximally stimulate the optimal number of motor units in a muscle. Each time you change the angle, whether it is the joint angle or the angle at which the force is exerted, you change the exercise to the extent that different motor units are used. When trying to develop optimal muscle mass it is important to use a set of exercises that stimulate these different biomechanical angles in order to make sure that the entire muscle is stimulated. Heavier resistances are also required to stimulate higher-threshold motor units. This is especially important for power development in women. The use of higher training volumes (e.g.,

multiple-set training) is also important to develop lean tissue mass, as multiple-set periodized training programs have been shown to be superior to single-set circuit training for women. Finally, all of these program elements can be integrated into a periodized training program for optimal progression and results.

Strength Development

Development of strength in women is dramatically related, as in men, to resistance-loading schemes. Many times, the lack of heavy resistances (3RM-5RM or >90% of 1RM) in the training program can reduce the effectiveness of optimizing strength. It has been well established that women need heavy resistances in order to develop maximal 1RM strength. Even clearer is the lack of heavy loading schemes in many women's sports, which reduces the ability to activate all muscle tissue as well as to improve connective tissue strength and density. While some sports may not require massive strength (e.g., cross country running), heavy resistances are needed for optimally developing connective tissues such as ligaments, tendons, and bones to help prevent injury. Interestingly, in one study, when high-intensity interval training was used, the group of women that did not follow a periodized resistance training program with heavy resistance workouts in the cycle saw an incidence of stress fractures with short-term training.

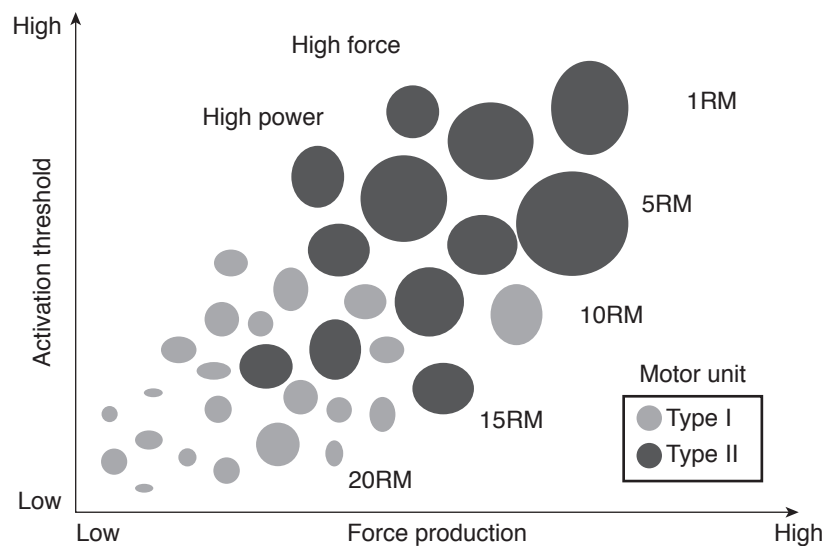

FIGURE 12.6 A theoretical paradigm for the size principle for a muscle with all of the different muscle fiber types, such as in major muscle groups. Circles represent the motor unit and its associated fiber, with the larger circles containing a higher number of fibers or bigger fibers. Recruitment of motor units go from low to high as the resistance loading increases the external demands for force production.

The most effective presentation for heavy loads is the use of a periodized training schedule (i.e., classical linear or nonlinear programs). This allows for recovery from heavy workouts that is needed in an optimal program. Again, while one cannot provide a “cookbook” for program design, it is necessary to include certain important features in any program. The sidebar titled Periodized Program for Development of Strength and Power is an example of a nonlinear periodized training program that has been used in several women’s studies.

Development of Muscular Power

Muscular power is becoming a prominent performance characteristic in almost all women’s sports. $P = Fd / t$ is the base equation that conditioning programs affect. Heavy strength training is needed at maintenance levels, at a minimum, so as not to reduce the impact on power, because when strength detrains, power plateaus are produced. As noted before, fundamental maximal strength is needed in the squat to optimize whole-body power movements and training. Power training is typically done in the concentric movement, but it is important to have catches in the power cleans and eccentric control of deceleration movements in plyometric drills to enhance deceleration capabilities that are important for sport movements and injury prevention. Thus, both heavy resistance training and explosive

power training are essential in any strength training program for women.

Some programs focus solely on the force component of the power equation, but just as important is using loads and exercises that can address the velocity component. For concentric exercise movements, power increases as the loading decreases from the isometric starting point. A 1RM lift is composed of a high force component and a relatively low power component. It is not until the resistance is considerably reduced that the maximum amount of power can be produced in the movement. This has been called maximal mechanical power output (Kraemer and Newton, 2000) (see figure 12.7). Maximal mechanical power typically takes place somewhere between 30% and 45% of 1RM in the squat jump and bench throw but can be higher in such lifts as the hang clean and pull (e.g., 60% and 70% of 1RM). However, it has been observed that this percentage can climb as high as 60% of 1RM, but with more specific training of the velocity component, maximal mechanical power slowly reverts back to 30% to 45% of 1RM. Olympic weightlifters typically do not maximally exercise with such a low percentage of 1RM and this may be why peak power is high in such lifts. Studies now show that it is important to train across the entire force–velocity curve to push the entire curve up at all velocities of movement.

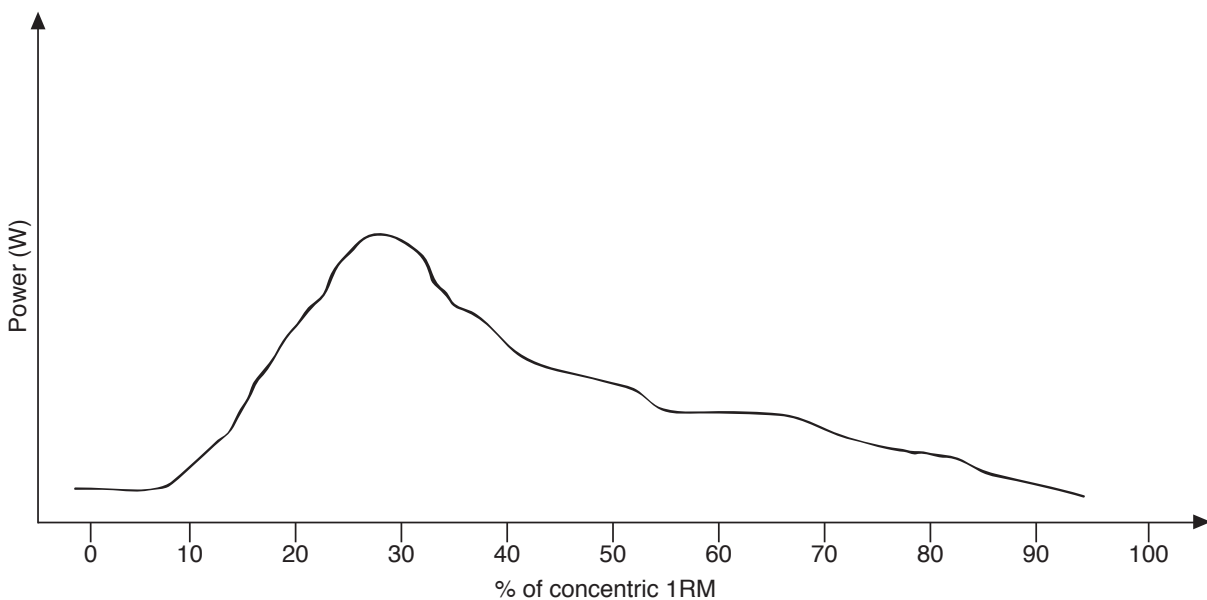

FIGURE 12.7 Theoretical relationship between the resistance used in a concentric exercise and the power production observed. Peak mechanical power will typically occur around 30% to 45% of the concentric 1RM in exercises like squat jumps and bench throws. Exercise choice is important to eliminate any deceleration of the mass. Nevertheless, an athlete needs to train power across the force–velocity continuum to demonstrate force–power with different loads.

Of dramatic importance when training for power is to choose exercises in which a limited amount of deceleration occurs over the range of motion. This typically requires an exercise that allows for continuous acceleration of the mass if using a machine, or pneumatics, that allows for high-velocity movements to occur. If the mass cannot be released, the body will attempt to protect the joint by activating antagonist muscles and limiting the firing of the agonists, making the exercise ineffective for power development. Muscular power can also be developed with supplemental training of the stretch-shortening cycle using plyometric muscle actions prior to rapid shortening. Such drills can help in power development by emphasizing the velocity component of the power equation.

It is imperative that one does not compromise the development of maximal strength, as any detraining of this part of the power equation can result in a power training plateau. Maximal force development is vital for improvements in power production. Findings have supported that a lack of heavy loading with a concentration on purely mechanical power loads along with lighter resistance can result in a

plateau of power and a decrease in strength over a training period. Thus, heavy resistances (90% to 100% of 1RM) must be included in workouts or training cycles. Strength and power development will interact and will need to be addressed over an entire training program. Programs that focus on one component alone, either strength or power, will diminish development of the other component.

Development of Local Muscular Endurance

The ability to produce multiple muscular contractions at different percentages of maximum can also be an important and trainable feature in a resistance training program for athletes. The ability to produce multiple efforts is related to the development of **local muscular endurance**. Training for local muscular endurance should be defined. Is the program attempting to develop high-intensity local muscular endurance or low-intensity local muscular endurance? Higher-intensity muscular endurance is developed by using heavier loads (60% to 80% of 1RM) and incorporating short rest periods and multiple sets. This repetitive endurance can become



Plyometric exercise increases development of the fast-twitch muscles needed for such high-velocity sports as hurdling.

Periodized Program for Development of Strength and Power

Progressions in resistance and number of sets continue over 12 wk with a week of active rest after the 12-wk cycle.

Exercises

Monday (heavy)	Wednesday (moderate)	Friday (light)
Barbell squat	Power clean	Jump squat (loaded 30%-50% 1RM)
Bench press	Leg extension	Dumbbell shoulder press
Leg press (sled)	Stiff-leg deadlift	High pull
Cable seated row	Pectoral dec fly	Bench press
Wide-grip lat pull-down	Dumbbell incline press	Seated row
Shoulder press	EZ arm curl	Dumbbell arm curl
Sit-ups	Triceps push-down	Sit-ups
Leg curl	Hyperextension	Stiff-leg deadlift
Dumbbell upright row	Split squat	Lunge

Rest Periods Between Sets and Exercises

- Monday: 3-4 min
- Wednesday: 1-2 min
- Friday: 2-3 min; jump squats, 3-4 min

Resistance and Set Ranges

- Monday: 3RM-5RM zone, 3-5 sets
- Wednesday: 6RM-8RM zone, 2-4 sets
- Friday: 12RM-14RM zone, 1-3 sets; jump squats, 6 sets of 3

Courtesy of Dr. Kraemer's laboratory.

especially important at higher percentages of maximal force and power production in sports that require repeated bursts of high-intensity efforts. This has been called power endurance or strength endurance, reflecting the need for such repetitive high-intensity efforts.

Conversely, lower-intensity muscular endurance can be developed with high numbers of repetitions. Using sets with resistances from 40% to 60% of 1RM or above 20RM loads will enhance local muscular endurance with little or no carryover to 1RM strength. If this is a needed feature for an athlete, then the training program must include these higher-repetition ranges for certain cycles in a periodized program.

Such training can be distributed over both isolated exercises as well as whole-body multijoint exer-

cises. Care needs to be taken that exercise technique and format are monitored at the end of such sets because fatigue becomes more detrimental to motor performance. Another method of improving this feature of muscular performance is to use shorter rest periods (3 min carefully progressing to 1 min) between sets, with loading allowing only 8 to 10 repetitions. With the high concentrations of lactic acid indicating changes in pH and H⁺ production, an extreme anabolic-glycolytic environment can be produced. While lactic acid does not cause fatigue or pH drops, such workouts can increase concentrations in the blood from 12 to 20 mmol·L⁻¹ making the workout extremely fatiguing (see figure 12.8). Here care is needed as short rest programs with such loads will require the progressive training of acid-base buffering systems arising from the bicarbonate

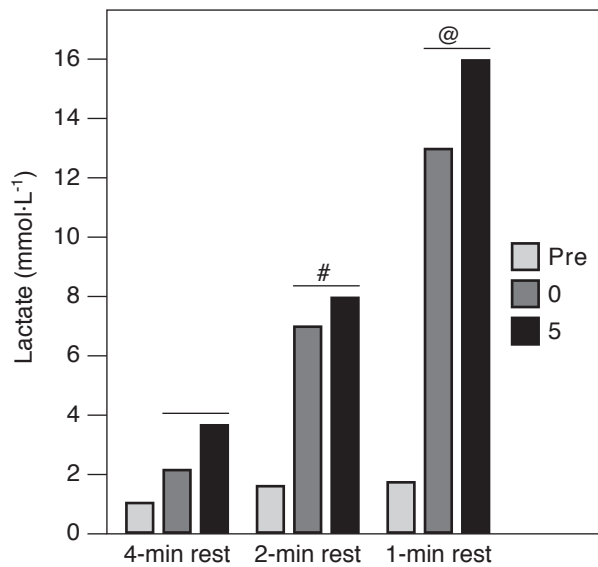

FIGURE 12.8 Relationship between the rest period length between sets and exercises, and lactic acid production after a resistance training workout in women using an eight-exercise program.

Bar = significantly ($p \leq 0.05$) greater than preesting value; # = different from 4-min values; @ = different from 2- and 4-min values.

Unpublished data from Dr. Kraemer's laboratory.

system in the blood and carnosine and phosphates in the muscle. Symptoms of dizziness, nausea, or vomiting are signs of sickness, not an indicator of a good training workout. The workout should be discontinued and a more gradual progression in cutting rest periods is needed. Here we see the potential for rhabdomyolysis if rest periods are not carefully progressed.

You have to be careful as to how you train on light days or train for muscular endurance, which may not be the same thing. Training for local muscular endurance does allow variation in the intensity profile of different training days or cycles in a periodized training program. Maintaining control of exercise volume will allow only low-threshold motor units to be used. Thus, if you are trying to use a light day for recovery of other motor units, you have to keep glycogen depletion directed just to those motor units that lift the lighter resistances. This can be done by limiting the volume of exercise, using one set of 20RM-25RM per exercise. The key is not to create a workout that causes damage due to chemical insults (i.e., excessive H^+ ion and free radical production) on the muscle fibers (indicated by high lactic acid profiles; see figure 12.8). Using rest periods under 2 min, again you want to limit

volume of total work by using only one set. Allowing rest and recovery of high-threshold motor units and their fibers is important because catabolic insults impact nonrecruited motor units—an important point to remember. If a high-intensity 10RM workout with high volume and short rest (2 min or less) is used, it is not a light recovery day; there should be at least one day of rest to support recovery, and the reductions in rest period lengths should be slowly progressed in order to allow for development of buffering capacities in the body. So do not destroy recovery processes by using light days or endurance day workouts. Recovery using light days is the basis for various models in periodized training programs, especially nonlinear methods, which use different training intensities on given days rather than complete cycles of weeks of training.

It is important that extreme high-rep sets are not done, or are done with great care, because the threat of rhabdomyolysis looms as a very dangerous possibility, especially at times of transition or when athletes lack experience with such volume schemes. At times, some coaches use this for punishment and work hardening, and tragic results have occurred at all levels. Thus, local muscular endurance can be created in a strength training program, but care and smart, prudent, and individualized programs are needed.

Physiological Contrasts Between Women and Men

It has become apparent over the past 20 years that women can be trained with programs that are almost identical to those used for men (Fleck and Kraemer, 2014). However, a number of facts need to be considered when designing strength training programs for women. While strength training has been common in women's strength and power sports for many years, other women's sports (e.g., tennis, golf, soccer, basketball) have only started over the past 10 years to incorporate more aggressive strength training protocols.

With more sports using strength training as part of their conditioning programs, some education is needed to calm certain fears and explain such programs' physiological effects. Along with proper instruction on weight room practices, exercise techniques, testing routines, and training procedures, the coach needs to allow ample time to develop team and individual conditioning goals. Due to the wide range of physiological variation within a sport, individualization, or working with individual athletes,

is essential to educate the athletes as to the effects of such training on their body. The most common fear of many women athletes is that strength training will make them look like a man. This can affect the quality of training if women are not completely comfortable with strength training because of this fear. Without anabolic drugs there is little chance of women looking like men through strength training.

Differences in Muscle Fibers

While at some points of development, women may have fewer numbers of muscle fibers in comparison to men, it has also been shown that they have smaller muscle fibers, again keeping in mind cases in which equal sex-group comparisons are made. This sex difference appears to take place during puberty when women have smaller cross-sectional areas when compared to men. In young men, type II muscle fibers are also larger than type I fibers, but size comparison in fiber types is not observed in untrained women. Typically, women's muscle fibers are smaller than those of men. Such facts about muscle contradict the myth of looking like a man through natural strength training. Women do have the same array of muscle fiber types as men, with both type I (slow twitch) and type II (fast twitch) and all of their subtypes. Slow-twitch fibers are primarily used for endurance demands on muscle, and fast-twitch fibers are primarily used for speed, strength, and power demands. A sex difference does exist as to the ratio of muscle fiber sizes in untrained individuals. About 75% of untrained women have slow-twitch muscle fibers that are larger than the fast-twitch muscle fibers. It may be that untrained women who have greater potential for strength and power sports may be in the 25% of women that have such a profile of fiber sizes. The cause of such different starting points for untrained women remains unclear but may be due to differential expression of the genotypes of men and women over time and with development. It has been speculated to be due to less strength and power demands in a woman's everyday activity profile. Or, it could be a true sexual dimorphism difference.

Nevertheless, these differences in muscle fibers can influence a strength training program; women may see more dramatic increases from a strength training program after a plateau, in which fast-twitch muscle fibers need the extra time to catch up and surpass slow-twitch fiber size. Important to this training phenomenon is the use of heavier resistances to stimulate faster growth of the type II

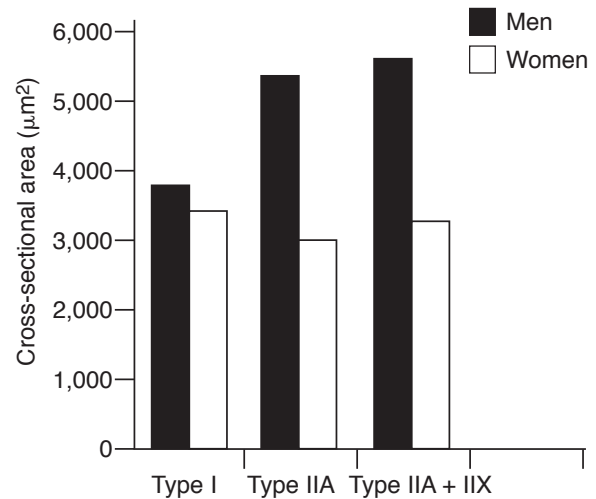

FIGURE 12.9 The relationship between young (20-25 years) untrained men ($n = 15$) and women ($n = 15$) for cross-sectional area of different fiber types. A significant ($p < .05$) difference exists between all of the muscle fiber types, with men having larger cross-sectional areas.

Unpublished data from Dr. Kraemer's laboratory.

muscle fibers found in the higher-threshold motor units. In addition, if slow-twitch muscle fibers predominate, a more rapid detraining phenomenon may result, requiring more frequent maintenance workouts, especially during any maintenance phases of training (e.g., two training sessions per week rather than one). The relationship between men's and women's fiber type over time can be seen in figure 12.9.

Differences in Strength and Power

The differences in the number of muscle fibers and the cross-sectional area of the fibers between men and women can be seen in the differences in absolute strength. Corrections for body size and mass can at times correct for the differences seen in lower-body strength but not upper-body strength, underscoring the need for upper-body development in women.

The average woman's maximal mean total-body strength is about 60% of the average man's maximal mean total-body strength. Average upper-body strength in women ranges from 25% to 55% of men's average upper-body strength. Lower-body strength has been shown to be a higher percentage at about 70% to 75% (Fleck and Kraemer, 2014). The gender influence is still observed in competitive lifts and totals when looking at powerlifters' and weightlifters' records.

It is important to note that these findings are related to broad group comparisons of similar athlete groups or untrained populations with very specific comparison conditions. Obviously, if we made a single comparison with no matching variable (e.g., age, body size), a given woman could demonstrate greater strength capabilities than a man. This was obvious in one study where one woman who had competed in powerlifting could squat 235 kg and none of the men in the study could even approach that level in their 1RM squat. The construction of the comparison is important in order to gain perspective in any gender-related effect.

The average woman has been reported to have 54% to 73% of the maximal vertical jump and 75% of the maximal standing long jump of the average man (Fleck and Kraemer, 2014). For the standing long jump this translates to the average woman generating approximately 63% of the power generated by the average man. One possible reason for this discrepancy is the difference in the size ratio of muscle fiber type between men and women. About 70% to 75% of women have type I muscle fibers with a cross-sectional size that is larger than that of their type II fast-twitch fibers. Power at faster velocities of movement could be affected if the force-velocity curve of women was different from that of men. However, it appears that the drop-off in force as the velocity of movement increases is similar in both genders, and peak velocity during knee extension is not different between genders. The rate of force development could affect power output. Men also have greater pennation angles (i.e., the angle of the muscle fiber's direction of pull relative to the direction of pull needed to produce movement) in many muscles, and this would also affect the mechanics of muscle actions. It does appear that the skeletal muscle's rate of force development is slower for the average woman than for the average man (Fleck and Kraemer, 2014). Thus, training for explosive strength is vital for female athletes in order to enhance rate of force development capabilities and improve power performances.

Differences in Hormone Concentrations

The most obvious difference underlying the fundamental mechanisms that mediate male versus female adaptations to resistance training is the male hormone, testosterone. While both men and women have resting circulatory concentrations, the resting concentrations in women are 10 to 20 times lower (see figure 12.10) (Kraemer and Ratamess, 2003).

This difference is most dramatic when changes occur in adolescent boys and girls, because testosterone mediates the boys' larger muscle size, shoulder girth, and strength. With women producing most of this hormone from the adrenal glands and from the ovaries, some women have higher concentrations of adrenal androgens, and this appears to give them an advantage over other women in their trainability of muscle. The values are still 10 to 20 times lower than that of men, but one can see small increases with the exercise stress as well as small increases over the training period. Concerns for testosterone's relationship to other pathologies remain somewhat epidemiological and have not been linked to training-related changes in women.

It appears that women depend more on the pituitary secretion of growth hormone and its variants or aggregates along with growth factors (e.g., IGF-I) to help mediate the changes in muscle, bone, and connective tissues. Bioactive growth hormone (growth hormone measured by bioassay) concentrations in women are higher at rest than in men, and changes occur differently with resistance training. Even the normal growth hormone levels in women are higher than in men and potentially provide compensatory mechanisms to help in the mediation of anabolic adaptations in muscle as well

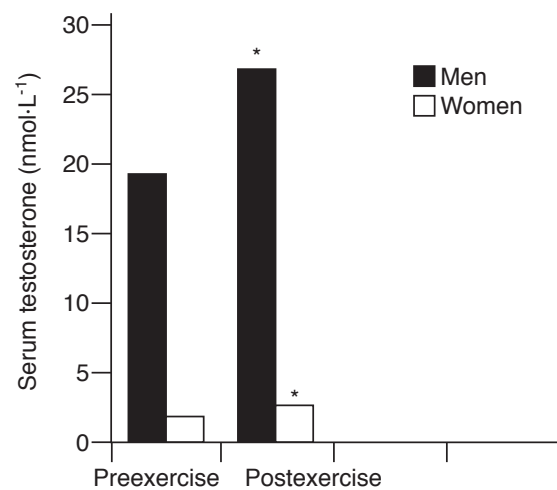

FIGURE 12.10 The relationship between young (20-25 years) trained men ($n = 12$) and trained women ($n = 12$) for serum total testosterone responses before and after a weight training workout. Both genders demonstrated a significant ($* = p < .05$ from preexercise values) increase after the workout with the change being greater in men than women. Note the concentrations for women are dramatically lower than men.

Unpublished data from Dr. Kraemer's laboratory.

as connective tissue (Kraemer and Ratamess, 2003; Kraemer, Ratamess, and Nindl, 2017).

It might be postulated that many biological factors related to the anabolic differences in women may account for differences between the sexes. Additionally, larger increases than normal in lean body mass and limb circumferences in some women are probably due to several factors including:

- higher than normal resting testosterone, growth hormone, or other hormones;
- greater hormonal response than normal to resistance training;
- lower than normal estrogen-to-testosterone ratio;
- genetic disposition to develop large muscle mass;
- mesomorphic profile allowing more muscle fibers present to be trained; and
- differential expression of genes in the genome augmenting protein synthesis.

The responses of muscle fibers for transitions in the quality of proteins are more rapid in women than in men. It has been shown that within two workouts the isoforms of myosin ATPase change to the faster type, where it takes four workouts to stimulate the same changes in men. Thus, women have been found to be very responsive to the resistance training stimulus. The key is to optimally load and vary the program so that a proper exercise stimulus, capable of stimulating the needed physiological responses leading to adaptations, is created.

The development of an effective workout protocol is the first step in creating a training program. Workout protocols for women have been found to be effective if they have varied training demands (periodized training), multiple sets, and a varied loading scheme that includes heavier resistances for strength development. Incorporation of training protocols that address the trainable characteristics of muscle in proportion to importance to the sport is vital to a successful strength training program for women.

Strength Training Guidelines for Women Athletes

A well-designed program for a woman should reflect both her individual needs as well as the demands of the sport she is participating in. The following guidelines can be used to create an individualized

program that has the key basic exercises needed for symmetrical development of the musculature in the upper and lower body. Additionally, it is important to use whole-body exercises to integrate performance of the body's entire kinetic chain. Appropriate exercises for sport-specific movements not included in the fundamental program can then be added. As outlined in the classic paper by Ebben and Jensen in 1998 and consistent with the position of the National Strength and Conditioning Association (NSCA), the following features might be considered as essential in a strength training program for women:

1. Well-designed strength training programs include exercises that use body weight resistance, free weights, and dumbbells. Both women and men should include these in their training, and women should train at the same intensities as men.
2. The use of strength training machines and abdominal exercises need not be discontinued, but emphasis should be placed on the use of free weight exercises, including foot-based lower-body exercises such as the lunge, diagonal lunge, walking lunge, step-up, lateral step-up, and squat.
3. Women should also include upper-body exercises that employ multiple muscle groups such as the bench press, incline press, latissimus dorsi pull-down, pull-ups, and back extension.
4. Women who have developed a strength base should consider using total-body exercises such as the push press, hang clean, power clean, clean and jerk, and snatch.
5. A training program should stress multi-planar, multijoint, functional exercises to develop intermuscular coordination, proprioception, and balance, which result in strength that transfers to sports and daily activities. For example, the step-up is superior to the leg extension machine because it offers functional strength for walking up a flight of stairs while carrying bags of groceries.
6. For athletes who play foot-based sports such as basketball, the squat is superior to using the leg press machine, because the squat is functionally more similar to the sport and requires greater balance, weight, and body control in all three planes of motion.

Incidence of Injury

For too many years many women “played themselves into shape,” which placed them in situations where their body was not ready to take on the demands of the sport. The incidence of injury in a weight room using aggressive training techniques is lower than in almost every competitive sport. It has been estimated that there are about 2.8 injuries or fewer per 1,000 training hours, with most injuries involving overuse of the lower back, knees, and feet. In addition, an increase in injuries typically occurs during times of increased training loads, particularly during the first 2 wk of sport practice and immediately following holidays. The temporal relationship between training load and injury suggests a causative link. Care should be taken any time there is an increase in the volume or intensity of a workout, as this is a susceptible time point where exercise technique and toleration of the workout must be carefully monitored by the strength and conditioning coach.

Specific to women, and especially basketball players, it has been observed that there are higher incidences of **anterior cruciate ligament (ACL)** injuries in women compared to men. While still a topic of intense investigation, it has begged the question as to whether women should train differently than men in order to reduce such a dramatic injury potential. It is known that men have greater ACL thickness than woman and that the trochanteric notch width gets bigger with taller men but not with taller women. This narrower trochanteric notch, along with anatomical factors beyond the scope of this chapter, can predispose women to greater incidence of ACL injury. In a classic review, Pettit and Bryson (2002) came up with an extensive set of recommendations for strength and conditioning programs to help prevent ACL injuries in women, especially basketball players, and readers are referred to this paper for a more detailed analysis. In Dr. Kraemer’s laboratory, it has been observed that while the joint may be healed, the brain signals for inhibitory stimulation of the limb may be still operational and thus, ACL injury or also concussions can lead to the potential for reinjury. Mental imagery and training the brain may be the next frontier for therapeutic approaches to help with recovery.

A key factor discovered by the late Coach Jerry Martin and Coach Andrea Hudby at the University of Connecticut may influence ACL injury prevention. The use of power cleans with the catch appeared

to be vital in preventing ACL injury as they trained women basketball players. Lifting the bar with feet in the narrower power position and landing with wider foot position placement in the strength position while catching the load as one decelerates allows the athlete to “train deceleration” with load. Additionally, it allows repetitive practice of jump takeoff and landing mechanics. Oftentimes strength and conditioning coaches eliminate the catch phase of the movement by using only high pulls and drops, which may take away a crucial aspect of training adaptation that impacts the ACL and jump-landing mechanics.

Menstrual Cycle and Strength Training

Surprisingly few data exist regarding the role of the **menstrual cycle** in strength training. While highly variable, it has been observed that a decrease in normal premenstrual symptoms such as breast enlargement, appetite cravings, bloating, and mood changes occur in trained individuals. This has led to a general concept that active women have fewer problems with premenstrual symptoms than sedentary women. How much exercise is needed and when such activity becomes detrimental to an athlete’s menstrual profile remain a topic of much interest. Menstrual abnormalities include **amenorrhea**, or the absence of menstrual bleeding, with primary amenorrhea being a delay of menarche beyond age 16, and secondary amenorrhea being the cessation of menstruation in a woman who had previously menstruated; **dysmenorrhea**, meaning painful menstrual periods; **hypermenorrhea**, meaning excessive or prolonged uterine bleeding in amount and duration of flow occurring at regular intervals; and **oligomenorrhea**, meaning infrequent or light menstrual cycles. It should be noted that women who reported higher levels of life-event stresses had an increased incidence of dysmenorrhea, hypermenorrhea, and abnormal menstrual cycle lengths.

Exercise Stress and the Menstrual Cycle

It is not just exercise that can cause menstrual cycle abnormalities. Other factors include inadequate caloric intake, which can interact with exercise training and competition and may induce menstrual problems. Many sports in which lower body weight appears to enhance performance (e.g., gymnastics, cross country running) or that have body weight classifications (e.g., weightlifting, women’s wrestling) may in fact promote problems with

menstrual cycle normality. In addition, high volumes of intense training accompanied by low levels of caloric intake may exacerbate such problems.

It is now known that the prevalence of secondary amenorrhea in athletes is higher than in normal women living a less active lifestyle, but the correlation is not evidence of cause and effect. A new paradigm on this problem dictates that all menstrual cycle problems exist on a continuum of severity and are affected by physical, nutritional, and behavioral components that modify severity.

For women it is essential that proper nutritional intake of total calories and diet composition (i.e., protein intake) are met in order to meet the demands for energy expenditure and for the repair and remodeling of muscle tissue. Many women do not eat enough protein to meet the demand for the amino acids needed for protein synthesis after a strength training workout. Such dietary behavior and other nutritional deficiencies (e.g., reduced calcium intake) can limit optimal adapta-

tion to a workout and training program, and may be a major contributing factor to menstrual cycle abnormalities.

Interestingly, 25% of 199 Olympic-style weightlifters, of an average age of 16 years, reported having irregular menses; only three of these athletes aged 13 to 15 had not yet begun to menstruate. In distance runners, greater training distance, intensity, frequency, and duration of training season have all been implicated as factors increasing the risk of menstrual irregularities. However, not all athletes performing high-volume, high-intensity training will experience menstrual irregularities. Again, caloric intake, exercise stress, and psychological factors can all contribute in different ways to menstrual problems, and the magnitude of each is highly individual.

Menstrual Cycle and Performance

Dysmenorrhea may increase with an increase in premenstrual symptoms. Dysmenorrhea is reported by

Some Advice to Pregnant Female Athletes

It may surprise you to know that the risk of heavy lifting in pregnancy is not injury to the baby but injury to the mother. Pregnancy hormones cause the ligaments to soften, which helps the pelvis widen to make room for childbirth. As a result of softer ligaments, joints may be less stable than usual, and injury may be more likely. Therefore, women should not start a new or more aggressive strength training program during pregnancy. Prior long-term strength training will dramatically help women more quickly return to their normal strength training routines after delivery.

Carl Petersen (2005), a physical therapist who works with many women during pregnancy, advises, "Continue doing what exercises feel comfortable, but don't strain yourself by attempting new, unfamiliar lifts or by using too much resistance. Exercises that mimic your daily activities, like step-ups, split squats, and mini-lunges, are best."

Here are some suggestions for specific exercises that can be performed during pregnancy:

Exercise Cautionary Notes

- Squats: Range of motion should be decreased (knees should never be flexed beyond 90°). If you want to increase the squat workout, decrease the pace (i.e., lower slowly to a count of three or four).
- Leg presses: Leg presses help keep the lower abdominals tight, which protects your back. However, limit this exercise to the first trimester only (exercises performed on the back should be phased out before the second trimester).
- Hip abductor machines: Working out on a hip abductor machine will build strength in the hips, which counteracts postural changes. Keep lower abdominals tight to avoid hyperextending the back. If you experience numbness, pain, or tingling down the back of your legs (sciatic symptoms), see a doctor.
- Ab work: Concentrate on gaining control of the lower abdominals by performing pelvic floor exercises (Kegels). Traditional sit-ups should be deleted from the exercise routine.

60% to 70% of adult women, and it increases with the age of women. Many women who suffer migraine headaches also see an increase in headaches and migraine attacks at the time of menstruation. It has been estimated that more than 60% of women who experience migraine headaches suffer from menstrual migraines. Similar to premenstrual symptoms, dysmenorrhea occurs less frequently and is less severe in athletes than in the normal population. Premenstrual symptoms or dysmenorrhea could have a detrimental effect on athletic performance, and some investigators recommend use of oral contraceptives or progesterone injections to control the occurrence of menses and to avoid competing while menstruating.

Strength is not different over the normal menstrual cycle, but other investigations indicate that the best physical performance probably occurs between the immediate postmenstrual period and the fifteenth day of the menstrual cycle. However, Olympic-medal performances have been demonstrated during all portions of the menstrual cycle. Thus, the effect of the menstrual cycle on performance is unclear and is probably highly individualistic. Oligomenorrhea or secondary amenorrhea should have no effect on performance. Participation in conditioning programs and athletic events should not be discouraged during menstruation; to date, negative effects are highly individual and no detrimental effects on health have been observed.

The Female Athlete Triad

The **female athlete triad** refers to a group of problems that could affect women athletes. The triad is composed of the following three factors; each, in its own right, can damage a woman's health, fitness, and performance.

1. *Disordered eating.* This involves a spectrum of problems from inappropriate body imaging to bingeing and purging disorders. Anorexia nervosa (self-starvation) and bulimia nervosa (binge eating and purging) are medical problems that need the care and attention of appropriately trained medical doctors. Nutritionists or conditioning professionals should not attempt to deal with these medical problems. Identification of the problem by the sports medicine team is crucial to successful care and treatment.

2. *Amenorrhea.* As discussed, amenorrhea involves not having a menstrual cycle for an

extended period of time. Primary amenorrhea is not having a period by the age of 16. Secondary amenorrhea is a phenomenon related to missing three or more consecutive periods once normal periods have begun.

3. *Osteoporosis.* This is the classic disease of abnormally low bone mineral density, which increases the risk of fractures, especially with aging.

Strength training when disordered eating habits exist remains difficult at best due to the inherent problem of meeting the protein and caloric needs to repair and remodel muscle. Typically, anorexic behavior focuses on endurance exercise, as it relates to greater caloric burn or a reducing of body size. Once caloric intake and nutrients are corrected, strength training has been used to help with exercise therapy, but little work has been done in this area and conditioning coaches need to work carefully with physicians in such situations.

In addition, men are also susceptible to eating disorders, especially with weight class sports (e.g., bulimia in wrestling) and extreme dieting for body image.

Strength training with various types of amenorrhea has not presented the same inherent problems when it is not associated with caloric deficits or dramatic endurance training volumes. However, due to its intimate linkage to eating behaviors, dietary analysis and counseling of women athletes can help in monitoring this aspect of the female triad.

Strength training has been viewed as an important intervention for osteoporosis, as it assists with bone maintenance. Even more important may be the initiation of resistance training early in a woman's life in order to accrue maximal bone mass and density before adulthood. The extent of the disease will dictate how effective strength training can be, and when exhibited in younger women athletes it is usually related to one or more triad interactions and associated behaviors.

Strength training programs have been conducted in the face of each of these problems.

While it is easy to oversimplify the causes of the different components of the female athlete triad, certain populations of athletes may be more susceptible than others, and the causes may vary. Many sports have very subjective judging that involves body form and image. Sports like figure skating, gymnastics, and diving place a great deal of stress on women, as body form is both revealed and viewed in the scope of the competition. Some coaches

actually encourage eating disorders by making ignorant comments and placing demands on the athlete's body mass or body fat. Small but negative influences such as these can have far-reaching and damaging effects for some women. All coaches and individuals involved in sports should therefore be careful to avoid such statements because they may precipitate negative consequences for a woman's health. Strength coaches should also be aware of

these issues within the context of their own sport-specific training programs.

Athletes are susceptible to the female athlete triad under the following types of conditions:

1. Sports that are judged subjectively (e.g., dance, figure skating, diving, gymnastics, aerobics)
2. Endurance sports (e.g., distance running, cycling, cross-country skiing)

Summary Points of the NSCA's Position on Strength Training for Women

In an effort to better understand the important issues for women and strength training, the NSCA put together a study task force, which released its findings in a position stand in 1990. These were the major points from that consensus panel regarding strength training and women.

1. Proper strength and conditioning exercise programs may increase athletic performance, improve physiological function, and reduce the risk of injuries. These effects are as beneficial to female athletes as they are to male athletes.
2. Due to similar physiological responses, it appears that males and females should train for strength in the same basic way, employing similar methodologies, programs, and types of exercises.
3. In the lower body, the relative strength (ratio of strength to lean body mass) of untrained women appears to be approximately equal to that of men.
4. Females can hypertrophy their muscles through resistance training relatively the same as men, but not absolutely the same.
5. Female athletes appear to have the same fiber-type distribution as men, although the female fibers appear to be smaller in cross-sectional area.
6. There is little research evidence to suggest that the onset of a normal menstrual period affects athletic performance.
7. Female athletes whose menstrual cycle has ceased have an increased likelihood of developing musculoskeletal injuries. Athletes experiencing amenorrhea or other menstrual problems should consult their gynecologist.
8. Resistance training using multijoint and structural exercises is recommended to induce sufficient stresses on the skeletal system and to enhance calcium storage in the bone.
9. Little data exist regarding weight training and pregnancy. Anecdotal evidence suggests that women may safely weight train during pregnancy; however, common sense must be employed when selecting training intensities and exercises.
10. Due to the influx of the hormone relaxin, which softens tendons and ligaments in preparation for delivery, caution is warranted for pregnant women in performing heavy multijoint exercises (squats, deadlifts, snatches, and cleans) after the first trimester. Also, the potential for increased body temperature in pregnant women warrants the use of precautions in dress and environmental conditions during all types of exercise.
11. Resistance training has demonstrated favorable changes in body composition with minimal change in body weight.
12. Because females are, in general, weaker than males in the upper body, adult females should work especially hard on upper-body strength training.

Adapted from National Strength and Conditioning Association, "Strength Training for Female Athletes: A Position Paper: Part II," *NSCA Journal* 11, no. 5 (1989) 29-37, by permission of the National Strength and Conditioning Association.

3. Sports in which women wear revealing or form-fitting clothing (e.g., volleyball, swimming, diving, track and field, cheerleading)
4. Weight classification sports (e.g., wrestling, weightlifting, rowing, some martial arts)
5. Sports in which a prepubescent body is emphasized (e.g., figure skating, gymnastics, diving)
6. Errant comments by coaches and teammates about being too fat (social media, etc.)

The younger the woman is when such factors come into play, the more dramatic the effects may be. In addition, many women have to deal with dramatic maturation processes in sports where body form and function are related to a more immature body type due to the biomechanical requirements of the sport skills (e.g., diving, figure skating, and gymnastics).

Summary

Developing strength training programs for women athletes requires matching the demands of the

sport to the physical attributes of women. Individualization of programs to prepare a woman's body for the sport is vital and involves addressing various aspects of physical development. The trainable features of muscle should be addressed along with injury prevention as related to women specifically (e.g., ACL injury). Power development is vital in most sports today and is supported by optimizing strength. Upper-body development (both muscle strength and size) can be a primary target beyond normal training program design in order to improve most sport performances where upper-body musculature is highly involved with the performance in the sport. While only subtle differences exist between the training of men and women, care should be taken never to assume that responses will be identical to a given workout or over a training cycle. As with men, evaluation of progress and fine-tuning of the exercise prescription are needed to optimize a strength training program for women.

This page intentionally left blank

STRENGTH TRAINING FOR YOUNG ATHLETES

With the growing trend of obesity in young children and a decline in participation in many youth team sports, physical activity of young children is more important than ever. Proper development of conditioning programs is vital for the long-term growth and maturation of the young athlete (Faigenbaum et al., 2009; Lloyd et al., 2016). Strength training is an important modality that can promote fitness behaviors, help fight obesity as a gateway modality for exercise behaviors, and most importantly prevent injuries in young athletes by “training to play.” In a study by Goldfield and colleagues (2017) in Canada, they found that adherence to a diet and healthy lifestyle and psychological well-being were fostered by the inclusion of a resistance training program with a traditional aerobic training program in boys and girls from 14-18 years of age who were overweight or fighting obesity.

Strength training has now become more accepted, yet often misinterpreted, by some parents and coaches as to its application. For the young athlete, it is important to use this modality properly with age-appropriate programs and targets for improving strength, coordination, and fitness, in a safe and enjoyable environment that promotes lifetime fitness values in conditioning and sports. Parents, coaches, and sports medicine professionals have come to realize the benefits of strength training for children as young as 5 and 6 years old. This conversion is due to our improved understanding of this modality’s efficacy, safety, and appropriateness of training protocols. If a program is appropriately





Resistance training for young athletes can benefit performance as well as provide health benefits to muscle and connective tissues.

modified for young athletes, they can participate in a wide variety of strength training programs. The young athlete can gain health benefits, improved athletic performance, and help with injury prevention if programs are properly designed and implemented by qualified individuals.

While professionals have supported the use of strength training programs by children, they have cautioned parents, teachers, and coaches about the need for proper program design, competent supervision, and correct instruction of exercise techniques. These areas are paramount for safe and effective resistance training programs for children. Some of the benefits (e.g., performance enhancement in pre-adolescence) require further study to explain anecdotal and clinical impressions. However, greater understanding has started to diminish unrealistic fears about children and resistance training.

The primary questions that are asked concerning strength training programs for younger athletes include the following:

1. Is it safe for a young athlete to lift weights?
2. When can a young athlete start to lift weights?
3. Will the young athlete gain any benefits from lifting weights?
4. What type of program should the young athlete use?

Safety and Strength Training for Young Athletes

The National Strength and Conditioning Association's position stand, which has been supported by other sports medical and science organizations, stipulates the following on strength training for younger children and adolescents including young athletes (Faigenbaum et al., 2009):

1. A properly designed and supervised resistance training program is relatively safe for youth.
2. A properly designed and supervised resistance training program can enhance the muscular strength and power of youth.
3. A properly designed and supervised resistance training program can improve the cardiovascular risk profile of youth.
4. A properly designed and supervised resistance training program can improve motor skill performance and may contribute to enhanced sports performance of youth.
5. A properly designed and supervised resistance training program can increase a young athlete's resistance to sports-related injuries.
6. A properly designed and supervised resistance training program can help improve the psychosocial well-being of youth.
7. A properly designed and supervised resistance training program can help promote and develop exercise habits during childhood and adolescence.

A major issue today is that young athletes are playing so many sports that too little time is allocated to prepare their bodies for the rigors of competitive stress. It has been shown that 1 out of 10 children may experience sports-related injuries a year and the overall incidence and severity is higher in boys (Rosendahl and Strouse, 2016). Girls see a higher incidence for ACL tears than boys, and sport injuries can have a long-term effect for other disease progressions (e.g., degenerative arthritis). Resistance training for young athletes can influence and provide benefits for movement control, reductions in body fat with proper diet, and can aid in the development of muscle and connective tissues. Many injuries that have been reported from strength training exist in case studies from the 1970s and 1980s when resistance training for young athletes was starting

Obesity and Inactivity

The Centers for Disease Control and Prevention (CDC) reported that the prevalence of childhood obesity in the United States is a serious problem that places children and adolescents at risk for poor health outcomes.

Obesity

The CDC reports the following statistics for children and adolescents aged 2-19 years:

- The prevalence of obesity was 18.5% and affected about 13.7 million children and adolescents.
- Obesity prevalence was 13.9% among 2- to 5-year-olds, 18.4% among 6- to 11-year-olds, and 20.6% among 12- to 19-year-olds. Childhood obesity is also more common among certain populations.
- Hispanics (25.8%) and non-Hispanic blacks (22.0%) had higher obesity prevalence than non-Hispanic whites (14.1%).
- Non-Hispanic Asians (11.0%) had lower obesity prevalence than non-Hispanic blacks and Hispanics.

Inactivity

Interestingly, 2017 CDC statistics show that for adolescents only 26.1% (range 24.1%-28.3%) were meeting the guidelines for aerobic physical activity (physically active ≥ 60 min per day on 7 days/wk), yet 51.1% (range 47.5%-54.7%) were meeting the guidelines for muscle-strengthening activities (muscle-strengthening activities on ≥ 3 days/wk), while only an average of 20% (range 17.2%-23%) met the guidelines for doing both types of programs.

Due to the digital environment that we now live in, sedentary behaviors have been engrained into everyone's lifestyle. Thus, conditioning activities are an important tool to help to fight the negative effects of the inactivity created by this ever-changing technological environment. With the high incidence of childhood obesity in the Western world, many children cannot do simple push-ups, pull-ups, and sit-ups. It has been shown that even body weight exercises are difficult to accomplish, and the inability to perform an exercise dramatically affects the child's desire to exercise due to negative feedback and lowered self-esteem. The ability to handle one's body mass is vital to optimal athletic performance, and weight training exercises should be used to reduce the loading and improve the base fitness levels of younger athletes so that they can develop the ability to control their body mass in exercises like push-ups and pull-ups. Progression in various machine and lifting exercises can help develop body mass control and movement, a critical feature of athletic performance. A strength training program can improve body composition and increase the child activity profile dramatically.

to appear in youth sports. Case studies cited injuries such as epiphyseal plate fractures and lower back injuries. Today it is better understood that such cases were often due to misuse of equipment, inappropriate weight load, improper technique, or lack of qualified adult supervision—underscoring the need for proper supervision (Myers et al., 2017; Dahab and McCambridge, 2009).

Thus, training the body to play a sport is vital not only to physical performance but also to help prevent injury. Safety in strength training is crucial

for the young athlete. Injury is primarily caused by mistakes in exercise technique, spotting (or lack thereof), or accident. Prevention of injury is an important factor, and reducing, if not eliminating, the injury potential of a strength training program can be the most prudent approach when training the young athlete. The types of injuries are typically related to the muscle and connective tissue and can be prevented with appropriate precautions. In 2014, 60 million youth ages 6 to 18 had participated in some form of athletics with about 3.5 million chil-

dren injured annually (Walters et al., 2018). Resistance training has been supported as a modality to help in the prevention of injuries related to sport and to help with the young athlete's ability to gain more physical literacy or movement control (Myers et al., 2017; Walters et al., 2018; Zwolski et al., 2017).

Types of Musculoskeletal Injuries

Resistance training in children, as with most physical activities, does carry some inherent risk of musculoskeletal injury, yet this risk is no greater than that of many other sports or recreational activities in which children regularly participate. In one prospective study that evaluated the incidence of sports-related injuries in children over a 1-year period, resistance training resulted in 0.7% of 1,576 injuries, whereas football and basketball resulted in 19% and 15%, respectively, of all injuries. When the data were evaluated in terms of 100 participants, football (28.3% of injuries) and wrestling (16.4% of injuries) were at the top of the list, but strength training was not included in this final analysis. However, the possibility of acute and chronic injuries to children's growth cartilage has been a valid concern. Therefore, a strength training program for young athletes should not focus primarily on lifting maximal or near-maximal amounts of resistance. Again, proper technique must always be stressed because most injuries in resistance exercise are related to improper exercise technique (Kraemer and Fleck, 2005). Young athletes need time to adapt to the stress of resistance training, and some children find it difficult to train or don't enjoy training at a particular age. Interest, growth, maturity, and understanding all contribute to a child's view of exercise training.

Growth-Cartilage Injury

In addition to the possibility of injury normally associated with adults, the prepubescent individual is subject to growth-cartilage injury. Growth cartilage is located at three sites: (1) the epiphyseal plate or growth plate, (2) the epiphysis or joint surface, and (3) the tendon insertion or apophyseal insertions. The long bones of the body grow in length from the epiphyseal plates located at each end of the long bones. Due to hormonal changes, these epiphyseal plates ossify after puberty. After **ossification**, growth of the long bones is no longer possible; thus, an increase in the height of an individual is also no longer possible. The epiphysis acts as a shock absorber between the bones that form a joint.

Damage to this cartilage may lead to a rough articular surface and subsequent pain during movement of the joint. The growth cartilage at apophyseal insertions of major muscle, tendon, and bone units ensures a solid connection between the tendon and bone. Damage to the growth cartilage at this site may cause pain and may also increase the chance of separation between the tendon and bone. All three growth-cartilage sites are more susceptible to injury during the adolescent growth spurt due to factors such as increased muscle tightness across joints. Such concerns about this injury with resistance training has diminished dramatically with proper programming and supervision (Milone et al., 2013).

Acute Injury

Acute injury refers to a single trauma causing an injury. Acute injuries to the skeletal system, such as growth-cartilage damage or bone fractures, are very rare during strength training. The most common acute injury risk for prepubescent weight trainers, as in adults, is muscle strains. Strains are many times the result of not warming up properly before a training session. Several sets of an exercise should be performed before performing the true training sets of a workout. The other common cause of muscular strain is attempting to lift too much weight for a particular number of repetitions. Young athletes should be instructed that the number of repetitions per set is a guideline as to the acceptable number of repetitions to perform.

Cases of epiphyseal plate fractures in prepubescent weight trainers have been reported. This area is prone to fracture in children because the epiphyseal plate has not yet ossified and does not have the structural strength of mature adult bone. All of these case reports involved overhead lifts (i.e., overhead press, clean and jerk) with near-maximal resistances. These case reports reveal two precautions for prepubescent programs. First, maximal or near-maximal lifts (1RMs) should not be stressed in prepubescent athletes, especially in unsupervised conditions. Second, because improper form is a contributing factor to any injury, proper form of all exercises (particularly overhead lifts) should be emphasized with young trainees.

Peak fracture incidence in boys occurs between the ages of 12 and 14 years and precedes the age of peak height increase or growth spurt. It appears the increased fracture rate is due to a lag in cortical bone thickness and mineralization compared to linear bone growth. Therefore, it is important to control

the resistance used by boys during weight training between the ages of 12 and 14 years. This same line of evidence may also apply to girls between the ages of 10 and 13 years.

Acute trauma can cause low back problems in adults as well as children. In resistance training, acute trauma may be caused by lifting maximal or near-maximal resistances and attempting to perform too many repetitions. In many cases, back pain is associated with improper form in the squat or deadlift. While performing these exercises, it is essential to keep the back in an upright position, using the legs as much as possible. This keeps the torque on the lumbar region low, protecting the lower back from excessive stress.

Chronic Injury

Chronic injury, or overuse injury, refers to repeated microtraumas causing injury. Shin splints (injuries to the front lower leg) and stress fractures are common overuse injuries. Improper technique over long periods of time can create overuse injuries (e.g., use of variable resistance machines that do not fit the child). It is possible to damage all three growth-cartilage sites due to physical stress. As an example, repeated microtrauma to the shoulder due to baseball pitching results in damage to the epiphyseal plate of the humerus. This damage causes pain with shoulder movement and is often called Little League shoulder. The growth cartilage on the articular surface of prepubescent joints is more prone to injury than that of adults. This is especially true for the articular cartilage at the ankle, knee, and elbow. Osteochondritis dissecans is a disorder in which a fragment of cartilage and subchondral bone separates from an articular surface. The knee is most commonly affected, but the elbow and ankle may also be involved. Repeated microtrauma appears to be responsible for many cases of osteochondritis dissecans at the elbows of young baseball pitchers and the ankle joints of young runners. The growth cartilage at the site of a tendon insertion onto a bone may be connected to the pain associated with Osgood-Schlatter disease. Although the cause of Osgood-Schlatter disease is not completely known, there is increasing evidence that it may in part be due to tiny avulsion fractures (i.e., pulling the tendon from the bone). Similar injuries in adolescents could be related to improper resistance exercise technique.

Repeated microtrauma can cause a compression fracture of the vertebrae resulting in pain. During a growth spurt, many children tend to develop lor-

dosis of the lumbar spine. Lordosis is an increased curvature of the normally curved lumbar spine. Excessive lordosis may cause an extreme inward curve in the lower back. This condition is also called swayback. Several factors contribute to lordosis, including enhanced growth in the anterior portion of the vertebral bodies and tight hamstrings. Not every incidence of lordosis requires medical treatment. However, when the curve is rigid (fixed), medical evaluation is warranted.

Back Injury

Back problems due to resistance training can be minimized by performing exercises that strengthen the abdominal muscles (e.g., sit-ups) and back musculature (e.g., good morning exercises, back hyperextensions). Strengthening these areas will aid in maintaining proper exercise technique, thus reducing stress on the lower back. When performing exercises to strengthen the lower back, the resistance should be at a light to moderate intensity that allows the performance of at least 10 repetitions.

There is the potential for a catastrophic injury if safety standards for youth resistance training such as adult supervision, safe equipment, and age-specific training guidelines are not followed. In one case study, a 9-year-old boy died when a barbell rolled off a bench press support and fell on his chest. This fatality underscores the importance of providing close adult supervision and safe training equipment for all youth resistance training programs, but especially for younger children.

Any exercise or activity recommendations for children have risks as well as benefits. Although resistance training injuries may occur, the risk can be minimized by close adult supervision, proper instruction, appropriate program design, and careful selection of training equipment. There are no justifiable safety reasons that preclude prepubescents or adolescents from participating in such a resistance training program.

Primary Factors in Avoiding Injury

The literature and opinions of sports medicine and sport science professionals support the idea that strength training for young athletes is safe and involves low risk with the caveat that competent supervision and proper programs must be incorporated into its implementation. The primary causes of injury in strength training programs are mistakes in exercise technique or accidental injury.

Each of these can be exacerbated in young athletes if proper instruction and supervision are not available. Accidental injury comes from a lack of proper weight room rules (e.g., not wearing shoes) and from equipment failures (e.g., inadequate construction of a bench to hold the weight), each of which can be addressed by a trained strength and conditioning specialist. Other factors that increase the potential for injury relate to overuse injuries from inappropriate program design, such as young adolescent boys doing 20 or 30 sets of arm curls each day to develop their biceps muscles. When it comes to strength training, young children left to their own devices will end up with less than optimal results. Thus, all of the major organizations, including the National Strength and Conditioning Association (NSCA), American College of Sports Medicine (ACSM), American Academy of Pediatrics (AAP), and American Orthopaedic Society for Sports Medicine (AOSSM), stress the importance of adult supervision and programs designed by trained personnel for young athletes. Supervised strength training has been found to be safe and effective even for the preadolescent athlete (Guy and Micheli, 2001). Competent supervision involves having an individual who understands exercise techniques, exercise prescription, and the ways in which children differ from adults in their needs and requirements for strength training. While coaches and parents can help in this process, they should be trained by a certified strength and conditioning specialist to ensure that all of the proper safeguards are in place when working with young athletes.

Proper Lifting Techniques

The most important aspects of safety for young athletes in the weight room is the proper instruction and subsequent comprehension of correct lifting and exercise techniques. Fundamentals of teaching lifts include

1. proper warm up,
2. proper warm-up sets,
3. proper stance,
4. body position and equipment fit,
5. proper grip,
6. correct range of motion for the exercise movements,
7. proper focus and attention to the lift, and
8. proper positioning of required spotters.

Additionally, it must be remembered that children are not just little adults. Physiologically their bodies are in a constant state of growth and development. Thus, children's nervous systems are still developing at a rapid pace and not completely matured until about 21 years of age. From the brain to the motor system, changes are taking place and neural pathways are being developed. Thus, teaching and learning are vital in athlete development (Lloyd et al., 2016). How a child's brain imagines and translates demonstrated exercise movements may be different from how an adult imagines it. Additionally, neuromuscular control of movements may be more challenging in many young athletes going through dramatic growth and development, and is often due to a lack of integrated control by the nervous system. Thus, feedback is so important and practice of movements from simple to complex has to be an important part of a training session. Loading too quickly or not carefully monitoring exercise techniques when intensity increases, even in experienced young athletes, can increase the risk of injury. It is also important to understand that as the lifts get more complex and require higher levels of neural coordination, teaching, monitoring, and practicing exercise techniques are even more important. Practice and evaluation are vital, and with video capabilities readily available on cell phones, feedback can be in real time. Simple apps showing body segments and movement analysis can also be helpful if understood and used appropriately.

Teaching lifts can become demanding for coaches as the complexity of the exercise technique increases. Free weight lifts such as squats, lunges, and bench presses, as well as Olympic-style weightlifting movements such as pulls, cleans, and snatches can be effectively taught and safely added to a strength training program. However, many times the inability of the coach to properly teach an exercise increases the potential for both acute injury and chronic overuse injuries, and ultimately reduces the training effectiveness of the exercise. Understanding proper exercise technique and the associated spotting requirements of the exercise is mandatory for a safe and effective strength training program. Teaching proper exercise technique is essential for both free weight and weight machine exercises. For extensive explanations of exercise techniques, see the book by Kraemer and Fleck (2005), which describes over 120 exercises in detail.

Proper Spotting Techniques

Spotting for both machine and free weight exercises is just as important as exercise technique. Spotting refers to an individual or individuals who assist the lifter as needed. Spotters not only assist the lifter with completion of a repetition, they also assist the lifter by correcting improper exercise technique. Spotters are vital for a safe strength training program. The following is a checklist developed by Kraemer and Fleck (2005) that spotters should use at all times:

1. Know proper exercise technique.
2. Know proper spotting technique.
3. Be sure you are strong enough to assist the lifter with the resistance used.
4. Know how many repetitions the lifter intends to do.
5. Be attentive to the lifter at all times.
6. Stop the exercise if incorrect technique is being used.
7. If incorrect exercise technique is used, correct the technique.
8. Know the plan of action for when a serious injury occurs.

The major goal of spotting is to prevent injury. A lifter should always have a spotter. No trainee should perform resistance training without proper supervision, including a spotter. Both you and the trainee should know correct exercise and spotting techniques for all exercises performed in a training program. If trainees are responsible enough, they may spot each other. If the child or adult cannot spot each other, enlist the help of other trained adults or reduce the number of people training at one time.

Proper Equipment Fit

It is important to understand that with young athletes, equipment fit is vital to safe training. If a child does not fit into a weight machine properly, a host of problems can arise including incomplete ranges of motion for exercises, inappropriate loading stresses leading to acute injury or overuse injuries, and improper muscular development. When using free weights these problems can be eliminated or reduced, but machine fit needs to be evaluated for each child. Most weight machines are made for the “normative male,” and a young person’s limb

size and body size may not match the machine. This is especially true for machines that attempt to change the resistance over the range of motion (called variable resistance), because strength curves (i.e., patterns of force that can be produced over the range of motion) of children will not match those of adults, and no one machine can typically fit the array of strength curves seen in a population of young athletes. Just moving a seat up or down or changing a pad may not fix the situation. Along with fit is the problem of the weight machine having too much weight for one repetition to be performed or increments that are too great from one stack plate to the next. If fit or loading are in doubt, come up with an alternative free weight exercise (Kraemer and Fleck, 2005).

Proper Breathing Technique

Breathe in before the lift and breathe out when lifting or pushing the weight out. Take a few deep breaths before you start a set and then get ready to perform the set of an exercise. Check for body position, stance, and grip and focus on what muscle you will be training. Then inhale just before the lift and breathe out as you lift the weight. As you lower or return the weight, plates, bands, or body mass back to the starting position, breathe in, getting ready for the next repetition. Try not to hold your breath, which can be a natural behavior as resistance or loading gets heavier and is typical of maximal lifting attempts. In most cases, the target of young athletes is not to lift the maximal weight, so be careful when lifting to failure because this is also where breath holding can occur when trying to squeeze out that last repetition; let it go because by that time there are diminishing benefits for struggling with the last rep in a set. Holding your breath can lead to increases in blood pressure and can reduce blood flow to the brain, resulting in light-headedness or fainting, and possibly injury. Because lifting maximal or near-maximal resistances is not the goal of weight training programs for children, there is no need for excessive breath holding. Proper breathing should be taught and encouraged at all times.

When to Start

A prerequisite for the development and administration of safe and effective youth resistance training is an understanding of established training principles and an appreciation for the physical and emotional maturity of children. Although there is

Proper Exercise Technique for Sample Exercises

The following are a few examples of exercises used in most weight training programs for young people.

Bench Press

Start position: Lie on your back on a flat bench. Grasp a barbell with an overhand grip, palms facing upward. The hands should be wider than shoulder-width apart. The barbell is held at arm's length above the upper chest (*a*). The back of the head, upper back, and buttocks are in contact with the bench. The feet are wider than hip-width apart and flat on the floor. The knees are at a 90° angle.

Movement and end position: Lower the barbell to the midchest in a controlled manner (*b*). Allow the barbell to touch the midchest and then extend the arms, returning the bar to the arm's-length position. The upper arms form a 65° to 90° angle to the torso in the chest-touch position. If viewed from the side, the end of the barbell travels in a smooth arc between the arm's-length position and the chest-touch position.

Spotting: When using light weights, one spotter can stand behind the lifter's head and assist if necessary. If heavy weights are used, two spotters should assist, one standing at each end of the bar, facing each other.



Squat

Start position: Stand erect, with your feet hip-width or slightly wider apart, feet flat on the floor and weight on your midfoot and heel areas, toes pointing straight forward or slightly to the outside, head upright and eyes looking forward, barbell resting on the spines of your shoulder blades, hands grasping the barbell with an overhand grip and palms facing forward, hands shoulder-width apart or wider (*a*). The barbell should be removed from a power rack or squat rack to get into the start position.

Movement and end position: Bend your knees and hips in a controlled manner until the tops of your thighs are parallel to the floor (*b*). Your knees should move forward and stay in a line above

your toes as your knees bend. Return to the start position in a controlled manner; your torso will lean forward but should remain as upright as possible at all times, your feet remain flat on the floor, and your weight remains on your midfoot and heel area at all times. The head stays upright, eyes look forward at all times, and shoulders stay back at all times.

Spotting: Squats should be done in a power rack or similar safety device. Two or three spotters are recommended with one on each end and one behind the lifter.



a

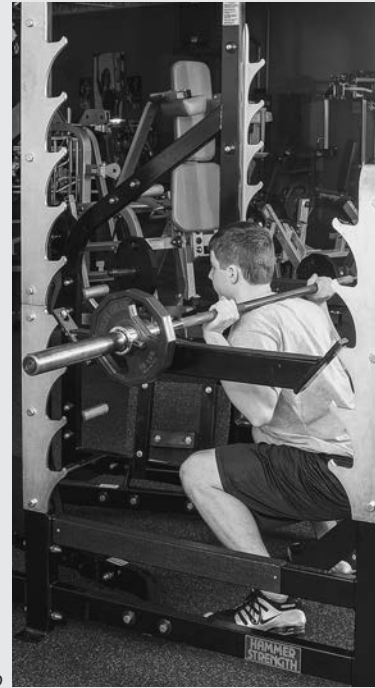

b

Seated Cable Row

Start position: Sit on the seat with your torso forming approximately a 90° angle with your thighs, feet hip-width apart and resting flat on the foot plates, and with a slight bend in your knees (a). Your torso should be upright with the back slightly arched backward, and neck and head in line with the rest of your back. Grasping the handle with an overhand grip, elbows straight with the handles held at arm's-length and your shoulder blades relaxed and separated, adjust the length of the cable or the seat position so that resistance is felt in the start position.

a



Movement and end position: Pull the handle in a controlled manner until it touches your chest (b). The pull is started by pulling your shoulder blades together and then by bending your elbows. When the handle touches your chest, your shoulder blades are still together and your elbows are slightly behind your back. Once your shoulder blades are together, they remain so for the entire pulling motion and do not separate until the end of the lowering motion. Briefly hold the chest-touch position and then return the handle in

b



(continued)

Proper Exercise Technique for Sample Exercises (*continued*)

a controlled manner to the start position by first straightening your elbows and then allowing your shoulder blades to separate.

Variations: Several types of handles allowing different hand positions can be used, as can grips of different widths. During the pull, height and distance of the elbows from the body can also be varied.

Spotting: Proper positioning and maintenance of good technique during the exercise are all that is necessary; no real spotting is required.

Lunge

Start position: Stand erect, your feet flat on the floor and hip-width or slightly wider apart, torso upright, head upright and eyes looking forward, barbell resting on the spines of your shoulder blades identical to the barbell position during a back squat, hands grasping the barbell wider than shoulder-width apart with an overhand grip and palms facing forward (*a*). Remove the barbell from a power rack or squat rack to get into the start position.

Movement and end position: In a controlled manner, step straight forward with one leg so that your feet are still hip-width apart after the step. The step should be long enough so that when in the end position, the knee of the leg that stepped forward is above your midfoot area and not in front of your toes or behind your heel. In a controlled manner, bend the knee of the leg that stepped forward until the knee of your rear leg almost touches the floor (*b*). The foot of the leg that stepped forward remains flat on the floor at all times, while your rear foot can rise up onto your toes as the front leg is bent. After bending the front leg, straighten it in a controlled manner but do not lock the knee. Repeat this motion until the desired number of repetitions are completed. After completing the desired number of repetitions, push off the floor with your front leg, and with two short backward steps of your front leg return to the start position. Repeat the exercise motion with the opposite leg for the desired number of repetitions. The torso should remain as upright as possible throughout the exercise motion.

Spotting: Technique is vital. Some common technique flaws include the following: the step forward is too short so that the knee of your stepping leg is in front of the toes when the knee is bent; the step forward is too long so that the knee of your stepping leg is behind your heel when the knee is bent; your feet aren't hip-width apart after completion of the step forward, which causes difficulty in maintaining balance during the exercise motion because of a narrow base of support; and you don't keep your torso as upright as possible, which places undue stress on the lower back. When it comes to spotting and safety for all lunges, a step forward that is not of the correct length places undue stress on the knee of your stepping leg. Two spotters, one at each end of the bar, are recommended (barbell lunge). With a dumbbell lunge, no spotting is normally needed. The dumbbell lunge is easier to perform than the barbell lunge because it is easier to keep your torso upright, thus reducing lower back strain.



no minimum age requirement at which children can begin resistance training, a child must be mentally and emotionally ready to comply with coaching instructions and ready to undergo the stress of a training program. In general, if children are ready for participation in sport activities, then they are ready for some type of resistance training. Prior to starting any sport or strength training program, a complete medical evaluation by a primary care physician should be completed.

Psychological Maturity

Psychological maturity, as well as the desire to participate in such conditioning programs, frame the quality of any strength training program. If young athletes do not understand why such programs are important or do not have the maturity to participate in a strength training program, success will be limited, and no young athlete should be forced to lift. Intense training is not for all young athletes, and burnout is a well-established phenomenon in youth sport. Forcing young athletes to undertake training programs that are beyond their physical and emotional capabilities will not result in long-term success. Exercise should become a positive part of a lifestyle and negative associations with it should be eliminated. Exercise should not be used as a punishment and should be viewed positively by both participants and coaches. An upsetting trend of using strength training for “work hardening” or “disciplinary time” at the higher levels of athletics are related to many tragic outcomes and should not be tolerated!

Physiological Maturity

If athletes are mature enough to participate in a sport, they should understand the need to condition their body to take on the rigors of the sport. As with any other athlete, the child’s body must be prepared to meet the demands of competition. Children often participate in two or three sports at the same time (e.g., soccer, karate, and basketball). This puts a tremendous stress on the young athlete’s body, and finding time to perform resistance training becomes impossible at times. In a society with a great deal of what psychologists call *hyperparenting*, time schedules may be limited at best and strength training is often the first activity jettisoned from the schedule. A reexamination of a young athlete’s schedule is warranted to make time for this aspect of sport participation. Even today, many young athletes begin a competitive season with little or no physical preparation to meet the demands of the

sport. The incidence of injury in all youth sports has ranged from about 1 to 10 injuries per 1,000 h and about a fifth of them are severe, requiring rehabilitation and nonparticipation for at least a month. Interestingly, about 20% of sport injuries are reoccurrences, and it is now becoming clear that concussions may influence injury potential or reoccurrence, with injury risk higher in team sports compared to individual sports and in competition compared to training (Theisen et al., 2014). Prevention initiatives may reduce injuries by 50% on average (Theisen et al., 2014). Thus, a distinct need has emerged, the need to better prepare these young athletes’ bodies to tolerate the practice and competitive stresses of sports.

Strength, Physical Growth, and Maturity

As noted earlier, a child’s body goes through dramatic growth and continual change for many years. Maturation and development are different for boys and girls, and among each age group and sex. Thus, when training a group of 12-year-olds, you potentially have one of the most diverse groups of individuals possible as to maturation. During childhood, many physiological changes related to growth and development occur dynamically and rapidly. Muscular strength normally increases from childhood through the early teenage years, at which time there is a striking acceleration of strength in boys and a general plateau of strength in girls. It should be remembered that the maximal force exerted by a muscle is quite different from the force exerted on the environment.

Strength gains that occur from inadequate workout stimuli may be indistinguishable from gains due to normal growth and development. If you want to see improvements beyond normal growth, prolonged periods of time and appropriate intensity and frequency of training must be employed. Growth is so fast that only with continued training can gains be maintained above normal growth and development effects (Blimkie, 1992; Faigenbaum et al., 2009).

Convincing evidence now exists that strength training is effective in youth (Kraemer and Fleck, 2005). Study upon study has shown that properly designed resistance training programs can facilitate the development of strength in prepubescents and adolescents beyond that which is normally due to growth and development. Young children at the age of 6 years have derived benefits from resistance training, and studies have been as long as 9 months in duration. To date, there is no clear evidence of any

major difference in strength as measured by selected strength tests between prepubescent boys and girls.

Many aspects are involved in the growth and development of a young athlete. Growth is not based on one single factor such as height. Many factors influence development and fitness gains including genetic potential, nutrition, and sleep. Maturation has been defined as progress toward adulthood. Several areas can be considered when examining the maturation of a child:

- Physical size
- Bone maturity
- Reproductive maturity
- Emotional maturity

Each of these areas can be clinically evaluated. It is common for the family physician to make various assessments as to the development of a child in these areas. Each individual has a chronological age and a physiological age. Physiological age is the most important as it determines functional capabilities and performance, and this should be considered when developing a strength training program. Physiological age is related to the rate of maturation of a child, which can vary among children as maturity progresses differently over a chronological time frame.

Physiological Mechanisms for Strength Development

Development of a child's body is a long-term phenomenon and many systems (e.g., nervous system) are not fully matured until about 21 years of age (Kraemer et al., 1989). Neural mechanisms appear to be the primary mechanism that mediates strength improvement in prepubescents. Several training studies have reported significant improvements

in strength during prepubescence without corresponding increases in gross limb morphology (Lloyd et al., 2009). Without adequate concentrations of circulating growth factors and androgens to stimulate increases in muscle size, prepubescents appear to experience more difficulty increasing their muscle mass as compared to older individuals. Thus, programs should not emphasize such goals in prepubescent training programs.

Without corresponding increases in fat-free mass, it appears that neural adaptations (i.e., a trend toward increased motor unit activation and changes in motor unit coordination, recruitment, and firing) and possibly other intrinsic muscle adaptations appear to be primarily responsible for training-induced strength gains during prepubescence. Enhancements in motor skill performance and the coordination of the involved muscle groups may also play a significant role because measured increases in training-induced strength are typically greater than changes in neuromuscular activation.

Of dramatic influence is the role of testosterone secretion in boys compared to girls. During puberty, testicular testosterone secretion in boys is associated with considerable increases in lean tissue mass as well as other sex-linked changes in shoulder width and facial hair. Training-induced strength gains during and after puberty in boys are reflected by this dramatic increase in circulating testosterone (figure 13.1). It has been demonstrated that in order for young boys (14-17 years of age) to see a dramatic increase in testosterone after a workout, 2 years of training are needed (Kraemer and Fleck, 2005; Kraemer et al., 1992).

Other hormone and growth factors (e.g., growth hormones, insulin, and insulin-like growth factors) are also involved with anabolic signals in the body

Growth Is Pulsatile

The most rapid phase of growth occurs in utero. This rate ranges from 0.5 to 2.5 cm/wk. Subsequently, postnatal growth is divided into three distinct phases: infancy, childhood, and puberty. During the first few years of life, the mean growth rate is 15 cm/year. This so-called infancy growth rate is dependent on fetal growth factors and contributes a mean of 79 cm to final adult male height. The growth rate slows in childhood, generally by 3 years of age, to an average rate of 6 cm/year. The childhood component of growth depends on growth hormone and contributes 85 cm of final height. The pubertal growth rate, which increases to a mean of 10 cm per year, is sex-steroid dependent, both by directly affecting growth and by augmenting growth hormone and IGF production.

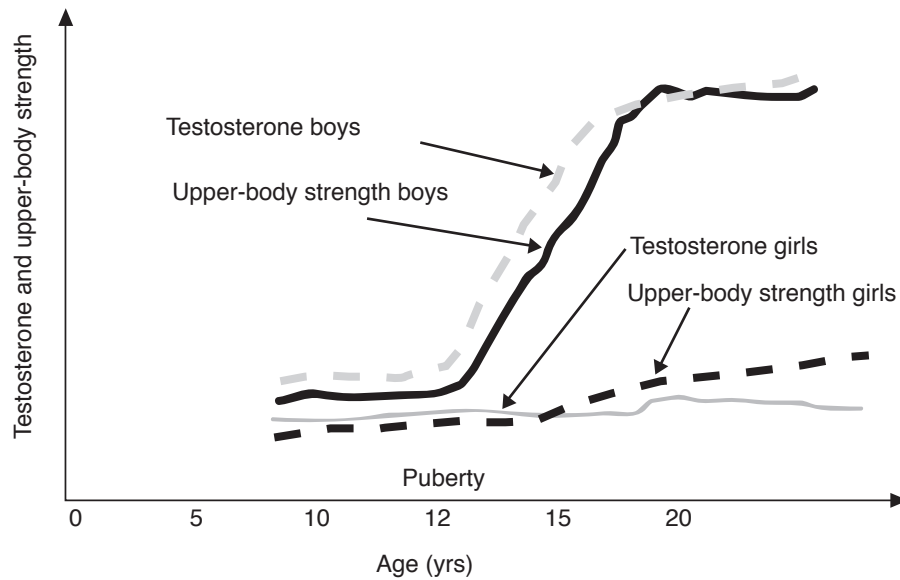

FIGURE 13.1 Theoretical relationships between boys and girls for resting testosterone concentrations and upper-body strength.

and may be especially important for muscular development in women. The growth hormones and insulin-like growth factor-1 (IGF-1) axis is recognized as both complex and polymorphic. This axis is composed of signal hormones coming from the hypothalamus to stimulate the release of growth hormone from the anterior pituitary gland. Released growth hormones then circulates in the blood and can stimulate the release of IGF-1 from the liver as well as stimulate muscle itself to engage the inherent IGF-1 in the muscle. Thus, growth hormones have many effects on many tissues when released from the pituitary gland. IGF-1 can interact with many tissues as well when released from the liver's hepatic cells, including muscle and bone tissues. Many anabolic hormones as well as growth factors are responsive both to physical growth and development and can be influenced by exercise.

Benefits of Strength Training for Young Athletes

Tremendous benefits can be gained from an appropriately designed and implemented strength training program for children. Confusion on this issue started in the 1970s with scientific studies on resistance training and children, which demonstrated few or no positive effects on strength. This caused many to think that there were no obvious benefits of strength training for children. However, a number of crucial experimental errors in design

and testing allowed such erroneous conclusions to be drawn. All of the subsequent studies in the mid-to late 1980s and beyond have shown improvements in strength and increases in lean tissue mass after **adolescence**, when such changes are possible. The majority of the scientific evidence over the last 25 years, however, also strongly suggests that children can significantly increase their strength—independent from growth and maturation—providing that the resistance training program is the correct length and intensity. The benefits may well reach beyond strength with improvements in other physiological systems such as connective tissue strength and density as well as improved physical performance and injury prevention (Kraemer and Fleck, 2005).

The primary benefits of strength training for children include

- increased muscular strength and local muscular endurance,
- improved sport performance,
- improved tissue strength and reliance,
- improved energy levels,
- improved motor control of movements,
- improved self-image and confidence,
- improved mood states,
- prevention of sport injuries, and
- development of lifelong exercise habits.

Strength Gains

For young athletes with no prior strength training, almost any type of program will yield some improvement in strength if progressed over time. Program variables of intensity, sets, and volume that are vital for younger athletes are not completely understood at this time, especially in younger individuals who have no resistance training experience. Nevertheless, the type of resistance training program used may well affect a specific type of training adaptation after initial adaptations are seen at a given age. This will require longer-term studies in the future. In addition, it appears that training programs will have to be periodized, or varied over time, or boredom could limit adherence to a program.

Muscle strength gains as great as 74% have been reported following 8 wk of progressive resistance training. On average, gains of roughly 30% to 50% are typically observed in children after short-term (8-20 wk) resistance training programs. How much of these gains are related to motor **learning effects** in the early phase of training remains to be definitively determined. Relative (percent improvement) strength gains achieved during prepubescence have been reported as equal to if not greater than the relative gains observed during adolescence. Obviously, absolute strength gains (e.g., amount of weight lifted) appear to be greater in adolescents compared to prepubescents, and adults can make even greater absolute gains than young adolescents.

When a young athlete stops training, a detraining phenomenon starts, and if cessation from strength training is long enough, natural growth rates will help untrained peers catch up and the athlete's physical strength advantage will be lost (Blimkie, 1992). The rapid growth phases of young athletes appear to bring both the untrained and previously trained young athlete to the same point in physiological development if given enough time, especially during the growth years of prepubescence and adolescence.

In one study, after 20 wk of strength training, maintenance performed once a week was not enough to maintain the strength gains of prepubescent boys, while a maintenance program of 1 day a week was just as sufficient as 2 days a week in retaining the strength gains made after 12 wk of resistance training in a group of pubescent male athletes (Blimkie, 1992). Nevertheless, it is apparent that for young athletes to maintain a physical advantage over their untrained peers, continued training of more than 1 day a week is needed.

Improved Sport Performance

Improvements in selected performances have been reported in children following resistance training programs. Several studies have reported increases in the long jump or vertical jump and decreases in sprint and agility run times. In contrast, reports of significant increases in strength without concomitant improvements in selected sport skills following a few weeks of strength training have also been reported, indicating a lack of transfer from the strength training program to the sport skills. Since the effects of resistance training are dependent on the duration, frequency, speed, and volume of the training stimulus, program design that is not specific enough may explain the lack of successful transfer.

When considering the influence of a strength training program on a sport skill, one must remember the principle of specificity. It appears that training adaptations in young athletes, like adults, are specific to movement pattern, velocity of movement, contraction type, and contraction force. How well the training programs match the biomechanical movement will determine in part the amount of transfer to the sport skill. Young athletes must also practice sport-specific skills. This begs the question as to when a young athlete should start to use sport-specific training methods. The answer to this question depends on the age of the athlete and how well the athlete has established a solid strength base to work from using core exercises.

While conclusions regarding the effects of strength training on sport performance during prepubescence and adolescence remain equivocal due to experimental design problems and limited training time to differentiate performance effects that have high-skill components, physical development is certainly enhanced. Collectively, limited direct and indirect evidence, as well as observations from older populations, indicate that a common-sense sport-specific resistance training program will result in some degree of improvement in athletic performance. Curtailment of preseason and in-season practice sessions to allow time for sport preparatory resistance training seems reasonable providing that the training program is competently supervised, progressive, and of sufficient duration and intensity. In addition, periodized training programs in research designs are needed to optimize programs, especially long-term training programs.

Reduced Injury Risk

As discussed previously, children cannot “play” themselves into shape, because the loads and demands of sport activity do not stimulate improved muscle and connective tissue growth and strength. Therefore, one of the greatest benefits of youth resistance training may be its ability to better prepare children for participation in sport and recreational activities, thus reducing injury risk (Faigenbaum et al., 2009; Milone et al., 2013; Zwolski et al., 2017).

Parents and coaches may share the desire to reduce injury risk through strength training, but improvement in sport performance also plays an important role in their interest in having young athletes participate in this form of supplemental conditioning. Young athletes primarily view strength training from an improved sport-performance perspective and because many have seen role models in high school and college participate in such training. Professional organizations that seek to decrease the incidence of injury from sport and strength training can play a vital role in ensuring that this benefit is realized (Faigenbaum et al., 1996; Faigenbaum et al., 2009).

Lifelong Exercise Habits and Other Benefits

Owing to the obesity epidemic in children and adults, as well as diabetes, resistance training has been a solid entry-level activity for many children who are overweight and not comfortable with endurance-type exercise. While always a part of a total conditioning program, strength training can help a variety of factors related to quality of life issues (e.g., improved mood states, self-image, energy levels, metabolic dysfunction) (Bea et al., 2017; Faigenbaum et al., 2009; Walters et al., 2018). In addition to the prevention of injury and improved physical development to enhance sport performance, other benefits of strength training exist. Development of a young athlete’s physical potential is the ultimate goal for any strength training program. However, the most important benefit is probably the development of an exercise habit, if young athletes truly enjoy their time in the weight room. With rising rates of obesity around the world, increases in activity profiles are important for young children. In order to realize all of the potential physical and psychosocial health benefits of youth resistance training, though, coaches and

instructors must appreciate the delicate psychological status and physical uniqueness of children.

Some of the other health and fitness benefits that can be gained from a properly designed and implemented strength training program for young athletes include

- improved blood pressure response to stress,
- improved bone mineral density,
- improved body composition profile, and
- improved psychological well-being.

With strength training, improved toleration to a sport or everyday activity stressor will help lower the cardiovascular response (e.g., blood pressure) to a given task. Furthermore, it will help the body adapt and improve toleration to spikes in blood pressure when maximal efforts are required. With stress, strain, compression, and bending of the bones from resistance training, the overall structure of the bone including bone density will be improved, an important benefit for young girls. Strength training can promote increases in the lean tissue mass (muscles and bones) and help to decrease body fat, giving one a better overall body composition profile. Strength training has been shown to enhance self-confidence and body image as well as helping one feel better psychologically. These benefits, resulting from a consistently performed strength training program, are important for the young athlete.

Myths of Strength Training for Children

Despite the myth that resistance training stunts the structural growth of children, current observations indicate that youth resistance training (up to 20 wk) will not have an adverse effect on growth patterns. If age-specific physical activity guidelines, as well as nutritional recommendations (e.g., adequate calcium) are adhered to, physical activity, including strength training, may favorably influence growth at any stage of development but will not affect the natural maximum height a young athlete can attain. Although health should not be defined as simply the absence of disease, an operational definition of health as it applies to children is difficult to define because the behaviors and exposures required to achieve optimal health remain debatable. Although it is tempting to extrapolate the findings from adult studies to children, caution must be exercised because what is deemed healthy

for an adult may not necessarily be so for children. Current research that supports the use of youth strength training to acquire favorable health-associated characteristics is limited. Nevertheless, this research supports the contention that the overall health of children is likely to improve rather than be adversely affected by strength training.

Young girls may have a different perspective depending on the sport and availability of weight rooms in school and health clubs. Too often girls associate strength training with masculine traits, and the fear of “getting big” or “getting muscles” limits some girls’ participation. In such cases, appropriate education and clarification of myths in strength training are necessary (e.g., girls cannot develop big muscles due to a lack of testosterone and number of muscle cells). In addition, role models for girls (e.g., successful women athletes who weight train) in the weight room are needed, along with competent coaches. This underscores the need for proper coaching and education about conditioning for women (see chapter 12).

Strength Training Guidelines for Young Athletes

Programs need to be appropriate for the age of the young athletes and complement their previous training background. Too often adults try to implement adult programs due to a lack of understanding of the important growth and development concerns that affect young athletes’ physiological and psychological capabilities. Answers to such questions as training efficacy, benefits, and proper programs have focused both the public’s and the medical profession’s interest on this modality (Kraemer and Fleck, 2005). Each of the major sports medicine and exercise science organizations has supported the use of strength training via position stands and training guidelines over the past 25 years.

Kraemer and Fleck (2005) have developed an important set of questions that should be addressed when developing strength training programs for young athletes:

1. Is the child psychologically and physically ready to participate in a resistance training program?
2. What resistance training program should the child follow?
3. Are the proper lifting techniques for each exercise in the program understood?

4. Are the safety spotting techniques for each lift in the program understood?
5. Are the safety concerns of each piece of equipment used in the program understood?
6. Does the resistance training equipment fit the child properly?
7. Does the child have a balanced physical exercise training program (i.e., participation in cardiovascular activities and other sports in addition to resistance training)?
8. As previously discussed, the concern for possible injury to the child’s growth cartilage must be considered in program development.
9. Are all exercise techniques appropriate for the child?

The child should be able to tolerate the exercise stress of the strength training program prescribed. The concepts of individualized exercise prescription, proper supervision, and program monitoring have been discussed throughout this text. In order for such concepts to work, the parent, teacher, and coach need to communicate with the young athlete regardless of age. Adults should encourage discussion and feedback and listen to children’s concerns and fears. Most important, trainers need to use common sense and provide exercise variations, active recovery periods, and rest from training. Do not fall into the trap that more is better.

While program suggestions can be made, these are only very general guidelines. No one ideal program exists. Young athletes should start with a program that is individually tolerable and one with which they can progress as they become older. Dramatic changes in the toleration of resistance training programs can reflect the increased maturation of a child. It is important not to overestimate the child’s ability to tolerate an exercise or sport program. It is better to start out slow rather than overshoot the young athlete’s exercise toleration and reduce the enjoyment of participation. Using the proper principles of strength training, a program can be designed that reflects the developmental status of the child. By following proper guidelines for program development, a resistance exercise program can be implemented at each stage of development that does not compromise enthusiasm and does not overestimate exercise toleration (Kraemer et al., 2000). Parents, teachers, and coaches must always remember that they are not the ones the program is being developed for and that children

should be free to not participate in an exercise or sport program. It is up to the adults to provide a positive environment that protects and serves the children who participate.

The updated position stand of the National Strength and Conditioning Association (Faigenbaum et al., 2009) stipulates the following guidelines:

1. Provide qualified instruction and supervision
2. Ensure the exercise environment is safe and free of hazards
3. Start each training session with a 5- to 10-minute dynamic warm-up period
4. Begin with relatively light loads and always focus on the correct exercise technique
5. Include specific exercises that strengthen the abdominal and lower back region
6. Focus on symmetrical muscular development and appropriate muscle balance around joints
7. Perform 1 to 3 sets of 3 to 6 repetitions on a variety of upper- and lower-body power exercises
8. Sensibly progress the training program depending on needs, goals, and abilities
9. Increase the resistance gradually (5%-10%) as strength improves
10. Cool down with less intense calisthenics and static stretching
11. Listen to individual needs and concerns throughout each session
12. Begin resistance training 2 to 3 times per week on nonconsecutive days
13. Use individualized workout logs to monitor progress
14. Keep the program fresh and challenging by systematically varying the training program
15. Optimize performance and recovery with healthy nutrition, proper hydration, and adequate sleep
16. Support and encouragement from instructors and parents will help maintain interest

Program for Beginners

It should be noted that the use of resistance programs using the child's own body weight and partner resistances can be effective in promoting

muscular fitness. Concerns arise if the child is overweight and unable to exercise in the needed ranges of motion, in which case partner exercises can be substituted. For an extensive overview of body weight and partner exercises, see Kraemer and Fleck (2005). A child should have developed a basic fitness level before starting a weight training program.

Starting points and programs are dramatically different depending on age. Kraemer and Fleck (2005) have developed a profile of starting points at different ages, as can be seen in table 13.1. In the beginning of resistance training programs for younger children (5 and 6 years of age), body weight exercises and partner exercises should be used to develop basic strength and prepare them for other resistance exercise programs as they grow older. Again, care must be taken that their body mass does not overload them, resulting in few or no complete repetitions of an exercise. If limits exist, light dumbbells or partner resistance exercises can be used to develop the strength needed to facilitate performance of body weight exercises.

Specifics of Strength Training for Young Athletes

The development of a strength training program for young athletes should follow the same steps as the development of a program for adults. A well-organized and well-supervised basic training program for children need not be any longer than 20 to 60 min per training session, three times per week. The resistance training program should be conducted in an atmosphere conducive to both safety and enjoyment. The training environment should reflect the goals and expectations of a program. As the child gets older, more advanced programs can be developed. Again, table 13.1 shows a program progression from 7 to 16 years of age. The child needs to be ready to participate in a strength training program and understand what is necessary in order to gain maximal benefits.

Exercise Classifications

Exercises can be classified in a number of ways.

- Single-joint exercises only require the stimulation of muscles around one joint.
- Multijoint exercises use coordinated movements around more than one joint.
- Machine exercises fix the path of movement and the young athlete must fit the equipment

TABLE 13.1 Basic Guidelines for Resistance Exercise Progression in Children

Age (years)	Considerations
7 or younger	Introduce child to basic exercises with little or no weight; develop the concept of a training session; teach exercise techniques; progress from body weight calisthenics, partner exercises, and lightly resisted exercises; keep volume low.
8-10	Gradually increase the number of exercises, practice exercise technique for all lifts, start gradual progressive loading of exercises, keep exercises simple, increase volume slowly, carefully monitor toleration to the exercise stress.
11-13	Teach all basic exercise techniques, continue progressive loading of each exercise, emphasize exercise technique, introduce more advanced exercises with little or no resistance.
14-15	Progress to more advanced resistance exercise programs, add sport-specific components, emphasize exercise techniques, increase volume.
16 or older	Enter adult programs after background experience has been gained.

If a child enters an age level with no previous experience, progression must start at previous levels and move to more advanced levels as exercise toleration, skill, and understanding permit.

Adapted by permission from W.J. Kraemer and S.J. Fleck, *Strength Training for Young Athletes*, 2nd ed. (Champaign, IL: Human Kinetics, 2005), 13.

used. No balance is needed that limits the use of assistance muscles.

- Free weight exercises do not fix the path of movement and they require balance and coordination to lift the weight and balance the moving mass. This requires the activation of many additional muscles for stabilizing the body position and assistant movers to help with the lift.
- Structural exercises require the whole body to lift the weight and require coordination in a multijoint exercise.

Examples of these different types of exercises can be seen in figure 13.2.

Program Variables

Initially, the resistance used for each exercise should be such that the minimum recommended number of repetitions can be performed. Once it is possible to perform the maximum number of repetitions the resistance is increased so that again the minimum number of repetitions can be performed. Form and spotting techniques should be continually stressed. The exercises should be performed in a controlled manner, which helps prevent injury due to losing control of the weights and also prevents damage to the weight stack of a machine or the free weights. Understanding how to perform an exercise and how to spot it is the first step in a successful strength training program, especially for young athletes.

Since the goals of a resistance training program are specific to the individual needs of each child,

programs will differ. Various combinations of the acute program variables (i.e., choice of exercise, order of exercise, resistance used, number of sets, rest period lengths between sets and exercises) have proven to be safe and effective for children, provided that program developers use scientific information, established training principles, and common sense. Young athletes must perform all exercises using the correct technique, and the exercise stress (resistance and rest periods) must be carefully monitored to ensure that each child is tolerating the prescribed training program. The ideal approach is to incorporate resistance training into a periodized conditioning program in which the volume and intensity of training change throughout the year. Instructors must recognize the normal variance in maturation rates of young athletes and be aware of the genetic predispositions for physical development. Children must not be treated as small adults, nor should adult exercise guidelines and training philosophies be imposed on children.

Sample Program

The sample program on pages 277-279 for football demonstrates some of the principles discussed in this chapter. As with any sample program, use it only as a guideline for different aspects of various sports. For more program profiles, see Kraemer and Fleck (2005).

Playing football requires speed, strength, and power. The requirements for each position are somewhat different; yet improving these three factors with resistance training can enhance sport performance and prevent injury. In this sport the young



FIGURE 13.2 Exercises are classified by the type of equipment used and the number of joints that are involved. (a) The leg curl is a single-joint, fixed-form weight machine exercise. (b) The leg press is a multijoint, fixed-form weight machine exercise. (c) The bilateral biceps curl is a free weight, free-form single-joint exercise. (d) The high pull exercise is an example of a free weight, free-form, multijoint structural exercise.

athlete must be physically prepared to play in such a way that prevents injury. Quarterbacks need to focus on exercise for the shoulders. All players need to perform exercises for the neck, shoulders, knees, and ankles—areas where injuries frequently occur.

Long-Term Athletic Development

The long-term development of an athlete has been a point of concern due to factors such as burnout, varied starting points in training history, injury prevention, resilience, lifelong effects, and the need for athleticism and appropriate training programs coinciding with guidelines for working with young athletes. The National Strength and Conditioning

Association has developed a position stand that is important for parents, coaches, physical educators, sports medicine professionals, and young athletes to understand. The following are the major points or pillars for successful long-term athletic development (Lloyd et al., 2016):

1. Long-term athletic development pathways should accommodate for the highly individualized and nonlinear nature of the growth and development of youth.
2. Youth of all ages, abilities, and aspirations should engage in long-term athletic development programs that promote both physical fitness and psychosocial well-being.

Position Stand on Youth Resistance Training From the National Strength and Conditioning Association

The following table presents guidelines for progression in a strength training program by the NSCA (Faigenbaum et al., 2009).

Recommendations for Progression During Resistance Training for Strength

	Novice	Intermediate	Advanced
Muscle action	ECC and CON	ECC and CON	ECC and CON
Exercise choice	SJ and MJ	SJ and MJ	SJ and MJ
Intensity	50%-70% 1RM	60%-80% 1RM	70%-85% 1RM
Volume	1-2 sets × 10-15 reps	2-3 sets × 8-12 reps	≥3 sets × 6-10 reps
Rest intervals (min)	1	1-2	2-3
Velocity	Moderate	Moderate	Moderate
Frequency (d/wk)	2-3	2-3	3-4

Recommendations for Progression During Resistance Training for Power

	Novice	Intermediate	Advanced
Muscle action	ECC and CON	ECC and CON	ECC and CON
Exercise choice	MJ	MJ	MJ
Intensity	30%-60% 1RM VEL	30%-60% 1RM VEL 60%-70% 1RM STR	30%-60% 1RM VEL 70% to ≥80% 1RM STR
Volume	1-2 sets × 3-6 reps	2-3 sets × 3-6 reps	≥3 sets × 1-6 reps
Rest intervals (min)	1	1-2	2-3
Velocity	Moderate/fast	Fast	Fast
Frequency (d/wk)	2	2-3	2-3

ECC = eccentric; CON = concentric; SJ = single joint; MJ = multijoint; 1RM = 1 repetition maximum; VEL = velocity; STR = strength; rep = repetition.

Reprinted by permission from A.D. Faigenbaum, W.J. Kraemer, W.J. Blimkie, et al., "Youth Resistance Training: Updated Position Statement Paper From the National Strength and Conditioning Association," *Journal of Strength and Conditioning Research* 23, suppl. 5 (2009): S60-S79.

- All youth should be encouraged to enhance physical fitness from early childhood, with a primary focus on motor skill and muscular strength development.
- Long-term athletic development pathways should encourage an early sampling approach for youth that promotes and enhances a broad range of motor skills.
- Health and well-being of the child should always be the central tenet of long-term athletic development programs.
- Youth should participate in physical conditioning that helps reduce the risk of injury to ensure their ongoing participation in long-term athletic development programs.
- Long-term athletic development programs should provide all youth with a range of training modes to enhance both health- and skill-related components of fitness.
- Practitioners should use relevant monitoring and assessment tools as part of a long-term athletic development strategy.

Strength Training Program for Football

Off-Season Program

Warm-up: General exercise consisting of jogging or cycling for about 5 min followed by a general stretching routine.

Exercises

The lifter performs exercises in the order listed. Italics indicate exercises that can be periodized for resistance within this phase.

- *Bench press*
- *Squat or leg press*
- *Overhead press*
- *Knee curl*
- Seated row
- Knee extension
- Elbow curl
- Abdominal exercise

Approximate Time

- Three training sessions per week with at least 1 day separating sessions
- 60 to 70 min per session

Additional Injury-Prevention Exercises

- Neck exercise
- Shoulder rotator cuff exercises
- Calf raise

Additional or Replacement Exercises

- *Deadlift*
- Lat pull-down
- Lunge
- *Front squat*
- *Narrow-grip bench press*

Advanced Exercises

- The lifter should perform no more than 5 repetitions per set, using 8RM to 10RM resistance for advanced exercises. If an advanced exercise is used, it should be performed at the beginning of the training session.
- Power clean or clean pull from knee or thigh level
- Power snatch or snatch pull from knee or thigh level

Off-Season Program Notes

- Format: Set–repetition
- Number of sets: 2 to 3
- Resistance: 10RM to 12RM
- Rest periods between sets and exercises: 2 to 3 min

(continued)

Strength Training Program for Football (*continued*)

- Repetitions per set for abdominal exercises: 20 to 30
- Other: Quarterbacks and offensive linemen perform supplemental shoulder girdle exercises.

Preseason Program

Warm-up: General exercise consisting of jogging or cycling for about 5 min followed by general stretching.

Exercises

The lifter performs exercises in the order listed. *Italics indicate exercises that can be periodized for resistance within this training phase.*

- Incline bench press
- *Back squat*
- Lat pull-down
- Knee curl
- Reverse elbow curl or elbow curl
- Abdominal exercise
- Shoulder internal rotation and shoulder external rotation (especially for quarterbacks)

Approximate Time

- Three training sessions per week with at least 1 day separating sessions
- 30 to 45 min per session

Additional Injury-Prevention Exercises

- Calf raise
- Additional shoulder rotator cuff exercises
- Neck exercise
- Knee extension

Additional or Replacement Exercises

- *Narrow-grip bench press*
- Seated row or bent-over rowing
- *Bench press*
- Wrist curl
- Deadlift

Advanced Exercises

- The lifter should perform no more than 5 repetitions per set using 8RM to 10RM resistance for advanced exercises. If an advanced exercise is used, it should be performed at the start of the training session.
- Power clean or clean pull from knee or thigh level
- Power snatch or snatch pull from knee or thigh level

Preseason Program Notes

- Format: Set–repetition
- Number of sets: 3

- Resistance: 8RM to 10RM
- Rest periods between sets and exercises: 1.5 to 2 min
- Repetitions per set for abdominal exercises: 20 to 30

In-Season Program

Warm-up: General exercise consisting of jogging or cycling for about 5 min followed by a general stretching routine.

Exercises

The lifter performs exercises in the order listed.

- Overhead press
- Back squat
- Bench press
- Knee curl
- Neck exercise
- Knee extension
- Shoulder internal rotation and shoulder external rotation
- Abdominal exercise

Approximate Time

- One to two training sessions per week with at least 1 day separating sessions
- 25 to 45 min per session

Additional Injury-Prevention Exercises

- None

Additional or Replacement Exercises

- Incline bench press
- Seated row
- Lat pull-down
- Lunge
- Front squat
- Calf raise
- Narrow-grip bench press

Advanced Exercises

- The lifter should perform no more than 5 repetitions per set using an 8RM to 10RM resistance for advanced exercises. If an advanced exercise is used, it should be performed at the beginning of the training session.
- Power clean or clean pull from knee or thigh level
- Power snatch or snatch pull from knee or thigh level

In-Season Program Notes

- Format: Set–repetition or circuit
- Number of sets or circuits: 2 to 3
- Resistance: 8RM to 10RM
- Rest periods between sets and exercises: 1 to 2 min
- Repetitions per set for abdominal exercises: 20 to 30

9. Practitioners working with youth should systematically progress and individualize training programs for successful long-term athletic development.
10. Qualified professionals and sound pedagogical approaches are fundamental to the success of long-term athletic development programs.

Summary

Strength training can be an effective and important part of a young athlete's conditioning program. It

has been shown to be effective for children of all ages if proper program design principles are followed. Correct exercise techniques and spotting are required for optimal safety, along with competent adult supervision. Core strength and power development is needed along with sport-specific training to facilitate carryover to sport performance. In addition, strength training can provide many health and fitness benefits, from the development of a solid exercise habit to improved bone health. Successful results are a function of optimal program design and implementation.

STRENGTH TRAINING FOR SENIOR ATHLETES

Dramatic changes occur in the sixth decade of life, but physical training, including strength training, can elevate the function and physiological status of individuals well above their expected aging curve. The primary threat to healthy aging is chronic diseases, and behaviors are the most important aspect in prevention. Strength training plays a major role in prevention by helping the neuromuscular system maintain function. While strength training can obviate dramatic reductions in physical performance due to aging, it has been shown that declines obviously do occur. In a study of senior athletes at the 2001 Senior Olympics, Wright and Perricelli (2008) found that both men and women decline in performance about 3.4% each year. Senior athletes' performances slowly declined (both men and women) approximately 3.4% per year from age 50 to 75 years. However, after 75 years of age this decline is much more dramatic, demonstrating the relentless effects of age on the human body. In men, the declines in performance were surprisingly similar for both sprint and endurance events; however, in women, the decline in sprint performance was greater than in endurance events, especially after the age of 75 years.

There is convincing evidence indicating that skeletal muscle responds rapidly to progressive heavy resistance training, and the plasticity of muscle can be maintained into older age with continued training (Frontera et al., 1988). Strength training may be one of the more dramatic conditioning modalities to help fight the aging process, allowing greater functionality for everyday activities and sport per-



formance, while improving health profiles of older adults (Bechshøft et al., 2017; Häkkinen, 2003; Papa et al., 2017; Wang et al., 2017). Even more important, it has been shown that the brain can benefit from long-term strength training as part of an exercise program because oxidative stress is reduced, growth factors are released, and cognitive performances and brain neural networks are improved (Greenlee et al., 2017; Portugal et al., 2015; Smolarek et al., 2016; Suo et al., 2016).

Progressive resistance training principles can be followed into old age and progression is still possible (ACSM, 2009; Fragala et al., 2019; Kraemer et al., 2002; Fleck and Kraemer, 2014). Injuries in the older athlete take longer to heal and can radically and permanently affect physical performance; therefore, senior-level athletes must be ready to take on the rigors of training and competition (Franklin et al., 2004). Health screening and preventive medical practices are also important for the senior athlete prior to and throughout a training program, despite being asymptomatic (Freeman et al., 2009). Thus, physical preparation and attention to detail in both conditioning and sport practices are vital. Strength training can provide the needed physical development to tolerate the stresses associated with sport practice and competition. In an extensive

recent position statement by the National Strength and Conditioning Association, it was conclusively stated that older men and women can benefit from a properly designed and implemented resistance training program with clear needs for individualization, targeted goals, and variations as a program progresses (Fragala et al., 2019).

Age and Its Effects on Strength and Power

Aging is a function of genetics, but it is also influenced by physical activity profiles. The most dramatic problem with aging, beyond pathologies, is disuse syndromes that can affect many different physiological systems in both structure and function. Improvements in muscular, skeletal, immune, endocrine, and cardiovascular systems can be realized by following conditioning programs that are properly prescribed and progressed over time (Singh, 2004).

The primary challenge facing older adults is to maintain the magnitude of physical function and capability with aging. As one ages, a decline in physical capabilities occurs. With strength training the ability to maintain function is promoted. Figure 14.1 shows the typical aging curve for men with age,

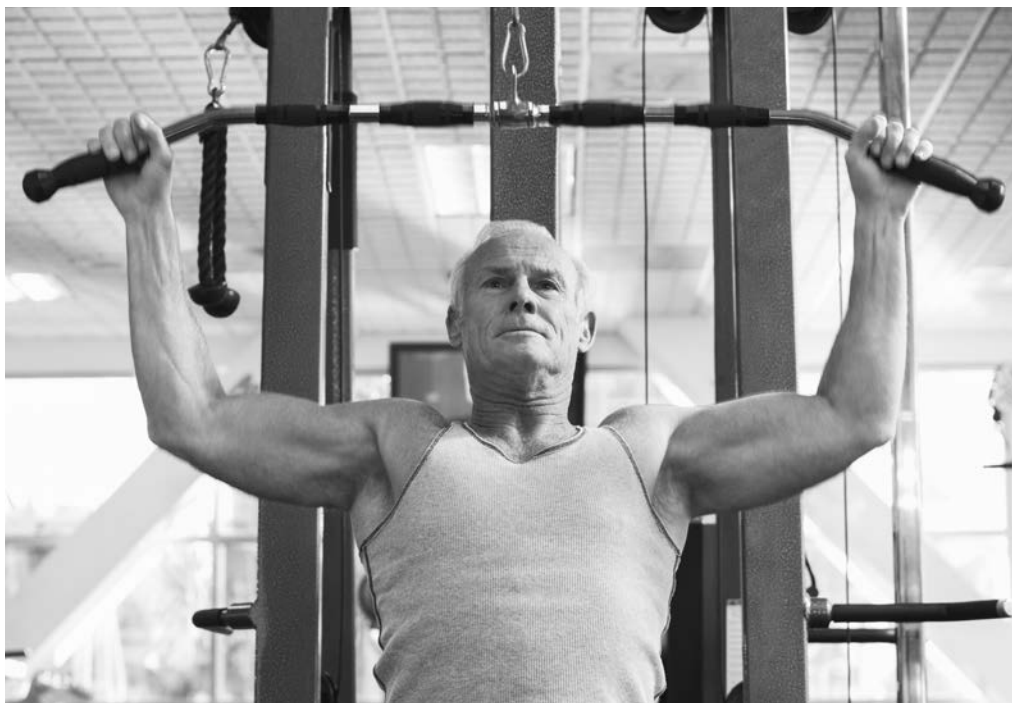

Strength training for the shoulders and back can enhance physical function and fight the negative effects of aging.

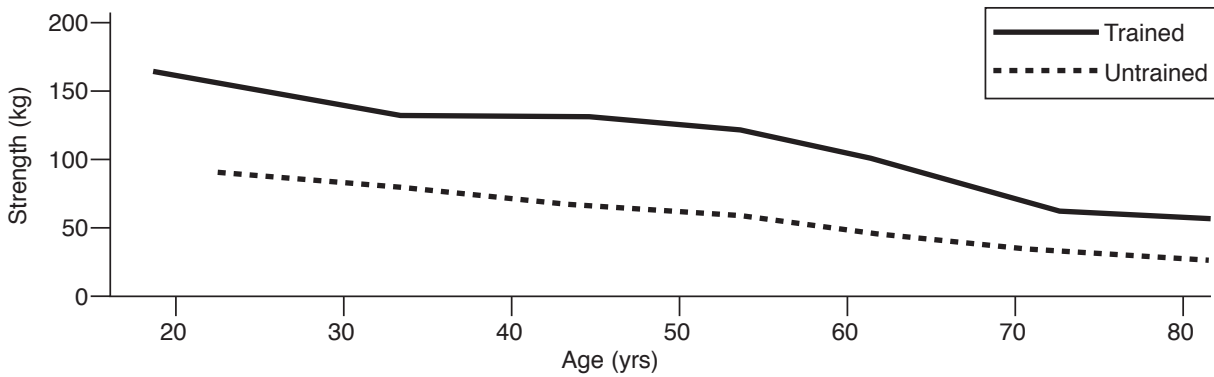

FIGURE 14.1 Changes with age in 1RM squat strength in men.

and how strength training elevates this function above that of nontrained individuals.

Older strength athletes have demonstrated impressive physical capabilities. There are some interesting results if one looks at relatively equal comparisons of men and women in two strength and power sports. For example, as of 2019, the International Weightlifting Federation world record for a woman in the 70+ age range and 55-kg weight class for the snatch lift is 31 kg; the clean and jerk record is 42 kg. For the same age men in the same body weight class, the snatch lift record is 62.5 kg and the clean and jerk is 68 kg. Making a gender comparison, this means that women's strength is 49.6% of men in the snatch lift and 61.8% of men in the clean and jerk lift. The snatch lift potentially requires more upper-body strength and the clean and jerk utilizes more lower-body musculature, diminishing the gender difference. Examination of the USA national records for men and women in the 70 to 74 age groups and 60-kg body weight class, the drug-tested U.S. Powerlifting Association records show the following gender comparisons for the three lifts: Women's records in the bench press is 37.5 kg, the squat is 50 kg, and the deadlift is 70 kg. Men's records in the bench press is 75.5 kg, the squat is 80 kg, and the deadlift is 140 kg.

Here the women show strength being 49.7% of men in the bench press, 62.5% of men in the squat, and 50% of men in the deadlift. As expected, the difference in the squat is not as great indicating the greater muscle mass and force potential in women's lower bodies. In the deadlift, both men and women show greater maximal strength compared to the other lifts, potentially due to lower technical biomechanical skill demands.

What remains to be true, even as time has gone by, was concluded by Anton and colleagues (2004),

who examined various records from both powerlifting and weightlifting. They observed that:

1. peak anaerobic muscular power, as assessed by peak lifting performance, decreases progressively from even earlier ages than previously thought;
2. the overall magnitude of decline in peak muscular power appears to be greater in tasks requiring more complex and powerful movements;
3. age-related rates of decline are greater in women than in men only in the events that require more complex and explosive power; and
4. upper- and lower-body muscular power demonstrate a similar rate of decline with age.

Thus, as shown in figure 14.1, aging affects neuromuscular function, but the magnitude of loss in a trained individual is far less than that in an untrained individual. It appears that continued strength training may be needed to maintain its benefits into older age.

As with any activity, the key is to get involved early in life, and strength training is no different. Early participation in a strength training program will influence the absolute magnitude of physical strength and power an individual is capable of producing (see chapter 13). In addition, neurological learning and robust physiological capabilities can enhance maturation and growth. Training during younger years, even from preadolescence, affects many developmental factors at crucial times in life (e.g., adolescence). Just as dramatic changes in endocrine function occur at the beginning of maturity for boys and girls, significant changes in endocrine function occur later in life during **andropause** (i.e.,

Older Athlete Benefits and Concerns From Sport Participation

The benefits and negative consequences of a lifetime of sports participation is only now beginning to be focused upon due to its many dimensions including type of sport, psychological versus physiological effects, and level of athlete ability (Baker et al., 2010). Athletic participation has many benefits for the older athlete in terms of continued participation in society and promotion of physical activity throughout one's lifetime. Older athletes have been observed to suffer less tension, fatigue, depression, confusion, and anger, and have improved vigor. Whether this is due to the conditioning process alone or the sport achievements themselves is yet unclear. Conversely, if an older athlete can no longer participate in a sport, some may find it difficult to cope and may have negative psychological feelings (e.g., guilt, shame, worthlessness) or greater fear of ill-health as one ages. Thus, our understanding of lifelong sports participation in its many forms is in its early evolution of study. Are there differences among sports? Are any positive benefits simply due to the needed physical training and conditioning maintained throughout a lifetime? How might this vary among sports?

reduction in male hormones that usually occurs around the age of 50) in men, and **menopause** (i.e., cessation of menstruation, usually between the ages of 45 and 55) in women. These are important physiological markers of changes in the endocrine system and occur at varying chronological ages. These periods have been called trigger points in physical development, as they mediate the robustness of the body's response to physical change and development.

Loss of Physiological Potential

The loss of certain component parts of motor units, including the programmed death of muscle fibers (apoptosis) and neuromuscular junctions that degrade with age, leads to ineffective motor units, which results in muscle weakness (Maxwell et al., 2018; Tudoraşcu et al., 2014). The greatest losses appear to take place in the high-threshold, fast motor units, which may be more susceptible to disuse over time. On average one might expect a 3% loss of strength every year after middle age if an optimal strength training program is not part of one's lifestyle. In other words, unless you are using relatively heavy loads (e.g., $\geq 80\%$ of 1RM) these motor units are not recruited. This loss is especially dramatic in women, who start out with a lower number of muscle fibers.

Sarcopenia is the loss of muscle fiber size and whole-muscle mass that results in diminished strength and power with age. Unfortunately, this is part of a normal aging process even in master athletes. However, function can be maintained above the norm with the use of a properly designed and loaded strength and power training program.

The significance of power was determined to be an important functional capability many years ago. However, its development in older individuals was found to be difficult (Kraemer and Newton, 2000). Only by performing exercises that could be done with higher velocities has this development been shown to be possible (e.g., Olympic-style-type lifts, hang cleans or pulls, or pneumatic machine exercises). Today, this style of training is an important part of a complete resistance training program for older individuals due to its transference to many functional activities and sport movements (McKinnon et al., 2017). However, it is clear that maximal force or strength is a vital part of the power equation and should not be diminished, but enhanced, in a training program.

It is well known that inactivity may accelerate programmed cell death (i.e., apoptosis). It appears that motor function is reduced due to the loss and degeneration of muscle fibers and neuromuscular junctions compromising the aging α -motor neurons. In studies of aging mammals α -motor neurons retained their size, but function was compromised due to a host of other factors (Maxwell et al., 2018). Thus, with the motor function loss that accompanies advancing age, one sees an increase in the risk of adverse health outcomes.

Recruitment of motor units across the spectrum of loads and the force-velocity continuum is vital for their retention beyond resting homeostatic levels. While it can occur in any older person, the more active senior athlete may not have the same time frame for sarcopenia unless their conditioning program in the weight room does not involve lifting heavier loads or include power-type exercises to enhance the

resilience of high-threshold type II motor units. The causes of sarcopenia are still unclear because many different factors can come into play that foster higher levels of catabolism when compared to anabolism. The goal of a total conditioning program, including strength training, is to slow the age-related decline of the structures and functions involved with force production (figure 14.2).

Recruitment of motor units help to maintain the major functions and their related structures. Strength and power training influences the function and integrity of the underlying cells, tissues, and physiological systems that are paramount for maintaining functional abilities needed for sport and everyday physical performances. One must be vigilant because other factors can contribute to loss of muscle mass. Such factors include an imbalanced diet without enough protein, an injury that causes immobility (need for fall prevention and safe homes), inflammatory diseases, inadequate recovery from workouts, and any severe life stress (e.g., loss of a loved one) that makes one vulnerable to negative physiological processes (e.g., increase in the stress hormone, cortisol). A proper strength training program and diet are two very important behaviors at the core of a lifestyle focused on reducing the rate of muscle loss and decreased physical and sport performances in senior athletes.

Cell Size Hypothesis

It now appears that each skeletal muscle fiber in the body has a minimum size that is set by genetic predisposition. When a muscle cell shrinks below this size, apoptotic processes occur resulting in cell death. The loss of skeletal muscle fibers with aging may be a result of a loss of contact with the nerve, resulting in denervation. It is also possible that muscle cells are damaged beyond repair and the body's immune response to clean up damaged materials (e.g., immune cell phagocytosis) is non-functional. Some muscle fibers are lost with age, but other fibers undergo a reinnervation process with increased activity. Lost muscle fibers are subsequently replaced with fat or fibrous connective tissue. No matter the reason, if the loss is permanent then the individual motor unit's functional ability to produce force is compromised. This affects basic metabolic functions of the entire muscle (such as caloric expenditure, which is reduced due to reduced muscle mass).

However, it is also well known that skeletal muscle fibers (cells) are constantly repairing and remodeling as a part of a motor unit that is being used in normal daily activities and exercise. This involves a complex set of biochemical and molecular processes to foster this regeneration (Tedesco et

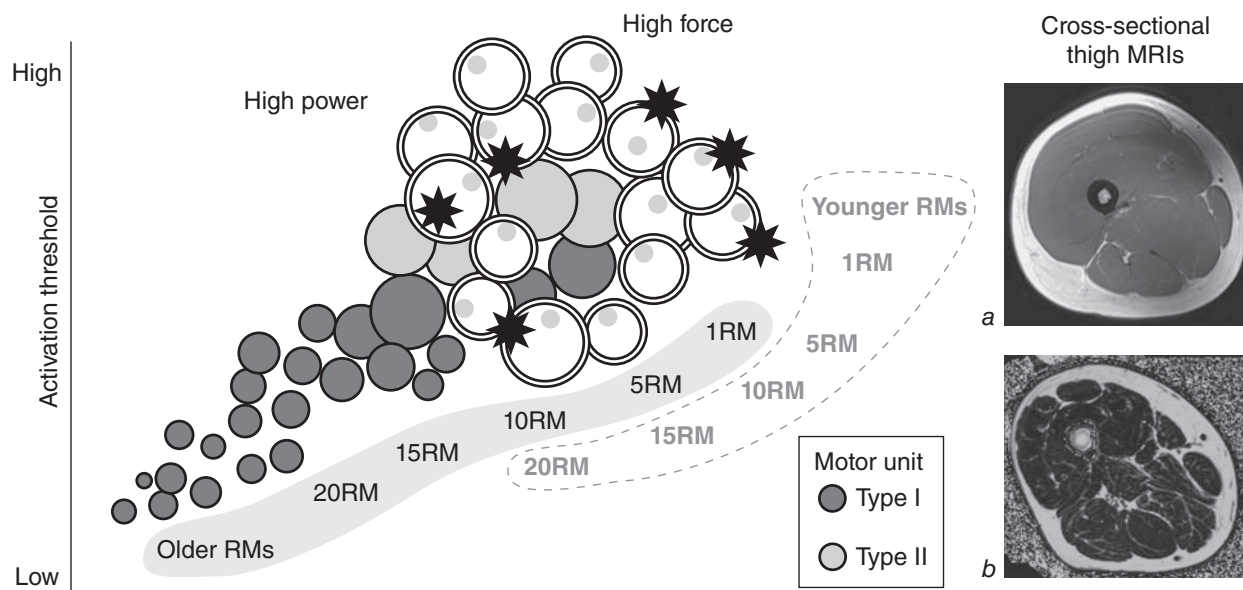

FIGURE 14.2 Muscle fibers, which are part of type I and type II motor units, are lost in men and women with age and disuse, especially in the higher-threshold type II motor unit array (white circles). When muscle is lost, it is then filled with fat cells and displays marbling (*b*), which is different from the young muscle shown here (*a*) that has no marbling in the gray area of the muscle (see Cross-sectional thigh magnetic resonance images [MRI]). With this loss of muscle fibers as part of the motor units, force production drops because all of the repetition maximum values drop to lower levels compared to previous years. Thus, a compressed form of the motor unit array and reduced force production is observed with aging.

al., 2010). It is well established that the number of skeletal muscle cells is genetically set at birth. Again, hypertrophy (increase in muscle fiber size), not hyperplasia (increase in cell number), is the major mechanism for increased force production. Satellite cells, located outside the sarcolemma, act as a type of stem cell to help in the regeneration of muscle. When the muscle cell is stimulated as part of a recruitment process, satellite cells can be activated to help in the repair of muscle. In the most common process, they are activated and produce myoblasts that act as a type of protein paste to help repair microtear damage of the fibers. If the regeneration of new fibers is needed, the myoblasts are further differentiated into myocytes and fuse to create a new muscle fiber replacing the old one as part of the motor unit (figure 14.3). If aging apoptotic processes stop this process, or if damage is too great, then scar tissue replaces the fibers and there is a permanent loss of muscle fibers leading to less force production (Shadrach and Wagers, 2011).

Critical Age-Dependent Thresholds for Strength Loss

Under normal conditions, strength performance appears to peak between the ages of 20 and 30, after

which changes in strength can remain relatively stable or slightly decrease over the next 20 years. After 50, strength may decline at a rate of about 3% a year if no strength training is used to mitigate the rate of loss. This decrease may be more dramatic in women, and cross-sectional studies may have seriously underestimated the magnitude of strength loss with age. This magnitude may be due to a lower level of absolute muscle fiber size with age. Figure 14.4 demonstrates the loss in the cross-sectional area (CSA) of type II fibers with age and is seen in both men and women.

It appears that muscle strength loss is most dramatic after the age of 70. Cross-sectional, as well as longitudinal, data indicate that muscle strength declines by approximately 15% per decade in the sixth and seventh decades, and about 30% thereafter. Maintenance of higher physiological and functional abilities appears to be mediated only with maintenance of training. Force is the product of mass and acceleration so in order to optimize force stimuli, some accelerative emphasis should be used in training.

Power Production Loss

It has been known for many years that the ability to produce power is an important physical capability

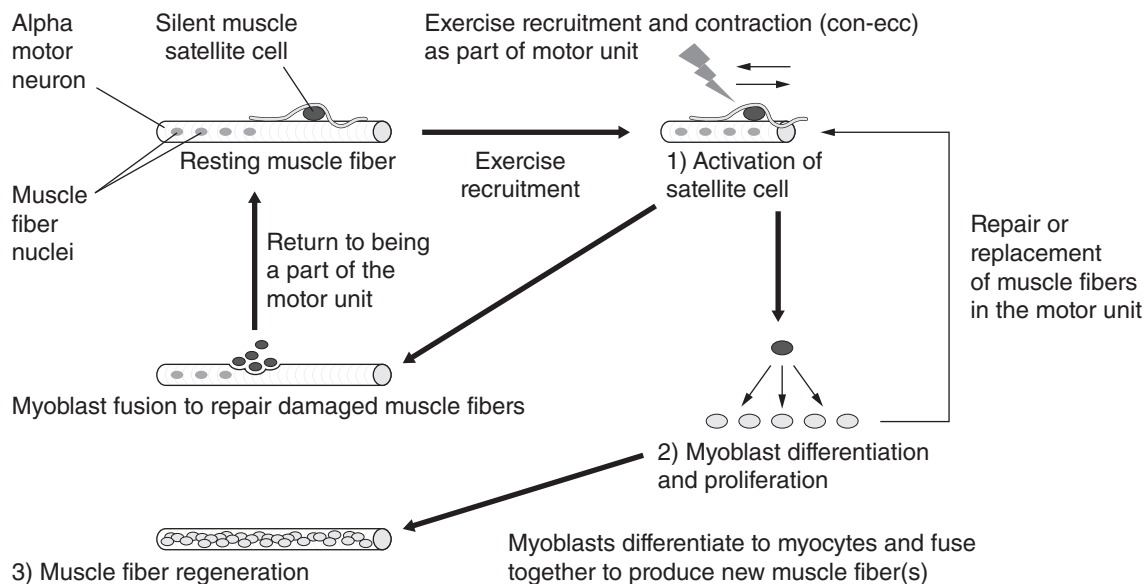

FIGURE 14.3 Muscle cell repair and regeneration of new fibers entails a complex molecular process that involves the satellite cells in the muscle fibers. When contraction occurs, mechanical, hormonal, and other molecular signals can stimulate the activation of these cells to produce myoblasts. It is thought that the eccentric phase of the contraction is most significant in the mechanical signals to these satellite cells. The myoblasts then fuse into the current muscle fiber to repair damage from the contractile stress. If further stimulated, the myoblasts then proliferate and differentiate into myocytes, fusing together to create a new fiber to replace the old one. It is important that the alpha motor neuron is still connected to its fiber.

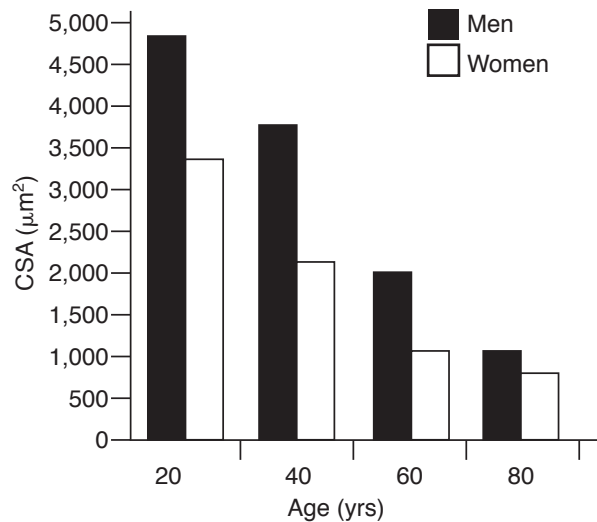

FIGURE 14.4 Changes in cross-sectional area (CSA) of type II muscle fibers of vastus lateralis in men and women with age ($n = 12$ in each group). The CSA in men was significantly greater than in women at each age ($p < .05$). Unpublished data from Dr. Kraemer's laboratory.

in the older adult, especially the older athlete. Correlations have been observed in both men and women between various measures of power and functional abilities. As already described in this book, power is specific to task characteristics, with load and percent of maximum strength determining the actual power output needed to complete a task.

Younger men and women have the ability to produce force more rapidly than their older counterparts. Force productions in the 0 to 200 ms range on the force-time curve are compromised by age. This is most likely due to absolute losses in fast-twitch alpha motor units or a decrease in other size factors. As shown in figure 14.4, the cross-sectional size of type II muscle fibers, and thus the contractile proteins, decrease with age. Such differences can be seen when comparing a span of ages for men and women. This characteristic may decrease even quicker than 1RM strength due to the inherent reliance upon very high-threshold motor units, which are generally composed of type II muscle fibers. With the loss of type II motor units during aging, only type I motor units with larger fibers exist and they have a diminished power capacity. This highlights the importance of not losing or reducing the rate of high-threshold motor units in the major muscle groups of the body needed for whole-body locomotion and kinetic function. It has been estimated that such rapid force production capabilities may be lost at a rate of 3.5% to 4.5% a year from the ages of 65 to 84 years with up to 50% to 70% loss in

power capability from 20 to 75 years of age depending upon the starting physiological profile of an individual. Countermovement vertical jump power and performance have been lost with age as well, which reflects the associated loss of the connective tissue making up the “elastic components” in the body. In addition, cell dehydration and water loss with age, along with sarcopenia may help explain such age-related decrements in power performances.

Underlying Reasons for Strength Loss With Age

A host of different studies have indicated that a decrease in muscle mass is the primary reason for the reduction in force production capabilities with age. This can even be observed in individuals who train but do not optimize force production with their loading routines. It appears that this effect on muscle mass is independent of muscle location (upper versus lower extremities) and function (extension versus flexion). The decline in muscle mass is due to the reduction in the size of the individual muscle fibers and the loss of individual muscle fibers. It also appears there is a preferential loss of type II (fast-twitch) muscle fibers with aging. The observed decline is more marked in type II muscle fibers, which fall from an average 60% in sedentary young men to below 30% after the age of 80. From examining elite weightlifters and their performances, we might speculate that the loss of high-threshold motor units containing type II muscle fibers may be reduced above the age-matched controls but is not prevented as decrements occur.

As noted by Anton and colleagues (2004), the decrease in the muscle's ability to exert force rapidly (power development) also appears to diminish more dramatically with age. The ability of muscles to produce force rapidly is vital and may serve as a protective mechanism when falling (McKinnon et al., 2017). The ability to make rapid direction changes and accelerations will also be affected by the loss of power.

Training for Strength Gains

Research studies over the past three decades or more have demonstrated that strength can be improved with a variety of protocols in older individuals. Improvements in maximal force production have ranged from 18% to 113% from pretraining values in older individuals from 60 to 96 years old (Häkkinen, 2003). Learning effects on maximal testing

most likely contribute to some of the higher percentage gains. The highest gains in strength are seen in the musculature of the lower body. Aging will reduce an individual's force production capabilities. However, at the present time no data exist to characterize the expected gains in strength that are possible at different ages. It appears that the relative improvements in muscle strength, especially from an untrained status, can be observed at any age. Starting from an untrained state, strength gains are greater over the first 24 wk of a 48-wk program compared to the last 24 wk. This indicates that gains in strength are greatest within the first 6 mo for a given exercise movement in older untrained individuals. Yet, few studies exist with long-term observations of highly motivated senior athletes involved in strength training.

Motor Unit Activation and Muscle Hypertrophy

It appears that large gains in strength are related to the increases in motor unit activation of trained muscles. Hypertrophy contributes to muscle strength as the training time elongates and nutritional intakes are adequate (increases in both calories and protein). Large individual variations are observed and may be related to the individual's previous activity profile, health, and recovery abilities.

Muscle hypertrophy is a primary mechanism to help mediate muscle strength increases. Type I and type II muscle fibers have been observed to increase in cross-sectional area. On average, type II muscle fibers increase their cross-sectional area to a greater degree than type I muscle fibers if loading in the training program includes heavy resistance. Heavier loading with higher forces will allow recruitment of the high-threshold MUs and will activate available muscle tissue more completely. Muscle hypertrophy across the length and diameter of the muscle will vary based on activation conditions of the strength training protocol. A significant number of MUs must be activated in order for whole-muscle hypertrophy to be observed. This requires large muscle-group exercises (e.g., squats) to be used with heavy loading cycles for upper- and lower-body exercise movements.

Hormonal Secretions

The area of hormonal secretions is complex at best with some factors that have been identified that are related to andropause and menopause conditions.

While these conditions truly exist, it is less clear as to how they relate to strength training. Hormonal secretions occur in both men and women and are manifested in part as menopause in women and andropause in men. However, recent studies have demonstrated that there is a great deal of individualization of resting concentrations of hormones over the later life span, and therefore it must be evaluated on an individual basis (Kraemer et al., 2017). The stereotype of all aging men having lower testosterone or growth hormone concentrations may not be true (Kraemer et al., 2017). For men, proper multivariate medical diagnosis of true hypogonadism is needed. Lower testosterone values at rest are not indicative of being hypogonadal; a host of other factors unrelated to a true hypogonadal condition can be involved (e.g., low caloric intakes, time of day, higher use by receptors). However, while resting concentration of hormones may not vary, it is quite possible that the aging of the receptors and transcription factors for various hormones might be compromised, reducing the signal impact from the hormone (Hunter et al., 2018; Munetomo et al., 2015).

With older age comes a dramatic reduction in many of the hormonal secretions in response to a strength training protocol or exercise stimulus. Most of the time this is due to less total work or the toleration of less physiological stress (e.g., pH changes, epinephrine changes) that reduce the exercise capacity, because it is the need for repair and remodeling that stimulates most hormonal changes in the blood during recovery. As such, when age-related changes in endocrine gland function occur, this reduces the ability of the body to respond with the same magnitude of signals for protein synthesis and metabolic support as that seen with younger individuals. Thus, due to the inability to produce as much work in an exercise to tolerate that stress level compared to younger subjects, the response of the hormone in the blood and its impact on the target tissues may be affected. Under these conditions, reduced anabolic hormonal responses (e.g., testosterone, growth hormone, IGF-1, insulin) explains many of the reduced physiological adaptations to training. Figure 14.5 shows the difference between 30- and 62-year-old men. Even over a short training period, older men are less responsive to the training stimulus, which demonstrates the more dynamic response capability of youth. Such changes underscore the need for longer recovery periods, and explain why the absolute magnitude of changes in

Does Low Testosterone in Men Really Mean a Man Is Hypogonadal?

Hypogonadal dysfunction is a medical condition in which the hypopituitary-gonadal axis is unable to produce adequate amounts of testosterone. With the rise in men's health clinics and the advertisements on the radio raising concerns of low testosterone levels, more men have been given testosterone supplements than ever before. The importance of this hormone for men is obvious because it represents characteristics of masculinity and virility. But is low testosterone actually an indicator for being "hypogonadal"? And can this be determined by a single blood test or a single variable? It is important to understand that hypogonadal dysfunction can come in many forms due to disease, aging, drug therapies, and can even come from taking prescribed, but unneeded, exogenous testosterone. When the secretions, receptors, and synthesis of the hypogonadal axis that starts above the hypothalamus are destroyed, then the need exists for external clinical management of androgen therapy.

Interestingly, it has been observed that a type of exercise-induced hypogonadal function exists due to the extreme demands of exercise training protocols. Here we see that high amounts of testosterone are pulled out of the circulation by receptors, resulting in lower concentrations in the blood. Poor nutritional intake, and calories not meeting the demands of the exercise repair and remodeling, may be part of the problem. But a single low testosterone measurement does not mean a man is hypogonadal. What are the criteria for a hypogonadal diagnosis? Having a clinically low testosterone concentration in addition to low testosterone values over a day is worthy of having follow-up tests for the presence of hypogonadal symptoms. Such symptoms include low bone density, erectile dysfunction, infertility, decrease in beard and body hair growth, fatigue, decreased sex drive, and hot flashes. However, it is important to note that a testosterone concentration alone does not diagnose hypogonadism and if there are no other symptoms of androgen deficiency, the individual is not hypogonadal and no treatment is necessary.

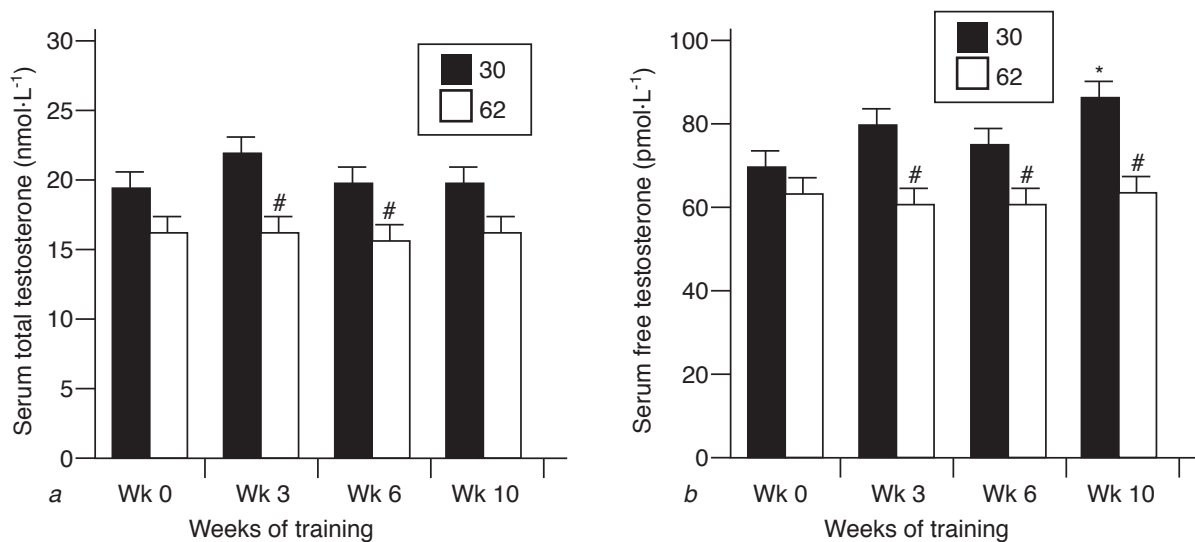

FIGURE 14.5 Differences in testosterone between 30-year-old and 62-year-old men over 10 wk of periodized strength training. # = significant difference between both groups and * = significant increase in serum free testosterone in the 30-year-olds at 10 wk of training.

Adapted by permission from W.J. Kraemer, K. Häkkinen, R.U. Newton, et al., "Effects of Heavy-Resistance Training on Hormonal Response Patterns in Younger vs. Older Men," *Journal of Applied Physiology* 87, no. 3 (1999): 982-992.

Male Andropause

With age, a reduction in the endocrine glands' capabilities to synthesize and secrete anabolic hormones (e.g., testosterone, growth hormone, IGF-1) occurs. As a consequence, lower concentrations of the hormones are found in the blood. In some cases, the concentrations are so low that physicians prescribe anabolic drugs to supplement natural production in order to limit the negative effects of reduced hormone levels on muscle and bone.

older athletes will not be similar to the magnitude of changes in younger athletes. A host of different anabolic and catabolic signaling systems may be affected and may mediate this lower adaptive response in younger versus older individuals.

Training for Muscular Power

Initial scientific studies directed at improving power capabilities in older individuals over short training cycles met with little success. Reasons for limited improvements appear to be the limited amount of time spent on the training component, the exercise choices, and the natural age losses in the neuromuscular system. Training with the use of power exercises (e.g., hang pulls, hang cleans, weighted jumps) or machines that allow the performance of explosive, high-speed power repetitions (e.g., pneumatics with no deceleration for fixed-form exercises) is needed. Subsequently, such changes in program design have demonstrated that power improvements are possible in older adults.

Power changes have typically been observed at the various percent of 1RM loads that are used in training. This typically has ranged from 30% to 55% of 1RM or a percent of body mass (50%-70%). Thus, peak mechanical power at higher percentages of 1RM can be produced by a strength training program but is highly dependent upon the force and power components of the program.

Training for muscular power in the older adult depends on a number of factors. One must train

each part of the power equation with strength and power exercises by doing the following:

1. Using proper exercises that eliminate large portions of deceleration through the range of motion for the exercise.
2. Loading 30% to 40% of 1RM for training maximal mechanical power.
3. Optimizing the acceleration component of the force equation.
4. Using plyometric exercises including vertical jumps and medicine ball exercises for upper-body power development.
5. Using optimal recovery times between high-force or high-power loading days, which may range from 3 to 7 days.
6. Using weight machines that allow for high-speed movements to occur without a large deceleration of the limb due to the need for protection of joint stability and function. Pneumatic resistances have been developed that are capable of producing this type of modality for training for speed and power. Isokinetic resistances have also been used for this purpose but are limited in exercise choice and availability.

Training for muscular strength is a vital part of enhancing power development because low strength levels make power development harder to achieve. Thus, a complete periodized program needs to

Loss of Neurological Function With Age

There is some evidence that the actual number of functional fast motor units can decrease slightly after age 50, about 10% per decade. If athletes stop training, they appear to have a greater percentage of slow-twitch fibers, which is thought to be primarily due to the selective atrophy or loss of fast-twitch fibers.



Training for muscular power in the older adult depends on a number of factors, one of which includes plyometric exercises such as jumping.

address heavy resistance training with power training. Strength is a fundamental characteristic that can be improved throughout a lifetime but heavier loads (e.g., $\geq 80\%$ of 1RM) in the major exercises need to be included. Many senior athlete programs use a leg press as the simplest way to increase load in major muscle groups with little technique, and then progress to barbell squats and power cleans to gain structural capabilities. Strength is a key factor to physical fitness and can be achieved across the life span of an athlete. Even athletes in their 70s and 80s have shown impressive physical capabilities. Optimal training is dependent upon a solid strength base with the use of proper exercises in a periodized program.

Nutrition, Aging, and Exercise Challenges

Research on nutrition, longevity, and fitness has proliferated almost exponentially. For the older

athlete who continues to exercise and compete, it is even more important to have dietary habits that meet energy demands and provide needed nutrients for tissue repair (Campbell and Geik, 2004). With age, there is a loss of cell water, making hydration and proper fluid intake mandatory, especially when strength training. As little as a 3% dehydration level can result in a loss of strength over 24 to 48 h. Water intake over the day is vital for every athlete but especially for older athletes. Not only is it important for thermal and fluid regulation, but one of the first signals for muscular hypertrophy is related to cell swelling, or the uptake of water into the cell to prepare for changing osmotic demands of protein accretion that leads to muscle fiber hypertrophy. According to Campbell and Geik (2004), older athletes need to consider the following points when they examine their dietary habits:

1. Nutrient intake must be monitored to ensure adequacy, especially regarding carbohydrate intake to promote glucose storage and to use as an energy source during exercise.
2. Protein intake must be monitored to promote muscle hypertrophy.
3. Emphasis should also be placed on the dietary intake of certain micronutrients, as well as the potential need for supplementation of certain vitamins and minerals, including the vitamins B₂, B₆, B₁₂, D, E, and folate, and the minerals calcium and iron.
4. Age-associated changes in thermoregulation and an increased susceptibility to dehydration underscore the importance of adequate fluid intake to sustain health and performance.

Additionally, Bernstein (2017) provides two more important points on nutritional needs for older adults:

1. The ability to consume the appropriate quality and quantity of foods is influenced by food accessibility, availability, acceptability (preference), preparation, and the eating process itself.
2. Age-related changes in nutrient digestion, absorption, and metabolism contribute to alterations in dietary requirements for macronutrients, vitamins, and minerals, underscoring the need for nutrient-dense foods.

Thus, nutrition is an important tool that the older athlete should use to enhance exercise performance and health. Timing of nutrient intake around workouts is important. To promote protein synthesis, essential amino acids and carbohydrate should be ingested about 30 min before and after a workout. The insulin response from the carbohydrate along with the availability of amino acids will aid the older athlete's protein synthesis and recovery from the workout.

Improved nutrition and dietary management should enhance the effects of resistance training on muscle mass in older individuals. There is a need for adequate protein in order to support muscle hypertrophy in older athletes. The need for protein may exceed the recommended RDA value of 0.8 g/kg/day (Campbell and Geik, 2004). Without the necessary protein and other nutrients, increases

in lean body mass will be compromised. Adequate intake of vitamins, minerals, micronutrients, and macronutrients is vital for optimal function in the recovery and remodeling process of tissues with resistance exercise and training.

Recovery From Resistance Exercise

Recovery is vital to all athletes, but especially to older athletes. The period after the workout is critical for optimal repair of tissues. Replacement of energy loss as well as proper rest are as important a part of program design as the strength training protocol itself.

Rest Between Workouts

It might be speculated that as people get older, muscles require longer periods of time to recover

Low Carbohydrate Diet

Each year more and more data are accumulating on the benefits of a properly formulated ketogenic or what is now called a low-carbohydrate, high-fat diet with normal amounts of protein. A properly formulated low-carbohydrate diet assists in fighting conditions such as type II diabetes and epilepsy, enhances brain function to hasten recovery time, and improves sleep. This type of diet is becoming mainstream, even for older individuals.

Creatine Supplementation

For older individuals, use of creatine monohydrate has been observed to increase strength, power, and functional capabilities in men and women. The monohydrate form of creatine is similar or identical to endogenous creatine produced in the liver, kidneys, and pancreas, which produces about 2 to 3 g a day. The additional creatine from supplementation allows for more creatine phosphate to be formed in the muscle, thereby creating a larger available pool of energy that can be used in the ATP-PC energy system. Using a fast loading phase (4 or 5 servings of 5 g of creatine monohydrate in fluids a day for 3 or 4 days) or slow loading phase (2 servings of 5 g of creatine monohydrate a day for 30 days) can fill the muscle to capacity with creatine. Most people have about 65% to 70% of their skeletal muscle filled with creatine, and the supplementation increases this pool to 100%. For some, creatine supplementation may not seem to work and may be due to their genetically high concentrations. As we say, the "cup" or muscle is already filled to capacity. One loses about 2 to 3 g a day and thus 5 g a day will maintain the pool at 100%. No side effects of ceasing creatine supplementation have been shown, and normal function resumes leading to lower creatine pool concentrations. This aids the expansion of the creatine pool in the muscle and helps with the rapid energetics so important for strength and power capabilities of the muscle. Additionally, creatine supplementation has been used to assist with brain function as well, helping to stabilize interneuron connections. Many seniors benefit, with better recovery and no real side effects, from taking the pure compound of creatine monohydrate as a supplement.

between exercise sessions. Muscle and connective tissue take longer to repair due to reductions in water content of cells as well as reductions in the body's natural hormonal signal strength. This indicates that the workouts need to be varied in intensity and volume so that recovery can take place, especially after workouts where sufficient muscle damage has occurred with heavy loads, which have higher eccentric load components, eccentric loads, or high volumes.

Muscle biopsy studies have shown that 7% to 10% of muscle fibers exhibit damage after a typical workout in older individuals, and this might be even higher in older athletes using much more dramatic training protocols. It appears that muscle damage is very evident in older individuals but is similar in younger and older men using standard strength training protocols. In another study, it was shown that older women exhibited higher percentages of muscle damage for a given muscle than younger women in response to a heavy resistance training workout. This appears to be due to the smaller size of the muscles in older women compared to younger women, producing a greater amount of tension per cross-sectional area of muscle. The lower absolute muscle mass and fewer operational motor units combine to create a much larger percentage of damaged area.

Oxidative Damage

It has become obvious over the past years that damage is needed to stimulate repair. Thus, free radicals and reactive oxidative species (ROS) that result from exercise and inflammation can be both positive and negative as it stimulates repair and remodeling (Bouzid et al., 2015). However, if inflammation from a poorly designed workout with too much physiological stress (e.g., high acidity, high lactic acid, high cortisol, heavy loadings) is excessive, recovery may be extended for days, and inflammation is only exacerbated if such workouts are accumulated without the needed recovery. Aging itself can lead to a dysregulation of the ROS system, and thus control of such inflammatory processes is made even more difficult to manage with training mistakes being made, extending recovery time far beyond desired time frames for senior athletes.

When examining markers of oxidative damage to DNA in younger and older men and women, significant oxidative damage was observed in the older individuals, with more oxidative damage observed in older men. This oxidative damage may be regu-

lated by hormonal factors since a gender difference exists. How exercise affects these markers remains unclear, as exercise can increase oxidative stress due to acute muscle tissue damage and resulting inflammation. We know that strength training does provide a protective effect from eccentric damage, which may result in faster recovery. However, this recovery length will depend on the amount of damage produced by the exercise protocol. In some cases, older lifters may only complete a very heavy day once every 2 wk. Depending upon the specific program goals, heavy and very heavy days need to be carefully placed in an exercise program. Various periodization models will facilitate this need.

Toleration of pH Changes

The toleration of high-intensity activity is important in most sports. Changes in the acid-base status and toleration of changes in the pH of the body's tissues, especially muscle and blood, are an important aspect of conditioning. Part of this essential adaptation can be addressed in a strength training program. Toleration of changes in pH decreases as one gets older, most likely due to the lack of training that creates such metabolic conditions.

It is now well known that lactic acid does not cause a drop in pH or in the acidity of the body, because it is just a by-product of glycolysis; however, it is a great marker of anaerobic glycolytic metabolism. ATP hydrolysis contributes to the changes observed, and development of both an intracellular and intercellular buffering capacity with gradual progression and adequate rest days can improve toleration to dramatic changes seen in such sport competitions (e.g., 800 m) or workouts (e.g., short rest resistance training protocols) with a high glycolytic component. Workouts that create high lactic acid responses, such as circuit resistance training protocols with short rest periods, create a lot of free radicals, or ROSs, as previously noted. Additionally, high cortisol levels produced by the adrenal cortex with such workouts can accumulate at rest after 24 h if a recovery day is not taken to allow these concentrations to return to normal levels. Thus, cortisol can also contribute to chemical damage after 24 h if rest and recovery is not allowed. It can also contribute to the catabolism of muscle tissue beyond the mechanical damage that occurs due to the load.

Gradual reductions in rest periods between sets and exercises (e.g., 3-4 min to 1-2 min) in a strength training protocol can help an individual adapt

and better meet such a physiological challenge by improving buffer capacity of the blood and muscle tissue. It has been observed that it takes about two training sessions per week for 8 wk to improve buffering capacity. However, it may take weeks to progress to the level needed to stimulate changes in the buffer capacity. It is vital that signs of fatigue be monitored carefully as this may be the most dramatic training for older athletes, comparable to preparing for 400-m and 800-m track events. If signs of nausea, light-headedness, or dizziness occur, the workout should be stopped immediately. The lengths of the rest periods should be increased for the next training session so that no symptoms occur. Such symptoms can indicate serious underlying disease or metabolic demands that are too high.

Joint Stress

One important aspect of recovery is the amount of joint stress experienced after the workout. Heavy loads will produce more extensive compressive forces, and this is augmented by the type of exercise used. A key factor appears to be how many reps are done to failure. While going to failure may be a popular training style, it may also produce greater compression and shear stresses on joints. Since most individuals can tell when they can do another repetition or not, limiting the set within a repetition zone of 3 repetitions (e.g., target a load that allows 3-5 reps but do not try to squeeze out the last rep of every set) limits the joint aches and pains during the recovery period. This type of training has been successfully used by cardiac patients where the fear of a Valsalva maneuver may be realized if they try to push out a final repetition to failure.

Strength Training and Bone Health

Resistance training has been a focus for many decades since osteoporosis became a major health issue for women. We are still learning more about

this modality as a crucial tool in bone development over the life span. Development of connective tissue (i.e., bones, tendons, ligaments, noncontractile elements in the muscle tissue) with strength and power training is vital for injury prevention, as well as general health in the older athlete. Older master female athletes have been shown to have stronger bones and be less prone to osteoporosis compared to normal controls or master athletes who only participate in endurance training. Leigey and colleagues (2009) studied senior Olympic athletes—298 women and 289 men—at a national championship. The athletes ranged in age from 50 to 93 years of age with an average age of about 66 years old, and were classified as high-impact sport athletes or running sport athletes. The major finding was that as one participated in high-impact sports such as basketball, bone mineral density was greater in the oldest senior athletes, indicating that connective tissue relishes compression and strain when it comes to remodeling.

In order to withstand the compressive forces, eccentric loadings, and stress demands on the body with sport, connective tissue must be strong enough to contribute a significant elastic element. The bones must be able to take on the rigors of structural integrity during sport competition. This requires a strength training program that uses proper exercise loads and forces to develop connective tissue strength. Bone metabolism and modeling as a structural tissue responds to strain, compression, and strain rates to adapt. Exercise prescriptions must reflect these loading requirements.

Strength Training Guidelines for Senior Athletes

The principles of program design are the same despite the athlete's age. This is reflected in the new position stand by the National Strength and Conditioning Association (Fragala et al., 2019). Because of variations in the functional capacity of many older individuals, the best program is individualized to

Over-the-Counter Joint Therapeutics

Clinical studies have concluded that a topical cream consisting of a blend of natural oils called cetylated fatty acids significantly increased range of motion and physical performance in older individuals with osteoarthritis of the knee with no reported side effects (Kraemer et al., 2004). Such topical creams can help older individuals improve their trainability by reducing pain and improving balance along with range of motion.

meet the needs and medical concerns of each person. At present, only a limited number of studies have examined periodized strength training programs for older adults. While more research is needed, it appears that periodized strength training may better optimize training programs for older adults. In addition, the inclusion of functional resistance training (i.e., use of exercises in an unstable environment) appears to significantly improve muscle balance, strength, and functional capacity, especially when incorporated into a weight training program.

As with any athlete, the process of developing a strength training program for senior athletes consists of developing pretesting methods, setting individualized goals, designing a program, and developing evaluation methods. Evaluation of training progress should include testing of strength (if possible, on the equipment used in training), body composition, functional abilities (e.g., lift chair, get out of chair), muscle size changes, nutritional assessments, and medical tracking of preexisting conditions.

Medical Clearances

The American College of Sports Medicine (ACSM) has advised that people who start an exercise program be classified into one of three risk categories:

1. Apparently healthy, less than one coronary risk factor (hypertension, smoking) or cardiopulmonary or metabolic disease
2. At higher risk, more than two coronary risk factors or cardiopulmonary or metabolic disease symptoms
3. Individuals who previously have been diagnosed with diseases such as cardiovascular, pulmonary, or metabolic disease

Consultation with and consent of a physician are recommended in all cases, with additional functional exercise testing for individuals in class 3 recommended by the ACSM. It is recommended that older athletes interact carefully with their family physician to optimize their health and minimize risks associated with more dramatic training paradigms.

Rate of Progression

The major concern for older athletes is proper progression without injury or acute overuse. Recovery from a training session takes longer, and care is needed to not overestimate the body's physiological ability to repair tissues after a workout. An overview of progression has been presented in an ACSM position stand (American College of Sports Medicine, 2009).

The design of a quality resistance training program for older athletes should attempt to improve their quality of life and competitive success by enhancing several components of muscular fitness including muscle hypertrophy, strength, power, and local muscular endurance. Programs that include variation, gradual progressive overload, specificity, and careful attention to recovery are recommended (Kraemer et al., 2002).

When the older adult's long-term resistance training goal is progression toward higher levels of muscular strength and hypertrophy, evidence supports the use of variation in the resistance training program. It is important that progression be introduced at a gradual pace because the potential for strength adaptation appears high. It should be noted that the rate of adaptation, as well as the magnitude of adaptation, will be smaller after basic improvements are made over the first year of training.

Injury Potential and Aging

It appears that older athletes are more prone to certain injuries, including rotator cuff and bicipital tendinitis, patellofemoral arthrosis, trochanteric (hip) bursitis, quadriceps tendinitis and rupture, gastrocnemius tear, bone fractures (in postmenopausal women), and discogenic low back pain (i.e., a degenerative condition with the term "discogenic pain" meaning one or more intervertebral discs are the source of the pain). For example, injury prevention can be accomplished by including certain exercises in the program (e.g., rotator cuff exercises), varying the loads that are used in the program (e.g., light, moderate, and careful use of heavy loads), not going to failure with each set of reps, listening to your body, and not trying to fight through pain and soreness. Interestingly enough, many studies indicate that resistance training can be used to work around various pathologies and injuries and be an important therapeutic tool.

Program design for the older athlete needs to address the important elements of sport performance using a periodized training program. Strength is at the core of any program, with power exercises and improved toleration of decreased pH needed for improving the dimensional physical capabilities of the older athlete. Along with the improvement in acid–base buffer capacity will come improved local muscular endurance.

Summary

The benefits of strength training for older adults include increased strength, endurance, and muscle capacity; increased flexibility; more energy; and

improved self-image and confidence (Fragala et al., 2019). As in any athlete, the two major components in a strength training program for an older athlete are strength and power. Muscle strengthening enhances everyday physical performance and quality of life. In addition, it enhances cardiovascular endurance by placing less stress on the heart and circulatory system because endurance activities are performed at a significantly lower percent of the maximal voluntary contraction. The enhancement of muscle and bone mass has important benefits for the health of athletes and their recovery potential. Proper design and progression of a resistance training program for the older athlete are vital to improved sport performance and health.

Glossary

3-year rule—The recommendation to perform exercises with a heavy barbell (like barbell squats) only after 3 years of preliminary general preparation.

abdominal hernia—Protrusion of an internal organ, or part of an organ, through the abdominal wall.

abduction—Movement of a limb away from the median plane of the body.

absolute indices of endurance—Endurance as determined by asking a number of subjects to overcome resistance of the same magnitude (e.g., to lift a 50-kg barbell).

absolute strength—Maximum amount of strength exerted regardless of body or muscle size.

acceleration—An increase in the rate or speed of something.

accentuation—Increasing muscular strength primarily at the angular position at which maximal efforts are developed during the main sport movement.

accommodating resistance—Increasing muscular strength throughout the complete range of joint motion.

accommodation—Decrease in the response of a biological object to a continued stimulus.

accumulative mesocycle—Mesocycle of training conducted to enhance the athlete's potential, that is, to improve basic motor abilities (conditioning) as well as sport technique (motor learning).

achievement goal theory—The study of how the role of achievement goals regulate the behavioral, cognitive, and affective outcomes of individual pursuits.

actin—One of two proteins in muscle filament, the other being myosin.

activity—See physical activity.

acute training effects—Changes that occur during exercise.

adaptation—Adjustment of an organism to its environment.

adduction—Movement of a limb toward the median plane of the body.

adenosine triphosphate (ATP)—Biochemical substance used by all cells as an immediate source of energy.

adolescence—Transitional stage of development between childhood and full adulthood, representing the period of time during which a person is biologically an adult but emotionally not at full maturity.

The ages that are considered to be part of adolescence vary by culture. In the United States, adolescence is generally considered to begin around age 13 and end around age 24.

adrenergic receptors—Specific molecular structures within effector cells that mediate the effects of neurotransmitters such as epinephrine.

aerobic exercise—Exercise during which energy is supplied by inspired oxygen.

agonistic muscle groups—Muscles that initiate and carry out motion.

A-gradient—Ratio used to quantify the rate of force development in the late stages of explosive muscular effort; $A\text{-gradient} = F_{0.5} / (T_{max} - T_{0.5})$.

all-or-none law—The concept that when stimulated at or above the threshold, all the muscle fibers in a motor unit are activated. If the threshold is not reached, none of the fibers will be activated.

alpha-motoneuron—See motoneuron.

amenorrhea—Absence of menstrual bleeding, with primary amenorrhea being a delay of menarche beyond age 16, and secondary amenorrhea being the cessation of menstruation in a woman who had previously menstruated.

amino acids—Organic compounds (“building blocks”) that constitute muscle proteins.

amino acids, essential—Indispensable amino acids that must be provided by food.

anabolism—Synthesis of complex substances from simple ones; the opposite of catabolism.

anaerobic exercise—Without oxygen.

anatomical match—Coupling the inhalation phase of breathing with trunk extension and the exhalation phase with trunk flexion.

androgen receptor—A nuclear receptor that functions as a transcription factor and regulates the development and growth of hormones such as testosterone.

andropause—Period of declining androgen levels in middle-aged men; the male version of menopause. Also called ADAM (androgen decline in the aging male).

annulus fibrosus—Fibrous ring that makes up the outer part of an intervertebral disc.

antagonist muscle groups—Muscle that produces tension in opposition to the tension of another muscle.

anterior cruciate ligament (ACL)—One of the two central ligaments in the knee, the ACL crosses from

- the underside of the femur (the thigh bone) to the top of the tibia (the bigger bone in the lower leg). The cruciate ligaments are so called because they cross each other in front of the knee.
- ATP**—See adenosine triphosphate.
- autoregulated progressive resistance exercise (APRE)**—A system of training programming that adjusts for an individual athlete's physiological and mental state.
- axon**—A nerve fiber.
- biomechanical match**—Matching the expiration phase of breathing with the forced phase of movement, regardless of its direction or anatomical position.
- calorie**—A quantity of energy, especially heat.
- caring climate**—How individuals perceive a setting to be safe, supportive, and providing the sense of respect or value.
- case study**—An analysis with only one subject ($n=1$).
- catabolism**—Disintegration of complex substances into simpler ones; the opposite of anabolism.
- central factors (in force production)**—Coordination of muscle activity by the central nervous system, including intramuscular and intermuscular coordination.
- circuit training**—Training that consists of several stations, with a specific exercise to be performed at each one.
- clean and jerk**—One of two lifts constituting the sport of weightlifting (Olympic style), in which the barbell is first lifted from the floor to the shoulders (clean phase) and then overhead (jerk phase). The other lift in Olympic-style weightlifting is the snatch.
- competition period**—In-season training.
- compliance**—Ratio of change in length per unit change in applied force.
- compound resistance**—Resistance provided by a combination of two or more sources, for instance lifting a heavy barbell that is connected to the floor by a rubber band.
- concentric (or miometric) muscle action**—Muscle shortening under tension, with the external resistance forces acting in the opposite direction from the motion.
- connective tissues**—Supporting tissues of the body, such as tendons, ligaments, bone, and cartilage.
- core stability**—Stabilization of the trunk and pelvis necessary to perform movements of the extremities.
- corridor (of motor units)**—Subpopulation of motor units recruited and trained in a given exercise set.
- cross-bridge attachment**—Connection between the head of the myosin cross-bridge and the actin filament during muscle action.
- cross-sectional area (of a muscle)**—Area of muscle fibers on a plane perpendicular to their longitudinal axes.
- cumulative training effects**—Results of the superimposition of many training sessions or even many seasons of training.
- delayed muscle soreness**—Pain and soreness that may occur 24 to 48 h after training workouts.
- delayed training effects**—Changes manifested over a certain time interval after a performed training routine.
- delayed transformation**—Delay of performance growth with respect to executed training work.
- delayed transmutation**—Time period needed to transform acquired motor potential into athletic performance.
- detraining load**—A load that leads to a decrease in performance results or functional capabilities of an athlete or both.
- diaphragm**—Musculomembranous wall separating the abdomen from the thoracic cavity.
- diuretic**—Drug that increases urine excretion.
- doubled stress microcycle**—Two stress microcycles in a row.
- drag**—Resistance to movement of a body offered by a medium, specifically air or water.
- dynamic effort method**—Lifting (throwing) a non-maximal load with the highest attainable speed.
- dynamic muscle action**—Muscle lengthening or shortening under tension; see also concentric, eccentric, and reversible muscle action.
- dysmenorrhea**—Painful menstrual periods.
- eccentric muscle action**—Muscle lengthening under tension, with the external forces acting in the same direction as the motion. Also known as plyometric muscle action.
- effect size**—Result gain computed as the following: $(\text{Posttraining mean} - \text{Pretraining mean}) / \text{Pretraining standard deviation}$.
- efferent**—Conducting impulses from the central nervous system.
- efficacy coefficient (in periodization)**—Proportion of athletes (%) who achieve their best performance during the most important competition of the season.
- elasticity**—Resistance provided by a deformed body, such as a rubber band or a spring.
- electromyography (EMG)**—Record of electric activity within or on the surface of a muscle.
- endurance**—Ability to bear fatigue.
- energetic theory of muscle hypertrophy**—The theory that muscle growth (hypertrophy) is influenced in part by the energy demands of the working muscle.
- energy**—Capacity to perform work.
- essential amino acids**—See amino acids, essential.
- explosive strength**—The ability to exert maximal forces in minimal time.

- explosive strength deficit (ESD)**—The relative difference between maximum maximum force (F_{mm}) and maximal force (F_m) when the time available for force development is short; $ESD (\%) = 100(F_{mm} - F_m) / F_{mm}$. ESD signifies the percentage of an athlete's strength potential not used in a given attempt.
- extensor**—Muscle that extends a limb or increases the joint angle.
- external force**—Force acting between an athlete's body and the environment. Only external forces are regarded as a measure of an athlete's strength.
- fasciae**—Fibrous membranes.
- fast-twitch fibers (type II)**—Muscle fibers that display high force, high rate of force development, and low endurance.
- fatigue**—The decline in ability of a muscle to generate force.
- fear of missing out**—Including tests within a protocol in the event that the results might be helpful.
- female athlete triad**—Disordered eating, amenorrhea, and osteoporosis.
- filament area density**—The ratio of the filament cross-sectional area to the muscle fiber cross-sectional area.
- filaments**—Thread-like structures in the muscle sarcomeres. There are the thick filaments that are composed of protein myosin and the thin filaments that are composed mainly of protein actin.
- fitness**—See physical fitness.
- fitness-fatigue theory**—See two-factor theory.
- flexor**—Muscle that flexes a limb or decreases the joint angle.
- force**—An instantaneous measure of the interaction between two bodies, force being characterized by magnitude, direction, and point of application.
- force feedback**—See Golgi tendon reflex.
- force gradient (S-gradient)**—Ratio characterizing the rate of force development at the beginning phase of a muscular effort; S-gradient = $F_{0.5} / T_{0.5}$, where $F_{0.5}$ is one half of the maximal force F_m and $T_{0.5}$ is the time required to attain that force.
- force-velocity relationship (curve)**—Parametric relationship between maximal force and velocity values attained when a parameter of the motor task has been altered in a systematic way; motion velocity decreases as force increases.
- functional overreaching**—When subsequent performance is enhanced after overreaching; it is often a desired training strategy to optimize later performance.
- general adaptation syndrome (GAS)**—The three-stage process of physiological changes the body undergoes when under stress.
- generalized training theories**—Simple models in which only the most essential features of sport training are taken into consideration.
- Golgi tendon organ**—Tension-sensing nerve ending located in series with muscle.
- Golgi tendon reflex**—Inhibition of muscle action evoked by a sharp rise of the pulling force applied to the muscle end.
- growth hormone (GH)**—Hormone made by the pituitary gland that controls the growth of the body.
- heart rate variability (HRV)**—A noninvasive method to determine the relative contributions of the sympathetic and parasympathetic nervous systems. It can be determined by the variability of the interval between heartbeats.
- hormone**—Chemical substance that is secreted into blood and transported to another organ, where it produces a specific effect.
- human strength curve**—See strength curve.
- hydrodynamic resistance**—Resistance provided by water.
- hypermenorrhea**—Excessive or prolonged uterine bleeding occurring at regular intervals.
- hyperplasia**—Increase in number of cells.
- hypertrophy**—Increase in cell or organ size.
- iliopsoas**—The compound iliacus and psoas magnus muscles.
- immediate training effects**—Effects that occur as the result of a single training session.
- impulse**—A force acting on a muscle to produce a change.
- index of explosive strength (IES)**—The ratio of $IES = F_m / T_m$, where F_m is the peak force and T_m is the time to peak force.
- indices of endurance**—See absolute indices of endurance; relative indices of endurance.
- individualization**—Efforts to train according to the interests, abilities, and other particular characteristics of an individual.
- inertia**—Resistance due to the property of a body to remain at rest or to continue its movement in a straight line unless acted on by an external force. Force is required to overcome inertia and to accelerate the body.
- inertia wheel**—Device used to study movement against inertial resistance in which the potential energy of the system is constant and all mechanical work, except small frictional losses, is converted into kinetic energy.
- intensity coefficient (IC)**—The ratio of average weight lifted compared to athletic performance.
- internal force**—Force exerted by one constituent part of the human body on another part.
- intervertebral disc**—Disc of fibrocartilage located between two adjacent vertebrae.
- intra-abdominal pressure (IAP)**—Pressure within the abdomen.

isokinetic muscle action—Muscle shortening at a constant rate; usually applied either to the constant angular velocity of a joint or to the constant linear velocity of a lifted load. Isokinetic means “with constant speed” and may refer to the rate of change of muscle length, velocity of the load being lifted, or angular velocity of the joint.

isometric muscle action—See static muscle action.

isotonic—With constant force; may refer to muscle action, a constant load being moved, or a constant joint torque over a range of motion.

kurtosis—This describes the shape of a normal distribution of scores, often called a “bell-shaped curve.” When graphed, a high level of kurtosis means the peak of the curve is sharp or pointed, indicating many values near the mean.

learning effects—Changes in a function based on practice and better neural functioning.

length feedback—See stretch reflex.

linear periodization—Training all targets sequentially in a season, one target after another.

line of best fit—The statistically derived line on a graph that describes the values, such as shown by straight or curved lines.

load—See training load.

loading spectrum—The range of external loads, from no load to supramaximal (e.g., more than can be concentrically lifted).

local muscular endurance—Ability of a certain muscle or muscle group to perform repeated contractions against a submaximal resistance. Examples include performing a maximal number of repetitions in the chin-up, parallel bar dip, or push-up exercises, or a resistance training exercise using a fixed load.

long-standing training—Training embracing the entire career of an athlete, from beginning to end.

long-term planning—Planning multiyear training.

lordosis—Curvature of the back bones (vertebrae) in the lower back, giving a swayback appearance.

macrocycle—One competition season; includes preparation, competition, and transition periods.

maladaptation—Negative changes within muscles in response to external loads or lack of sufficient recovery after training.

maximal effort method—Lifting a maximum load, or exercising against maximal resistance.

maximal muscular performance—The best achievement in a given motor task when the magnitude of a motor task parameter (for instance, weight of an implement or running distance) is fixed; the symbol P_m (or V_m for maximal velocity, F_m for maximal force, and so on) is used throughout the book to specify maximal muscular performance.

maximal nonparametric relationship—See nonparametric relationship.

maximum competition weight (CF_{mm})—Athletic performance attained during an official sport competition.

maximum maximorum performance—Highest performances among the maximal, represented by the symbols P_{mm} (power), F_{mm} (force), and V_{mm} (velocity); for instance V_{mm} and F_{mm} are the highest maximal velocity and force, respectively, that can be achieved under the most favorable conditions.

maximum training weight (TF_{mm})—Heaviest weight (1-repetition maximum) an athlete can lift without substantial emotional stress.

mechanical feedback—Impact of force generated by an athlete on the external resistance, by the movement performed, or both.

medico-mechanical gymnastics—Exercises on strength exercise machines incorporating accommodating resistance (an old term used mainly to describe the exercises and machines suggested in 1879 by Zander).

medium-term planning—Planning macrocycles.

menopause—Permanent cessation of menstrual cycles.

menstrual cycle—Monthly cycle of discharge of blood and tissues from the uterus that occurs during a woman’s reproductive years.

mesocycle—A system of several microcycles. Types include accumulative, transmutative, and realizational.

meta-analysis—A statistical analysis that combines the results of multiple scientific studies.

metabolic rate—Speed at which the body uses energy. Resting metabolic rate is the rate of energy use at rest.

microcycle—Grouping of several training days.

miometric muscle action—See concentric muscle action.

moment arm (of a muscle force)—Shortest distance from the line of muscle force action to the center of rotation at the joint.

moment of force (or moment)—See torque.

momentum—The quantity of motion of a moving body.

motion—Movement determined only by its geometry; if all body parts move in different attempts along the same or very similar trajectories, the motion is considered the same, regardless of differences in force, time, velocity, and the like.

motoneuron (or motor neuron)—Nerve cell that innervates muscle cells.

motor unit (MU)—A motoneuron and the muscle fibers it innervates.

motor unit activation—Stimulation of a motor unit and its fibers.

multiyear training—See long-standing training.

muscle fiber—Skeletal muscle cell.

muscle force arm—Shortest distance between the axis of joint rotation and the line of muscle action.

- muscle spindle**—Length-sensitive receptor located in muscle.
- muscle strength deficit (MSD)**—The ratio of $100(\text{Force during electrostimulation} - \text{Maximal voluntary force}) / \text{Maximal voluntary force}$.
- muscular corset**—Muscles of the lumbar region.
- muscular endurance**—Type of endurance manifested in exercises with heavy resistance that do not require considerable activation of the cardiovascular and respiratory systems.
- muscular strength**—See strength, muscular.
- myofibril**—Longitudinal unit of muscle fiber containing thick and thin contractile filaments.
- myosin**—Contractile protein in the thick filament of a myofibril.
- myotatic reflex**—See stretch reflex.
- neural mechanisms**—This refers to contributions of the nervous system to strength training adaptations and responses.
- neuron**—Nerve cell.
- nonfunctional overreaching**—When recovery from overreaching takes longer than two weeks and produces no supercompensation or enhanced performance.
- nonparametric relationship**—Relationship between maximum maximum performance (P_{mm}, V_{mm}, F_{mm}), on the one hand, and maximal performance (P_m, V_m, F_m, T_m), on the other; nonparametric relationships, in contrast to parametric ones, are typically positive.
- nucleus pulposus**—The cushioning, jellylike center of an intervertebral disc.
- oligomenorrhea**—Infrequent or light menstrual cycles.
- Olympic cycle**—Cycle of training that lasts from one Olympic Games to another; 4 years in length.
- one-factor theory**—Theory stating that the immediate training effect of a workout is a depletion of certain biochemical substances and that, after the restoration period, the level of the substance increases above the initial level (supercompensation).
- ossification**—Hardening of bone by the deposition of calcium.
- osteoporosis**—Decrease in bone mass and bone density that results in an increased risk of fracture.
- overload**—Training load (intensity, volume) exceeding a normal magnitude.
- overreaching**—Being able to attain full recovery from training within one or two weeks.
- overtraining**—The process by which volumes and intensities of the training being performed that contribute to the inability of the human body to adequately recover.
- overtraining syndrome**—A myriad of symptoms and conditions that collectively contribute to impaired performances.
- parameter**—Variable, such as mass or distance, that determines the outcome of a motor task.
- parametric relationship**—Relationships between maximal force (F_m) and maximal velocity (V_m) attained in various attempts in the same motion (e.g., in the shot put) when the values of the motor task parameter (e.g., shot mass) have been altered in a systematic way. The parametric relationship between F_m and V_m is typically negative: the greater the force (F_m), the lower the velocity (V_m).
- partial training effects**—Changes produced by a single training exercise (e.g., bench press).
- Pascal's law**—Law stating that, in liquids, pressure is distributed equally on all sides; intradisc pressure measurements are based on this law.
- peak-contraction principle**—Increasing muscle strength primarily at the weakest (“sticking”) point of a joint motion.
- peaking**—See tapering.
- periodization**—Division of the training season into smaller and more manageable intervals (periods, mesocycles, and microcycles), with the ultimate goal of reaching the best performance during the primary competitions of the season.
- period of delayed transformation**—Time period between a peak training load and a peak performance.
- period of training**—System of several mesocycles.
- peripheral factors (in force production)**—The maximal force capabilities of individual muscles.
- physical activity**—Body movements that require energy to perform.
- physical fitness**—Slow-changing motor components of an athlete's preparedness.
- plyometric muscle action**—See eccentric muscle action.
- pneumatic**—Operated by compressed air.
- power**—Work per unit of time.
- powerlifting**—Sport consisting of lifting maximal weights in the bench press, squat, and deadlift exercises.
- preparation period (of training)**—Off-season training.
- preparedness**—An athlete's disposition for a competition, characterized by that person's potential sport performance.
- principle of diminishing returns**—With an increase in training volume or duration, the magnitude of adaptations diminishes.
- Profile of Mood States (POMS)**—A psychological rating scale used to assess distinct, transient mood states.
- progressive resistance training**—Progressive increase of resistance as strength gains are made.

propulsive (force)—The strength needed to convert power into motion.

puberty—Period in life at which sexual maturity is attained, occurring between the ages of 13 and 15 in boys and 10 and 16 in girls.

pyramid training—Gradually changing the load in a series of sets in an ascending and then descending manner.

quick-release technique—A subject develops force under isometric conditions with a body segment mechanically locked into position; the lock is then trigger released, permitting performance of a movement.

range of motion—The full measurement of a joint's movement.

rate of force development—Force produced at different times from the initiation of the muscle action.

reactive strength index—The ratio of ground contact time during a depth jump, to height attained during the depth jump. Numerous variations of this ratio are also often used.

reactivity coefficient (RC)— $RC = F_m / (T_m W)$, where F_m is peak force, T_m is the time to peak force, and W is an athlete's weight.

realizational mesocycle (precompetitive mesocycle)—Mesocycle planned to elicit the best sport performance within a given range of fitness.

recruit—The ability of the nervous system to activate motor units in skeletal muscle.

relative indices of endurance—Endurance as determined by asking subjects to overcome resistance that equals a specified percentage of their maximum strength (e.g., to lift a barbell 50% of F_{mm}).

relative strength—The strength per kilogram of body weight.

repeated effort method—Lifting a nonmaximal load to failure; during the final repetitions, the muscles develop the maximum force possible in a fatigued state.

repetition—Number of times a movement is repeated within a single exercise set.

repetition maximum (RM)—Maximal load that can be lifted a given number of repetitions in 1 set before fatigue; for instance, 3RM is the weight that can be lifted in 1 set only three times.

residual training effects—Retention of changes following the cessation of training beyond time periods when possible adaptation takes place.

rest interval—Time period between sets in a workout or between workouts.

retaining load—A load in the neutral zone at which the level of fitness is maintained.

reversible muscle action—Muscle action consisting of eccentric (stretch) and concentric (shortening) phases.

rhabdomyolysis—Breakdown of muscle fibers resulting in the release of muscle fiber contents into circulation; caused by overexertion.

rule of 60%—Empirical rule stating that the training volume of a day (microcycle) with minimal loading should be around 60% of the volume of a maximal day (microcycle) load.

sarcomere—Repeated contractile unit of a myofibril.

sarcopenia—Loss of muscle fiber size and whole-muscle mass that results in diminished strength with age.

self-efficacy—The sense of confidence in the ability to exert control over one's own motivation, behavior, and social environment.

S-gradient—See force gradient.

short-term planning—Planning workouts, microcycles, and mesocycles.

simultaneous training—The training of different motor abilities, e.g., muscular strength and speed, during the same time periods, e.g., on the same training day.

size principle (of motor neuron recruitment)—To control the force generated by a muscle, the central nervous system activates motor neurons according to size, from small motoneurons at low forces to large motoneurons at high forces. Because small motor neurons innervate slow-twitch fibers while large motor neurons innervate fast-twitch fibers, the size principle implies that at low forces only the slow muscle fibers are active.

skewness—The distribution of scores are distributed in a similar manner both above and below the mean of the scores. This is a characteristic of normally distributed scores, sometimes called a "bell-shaped curve."

slow-twitch fibers (type I)—Muscle fibers that display low force, low rate of force development, and high endurance.

snatch—One of two lifts constituting the sport of Olympic-style weightlifting, in which the barbell is lifted in one continuous motion from the floor to an overhead position. The other lift in Olympic-style weightlifting is the clean and jerk.

specificity—Similarity between adaptation induced by a training drill and adaptation required by a main sport movement.

speed-resisted training—Performing the main sport exercise against increased resistance.

split table—Apparatus used for spinal traction.

split training—Training different body parts on various days.

sport-specific exercises—Training drills relevant to demands of the event for which an athlete is training.

stagnation—Power decrements as a result of excessive use of maximal loads, high power, or high volumes of resistance exercise.

- staleness**—A term often used during stages of overreaching or overtraining, where progress stagnates and the desire to train decreases.
- static (isometric) muscle action**—Muscle action at which muscle length is constant; no movement occurs. Isometric means “without change” in muscle (or muscle plus tendon) length.
- sticking point**—Weakest body position (joint angle), possessing minimal strength values.
- stimulating load**—Training load of a magnitude above the neutral level, eliciting positive adaptation.
- strength, muscular**—Ability to overcome or counteract external resistance by muscular effort; also, the ability to generate maximum maximum external force, F_{mm} .
- strength curve**—Plot of force exerted by an athlete (or the moment of force) versus an appropriate body position measure (i.e., joint angle).
- strength topography**—Comparative strength of different muscle groups.
- stress (impact) microcycles**—Microcycles in which training loads are high and rest intervals are short and insufficient for restitution; fatigue is accumulated from day to day.
- stretch reflex (myotatic reflex)**—Contraction of a muscle in response to a stretch.
- stretch-shortening cycle**—See reversible muscle action.
- submaximal effort method**—Lifting of nonmaximal loads an intermediate number of times (not to failure).
- supercompensation phase**—Time period in which there is an enhanced level of a biochemical substance after a workout.
- supercompensation theory**—See one-factor theory.
- superposition of training effects**—Concurrent or sequential interaction of immediate and delayed partial training effects.
- tapering (peaking)**—Training phase occurring immediately before an important competition; combines features of the transmutation and realization mesocycles.
- testosterone**—Male sex hormone produced in the testes.
- time-deficit zone**—Time period too short to generate maximum maximum force.
- time under tension**—The time muscles are under a load.
- timing of training**—Distribution of exercises and training loads over certain time periods.
- torque (moment of force)**—Turning effect produced by a force; the external torque generated by a muscle is a product of the force generated by the muscle and the muscle force arm.
- training effects**—Changes that occur within the body as a result of training, including acute effects, immediate effects, cumulative effects, delayed effects, partial effects, and residual effects.
- training load**—Integral characteristic of the magnitude of performed training work. A load is the amount of weight lifted.
- training residuals**—See residual training effects.
- training session (workout)**—Lesson comprising exercise and rest periods.
- transfer of training results**—Performance gain in a nontrained exercise.
- transformation (of training work)**—Performance gain as a result of adaptation to the executed training work.
- transition period (of training)**—Period of training immediately following a season.
- transmutation (of motor potential)**—Conversion of nonspecific motor potential into specific athletic performance.
- transmutative mesocycle**—Mesocycle employed to transmute increased nonspecific fitness into specific athlete preparedness.
- two-factor theory**—Theory according to which the immediate training effect after a workout is a superimposition of two processes: gain in fitness prompted by the workout and fatigue.
- type I fibers**—See slow-twitch fibers.
- type II fibers**—See fast-twitch fibers.
- Valsalva maneuver**—Expiratory effort with the glottis closed.
- variable resistance**—Using different degrees of force on target muscles to cause the muscle to work harder.
- velocity**—The speed of something in a given direction.
- velocity-based training**—Using speed to prescribe training loads.
- viscosity**—Property of a semifluid, such as oil, that enables it to develop force dependent on the velocity of flow.
- volume-load**—A simple method of calculating strength training volume, where the loads lifted (kg) are multiplied by the repetitions performed. Values for all exercises and sets during a training session are summed for the total value in kg.
- weight**—Resistance due to gravity.
- weightlifting, Olympic style**—An Olympic sport consisting of the snatch lift and the clean and jerk.
- work**—Force multiplied by distance.
- workout**—See training session.

Bibliography

Chapter 1

- Bompa, T.O., and Buzzichelli, C.A. (2019). *Periodization: Theory and methodology of training* (6th ed.). Champaign, IL: Human Kinetics.
- Fitz-Clarke, J.R., Morton, R.H., and Banister, E.W. (1991). Optimizing athletic performance by influence curves. *Journal of Applied Physiology*, 71(3), 1151-1158.
- Fleck, S.J., and Kraemer, W.J. (2014). *Designing resistance training programs* (4th ed.). Champaign, IL: Human Kinetics.
- Haff, G.G., Triplett, N.T., and National Strength and Conditioning Association. (2016). *Essentials of strength training and conditioning* (4th ed.). Champaign, IL: Human Kinetics.
- Hopkins, W.G. (1991). Quantification of training in competition sports: Methods and applications. *Sports Medicine*, 12, 161-183.
- Siff, M.C., and Verkhoshansky, Y.V. (1993). *Supertraining*. Johannesburg, South Africa: University of Witwatersrand.
- Smith, D.J. (2003). A framework for understanding the training process leading to elite performance. *Sports Medicine*, 33, 1103-1126.

Chapter 2

- Fitts, R.H., and Widrick, J.J. (1996). Muscle mechanics: Adaptations with exercise training. *Exercise and Sport Sciences Reviews*, 26, 427-474.
- Komi, P.V., and Nicol, C. (2000). Stretch-shortening cycle of muscle function. In V.M. Zatsiorsky (Ed.), *Biomechanics in sport: Performance enhancement and injury prevention* (pp. 87-102). Oxford: IOC Medical Commission/Blackwell Science.
- Kulig, A., Andrews, J., and Hay, J.G. (1984). Human strength curves. *Exercise and Sport Science Reviews*, 12, 417-466.
- Pandy, M.C. (1999). Moment arm of a muscle force. *Exercise and Sport Science Reviews*, 27, 79-118.
- Prilutsky, B.I. (2000). Eccentric muscle action in sport and exercise. In V.M. Zatsiorsky (Ed.), *Biomechanics in sport: Performance enhancement and injury prevention* (pp. 56-86). Oxford: IOC Medical Commission/Blackwell Science.
- Wilkie, D.R. (1950). The relation between force and velocity in human muscle. *Journal of Physiology*, 110, 249-280.
- Zatsiorsky, V.M. (2003). Biomechanics of strength and strength training. In P.V. Komi (Ed.), *Strength and power in sport* (pp. 439-487). Oxford: IOC Medical Commission/Blackwell Science.

Chapter 3

- Beyfuss, K., and Hood, D.A. (2018). A systematic review of p53 regulation of oxidative stress in skeletal muscle. *Redox Report*, 23(1), 100-117.
- Billeter, R., and Hoppeler, H. (2003). Muscular basis of strength. In P.V. Komi (Ed.), *Strength and power in sport* (pp. 50-72). Oxford: IOC Medical Commission/Blackwell Science.
- Butterfield, T.A. (2010). Eccentric exercise in vivo: Strain-induced muscle damage and adaptation in a stable system. *Exercise and Sport Sciences Reviews*, 38(2), 51-60.
- De Luca, C.J., and Contessa, P. (2012). Hierarchical control of motor units in voluntary contractions. *Journal of Neurophysiology*, 107(1), 178-195.
- Duchateau, J., and Enoka, R.M. (2011). Human motor unit recordings: Origins and insight into the integrated motor system. *Brain Research*, 1409, 42-61.
- Fogelholm, M. (1994). Effects of bodyweight reduction on sports performance. *Sports Medicine*, 18, 249-267.
- Frontera, W.R., and Ochala, J. (2015). Skeletal muscle: A brief review of structure and function. *Calcified Tissue International*, 96(3), 183-195.
- Herzog, W., Powers, K., Johnston, K., and Duvall, M. (2015). A new paradigm for muscle contraction. *Frontiers in Physiology*, 6, 174.
- Hessel, A.L., Lindstedt, S.L., and Nishikawa, K.C. (2017). Physiological mechanisms of eccentric contraction and its applications: A role for the giant titin protein. *Frontiers in Physiology*, 8, 70.
- Hessel, A.L., and Nishikawa, K.C. (2017). Effects of a titin mutation on negative work during stretch-shortening cycles in skeletal muscles. *Journal of Experimental Biology*, 220(Pt 22), 4177-4185.
- Jaric, S. (2003). Role of body size in the relation between muscle strength and movement performance. *Exercise and Sport Science Reviews*, 31, 8-12.
- Kraemer, W.J., Fleck, S.J., and Evans, W.J. (1996). Strength and power training: Physiological mechanisms of adaptation. *Exercise and Sport Science Reviews*, 24, 363-398.
- Kraemer, W.J., Ratamess, N.A., and Nindl, B.C. (2017). Recovery responses of testosterone, growth hormone, and IGF-1 after resistance exercise. *Journal of Applied Physiology*, 122(3), 549-558.
- Kraemer, W.J., Spiering, B.A., Volek, J.S., Ratamess, N.A., Sharman, M.J., Rubin, M.R., and French, D.N. (2006). Androgenic responses to resistance exercise: Effects of

- feeding and L-carnitine. *Medicine and Science in Sports and Exercise*, 38(7), 1288-1296.
- Kraemer, W.J., Volek, J.S., Bush, J.A., Putukian, M., and Sebastianelli, W.J. (1998). Hormonal responses to consecutive days of heavy-resistance exercise with or without nutritional supplementation. *Journal of Applied Physiology*, 85(4), 1544-1555.
- LaStayo, P.C., Woolf, J.M., Lewek, M.D., Snyder-Mackler, L., Reich, T., and Lindstedt, S.L. (2003). Eccentric muscle contractions: Their contribution to injury, prevention, rehabilitation, and sport. *Journal of Orthopaedic and Sports Physical Therapy*, 33(10), 557-571.
- Narici, M., Franchi, M., and Maganaris, C. (2016). Muscle structural assembly and functional consequences. *Journal of Experimental Biology*, 219(Pt 2), 276-284.
- Nishikawa, K.C., Lindstedt, S.L., and LaStayo, P.C. (2018). Basic science and clinical use of eccentric contractions: History and uncertainties. *Journal of Sport and Health Science*, 7(3), 265-274.
- Peake, J.M., Neubauer, O., Della Gatta, P.A., Nosaka, K. (2017). Muscle damage and inflammation during recovery from exercise. *Journal of Applied Physiology*, 122(3), 559-570.
- Semmler, J.G., and Enoka, R.M. (2000). Neural contribution to changes in muscle strength. In V.M. Zatsiorsky (Ed.), *Biomechanics in sport: Performance enhancement and injury prevention* (pp. 3-20). Oxford: IOC Medical Commission/Blackwell Science.
- Volek, J.S. (2003). Strength nutrition. *Current Sports Medicine Reports*, 2(4), 189-193.
- Volek, J.S., Noakes, T., and Phinney, S.D. (2015). Rethinking fat as a fuel for endurance exercise. *European Journal of Sport Science*, 15(1), 13-20.
- ### Chapter 4
- Ahtiainen, J.P., Pakarinen, A., Kraemer, W.J., and Häkkinen, K. (2003). Acute hormonal and neuromuscular responses and recovery to forced vs maximum repetitions multiple resistance exercises. *International Journal of Sports Medicine*, 24(6), 410-418.
- Atha, J. (1981). Strengthening muscle. *Exercise and Sport Science Reviews*, 9, 1-73.
- Casa, D.J., Anderson, S.A., Baker, L., Bennett, S., Bergeron, M.F., Connolly, D., and Courson, R. (2012). The inter-association task force for preventing sudden death in collegiate conditioning sessions: Best practices recommendations. *Journal of Athletic Training*, 47(4), 477-480.
- Cormie, P., McGuigan, M.R., and Newton, R.U. (2011). Developing maximal neuromuscular power: Part 1 - biological basis of maximal power production. *Sports Medicine*, 41(1), 17-38.
- Cormie, P., McGuigan, M.R., and Newton, R.U. (2011). Developing maximal neuromuscular power: Part 2 - training considerations for improving maximal power production. *Sports Medicine*, 41(2), 125-146.
- Kraemer, W.J., Adams, K., Cafarelli, E., Dudley, G.A., Dooly, C., Feigenbaum, M.S., and Fleck, S.J. (2002). American College of Sports Medicine position stand: Progression models in resistance training for healthy adults. *Medicine and Science in Sports and Exercise*, 34, 364-380.
- Kraemer, W.J., and Ratamess, N.A. (2004). Fundamentals of resistance training: Progression and exercise prescription. *Medicine and Science in Sports and Exercise*, 36, 674-688.
- Peterson, M.D., Rhea, M.R., and Alvar, B.A. (2004). Maximizing strength development in athletes: A meta-analysis to determine the dose-response relationship. *Journal of Strength and Conditioning Research*, 18(2), 377-382.
- Peterson, M.D., Rhea, M.R., and Alvar, B.A. (2005). Applications of the dose-response for muscular strength development: A review of meta-analytic efficacy and reliability for designing training prescription. *Journal of Strength and Conditioning Research*, 19(4), 950-958.
- Rhea, M.R., Alvar, B.A., Burkett, L.N., and Ball, S.D. (2003). A meta-analysis to determine the dose response for strength development. *Medicine and Science in Sports and Exercise*, 35, 456-464.
- Tan, B. (1999). Manipulating resistance training program variables to optimize maximum strength in men: A review. *Journal of Strength and Conditioning Research*, 13(3), 289-304.
- Zatsiorsky, V.M. (1992). Intensity of strength training. *National Strength and Conditioning Association Journal*, 14(5), 46-57.
- ### Chapter 5
- Baker, D., Wilson, G., and Carlyon, R. (1994). Periodization: The effect on strength of manipulating volume and intensity. *Journal of Strength and Conditioning Research*, 8, 235-242.
- Casa, D.J., Almquist, J., Anderson, S.A., Baker, L., Bergeron, M.F., Biagioli, B., and Boden, B. (2012). The inter-association task force for preventing sudden death in collegiate conditioning sessions: Best practices recommendations. *Journal of Athletic Training*, 47(4), 477-480.
- Fleck, S.J. (1999). Periodized strength training: A critical review. *Journal of Strength and Conditioning Research*, 13(1), 82-89.
- Fleck, S.J. (2011). Non-linear periodization for general fitness and athletes. *Journal of Human Kinetics*, 29A, 41-45.
- Fleck, S.J., and Kraemer, W.J. (1996). *Periodization breakthrough!: The ultimate training system*. New York: Advanced Research Press.
- Fleck, S.J., and Kraemer, W.J. (2014). *Designing resistance training programs* (4th ed.). Champaign, IL: Human Kinetics.
- Hudy, A. (2014). *Power positions*. Kansas City, MO: Andrews McMeel Publishing LLC.
- Kraemer, W.J., and Beeler, M.K. (2019). Periodization of resistance training: Concepts and paradigms. In T.J. Chandler and L.E. Brown (Eds.), *Conditioning for strength and human performance* (3rd ed.) (pp. 371-394). New York, NY: Routledge Publishers.

- Kraemer, W.J., Häkkinen, K., Triplett-McBride, N.T., Fry, A.C., Koziris, L.P., Ratamess, N.A., and Bauer, J.E. (2003). Physiological changes with periodized resistance training in women tennis players. *Medicine and Science in Sports and Exercise*, 35(1), 157-168.
- Kraemer, W.J., Ratamess, N., Fry, A.C., Triplett-McBride, T., Koziris, L.P., Bauer, J.A., and Lynch, J.M. (2000). Influence of resistance training volume and periodization on physiological and performance adaptations in collegiate women tennis players. *American Journal of Sports Medicine*, 28(5), 626-633.
- Monteiro, A.G., Aoki, M.S., Evangelista, A.L., Alveno, D.A., Monteiro, G.A., Piçarro, I da C., and Ugrinowitsch, C. (2009). Nonlinear periodization maximizes strength gains in split resistance training routines. *Journal of Strength and Conditioning Research*, 23(4), 1321-1326.
- Smith, R.A., Martin, G.J., Szivak, T.K., Comstock, B.A., Dunn-Lewis, C., Hooper, D.R., and Flanagan, S.D. (2014). The effects of resistance training prioritization in NCAA Division I football summer training. *Journal of Strength and Conditioning Research*, 28(1), 14-22.
- Stone, M.H., and O'Bryant, H.S. (1987). *Weight training: A scientific approach*. Minneapolis: Burgess.
- ### Chapter 6
- Aagaard, P. (2018). Spinal and supraspinal control of motor function during maximal eccentric muscle contraction: Effects of resistance training. *Journal of Sport and Health Science*, 7(3), 282-293.
- Albert, M. (1995). *Eccentric muscle training in sports and orthopaedics*. New York: Churchill Livingstone.
- Bobbert, M.F. (1990). Drop jumping as a training method for jumping ability. *Sports Medicine*, 9, 7-22.
- Brown, F., Gissane, C., Howatson, G., van Someren, K., Pedlar, C., and Hill, J. (2017). Compression garments and recovery from exercise: A meta-analysis. *Sports Medicine*, 47(11), 2245-2267.
- Cormie, P., McGuigan, M.R., and Newton, R.U. (2010). Influence of strength on magnitude and mechanisms of adaptation to power training. *Medicine and Science in Sports and Exercise*, 42(8), 1566-1581.
- DuPont, W.H., Meuris, B.J., Hardesty, V.H., Barnhart, E.C., Tompkins, L.H., Golden, M.J., and Usher, C.J. (2017). The effects combining cryocompression therapy following an acute bout of resistance exercise on performance and recovery. *Journal of Sports Science and Medicine*, 16(3), 333-342.
- Enoka, R.M. (2002). *Neuromechanics of human movement*. Champaign, IL: Human Kinetics.
- Hettinger, T. (1983). *Isometrisches muskeltraining*. Stuttgart: Thieme Verlag.
- Komi, P.V. (2003). Stretch-shortening cycle. In P.V. Komi (Ed.), *Strength and power in sport* (pp. 184-202). Oxford: IOC Medical Commission/Blackwell Science.
- Kraemer, W.J., Bush, J.A., Wickham, R.B., Denegar, C.R., Gómez, A.L., Gotshalk, L.A., and Duncan, N.D. (2001). Influence of compression therapy on symptoms following soft tissue injury from maximal eccentric exercise. *Journal of Orthopaedic and Sports Physical Therapy*, 31(6), 282-290.
- Kraemer, W.J., Flanagan, S.D., Comstock, B.A., Fragala, M.S., Earp, J.E., Dunn-Lewis, C., and Ho, J.Y. (2010). Effects of a whole body compression garment on markers of recovery after a heavy resistance workout in men and women. *Journal of Strength and Conditioning Research*, 24(3), 804-814.
- Kraemer, W.J., Hooper, D.R., Kupchak, B.R., Saenz, C., Brown, L.E., Vingren, J.L., and Luk, H.Y. (2016). The effects of a roundtrip trans-American jet travel on physiological stress, neuromuscular performance, and recovery. *Journal of Applied Physiology*, 121(2), 438-448.
- McBride, J.M., Haines, T.L., and Kirby, T.J. (2011). Effect of loading on peak power of the bar, body, and system during power cleans, squats, and jump squats. *Journal of Sports Sciences*, 29(11), 1215-1221.
- Mester, J., Spitzenpfeil, P., and Yue, Z. (2003). Vibration loads potential for strength and power development. In P.V. Komi (Ed.), *Strength and power in sport* (pp. 488-501). Oxford: IOC Medical Commission/Blackwell Science.
- Nuzzo, J.L., and McBride, J.M. (2013). The effect of loading and unloading on muscle activity during the jump squat. *Journal of Strength and Conditioning Research*, 27(7), 1758-1764.
- Saeterbakken, A.H., Andersen, V., and van den Tillaar, R. (2016). Comparison of kinematics and muscle activation in free-weight back squat with and without elastic bands. *Journal of Strength and Conditioning Research*, 30(4), 945-952.
- Sekowitz, D.M. (1990). High frequency electrical stimulation in muscle strengthening: A review and discussion. *American Journal of Sports Medicine*, 17, 101-111.
- ### Chapter 7
- Alcazar, J., Csapo, R., Ara, I., and Alegre, L.M. (2019). On the shape of the force-velocity relationship in skeletal muscles: The linear, the hyperbolic, and the double-hyperbolic. *Frontiers in Physiology*, 10(769). doi:10.3389/fphys.2019.00769
- Alcazar, J., Navarro-Cruz, R., Rodriguez-Lopez, C., Vila-Maldonado, S., Ara, I., and Alegre, L.M. (2018). The double-hyperbolic force-velocity relationship in humans. *Acta Physiologica*, 226(4). doi:10.1111/apha.13165
- Comfort, P., Dos'Santos, T., Beckham, G.K., Stone, M.H., Guppy, S.N., and Haff, G.G. (2019). Standardization and methodological considerations for the isometric midhigh pull. *Strength and Conditioning Journal*, 41(2), 57-79.
- Conceição, F., Fernandes, J., Lewis, M., González-Badillo, J.J., and Jimenez-Reyes, P. (2016). Movement velocity as a measure of exercise intensity in three lower limb exercises. *Journal of Sports Sciences*, 34(12), 1099-1106.
- Faulkner, J.A., Claflin D.R., and McCully, K.K. (1986). Power output of fast and slow fibers from human skeletal

- muscle. In N.L. Jones, N. McCartney, and A.J. McComas (Eds.), *Human muscle power* (pp. 81-94). Champaign, IL: Human Kinetics.
- Fitts, R.H., and Widrick, J.J. (1997). Muscle mechanics: Adaptations with exercise training. In J.O. Holloszy (Ed.), *Exercise and sport sciences review* (pp. 427-473). Baltimore, MD: Williams and Wilkins.
- González-Badillo, J.J., and Sánchez-Medina, L. (2010). Movement velocity as a measure of loading intensity in resistance training. *International Journal of Sports Medicine*, 31, 347-352.
- González-Badillo, J.J., Yañez-García, J.M., Mora-Custodio, R., and Rodríguez-Rosell, D. (2017). Velocity loss as a variable for monitoring resistance exercise. *International Journal of Sports Medicine*, 38(3), 217-225.
- Haff, G.G. (2019). Strength – isometric and dynamic testing. In P. Comfort, P.A. Jones, and J.J. McMahon (Eds.), *Performance assessment in strength and conditioning* (pp. 166-192). London, UK: Routledge.
- Hahn, D. (2018). Stretching the limits of maximal voluntary eccentric force production in vivo. *Journal of Sport and Health Science*, 7(3), 275-281.
- Mann, B. (2016). *Developing explosive athletes: Use of velocity based training in athletes*. Michigan: Ultimate Athlete Concepts.
- McGuigan, M. (2017). *Monitoring training and performance in athletes*. Champaign, IL: Human Kinetics.
- Moore, C.A., Fry, A.C., Melton, A.J., Weiss, L.W., and Rosato, F.D. (2003). “Power production for different relative intensities for the hang power clean exercise [abstract],” NSCA National Conference, Indianapolis, IN.
- Randell, A.D., Cronin, J.B., Keogh, J.W., Gill, N.D., and Pedersen, M.C. (2011). Effect of instantaneous performance feedback during 6 weeks of velocity-based resistance training on sport-specific performance tests. *Journal of Strength and Conditioning Research*, 25, 87-93.
- Sanchez-Medina, L., and González-Badillo, J.J. (2011). Velocity loss as an indicator of neuromuscular fatigue during resistance training. *Medicine and Science in Sports and Exercise*, 43, 1725-1734.
- Sánchez-Medina, L., Pallarés, J.G., Pérez, C.E., Morán-Navarro, R., and González-Badillo, J.J. (2017). Estimation of relative load from bar velocity in the full back squat exercise. *Sports Medicine International Open*, 1, E80-E88. doi:10.1055/s-0043-102933
- Spitz, R.W., Gonzalez, A.M., Ghigiarelli, J.J., Sell, K.M., and Mangine, G.T. (2019). Load-velocity relationships of the back vs. front squat exercises in resistance-trained men. *Journal of Strength and Conditioning Research*, 33(2), 301-306.
- Stasinaki, A.N., Zaras, N., Methenitis, S., Bogdanis, G., and Terzis, G. (2019). Rate of force development and muscle architecture after fast and slow velocity eccentric training. *Sports*, 7(2), 41. doi:10.3390/sports7020041
- Stone, M.H., Stone, M., and Sands, W.A. (2007). *Principles and practice of resistance training*. Champaign, IL: Human Kinetics.
- Suchomel, T.J., McMahon, J.J., and Lake, J.P. (2019). Combined assessment methods. In P. Comfort, P.A. Jones, and J.J. McMahon (Eds.), *Performance assessment in strength and conditioning* (pp. 275-290). London, UK: Routledge.

Chapter 8

- Anderson, M.K., and Hall, S.J. (1997). *Fundamentals of sports injury management*. Baltimore, MD: Williams and Wilkins.
- Chiu, L.Z.F., and Burkhardt, E. (2011). A teaching progression for squatting exercises. *Strength and Conditioning Journal*, 33(2), 46-54.
- Eliassen, W., Saeterbakken, A.H., and van den Tillaar, R. (2018). Comparison of bilateral and unilateral squat exercises on barbell kinematics and muscle activation. *International Journal of Sports Physical Therapy*, 13(5), 871-881.
- Fuglsang, E.I., Telling, A.S., and Sørensen, H. (2017). Effect of ankle mobility and segment ratios on trunk lean in the barbell back squat. *Journal of Strength and Conditioning Research*, 31(11), 3024-3033.
- Glassbrook, D.J., Helms, E.R., Brown, S.R., and Storey, A.G. (2017). A review of the biomechanical differences between the high-bar and low-bar back-squat. *Journal of Strength and Conditioning Research*, 31(9), 2618-2634.
- Hrysomallis, C., and Goodman, C. (2001). A review of resistance exercise and posture realignment. *Journal of Strength and Conditioning Research*, 15(3), 385-390.
- Kellis, E., and Baltzopoulos, V. (1995). Isokinetic eccentric exercise. *Sports Medicine*, 19, 202-222.
- Layer, J.S., Grenz, C., Hinshaw, T.J., Smith, D.T., Barrett, S.F., and Dai, B. (2018). Kinetic analysis of isometric back squats and isometric belt squats. *Journal of Strength and Conditioning Research*, 32(12), 3301-3309.
- Lee, T.S., Song, M.Y., and Kwon, Y.J. (2016). Activation of back and lower limb muscles during squat exercises with different trunk flexion. *Journal of Physical Therapy Science*, 28(12), 3407-3410.
- Lorenzetti, S., Ostermann, M., Zeidler, F., Zimmer, P., Jentsch, L., List, R., and Taylor, W.R. (2018). How to squat? Effects of various stance widths, foot placement angles and level of experience on knee, hip and trunk motion and loading. *BMC Sports Science, Medicine and Rehabilitation*, 10, 14.
- Mazur, L.J., Yetman, R.J., and Riser, W.L. (1993). Weight-training injuries and preventative methods. *Sports Medicine*, 16, 57-63.
- McGill, S. (2004). *Ultimate back fitness and performance*. Waterloo, Canada: Wabuno.
- McGill, S.M. (2015). *Low back disorders: Evidence-based prevention and rehabilitation* (3rd ed.). Champaign, IL: Human Kinetics.
- Miles, M.P., and Clarkson, P.M. (1994). Exercise-induced muscle pain, soreness, and cramps. *Journal of Sports Medicine and Physical Fitness*, 34, 203-216.

- Myer, G.D., Kushner, A.M., Brent, J.L., Schoenfeld, B.J., Hugentobler, J., Lloyd, R.S., and Vermeil, A. (2014). The back squat: A proposed assessment of functional deficits and technical factors that limit performance. *Strength and Conditioning Journal*, 36(6), 4-27.
- National Strength and Conditioning Association. (2017). NSCA Strength and Conditioning Professional Standards and Guidelines. *Strength and Conditioning Journal*, 39(6), 1-24.
- Oshikawa, T., Morimoto, Y., and Kaneoka, K. (2018). Lumbar lordosis angle and trunk and lower-limb electromyographic activity comparison in hip neutral position and external rotation during back squats. *Journal of Physical Therapy Science*, 30(3), 434-438.
- Plowman, S.A. (1992). Physical activity, physical fitness, and low back pain. *Exercise and Sport Science Reviews*, 20, 221-242.
- Sands, W.A., Wurth, J.J., and Hewitt, J.K. (2012). *The National Strength and Conditioning Association's (NSCA) basics of strength and conditioning manual*. Retrieved from https://www.nasca.com/contentassets/116c55d64e1343d2b264e05aaf158a91/basics_of_strength_and_conditioning_manual.pdf
- van den Tillaar, R. (2019). Effect of descent velocity upon muscle activation and performance in two-legged free weight back squats. *Sports (Basel)*, 7(1), E15.
- Whiting, W.C., and Zernicke, R.F. (1998). *Biomechanics of musculoskeletal injury*. Champaign, IL: Human Kinetics.
- ## Chapter 9
- Adlercreutz, H., Härkönen, M., Kuoppasalmi, K., Näveri, H., Huhtaniemi, I., Tikkanen, H., and Remes, K. (1986). Effect of training on plasma anabolic and catabolic steroid hormones and their response during physical exercise. *International Journal of Sports Medicine*, 7(Suppl.), 27-28.
- Fry, A.C. (1998). The role of training intensity in resistance exercise overtraining and overreaching. In R.B. Kreider, A.C. Fry, and M.L. O'Toole (Eds.), *Overtraining and overreaching in sports* (pp. 107-130). Champaign, IL: Human Kinetics.
- Fry, A.C. (1999). Overload and regeneration during resistance exercise. In M. Lehmann, C. Foster, U. Gastmann, H. Keizer, and J.M. Steinacker (Eds.), *Overload, performance incompetence, and regeneration in sport* (pp. 149-162). New York: Kluwer Academic/Plenum Publishers.
- Fry, A.C., and Kraemer, W.J. (1997). Resistance exercise overtraining and overreaching: Neuroendocrine responses. *Sports Medicine*, 23(2), 106-129.
- Fry, A.C., Kraemer, W.J., Gordon, S.E., Stone, M.H., Warren, B.J., Fleck, S.J., and Kearney, J.T. (1994). Exercise-induced endocrine responses to overreaching before and after one year of weightlifting training. *Canadian Journal of Applied Physiology*, 14(4), 400-410.
- Fry, A.C., Kraemer, W.J., Lynch, J.M., Marsit, J.L., Roy, E.P., Triplett, N.T., and Knuttgen, H.G. (1994). Performance decrements with high intensity resistance exercise overtraining. *Medicine and Science in Sports and Exercise*, 26(9), 1165-1173.
- Fry, A.C., Kraemer, W.J., Van Borselen, F., Lynch, J.M., Triplett, N.T., Koziris, L.P., and Fleck, S.J. (1994). Catecholamine responses to short-term high intensity resistance exercise overtraining. *Journal of Applied Physiology*, 77(2), 941-946.
- Haff, G.G., Jackson, J.R., Kawamori, N., Carlock, J.M., Hartman, M.J., Kilgore, J.L., and Morris, R.T. (2008). Force-time curve characteristics and hormonal alterations during an eleven-week training period in elite women weightlifters. *Journal of Strength and Conditioning Research*, 22(2), 433-446.
- Kraemer, W.J., and Nindl, B.C. (1998). Factors involved with overtraining for strength and power. In R.B. Kreider, A.C. Fry, and M.L. O'Toole (Eds.), *Overtraining and overreaching in sports* (pp. 69-86). Champaign, IL: Human Kinetics.
- Meeusen, R., Duclos, M., Foster, C., Fry, A., Gleeson, M., Nieman, D., and Raglin, J. (2013). Prevention, diagnosis and treatment of the overtraining syndrome: Joint consensus statement of the European College of Sport Science (ECSS) and the American College of Sports Medicine (ACSM). *European Journal of Sport Science*, 13(1), 1-24.
- Meeusen, R., Duclos, M., Gleeson, M., Rietjens, G., Steinacker, J., and Urhausen, A. (2006). Prevention, diagnosis and treatment of the overtraining syndrome: ECSS Position Statement Task Force. *European Journal of Sport Science*, 6(1), 1-14.
- Moore, C.A., and Fry, A.C. (2007). Nonfunctional overreaching during off-season training for skill position players in collegiate American football. *Journal of Strength and Conditioning Research*, 21(3), 793-800.
- Nicoll, J.X., Fry, A.C., Galpin, A.J., Sterczala, A.J., Thomason, D.B., Moore, C.A., and Weiss, L.W. (2016). Changes in resting mitogen-activated protein kinases following resistance exercise overreaching and overtraining. *European Journal of Applied Physiology*, 116(11-12), 2401-2413.
- Nicoll, J.X., Fry, A.C., Mosier, E.M., Olsen, L.A., and Sontag, S.A. (2019). MAPK, androgen, and glucocorticoid receptor phosphorylation following high-frequency resistance exercise non-functional overreaching. *European Journal of Applied Physiology*, 119(10), 2237-2253.
- Nilsson, S. (1987). Overtraining. In S. Maehlum, S. Nilsson, and P. Renström (Eds.), *An update on sports medicine – Proceedings from the second Scandinavian Conference on Sports Medicine, Soria Maria, Oslo, Norway, March 9-15, 1986* (pp. 97-104). Oslo, Norway: Danish and Norwegian Sports Medicine Association, Swedish Society of Sports Medicine.
- Ratamess, N.A., Kraemer, W.J., Volek, J.S., Rubin, M.R., Gomez, A.L., French, D.N., and Sharman, M.J. (2003). The effects of amino acid supplementation on muscular performance during resistance training overreaching. *Journal of Strength and Conditioning Research*, 17(2), 250-258.

- Selye, H. (1936). A syndrome produced by diverse nocuous agents. *Nature*, 138, 32.
- Sterczala, A.J., Fry, A.C., Chiu, L.Z.F., Schilling, B.K., Weiss, L.W., and Nicoll, J.X. (2017). β 2-adrenergic receptor maladaptations to high power resistance exercise overreaching. *Human Physiology*, 43(4), 446-454.
- Stone, M.H., and Fry, A.C. (1998). The role of increased training volume in resistance exercise overtraining and overreaching. In R.B. Kreider, A.C. Fry, and M.L. O'Toole (Eds.), *Overtraining and overreaching in sports* (pp. 87-106). Champaign, IL: Human Kinetics.
- Stone, M.H., Keith, R., Kearney, J.T., Wilson, G.D., and Fleck, S.J. (1991). Overtraining: A review of the signs and symptoms of overtraining. *Journal of Applied Sports Science Research*, 5, 35-50.
- Volek, J.S., Ratamess, N.A., Rubin, M.R., Gomez, A.L., French, D.N., McGuigan, M.M., and Scheett, T.P. (2004). The effects of creatine supplementation on muscular performance and body composition responses to short-term resistance training overreaching. *European Journal of Applied Physiology*, 91(5-6), 628-637.
- Wilson, J.M., Joy, J.M., Lowery, R.P., Roberts, M.D., Lockwood, C.M., Manninen, A.H., and Fuller, J.C. (2013). Effects of oral adenosine-5'-triphosphate supplementation on athletic performance, skeletal muscle hypertrophy and recovery in resistance-trained men. *Nutrition and Metabolism*, 10(1), 57.
- Chapter 10**
- Amonette, W.E., English, K.L., and Kraemer, W.J. (2016). *Evidence-based practice in exercise science*. Champaign, IL: Human Kinetics.
- Anshel, M.H., Petrie, T.A., and Steinfeldt, J.A. (Eds.). (2019). *APA handbooks in psychology series. APA handbook of sport and exercise psychology, Vol. 1. Sport psychology*. Washington, D.C.: American Psychological Association.
- Calle, M.C., and Fernandez, M.L. (2010). Effects of resistance training on the inflammatory response. *Nutrition Research and Practice*, 4(4), 259-269.
- Comfort, P., Jones, P.A., and McMahon, J.J. (Eds.). (2019). *Performance assessment in strength and conditioning*. London: Routledge.
- Connolly, F., and White, P. (2017). *Game changer: The art of sport science*. Canada: Victory Belt Publishing.
- Coyne, J.O.C., Haff, G.G., Coutts, A.J., Newton, R.U., and Nimphius, S. (2018). The current state of subjective training load monitoring: A practical perspective and call to action. *Sports Medicine*, 4, 58.
- Fleck, S.J., and Kraemer, W.J. (2014). *Designing resistance training programs* (4th ed.). Champaign, IL: Human Kinetics.
- Genner, K.M., and Weston, M.A. (2014). A comparison of workload quantification methods in relation to physiological responses to resistance exercise. *Journal of Strength and Conditioning Research*, 28(9), 2621-2627.
- Gore, C.J. (Ed.). (2000). *Physiological tests for elite athletes*. Champaign, IL: Human Kinetics.
- Haff, G.G., and Triplett, N.T. (Eds.). (2016). *Essentials of strength training and conditioning* (4th ed.). Champaign, IL: Human Kinetics.
- Hopkins, W., Marshall, S., Batterham, A., and Hanin, J. (2009). Progressive statistics for studies of sports medicine and exercise science. *Medicine and Science in Sports and Exercise*, 41, 3-13.
- Kellmann, M. (2010). Preventing overtraining in athletes in high-intensity sports and stress/recovery monitoring. *Scandinavian Journal of Medicine and Science in Sports*, 20(Suppl. 2), 95-102.
- Knuttggen, H.G., and Kraemer, W.J. (1987). Terminology and measurement in exercise performance. *Journal of Strength and Conditioning Research*, 1(1), 1-10.
- Lee, E.C., Fragala, M.S., Kavaouras, S.A., Queen, R.M., Pryor, J.L., and Casa, D.J. (2017). Biomarkers in sports and exercise: Tracking health, performance, and recovery in athletes. *Journal of Strength and Conditioning Research*, 31(10), 2920-2937.
- Maud, P.J., and Foster, C. (Eds.). (2006). *Physiological assessment of human fitness*. Champaign, IL: Human Kinetics.
- McGuigan, M. (2017). *Monitoring training and performance in athletes*. Champaign, IL: Human Kinetics.
- Nielsen, R.Ø., Malisoux, L., Møller, M., Thiesen, D., and Parner, E.T. (2016). Shedding light on the etiology of sports injuries: A look behind the scenes of time-to-event analyses. *Journal of Orthopedic and Sports Physical Therapy*, 46(4), 300-311.
- Ratamess, N. (2011). *ACSM's foundations of strength training and conditioning*. Baltimore, MD: Lippincott, Williams and Wilkins.
- Sands, W.A., Cardinale, M., NcNeal, J., Murray, S., Sole, C., Reed, J., and Apostolopoulos, N. (2019). Recommendations for measurement and management of an elite athlete. *Sports*, 7, 105.
- Sands, W.A., McNeal, J.R., and Stone, M.H. (2005). Plaudits and pitfalls in studying elite athletes. *Perceptual and Motor Skills*, 100, 22-24.
- Starling, L., and Lambert, M. (2018). Monitoring rugby players for fitness and fatigue: What do coaches want? *International Journal of Sports Physiology and Performance*, 13(6), 777-782.
- Stone, M.H., Stone, M., and Sands, W.A. (2007). *Principles and practice of resistance training*. Champaign, IL: Human Kinetics.
- Viru, A., and Viru, M. (2001). *Biochemical monitoring of sport training*. Champaign, IL: Human Kinetics.
- Wiseman, A. (2019, May). *Player monitoring and the four pillars of confidence*. Retrieved from <https://soccerologysite.blog/2019/05/07/player-monitoring-the-four-pillars-of-confidence/>
- Chapter 11**
- Amonette, W.E., English, K.L., and Kraemer, W.J. (2016). *Evidence-based practice in exercise science*. Champaign, IL: Human Kinetics.

- Campos, G.E., Luecke, T.J., Wendeln, H.K., Toma, K., Hagerman, F.C., Murray, T.F., and Ragg, K.E. (2002). Muscular adaptations in response to three different resistance-training regimens: Specificity of repetition maximum training zones. *European Journal of Applied Physiology*, 88(1-2), 50-60.
- Casa, D.J., Almquist, J., Anderson, S.A., Baker, L., Bergeron, M.F., Biagioli, B., and Boden, B. (2012). The inter-association task force for preventing sudden death in collegiate conditioning sessions: Best practices recommendations. *Journal of Athletic Training*, 47(4), 477-480.
- Casa, D.J., Almquist, J., Anderson, S.A., Baker, L., Bergeron, M.F., Biagioli, B., and Boden, B. (2013). The inter-association task force for preventing sudden death in secondary school athletics programs: Best-practices recommendations. *Journal of Athletic Training*, 48(4), 546-553.
- Fyfe, J.J., Bishop, D.J., and Stepto, N.K. (2014). Interference between concurrent resistance and endurance exercise: Molecular bases and the role of individual training variables. *Sports Medicine*, 44(6), 743-762.
- Hoff, J., and Helgerud, J. (2004). Endurance and strength training for soccer players: Physiological considerations. *Sports Medicine*, 34, 165-180.
- Katch, R.K., Scarneo, S.E., Adams, W.M., Armstrong, L.E., Belval, L.N., Stamm, J.M., and Casa, D.J. (2017). Top 10 research questions related to preventing sudden death in sport and physical activity. *Research Quarterly for Exercise and Sport*, 88(3), 251-268.
- Kraemer, W.J., and Fragala, M.S. (2006). Personalize it: Program design in resistance training. *ACSM's Health and Fitness Journal*, 10(4), 7-17.
- Kraemer, W.J., Mazetti, S.A., Ratamess, N.A., and Fleck, S.J. (2000). Specificity of training modes. In L.E. Brown (Ed.), *Isokinetics in human performance* (pp. 25-41). Champaign, IL: Human Kinetics.
- Kraemer, W.J., Patton, J.F., Gordon, S.E., Harman, E.A., Deschenes, M.R., Reynolds, K., Newton, R.U., et al. (1995). Compatibility of high-intensity strength and endurance training on hormonal and skeletal muscle adaptations. *Journal of Applied Physiology*, 78(3), 976-989.
- Leveritt, M., Abernethy, P.J., Barry, B.K., and Logan, P.A. (1999). Concurrent strength and endurance training: A review. *Sports Medicine*, 28, 413-427.
- Mann, J.B., Ivey, P.A., Stoner, J.D., Mayhew, J.L., and Brechue, W.F. (2015). Efficacy of the National Football League-225 test to track changes in one repetition maximum bench press after training in national collegiate athletic association division IA football players. *Journal of Strength and Conditioning Research*, 29(11), 2997-3005.
- McCarthy, J.P., Agre, J.C., Graf, B.K., Pozniak, M.A., and Vailas, A.C. (1995). Compatibility of adaptive responses with combining strength and endurance training. *Medicine and Science in Sports and Exercise*, 27(3), 429-436.
- Sabag, A., Najafi, A., Michael, S., Esgin, T., Halaki, M., and Hackett, D. (2018). The compatibility of concurrent high intensity interval training and resistance training for muscular strength and hypertrophy: A systematic review and meta-analysis. *Journal of Sports Sciences*, 36(21), 2472-2483.
- Sale, D., and MacDougall, D. (1981). Specificity in strength training: A review for the coach and athlete. *Canadian Journal of Applied Sports Science*, 6, 87-92.
- Smidtbleicher, D. (1992). Training for power events. In P.V. Komi (Ed.), *Strength and power in sport* (pp. 381-395). Oxford: IOC Medical Commission/Blackwell Science.
- Tanaka, H., and Swensen, T. (1998). Impact of resistance training on endurance performance: A new form of cross-training? *Sports Medicine*, 25, 191-200.
- Viru, A. (1995). *Adaptation in sports training*. Boca Raton, FL: CRC Press.
- Widow, G. (1990). Aspects of strength training in athletics. *New Studies in Athletics*, 5(1), 93-110.

Chapter 12

- Clifton, D.R., Hertel, J., Onate, J.A., Currie, D.W., Pierpoint, L.A., Wasserman, E.B., and Knowles, S.B. (2018). The first decade of web-based sports injury surveillance: Descriptive epidemiology of injuries in US high school girls' basketball (2005-2006 through 2013-2014) and National Collegiate Athletic Association women's basketball (2004-2005 through 2013-2014). *Journal of Athletic Training*, 53(11), 1037-1048.
- De Souza, M.J. (2003). Menstrual disturbances in athletes: A focus on luteal phase defects. *Medicine and Science in Sports and Exercise*, 35(9), 1553-1563.
- Ebben, W.P., and Jensen, R.L. (1998). Strength training for women: Debunking myths that block opportunity. *The Physician and Sportsmedicine*, 26(5), 86-97.
- Fleck, S.J., and Kraemer, W.J. (2014). *Designing resistance training programs* (4th ed.). Champaign, IL: Human Kinetics.
- Gilbert, W. (2016). *Coaching better every season: A year-round system for athlete development and program success*. Champaign, IL: Human Kinetics.
- Heck, A.L., and Handa, R.J. (2019). Sex differences in the hypothalamic-pituitary-adrenal axis' response to stress: An important role for gonadal hormones. *Neuropsychopharmacology*, 44(1), 45-58.
- Holloway, J.B., and Baechle, T.R. (1990). Strength training for female athletes. A review of selected aspects. *Sports Medicine*, 9(4), 216-228.
- Holloway, J.B., Gater, D., Ritchie, M., Gilstrap, L., Stoessel, L., Todd, J., and Kontor, K. (1989). Strength training for female athletes: A position paper: Part I. *National Strength and Conditioning Association Journal*, 11(4), 43-51.
- Holloway, J.B., Gater, D., Ritchie, M., Gilstrap, L., Stoessel, L., Todd, J., and Kontor, K. (1989). Strength training for female athletes: A position paper: Part II. *National Strength and Conditioning Association Journal*, 11(5), 29-36.
- Kraemer, W.J. (2002). Development of the offseason resistance training programs for athletes. In M.B. Mellion, W.M. Walsh, C. Madden, M. Putukian, and G.L. Shelton

- (Eds.), *The team physician's handbook* (pp. 120-127). Philadelphia: Hanley and Belfus.
- Kraemer, W.J., and Newton, R.U. (2000). Training for muscular power. In J. Young (Ed.), *Clinics in sports medicine* (pp. 341-368). Philadelphia: W.B. Saunders.
- Kraemer, W.J., Nindl, B.C., Marx, J.O., Gotshalk, L.A., Bush, J.A., Welsch, J.R., and Volek, J.S. (2006). Chronic resistance training in women potentiates growth hormone in vivo bioactivity: Characterization of molecular mass variants. *American Journal of Physiology. Endocrinology and Metabolism*, 291(6), E1177-1187.
- Kraemer, W.J., Nindl, B.C., Ratamess, N.A., Gotshalk, L.A., Volek, J.S., Fleck, S.J., and Newton, R.U. (2004). Changes in muscle hypertrophy in women with periodized resistance training. *Medicine and Science in Sports and Exercise*, 36(4), 697-708.
- Kraemer, W.J., and Ratamess, N.A. (2003). Endocrine responses and adaptations to strength and power training. In P.V. Komi (Ed.), *Strength and power in sport* (pp. 361-386). Oxford: IOC Medical Commission/Blackwell Science.
- Kraemer, W.J., Ratamess, N.A., and Nindl, B.C. (2017). Recovery responses of testosterone, growth hormone, and IGF-1 after resistance exercise. *Journal of Applied Physiology*, 122(3), 549-558.
- Kraemer, W.J., Rubin, M.R., Häkkinen, K., Nindl, B.C., Marx, J.O., Volek, J.S., and French, D.N. (2003). Influence of muscle strength and total work on exercise-induced plasma growth hormone isoforms in women. *Journal of Science and Medicine in Sport*, 6(3), 295-306.
- Loucks, A.B. (2003). Introduction to menstrual disturbances in athletes. *Medicine and Science in Sports and Exercise*, 35(9), 1551-1552.
- Miller, J.D., Ventresca, H.C., and Bracken, L.E. (2018). Rate of performance change in American female weightlifters over ten years of competition. *International Journal of Exercise Science*, 11(6), 290-307.
- Naclerio, F., Faigenbaum, A.D., Larumbe-Zabala, E., Perez-Bibao, T., Kang, J., Ratamess, N.A., and Triplett, N.T. (2013). Effects of different resistance training volumes on strength and power in team sport athletes. *Journal of Strength and Conditioning Research*, 27(7), 1832-1840.
- National Eating Disorders Association. (2018). Tips for coaches: *Preventing eating disorders in athletes*. Retrieved from <https://www.nationaleatingdisorders.org/learn/help/coaches-trainers>
- National Strength and Conditioning Association (NSCA). (1990). *National Strength and Conditioning Association position paper: Strength training for female athletes*. Colorado Springs, CO: NSCA.
- Patterson, M.S., Umstadd Meyer, M.R., and Beville, J.M. (2015). Potential predictors of college women meeting strength training recommendations: Application of the integrated behavioral model. *Journal of Physical Activity and Health*, 12(7), 998-1004.
- Petersen, C. (2005). Weightlifting during pregnancy. Retrieved November 6, 2005, from http://parenting.ivillage.com/pregnancy/pfitness/0,dfexc_nc1d,00.html
- Petrella, J.K., Kim, J.S., Cross, J.M., Kosek, D.J., and Bamman, M.M. (2006). Efficacy of myonuclear addition may explain differential myofiber growth among resistance-trained young and older men and women. *American Journal of Physiology. Endocrinology and Metabolism*, 291(5), E937-946.
- Pettitt, R.W., and Bryson, E.R. (2002). Training for women's basketball: A biomechanical emphasis for preventing anterior cruciate ligament injury. *Strength and Conditioning Journal*, 24(5), 20-29.
- Rana, S.R., Chleboun, G.S., Gilders, R.M., Hagerman, F.C., Herman, J.R., Hikida, R.S., and Kushnick, M.R. (2008). Comparison of early phase adaptations for traditional strength and endurance, and low velocity resistance training programs in college-aged women. *Journal of Strength and Conditioning Research*, 22(1), 119-127.
- Ritchie, S.J., Cox, S.R., Shen, X., Lombardo, M.V., Reus, L.M., Alloza, C., and Harris, M.A. (2018). Sex differences in the adult human brain: Evidence from 5216 UK biobank participants. *Cerebral Cortex*, 28(8), 2959-2975.
- Staron, R.S., Hagerman, F.C., Hikida, R.S., Murray, T.F., Hostler, D.P., Crill, M.T., and Ragg, K.E. (2000). Fiber type composition of the vastus lateralis muscle of young men and women. *Journal of Histochemistry and Cytochemistry*, 48(5), 623-629.
- Staron, R.S., Herman, J.R., and Schuenke, M.D. (2012). Misclassification of hybrid fast fibers in resistance-trained human skeletal muscle using histochemical and immunohistochemical methods. *Journal of Strength and Conditioning Research*, 26(10), 2616-2622.
- Staron, R.S., Karapondo, D.L., Kraemer, W.J., Fry, A.C., Gordon, S.E., Falkel, J.E., and Hagerman, F.C. (1994). Skeletal muscle adaptations during early phase of heavy-resistance training in men and women. *Journal of Applied Physiology*, 76(3), 1247-1255.
- Staron, R.S., Leonardi, M.J., Karapondo, D.L., Malicky, E.S., Falkel, J.E., Hagerman, F.C., and Hikida, R.S. (1991). Strength and skeletal muscle adaptations in heavy-resistance-trained women after detraining and retraining. *Journal of Applied Physiology*, 70(2), 631-640.
- Staron, R.S., Malicky, E.S., Leonardi, M.J., Falkel, J.E., Hagerman, F.C., and Dudley, G.A. (1990). Muscle hypertrophy and fast fiber type conversions in heavy resistance-trained women. *European Journal of Applied Physiology and Occupational Physiology*, 60(1), 71-79.
- Thompson, C. (2014). *Eating disorders in athletes*. Retrieved from <https://www.mirror-mirror.org/athlete.htm>
- Volek, J.S., Forsythe, C.E., and Kraemer, W.J. (2006). Nutritional aspects of women strength athletes. *British Journal of Sports Medicine*, 40(9), 742-748.
- Williams, N.I. (2003). Lessons from experimental disruptions of the menstrual cycle in humans and monkeys. *Medicine and Science in Sports and Exercise*, 35(9), 1564-1572.

Chapter 13

- American College of Sports Medicine (ACSM). (1993). The prevention of sports injuries of children and adolescents. *Medicine and Science in Sports and Exercise*, 25(8), 1-7.
- American Orthopaedic Society for Sports Medicine (AOSSM). (1988). Proceedings of the conference on strength training and the prepubescent. Chicago: AOSSM.
- Bar-Or, O. (1989). Trainability of the prepubescent child. *Physician and Sportsmedicine*, 17(5), 65-82.
- Bea, J.W., Blew, R.M., Howe, C., Hetherington-Rauth, M., and Going, S.B. (2017). Resistance training effects on metabolic function among youth: A systematic review. *Pediatric Exercise Science*, 29(3), 297-315.
- Blimkie, C.J. (1992). Resistance training during pre- and early puberty: Efficacy, trainability, mechanisms, and persistence. *Canadian Journal of Sport Sciences*, 17(4), 264-279.
- Blimkie, C.J.R. (1993). Resistance training during preadolescence: Issues and controversies. *Sports Medicine*, 15(6), 389-407.
- Committee on Sports Medicine and Fitness. (2001). American Academy of Pediatrics: Strength training by children and adolescents. *Pediatrics*, 107(6), 1470-1472.
- Dahab, K.S., and McCambridge, T.M. (2009). Strength training in children and adolescents: Raising the bar for young athletes? *Sports Health*, 1(3), 223-226.
- Faigenbaum, A.D., Kraemer, W.J., Blimkie, C.J., Jeffreys, I., Micheli, L.J., Nitka, M., and Rowland, T.W. (2009). Youth resistance training: Updated position statement paper from the national strength and conditioning association. *Journal of Strength and Conditioning Research*, 23(5 Suppl), S60-79.
- Faigenbaum, A.D., Kraemer, W.J., Cahill, B., Chandler, J., Dziadosz, J., Elfrink, L.D., and Forman, E. (1996). Youth resistance training: Position statement paper and literature review. *Strength and Conditioning*, 18(6), 62-76.
- Faigenbaum, A., and Westcott, W. (2000). *Strength and power training for young athletes*. Champaign, IL: Human Kinetics.
- Goldfield, G.S., Kenny, G.P., Alberga, A.S., Tulloch, H.E., Doucette, S., Cameron, J.D., and Sigal, R.J. (2017). Effects of aerobic or resistance training or both on health-related quality of life in youth with obesity: The HEARTY Trial. *Applied Physiology, Nutrition, and Metabolism*, 42(4), 361-370.
- Guy, J.A., and Micheli, L.J. (2001). Strength training for children and adolescents. *Journal of the American Academy of Orthopaedic Surgeons*, 9(1), 29-36.
- Kraemer, W.J., Faigenbaum, A.D., Bush, J.A., and Nindl, B.C. (1999). Resistance training and youth: Enhancing muscle fitness. In J.M. Rippe (Ed.), *Lifestyle medicine* (pp. 626-637). Cambridge, MA: Blackwell Science.
- Kraemer, W.J., and Fleck, S.J. (2004). *Strength training for young athletes* (2nd ed.). Champaign, IL: Human Kinetics.
- Kraemer, W.J., Fry, A.C., Frykman, P.N., Conroy, B., and Hoffman, J. (1989). Resistance training and youth. *Pediatric Exercise Science*, 1, 336-350.
- Kraemer, W.J., Fry, A.C., Warren, B.J., Stone, M.H., Fleck, S.J., Kearney, J.T., Conroy, B.P., Maresh, C.M., Weseman, C.A., Triplett, N.T., et al. (1992). Acute hormonal responses in elite junior weightlifters. *International Journal of Sports Medicine*, 13(2), 103-109.
- Kraemer, W.J., Ratamess, N.A., and Rubin, M.R. (2000). Basic principles of resistance training. In C.G.R. Jackson (Ed.), *Nutrition and the strength athlete* (pp. 1-29). Boca Raton, FL: CRC Press.
- Lloyd, R.S., Cronin, J.B., Faigenbaum, A.D., Haff, G.G., Howard, R., Kraemer, W.J., and Micheli, L.J. (2016). National Strength and Conditioning Association position statement on long-term athletic development. *Journal of Strength and Conditioning Research*, 30(6), 1491-1509.
- Malina, R.M., and Bouchard, C. (1991). *Growth, Maturation, and Physical Activity*. Champaign, IL: Human Kinetics.
- Milone, M.T., Bernstein, J., Freedman, K.B., and Tjoumakaris, F. (2013). There is no need to avoid resistance training (weight lifting) until physeal closure. *Physician and Sportsmedicine*, 41, 101-105.
- Myers, A.M., Beam, N.W., and Fakhoury, J.D. (2017). Resistance training for children and adolescents. *Translational Pediatrics*, 6(3), 137-143.
- Payne, V.G., Morrow, J.R., Johnson, L., and Dalton, S.N. (1997). Resistance training in children and youth: A meta-analysis. *Research Quarterly for Exercise and Sport*, 68(1), 80-88.
- Rosendahl, K., and Strouse, P.J. (2016). Sports injury of the pediatric musculoskeletal system. *Radiologia Medica*, 121(5), 431-441.
- Theisen, D., Malisoux, L., Seil, R., and Urhausen, A. (2014). Injuries in youth sports: Epidemiology, risk factors and prevention. *Deutsche Zeitschrift für Sportmedizin*, 65, 248-252.
- Walters, B.K., Read, C.R., and Estes, A.R. (2018). The effects of resistance training, overtraining, and early specialization on youth athlete injury and development. *Journal of Sports Medicine and Physical Fitness*, 58(9), 1339-1348.
- Zwolski, C., Quatman-Yates, C., and Paterno, M.V. (2017). Resistance training in youth: Laying the foundation for injury prevention and physical literacy. *Sports Health*, 9(5), 436-443.

Chapter 14

- American College of Sports Medicine. (2009). American College of Sports Medicine position stand. Progression models in resistance training for healthy adults. *Medicine and Science in Sports and Exercise*, 41(3), 687-708.
- Anton, M.M., Spirduso, W.W., and Tanaka, H. (2004). Age-related declines in anaerobic muscular performance: Weightlifting and powerlifting. *Medicine and Science in Sports and Exercise*, 36(1), 143-147.

- Arver, S., and Lehtihet, M. (2009). Current guidelines for the diagnosis of testosterone deficiency. *Frontiers of Hormone Research*, 37, 5-20.
- Baker, J., Fraser-Thomas, J., Dionigi, R.A., and Horton, S. (2010). Sport participation and positive development in older persons. *European Review of Aging and Physical Activity*, 7, 3-12.
- Bechshøft, R.L., Malmgaard-Clausen, N.M., Gliese, B., Beyer, N., Mackey, A.L., Andersen, J.L., and Kjær, M. (2017). Improved skeletal muscle mass and strength after heavy strength training in very old individuals. *Experimental Gerontology*, 92, 96-105.
- Bernstein, M. (2017). Nutritional needs of the older adult. *Physical Medicine and Rehabilitation Clinics in North America*, 28(4), 747-766.
- Bhasin, S., and Basaria, S. (2011). Diagnosis and treatment of hypogonadism in men. *Best Practice and Research. Clinical Endocrinology and Metabolism*, 25(2), 251-270.
- Bouzid, M.A., Filaire, E., McCall, A., and Fabre, C. (2015). Radical oxygen species, exercise and aging: An update. *Sports Medicine*, 45(9), 1245-1261.
- Campbell, W.W., and Geik, R.A. (2004). Nutritional considerations for the older athlete. *Nutrition*, 20(7-8), 603-608.
- Fleck, S.J., and Kraemer, W.J. (2014). *Designing resistance training programs* (4th ed.). Champaign, IL: Human Kinetics.
- Fragala, M.S., Cadore, E.L., Dorgo, S., Izquierdo, M., Kraemer, W.J., Peterson, M.D., and Ryan, E.D. (2019). Resistance training for older adults: Position statement from the National Strength and Conditioning Association. *Journal of Strength and Conditioning Research*, 33(8), 2019-2052.
- Franklin, B.A., Fern, A., and Voytas, J. (2004). Training principles for elite senior athletes. *Current Sports Medicine Reports*, 3(3), 173-179.
- Freeman, J., Froelicher, V., and Ashley, E. (2009). The ageing athlete: Screening prior to vigorous exertion in asymptomatic adults without known cardiovascular disease. *British Journal of Sports Medicine*, 43(9), 696-701.
- Frontera, W.R., Meredith, C.N., O'Reilly, K.P., Knuttgen, H.G., and Evans, W.J. (1988). Strength conditioning in older men: Skeletal muscle hypertrophy and improved function. *Journal of Applied Physiology*, 64(3), 1038-1044.
- Gotshalk, L.A., Kraemer, W.J., Mendonca, M.A., Vingren, J.L., Kenny, A.M., Spiering, B.A., and Hatfield, D.L. (2008). Creatine supplementation improves muscular performance in older women. *European Journal of Applied Physiology*, 102(2), 223-231.
- Gotshalk, L.A., Volek, J.S., Staron, R.S., Denegar, C.R., Hagerman, F.C., and Kraemer, W.J. (2002). Creatine supplementation improves muscular performance in older men. *Medicine and Science in Sports and Exercise*, 34(3), 537-543.
- Greenlee, T.A., Greene, D.R., Ward, N.J., Reeser, G.E., Allen, C.M., Baumgartner, N.W., and Cohen, N.J. (2017). Effectiveness of a 16-week high-intensity cardioresistance training program in adults. *Journal of Strength and Conditioning Research*, 31(9), 2528-2541.
- Häkkinen, K. (2003). Aging and neuromuscular adaptation to strength training. In P.V. Komi (Ed.), *Strength and power in sport* (pp. 409-425). Oxford: IOC Medical Commission/Blackwell Science.
- Hooper, D.R., Tenforde, A.S., and Hackney, A.C. (2018). Treating exercise-associated low testosterone and its related symptoms. *The Physician and Sportsmedicine*, 46(4), 427-434.
- Hunter, I., Hay, C.W., Esswein, B., Watt, K., and McEwan, I.J. (2018). Tissue control of androgen action: The ups and downs of androgen receptor expression. *Molecular and Cellular Endocrinology*, 465, 27-35.
- Kraemer, W.J., Adams, K., Cafarelli, E., Dudley, G.A., Dooly, C., Feigenbaum, M.S., and Fleck, S.J. (2002). American College of Sports Medicine (ACSM) position stand: Progression models in resistance training for healthy adults. *Medicine and Science in Sports and Exercise*, 34(2), 364-380.
- Kraemer, W.J., Fleck, S.J., and Evans, W.J. (1996). Strength and power training: Physiological mechanisms of adaptation. *Exercise and Sport Sciences Review*, 24, 363-397.
- Kraemer, W.J., Kennett, M.J., Mastro, A.M., McCarter, R.J., Rogers, C.J., DuPont, W.H., and Flanagan, S.D. (2017). Bioactive growth hormone in older men and women: It's relationship to immune markers and healthspan. *Growth Hormone and IGF Research*, 34, 45-54.
- Kraemer, W.J., and Newton, R.U. (2000). Training for muscular power. *Physical Medicine and Rehabilitation Clinics of North America*, 11(2), 341-368.
- Kraemer, W.J., Ratamess, N.A., Anderson, J.M., Maresh, C.M., Tiberio, D.P., Joyce, M.E., and Messinger, B.N. (2004). Effect of a cetylated fatty acid topical cream on functional mobility and quality of life of patients with osteoarthritis. *Journal of Rheumatology*, 31(4), 767-774.
- Leigey, D., Irrgang, J., Francis, K., Cohen, P., and Wright, V. (2009). Participation in high-impact sports predicts bone mineral density in senior Olympic athletes. *Sports Health*, 1(6), 508-513.
- Ludwig, D.S., Willett, W.C., Volek, J.S., and Neuhausser, M.L. (2018). Dietary fat: From foe to friend? *Science*, 362(6416), 764-770.
- Maxwell, N., Castro, R.W., Sutherland, N.M., Vaughan, K.L., Szarowicz, M.D., de Cabo, R., and Mattison, J.A. (2018). α -Motor neurons are spared from aging while their synaptic inputs degenerate in monkeys and mice. *Aging Cell*, 17(2).
- McKinnon, N.B., Connelly, D.M., Rice, C.L., Hunter, S.W., and Doherty, T.J. (2017). Neuromuscular contributions to the age-related reduction in muscle power: Mechanisms and potential role of high velocity power training. *Ageing Research Reviews*, 35, 147-154.
- Munetomo, A., Hojo, Y., Higo, S., Kato, A., Yoshida, K., Shirasawa, T., and Shimizu, T. (2015). Aging-induced changes in sex-steroidogenic enzymes and sex-steroid

- receptors in the cortex, hypothalamus and cerebellum. *Journal of Physiological Sciences*, 65(3), 253-263.
- Noakes, T., Volek, J.S., and Phinney, S.D. (2014). Low-carbohydrate diets for athletes: What evidence? *British Journal of Sports Medicine*, 48(14), 1077-1078.
- Paoli, A., Rubini, A., Volek, J.S., and Grimaldi, K.A. (2013). Beyond weight loss: A review of the therapeutic uses of very-low-carbohydrate (ketogenic) diets. *European Journal of Clinical Nutrition*, 67(8), 789-796.
- Papa, E.V., Dong, X., and Hassan, M. (2017). Resistance training for activity limitations in older adults with skeletal muscle function deficits: A systematic review. *Clinical Interventions in Aging*, 12, 955-961.
- Portugal, E.M., Vasconcelos, P.G., Souza, R., Lattari, E., Monteiro-Junior, R.S., Machado, S., and Deslandes, A.C. (2015). Aging process, cognitive decline and Alzheimer's disease: Can strength training modulate these responses? *CNS and Neurological Disorders Drug Targets*, 14(9), 1209-1213.
- Roubenoff, R. (2000). Sarcopenia and its implications for the elderly. *European Journal of Clinical Nutrition*, 54(Suppl. 3), S40-S47.
- Shadrach, J.L., and Wagers, A.J. (2011). Stem cells for skeletal muscle repair. *Philosophical Transactions of the Royal Society B: Biological Sciences*, 366(1575), 2297-2306.
- Siegmann, M.J., Athinarayanan, S.J., Hallberg, S.J., McKenzie, A.L., Bhanpuri, N.H., Campbell, W.W., and McCarter, J.P. (2019). Improvement in patient-reported sleep in type 2 diabetes and prediabetes participants receiving a continuous care intervention with nutritional ketosis. *Sleep Medicine*, 55, 92-99.
- Singh, M.A. (2004). Exercise and aging. *Clinical Geriatric Medicine*, 20(2), 201-221.
- Smolarek Ade, C., Ferreira, L.H., Mascarenhas, L.P., McAnulty, S.R., Varela, K.D., Dangui, M.C., and de Barros, M.P. (2016). The effects of strength training on cognitive performance in elderly women. *Clinical Interventions in Aging*, 11, 749-754.
- Suo, C., Singh, M.F., Gates, N., Wen, W., Sachdev, P., Brodaty, H., and Saigal, N. (2016). Therapeutically relevant structural and functional mechanisms triggered by physical and cognitive exercise. *Molecular Psychiatry*, 21(11), 1633-1642.
- Tedesco, S.F., Dellavalle, A., Diaz-Manera, J., Messina, G., and Cossu, G. (2010). Repairing skeletal muscle: Regenerative potential of skeletal muscle stem cells. *Journal of Clinical Investigation*, 120(1), 11-19.
- Trappe, S. (2001). Master athletes. *International Journal of Sport Nutrition and Exercise Metabolism*, 11(Suppl.), S196-S207.
- Tudorașcu, I., Sfredel, V., Riza, A.L., Dănciulescu Miulescu, R., Ianoși, S.L., and Dănoiu, S. (2014). Motor unit changes in normal aging: A brief review. *Romanian Journal of Morphology and Embryology*, 55(4), 1295-1301.
- Turner, C.E., Byblow, W.D., and Gant, N. (2015). Creatine supplementation enhances corticomotor excitability and cognitive performance during oxygen deprivation. *Journal of Neuroscience*, 35(4), 1773-1780.
- Wang, E., Nyberg, S.K., Hoff, J., Zhao, J., Leivseth, G., Tørhaug, T., and Husby, O.S. (2017). Impact of maximal strength training on work efficiency and muscle fiber type in the elderly: Implications for physical function and fall prevention. *Experimental Gerontology*, 91, 64-71.
- Wright, V.J., and Perricelli, B.C. (2008). Age-related rates of decline in performance among elite senior athletes. *American Journal of Sports Medicine*, 36(3), 443-450.

Index

A

AAP (American Academy of Pediatrics) 262
abdominal hernias 167-168
abduction 230
absolute indices of endurance 224-225
absolute strength 47-50, 148, 248, 270
acceleration 21, 22, 66-67, 125, 128, 143-144
accelerometers 128-129, 133, 189, 203
accentuation 111-113
accidental injuries 261-262
accommodating resistance 110-111
accommodation
 adaptation and 5-6
 avoiding in Olympic cycles 6
 defined 5
 delayed transformation and 87
 EMS training and 121
 to isometric exercises 113
 power training and 220
 variability in training and 86, 93, 218
accumulative mesocycles 80, 87-88
achievement goal theory 182, 184
acid-base status. *See* pH changes
ACL (anterior cruciate ligament) 251, 258
ACSM (American College of Sports Medicine) 262, 295
actin 42-44, 54
acute:chronic workload ratio (ACWR) 205
acute injuries 260-261
acute training effects 13
adaptation
 accommodation and 5-6
 anabolic 249-250
 circuit training and 84-85
 de-adaptation 88, 97
 defined 3
 delayed transformation and 87
 general adaptation syndrome 179-181
 individualization of training 8
 as main law of training 3-8
 maladaptation 4
 overload and 4-5
 physical activity as stimulus for 4
 rest-exercise alternation and 82-83
 specificity of 6-8
 variability in training and 86, 93, 218

added resistance exercises 118-121, 222
adduction 230
adenosine triphosphate (ATP) 10, 45, 293
adenosine triphosphate debt theory 45
adolescents. *See* young athletes
adrenal androgens 249
adrenal glands 51, 249
adrenergic receptors 191, 192
aerobic capacity 6, 89, 227
aerobic exercise 54
aerodynamic resistance 119-120
agility tests 182
aging athletes. *See* senior athletes
aging curve 282-283
agonist muscle groups 113-114, 245
A-gradient 25
all-or-none law of motor unit activation 55
alpha-motoneurons 33
amenorrhea 251-253
American Academy of Pediatrics (AAP) 262
American College of Sports Medicine (ACSM) 262, 295
American Orthopaedic Society for Sports Medicine (AOSSM) 262
amino acids 46, 51, 53, 207, 252, 292
anabolic adaptations 249-250
anabolic drugs 248, 290
anabolic hormones 45, 51, 53, 269, 288
anabolic signals 222, 268
anabolism 46, 47, 51, 64
anaerobic capacity 88
anaerobic exercise 9
anatomical match 123
andropause 283-284, 288, 290
angles
 biomechanical 243
 exercise 223, 238, 239
 joint 34, 36-38
 pennation 249
annulus fibrosus 161
anorexia nervosa 51, 236, 253
antagonist muscle groups 67, 114, 245
anterior cruciate ligament (ACL) 251, 258
anterior pituitary gland 53, 269
AOSSM (American Orthopaedic Society for Sports Medicine) 262
apophyseal insertions 260

apoptosis 284, 285
applied vs. basic research 204
APRE (autoregulated progressive resistance exercise) 157, 198, 205-206
arm curls 87, 109, 262, 275
assessment programs 195-212
 administration of 196-197
 analysis of results from 209-212
 application of data from 144-148
 collaboration in 199-200
 common areas of assessment 197
 evidence-based practice in 196
 familiarization with tests in 131, 198
 fatigue testing 155-156, 202-203
 in goal-specific training 216-217
 health and injury parameters for 208-209
 instructions for tests in 130-131
 last repetition effect in 132, 133
 lifting power data in 202-203
 lifting velocity data in 202
 location of attached devices in 133-134
 logistics of 198, 202
 muscular strength data in 200-202
 order of testing in 198-199
 overtraining and 187-189
 physiological parameters for 206-208
 progression assessment 146-147
 psychological parameters for 209
 purpose of 195-197, 204
 rate of force development data in 203-204
 reporting results from 199, 208, 211, 212
 sampling rate in 131, 202, 203
 short-term vs. long-term 198, 199
 target populations for 199, 200
 technology and devices used in 132-133, 198, 201
 training program assessment 204-206
 velocity and 130-134, 144-151
 weightlifting issues in 131, 132
ATP (adenosine triphosphate) 10, 45, 293
atrophy 290
augmented eccentric loading 152
autonomic nervous system 191, 192, 208
autoregulated progressive resistance exercise (APRE) 157, 198, 205-206
axons 54

B

back extensions 250
 back hyperextensions 261
 back pain. *See* low back pain syndrome (LBPS)
 barbell squats
 center of mass in 132-135
 elite athlete training intensity 68
 exercise specificity and 112
 force-time curve for 131
 gender differences in 283
 ground reaction force during 128, 139
 injury prevention in 166-167
 maximal effort method and 72
 maximal strength in 218
 metabolic reactions and 64-65
 muscle groups used in 103, 104
 overtraining and 184, 185
 proper technique for 264-265
 propulsive phase in 132
 repetition maximum 62, 63
 semisquatting 112
 speed squat fatigue testing 151
 training intensity determination for 64
 transfer of training results and 6-8, 181, 182
 velocity characteristics 134-136, 139-142, 144-145
 baseball 7, 29, 150, 261
 basic vs. applied research 204
 basketball
 flexible nonlinear periodization and 90
 injuries related to 251, 260
 power demands for women in 239
 strength, power, and velocity training for 136, 152, 250
 basket hang 168
 Bayesian statistics 211
 beginning athletes 5-6, 55, 100-101, 123, 167, 273
 bench press
 center of mass in 133
 endurance and 224-225
 gender differences in 283
 ground reaction force during 138
 injuries involving 261
 proper technique for 264
 propulsive phase in 132
 repetition maximum 63
 velocity characteristics 138, 140, 144-145
 for women 250
 for young athletes 262
 biceps curls 262, 275
 bicipital tendonitis 295
 bilateral deficits 57
 Bilozherchev, Dmitri 52

binge eating 253
 biomarkers 206-207
 biomechanical analysis 103, 127, 162
 biomechanical angles 243
 biomechanical match 124
 biomechanical variables 66-68, 201
 biopsy studies 293
 birch tree exercise 168
 birth control 253
 blood, as biomarker 206
 blood overcirculation hypothesis 45
 blood pressure 123
 bodybuilding 51, 222-223, 239-242
 body composition 49, 236, 241-242, 259, 271
 body dimension variations 47-48, 50
 body fat 49, 239, 240, 254, 258, 271
 body weight (BW)
 cautions regarding 51
 logarithm of 48-49
 muscle strength and 46-50
 obesity 257, 259, 271
 partner resistance exercises and 273
 static load and 163-164
 training targets and 25
 bolsters 171
 bone fractures 243, 253, 259-261, 295
 bone health 239, 253, 271, 294
 Bosco repeated vertical jump test 185-186
 bottleneck effect 57
 breathing patterns/techniques 123-124, 263
 bulimia nervosa 51, 253
 burnout 267, 275
 bursitis 295
 Bushuev, Victor 84
 BW. *See* body weight (BW)

C

caloric intake. *See* nutrition
 canoeing
 EMS training and 121
 exercises for 102
 hydrodynamic resistance in 104
 parametric relationships in 17
 carbohydrates 10, 50, 53, 291, 292
 caring climates 182, 184, 209
 Caring Climate Scale (CCS) 209
 case studies 212, 258-259
 catabolic hormones 51
 catabolism 44, 46, 51, 64-65
 CCS (Caring Climate Scale) 209
 cell dehydration 287, 291
 cell size hypothesis 285-286
 Centers for Disease Control and Prevention (CDC) 259
 central (neural) factors 41, 52, 54-57
 centralized preparation 80
 central nervous system (CNS)
 excitatory output from 82
 maximal effort method and 71
 muscle strength and 41, 52, 54-57
 cetylated fatty acids 294
 chains, resistance exercises with 153, 154
 children. *See* young athletes
 chin-ups 38, 104
 chronic injuries 261
 chronological age 268
 chronophotography 127
 circuit training 84-85, 226-227
 CK (creatinine kinase) 186, 192
 clean and jerk lifts
 body weight and 47, 48
 elite athlete training intensity 68-70
 gender differences in 283
 hormonal status and 52, 53
 repetition maximum 62
 strength in relation to 139
 for women 250
 CNS. *See* central nervous system (CNS)
 coaching style 237-238
 coefficient of variation (CV) 181-182
 collaboration in assessment programs 199-200
 communication. *See also* feedback
 gender differences in 238
 of test results 199, 208, 212
 competition period 80
 compliance of muscles and tendons 31, 32
 compound resistance 22
 compression fractures 261
 compressive force 294
 concentric muscle action
 exertion of force in 19, 30
 muscular power and 244
 rate of force development with 204
 slow velocity 138-143
 yielding exercises and 115
 connective tissue
 aging and 285, 287, 293
 hormonal influences on 249
 injuries involving 259
 mechanical strength of 229
 strength training and 218, 226, 239, 243, 294
 continuous training 97
 contraceptives 253
 contractile proteins 44-46, 50, 54
 contrasting exercises 84
 core stability 230
 corridor of motor units 73, 74, 227
 cortisol 51, 180, 191, 206, 293
 Coulomb's friction 105
 creatine kinase (CK) 186, 192
 creatine supplementation 292
 cross-bridge attachments 42

- cross country. *See* distance running
- cross-sectional areas 42, 242, 248, 249, 285-288, 293
- cumulative training effects 13
- CV (coefficient of variation) 181-182
- cycling 17, 118, 153
- cytokines 45
- D**
- damage theory of delayed muscle soreness 114
- de-adaptation 88, 97
- deadlift 131, 140-144, 261, 283
- deformation of muscles and tendons 31, 32
- dehydration 287, 291
- delayed muscle soreness 114-115, 186
- delayed training effects 4, 13
- delayed transformation 87, 94
- delayed transmutation 87-88, 94
- detraining
- defined 5
 - long breaks resulting in 97
 - muscle fibers and 46
 - training load and 4, 87-90
 - in women 244, 245, 248
 - in young athletes 270
- diaphragm 166
- diet. *See* nutrition
- diminishing returns, principle of 5-6
- dimorphic genetic expression 238
- dips 104
- direction of movement, as intrinsic factor 30-34
- discogenic pain 295
- disordered eating 51, 236, 253, 254
- distance running 225-226, 237, 252
- disuse syndromes 282
- diuretics 50
- diving 253-255
- doubled stress microcycles 86
- downhill ambulation 17
- drop jump 33-34, 116-118
- dryland training for swimmers 22, 103, 104, 228
- dynamic effort method 71, 76
- dynamic exercises. *See* isotonic exercises
- dynamic stretching 153
- dynamographs 127
- dynamometers 129, 139, 189, 200
- dysmenorrhea 251-253
- E**
- eating disorders 51, 236, 253, 254
- eating habits. *See* nutrition
- eccentric loading 152
- eccentric muscle action
- damage caused by 293
 - examples of 30
- exertion of force in 19, 30
- force-velocity curve for 30
- ground reaction force during 30
- loadings and 294
- rate of force development with 204
- slow velocity 143-144
- yielding exercises and 114-116
- effect size 8, 212
- efferent discharge 33
- efficacy coefficient 87
- elastic bands, resistance exercises with 153
- elasticity 21, 31, 32
- elderly athletes. *See* senior athletes
- electromyography (EMG) 30, 103, 190-191, 208
- electrostimulation (EMS) 56, 66, 121-122
- emotional stress 62, 64, 71
- end-point force 39
- endurance
- circuit training and 84
 - defined 224
 - EMS training for 121
 - in goal-specific training 224-229
 - improvement of 8
 - indices of 224-225
 - isometric exercises for 113
 - muscular 18, 224-227, 245-247
 - power 202, 246
 - strength training and 89
- endurance sports 81, 227-229
- energetic theory of muscle hypertrophy 46, 64, 72
- energy
- expenditure of 30, 65, 76, 97, 252
 - kinetic 21, 109, 116, 154, 163
 - potential 21, 47
 - for protein synthesis 46, 47, 64
 - in reversible muscle action 31, 32
- epaxial muscles 169
- epinephrine 191, 192, 208
- epiphyseal plate 259-261
- epiphysis 260
- equipment fit for young athletes 263
- ESD. *See* explosive strength deficit (ESD)
- essential amino acids 51, 53
- estrogen 250
- evaluation. *See* assessment programs
- evidence-based practice 196, 215-216
- exercise angles 223, 238, 239
- exercise machines
- in circuit training 226
 - free weights vs. 102, 230, 250
 - hip abductor 252
 - resistance and 104-105
 - strength training with 290
 - swing machines 118
 - for young athletes 263, 273-274
- exercise-rest ratio 83
- exercises 99-124. *See also* workouts; *specific exercises*
- autoregulated progressive 157, 198, 205-206
 - for beginning athletes 100-101, 123, 167, 273
 - breathing during 123-124, 263
 - classification of 99-100, 273-275
 - contrasting 84
 - coordination patterns 230
 - dynamic (isotonic) 99-100, 112
 - fixed-form 290
 - flexibility 84, 172
 - force-posture relations in 106-113
 - functional 250, 295
 - isokinetic 99, 110, 111, 290
 - isometric 99, 108, 113, 168
 - multijoint 188-189, 200-201, 203, 273, 275
 - partial range of motion 155
 - partner resistance 273
 - plyometric 245, 290
 - pregnancy considerations 252
 - for qualified athletes 101-113
 - relaxation 173
 - resistance in 64-68, 104-105
 - with reversible muscle action 99, 116-118
 - selection of 100-113
 - self-resistance 113-114
 - sequencing of 83
 - single-joint 188, 189, 200-201, 203, 273, 275
 - specificity of 6, 100-102, 111-112, 270
 - in speed-resisted training 118-121
 - stretching 115, 153, 172
 - time and rate of force development in 105-106
 - velocity and 106, 130
 - working muscles in 102-104
 - yielding 114-116
- experimental strength training methods 121-123
- explosive strength 24, 25, 136, 249
- explosive strength deficit (ESD) 24, 105-106, 201, 219
- extensor muscles 33
- external force 19
- external muscular torque 38
- external resistance 20, 57, 104
- extrinsic factors 20-22
- F**
- familiarization with tests 131, 198
- fasciae 169, 170
- fast-twitch (FT) muscle fibers
- aging and 242, 287-288
 - EMS activation of 121

- fast-twitch (FT) muscle fibers (*continued*)
 endurance sports and 227, 228
 gender differences in 248, 249
 hypertrophy and 46
 individual variations in 243
 intramuscular coordination and 54-55
 plyometric exercises and 245
 strength enhancement and 73, 74
- fatigue
 delayed transformation and 87
 disposition toward competition and 11
 monitoring 155-156, 202-203
 performance degradation due to 4, 246
 preparedness in relation to 12-13
 in senior athletes 294
 short-term training and 81-86
 speed squat fatigue testing 151
- fear of missing out 197
- feedback
 force 33
 immediate 130, 155, 156
 length 33
 mechanical 20, 110
 turnaround time for 208
 for young athletes 262
- female athlete triad 253-255
- females. *See* women
- fiber hyperplasia 42, 238
- fiber hypertrophy 42-44, 50-51, 57, 228, 238, 291
- field testing 201
- figure skating 115, 117, 253-255
- filament area density 42
- filaments 42-44
- finger snap vs. finger extension 24
- fitness-fatigue theory 10-13
- fixed-form exercises 290
- flexibility exercises 84, 172
- flexible nonlinear periodization 90-92
- flexors 86
- fluid regulation 291
- flushing 45, 223
- food. *See* nutrition
- football
 balance between strength and power in 134
 bench press test in 225
 injuries related to 260
 overreaching in 180, 181
 sample training program for 274-275, 277-279
 transference of training effects in 181, 182
- foot inversion 231
- force. *See also* ground reaction force; maximal force (F_m); maximum maximum force (F_{mm}); muscular force (F_{mv}); rate of force development (RFD)
 compressive 294
 defined 18, 20
 elasticity-based resistance and 21
 end-point 39
 equation for 125
 external 19
 hydrodynamic resistance and 22
 internal 19
 mean 135, 137-138, 141-145, 201
 moment of 37-38
 overtraining and 185, 186
 parametric relationships involving 16
 peak 23-25, 57, 135, 137-138, 141-144, 201
 in propulsive phase 132
 senior athlete production of 285-288
 time to peak force 23-25
 transfer of training results and 6, 8, 9
 viscosity resistance and 22, 105
 weight-based resistance and 21-22
- force-feedback component 33
- force gradient 25
- force plates
 availability of data from 185, 188
 barbell squats on 139-141
 center of mass measurements and 132-138
 characteristics of 130
 isometric tests with 186, 200, 203
- force-posture relations 34-39, 106-113
- force-time curve 131, 132, 150-151, 186, 219
- force-time histories 24, 25
- force-velocity curve
 for eccentric muscle action 30
 gender differences in 249
 graphical depiction of 26, 27
 Hill's equation for 26
 hydrodynamic resistance and 120-121
 importance for sport practice 27-30
 isokinetic 139, 140, 143
 power performance and 218-221
 for strength training exercises 106
- fractures 243, 253, 259-261, 295
- free radicals 293
- free weights
 in circuit training 226
 exercise machines vs. 102, 230, 250
 as resistance 112-113
 rules for injury prevention 160
 speed squat testing with 151
 teaching lifts with 262
 velocity and 139, 140, 143
 for young athletes 262, 263, 274
- FT muscle fibers. *See* fast-twitch (FT) muscle fibers
- functional exercises 250, 295
- functional flatfoot 122
- functional overreaching 178
- functional resistance training 295
- functional strength 239, 250
- ## G
- GAS (general adaptation syndrome) 179-181
- gender differences. *See also* women
 in age-related decline 281, 283, 286
 coaching style and 237-238
 in communication 238
 in hormone concentrations 207, 249-250, 268
 in memory 238
 in muscle fibers 238, 248, 249
 in muscle hypertrophy 51
 physiological 247-250
 in strength and power 248-249
 in velocity development 130
 in weightlifting 283
- general adaptation syndrome (GAS) 179-181
- generalized training theories 9-13
- genetic predisposition 161, 240, 274, 285
- GH. *See* growth hormone (GH)
- Gilbert, Wade 237-238
- glucose storage 291
- glycogen depletion 9, 10, 50, 192, 247
- glycolysis 293
- goal-specific training 213-232
 endurance performance in 224-229
 evidence-based practice in 215-216
 injury prevention in 229-231
 muscle mass in 222-223
 overview 213
 power performance in 218-222
 strength performance in 217-218
 target goal development 214-215
 testing and monitoring progress in 216-217
- Golgi tendon reflex 31, 33-34, 116
- good morning exercise 261
- gravity
 acceleration due to 128, 143, 144
 center of 65, 108, 163
 muscular force and 22
- grip strength 101
- ground reaction force
 barbell squats and 128, 139
 bench press and 138
 in eccentric muscle action 30
 in isometric muscle action 139, 203
 measurement of 128, 130
 pitch velocity and 156
 vertical jump and 185, 188
- growth, strength in relation to 52
- growth cartilage 260, 261, 272
- growth hormone (GH) 51-53, 206, 249-250, 269, 288, 290
- growth (epiphyseal) plate 259-261
- growth spurts 52, 260, 261

- gymnastics
 body dimensions and 50
 body weight and strength in 49-51
 competition readiness test for 185
 EMS training and 122
 endurance training in 225
 female athlete triad and 253-254
 growth and strength related to 52
 isometric exercises for 113
 medico-mechanical 110
 mixed training sessions in 84
 yielding exercises in 115
- H**
- half-mesocycles 90, 94
 hammer throw 93, 100
 hand grip strength 101
 hang clean 136, 244, 250
 hanging exercises 168
 heart rate
 emotional stress and 64
 maximum training weight and 62
 monotony of training and 181, 205
 overtraining and 191
 resting 191, 208
 Valsalva maneuver and 123
 heart rate variability (HRV) 191, 208
 height, impact on velocity-based training 148, 149
 helicoptering 133-134
 Henrich, Christy 51
 hidden potential of human muscle 66
 high pulls 251, 275
 high-velocity training methods 134-138
 Hill's equation 26
 hip abductor machines 252
 hip flexion, strength curve in 108
 hormones. *See also specific hormones*
 aging and 283-284, 288-290, 293
 anabolic 45, 51, 53, 269, 288
 as biomarker 206, 207
 catabolic 51
 gender differences in 207, 249-250, 268
 in overtraining and overreaching 180, 191
 in protein synthesis 45
 strength and 51-53
 in young athletes 268-269
 HRV (heart rate variability) 191, 208
 Hudy, Andrea 251
 hurdling 245
 hydration 173-174, 291
 hydrodynamic resistance 22, 104, 120-121
 hyperbolic equations 26
 hypermenorrhea 251
 hyperparenting 267
 hyperplasia 42, 238
 hypertrophy. *See fiber hypertrophy; muscle hypertrophy*
- hypogonadism 288, 289
 hypothalamus 269, 289
 hypoxia hypothesis 45
- I**
- IAP (intra-abdominal pressure) 164-169, 171-172
 IES (index of explosive strength) 25
 IGF-1. *See insulin-like growth factor-1 (IGF-1)*
 iliopsoas muscle 167
 immediate feedback 130, 155, 156
 immediate training effects 4, 13
 immune markers 207
 impact loads 162-163
 implements for training 171-172
 impulses 54, 201
 IMTP. *See isometric midhigh pull (IMTP)*
 inactive lifestyles 259
 incline press 250
 index of explosive strength (IES) 25
 individualization of training 8, 236, 250, 274, 294-295
 inertia, resistance based on 21
 inertia wheels 21
 inflammatory markers 207
 injuries. *See also injury prevention; specific injuries*
 accidental 261-262
 acute 260-261
 assessment of 208-209
 chronic 261
 musculoskeletal 260-261
 orthopedic 187
 overuse 187, 261-263
 rehabilitation procedures for 173-175
 risk factors for 159-160
 senior athletes and 282, 295
 training rules for avoidance of 160
 women and 251
 young athletes and 258-263, 267
 injury prevention
 in goal-specific training 229-231
 to lumbar region 166-175
 proper sport technique for 170-171
 training rules for 160
 for young athletes 259-263, 267, 271
 instructions for tests 130-131
 insulin 53, 288, 292
 insulin-like growth factor-1 (IGF-1) 51, 53, 269, 288, 290
 intensity coefficient 62
 intensity of training 61-77
 comparative research on 70-71
 dynamic effort method and 71, 76
 of elite athletes 68-70
 maximal effort method and 71-72, 74-76
 measurement techniques 61-64
 optimal 70-71
 repeated effort method and 71-76
 resistance levels and 64-68
 submaximal effort method and 71-76
 variation in 83-84
 intermuscular coordination
 biomechanical variables and 66-68
 defined 52
 maximal effort method and 71
 maximal force generation and 41
 muscle strength and 52, 56-57
 training intensity and 66-68
 in women 250
 internal abdominis muscles 168-169
 internal force 19
 International Olympic Committee (IOC) 50
 intervertebral discs
 biomechanical properties of 161-162
 iliolumbar muscles and 167
 impact loads and 162-163
 mechanical load affecting 162-166
 rehabilitation procedures for 173-175
 static load acting on 163-166
 intra-abdominal pressure (IAP) 164-169, 171-172
 intradisc pressure 161
 intramuscular coordination
 defined 52
 maximal effort method and 71
 maximal force generation and 41
 muscle strength and 52, 54-56
 training intensity and 65-66
 intrastomachic pressure 164
 intrinsic factors 22-39
 direction of movement 30-34
 overview 22-23
 posture and strength curves 34-39
 time to peak force 23-25
 velocity 25-30
 inverse curls 69, 70, 72, 109
 IOC (International Olympic Committee) 50
 ischemia 114
 isokinetic devices 20, 27, 110, 200-201, 230
 isokinetic exercises 99, 110, 111, 290
 isokinetic force-velocity curve 139, 140, 143
 isokinetic resistance 154-155
 isometric midhigh pull (IMTP) 150-151, 186, 188-189, 200, 203
 isometric muscle action
 exercises involving 99, 108, 113, 168
 exertion of force in 19, 20
 ground reaction force during 139, 203
 isotonic exercises 99-100, 112

J

javelin throwing, training for 29
 Johnson, Michael 200
 joint angles 34, 36-38
 joint moments 34, 37-39
 joint strength curve 34, 36, 37
 joint stress 294
 joint therapeutics 294
 jumping. *See also* landing; takeoff; vertical jump
 drop jump 33-34, 116-118
 foot position in 231
 importance of strength training for 19
 long jump 50, 249, 270
 standing jump 30
 velocity measurement during 128
 juveniles. *See* young athletes

K

Kansas Squat Test 151, 202-203
 kayaking
 circuit training for 84
 EMS training and 121, 122
 hydrodynamic resistance in 22, 104
 parametric relationships in 17
 Kegel exercises 252
 ketogenic diet 292
 kinetic energy 21, 109, 116, 154, 163
 knee extensions 153, 184, 186, 188, 249
 kurtosis 210

L

lactate response 192, 208
 lactic acid 246-247, 293
 landing
 in drop jumps 117
 eccentric muscle action during 30
 foot inversion on 231
 impact loads and 162-163
 reversible muscle action during 30, 31
 soft landing techniques 163
 last repetition effect 132, 133
 latissimus dorsi pull-downs 250
 LBPS. *See* low back pain syndrome (LBPS)
 lean tissue mass 241-247, 268, 269, 271
 learning effects 270, 287-288
 leg curls 275
 leg extensions 20, 30, 39
 leg press 112, 130, 252, 275, 291
 leg raises 168
 length-feedback component 33
 lifting chains 111
 lifting power 184-185, 202-203
 lifting techniques 262
 lifting velocity 156-157, 202
 ligaments 243, 294
 limb circumference 114, 230, 240, 250

linear periodization 89, 90
 line of best fit 145-146
 Little League shoulder 261
 loading spectrum 201
 load-velocity curve 145-148, 155, 156, 202
 local muscular endurance 238, 245-247, 295
 logarithm of body weight 48-49
 logistics of assessment programs 198, 202
 long jump 50, 249, 270
 long-term monitoring 198, 199
 long-term planning 81
 low back pain syndrome (LBPS)
 diagnosis of 173
 flexibility development for alleviation of 172
 management strategies 173
 muscle strengthening for prevention of 166-169
 posture correction for alleviation of 172
 prevalence and causes of 161
 prevalence of 160-161
 proper sport technique for alleviation of 170-171
 rehabilitation procedures for 173-175
 in senior athletes 295
 in young athletes 261
 lower-body strength 248
 lumbar lordosis 167, 169-172, 174, 261
 lumbar region. *See* intervertebral discs;
 low back pain syndrome (LBPS)
 lunges 250, 252, 262, 266

M

machines. *See* exercise machines
 macrocycles 80, 92-94, 198, 199, 205
 macronutrients 291, 292
 magnitude-based inferences 211
 magnitude of resistance 61-62, 71
 making weight 49
 maladaptation 4
 Marandino, Roger 166
 marathons 225-226, 237
 Martin, Jerry 216, 251
 mass-distance curve 140, 145
 maturity of young athletes 267-269
 maximal effort method 71-72, 74-76, 218
 maximal force (F_m)
 explosive strength deficit and 24, 105-106
 extrinsic factors related to 20-21
 individual differences in generation of 41
 inertial wheels and 21
 isometric tests of 200
 mechanical feedback and 20
 muscle structure and 42
 parametric relationships involving 16
 power production and 245
 reversible muscle action and 34
 strength curve and 34, 35, 108
 transfer of training results and 6, 8, 9
 maximal mechanical power (P_{mm}) 28-30, 244-245
 maximal muscular performance (P_m) 15-18
 maximal nonparametric relationships 16-18
 maximal parametric relationships 16, 17
 maximal velocity (V_m) 16, 17
 maximal voluntary contraction (MVC) 188
 maximum competition weight (CF_{mm})
 defined 62
 in elite athlete training 68-70
 for intensity measurement 62, 64
 intramuscular coordination and 66
 maximal effort method and 71, 72
 maximum maximorum force (F_{mm})
 biomechanical variables and 68
 explosive strength deficit and 24
 extrinsic factors related to 20
 force-velocity curve and 26-28
 intermuscular coordination and 68
 isometric (static) exercises and 113
 as measure of strength 18, 19
 nonparametric relationships involving 17-18, 28
 resistance and 20, 57
 reversible muscle action and 31, 34
 strength curve and 34, 37
 maximum maximorum performance 16-17
 maximum maximorum velocity (V_{mm}) 17, 27-29
 maximum training weight (TF_{mm})
 defined 62
 in elite athlete training 70
 for intensity measurement 62, 64
 intermuscular coordination and 68
 intramuscular coordination and 66
 maximal effort method and 71, 72
 mean force 135, 137-138, 141-145, 201
 mean velocity 131, 135, 137, 138, 202
 mechanical feedback 20, 110
 mechanical power 28-30, 244-245
 mechanical work 201-202
 medical clearances 295
 medicine balls 107, 145, 150-151, 290
 medico-mechanical gymnastics 110
 medium-term planning. *See* periodization
 memory, gender differences in 238
 men. *See* gender differences

- menopause 284, 288
 menstrual cycle 207, 251-253
 mental skills 209
 mesocycles
 accumulative 80, 87-88
 adequate recovery during 85-86
 assessment programs and 198, 199, 204-205
 defined 80
 in endurance training 229
 in goal-specific training 218
 half-mesocycles 90, 94
 parachute training and 120
 realizational 80, 87-88
 short-term planning of 80-86
 transmutative 80, 87-88
 variability during 86
 velocity testing and 157
 meta-analysis 71
 metabolic markers 207, 208
 metabolic rate 240
 metabolic reactions 64-65
 microcycles
 adequate recovery during 85-86
 defined 80
 doubled stress 86
 in goal-specific training 218
 overloading 10, 12
 parachute training and 120
 short-term planning of 80-86
 stress (impact) 86
 variability during 86
 micronutrients 291, 292
 minimax position 109
 miometric muscle action. *See* concentric muscle action
 mixed training sessions 84, 96
 moment arm 37-38
 moment of force 37-38
 monitoring athletes. *See* assessment programs
 monotony of training programs 181-182, 205
 mood states 182, 209
 motion
 muscle action in relation to 19
 Newton's second law of 21
 range of 36, 155, 208
 motion capture systems 129-130
 motivational climate 184, 209
 motoneurons 33, 54, 55, 65, 66, 75-77
 motor control 161, 208
 motor units (MUs)
 activation of 43-45, 55, 242
 aging and 242, 284-286, 290, 293
 corridor of 73, 74, 227
 defined 43, 54
 in endurance training 247
 individual variations in 242-243
 rate coding 54, 56
 recruitment of 54-56, 72-74, 238
 structure of 54
 synchronization of 54, 56
 training intensity and 65-66
 MSD (muscle strength deficit) 66
 multijoint exercises 188-189, 200-201, 203, 273, 275
 muscle balance 230, 295
 muscle dimensions 42-46
 muscle fibers. *See also* fast-twitch (FT) muscle fibers; slow-twitch (ST) muscle fibers
 activation of 30
 aging and 242, 284-287
 cross-sectional areas 242, 248, 249, 285-288, 293
 endurance training and 227-228
 gender differences in 238, 248, 249
 hypertrophy of 42-44, 50-51, 57, 228, 291
 metabolic state of 51
 power-load curve and 147
 regeneration of 285-286
 sarcopenia and 284-285
 structure of 42, 43
 velocity-load curve and 147
 muscle force potential factors. *See* peripheral factors
 muscle groups
 agonist 113-114, 245
 antagonist 67, 114, 245
 nonspecific 229-230
 working 102-104
 muscle hyperemization 45
 muscle hypertrophy
 aging and 288, 295
 as bodybuilding goal 222
 causes of 42
 defined 42
 fluid regulation and 291
 gender differences in 51
 hormonal status and 51
 maximal effort method and 72
 repeated effort method and 72, 75
 submaximal effort method and 72
 theories related to 45-46, 64, 72
 training protocols for inducing 222-223
 muscle hypoxia hypothesis 45
 muscle mass
 aging and 284, 285, 287, 292, 293
 body weight and 46-50
 in goal-specific training 222-223
 power development and 243
 in young athletes 268
 muscle palpation 103
 muscle soreness 114-115, 186
 muscle spindles 33
 muscle strains 260
 muscle strength deficit (MSD) 66
 muscular corset 166, 168, 169
 muscular endurance 18, 224-227, 245-247
 muscular force (F_{mus})
 body position and 36-37
 body weight and 46-50
 central factors related to 41, 52, 54-57
 gravity and 22
 hormonal status and 51-53
 muscle dimensions and 42-46
 nutrition and 50-51, 53
 overtraining and 189-190
 in strength taxonomy 57
 transformation into joint moments 37-38
 muscular power 244-245, 283, 290-291
 muscular strength. *See* strength
 musculoskeletal injuries 260-261
 MVC (maximal voluntary contraction) 188
 myofibrillar hypertrophy 43-44
 myofibrils 42-44, 46
 myokines 45
 myosin 42-44, 54, 147, 250
 myotatic (stretch) reflex 31, 33
- ## N
- National Collegiate Athletic Association (NCAA) 97
 National Strength and Conditioning Association (NSCA)
 on senior athletes 282, 294
 Strength and Conditioning Professional Standards and Guidelines 160
 on women's training 250, 254
 on young athletes 258, 262, 273, 275, 276
 neural mechanisms
 muscle strength and 41, 52, 54-57, 223
 in reversible muscle action 31, 33-34
 in young athletes 262, 268
 neurological function 283, 290
 neuromuscular markers 208
 Newton's second law of motion 21
 noncontractile proteins 43-46, 54
 nonfunctional overreaching 178, 181, 213
 nonlinear periodization 89-92, 244, 247
 nonparametric relationships 16-18, 210-211
 nonspecific muscle groups 229-230
 nonstatistical examination 212
 Nordic-combined competitions 90
 NSCA. *See* National Strength and Conditioning Association (NSCA)
 nucleus pulposus 161, 162

- nutrition
 body composition and 241-242
 energy expenditure and 97, 252
 mechanical work and 201-202
 menstrual cycle and 251-252
 muscular force and 50-51, 53
 protein synthesis and 50-51
 for senior athletes 291-292
 strength and 50-51, 53
 in tissue repair and remodeling 115
 for women 251-252
- O**
- obesity 257, 259, 271
 oblique abdominis muscles 168-169
 older athletes. *See* senior athletes
 oligomenorrhea 251, 253
 Olympic cycles 6, 80
 one-factor theory 9-13
 one repetition maximum (1RM) 200
 oral contraceptives 253
 order of testing 198-199
 orthopedic injuries 187
 Osgood-Schlatter disease 261
 ossification 260
 osteoarthritis 294
 osteochondritis dissecans 261
 osteoporosis 239, 253, 294
 ovaries 249
 overexertion 74
 overhead press 260
 overload 4-5. *See also* training load
 overloading microcycles 10, 12
 overreaching
 functional 178
 hormone levels and 180, 191
 international task force on 178
 lifting power decrements and 184
 missed workouts and 91
 nonfunctional 178, 181, 213
 strength decrements and 187
- overtraining 177-194
 autonomic nervous system and 191, 192
 avoidance of 193
 definitions of 177, 178
 effects on performance 193-194
 EMG activity and 190-191
 exercise-related variables 182, 183
 general adaptation syndrome and 179-181
 glucose stores and 192
 heart rate and 191
 hormone levels and 180, 191
 international task force on 178
 lactate response and 192
 lifting power decrements and 184-185
 muscle damage from 186, 192
 muscular force decreases and 189-190
- performance tests for monitoring 187-189
 peripheral maladaptation and 188, 189
 physiology of 189-192
 psychology of 182-184
 rate of force development and 186, 188
 research challenges 179
 sequence of impairments in 192, 193
 sprint speed and 183-184
 strength decrements and 186-187
 terms commonly associated with 177, 178
 vertical jump and 185-186, 188
- overtraining syndrome 177-180, 186, 187, 191-193, 213
 overuse injuries 187, 261-263
 oxidative damage 293
- P**
- parachutes, exercises with 118-120
 parameters, defined 16
 parametric relationships 16, 17, 210
 parasympathetic nervous system 191, 208
 partial range of motion exercises 155
 partial training effects 13
 partner resistance exercises 273
 Pascal's law 161
 patellofemoral arthrosis 295
 peak-contraction principle 108-110
 peak force 23-25, 57, 135, 137-138, 141-144, 201
 peaking (tapering) periods 13, 87
 peak velocity 131, 135, 137, 138, 202
 pelvic tilt exercise 169
 pennation angles 249
 Perceived Motivational Climate in Sport Questionnaire (PMCSQ) 209
 performance assessment. *See* assessment programs
 periodization
 assessment of 204-205
 defined 80, 86
 delayed transformation and 87, 94
 delayed transmutation and 87-88, 94
 linear 89, 90
 nonlinear 89-92, 244, 247
 senior athletes and 290-291, 293, 295, 296
 superposition of training effects and 87-89
 of training loads 187
 training residuals and 87-89, 94
 variability of training stimuli and 86, 93-94
 women and 239, 243, 244, 246
 young athletes and 270, 274
 period of delayed transformation 87
- periods of training 80
 peripheral factors 41-52
 body weight 46-50
 defined 41
 hormonal status 51-53
 muscle dimensions 42-46
 nutrition 50-51, 53
 peripheral maladaptation 188, 189
 pH changes 246, 293-294, 296
 phosphorylation 190, 191
 photographic technology 127
 physical activity
 aging and 282
 guidelines for 259, 271
 mechanisms of biological adaptation to 84
 promotion of 271, 284
 relationship building through 238
 as stimulus for adaptation 4
 physical fitness
 components of 208-209
 detraining effects on 97
 improvement of 3, 8
 maintenance of 13
 of senior athletes 291
 training load in relation to 4
 use of term 11
 of young athletes 170, 275-276
 physiological age 268
 physiological maturity 267-269
 pitching 7, 36, 37, 156, 261
 planned nonlinear periodization program model 91
 plasticity of muscle 281
 plyometric exercises 245, 290
 plyometric muscle action. *See* eccentric muscle action
 PMCSQ (Perceived Motivational Climate in Sport Questionnaire) 209
 pneumatics 245, 290
 POMS (Profile of Mood States) 182, 209
 position transducers 128, 129, 133-135, 137, 203
 postactivation potentiation 152-153
 posture 34-39, 106-113, 172
 potential energy 21, 47
 power
 balance between strength and 134
 equation for 125
 gender differences in 248-249
 lifting 184-185, 202-203
 maximal mechanical 28-30, 244-245
 muscular 244-245, 283, 290-291
 sport performance and 136, 152
 sprint cycling 153
 total-body 238, 239
 training load and 127
 power cleans
 barbell trajectories for 132

catches in 244, 251
 power demands for 239
 transfer of training results and 181, 182
 velocity characteristics 127, 136-138, 148
 for women 250
 power density 203
 power development
 aging and 286-287, 290-291
 muscular 244-245, 283, 290-291
 for women 239, 243
 power endurance 202, 246
 powerlifting 249, 283
 power-load curve 133, 146, 147, 155, 156, 202
 power performance 184-185, 218-222, 228, 249, 287
 power position 166
 precompetitive mesocycles 80, 87-88
 pregnancy 252
 premenstrual symptoms 251-253
 preparation period 80
 preparedness 9-13
 preregistered research studies 210
 preventive medicine 214, 282
 principle of diminishing returns 5-6
 Profile of Mood States (POMS) 182, 209
 progesterone 253
 progression
 assessment of 146-147
 in resistance training 5, 68, 282
 for senior athletes 282, 295-296
 for young athletes 273, 274
 proper sport technique 170-171, 262-266
 proprioception 250
 propulsive phase 131-132
 protein degradation 44-46, 64-65, 72
 protein intake 51, 53, 115, 252, 291, 292
 protein synthesis
 energy supply for 46, 47, 64
 hormonal status and 45, 51, 53
 mechanisms of 44-45, 72
 nutrition status and 50-51
 psychological maturity 267
 puberty 52, 248, 260, 268
 pull-ups 38, 47, 100, 250, 259
 purging 253
 push press 240, 250
 push-ups 107
 pyramid training 83-84

Q

quadriceps 187-189, 230, 295
 qualitative training load modifications 6
 quantitative training load modifications 6
 quick-release technique 27

R

radar graphs 217
 range of motion 36, 155, 208
 rate coding 54, 56
 rate of force development (RFD)
 assessment measures 203-204
 exercise selection and 105-106
 gender differences in 249
 in high-level performance 24-25
 indices for estimation of 25
 overtraining and 186, 188
 power performance and 219-220
 velocity and 148, 150-151
 ratings of perceived exertion (RPE)
 scales 192
 reactive oxidative species (ROS) 293
 reactive strength index 201
 reactivity coefficient (RC) 25
 readiness to train 209
 realizational mesocycles 80, 87-88
 Recovery-Stress Questionnaire for Athletes (RESTQ) 182, 209
 recovery time
 assessment of 205
 during microcycles 85-86
 muscle size and 86
 for senior athletes 292-294
 recruitment of motor units 54-56, 72-74, 238
 rectus abdominis muscle 167-169
 regression coefficient 49
 rehabilitation procedures 173-175
 reinnervation process 285
 relative indices of endurance 224
 relative strength 47-50, 52, 270
 relaxation exercises 173
 relaxin 254
 repeated effort method 71-76, 218, 223
 repetition maximum (RM) 62, 63, 200
 repetitions
 in elite athlete training 68-70
 for intensity measurement 61-64
 last repetition effect 132, 133
 maximal effort method and 71-72
 with maximal resistance 64, 69
 repeated effort method and 72-75
 for senior athletes 294
 submaximal effort method and 72-75
 in training load 5
 for young athletes 260, 273
 residual training effects 13, 87-89, 94
 resistance
 accommodating 110-111
 aerodynamic 119-120
 chains for 153, 154
 compound 22
 elastic bands for 153
 elasticity-based 21
 in exercises 104-105

external 20, 57, 104
 hydrodynamic 22, 104, 120-121
 inertia-based 21
 intermuscular coordination and 66-68
 intramuscular coordination and 65-66
 isokinetic 154-155
 magnitude of 61-62, 71
 metabolic reactions and 64-65
 rotational 153-154
 self-resistance 113-114
 training intensity and 64-68
 variable 110-111, 153, 263
 viscosity 22
 weight-based 21-22, 104
 rest-exercise alternation 82-83
 resting heart rate 191, 208
 rest intervals
 in endurance training 246-247
 exercise-rest ratio 83
 lactic acid production and 246-247
 in one-factor theory 9-13
 for senior athletes 292-293
 in two-factor theory 13
 RESTQ (Recovery-Stress Questionnaire for Athletes) 182, 209
 result gain 7-9
 retaining loads 5, 90, 94
 reversible muscle action
 defined 30
 elasticity and 31, 32
 examples of 30, 31
 exercises with 99, 116-118
 neural mechanisms in 31, 33-34
 power performance and 220, 222
 training for 34
 visualization of 35
 RFD. *See* rate of force development (RFD)
 rhabdomyolysis 44, 74, 160, 192, 247
 RM (repetition maximum) 62, 63, 200
 ROS (reactive oxidative species) 293
 rotational resistance 153-154
 rotator cuff 91, 295
 rounded back position 170, 171
 rowing
 circuit training for 84
 EMS training and 122
 endurance training for 226
 hydrodynamic resistance in 22, 104, 120
 parametric relationships in 17
 RPE (ratings of perceived exertion)
 scales 192
 rule of 60% 86, 94

S

saliva, as biomarker 206
 Salnikov, Vladimir 227-229

- sampling rate 131, 202, 203
sarcomeres 42, 43
sarcopenia 284-285, 287
sarcolemmal hypertrophy 43, 44
satellite cells 45, 286
sciatic symptoms 252
SD (standard deviation) 7-8, 205
seated cable row 265-266
seated shot put test 150-151
sedentary lifestyles 259
self-efficacy 182, 183
self-resistance exercises 113-114
Selye, Hans 179
semisquatting 112
senior athletes 281-296
 aging curve for 282-283
 benefits and concerns from sport participation 284
 bone health and 294
 force production in 285-288
 guidelines for program design 294-296
 hormonal status and 283-284, 288-290, 293
 injuries among 282, 295
 intervertebral discs in 161, 162
 medical clearances for 295
 motor units in 284-286, 290, 293
 muscle fibers in 284-287
 muscle mass in 284, 285, 287, 292
 muscular power development in 283, 290-291
 neurological function and 283, 290
 nutrition for 291-292
 oxidative damage and 293
 physical performance decline in 281
 physiological potential of 284-286
 plasticity of muscle in 281
 power production loss in 286-287
 recovery from resistance exercise 292-294
 strength gains, training for 287-290
 toleration of pH changes in 293-294
sequencing of exercises 83
serotonin 238
sex hormone-binding globulin (SHBG) 51-53
sexual dimorphisms 238, 248
S-gradient 25
shin splints 261
short-term monitoring 198, 199
short-term planning 80-86
shot put
 body dimensions and 50
 gravity and muscular force in 22
 heavy resistance training for 29
 maximal muscular performance and 15-16
 nutrition considerations for 51
 parametric relationships in 16
 power performance and 219, 221
 seated shot put test 150-151
single-joint exercises 188, 189, 200-201, 203, 273, 275
sit-ups 168, 169, 252
size principle 55, 58, 72-73, 76, 242-243
skewness of data 210
sliding-filament theory 42
slow start in strength drills 109-110
slow-twitch (ST) muscle fibers
 aging and 288
 endurance sports and 227, 228
 gender differences in 248, 249
 hypertrophy and 46
 individual variations in 243
 intramuscular coordination and 54-55
 resistance to damage 45
slow-velocity training methods 138-143
snatch lifts
 classification of 218
 elite athlete training and 68-70
 gender differences in 283
 motion related to 19
 overreaching and 187
 repetition maximum 62
 strength in relation to 139
 for women 250
 for young athletes 262
SNS (sympathetic nervous system) 191, 192, 208
softball 29, 156
soft landing techniques 163
somatomedins 51
somatotropin. *See* growth hormone (GH)
soreness of muscles 114-115, 186
spasm theory of delayed muscle soreness 114
special training devices 109
specificity
 of adaptation 6-8
 delayed transmutation and 87
 of exercises 6, 100-102, 111-112, 270
 power performance and 218-219
 of training load 227
speed-resisted training 118-121
speed squat fatigue testing 151
spider graphs 217
spinal traction 174-175
split table apparatus 174
split training 223
sport psychology 182-184
sport-specific exercises 6, 100-102, 111-112, 270
sport training theory 3
spotting 159, 259, 262-266, 274
sprint cycling power 153
sprinting
 overtaining effects on speed 183-184
 starting velocity in 116-117
 strength training for 19, 203
squats 249, 250, 252, 262. *See also* barbell squats
stagnation 185
staleness 72, 82, 85-86, 93, 95, 218
standard deviation (SD) 7-8, 205
standing jump 30
static loads 163-166
static muscle action. *See* isometric muscle action
static stretching 153
step-up 250
sticking points 34, 131
stiffness of muscles and tendons 31, 32
stimulating loads 5
ST muscle fibers. *See* slow-twitch (ST) muscle fibers
strains 260
strength. *See also* intrinsic factors; peripheral factors
 absolute 47-50, 148, 248, 270
 age-dependent thresholds for loss of 286
 balance between power and 134
 body weight and 46-50
 central factors related to 41, 52, 54-57
 definitions of 18-19
 elements of 15-19
 estimation of development 101
 explosive 24, 25, 136, 249
 extrinsic factors related to 20-22
 functional 239, 250
 gender differences in 248-249
 growth and 52
 hormonal status and 51-53
 lower-body 248
 maximal muscular performance and 15-18
 nutrition and 50-51, 53
 relative 47-50, 52, 270
 taxonomy of 57
 total-body 239, 248
 upper-body 238-239, 248, 269, 283
 weightlifting performance in relation to 139
strength curve
 body position and 36-37
 defined 34
 end-point force and 39
 in hip flexion 108
 joint curve 34, 36, 37
 joint moments and 34, 37-39
 for weightlifting 34, 35
 for young athletes 263
strength endurance. *See* power endurance
strength position 166
strength topography 100, 160
strength training
 adaptation as main law of 3-8

- bone health and 294
breathing during 123-124, 263
for children and adolescents. *See*
young athletes
continuous 97
defining targets for 25
delayed effects of 4
detraining. *See* detraining
exercises for. *See* exercises
experimental methods of 121-123
factors impacting quality of 236, 237
generalized theories of 9-13
goal-specific. *See* goal-specific training
immediate effects of 4
individualization of 8, 236, 250, 274,
294-295
intensity of. *See* intensity of training
monotony of 181-182, 205
overtraining. *See* overtraining
progressive resistance 5, 68, 282
pyramid 83-84
for seniors. *See* senior athletes
speed-resisted 118-121
3-year rule for 166
timing of. *See* timing of training
variability of 83-84, 86, 93-94, 181-
182, 218
velocity-based 147-149, 151-156, 202
vibration 122-123
for women. *See* women
stress, emotional 62, 64, 71
stress fractures 243, 261
stress (impact) microcycles 86
stretching exercises 115, 153, 172
stretch reflex 31, 33, 116
stretch-shortening cycle. *See* reversible
muscle action
structural exercises 274, 275
structural units of training 79-81
subcutaneous fat stores 241-242
subjective training load assessment 206
submaximal effort method 71-76, 218,
223
supercompensation of muscle proteins
44, 46
supercompensation phase 9, 10
supercompensation (one-factor) theory
9-13
superposition of training effects 87-89,
218
swayback 261
swimming 22, 102-104, 120-121, 228
swing exercise machines 118
sympathetic nervous system (SNS) 191,
192, 208
synchronization of motor units 54, 56
- T**
takeoff
in drop jumps 116-117
explosive strength deficit in 24
reversible muscle action during 30, 33
tapering (peaking) periods 13, 87
target goals 214-215
task-oriented environment 182, 184
taxonomy of strength 57
teenagers. *See* young athletes
tendonitis 295
tennis 170-171, 239
testing. *See* assessment programs
testosterone
aging and 288-290
as biomarker 206
gender differences in 249, 250, 268,
269
hypogonadism and 288, 289
overtraining and 180, 191
in protein synthesis 45, 51
strength training and 51-53, 83
in young athletes 268, 269
tether-based devices 128, 129, 133-134,
153-154
therapeutics 294
thermoregulation 291
three-dimensional (3-D) cameras 129-
130
3-year rule 166
throwing
explosive strength deficit in 24
hammer throw 93, 100
javelin throwing 29
parametric relationships in 17
pitching 7, 36, 37, 156, 261
weight and throwing distance 26
windup movement in 30
time-deficit zone 105, 201
time to peak force (T_m) 23-25
time under tension 144
timing of sample collection 206
timing of training 79-98. *See also* peri-
odization
continuous training 97
long-term planning and 81
short-term planning and 80-86
structural units and 79-81
TLAR method 212
topical creams 294
torque 37-38
total-body power 238, 239
total-body strength 239, 248
training. *See* strength training
training days 82-85
training effects
acute 13
classification of 13
cumulative 13
defined 13
delayed 4, 13
immediate 4, 13
partial 13
residual 13, 87-89, 94
superposition of 81, 82, 87-89, 218
training load
for beginning athletes 5-6
classification of 5
delayed transformation of 87
detraining and 4, 87-90
in goal-specific training 218
modification of 6
periodization of 187
physical fitness in relation to 4
power and 127
in short-term training 81-86
specificity of 227
subjective assessment of 206
variability of 83-84, 86, 93
velocity and 127, 156-157
training periods 80
training residuals 13, 87-89, 94
training science 3
training session. *See* workout
training volume. *See* training load
transference index 181, 182
transfer of training results 6-9, 204
transition period 80
transmutative mesocycles 80, 87-88
trochanteric (hip) bursitis 295
trunk rotations 169
two-factor theory 10-13
type I muscle fibers. *See* slow-twitch (ST)
muscle fibers
type II muscle fibers. *See* fast-twitch (FT)
muscle fibers
- U**
uphill ambulation 17, 119
upper-body musculature 238-242
upper-body strength 238-239, 248,
269, 283
up regulations 53
urine, as biomarker 206
- V**
Valsalva maneuver 123, 164
variability of training programs 83-84,
86, 93-94, 181-182, 218
variable resistance 110-111, 153, 263
velocity 125-157. *See also* force-velocity
curve
assessment of 130-134, 144-151
equation for 125
exercise characteristics and 106, 130
height and 148, 149
high-velocity lifts 134-138
immediate feedback and 155, 156
intermuscular coordination and
66-67
as intrinsic factor 25-30

velocity 125-157. *See also* force-velocity curve (*continued*)
 lifting 156-157, 202
 load-velocity curve 145-148, 155, 156, 202
 maximal 16, 17
 maximum maximorum 17, 27-29
 mean 131, 135, 137, 138, 202
 measurement of 126-130, 134-138
 mechanical feedback and 20
 motion velocity and movement variables 28-30
 overtraining and 184-185, 188, 189
 parametric relationships involving 16
 peak 131, 135, 137, 138, 202
 power performance and 220-221
 in propulsive phase 132
 rate of force development and 148-151
 slow-velocity lifts 138-144
 training load and 127, 156-157
 training methods involving 147-149, 151-156, 202
 variables related to 125-126
 young athletes and 130

vertical jump
 aging-related changes 287
 force-time curve for 150
 gender differences in 249
 ground reaction force for 185, 188
 motion related to 19
 nonparametric relationships in 17
 overtraining and 185-186, 188
 parametric relationships in 17
 power and 239, 290
 transference of training effects 182
 young athletes and 270

vertical jump tests 149-150, 185-186
 vibration training 122-123
 videography 127-128
 viscosity resistance 22, 105
 volleyball 239
 volume-load measure 181-182, 201, 203

W

warm-up sets 115, 160, 260, 273
 weight. *See also* body weight (BW)
 maximum competition 62
 maximum training 62
 resistance based on 21-22, 104
 throwing distance and 26
 weight control 49-50
 weightlifting. *See also* barbell squats; bench press; clean and jerk lifts; snatch lifts
 body weight and 46-49

deadlift 131, 140-144, 261, 283
 distribution of training weights 68, 94, 96
 elite athlete training intensity 68-70
 gender differences in 283
 high-velocity lifts 134-138
 hormonal status and 51-53
 implements for 171-172
 injury prevention checklist 171
 intra-abdominal pressure during 165
 maximum competition weight 62
 maximum training weight 62
 measurement problems in 131, 132
 menstrual cycle issues and 252
 nutrition considerations for 51
 overreaching and 187
 overtraining and 184-185
 posture and strength curves for 34-36
 power cleans 136-138
 proper techniques for 262, 264
 propulsive phase in 132
 repetition maximum in 62, 63
 senior athletes and 283
 slow-velocity lifts 138-144
 spotting and 159, 259, 262-266, 274
 strength in relation to 139
 training load and 94-96
 workout schedule for 80
 yielding exercises for 115

weightlifting belts 171-172
 weight loss methods 49-50
 Wingate Anaerobic Test 151, 202
 women 235-255. *See also* gender differences
 benefits of strength training for 239-240
 eating disorders among 51, 236, 253, 254
 female athlete triad 253-255
 guidelines for strength training 250
 individualization of training for 236, 250
 injuries among 251
 lean tissue mass development in 241-247
 local muscular endurance in 245-247
 menstrual cycle issues for 207, 251-253
 muscular power development in 244-245
 myths of strength training for 240-241
 need for strength training 238-239
 nutrition for 251-252

osteoporosis among 294
 power development for 239, 243
 pregnancy considerations 252
 prevalence of strength training among 235-236
 strength development for 243-244
 upper-body musculature of 238-242
 weightlifting guidelines for 171

work, defined 201
 work hardening 92, 115, 213, 237, 247, 267
 workout density 61, 83
 workouts. *See also* exercises
 circuit training in 84-85
 contrasting exercises in 84
 defined 79
 intensity variation in 83-84
 mixed 84, 96
 rest-exercise alternation in 82-83
 scheduling example 80
 sequencing of exercises in 83
 timing of 82-85
 variability of 83-84, 86

wrestling
 body weight and 47, 49
 injuries related to 260
 target goals for 214, 215
 timing of training 80

Y

yielding exercises 114-116
 young athletes 257-280
 abdominal hernias in 168
 benefits of strength training for 257-258, 269-271
 drop jumps among 117
 equipment fit for 263
 growth and strength of 52
 guidelines for strength training 171, 272-275
 injuries among 258-263, 267
 intervertebral discs in 161, 162
 long-term development of 275-276, 280
 myths of strength training for 271-272
 neglect of conditioning training in 170
 physiological maturity of 267-269
 psychological maturity of 267
 safety issues in training of 258-260
 sample programs for 264-266, 274-275, 277-279
 velocity development in 130

About the Authors

Vladimir M. Zatsiorsky, PhD, is an emeritus professor of kinesiology at Penn State University. A strength and conditioning consultant for Olympic teams from the former Soviet Union for 26 years, Zatsiorsky has trained hundreds of world-class athletes. He has also authored or coauthored 15 books



Vladimir M. Zatsiorsky

and more than 350 scientific papers. His books have been published in a variety of languages, including English, Russian, German, Spanish, Chinese, Japanese, Portuguese, Italian, Polish, Czech, Rumanian, Serbo-Croatian, Hungarian, and Bulgarian. He has received honorary doctoral degrees from universities in Poland and Russia and is an honorary member of the International Association of Sport Kinetics. Zatsiorsky served for 20 years on the Medical Commission of the International Olympic Committee. In his spare time, he enjoys reading, listening to classical music, and exercising.

William J. Kraemer, PhD, is a full professor in the department of human sciences in the College of Education and Human Ecology at The Ohio State University. Prior to this appointment, he held full professorships at the University of Connecticut, Ball State University, and Pennsylvania State University, along with joint appointments at the medical schools of these institutions. He also has been a teacher and coach at the secondary and college levels and was a captain in the U.S. Army, working at the U.S. Army's Research Institute of Environmental Medicine in Natick, Massachusetts. He



William J. Kraemer

has had extensive experience working with coaches and athletes in developing their strength training programs. Dr. Kraemer is a fellow of several organizations, including the American College of Sports Medicine (ACSM) and the National Strength and Conditioning Association (NSCA). He has served as a member of the ACSM's board of trustees and their administrative council, and he is a past president of the NSCA. He has authored and coauthored over 500 peer-reviewed manuscripts in the scientific literature. He has received numerous awards for his work and research, including the 2020 ACSM Citation Award, ACSM's Joseph B. Wolfe Memorial Lecture Award, and NSCA's Lifetime Achievement Award. In 2016 he received an honorary doctorate from the University of Jyväskylä in Finland. He has been ranked as one of the top strength and conditioning and sport science professionals in the world.

Andrew C. Fry, PhD, is a professor in the department of health, sport, and exercise sciences at the University of Kansas. After obtaining his bachelor's degree in physical education at Nebraska Wesleyan University, he earned his master's degree in exercise science from the University of Nebraska-Lincoln and his doctorate in exercise physiology from Penn State University.



University of Kansas

During his two-year postdoctoral training, Fry studied cellular and molecular muscle physiology at Ohio University. This was followed by 13 years at the University of Memphis, where he was the director of the Exercise Biochemistry Laboratory. At the University of Kansas, he helped develop the Research and Coaching Performance Team in collaboration with University of Kansas Athletics. His research interests over the years have consistently focused on physiological and performance responses and adaptations to resistance exercise, as well as overtraining.

You read the book—now complete the companion CE exam to earn continuing education credit!

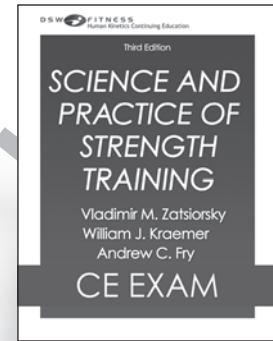
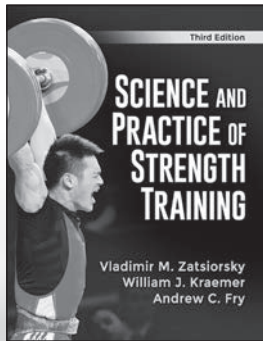

Cover not final

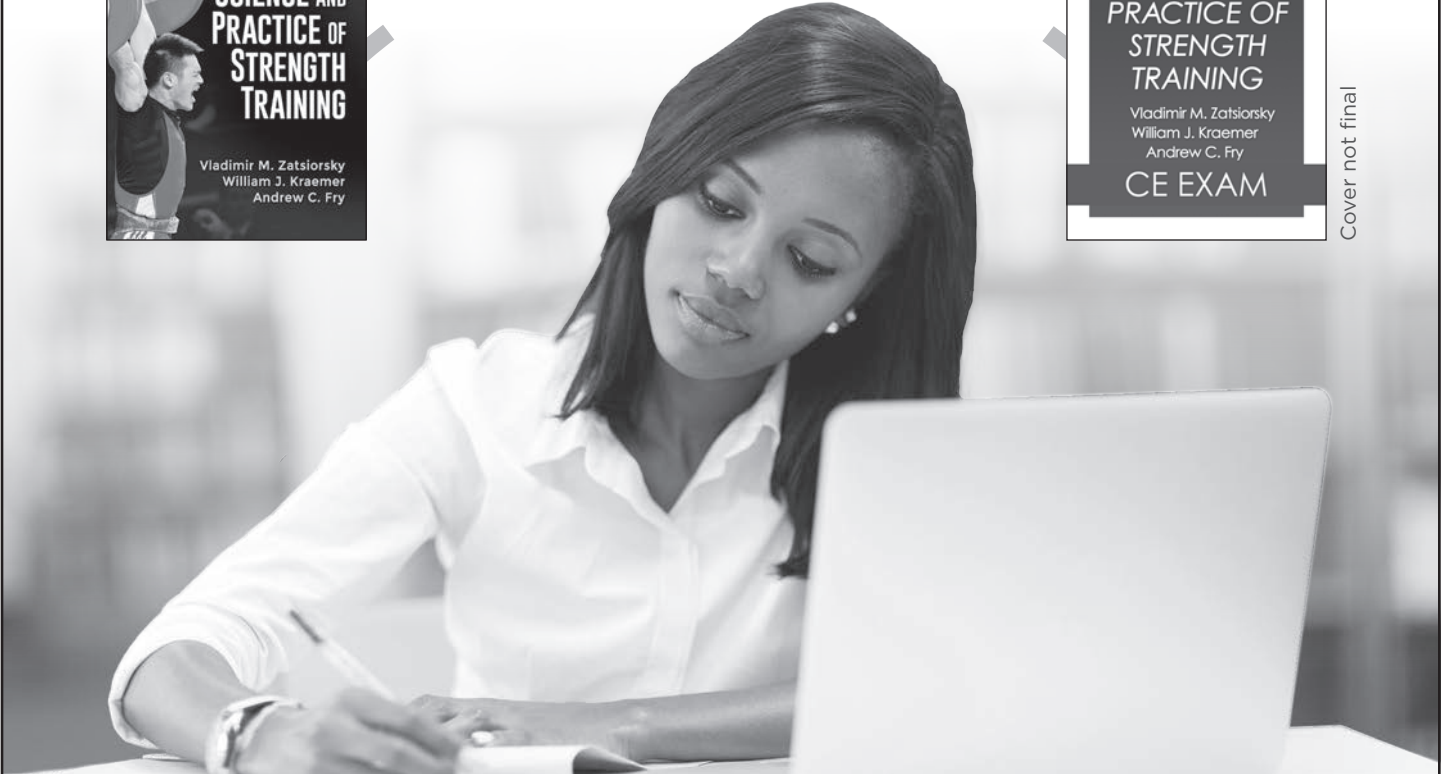

Find and purchase the companion CE exam here:
US.HumanKinetics.com/collections/CE-Exam
Canada.HumanKinetics.com/collections/CE-Exam

50% off the companion CE exam with this code

SPST2021



HUMAN KINETICS